

# Table of Contents

<b>Introduction</b>	<b>2</b>
Congratulations	4
Safety and environment protection	6
Vehicle symbol glossary	8
<b>Instrument Cluster</b>	<b>10</b>
Warning lights and chimes	10
Gauges	19
<b>Entertainment Systems</b>	<b>22</b>
AM/FM stereo with cassette and AM/FM stereo with CD player	25
AM/FM stereo with 6 disc CD player	41
Audiophile audio system	58
MACH 500 audio system	59
<b>Climate Controls</b>	<b>62</b>
Heating and ventilation	62
Air conditioning	66
<b>Lights</b>	<b>74</b>
Headlamps	74
Turn signal control	80
Interior lights	80
Bulb replacement	81
<b>Driver Controls</b>	<b>91</b>
Windshield wiper/washer controls	91
Steering wheel adjustment	94
Power windows	95
Mirrors	96
Speed control	97
Sunroof	101
AdvanceTrac™	104

# Table of Contents

<b>Locks and Security</b>	<b>111</b>
Keys	111
Locks	111
Anti-theft system	123
<b>Seating and Safety Restraints</b>	<b>129</b>
Seating	129
Safety restraints	134
Air bags	156
Child restraints	165
<b>Driving</b>	<b>180</b>
Starting	180
Brakes	188
Steering	193
Transmission operation	194
Vehicle loading	205
Trailer towing	209
Towing your vehicle behind another vehicle	213
<b>Roadside Emergencies</b>	<b>216</b>
Getting roadside assistance	216
Hazard flasher switch	217
Fuel pump shut-off switch	218
Fuses and relays	219
Changing tires	227
Jump starting	234
Wrecker towing	241
<b>Customer Assistance</b>	<b>243</b>
Getting the service you need	243
The dispute settlement board	246
Utilizing the mediation/arbitration	249
Getting assistance outside the U.S. and Canada	250
Ordering additional Owner's Literature	250
Reporting safety defects (U.S. only)	251

# Table of Contents

<b>Cleaning</b>	<b>252</b>
Cleaning your vehicle	252
Underbody preservation	265
<b>Maintenance and Specifications</b>	<b>267</b>
Hood	268
Engine compartment	269
Washer fluid	271
Engine oil	271
Battery	274
Coolant	278
Fuel information	290
Power steering fluid	308
Brake fluid	309
Transaxle fluid	310
Clutch fluid	313
Tire information	317
Part numbers	321
Refill capacities	321
Lubricant specifications	323
Engine data	324
Vehicle dimensions	325
Identifying your vehicle	328
<b>Accessories</b>	<b>330</b>
<b>Index</b>	<b>328</b>

All rights reserved. Reproduction by any means, electronic or mechanical including photocopying, recording or by any information storage and retrieval system or translation in whole or part is not permitted without written authorization from Ford Motor Company.

Copyright © 2001 Ford Motor Company

## Introduction

### CALIFORNIA PROPOSITION 65

#### Warning



**Warning:** Engine exhaust, some of its constituents, and certain vehicle components contain or emit chemicals known to the State of California to cause cancer and birth defects or other reproductive harm. In addition, certain fluids contained in vehicles and certain products of component wear contain or emit chemicals known to the State of California to cause cancer and birth defects or other reproductive harm.

### CONGRATULATIONS

Congratulations on acquiring your new Ford. Please take time to get well acquainted with your vehicle by reading this handbook. The more you know and understand about your vehicle the greater the safety and pleasure you will derive from driving it.

For more information on Ford Motor Company and its products visit the following websites:

In the United States: [www.ford.com](http://www.ford.com)

In Canada: [www.ford.ca](http://www.ford.ca)

In Mexico: [www.ford.com.mx](http://www.ford.com.mx)

In Australia: [www.ford.com.au](http://www.ford.com.au)

Additional owner information is given in separate publications.

## Introduction



This Owner's Guide describes every option and model variant available and therefore some of the items covered may not apply to your particular vehicle. Furthermore, due to printing cycles it may describe options before they are generally available.



Remember to pass on the Owner's Guide when reselling the vehicle. It is an integral part of the vehicle.



### **Fuel pump shut-off switch**

In the event of an accident the safety switch will automatically cut off the fuel supply to the engine. The switch can also be activated through sudden vibration (e.g. collision when parking). To reset the switch refer to the Fuel pump shut-off switch in the Roadside emergencies chapter.

# Introduction

## SAFETY AND ENVIRONMENT PROTECTION



### Warning symbols in this guide

How can you reduce the risk of personal injury and prevent possible damage to others, your vehicle and its equipment? In this guide, answers to such questions are contained in comments highlighted by the warning triangle symbol. These comments should be read and observed.



### Warning symbols on your vehicle

When you see this symbol, it is imperative that you consult the relevant section of this guide before touching or attempting adjustment of any kind.



### Protecting the environment

We must all play our part in protecting the environment. Correct vehicle usage and the authorized disposal of waste cleaning and lubrication materials are significant steps towards this aim. Information in this respect is highlighted in this guide with the tree symbol.



If possible, you should avoid full use of the brakes for the first 1,600 km (1,000 miles).

# Introduction

## Special instructions

For your safety, your vehicle is fitted with sophisticated electronic controls.



By operating other electronic equipment (e.g. mobile telephone without exterior aerial) electromagnetic fields can occur which can cause malfunctions of the vehicle electronics. Therefore you should observe the instructions of the equipment manufacturers.



Please read the section *Air bag* in the *Seating and Safety Restraints* chapter. Failure to follow the specific warnings and instructions could result in personal injury.



Rear facing child or baby seats should **NEVER** be used in front of a passenger side air bag.

# Introduction

## Vehicle symbol glossary

These are some of the symbols you may have on your vehicle.

Safety Alert		See Owner's Guide	
Fasten Safety Belt		Airbag - Front	
Airbag - Side		Child Seat	
Child Seat Installation Warning		Child Seat Tether Anchorage	
Brake System		Anti-Lock Brake System	
Brake Fluid - Non-Petroleum Based		AdvanceTrac™	
Master Lighting Switch		Hazard Warning Flasher	
Fog Lamps - Front		Fuse Compartment	
Fuel Pump Reset		Windshield Wash/Wipe	
Windshield Defrost/Demist		Rear Window Defrost/Demist	
Power Windows Front/Rear		Power Window Lockout	

# Introduction

## Vehicle symbol glossary

Child Safety Door Lock/Unlock		Panic Alarm	
Engine Oil		Engine Coolant	
Engine Coolant Temperature		Do Not Open When Hot	
Battery		Avoid Smoking, Flames, or Sparks	
Battery Acid		Explosive Gas	
Fan Warning		Power Steering Fluid	
Maintain Correct Fluid Level		Emission System	
Engine Air Filter		Passenger Compartment Air Filter	
Jack		Interior Luggage Compartment Release Symbol	
Check fuel cap		Low tire warning	

# Instrument Cluster

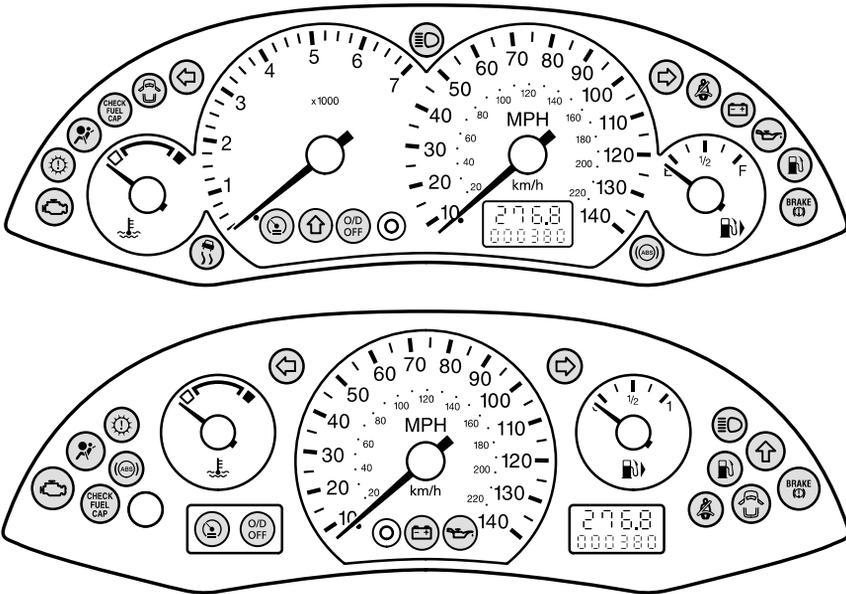

## INSTRUMENT CLUSTER WARNING LIGHTS AND CHIMES

### Check engine

Your vehicle is equipped with a computer that monitors the engine's emission control system. This system is commonly known as the On Board Diagnostics System (OBD II). This OBD II system protects the environment by ensuring that your vehicle continues to meet government emission standards. The OBD II system also assists the service technician in properly servicing your vehicle.

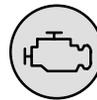

## Instrument Cluster

The *Check engine* indicator light illuminates when the ignition is first turned to the ON/RUN position to check the bulb. If it comes on after the engine is started, one of the engine's emission control systems may be malfunctioning. The light may illuminate without a driveability concern being noted. The vehicle will usually be driveable and will not require towing.

### ***What you should do if the check engine light illuminates***

#### **Light turns on solid:**

This means that the OBD II system has detected a malfunction.

Temporary malfunctions may cause your *Check engine* light to illuminate. Examples are:

1. The vehicle has run out of fuel. (The engine may misfire or run poorly).
2. Poor fuel quality or water in the fuel.
3. The fuel cap may not have been properly installed and securely tightened.

These temporary malfunctions can be corrected by filling the fuel tank with good quality fuel and/or properly installing and securely tightening the gas cap. After three drive cycles without these or any other temporary malfunctions present, the *Check engine* light should turn off. (A driving cycle consists of a cold engine startup followed by mixed city/highway driving). No additional vehicle service is required.

## Instrument Cluster

If the *Check engine* light remains on, have your vehicle serviced at the first available opportunity.

### **Light is blinking:**

Engine misfire is occurring which could damage your catalytic converter. You should drive in a moderate fashion (avoid heavy acceleration and deceleration) and have your vehicle serviced at the first available opportunity.



Under engine misfire conditions, excessive exhaust temperatures could damage the catalytic converter, the fuel system, interior floor coverings or other vehicle components, possibly causing a fire.

### **Check fuel cap**

Momentarily illuminates when the ignition is turned to the ON/RUN position to ensure your bulb is working. When the light turns on, check the fuel filler cap. Continuing to operate the vehicle with the check fuel cap light on, can activate the *Service Engine soon/Check Engine* warning light. **It may take a long period of time for the system to detect an improperly installed fuel filler cap.**

When the fuel filler cap is properly re-installed, the light(s) will turn off after a period of normal driving.

For more information, refer to *Fuel filler cap* in *Fuel information* in the *Maintenance and Specifications* chapter.



## Instrument Cluster

### Brake system warning

Momentarily illuminates when the ignition is turned to the ON/RUN position and the engine is off. If brake warning lamp does not illuminate at this time, seek service immediately. Also illuminates when the parking brake is engaged. Illumination after releasing the parking brake indicates low brake fluid level or ABS (if equipped) failure and the brake system should be serviced immediately.



### Anti-lock brake system (ABS) (if equipped)

Momentarily illuminates when the ignition is turned to the ON/RUN position and the engine is off. If the light remains on, continues to flash or fails to illuminate, have the system serviced immediately. With the ABS light on, the anti-lock brake system is disabled and normal braking is still effective unless the brake warning light also remains illuminated with parking brake released.



## Instrument Cluster

### Upshift (if equipped)

Illuminates when it is best to shift to the next highest manual transaxle gear for the maximum fuel economy.

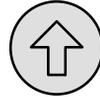

### O/D off (if equipped)

Illuminates when the transaxle control switch has been pushed. When the light is on, the transaxle does not switch into overdrive.



### Safety belt

Momentarily illuminates when the ignition is turned to the ON/RUN position to remind you to fasten your safety belts. For more information, refer to the *Seating and Safety Restraints* chapter.



### Air bag readiness

Momentarily illuminates when the ignition is turned on. If the light fails to illuminate, continues to flash or remains on, have the system serviced immediately.



## Instrument Cluster

### Charging system

Illuminates when the ignition is turned to the ON/RUN position and the engine is off. The light also illuminates when the battery is not charging properly, requiring electrical system service.

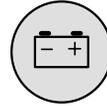

### Engine oil pressure

Illuminates when the oil pressure falls below the normal range. Stop the vehicle as soon as safely possible and switch off the engine immediately. Check the oil level and add oil if needed. Refer to *Engine oil* in the *Maintenance and Specifications* chapter.



### Multi-function: Automatic transaxle/cooling system (On Zetec or automatic transaxle vehicles only)

Momentarily illuminates when the ignition is turned to the ON/RUN position and the engine is off. If the light illuminates while driving, have your vehicle serviced.



## Instrument Cluster

### AdvanceTrac™

Momentarily illuminates when the ignition is turned on, to confirm that the system is operational.

While driving, the light flashes when the feature is active. The control switch will toggle the feature on or off, but the feature will default to on after each cycle of the ignition key. The light illuminates continuously when the feature is switched off.

After turning the ignition on, if the light does not illuminate or illuminates continuously (assuming the light has not come as a result of pressing the AdvanceTrac™ switch, which disables the system) while driving, it indicates a malfunction. During a malfunction the system will be switched off. Have the system serviced.

For further details, refer to the *AdvanceTrac™ stability enhancement system* in the *Driver Controls* chapter.



### Low fuel level warning light

When the warning light illuminates, refuel as soon as possible.



## Instrument Cluster

### Speed control (if equipped)

Illuminates when the speed control system is switched on. Refer to *Speed control* in the *Driver Controls* chapter.



### Turn signal

Illuminates when the left or right turn signal or the hazard lights are turned on. If one or both of the indicators stay on continuously or flash faster, check for a burned-out turn signal bulb. Refer to *Replacing exterior bulbs* or *Replacing front parking lamp turn signal bulbs* in the *Lights* chapter.

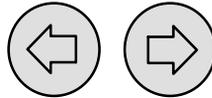

### High beams

Illuminates when the high beam headlamps are turned on.



### Doors ajar

Illuminates when the ignition is in the ON/RUN or START position and any door or the luggage compartment is open.



## Instrument Cluster

### **Safety belt warning chime**

Chimes to remind you to fasten your safety belts.

For information on the safety belt warning chime, refer to *Safety Restraints* in the *Seating and Safety Restraints* chapter.

### **Supplemental restraint system (SRS) warning chime**

For information on the SRS warning chime, refer to *Airbag* in the *Seating and Safety Restraints* chapter.

### **Headlamps on warning chime**

Sounds when the headlamps or parking lamps are on, the ignition is off (and the key is not in the ignition) and the driver's door is opened.

### **Key-in-ignition warning chime**

Sounds when the key is left in the OFF/LOCK, ACC or ON/RUN position and the driver's door is opened.

### **Gearshift warning chime (automatic transaxle only)**

Sounds when the gearshift lever is not in P (Park) and the driver's door is opened.

## Instrument Cluster

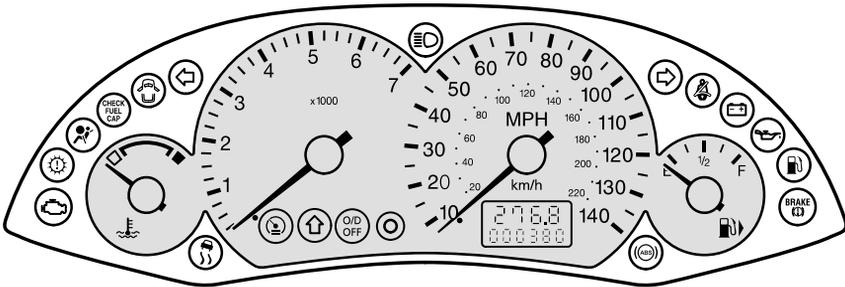

### INSTRUMENT CLUSTER GAUGES

#### Temperature gauge

Indicates the temperature of the engine coolant. At normal operating temperature, the needle remains within the normal area. If it enters the red section, the engine is overheating. Stop the vehicle as soon as safely possible, switch off the engine immediately and let the engine cool. Refer to *Engine coolant* in the *Maintenance and Specifications* chapter.

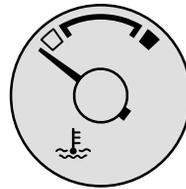

Never remove the coolant reservoir cap while the engine is running or hot.

## Instrument Cluster

This gauge indicates the temperature of the engine coolant, not the coolant level. If the coolant is not at its proper level the gauge indication will not be accurate. If the gauge enters the red section and the multi-function warning light illuminates, refer to *How fail safe cooling works in coolant* in the *Maintenance and Specifications* chapter.



Never remove the coolant reservoir cap while the engine is running or hot.

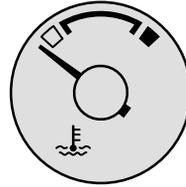

### Fuel gauge

Displays approximately how much fuel is in the fuel tank (when the key is in the ON/RUN position). The fuel gauge may vary slightly when the vehicle is in motion. The ignition should be in the OFF position while the vehicle is being refueled. When the gauge first indicates empty, there is a small amount of reserve fuel in the tank. When refueling the vehicle from empty indication, the amount of fuel that can be added will be less than the advertised capacity due to the reserve fuel.

If the key is not in the OFF position when you refuel the vehicle, the fuel gauge will not indicate the new volume until the ignition is turned OFF and then to ON/RUN.

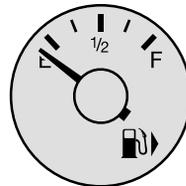

## Instrument Cluster

### Speedometer

Indicates the current vehicle speed.

### Odometer

Registers the total miles (kilometers) of the vehicle.

### Tripmeter

Registers the miles (kilometers) of individual journeys. To reset depress the control.

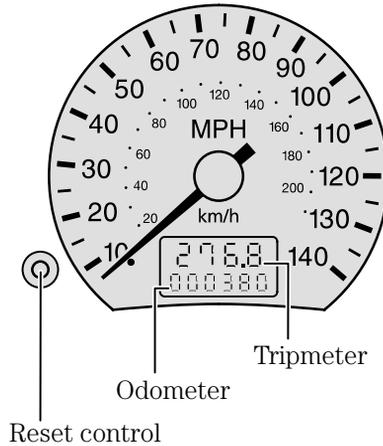

### Tachometer (if equipped)

Indicates the engine speed in revolutions per minute.

Driving with your tachometer pointer continuously at the top of the scale may damage the engine.

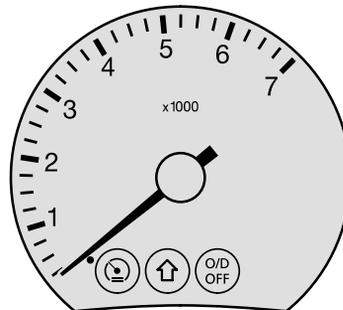

# Entertainment Systems

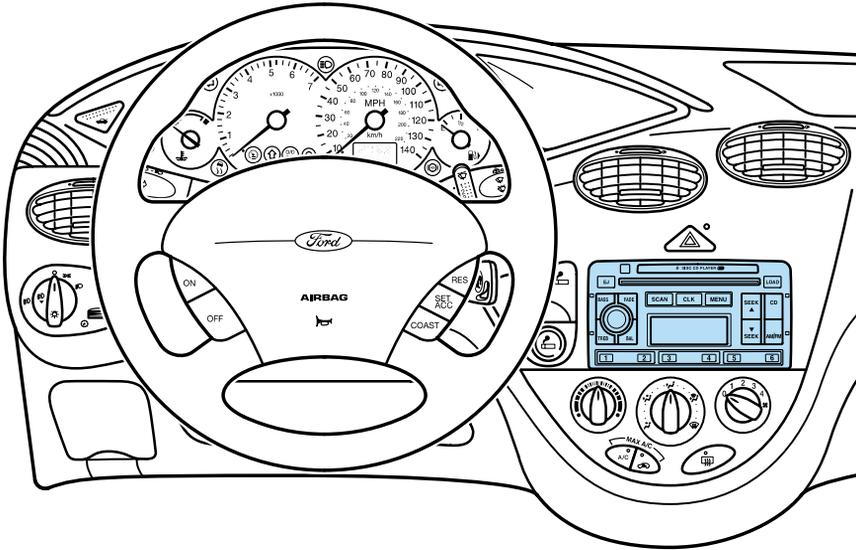

## AUDIO SYSTEM

### Anti-theft protection panel

To deter would-be thieves, Ford audio units have a removable front panel without which the unit will not work.

Avoid touching the contacts on the back of the panel and do not use excessive force to refit it.

Slide the security release button to the left and remove the front panel (on units with a 6 disc CD player, press the security release button). To reposition the panel, insert the right-hand edge first, then the left-hand side, until the retaining latch is engaged.

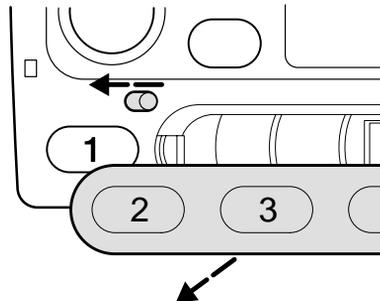
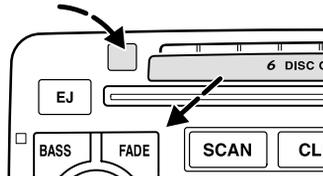

## Entertainment Systems

### **Replacement panels**

Your Ford Dealer will require the following if you need to order a replacement panel:

1. Your name and address.
2. The Vehicle Identification Number (visible on a plate mounted on the instrument panel). Refer to illustration under *Identifying your vehicle* in the *Maintenance and Specifications* chapter.
3. The Audio unit type:  
4500 AM/FM Stereo with Cassette,  
4600 AM/FM Stereo with CD Player,  
6006N AM/FM Stereo with 6 Disc  
CD Player, Audiophile Audio  
System with 6 Disc CD Player,  
MACH 500 Audio System.
4. Proof of identification (e.g.,  
driver's license, identity card).
5. A vehicle invoice (if the audio  
unit was installed in the vehicle  
prior to delivery) or a parts invoice  
if the audio unit was purchased  
separately from the vehicle, or an  
appropriate vehicle registration  
document.

# Entertainment Systems

## **Radio reception**

To gain the best reception, always tune to the strongest station signal available.

The following tips will help you gain the best reception from your Ford audio system.

### ***AM reception***

Under most conditions, strong signals provide stable sound quality and little signal disturbance.

However, at night, atmospheric conditions may sometimes lead to interference from other stations.

### ***FM reception***

The FM waveband offers higher quality sound broadcasts, but signal strength can be subject to interference caused by:

- The limited range of some transmitters.
- Reception distortion as signals reflect off local buildings and other objects.
- Signal “dead spots” where reception is obstructed or restricted.

# Entertainment Systems

## AM/FM STEREO WITH CASSETTE AND AM/FM STEREO WITH CD PLAYER

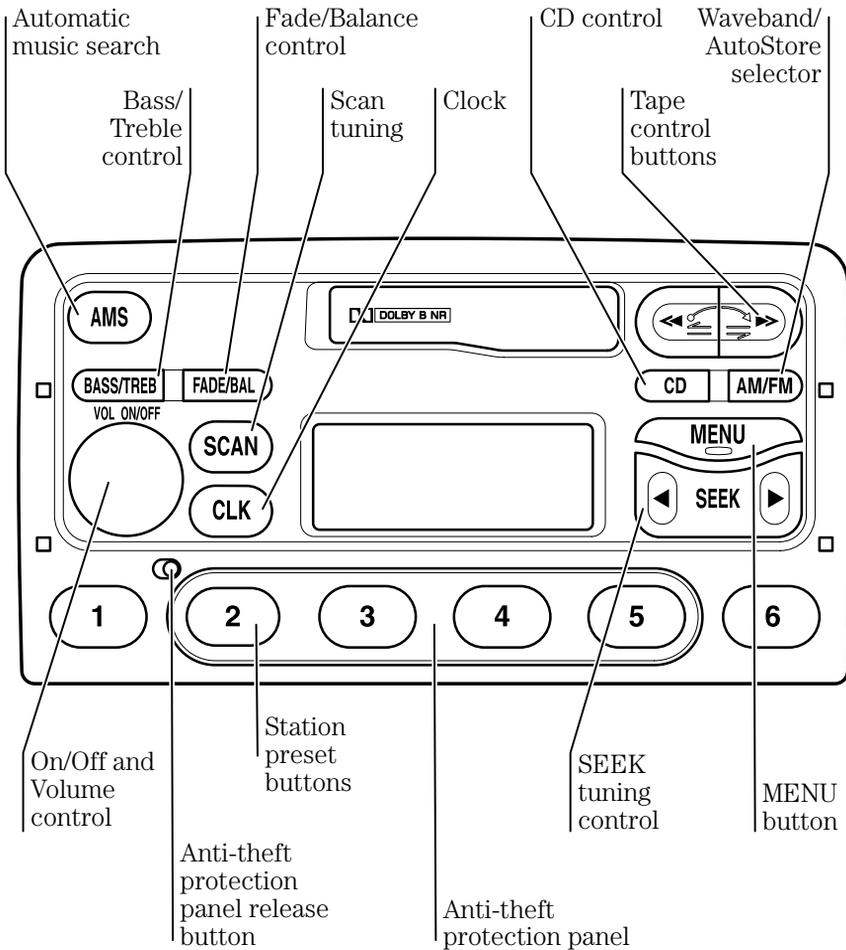

# Entertainment Systems

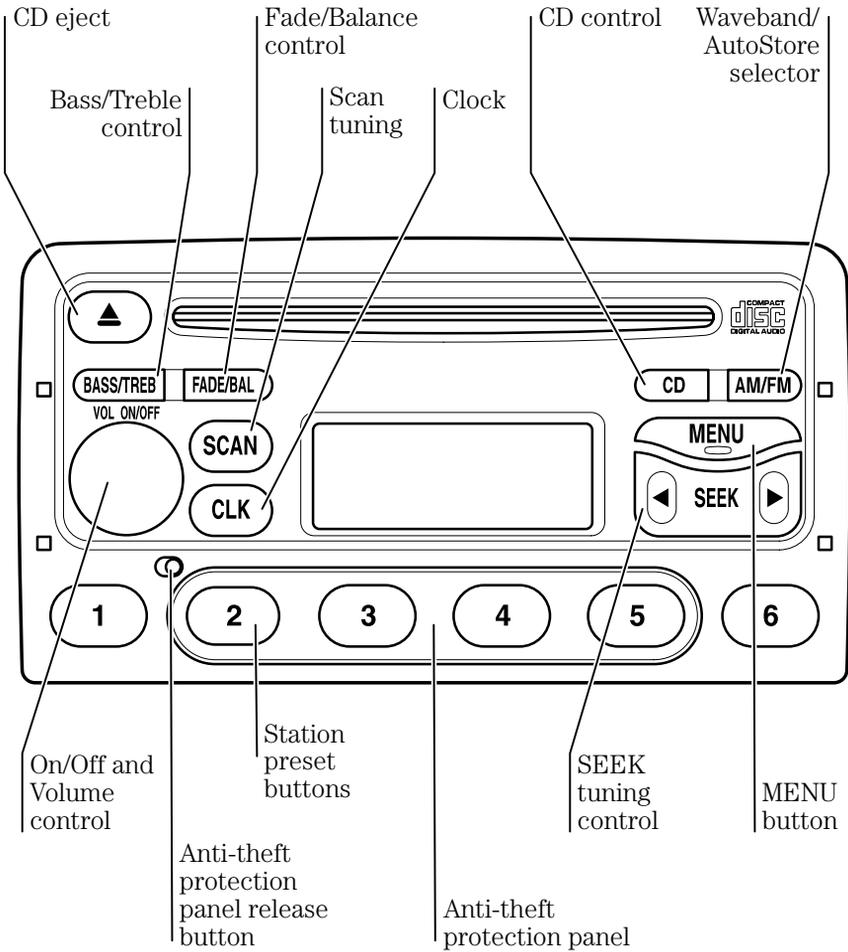

## Entertainment Systems

### On/off

Press for on/off. This button can also operate the radio for up to one hour with the ignition turned off. The radio automatically switches off after one hour. This function can be used repeatedly.

VOL ON/OFF

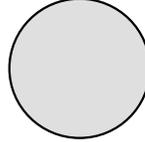

### Volume control

The display indicates the level selected.

VOL ON/OFF

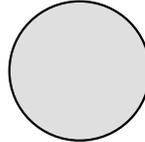

### Bass/Treble control

Press "BASS/TREB" once for bass or twice for treble and use the volume control for adjustment. The display indicates the level selected. To adjust beyond the "0" setting, stop rotating the control at "0" then restart.

BASS/TREB

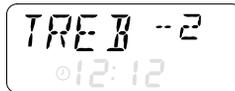

## Entertainment Systems

### Fade/Balance control

Press “FADE/BAL” once for fade (front to rear) or twice for balance (left to right), and use the volume control for sound system adjustment. The display indicates the level selected. To adjust beyond the “0” setting, stop rotating the control at “0” then restart.

The fade function is applicable to vehicles with front and rear speakers only.

FADE/BAL



### Seek tuning control (SEEK)

During radio reception, press ◀ or ▶ to locate the next station down or up the waveband selected.



### Scan tuning control

Press the SCAN button. The radio tunes to and plays the next station on the waveband. After a short period it tunes to and plays the next station.

During this scan, “SCAN” flashes in the display.

If you wish to continue listening to a station tuned to, press SCAN.

Pressing SCAN at any time will end the scan.

SCAN



## Entertainment Systems

### Waveband selector (AM/FM)

- Press repeatedly during radio reception to select AM, FM1, FM2 or AutoStore (see *AutoStore selector*). The display indicates the selection made.
- Press during tape or CD playback to return to radio reception.



### CD playback

Press the CD button for CD playback. Press AM/FM to return to radio reception.

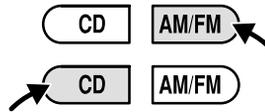

### AutoStore selector

AutoStore selects six strong FM station signals and stores them on the preset buttons.

- Press and hold the AM/FM button to activate AutoStore.
- "AST" flashes in the display while the unit searches through the FM frequencies. You can release the button at this point.
- When the search is complete, sound is restored on preset button 1.
- Other stored stations can be selected using the other preset buttons.
- Alternatively, AutoStore can be used as an additional waveband to store other stations manually (see *Station preset buttons*).

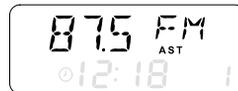

## Entertainment Systems

### Station preset buttons

Select a waveband (FM or AM) and tune to the station required. Press and hold one of the preset buttons. When sound returns, the station has been stored.

24 preset frequencies can be stored – six on each of the AM, FM1, FM2 and AutoStore bands.

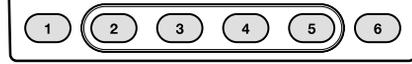

### Stereo indicator

The **ST** symbol shows whenever a stereo signal is received.



### Clock (CLK)

Press CLK to alternate the display between clock and, when playing, CD elapsed time.

With the ignition switched off, the time is permanently displayed on the radio LCD.



### Adjusting the clock

With the radio switched on, press and hold CLK until the hour digit flashes. Use the volume control to adjust.

Press CLK again for the minutes and use the volume control to adjust. Press CLK again to return to normal operation.



## Entertainment Systems

### **MENU button (main features) – radio**

Use the MENU button to access main menu features and the SEEK button for adjustment.



### **Manual tuning**

Press the MENU button once until a display like the one shown opposite appears. Then use the SEEK button to make manual tuning adjustments. The FM waveband allows 0.2 MHz tuning steps, and the AM band 10kHz steps.

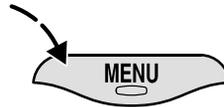

### **Automatic Volume Control (AVC)**

This feature is not available on some vehicles and will not appear as a menu function.

The AVC feature works in both modes – radio and cassette or CD.

Press the MENU button twice until a display like the one shown opposite appears. Then use the SEEK button to turn this function on (“AVC + 1” to “AVC + 7”) or off (“AVC OFF”).

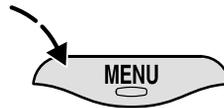

- When selected, Automatic Volume Control increases or decreases the audio unit's volume level to compensate for engine and road speed noise.
- The SEEK button provides a selection of settings between “AVC OFF” and “AVC +7”. The display shows the level selected.

# Entertainment Systems

## AM/FM stereo with cassette only

### **Tape control buttons**

Insert a tape and playback will automatically override radio or CD. "TAPE A" or "TAPE B" appears in the display to indicate which side of the tape is playing. Note that the tape side facing upward in the audio unit is always considered "TAPE A".



### **Fast forward/rewind**

- Press **▶▶** button fully in for fast forward.
- Press and release **◀◀** button to end fast forward and restart the tape.
- Press **◀◀** button fully in for rewind.
- Press and release **▶▶** button to end rewind and restart the tape. If the beginning of the tape is reached, playback will start automatically.

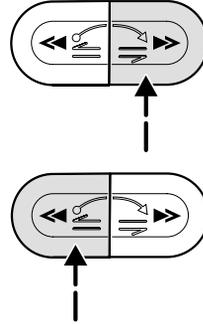

During fast forward and rewind, radio transmission is automatically restored (with Automatic Music Search function turned off).

### **Auto reverse**

If the end of the tape is reached, auto reverse operates with playback resuming at the start of the tape's other side.

## Entertainment Systems

### ***Tape side selection***

During tape playback, press both ◀▶ and ▶▶ buttons partially in to change the tape side being played.

### ***Tape eject***

Press both ◀▶ and ▶▶ buttons fully in to eject the cassette and restore radio reception.

### ***To pause tape playback***

Press AM/FM to pause tape playback and restore radio reception, or the CD button for CD playback.

A square in the display indicates there is a tape inserted.

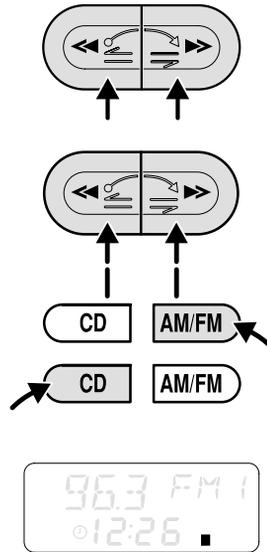

## Entertainment Systems

### **To restart tape playback**

Press both tape buttons partially in or press AMS to resume tape playback.

An oval-shaped button with the text "AMS" inside.

### **Automatic Music Search (AMS)**

Press AMS to turn this function on or off.

With this feature activated, press either ◀ or ▶ buttons (as appropriate), to obtain the previous or next track on the tape.



### **Cassette care and maintenance**

For best possible sound quality, use tape cassettes that are clean and in good condition.

It is also recommended that the tape head in the audio unit is cleaned regularly with a wet cleaning cassette, which is available from your Ford Dealer.

### **MENU button (main features) – tape**

Use the MENU button to access main menu features, and the SEEK button for adjustment.

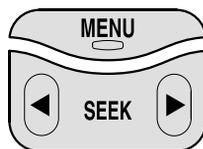

### **Dolby B® noise reduction**

Press the MENU button repeatedly until a display like the one shown opposite appears. Then use the SEEK button to turn this function on ("NR ON") or off ("NR OFF"). With the function on, background tape noise is reduced.



## Entertainment Systems

### **Automatic Volume Control (AVC)**

This feature is not available on certain vehicles and will not appear as a menu function.

The AVC feature works in both modes - radio and cassette or CD.

Press the MENU button repeatedly until a display like the one shown opposite appears. Then use the SEEK button to turn this function on ("AVC + 1" to "AVC + 7") or off ("AVC OFF").

- When selected, Automatic Volume Control increases or decreases the audio unit's volume level to compensate for engine and road speed noise.
- The SEEK button provides a selection of settings between "AVC OFF" and "AVC +7". The display shows the level selected.

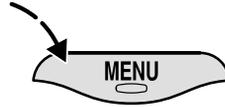

# Entertainment Systems

## AM/FM stereo with CD player only

### CD Playback



The CD player is designed to play commercially pressed 8 cm and 12 cm audio compact discs only. Due to technical incompatibility, certain recordable and re-recordable compact discs may not function correctly when used in Ford CD players. Irregular shaped CDs, CDs with cleaning brushes, CDs with a scratch protection film attached and CDs with homemade paper (adhesive) labels should not be inserted into the CD player. The label may peel and cause the CD to become jammed. It is recommended that homemade CDs be identified with a permanent marker rather than adhesive labels. Please contact your dealer for further information.

CD playback starts and radio reception is interrupted, when a CD is inserted into the entry slot. "PLAY CD" appears in the display.

Press CD to start playback from a CD already in the audio unit. If no disc is inserted, "NO CD" appears in the display.

Pressing CLK alternates the display between elapsed track time and clock time.

The display indicates elapsed track time up to 19:59. If the track is longer than twenty minutes, the first digit flashes while the rest of the numeral returns to zero and starts counting again.

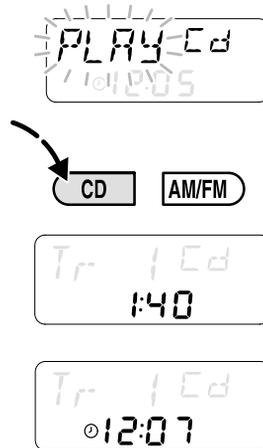

## Entertainment Systems

### **Track selection**

Press ◀ SEEK to return to the start of the track being played. If pressed within three seconds of the start of a track, the previous track will be selected. Press repeatedly to select previous tracks.

Press SEEK ▶ to select the next track or press repeatedly to access later tracks.

### **Fast forward/reverse**

Press and hold ◀ SEEK or SEEK ▶ to search backwards or forwards across the tracks on the disc.

### **Scan mode**

Press the SCAN button. Each track is played in turn for a short period.

During this scan, "SCAN" appears in the display. To continue listening to a track, press SCAN.

Pressing SCAN at any time will end the scan.

### **To end CD playback**

Press the AM/FM button to restore radio reception without ejecting the disc. If reselected, the CD will start from wherever playback was last interrupted.

A square in the display indicates there is a disc inserted.

When ejected, the disc is held ready for removal. If it is left as it is, the disc will be pulled back inside the audio unit automatically, and retained ready for playback.



# Entertainment Systems

### **CD eject**

Press ▲ to eject CD.



### **CD care and maintenance**

For best possible sound quality, use CDs that are clean and in good condition.



### **CD error codes**

Codes may be shown in the audio unit display that indicate errors with the CD unit. These codes are as follows:

Display	Description/rectification
E11 or E15	Internal fault, see your dealer.
E12	Clean the disc and try again. Certain recordable and re-recordable CDs may also cause this error - try a regular CD. If error still shows, see your dealer.
E14	Ambient temperature too hot - unit will not work until it has cooled down.
E16	There is an eject fault, see your dealer.

### **MENU button (main features) – CD**

Use the MENU button to access main menu features, and the SEEK button for adjustment.



## Entertainment Systems

### **Random track playback (SHUF)**

Press the MENU button until a display like the one shown opposite appears. Then use the SEEK button to turn this function on (“SHUF-ON”) or off (“SHUF-OFF”).

With the function on, the “Cd” indicator is replaced by “SHUF” as a new track is selected.

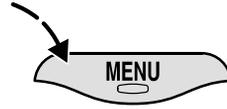

### **Track compression (COMP)**

Press the MENU button repeatedly until a display like the one shown opposite appears. Then use the SEEK button to turn this function on (“COMP ON”) or off (“COMP OFF”).

With the function on, quieter music is boosted and louder music lowered to minimize repeated volume adjustments.

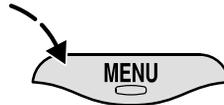

## Entertainment Systems

### **Automatic Volume Control**

This feature is not available on certain vehicles and will not appear as a menu function.

The AVC feature works in both modes - radio and cassette or CD.

Press the MENU button repeatedly until a display like the one shown opposite appears. Then use the SEEK button to turn this function on ("AVC + 1" to "AVC + 7") or off ("AVC OFF").

- When selected, Automatic Volume Control increases or decreases the audio unit's volume level to compensate for engine and road speed noise.
- The SEEK button provides a selection of settings between "AVC OFF" and "AVC +7". The display shows the level selected.

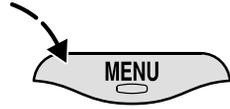

# Entertainment Systems

## AM/FM STEREO WITH 6 DISC CD PLAYER

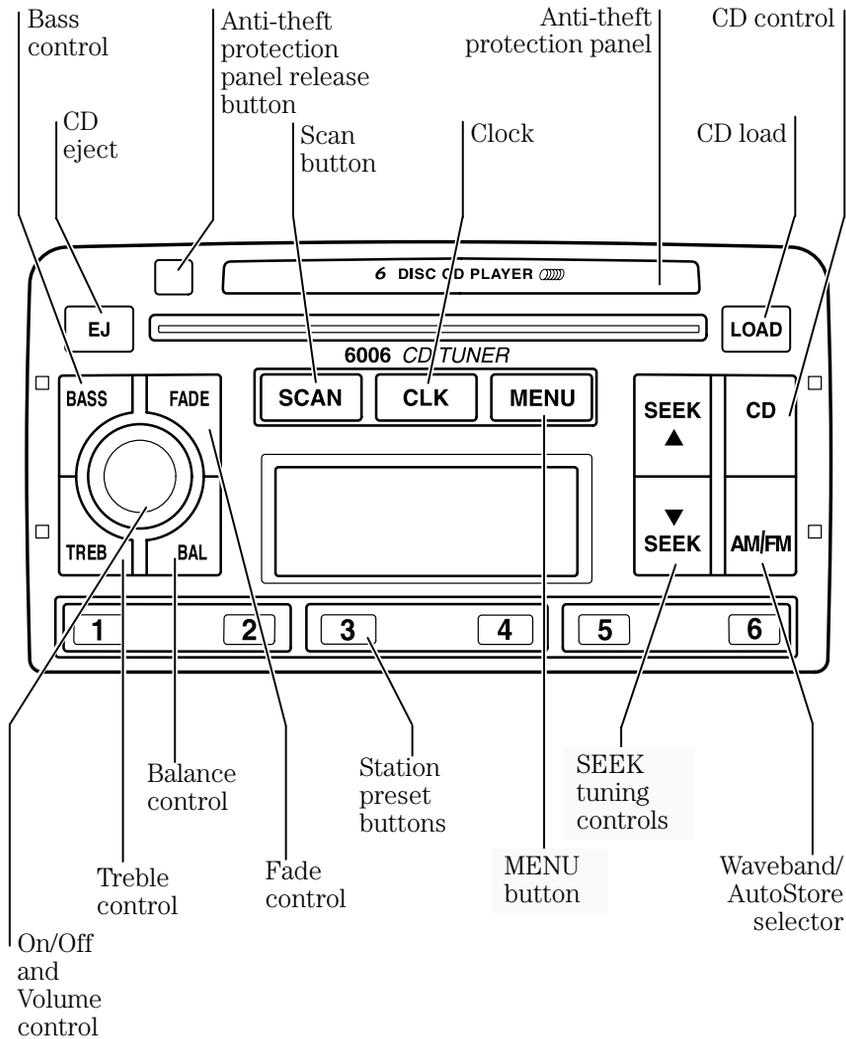

# Entertainment Systems

## On/Off power and volume control

- Press for on/off. This button can also operate the unit for up to one hour with the ignition turned off. The radio automatically switches off after one hour.

VOL ON/OFF

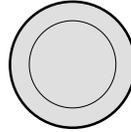

- Rotate, and the display indicates the volume level selected.

See also *Audio distortion reduction (CLIP)*.



## Bass Control

Press “BASS” and use the volume control for adjustment. The display indicates the level selected.

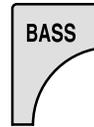

## Treble control

Press “TREB” and use the volume control for adjustment.

The display indicates the level selected.



## Entertainment Systems

### Fade control

Press FADE (for fade front to rear) and use the volume control for sound system adjustment. The display indicates the level selected.



### Balance control

Press BAL (for balance left to right) and use the volume control for sound system adjustment. The display indicates the level selected.

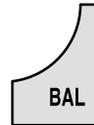

### Seek tuning control

During radio reception, press SEEK ▼ or SEEK ▲ to locate the next station down or up the waveband selected.

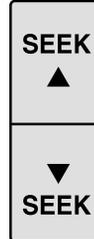

### Waveband selector

- Press repeatedly during radio reception to select AM, FM1, FM2 or AutoStore (see following). The display indicates the selection made.

- Press during CD playback, to return to radio reception.



## Entertainment Systems

### Autostore selector

AutoStore selects six strong FM station signals and stores them on the preset buttons.

- Press and hold the AM/FM button to activate AutoStore.
- 'AST' flashes in the display while the unit searches through the FM frequencies.
- When the search is complete, sound is restored.
- The Autostore waveband can be used to store stations manually. See *Station preset buttons*.



### Stations preset buttons

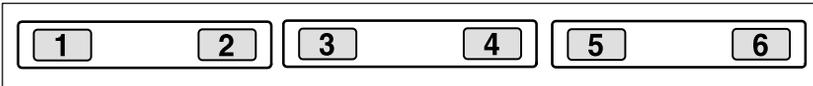

Select a waveband (FM or AM) and tune to the station required. Press and hold one of the preset buttons. When sound returns, the station has been stored. 24 preset frequencies can be stored – six on each of the AM, FM1, FM2 and AutoStore bands.

### Clock (CLK)

Press CLK to alternate the display between clock and, when playing, CD time elapsed.

With the ignition switched off, the time is permanently displayed on the radio LCD.

## Entertainment Systems

### Adjusting the clock

- With the radio switched on, press and hold CLK until the hour digit flashes. Use the volume control to adjust.
- Press CLK again for the minutes and use the volume control to adjust.
- Press CLK again to return to normal operation.

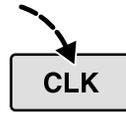

### Choosing 12 or 24 hour format

The time can be displayed in either 12 or 24 hour format.

- Press and hold the MENU button to enter the extended menu, then press MENU repeatedly until 12/24 Hour is displayed.
- Press the SEEK ▲/SEEK ▼ buttons to toggle between 12 and 24 hour modes.

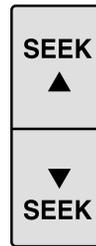
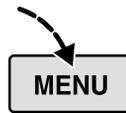

### Stereo indicator

This shows whenever a stereo signal is received. In poor signal conditions, the indicator will flicker and then go out when the signal is finally lost.



## Entertainment Systems

### **Scan tuning**

Use the SCAN button to scan up the waveband selected. 'Scn' flashes in the display and each station is played for a few seconds in turn. Press SCAN again to continue listening to a station.



### **MENU button**

#### **Main features – radio**

Use the MENU button to access main menu features, and the SEEK button for adjustment.



### **Manual tuning**

Press the MENU button repeatedly until a display like the one shown opposite appears.



Then use the SEEK button to make manual tuning adjustments. The FM waveband allows 0.2MHz tuning steps, and the AM band 10kHz steps.

## Entertainment Systems

### **Automatic Volume Control (AVC)**

This feature is not available on certain vehicles and will not appear as a menu function.

The AVC feature works in both modes - radio and CD.

Press the MENU button repeatedly until a display like the one shown opposite appears. Then use the SEEK button to turn this function on ("AVC + 1" to "AVC + 7") or off ("AVC OFF").

- When selected, Automatic Volume Control increases or decreases the audio unit's volume level to compensate for engine and road speed noise.
- The SEEK button provides a selection of settings between "AVC OFF" and "AVC +7". The display shows the level selected.

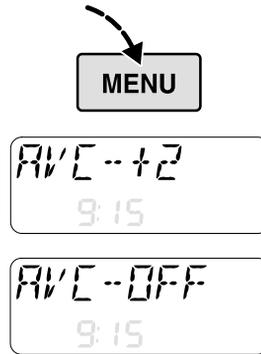

## Entertainment Systems

### **Audio distortion reduction (CLIP)**

Press and hold the MENU button until the display changes.

Then press the MENU button repeatedly until a display like the one shown opposite appears. Then use the SEEK button to turn this function on or off.

With the feature activated, the audio unit automatically detects sound distortion and reduces the unit's volume level until the distortion has been eliminated.

This means that when the volume control is adjusted, with the CLIP function switched on, there may not be an increase in sound.



## Entertainment Systems

### CD playback



The 6 disc CD player is designed to play commercially pressed 12 cm audio compact discs only. Due to technical incompatibility, certain recordable and re-recordable compact discs may not function correctly when used in Ford CD players. Irregular shaped CDs, CDs with cleaning brushes, CDs with a scratch protection film attached and CDs with homemade paper (adhesive) labels should not be inserted into the CD player. The label may peel and cause the CD to become jammed. It is recommended that homemade CDs be identified with a permanent marker rather than adhesive labels. Please contact your dealer for further information.

# Entertainment Systems

## Loading CDs

### To load a single CD

- Press LOAD and either 'WAIT' or 'LOAD' will appear in the display.

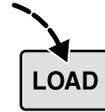

- When this changes to 'INSERT', and lights flash in the CD entry slot, insert a CD into the audio unit. 'WAIT' or 'LOAD' and a disc icon flash in the display. The CD will be loaded into the first available location.

**Do not attempt to insert a CD while the display reads "WAIT" or "LOAD". Only insert a CD when the display reads "INSERT".**

**Do not force a CD into the CD entry slot. The audio unit will accept the CD only when "INSERT" is displayed.**

- A numeral appears in one of the six disc icons to confirm the CD's location, and playback starts automatically.



## Entertainment Systems

### To load more than one CD

- Press and hold LOAD until either 'WAIT' or 'LOAD' appears in the display.

**Do not attempt to insert a CD while the display reads "WAIT" or "LOAD". Only insert a CD when the display reads "INSERT".**

- When this changes to 'INSERT' and lights flash in the CD entry slot, insert a single CD into the audio unit. 'WAIT' or 'LOAD' and a disc icon flash in the display.

**Do not force a CD into the CD entry slot. The audio unit will accept the CD only when "INSERT" is displayed.**

- Once the disc is loaded, the display changes to 'WAIT' and then 'INSERT', to confirm that another CD may be loaded.
- Up to six CDs may be loaded.

### To start CD playback

- During radio reception, press CD.
- CD playback starts and radio reception is interrupted whenever a CD is inserted into the audio unit.
- If two or more CDs are loaded one after the other, playback will start with the last CD loaded.

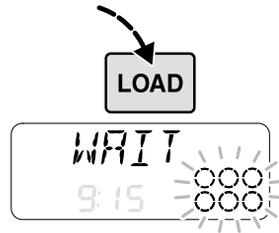

# Entertainment Systems

## Disc selection

- During CD playback, press the preset button that corresponds to the CD required. The display will show the disc selected.

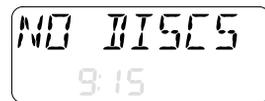
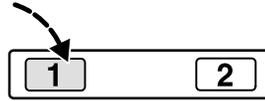

- During playback, pressing CLK alternates the display between clock time and elapsed CD track time. If the track is longer than the display allows, the first digit flashes while the rest of the numerals return to zero and start counting again. During normal operation, CDs and tracks are automatically selected and played sequentially in ascending order. Disc one follows disc six.

- If a selected disc is missing, the display shows 'NO DISC' and playback continues. If CD is pressed when no discs are loaded, the display shows 'NO DISCS'.

## Track selection

- Press SEEK ▲ to select the next track. Track selection, forward or backwards, only applies to tracks on the disc selected.

- Press SEEK ▼ once to return to the start of the track being played. Press twice, rapidly, to select the previous track.

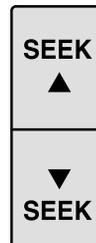

## Entertainment Systems

### Fast forward/reverse

- Press and hold SEEK ▼ or SEEK ▲ to search backwards or forwards across the tracks on the disc.

### To end CD playback

- Press AM/FM to restore radio reception without ejecting a disc.



### To resume CD playback

- Press the CD button again.



### CD eject

- If EJ is pressed in error, press the button again to cancel.



### During CD playback

- Press EJ to eject the disc being played. To eject any other disc, select that disc and press EJ. 'EJECT' and 'REMOVE' appear in the display and the disc is held ready for removal. If it is not removed, the disc will be pulled back into the audio unit and CD playback starts again. 'INSERT' is briefly displayed, to allow a new disc to be inserted if required.



## Entertainment Systems

### **To eject a disc during radio reception**

- Press EJ. While 'SELECT' is displayed, press the preset button that corresponds to the disc to be ejected. 'EJECT' and 'REMOVE' appear in the display and the disc is held ready for removal.

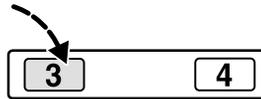

### **To eject all discs**

- Press and hold EJ until 'EJECT' is displayed. The screen will alternate between flashing 'EJECT' and 'REMOVE'. When 'REMOVE' is displayed, take the disc out of the unit. This repeats until all discs have been removed.



## Entertainment Systems

### CD error codes

Codes may be shown in the audio unit display which indicate errors with the CD unit. These codes are as follows:

Display	Description/rectification
E2	Ambient temperature too hot - unit will not work until it has cooled down.
E1, E3 or E5	Internal fault - see your Ford Dealer.
E4	Disc upside down or dirty. Clean the disc and try again. Certain recordable and re-recordable CDs may also cause this error - try a regular CD. If error still shows, see your Ford Dealer.

### MENU BUTTON



MENU

#### Main features – CD

Use the MENU button to access main menu features, and the SEEK button for adjustment.

#### **Random track playback (SHUF)**

- Press the MENU button repeatedly until a display like the one opposite appears. Then use the SEEK button to turn this function on or off.
- With the function on, SHUFFLE is displayed as a new track is selected.



## Entertainment Systems

### **Track compression (COMP)**

- Press the MENU button repeatedly until a display like the one shown opposite appears. Then use the SEEK button to turn this function on or off.
- With the function on, quieter music is boosted and louder music lowered to minimise repeated volume adjustments.
- The COMP icon will illuminate when compression is selected.



### **Automatic Volume Control (AVC)**

This feature is not available on certain vehicles and will not appear as a menu function.

The AVC feature works in both modes - radio and CD.

Press the MENU button repeatedly until a display like the one shown opposite appears. Then use the SEEK button to turn this function on ("AVC + 1" to "AVC + 7") or off ("AVC OFF").

- When selected, Automatic Volume Control increases or decreases the audio unit's volume level to compensate for engine and road speed noise.
- The SEEK button provides a selection of settings between "AVC OFF" and "AVC +7". The display shows the level selected.

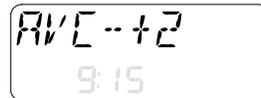
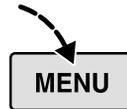

## Entertainment Systems

### ***Track Scanning***

- Press the SCAN button to scan up or down the tracks selected. 'Scn' flashes in the display and each track is played for a few seconds in turn. Press SCAN again to continue listening to a track.

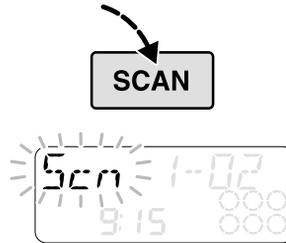

# Entertainment Systems

## AUDIOPHILE AUDIO SYSTEM

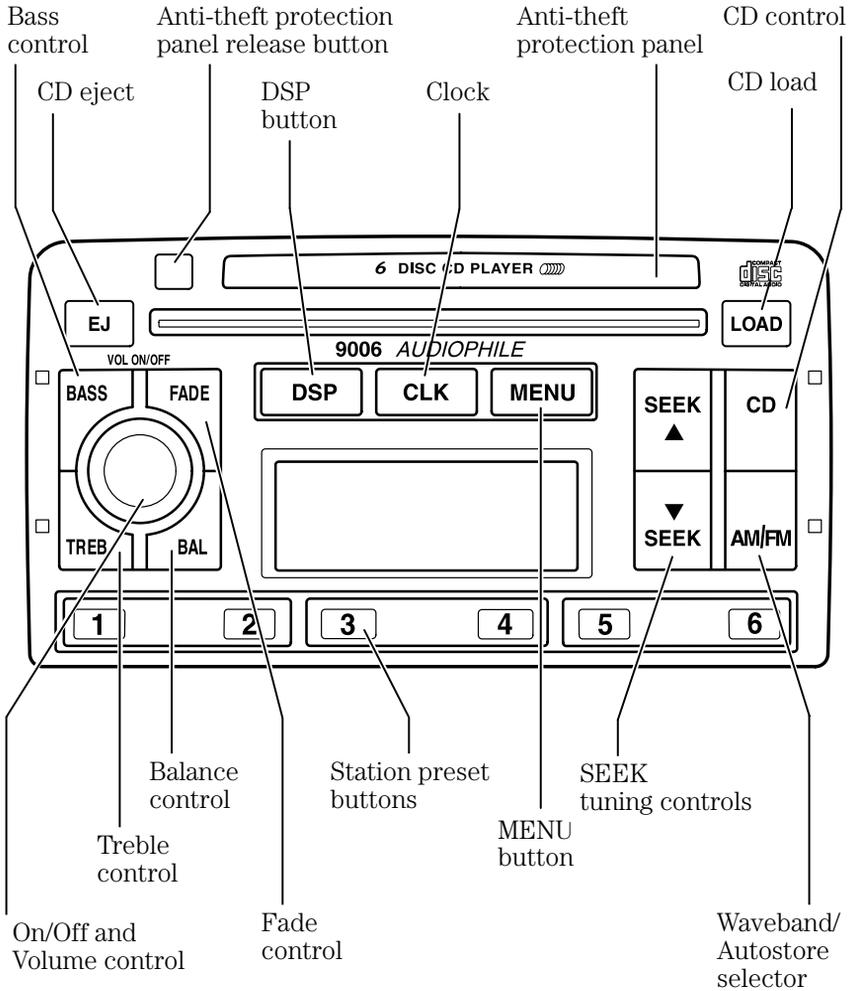

The Audiophile package includes:

- Upgraded 2-way front speakers
- 8 inch subwoofer with amplifier and enclosure

# Entertainment Systems

## MACH 500 AUDIO SYSTEM

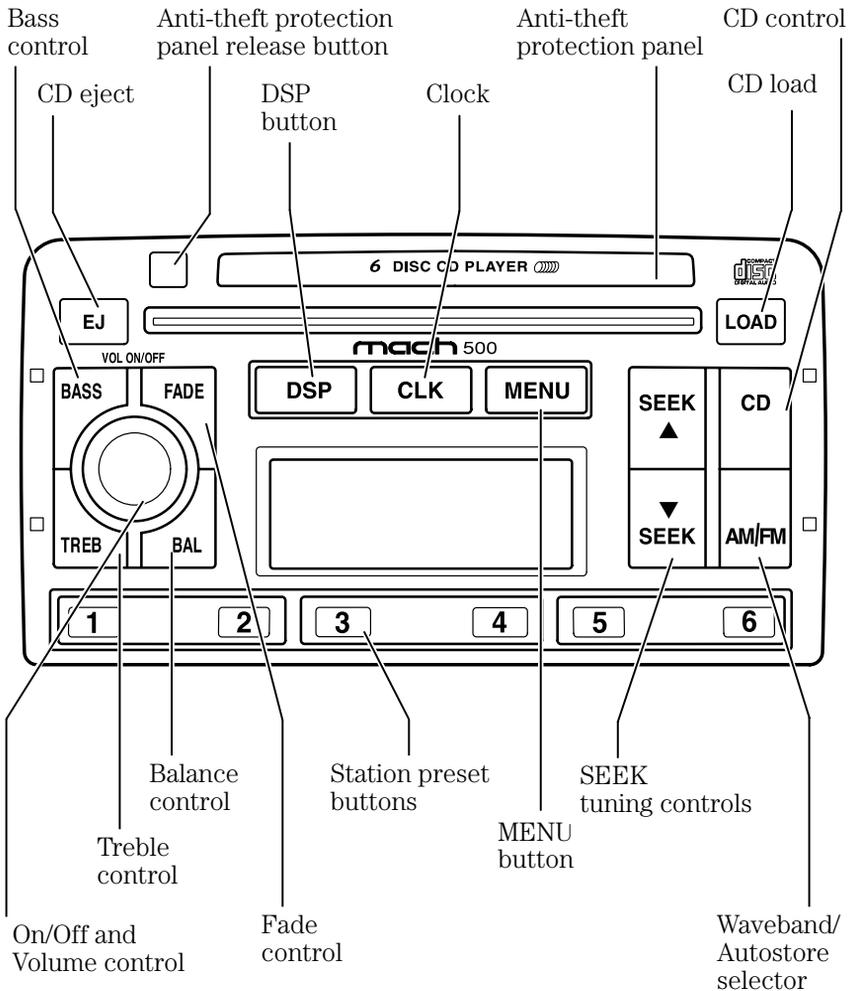

The MACH 500 package includes:

- Upgraded 2-way speakers in all four locations
- 10 inch subwoofer with amplifiers and enclosure

## Entertainment Systems

Please refer to the AM/FM stereo with 6 disc CD player for the basic operating instructions for the Audiophile and MACH 500 audio systems. Additional features of these systems are listed below.

### MACH 500 activation

When the radio is switched on, MACH 500 will be displayed. After a short duration, the display will revert to the previously selected mode (AM, FM or CD).

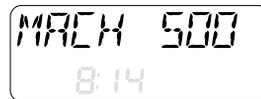

### RBDS

The Audiophile and MACH 500 audio systems are equipped with a Radio Broadcast Data System (RBDS) decoder which picks up special signals transmitted on the FM waveband when tuned to some stations.

### Station name displays

The Audiophile and MACH 500 audio systems will display a selected radio station's name when the information is broadcast using RBDS.



If the radio is tuned to a station that is capable of broadcasting Traffic Announcements, the  symbol will be visible in the display (may not be available in all areas).

### Station preset buttons

30 preset frequencies can be stored – six on each of the AM, AM-AST, FM1, FM2 and FM-AST.

## Entertainment Systems

### DSP button

Press the **DSP** button once to enter Occupancy mode and use the volume control to select one of the 3 EQ settings: ALL (default setting), DRIVER (SEAT) or REAR (for Audiophile) or MACH 500 (for MACH 500 - this mode features enhanced bass output).



Press the **DSP** button twice to enter Effects mode and use the volume control to select one of 5 effects: DSP OFF (default setting), NEWS, JAZZ, CONCERT, CHURCH or STADIUM.



### MENU BUTTON

#### Additional features – radio

Use the MENU button to access main menu features and the SEEK button for adjustment.

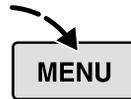

### Scan tuning

Press the MENU button repeatedly until a display like the one opposite appears. Then use the SEEK button to scan up the waveband selected. 'Scn' flashes in the display and each station is played for a few seconds in turn. Press SEEK again to continue listening to a station.



# Climate Controls

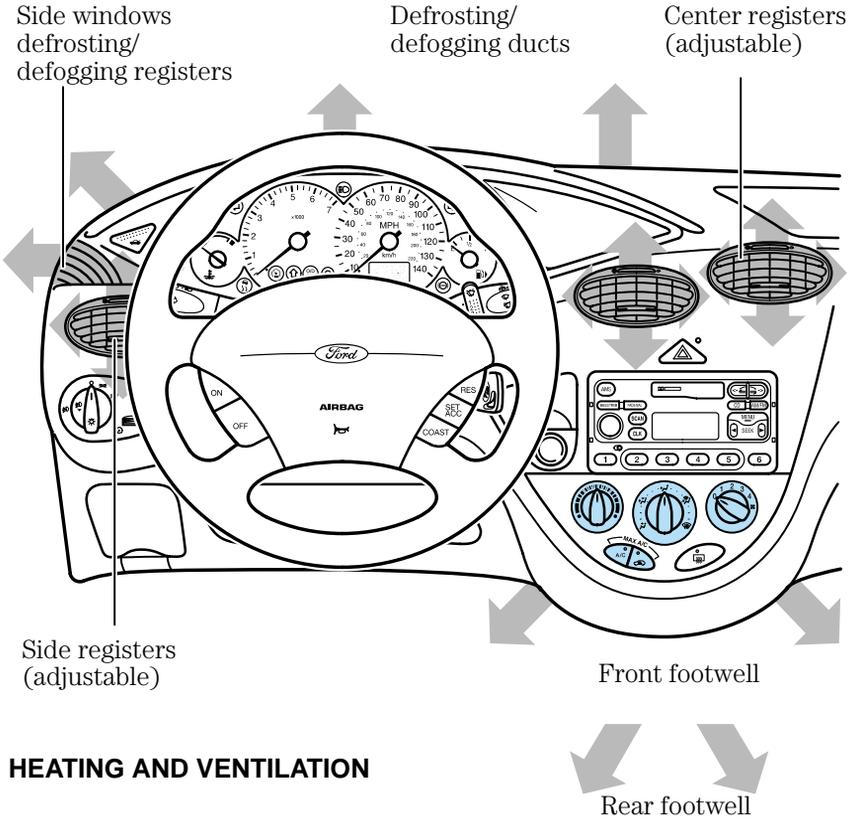

## HEATING AND VENTILATION

### Air distribution

The air flow volume and direction can be regulated with the controls on the instrument panel and the controls on the side and center registers.

### Center and side registers

Adjust as necessary for comfort or to direct air to the windows for defogging.

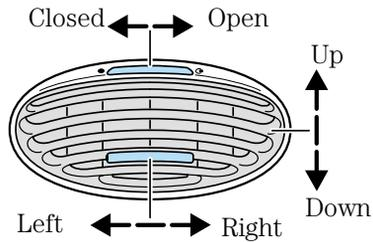

## Climate Controls

### Temperature control

Adjust as necessary.

**Note:** The heating effect depends upon the coolant temperature and is therefore only effective when the engine is warm.

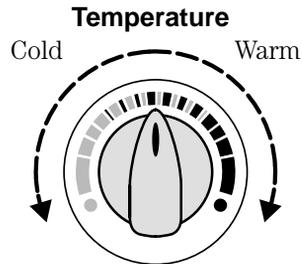

### Mode selector control

Controls the direction of the airflow to the interior of the vehicle. Selecting a position part way between modes will distribute the air accordingly.

Air is distributed as follows:

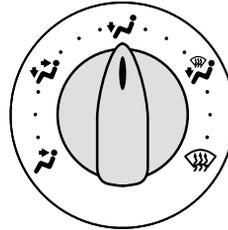

#### Panel Mode

The main air stream flows from the instrument panel registers to the face level area or to the side windows.

#### Panel and Floor Mode

The air stream flows from the instrument panel registers and the floor ducts to the face level area and to the front and rear footwell areas. A small portion of air is directed to the windshield.

#### Floor Mode

The main air stream flows from the floor ducts to the front and rear footwell areas. A small portion of air is directed to the windshield.

# Climate Controls

## Floor and Defrost Mode

The air stream flows from the floor ducts and the windshield defroster ducts to the front and rear footwell areas and towards the windshield.

## Defrost Mode

The main air stream flows from the windshield defroster ducts towards the windshield to defrost or defog it. When this mode is selected, the recirculated air will be turned off automatically.

**If equipped, the air conditioning will switch on automatically to dehumidify the air.**

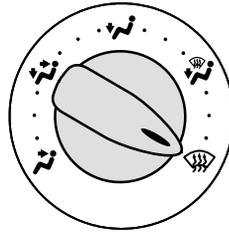

## Fan speed control

Controls the volume of air circulated in the vehicle. To increase air flow, select a higher number.

The fan is in the off position when position **0** is selected. At higher road speeds air may continue to flow into the passenger compartment even with the fan turned to **0**. To stop it, activate the recirculated air function.

Do not turn the fan to **0** when  has been selected. In certain weather conditions, the windshield may fog.

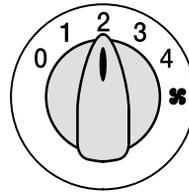

## Climate Controls

### Recirculated Air Control

Press the button to toggle between outside air and recirculated air. The control light in the switch illuminates while the recirculated air function is active, indicating that no outside air is flowing into the vehicle.

Activate the recirculated air function to help stop undesirable odors from entering the vehicle.

**The recirculated air function cannot be activated when  has been selected.**

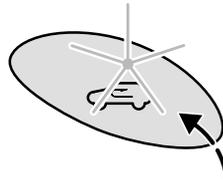

### Air Conditioning Control (if equipped)

Press the air conditioning button to cool the vehicle. The control light in the switch illuminates to indicate operation.

**Press the air conditioning and recirculated air buttons for maximum air conditioning performance.** This will cool the vehicle using recirculated air.

**The air conditioning will switch off automatically if the fan is turned to 0.** When the fan is turned on again, the air conditioning will reactivate.



# Climate Controls

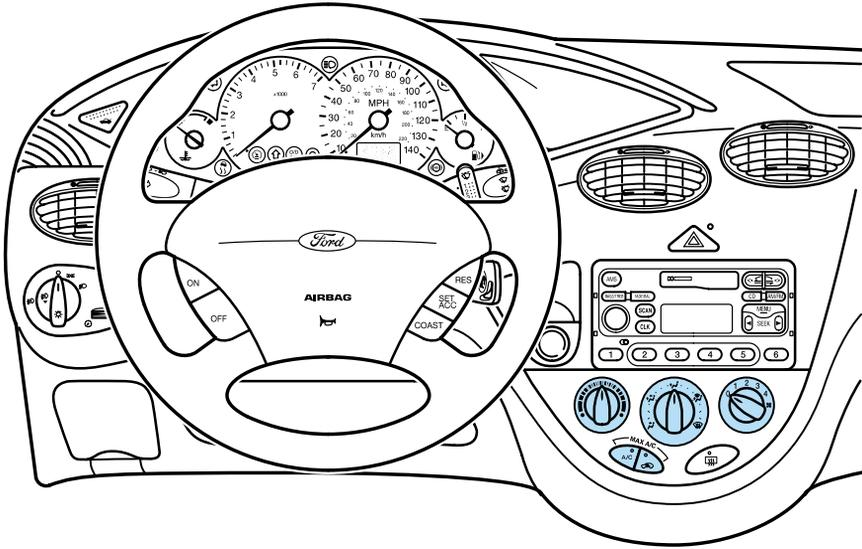

## AIR CONDITIONING (if equipped)

**The air conditioning system operates only when the temperature is above +4\_C (40\_F), the engine is running and the fan is turned on.**

When the mode selector control is set to , the **air conditioning is automatically activated** to dehumidify the air.

The air conditioning removes moisture from the cooled air (condensation). Therefore, it is normal to see a small pool of water underneath the vehicle when it is parked.

When entering a hot vehicle, open the windows for a couple of minutes to let out the hot air. This will aid cooling performance.

## Climate Controls

### Maximum air conditioning – Cooling with recirculated air

To rapidly cool the interior of the vehicle, set the temperature control to the coldest setting, select , select a fan speed of **2**, **3** or **4** and activate the air conditioning and recirculated air. To avoid stale air, deactivate the recirculated air once the vehicle has cooled.

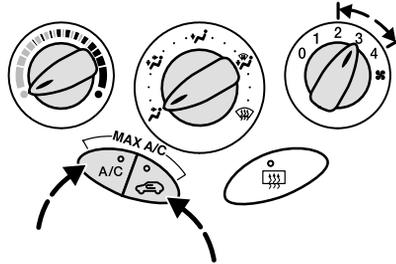

### Cooling with outside air

To cool the interior of the vehicle, set the temperature control to cold, select , select a fan speed and turn the air conditioning on.

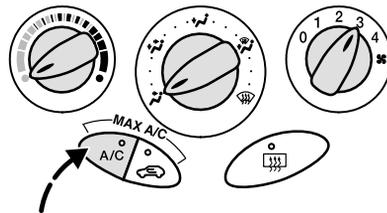

### Rapid heating

To warm the interior of the vehicle, set the temperature control to the warmest setting, select  or , and select a fan speed of **3** or **4**. Turn the rear window defroster on for a clear view.

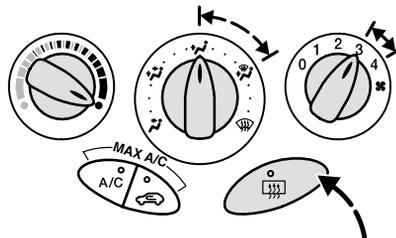

### Windshield defrost/defogging

To clear the windows of frost or fog, set the temperature control to the warmest setting, select  and select a fan speed of **2**, **3** or **4**. The air conditioning will be activated automatically to dehumidify the air. Recirculated air can not be selected in this mode and will turn off automatically. Turn the rear window defroster on for a clear view.

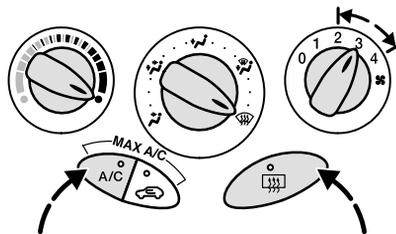

# Climate Controls

## Suitable comfort settings

To maintain comfort at moderate outside temperatures, set the desired temperature, select any mode and select a fan speed of **1** or **2**. Activate the air conditioning as needed to maintain comfort or prevent fogging. The air conditioning may be deactivated for improved fuel economy.

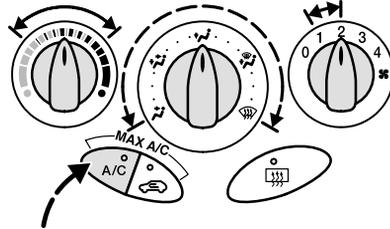

## Stabilized comfort/defogging

To maintain comfort at moderate outside temperatures and to clear the windows of fog, set the temperature control, select  or , select a fan speed of **1**, **2** or **3** and turn the air conditioning on for dehumidification. The air conditioning may be deactivated for improved fuel economy.

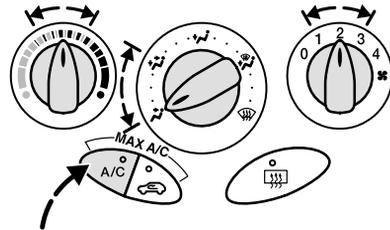

## Temporary outside odor

To help stop undesirable odors from entering the vehicle, activate the recirculated air function. Deactivate the recirculated air function when the odor has cleared or if window fogging occurs.

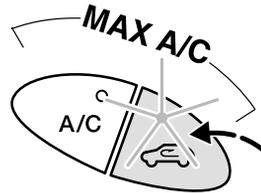

## Climate Controls

### Without air conditioning:

#### Maximum ventilation

To rapidly ventilate the interior of the vehicle, set the temperature control to the coldest setting, select  or  and select a fan speed of **2, 3** or **4**.

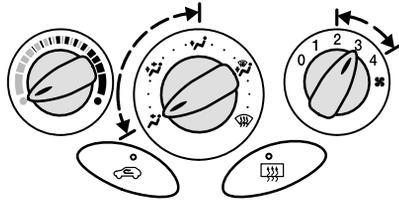

#### Rapid heating

To warm the interior of the vehicle, set the temperature control to the warmest setting, select  or  and select a fan speed of **3** or **4**. Turn the rear window defroster on for a clear view.

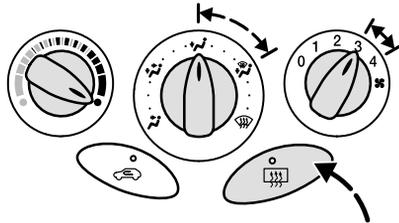

#### Windshield defrost/defogging

To clear the windows of frost or fog, set the temperature control to the warmest setting, select  and select a fan speed of **2, 3** or **4**. Recirculated air can not be selected in this mode and will turn off automatically. Turn the rear window defroster on for a clear view. After the fog or frost has cleared, select  to obtain comfortable distribution of the air flow.

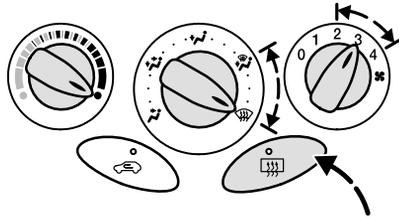

# Climate Controls

## Suitable comfort settings

To maintain comfort at moderate outside temperatures, set the desired temperature, select any mode and select a fan speed of **1** or **2**.

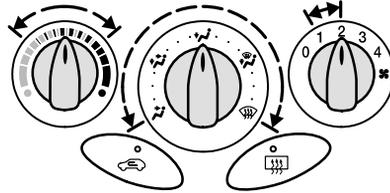

## Stabilized comfort/defogging

To maintain comfort at moderate outside temperatures and to clear the windows of fog, set the desired temperature, select  or  and select a fan speed of **1**, **2** or **3**.

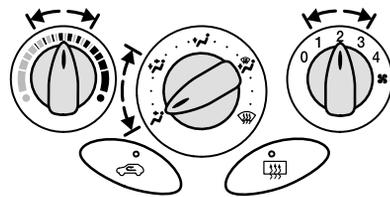

## Temporary outside odor

To help stop undesirable odors from entering the vehicle, activate the recirculated air function. Deactivate the recirculated air function when the odor has cleared or if window fogging occurs.

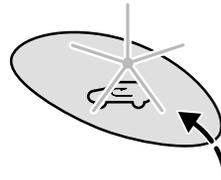

## Climate Controls

### ***Operating Tips***

- Do not put objects under the front seats that will interfere with airflow to the back seats.
- Do not place objects on top of your instrument panel. These objects can block air flow or fall into the defroster outlets and possibly damage your climate control system. Objects placed on top of your instrument panel can also reduce your ability to see through the windshield.
- Remove snow, ice or leaves from the air intake area (located at the bottom of the windshield under the hood).
- If the vehicle has been parked with the windows closed during hot weather, the air conditioning will do a much faster job of cooling if you drive for a few minutes with the windows open. This will force most of the hot, stale air out of the vehicle.
- Clean the inside and outside of the windows periodically with a clean, soft cloth. This will remove the dirt film that can absorb moisture and increase window fogging.

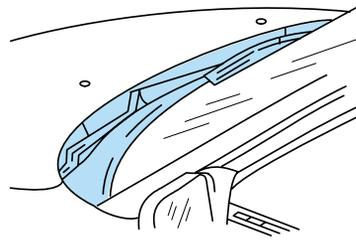

## Climate Controls

- Do not use recirculated air when defogging the windows.
- If equipped, activate the air conditioning when fogging occurs. Use of the air conditioning system is the most effective technique for dehumidifying the air and reducing fogging/misting of the windows.
- Additional ways to reduce window fogging include: Select  and adjust the registers to blow along the windows. Increase the blower speed. This reduces moisture by increasing the air flow rate. Increase the temperature setting. This will warm up the glass and reduce fogging/misting of the windows.
- Before turning the vehicle off, turn off the air conditioning, select fan speed **4** and allow the system to operate at this speed for a few minutes. This will help reduce any fogging that may occur the next time the vehicle is started.



Do not place objects on top of the instrument panel, as these objects may become projectiles in a collision or sudden stop.

## Climate Controls

### REAR WINDOW DEFROSTER

The rear window defroster control is located on the instrument panel.

Press the defroster control to clear the rear window of thin ice and fog.

The small LED will illuminate when the defroster is activated.

The defroster turns off automatically after 14 minutes or when the ignition is turned to the OFF position. To manually turn off the defroster before 14 minutes have passed, push the control again.

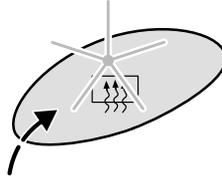

# Lights

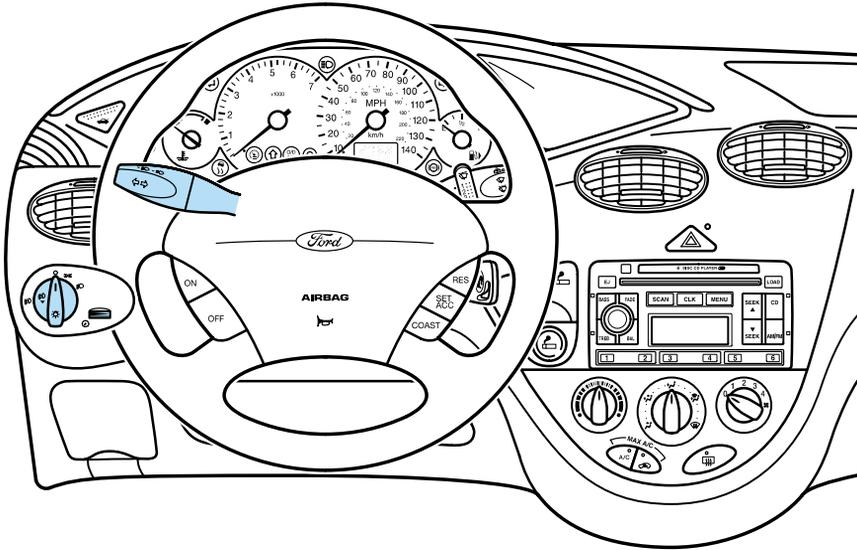

## HEADLAMP CONTROL

Rotate the headlamp control to the first position to turn on the parking lamps. Rotate to the second position to also turn on the headlamps.

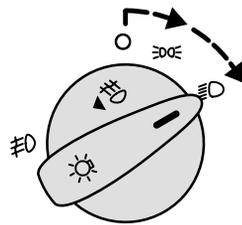

## EXTERIOR LIGHTS

### Daytime running lights (DRL) (if equipped)

Turns the headlamps on. To activate:

- The engine must be running and
- The headlamp control is in the OFF or parking lamps position.



The Daytime Running Light (DRL) system will not illuminate the tail lamps and parking lamps. Turn on your headlamps at dusk. Failure to do so may result in a collision.

### ☞ Fog lights (if equipped) ☞

Switch on the headlamps and pull out the control switch one position.

Fog lights do not operate when high beams are activated.

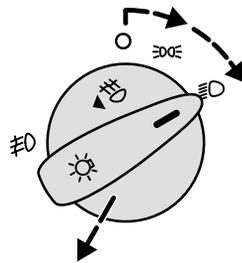

The control light will illuminate when the fog lights are in use. The **fog lights** should be used only when visibility is considerably restricted by fog, snow or rain.

## Lights

### High beams

Pull toward you to activate. To deactivate, pull the lever toward you again.

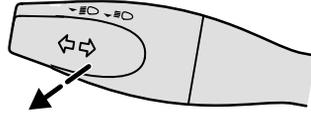

### Flash to pass

Pull the lever slightly toward you and release to deactivate.

### PANEL DIMMER CONTROL

This can be adjusted to vary the intensity of the panel lighting. Operates only when the exterior lights are switched on.

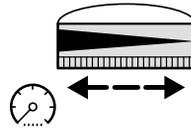

### AIMING THE HEADLAMPS

The headlamps on your vehicle are properly aimed at the assembly plant.

If your vehicle has been in an accident the alignment of your headlamps should be checked by a qualified service technician.

### Vertical aim adjustment

Your vehicle is fitted with either VOR (conventional) or VOL (HID) headlamps. The adjustment procedure depends on the type of headlamps fitted. VOR or VOL is printed on the headlamp lens in the following positions:

- VOR - on the inboard bottom surface of the lens.
- VOL - on the inboard top surface of the lens above the high beam bulb. You will need to open the hood in order to view it.

Follow the aim adjustment procedure for the type of headlamps fitted to your vehicle.

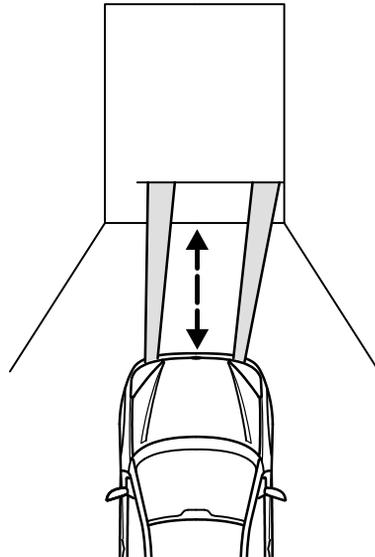

### VOR

1. Park the vehicle on a level surface approximately 7.6 meters (25 feet) from a vertical wall or screen directly in front of it.
2. Measure the height of the headlamp bulb center from the ground and mark a 2.5 meters (8 foot) horizontal reference line on the vertical wall or screen at this height. (A piece of masking tape works well.)
3. Turn on the low beam headlamps to illuminate the wall or screen and open the hood.
4. On the wall or screen you will observe an area of high intensity light. The top of the high intensity area should touch the horizontal reference line. If not, the beam will need to be adjusted.

## Lights

5. Locate the vertical adjuster on each headlamp. Using a 7 mm Allen head wrench, turn the adjuster either clockwise (to adjust down) or counterclockwise (to adjust up). The high intensity area should touch the horizontal reference line.

**Note:** HORIZONTAL AIM IS NOT REQUIRED FOR THIS VEHICLE AND IS NON-ADJUSTABLE.

6. Close the hood and turn off the lamps.

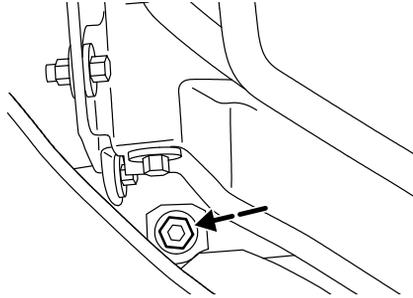

## VOL



On vehicles fitted with VOL (HID) headlamps, have your Ford Dealer change the headlamp bulbs. There is a risk of injury due to high voltage.

1. Park the vehicle on a level surface approximately 7.6 meters (25 feet) from a vertical wall or screen directly in front of it.
2. Measure the height of the headlamp bulb center from the ground, subtract 53.3 mm (2.1 inches), and make a 2.5 meters (8 foot) horizontal reference line on the vertical wall or screen at this height. (A piece of masking tape works well.)
3. Open the hood.
4. Remove the battery cover.

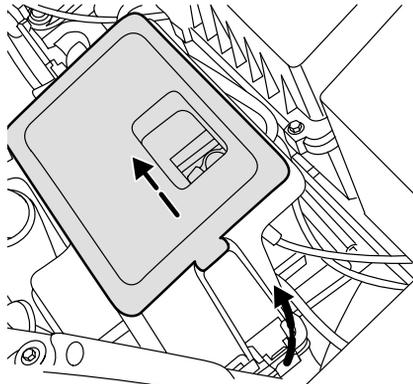

## Lights

5. Remove the headlamp bulb cover by releasing the four snap hooks (two top and two bottom).

**Note:** On the left headlamp, pull the bulb cover approx. 1 inch rearward and then slide outboard until the vertical aiming adjuster is accessible.

6. Turn on the low beam to illuminate the wall or screen. On the wall or screen you will observe an area of high intensity light. If the left side of each light pattern is not at the reference line, the beam needs to be adjusted.

7. The adjusting screw has a thumb wheel that can be operated by hand. Turn the aiming screw clockwise for upward movement and counter-clockwise for downward movement.

**Note:** HORIZONTAL AIM IS NOT REQUIRED FOR THIS VEHICLE AND IS NON-ADJUSTABLE..

8. Turn off the headlamp.

9. Attach the headlamp bulb covers.

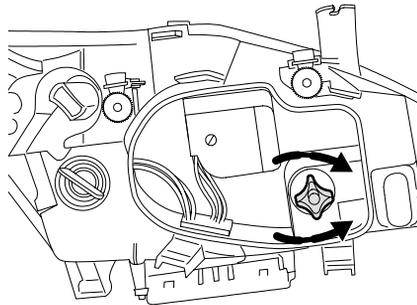
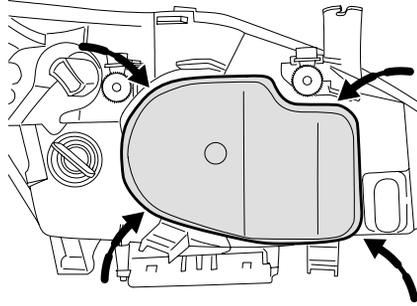

Insure that all four snap hooks are engaged (click sound).

10. Attach the battery cover.

11. Close the hood.

# Lights

## TURN SIGNAL CONTROL

- Push down to activate the left turn signal.
- Push up to activate the right turn signal.

The control also activates the high beams. Refer to *Headlamp control* in this chapter.

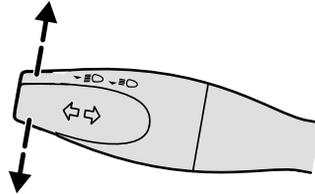

## INTERIOR LAMPS

### Dome lamps

The dome lamp equipped with a control switch will illuminate when:

- the doors are closed and the switch is in the on position.
- the switch is in the door activated position and any door is open.

When the dome lamp switch is in the off position, it will not illuminate when you open the doors.

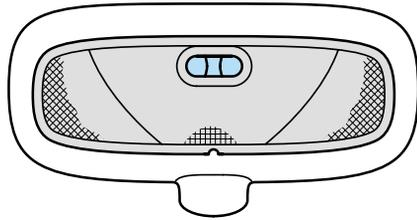

### Reading lamps (if equipped)

The reading lamps are operated by separate on/off controls.

Theater dimming: The dome lamp dims 20 seconds after the doors are closed.

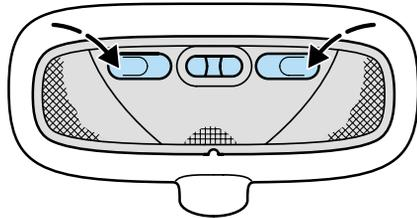

## BULB REPLACEMENT

### Replacing exterior bulbs

Check the operation of the following lamps frequently:

- Headlamps
- Tail lamps
- Brakelamps
- High-mounted brakelamp
- Turn signals
- Backup lamps
- License plate lamp

Do not remove lamp bulbs unless they will be replaced immediately. If a bulb is removed for an extended period of time, contaminants may enter the lamp housings and affect performance.

### Replacing headlamp bulbs



Handle a halogen bulb carefully and keep out of children's reach. Grasp the bulb only by its plastic base and do not touch the glass; the oil from your hand could cause the bulb to break the next time that the headlamps are operated.



Have the headlight alignment checked after each replacement of a bulb.



On vehicles fitted with VOL (HID) headlights, have your Ford Dealer change the headlight bulbs. There is a risk of injury due to high voltage.

## Lights

To remove the headlamp bulb:

1. Make sure that the headlamp control is in OFF position.
2. Open the hood.
3. Rotate the bulb cover counterclockwise and remove.
4. Swivel the wire clip to the side and pull out the lamp.
5. Remove bulb from electrical connector.
6. Install in reverse order.

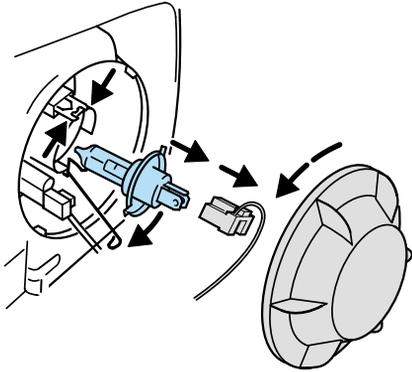
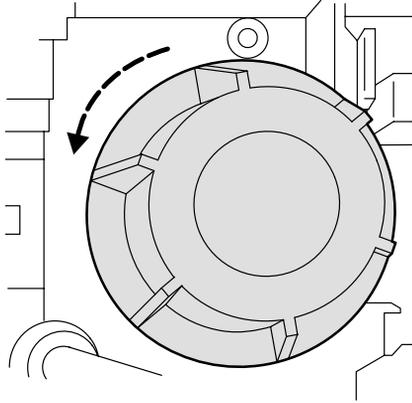

### Replacing grille-mounted front parking lamp/turn signal bulbs

1. Make sure the headlamp control is in OFF position.
2. Open the hood and remove the cover panel at the front of the engine compartment. Remove the bulb socket from the grille by turning counterclockwise.

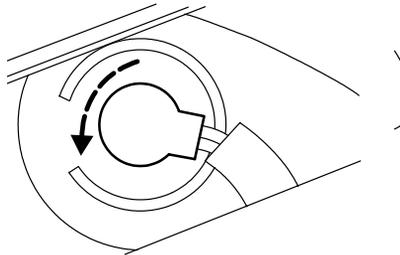

## Lights

3. Pull the bulb straight out of the socket and push in the new bulb.
4. Install the bulb socket in grille by turning clockwise.

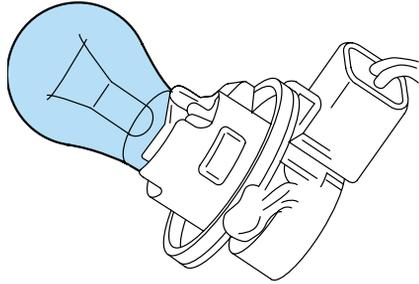

### Turn signal lamp (VOL)/Park lamp (VOL)

1. Make sure the headlamp control is in the OFF position.
2. Open the hood and remove the bulb socket from the headlamp unit by turning it counterclockwise.
3. Pull the bulb straight out of the socket and push in the new bulb.
4. Install the bulb socket in the headlamp unit by turning it clockwise.

**Note:** On vehicles fitted with VOL (HID) headlights, have your Ford Dealer change the park lamp bulbs.

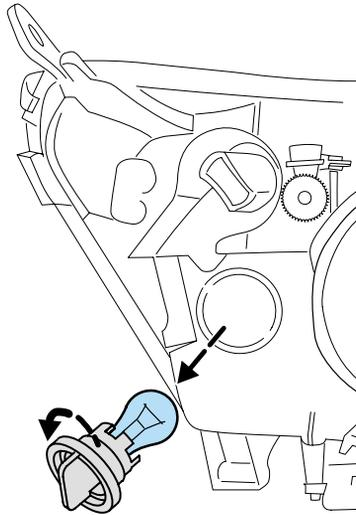

## Lights

### Replacing foglamp bulbs

1. Reach under the bumper cover and remove the bulb socket from the foglamp by turning counterclockwise.
2. Disconnect the electrical connector from the foglamp bulb.
3. Connect the electrical connector to the new foglamp bulb.
4. Install the bulb socket in the foglamp turning clockwise.

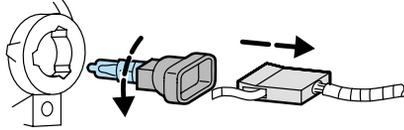
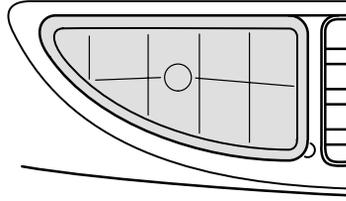

### Side marker lamp

1. Reach under front fender and grasp the bulb socket, turn the light housing counterclockwise.
2. Pull the bulb out.
3. Install in reverse order.

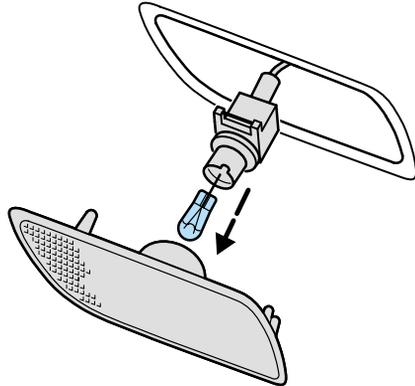

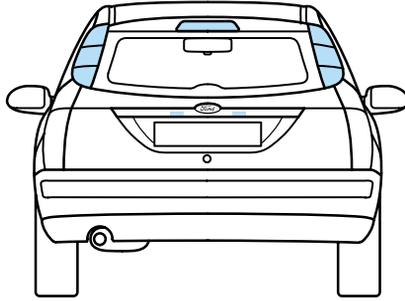

### Replacing tail/brake/backup lights and turn signal bulbs (Coupe)

1. Open the hatchback.
2. From inside the luggage compartment remove the wing nut of the rear light assembly cover.
3. Using a Phillips screw driver remove the screw. The lamp is still retained by a spring loaded clip. Remove by gently pulling out the light housing.
4. Turn the bulb socket counterclockwise as far as possible and pull it out.
5. Pull the bulb straight out of the socket and push in the new bulb.
6. Install the bulb socket in lamp assembly by turning clockwise.

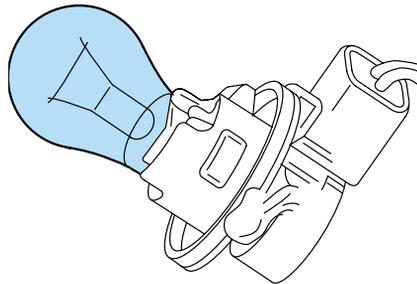
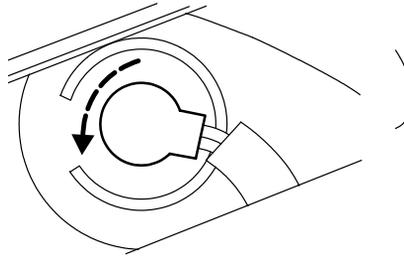

## Lights

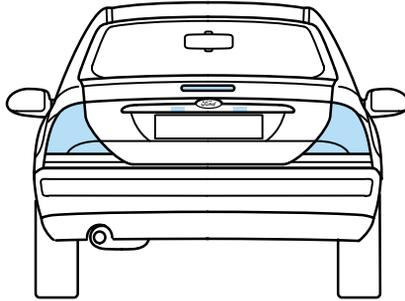

### Replacing tail/brake/backup lights and turn signal bulbs (Sedan)

1. Open the trunk.
2. From inside the luggage compartment remove the three wing nuts of the light housing.
3. Gently pull the light housing to the outside.
4. Turn the bulb socket counterclockwise and pull out the socket.
5. Pull the bulb straight out of the socket and push in the new bulb.
6. Install the bulb socket in lamp assembly by turning clockwise.

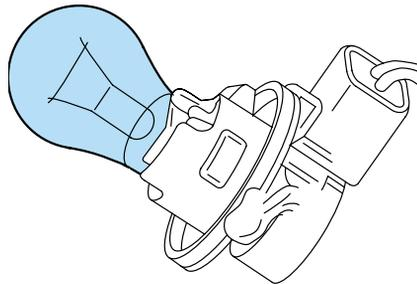
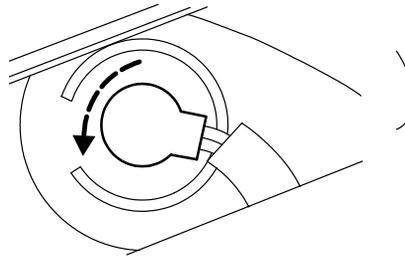

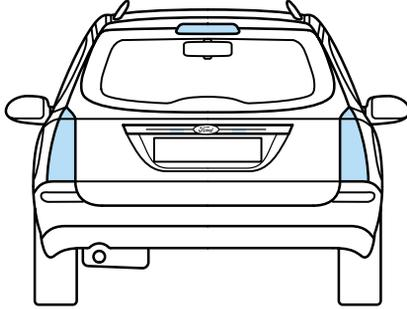

### Replacing tail/brake/backup lights and turn signal bulbs (Wagon)

1. Open the hatchback.
2. Using a screw driver remove the fixings and trim from the body.
3. Remove the socket from the lamp assembly.
4. Pull the bulb straight out of the socket and push in the new bulb.
5. Install the bulb socket in lamp assembly by turning clockwise.

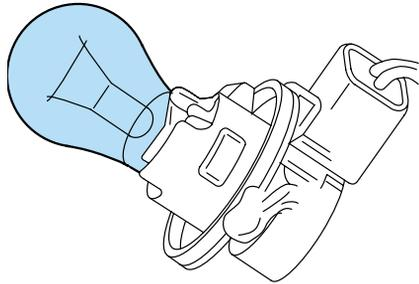
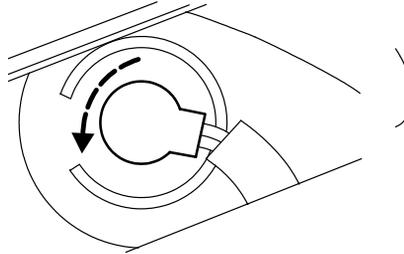

# Lights

## High-mount brake lamp bulbs

### **Sedan**

Open the luggage compartment. Using a screw driver remove the fixings and trim from the tailgate. Pull the bulb holder from the lamp assembly. Pull the bulb out.

Install in reverse order.

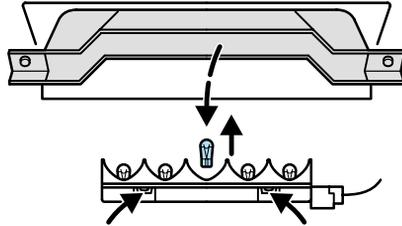

### **Coupe and Wagon**

Remove the screws using a torx T20 screwdriver and take out the glass cover.

Unclip the bulb holder from the reflector. Pull the bulb out.

Install in the reverse order.

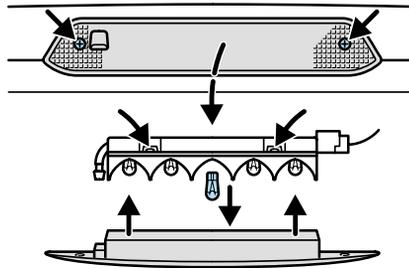

## Replacing interior lights

Switch off the interior lights (middle switch position). Pry out the light assembly with a flat screw driver at the side opposite the switch.

### **Dome lamp**

Replace the bulb. Fit new bulb in the reverse order.

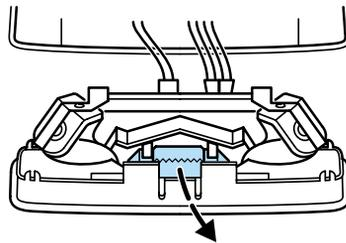

## Lights

### **Rear dome lamp**

Remove the reflector and replace the bulb. Fit new bulb in the reverse order.

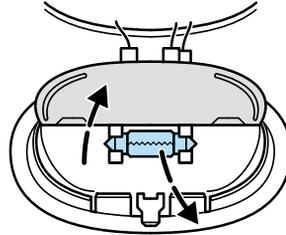

### **Map lamps**

The bulbs can be replaced after the contact plate has been hinged back.

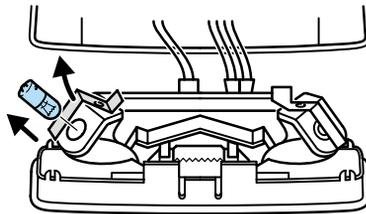

### **Luggage compartment light**

Carefully pry out the light assembly from the holder with a flat-bladed screwdriver and remove the bulb.

Install in the reverse order.

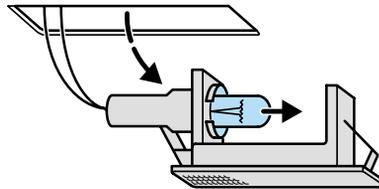

# Lights

## Using the right bulbs

Function	Trade number
Headlamps (VOR)	HB2
Headlamps (high beam, VOL)	H7
Headlamps (low beam, VOL)	D2S
Park lamp (front, VOL)	W5W
Turn lamp (front, VOL)	3457K
Park and turn lamp (front)	3157K
Side marker lamp (front)	GE194
Foglamps (if equipped)	899
Stop/turn and tail lamps	3157K
Back up lamp (Sedan/Wagon)	3156K
(Coupe)	921
License plate lamp	C-5W
High-mount brakelamp	W5W
Dome lamp (front/rear)	12V10W
Map lamp	12V6W
Luggage compartment	12V10W

To replace all instrument panel lights - see your dealer.

## Driver Controls

### WINDSHIELD WIPER/WASHER CONTROL

Move the lever down for a single wipe.

For intermittent operation, move the lever up one position and adjust the rotary switch to the desired speed.

For normal operation, move the lever up two positions.

For high speed operation, move the lever up three positions.

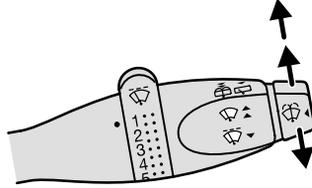

### Rear window wiper and washer (if equipped)

Pull the lever towards you for intermittent wiping.

Pull the lever further to operate the washer.

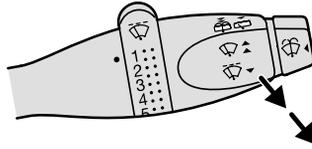

## Driver Controls

### Mist function

To operate the mist function of the windshield wipers, push and release the windshield washer control quickly. The wipers will cycle two or three times. Four seconds after the last cycle, the wipers will cycle one more time to clear the windshield.

When the front washer is selected, washer fluid is sprayed on the front windshield. If the wipers were set to intermittent or OFF, the wipers will begin wiping at normal speed and provide three wipes after the wash is turned off, then return to intermittent mode or OFF. If the wipers were set to mist, normal or high speed mode, the wipers will continue to wipe at normal or high speed during the wash time. If the wipers are switched to intermittent or OFF during the wash, the wipers will provide three wipes after the the wash is turned off.

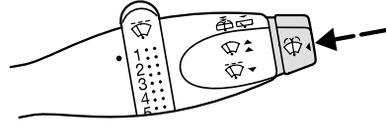

## Driver Controls

### WINDSHIELD WIPER BLADES

Change the wiper blades on your vehicle at least twice a year or when they seem less effective. Substances such as tree sap and some hot wax treatments used by commercial car washes reduce the effectiveness of wiper blades.

#### Checking the wiper blades

If the wiper blades do not wipe properly, clean both the windshield and wiper blades using undiluted windshield wiper solution or a mild detergent. Rinse thoroughly with clean water. To avoid damaging the blades, do not use fuel, kerosene, paint thinner or other solvents.

#### Changing the wiper blades

To replace the wiper blades:

1. Pull the wiper arm away from the windshield and lock into the service position.
2. Turn the blade at an angle from the wiper arm. Push the lock pin manually to release the blade and pull the wiper blade down toward the windshield to remove it from the arm.
3. Attach the new wiper to the wiper arm and press it into place until a click is heard.

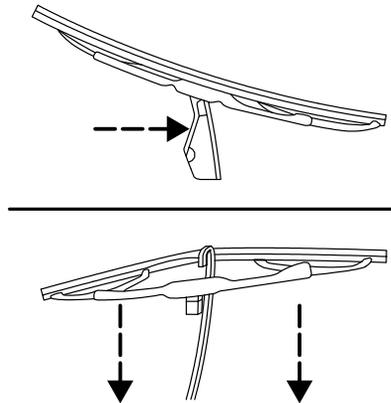

## Driver Controls

### TILT AND TELESCOPE STEERING (if equipped)

 Never adjust the steering wheel while the vehicle is moving.

Pull the locking lever down to adjust the steering column position. Return the lever to its original position to secure the wheel from “sliding”.

Always place both hands opposite each other on the steering wheel to adjust telescope position.

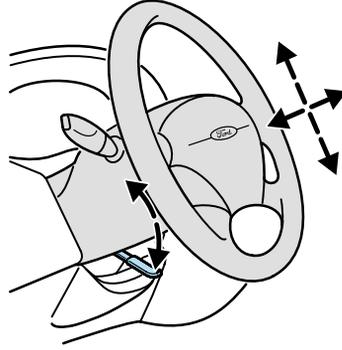

### HORN

Press the steering wheel pad.  
The horn can be operated when the ignition is off.

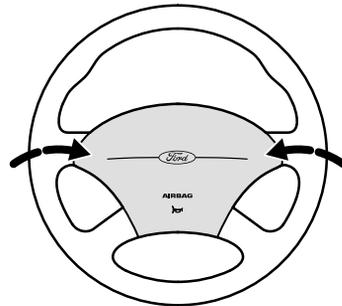

## Driver Controls

### ASHTRAY (if equipped)

Pull to open.

To empty, push the cover completely down and firmly extract the ashtray.

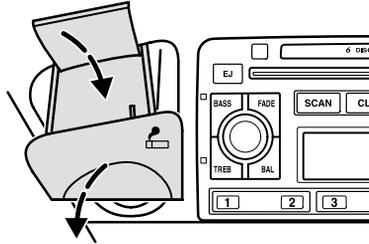

### CUP HOLDER

To re-install the cup holder inserts after cleaning, push down on the insert so that the locating tip underneath the insert is inserted firmly into the locator hole. This will aid in retaining the insert in the cup holder.

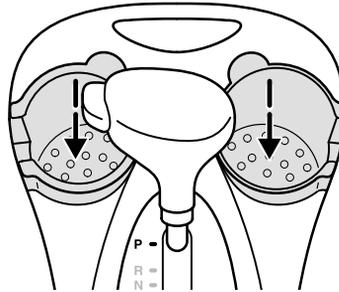

### POWER WINDOWS (if equipped)

Press and hold the rocker switches to open and close the windows.

- Press the top portion of the rocker switch to close.
- Press the bottom portion of the rocker switch to open.

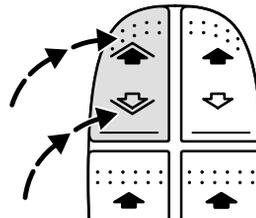

### One touch down

To make the driver window open fully without holding the window control, momentarily press the driver window control completely down then release. Press again to stop window operation.

## Driver Controls

### Window lock

The window lock feature allows only the driver to operate the rear power windows.

To lock out the rear window controls slide the control to the left. Slide the control to the right to restore the window controls.

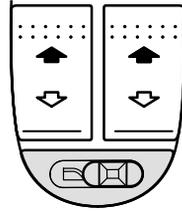

### MIRRORS

#### Interior rear view mirror

To reduce glare when driving at night dip the mirror by pulling the lever to the rear.

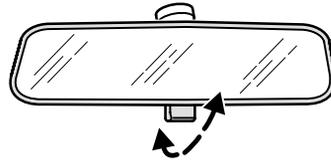

#### Door mounted mirrors

#### Manually adjustable door mirrors

Both door mirrors are adjustable from inside the vehicle.

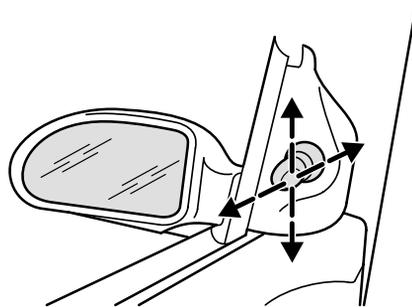

## Driver Controls

### POWER SIDE VIEW MIRRORS

The control can be swiveled and turned.

Turn the control counterclockwise to adjust the driver's side mirror, and clockwise to adjust the passenger's side mirror. Adjust the selected mirror by moving the center control in the desired direction. Then turn the control back to the center position.

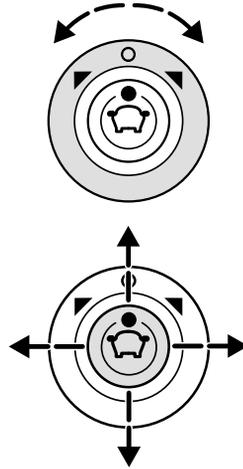

### SPEED CONTROL (if equipped)

#### To turn speed control on

- Press ON.

Vehicle speed cannot be controlled until the vehicle is travelling at or above 48 km/h (30 mph).



Do not use the speed control in heavy traffic or on roads that are winding, slippery, or unpaved.

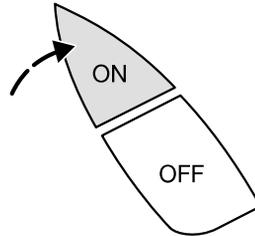

Do not shift the gearshift lever into N (Neutral) with the speed control on.

#### To turn speed control off

- Press OFF or
- turn off the vehicle ignition.

Once speed control is switched off, the previously programmed set speed will be erased.

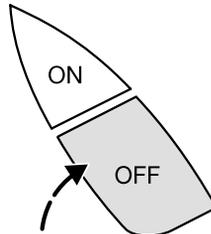

## Driver Controls

### To set a speed

- Press SET ACC. For speed control to operate, the speed control must be ON and the vehicle speed must be greater than 48 km/h (30 mph).

The control light in the instrument panel will illuminate.

If you drive up or down a steep hill, your vehicle speed may vary momentarily slower or faster than the set speed. This is normal.

Speed control cannot reduce the vehicle speed if it increases above the set speed on a downhill. If your vehicle speed is faster than the set speed while driving on a downhill in overdrive, you may want to shift to the next lower gear or apply the brakes to reduce your vehicle speed.

If your vehicle slows down more than 16 km/h (10 mph) below your set speed on an uphill, your speed control will disengage. This is normal. Pressing RES will re-engage it.

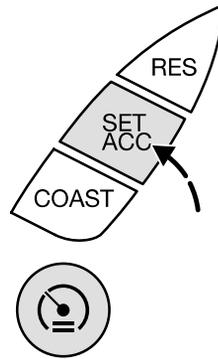

Do not use the speed control in heavy traffic or on roads that are winding, slippery, or unpaved.

## Driver Controls

### To set a higher speed

- Press and hold SET ACC. Release the control when the desired vehicle speed is reached, or
- press and release SET ACC. Each press will increase the set speed by 1.6 km/h (1 mph) or
- accelerate with your accelerator pedal. When the desired vehicle speed is reached, press and release SET ACC.

You can accelerate with the accelerator pedal at any time during speed control usage. Releasing the accelerator pedal will return your vehicle to the previously programmed set speed.

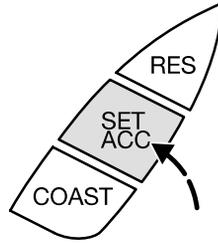

### To set a lower speed

- Press and hold COAST. Release the control when the desired vehicle speed is reached, or
- press and release COAST. Each press will decrease the set speed by 1.6 km/h (1 mph), or
- depress the brake pedal. When the desired vehicle speed is reached, press SET ACC or COAST.

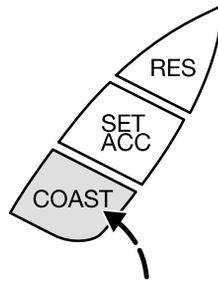

## Driver Controls

### To disengage speed control

- Depress the brake pedal or

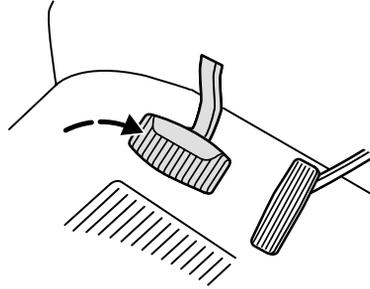

- depress the clutch pedal (if equipped).

Disengaging the speed control will not erase the previously programmed set speed.

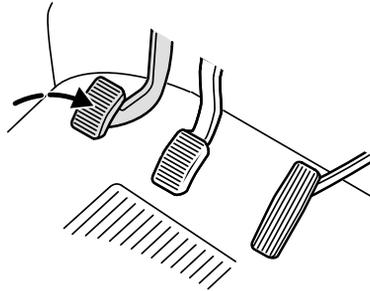

### To return to a set speed

- Press RES. For RES to operate, the vehicle speed must be faster than 48 km/h (30 mph).

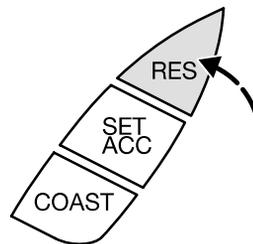

## Driver Controls

### SUNROOF

The power sunroof can be operated only when the ignition is switched on.

 Always remove the ignition key when leaving children alone in the vehicle in order to avoid the risk of injury through inadvertent operation of the electric sunroof.

The sunroof is operated by a switch located between the sun visors.

**Note:** When the sunroof is operated often during a short period of time, the system might become inoperable for a certain time to prevent damage due to overheating.

There are two ways of opening the sunroof - the rear of the sunroof lifts open or the sunroof opens from the front, sliding back under the roof. In order to change from one opening mode to the other, you have to close the sunroof first. The sunroof opens/closes when the switch is pressed.

**Note:** If your vehicle is equipped with a power sunroof, you may hear a buffeting noise at low speeds with the sunroof fully open. To reduce this noise, close the sunroof by approximately 2 inches (5 cm) or lower any of the side windows by a small amount.

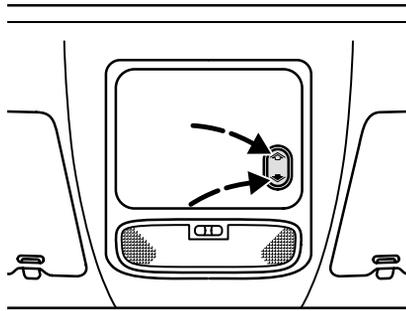

## Driver Controls

### *To open and close the sunroof*

- **With the sunroof closed:**

Press  to open.

Press  to lift the rear of the sunroof.

- **With the rear of the sunroof partly lifted:**

Press  to lift the rear of the sunroof further.

Press  to close the sunroof.

- **With the sunroof partly open:**

Press  to open further.

Press  to close.

### ***To open/close the sunroof automatically***

The sunroof can be opened or closed automatically. Briefly press either side of the switch to the second action point. Press again to stop. If the closed position is reached, the sunroof stops automatically. Movement can be interrupted by pressing the switch in any direction.

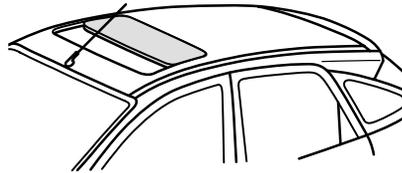
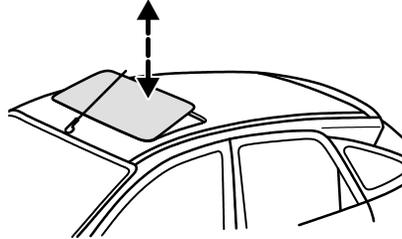

## Driver Controls

### **Relearning function**

In case the sunroof does not close properly anymore, follow this relearning procedure:

- Lift the rear of the sunroof as far as possible. Release the switch.
- Press and hold the same switch again for 30 seconds until you see the sunroof move.
- Release the switch and immediately press and hold it again. The sunroof will close, open fully and then close again. Do not release the switch before the sunroof has reached the closed position for the second time.

If the switch is not pressed continuously, the relearning function will be interrupted. Start the procedure once more from the beginning.

### **Safety mode**

If the system detects a malfunction, it enters a safety mode. The sunroof will move for only about 0.5 seconds at a time and then stop again. Close the sunroof by pressing the switch again when the sunroof stops moving. When the rear of the sunroof is lifted, lift the rear all the way and then close the sunroof. Have the system checked by your Ford Dealer immediately.

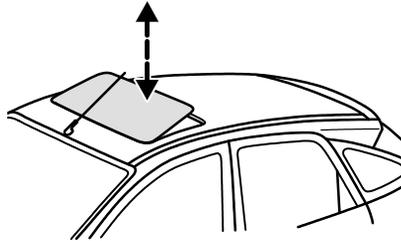

## Driver Controls

### **AdvanceTrac™ Stability Enhancement System (if equipped)**

The AdvanceTrac™ system helps the driver maintain the stability and steerability of the vehicle. The system integrates the anti-lock braking (ABS) and Traction Control™ systems with a yaw reduction feature, to further enhance the stability of the vehicle. The system shares many of the electronic and mechanical elements already present in the Traction Control™ and ABS systems.

AdvanceTrac™ constantly monitors the vehicle motion relative to the driver's intended course. This is done by using added sensors that compare the steering inputs from the driver with the actual motion of the vehicle. When there is a discrepancy between the driver's inputs and the vehicle motion, AdvanceTrac™ changes the force at each tire to help control the vehicle. If the vehicle begins to rotate excessively left or right, spin out, or slide sideways, the system will attempt to correct the excessive motion. If the vehicle does not respond to steering inputs, the system will attempt to alter the turning response of the vehicle.

## Driver Controls

AdvanceTrac<sup>™</sup> enhances stability during maneuvers that require all available tire traction to control the vehicle. The benefits of the AdvanceTrac<sup>™</sup> system are most noticeable when driving in wet/snowy/icy road conditions and/or when performing emergency maneuvers. In an emergency lane-change, the driver will have better control of the vehicle.

Driving conditions which may activate AdvanceTrac<sup>™</sup> include:

- Taking a turn too fast
- Evasively maneuvering to avoid an accident, pedestrian or obstacle
- Hitting a patch of ice
- Changing lanes on a snow-rutted road
- Entering a snow-free road from a snow-covered side street
- Entering a paved road from a gravel road
- Hitting a curb while turning
- Driving on slick surfaces

During AdvanceTrac<sup>™</sup> operation you may experience the following:

- A rumble or grinding sound much like ABS
- A slight deceleration or a reduction in the acceleration of the vehicle

## Driver Controls

The AdvanceTrac<sup>™</sup> indicator light will flash:

- If your foot is on the brake pedal, you will feel a vibration in the pedal much like ABS. As with any vehicle equipped with four-wheel ABS, do not pump the brakes, but instead, press firmly on the pedal.
- If your foot is not on the brake, the brake pedal will move to apply higher brake forces. You may also hear a whoosh of air from under the instrument panel during the event.

All these conditions are normal during AdvanceTrac<sup>™</sup> operation.

The AdvanceTrac<sup>™</sup> system defaults to ON when the engine is started. The system does not work when the vehicle is traveling backwards. In reverse, the ABS and Traction Control<sup>™</sup> systems will continue to function.

The AdvanceTrac<sup>™</sup> system continually monitors and checks all sensors used in improving the stability of the vehicle. Some drivers may notice a slight movement of the brake pedal when the system checks itself.

## Driver Controls



Aggressive driving in any road conditions can cause you to lose control of your vehicle increasing the risk of severe personal injury or property damage. The occurrence of an AdvanceTrac<sup>™</sup> event is an indication that at least some of the tires have exceeded their ability to grip the road and that you may lose control of the vehicle. If you experience a severe road event, SLOW DOWN.



If you find yourself regularly experiencing AdvanceTrac<sup>™</sup> events, you are driving too fast for conditions, you should reduce your speed, and drive less aggressively. AdvanceTrac<sup>™</sup> is limited by the laws of physics. It is always possible to lose control of a vehicle due to inappropriate driver inputs for the conditions. The occurrence of an AdvanceTrac<sup>™</sup> event is an indication that at least some of the tires have exceeded their ability to grip the road; this may cause you to lose control of the vehicle increasing the risk of severe personal injury or property damage.

## Driver Controls

### Switching off AdvanceTrac™

If you should become stuck in snow or on a very slippery road surface, try switching the AdvanceTrac™ system off. This may allow excess wheel spin to “dig” the vehicle out or enable a successful “rocking” maneuver. Do not rock the vehicle for more than a few minutes, because it could damage the vehicle.

The AdvanceTrac™ light in the instrument cluster illuminates continuously when the system has been switched off. To reactivate the system, press the switch again or restart the vehicle.

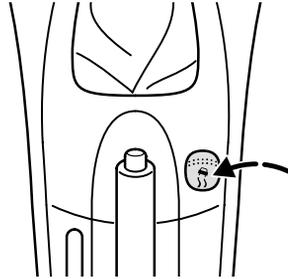

### POSITIVE RETENTION FLOOR MAT

Position the floor mat so that the eyelet is over the pointed end of the retention post and rotate forward to lock in. Make sure that the mat does not interfere with the operation of the accelerator or the break pedal. To remove the floor mat, reverse the installation procedure.

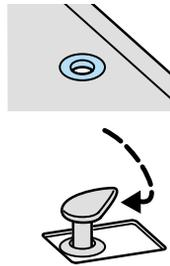

## Driver Controls

### LUGGAGE COVER

#### Coupe

Detach the lifting straps on the liftgate. Release the cover at the sides and pull it out horizontally without tilting it.

Replace in reverse order. Make sure the cover is properly aligned when inserting it.

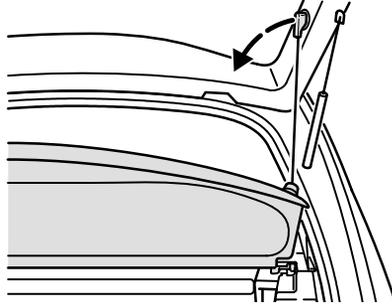

#### Wagon

Pull out the roller cover and secure the retaining points. The cover can be removed completely by pressing inward on both ends of the support.



To prevent the possibility of injury, the luggage cover must be properly attached to the mounting clips.



Do not place any objects on the luggage cover. They may obstruct your vision or strike occupants of the vehicle in the case of a sudden stop or collision.

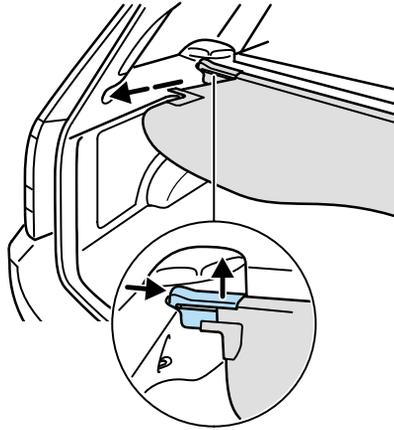

## Driver Controls

### LUGGAGE RACK (if equipped)

The maximum load is 100 kg (220 lb) on the luggage rack structure. The load **must** be placed directly on the luggage rack. The vehicle's roof panel **is not** designed to carry a load.

When loading the luggage rack, it is recommended to evenly distribute the load, as well as maintain a low center of gravity. Ensure that the load is securely fastened.

Driving with items on the luggage rack will result in a deterioration in fuel economy.

When rack is loaded, check tightness of rear adjusting thumbwheel before driving. Recheck tightness of rear thumbwheel at each refueling stop if rack is loaded.



## Locks and Security

### KEYS

Your vehicle is supplied with two coded keys. Only a coded key will start your vehicle. Spare coded keys can be purchased from your dealership. Your dealership can program your key or you can “do it yourself”, refer to *Programming spare SecuriLock keys*.

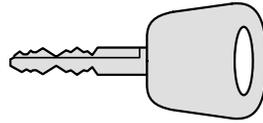

### LOCKS

#### Door locks

All doors can be locked and unlocked from the outside with the key on the driver's door. When inside the vehicle, all doors can be locked with the locking button on the driver's door and unlocked using the door handle.

To lock the passenger's door and the rear doors individually, depress the locking button and close the door when leaving the vehicle.

To operate the anti-theft alarm, refer to the appropriate section on the following pages.

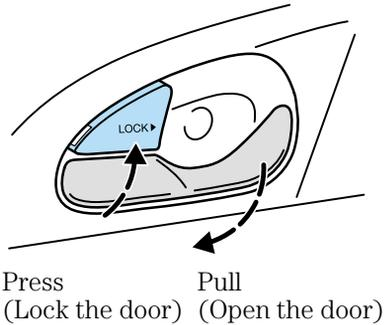

## Locks and Security

### Childproof rear door locks

When these locks are set, the rear doors cannot be opened from inside. The rear doors can be opened from the outside when the doors are unlocked.

The childproof locks are located on the rear edge of each rear door and must be set separately for each door. Setting the lock for one door will not automatically set the lock for both doors.

Insert the key and turn to the lock position (key vertical). Turn the key towards the center of the vehicle to disengage.

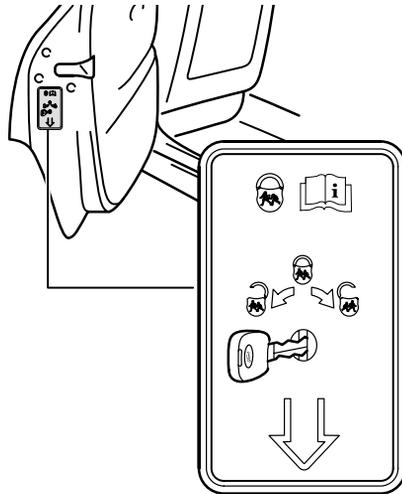

### CENTRAL DOOR LOCKING SYSTEM

The central locking system can be activated from the driver's door. It operates only when the driver's door is closed. Other doors may still be open. It is activated from the outside with the key or from inside by depressing the locking button on the door handle.

The luggage compartment remains locked.

To prevent entry into any part of the vehicle (including the luggage compartment) during a journey (e.g. when stopping at traffic lights) you should drive with the doors locked.

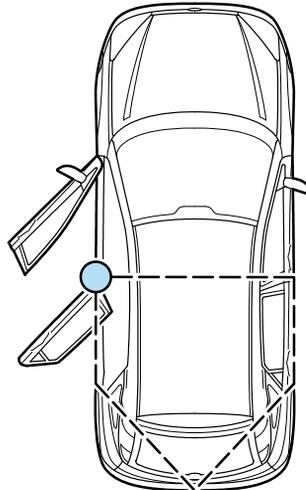

## Locks and Security

### Autolocking

The Autolocking feature locks all the doors when all doors are closed and the vehicle speed exceeds 4 mph (7 km/h).

To disable/enable the Autolocking feature, proceed as follows:

- Turn the key to the ON/RUN position with the engine off.
- Press the door unlock button three times and then turn the key to the OFF position.
- Press the door unlock button three more times and then turn the key back to the ON/RUN position with the engine off.
- A horn chirp will sound. Then press the unlock button once followed by the lock button once.
- If a short horn chirp is produced, the autolock system is disabled. If a long chirp is produced, the autolock system is enabled.
- Turn the key to the OFF position and another chirp will sound to verify that you are no longer in program mode. Repeat the procedure to the desired mode.

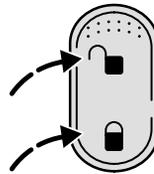

## Locks and Security

### Power locking

All of the vehicle's doors and the luggage compartment can be central locked/unlocked by pressing the interior power lock switch. Power locking/unlocking of the doors operates independent of the position of the ignition and of the vehicle's speed.

The power door lock switches are disabled 20 seconds after the ignition is turned to the OFF position.

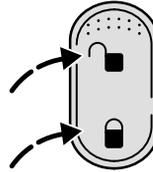

### REMOTE LUGGAGE COMPARTMENT RELEASE (if equipped)

To open the luggage compartment, press the control.

The control does not function if the vehicle is traveling faster than 7 km/h (4 mph).

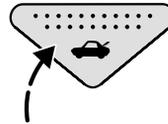

### Interior luggage compartment release (if equipped)

Your vehicle is equipped with a mechanical interior luggage compartment release handle that provides a means of escape for children and adults in the event they become trapped inside the luggage compartment.

All drivers are advised to familiarize themselves with the operation and location of the release handle.

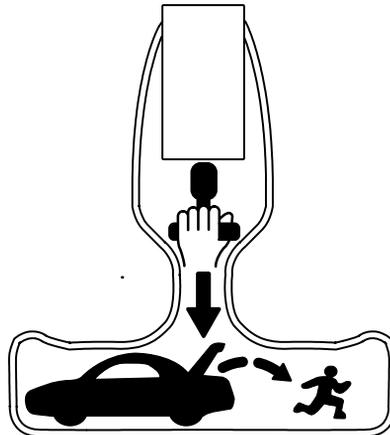

## Locks and Security

To open the luggage compartment door (lid) from the inside, pull the illuminated “T” shaped handle and push open the door (lid). The material the handle is made of will glow in the darkness of the luggage compartment following a brief exposure to ambient light.

The “T” shaped handle is located on the luggage compartment door (lid).



Keep vehicle doors and luggage compartment locked and keep keys out of a child's reach. Unsupervised children could lock themselves in an open trunk and risk injury. Children should be taught not to play in vehicles.

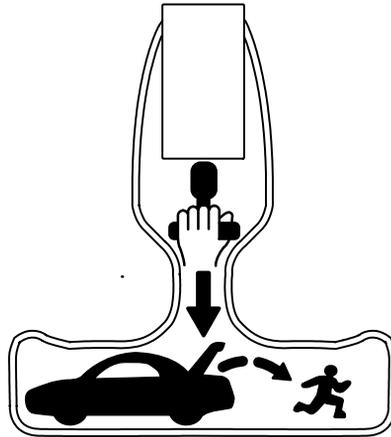

## Locks and Security



On hot days, the temperature in the trunk can rise very quickly and cause injury or death to any living thing (animal, small child) entrapped in the trunk.

Sedans may be equipped with unlocking controls, which allow a means of escape by exiting through the folding rear seatback.

These are located near the upper front edge of the decklid opening, on each side of the opening.

Pull one or both of the unlocking controls and push the rear seatback forward.

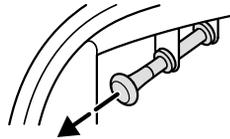

### REMOTE ENTRY SYSTEM (if equipped)

Your vehicle is equipped with a remote entry system which allows you to:

- unlock the vehicle doors without a key.
- lock all the vehicle doors without a key.
- open the luggage compartment without a key.
- activate the personal alarm.
- arm and disarm the perimeter anti-theft system.
- operate the illuminated entry feature.

The remote entry features only operate with the ignition in the OFF or ACC positions. The personal alarm feature, however, will not operate when the ignition is in the ON/RUN position.

## Locks and Security

### Locking the doors

Press this control to lock all doors. The hazard flashers will flash.

To confirm the doors are locked, press the control a second time within three seconds. The horn will chirp once and the hazard flashers will flash. If any door, or the luggage compartment is open, the horn will chirp twice to indicate that all the doors were locked but one or more doors are ajar.

If the vehicle is equipped with the perimeter anti-theft system, it will arm when the control is pressed the second time.



### Unlocking the doors

Press this control to unlock the driver door and disarm the anti-theft system (if equipped). The interior lamps will illuminate.

Press the control again within three seconds to unlock all doors.

**Note:** After locking your vehicle with the key fob, if  is accidentally pressed, the doors will automatically relock after 45 seconds. Manually opening a door or the luggage compartment cancels this relock feature. For further information, refer to *Unlocking the doors*.

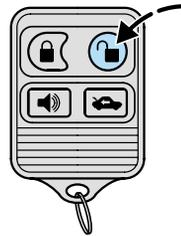

## Locks and Security

### Sounding a panic alarm 🗣️

Press this control to turn on the alarm.

Press the control a second time to turn off the personal alarm. The personal alarm will also turn off if the ignition switch is turned to the ON/RUN position, or after 2 minutes of operation.

This device complies with part 15 of the FCC rules and with RS-210 of Industry Canada. Operation is subject to the following two conditions: (1) This device may not cause harmful interference, and (2) This device must accept any interference received, including interference that may cause undesired operation.

**Changes or modifications not expressly approved by the party responsible for compliance could void the user's authority to operate the equipment.**

### Opening the luggage compartment 🚗

Press the control once to open the luggage compartment. This function will only work if the ignition is in the OFF/ACC position or the vehicle speed is less than 4 mph (7 kph).

Be certain the luggage compartment is closed before driving your vehicle. The luggage compartment may appear closed, but it may not be latched. Failure to do so may cause objects to fall out of the luggage compartment or block rear view vision.

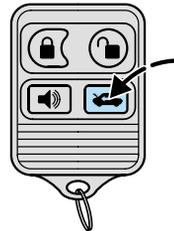
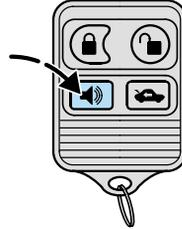

## Locks and Security

### Replacing the battery

The transmitter is powered by one coin type three-volt lithium battery CR2032 or equivalent. Typical operating range will allow you to be up to 10 meters (33 feet) away from your vehicle.

A decrease in operating range can be caused by:

- weather conditions
- nearby radio towers
- structures around the vehicle
- other vehicles parked next to the vehicle.

To replace the battery:

1. Twist a thin coin between the two halves of the transmitter near the key ring. **DO NOT TAKE THE FRONT PART OF THE TRANSMITTER APART.**
2. Place the positive (+) side of new battery in the same orientation. Refer to the diagram inside the transmitter unit.
3. Snap the two halves back together.

Replacement of the battery will **not** cause the remote transmitter to become deprogrammed from your vehicle. The remote transmitter should operate normally after battery replacement.

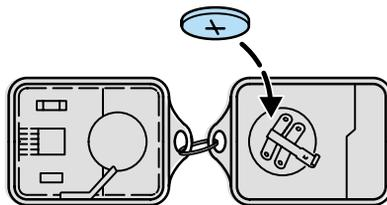

## Locks and Security

### Replacing lost transmitters

If a remote transmitter has been lost and you would like to remove it from the vehicle's memory, or you would like to purchase additional transmitters for your vehicle (up to four may be programmed into memory), take **all** your vehicle's remote transmitters either to your dealer or perform the programming procedure yourself. It will be necessary to reprogram **all** the remote transmitters to your vehicle at the same time while performing this service.

### Programming procedure

1. Close all doors and fasten the seat belt to ensure conflicting chimes do not sound during programming.
2. Turn the ignition lock from OFF (2) to ON/RUN (3) at least 4 times in 6 seconds.
3. Switch off the ignition.

Now the control module has entered the "learning mode" for 10 seconds. This mode is indicated by a chime.

4. While the control module is in the "learning mode", press and hold one of the buttons of the remote transmitter until a chime sounds. This indicates a new transmitter code has been successfully received. After each successful programming, another 10 second "learning mode" is automatically entered, up to a maximum of four times. Another transmitter can now be programmed (repeat step 4).

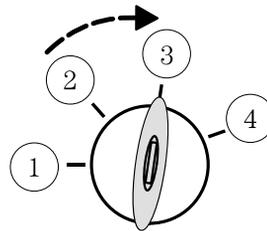

## Locks and Security

5. The system will leave the “learning mode” after starting the ignition, if no new transmitter is programmed during the 10 seconds, or if 4 remotes have been programmed. After successful programming, only the new programmed transmitters will be accepted. Note that an incorrect programming procedure does not affect the stored codes.
6. After programming, the system can be checked by activating/deactivating the remote locking functions.

### **Illuminated entry**

The interior lamps will illuminate when the remote entry system is used to unlock the door(s).

The illuminated entry system will automatically turn off the interior lights if the ignition switch is turned to the ON/RUN position, or if the remote transmitter lock control is pressed, or after 25 seconds of illumination if all doors are closed.

Note that the illuminated entry system will not function if the dome lamp switch is in the OFF position.

## Locks and Security

### PERIMETER ALARM SYSTEM (if equipped)

The perimeter anti-theft system will help prevent your vehicle from unauthorized entry.

#### Arming the system

When armed, the perimeter alarm will help protect your vehicle from unauthorized entry. When unauthorized entry occurs, the system will flash the hazard flashers and will sound the horn.

The system is ready to arm whenever the key is out of ignition. Any of the following actions will arm the alarm system:

- Press the remote transmitter lock control.
- Lock all doors with the key.

If a door is open, the system is prearmed and is waiting for the door to close. Once the doors are closed, the system will arm in 20 seconds.

#### Disarming the system

You can disarm the system by any of the following actions:

- Unlock the doors by using your remote entry transmitter.
- Unlock the doors by using your key.



## Locks and Security

### **SECURILOCK™ PASSIVE ANTI-THEFT SYSTEM**

Your vehicle is equipped with a coded-key anti-theft system. Only the correct key will be able to start your vehicle. If your keys are lost or stolen, you must take your vehicle to your dealership for key reprogramming.

The SecuriLock™ passive anti-theft system provides an advanced level of vehicle theft protection. Your vehicle's engine can only be started with the two special SecuriLock™ electronically coded keys provided with your vehicle. Each time you start your vehicle, the SecuriLock™ key is read by the SecuriLock™ passive anti-theft system. If the SecuriLock™ key identification code matches the code stored in the SecuriLock™ anti-theft system, the vehicle's engine is allowed to start. If the SecuriLock™ key identification code does not match the code stored in the system or if a SecuriLock™ key is not detected (vehicle theft situation), the vehicle's engine will not operate.

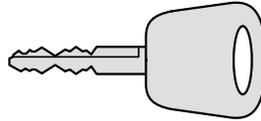

## Locks and Security

The SecuriLock™ passive anti-theft system is not compatible with non-Ford (aftermarket) remote start systems. Use of these systems may result in vehicle starting problems and a loss of security protection. Large metallic objects, electronic devices on the key chain that can be used to purchase gasoline or similar items, or a second key on the same key ring as the coded key ignition key may cause vehicle starting issues. If present, you need to keep these objects from touching the coded key ignition key while starting the engine. These objects and devices cannot damage the coded key ignition key, but can cause a momentary issue if they are too close to the key during engine start. If a problem occurs, turn ignition OFF and restart the engine with all other objects on the key ring held away from the ignition key. Check to make sure the coded key ignition key is an approved Ford coded key ignition key.

Spare SecuriLock™ keys can be purchased from your dealership and programmed to your SecuriLock™ passive anti-theft system. Refer to *Programming spare SecuriLock™ keys* for more information.

If one or both of your SecuriLock™ keys are lost or stolen and you want to ensure the lost or stolen key will not operate your vehicle, bring your vehicle and all available SecuriLock™ keys to your dealership for reinitialization.

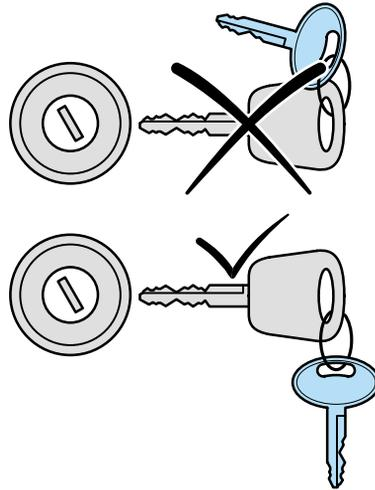

## Locks and Security

### Theft indicator

When the ignition is turned to ON/RUN or START, the theft indicator on the instrument panel will light for three seconds and then go out (indicates proper SecuriLock™ system operation). If the key is in the ignition and the theft indicator stays on for an extended period of time or flashes rapidly, have the system serviced by your dealership or a qualified technician.

### Programming spare SecuriLock™ keys

Spare SecuriLock™ keys can be purchased from your dealership and programmed to your SecuriLock™ anti-theft system (up to a total of 8 keys). Your dealership can program your new SecuriLock™ key(s) to your vehicle or you can do it yourself using the following simple procedure.

To program a new SecuriLock™ key yourself, you will need two previously programmed SecuriLock™ keys (keys that already operate your vehicle's engine). If two previously programmed SecuriLock™ keys are not available (one or both of your original keys were lost or stolen), you must bring your vehicle to your dealership to have the spare SecuriLock™ key(s) programmed.

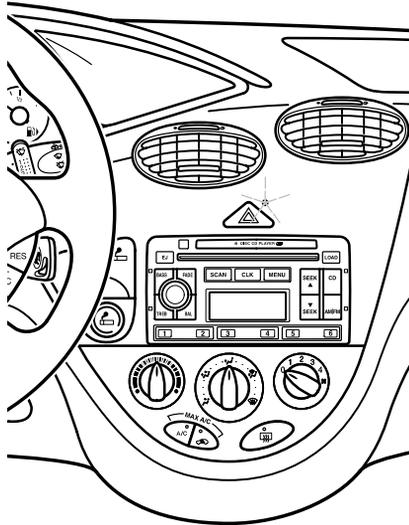

## Locks and Security

### Procedure to program spare SecuriLock™ keys

New SecuriLock™ keys must have the correct mechanical key cut for your vehicle.

Conventional (non SecuriLock™) keys **cannot** be programmed to your vehicle.

The correct type of SecuriLock™ key for your vehicle is identifiable by the alphanumeric characters stamped on the key blade. The SecuriLock™ key identification for your vehicle is: one letter of the English alphabet followed by the number “1”. For example, “S1” or “I1” on the key blade indicate you have the correct type of SecuriLock™ key.) If the SecuriLock™ key does not have this information stamped on the key blade, the key will not operate your vehicle.

You will need to have two previously programmed SecuriLock™ keys and the new unprogrammed SecuriLock™ key readily accessible for timely implementation of each step in the procedure. Please read and understand the entire procedure before you begin.

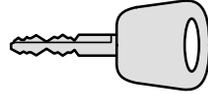
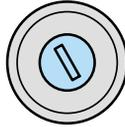

## Locks and Security

1. Insert the first previously programmed SecuriLock™ key into the ignition and turn the ignition from OFF (1) to ON/RUN (3). (Maintain ignition in ON/RUN for at least one second.)
2. Turn ignition to OFF and remove the first SecuriLock™ key from the ignition.
3. Within five seconds of turning the ignition to OFF, insert the second previously programmed SecuriLock™ key into the ignition and turn the ignition from OFF to ON/RUN. (Maintain ignition in ON/RUN for at least one second but no more than 5 seconds.)
4. Turn the ignition to OFF and remove the second SecuriLock™ key from the ignition.
5. Within 10 seconds of turning the ignition to OFF, insert the unprogrammed SecuriLock™ key (new key/valet key) into the ignition and turn the ignition from OFF to ON/RUN. (Maintain ignition in ON/RUN for at least one second.) This step will program your new SecuriLock™ key.
6. To program additional SecuriLock™ key(s), repeat this procedure from step 1.

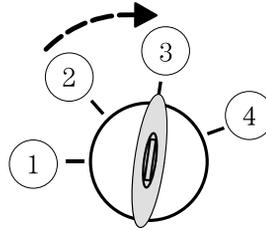

## Locks and Security

If the programming procedure was successful, the new SecuriLock<sup>™</sup> key(s) will start the vehicle's engine. The theft indicator (located on the instrument panel) will light for three seconds and then go out.

If the programming procedure was not successful, the new SecuriLock<sup>™</sup> key(s) will not operate the vehicle's engine. The theft indicator will flash on and off. Wait at least one minute and then repeat the procedure from step 1. If failure repeats, bring your vehicle to your dealership to have the spare SecuriLock<sup>™</sup> key(s) programmed.

## Seating and Safety Restraints

### SEATING

 Never adjust the driver's seat or seatback when the vehicle is moving.

### Head restraints

#### **Front seat**

Your vehicle is equipped with head restraints which are vertically adjustable. The purpose of these head restraints is to limit head motion in the event of a rear collision. To properly adjust your head restraints, lift the head restraint so that it is located directly behind your head or as close to that position as possible. Refer to the following to raise and lower the head restraints.

To raise: Pull the head restraint up.

To lower: Press the control on the left-hand stem and push the head restraint down.

To remove the head restraint, see your dealer or qualified technician.

#### **Rear seat (if equipped)**

Rear head restraints can be removed altogether if the left-hand locking button is pressed.

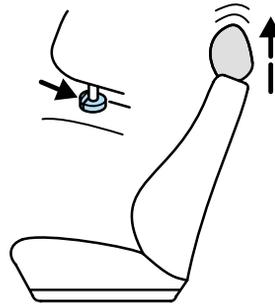

# Seating and Safety Restraints

## SEAT ADJUSTMENT

### Front seats

Lift the lever to slide the seat forward or backward.

Turn the control to adjust lumbar support (if equipped).

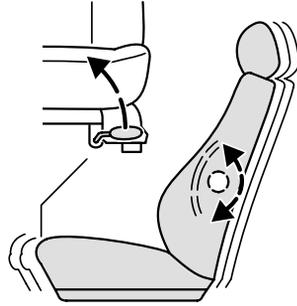

Turn the handle to adjust the height of the seat.

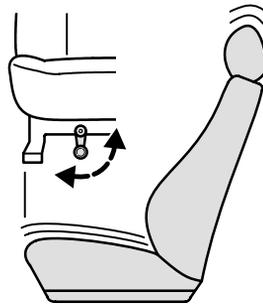

Lift the control to adjust the angle of the seatback.

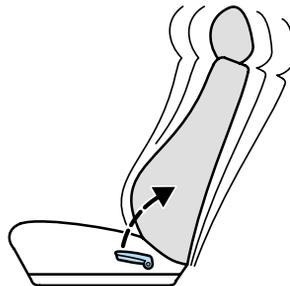

## Seating and Safety Restraints

### **Tip/slide front seat (Coupe)**

Lift the control and fold the seatback forwards.

The seat can be slid forwards to allow easier entry to the rear seats. Slide the seat back and fold back the seatback until it locks with a distinct “click”. The seatback will return to its original position. Rock the seat to ensure that the catch is securely engaged.



On three door models, front safety belts should be pulled backwards, overcoming their parking feature, to allow easier entry to the rear seats.



Do not place any objects behind the seat which could prevent the engagement of the seat lock.

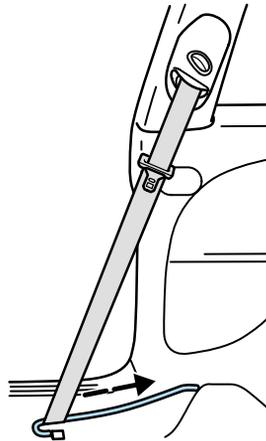

## Seating and Safety Restraints

### Folding the rear seat cushion forward

Lift the seat cushion and pull it forward.

 When returning the seats back to their original positions, make sure the safety restraints will function properly and are positioned in front of the seat back.

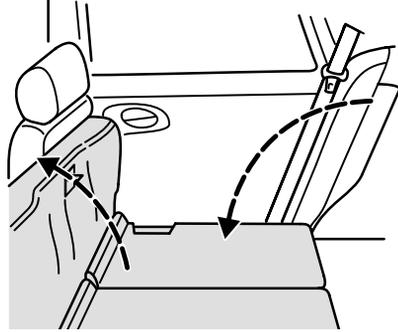

### Folding the rear seatback forward

#### *Coupe and wagon*

Remove the head restraints (if equipped) of the rear seats and stow them on the floor behind the front seats.

Push the unlocking control on the rear seatback and fold the rear seatback forward.

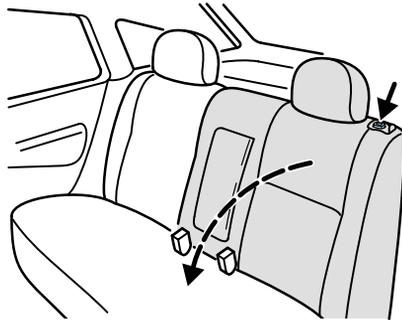

#### *Sedan*

Remove the head restraints (if equipped) of the rear seats and stow them on the floor behind the front seats.

Pull one or both of the unlocking controls in the luggage compartment and fold the rear seatback forward.

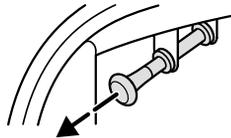

## Seating and Safety Restraints

### Returning the rear seatback to an upright position

Fold back the seatback until it locks with a distinct “click”. Do not place any objects behind the seat which could prevent the seat from locking.



Make sure the safety restraints will function properly and are positioned in front of the seatback. Reinstall the head restraints (if equipped).

Note that the center rear seat belt cannot be pulled out until the seatback has latched completely.

### Folding the seat cushion and seatback forwards

Pull the loop between the respective seat cushion and seatback, and fold the seat cushion on that side forward.

Remove the head restraint(s) (if equipped) of the rear seat, and fold the seatback forward.

Stow the head restraint(s) in the plastic retainers provided in the now upright underside of the seat cushion, as shown on the decal.

When returning the seats to their original positions, make sure the seat belts will function properly and are positioned in front of the seatback.

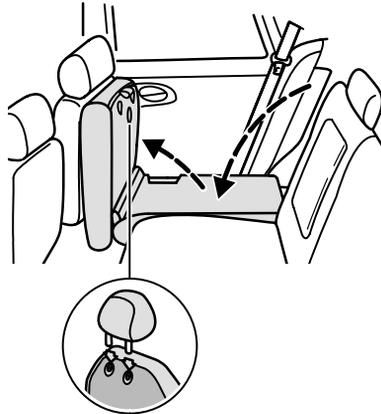

# Seating and Safety Restraints

## SAFETY RESTRAINTS

### Personal Safety System

The Personal Safety System provides an improved overall level of frontal crash protection to front seat occupants and is designed to help further reduce the risk of air bag-related injuries. The system is able to analyze different occupant conditions and crash severity before activating the appropriate safety devices to help better protect a range of occupants in a variety of frontal crash situations.

Your vehicle's Personal Safety System consists of:

- Driver and passenger dual-stage air bag supplemental restraints.
- Front safety belts with pretensioners, energy management retractors, and safety belt usage sensors.
- Driver's seat position sensor.
- Front crash severity sensor.
- Restraints Control Module (RCM) with impact and safing sensors.
- Restraint system warning light and back-up tone.
- The electrical wiring for the air bags, crash sensor(s), safety belt pretensioners, front safety belt usage sensors, driver seat position sensor, and indicator lights.

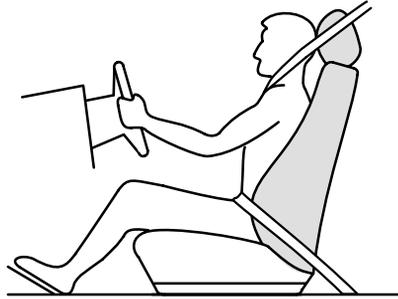

## Seating and Safety Restraints

### **How does the personal safety system work?**

The Personal Safety System can adapt the deployment strategy of your vehicle's safety devices according to crash severity and occupant conditions. A collection of crash and occupant sensors provides information to the Restraints Control Module (RCM). During a crash, the RCM activates the safety belt pretensioners and/or either one or both stages of the dual-stage air bag supplemental restraints based on crash severity and occupant conditions.

The fact that the pretensioners or air bags did not activate for both front seat occupants in a collision does not mean that something is wrong with the system. Rather, it means the Personal Safety System determined the accident conditions (crash severity, belt usage, etc.) were not appropriate to activate these safety devices. Front air bags and pretensioners are designed to activate only in frontal and near-frontal collisions, not rollovers, side-impacts, or rear-impacts unless the collision causes sufficient longitudinal deceleration.

## Seating and Safety Restraints

### **Driver and passenger dual-stage air bag supplemental restraints**

The dual-stage air bags offer the capability to tailor the level of air bag inflation energy. A lower, less forceful energy level is provided for more common, moderate-severity impacts. A higher energy level is used for the most severe impacts. Refer to *Air bag supplemental restraints system (SRS)* section in this chapter.

### **Front crash severity sensor**

The front crash severity sensor enhances the ability to detect the severity of an impact. Positioned up front, it provides valuable information early in the crash event on the severity of the impact. This allows your Personal Safety System to distinguish between different levels of crash severity and modify the deployment strategy of the dual-stage air bags and safety belt pretensioners.

### **Driver's seat position sensor**

The driver's seat position sensor allows your Personal Safety System to tailor the deployment level of the driver dual-stage air bag based on seat position, modifying the level of restraint as appropriate for smaller drivers.

## Seating and Safety Restraints

### **Front safety belt usage sensors**

The front safety belt usage sensors detect whether or not the driver and front outboard passenger safety belts are fastened. This information allows your Personal Safety System to tailor the air bag deployment and safety belt pretensioner activation depending upon safety belt usage. Refer to *Safety restraints* section in this chapter.

### **Front safety belt pretensioners**

The safety belt pretensioners are designed to tighten the safety belts firmly against the occupant's body during a collision. This maximizes the effectiveness of the safety belts and helps properly position the occupant relative to the air bag to improve protection. The safety belt pretensioners can be either activated alone or, if the collision is of sufficient severity, together with the air bags.

### **Front safety belt energy management retractors**

The front safety belt energy management retractors allow webbing to be pulled out of the retractor in a gradual and controlled manner in response to the occupant's forward momentum. This helps reduce the risk of force-related injuries to the occupant's chest by limiting the load on the occupant. Refer to *Safety restraints* section in this chapter.

## Seating and Safety Restraints

### Determining if the Personal Safety System is operational

The Personal Safety System uses a warning light in the instrument cluster or a back-up tone to indicate the condition of the system. Refer to the *Warning lights and chimes* section in the *Instrument Cluster* section. Routine maintenance of the Personal Safety System is not required.

The Restraints Control Module (RCM) monitors its own internal circuits and the circuits for the air bag supplemental restraints, crash sensor(s), safety belt pretensioners, front safety belt buckle sensors, and the driver seat position sensor. In addition, the RCM also monitors the restraints warning light in the instrument cluster. A difficulty with the system is indicated by one or more of the following.

- The warning light will either flash or stay lit.
- The warning light will not illuminate immediately after ignition is turned on.
- A series of five beeps will be heard. The tone pattern will repeat periodically until the problem and warning light are repaired. If any of these things happen, even intermittently, have the Personal Safety System serviced at your dealership or by a qualified technician immediately. Unless serviced, the system may not function properly in the event of a collision.

## Seating and Safety Restraints

### ***When are the front air bags and pretensioners deployed?***

Front air bags and pretensioners are designed to activate in frontal and near-frontal collisions, not rollover, side-impacts, or rear-impacts unless the collision causes sufficient longitudinal deceleration. The fact that the pretensioners or air bags did not activate in a collision does not mean that something is wrong with the system. Rather, it means the Personal Safety System determined the occupant conditions or crash severity were not appropriate to activate these safety devices.

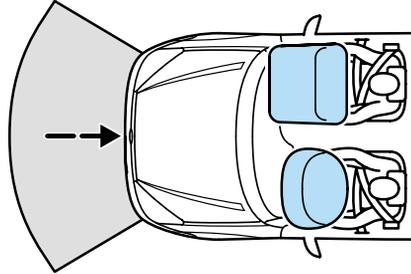

## Seating and Safety Restraints

### Safety restraints precautions



Always drive and ride with your seatback upright and the lap belt snug and low across the hips.



To reduce the risk of injury, make sure children sit where they can be properly restrained.



Always transport children 12 years old and under in the back seat and always use appropriate child restraints.



Never let a passenger hold a child on his or her lap while the vehicle is moving. The passenger cannot protect the child from injury in a collision.



All occupants of the vehicle, including the driver, should always properly wear their safety belts, even when an air bag SRS is provided.



Reclining the seat back can reduce the effectiveness of the seat's safety belt in the event of a collision.

## Seating and Safety Restraints

 It is extremely dangerous to ride in a cargo area, inside or outside of a vehicle. In a collision, people riding in these areas are more likely to be seriously injured or killed. Do not allow people to ride in any area of your vehicle that is not equipped with seats and safety belts. Be sure everyone in your vehicle is in a seat and using a safety belt properly.

 Each seating position in your vehicle has a specific safety belt assembly which is made up of one buckle and one tongue that are designed to be used as a pair. 1) Use the shoulder belt on the outside shoulder only. Never wear the shoulder belt under the arm. 2) Never swing it around your neck over the inside shoulder. 3) Never use a single belt for more than one person.

### Combination lap and shoulder belts

1. Insert the belt tongue into the proper buckle (the buckle closest to the direction the tongue is coming from) until you hear a snap and feel it latch. Make sure the tongue is securely fastened in the buckle.

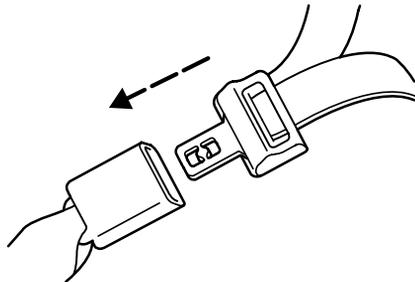

## Seating and Safety Restraints

2. To unfasten, push the release button and remove the tongue from the buckle.

The front outboard and rear safety restraints in the vehicle are combination lap and shoulder belts. The front and rear seat passenger safety belts have two types of locking modes described below:

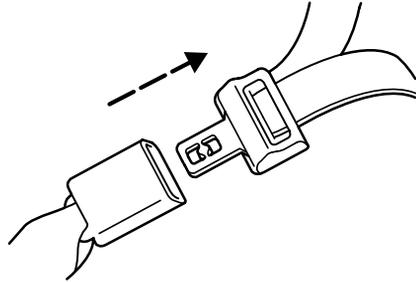

### Energy Management Feature

This vehicle has a seat belt system with an energy management feature at the front outboard seating positions to help further reduce the risk of injury in the event of a head-on collision.

This seat belt system has a retractor assembly that is designed to pay out webbing in a controlled manner. This feature is designed to help reduce the belt force acting on the occupant's chest.

## Seating and Safety Restraints



### **BELT AND RETRACTOR ASSEMBLY MUST BE**

**REPLACED** if the seat belt assembly automatic locking retractor feature or any other seat belt function is not operating properly when checked according to the procedures in Workshop Manual.



Failure to replace the Belt and Retractor assembly could increase the risk of injury in collisions.

### **Vehicle sensitive mode**

The vehicle sensitive mode is the normal retractor mode, allowing free shoulder belt length adjustment to your movements and locking in response to vehicle movement. For example, if the driver brakes suddenly or turns a corner sharply, or the vehicle receives an impact of 8 km/h (5 mph) or more, the combination safety belts will lock to help reduce forward movement of the driver and passengers.

## Seating and Safety Restraints

### Safety belt pretensioner

Your vehicle is equipped with safety belt pretensioners at the driver and front passenger seating positions.

The safety belt pretensioner is a device which removes excess webbing from the safety belt system. The safety belt pretensioner uses the same crash sensor system as the front air bag supplemental restraint system (SRS). When the safety belt pretensioner deploys, webbing from the lap and shoulder belt is tightened.



The driver and front passenger seat belt system (including retractors, buckles and height adjusters) must be replaced if the vehicle is involved in a collision that results in deployment of front airbags and safety belt pretensioners.

### Automatic locking mode

In this mode, the shoulder belt is automatically pre-locked. The belt will still retract to remove any slack in the shoulder belt.

The automatic locking mode is not available on the driver safety belt.

## Seating and Safety Restraints

### ***When to use the automatic locking mode***

- When a tight lap/shoulder fit is desired.
- **Anytime** a child safety seat is installed in a passenger front or outboard rear seating position (if equipped). Refer to *Safety restraints for children* or *Safety seats for children* later in this chapter.



Always transport children 12 years old and under in the back seat and always use appropriate child restraints.

### ***How to use the automatic locking mode***

- Buckle the combination lap and shoulder belt.
- Grasp the shoulder portion and pull downward until the entire belt is extracted.
- Allow the belt to retract. As the belt retracts, you will hear a clicking sound. This indicates the safety belt is now in the automatic locking mode.

### ***How to disengage the automatic locking mode***

Disconnect the combination lap/shoulder belt and allow it to retract completely to disengage the automatic locking mode and activate the vehicle sensitive (emergency) locking mode.

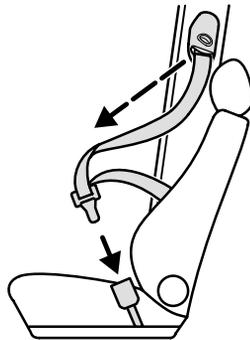

## Seating and Safety Restraints

 After any vehicle collision, the seat belt system at all passenger seating positions must be checked by a qualified technician to verify that the automatic locking retractor for child seats is still functioning properly in addition to other checks for proper seat belt function.

### Front safety belt height adjustment

Your vehicle has safety belt height adjustments for the driver and front passenger. Adjust the height of the shoulder belt so the belt rests across the middle of your shoulder.

To lower the shoulder belt height, push the button and slide the height control down. To raise the height of the shoulder belt, slide the height adjuster up. Pull down on the height adjustment assembly to make sure it is locked in place.

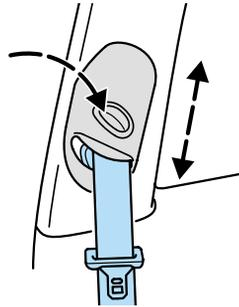

 Position the shoulder belt height adjuster so that the belt rests across the middle of your shoulder. Failure to adjust the safety belt properly could reduce the effectiveness of the safety belt and increase the risk of injury in a collision.

## Seating and Safety Restraints

Your vehicle is equipped with a safety belt parking feature for the driver and front passenger. The purpose of the parking feature is to allow the driver or passenger to reach the safety belt. Fasten your seatbelt normally and the parking feature will activate itself. Pull the safety belt backwards, overcoming its parking feature, to allow easier entry to the rear seats.

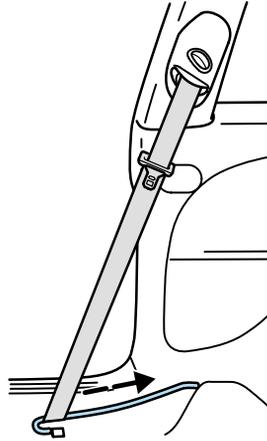

### **Safety belt warning light and warning chime**

Illuminates in the instrument cluster and a chime sounds to remind the driver to fasten his or her safety belt.



### **Conditions of operation**

<b>If...</b>	<b>Then...</b>
If the driver's safety belt is not buckled before the ignition switch is turned to the ON/RUN position ...	The <i>Safety belt</i> warning light illuminates for one to two minutes and the warning chime sounds for four to eight seconds.
The driver's safety belt is buckled while the indicator light is illuminated and the warning chime is sounding...	The <i>Safety belt</i> warning light and warning chime turn off.
The driver's safety belt is buckled before the ignition switch is turned to the ON/RUN position ...	The <i>Safety belt</i> warning light and warning chime remain off.

## Seating and Safety Restraints

### Beltminder (if equipped)

The Beltminder feature is a supplemental warning to the safety belt warning function. This feature provides additional reminders to the driver that the driver's safety belt is unbuckled by intermittently sounding a chime and illuminating the *Safety belt* warning light in the instrument cluster once the vehicle speed has exceeded 3 mph (5 km/h).



If...	Then...
If the driver's safety belt is not buckled approximately 5 seconds after the safety belt warning light has turned off ...	The Beltminder feature is activated - the <i>Safety belt</i> warning light illuminates and the warning chime sounds for 6 seconds every 30 seconds, repeating for approximately 5 minutes or until safety belt is buckled.
The driver's safety belt is buckled while the indicator light is illuminated and the warning chime is sounding...	The Beltminder feature will not activate.
The driver's safety belt is buckled before the ignition switch is turned to the ON/RUN position ...	The Beltminder feature will not activate.

## Seating and Safety Restraints

The purpose of the Beltminder is to remind occasional wearers to wear safety belts all of the time.

The following are reasons most often given for not wearing safety belts: (All statistics based on U.S. data)

Reasons given...	Consider...
“Crashes are rare events”	<b>36,700 crashes occur every day.</b> The more we drive, the more we are exposed to “rare” events, even for good drivers. <i>1 in 4 of us will be seriously injured in a crash during our lifetimes.</i>
“I’m not going far”	<b>3 of 4</b> fatal crashes occur within 25 miles of home.
“Belts are uncomfortable”	Ford designs its safety belts to enhance comfort. If you are uncomfortable - try different positions for the safety belt upper anchorage and seatback which should be as upright as possible; this can improve comfort.
“I was in a hurry”	<b>Prime time for an accident.</b> Beltminder reminds us to take a few seconds to buckle up.
“Seat belts don’t work”	<b>Safety belts</b> , when used properly, <b>reduce risk of death</b> to front seat occupants by <b>45% in cars</b> , and by <b>60% in light trucks</b> .
“Traffic is light”	<b>Nearly 1 of 2 deaths occur in single-vehicle crashes</b> , many when no other vehicles are around.

## Seating and Safety Restraints

Reasons given...	Consider...
“Belts wrinkle my clothes”	Possibly, but a serious crash can do much more than wrinkle your clothes, particularly if you are unbelted.
“The people I’m with don’t wear belts”	Set the example, teen deaths occur 4 times more often in vehicles with TWO or MORE people. Children and younger brothers/sisters imitate behavior they see.
“I have an air bag”	Air bags offer greater protection when used with safety belts. Frontal airbags are not designed to inflate in rear and side crashes or rollovers.
“I’d rather be thrown clear”	Not a good idea, <b>people</b> who are <b>ejected are 40 times more likely to DIE.</b> Safety belts help prevent ejection. WE CAN’T “PICK OUR CRASH”.

## Seating and Safety Restraints



Do not sit on top of a buckled safety belt to avoid the Beltminder chime. Sitting on the safety belt will increase the risk of injury in an accident. To disable (one time) or deactivate the Beltminder feature please follow the directions stated below.

### **One time disable**

Any time the safety belt is buckled and then unbuckled during an ignition ON/RUN cycle, Beltminder will be disabled for that ignition cycle only.

### **Deactivating/activating the Beltminder feature**

*Read steps 1-9 thoroughly before proceeding with the deactivation/activation programming procedure.*

The Beltminder feature can be deactivated/activated by performing the following procedure:

Before following the procedure, make sure that:

- the parking brake is set.
- the gearshift is in P (Park) (automatic transaxle) or the neutral position (manual transaxle).
- the ignition switch is in the OFF position.
- all vehicle doors are closed.

## Seating and Safety Restraints

- the driver's safety belt is unbuckled.
- the parklamps/headlamps are in OFF position.



To reduce the risk of injury, do not deactivate/activate the Beltminder feature while driving the vehicle.

1. Turn the ignition switch to the ON/RUN position (DO NOT START THE ENGINE.)
2. Wait until the *Safety belt* warning light turns off (approximately 1-2 minutes).
  - Steps 3-5 must be completed within 60 seconds or the procedure will have to be repeated.
3. Slowly buckle then unbuckle the safety belt three times, ending with the safety belt unbuckled. This can be done before or during Beltminder warning activation.
4. Turn on the headlamps, turn off the headlamps.
5. Slowly buckle then unbuckle the safety belt three times, ending with the safety belt unbuckled.
  - After step 5, the *Safety belt warning light* will be turned on for three seconds.

## Seating and Safety Restraints

6. Within seven seconds of the *Safety belt* warning light turning off, buckle then unbuckle the safety belt.

- This will disable Beltminder if it is currently enabled, or enable Beltminder if it is currently disabled.

7. Confirmation of disabling Beltminder is provided by flashing the *Safety belt* light four times per second for three seconds.

8. Confirmation of enabling Beltminder is provided by flashing the *Safety belt* light four times per second for three seconds, followed by three seconds with the *Safety belt* light off, then followed by flashing the *Safety belt* light four times per second for three seconds again.

9. After receiving confirmation, the deactivation/activation procedure is complete.

## Seating and Safety Restraints

### **Safety belt extension assembly**

If the safety belt is too short, even when fully extended, 20 cm (8 inches) can be added to the safety belt assembly by adding a safety belt extension assembly (part number 611C22). Safety belt extension assemblies can be obtained from your dealer at no cost.

Use only extensions manufactured by the same supplier as the safety belt. Manufacturer identification is located at the end of the webbing on the label.

Also, use the safety belt extension only if the safety belt is too short for you when fully extended. Do not use extensions to change the fit of the shoulder belt across the torso.

## Seating and Safety Restraints

### Safety belt maintenance

Inspect the safety belt systems periodically to make sure they work properly and are not damaged. Inspect the safety belts to make sure there are no nicks, wears or cuts, replacing if necessary. All safety belt assemblies (slide bar) (if equipped), shoulder belt height adjusters (if equipped), child safety seat tether bracket assemblies (if equipped), and attaching hardware, should be inspected after a collision. Ford recommends that all safety belt assemblies used in vehicles involved in a collision be replaced. However, if the collision was minor and a qualified technician finds that the belts do not show damage and continue to operate properly, they do not need to be replaced. Safety belt assemblies not in use during a collision should also be inspected and replaced if either damage or improper operation is noted.



Failure to inspect and, if necessary, replace the safety belt assembly under the above conditions could result in severe personal injuries in the event of a collision.

Refer to *Cleaning and maintaining the safety belts* in the *Cleaning* chapter.

## Seating and Safety Restraints

### AIR BAG SUPPLEMENTAL RESTRAINT SYSTEM (SRS)

#### Important supplemental restraint system (SRS) precautions

The supplemental restraint system is designed to work with the safety belt to help protect the driver and right front passenger from certain upper body injuries.

Air bags DO NOT inflate slowly or gently and the risk of injury from a deploying air bag is the greatest close to the trim covering the air bag module.

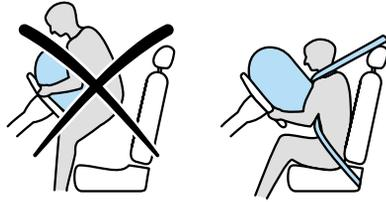

All occupants of the vehicle including the driver should always properly wear their safety belts even when air bag SRS is provided.



Always transport children 12 years old and under in the back seat and always use appropriate child restraints.

## Seating and Safety Restraints

 NHTSA recommends a minimum distance of at least 25 cm (ten [10] inches) between an occupant's chest and the air bag module.

 Never place your arm over the air bag module as a deploying air bag can result in serious arm fractures or other injuries.

Steps you can take to properly position yourself away from the air bag:

- Move your seat to the rear as far as you can while still reaching the pedals comfortably.
- Recline your seat slightly (one or two degrees) from the upright position.

 Do not put anything on or over the air bag module. Placing objects on or over the air bag inflation area may cause those objects to be propelled by the air bag into your face and torso causing serious injury.

 Do not attempt to service, repair, or modify the Air Bag Supplemental Restraint System or its fuses. See your Ford or Lincoln-Mercury dealer.

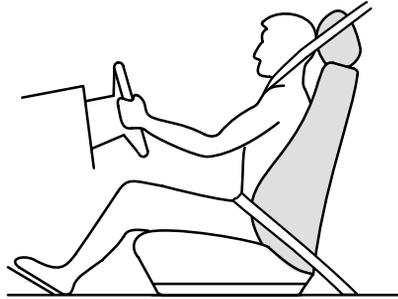

## Seating and Safety Restraints

### Children and air bags

For additional important safety information, read all information on safety restraints in this guide.

Children must always be properly restrained. Accident statistics suggest that children are safer when properly restrained in the rear seating positions than in the front seating positions. Failure to follow these instructions may increase the risk of injury in a collision.



Air bags can kill or injure a child in a child seat.

**NEVER** place a rear-facing child seat in front of an active air bag. If you must use a forward-facing child seat in the front seat, move the seat all the way back.

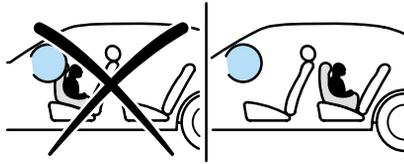

### HOW DO THE AIR BAG SUPPLEMENTAL RESTRAINTS WORK?

The air bag supplemental restraint system consists of:

- driver and passenger dual stage air bag modules (which include the inflators and air bags).
- side air bags (if equipped). Refer to *Side air bag system (if equipped)* later in this chapter.
- one or more impact and safing sensors.
- the same indicator light, RCM (restraints control module) and diagnostic unit used for the Personal safety system.

## Seating and Safety Restraints

The air bag supplemental restraints are an integral part of the Personal Safety System. They are designed to be deployed in cases where the Personal Safety System has determined the occupant conditions and crash severity are appropriate to activate these devices. Refer to the *Personal Safety System* in this chapter.

The fact that the air bags did not inflate in a collision does not mean that something is wrong with the system. Rather, it means the forces were not of the type sufficient to cause activation. The front air bags are designed to inflate in frontal and near-frontal collisions, not rollover, side-impact, or rear impacts.

For information on side-impact collisions, refer to *Side airbag system (if equipped)* in this chapter.

The air bags inflate and deflate rapidly upon activation. After air bag deployment, it is normal to notice a smoke-like, powdery residue or smell the burnt propellant. This may consist of cornstarch, talcum powder (to lubricate the bag) or sodium compounds (e.g., baking soda) that result from the combustion process that inflates the air bag. Small amounts of sodium hydroxide may be present which may irritate the skin and eyes, but none of the residue is toxic.



## Seating and Safety Restraints

While the system is designed to help reduce serious injuries, it may also cause abrasions, swelling or temporary hearing loss.

Because air bags must inflate rapidly and with considerable force, there is the risk of death or serious injuries such as fractures, facial and eye injuries or internal injuries, particularly to occupants who are not properly restrained or are otherwise out of position at the time of air bag deployment. Thus, it is extremely important that occupants be properly restrained as far away from the air bag module as possible while maintaining vehicle control.



Several air bag system components get hot after inflation. Do not touch them after inflation.



If the air bag is inflated, **the air bag will not function again and must be replaced immediately.** If the air bag is not replaced, the unrepaired area will increase the risk of injury in a collision.

## Seating and Safety Restraints

### Side air bag system (if equipped)



Do not use accessory seat covers. The use of accessory seat covers may prevent the deployment of the side air bags and increase the risk of injury in an accident.



Do not lean your head on the door; the side air bag could injure you as it deploys from the side of the seatback.



Do not place objects or mount equipment on or near the airbag cover on the side of the seatbacks of the front seats or in front seat areas that may come into contact with a deploying air bag. Failure to follow these instructions may increase the risk of personal injury in the event of a collision.

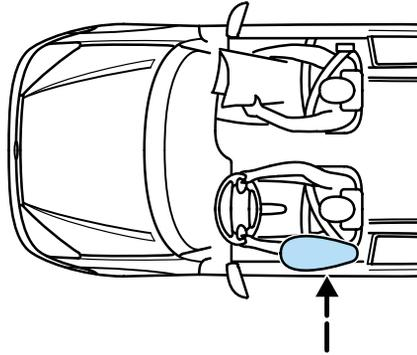

## Seating and Safety Restraints



Do not attempt to service, repair, or modify the air bag Supplemental Restraint System or its fuses. See your Ford or Lincoln-Mercury dealer.



All occupants of the vehicle including the driver should always wear their safety belts even when an air bag SRS is provided.

### ***How does the side air bag system work?***

The side air bag system consists of the following:

- An inflatable nylon bag (air bag) with a gas generator concealed behind the outboard bolster of the driver and front passenger seatbacks.
- The same warning light, electronic control and diagnostic unit as used for the front air bags.
- Two crash sensors located under the outboard side of the front seats, attached to the floor.

Side air bags, in combination with seat belts, can help reduce the risk of severe injuries in the event of a significant side impact collision.

## Seating and Safety Restraints

The side air bags are fitted on the outboard side of the seatbacks of the front seats. In certain lateral collisions, the air bag on the side affected by the collision will be inflated, even if the respective seat is not occupied. The air bag was designed to inflate between the door panel and occupant to further enhance the protection provided occupants in side impact collisions.

The air bag SRS is designed to activate when the vehicle sustains sufficient lateral deceleration to cause the sensors to close an electrical circuit that initiates air bag inflation.

The fact that the air bags did not inflate in a collision does not mean that something is wrong with the system. Rather, it means the forces were not of the type sufficient to cause activation. Side air bags are designed to inflate in side-impact collisions, not rollover, rear-impact, frontal or near-frontal collisions, unless the collision causes sufficient lateral deceleration.

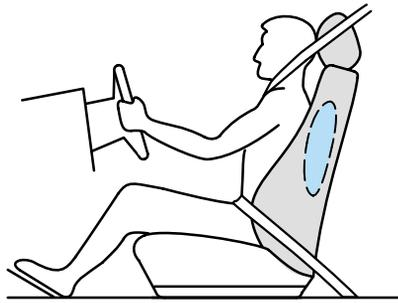

Several air bag system components get hot after inflation. Do not touch them after inflation.

## Seating and Safety Restraints



If the side air bag has deployed, **the air bag will not function again. The side air bag system (including the seat) must be inspected and serviced by a qualified technician in accordance with the vehicle service manual.** If the air bag is not replaced, the unrepaired area will increase the risk of injury in a collision.

### ***Determining if the system is operational***

The supplemental restraints system (SRS) uses a readiness light in the instrument cluster or a tone to indicate the condition of the system. Refer to the *Air bag readiness* section in the *Instrument Cluster* chapter. Routine maintenance of the air bag is not required.

A difficulty with the system is indicated by one or more of the following:

- The readiness light will either flash or stay lit.
- The readiness light will not illuminate immediately after ignition is turned on.

## Seating and Safety Restraints

If either of these indications occurs, even intermittently, have the SRS serviced at your dealership or by a qualified technician immediately. Unless serviced, the system may not function properly in the event of a collision.

### Disposal of air bags and air bag equipped vehicles

For disposal of air bags or air bag equipped vehicles, see your local dealership or a qualified technician. Air bags **MUST BE** disposed of by qualified personnel.

### SAFETY RESTRAINTS FOR CHILDREN

See the following sections for directions on how to properly use safety restraints for children. Also see *Air Bag Supplemental Restraint System (SRS)* in this chapter for special instructions about using air bags.



Rear-facing child seats or infant carriers should never be placed in the front seats.



To reduce the risk of injury, make sure children sit where they can be properly restrained.

## Seating and Safety Restraints



Always transport children 12 years old and under in the back seat and always use appropriate child restraints.

Accident statistics indicate that children are safer when properly restrained in the rear seats.



Do not leave children, unreliable adults, or pets unattended in your vehicle.



Safety belts and seats can become hot in a vehicle that has been closed up in sunny weather. They could burn a small child. Check seat covers and buckles before you place a child anywhere near them.

## Seating and Safety Restraints

### Important child restraint precautions

You are required by law to use safety restraints for children in the U.S. and Canada. If small children ride in your vehicle (generally children who are four years old or younger and who weigh 18 kg [40 lbs] or less), you must put them in safety seats made especially for children. Check your local and state or provincial laws for specific requirements regarding the safety of children in your vehicle.



Never let a passenger hold a child on his or her lap while the vehicle is moving. The passenger cannot protect the child from injury in a collision.

Always follow the instructions and warnings that come with any infant or child restraint you might use.

When possible, place children in the rear seat of your vehicle. Accident statistics suggest that children are safer when properly restrained in the rear seating positions than in the front seating positions.

## Seating and Safety Restraints

### Children and safety belts

If the child is the proper size, restrain the child in a safety seat.

Children who are too large for child safety seats (as specified by the child safety seat manufacturer) should always wear safety belts.

Follow all the important safety restraints and air bag precautions that apply to adult passengers in your vehicle.

If the shoulder belt portion of a combination lap and shoulder belt can be positioned so it does not cross or rest in front of the child's face or neck, the child should wear the lap and shoulder belt. Moving the child closer to the center of the vehicle may help provide a good shoulder belt fit.



Do not leave children, unreliable adults, or pets unattended in your vehicle.

## Seating and Safety Restraints

To improve the fit of lap and shoulder belts on children who have outgrown child safety seats, Ford recommends use of a belt-positioning booster seat that is labelled as conforming to all Federal motor vehicle safety standards. Belt-positioning booster seats raise the child and provide a shorter, firmer seating cushion that encourages safer seating posture and better fit of lap and shoulder belts on the child.

A belt-positioning booster seat should be used if the shoulder belt rests in front of the child's face or neck, or if the lap belt does not fit snugly on both thighs, or if the thighs are too short to let the child sit all the way back on the seat cushion when the lower legs hang over the edge of the seat cushion. You may wish to discuss the special needs of your child with your pediatrician.



## Seating and Safety Restraints

### SAFETY SEATS FOR CHILDREN

#### Child and infant or child safety seats

Use a safety seat that is recommended for the size and weight of the child. Carefully follow all of the manufacturer's instructions with the safety seat you put in your vehicle. If you do not install and use the safety seat properly, the child may be injured in a sudden stop or collision.



When installing a child safety seat:

- Review and follow the information presented in the *Air Bag Supplemental Restraint System (SRS)* in this chapter.
- Use the correct safety belt buckle for that seating position.
- Insert the belt tongue into the proper buckle until you hear a snap and feel it latch. Make sure the tongue is securely fastened in the buckle.
- Keep the buckle release button pointing up and away from the safety seat, with the tongue between the child seat and the release button, to prevent accidental unbuckling.

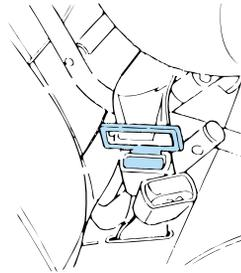

## Seating and Safety Restraints

- Place seatback in upright position.
- Put the safety belt in the automatic locking mode. Refer to *Automatic locking mode* (passenger side front and outboard rear seating positions) (if equipped).

Ford recommends the use of a child safety seat having a top tether strap. Install the child safety seat in a seating position which is capable of providing a tether anchorage. For more information on top tether straps see *Attaching child safety seats with tether straps* in this chapter.



Carefully follow all of the manufacturer's instructions included with the safety seat you put in your vehicle. If you do not install and use the safety seat properly, the child may be injured in a sudden stop or collision.

## Seating and Safety Restraints

### Installing child safety seats in combination lap and shoulder belt seat positions

1. Position the child safety seat in a seat with a combination lap and shoulder belt. **NEVER** place a rear-facing child seat in front of an active air bag.



Air bags can kill or injure a child in a child seat. If you must use a forward-facing child seat in the front seat, move the seat all the way back.



Rear-facing child seats should **NEVER** be placed in the front seats.

2. Pull down on the shoulder belt and then grasp the shoulder belt and lap belt together.

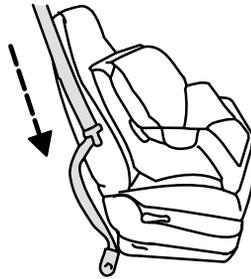
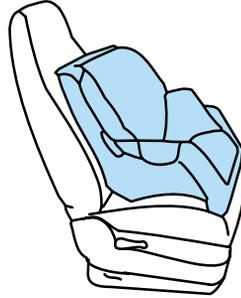

## Seating and Safety Restraints

3. While holding the shoulder and lap belt portions together, route the tongue through the child seat according to the child seat manufacturer's instructions. Be sure the belt webbing is not twisted.

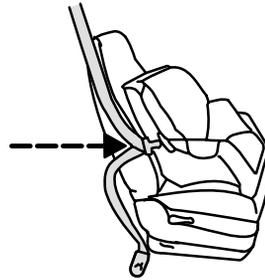

4. Insert the belt tongue into the proper buckle (the buckle closest to the direction the tongue is coming from) for that seating position until you hear and feel the latch engage. Make sure the tongue is latched securely by pulling on it.

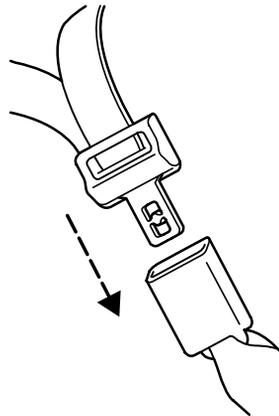

5. To put the retractor in the automatic locking mode, grasp the shoulder portion of the belt and pull downward until all of the belt is extracted and a click is heard.



## Seating and Safety Restraints

6. Allow the belt to retract. The belt will click as it retracts to indicate it is in the automatic locking mode.

7. Pull the lap belt portion across the child seat toward the buckle and pull up on the shoulder belt while pushing down with your knee on the child seat.

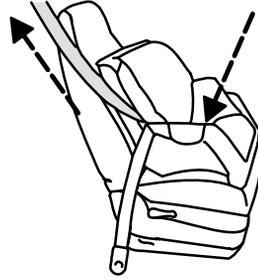

8. Allow the safety belt to retract to remove any slack in the belt.

9. Before placing the child in the seat, forcibly tilt the seat forward and back to make sure the seat is securely held in place. To check this, grab the seat at the belt path and attempt to move it side to side and forward and back. There should be no more than one inch of movement for proper installation.

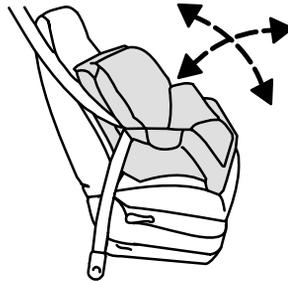

10. Try to pull the belt out of the retractor to make sure the retractor is in automatic locking mode (you should not be able to pull more belt out). If the retractor is not locked, unbuckle the belt and repeat steps two through nine.

Check to make sure the child seat is properly secured before each use.

## Seating and Safety Restraints

### Attaching child safety seats with LATCH attachments (Lower Anchors and Tethers for children)

Some child safety seats have two rigid or webbing mounted attachments that connect to two LATCH anchors at specific seating positions in your vehicle. This type of child seat eliminates the need to use seat belts to attach the child seat. For forward-facing child seats, the tether strap must also be attached to the proper tether anchor. See *Attaching child safety seats with tether straps* in this chapter.

LATCH lower anchors have been provided in your vehicle at the following locations:

The anchors on both sides of the center of the rear seat are provided primarily for child seats at the outboard seats and are further apart than the pairs of lower anchors for child seat installation at other seats. A child seat with rigid LATCH attachments cannot be installed at the center rear seat. A child seat with LATCH attachments on belt webbing can be used at the center rear seat unless a child seat at an outboard rear seat is attached to one of these lower anchors. Install a child seat onto the lower anchors at the center rear seat **ONLY IF** the child restraint manufacturer recommends that the child seat can be installed to anchors that are spaced up to 450 mm apart.

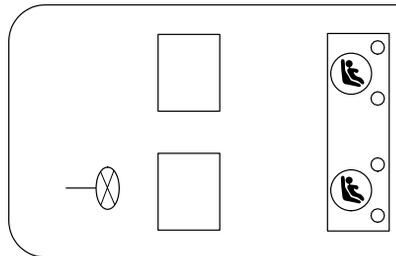

## Seating and Safety Restraints

 Never attach two LATCH child safety seats to the same anchor. In a crash, one anchor may not be strong enough to hold two child seat attachments and may break, causing serious injury or death.

The LATCH anchors are located on the rear section of the seat cushion, at the bottom of the seatback.

Follow the child seat manufacturer's instructions to properly install safety seats with LATCH attachments.

 Attach the LATCH lower attachments of the child seat only to the anchors shown.

Once you have installed the LATCH safety seat, assure that the seat is properly attached to the LATCH and tether anchors. Also, test the safety seat before you place the child in it. Tilt the seat from side to side. Also try to tug the seat forward. Check to see if the anchors hold the seat in place.

 If the safety seat is not anchored properly, the risk of a child being injured in a collision greatly increases.

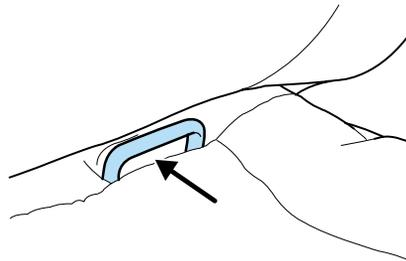
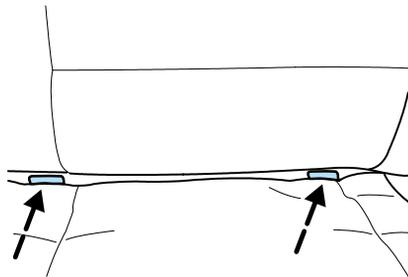

## Seating and Safety Restraints

### Attaching child safety seats with tether straps

Most new forward-facing child safety seats include a tether strap which goes over the back of the seat and hooks to an anchoring point. Tether straps are available as an accessory for many older safety seats. Contact the manufacturer of your child safety seat for information about ordering a tether strap.

The rear seats of your vehicle are equipped with built-in tether strap anchors located behind the seats as described below.

The tether anchors in your vehicle are either located under a cover marked with the tether anchor symbol (shown with title) or are recessed bars on the back side of the seatback.

The tether strap anchors in your vehicle are in the following positions (shown from top view, left is front of vehicle):



Attach the tether strap only to the appropriate tether anchor as shown. The tether strap may not work properly if attached somewhere other than the correct tether anchor.

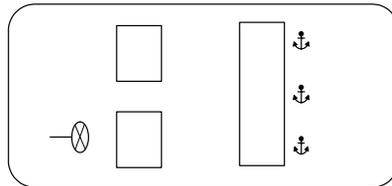

1. Position the child safety seat on the seat cushion.

## Seating and Safety Restraints

2. Route the child safety seat tether strap over the back of the seat.

On hatchbacks, the removable luggage area cover must be removed prior to attaching the tether strap to the tether anchor.

On wagons, it may be necessary to remove the cargo cover assembly prior to attaching the tether strap to the tether anchor. The tether must not go around the cargo cover retractor assembly.

For vehicles with adjustable head restraints, route the tether strap under the head restraint and between the head restraint posts, otherwise route the tether strap over the top of the seatback.

3. Locate the correct anchor for the selected seating position.

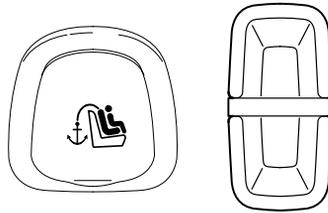

4. On a sedan, open the tether anchor cover.

5. Clip the tether strap to the anchor as shown.

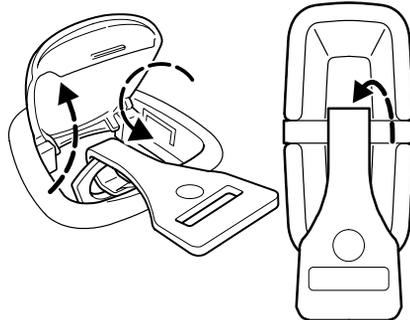

## Seating and Safety Restraints



If the tether strap is clipped incorrectly, the child safety seat may not be retained properly in the event of a collision.

6. Refer to the *Installing child safety seats in combination lap and shoulder belt seating positions* section of this chapter for further instructions to secure the child safety seat.

7. Tighten the child safety seat tether strap according to the manufacturer's instructions.



If the safety seat is not anchored properly, the risk of a child being injured in a collision greatly increases.

# Driving

## STARTING

### POSITIONS OF THE IGNITION

1. LOCK, locks the steering wheel, automatic transmission gearshift lever and allows key removal.

**Note:** The key may be difficult to remove if the ignition is switched off with an automatic gearshift lever in any other position than P (Park). If this occurs, place the gearshift lever in P (Park), turn the ignition switch to the ON/RUN and then to the OFF position. Remove the key normally.

2. OFF, shuts off the engine and all accessories without locking the steering wheel. The audio system will still function.

3. ON/RUN, all electrical circuits operational. Warning lights illuminated. Key position when driving.

4. START, cranks the engine. Release the key as soon as the engine starts.

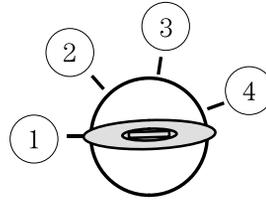

### PREPARING TO START YOUR VEHICLE

Engine starting is controlled by the ignition system. This system meets all Canadian Interference-Causing Equipment standard requirements regulating the impulse electrical field strength of radio noise.

When starting a fuel-injected engine, avoid pressing the accelerator before or during starting. Only use the accelerator pedal when you have difficulty starting the engine. For more information on starting the vehicle, refer to *Starting the engine* in this chapter.

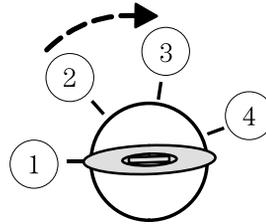

Extended idling at high engine speeds can produce very high temperatures in the engine and exhaust system, creating the risk of fire or other damage.



Do not park, idle, or drive your vehicle in dry grass or other dry ground cover. The emission system heats up the engine compartment and exhaust system, which can start a fire.

## Driving



Do not start your vehicle in a closed garage or in other enclosed areas. Exhaust fumes can be toxic. Always open the garage door before you start the engine. See *Guarding against exhaust fumes* in this chapter for more instructions.



If you smell exhaust fumes inside your vehicle, have your dealer inspect your vehicle immediately. Do not drive if you smell exhaust fumes.

### Important safety precautions

A computer system controls the engine's idle revolutions per minute (RPM). When the engine starts, the idle RPM runs faster to warm the engine. If the engine idle speed does not slow down automatically, have the vehicle checked.

## Driving

Before starting the vehicle:

1. Make sure all vehicle occupants have buckled their safety belts. For more information on safety belts and their proper usage, refer to the *Seating and Safety Restraints* chapter.
2. Make sure the headlamps and vehicle accessories are off.

If starting a vehicle with an automatic transaxle:

- Make sure the parking brake is set.
- Make sure the gearshift is in P (Park).

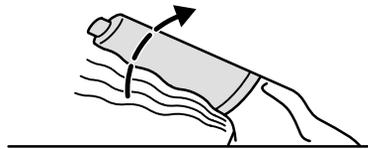
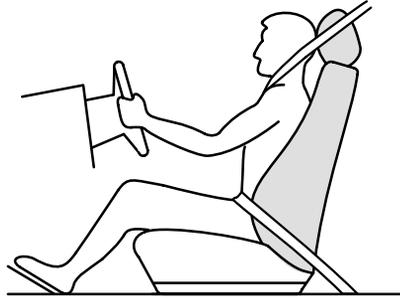

If starting a vehicle with a manual transaxle:

- Make sure the parking brake is set.
- Push the clutch pedal to the floor.

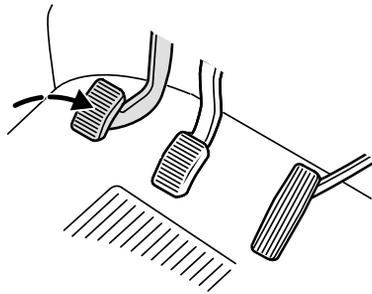

3. Turn the key to 3 (ON/RUN) without turning the key to 4 (START).

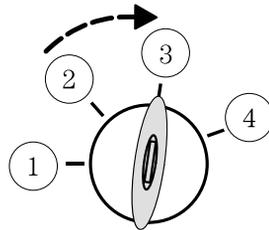

# Driving

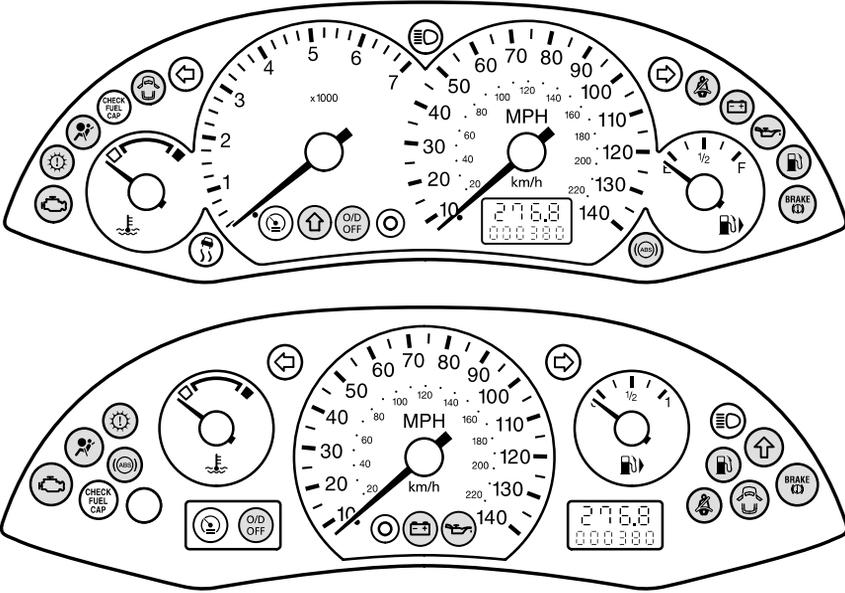

Make sure the corresponding lights (if equipped) illuminate briefly. If a light fails to illuminate, have the vehicle serviced.

- If the driver's safety belt is fastened the light will not illuminate.



## STARTING THE ENGINE

1. Turn the key to 4 (START) without pressing the accelerator pedal and release as soon as the engine starts. The key will return to 3 (ON/RUN).

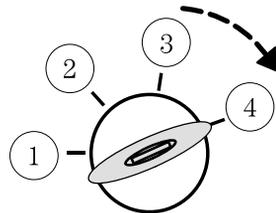

2. If the temperature is above  $-12^{\circ}\text{C}$  ( $10^{\circ}\text{F}$ ) and the engine does not start within five seconds on the first try, turn the key to OFF, wait ten seconds and try again.
3. If the temperature is below  $-12^{\circ}\text{C}$  ( $10^{\circ}\text{F}$ ) and the engine does not start in fifteen seconds on the first try, turn the key to OFF and wait ten seconds and try again. If the engine does not start in two attempts, depress the accelerator and start the engine while holding the accelerator down to the floor. Release the accelerator when the engine starts.
4. After idling for a few seconds, apply the brake and release the parking brake.

### **Using the engine block heater (if equipped)**

An engine block heater warms the engine coolant, which improves starting, warms up the engine faster and allows the heater- defroster system to respond quickly. Use of an engine block heater is strongly recommended if you live in a region where temperatures reach  $-23^{\circ}\text{C}$  ( $-10^{\circ}\text{F}$ ) or below.

For best results, plug the heater in at least three hours before starting the vehicle. Using the heater for longer than three hours will not harm the engine, so the heater can be plugged in the night before starting the vehicle.

## Driving

 To prevent electrical shock, do not use your heater with ungrounded electrical systems or two-pronged (cheater) adapters.

### Guarding against exhaust fumes

Although odorless and colorless, carbon monoxide is present in exhaust fumes. Take precautions to avoid its dangerous effects.

 If you ever smell exhaust fumes of any kind inside your vehicle, have your dealer inspect and fix your vehicle immediately. Do not drive if you smell exhaust fumes. These fumes are harmful and could kill you.

Have the exhaust and body ventilation system checked whenever:

- the vehicle is raised for service.
- the sound of the exhaust system changes.
- the vehicle has been damaged in a collision.

### **CALIFORNIA PROPOSITION 65**

#### **Warning**



Engine exhaust, some of its constituents, and certain vehicle components contain or emit chemicals known to the State of California to cause cancer and birth defects or other reproductive harm. In addition, certain fluids contained in vehicles and certain products of component wear contain or emit chemicals known to the State of California to cause cancer and birth defects or other reproductive harm.

#### **Important ventilating information**

If the engine is idling while the vehicle is stopped in an open area for long periods of time, open the windows at least 2.5 cm (one inch).

Adjust the heating or air conditioning (if equipped) to bring in fresh air.

Improve vehicle ventilation by keeping all air inlet vents clear of snow, leaves and other debris.

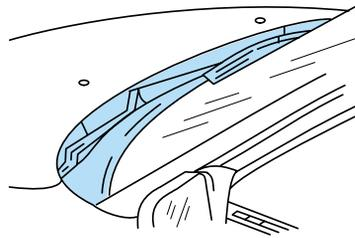

## Driving

### BRAKES

Your service brakes are self-adjusting. Refer to the “Scheduled Maintenance Guide” for scheduled maintenance.

Occasional brake noise is normal and often does not indicate a performance concern with the vehicle’s brake system. In normal operation, automotive brake systems may emit occasional or intermittent squeal or groan noises when the brakes are applied. Such noises are usually heard during the first few brake applications in the morning; however, they may be heard at any time while braking and can be aggravated by environmental conditions such as cold, heat, moisture, road dust, salt or mud. If a “metal-to-metal”, “continuous grinding” or “continuous squeal” sound is present while braking, have the brakes inspected by a qualified service technician.

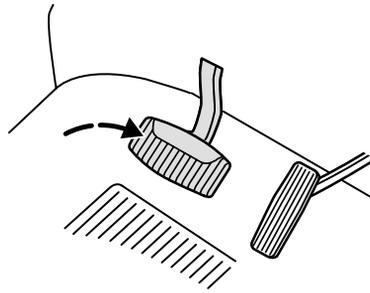

### Parking brake

Apply the parking brake whenever the vehicle is parked. To set the parking brake, pull the handle up as far as possible.

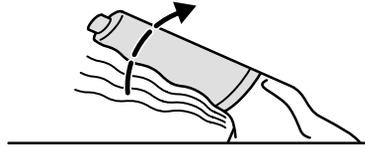

The *brake* warning lamp in the instrument cluster illuminates and remains illuminated (when the ignition is turned ON/RUN) until the parking brake is released.



The parking brake is not recommended to stop a moving vehicle. However, if the normal brakes fail, the parking brake can be used to stop your vehicle in an emergency. Since the parking brake applies only the rear brakes, the vehicle's stopping distance will increase greatly and the handling of your vehicle will be adversely affected.



Always set the parking brake fully and make sure that the gearshift is securely latched in P (Park) (Automatic transaxle) or in 1 (First) (manual transaxle).

Push the button on the end of the parking brake and push the handle down as far as possible to release the brake. Driving with the parking brake on will cause the brakes to wear out quickly and reduce fuel economy.

## Driving

### **Anti-lock brake system (ABS) (if equipped)**

On vehicles equipped with an anti-lock braking system (ABS), a noise from the hydraulic pump motor and pulsation in the pedal may be observed during ABS braking events. Rapid pedal pulsation coupled with noise while braking under panic conditions or on loose gravel, bumps, wet or snowy roads is normal and indicates proper functioning of the vehicle's anti-lock brake system. The ABS performs a self-check at 17 km/h (10 mph) after you start the engine and begin to drive away. A brief mechanical noise may be heard during this test. This is normal. If a malfunction is found, the ABS warning light will come on. If the vehicle has continuous vibration or shudder in the steering wheel while braking, the vehicle should be inspected by a qualified service technician.

The ABS continuously monitors all four wheel speeds and detects the onset of wheel lockup during brake applications and, if required, modulates brake pressure to individual wheels to maintain braking at optimum efficiency and ensure that steering control is not adversely affected. The wheels are prevented from locking even when the brakes are firmly applied. The accompanying illustration depicts the advantage of an ABS equipped vehicle (on bottom) to a non-ABS equipped vehicle (on top) during hard braking with loss of front braking traction.

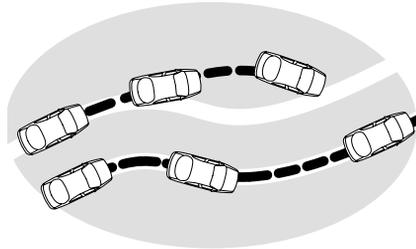

### **ABS warning lamp (if equipped)**

The *ABS* warning lamp in the instrument cluster momentarily illuminates when the ignition is turned on and the engine is off. If the light does not illuminate momentarily at start up, remains on or continues to flash, the *ABS* needs to be serviced. With the *ABS* light on, the anti-lock brake system is disabled and normal braking is still effective unless the *brake* warning light also remains illuminated with parking brake released.

If the *ABS* and/or *brake* warning lights illuminate when the engine is on and the parking brake is in the fully off position, have your vehicle serviced immediately.



## Driving

### Using ABS (if equipped)

- In an emergency or when maximum efficiency from the ABS is required, apply continuous full force on the brake. The ABS will be activated immediately, thus allowing you to retain full steering control of your vehicle and, providing there is sufficient space, will enable you to avoid obstacles and bring the vehicle to a controlled stop.
- The Anti-Lock system does not decrease the time necessary to apply the brakes or always reduce stopping distance. Always leave enough room between your vehicle and the vehicle in front of you to stop.
- We recommend that you familiarize yourself with this braking technique. However, avoid any unnecessary risks.

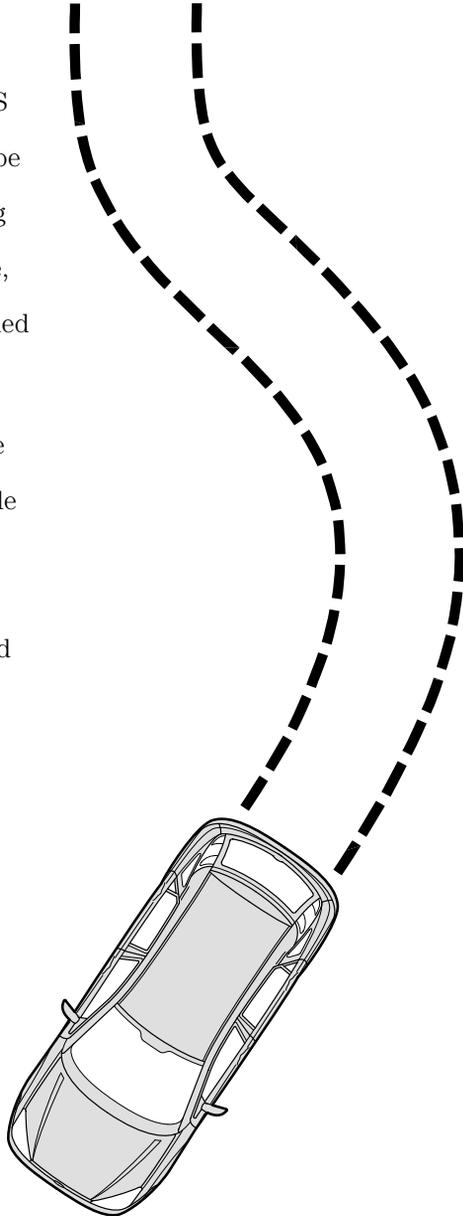

### STEERING

Your vehicle is equipped with power steering. Power steering uses energy from the engine to help steer the vehicle.

To prevent damage to the power steering pump:

- Never hold the steering wheel to the extreme right or the extreme left for more than a few seconds when the engine is running.
- Do not operate the vehicle with a low power steering pump fluid level.

If the power steering system breaks down (or if the engine is turned off), you can steer the vehicle manually, but it takes more effort.

If the steering wanders or pulls, the condition could be caused by any of the following:

- underinflated tire(s) on any wheel(s)
- high crosswinds
- wheels out of alignment
- loose or worn components in steering linkage.

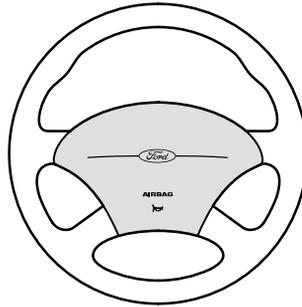

## Driving

### **AUTOMATIC TRANSAXLE OPERATION (if equipped)**

#### **Brake-shift interlock**

This vehicle is equipped with a brake-shift interlock feature that prevents the gearshift from being moved from P (Park) unless the brake pedal is depressed.

If you cannot move the gearshift out of P (Park) with the brake pedal depressed:

1. Apply the parking brake, turn ignition key to LOCK, then remove the key.
2. Remove the protective cover to the interlock access hole on the console. Insert a screwdriver or other similar tool to release the interlock. Apply the brake pedal and shift to N (Neutral).
3. Start the vehicle.

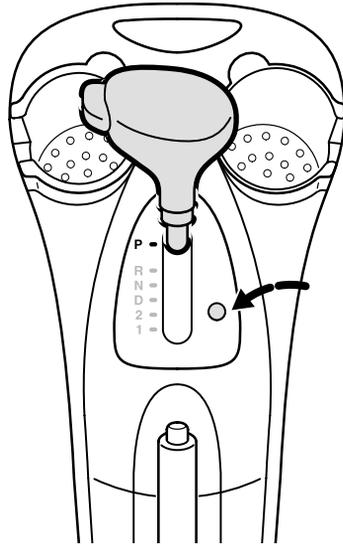

If it is necessary to use the above procedure to move the gearshift, it is possible that a fuse has blown or the vehicle's brakelamps are not operating properly. Refer to *Fuses and relays* in the *Roadside Emergencies* chapter.



Do not drive your vehicle until you verify that the brakelamps are working.

If your vehicle gets stuck in mud or snow it may be rocked out by shifting between forward and reverse gears, stopping between shifts, in a steady pattern. Press lightly on the accelerator in each gear.

**Do not rock the vehicle for more than a few minutes or excessively spin the wheels. The transaxle and tires may be damaged or the engine may overheat.**



Always set the parking brake fully and make sure the gearshift is latched in P (Park). Turn off the ignition whenever you leave your vehicle.

## Driving

### Driving with automatic transaxle (if equipped)

#### Understanding gearshift positions

Depress the locking button and move the automatic gearshift to the desired position.

 Hold the brake pedal down while you move the gearshift lever from P (Park) to another position. If you do not hold the brake pedal down, your vehicle may move unexpectedly and injure someone.

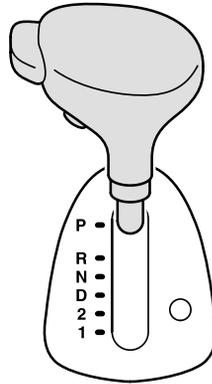

#### P (Park)

Always come to a complete stop before shifting into P (Park). Make sure the gearshift is securely latched in P (Park). This position locks the transaxle and prevents the front wheels from turning.

 Always set the parking brake fully and make sure the gearshift is securely latched in P (Park).

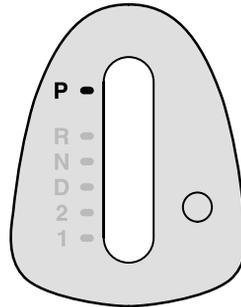

If the gearshift is not in P (Park) and the driver's door is open, a warning chime will sound.

**Note:** The key may be difficult to remove if the ignition is switched off with an automatic gearshift lever in any other position than P (Park). If this occurs, place the gearshift lever in P (Park), turn the ignition switch to the ON/RUN and then to the OFF position. Remove the key normally.



Never leave your vehicle unattended while it is running.

## **R (Reverse)**

With the gearshift in R (Reverse), the vehicle will move backward. Always come to a complete stop before shifting into and out of R (Reverse)

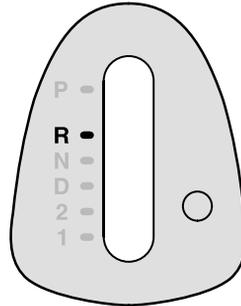

## **N (Neutral)**

With the gearshift in N (Neutral), the vehicle can be started and is free to roll. Hold the brake pedal down while in this gear.

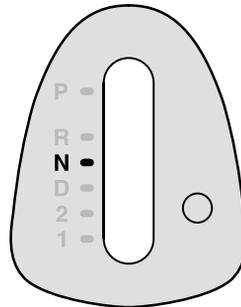

## Driving

### **D (Overdrive)**

The normal driving position for the best fuel economy. Transaxle operates in gears One through Four.

D (Overdrive) can be deactivated by pressing the transaxle control switch on the gearshift lever.

The O/D OFF light will illuminate on the instrument cluster.

Engine braking is provided in gears 2, 3, and 4.

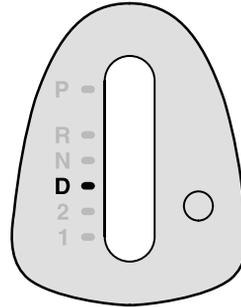

### **D (Drive)**

Transaxle operates in gears One through Three. Activate by pressing the transaxle control switch on the gearshift lever. The O/D OFF light will illuminate on the instrument cluster. D (Drive) provides engine braking in gears 2 and 3 and is useful when:

- driving with a heavy load.
- towing a trailer up or down steep hills.
- additional engine downhill braking is desired. If towing a trailer, refer to *Driving while you tow* in the *Trailer towing* section of this chapter.

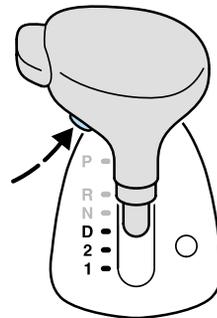

To return to D (Overdrive) mode, press the transaxle control switch and the O/D OFF light will no longer be illuminated.

Each time the vehicle is started, the transaxle will automatically return to normal overdrive mode.

## **2 (Second)**

Use 2 (Second) to start-up on slippery roads or to provide additional engine braking on downgrades.

Upshifts can be made by shifting to D (Drive) or D (Overdrive). Selecting 2 (Second) at higher speeds causes the transaxle to shift to a lower gear, and will shift to 2 (Second) after vehicle decelerates to the proper speed.

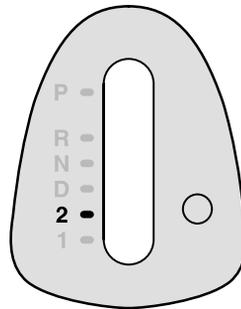

## **1 (First)**

Use 1 (First) to provide maximum engine braking on steep downgrades.

Upshifts can be made by shifting to 2 (Second), D (Drive) or D (Overdrive). Selecting 1 (First) at higher speeds causes the transaxle to shift to a lower gear, and will shift to 1 (First) after vehicle decelerates to the proper speed.

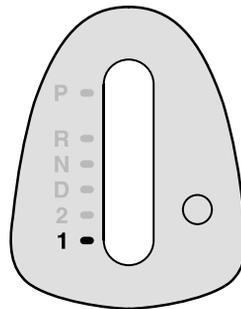

# Driving

## Manual transaxle operation (if equipped)

### *Using the clutch*

Vehicles equipped with a manual transaxle have a starter interlock that prevents cranking the engine unless the clutch pedal is fully depressed.

When starting a vehicle with a manual transaxle, you must:

1. Put gearshift in N (Neutral).
2. Hold down brake pedal.
3. Depress clutch pedal.

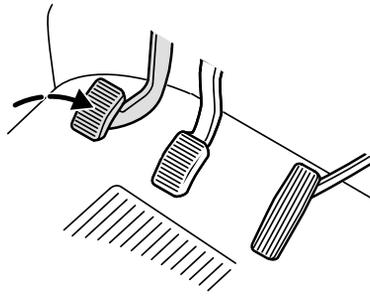
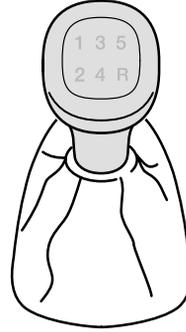

4. Turn ignition to position 4 (START) to start the engine, let the engine idle for a few seconds, then shift into gear.
5. Release the brake pedal.
6. Release clutch slowly while pressing down slowly on the accelerator pedal.

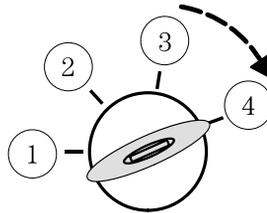

Do not drive with your foot resting on the clutch pedal and do not use the clutch to hold your vehicle at a standstill while waiting on a hill. These actions will seriously reduce clutch life.

### **Recommended shift speeds**

Upshift and downshift according to the following charts for your specific engine/drivetrain combination:

<b>Upshifts when accelerating (recommended for best fuel economy)</b>		
<b>5-speed manual transaxle</b>		
Shift from:	km/h	mph
First to second	23	14
Second to third	40	25
Third to fourth	58	36
Fourth to fifth	72	45

## Driving

### **Parking your vehicle**

1. Apply brake and shift into N (Neutral).
2. Set parking brake.
3. Shift into 1 (First).

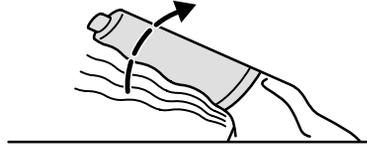

4. Turn ignition to position 2 (OFF).



Do not park your vehicle in Neutral, it may move unexpectedly and injure someone. Use 1 (First) gear and set the parking brake fully.

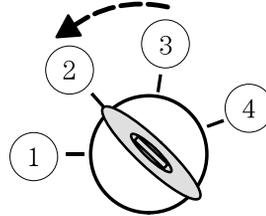

### **Reverse**

Make sure that your vehicle is at a complete stop before you shift into R (Reverse). Failure to do so may damage the transaxle.

Put the gearshift in N (Neutral) and wait at least three seconds before shifting into R (Reverse).

- **IB5 transaxle (with SPI engine)**

You shift into R (Reverse) only by moving the gearshift fully to the right against a spring pressure and then rearward into R (Reverse) gear.

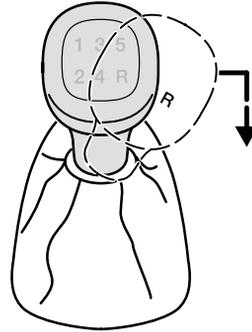

- **MTX 75 transaxle (with Zetec engine)**

To select reverse gear, lift the locking ring (1) and then move the gearshift fully to the right and rearward into R (Reverse) gear (2).

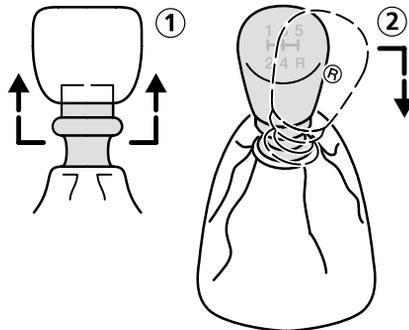

### **Removing key from ignition**

- Turn the ignition key to position 1.
- Remove the ignition key.

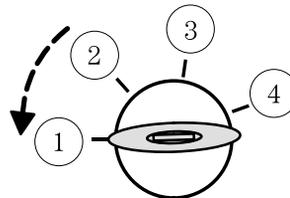

## Driving

### **DRIVING THROUGH WATER**

Do not drive quickly through standing water, especially if the depth is unknown. Traction or brake capability may be limited and if the ignition system gets wet, your engine may stall. Water may also enter your engine's air intake and severely damage your engine.

If driving through deep or standing water is unavoidable, proceed very slowly. Never drive through water that is higher than the bottom of the hubs.

Once through the water, always try the brakes. Wet brakes do not stop the vehicle as effectively as dry brakes. Drying can be improved by moving your vehicle slowly while applying light pressure on the brake pedal.

**Driving through deep water where the transaxle is submerged may allow water into the transaxle and cause internal transaxle damage.**

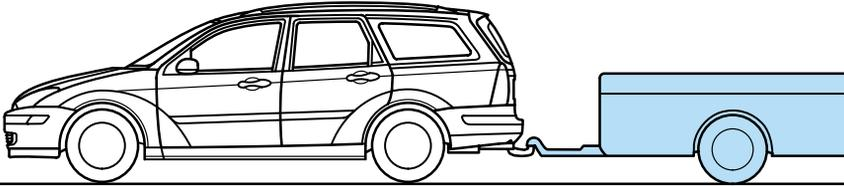

### VEHICLE LOADING

Before loading your vehicle, familiarize yourself with these terms.

- **Base curb weight:** Weight of the vehicle including any standard equipment, fluids, lubricants, etc. It does not include passengers or aftermarket equipment.
- **Payload:** Combined maximum allowable weight of cargo, passengers and optional equipment. The payload equals the gross vehicle weight rating minus base curb weight.
- **GVW (Gross Vehicle Weight):** Base curb weight plus payload weight. The GVW is not a limit or a specification.
- **GVWR (Gross Vehicle Weight Rating):** Maximum total weight of the base vehicle, passengers, optional equipment and cargo. The GVWR is specific to each vehicle and is listed on the Safety Compliance Certification Label on the driver's door pillar.

## Driving

- **GAWR (Gross Axle Weight Rating):** Carrying capacity for each axle system. The GAWR is specific to each vehicle and is listed on the Safety Compliance Certification Label on the driver's door pillar.
- **GCWR (Gross Combined Weight Rating):** Maximum combined weight of towing vehicle (including passengers and cargo) and the trailer. The GCWR indicates the maximum loaded weight that the vehicle is designed to tow.
- **Maximum Trailer Weight Rating:** Maximum weight of a trailer the vehicle is permitted to tow. The maximum trailer weight rating is determined by subtracting the vehicle curb weight for each engine/transaxle combination, any required option weight for trailer towing and the weight of the driver from the GCWR for the towing vehicle.
- **Maximum Trailer Weight:** Maximum weight of a trailer the loaded vehicle (including passengers and cargo) is permitted to tow. It is determined by subtracting the weight of the loaded trailer towing vehicle from the GCWR for the towing vehicle.

- **Trailer Weight Range:** Specified weight range that the trailer must fall within that ranges from zero to the maximum trailer weight rating.

Remember to figure in the tongue load of your loaded trailer when figuring the total weight.



Do not exceed the GVWR or the GAWR specified on the Safety Compliance Certification Label.

Do not use replacement tires with lower load carrying capacities than the originals because they may lower the vehicle's GVWR and GAWR limitations. Replacement tires with a higher limit than the originals do not increase the GVWR and GAWR limitations.

The Certification Label, found on the inside pillar of the driver's door, lists several important vehicle weight rating limitations. Before adding any additional equipment, refer to these limitations.

## Driving

If you are adding weight to the front of your vehicle (potentially including weight added to the cab), the weight added should not exceed the Front Axle Reserve Capacity (FARC). Additional frontal weight may be added to the front axle reserve capacity provided you limit your payload in other ways (i. e. restrict the number of passengers or amount of cargo carried).

You may add equipment throughout your vehicle if the total weight added is equal to or less than the Total Axle Reserve Capacity (TARC) weight. You should NEVER exceed the Total Axle Reserve Capacity.

Always ensure that the weight of passengers, cargo and equipment being carried is within the weight limitations that have been established for your vehicle including both Gross Vehicle Weight and Front and Rear Gross Axle Weight Rating limits. Under no circumstance should these limitations be exceeded. Exceeding any vehicle weight rating limitation could result in serious damage to the vehicle and/or personal injury.

### TRAILER TOWING

Your vehicle is capable of towing a trailer up to 454 kg (1,000 lbs.) gross trailer weight with a maximum tongue load of 45 kg (100 lbs.). Do not tow a trailer until your vehicle has been driven at least 800 km (500 miles).

Towing a trailer places an additional load on your vehicle's engine, transaxle, brakes, tires and suspension. Inspect these components carefully after towing.



Do not exceed the GVWR or the GAWR specified on the certification label.



Towing trailers beyond the maximum recommended gross trailer weight exceeds the limit of the vehicle and could result in engine damage, transaxle damage, structural damage, loss of control and personal injury.

### Preparing to tow

Use the proper equipment for towing a trailer, and make sure it is properly attached to your vehicle. See your dealer or a reliable trailer dealer if you require assistance.

## Driving

### Hitches

Do not use hitches that clamp onto the vehicle bumper. Use a load carrying hitch. You must distribute the load in your trailer so that 10 % of the total weight of the trailer is on the tongue.

### Safety chains

Always connect the trailer's safety chains to the frame or hook retainers of the vehicle hitch. To connect the trailer's safety chains , cross the chains under the trailer tongue and allow slack for turning corners.

If you use a rental trailer, follow the instructions that the rental agency gives to you.

**Do not attach safety chains to the bumper.**

### Trailer brakes

Electric brakes and manual automatic or surge-type trailer brakes are safe if installed properly and adjusted to the manufacturer's specifications. The trailer brakes must meet local and Federal regulations.



Do not connect a trailer's hydraulic brake system directly to your vehicle's brake system. Your vehicle may not have enough braking power and your chances of having a collision greatly increase.

The braking system of the tow vehicle is rated for operation at the GVWR not GCWR.

### **Trailer lamps**

Trailer lamps are required on most towed vehicles. Make sure your trailer lamps conform to local and Federal regulations. See your dealer or trailer rental agency for proper instructions and equipment for hooking up trailer lamps.

### **Driving while you tow**

When towing a trailer:

- Ensure that you turn off your speed control. The speed control may shut off automatically when you are towing on long, steep grades.
- Consult your local motor vehicle speed regulations for towing a trailer.
- Use a lower gear when towing up or down steep hills. This will eliminate excessive downshifting and upshifting for optimum fuel economy and transaxle cooling.
- Anticipate stops and brake gradually.

**Exceeding the GCWR rating may cause internal transaxle damage and void your warranty coverage.**

## Driving

### Servicing after towing

If you tow a trailer for long distances, your vehicle will require more frequent service intervals.

Refer to your scheduled maintenance guide for more information.

### Trailer towing tips

- Practice turning stopping and backing up before starting on a trip to get the feel of the vehicle trailer combination. When turning, make wider turns so the trailer wheels will clear curbs and other obstacles.
- Allow more distance for stopping with a trailer attached.
- The trailer tongue weight should be 10% of the loaded trailer weight.
- After you have traveled 80 km (50 miles), thoroughly check your hitch electrical connections and trailer wheel lug nuts.
- When stopped in traffic for long periods of time in hot weather, place the gearshift in P (Park) and increase idle speed. This aids engine cooling and air conditioner efficiency.
- Vehicles with trailers should not be parked on a grade. If you must park on a grade, place wheel chocks under the trailer's wheels.

Canadian customers who require roadside assistance call 1-800-665-2006.

Should you need to arrange assistance for yourself, Ford will reimburse a reasonable amount. To obtain information, U.S. Ford or Mercury vehicle customers call 1-800-241-3673; Lincoln vehicle customers call 1-800 501-4140. Canadian customers who need to obtain reimbursement information call 1-800-665-2006.

### **TOWING YOUR VEHICLE BEHIND ANOTHER VEHICLE**

At times you may want to tow your vehicle behind another vehicle. Before you have your vehicle towed:

- Release the parking brake.
- Move the gearshift to N (Neutral).
- Turn the key in the ignition to off.
- Unlock the steering wheel.

# Driving

## **Recreational towing**

Follow these guidelines for your specific powertrain combination to tow your vehicle with all four wheels on the ground (such as behind a recreational vehicle).

These guidelines are designed to ensure that your transmission is not damaged due to insufficient lubrication flow.

### ***All Front Wheel Drive (FWD) vehicles***

An example of recreational towing is towing your vehicle behind a Motorhome. The following recreational towing guidelines are designed to ensure that your transmission is not damaged. It is not recommended to tow front wheel drive vehicles with the front drive wheels on the ground. It is recommended to tow your vehicle with the drive wheels on a dolly or two wheel car hauling trailer.

### **Automatic transaxle**

In case of a roadside emergency with a disabled vehicle (without access to wheel dollies, car hauling trailer or flatbed transport vehicle) your vehicle can be flat towed (all wheels on the ground) under the following conditions.

- Transmission is placed in N (Neutral).
- Maximum speed is 50 km/h (30 mph).
- Maximum distance is 50 km (30 miles).

### Manual transaxle

In case of a roadside emergency with a disabled vehicle (without access to wheel dollies, car hauling trailer or flatbed transport vehicle) your vehicle can be flat towed (all wheels on the ground):

- Place the transmission in N (Neutral).
- Your maximum towing distance is unlimited.



Never use a tow bar that attaches to the bumper when you tow your vehicle. You could damage the bumper and cause an accident.

## Roadside Emergencies

### GETTING ROADSIDE ASSISTANCE

To fully assist you should you have a vehicle concern, Ford offers a complimentary roadside assistance program. This program is separate from the New Vehicle Limited Warranty. The service is available:

- 24-hours, seven days a week
- for the Basic warranty period (Canada) or New Vehicle Limited Warranty period (U.S.) of three years or 60,000 km (36,000 miles), whichever comes first on Ford and Mercury vehicles, and four years or 80,000 km (50,000 miles) on Lincoln vehicles.

Roadside assistance will cover

- changing a flat tire
- jump-starts
- lock-out assistance
- limited fuel delivery\*
- towing of your disabled vehicle to the nearest Ford Motor Company dealership, or your selling dealer if within 25 kms (15.5 miles) of the nearest Ford Motor Company dealership (one tow per disablement). Even non-warranty related tows, like accidents or getting stuck in the mud or snow, are covered (some exclusions apply, such as impound towing or repossession).

\* Canadian customers refer to your *Roadside Assistance supplement* for exact fuel amounts.

### Using roadside assistance

Complete the roadside assistance identification card and place it in your wallet for quick reference. In the United States, this card is found in the Owner Guide portfolio in the glove compartment in Ford vehicles and is mailed to you if you own a Mercury or Lincoln. In Canada, it's found in the Roadside Assistance book in the glove compartment. U.S. Ford or Mercury vehicle customers who require roadside assistance, call 1-800-241-3673; Lincoln vehicle customers call 1-800-521-4140. Canadian customers who require roadside assistance call 1-800-665-2006.

If you need to arrange roadside assistance for yourself, Ford Motor Company will reimburse a reasonable amount. To obtain reimbursement information, U.S. Ford or Mercury vehicle customers call 1-800-241-3673; Lincoln customers call 1-800-521-4140. Canadian customers who need to obtain reimbursement information call 1-800-665-2006.

## Roadside Emergencies

### ROADSIDE COVERAGE BEYOND BASIC WARRANTY

In the United States, you may purchase additional roadside assistance coverage beyond this period through the Ford Auto Club by contacting your Ford or Lincoln-Mercury dealer. Similarly in Canada, for uninterrupted roadside assistance coverage, you may purchase extended coverage prior to your Basic Warranty's Roadside Assistance expiring. For more information and enrollment, contact 1-877-294-2582 or visit our website at: [www.ford.ca](http://www.ford.ca).

### HAZARD FLASHER CONTROL

Use only in an emergency to warn traffic of vehicle breakdown, approaching danger, etc. The hazard flashers can be operated when the ignition is on or off.

- The hazard lights control is located on the instrument panel.
- Depress hazard lights control to activate all hazard flashers simultaneously.
- Depress control again to turn the flashers off.

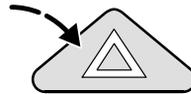

## Roadside Emergencies

### FUEL PUMP SHUT-OFF SWITCH

After a collision, if the engine cranks but does not start, the fuel pump shut-off switch may have been activated. The shut-off switch is a device intended to stop the electric fuel pump when your vehicle has been involved in a substantial jolt.

1. Turn the ignition to the OFF position.
2. Check the fuel system for leaks.
3. If no fuel leak is apparent, remove the cover plug in the trim and reset the fuel pump shut-off switch by pushing in the button on the switch.
4. Turn the ignition to the ON/RUN position. Pause for a few seconds and return the key to the OFF position.
5. Make a further check for leaks in the fuel system.

The fuel pump shut-off switch is located in the passenger's foot well, behind the kick panel. The reset button is accessible through the recess in the kick panel.

Replace the cover plug in trim after reset procedure.

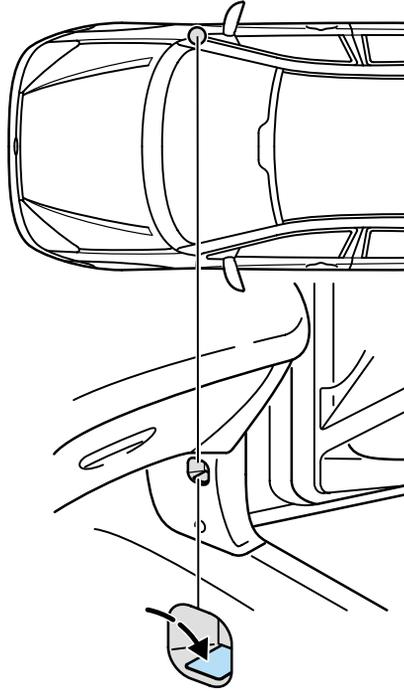

## Roadside Emergencies

### FUSES AND RELAYS

#### Fuses

If electrical components in the vehicle are not working, a fuse may have blown. Blown fuses are identified by a broken wire within the fuse. Check the appropriate fuses before replacing any electrical components.

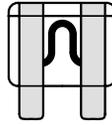

Always replace a fuse with one that has the specified amperage rating. Using a fuse with a higher amperage rating can cause severe wire damage and could start a fire.

# Roadside Emergencies

## Standard fuse amperage rating and color

Color				
Fuse rating	Mini fuses	Standard fuses	Maxi fuses	Fuse link cartridge
2A	Grey	Grey	-	-
3A	Violet	Violet	-	-
4A	Pink	Pink	-	-
5A	Tan	Tan	-	-
7.5A	Brown	Brown	-	-
10A	Red	Red	-	-
15A	Blue	Blue	-	-
20A	Yellow	Yellow	Yellow	Blue
25A	Natural	Natural	-	-
30A	Green	Green	Green	Pink
40A	-	Orange	Orange	Orange
50A	-	-	Red	Red
60A	-	-	Blue	Yellow
70A	-	-	Tan	Brown
80A	-	-	Natural	Black

## Passenger compartment fuse panel

The fuse panel is located below and to the left of the steering wheel by the brake pedal. Remove the panel cover to view the fuses.

Access the fuses from below the panel cover.

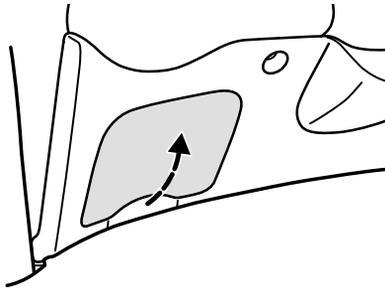

# Roadside Emergencies

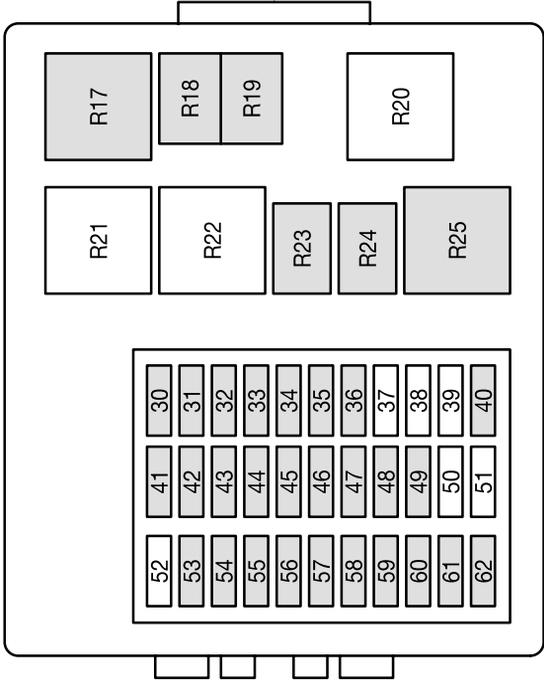

The fuses and relays are coded as follows.

## Roadside Emergencies

Passenger compartment fuse panel		
Fuse	Fuse amp. rating	Description
30	10	Light switch
31	15	Radio
32	15	Turn signal
33	20	Horn
34	20	Power sunroof
35	7.5	Interior lamps, power mirrors
36	7.5	A/C switch, hazard flasher, instrument cluster
37	-	Not used
38	-	Not used
39	-	Not used
40	10	Back-up lamps (automatic transmission)
41	7.5	Radio and cluster (accessory)
42	15	Stop lamps
43	15	Rear wiper
44	20	Fog lamps
45	7.5	Recirculated air, air conditioning
46	7.5	ABS
47	20	Cigar lighter
48	10	Data link connector
49	25	Rear defrost
50	-	Not used

## Roadside Emergencies

<b>Passenger compartment fuse panel</b>		
Fuse	Fuse amp. rating	Description
51	-	Not used
52	-	Not used
53	10	Back-up lamps (manual transmission), speed control
54	25	Rear power windows
55	25	Front power windows
56	20	Front wipers
57	7.5	Position and side lights (right)
58	7.5	Position and side lights (left)
59	7.5	Light switch (headlamps)
60	7.5	Air bag module
61	7.5	PATS modules, instrument cluster
62	7.5	License plate lamp
63	20	Power locks (GEM) (on back side of fuse panel)

<b>Relays in the passenger compartment fuse panel</b>	
Relay	Description
17	Starter
18	Rear intermittent wiper
19	Front intermittent wiper
20	Not used
21	Not used
22	Not used
23	Horn
24	Battery saver
25	Rear defrost

# Roadside Emergencies

## Power distribution box

The power distribution box is located in the engine compartment. The power distribution box contains high-current fuses that protect your vehicle's main electrical systems from overloads.

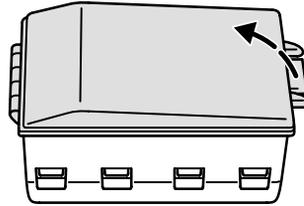

Always disconnect the battery before servicing high current fuses.



Always replace the cover to the Power Distribution Box before reconnecting the battery or refilling fluid reservoirs.

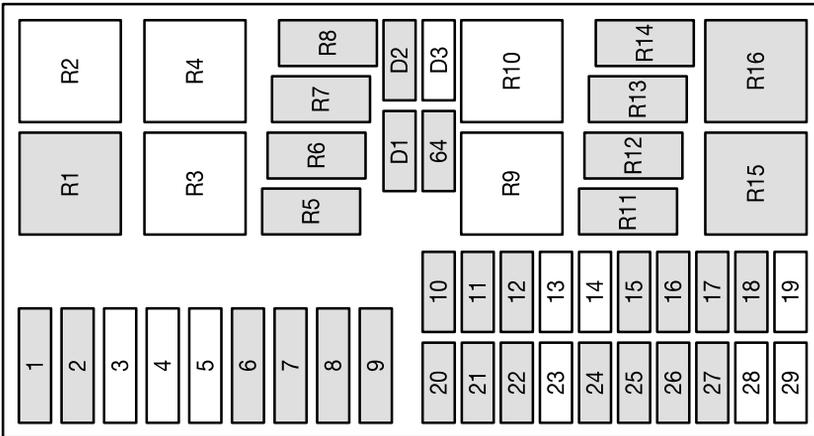

The high-current fuses are coded as follows.

## Roadside Emergencies

Power distribution box		
Fuse	Fuse amp. rating	Description
1	40	Main power supply to electrical system
2	30	Engine cooling fan (A/C) 2nd fuse
3	-	Not used
4	-	Not used
5	-	Not used
6	50	Engine cooling fan (A/C) 1st fuse
7	40	Main power supply to electrical system
8	30	Ignition switch, starter
9	20	Engine management
10	10	Battery voltage sensor
11	30	ABS
12	15	Fuel pump
13	-	Not used
14	-	Not used
15	10	AC clutch solenoid
16	10	Low beam (left side - conventional headlamps)
	15	Low beam (left side - HID headlamps)
17	10	Low beam (right side - conventional headlamps)
	15	Low beam (right side - HID headlamps)
18	10	Heated oxygen sensors
19	-	Not used
20	10	Engine module
21	20	ABS
22	20	Low beam (DRL)
23	-	Not used
24	30	MACH 500 subwoofer
25	30	MACH 500 subwoofer
26	10	High beam (left side)
27	10	High beam (right side)
28	-	Not used
29	-	Not used
64	40	Heater blower motor

## Roadside Emergencies

Relays in the power distribution box	
Relay	Description
1	Ignition
2	Not used
3	Not used
4	Not used
5	High beams
6	Low beams
7	Fuel pump
8	Engine management
9	Not used
10	Not used
11	Air conditioning
12	Daytime running lights
13	Fog lamps
14	Stop lamp inhibit relay (AdvanceTrac <sup>™</sup> only)
15	Engine cooling fan level 2 (A/C)
16	Engine cooling fan level 1

## Roadside Emergencies

### CHANGING THE TIRES

If you get a flat tire while driving, do not apply the brake heavily. Instead, gradually decrease your speed. Hold the steering wheel firmly and slowly move to a safe place on the side of the road.

### The temporary spare tire

Your vehicle has a temporary spare tire. The temporary spare tire for your vehicle is labeled as such. It is smaller than a regular tire and is designed for emergency use only.

Vehicles with AdvanceTrac™ (if equipped) may exhibit some unusual driving characteristics which can be avoided by switching AdvanceTrac™ off. Drive cautiously and replace the temporary spare tire as soon as possible.

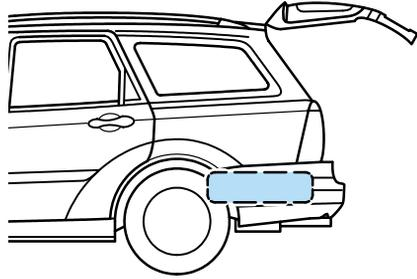

If you use the temporary spare tire continuously or do not follow these precautions, the tire could fail, causing you to lose control of the vehicle, possibly injuring yourself or others.

## Roadside Emergencies

When driving with a temporary spare tire **do not**:

- exceed 80 km/h (50 mph) or drive further than 3,200 km (2,000 miles) total under any circumstances
- load the vehicle beyond maximum vehicle load rating listed on the Safety Compliance Label
- tow a trailer
- drive through an automatic car wash, because of the vehicle's reduced ground clearance
- try to repair the temporary spare tire or remove it from its wheel
- drive for long distances when the temporary-use spare is on
- operate the vehicle with more than one temporary-use spare tire
- improperly inflate the temporary-use spare
- use the wheel for any other type of vehicle
- use more than one temporary spare tire a time

Use of a temporary spare tire at any one wheel location can lead to impairment of the following:

- Handling, stability and braking performance
- Comfort and noise
- Ground clearance and parking at curbs
- Winter driving capability



## Roadside Emergencies

 WHEN TREADWEAR INDICATORS APPEAR ON THE TIRE, REPLACE THE TIRE AND WHEEL. DO NOT RE-USE THIS WHEEL ONCE THE ORIGINAL TIRE IS WORN OUT. THE LIMITED LIFE DESIGN OF THIS WHEEL NECESSITATES ITS REPLACEMENT AFTER THE SERVICE LIFE OF ONE TIRE IS EXHAUSTED.

### Tire change procedure

 To prevent the vehicle from moving when you change a tire, be sure the parking brake is set, then block (in both directions) the wheel that is diagonally opposite (other side and end of the vehicle) to the tire being changed.

 If the vehicle slips off the jack, you or someone else could be seriously injured.

1. Park on a level surface, activate hazard flashers and set parking brake.
2. Place gearshift lever in P (Park) or R (manual transaxle), turn engine OFF, and block the wheel diagonally opposite from the flat tire.

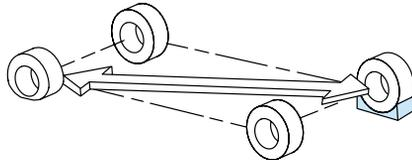

## Roadside Emergencies

3. Remove the spare tire by loosening the tie down bolt in a counterclockwise direction. Take note of the jack position before removal in order to assist in restowing when finished. The jack can be removed by loosening the jack tie down bolt in the counterclockwise direction.

The lug wrench is located in a bag next to the spare tire in the tub (Coupe and 5-door) or in a foam donut on top of the spare tire (Sedan and Wagon).

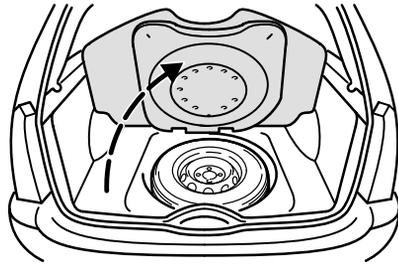
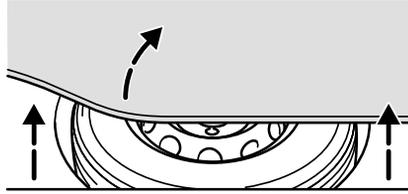

On Coupe models, remove the access door (if equipped) on the lower rocker moulding by unsnapping. This allows access to the proper jack lift points.

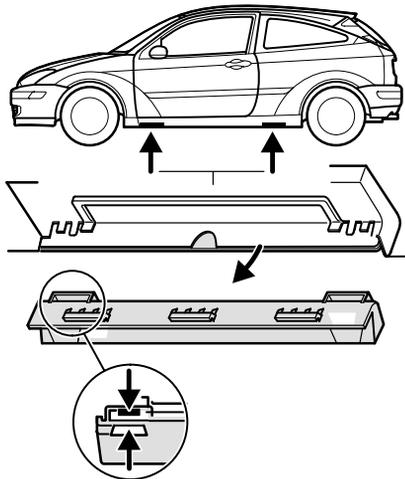

## Roadside Emergencies

4. Remove the center cap or wheel cover. Loosen each wheel lug nut one-half turn counterclockwise but do not remove them until the wheel is raised off the ground.

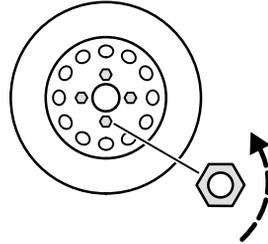

5. The vehicle jacking points are depicted on the yellow warning label on the jack shown here. Locate the jack at the half moon cutout located

- approximately 15 cm (6 inches) from the front wheel opening (1).
- approximately 38 cm (15 inches) from the rear wheel opening (2).

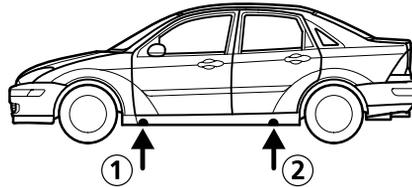
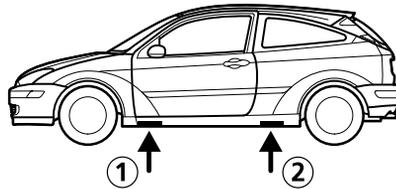

**Jack at the specified locations to avoid damage to the vehicle.**

Turn the jack handle counterclockwise to lower the jack until it can be inserted under the vehicle at the jacking point.

Turn the jack handle clockwise to raise the jack. While raising the jack, be sure the body flange engages the slot on top of jack as shown.

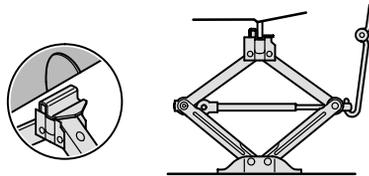

Turn the jack handle clockwise until the wheel is completely off the ground.

## Roadside Emergencies

In a heavily loaded vehicle condition and/or unusual emergency conditions such as the loss of the tire from the wheel rim, the vehicle may be resting so close to the ground that it may be difficult to insert the jack under the vehicle at the specified jacking location. In this event, insert the jack under the vehicle at a point forward or rearward of the jacking location and slide it into the correct jacking position location.



To lessen the risk of personal injury, do not put any part of your body under the vehicle while changing a tire. Do not start the engine when your vehicle is on the jack. The jack is only meant for changing the tire.

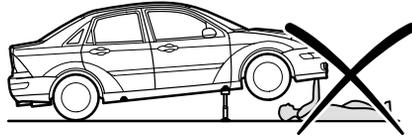

**Do not use the suspension as a jacking point.**

## Roadside Emergencies

6. Remove the lug nuts with the lug wrench.
7. Replace the flat tire with the spare tire, making sure the valve stem is facing outward. Reinstall lug nuts until the wheel is snug against the hub. Do not fully tighten the lug nuts until the wheel has been lowered.

When using a temporary tire, the lug nut washers will not appear to be flush with the rim. This is normal when using the temporary spare tire only.

8. Lower the wheel by turning the jack handle counterclockwise.
9. Remove the jack and fully tighten the lug nuts in the order shown.
10. Put flat tire, jack and lug wrench away. Make sure jack and flat tire are fastened so they do not rattle when you drive.

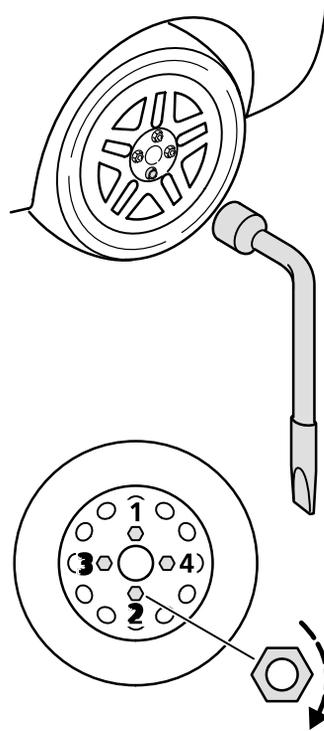

To restow the jack, adjust the jack to the half raised position. The jack has been correctly adjusted for restowage when the tip of the jack screw extends 1 inch beyond the edge on the jack channel as shown. Reposition the jack under the spare and fasten with the hold down screw. Reinstall the spare tire and lug wrench and fasten into position.

11. On Coupe models, reinstall lower rocker moulding access door (if equipped).
12. Unblock the wheels.

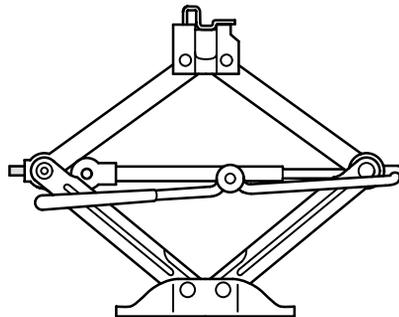

## Roadside Emergencies

### JUMP STARTING YOUR VEHICLE



The gases around the battery can explode if exposed to flames, sparks, or lit cigarettes. An explosion could result in injury or vehicle damage.



Do not push start your vehicle. You could damage the catalytic converter.



Batteries contain sulfuric acid which burns skin, eyes, and clothing, if contacted.

**Do not attempt to push start your vehicle. Automatic transaxles do not have push-start capability.**

### Preparing your vehicle

1. **Use only a 12-volt supply to start your vehicle.**
2. Do not disconnect the battery of your disabled vehicle as this could damage the vehicle's electrical system.

## Roadside Emergencies

3. Park the booster vehicle close to the hood of your disabled vehicle, making sure the two vehicles **do not** touch. Set the parking brake on both vehicles and stay clear of the engine cooling fan and other moving parts.
4. Check all battery terminals and remove any excessive corrosion before you attach the battery cables. Ensure that vent caps are tight and level.
5. Turn all accessories off.

### Connecting the jumper cables

1. Connect the positive (+) booster cable to the positive (+) terminal of the discharged battery.

**Note:** In the illustrations, *lightning bolts* are used to designate the assisting (boosting) battery.

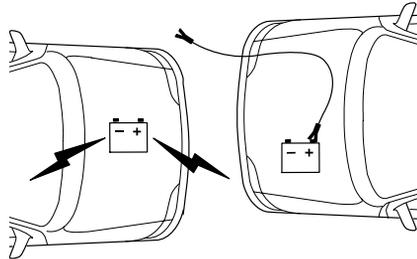

## Roadside Emergencies

2. Connect the other end of the positive (+) cable to the positive (+) terminal of the assisting battery.

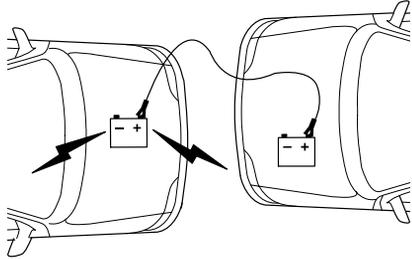

3. Connect the negative (-) cable to the negative (-) terminal of the assisting battery.

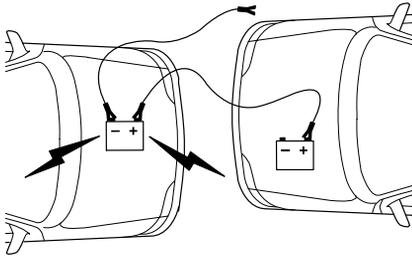

## Roadside Emergencies

4. Make the final connection of the negative (-) cable to an exposed metal part of the stalled vehicle's engine, away from the battery.

**Do not** use fuel lines, engine rocker covers, or the intake manifold as *grounding* points.



Do not connect the end of the second cable to the negative (-) terminal of the battery to be jumped. A spark may cause an explosion of the gases that surround the battery.

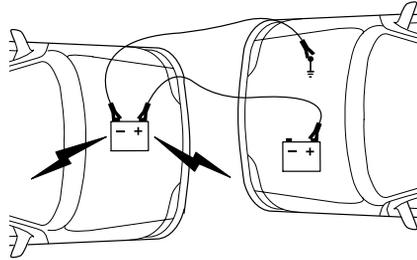

- 2.0 litre Zetec engine

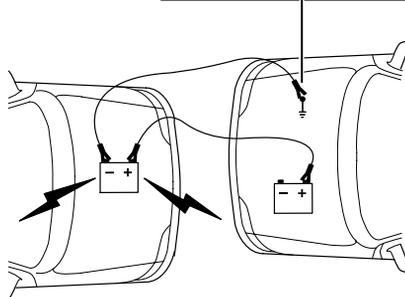
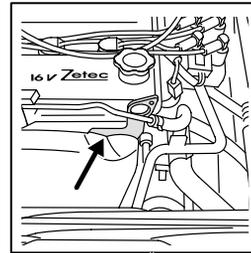

## Roadside Emergencies

- 2.0 litre SPI engine
5. Be sure that the cables are clear of fan blades, belts and other moving parts of both engines.

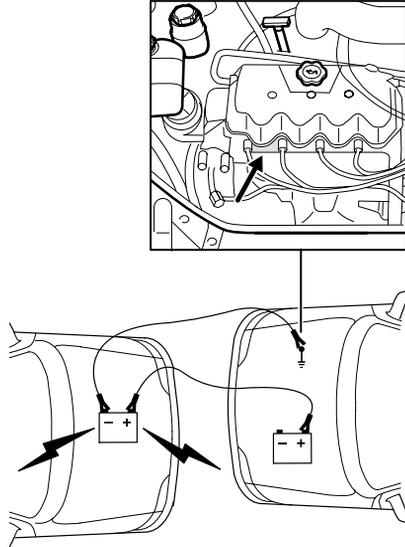

## Roadside Emergencies

### Jump starting

1. Start the engine of the booster vehicle and run the engine at a moderately increased speed.
2. Start the engine of the disabled vehicle.
3. Once the disabled vehicle has been started, run both engines for a further three minutes before disconnecting the jumper cables.

### Removing the jumper cables

**Remove the jumper cables in the reverse order that they were connected.**

1. Remove the jumper cable from the *ground* metal surface.

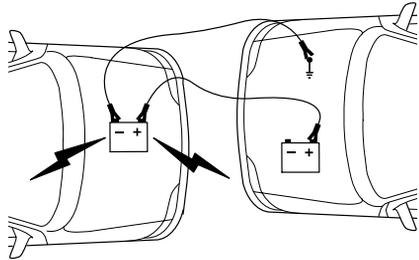

## Roadside Emergencies

2. Remove the jumper cable on the negative (-) connection of the booster vehicle's battery.

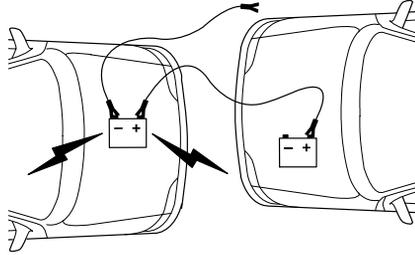

3. Remove the jumper cable from the positive (+) terminal of the booster vehicle's battery.

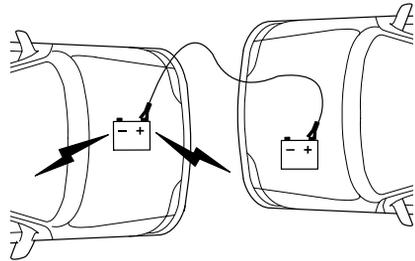

4. Remove the jumper cable from the positive (+) terminal of the disabled vehicle's battery.

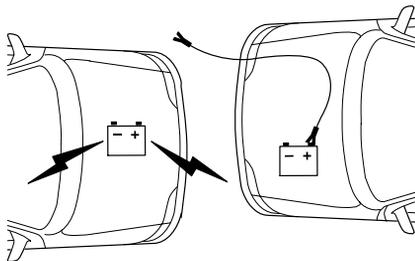

After the disabled vehicle has been started and the jumper cables removed, allow it to idle for several minutes so the engine computer can *relearn* its idle conditions.

## Roadside Emergencies

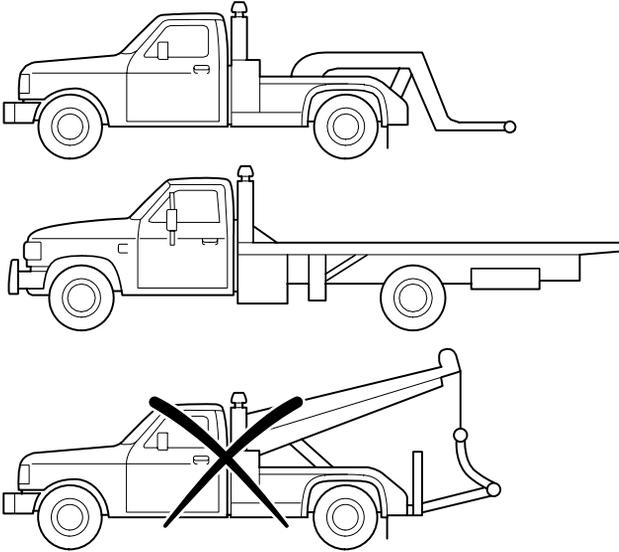

### **WRECKER TOWING**

If you need to have your vehicle towed, contact a professional towing service or, if you are a member, your roadside assistance center.

It is recommended that your vehicle be towed with a wheel lift or flatbed equipment. Do not tow with a slingbelt. Ford Motor Company has not approved a slingbelt towing procedure.

## Roadside Emergencies

If your vehicle is to be towed from the rear using wheel lift equipment, the front wheels (drive wheels) must be placed on a dolly to prevent damage to the transaxle.

Ford Motor Company provides a towing manual for all authorized tow truck operators. Have your tow truck operator refer to this manual for proper hook-up and towing procedures for your vehicle.

In case of a roadside emergency with a disabled vehicle (without access to wheel dollies, car hauling trailer or flatbed transport vehicle) your vehicle can be flat towed (all wheels on the ground) under the following conditions:

- The transmission is placed in N (Neutral).
- Maximum speed is 56 km/h (35 mph).
- Maximum distance is 80 km (50 miles).

## Customer Assistance

### GETTING THE SERVICE YOU NEED

#### At home

Ford Motor Company and Ford of Canada have authorized dealerships to service your vehicle. When you need warranty repairs your selling dealer would like you to return to it for that service, but you may also take your vehicle to another Ford Motor Company dealership authorized for warranty repairs. Certain warranty repairs require special training though, so not all dealers are authorized to perform all warranty repairs. That means that depending on the warranty repair needed, the vehicle may need to be taken to another dealer. If a particular dealership can not assist you, then contact the Customer Assistance Center.

If you are not satisfied with the service you receive at the dealership, contact your Service Advisor for assistance. If the concern or injury remains unresolved, speak with the service manager. If you are still not satisfied, speak with the owner or general manager of the dealership. In most cases, your concern will be resolved at this level.

Ford Motor Company and Ford of Canada dealerships also carry genuine Ford parts and accessories, providing you with original equipment reliability.

#### Away from home

If you are away from home when your vehicle needs service, or if you need more help than the dealership could provide after following the steps described above, contact the Ford Customer Assistance Center to find an authorized dealership to help you in the United States

Ford Motor Company  
Customer Assistance Center  
16800 Executive Plaza Drive  
P.O. Box 6248  
Dearborn, Michigan 48121  
1-800-392-3673 (FORD)  
(TDD for the hearing impaired:  
1-800-232-5952)

In Canada:  
Customer Assistance Centre  
Ford Motor Company of Canada,  
Limited  
P.O. Box 2000  
Oakville, Ontario L6J 5E4  
1-800-565-3673 (FORD)

Please have the following information available when contacting Ford Customer Assistance:

- Your telephone number (home and business)
- The name of the dealer and the city where the dealership is located
- The year and make of your vehicle

## Customer Assistance

- The date of vehicle purchase
- The current odometer reading
- The vehicle identification number (VIN)

If you still have a complaint involving a warranty dispute, you may wish to contact the Dispute Settlement Board (U.S.) or the Mediation/Arbitration Program (Canada).

In the United States, a warranty dispute must be submitted to the Dispute Settlement Board before taking action under the Magnuson-Moss Warranty Act, or to the extent allowed by state law, before pursuing replacement or repurchase remedies provided by certain state laws. This dispute handling procedure is not required prior to enforcing state created rights or other rights which are independent of the Magnuson-Moss Warranty Act or state replacement or repurchase laws.

## Customer Assistance

### Ford extended service plan

You can get more protection for your new car or light truck by purchasing Ford Extended Service Plan (Ford ESP) coverage. Ford ESP is an optional service contract which is backed by Ford Motor Company or Ford Motor Service Company (in the U.S.) and Ford of Canada (in Canada). It provides:

- Protection against repair costs after your New Vehicle Limited Warranty period expires;

and

- other benefits during the warranty period (such as reimbursement for rentals and towing).

You may purchase Ford ESP from any participating Ford or Lincoln-Mercury or Ford of Canada dealer. There are several plans available in various time, distance and deductible combinations which can be tailored to fit your own driving needs. Ford ESP also offers reimbursement benefits for towing and rental coverage. (In Hawaii, rules vary. See your dealer for details.)

When you buy Ford ESP you receive Peace-of-Mind protection throughout the United States and Canada, provided by a network of more than 5,200 participating Ford, Lincoln-Mercury and Ford of Canada dealers.

If you did not take advantage of the Ford Extended Service Plan at the time of purchasing your vehicle, you may still be eligible. Please contact your dealer for further information. Since this information is subject to change, please ask your dealer for complete details about Ford Extended Service Plan coverage options.

Also, please be aware that some dealers offer service contracts that are not backed by Ford Motor Company or Ford of Canada. On the surface, many independent plans appear to be like Ford's. The problem is that they can often require the use of non-factory approved parts and have much more complex and restrictive claims coverage terms than Ford.

At Ford Motor Company and Ford of Canada, we are dedicated to providing Ford, Lincoln and Mercury vehicle owners with programs that will enhance your ownership experience and protect you from unexpected repair bills. Genuine Ford ESP is the only Extended Service Plan that enables us to provide that service.

## Customer Assistance

### THE DISPUTE SETTLEMENT BOARD (U.S. only)

The Dispute Settlement Board (DSB) is

- an independent, third-party arbitration program for warranty disputes
- available free to owners and lessees of qualifying Ford Motor Company vehicles

NOTE: The Dispute Settlement Board may not be available in all states: Ford Motor Company reserves the right to change eligibility limitations, modify procedures and/or to discontinue this service without notice and without incurring obligations per applicable state law.

### What kinds of cases does the Board review?

Unresolved warranty repair concerns or vehicle performance as designed concerns on Ford, Mercury and Lincoln cars and Ford, Mercury and Lincoln light trucks which are within the terms of any applicable written new vehicle warranty are eligible for review, except those involving:

- a non-Ford product
- a non-Ford dealership

- sales disputes between customer and dealer except those associated with warranty repairs or concerns with the vehicle's performance as designed
- a request for reimbursement of consequential expenses unless a service or product concern is being reviewed
- items not covered by the New Vehicle Limited Warranty (including maintenance and wear items)
- alleged personal injury/property damage claims
- cases currently in litigation
- vehicles not used primarily for family, personal or household purposes (except in states where the Dispute Settlement Board is required to review commercial vehicles).
- vehicles with non-U.S. warranties

Concerns are ineligible for review if the New Vehicle Limited Warranty has expired at receipt of your application and in certain states eligibility is dependent upon the customer's possession of the vehicle.

Eligibility may differ according to state law. For example see the unique brochures for California, West Virginia, Georgia and Wisconsin purchasers/lessees.

## Customer Assistance

### Board membership

The Board consists of:

- three consumer representatives
- a Ford or Lincoln-Mercury dealership representative

Consumer candidates for Board membership are recruited and trained by an independent consulting firm. The dealership Board member is chosen from Ford and Lincoln-Mercury dealership management, recognized for their business leadership qualities.

### What the Board needs

To have your case reviewed you must complete the application in the DSB brochure and mail it to the address provided on the application form.

Your application is reviewed and, if it is determined to be eligible, you will receive an acknowledgement indicating:

- the file number assigned to your application
- the toll-free phone number of the DSB's independent administrator

Your dealership and a Ford Motor Company representative will be asked to submit statements.

To properly review your case, the Board needs the following information:

- legible copies of all documents and maintenance or repair orders relevant to the case
- the year, make, model, and Vehicle Identification Number (VIN) listed on your vehicle ownership license
- the date of repair(s) and mileage at the time of occurrence(s)
- the current mileage
- the name of the dealer(s) who sold or serviced the vehicle
- a brief description of your unresolved concern
- a brief summary of the action taken by the dealer(s) and Ford Motor Company
- the names (if known) of all the people you contacted at the dealership(s)
- a description of the action you expect to resolve your concern

You will receive a letter of explanation if your application does not qualify for Board review.

## Customer Assistance

### Oral presentations

If you would like to make an oral presentation indicate YES to question #6 on the application. While it is your right to make an oral presentation before the Board, this is not a requirement and the Board will decide the case whether or not an oral presentation is made. Oral presentation may be requested by the Board as well.

### Making a decision

Board members review all available information related to each complaint, including oral presentations, and arrive at a fair and impartial decision.

Every effort is made to decide the case within 40 days of the date that all requested information is received by the Board. Since the Board generally meets once a month, it may take longer for the Board can consider some cases.

After a case is reviewed, the Board mails you a decision letter and a form on which to accept or reject the Board's decision. The decisions of the Board are binding on Ford (and, in some cases, on the dealer) but not on consumers who are free to pursue other remedies available to them under state or federal law.

### To request a DSB brochure/application

For a brochure/application, speak to your dealer or write/call to the Board at the following address/phone number:

Dispute Settlement Board  
P.O. Box 5120  
Southfield, MI 48086-5120  
1-800-428-3718

You may also contact the North American Customer Assistance Center at 1-800-392-3673 (Ford). TDD for the hearing impaired: 1-800-232-5952 or by writing to the Center at the following address:

Ford Motor Company  
Customer Assistance Center  
16800 Executive Plaza Drive  
P.O. Box 6248  
Dearborn, Michigan 48121

## Customer Assistance

### **UTILIZING THE MEDIATION/ARBITRATION PROGRAM (CANADA ONLY)**

In those cases where you continue to feel that the efforts by Ford and the dealer to resolve a factory-related vehicle service concern have been unsatisfactory, Ford of Canada participates in an impartial third party mediation/arbitration program administered by the Canadian Motor Vehicle Arbitration Plan (CAMVAP)

The CAMVAP program is a straight forward and relatively speedy alternative to resolve a disagreement when all other efforts to produce a settlement have failed. This procedure is without cost to you and is designed to eliminate the need for lengthy and expensive legal proceedings.

In the CAMVAP program, impartial third party arbitrators conduct hearings at mutually convenient times and places in an informal environment. These impartial arbitrators review the positions of the parties, make decisions and, when appropriate, render awards to resolve disputes. CAMVAP decisions are fast, fair, and final, the arbitrator's award is binding both to you and Ford of Canada.

CAMVAP services are available in all territories and provinces. For more information, without charge or obligation, call your CAMVAP Provincial Administrator directly at 1 800-207-0685.

## Customer Assistance

### GETTING ASSISTANCE OUTSIDE THE U.S. AND CANADA

Before exporting your vehicle to a foreign country, contact the appropriate foreign embassy or consulate. These officials can inform you of local vehicle registration regulations and where to find unleaded fuel.

If you cannot find unleaded fuel or can only get fuel with an anti-knock index lower than is recommended for your vehicle, contact a district or owner relations/customer assistance office.

The use of leaded fuel in your vehicle without proper conversion may damage the effectiveness of your emission control system and may cause engine knocking or serious engine damage. Ford Motor Company/Ford of Canada is not responsible for any damage caused by use of improper fuel.

In the United States, using leaded fuel may also result in difficulty importing your vehicle back into the U.S.

If your vehicle must be serviced while you are traveling or living in Central or South America, the Caribbean, or the Middle East, contact the nearest Ford dealership. If the dealership cannot help you, write or call:

FORD MOTOR COMPANY  
WORLDWIDE DIRECT MARKET  
OPERATIONS  
1555 Fairlane Drive

Fairlane Business Park #3  
Allen Park, Michigan 48101  
U.S.A.

Telephone: (313) 594-4857  
FAX: (313) 390-9804

If you are in another foreign country, contact the nearest Ford dealership. If the dealership employees cannot help you, they can direct you to the nearest Ford affiliate office.

If you buy your vehicle in North America and then relocate outside of the U.S. or Canada, register your vehicle identification number (VIN) and new address with Ford Motor Company Worldwide Direct Market Operations.

### ORDERING ADDITIONAL OWNER'S LITERATURE

To order the publications in this portfolio:

Make checks payable to:  
HELM, INCORPORATED  
P.O. Box 07150  
Detroit, Michigan, 48207

**For a free publication catalog,  
order toll free: 1-800-782-4356**

Monday-Friday 8:00 a.m. - 6:00  
p.m. EST,  
for credit card holders only.

## Customer Assistance

### **REPORTING SAFETY DEFECTS (U.S. ONLY)**

If you believe that your vehicle has a defect which could cause a crash, or could cause injury or death, you should immediately inform the National Highway Traffic Safety Administration (NHTSA) in addition to notifying Ford Motor Company.

If NHTSA receives similar complaints, it may open an investigation, and if it finds that a safety defect exists in a group of vehicles, it may order a recall and remedy campaign. However, NHTSA cannot become involved in individual problems between you, your dealer or Ford Motor Company.

To contact NHTSA, you may either call the Auto Safety Hotline toll-free at 1-800-424-9393 (202-366-0123 in the Washington D.C. area) or write to:

NHTSA  
U.S. Department of Transportation  
400 Seventh Street  
Washington D.C. 20590

You can also obtain other information about motor vehicle safety from the Hotline.

*Ford Motor Company*

# Cleaning

## CLEANING AND CARING FOR YOUR VEHICLE

Refer to the *Accessories* chapter for a list of Ford-approved cleaners, polishes and sealants.

### **Washing the exterior of your vehicle**

Never wash a vehicle that is "hot to the touch" or during exposure to strong, direct sunlight. It is recommended that you wash your vehicle regularly with cool or lukewarm water and a neutral Ph shampoo, such as Detail Wash (ZC-3-A), which is available from your authorized Ford, Lincoln or Mercury dealer. Always use a clean sponge or carwash mitt with plenty of water for best results. Dry the vehicle with a chamois or soft terry cloth towel in order to eliminate water spotting.

**Never use strong household detergents or soap, such as dish washing or laundry liquid. These products can discolor and spot painted surfaces.**

It is especially important to wash the vehicle regularly during winter months, as dirt and road salt are difficult to remove and do cause damage to the vehicle. Items such as gasoline, diesel fuel, bird droppings and insect deposits should be washed and sponged off as soon as possible. Deposits not removed promptly can cause damage to the vehicle's paintwork and trim over time.

**Remove any exterior accessories, such as antennas, before entering a car wash.**

### **Protecting your vehicles' paint finish**

Applying a polymer paint sealant to your vehicle on a regular basis will assist in reducing minor scratches and paint damage. A typical paint sealant lasts approximately six months to a year, depending on local weather conditions and the cleaning soap that is used in washing the vehicle.

**Do not use a wax that beads excessively.**

**Do not allow paint sealant to come in contact with any non-body (low-gloss black) colored trim, such as grained door handles, roof racks, bumpers, side moldings, mirror housings or the windshield cowl area. The paint sealant will "gray" or stain the parts over time.**

## Cleaning

### Repairing paint chips

Remove particles such as bird droppings, tree sap, insect deposits, tar spots, road salt and industrial fallout before repairing paint chips.

Minor scratches or paint damage from road debris may be repaired using the Ultra Touch Prep and Finishing Kit (F7AZ-19K507-BA), which is available at your authorized Ford, Lincoln or Mercury dealer. This kit contains:

- Lacquer Touch-Up Paint (ALBZ-19500-XXXXA)
- Exterior Acrylic Spray Lacquer (ALAZ-19500-XXXXA)

Please note that the part numbers (shown as XXXX above) will vary with your vehicle's specific coloring.

**Carefully observe the application instructions on the products.**

### Cleaning the wheel rims and covers

**Aluminum wheel rims or covers are coated with a clearcoat paint finish.**

Some automatic car washes may cause damage to the finish on your wheel rims or covers. Chemical-strength cleaners, or cleaning chemicals, in combination with brush agitation to remove brake dust and dirt, could wear away the clearcoat finish over time.

**Do not use hydrofluoric acid-based or high caustic-based wheel cleaners, steel wool, fuels or strong household detergents for soiled wheel rims and covers.**

Never apply any cleaning chemical to hot or warm wheel rims or covers.

Clean wheel rims and covers with Detail Wash (ZC-3-A), which is available from your authorized Ford, Lincoln or Mercury dealer. Spray cleaner on cool wheel rims or covers and allow to set for 2-5 minutes. Agitate the area with a sponge and rinse off with plenty of water.

Use Extra Strength Tar and Road Oil Removal (B7A-19520-AA), available from your authorized Ford, Lincoln or Mercury dealer, in order to remove tar and grease from wheel rims and covers.

## Cleaning

### Cleaning the engine

Engines are more efficient when they are clean because grease and dirt buildup keep the engine warmer than normal. When washing:

- The engine must be cool to the touch before spraying with water.
- **Never spray a hot engine with cold water, as damage to the engine block or engine components may occur.**
- Use caution when using a self-serve power washer (1000psi maximum pressure) to clean the engine, as the high-pressure fluid could penetrate the sealed parts and cause damage.
- **Never apply anything to any exposed belts in the engine compartment, including the belt dressing.**

For general cleaning of the engine and engine compartment, spray Engine Shampoo and Degreaser (FYAZ-19A536-A) on all parts that require cleaning and pressure rinse the area with cool water.

**Never wash or rinse the engine while it is running; water in the running engine may cause internal damage.**

## Cleaning

### 2.0 L SPI Engine

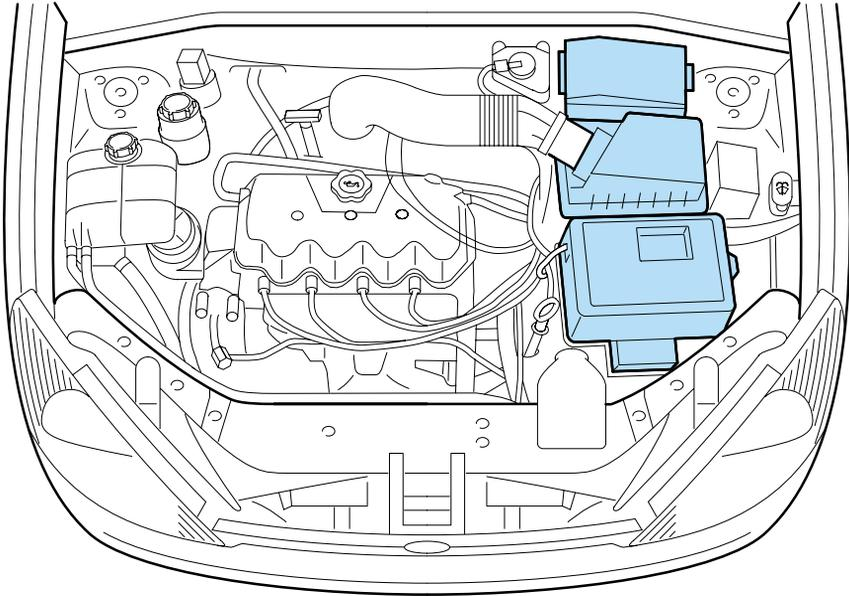

Cover the highlighted areas to prevent water damage when cleaning

# Cleaning

## 2.0 L Zetec-E Engine

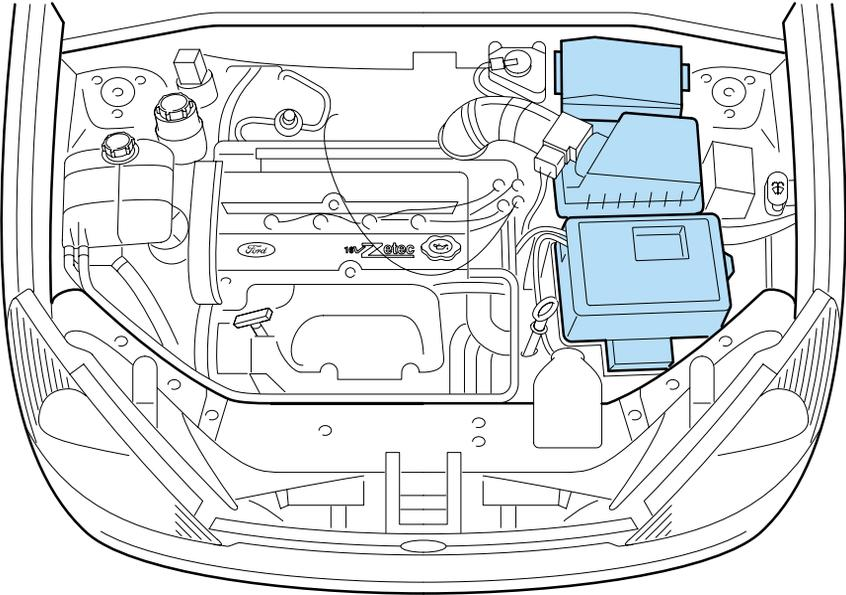

Cover the highlighted areas to prevent water damage when cleaning

### **Washing non-painted plastic exterior parts**

Use Detail Wash (ZC-3-A) for routine cleaning.

If tar or grease spots are present, clean with Extra Strength Tar and Road Oil Removal (B7A-19520-AA).

### **Use only approved products to clean plastic parts.**

These products are available from your authorized Ford, Lincoln or Mercury dealer.

### **Washing mirrors, mirror housings and reflective surfaces**

### **Do not clean mirrors, mirror housings or reflective surfaces with abrasive materials or a dry cloth.**

Use a soft cloth and Detail Wash (ZC-3-A) mixed with water in order to clean the mirror housing. Use Glass Cleaner (E4AZ-19C507-AA) in order to clean the reflective mirror surface.

Use care when removing ice from outside mirrors as you may damage the reflective surface.

## Cleaning

### **Washing the exterior lamps**

**In order to avoid scratching the plastic lamps, do not use dry paper towels, non-approved chemical solvents or abrasive cleaners.**

Use a soft cloth and a solution of Triple Clean (EOAZ-19526-AA), mixed properly with water, in order to remove bug residue. If tar or grease spots are present, clean with Extra Strength Tar and Road Oil Removal (B7A-19520-AA).

### **Cleaning the windshield, wiper blades and rear window**

If the wiper does not wipe properly, substances on the windshield, rear window or the wiper blades may be the cause. These may include hot wax treatments used by commercial car washes, tree sap, or other organic contamination.

**Do not clean the windshield or rear window glass with abrasives, as they may cause scratches.**

**Do not use fuel, kerosene, or paint thinner to clean the windshield, rear window or the wiper blades as damage may occur.**

## Cleaning

Clean the outside of the windshield or rear window with a non-abrasive cleaner such as Ultra Clear Spray Glass Cleaner (E4AZ-19C507-AA), available from your authorized Ford, Lincoln or Mercury dealer. If after cleaning the glass surface, the water sheets from the glass (e.g., does not bead), then the window is clean.

The windshield, rear window and wiper blades should be cleaned regularly. Wiper blades can be cleaned with isopropyl (rubbing) alcohol or windshield washer solution. Be sure to replace wiper blades when they appear worn or do not function properly.

### **Cleaning the instrument panel**

Clean the instrument panel with a damp cloth, then dry with a dry cloth.

Avoid cleaners or polish that increase the gloss of the upper portion of the instrument panel. The dull finish in this area helps protect the driver from undesirable windshield reflection.



Do not use chemical solvents or strong detergents when cleaning the steering wheel or instrument panel to avoid contamination of the air bag system.

## Cleaning

### **Cleaning the instrument cluster lens**

Wipe the cluster area with a soft, damp cotton towel. Dry the area with a clean, dry towel.

### **Cleaning seats equipped with side air bags**

Remove dust and loose dirt with a vacuum cleaner. In order to remove stains and soil, clean with Extra Strength Upholstery Cleaner (E8AZ-19523-AA).

### **Never saturate the seat covers with any cleaning solution.**



Do not use chemical solvents or strong detergents when cleaning the seat where the side air bag is mounted. Such products could contaminate the side air bag system and affect performance of the side air bag in a collision. The air bag may not function correctly and not provide injury reduction benefits.

### **Cleaning the interior fabric, carpets and cloth seats**

Remove dust and loose dirt with a vacuum cleaner. Remove light stains and soil with Extra Strength Upholstery Cleaner (E8AZ-19523-AA).

## Cleaning

**Never saturate the seat covers with cleaning solution.**

**Do not use household cleaning products or glass cleaners, which can stain and discolor the fabric and affect the flame retardent abilities of the seat materials.**

If grease or tar is present on the material, spot-clean the area first with Spot and Stain Remover (F3AZ-19521-WA). Follow up by recleaning the area with Extra Strength Upholstery Cleaner (E8AZ-19523-AA).



Do not use chemical solvents or strong detergents when cleaning the steering wheel or instrument panel to avoid contamination of the air bag system.

### **Cleaning leather seats (if equipped)**

All Ford, Lincoln and Mercury vehicles with leather seating surfaces have a clear, protective coating over the leather.

To clean the leather seats, simply use a soft cloth with Deluxe Leather and Vinyl Cleaner (F2AZ-19521-WA). Dry the area with a soft cloth.

## Cleaning

It is recommended that you use the Deluxe Leather Care Kit (F8AZ-19G253-AA), available from your authorized Ford, Lincoln or Mercury dealer. The mild cleaner and special pad available in the kit cleans the leather and maintains its natural beauty. For best results, follow the instructions printed on the cleaner label. Regular cleaning of your leather upholstery helps maintain its resiliency and color.

**Do not use household cleaning products, alcohol solutions, solvents or cleaners intended for rubber, vinyl and plastics, or oil/petroleum-based leather conditioners. These products may cause premature wearing of the clear, protective coating.**

### **Cleaning the inside windows**

Use Ultra Clear Spray Glass Cleaner (E4AZ-19C507-AA) for the inside windows if they become fogged.

To clean, use two lint-free, soft towels, folded into a pad-shape. Mist the glass completely with cleaner, and use one of the towels to evenly agitate the surface. Use the other towel to remove the residue.

### **Cleaning and maintaining the safety belts**

Clean the safety belts with Extra Strength Upholstery Cleaner (E8AZ-19523-AA), available from your authorized Ford, Lincoln or Mercury dealer.

**Do not use bleach, dye or any other solvent to clean the belts, as these actions may weaken the belt webbing.**

### **Underbody**

Flush the complete underside of your vehicle frequently. Keep body and door drain holes free from packed dirt.

### **Ford, Lincoln and Mercury car care products**

Your Ford, Lincoln or Mercury dealer has many quality products available to clean your vehicle and protect its finishes. These quality products have been specifically engineered to fulfill your automotive needs; they are custom designed to complement the style and appearance of your vehicle. Each product is made from high quality materials that meet or exceed rigid specifications. For best results, use the following or products of equivalent quality:

## Cleaning

- Ford Custom Clearcoat Polish\*
  - Ford Custom Silicone Gloss Polish
  - Ford Custom Vinyl Protectant\* (not available in Canada)
  - Motorcraft Vinyl Conditioner (Canada only)
  - Ford Deluxe Leather and Vinyl Cleaner (not available in Canada)
  - Motorcraft Vinyl Cleaner (Canada only)
  - Ford Extra Strength Tar and Road Oil Remover\* (not available in Canada)
  - Ford Extra Strength Upholstery Cleaner (not available in Canada)
  - Ford Custom Bright Metal Cleaner
  - Motorcraft Premium Car Wash Concentrate
  - Motorcraft Carlite Glass Cleaner (Canada only)
  - Ford Spot and Stain Remover\*
  - Ford Super Premium Tire and Trim Dressing
  - Ford Triple Clean
  - Ford Ultra-Clear Spray Glass Cleaner (not available in Canada)
  - Ford Engine Shampoo and Degreaser
- \* May be sold with the Motorcraft name

## Maintenance and Specifications

### **SERVICE RECOMMENDATIONS**

To help you service your vehicle:

- We highlight do-it-yourself items in the engine compartment for easy location.
- We provide a “Scheduled Maintenance Guide” which makes tracking routine service easy.

If your vehicle requires professional service, your dealership can provide necessary parts and service. Check your “Warranty Guide” to find out which parts and services are covered.

Use only recommended fuels, lubricants, fluids and service parts conforming to specifications. Motorcraft parts are designed and built to provide the best performance in your vehicle.

### **PRECAUTIONS WHEN SERVICING YOUR VEHICLE**

Be especially careful when inspecting or servicing your vehicle.

- Do not work on a hot engine.
- When the engine is running, keep loose clothing, jewelry or long hair away from moving parts.

## Maintenance and Specifications

- Do not work on a vehicle with the engine running in an enclosed space, unless you are sure you have enough ventilation.
- Keep all lit cigarettes, open flames and other lit material away from the battery and all fuel related parts.

If you disconnect the battery, the engine must “relearn” its idle conditions before your vehicle will drive properly, as explained under the *Battery* section in this chapter.

### OPENING THE HOOD

1. Inside the vehicle, pull the hood release handle located at the bottom of the instrument panel below the steering wheel.
2. Go to the front of the vehicle and release the auxiliary latch that is located under the front of the hood.
3. Lift the hood and support it with the yellow end of its strut in the holes in the hood ensuring it is secure.
4. To close, replace the support strut in its retaining clip, lower the hood and allow it to drop into the catch for at least 20 - 30 cm (8 - 12 inches).

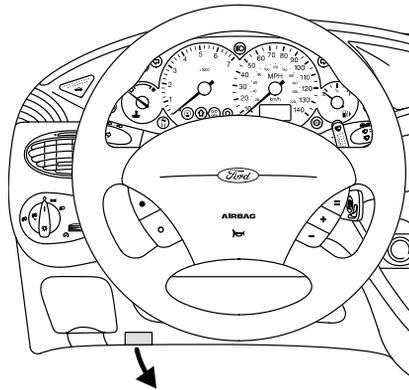

# Maintenance and Specifications

## IDENTIFYING COMPONENTS IN THE ENGINE COMPARTMENT

### 2.0 L SPI Engine

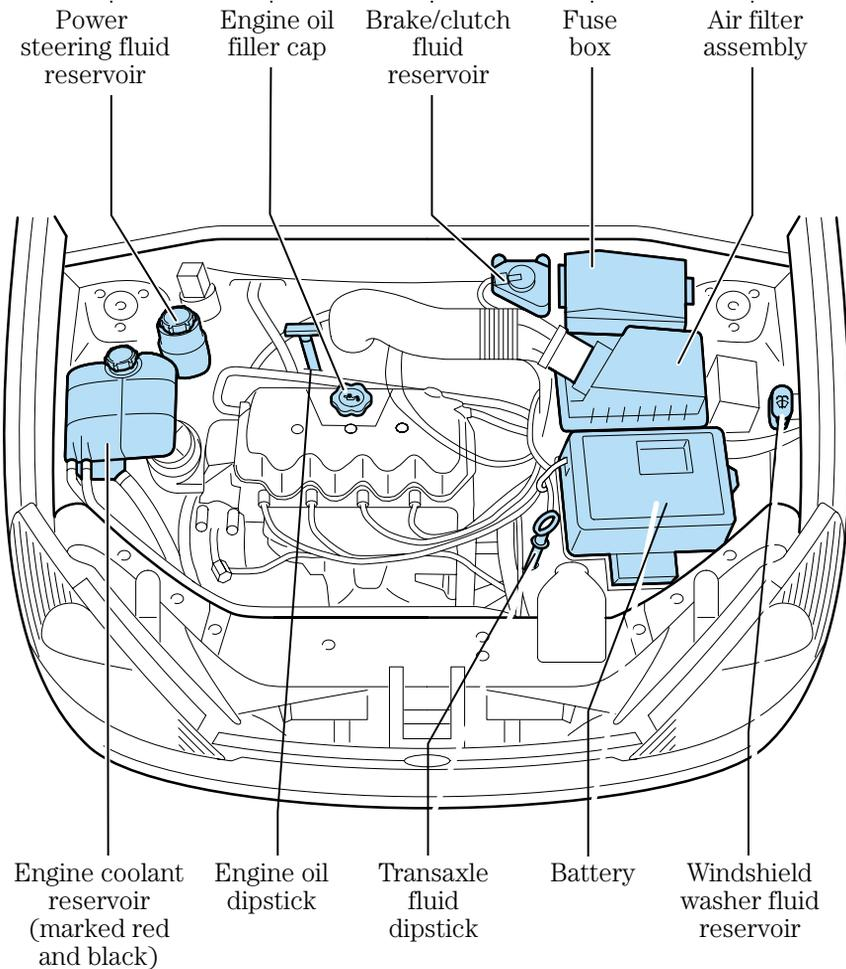

For ease of identification, most filler caps and the engine oil dipstick are marked yellow and black.

# Maintenance and Specifications

## IDENTIFYING COMPONENTS IN THE ENGINE COMPARTMENT

### 2.0 L Zetec-E Engine

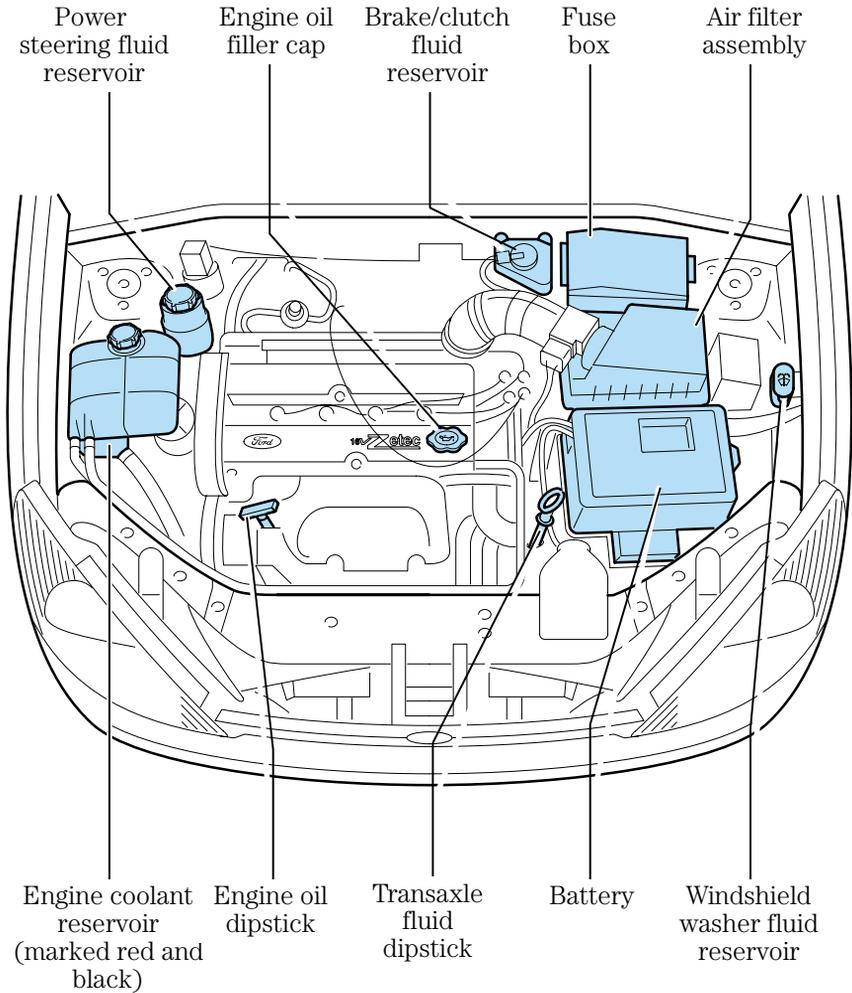

For ease of identification, most filler caps and the engine oil dipstick are marked yellow and black.

## Maintenance and Specifications

### WINDSHIELD WASHER FLUID

#### Checking and adding washer fluid



Check the washer fluid whenever you stop for fuel.

If the level is low, add enough fluid to fill the reservoir. In very cold weather, do not fill the reservoir all the way.

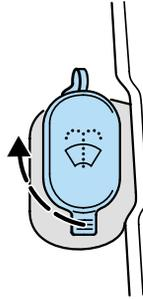

Do not put engine coolant in the container for the windshield washer fluid. If sprayed on the windshield, engine coolant could make it difficult to see through the windshield.

### ENGINE OIL

#### Checking the engine oil

Refer to the “Scheduled Maintenance Guide” for the appropriate intervals for checking the engine oil.

1. Make sure the vehicle is on level ground.
2. Turn the engine off and wait a few minutes for the oil to drain into the oil pan.
3. Set the parking brake and ensure the gearshift is securely latched in P (Park) (automatic transaxle) or 1 (First) (manual transaxle).
4. Open the hood. Protect yourself from engine heat.
5. Locate and carefully remove the engine oil level indicator (dipstick).
6. Wipe the indicator clean. Insert the indicator fully, then remove it again.

## Maintenance and Specifications

- If the oil level is **between the MIN and MAX marks** (2.0 SPI engine) or **between ADD and FULL** (2.0 Zetec-engine), the oil level is acceptable. **DO NOT ADD OIL.**

- If the oil level is below the MIN/ADD mark, add enough oil to raise the level within the MIN-MAX/ADD-FULL range.

- Oil levels above the MAX/FULL mark may cause engine damage. Some oil must be removed from the engine by a service technician.

7. Put the indicator back in and ensure it is fully seated.

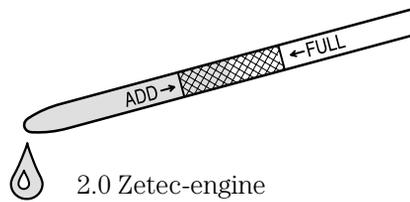
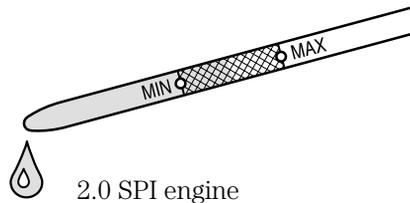

### Adding engine oil

1. Check the engine oil. For instructions, refer to *Checking the engine oil* in this chapter.

2. If the engine oil level is not within the MIN and MAX/ADD and FULL ranges, add only certified engine oil of the recommended viscosity. Remove the engine oil filler cap and use a funnel to pour the engine oil into the opening.

3. Recheck the oil level. **Make sure the oil level is not above the MAX mark** (2.0 SPI engine) **or the FULL mark** (2.0 Zetec-engine) **on the dipstick.**

4. Replace oil filler cap and ensure it is fully tightened.

## Maintenance and Specifications

### Engine oil and filter recommendations

Look for this certification trademark.

### SAE 5W-20 engine oil is recommended.

Use oils “Certified For Gasoline Engines” by the American Petroleum Institute (API).

Use Motorcraft or an equivalent oil meeting Ford specification WSS-M2C153-H. Use oils “Certified For Gasoline Engines” by the American Petroleum Institute (API). SAE 5W-20 oil provides optimum fuel economy and durability performance meeting all requirements for your vehicle’s engine. Do not use supplemental engine oil additives or other engine treatments. They are unnecessary and could lead to engine damage that is not covered by Ford warranty. Change your engine oil according to the appropriate schedule listed in the Scheduled Maintenance Guide.

Ford production and aftermarket (Motorcraft) oil filters are designed for added engine protection and long life. If a replacement oil filter is used that does not meet Ford material and design specifications, start-up engine noises or knock may be experienced.

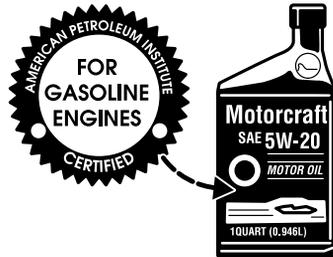

## Maintenance and Specifications

It is recommended you use the appropriate Motorcraft oil filter (or another brand meeting Ford specifications) for your engine application.

### BATTERY

Your vehicle is equipped with a Motorcraft maintenance-free battery which normally does not require additional water during its life of service.

However, for severe usage or in high temperature climates, check the battery electrolyte level. Refer to the “Scheduled Maintenance Guide” for the service interval schedules.

If the electrolyte level in the battery is low, you can add plain tap water to the battery, as long as you do not use hard water (water with a high mineral or alkali content). If possible, however, try to only fill the battery cells with distilled water. If the battery needs water often, have the charging system checked.

**Keep the electrolyte level in each cell up to the “level indicator”. Do not overfill the battery cells.**

For longer, trouble-free operation, keep the top of the battery clean and dry. Also, make certain the battery cables are always tightly fastened to the battery terminals.

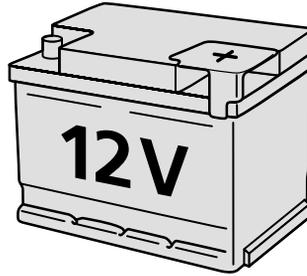

## Maintenance and Specifications

If you see any corrosion on the battery cables or terminals, remove the cables from the terminals and clean with a wire brush. You can neutralize the acid with a solution of baking soda and water. Reinstall the cables when you are done cleaning them.

**If your battery has a cover/shield, make sure it is reinstalled after the battery has been cleaned or replaced.**



Batteries normally produce explosive gases which can cause personal injury. Therefore, do not allow flames, sparks or lighted substances to come near the battery. When working near the battery, always shield your face and protect your eyes. Always provide proper ventilation.

## Maintenance and Specifications



When lifting a plastic-cased battery, excessive pressure on the end walls could cause acid to flow through the vent caps, resulting in personal injury and/or damage to the vehicle or battery. Lift the battery with a battery carrier or with your hands on opposite corners.



Keep batteries out of reach of children. Batteries contain sulfuric acid. Avoid contact with skin, eyes or clothing. Shield your eyes when working near the battery to protect against possible splashing of acid solution. In case of acid contact with skin or eyes, flush immediately with water for a minimum of 15 minutes and get prompt medical attention. If acid is swallowed, call a physician immediately.



Battery posts, terminals and related accessories contain lead and lead compounds. **Wash hands after handling.**

Because your vehicle's engine is electronically controlled by a computer, some control conditions are maintained by power from the battery. When the battery is disconnected or a new battery is installed, the engine must relearn its idle conditions before your vehicle will drive properly. To begin this process:

## Maintenance and Specifications

1. Set your parking brake.
2. Put the gearshift in P (Park) (automatic transaxle) or the neutral position (manual transaxle). Turn off all accessories and start the engine.
3. Let the engine idle for at least one minute.
4. The relearning process will automatically complete as you drive the vehicle.
  - If you do not allow the engine to relearn its idle, the idle quality of your vehicle may be adversely affected until the idle is eventually relearned.
  - If the battery has been disconnected or if a new battery has been installed, the clock and preset radio stations must be reset once the battery is reconnected.



Always dispose of automotive batteries in a responsible manner. Follow your local authorized standards for disposal. Call your local authorized recycling center to find out more about recycling automotive batteries.

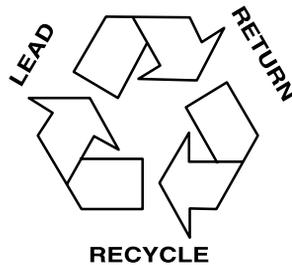

## Maintenance and Specifications

### ENGINE COOLANT

#### Checking engine coolant

The concentration and level of engine coolant should be checked at the mileage intervals listed in the "Scheduled Maintenance Guide". The coolant concentration should be maintained at 50/50 coolant and water, which equates to a freeze point of  $-36^{\circ}\text{C}$  ( $-34^{\circ}\text{F}$ ). Coolant concentration testing is possible with a hydrometer or antifreeze tester (such as the Rotunda Battery and Antifreeze Tester, 014-R1060). The level of coolant should be maintained at the "cold full" or "cold fill range" level in the coolant reservoir. If the level falls below, add coolant per the instructions in the *Adding Engine Coolant* section.

Your vehicle was factory-filled with a 50/50 engine coolant and water concentration. If the concentration of coolant falls below 40% or above 60%, the engine parts could become damaged or not work properly.

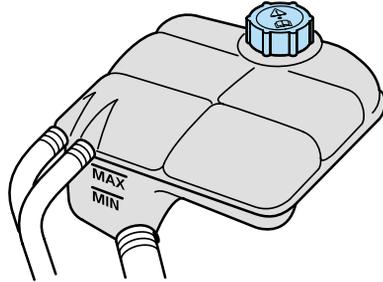

## Maintenance and Specifications

**A 50-50 mixture of coolant and water provides the following:**

- **Freeze protection down to -36° C (-34° F).**
- **Boiling protection up to 129° C (265° F).**
- **Protection against rust and other forms of corrosion.**
- **Enables calibrated gauges to work properly.**

When the engine is cold, check the level of the engine coolant in the reservoir.

- The engine coolant should be at the "cold fill level" or within the "cold fill range" as listed on the engine coolant reservoir (depending upon application).
- Refer to the Scheduled Maintenance Guide for service interval schedules.
- Be sure to read and understand *Precautions when servicing your vehicle* in this chapter.

## Maintenance and Specifications

If the engine coolant has not been checked at the recommended interval, the engine coolant reservoir may become low or empty. If the reservoir is low or empty, add engine coolant to the reservoir. Refer to *Adding engine coolant* in this chapter.

**Note:** Automotive fluids are not interchangeable; do not use engine coolant, antifreeze or windshield washer fluid outside of its specified function and vehicle location.

### Adding engine coolant

When adding coolant, make sure it is a 50/50 mixture of engine coolant and distilled water. Add the mixture to the coolant reservoir, when the engine is cool, until the appropriate fill level is obtained.



Do not add engine coolant when the engine is hot. Steam and scalding liquids released from a hot cooling system can burn you badly. Also, you can be burned if you spill coolant on hot engine parts.



Do not put engine coolant in the windshield washer fluid container. If sprayed on the windshield, engine coolant could make it difficult to see through the windshield.

## Maintenance and Specifications

The cooling system in your vehicle is filled with either green-colored Motorcraft Premium Engine Coolant meeting Ford specification ESE-M97B44-A or yellow-colored Motorcraft Premium Gold Engine Coolant meeting Ford Specification WSS-M97B51-A1. To determine your vehicle's coolant type (color), check your coolant reservoir.

- **Add Motorcraft Premium Engine Coolant (green-colored), VC-4-A (U.S.) or CXC-10 (Canada) or Motorcraft Premium Gold Engine Coolant (yellow-colored), VC-7-A, depending on the type of coolant originally equipped in your vehicle.** If you are unsure which type of coolant your vehicle requires, check your coolant reservoir or contact your local dealer.

**Note:** Use of Motorcraft Cooling System Stop Leak Pellets, VC-6, darkens the color of Motorcraft Premium Engine Coolant from yellow to golden tan.

## Maintenance and Specifications

- **Do not add/mix an orange-colored, extended life coolant such as Motorcraft Speciality Orange Engine Coolant, VC-2 (US) or CXC-209 (Canada), meeting Ford specification WSS-M97B44-D with the factory-filled coolant.**

Mixing Motorcraft Speciality Orange Engine Coolant or any orange-colored extended life product with your factory filled coolant can result in degraded corrosion protection.

- A large amount of water without engine coolant may be added, in case of emergency, to reach a vehicle service location. In this instance, the cooling system must be drained and refilled with a 50/50 mixture of engine coolant and distilled water as soon as possible. Water alone (without engine coolant) can cause engine damage from corrosion, overheating or freezing.

- **Do not use alcohol, methanol or brine or any engine coolants mixed with alcohol or methanol antifreeze (coolant).** Alcohol and other liquids can cause engine damage from overheating or freezing.

- **Do not add extra inhibitors or additives to the coolant.** These can be harmful and compromise the corrosion protection of the engine coolant.

- **Do not mix with recycled coolant unless from a Ford-approved recycling process (see *Recycled Engine Coolant* section).**

## Maintenance and Specifications



To avoid personal injury, make sure the engine is cool before unscrewing the coolant pressure relief cap. The cooling system is under pressure; steam and hot liquid can come out forcefully when the cap is loosened slightly.

1. Before you begin, turn the engine off and let it cool.
2. When the engine is cool, wrap a thick cloth around the coolant pressure relief cap on the coolant reservoir (an opaque plastic bottle). Slowly turn cap counterclockwise (left) until pressure begins to release.
3. Step back while the pressure releases.
4. When you are sure that all the pressure has been released, use the cloth to turn it counterclockwise and remove the cap.

## Maintenance and Specifications

5. Fill the coolant reservoir slowly with the proper coolant mixture (see above), to within the "cold fill range" or the "cold full" level on the reservoir. If you removed the radiator cap in an overflow system, fill the radiator until the coolant is visible and radiator is almost full.

6. Replace the cap. Turn until tightly installed. (Cap must be tightly installed to prevent coolant loss.) After any coolant has been added, check the coolant concentration (see *Checking Engine Coolant* section). If the concentration is not 50/50 (protection to -34° F/-36° C), drain some coolant and adjust the concentration. It may take several drains and additions to obtain a 50/50 coolant concentration.

Whenever coolant has been added, the coolant level in the coolant reservoir should be checked the next few times you drive the vehicle. If necessary, add enough 50/50 concentration of engine coolant and distilled water to bring the liquid level to the proper level.

If you have to add more than 1.0 liter (1.0 quart) of engine coolant per month, have your dealer check the engine cooling system. Your cooling system may have a leak. Operating an engine with a low level of coolant can result in engine overheating and possible engine damage.

## Maintenance and Specifications

### Recycled engine coolant

Ford Motor Company recommends the use of a recycled engine coolant produced by Ford-approved processes in vehicles originally equipped with Motorcraft Premium Engine Coolant (green-colored). However, not all coolant recycling processes produce coolant that meets Ford specification ESE-M97B44-A. Use of such coolant may harm the engine and cooling system components.

Ford Motor Company does NOT recommend the use of recycled engine coolant in vehicles originally equipped with Motorcraft Premium Gold Engine Coolant since a Ford-approved recycling process is not yet available.



Used engine coolant should be disposed of in an appropriate manner. Follow your community's regulations and standards for recycling and disposing of automotive fluids.

### Coolant refill capacity

To find out how much fluid your vehicle's cooling system can hold, refer to *Refill capacities* in this chapter.

Fill your engine coolant reservoir as outlined in *Adding engine coolant* in this chapter.

## Maintenance and Specifications

### Severe climates

If you drive in extremely cold climates (less than  $-36^{\circ}\text{C}$  [ $-34^{\circ}\text{F}$ ]):

- **It may be necessary to increase the coolant concentration above 50%.**
- **NEVER increase the coolant concentration above 60%.**
- **Increased engine coolant concentrations above 60% will decrease the overheat protection characteristics of the engine coolant and may cause engine damage.**
- **Refer to the chart on the coolant container to ensure the coolant concentration in your vehicle will provide adequate freeze protection at the temperatures in which you drive in the winter months.**

If you drive in extremely hot climates:

- **It is still necessary to maintain the coolant concentration above 40%.**
- **NEVER decrease the coolant concentration below 40%. Decreased engine coolant concentrations below 40% will decrease the corrosion and the freeze protection characteristics of the engine coolant and may cause engine damage.**

## Maintenance and Specifications

- **Refer to the chart on the coolant container to ensure the coolant concentration in your vehicle will provide adequate protection at the temperatures in which you drive.**

Vehicles driven year-round in non-extreme climates should use a 50/50 mixture of engine coolant and distilled water for optimum cooling system and engine protection.

### **What you should know about fail-safe cooling (2.0 L Zetec engines only)**

If the engine coolant supply is depleted, this feature allows the vehicle to be driven temporarily before incremental component damage is incurred. The "fail-safe" distance depends on ambient temperatures, vehicle load and terrain.

## Maintenance and Specifications

### **How fail-safe cooling works**

If the engine begins to overheat:

- The engine coolant temperature gauge will move to the red area.
- The *Multi-function warning light:automatic tranaxle/cooling system* will illuminate.
- The *Check Engine* indicator will illuminate.

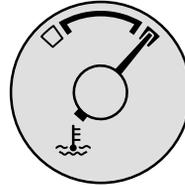

If the engine reaches a preset over-temperature condition, the engine will automatically switch to alternating cylinder operation. Each disabled cylinder acts as an air pump and cools the engine.



When this occurs the vehicle will still operate. However:

- The engine power will be limited.
- The air conditioning system will be disabled.
- The *Check Engine* warning light also illuminates.



Extended operation will increase the engine temperature and the engine will completely shut down, causing steering and braking effort to increase.

Once the engine temperature cools, the engine can be re-started. Take your vehicle to a service facility as soon as possible to minimize engine damage.

## Maintenance and Specifications

### ***When fail-safe mode is activated***

You have limited engine power when in the fail-safe mode, so drive the vehicle with caution. The vehicle will not be able to maintain high-speed operation and the engine will run rough. Remember that the engine is capable of completely shutting down automatically to prevent engine damage, therefore:

1. Pull off the road as soon as safely possible and turn off the engine.
2. Arrange for the vehicle to be taken to a service facility.
3. If this is not possible, wait a short period for the engine to cool.
4. Check the coolant level and replenish if low.



Never remove the coolant reservoir cap while the engine is running or hot.

5. Re-start the engine and take your vehicle to a service facility.

**Driving the vehicle without repairing the engine problem increases the chance of engine damage. Take your vehicle to a service facility as soon as possible.**

## Maintenance and Specifications

### WHAT YOU SHOULD KNOW ABOUT AUTOMOTIVE FUELS

#### Important safety precautions



Do not overfill the fuel tank. The pressure in an overfilled tank may cause leakage and lead to fuel spray and fire.



If you do not use the proper fuel cap, the pressure in the fuel tank can damage the fuel system or cause it to work improperly in a collision.



The fuel system may be under pressure. If the fuel cap is venting vapor or if you hear a hissing sound, wait until it stops before completely removing the cap.



Automotive fuels can cause serious injury or death if misused or mishandled.

## Maintenance and Specifications

Observe the following guidelines when handling automotive fuel:

- Extinguish all smoking materials and any open flames before fueling your vehicle.
- Always turn off the vehicle before fueling.
- Automotive fuels can be harmful or fatal if swallowed. Fuel such as gasoline is highly toxic and if swallowed can cause death or permanent injury. If fuel is swallowed, call a physician immediately, even if no symptoms are immediately apparent. The toxic effects of fuel may not be visible for hours.
- Avoid inhaling fuel vapors. Inhaling too much fuel vapor of any kind can lead to eye and respiratory tract irritation. In severe cases, excessive or prolonged breathing of fuel vapor can cause serious illness and permanent injury.
- Avoid getting fuel liquid in your eyes. If fuel is splashed in the eyes, remove contact lenses (if worn), flush with water for 15 minutes and seek medical attention. Failure to seek proper medical attention could lead to permanent injury.



## Maintenance and Specifications

- Fuels can also be harmful if absorbed through the skin. If fuel is splashed on the skin and/or clothing, promptly remove contaminated clothing and wash skin thoroughly with soap and water. Repeated or prolonged skin contact with fuel liquid or vapor causes skin irritation.
- Be particularly careful if you are taking “Antabuse” or other forms of disulfiram for the treatment of alcoholism. Breathing gasoline vapors or skin contact could cause an adverse reaction. In sensitive individuals, serious personal injury or sickness may result. If fuel is splashed on the skin, promptly wash skin thoroughly with soap and water. Consult a physician immediately if you experience an adverse reaction.

## Maintenance and Specifications

### Fuel filler cap

After refueling, if the *Check fuel cap* indicator comes on and stays on when you start the engine, the fuel filler cap may not be properly installed. Turn off the engine, remove the fuel filler cap, align the cap properly and reinstall it securely. The *Check fuel cap* indicator should turn off after three driving cycles with the fuel filler cap properly installed. A driving cycle consists of a cold engine start-up followed by mixed city/highway driving.

**If you must replace the fuel filler cap, replace it with a fuel filler cap that is designed for your vehicle. The customer warranty may be void for any damage to the fuel tank or fuel system if the correct genuine Ford or Motorcraft fuel filler cap is not used.**



The fuel system may be under pressure. If the fuel filler cap is venting vapor or if you hear a hissing sound, wait until it stops before completely removing the fuel filler cap. Otherwise, fuel may spray out and injure you or others.



If you do not use the proper fuel filler cap, excessive pressure or vacuum in the fuel tank may damage the fuel system or cause the fuel cap to disengage in a collision, which may result in possible personal injury.

### ***Fuel filler cap lock (if equipped)***

Your vehicle may be equipped with a locking fuel filler cap.

When fueling your vehicle:

1. Turn the engine off.
2. Open the fuel filler flap.
3. Unlock the fuel filler cap, using the key and turn cap counterclockwise to remove.
4. To close, turn the cap clockwise until it clicks.

Refer to the previous section *Fuel filler cap* for additional information.

## Maintenance and Specifications

### Choosing the right fuel

Use only UNLEADED FUEL. The use of leaded fuel is prohibited by law and could damage your vehicle.

Your vehicle was not designed to use fuel or fuel additives with metallic compounds, including manganese-based compounds containing (MMT).

Vehicles certified to meet California emission standards (indicated on the underhood Vehicle Emission Control Information label) are designed to operate on California reformulated gasolines. If California reformulated gasoline is not available when you refuel, your vehicle can be operated on non-California fuels. However, even though your engine will perform adequately on other gasolines, the performance of the emission control devices and systems may be adversely affected.

Repair of damage caused by using a fuel for which your vehicle was not designed may not be covered by your warranty.

## Maintenance and Specifications

### Octane recommendations

Your vehicle is designed to use “regular” unleaded gasoline with an (R+M)/2 octane rating of 87. We do not recommend gasolines labeled as “Regular” that are sold with octane ratings of 86 or lower in high altitude areas.

Do not be concerned if your engine sometimes knocks lightly. However, if it knocks heavily under most driving conditions while you are using fuel with the recommended octane rating, see your dealer or a qualified service technician to prevent any engine damage.

### Fuel quality

If you are experiencing starting, rough idle or hesitation driveability problems during a cold start, try a different brand of “Regular” unleaded gasoline. “Premium” unleaded gasoline is not recommended (particularly in the United States) because it may cause these problems to become more pronounced. If the problems persist, see your dealer or qualified service technician.

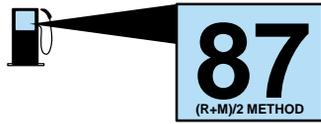

## Maintenance and Specifications

It should not be necessary to add any aftermarket products to your fuel tank if you continue to use high quality fuel of the recommended octane rating. Aftermarket products could cause damage to the fuel system. Repairs to correct the effects of using an aftermarket product in your fuel may not be covered by your warranty.

Many of the world's automakers issued the World-wide Fuel Charter that recommends gasoline specifications to provide improved performance and emission control system protection for your vehicle. Gasolines that meet the World-wide Fuel Charter should be used when available. Ask your fuel supplier about gasolines that meet the World-wide Fuel Charter. In Canada, look for fuels that display the **Auto Makers' Choice**<sup>™</sup> logo.



### Cleaner air

Ford endorses the use of reformulated “cleaner-burning” gasolines to improve air quality.

Do not use gasolines containing methanol, which can damage critical fuel system components. Damage resulting from the use of methanol may not be covered by your warranty.

## Maintenance and Specifications

### Running out of fuel

Avoid running out of fuel because this situation may have an adverse affect on modern powertrain components.

If you have run out of fuel:

- You may need to crank the engine several times before the system starts to pump fuel from the tank to the engine.
- Your *Check engine* light may come on. For more information on the *Check engine* light, refer to the *Instrument Cluster* chapter.



### Fuel filter

Your vehicle is equipped with a fuel filter that is mounted on the underbody.

For fuel filter replacement, see your dealer or a qualified service technician. Refer to the “Scheduled Maintenance Guide” for the appropriate intervals for changing the fuel filter.

**If you replace the fuel filter, replace it with an authorized Motorcraft part. The customer warranty may be void for any damage to the fuel system if an authorized Motorcraft fuel filter is not used.**

# Maintenance and Specifications

## ESSENTIALS OF GOOD FUEL ECONOMY

### Measuring techniques

Your best source of information about actual fuel economy is you, the driver. You must gather information as accurately and consistently as possible. Fuel expense, frequency of fillups or fuel gauge readings are NOT accurate as a measure of fuel economy. We do not recommend taking fuel economy measurements during the first 1,600 km (1,000 miles) of driving (engine break-in period). You will get a more accurate measurement after 3,000 km - 5,000 km (2,000 miles - 3,000 miles).

The advertised fuel capacity of the fuel tank on your vehicle is equal to the rated refill capacity of the fuel tank as listed in the Refill Capacities chart in this "Owner Guide". The advertised capacity is the amount of the Indicated Capacity and the Empty Reserve combined. Indicated Capacity is the difference in the amount of fuel in a full tank and a tank when the fuel gauge indicates empty. Empty Reserve is the small amount of usable fuel remaining in the fuel tank after the fuel gauge indicates empty.

## Maintenance and Specifications

**The amount of Empty Reserve varies and should not be relied upon to increase driving range. When refueling your vehicle after the fuel gauge indicates empty, you might not be able to refuel the full amount of the advertised capacity of the fuel tank due to the empty reserve still present in the tank.**

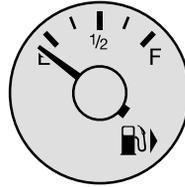

### Filling the tank

Use the same filling rate setting (low - medium - high) each time the tank is filled. Allow three automatic click-offs when filling. Always use fuel with the recommended octane rating of a known quality gasoline, preferably a national brand.

It may seem insignificant, but you should use the same side of the same pump and have the vehicle facing the same direction each time you fill up. The driver should also have the vehicle loading and distribution the same every time. Your results will be most accurate if your filling method is consistent. This is also true when calculating fuel economy.

## Maintenance and Specifications

### Calculating fuel economy

1. Fill the fuel tank completely and record the initial odometer reading.
2. Each time you fill the tank, record the amount of fuel added (in liters or gallons).
3. After at least three to five tank fill-ups, fill the fuel tank and record the current kilometer (mileage) reading.
4. Follow one of the simple calculations in order to determine fuel economy:

**Multiply liters used by 100, then divide by total kilometers traveled.**

**Divide total miles traveled by total gallons used.**

Keep a record for at least one month and record the type of driving (city or highway). This will provide an accurate estimate of the vehicle's fuel economy under current driving conditions. Additionally, keeping records during summer and winter will show how temperature impacts fuel economy. In general, lower temperatures give a deterioration in fuel economy.

## Maintenance and Specifications

### Driving style – good driving and fuel economy habits

Give consideration to the lists that follow and you may be able to change a number of variables and improve your fuel economy.



#### **Habits**

- Smooth, moderate operation can yield up to 10% savings in fuel.
- Steady speeds without stopping will always give the best fuel economy.
- Idling for long periods of time (greater than one minute) will waste fuel.
- Anticipate stopping; slowing down may eliminate the need to stop.
- Sudden or hard accelerations will deteriorate fuel economy.
- Slow down gradually.
- Driving at reasonable speeds (traveling at 105 km/h [65 mph] uses 15% more fuel than traveling at 88 km/h [55 mph]).
- Revving the engine before turning it off will deteriorate fuel economy.
- Use of the air conditioner or defroster may deteriorate fuel economy.

## Maintenance and Specifications

- Use of speed control (if equipped) can improve fuel economy. Speed control can help maintain a constant speed and reduce speed changes. You may want to turn off the speed control in hilly terrain as unnecessary shifting between third and fourth gears may occur causing deterioration in fuel economy.
- Warming up a vehicle on cold mornings is not required and deteriorates fuel economy.
- Resting your foot on the brake pedal while driving will deteriorate fuel economy.
- Combine errands and minimize stop-and-go driving.

### **Maintenance**

- Keep tires properly inflated and use only recommended size.
- Operating a vehicle with the wheels out of alignment will deteriorate fuel economy.
- Use recommended engine oil. Refer to *Lubricant Specifications*.
- Perform all regularly scheduled maintenance items. Follow the recommended maintenance schedule and owner maintenance checks found in your vehicle “Scheduled Maintenance Guide”.

## Maintenance and Specifications

### **Conditions**

- Heavily loading a vehicle or towing a trailer will sharply deteriorate fuel economy at any speed.
- Carrying unnecessary weight will deteriorate fuel economy (approximately 0.4 l/100 km [1 mpg] is lost for every 180 kg [400 lb] of weight carried).
- Adding certain accessories to your vehicle (for example bug deflectors, rollover/light bars, running boards, ski/luggage racks) will deteriorate fuel economy.
- Use of fuel blended with alcohol will deteriorate fuel economy.
- Fuel economy will deteriorate with lower temperatures during the first 12 - 16 km (8 - 10 miles) of driving.
- Flat terrain driving improves fuel economy over hilly roads.
- Transaxles give their best fuel economy when operated in the top cruise gear and with steady pressure on the gas pedal.
- Close windows for high speed driving.



## Maintenance and Specifications

### **EPA window sticker**

Every new vehicle should have the EPA window sticker. Contact your dealer if the window sticker is not supplied with your vehicle. The EPA window sticker should be your guide for the fuel economy comparisons with other vehicles.

It is important to note the box in the lower left corner of the window sticker. These numbers represent the Range of L/100 km (MPG) expected on the vehicle depending upon the driver's method of operation and conditions.

### **EMISSION CONTROL SYSTEM**

Your vehicle is equipped with various emission control components and a catalytic converter which will enable your vehicle to comply with applicable exhaust emission standards. To make sure that the catalytic converter and other emission control components continue to work properly:

## Maintenance and Specifications

- Use only unleaded fuel.
- Avoid running out of fuel.
- Do not turn off the ignition while your vehicle is moving, especially at high speeds.
- Have the items listed in your “Scheduled Maintenance Guide” performed according to the specified schedule.

The scheduled maintenance items listed in the “Scheduled Maintenance Guide” are essential to the life and performance of your vehicle and to its emissions system.

If other than Ford, Motorcraft or Ford-authorized parts are used for maintenance replacements or for service of components affecting emission control, such non-Ford parts should be equivalent to genuine Ford Motor Company parts in performance and durability.



Do not park, idle, or drive your vehicle in dry grass or other dry ground cover. The emission system heats up the engine compartment and exhaust system, which can start a fire.

## Maintenance and Specifications

Illumination of the *Charging system* warning light, *Check engine* light or a high engine temperature, fluid leaks, strange odors, smoke or loss of oil pressure, could indicate that the emission control system is not working properly.



Exhaust leaks may result in entry of harmful and potentially lethal fumes into the passenger compartment.

Do not make any unauthorized changes to your vehicle or engine. By law, vehicle owners and anyone who manufactures, repairs, items, sells, leases, trades vehicles, or supervises a fleet of vehicles are not permitted to intentionally remove an emission control device or prevent it from working.

Information about your vehicle's emission system is on the Vehicle Emission Control Information Decal located on or near the engine. This decal identifies engine displacement and gives some tune up specifications.

Please consult your "Warranty Guide" for complete emission warranty information.

## Maintenance and Specifications

### Readiness for inspection/ maintenance (I/M) testing

In some localities, it may be a legal requirement to pass an I/M test of the on-board diagnostics system (OBD-II). If your *Check engine* light is on, refer to the description in the *Warning Lights and Chimes* section of the *Instrument Cluster* chapter. Your vehicle may not pass the I/M test with the *Check engine* light on.

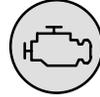

If the vehicle's powertrain system or its battery has just been serviced, the OBD-II system is reset to a "not ready for I/M test" condition. To ready the OBD-II system for I/M testing, a minimum of 30 minutes of city and highway driving is necessary as described below:

- First, at least 10 minutes of driving on an expressway or highway.
- Next, at least 20 minutes driving in stop-and-go, city-type traffic with at least four idle periods.

Allow the vehicle to sit for at least eight hours without starting the engine. Then, start the engine and complete the above driving cycle. The engine must warm up to its normal operating temperature. Once started, do not turn off the engine until the above driving cycle is complete.

## Maintenance and Specifications

### CHECKING AND ADDING POWER STEERING FLUID

Check the power steering fluid. Refer to the “Scheduled Maintenance Guide” for the service interval schedules. If adding fluid is necessary, use only Motorcraft MERCON® ATF.

1. The power steering fluid level should be checked before starting the engine.
2. Check the fluid level in the reservoir. It should be between the MIN and MAX lines. Do not add fluid if the level is in this range.
3. If the fluid is low, add fluid in small amounts, continuously checking the level until it reaches the range between the MIN and MAX lines. Be sure to put the cap back on the reservoir.



## Maintenance and Specifications

### BRAKE FLUID

#### Checking and adding brake fluid

Brake fluid should be checked and refilled as needed. Refer to the “Scheduled Maintenance Guide” for the service interval schedules:

1. Clean the reservoir cap before removal to prevent dirt or water from entering the reservoir.
2. Visually inspect the fluid level.
3. If necessary, add brake fluid until the level reaches MAX. Do not fill above this line.
4. Use only brake fluids certified to meet Ford specifications. Refer to *Lubricant specifications* in this chapter. Use only DOT 3 brake fluid from a sealed container.



Brake fluid is toxic.



If you use DOT 5 or any other brake fluid that is not DOT 3 or DOT 4, you will cause permanent damage to your brakes.



Do not let the reservoir for the master cylinder run dry. This may cause the brakes to fail.

# Maintenance and Specifications

## TRANSAXLE FLUID

### Checking automatic transaxle fluid

Refer to your “Scheduled Maintenance Guide” for scheduled intervals for fluid checks and changes. Your transaxle does not consume fluid. However, the fluid level should be checked if the transaxle is not working properly, i. e., if the transaxle slips or shifts slowly or if you notice some sign of fluid leakage.

Automatic transaxle fluid expands when warmed. To obtain an accurate fluid check, drive the vehicle until it is warmed up (approximately 30 km [20 miles]). If your vehicle has been operated for an extended period at high speeds, in city traffic during hot weather or pulling a trailer, the vehicle should be turned off for about 30 minutes to allow fluid to cool before checking.

1. Drive the vehicle 30 km (20 miles) or until it reaches normal operating temperature.
2. Park the vehicle on a level surface and engage the parking brake.

## Maintenance and Specifications

3. With the parking brake engaged and your foot on the brake pedal, start the engine and move the gearshift lever through all of the gear ranges. Allow sufficient time for each gear to engage.
4. Latch the gearshift lever in P (Park) and leave the engine running.
5. Remove the dipstick, wiping it clean with a clean, dry lint free rag.
6. Install the dipstick making sure it is fully seated in the filler tube.
7. Remove the dipstick and inspect the fluid level. The fluid should be in the designated areas indicated by the figure to the right.

### **Low fluid level**

Do not drive the vehicle if the fluid level is at the bottom of the dipstick and the outside temperatures are above 10°C (50°F).

### **Correct fluid level**

The transaxle fluid should be checked at normal operating temperatures of 50°C-60°C (120°F-140°F) on a level surface. The transaxle fluid should be within the MIN and MAX marks shown on the indicator.

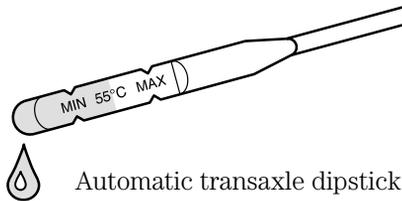

Automatic transaxle dipstick

## Maintenance and Specifications

### ***High fluid level***

Fluid levels above the safe range may result in transaxle failure. An overfill condition of transaxle fluid may cause shift and/or engagement concerns and/or possible damage.

High fluid levels can be caused by overheated or aerated fluid. This can be caused by operating for an extended period at high speeds, in city traffic during hot weather, pulling a trailer, aggressive braking or aggressive steering maneuvers. If this occurs turn the vehicle off for about 30 minutes. This will allow the transaxle to return to normal operating conditions. Recheck the fluid level before correction of the overfill condition.

### ***Adjusting automatic transaxle fluid levels***

Before adding any fluid, make sure the correct type is used. The type of fluid used is normally indicated on the dipstick and/or dipstick handle and also in the *Lubricant specifications* section in this chapter.

### **Use of a non-approved automatic transaxle fluid may cause internal transaxle component damage.**

If necessary, add fluid in 250 ml (1/2 pint) increments through the filler tube until the level is correct.

If an overfill occurs, excess fluid should be removed by a qualified technician.

## Maintenance and Specifications

**An overfill condition of transaxle fluid may cause shift and/or engagement concerns and/or possible damage.**

### **Checking and adding manual transmission fluid (if equipped)**

1. Clean the filler plug.
2. Remove the filler plug and inspect the fluid level.
3. The fluid level should be at the bottom of the opening.
4. Add enough fluid through the filler hole so that the fluid level is at the bottom of the opening.
5. Install and tighten the filler plug securely.

Use only fluid which has been released by Ford under WSD M2C 200C.

### **CLUTCH FLUID (if equipped)**

Check the clutch fluid level. Refer to the “Scheduled Maintenance Guide” for the service interval schedules.

The clutch master cylinder and brake master cylinder are part of the same system; both are refillable through the brake master cylinder with brake fluid. During normal operation, the fluid level in the brake fluid reservoir should remain constant. For more information on brake fluid maintenance, refer to *Brake fluid* in this chapter.

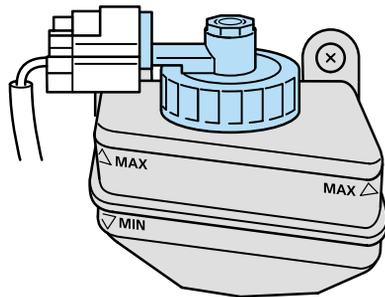

## Maintenance and Specifications

### INFORMATION ABOUT UNIFORM TIRE QUALITY GRADING

New vehicles are fitted with tires that have a rating on them called Tire Quality Grades. The Quality grades can be found where applicable on the tire sidewall between tread shoulder and maximum section width. For example:

- **Treadwear 200 Traction AA Temperature A**

These Tire Quality Grades are determined by standards that the United States Department of Transportation has set.

Tire Quality Grades apply to new pneumatic tires for use on passenger cars. They do not apply to deep tread, winter-type snow tires, space-saver or temporary use spare tires, tires with nominal rim diameters of 10 to 12 inches or limited production tires as defined in Title 49 Code of Federal Regulation Part 575.104(c)(2).

**U.S. Department of Transportation-Tire quality grades:** The U.S. Department of Transportation requires Ford to give you the following information about tire grades exactly as the government has written it.

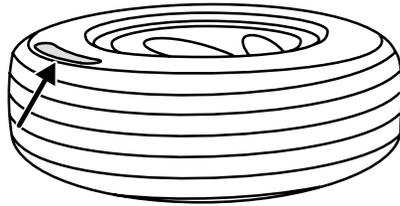

## Maintenance and Specifications

### Treadwear

The treadwear grade is a comparative rating based on the wear rate of the tire when tested under controlled conditions on a specified government test course. For example, a tire grade 150 would wear one and one-half (1 1/2) times as well on the government course as a tire grade 100. The relative performance of tires depends upon the actual conditions of their use, however, and may depart significantly from the norm due to variations in driving habits, service practices, and differences in road characteristics and climate.

### Traction AA A B C

The traction grades, from highest to lowest are AA, A, B, and C. The grades represent the tire's ability to stop on wet pavement as measured under controlled conditions on specified government test surfaces of asphalt and concrete. A tire marked C may have poor traction performance.



The traction grade assigned to this tire is based on straight-ahead braking traction tests, and does not include acceleration, cornering, hydroplaning, or peak traction characteristics.

## Maintenance and Specifications

### Temperature A B C

The temperature grades are A (the highest), B, and C, representing the tire's resistance to the generation of heat and its ability to dissipate heat when tested under controlled conditions on a specified indoor laboratory test wheel. Sustained high temperature can cause the material of the tire to degenerate and reduce tire life, and excessive temperature can lead to sudden tire failure. The grade C corresponds to a level of performance which all passenger car tires must meet under the Federal Motor Vehicle Safety Standard No. 109. Grades B and A represent higher levels of performance on the laboratory test wheel than the minimum required by law.



The temperature grade for this tire is established for a tire that is properly inflated and not overloaded. Excessive speed, underinflation, or excessive loading, either separately or in combination, can cause heat buildup and possible tire failure.

# Maintenance and Specifications

## SERVICING YOUR TIRES

### Checking the tire pressure

- Use an accurate tire pressure gauge.
- Check the tire pressure when tires are cold, after the vehicle has been parked for at least one hour or has been driven less than 5 km (3 miles).
- Adjust tire pressure to recommended specifications found on the label on the inside of the fuel filler door or on the safety compliance label.



Improperly inflated tires can affect vehicle handling and can fail suddenly, possibly resulting in loss of vehicle control.

### Tire rotation

Because your vehicle's tires perform different jobs, they often wear differently. To make sure your tires wear evenly and last longer, rotate them as indicated in the "Scheduled Maintenance Guide". If you notice that the tires wear unevenly, have them checked.

- Four tire rotation

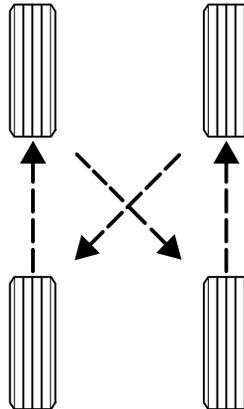

## Maintenance and Specifications

### Replacing the tires

Replace tires when the wear band is visible through the tire treads.



When replacing full size tires, never mix radial, bias-belted, or bias-type tires. Use only the tire sizes that are listed on the Certification Label. Make sure that all tires are the same size, speed rating, and load-carrying capacity. Use only the tire combinations recommended on the label. If you do not follow these precautions, your vehicle may not drive properly and safely.



Make sure that all replacement tires are of the same size, type, load-carrying and tread design (e.g., “All Terrain”, etc.), as originally offered by Ford.



Failure to follow these precautions may adversely affect the handling of the vehicle and make it easier for the driver to lose control and roll over.

Tires that are larger or smaller than your vehicle’s original tires may also affect the accuracy of your speedometer.

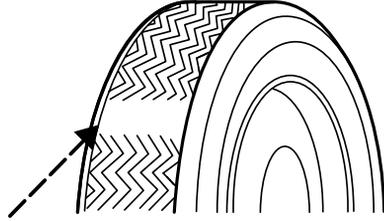

## Maintenance and Specifications

### SNOW TIRES AND CHAINS



Snow tires must be the same size and grade as the tires you currently have on your vehicle.

The tires on your vehicle have all-weather treads to provide traction in rain and snow. However, in some climates, you may need to use snow tires and chains. If you need to use chains, it is recommended that steel wheels (of the same size and specifications) be used as chains may chip aluminum wheels.

Vehicles with AdvanceTrac<sup>™</sup> (if equipped) may exhibit some unusual driving characteristics, when using snow chains, which can be avoided by switching AdvanceTrac<sup>™</sup> off.

Follow these guidelines when using snow tires and chains:

**Snow chains should only be fitted to size P 185/65 R14 tires.**

**Snow chains should never be used on the spare tire.**

## Maintenance and Specifications

- Use only SAE Class S chains.
- Install chains securely, verifying that the chains do not touch any wiring, brake lines or fuel lines.
- Drive cautiously. If you hear the chains rub or bang against your vehicle, stop and re-tighten the chains. If this does not work, remove the chains to prevent damage to your vehicle.
- If possible, avoid fully loading your vehicle.
- Remove the tire chains when they are no longer needed. Do not use tire chains on dry roads.
- The suspension insulation and bumpers will help prevent vehicle damage. Do not remove these components from your vehicle when using snow tires and chains.

## Maintenance and Specifications

### MOTORCRAFT PART NUMBERS

Component	2.0L SPI engine	2.0L Zetec-E engine
Air filter	FA-1688	FA-1688
Battery	BXT-40R	BXT-96R
Oil filter	FL-400 S	FL-2005
PCV valve	EV-244	EV-250
Spark plug*	AGSF 34EE **	AZFS 32FE

\* Refer to Vehicle Emission Control Information (VECI) decal for spark plug gap information.

\*\* If a spark plug is removed for inspection purposes, it must be reinstalled in the same cylinder it was taken from. If a spark plug requires replacement, use only spark plugs with the same service part number suffix letter as shown on the engine decal.

### REFILL CAPACITIES

Fluid	Ford part name	Application	Capacity
Brake fluid	Motorcraft High performance DOT 3 brake fluid.	All	Fill to line on reservoir
Engine oil (includes filter change)	Motorcraft 5W20 Super Premium Motor Oil	Zetec engine	4.25 L (4.5 quarts)
		SPI engine	3.78 L (4.0 quarts)

## Maintenance and Specifications

Fluid	Ford part name	Application	Capacity
Engine coolant <sup>1</sup>	Motorcraft Premium Engine Coolant (green-colored) or Motorcraft Premium Gold Engine Coolant (yellow colored)	All	5.75 L (6.1 quarts)
Power steering fluid	Motorcraft MERCON® ATF	All	Fill to line on reservoir 0.9 L (0.95 quarts)
Fuel tank	N/A	All	50 L (13.2 gallons)
Transaxle fluid	Motorcraft Full Synthetic Manual Transmission Fluid	Manual <sup>2</sup>	2.0 L (2.1 quarts)
	Motorcraft MERCON® V ATF	Automatic <sup>3</sup>	6.6 L (6.9 quarts)
Windshield washer fluid	Ultra-Clear Windshield Washer Concentrate	Sedan	2.5 L (2.6 quarts)
		Coupe, Wagon	4.0 L (4.2 quarts)

<sup>1</sup> Add the coolant type originally equipped in your vehicle.

<sup>2</sup> Service refill capacity is determined by filling the transmission to the bottom of the filler hole with the vehicle on a level surface.

<sup>3</sup> Ensure the correct automatic transmission fluid is used. Transmission fluid requirements are indicated on the dipstick or on the dipstick handle. MERCON® and MERCON® V are not interchangeable. DO NOT mix MERCON® and MERCON® V. Refer to your scheduled maintenance guide to determine the correct service interval.

## Maintenance and Specifications

### LUBRICANT SPECIFICATIONS

Item	Ford part name or equivalent	Ford part number	Ford specification
Brake fluid	Motorcraft High performance DOT 3 brake fluid	PM-1	ESA-M6C25-A
Door weatherstrips	Silicone Lubricant	F7AZ-19G208-BA and F5AZ-19553-AA	ESR-M13P4-A
Door + hood latches, door hinges, striker plates, seat tracks, fuel filler door hinge	Multi-Purpose Grease	XG-4 or F5AZ-19G209-AA	ESR-M1C159-A
Engine coolant	Motorcraft Premium Engine Coolant (green-colored)	VC-4-A (US) or CXC-10 (Canada)	ESE-M97B44-A
	Motorcraft Premium Gold Engine Coolant (yellow-colored)	VC-7-A	WSS-M97B51-A1
Engine oil	Motorcraft 5W-20 Super Premium Motor Oil	XO-5W20-QSP	WSS-M2C153-H with API Certification Mark
Lock cylinders	Motorcraft Penetrating Lubricant	XL-1	None

## Maintenance and Specifications

Item	Ford part name or equivalent	Ford part number	Ford specification
Power steering fluid	Motorcraft MERCON® Automatic Transmission Fluid	XT-2-QDX	MERCON®
Automatic transaxle fluid	Motorcraft MERCON® V ATF	XT-5-QM	MERCON® V
Manual transaxle fluid - IB5	Motorcraft Full Synthetic Manual Transmission Fluid	XT-M5-QS	WSD-M2C200-C
Manual transaxle fluid - MTX 75	Motorcraft Full Synthetic Manual Transmission Fluid	XT-M5-QS	WSD-M2C200-C
Windshield washer fluid	Ultra-Clear Windshield Washer Concentrate	C9AZ-19550-AB	ESR-M17P5-A

## ENGINE DATA

Engine	2.0L SPI engine	2.0L Zetec-E engine
Cubic inches	121	121
Horsepower	110 @ 5000	130 @ 5300 rpm
Torque	125 lb-ft @ 3750 rpm	130 lb-ft @ 4500 rpm
Recommended fuel	87 octane	87 octane
Firing order	1-3-4-2	
Spark plug gap	1.4 mm (0.054 inch)	1.3 mm (0.051 inch)
Ignition system	Electronic ignition	
Compression ratio	9.35:1	9.6:1

## Maintenance and Specifications

### Sedan

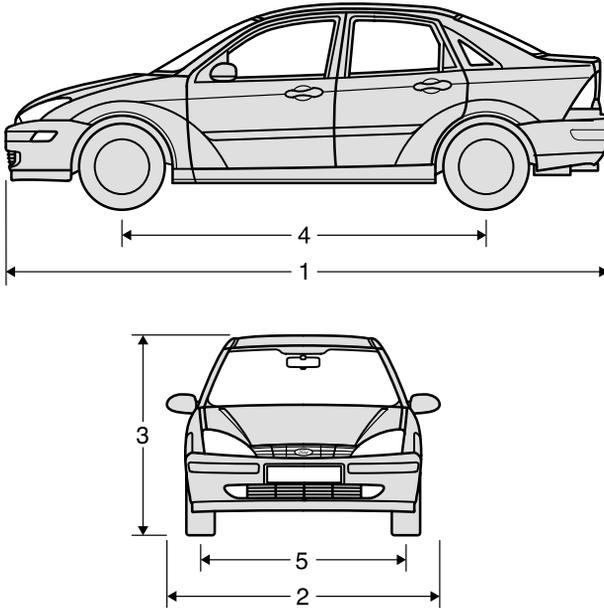

### VEHICLE DIMENSIONS

Dimensions		mm (in)
(1) Overall length		4400-4447 (174.8-175.1)
(2) Overall width		1998 (78.7)
(3) Overall height		1440-1481 (56.7-58.3)
(4) Wheelbase		2615 (103)
(5) Track	front	1484-1502 (58.4-59.1)
	rear	1477-1495 (58.1-58.9)

# Maintenance and Specifications

## Coupe

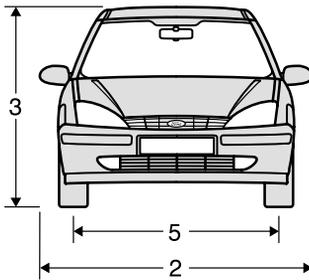
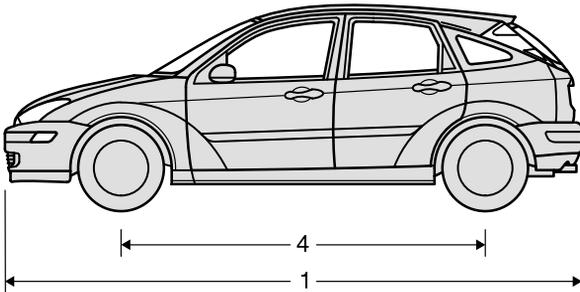
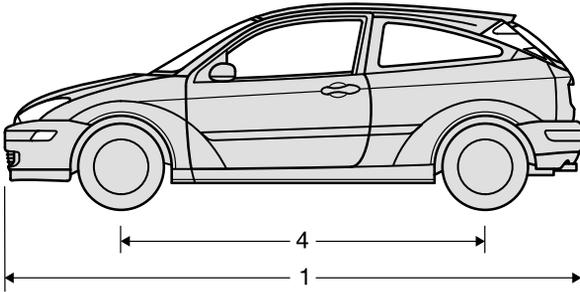

Dimensions		mm (in)
(1) Overall length		4269-4297 (168.1-169.2)
(2) Overall width		1998 (78.7)
(3) Overall height		1440-1481 (56.7-58.3)
(4) Wheelbase		2615 (103)
(5) Track	front	1484-1502 (58.4-59.1)
	rear	1477-1495 (58.1-58.9)

## Maintenance and Specifications

### Wagon

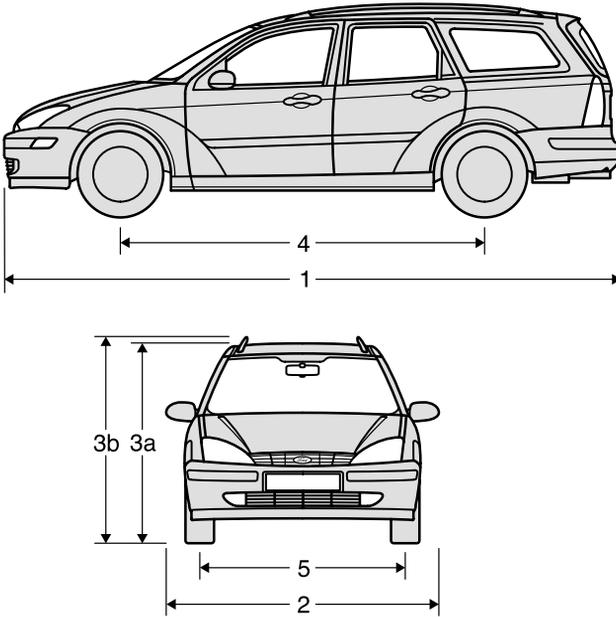

Dimensions		mm (in)
(1) Overall length		4523-4550 (178.1-179.1)
(2) Overall width		1998 (78.7)
(3a) Overall height (w/o roofrack)		1451-1491 (57.1-58.7)
(3b) Overall height (with roofrack)		1492-1532 (58.7-60.3)
(4) Wheelbase		2615 (103)
(5) Track	front	1484-1502 (58.4-59.1)
	rear	1477-1495 (58.1-58.9)

# Maintenance and Specifications

## IDENTIFYING YOUR VEHICLE

### Safety compliance label

The National Highway Traffic Safety Administration Regulations require that a Safety Compliance Certification Label be affixed to a vehicle and prescribe where the Safety Compliance Certification Label may be located. The Safety Compliance Certification Label is located on the front door latch pillar on the driver's side.

<b>MFD. BY FORD MOTOR CO. IN U.S.A.</b>					
DATE: XXXXX	GVWR: XXXXX	LB/ XXXXX	KG		
FGAWR: XXXXXXX/XXXXXXXX	RGAWR: XXXXXXX/XXXXXXXX				
THIS VEHICLE CONFORMS TO ALL APPLICABLE FEDERAL MOTOR VEHICLE SAFETY STANDARDS IN EFFECT ON THE DATE OF MANUFACTURE SHOWN ABOVE.					
VIN: XXXXXXXXXXXXXXXXXXXX	TYPE: XXXXXXXXXXXXXXXXXXXX				
					
MAXIMUM LOAD=OCCUPANTS + LUGGAGE=XXXKG/XXXLB					
OCCUPANTS: X TOTAL X FR X 2ND X RR OCCUPANTS LUGGAGE					
			XX	XXXKG/XXXLB	
TIRE: XXXX/XXXX XXX			X	XXXKG/XXXLB	
PRESSURE (FR) XXX kPa/33 PSI COLD					
PRESSURE (RR) XXX kPa/33 PSI COLD					
<small>TRAILER TOWING - SEE OWNER GUIDE</small>					
EXT PNT: XXXXXX XXXXXX	RC: XX	DSO: XXXX	F0000		
BAR   INT TR   TP/PS   R   AXLE   TR   SPR   T0000					
X	XX	XXX	X	XX	X XXXX
UTC VFOHT-15294A10-GA					

## Maintenance and Specifications

### Vehicle identification number

The vehicle identification number (VIN) is attached to a metal tag and is located on the driver side instrument panel. The VIN tag may be seen by looking through the windshield from outside the vehicle.

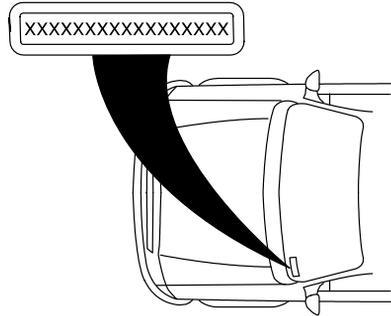

### Engine number

The engine number (the last eight numbers of the vehicle identification number) is stamped on the engine block, transaxle, frame and transfer case (if equipped).

## Accessories

### FORD ACCESSORIES FOR YOUR VEHICLE

A wide selection of accessories is available through your local authorized Ford, Lincoln-Mercury or Ford of Canada dealer. These quality accessories have been specifically engineered to fulfill your automotive needs; they are custom designed to complement the style and aerodynamic appearance of your vehicle. In addition, each accessory is made from high quality materials and meets or exceeds Ford's rigid engineering and safety specifications. Ford Motor Company will repair or replace any properly dealer-installed Ford accessory found to be defective in factory-supplied materials or workmanship during the warranty period, as well as any component damaged by the defective accessory. The accessory will be warranted for whichever provides you the greatest benefit:

- 12 months or 12,000 miles/ 20,000 km (whichever occurs first) or
- the remainder of your new vehicle Limited Warranty.

This means that Ford accessories purchased along with your new vehicle and installed by the dealer are covered for the full length of your New Vehicle's Limited Warranty-3 years or 36,000 miles/ 60,000 km (whichever occurs first). Contact your dealer for details and a copy of the Warranty.

**Not all accessories are available for all models.**

### Vehicle Security

Remote keyless entry  
Vehicle security systems  
Wheel locks for alloy wheels

### Comfort and convenience

Air conditioner  
Cabin air filtration  
Cargo nets, shade, organizer and tray  
Dash trim  
Electrochromic compass mirror  
Electrochromic compass mirror with outside temp  
Engine block heater  
Remote start system

### Travel equipment

Automatic headlamp system  
Console  
Daytime running lights  
Luggage rack adapters, bike, ski, snowboard  
First aid kit  
Fog lights  
Highway Safety kit  
Luggage/cargo basket  
Pet guard  
Removable luggage rack  
Removable luggage rack adapters  
Speed control

## Accessories

### Protection and appearance equipment

All weather floor mats

Car cover

Carpet floor mats

Chrome exhaust trim

Door edge guards

Door sill scuff plates

Flat splash guards

Front end covers (full and mini)

Ground effects kit

Hood deflectors

Leather wrap steering wheel

Molded splash guards

Rear decklid spoilers

Side window air deflectors

For maximum vehicle performance, keep the following information in mind when adding accessories or equipment to your vehicle:

- When adding accessories, equipment, passengers and luggage to your vehicle, do not exceed the total weight capacity of the vehicle or of the front or rear axle (GVWR or GAWR as indicated on the Safety Compliance Certification Label). Consult your dealer for specific weight information.

- The Federal Communications Commission (FCC) and Canadian Radio Telecommunications Commission (CRTC) regulate the use of mobile communications systems - such as two-way radios, telephones and theft alarms - that are equipped with radio transmitters. Any such equipment

installed in your vehicle should comply with FCC or CRTC regulations and should be installed only by a qualified service technician.

- Mobile communications systems may harm the operation of your vehicle, particularly if they are not properly designed for automotive use or are not properly installed. When operated, such systems may cause the engine to stumble or stall. In addition, such systems may be damaged or their performance may be affected by operating your vehicle. (Citizens band [CB] transceivers, garage door openers and other transmitters with outputs of five watts or less will not ordinarily affect your vehicle's operation.)

- Ford cannot assume responsibility for any adverse effects or damage that may result from the use of such equipment.

# Index

## A

ABS warning lamp . . . . . 191  
Accessories . . . . . 330  
Adding brake fluid . . . . . 309  
Adding washer fluid . . . . . 271  
Additives, engine oil . . . . . 271  
AdvanceTracT . . . . . 16, 104  
AdvanceTracT light . . . . . 16  
Air bag disposal . . . . . 165  
Air bag readiness light . . . . . 14  
Air bag supplemental  
restraint system . . . . . 156-165  
Air bag system, side . . . . . 161-164  
Air conditioning . . . . . 66-72  
Air distribution . . . . . 62-65  
Air filter . . . . . 321  
Anti-lock brake system  
(ABS) . . . . . 190-192  
Anti-lock brake system  
(ABS) light . . . . . 13  
Anti-theft protection panel . . . . . 22  
Ashtray . . . . . 95  
Audio System . . . . . 22  
Automatic transaxle fluid . . . . . 324  
Automatic transaxle operation . . . . . 194

## B

Backup lamps . . . . . 85-87  
Base curb weight . . . . . 205  
Battery . . . . . 234, 274, 321  
Beltminder . . . . . 148-153  
Brake fluid . . . . . 309, 321  
Brake lamps . . . . . 85-88  
Brake system warning . . . . . 13  
Brake-shift interlock . . . . . 194  
Brake/clutch fluid . . . . . 323  
Brakes . . . . . 188

## B

Bulb replacement . . . . . 81-89  
Bulb specifications . . . . . 90

## C

Cabin air filter . . . . . 321  
Capacities . . . . . 321-322  
Car care products . . . . . 330  
Catalytic converter . . . . . 12  
Changing the tires . . . . . 227-233  
Charging system warning light . . . . . 15  
Child restraint precautions . . . . . 167  
Child safety seats, installing . . . . . 172  
Child safety seats, tether straps . . . . . 177  
Childproof door locks . . . . . 112  
Children and air bags . . . . . 158  
Children and safety belts . . . . . 168  
Chimes . . . . . 18  
Clock . . . . . 30, 44  
Clutch fluid . . . . . 313  
Components in the engine  
compartment . . . . . 269, 270  
Control lights . . . . . 10-17  
Cooling system, warning lights . . . . . 15  
Cruise control. *See* Speed control  
Cup holder . . . . . 95  
Customer assistance . . . . . 216

## D

Daytime running lights (DRL) . . . . . 75  
De-icing the windows . . . . . 67  
Dimensions . . . . . 325-327  
Dispute settlement board . . . . . 246  
Dome lamps . . . . . 80  
Door mirrors . . . . . 96  
Doors ajar, warning light . . . . . 17

## Index

### D

Driving through water . . . . . 204  
Driving with a trailer . . . . . 209-213  
Driving with automatic  
transaxle . . . . . 196-199

### E

Emission control system . . 304-306  
Engine compartment . . . . 269, 270  
Engine coolant . . . . . 278, 322, 323  
Engine data . . . . . 324  
Engine number . . . . . 329  
Engine oil . . . . . 271, 321, 323  
Engine oil pressure warning light 15  
EPA window sticker . . . . . 304  
Exhaust fumes . . . . . 186

### F

Fail safe cooling system . . . . . 19  
Fail-safe cooling . . . . . 287-289  
Fan speed control . . . . . 64  
Floor mat . . . . . 108  
Fog lights . . . . . 75  
Fog lights, replacing bulbs . . . . . 84  
Footwell heating . . . . . 62-64  
Front seats . . . . . 129  
Fuel economy . . . . . 298  
Fuel economy habits . . . . . 301  
Fuel filler cap . . . . . 293  
Fuel filter . . . . . 297, 321  
Fuel for cleaner air . . . . . 296  
Fuel gauge . . . . . 20  
Fuel level . . . . . 16  
Fuel pump shut-off switch . . . . 218  
Fuel quality . . . . . 295  
Fuel tank . . . . . 322

### F

Fuel, choosing . . . . . 294  
Fuel, octane recommendations 295  
Fuel, safety information . . . . . 290  
Fuses and relays . . . . . 219-226

### G

Gearshift warning chime . . . . . 18  
Good fuel economy . . . . . 298  
Gross axle weight rating  
(GAWR) . . . . . 206  
Gross combined weight (GCW) 206  
Gross vehicle weight (GVW) . . 205  
Gross vehicle weight rating  
(GVWR) . . . . . 205

### H

Hazard flasher control . . . . . 217  
Head restraints . . . . . 129  
Headlamp control . . . . . 74  
Headlamps on warning chime . . . 18  
Headlamps, aiming . . . . . 76  
Headlamps, replacing bulbs . . 81-82  
Heating and ventilation . . . . . 62  
High beams . . . . . 17, 76  
Hood, opening . . . . . 268

### I

Identifying your vehicle . . . . . 328  
Ignition positions . . . . . 180  
Instrument cluster . . . . . 10-21  
Instrument cluster gauges . . 19-21  
Interior rear view mirror . . . . . 96  
Introduction . . . . . 4

# Index

## J

- Jack . . . . . 230-233
- Jack positioning . . . . . 231
- Jump starting . . . . . 234

## K

- Key programming . . . . . 125
- Key-in-ignition warning chime . 18
- Keys . . . . . 111

## L

- Lamps, replacing bulbs . . . . . 81-89
- LATCH attachments . . . . . 175
- Lights, warning and indicator 10-17
- Load limits . . . . . 205
- Loading your vehicle . . . . . 205
- Locking system
  - Central door locking . . . . 112-118
  - Door locks . . . . . 111
  - Locks . . . . . 111-118
- Locks and keys . . . . . 111
- Lost transmitters . . . . . 120
- Lubricant specifications . . . . . 323
- Luggage compartment . . . . . 114
- Luggage cover . . . . . 109
- Luggage rack . . . . . 110

## M

- Manual transaxle operation . . . 200
- Mileage. *See* Fuel economy
- Mirror . . . . . 97
- Mirrors . . . . . 96
- Motorcraft parts . . . . . 321

## N

- National Highway Traffic Safety Administration . . . . . 251

## O

- Octane rating . . . . . 295
- Odometer . . . . . 21
- Oil filter . . . . . 321
- Opening the luggage compartment . . . . . 114
- Overdrive, indicator light . . . . . 14
- Owner's literature . . . . . 250

## P

- Panic alarm . . . . . 118
- Parking brake . . . . . 189
- Parts . . . . . 321
- Payload . . . . . 205
- PCV valve . . . . . 321
- Perimeter alarm system . . . . . 122
- Power distribution box . . . . . 224
- Power side view mirrors . . . . . 97
- Power steering . . . . . 193, 322, 324
- Power steering fluid . . . . . 308
- Power windows . . . . . 95
- Preparing to start your vehicle . 181

## R

- Radio . . . . . 22
- Reading lamps . . . . . 80
- Rear view mirrors . . . . . 96
- Rear window defroster . . . . . 73
- Recirculated air . . . . . 65, 67
- Refill capacities . . . . . 321
- Registers . . . . . 62
- Relays . . . . . 219

## Index

### R

- Remote entry system . . . . . 116
- Reporting safety defects . . . . . 251
- Roadside assistance . . . . . 216
- Running out of fuel . . . . . 297

### S

- Safety belt extension assembly 154
- Safety belt maintenance . . . . . 155
- Safety belt warning chime . . 18, 147
- Safety belt warning light . . . 14, 147
- Safety belts . . . . . 134
- Safety belts for children . . . . . 170
- Safety compliance label . . . . . 328
- Safety defects, reporting . . . . . 251
- Safety restraints . . . . . 134
- Safety restraints for children . . 165
- Seating . . . . . 129
- SecuriLockT passive anti-theft system . . . . . 123
- Service plan . . . . . 245
- Servicing your vehicle . . . . . 267
- Snow tires and chains . . . . . 319
- Spare tire . . . . . 227
- Spark plugs . . . . . 321
- Specifications . . . . . 321
- Speed control . . . . . 17, 97
- Speedometer . . . . . 21
- Steering . . . . . 193
- Steering column . . . . . 94
- Sunroof . . . . . 101-103
  - Safety mode . . . . . 103

### T

- Tachometer . . . . . 21
- Temperature control . . . . . 63
- Temperature gauge . . . . . 19

### T

- Tilt steering wheel . . . . . 94
- Tires, changing . . . . . 227-233
- Tires, checking the pressure . . . 317
- Tires, replacing . . . . . 318
- Tires, spare . . . . . 227
- Tires, tire grades . . . . . 314
- Tires, treadwear . . . . . 315
- Towing your vehicle . . . . . 213, 241
- Trailer towing . . . . . 209
- Transaxle fluid . . . . . 310
- Transaxle, automatic . . . . . 194, 268
- Transaxle, manual . . . . . 200, 268
- Tripmeter . . . . . 21
- Trunk. *See* Luggage compartment
- Turn signal control . . . . . 80
- Turn signals . . . . . 17

### U

- Upshift . . . . . 14

### V

- Vehicle identification number . . 329
- Vehicle symbol glossary . . . . . 8
- Viscosity. *See* Engine oil

### W

- Warning lights . . . . . 10-17
- Weight limits . . . . . 205
- Windshield washer fluid . . . . . 268, 271, 322
- Windshield wiper . . . . . 91
- Windshield wiper blades . . . . . 93
- Wrecker towing . . . . . 241

## Filling station information

Item	Information
Recommended fuel	Unleaded fuel only - 87 octane
Fuel tank capacity	50 L (13.2 gallons)
Engine oil capacity (includes filter change)	2.0 L Zetec-E: 4.25 L (4.5 quarts) 2.0 L SPI: 3.78 L (4.0 quarts)
Tire size and pressure	See label on the inside of the fuel filler door or the safety compliance label.
Hood release	Pull handle under the left side of the instrument panel
Coolant capacity*	5.75 L (6.1 quarts)
Power steering fluid capacity	Fill to line on reservoir.
Manual transaxle fluid capacity	2.0 L (2.1 quarts)
Automatic transaxle fluid capacity**	6.6 L (6.9 quarts)

\* If your engine requires additional coolant, use Ford Premium Cooling System Fluid. Refer to *Lubricant Specifications*.

\*\* Ensure correct automatic transaxle fluid is used for a specific application. Check the container to verify the fluid is MERCON® and/or MERCON® V approved. Some fluids have been approved as meeting both MERCON® and MERCON® V requirements and will be labeled as such. Fluids labeled as meeting only MERCON® or only MERCON® V requirements must not be used interchangeably. DO NOT mix MERCON® and MERCON® V. Transaxle fluid requirements are indicated on the dipstick or on the dipstick handle. Refer to your “Scheduled Maintenance Guide” to determine the correct service interval.