

## Table of Contents

<b>Introduction</b>	<b>4</b>
<b>Instrument Cluster</b>	<b>12</b>
Warning and control lights	12
Gauges	15
<b>Entertainment Systems</b>	<b>19</b>
AM/FM stereo	19
AM/FM stereo cassette	21
AM/FM stereo cassette with CD	23
AM/FM stereo with CD	27
CD changer	31
<b>Climate Controls</b>	<b>35</b>
Heater only	35
Manual heating and air conditioning	36
<b>Lights</b>	<b>38</b>
Headlamps	38
Turn signal control	41
Bulb replacement	42
<b>Driver Controls</b>	<b>48</b>
Windshield wiper/washer control	48
Steering wheel adjustment	49
Moon roof	51
Power windows	52
Mirrors	53
Speed control	56
Message center	59

<b>Table of Contents</b>	
<b>Locks and Security</b>	<b>65</b>
Keys	65
Locks	65
Anti-theft system	67
<b>Seating and Safety Restraints</b>	<b>72</b>
Seating	72
Safety restraints	77
Air bags	90
Child restraints	99
<b>Driving</b>	<b>110</b>
Starting	110
Brakes	115
Transmission operation	118
Trailer towing	146
<b>Roadside Emergencies</b>	<b>174</b>
Getting roadside assistance	174
Hazard flasher switch	175
Fuel pump shut-off switch	175
Fuses and relays	176
Changing tires	181
Jump starting	192
Wrecker towing	197
<b>Customer Assistance</b>	<b>199</b>
Reporting safety defects (U.S. only)	207
<b>Cleaning</b>	<b>208</b>

## Table of Contents

<b>Maintenance and Specifications</b>	<b>215</b>
Engine compartment	217
Engine oil	218
Battery	221
Fuel information	229
Air filter(s)	246
Part numbers	253
Refill capacities	254
Lubricant specifications	257
<b>Accessories</b>	<b>270</b>
<b>Index</b>	<b>274</b>

All rights reserved. Reproduction by any means, electronic or mechanical including photocopying, recording or by any information storage and retrieval system or translation in whole or part is not permitted without written authorization from Ford Motor Company. Ford may change the contents without notice and without incurring obligation.

Copyright © 2003 Ford Motor Company

## Introduction

### CALIFORNIA Proposition 65 Warning



**WARNING:** Engine exhaust, some of its constituents, and certain vehicle components contain or emit chemicals known to the State of California to cause cancer and birth defects or other reproductive harm. In addition, certain fluids contained in vehicles and certain products of component wear contain or emit chemicals known to the State of California to cause cancer and birth defects or other reproductive harm.

### CONGRATULATIONS

Congratulations on acquiring your new Ford. Please take the time to get well acquainted with your vehicle by reading this handbook. The more you know and understand about your vehicle the greater the safety and pleasure you will derive from driving it.

For more information on Ford Motor Company and its products visit the following website:

- In the United States: [www.ford.com](http://www.ford.com)
- In Canada: [www.ford.ca](http://www.ford.ca)
- In Australia: [www.ford.com.au](http://www.ford.com.au)
- In Mexico: [www.ford.com.mx](http://www.ford.com.mx)

Additional owner information is given in separate publications.

This Owner's Guide describes every option and model variant available and therefore some of the items covered may not apply to your particular vehicle. Furthermore, due to printing cycles it may describe options before they are generally available.

Remember to pass on the Owner's Guide when reselling the vehicle. It is an integral part of the vehicle.



**Fuel pump shut-off switch** In the event of an accident the safety switch will automatically cut off the fuel supply to the engine. The switch can also be activated through sudden vibration (e.g. collision when parking). To reset the switch, refer to the *Fuel pump shut-off switch* in the *Roadside emergencies* chapter.

### SAFETY AND ENVIRONMENT PROTECTION

#### **Warning symbols in this guide**

How can you reduce the risk of personal injury and prevent possible damage to others, your vehicle and its equipment? In this guide, answers to such questions are contained in comments highlighted by the warning triangle symbol. These comments should be read and observed.

#### **Warning symbols on your vehicle**

When you see this symbol, it is imperative that you consult the relevant section of this guide before touching or attempting adjustment of any kind.



#### **Protecting the environment**

We must all play our part in protecting the environment. Correct vehicle usage and the authorized disposal of waste cleaning and lubrication materials are significant steps towards this aim. Information in this respect is highlighted in this guide with the tree symbol.



#### **BREAKING-IN YOUR VEHICLE**

Your vehicle does not need an extensive break-in. Try not to drive continuously at the same speed for the first 1,600 km (1,000 miles) of new vehicle operation. Vary your speed to allow parts to adjust themselves to other parts.

Drive your new vehicle for at least 800 km (500 miles) before towing a trailer or snowplowing.

Do not add friction modifier compounds or special break-in oils during the first few thousand kilometers (miles) of operation, since these additives may prevent piston ring seating. See *Engine oil* in the *Maintenance and specifications* chapter for more information on oil usage.

## Introduction

### SPECIAL NOTICES

#### Emission warranty

The New Vehicle Limited Warranty includes Bumper-to-Bumper Coverage, Safety Restraint Coverage, Corrosion Coverage, and 7.3L Power Stroke Diesel Engine Coverage. In addition, your vehicle is eligible for Emissions Defect and Emissions Performance Warranties. For a detailed description of what is covered and what is not covered, refer to the *Warranty Guide* that is provided to you along with your Owner's Guide.

#### Data Recording

Computers in your vehicle are capable of recording detailed data potentially including but not limited to information such as:

- the use of restraint systems including seat belts by the driver and passengers,
- information about the performance of various systems and modules in the vehicle, and
- information related to engine, throttle, steering, brake or other system status.

Any of this information could potentially include information regarding how the driver operates the vehicle, potentially including but not limited to information regarding vehicle speed, brake or accelerator application, or steering input. This information may be stored during regular operation or in a crash or near crash event.

This stored information may be read out and used by:

- Ford Motor Company.
- service and repair facilities.
- law enforcement or government agencies.
- others who may assert a right or obtain your consent to know such information.

## Introduction

### Special instructions

For your added safety, your vehicle is fitted with sophisticated electronic controls.



Please read the section *Supplemental Restraint System (SRS)* in the *Seating and safety restraints* chapter. Failure to follow the specific warnings and instructions could result in personal injury.



Front seat mounted rear facing child or infant seats should **NEVER** be used in front of a passenger side air bag unless the air bag can be and is turned OFF.

### Notice to owners of diesel-powered vehicles

Read the 6.0 Liter Power Stroke Direct Injection Turbo Diesel Owner's Guide Supplement for information regarding correct operation and maintenance of your Diesel-powered light truck.

### Notice to owners of pickup trucks and utility type vehicles



Utility vehicles have a significantly higher rollover rate than other types of vehicles.

Before you drive your vehicle, please read this Owner's Guide carefully. Your vehicle is not a passenger car. As with other vehicles of this type, failure to operate this vehicle correctly may result in loss of vehicle control, vehicle rollover, personal injury or death.

Be sure to read *Driving off road* in the *Driving* chapter.

## Introduction

### Using your vehicle with a snowplow

For more information and guidelines for using your vehicle with a snowplow, refer to the *Driving* chapter.

### Using your vehicle as an ambulance

If your light truck is equipped with the Ford Ambulance Preparation Package, it may be utilized as an ambulance. Ford urges ambulance manufacturers to follow the recommendations of the *Ford Incomplete Vehicle Manual*, *Ford Truck Body Builder's Layout Book* and the *Qualified Vehicle Modifiers (QVM) Guidelines* as well as pertinent supplements. For additional information, please contact the Truck Body Builders Advisory Service 1-877-840-4338.

Use of your Ford light truck as an ambulance, without the Ford Ambulance Preparation Package voids the Ford New Vehicle Limited Warranty and may void the Emissions Warranties. In addition, ambulance usage without the preparation package could cause high underbody temperatures, overpressurized fuel and a risk of spraying fuel which could lead to fires.

If your vehicle is equipped with the Ford Ambulance Preparation Package, it will be indicated on the Certification label. The label is located on the driver's side door pillar or on the rear edge of the driver's door. You can determine whether the ambulance manufacturer followed Ford's recommendations by directly contacting that manufacturer. Ford Ambulance Preparation Package is only available on certain 6.0L Diesel engine equipped vehicles.

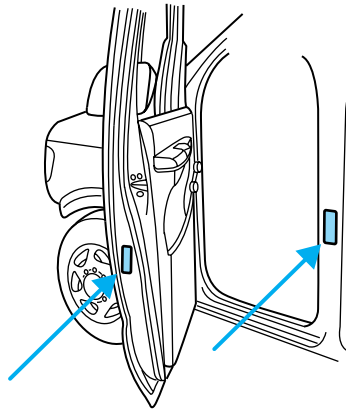



## Introduction

### **Notice to owners with vehicles equipped with Power Take Off (PTO) capability**

Refer to the *Driving* chapter for more information and guidelines for operating vehicles equipped with PTO.

### **Middle East/North Africa vehicle specific information**

For your particular global region, your vehicle may be equipped with features and options that are different from the ones that are described in this Owner Guide; therefore, a supplement has been supplied that complements this book. By referring to the pages in the provided supplement, you can properly identify those features, recommendations and specifications that are unique to your vehicle. **Refer to this Owner Guide for all other required information and warnings.**

## Introduction

These are some of the symbols you may see on your vehicle.

### Vehicle Symbol Glossary

Safety Alert		See Owner's Guide	
Fasten Safety Belt		Air Bag-Front	
Air Bag-Side		Child Seat	
Child Seat Installation Warning		Child Seat Lower Anchor	
Child Seat Tether Anchor		Brake System	
Anti-Lock Brake System		Brake Fluid - Non-Petroleum Based	
Traction Control		AdvanceTrac <sup>™</sup>	
Master Lighting Switch		Hazard Warning Flasher	
Fog Lamps-Front		Fuse Compartment	
Fuel Pump Reset		Windshield Wash/Wipe	
Windshield Defrost/Demist		Rear Window Defrost/Demist	

## Introduction

### Vehicle Symbol Glossary

Power Windows Front/Rear		Power Window Lockout	
Child Safety Door Lock/Unlock		Interior Luggage Compartment Release Symbol	
Panic Alarm		Engine Oil	
Engine Coolant		Engine Coolant Temperature	
Do Not Open When Hot		Battery	
Avoid Smoking, Flames, or Sparks		Battery Acid	
Explosive Gas		Fan Warning	
Power Steering Fluid		Maintain Correct Fluid Level	
Emission System		Engine Air Filter	
Passenger Compartment Air Filter		Jack	
Check fuel cap		Low tire warning	

## Instrument Cluster

### WARNING LIGHTS AND CHIMES

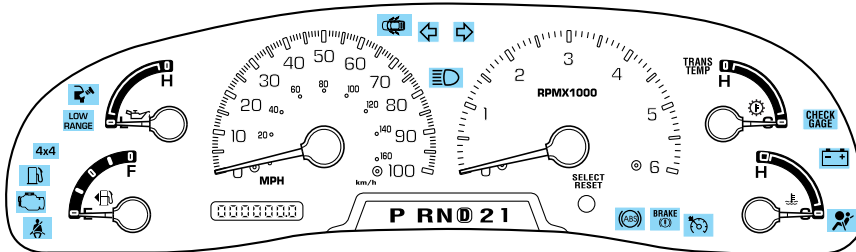

Warning lights and gauges can alert you to a vehicle condition that may become serious enough to cause expensive repairs. A warning light may illuminate when a problem exists with one of your vehicle's functions. Many lights will illuminate when you start your vehicle to make sure the bulb works. If any light remains on after starting the vehicle, have the respective system inspected immediately.

**Service engine soon:** The *Service engine soon* indicator light

illuminates when the ignition is first turned to the ON position to check the bulb. Solid illumination after the engine is started indicates the On Board Diagnostics System (OBD-II) has detected a malfunction. Refer to *On board diagnostics (OBD-II)* in the *Maintenance and Specifications* chapter. If the light is blinking, engine misfire is occurring which could damage your catalytic converter. Drive in a moderate fashion (avoid heavy acceleration and deceleration) and have your vehicle serviced immediately.

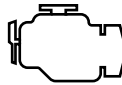

Under engine misfire conditions, excessive exhaust temperatures could damage the catalytic converter, the fuel system, interior floor coverings or other vehicle components, possibly causing a fire.

**Check fuel cap (if equipped):**

Illuminates when the fuel cap may not be properly installed. Continued driving with this light on may cause the Service engine soon warning light to come on. Refer to *Fuel filler cap* in the *Maintenance and Specifications* chapter.



## Instrument Cluster

**Check gage:** Illuminates when any of the following conditions has occurred:

- The engine coolant temperature is high.
- The engine oil pressure is low.
- The fuel gauge is at or near empty.

**CHECK  
GAGE**

**Brake system warning light:** To confirm the brake system warning light is functional, it will momentarily illuminate when the ignition is turned to the ON position when the engine is not running, or in a position between ON and START, or by applying the parking brake when the ignition is turned to the ON position. If the brake system warning light does not illuminate at this time, seek service immediately from your dealership. Illumination after releasing the parking brake indicates low brake fluid level and the brake system should be inspected immediately by your servicing dealership.

**BRAKE**  



Driving a vehicle with the brake system warning light on is dangerous. A significant decrease in braking performance may occur. It will take you longer to stop the vehicle. Have the vehicle checked by your dealer immediately.

**Anti-lock brake system:** If the ABS light stays illuminated or continues to flash, a malfunction has been detected, have the system serviced immediately. Normal braking is still functional unless the brake warning light also is illuminated.



**Air bag readiness:** If this light fails to illuminate when ignition is turned to ON, continues to flash or remains on, have the system serviced immediately. A chime will also sound when a malfunction in the supplemental restraint system has been detected.



## Instrument Cluster

**Safety belt:** Reminds you to fasten your safety belt. A chime will also sound to remind you to fasten your safety belt.



**Charging system:** Illuminates when the battery is not charging properly.



**Low fuel:** Illuminates when the fuel level in the fuel tank is at or near empty (refer to *Fuel gauge* in this chapter).



**Speed control:** Illuminates when the speed control is activated. Turns off when the speed control system is deactivated.



### **Transmission Tow/Haul Feature (5-speed automatic transmission) (if equipped):**

The ON light on the end of the gearshift lever illuminates when the Tow/Haul feature has been selected. Refer to the *Driving* chapter for transmission function and operation. If the light flashes steadily, have the system serviced immediately, damage to the transmission could occur.

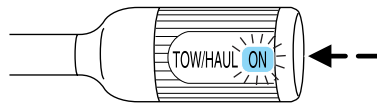

### **Transmission control indicator light (TCIL) (4-speed automatic transmission) (if equipped):**

Illuminates when the overdrive function of the transmission has been turned OFF, refer to the *Driving* chapter. If the light flashes steadily, have the system serviced immediately, damage to the transmission could occur.

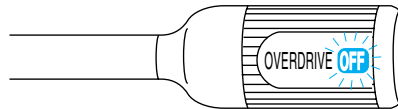

**Four wheel drive low (if equipped):** Illuminates when four-wheel drive low is engaged.

**LOW  
RANGE**

## Instrument Cluster

**Four wheel drive indicator (if equipped):** Illuminates when four-wheel drive is engaged.

4x4

**Door ajar:** Illuminates when the ignition is in the ON position and any door is open.



**Turn signal:** Illuminates when the left or right turn signal or the hazard lights are turned on. If the indicators stay on or flash faster, check for a burned out bulb.



**High beams:** Illuminates when the high beam headlamps are turned on.



**Key-in-ignition warning chime:** Sounds when the key is left in the ignition in the OFF/LOCK or ACC position and the driver's door is opened.

**Headlamps on warning chime:** Sounds when the headlamps or parking lamps are on, the ignition is off (the key is not in the ignition) and the driver's door is opened.

**Parking brake ON warning chime:** Sounds when the parking brake is set, the engine is running and the vehicle is driven more than 5 Km (3 mph).

## GAUGES

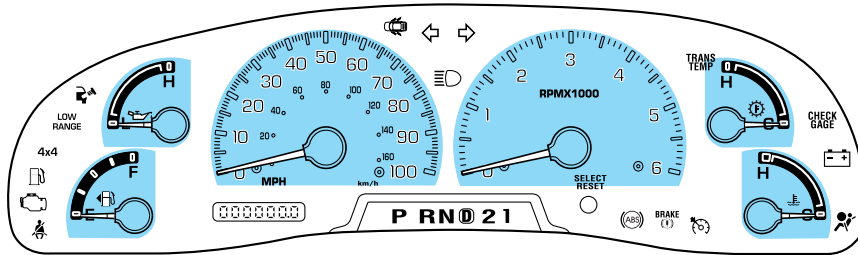

## Instrument Cluster

**Speedometer:** Indicates the current vehicle speed.

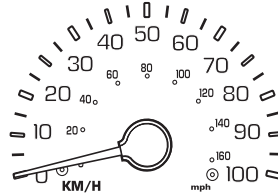

**Engine coolant temperature gauge:** Indicates engine coolant temperature. At normal operating temperature, the needle will be in the normal range (between “H” and “C”). **If it enters the red section, the engine is overheating. Stop the vehicle as soon as safely possible, switch off the engine and let the engine cool.**

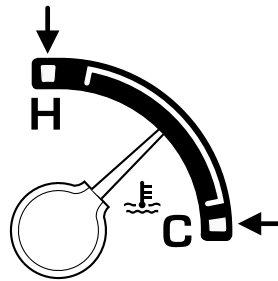

Never remove the coolant reservoir cap while the engine is running or hot.

**Odometer:** Registers the total kilometers (miles) of the vehicle.



**Trip odometer:** Registers the kilometers (miles) of individual journeys. Press the control once to switch from the odometer to the trip odometer. To reset the trip, press the control again until the trip reading is 0.0 miles.

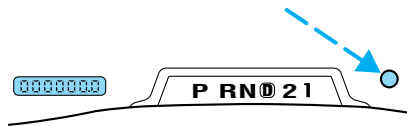

**Tachometer:** Indicates the engine speed in revolutions per minute. Driving with your tachometer pointer continuously at the top of the scale may damage the engine.

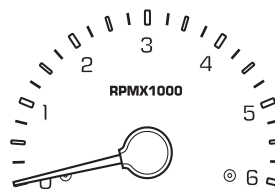



## Instrument Cluster

**Battery voltage gauge (manual transmission only):** Indicates the battery voltage when the ignition is in the ON position. If the pointer moves and stays outside the normal operating range (as indicated by arrows), have the vehicle's electrical system checked as soon as possible.

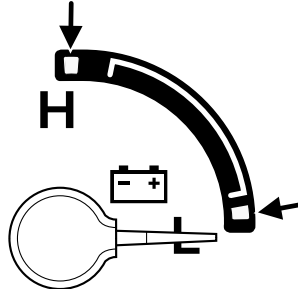

**Engine oil pressure gauge:** Indicates engine oil pressure. The needle should stay in the normal operating range (between "L" and "H"). If the needle falls below the normal range, stop the vehicle, turn off the engine and check the engine oil level. Add oil if needed. If the oil level is correct, have your vehicle checked at your dealership or by a qualified technician.

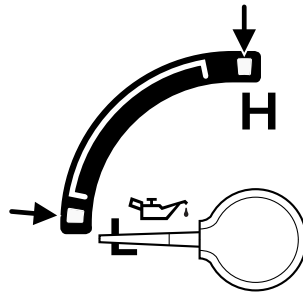

**Fuel gauge:** Indicates approximately how much fuel is left in the fuel tank (when the ignition is in the ON position). The fuel gauge may vary slightly when the vehicle is in motion or on a grade.

Refer to *Filling the tank* in the *Maintenance and Specifications* chapter for more information.

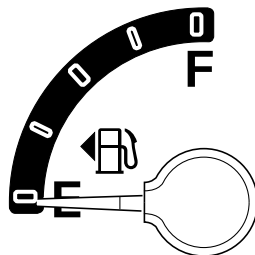

## Instrument Cluster

**Transmission fluid temperature gauge (automatic transmission only):** If the gauge is in the:

**White area** (normal) - the transmission fluid is within the normal operating temperature (between "H" and "C").

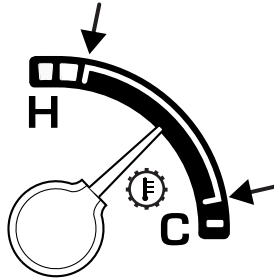

**Yellow area** (warning) — the transmission fluid is higher than normal operating temperature. This can be caused by special operation conditions (i.e. snowplowing, towing or off road use). Refer to *Special Operating Conditions* in the scheduled maintenance guide for instructions. Operating the transmission for extended periods of time with the gauge in the yellow area may cause internal transmission damage.

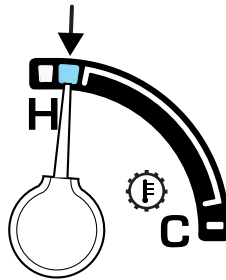

Altering the severity of the driving conditions is recommended to lower the transmission temperature into the normal range.

**Red area** (over temperature) — the transmission fluid is overheating. Stop the vehicle to allow the temperature to return to normal range.

If the gauge is operating in the Yellow or Red area, stop the vehicle and verify the airflow is not restricted such as snow or debris blocking airflow through the grill. If the gauge continues to show high temperatures, see your Ford dealer.

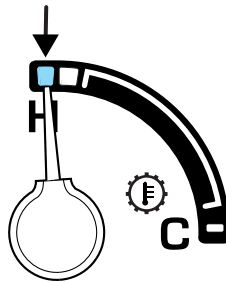

## Entertainment Systems

### AM/FM STEREO

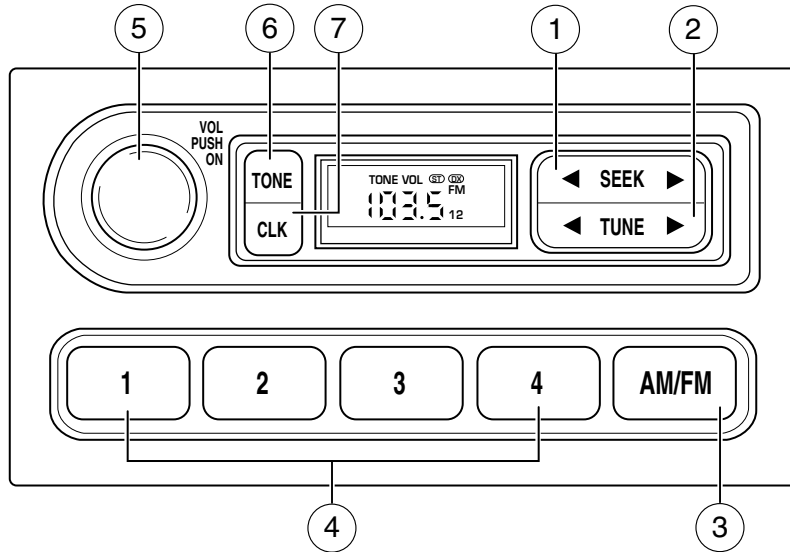

1. **Seek:** Press ◀ / ▶ to find the next strong station down/up the frequency band.



2. **Tune:** Press ◀ / ▶ to manually change radio frequency down/up.



3. **AM/FM:** Press to choose a frequency band in radio mode.



## Entertainment Systems

4. **Memory preset buttons:** To set a station: Select frequency band AM/FM; tune to a station, press and hold a preset button until sound returns.



5. **Power/volume:** Press to turn ON/OFF; turn to increase or decrease volume levels.

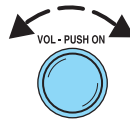

6. **Tone:** Press TONE until the desired level — Bass, Treble, Fade appears on the display. Turn the volume control to raise/lower the levels, or to move the audio sound from the right to left or the front to back (if equipped).

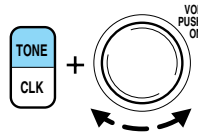

7. **CLK (Clock):** To set the hour, press and hold CLK until CLOCK SET appears in the display. Press SEEK to decrease ◀ or increase ▶ the hours.



To set the minute, press and hold CLK until CLOCK set appears in the display. Press TUNE to decrease ◀ or increase ▶ the minutes.

## Entertainment Systems

### AM/FM STEREO CASSETTE

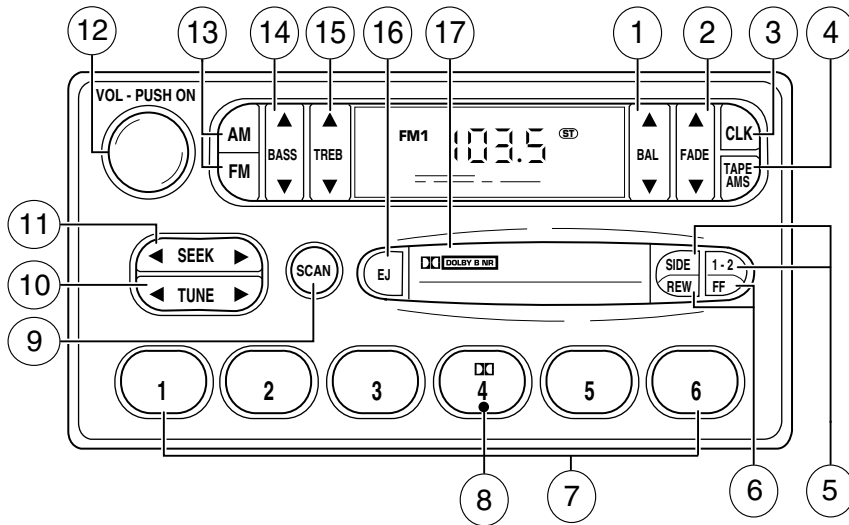

1. **Balance:** Press to shift sound to the left/right speakers.



2. **Fade:** Press to shift sound to the rear/front speakers.



3. **CLK:** To set the hour, press and hold CLK. Then press SEEK to decrease ◀ or increase ▶ the hours.



To set the minute, press and hold CLK and press TUNE to decrease ◀ or increase ▶ the minutes.

## Entertainment Systems

4. **Tape AMS:** In tape mode, press and hold to activate Automatic Music Search (allows you to quickly locate the beginning of the tape selection being played or to skip to the next selection). Then, press REW (for the beginning of the current selection) or FF (to advance to the next selection). The tape MUST have a blank section of at least four seconds duration between programs.



5. **Side 1-2:** Press to change tape direction.

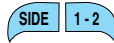

6. **REW (rewind):** Press to rewind the tape.



**FF (fast forward):** Press to advance the tape.



7. **Memory preset buttons:** To set a station: Select frequency band AM/FM1/FM2; tune to a station, press and hold a preset button until sound returns.



8. **Dolby® noise reduction:** Works in tape mode only. Reduces tape noise and hiss; press to activate/deactivate.

9. **Scan:** Press SCAN to hear a brief sampling of all listenable radio stations or all tape selections. Press again to stop.



10. **Tune:** Works in radio mode only. Press TUNE ◀ / ▶ to change frequency down/up



11. **Seek:** Press and release ◀ / ▶ for previous/next strong station, selection or track.



12. **Power/volume:** Press to turn ON/OFF; turn to increase or decrease volume levels.

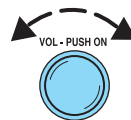

## Entertainment Systems

13. **AM/FM:** Press to choose a frequency band in radio mode.



14. **Bass:** Press ▼ / ▲ to decrease/increase the bass output.



15. **Treble:** Press ▼ / ▲ to decrease/increase the treble output.



16. **EJ (Eject):** Press to eject a tape.



17. **Cassette door:** Insert a cassette into the cassette door.

### PREMIUM AM/FM STEREO/CASSETTE/SINGLE CD

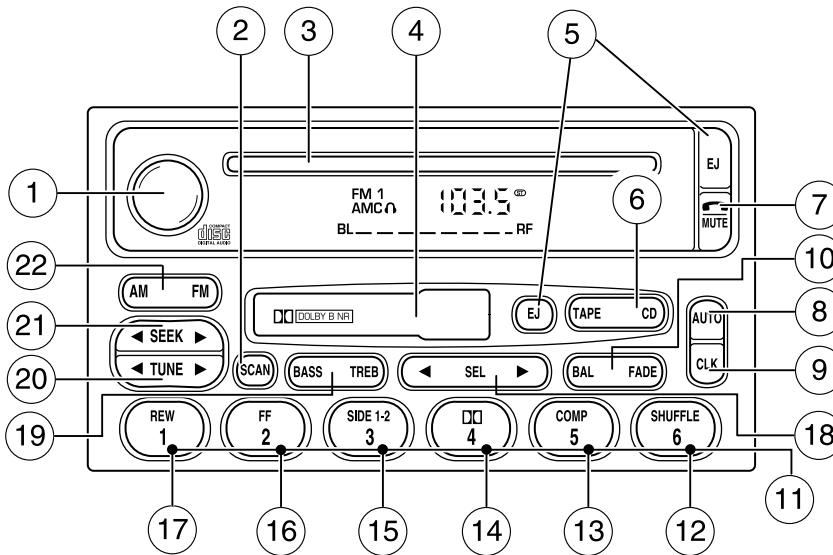

## Entertainment Systems

1. **Power/volume:** Press to turn ON/OFF; turn to increase/decrease volume.

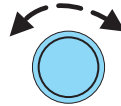

2. **Scan:** Press to hear a brief sampling of all listenable stations, tape selections or CD tracks. Press again to stop.



3. **CD Door:** Insert a CD with the label side up.

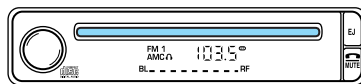

**CD units are designed to play commercially pressed 12 cm (4.75 in) audio compact discs only. Due to technical incompatibility, certain recordable and re-recordable compact discs may not function correctly when used in Ford CD players. Irregular shaped CDs, CDs with a scratch protection film attached, and CDs with homemade paper (adhesive) labels should not be inserted into the CD player. The label may peel and cause the CD to become jammed. It is recommended that homemade CDs be identified with permanent felt tip marker rather than adhesive labels. Ballpoint pens may damage CDs. Please contact your dealer for further information.**

4. **Cassette door:** Insert the cassette with the opening to the right.

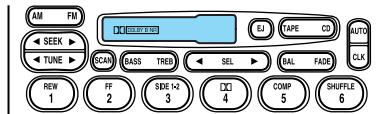

5. **Eject:** Press to eject the cassette/CD. The radio will resume playing.

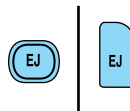

6. **Tape:** Press to start tape play. Press to stop tape during rewind/fast forward.





## Entertainment Systems

**CD:** Press to start CD play. With the dual media audio, press CD to toggle between single CD and CD changer play (if equipped).



7. **Mute:** Press to MUTE playing media; press again return to playing media.



8. **Auto:** Press to set first six strongest stations (if available) into AM, FM1 or FM2 memory buttons; press again to return to normal stations.



9. **Clock:** Press and hold to set the clock. Press the ◀ SEEK to decrease hours or SEEK ▶ to increase hours. Press the ◀ TUNE to decrease minutes or TUNE ▶ to increase minutes. If your vehicle has a stand alone clock this control will not function.



10. **Balance:** Press BAL; then press SEL ◀ / ▶ to shift sound to the left/right speakers.

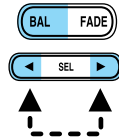

**Fade:** Press FADE; then press SEL ◀ / ▶ to shift sound to the rear/front speakers.

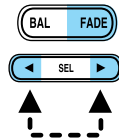

11. **Memory preset buttons:** To set a station: Select frequency band AM/FM, tune to a station, press and hold a preset button until sound returns.

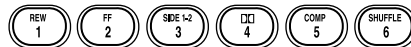

## Entertainment Systems

12. **Shuffle (CD):** Press to play tracks in random order.



13. **Compression (CD):** Press to bring soft and loud passages together for a more consistent listening level.



14. **Dolby® noise reduction:** Works in tape mode only. Reduces tape noise and hiss; press to activate/deactivate.



The Dolby® noise reduction system is manufactured under license from Dolby Laboratories Licensing Corporation. Dolby® and the double-D symbol are registered trademarks of Dolby Laboratories Licensing Corporation.

15. **Side 1-2:** Works in tape mode only. Press to play reverse side of the tape.



16. **Fast Forward (FF):** Press for a slow advance, press and hold for a fast advance.



17. **Rewind (REW):** Press for a slow rewind, press and hold for a fast rewind.



18. **Select (SEL):** Use with Bass, Treble, Balance and Fade controls.

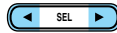

19. **Bass:** Press BASS; then press SEL ◀/▶ to decrease/increase the bass output.

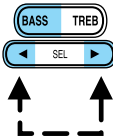

## Entertainment Systems

**Treble:** Press TREB; then press SEL ◀/▶ to decrease/increase the treble output.

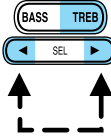

20. **Tune:** Works in radio mode only. Press TUNE ◀/▶ to change frequency down/up.

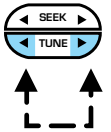

21. **Seek:** Press and release SEEK ◀/▶ for previous/next strong station, selection or track.

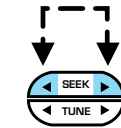

22. **AM/FM:** Press to select AM/FM1/FM2 frequency band.



### PREMIUM IN-DASH SIX CD SOUND SYSTEM

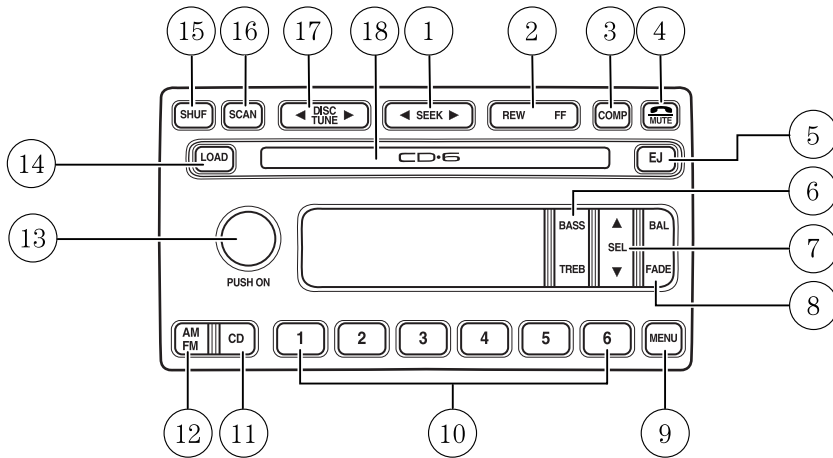

## Entertainment Systems

1. **Seek:** Press and release SEEK ◀ / ▶ for previous/next strong station, or track of current disc.



2. **Rewind:** Press for a slow rewind, press and hold for a fast rewind.



**Fast forward:** Press for a slow advance, press and hold for a fast advance.



3. **Comp** (Compression): In CD mode, press to adjust the soft and loud passages together for a more consistent listening level. Press the COMP control until COMP ON is displayed.

4. **Mute:** Press to MUTE playing media; press again return to playing media. In CD mode, MUTE acts as a pause feature.



5. **Eject:** Press to eject a CD. Press and hold to auto eject all loaded discs.



6. **Bass:** Press BASS; then press SEL ◀ / ▶ to decrease/increase the bass output.

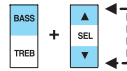

**Treble:** Press TREB; then press SEL ◀ / ▶ to decrease/increase the treble output.



7. **Select:** Use with Bass, Treble, Balance and Fade controls to adjust levels. Use with MENU to set the clock and engage RDS.

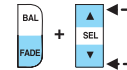

8. **Balance:** Press BAL; then press SEL ◀ / ▶ to shift sound to the left/right speakers.

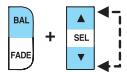

## Entertainment Systems

**Fade:** Press FADE; then press SEL ◀/▶ to shift sound to the rear/front speakers.

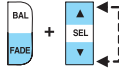

9. **Menu:** Press MENU and SEL to access clock mode, RDS on/off, Traffic, Program type, Show type and Compression modes.

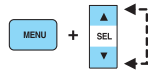

**Traffic:** Allows you to hear traffic broadcasts. With the feature ON, press SEEK or SCAN to find a station broadcasting a traffic report (if it is broadcasting RDS data). *Traffic information is not available in most U.S. markets.*

**FIND Program type:** Allows you to search RDS-equipped stations for a certain category of music format: Classic, Country, Info, Jazz, Oldies, R&B, Religious, Rock, Soft, Top 40.

**Show TYPE:** Displays the station's call letters and format.

**Compression:** Brings soft and loud CD passages together for a more consistent listening level.

**Setting the clock:** Press MENU until SELECT HOUR or SELECT MINUTE is displayed. Use SEL to manually increase (▲) or decrease (▼) the hours/minutes. Press MENU again to disengage clock mode.

10. **Memory presets:** To set a station: Select frequency band AM/FM; tune to a station, press and hold a preset button until sound returns. In CD mode, press to move between CDs.



This radio is equipped with six station memory preset controls which allow you to set up to six AM stations and 12 FM stations (six in FM1 and six in FM2).

11. **CD:** Press to select CD mode.



**Seamless play:** In CD mode, the transition between the end of one CD and the beginning of another will not contain delay time unless SEEK or a preset control is pressed.

12. **AM/FM:** Press to select a frequency band in radio mode.



## Entertainment Systems

**Autostore:** Allows you to set the strongest local radio stations without losing your original manually set preset stations for AM/FM1/FM2 . Press and momentarily hold AM/FM. AUTOSTORE will flash on the display. When the six strongest stations are filled, the station stored in preset 1 will begin playing. If there are less than six strong stations, the system will store the last one in the remaining presets. Press again to disengage.

13. **Power/volume:** Press to turn ON/OFF; turn to increase or decrease volume levels.



14. **Load:** Press to load a CD. Press and hold to load up to six discs.



15. **Shuffle:** Press to play tracks in random order. Press SHUF to cycle through SHUF TRAC, SHUF DISC or SHUF OFF.



16. **Scan:** Press to hear a brief sampling of all listenable stations or CD tracks. Press again to stop.



17. **Disc/Tune:** Radio: Press ◀ or ▶ to manually tune down or up the frequency band.



CD: Press ◀ or ▶ to select the previous or next track on the CD.

18. **CD door:** Insert a CD label side up.



## Entertainment Systems

### CD CHANGER (IF EQUIPPED)

Your CD changer is in one of the following locations:

- Behind the passenger's seat
- In the center console
- Under the rear bench on the driver's side (see instructions below)
- In the stowage bin on the passenger's side

1. Slide the door to access the CD changer magazine.

2. Press ▲ to eject the magazine.

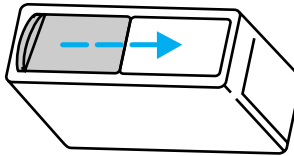

3. Turn the magazine (A) over.

4. Using the disc holder release knob (C), pull the disc holder (B) out of the magazine.

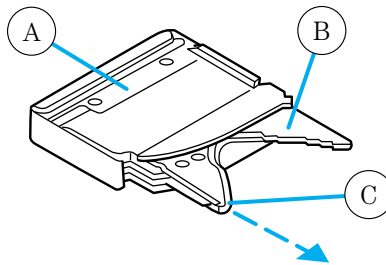

Do not pull too hard on the disc holder as the disc holder may come completely out of the magazine. If this happens, reinsert the disc holder back into the magazine while pressing on the lever.

5. Line up the CD with the groove of the disc holder. Ensure that the label on the CD faces downwards.

6. Press the disc holder until it locks securely into the magazine.

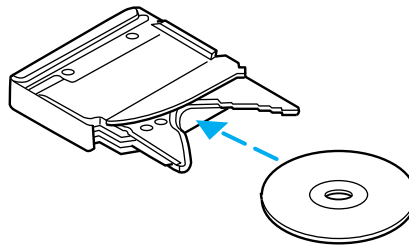

## Entertainment Systems

Ensure that the disc holder is evenly inserted and at the same level as the magazine (A). The unit will not operate if the disc holder is not inserted at the same level (B).

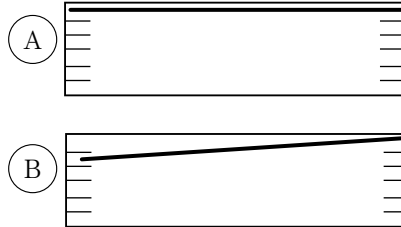

### If your CD changer is located under the rear bench, the following instructions apply to load discs:

1. Load the discs into the magazine slots (numbered 1 through 6 on the window) one at a time with labeled surfaces upward. (The holders DO NOT pull out. )

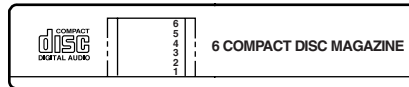

2. Begin with the bottom slot number 1.

3. Insert the loaded magazine into the CD changer with the arrow pointing toward the changer.

#### To remove discs:

1. Slide the corresponding lever on the opposite side of the magazine window. The disc will partially eject.

2. Remove the disc.

Radio power must be turned on to play the CDs in the changer. The magazine may be stored in the glove box when not being used.

The CD magazine may be inserted or ejected with the radio power off.

ONLY use the magazine supplied with the CD changer, other types will damage the unit.

Keep the CD changer door closed. Coins and foreign objects will damage the CD player and void your audio system warranty.

### RADIO FREQUENCIES

AM and FM frequencies are established by the Federal Communications Commission (FCC) and the Canadian Radio and Telecommunications Commission (CRTC). Those frequencies are:

AM - 530, 540–1700, 1710 kHz

FM- 87.7, 87.9–107.7, 107.9 MHz



## Entertainment Systems

### **RADIO RECEPTION FACTORS**

There are three factors that can affect radio reception:

- Distance/strength: The further you travel from an FM station, the weaker the signal and the weaker the reception.
- Terrain: Hills, mountains, tall buildings, power lines, electric fences, traffic lights and thunderstorms can interfere with your reception.
- Station overload: When you pass a broadcast tower, a stronger signal may overtake a weaker one and play while the weak station frequency is displayed.

### **CASSETTE/PLAYER CARE**

Do:

- Use only cassettes that are 90 minutes long or less.
- Tighten very loose tapes by inserting a finger or pencil into the hole and turning the hub.
- Remove loose labels before inserting tapes.
- Allow tapes which have been subjected to extreme heat, humidity or cold to reach a moderate temperature before playing.
- Clean the cassette player head with a cassette cleaning cartridge after 10–12 hours of play to maintain good sound/operation.

Don't:

- Expose tapes to direct sunlight, extreme humidity, heat or cold.
- Leave tapes in the cassette player for a long time when not being played.

## Entertainment Systems

### CD/CD PLAYER CARE

Do:

- Handle discs by their edges only. Never touch the playing surface.
- Inspect discs before playing. Clean only with an approved CD cleaner and wipe from the center out.

Don't:

- Expose discs to direct sunlight or heat sources for extended periods of time.
- Insert more than one disc into each slot of the CD changer magazine.
- Clean using a circular motion.

**CD units are designed to play commercially pressed 12 cm (4.75 in) audio compact discs only. Due to technical incompatibility, certain recordable and re-recordable compact discs may not function correctly when used in Ford CD players. Irregular shaped CDs, CDs with a scratch protection film attached, and CDs with homemade paper (adhesive) labels should not be inserted into the CD player. The label may peel and cause the CD to become jammed. It is recommended that homemade CDs be identified with permanent felt tip marker rather than adhesive labels. Ball point pens may damage CDs. Please contact your dealer for further information.**

### AUDIO SYSTEM WARRANTY AND SERVICE

Refer to the *Warranty Guide* for audio system warranty information. If service is necessary, see your dealer or qualified technician.

## Climate Controls

### HEATER ONLY SYSTEM (IF EQUIPPED)

1. **Fan speed adjustment:** Controls the volume of air circulated in the vehicle.

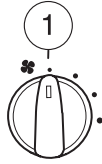

2. **Temperature selection:** Controls the temperature of the airflow in the vehicle.





3. **Air flow selections:** Controls the direction of the airflow in the vehicle. See the following for a brief description on each control.



 : Distributes outside air through the instrument panel vents.

**OFF:** Outside air is shut out and the fan will not operate.

 : Distributes outside air through the instrument panel vents and the floor vents.

 : Distributes outside air through the floor vents.

 : Distributes outside air through the windshield defroster vents and floor vents.

 : Distributes outside air through the windshield defroster vents.

### Operating tips

- To reduce fog build up on the windshield during humid weather, place the air flow selector in the  position.
- To reduce humidity build up inside the vehicle during cold or warm weather, do not drive with the air flow selector in the OFF position.
- Under normal weather conditions, do not leave the air flow selector in OFF when the vehicle is parked. This allows the vehicle to “breathe” using the outside air inlet vents.
- Do not put objects under the front seats that will interfere with the air flow to the back seats.
- Remove any snow, ice or leaves from the air intake area at the base of the windshield.

## Climate Controls

To aid in side window defogging/demisting in cold weather:

1. Select 
2. Set the temperature control to full heat
3. Set the fan speed to the highest setting.
4. Direct the outer instrument panel vents towards the side windows

To increase airflow to the outer instrument panel vents, close the vents located in the middle of the instrument panel.



Do not place objects on top of the instrument panel as these objects may become projectiles in a collision or sudden stop.

### MANUAL HEATING AND AIR CONDITIONING SYSTEM

1. **Fan speed adjustment:** Controls the volume of air circulated in the vehicle.



2. **Temperature selection:**

Controls the temperature of the airflow in the vehicle.

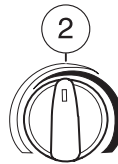

3. **Air flow selections:** Controls the direction of the airflow in the vehicle. See the following for a brief description on each control.

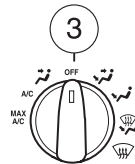

**MAX A/C:** Uses recirculated air to cool the vehicle. Air flows from the instrument panel vents only.

**A/C:** Uses outside air to cool the vehicle. Air flows from the instrument panel vents only.

 : Distributes outside air through the instrument panel vents.

**OFF:** Outside air is shut out and the fan will not operate.

 : Distributes outside air through the instrument panel vents and the floor vents.

 : Distributes outside air through the floor vents.

 : Distributes outside air through the windshield defroster vents and floor vents.

 : Distributes outside air through the windshield defroster vents.

## Climate Controls

### Operating tips

- To reduce fog build up on the windshield during humid weather, place the air flow selector in the  position.
- To reduce humidity build up inside the vehicle: do not drive with the air flow selector in the OFF or MAX A/C position.
- Under normal weather conditions, do not leave the air flow selector in MAX A/C or OFF when the vehicle is parked. This allows the vehicle to “breathe” using the outside air inlet vents.
- Do not put objects under the front seats that will interfere with the airflow to the back seats.
- Remove any snow, ice or leaves from the air intake area at the base of the windshield.

To aid in side window defogging/demisting in cold weather:

1. Select 
2. Select A/C
3. Modulate the temperature control to maintain comfort.
4. Set the fan speed to the highest setting.
5. Direct the outer instrument panel vents towards the side windows

To increase airflow to the outer instrument panel vents, close the vents located in the middle of the instrument panel.



Do not place objects on top of the instrument panel as these objects may become projectiles in a collision or sudden stop.

## Lights

### HEADLAMP CONTROL ☀️

- Turns the lamps off.
- P☀️ Turns on the parking lamps, instrument panel lamps, license plate lamps and tail lamps.
- ☀️ Turns the headlamps on.

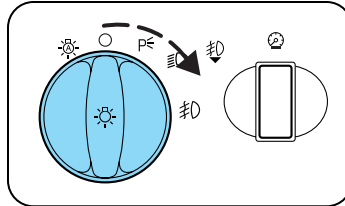

### Autolamp control (if equipped) ☀️

The autolamp system provides light sensitive automatic on-off control of the exterior lights normally controlled by the headlamp control.

The autolamp system also keeps the lights on for approximately 20 seconds after the ignition switch is turned to OFF.

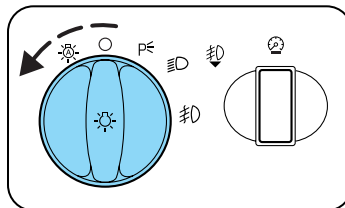

To change the delay time of the autolamp feature, do the following:

1. Start with the ignition in OFF and the autolamps selected.
2. Deselect the autolamps.
3. Put the ignition in RUN.
4. Put the ignition in OFF.
5. Select the autolamps. Steps 2 through 5 must be performed within a 10 second period. At this point, the headlamps and parking lamps will turn on.
6. Deselect the autolamps after the desired autolamp delay time (maximum of 3 minutes). At this point, the headlamps and parking lamps will turn off.



## Lights

### Foglamp control (if equipped)

The headlamp control also operates the foglamps. The foglamps can be turned on only when the headlamp control is in the ,  or  position and the high beams are not turned on.

Pull headlamp control towards you to turn foglamps on. The foglamp indicator light  will illuminate when the switch is pulled and the parklamps are on.

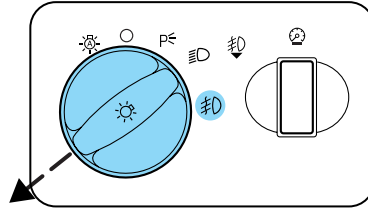

### Daytime running lamps (DRL) (if equipped)

Turns the headlamps on with a reduced output.

To activate:

- the ignition must be in the ON position and
- the headlamp control is in the OFF, parking lamp or autolamp position.

 Always remember to turn on your headlamps at dusk or during inclement weather. The Daytime Running Lamp (DRL) system does not activate with your tail lamps and generally may not provide adequate lighting during these conditions. Failure to activate your headlamps under these conditions may result in a collision.

### High beams

Push the lever toward the instrument panel to activate. Pull the lever towards you to deactivate.

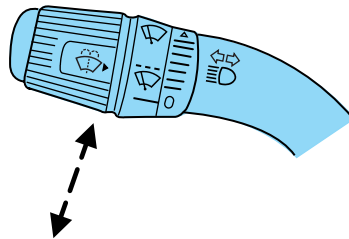

## Lights

### Flash to pass

Pull toward you slightly to activate and release to deactivate.

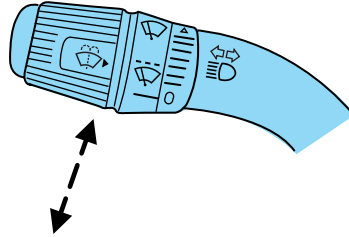

### PANEL DIMMER CONTROL

Use to adjust the brightness of the instrument panel and all applicable switches in the vehicle during headlamp and parklamp operation.

Move the control to the full upright position, past detent, to turn on the interior lamps.

Move the control to the full down position, past detent, to prevent the interior lights from illuminating when the doors are opened.

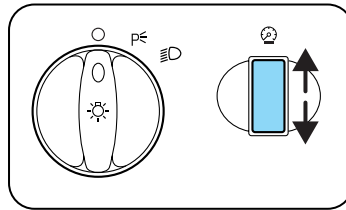

### AIMING THE HEADLAMPS

The headlamps on your vehicle are properly aimed at the assembly plant. If your vehicle has been in an accident the alignment of your headlamps should be checked by a qualified service technician.



## Lights

### TURN SIGNAL CONTROL ⇐⇒

- Push down to activate the left turn signal.
- Push up to activate the right turn signal.

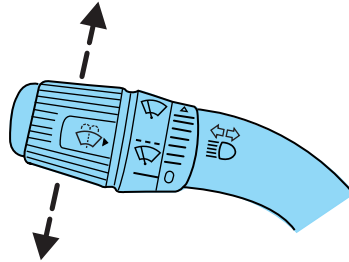

### COURTESY/READING LAMPS (IF EQUIPPED)

The dome lamp lights when the control is in the DOOR (left) position, any door is open, the instrument panel switch is pushed past the detent and when any of the remote entry controls are pressed while the ignition is off.

The reading lamps can be turned on by pressing the rocker controls next to each lamp.

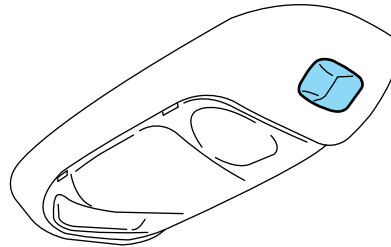

## Lights

### MAP LAMPS

With trip computer

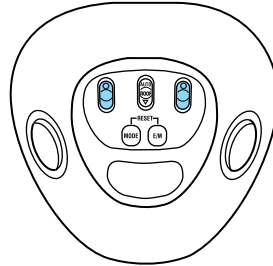

Without trip computer

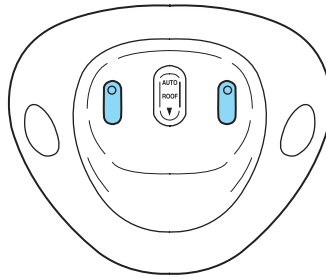

To turn on the map lamps, press the control next to each lamp.

### BULBS

#### Replacing exterior bulbs

Check the operation of all the bulbs frequently.

#### Using the right bulbs

Replacement bulbs are specified in the chart below. Headlamp bulbs must be marked with an authorized "D.O.T." for North America and an "E" for Europe to assure lamp performance, light brightness and pattern and safe visibility. The correct bulbs will not damage the lamp assembly or void the lamp assembly warranty and will provide quality bulb burn time.

## Lights

Function	Number of bulbs	Trade number
Headlamps (aerodynamic)	2	9007
Headlamps (sealed beam)	2	H6054
Park/turn	2	3157
Sidemarkers	2	194
Tail/stop/turn/sidemarkers	2	3157 K
Backup	2	3156K
High-mount stoplamp	1	921
Foglamp	2	899
License plate lamp	2	168
Cargo lamp	2	906
Roofmarker	5	194
Rear fender clearance*	4	<sup>(a)</sup>
Interior visor lamp (if equipped)	4	194
Rear identification	3	194
All replacement bulbs are clear in color except where noted.		
To replace all instrument panel lights - see your dealer		
<sup>(a)</sup> Replace entire lamp assembly; bulb is not serviceable.		
* Dual rear wheels or if equipped.		

### Replacing headlamp bulbs (aerodynamic)

1. Make sure that the headlamp control is in the OFF position open the hood.
2. Disconnect the electrical connector from the bulb by pulling rearward.
3. Remove bulb retainer ring by turning it counterclockwise, then slide the ring off the plastic base
4. Pull bulb out of headlamp assembly.

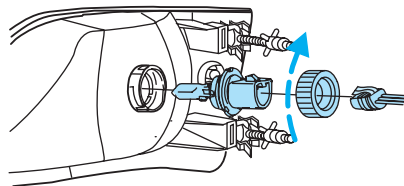

## Lights

 Handle a halogen headlamp bulb carefully and keep out of children's reach. Grasp the bulb only by its plastic base and do not touch the glass. The oil from your hand could cause the bulb to break the next time the headlamps are operated.

Install the new bulb(s) in reverse order.

### **Replacing headlamp bulbs (sealed beam)**

1. Make sure headlamp switch is in OFF position and open the hood.
2. Remove the two screws and parking lamp/side marker assembly by pulling gently
3. Disconnect the electrical connectors from the parking lamp/side marker assembly and remove.

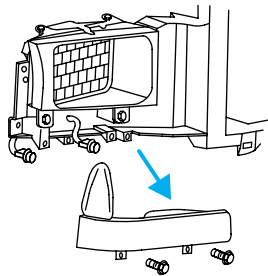

4. Remove the four bolts and headlamp bezel.

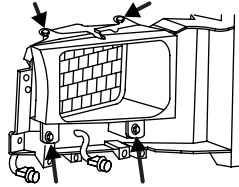

5. Remove the four screws and the headlamp retaining ring from headlamp.
6. Disconnect the electrical connector and remove headlamp.

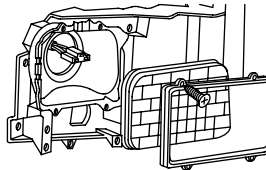

Install the new bulb(s) in reverse order.

## Lights

### **Replacing front parking/turn signal bulbs**

1. Make sure headlamp switch is in OFF position and open the hood.
2. Remove the two screws and carefully disengage parking lamp/turn signal assembly from the vehicle.

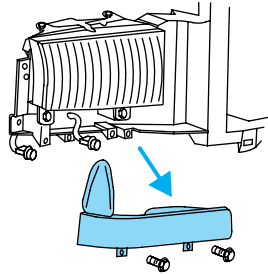

3. Rotate bulb socket counterclockwise and remove from lamp assembly.



4. Carefully pull bulb straight out of the socket and push in the new bulb.

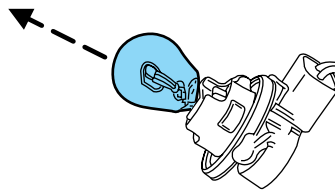

Install the new bulb(s) in reverse order.

### **Replacing tail lamp/turn/backup lamp bulbs — F250/F350 only**

1. Make sure the headlamp switch is in the OFF position and then open the tailgate to expose the lamp assemblies.
2. Remove the two bolts from the tail lamp assembly and carefully pull the lamp assembly from the tailgate pillar by releasing the two retaining tabs.

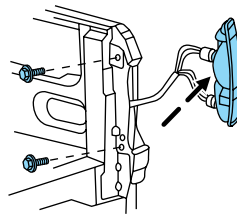

## Lights

3. Rotate the bulb socket counterclockwise and remove from lamp assembly.
4. Pull the bulb straight out of the socket.

Install the new bulb(s) in reverse order.

### **Replacing brake/tail/backup lamp bulbs — F450/F550 only**

1. Make sure the headlamp switch is in the OFF position.
2. Remove the four screws and the lamp lens from lamp assembly.
3. Carefully pull the bulb straight out of the socket and push in the new bulb.

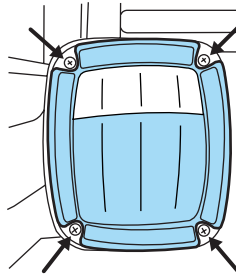

### **Replacing cargo lamp and high-mount brakelamp bulbs**

1. Make sure the headlamp switch is in the OFF position.
2. Remove the two screws and lamp assembly from vehicle as wiring permits.
3. Remove the bulb socket by rotating counterclockwise.
4. Pull the bulb straight out of the socket.

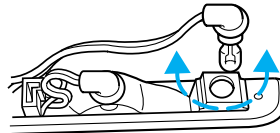
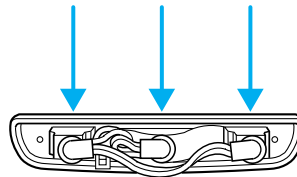

## Lights

### **Replacing roof marker bulbs**

1. Make sure the headlamp switch is in the OFF position.
2. Remove the screw and lens from the lamp assembly.
3. Pull the bulb straight out of the socket.

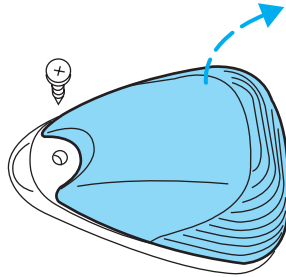

### **Replacing foglamp bulbs (if equipped)**

1. Make sure the headlamp switch is in the OFF position.
2. Remove the bulb socket from the foglamp by turning counterclockwise.
3. Disconnect the electrical connector from the foglamp bulb.

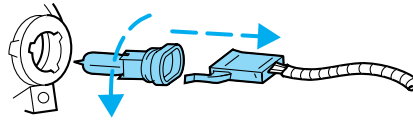

Install the new bulb(s) in reverse order.

### **Replacing license plate lamp bulbs**

The license plate bulbs are located behind the rear bumper. To change the license plate lamp bulbs:

1. Reach behind the rear bumper to locate the bulb.
2. Twist the bulb socket counterclockwise and carefully pull to remove it from the lamp assembly.
3. Pull out the old bulb from the socket and push in the new bulb.
4. Install the bulb socket in lamp assembly by turning it clockwise.

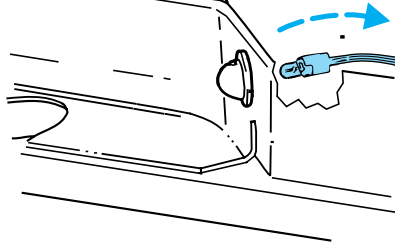

## Driver Controls

### MULTI-FUNCTION LEVER

**Windshield wiper:** Rotate the end of the control away from you to increase the speed of the wipers; rotate towards you to decrease the speed of the wipers.

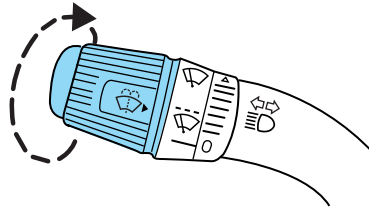

**Windshield washer:** Push the end of the stalk:

- briefly: causes a single swipe of the wipers without washer fluid.
- a quick push and hold: the wipers will swipe three times with washer fluid.
- a long push and hold: the wipers and washer fluid will be activated for up to ten seconds.

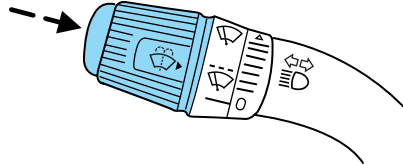

### Changing the wiper blades

1. Pull the wiper arm away from the vehicle. Turn the blade at an angle from the wiper arm. Push the lock pin manually to release the blade and pull the wiper blade down toward the windshield to remove it from the arm.

2. Attach the new wiper to the wiper arm and press it into place until a click is heard.

3. Replace wiper blades every 6 months for optimum performance.

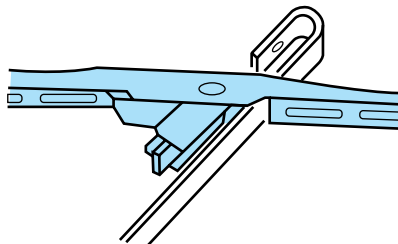



## Driver Controls

### TILT STEERING WHEEL (IF EQUIPPED)

To adjust the steering wheel:

1. Pull and hold the steering wheel release control toward you.
2. Move the steering wheel up or down until you find the desired location.
3. Release the steering wheel release control. This will lock the steering wheel in position.

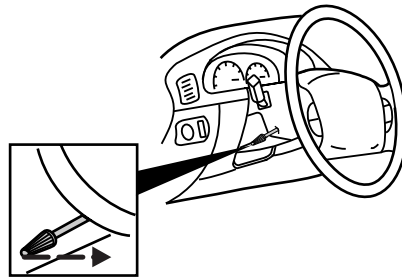

Never adjust the steering wheel when the vehicle is moving.

### TRANSMISSION CONTROL

#### Tow/Haul feature

#### (5-speed automatic transmission) (if equipped)

To activate, press the transmission control switch (TCS) located on the gearshift. The ON indicator light will illuminate on the gearshift. The transmission will operate in all gears. Press the transmission control switch again to deactivate Tow Haul mode. When you shut off and re-start your vehicle, the transmission will automatically return to normal mode with Tow Haul feature deactivated.

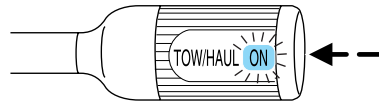

#### Overdrive cancel

#### (4-speed automatic transmission) (if equipped)

To deactivate overdrive, press the transmission control switch (TCS) located on the gearshift. The OFF indicator light will illuminate on the gearshift. The transmission will operate in all gears except overdrive. Press the transmission control switch again to return to normal overdrive mode. When you shut off and re-start your vehicle, the transmission will automatically return to normal (Overdrive) mode.

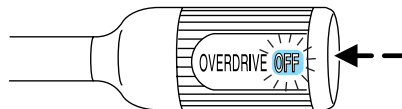

For additional information about the gearshift and the transmission control switch operation refer to the *Driving* chapter.

## Driver Controls

### ILLUMINATED VISOR MIRROR (IF EQUIPPED)

Lift the mirror cover to turn on the visor mirror lamps.

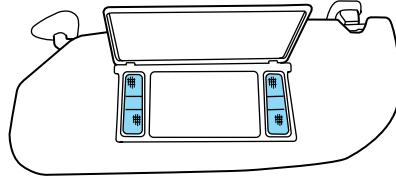

### OVERHEAD CONSOLE (IF EQUIPPED)

The appearance of your vehicle's overhead console will vary according to your option package.

#### Storage compartment (if equipped)

Press the OPEN control to open the storage compartment. The door will open slightly and can be moved to full open.

The storage compartment may be used to secure sunglasses or a similar object.

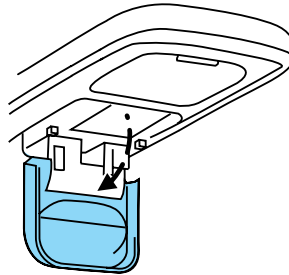

#### Install a garage door opener (if equipped)

The storage compartment can be used to hold a variety of aftermarket garage door openers. To install your garage door opener:

1. Open the storage compartment door.
2. Remove the storage clip and stow it away.
3. Place the Velcro<sup>™</sup> strip onto the back of the garage door opener control.
4. Adhere the back of garage door opener control to the Velcro<sup>™</sup> strip found inside the storage compartment. Make sure that the controls for the garage door opener face outward.

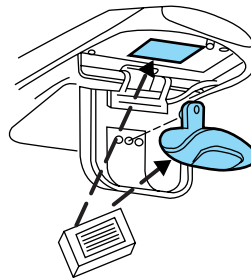

## Driver Controls

5. Place the height adjusters onto the back of the storage compartment door. Add as many adjusters needed to activate the garage door opener.

6. Close the storage compartment door and press the garage door opener control to verify that it works. If not, you may need to add more adjusters.

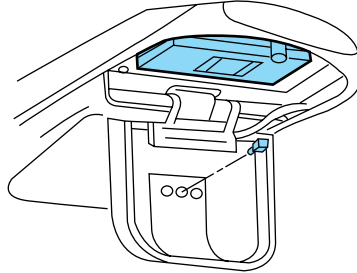

### One-touch moon roof (if equipped)

#### With trip computer

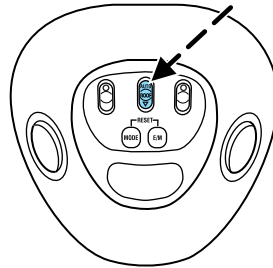

#### Without trip computer

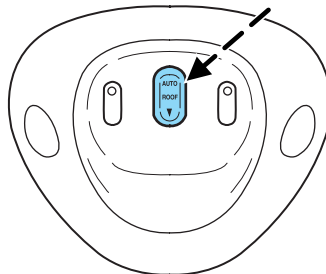

To **open** the moon roof using the one-touch operation switch:

- Press and release the rear portion of the one-touch moon roof control.
- To halt motion at any point during one-touch opening, press the control a second time.

To **close** the moon roof:

- Press and hold the front portion of the moon roof control. Release the control to stop the roof closing at any position.

## Driver Controls

To **tilt** the moon roof:

- To tilt into the vent position (when the glass panel is closed), press and hold the front portion of the moon roof control. To close from the vent position, press and hold the rear portion of the control until the glass panel stops moving.

Sliding shade:

- The moon roof has a built-in sliding shade that can be manually opened or closed when the glass panel is shut.
- To close the shade, pull it toward the front of the vehicle.

 When closing the moon roof, you should verify that it is free of obstructions and ensure that children and/or pets are not in the proximity of the moon roof opening.

### AUXILIARY POWER POINT 12V

**Power outlets are designed for accessory plugs only. Do not hang any type of accessory or accessory bracket from the plug. Improper use of the power outlet can cause damage not covered by your warranty.**

The auxiliary power point is located on the instrument panel.

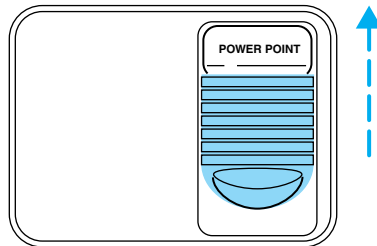

**Do not plug optional electrical accessories into the cigarette lighter. Use the power point.**

### POWER WINDOWS (IF EQUIPPED)

 When closing the power windows, you should verify they are free of obstructions and ensure that children and/or pets are not in the proximity of the window openings.

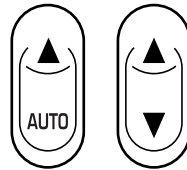

Press and hold the bottom part of the rocker switch to open the window.  
Press and hold the top part of the rocker switch to close the window.

## Driver Controls

### One touch down

Allows the driver's window to open fully without holding the control down. Press completely down on AUTO and release quickly. Press again to stop.

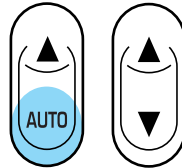

### Window lock (if equipped)

The window lock feature allows only the driver to operate the power windows.

To lock out all the window controls except for the driver's press the left side of the control. Press the right side to restore the window controls.

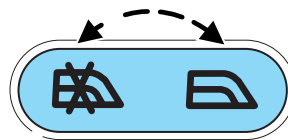

### Accessory delay (if equipped)

With accessory delay, the window switches may be used for up to ten minutes after the ignition switch is turned to the OFF position or until any door is opened.

### POWER SIDE VIEW MIRRORS (IF EQUIPPED)

To adjust your mirrors:

1. Select **L** to adjust the left mirror or **R** to adjust the right mirror.
2. Move the control in the direction you wish to tilt the mirror.
3. Return to the center position to disable the adjust function.



## Driver Controls

### Heated outside mirrors (if equipped)

The main mirror glass is heated automatically to remove ice, mist and fog and activates when the vehicle is started.

**Note:** The mirrors may be **hot** to the touch but will not burn. This is a normal condition.

The mirror heating elements are designed to operate regardless of the geographic location of the vehicle. There is no switch to turn on, or other operator involvement required other than to start the vehicle.

The spotter mirror, below the main mirror, is not heated and must be adjusted manually.

**Do not remove ice from the mirrors with a scraper or attempt to readjust the mirror glass if it is frozen in place. These actions could cause damage to the glass and mirrors.**

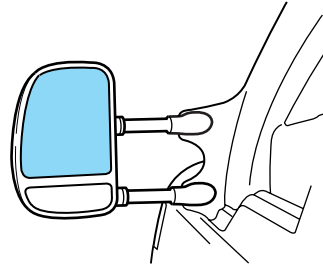

### Signal mirrors (if equipped)

#### ***Mirror mounted side turn signal indicator (if equipped)***

When the vehicle turn signals are activated, the outer portion of the mirror housing will blink amber.

The turn signal feature can be seen by other drivers who may approach from the rear of the vehicle.

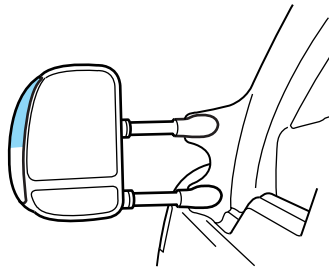

## Driver Controls

### Clearance lamps (if equipped)

Illuminates when the headlamps or parking lamps are switched on.

This provides additional visibility of your vehicle to other drivers on the road.

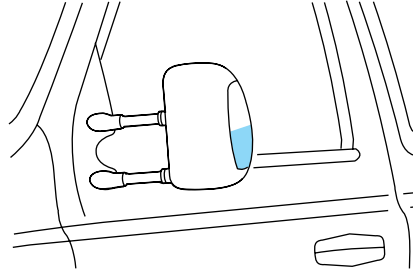

### Fold-away mirrors

The mirrors can be manually folded forward or backwards for narrow spaces like driving through an automatic car wash or backing out of a garage with the trailer tow mirror.

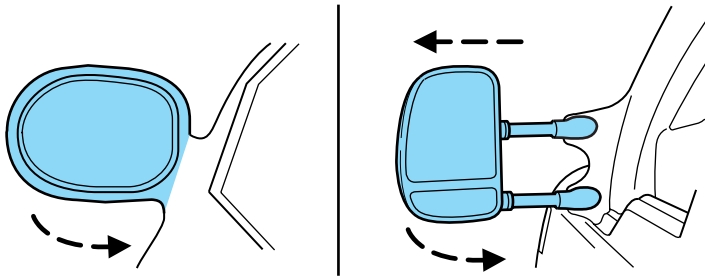

The telescoping feature (if equipped) allows the mirror to extend approximately 76 mm (3 inches). This feature is especially useful to the driver when towing a trailer.

## Driver Controls

### POWER ADJUSTABLE FOOT PEDALS (IF EQUIPPED)

The accelerator and brake pedal should only be adjusted when the vehicle is stopped and the gearshift lever is in the P (Park) position.

Press and hold the rocker control to adjust accelerator and brake pedal toward you or away from you.

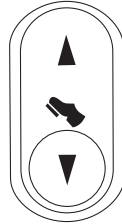

The adjustment allows for approximately 73 mm (3 inches) of maximum travel.



Never adjust the accelerator and brake pedal with feet on the pedals while the vehicle is moving.

### SPEED CONTROL (IF EQUIPPED)

With speed control set, you can maintain a speed of 48 km/h (30 mph) or more without keeping your foot on the accelerator pedal. Speed control does not work at speeds below 48 km/h (30 mph).



Do not use the speed control in heavy traffic or on roads that are winding, slippery or unpaved.

### Setting speed control

The controls for using your speed control are located on the steering wheel for your convenience.

1. Press the ON control and release it.
2. Accelerate to the desired speed.

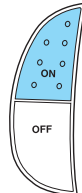



## Driver Controls

3. Press the SET ACCEL control and release it.
4. Take your foot off the accelerator pedal.
5. The indicator light on the instrument cluster will turn on.



### Note:

- Vehicle speed may vary momentarily when driving up and down a steep hill.
- If the vehicle speed increases above the set speed on a downhill, you may want to apply the brakes to reduce the speed.
- If the vehicle speed decreases more than 16 km/h (10 mph) below your set speed on an uphill, your speed control will disengage.

### Resuming a set speed

Press the RES (resume) control and release it. This will automatically return the vehicle to the previously set speed. The RES control will not work if the vehicle speed is not faster than 48 km/h (30 mph).



### Increasing speed while using speed control

There are two ways to set a higher speed:

- Press and hold the SET ACCEL control until you get to the desired speed, then release the control. You can also use the SET ACCEL control to operate the Tap-Up function. Press and release this control to increase the vehicle set speed in increments by 1.6 km/h (1 mph).
- Use the accelerator pedal to get to the desired speed. When the vehicle reaches that speed press and release the SET ACCEL control.



## Driver Controls

### Reducing speed while using speed control

There are two ways to reduce a set speed:

- Press and hold the COAST control until you get to the desired speed, then release the control. You can also use the COAST control to operate the Tap-Down function. Press and release this control to decrease the vehicle set speed in increments by 1.6 km/h (1 mph).
- Depress the brake pedal until the desired vehicle speed is reached, press the SET ACCEL control.

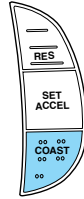

### Turning off speed control

There are two ways to turn off the speed control:

- Depress the brake pedal or the clutch pedal (if equipped). This will not erase your vehicle's previously set speed.
- Press the speed control OFF control.

**Note:** When you turn off the speed control or the ignition, your speed control set speed memory is erased.

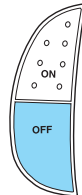

### Indicator light (if equipped)

This light comes on when either the SET ACCEL or RES controls are pressed. The vehicle speed must be at or above 48 km/h (30 mph). It turns off when the speed control OFF control is pressed, the brake or clutch is applied, or the ignition is turned to the OFF position.



## Driver Controls

### CENTER CONSOLE (IF EQUIPPED)

Your vehicle may be equipped with a variety of console features. These include:

- Utility compartment with cassette/CD holder
- Coin holder
- Pen holder
- Writing surface



Use only soft cups in the cupholder. Hard objects can injure you in a collision.

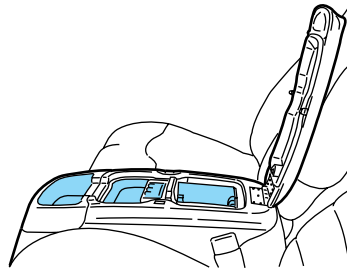

### CELL PHONE USE

The use of Mobile Communications Equipment has become increasingly important in the conduct of business and personal affairs. However, drivers must not compromise their own or others' safety when using such equipment. Mobile Communications can enhance personal safety and security when appropriately used, particularly in emergency situations. Safety must be paramount when using mobile communications equipment to avoid negating these benefits.

Mobile Communication Equipment includes, but is not limited to cellular phones, pagers, portable email devices, in vehicle communications systems, telematics devices and portable two-way radios.



A driver's first responsibility is the safe operation of the vehicle. The most important thing you can do to prevent a crash is to avoid distractions and pay attention to the road. Wait until it is safe to operate Mobile Communications Equipment.

### TRIP COMPUTER (IF EQUIPPED)

The trip computer tells you about the condition of your vehicle through a constant monitor of vehicle systems. You may select display features on the trip computer for a display of status.

The appearance of your vehicle's trip computer may differ depending on your vehicle's option package, but the functions are the same.

The trip computer only operates with the ignition in the ON position. Trip computer features are as follows:

## Driver Controls

### Selectable features

#### **English/metric display**

Press this control to change the trip computer display between metric and English units.

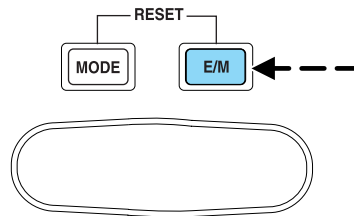

#### **Mode control**

Each press of the MODE control will display a different feature as follows:

**Average fuel economy.** The display will indicate the vehicle's average fuel economy in liters/100 km (or miles/gallon) since the average fuel economy was last reset.

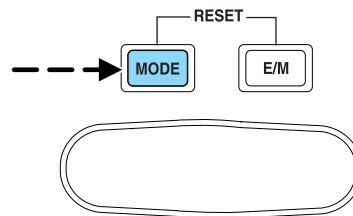

If you calculate your average fuel economy by dividing liters of fuel used by 100 kilometers traveled (miles traveled by gallons used), your figure may be different than displayed for the following reasons:

- your vehicle was not perfectly level during fill-up
- differences in the automatic shut-off points on the fuel pumps at service stations
- variations in top-off procedure from one fill-up to another
- rounding of the displayed values to the nearest liter (gallon)

To reset the average fuel economy:

1. Press the MODE control repeatedly until average fuel economy is displayed (this is the only resettable display).

## Driver Controls

2. Press the E/M and MODE controls simultaneously. The display will illuminate the “AVG” indicator. While the indicator is lit, release both controls to reset the average fuel economy.

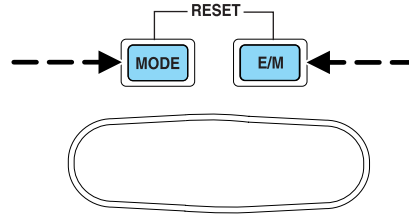

**Fuel range.** This function estimates approximately how far you can drive with the fuel remaining in your tank under normal driving conditions. Remember to turn the ignition OFF when refueling to allow this feature to correctly detect the added fuel.

The DTE function will flash for 5 seconds when you have approximately:

- 80 km (50 miles) left before you run out of fuel
- 40 km (25 miles)
- 16 km (10 miles)

DTE is calculated using a running average fuel economy, which is based on your recent driving history of 800 km (500 miles). This value is not the same as the average fuel economy display. The running average fuel economy is reinitialized to a factory default value if the battery is disconnected.

### Outside air temperature

The temperature can be displayed in Centigrade or Fahrenheit by pressing the E/M control.

If the outside temperature falls below 3°C (38°F), the display will alternate from “ICE” to the outside temperature at a two second rate for one minute.

**Off.** In this mode the display is off.

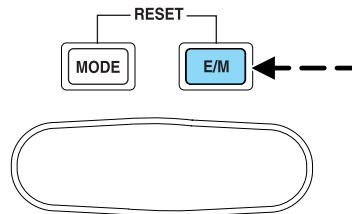

## Driver Controls

### Compass

The compass display is contained in the overhead console. The vehicle heading is displayed as one of N, NE, E, SE, S, SW, W and NW.

The compass heading is displayed in average fuel economy modes, fuel range modes and temperature modes.

The compass reading may be affected when you drive near large buildings, bridges, power lines and powerful broadcast antennas. Magnetic or metallic objects placed in or on the vehicle may also affect compass accuracy. Adjustments may need to be made to the zone and calibration of the compass.

### Compass zone adjustment

1. Determine which magnetic zone you are in for your geographic location by referring to the zone map.
2. Locate the trip computer on the overhead console.
3. Turn ignition to the ON position.

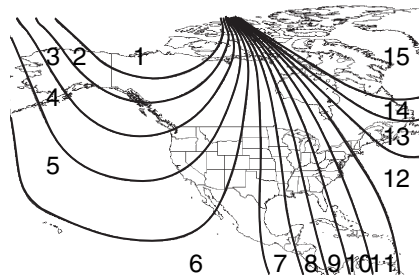

4. Press and hold both trip computer controls. After approximately four seconds, the trip computer will enter zone setting mode. Zone setting mode is indicated when the display lights the "ZONE" indicator.

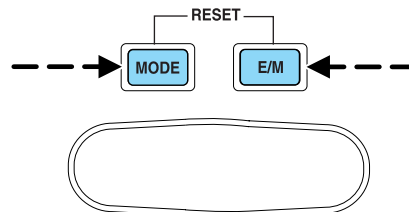

5. Release both controls. Subsequent pressing of either control will increment the zone. Press the control repeatedly until the correct zone setting for your geographic location is displayed on the trip computer.
6. To exit the zone setting mode and save the displayed zone in memory, release both controls for greater than five seconds.

## Driver Controls

### **Compass calibration adjustment**

Perform this adjustment in an open area free from steel structures and high voltage lines.

For optimum calibration, turn off all electrical accessories (heater/air conditioning, wipers, etc.) and make sure all vehicle doors are shut.

1. Locate the trip computer located in the overhead console.
2. Start the vehicle.

3. Press and hold both trip computer controls. After approximately eight seconds, the trip computer will enter CAL mode. CAL mode is indicated when the display lights the "CAL" indicator.

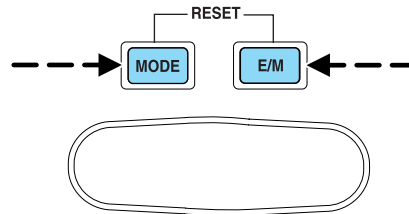

4. Release both controls. The display will return to normal, except that the CAL indicator will remain lit until the compass is successfully calibrated.
5. Slowly drive the vehicle in a circle (less than 5 km/h [3 mph]) until the CAL indicator turns off. It may take up to five circles to complete calibration.
6. The compass is now calibrated.

## Driver Controls

### TAILGATE LOCK (IF EQUIPPED)

Your vehicle may be equipped with a tailgate lock designed to prevent theft of the tailgate.

- Insert ignition key and turn to the right to engage lock.
- Turn ignition key to the left to unlock.

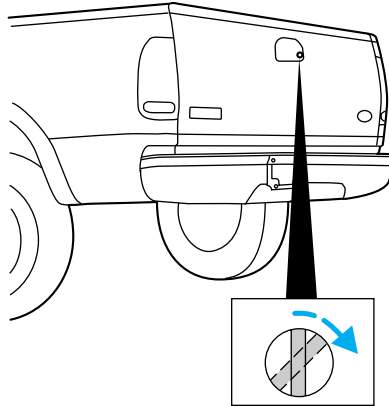

### Tailgate removal

Your tailgate is removable to allow more room for loading.

1. Lower the tailgate.
2. Use a screwdriver to pry the spring clip (on each connector) past the head of the support screw. Disconnect cable.
3. Disconnect the other cable.
4. Lift tailgate to a 45 degree angle.
5. Lift right side off of its hinge.
6. Lift left side off of its hinge.

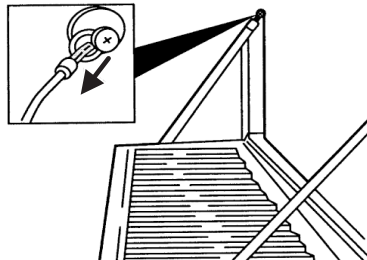

To install, follow the removal procedures in reverse order.



## Locks and Security

### KEYS

The key operates all locks on your vehicle. In case of loss, replacement keys are available from your dealer.

You should always carry a second key with you in a safe place in case you require it in an emergency.

### POWER DOOR LOCKS (IF EQUIPPED)

Press control to unlock all doors.

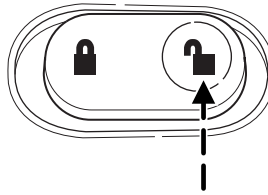

Press control to lock all doors.

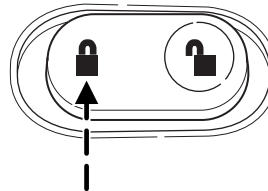

### Smart locks (if equipped)

This feature prevents you from locking yourself out of the vehicle if your key is still in the ignition.

When you open the driver's door and you lock the vehicle with the power door locks, all the doors will lock, then the driver's door will automatically unlock reminding you that your key is still in the ignition.

The vehicle can still be locked, with the key in the ignition, using the manual lock button on the door, locking the driver's door with a key, or using the lock button on the remote entry transmitter (if equipped).

## Locks and Security

### Childproof door locks

- When these locks are set, the rear doors cannot be opened from the inside.
- The rear doors can be opened from the outside when the doors are unlocked.

The childproof locks are located on rear edge of each rear door and must be set separately for each door. Setting the lock for one door will not automatically set the lock for both doors.

- Move lock control up to engage the childproof lock.
- Move control down to disengage childproof locks.

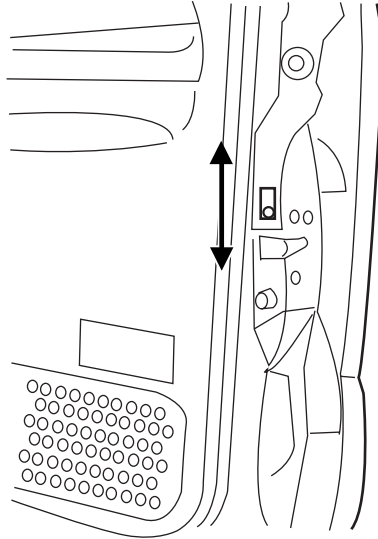

### REMOTE ENTRY SYSTEM (IF EQUIPPED)

This device complies with part 15 of the FCC rules and with RS-210 of Industry Canada. Operation is subject to the following two conditions: (1) This device may not cause harmful interference, and (2) This device must accept any interference received, including interference that may cause undesired operation.

**Changes or modifications not expressly approved by the party responsible for compliance could void the user's authority to operate the equipment.**

## Locks and Security

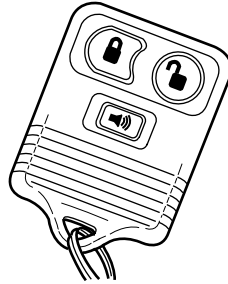

Your vehicle is equipped with a remote entry system which allows you to:

- unlock the vehicle doors without a key.
- lock all the vehicle doors without a key.
- activate the personal alarm.





If there is any potential remote keyless entry problem with your vehicle, ensure **ALL remote entry transmitters** are taken to the dealership, to aid in troubleshooting.

### Unlocking the doors

1. Press  and release to unlock the driver's door. **Note:** The interior lamps will illuminate.
2. Press  and release again within three seconds to unlock all the doors.

### Locking the doors

1. Press  and release to lock all the doors. The parking lamps will flash if all the doors are closed and locked.
2. Press  and release again within three seconds to confirm that all the doors are closed and locked. **Note:** The doors will lock again, the horn will chirp once, and the parking lamps will flash once more.

If any of the doors are not properly closed the horn will make two quick chirps.

### Power door lock disable feature (if equipped)

The UNLOCK  feature on your power door locks will not work from inside the vehicle when:

- the ignition has been turned to the OFF position, and
- 20 seconds elapse after all vehicle doors are closed and locked using the remote entry transmitter, or the power door lock control (while the accompanying door is open).

## Locks and Security

The UNLOCK  feature will work again after:

- a door has become ajar,
- the ignition is turned to the ON position,
- or using the UNLOCK  control on your remote entry transmitter (if equipped).

This feature is initially deactivated, but may be activated by taking your vehicle to an authorized Ford dealer.

### Sounding a panic alarm

Press  to activate the alarm. Press again or turn the ignition to ACC or ON to deactivate.

**Note:** The panic alarm will only operate when the ignition is in the OFF position.

### Replacing the battery

The remote entry transmitter uses one coin type three-volt lithium battery CR2032 or equivalent. The typical operating range for your remote entry transmitter is approximately 10 meters (33 feet). A decrease in the operating range could be caused by:

- weather conditions,
- nearby radio towers,
- structures around the vehicle and
- other vehicles parked next to the vehicle.

To replace the battery:

1. Twist a thin coin between the two halves of the remote entry transmitter near the key ring. DO NOT TAKE THE RUBBER COVER AND CIRCUIT BOARD OFF THE FRONT HOUSING OF THE REMOTE ENTRY TRANSMITTER.

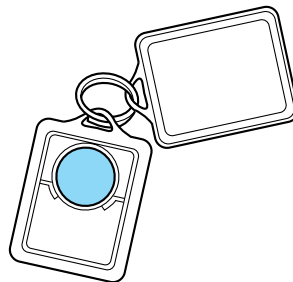

## Locks and Security

2. Do not wipe off any grease on the battery terminals on the back surface of the circuit board.

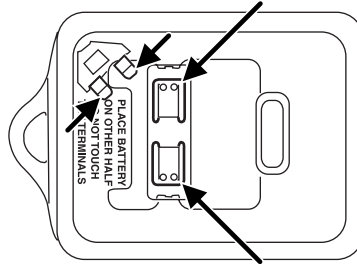

3. Remove the old battery.

4. Insert the new battery. Refer to the diagram inside the remote entry transmitter for the correct orientation of the battery. Press the battery down to ensure that the battery is fully seated in the battery housing cavity.

5. Snap the two halves back together.

**Note:** Replacement of the battery will **not** cause the remote transmitter to become deprogrammed from your vehicle. The remote transmitter should operate normally after battery replacement.

### Replacing lost remote entry transmitters

If you would like to have your remote entry transmitter reprogrammed because you lost one, or would like to buy additional remote entry transmitters, you can either reprogram them yourself, or take **all remote entry transmitters** to your authorized dealer for reprogramming.

### How to reprogram your remote entry transmitters

You must have **all remote entry transmitters** (maximum of four) available before beginning this procedure.

## Locks and Security

To reprogram the remote entry transmitters:

1. Ensure the vehicle is electronically unlocked.
2. Put the key in the ignition.
3. Turn the key from the 2 (LOCK) position to 3 (OFF).
4. Cycle eight times rapidly (within 10 seconds) between the 3 (OFF) position and 4 (ON). **Note:** The eighth turn must end in the 4 (ON) position.
5. The doors will lock, then unlock, to confirm that the programming mode has been activated.
6. Within 20 seconds press any button on the remote entry transmitter. **Note:** If more than 20 seconds have passed you will need to start the procedure over again.
7. The doors will lock, then unlock, to confirm that this remote entry transmitter has been programmed.
8. Repeat Step 6 to program each additional remote entry transmitter.
9. Turn the ignition to the 3 (OFF) position after you have finished programming all of the remote entry transmitters. **Note:** After 20 seconds, you will automatically exit the programming mode.
10. The doors will lock, then unlock, to confirm that the programming mode has been exited.

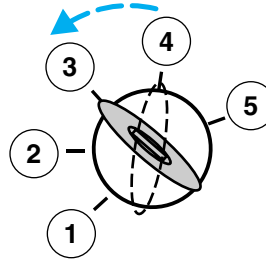

### Illuminated entry

The interior lamps illuminate when the remote entry system is used to unlock the door(s).

The illuminated entry system will turn off the interior lights if:

- the ignition switch is turned to the ON position, or
- the remote transmitter lock control is pressed, or
- after 25 seconds of illumination.

The dome lamp control (if equipped) must **not** be set to the OFF position for the illuminated entry system to operate.

The inside lights will not turn off if:

- they have been turned on with the dimmer control, or
- any door is open.

## Locks and Security

The battery saver will shut off the interior lamps 30 minutes after the ignition has been turned to the OFF position, 10 minutes after if the dome lamp is off, and 30 minutes after if the dome lamp switch is left on.

### **Autolock (if equipped)**

This feature automatically locks all vehicle doors when the following conditions are met:

- the ignition is in the ON position,
- all doors are closed,
- the brake is pressed before reaching 8 km/h (5 mph) and
- the vehicle is traveling more than 8 km/h (5 mph).

### **Relock**

The autolock feature repeats when the following conditions are met:

- the vehicle's speed is less than 8 km/h (5 mph), and
- any door is opened then closed while the ignition is in the RUN position, and
- the brake is pressed before reaching 8 km/h (5 mph), and
- the vehicle is traveling more than 8 km/h (5 mph).

### **Deactivating/activating the autolock feature**

Before following the procedure, make sure that the ignition is OFF and all vehicle doors are closed.

You must complete steps 1-7 within 30 seconds or the procedure will have to be repeated. If the procedure needs to be repeated, you must wait 30 seconds.

1. Turn the ignition key to ON.
2. Press the power door unlock control three times.
3. Turn the ignition key from ON to OFF.
4. Press the power door unlock control three times.
5. Turn the ignition back to ON. The horn will chirp.
6. Press the unlock control, then press the lock control. The horn will chirp once if autolock was deactivated or twice (one short and one long chirp) if autolock was activated. **Note:** Pressing the power door lock/unlock control again will toggle between activating and deactivating the autolock feature.
7. Turn the ignition to OFF. The horn will chirp once to confirm the procedure is complete.

## Seating and Safety Restraints

### SEATING

#### Notes:



Reclining the seatback can cause an occupant to slide under the seat's safety belt, resulting in severe personal injuries in the event of a collision.



Do not pile cargo higher than the seatbacks to reduce the risk of injury in a collision or sudden stop.

#### Full bench seat (if equipped)

- Lift the release bar to move the seat forward or backward. Ensure that the seat is relatched into place.
- Pull up on the lever located at the bottom of the seatback to quickly fold the seatback forward.

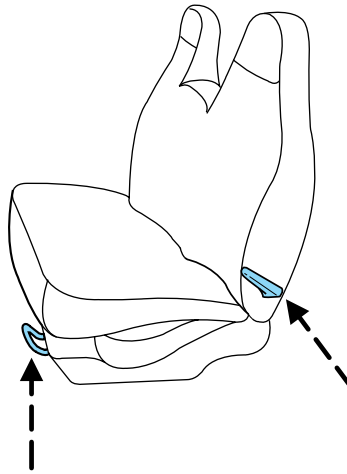



## Seating and Safety Restraints

### 40/20/40 split bench seat (if equipped)

- Lift the track release bar to move the seat forward or backward. Ensure the seat is relocked into place.
- Pull the handle on the side of the seat up to recline the seat.
- Push down the lever located at the bottom of the seatback to quickly fold the seatback forward.

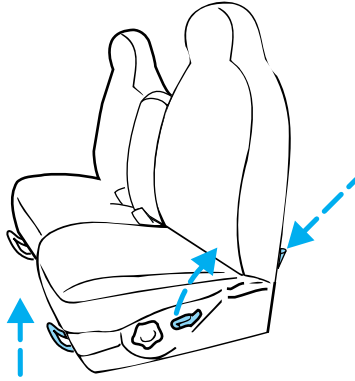

### 40/20/40 front seat armrest and console (if equipped)

To release the armrest, pull forward on the strap and pull the armrest down. Lift up armrest to return it to a center seatback.

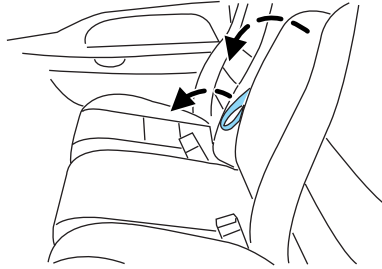

## Seating and Safety Restraints

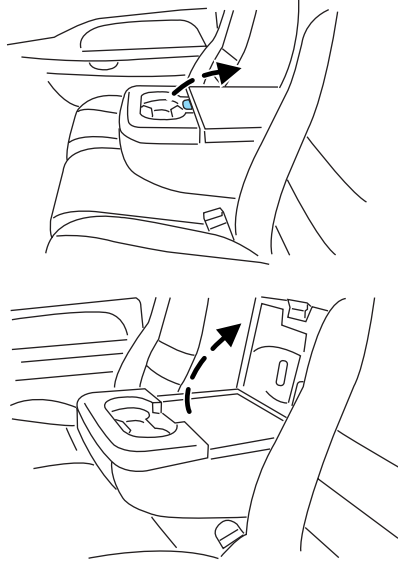

To gain access to the storage compartment in your armrest, lift the latch to open the lid. The lid cannot be opened in the upright position.

### Captain's chair (if equipped)

- Lift the bar to move the seat forward or rearward. Make sure that the seat is related into place.
- To recline the seatback, pull the release lever handle located on the side of the seat up.
- Push down the lever (if equipped) located at the bottom of the seatback to quickly fold the seatback forward.

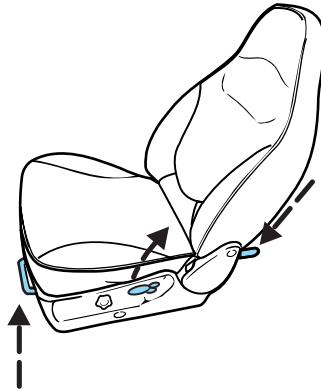

## Seating and Safety Restraints

### Adjusting the front power seat (if equipped)

The control is located on the outboard side of the seat cushion.

Your vehicle will only be equipped with one of the two controls shown.

Press to raise or lower the front portion of the seat cushion.

- Type A

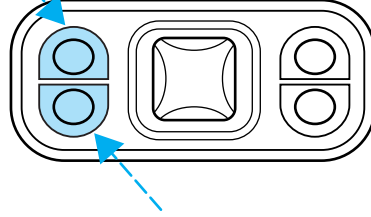

- Type B



Press to raise or lower the rear portion of the seat cushion.

- Type A

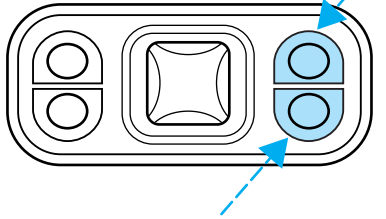

- Type B



## Seating and Safety Restraints

- Type A

Press the control to move the seat forward, backward, up or down.

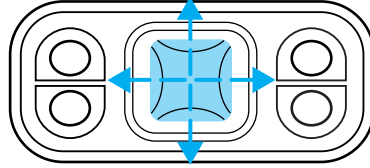

- Type B

Press the control to move the seat forward or backward.

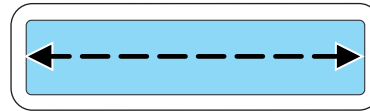

### Using the manual lumbar support

For more lumbar support, turn the lumbar support control toward the front of vehicle.

For less lumbar support, turn the lumbar support control toward the rear of vehicle.

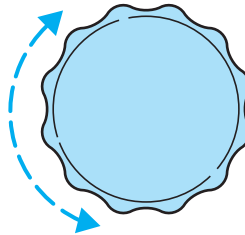

### Heated seats (if equipped)

To operate the heated seats, do the following:

- Push control to activate.
- Push again to deactivate.

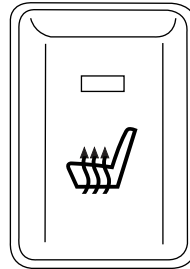

The indicator light on the control will illuminate when activated.

The system automatically shuts off after 10 minutes.

## Seating and Safety Restraints

### FOLDING UP THE REAR SEATS (IF EQUIPPED — SUPERCAB ONLY)

The rear seatback has a split 60/40 seat. Each seat cushion can be flipped up into the seatback position.

1. Pull lever to release seat cushion.
2. Rotate seat cushion up until it locks into vertical storage position.

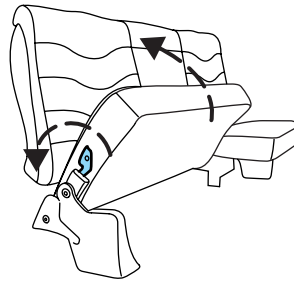

### RETURNING THE SEAT TO SEATING POSITION



Always be sure that the seat is in a latched position, whether the seat is occupied or empty. If not latched, the seat may cause injury during a sudden stop.

1. Pull lever on the side of the seat to release seat cushion from storage position.
2. Push seat cushion down until it locks into horizontal position.

### SAFETY RESTRAINTS

#### Safety restraints precautions



Always drive and ride with your seatback upright and the lap belt snug and low across the hips.



To reduce the risk of injury, make sure children sit where they can be properly restrained.



Never let a passenger hold a child on his or her lap while the vehicle is moving. The passenger cannot protect the child from injury in a collision.

## Seating and Safety Restraints



All occupants of the vehicle, including the driver, should always properly wear their safety belts, even when an air bag (SRS) is provided.



It is extremely dangerous to ride in a cargo area, inside or outside of a vehicle. In a collision, people riding in these areas are more likely to be seriously injured or killed. Do not allow people to ride in any area of your vehicle that is not equipped with seats and safety belts. Be sure everyone in your vehicle is in a seat and using a safety belt properly.



In a rollover crash, an unbelted person is significantly more likely to die than a person wearing a safety belt.



Each seating position in your vehicle has a specific safety belt assembly which is made up of one buckle and one tongue that are designed to be used as a pair. 1) Use the shoulder belt on the outside shoulder only. Never wear the shoulder belt under the arm. 2) Never swing the safety belt around your neck over the inside shoulder. 3) Never use a single belt for more than one person.



Always transport children 12 years old and under in the back seat and always properly use appropriate child restraints.



Safety belts and seats can become hot in a vehicle that has been closed up in sunny weather; they could burn a small child. Check seat covers and buckles before you place a child anywhere near them.

## Seating and Safety Restraints

### Combination lap and shoulder belts

1. Insert the belt tongue into the proper buckle (the buckle closest to the direction the tongue is coming from) until you hear a snap and feel it latch. Make sure the tongue is securely fastened in the buckle.

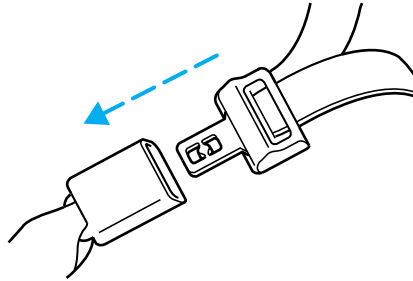

2. To unfasten, push the release button and remove the tongue from the buckle.

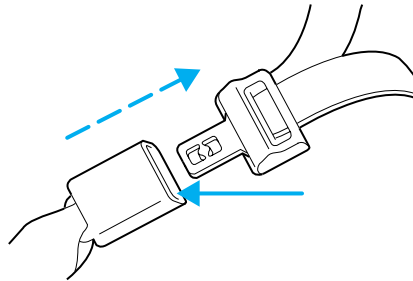

The front outboard and rear outboard safety restraints in the vehicle are combination lap and shoulder belts. The front outboard passenger and rear seat outboard safety belts have two types of locking modes described below:

### Vehicle sensitive mode

This is the normal retractor mode, which allows free shoulder belt length adjustment to your movements and locking in response to vehicle movement. For example, if the driver brakes suddenly or turns a corner sharply, or the vehicle receives an impact of approximately 8 km/h (5 mph) or more, the combination safety belts will lock to help reduce forward movement of the driver and passengers.

On SuperCab and CrewCab models, the front seat belt system can also be made to lock manually by quickly pulling on the shoulder belt.

Rear seat belts (if equipped) cannot be made to lock up by pulling quickly on the belt.

### Automatic locking mode

The automatic locking mode is not available on the driver safety belt.

## Seating and Safety Restraints

### **When to use the automatic locking mode**

In this mode, the shoulder belt is automatically pre-locked. The belt will still retract to remove any slack in the shoulder belt. The automatic locking mode is not available on the driver safety belt.

This mode should be used **any time** a child safety seat is installed in a passenger front or outboard rear seating position (if equipped). Children 12 years old and under should be properly restrained in the rear seat whenever possible. Refer to *Safety restraints for children* or *Safety seats for children* later in this chapter.

### **How to use the automatic locking mode**

- Buckle the combination lap and shoulder belt.

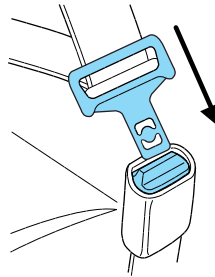

- Grasp the shoulder portion and pull downward until the entire belt is pulled out.



- Allow the belt to retract. As the belt retracts, you will hear a clicking sound. This indicates the safety belt is now in the automatic locking mode.



## Seating and Safety Restraints

### ***How to disengage the automatic locking mode***

Disconnect the combination lap/shoulder belt and allow it to retract completely to disengage the automatic locking mode and activate the vehicle sensitive (emergency) locking mode.

 After any vehicle collision, the front passenger and rear outboard seat belt systems must be checked by a qualified technician to verify that the “automatic locking retractor” feature for child seats is still functioning properly. In addition, all seat belts should be checked for proper function.

 BELT AND RETRACTOR ASSEMBLY MUST BE REPLACED if the seat belt assembly “automatic locking retractor” feature or any other seat belt function is not operating properly when checked according to the procedures in Workshop Manual. Failure to replace the Belt and Retractor assembly could increase the risk of injury in collisions.

### **Energy Management Feature**

- This vehicle has a seat belt system with an energy management feature at the front outboard seating positions to help further reduce the risk of injury in the event of a head-on collision.
- The front outboard seat belt systems have a retractor assembly that is designed to pay out webbing in a controlled manner. This feature is designed to help reduce the belt force acting on the occupant’s chest.

### **Safety belt replacement label**

The short plastic boot on the front safety belt at the passenger outboard anchor location covers a “Replace Belt” label on the safety belt.

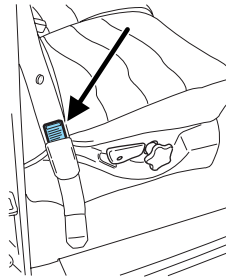

## Seating and Safety Restraints

In the event of a collision, the colored label (REPLACE BELT) may become visible. If this occurs, *the safety belt must be replaced.*

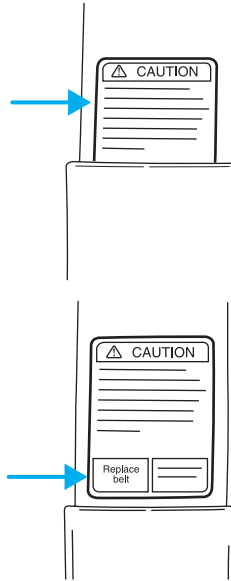

 Whenever the yellow portion of the label is visible, the safety belt must be replaced.

 Failure to follow these instructions will affect the performance of the safety belts and increase the risk of personal injury.

### Safety belt pretensioner

Your vehicle is equipped with safety belt pretensioners at the driver and front outboard passenger seating positions.

The Seat Integrated Restraints (SIR) seat (which has shoulder belts attached to the corners of the front seat back) is equipped with a buckle pretensioner. Do NOT place objects between the seats, this could interfere with the functioning of the pretensioner. For the SuperCab and CrewCab base bench seats and all Regular Cab seating positions, the safety belts are equipped with a retractor pretensioner.

The driver and front outboard passenger safety belt pretensioners are designed to activate only during certain frontal or near-frontal collisions with sufficient longitudinal deceleration. A safety belt pretensioner is a device which tightens the webbing of the lap and shoulder belts during some collisions in such a way that they fit more snugly against the body.

## Seating and Safety Restraints

The driver and front outboard passenger safety belt system (including retractors, buckles and height adjusters) must be replaced if the vehicle is involved in a collision that results in the activation of the safety belt pretensioners. Refer to the *Safety belt maintenance* section in this chapter.



Failure to replace the safety belt assembly under the above conditions could result in severe personal injuries in the event of a collision.

### Front safety belt height adjustment

If your shoulder belts come out of the seatback, you will not have a safety belt height adjuster.

Adjust the height of the shoulder belt so the belt rests across the middle of your shoulder.

- Regular Cab and 4-door CrewCab

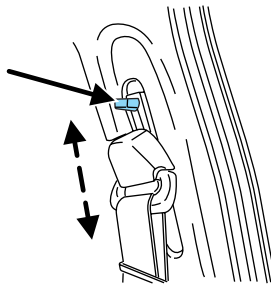

- 4-door Super Cab (if equipped)

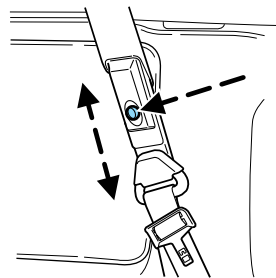

To adjust the shoulder belt height, push the button and slide the height adjuster up or down. Release the button and pull down on the height adjuster to make sure it is locked in place.

## Seating and Safety Restraints

 Position the safety belt height adjusters so that the belt rests across the middle of your shoulder. Failure to adjust the safety belt properly could reduce the effectiveness of the seat belt and increase the risk of injury in a collision.

### Lap belts

#### Adjusting the lap belt

 The lap belt should fit snugly and as low as possible around the hips, not across the waist.

#### • 1st row and 3rd row (if equipped) center seating positions

The lap belt does not adjust automatically.

Insert the tongue into the correct buckle (the buckle closest to the direction the tongue is coming from). To lengthen the belt, turn the tongue at a right angle to the belt and pull across your lap until it reaches the buckle. To tighten the belt, pull the loose end of the belt through the tongue until it fits snugly across the hips.

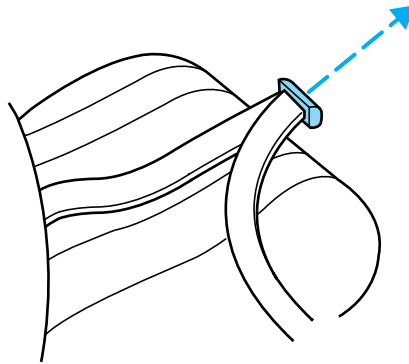

Shorten and fasten the belt when not in use.

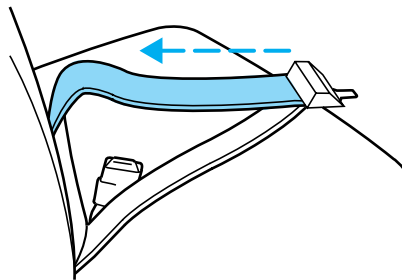

## Seating and Safety Restraints

### • 2nd row center seating position (if equipped)

The lap belt will not adjust automatically. To fasten, grasp the tongue, and with a continuous motion, pull out enough webbing to buckle the tongue into the correct buckle. If you did not pull out enough webbing to reach the buckle, allow the tongue to retract fully before trying to pull it out again.

### Safety belt warning light and indicator chime

The safety belt warning light illuminates in the instrument cluster and a chime sounds to remind the occupants to fasten their safety belts.

### Conditions of operation

If...	Then...
The driver's safety belt is not buckled before the ignition switch is turned to the ON position...	The safety belt warning light illuminates 1-2 minutes and the warning chime sounds 4-8 seconds.
The driver's safety belt is buckled while the indicator light is illuminated and the warning chime is sounding...	The safety belt warning light and warning chime turn off.
The driver's safety belt is buckled before the ignition switch is turned to the ON position...	The safety belt warning light and indicator chime remain off.

### BeltMinder

The BeltMinder feature is a supplemental warning to the safety belt warning function. This feature provides additional reminders to the driver that the driver's safety belt is unbuckled by intermittently sounding a chime and illuminating the safety belt warning lamp in the instrument cluster.

## Seating and Safety Restraints

If...	Then...
The driver's safety belt is not buckled before the vehicle has reached at least 5 km/h (3 mph) and 1-2 minutes have elapsed since the ignition switch has been turned to ON...	The BeltMinder feature is activated - the safety belt warning light illuminates and the warning chime sounds for 6 seconds every 30 seconds, repeating for approximately 5 minutes or until safety belt is buckled.
The driver's safety belt is buckled while the safety belt indicator light is illuminated and the safety belt warning chime is sounding...	The BeltMinder feature will not activate.
The driver's safety belt is buckled before the ignition switch is turned to the ON position...	The BeltMinder feature will not activate.

The following are reasons most often given for not wearing safety belts:  
(All statistics based on U.S. data)

Reasons given...	Consider...
"Crashes are rare events"	<b>36700 crashes occur every day.</b> The more we drive, the more we are exposed to "rare" events, even for good drivers. <i>1 in 4 of us will be seriously injured in a crash during our lifetime.</i>
"I'm not going far"	<b>3 of 4</b> fatal crashes occur within <b>25</b> miles of home.
"Belts are uncomfortable"	We design our safety belts to enhance comfort. If you are uncomfortable - try different positions for the safety belt upper anchorage and seatback which should be as upright as possible; this can improve comfort.
"I was in a hurry"	<b>Prime time for an accident.</b> BeltMinder reminds us to take a few seconds to buckle up.

## Seating and Safety Restraints

Reasons given...	Consider...
“Safety belts don’t work”	<b>Safety belts</b> , when used properly, <b>reduce risk of death</b> to front seat occupants by <b>45% in cars</b> , and by <b>60% in light trucks</b> .
“Traffic is light”	<b>Nearly 1 of 2 deaths occur in single-vehicle crashes</b> , many when no other vehicles are around.
“Belts wrinkle my clothes”	Possibly, but a serious crash can do much more than wrinkle your clothes, particularly if you are unbelted.
“The people I’m with don’t wear belts”	Set the example, teen deaths occur 4 times more often in vehicles with TWO or MORE people. Children and younger brothers/sisters imitate behavior they see.
“I have an air bag”	Air bags offer greater protection when used with safety belts. Frontal airbags are not designed to inflate in rear and side crashes or rollovers.
“I’d rather be thrown clear”	Not a good idea. <b>People</b> who are <b>ejected are 40 times more likely to DIE</b> . Safety belts help prevent ejection, WE CAN’T “PICK OUR CRASH”.

 Do not sit on top of a buckled safety belt to avoid the Belt Minder chime. Sitting on the safety belt will increase the risk of injury in an accident. To disable (one-time) or deactivate the Belt Minder feature please follow the directions stated below.

### **One time disable**

Any time the safety belt is buckled and then unbuckled during an ignition ON cycle, the BeltMinder will be disabled for that ignition cycle only.

### **Deactivating/activating the BeltMinder feature**

*Read steps 1 - 9 thoroughly before proceeding with the deactivation/activation programming procedure.*

## Seating and Safety Restraints

The BeltMinder feature can be deactivated/activated by performing the following procedure:

Before following the procedure, ensure that the following conditions are met:

- The parking brake is set.
- The gearshift is in P (Park) (automatic transmission) or the neutral position (manual transmission).
- The ignition switch is in the OFF position.
- All vehicle doors are closed.
- The driver's safety belt is unbuckled.
- The parklamps/headlamps are in OFF position (If vehicle is equipped with Autolamps, this will not affect the procedure).



To reduce the risk of injury, do not deactivate/activate the Belt Minder feature while driving the vehicle.

### **BeltMinder activation and deactivation procedure**

1. Turn the ignition switch to the RUN (or ON) position. (DO NOT START THE ENGINE.)
2. Wait until the safety belt warning light turns off. (Approximately 1–2 minutes.)
  - Steps 3–5 must be completed within 60 seconds or the procedure will have to be repeated.
3. Buckle then unbuckle the safety belt three times, ending with the safety belt unbuckled. This can be done before or during BeltMinder warning activation.
4. Turn on the parklamps/headlamps, turn off the parklamps/headlamps.
5. Buckle then unbuckle the safety belt three times, ending with the safety belt unbuckled.
  - After step 5 the safety belt warning light will be turned on for three seconds.
6. Within seven seconds of the safety belt warning light turning off, buckle then unbuckle the safety belt.
  - This will disable BeltMinder if it is currently enabled, or enable BeltMinder if it is currently disabled.
7. Confirmation of disabling BeltMinder is provided by the safety belt warning light flashing four times per second for three seconds.



## Seating and Safety Restraints

8. Confirmation of enabling BeltMinder is provided by:
  - The safety belt warning light flashing four times per second for three seconds.
  - Followed by three seconds with the safety belt warning light off.
  - Once again, the safety belt warning light will flash four times per second for three seconds.
9. After receiving confirmation, the deactivation/activation procedure is complete.

### Safety belt extension assembly

If the safety belt is too short when fully extended, there is a 20 cm (8 inch) safety belt extension assembly that can be added (part number 611C22). This assembly can be obtained from your dealer at no cost.

Use only extensions manufactured by the same supplier as the safety belt. Manufacturer identification is located at the end of the webbing on the label. Also, use the safety belt extension only if the safety belt is too short for you when fully extended.



Do not use extensions to change the fit of the shoulder belt across the torso.

### Safety belt maintenance

Inspect the safety belt systems periodically to make sure they work properly and are not damaged. Inspect the safety belts to make sure there are no nicks, tears or cuts. Replace if necessary. All safety belt assemblies, including retractors, buckles, front seat belt buckle assemblies, buckle support assemblies (slide bar-if equipped), shoulder belt height adjusters (if equipped), shoulder belt guide on seatback (if equipped), child safety seat LATCH and tether anchors, and attaching hardware, should be inspected after a collision. Ford Motor Company recommends that all safety belt assemblies used in vehicles involved in a collision be replaced. However, if the collision was minor and a qualified technician finds that the belts do not show damage and continue to operate properly, they do not need to be replaced. Safety belt assemblies not in use during a collision should also be inspected and replaced if either damage or improper operation is noted.



Failure to inspect and if necessary replace the safety belt assembly under the above conditions could result in severe personal injuries in the event of a collision.

Refer to *Interior* in the *Cleaning* chapter.

## Seating and Safety Restraints

### AIR BAG SUPPLEMENTAL RESTRAINT SYSTEM (SRS)

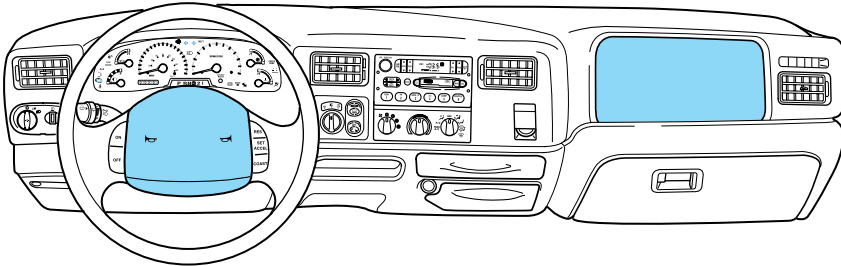

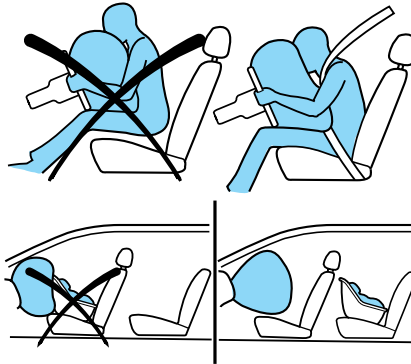

#### Important SRS precautions

The SRS is designed to work with the safety belt to help protect the driver and right front passenger from certain upper body injuries. Air bags DO NOT inflate slowly; there is a risk of injury from a deploying air bag.



 All occupants of the vehicle, including the driver, should always properly wear their safety belts, even when an air bag (SRS) is provided.

 Always transport children 12 years old and under in the back seat and always properly use appropriate child restraints.

 The National Highway Traffic Safety Administration (NHTSA) recommends a minimum distance of at least 25 cm (10 inches) between an occupant's chest and the driver air bag module.

## Seating and Safety Restraints



Never place your arm over the air bag module as a deploying air bag can result in serious arm fractures or other injuries.

To properly position yourself away from the air bag:

- Move your seat to the rear as far as you can while still reaching the pedals comfortably.
- Recline the seat slightly one or two degrees from the upright position.



Do not put anything on or over the air bag module. Placing objects on or over the air bag inflation area may cause those objects to be propelled by the air bag into your face and torso causing serious injury.



Do not attempt to service, repair, or modify the air bag supplemental restraint systems or its fuses. See your Ford or Lincoln Mercury dealer.



The front passenger air bag is not designed to offer protection to an occupant in the center front seating position.



Modifying or adding equipment to the front end of the vehicle (including frame, bumper, front end body structure and tow hooks) may affect the performance of the air bag system, increasing the risk of injury. Do not modify the front end of the vehicle.



Additional equipment such as snowplow equipment may effect the performance of the air bag sensors increasing the risk of injury. Please refer to the Body Builders Layout Book for instructions about the appropriate installation of additional equipment.



Removing the blocker beam without installing snow plow attachment hardware may effect air bag deployment in a crash. Do not operate the truck unless either the blocker beam or snow plow attachment hardware is installed on the vehicle.

## Seating and Safety Restraints

### Children and air bags

For additional important safety information, read all information on safety restraints in this guide.

Children must always be properly restrained. Failure to follow these instructions may increase the risk of injury in a collision.



An infant in a rear-facing seat faces a high risk of serious or fatal injuries from a deploying passenger air bag. Rear facing infant seats should NEVER be placed in the front seats, unless the passenger air bag is turned off. See *Passenger air bag ON/OFF switch*.

### How does the air bag supplemental restraint system work?

The air bag SRS is designed to activate when the vehicle sustains sufficient longitudinal deceleration. The fact that the air bags did not inflate in a collision does not mean that something is wrong with the system. Rather, it means the forces were not of the type sufficient to cause activation. Air bags are designed to inflate in frontal and near-frontal collisions, not rollover, side-impact, or rear-impacts.

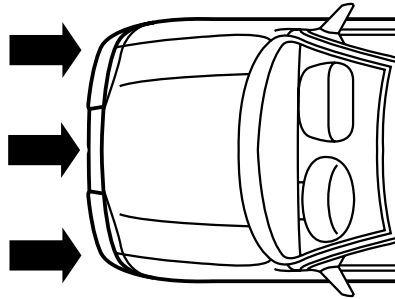

The air bags inflate and deflate rapidly upon activation. After air bag deployment, it is normal to notice a smoke-like, powdery residue or smell the burnt propellant. This may consist of cornstarch, talcum powder (to lubricate the bag) or sodium compounds (e.g., baking soda) that result from the combustion process that inflates the air bag. Small amounts of sodium hydroxide may be present which may irritate the skin and eyes, but none of the residue is toxic.



## Seating and Safety Restraints

While the system is designed to help reduce serious injuries, it may also cause minor abrasions, swelling or temporary hearing loss. Because air bags must inflate rapidly and with considerable force, there is the risk of death or serious injuries such as fractures, facial and eye injuries or internal injuries, particularly to occupants who are not properly restrained or are otherwise out of position at the time of air bag deployment. Thus, it is extremely important that occupants be properly restrained as far away from the air bag module as possible while maintaining vehicle control.



Several air bag system components get hot after inflation. Do not touch them after inflation.



If the air bag has deployed, **the air bag will not function again and must be replaced immediately.** If the air bag is not replaced, the unrepaired area will increase the risk of injury in a collision.

The SRS consists of:

- driver and passenger (if equipped) air bag modules (which include the inflators and air bags),
- one or more impact and safing sensors,
- a readiness light and tone
- and the electrical wiring which connects the components.

The diagnostic module monitors its own internal circuits and the supplemental air bag electrical system warning (including the impact sensors), the system wiring, the air bag system readiness light, the air bag back up power and the air bag ignitors.

## Seating and Safety Restraints

### Determining if the system is operational

The SRS uses a readiness light in the instrument cluster or a tone to indicate the condition of the system. Refer to *Air bag readiness* section in the *Instrument cluster* chapter. Routine maintenance of the air bag is not required.

A difficulty with the system is indicated by one or more of the following:

- The readiness light will either flash or stay lit.
- The readiness light will not illuminate immediately after ignition is turned on.
- A series of five beeps will be heard. The tone pattern will repeat periodically until the problem and/or light are repaired.



If any of these things happen, even intermittently, have the SRS serviced at your dealership or by a qualified technician immediately. Unless serviced, the system may not function properly in the event of a collision.

### Disposal of air bags and air bag equipped vehicles (including pretensioners)

See your local dealership or qualified technician. Air bags **MUST BE** disposed of by qualified personnel.

### Passenger air bag ON/OFF switch



An air bag ON/OFF switch has been installed in this vehicle. Before driving, *always* look at the face of the switch to be sure the switch is in the proper position in accordance with these instructions and warnings. Failure to put the switch in a proper position can increase the risk of serious injury or death in a collision.

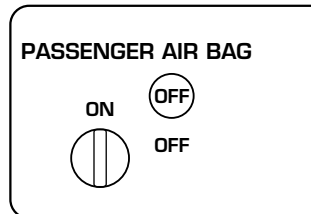



## Seating and Safety Restraints

### Turning the passenger air bag off

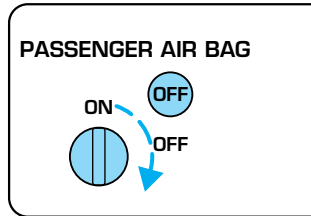
1. Insert the ignition key, turn the switch to OFF position and hold in OFF position while removing the key.
2. When the ignition is turned to the ON position the OFF light illuminates briefly, momentarily shuts off and then turns back on. This indicates that the passenger air bag is deactivated.



 If the light fails to illuminate when the passenger air bag switch is in the OFF position and the ignition switch is in ON, have the passenger air bag switch serviced at your Ford or Lincoln-Mercury dealer immediately.

 In order to avoid inadvertent activation of the switch, always remove the ignition key from the passenger air bag ON/OFF switch.

### Turning the passenger air bag back on

The passenger air bag remains OFF until you turn it back ON.

1. Insert the ignition key and turn the switch to ON.
2. The OFF light will briefly illuminate when the ignition is turned to On. This indicates that the passenger air bag is operational.

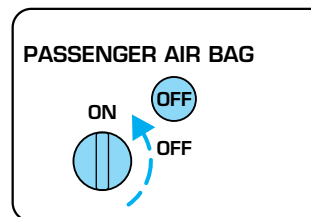

 If the OFF light is illuminated when the passenger air bag switch is in the ON position and the ignition switch is in ON, have the passenger air bag switch serviced at your Ford or Lincoln-Mercury dealer immediately.

## Seating and Safety Restraints

The passenger side air bag should always be ON (the air bag OFF light should *not* be illuminated) unless the passenger is a person who meets the requirements stated either in Category 1, 2 or 3 of the NHTSA/Transport Canada deactivation criteria which follows.



The safety belts for the driver and right front passenger seating positions have been specifically designed to function together with the air bags in certain types of crashes. When you turn OFF your air bag, you not only lose the protection of the air bag, you also may reduce the effectiveness of your safety belt system, which was designed to work with the air bag. If you are not a person who meets the requirements stated in the NHTSA/Transport Canada deactivation criteria turning OFF the air bag can increase the risk of serious injury or death in a collision.



If your vehicle has rear seats, always transport children who are 12 and younger in the rear seat. Always use safety belts and child restraints properly. If a child in a rear facing infant seat must be transported in front, the passenger air bag *must* be turned OFF. This is because the back of the infant seat is too close to the inflating air bag and the risk of a fatal injury to the infant when the air bag inflates is substantial.

The vast majority of drivers and passengers are much safer with an air bag than without. To do their job and reduce the risk of life threatening injuries, air bags must open with great force, and this force can pose a potentially deadly risk in some situations, particularly when a front seat occupant is not properly buckled up. The most effective way to reduce the risk of unnecessary air bag injuries without reducing the overall safety of the vehicle is to make sure all occupants are properly restrained in the vehicle, especially in the front seat. This provides the protection of safety belts and permits the air bags to provide the additional protection they were designed to provide. If you choose to deactivate your air bag, you are losing the very significant risk reducing benefits of the air bag and you are also reducing the effectiveness of the safety belts, because safety belts in modern vehicles are designed to work as a safety system with the air bags.

Read all air bag Warning labels in the vehicle as well as the other important air bag instructions and Warnings in this Owner's Guide.



## Seating and Safety Restraints

### **NHTSA deactivation criteria (excluding Canada)**

1. **Infant.** An infant (less than 1 year old) must ride in the front seat because:
  - the vehicle has no rear seat;
  - the vehicle has a rear seat too small to accommodate a rear-facing infant seat; or
  - the infant has a medical condition which, according to the infant's physician, makes it necessary for the infant to ride in the front so that the driver can constantly monitor the child's condition.
2. **Child age 1 to 12.** A child age 1 to 12 must ride in the front seat because:
  - the vehicle has no rear seat;
  - although children ages 1 to 12 ride in the rear seat(s) whenever possible, children ages 1 to 12 sometimes must ride in the front because no space is available in the rear seat(s) of the vehicle; or
  - the child has a medical condition which, according to the child's physician, makes it necessary for the child to ride in the front seat so that the driver can constantly monitor the child's condition.
3. **Medical condition.** A passenger has a medical condition which, according to his or her physician:
  - causes the passenger air bag to pose a special risk for the passenger; and
  - makes the potential harm from the passenger air bag in a crash greater than the potential harm from turning OFF the air bag and allowing the passenger, even if belted, to hit the dashboard or windshield in a crash.



This vehicle has special energy management safety belts for the driver and right front passenger. These particular belts are specifically designed to work with air bags to help reduce the risk of injury in a collision. The energy management safety belt is designed to give or release additional belt webbing in some accidents to reduce concentration of force on an occupant's chest and reduce the risk of certain bone fractures and injuries to underlying organs. In a crash, if the air bag is turned OFF, this energy management safety belt might permit the person wearing the belt to move forward enough to incur a serious or fatal injury. The more severe the crash, and the heavier the occupant, the greater the risk is. Be sure the air bag is turned ON for any person who does not qualify under the NHTSA deactivation criteria.

## Seating and Safety Restraints

### **Transport Canada deactivation criteria (Canada Only)**

1. **Infant:** An infant (less than 1 year old) must ride in the front seat because:
  - my vehicle has no rear seat;
  - the rear seat in my vehicle cannot accommodate a rear-facing infant seat; or
  - the infant has a medical condition which, according to the infant's physician, makes it necessary for the infant to ride in the front seat so that the driver can monitor the infant's condition.
2. **Child age 12 or under:** A child age 12 or under must ride in the front seat because:
  - my vehicle has no rear seat;
  - although children age 12 and under ride in the rear seat whenever possible, children age 12 and under have no option but to sometimes ride in the front seat because rear seat space is insufficient; or
  - the child has a medical condition that, according to the child's physician, makes it necessary for the child to ride in the front seat so that the driver can monitor the child's condition.
3. **Medical condition:** A passenger has a medical condition that, according to his or her physician:
  - poses a special risk for the passenger if the air bag deploys; and
  - makes the potential harm from the passenger air bag deployment greater than the potential harm from turning OFF the air bag and experiencing a crash without the protection offered by the air bag



This vehicle has special energy management safety belts for the driver and right front passenger. These particular belts are specifically designed to work with air bags to help reduce the risk of injury in a collision. The energy management safety belt is designed to give or release additional belt webbing in some accidents to reduce concentration of force on an occupant's chest and reduce the risk of certain bone fractures and injuries to underlying organs. In a crash, if the air bag is turned OFF, this energy management safety belt might permit the person wearing the belt to move forward enough to incur a serious or fatal injury. The more severe the crash, and the heavier the occupant, the greater the risk is. Be sure the air bag is turned ON for any person who does not qualify under the NHTSA deactivation criteria.

## Seating and Safety Restraints

### SAFETY RESTRAINTS FOR CHILDREN

See the following sections for directions on how to properly use safety restraints for children. Also see *Air bag supplemental restraint system (SRS)* in this chapter for special instructions about using air bags.

#### Important child restraint precautions

You are required by law to use safety restraints for children in the U.S. and Canada. If small children (generally children who are four years old or younger and who weigh 18 kg [40 lbs] or less) ride in your vehicle, you must put them in safety seats made especially for children. Check your local and state or provincial laws for specific requirements regarding the safety of children in your vehicle. When possible, always place children under age 12 in the rear seat of your vehicle. Accident statistics suggest that children are safer when properly restrained in the rear seating positions than in the front seating position.



Never let a passenger hold a child on his or her lap while the vehicle is moving. The passenger cannot protect the child from injury in a collision.

Always follow the instructions and warnings that come with any infant or child restraint you might use.

#### Children and safety belts

If the child is the proper size, restrain the child in a safety seat. Children who are too large for child safety seats (as specified by your child safety seat manufacturer) should always wear safety belts.

Follow all the important safety restraint and air bag precautions that apply to adult passengers in your vehicle.

If the shoulder belt portion of a combination lap and shoulder belt can be positioned so it does not cross or rest in front of the child's face or neck, the child should wear the lap and shoulder belt. Moving the child closer to the center of the vehicle may help provide a good shoulder belt fit.



Do not leave children, unreliable adults, or pets unattended in your vehicle.

## Seating and Safety Restraints

### **Child booster seats**

Children outgrow a typical convertible or toddler seat when they weigh 40 pounds and are around 4 years of age. Although the lap/shoulder belt will provide some protection, these children are still too small for lap/shoulder belts to fit properly, which could increase the risk of serious injury.

To improve the fit of both the lap and shoulder belt on children who have outgrown child safety seats, Ford Motor Company recommends use of a belt-positioning booster.

Booster seats position a child so that safety belts fit better. They lift the child up so that the lap belt rests low across the hips and the knees bend comfortably. Booster seats also make the shoulder belt fit better and more comfortably for growing children.

### **When children should use booster seats**

Children need to use booster seats from the time they outgrow the toddler seat until they are big enough for the vehicle seat and lap/shoulder belt to fit properly. Generally this is when they weigh about 80 lbs (about 8 to 12 years old).

Booster seats should be used until you can answer YES to ALL of these questions:

- Can the child sit all the way back against the vehicle seat back with knees bent comfortably at the edge of the seat without slouching?

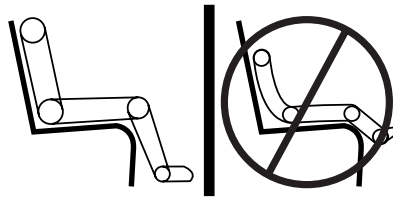

- Does the lap belt rest low across the hips?
- Is the shoulder belt centered on the shoulder and chest?
- Can the child stay seated like this for the whole trip?

## Seating and Safety Restraints

### **Types of booster seats**

There are two types of belt-positioning booster seats:

- Those that are backless.

If your backless booster seat has a removable shield, remove the shield and use the lap/shoulder belt. If a seating position has a low seat back and no head restraint, a backless booster seat may place your child's head (top of ear level) above the top of the seat. In this case, move the backless booster to another seating position with a higher seat back and lap/shoulder belts.



- Those with a high back.

If, with a backless booster seat, you cannot find a seating position that adequately supports your child's head, a high back booster seat would be a better choice.



Both can be used in any vehicle in a seating position equipped with lap/shoulder belts if your child is over 40 lbs.

The shoulder belt should cross the chest, resting snugly on the center of the shoulder. The lap belt should rest low and snug across the hips, never up high across the stomach.

If the booster seat slides on the vehicle seat, placing a rubberized mesh sold as shelf or carpet liner under the booster seat may improve this condition.

### **The importance of shoulder belts**

Using a booster without a shoulder belt increases the risk of a child's head hitting a hard surface in a collision. For this reason, you should never use a booster seat with a lap belt only. It is best to use a booster seat with lap/shoulder belts in the back seat- the safest place for children to ride.

## Seating and Safety Restraints



Follow all instructions provided by the manufacturer of the booster seat.



Never put the shoulder belt under a child's arm or behind the back because it eliminates the protection for the upper part of the body and may increase the risk of injury or death in a collision.



Never use pillows, books, or towels to boost a child. They can slide around and increase the likelihood of injury or death in a collision.

### SAFETY SEATS FOR CHILDREN



#### Child and infant or child safety seats

Use a safety seat that is recommended for the size and weight of the child. Carefully follow all of the manufacturer's instructions with the safety seat you put in your vehicle. If you do not install and use the safety seat properly, the child may be injured in a sudden stop or collision.

## Seating and Safety Restraints

When installing a child safety seat:

- Review and follow the information presented in the *Air bag supplemental restraint system (SRS)* section in this chapter.
- Use the correct safety belt buckle for that seating position (the buckle closest to the direction the tongue is coming from).
- Insert the belt tongue into the proper buckle until you hear a snap and feel it latch. Make sure the tongue is securely fastened in the buckle.
- Keep the buckle release button pointing up and away from the safety seat, with the tongue between the child seat and the release button, to prevent accidental unbuckling.
- Place seat back in upright position.
- Put the safety belt in the automatic locking mode. Refer to *Automatic locking mode* (passenger side front and outboard rear seating positions) (if equipped) section in this chapter.

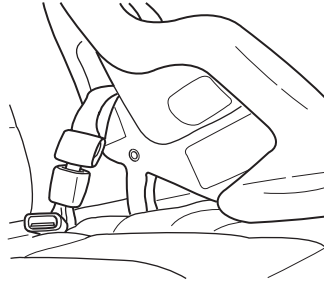

Ford recommends the use of a child safety seat having a top tether strap. Install the child safety seat in a seating position with a tether anchor. For more information on top tether straps, refer to *Attaching child safety seats with tether straps*. in this chapter.



Carefully follow all of the manufacturer's instructions included with the safety seat you put in your vehicle. If you do not install and use the safety seat properly, the child may be injured in a sudden stop or collision.



Rear-facing child seats or infant carriers should never be placed in the front seats, unless the passenger airbag On/Off switch is turned off. See *Passenger airbag on/off switch* in this chapter.

## Seating and Safety Restraints

### Installing child safety seats with combination lap and shoulder belts

1. Position the child safety seat in a seat with a combination lap and shoulder belt.

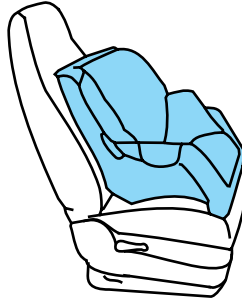

Air bags can kill or injure a child in a child seat. NEVER put a rear-facing child seat in the front unless the passenger air bag switch is turned off. If you must use a forward-facing child seat in the front seat, move the seat all the way back and turn the passenger air bag off. See *Passenger air bag on/off switch*.



An air bag can kill or injure a child in a child seat. Child seats should never be placed in the front seats, unless the passenger air bag switch is turned off, See *Passenger air bag on/off switch*.



Rear facing child seats should NEVER be placed in the front seats unless the passenger airbag switch is turned off.

2. Pull down on the shoulder belt and then grasp the shoulder belt and lap belt together.

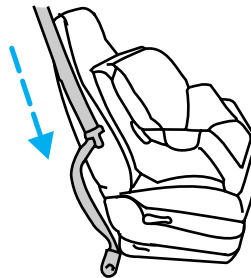



## Seating and Safety Restraints

3. While holding the shoulder and lap belt portions together, route the tongue through the child seat according to the child seat manufacturer's instructions. Be sure the belt webbing is not twisted.

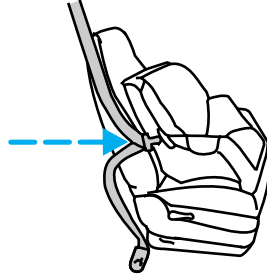

4. Insert the belt tongue into the proper buckle (the buckle closest to the direction the tongue is coming from) for that seating position until you hear and feel the latch engage. Make sure the tongue is latched securely by pulling on it.

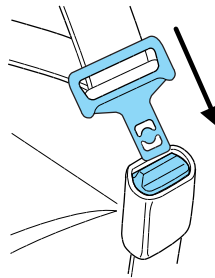

5. To put the retractor in the automatic locking mode, grasp the shoulder portion of the belt and pull downward until all of the belt is extracted and a click is heard.

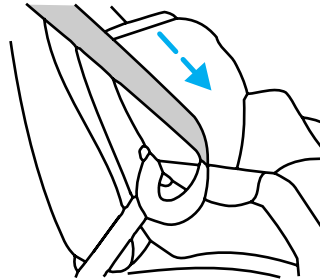

6. Allow the belt to retract. The belt will click as it retracts to indicate it is in the automatic locking mode.

## Seating and Safety Restraints

7. Pull the lap belt portion across the child seat toward the buckle and pull up on the shoulder belt while pushing down with knee on the child seat.

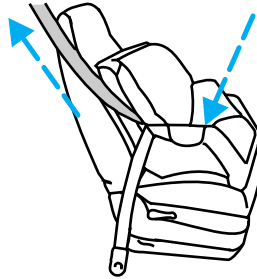

8. Allow the safety belt to retract to remove any slack in the belt.

9. Before placing the child in the seat, forcibly tilt the seat forward and back to make sure the seat is securely held in place. To check this, grab the seat at the belt path and attempt to move it side to side and forward. There should be no more than one inch of movement for proper installation.

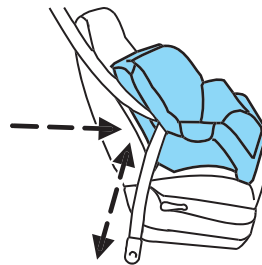

10. Try to pull the belt out of the retractor to make sure the retractor is in the automatic locking mode (you should not be able to pull more belt out). If the retractor is not locked, unbuckle the belt and repeat steps two through nine.

Check to make sure the child seat is properly secured before each use.

### Attaching child safety seats with tether straps

Most new forward-facing child safety seats include a tether strap which goes over the back of the seat and hooks to an anchoring point. Tether straps are available as an accessory for many older safety seats. Contact the manufacturer of your child seat for information about ordering a tether strap.

The passenger seats of your vehicle may be equipped with built-in tether strap anchors located behind the seats as described below.

The tether anchors in your vehicle may be straps on the seatback or an anchor bracket on the rear edge of the seat cushion or an anchor bracket mounted to the body shell on the back panel.

## Seating and Safety Restraints

The SuperCab rear seat has three straps behind the top of the seat back that function as both routing loops for the tether straps and anchor loops. The tether strap anchors in your vehicle are in the following positions (shown from top view):

 Attach the tether strap only to the appropriate tether anchor as shown. The tether strap may not work properly if attached somewhere other than the correct tether anchor.

### • F—Series Regular Cab

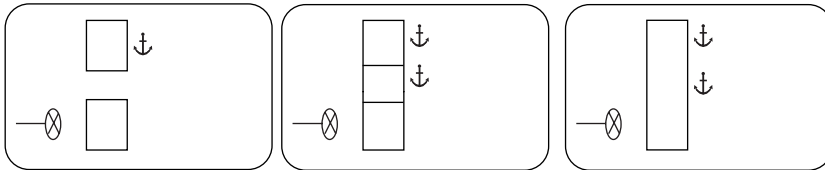

### • F—Series SuperCab

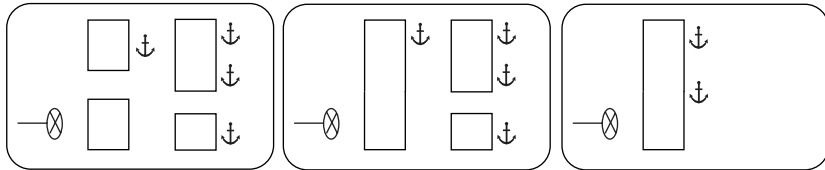

### • F—Series Crew Cab

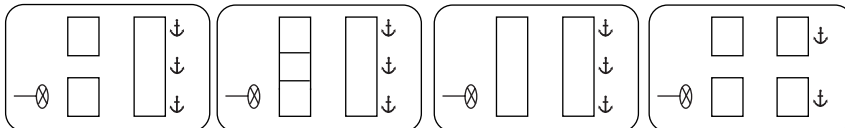

### Tether strap attachment

1. Position the child safety seat on the seat cushion.
2. Route the child safety seat tether strap over the back of the seat.
3. Locate the correct anchor for the selected seating position.
4. You may need to pull the seatback forward to access the tether anchors. Make sure the seat is locked in the upright position before installing the child seat. Refer to the *Folding down the rear seats* section in this chapter for information on how to operate the rear seats.

## Seating and Safety Restraints

5. Clip the tether strap to the anchor as shown.

- Front seat (SuperCab only)

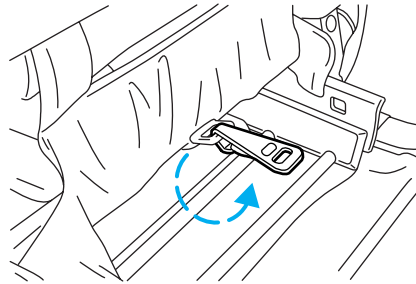

- Front seats (Regular Cab) and Rear seats (Crew Cab only)

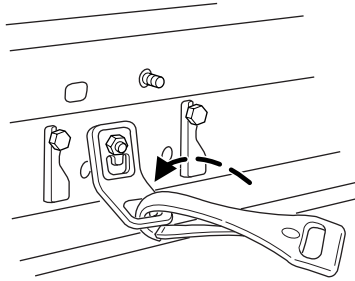

If the tether strap is clipped incorrectly, the child safety seat may not be retained properly in the event of a collision.

6. Refer to the *Installing child safety seats in combination lap and shoulder belt seating positions* section of this chapter for further instructions to secure the child safety seat.

7. Tighten the child safety seat tether strap according to the manufacturer's instructions.



If the safety seat is not anchored properly, the risk of a child being injured in a collision greatly increases.

### **Tether strap attachment rear SuperCab only**

There are three loops of webbing just above the back of the rear seat (along the bottom edge of the rear window) in the SuperCab. These loops are to be used as both routing loops and anchor loops for child safety seat tether straps.

## Seating and Safety Restraints

Many tether straps cannot be tightened if the tether strap is hooked to the loop directly behind the child seat. To provide a tight tether strap:

1. Route the tether strap through the loop directly behind the child seat.



2. Attach the strap hook onto the loop behind an adjacent seating position.

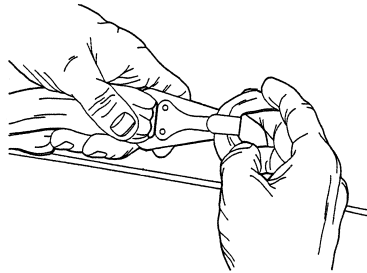

3. Install the child safety seat tightly using the vehicle belts. Follow the instructions in this chapter.

4. Tighten the tether strap according to the child seat manufacturer's instructions.

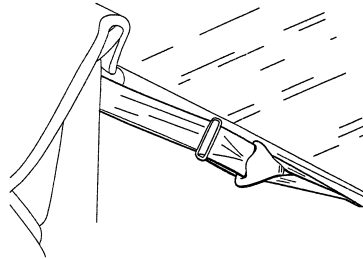

A single loop can be used to route and anchor more than one child seat. For example, the center loop can be used as a routing loop for a child safety seat in the center rear seat and as an anchoring loop for child seats installed in the outboard rear seats.

## Driving

### STARTING

#### Positions of the ignition

1. ACCESSORY, allows the electrical accessories such as the radio to operate while the engine is not running.

2. LOCK, locks the steering wheel, automatic transmission gearshift lever and allows key removal. For vehicle equipped with a manual transmission, you must depress the ignition release lever to release the key.

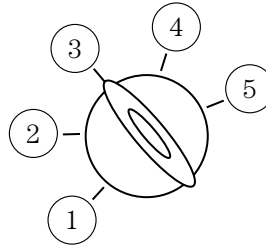

3. OFF, shuts off the engine and all accessories without locking the steering wheel. This position also allows the automatic transmission shift lever to be moved from the P (Park) position without the brake pedal being depressed.



When the key is in the ignition OFF position, the automatic transmission shift lever can be moved from the P (Park) position without the brake pedal depressed. To avoid unwanted vehicle movement, always set the parking brake.

4. ON, all electrical circuits operational. Warning lights illuminated. Key position when driving.

5. START, cranks the engine. Release the key as soon as the engine starts.

#### Preparing to start your vehicle

Engine starting is controlled by the powertrain control system. This system meets all Canadian Interference-Causing Equipment standard requirements regulating the impulse electrical field strength of radio noise.

When starting a fuel-injected engine, don't press the accelerator before or during starting. Only use the accelerator when you have difficulty starting the engine. For more information on starting the vehicle, refer to *Starting the engine* in this chapter.

## Driving



Extended idling at high engine speeds can produce very high temperatures in the engine and exhaust system, creating the risk of fire or other damage.



Do not park, idle, or drive your vehicle in dry grass or other dry ground cover. The emission system heats up the engine compartment and exhaust system, which can start a fire.



Do not start your vehicle in a closed garage or in other enclosed areas. Exhaust fumes can be toxic. Always open the garage door before you start the engine. See *Guarding against exhaust fumes* in this chapter for more instructions.



If you smell exhaust fumes inside your vehicle, have your dealer inspect your vehicle immediately. Do not drive if you smell exhaust fumes.

### **Important safety precautions**

When the engine starts, the idle RPM runs faster to warm the engine. If the engine idle speed does not slow down automatically, have the vehicle checked. The following starting instructions are for vehicles equipped with a gasoline engine; if your vehicle is equipped with a Diesel engine, refer to *Starting the engine* in the your Diesel owner guide supplement.

Before starting the vehicle:

1. Make sure all occupants buckle their safety belts. For more information on safety belts and their proper usage, refer to the *Seating and Safety Restraints* chapter.
2. Make sure the headlamps and electrical accessories are off.

## Driving

If starting a vehicle with an automatic transmission:

1. Make sure the parking brake is set.

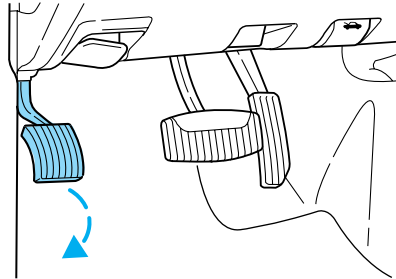

2. Make sure the gearshift is in P (Park).



If starting a vehicle with a manual transmission:

1. Make sure the parking brake is set.
2. Push the clutch pedal to the floor.

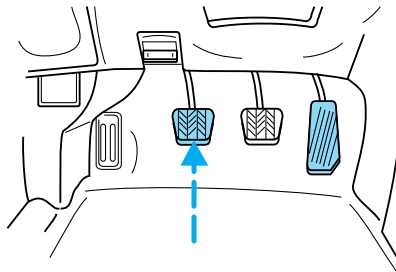



## Driving

- Turn the key to 4 (ON) without turning the key to 5 (START).

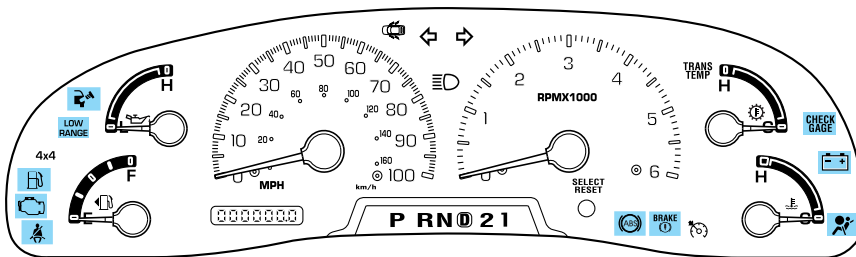
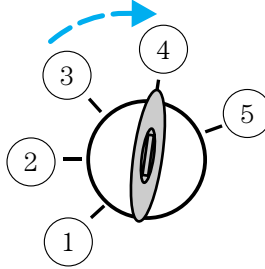

Make sure the corresponding lights illuminate or illuminate briefly. If a light fails to illuminate, have the vehicle serviced.

- If the driver's safety belt is fastened, the  light may not illuminate.

### Starting the engine

1. Turn the key to 4 (ON) without turning the key to 5 (START).
2. Turn the key to 5 (START), then release the key as soon as the engine starts. Excessive cranking could damage the starter.

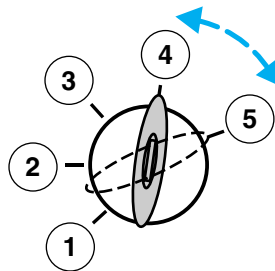

**Note:** If the engine does not start within five seconds on the first try, turn the key to 3 (OFF), wait 10 seconds and try again. If the engine still fails to start, press the accelerator to the floor and try again; this will allow the engine to crank with the fuel shut off in case the engine is flooded with fuel.

## Driving

### Using the engine block heater (if equipped)

Use of an engine block heater is strongly recommended if you live in a region where temperatures reach  $-23^{\circ}\text{C}$  ( $-10^{\circ}\text{F}$ ) or below. For best results, plug the heater in at least three hours before starting the vehicle. The heater can be plugged in the night before starting the vehicle. The plug for the block heater is exposed in the front of the vehicle, beneath the grille. Vehicles equipped with a gasoline engine have the plug exposed on the driver side of the vehicle; vehicles equipped with a Diesel engine have the plug exposed on the passenger side of the vehicle.

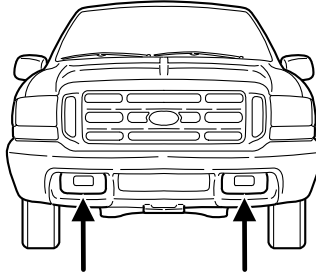

To reduce the risk of electrical shock, do not use your heater with ungrounded electrical systems or two-pronged (cheater) adapters.

### Guarding against exhaust fumes

Carbon monoxide is present in exhaust fumes. Take precautions to avoid its dangerous effects.



If you smell exhaust fumes inside your vehicle, have your dealer inspect your vehicle immediately. Do not drive if you smell exhaust fumes.

### Important ventilating information

If the engine is idling while the vehicle is stopped for a long period of time, open the windows at least 2.5 cm (one inch) or adjust the heating or air conditioning to bring in fresh air.

### **BRAKES**

Occasional brake noise is normal. If a metal-to-metal, continuous grinding or continuous squeal sound is present, the brake linings may be worn-out and should be inspected by a qualified service technician. If the vehicle has continuous vibration or shudder in the steering wheel while braking, the vehicle should be inspected by a qualified service technician.

#### **Four-wheel anti-lock brake system (ABS) (if equipped)**

Your vehicle may be equipped with an Anti-lock Braking System (ABS). This system helps you maintain steering control during emergency stops by keeping the brakes from locking. Noise from the ABS pump motor and brake pedal pulsation may be observed during ABS braking; any pulsation or mechanical noise you may feel or hear is normal.

#### **ABS warning lamp**

The  lamp in the instrument cluster momentarily illuminates when the ignition is turned to ON. If the light does not illuminate during start up, remains on or flashes, the ABS may be disabled and may need to be serviced.

Even when the ABS is disabled, normal braking is still effective. (If your BRAKE warning lamp illuminates with the parking brake released, have your brake system serviced immediately.)

**BRAKE**  



#### **Using ABS**

When hard braking is required, apply continuous force on the brake pedal; do not pump the brake pedal since this will reduce the effectiveness of the ABS and will increase your vehicle's stopping distance. The ABS will be activated immediately, allowing you to retain full steering control during hard braking and on slippery surfaces. However, the ABS does not decrease stopping distance.

## Driving

### Parking brake (P)

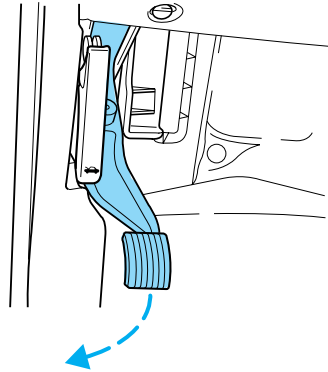
To set the parking brake, press the parking brake pedal down until the pedal stops.



The BRAKE warning lamp in the instrument cluster illuminates and remains illuminated until the parking brake is released.

**BRAKE**  
(!)

Pull the right side of the release lever to release the parking brake; the release lever pulls at an angle toward the driver's door. To prevent the pedal from releasing too quickly, place your left foot on the parking brake pedal, then pull the release lever, making sure the pedal fully releases. You may want to pull the release lever again to make sure the parking brake is fully released.

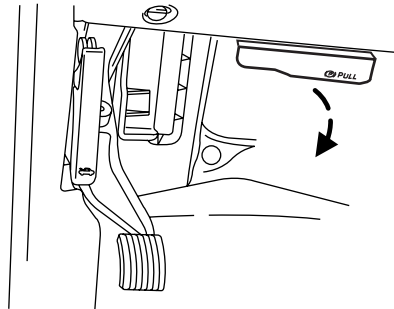

 Always set the parking brake fully and make sure that the gearshift is securely latched in P (Park) (automatic transmission) or in 1 (First) (manual transmission).

**Note:** If your vehicle is equipped with a manual transmission, the engine may be required to run while power accessories operate and the parking brake is set. It is recommended that wheel chocks be used during this operation.

## Driving

If you're parking your vehicle on a grade or with a trailer, press and hold the brake pedal down, then set the parking brake. There may be a little vehicle movement as the parking brake sets to hold the vehicle's weight. This is normal and should be no reason for concern. If needed, press and hold the service brake pedal down, then try reapplying the parking brake. Chock the wheels if required. If the parking brake cannot hold the weight of the vehicle, the parking brake may need to be serviced or the vehicle may be overloaded.

### STEERING

To prevent damage to the power steering system:

- Never hold the steering wheel at its furthest turning points (until it stops) for more than a few seconds when the engine is running.
- Do not operate the vehicle with a low power steering pump fluid level (below the MIN mark on the reservoir).

If the power steering system breaks down (or if the engine is turned off), you can steer the vehicle manually, but it takes more effort.

If the steering wanders or pulls, check for:

- an improperly inflated tire
- uneven tire wear
- loose or worn suspension components
- loose or worn steering components
- improper steering alignment

A high crown in the road or high crosswinds may also make the steering seem to wander/pull.

### TRACTION-LOK AXLE (IF EQUIPPED)

This axle provides added traction on slippery surfaces, particularly when one wheel is on a poor traction surface. Under normal conditions, the Traction-Lok axle functions like a standard rear axle.

### PREPARING TO DRIVE YOUR VEHICLE



Utility vehicles have a significantly higher rollover rate than other types of vehicles.



In a rollover crash, an unbelted person is significantly more likely to die than a person wearing a safety belt.

## Driving

Your vehicle has larger tires and increased ground clearance, giving the vehicle a higher center of gravity than a passenger car.



Vehicles with a higher center of gravity such as utility and four-wheel drive vehicles handle differently than vehicles with a lower center of gravity. Utility and four-wheel drive vehicles are **not** designed for cornering at speeds as high as passenger cars any more than low-slung sports cars are designed to perform satisfactorily under off-road conditions. Avoid sharp turns, excessive speed and abrupt maneuvers in these vehicles. Failure to drive cautiously could result in an increased risk of loss of vehicle control, vehicle rollover, personal injury and death.



Loaded vehicles, with a higher center of gravity, may handle differently than unloaded vehicles. Extra precautions, such as slower speeds and increased stopping distance, should be taken when driving a heavily loaded vehicle.

## AUTOMATIC TRANSMISSION OPERATION (IF EQUIPPED)

### Brake-shift interlock

This vehicle is equipped with a brake-shift interlock feature that prevents the gearshift lever from being moved from P (Park) when the ignition is in the ON position unless brake pedal is depressed.

If you cannot move the gearshift lever out of P (Park) with ignition in the ON position and the brake pedal depressed:

1. Apply the parking brake, turn ignition key to LOCK, then remove the key.
2. Insert the key and turn it to OFF. **Apply the brake pedal and shift to N (Neutral).**



When the key is in the ignition OFF position, the automatic transmission shift lever can be moved from the P (Park) position without the brake pedal depressed. To avoid unwanted vehicle movement, always set the parking brake.

3. Start the vehicle.

If it is necessary to use the above procedure to move the gearshift lever, it is possible that a fuse has blown or the vehicle's brakelamps are not operating properly. Refer to *Fuses and relays* in the *Roadside emergencies* chapter.

## Driving



Do not drive your vehicle until you verify that the brakelamps are working.



Always set the parking brake fully and make sure the gearshift is latched in P (Park). Turn the ignition to the LOCK position and remove the key whenever you leave your vehicle.



If the parking brake is fully released, but the brake warning lamp remains illuminated, the brakes may not be working properly. See your dealer or a qualified service technician.

### Understanding the gearshift positions of the 4-speed automatic transmission (if equipped-gasoline engines only)



#### **P (Park)**

This position locks the transmission and prevents the rear wheels from turning.

To put your vehicle in gear:

- Start the engine
- Depress the brake pedal
- Move the gearshift lever into the desired gear

To put your vehicle in P (Park):

- Come to a complete stop
- Move the gearshift lever and securely latch it in P (Park)



Always set the parking brake fully and make sure the gearshift is latched in P (Park). Turn the ignition to the LOCK position and remove the key whenever you leave your vehicle.

#### **R (Reverse)**

With the gearshift lever in R (Reverse), the vehicle will move backward. Always come to a complete stop before shifting into and out of R (Reverse).

## Driving

### N (Neutral)

With the gearshift lever in N (Neutral), the vehicle can be started and is free to roll. Hold the brake pedal down while in this position.

### D (Overdrive)

The normal driving position for the best fuel economy. Transmission operates in gears one through four.



D (Overdrive) can be deactivated by pressing the transmission control switch on the end of the gearshift lever.

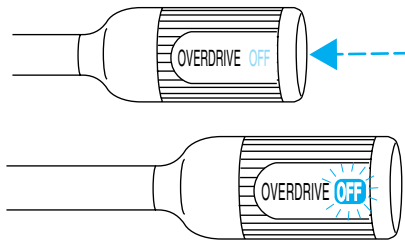

This transmission control indicator light (TCIL) will illuminate on the end of the gearshift.

**Note:** If the Overdrive OFF light flashes steadily at any time, have the system serviced immediately.

### Drive (not shown)

Drive is activated when the transmission control switch is pressed.

- This position allows for all forward gears except overdrive.
- O/D OFF lamp is illuminated.
- Provides engine braking.
- Use when driving conditions cause excessive shifting from O/D to other gears. Examples: city traffic, hilly terrain, heavy loads, trailer towing and when engine braking is required.
- To return to O/D (overdrive mode), press the transmission control switch. The O/D OFF lamp will not be illuminated.
- O/D (Overdrive) is automatically returned each time the key is turned off regardless of last mode of operation.



### **2 (Second)**

This position allows for second gear only.

- Provides engine braking.
- Use to start-up on slippery roads.
- To return to **D** (Overdrive), move the gearshift lever into the **D** (Overdrive) position.
- Selecting 2 (Second) at higher speeds will cause the transmission to downshift to second gear at the appropriate vehicle speed.

### **1 (First)**

- Provides maximum engine braking.
- Allows upshifts by moving gearshift lever.
- Will not downshift into 1 (First) at high speeds; allows for 1 (First) when vehicle reaches slower speeds.

### **Forced downshifts**

- Allowed in **D** (Overdrive) or Drive.
- Depress the accelerator to the floor.
- Allows transmission to select an appropriate gear.

### ***Shift strategy (4R100 automatic transmission)***

To account for customer driving habits and conditions, your 4R100 automatic transmission electronically controls the shift quality by using an adaptive learning strategy. The adaptive learning strategy is maintained by power from the battery. When the battery is disconnected or a new battery is installed, the transmission must relearn its adaptive strategy. Optimal shifting will resume within a few hundred kilometers (miles) of operation.

**If the shift quality does not improve within a few hundred kilometers (miles) of operation, or if the downshifts and other throttle conditions do not function normally, see your dealer or a qualified service technician as soon as possible.**

## Driving

### Understanding the shift positions of the 5-speed automatic transmission (if equipped-Diesel engines only)



Your transmission is equipped with an adaptive learning strategy found in the vehicle computer. This feature is designed to increase durability, and provide consistent shift feel over the life of the vehicle. A new vehicle or transmission may have firm and/or soft shifts. This operation is considered normal and will not affect function or durability of the transmission. Over time, the adaptive learning process will fully update transmission operation. Additionally, whenever the battery is disconnected or a new battery installed, the strategy must be relearned.

#### **P (Park)**

This position locks the transmission and prevents the rear wheels from turning.

To put your vehicle in gear:

- Start the engine
- Depress the brake pedal
- Move the gearshift lever into the desired gear

To put your vehicle in P (Park):

- Come to a complete stop
- Move the gearshift lever and securely latch it in P (Park)



Always set the parking brake fully and make sure the gearshift is latched in P (Park). Turn the ignition to the LOCK position and remove the key whenever you leave your vehicle.

#### **R (Reverse)**

With the gearshift lever in R (Reverse), the vehicle will move backward. Always come to a complete stop before shifting into and out of R (Reverse).

#### **N (Neutral)**

With the gearshift lever in N (Neutral), the vehicle can be started and is free to roll. Hold the brake pedal down while in this position.

### **D (Overdrive) with Tow/Haul OFF**

D (Overdrive) with Tow/Haul OFF is the normal driving position for the best fuel economy. The overdrive function allows automatic upshifts and downshifts through gears one through five.

### **D (Overdrive) with Tow/Haul ON**

The Tow/Haul feature improves transmission operation when towing a trailer or a heavy load. All transmission gear ranges are available when using Tow/Haul.

To activate Tow/Haul, press the button on the end of the gearshift lever.

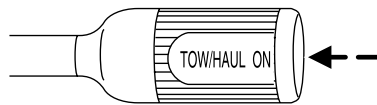

The ON light on the end of the gearshift lever will illuminate when it is activated.

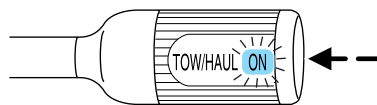

The TOW HAUL indicator light will illuminate on the end of the gearshift lever.

Tow/Haul delays upshifts to reduce frequency of transmission shifting. Tow/Haul also provides engine braking in all forward gears when the transmission is in the D (Overdrive) position; this engine braking will slow the vehicle and assist the driver in controlling the vehicle when descending a grade. Depending on driving conditions and load conditions, the transmission may downshift, slow the vehicle and control the vehicle speed when descending a hill, without the accelerator pedal being pressed. The amount of downshift braking provided will vary based upon the amount the brake pedal is depressed.

To deactivate the Tow/Haul feature and return to normal driving mode, press the button on the end of the gearshift lever. The ON light will no longer be illuminated.

When you shut-off and restart the engine, the transmission will automatically return to normal D (Overdrive) mode (Tow/Haul OFF).

### **3 (Third)**

Transmission operates up to third gear only.

## Driving

Used for improved traction on slippery roads. Selecting 3 (Third) provides engine braking.

### **2 (Second)**

Use 2 (Second) to start-up on slippery roads or to provide additional engine braking on downgrades.

### **1 (First)**

- Provides maximum engine braking.
- Allows upshifts by moving gearshift lever.
- The transmission will not downshift into 1 (First) at high speeds; it will downshift to a lower gear and then shift into 1 (First) when the vehicle reaches slower speeds.

### **Forced downshifts**

- Allowed in **D** (Overdrive) or Drive.
- Depress the accelerator to the floor.
- Allows transmission to select an appropriate gear.

### **If your vehicle gets stuck in mud or snow**

If your vehicle gets stuck in mud or snow, it may be rocked out by shifting from forward and reverse gears, stopping between shifts in a steady pattern. Press lightly on the accelerator in each gear.

**Do not rock the vehicle if the engine is not at normal operating temperature or damage to the transmission may occur.**

**Do not rock the vehicle for more than a minute or damage to the transmission and tires may occur, or the engine may overheat.**

### **MANUAL TRANSMISSION OPERATION (IF EQUIPPED)**

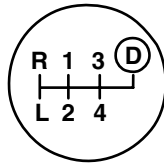

### **Using the clutch**

The manual transmission has a starter interlock that prevents cranking the engine unless the clutch pedal is fully depressed.

## Driving

To start the vehicle:

1. Make sure the parking brake is fully set.
2. Press the clutch pedal to the floor, then put the gearshift lever in the neutral position.
3. Start the engine, then press the brake pedal and release the parking brake.
4. Move the gearshift lever to the desired gear, then slowly release the clutch pedal while slowly pressing on the accelerator.

During each shift, the clutch pedal must be fully depressed to the floor. Failure to fully depress the clutch pedal to the floor may cause increased shift efforts and prematurely wear components in the transmission. Make sure the floor mat is properly positioned so it doesn't interfere with the full extension of the clutch pedal.

Do not drive with your foot resting on the clutch pedal or use the clutch pedal to hold your vehicle at a standstill while waiting on a hill. These actions will reduce the life of the clutch.

### Recommended shift speeds

Upshifts when accelerating (recommended for best fuel economy)		
6-speed transmission		
Shift from:	Transfer case position <sup>1</sup> (if equipped)	
	2H or 4H	4L
LO-1	8 km/h (5 mph)	3 km/h (2 mph)
1-2	16 km/h (10 mph)	6 km/h (4 mph)
2-3	32 km/h (20 mph)	13 km/h (8 mph)
3-4	48 km/h (30 mph)	19 km/h (12 mph)
4	64 km/h (40 mph)	24 km/h (15 mph)
- <b>D</b> (Overdrive)		

## Driving

Maximum downshift speeds <sup>1</sup>		
6-speed transmission		
Shift from:	Transfer case position (if equipped) <sup>2</sup>	
	2H or 4H	4L
ⓓ (Overdrive) - 4	72 km/h (45 mph)	26 km/h (16 mph)
4-3	56 km/h (35 mph)	19 km/h (12 mph)
3-2	32 km/h (20 mph)	13 km/h (8 mph)
2-1	8 km/h (5 mph)	3 km/h (2 mph)
1-LO	Only shift to LO when at a stop.	
<sup>1</sup> Use 2H or 4H for 4WD equipped vehicles.		
<sup>2</sup> Downshift at lower speeds when driving on slippery surfaces.		

### Reverse

1. Make sure that your vehicle is at a complete stop before you shift into R (Reverse). Failure to do so may damage the transmission.
2. Move the gearshift lever into the neutral position and wait at least three seconds before shifting into R (Reverse).
  - The gearshift lever can only be moved into R (Reverse) by moving it from left of 3 (Third) and 4 (Fourth) before shifting into R (Reverse). This is a lockout feature that protects the transmission from accidentally being shifted into R (Reverse) from ⓓ (Overdrive).

### Parking your vehicle

1. Apply the brake and shift into the neutral position.
2. Fully apply the parking brake, then shift into 1 (First).
3. Turn the ignition off.



Do not park your vehicle in Neutral, it may move unexpectedly and injure someone. Use 1 (First) gear and set the parking brake fully.

## Driving

### Removing the key

Turn the ignition off, push the release lever (located above the ignition), then turn the key toward you and remove the key.



### REVERSE SENSING SYSTEM (IF EQUIPPED)

The Reverse Sensing System (RSS) sounds a tone to warn the driver of obstacles near the rear bumper when the R (Reverse) is selected and the vehicle is moving at speeds less than 5 km/h (3 mph). The system is not effective at speeds above 5 km/h (3 mph) and may not detect certain angular or moving objects.

 To help avoid personal injury, please read and understand the limitations of the reverse sensing system as contained in this section. Reverse sensing is only an aid for some (generally large and fixed) objects when moving in reverse on a flat surface at “parking speeds”. Inclement weather may also affect the function of the RSS; this may include reduced performance or a false activation.

 To help avoid personal injury, always use caution when in reverse and when using the RSS.

 This system is not designed to prevent contact with small or moving objects. The system is designed to provide a warning to assist the driver in detecting large stationary objects to avoid damaging the vehicle. The system may not detect smaller objects, particularly those close to the ground.

## Driving

The RSS detects obstacles up to 2 meters (6 ft.) from the rear bumper with a decreased coverage area at the outer corners of the bumper, (refer to the figures for approximate zone coverage areas). As you move closer to the obstacle, the rate of the tone increases. When the obstacle is less than 25.0 cm (10 in.) away, the tone will sound continuously. If the RSS detects a stationary or receding object further than 25.0 cm (10 in.) from the side of the vehicle, the tone will sound for only three seconds. Once the system detects an object approaching, the tone will sound again.

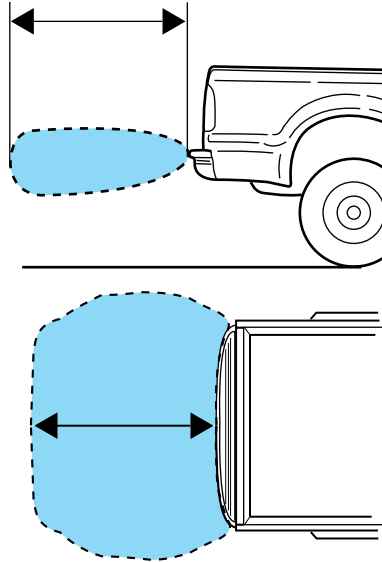

The RSS may have reduced performance or an increased chance of false detection if the tailgate is not locked and in the upright position. If the tailgate is down, the RSS tone may be heard intermittently or continuously. The tone may also be heard if items in the truck bed protrude rearward outside the bed.

The RSS automatically turns on when the gear selector is placed in R (Reverse) and the ignition is ON.



An RSS control allows the driver to turn the RSS on and off. To turn the RSS off, the ignition must be ON, and the gear selector in R (Reverse). An indicator light on the control will illuminate when the system is turned off. If the indicator light illuminates when the RSS is not turned off, it may indicate a failure in the RSS. The RSS will remain off until either the RSS control is pushed again or the ignition switch is recycled.

**Keep the RSS sensors (located on the rear bumper/fascia) free from snow, ice and large accumulations of dirt (do not clean the sensors with sharp objects). If the sensors are covered, it will affect the accuracy of the RSS.**

**If your vehicle sustains damage to the rear bumper/fascia, leaving it misaligned or bent, the sensing zone may be altered causing inaccurate measurement of obstacles or false alarms.**



### FOUR-WHEEL DRIVE (4WD) OPERATION (IF EQUIPPED)



For important information regarding safe operation of this type of vehicle, see **Preparing to drive your vehicle** in this chapter.

When four-wheel drive (4WD) is engaged, power is supplied to all four wheels through a transfer case. 4WD can be selected when additional driving power is desired.

4WD operation is not recommended on dry pavement. Doing so could result in difficult disengagement of the transfer case, increased tire wear and decreased fuel economy.

#### Manual 4x4 system (if equipped)

The 4WD system is engaged or disengaged by rotating the control for both front wheel hub locks from the FREE or LOCK position, then manually engaging or disengaging the transfer case with the floor-mounted shifter. For increased fuel economy in 2WD, rotate both hub locks to the FREE position.

- **For proper operation, make sure that the arrow and the indicator dot on the hub are aligned, and that both hub locks are set to the same position (both set to LOCK or both set to FREE).**

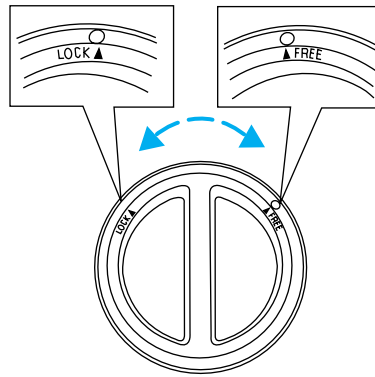

#### Electronic shift on the fly (ESOF) 4x4 system (if equipped)

If equipped with the Electronic Shift 4WD System, and 4WD Low is selected while the vehicle is moving, the 4WD system will not engage. This is normal and should be no reason for concern.

Before 4WD Low can be engaged, the vehicle must be brought to a complete stop, the brake pedal depressed and the transmission placed in N (Neutral) (on automatic transmissions or the clutch pedal depressed on manual transmissions).

The 4WD system:

- provides 4x4 High engagement and disengagement while the vehicle is moving.

## Driving

- is operated by a rotary control located on the instrument panel that allows you select 2WD, 4x4 High or 4x4 Low operation.
- uses auto-manual hub locks that can be engaged and disengaged automatically based on the 4x4 mode selected.
- auto-manual hub locks can be manually overridden by rotating the hub lock control from AUTO to LOCK if desired.
- **automatic operation of the hub locks is recommended**, and will increase fuel economy
- **For proper operation, make sure that the arrow and the indicator dot on the hub are aligned, and that both hub locks are set the same (both set to AUTO or both set to LOCK).**

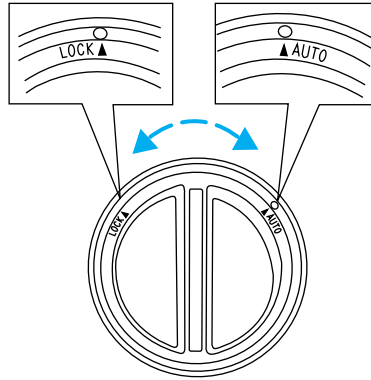

### 4WD system indicator lights

The 4WD system indicator lights illuminate only under the following conditions. If these lights illuminate when driving in 2WD, contact your Ford dealer as soon as possible.

- **4x4** - momentarily illuminates after the engine is started. Illuminates when 4H (4x4 High) or 4L (4x4 Low) is engaged.
- **LOW RANGE** – momentarily illuminates when the ignition is turned to the ON position. Illuminates when 4L (4x4 Low) is engaged.

4x4

LOW  
RANGE

### Using a manual 4WD system (if equipped)

**Note:** Some noise may be heard as the 4WD system shifts or engages. This is normal.

**2H (2WD High)** – For general on-road driving. Sends power to the rear wheels only.

**4H (4WD High)** – For winter and off-road conditions. Sends power to front and rear wheels.

**N (Neutral)** – Only used when towing the vehicle.

**4L (4WD Low)**– For low-speed off-road applications that require extra power such as steep grades, deep sand or pulling a boat out of the water. Sends power to front and rear wheels.

### Shifting from 2H (2WD High) to 4H (4WD High)

Engage the locking hubs by rotating the hub lock control from FREE to LOCK, then move the transfer case lever from 2H (2WD High) to 4H (4WD High).

- **For proper operation, make sure that the arrow and the indicator dot on the hub are aligned, and that both hubs are set to LOCK.**

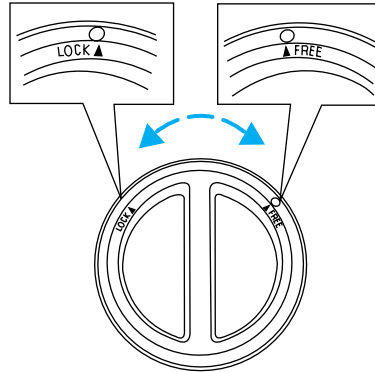

- **Do not shift into 4H (4WD High) with the rear wheels slipping.**

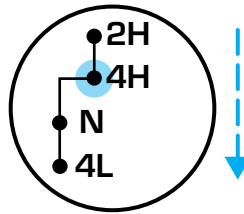

### Shifting from 4H (4WD High) to 2H (2WD High)

Move the transfer case lever to 2H (2WD High) at a stop or any forward speed up to 88 km/h (55 mph).

With the vehicle at complete stop, disengage the locking hubs (optional) by rotating the hub lock control from LOCK to FREE.

- **For proper operation, make sure that the arrow and the indicator dot on the hub are aligned, and that both hubs are set to FREE**

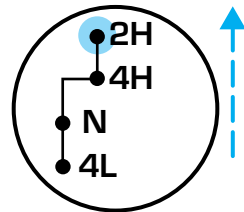

## Driving

### **Shifting from 4H (4WD High) to 4L (4WD Low)**

1. Bring the vehicle to a complete stop.
2. Depress the brake.
3. Place the gearshift lever in N (Neutral) (automatic transmission) or depress the clutch (manual transmission).
4. Move the transfer case shift lever through N (Neutral) directly to 4L (4WD Low).
5. If the transfer case **will not** engage into 4L (4WD Low), drive the vehicle above 8 km/h (5 mph), then repeat steps 1 through 4.

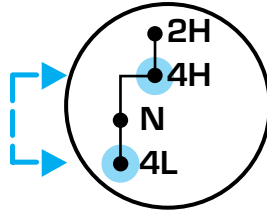

### **Shifting from 4L (4WD Low) to 4H (4WD High) or 2H (2WD High)**

1. Bring the vehicle to a complete stop.
2. Depress the brake.
3. Place the gearshift lever in N (Neutral) (automatic transmission) or depress the clutch (manual transmission).
4. Move the transfer case shift lever through N (Neutral) directly to 4H (4WD High) or 2H (2WD High).
5. If the transfer case **will not** disengage from 4L (4WD Low), drive the vehicle above 8 km/h (5 mph), then repeat steps 1 through 4.
6. If shifting to 2H (2WD High) with the vehicle at a complete stop, disengage the locking hubs (optional) by rotating the hub lock control from LOCK to FREE.

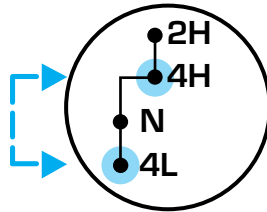

### **Using the N (Neutral) position**

**The transfer case neutral position overrides the transmission and puts the vehicle in neutral regardless of transmission gearshift lever position. The vehicle can move forward or backwards.**

## Driving

This position should only be used when towing the vehicle.

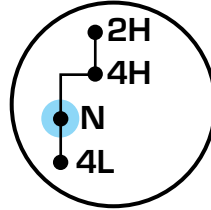

Do not leave the vehicle unattended with the transfer case in the N (Neutral) position. Always set the parking brake fully and turn off the ignition when leaving the vehicle.

### Using the electronic shift 4WD system (if equipped)

#### *Positions of the electronic shift system*

**The electronic shift 4WD system is designed to allow up to 45 seconds before a shift command is performed. In the event that conflicting shift commands are selected, allow up to 45 seconds for the shift command to be performed prior to reporting any shift concerns to your dealer.**

**Note:** Some noise may be heard as the 4WD system shifts or engages. This is normal.

**2H (2WD High)** – For general on-road driving. Sends power to the rear wheels only.

**4H (4WD High)** – For winter and off-road conditions. Sends power to front and rear wheels.

**4L (4WD Low)**– For low-speed off-road applications that require extra power such as steep grades, deep sand or pulling a boat out of the water. Sends power to front and rear wheels.

## Driving

### **Shifting from 2WD (2WD High) to 4x4 HIGH (4WD High)**

Rotate the 4WD control to the 4x4 HIGH position at speeds up to 88 km/h (55 mph).

- **The electronic shift 4WD system is designed to engage 4x4 HIGH (4WD High) when the vehicle is moving. If shifted to 4x4 HIGH (4WD HIGH) while at complete stop, 4x4 may not engage and the 4x4 indicator may not illuminate until the vehicle is driven above 8 km/h (5 mph).**
- **Do not shift into 4x4 HIGH with the rear wheels slipping.**

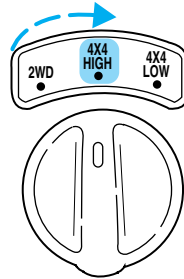

### **Shifting from 4x4 HIGH (4WD High) to 2WD (2WD High)**

Rotate the 4WD control to 2WD at any forward speed. Disengagement of the transfer case and front hubs may be delayed due to torque bind which is caused by driving on dry hard surfaces or performing tight turns while using the 4WD system.

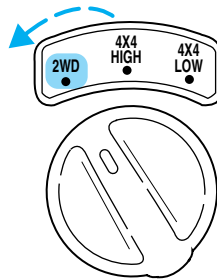

- You **do not** need to operate the vehicle in R (Reverse) to disengage your front hubs, but it will eliminate any torque bind and allow the system to immediately disengage.

### **Shifting from 4x4 HIGH (4WD High) to 4x4 LOW (4WD Low)**

1. Bring the vehicle to a complete stop.
2. Depress the brake.
3. Place the gearshift in N (Neutral) (automatic transmission) or depress the clutch (manual transmission).

## Driving

4. Move the 4WD control to the 4x4 LOW position.
5. Hold the shift conditions until the LOW RANGE indicator light illuminates.
6. If the LOW RANGE indicator light **does not** illuminate within 15 seconds, drive the vehicle above 8 km/h (5 mph), then repeat steps 1 through 5 before reporting any shift concerns to your dealer.

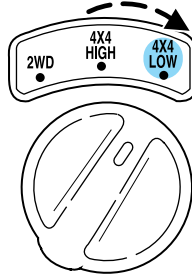

### **Shifting from 4x4 LOW (4WD Low) to 4x4 HIGH (4WD High) or 2WD (2WD High)**

1. Bring the vehicle to a complete stop.
2. Depress the brake.
3. Place the gearshift in N (Neutral) (automatic transmission) or depress the clutch (manual transmission).
4. Move the 4WD control to the 4x4 HIGH (4WD High) or 2WD (2WD High) position.

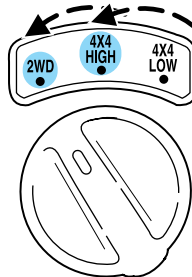

5. Hold the shift conditions until the LOW RANGE indicator light shuts off.
6. If the LOW RANGE indicator light **does not** shut off within 15 seconds, drive the vehicle above 8 km/h (5 mph), then repeat steps 1 through 5 before reporting any shift concerns to your dealer.

### **Driving off-road with truck and utility vehicles**

4WD vehicles are specially equipped for driving on sand, snow, mud and rough terrain and have operating characteristics that are somewhat different from conventional vehicles, both on and off the road.

#### **How your vehicle differs from other vehicles**

Truck and utility vehicles can differ from some other vehicles. Your vehicle may be higher to allow it to travel over rough terrain without getting hung up or damaging underbody components.

The differences that make your vehicle so versatile also make it handle differently than an ordinary passenger car.

## Driving

Maintain steering wheel control at all times, especially in rough terrain. Since sudden changes in terrain can result in abrupt steering wheel motion, make sure you grip the steering wheel from the outside. Do not grip the spokes.

Drive cautiously to avoid vehicle damage from concealed objects such as rocks and stumps.

You should either know the terrain or examine maps of the area before driving. Map out your route before driving in the area. To maintain steering and braking control of your vehicle, you must have all four wheels on the ground and they must be rolling, not sliding or spinning.

### ***Basic operating principles***

- Do not use 4WD on dry, hard surfaced roads. Doing so will produce excessive noise, increase tire wear and may damage drive components. 4WD modes are only intended for consistently slippery or loose surfaces.
- Drive slower in strong crosswinds which can affect the normal steering characteristics of your vehicle.
- Be extremely careful when driving on pavement made slippery by loose sand, water, gravel, snow or ice.

### ***If your vehicle goes off the edge of the pavement***

- If your vehicle goes off the edge of the pavement, slow down, but avoid severe brake application, ease the vehicle back onto the pavement only after reducing your speed. Do not turn the steering wheel too sharply while returning to the road surface.
- It may be safer to stay on the apron or shoulder of the road and slow down gradually before returning to the pavement. You may lose control if you do not slow down or if you turn the steering wheel too sharply or abruptly.
- It often may be less risky to strike small objects, such as highway reflectors, with minor damage to your vehicle rather than attempt a sudden return to the pavement which could cause the vehicle to slide sideways out of control or roll over. Remember, your safety and the safety of others should be your primary concern.



## Driving



Vehicles with a higher center of gravity such as utility and four-wheel drive vehicles handle differently than vehicles with a lower center of gravity. Utility and four-wheel drive vehicles are **not** designed for cornering at speeds as high as passenger cars any more than low-slung sports cars are designed to perform satisfactorily under off-road conditions. Avoid sharp turns, excessive speed and abrupt maneuvers in these vehicles. Failure to drive cautiously could result in an increased risk of loss of vehicle control, vehicle rollover, personal injury and death.

### ***If your vehicle gets stuck***

If your vehicle gets stuck in mud or snow it may be rocked out by shifting between forward and reverse gears, stopping between shifts, in a steady pattern. Press lightly on the accelerator in each gear.

**Do not rock the vehicle if the engine is not at normal operating temperature or damage to the transmission may occur.**

**Do not rock the vehicle for more than a few minutes or damage to the transmission and tires may occur or the engine may overheat.**



Always set the parking brake fully and make sure the gearshift is latched in P (Park). Turn the ignition to the LOCK position and remove the key whenever you leave your vehicle.



If the parking brake is fully released, but the brake warning lamp remains illuminated, the brakes may not be working properly. See your dealer or a qualified service technician.



Do not spin the wheels at over 56 km/h (35 mph). The tires may fail and injure a passenger or bystander.

Refer to *Transmission temperature gauge* in the *Instrument cluster* chapter for transmission fluid temperature information.

## Driving

### **Emergency maneuvers**

- In an unavoidable emergency situation where a sudden sharp turn must be made, remember to avoid “over-driving” your vehicle, i.e., turn the steering wheel only as rapidly and as far as required to avoid the emergency. Excessive steering will result in less vehicle control, not more. Additionally, smooth variations of the accelerator and/or brake pedal pressure should be utilized if changes in vehicle speed are called for. Avoid abrupt steering, acceleration or braking which could result in an increased risk of loss of vehicle control, vehicle rollover and/or personal injury. Use all available road surface to return the vehicle to a safe direction of travel.
- In the event of an emergency stop, avoid skidding the tires and do not attempt any sharp steering wheel movements.



Vehicles with a higher center of gravity such as utility and four-wheel drive vehicles handle differently than vehicles with a lower center of gravity. Utility and four-wheel drive vehicles are **not** designed for cornering at speeds as high as passenger cars any more than low-slung sports cars are designed to perform satisfactorily under off-road conditions. Avoid sharp turns, excessive speed and abrupt maneuvers in these vehicles. Failure to drive cautiously could result in an increased risk of loss of vehicle control, vehicle rollover, personal injury and death.

- If the vehicle goes from one type of surface to another (i.e., from concrete to gravel) there will be a change in the way the vehicle responds to a maneuver (steering, acceleration or braking). Again, avoid these abrupt inputs.

### **Parking**

On some 4WD vehicles, when the transfer case is in the N (Neutral) position, the engine and transmission are disconnected from the rest of the driveline. Therefore, the vehicle is free to roll even if the automatic transmission is in P (Park) or the manual transmission is in gear. Do not leave the vehicle unattended with the transfer case in the N (Neutral) position. Always set the parking brake fully and turn off the ignition when leaving the vehicle.

### **4WD Systems**

4WD (when you select a 4WD mode), uses all four wheels to power the vehicle. This increases traction, enabling you to drive over terrain and road conditions that a conventional two-wheel drive vehicle cannot.

## Driving

Power is supplied to all four wheels through a transfer case. On 4WD vehicles, the transfer case allows you to select 4WD when necessary. Information on transfer case operation and shifting procedures can be found in the *Driving* chapter. Information on transfer case maintenance can be found in the *Maintenance and specifications* chapter. You should become thoroughly familiar with this information before you operate your vehicle.

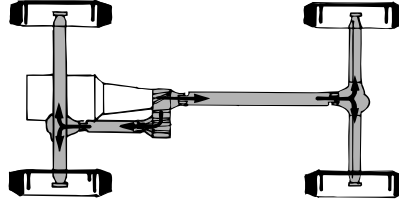

### **Normal characteristics**

On some 4WD models, the initial shift from two-wheel drive to 4x4 while the vehicle is moving can cause some momentary clunk and ratcheting sounds. This is the front drivetrain coming up to speed and the automatic locking hubs engaging and is not cause for concern.

### **Sand**

When driving over sand, try to keep all four wheels on the most solid area of the trail. Avoid reducing the tire pressures but shift to a lower gear and drive steadily through the terrain. Apply the accelerator slowly and avoid spinning the wheels.

If you must reduce the tire pressure for whatever reason in sand, make sure you re-inflate the tires as soon as possible.

Avoid excessive speed because vehicle momentum can work against you and cause the vehicle to become stuck to the point that assistance may be required from another vehicle. Remember, you may be able to back out the way you came if you proceed with caution.

### **Mud and water**

If you must drive through high water, drive slowly. Traction or brake capability may be limited.

When driving through water, determine the depth; avoid water higher than the bottom of the hubs (if possible) and proceed slowly. If the ignition system gets wet, the vehicle may stall.



## Driving

Once through water, always try the brakes. Wet brakes do not stop the vehicle as effectively as dry brakes. Drying can be improved by moving your vehicle slowly while applying light pressure on the brake pedal.

Be cautious of sudden changes in vehicle speed or direction when you are driving in mud. Even 4WD vehicles can lose traction in slick mud. As when you are driving over sand, apply the accelerator slowly and avoid spinning your wheels. If the vehicle does slide, steer in the direction of the slide until you regain control of the vehicle.

If the transmission, transfer case or front axle are submerged in water, their fluids should be checked and changed, if necessary.

### **Driving through deep water may damage the transmission.**

Refer to *Transmission temperature gauge* in the *Instrument cluster* chapter for transmission fluid temperature information.

If the front or rear axle is submerged in water, the axle lubricant should be replaced.

After driving through mud, clean off residue stuck to rotating driveshafts and tires. Excess mud stuck on tires and rotating driveshafts causes an imbalance that could damage drive components.

“Tread Lightly” is an educational program designed to increase public awareness of land-use regulations and responsibilities in our nation's wilderness areas. Ford Motor



Company joins the U.S. Forest Service and the Bureau of Land Management in encouraging you to help preserve our national forest and other public and private lands by “treading lightly.”

### **Driving on hilly or sloping terrain**

Although natural obstacles may make it necessary to travel diagonally up or down a hill or steep incline, you should always try to drive straight up or straight down. **Avoid driving crosswise or turning on steep slopes or hills.** A danger lies in losing traction, slipping sideways and possibly rolling over. Whenever driving on a hill, determine beforehand the route you will use. Do not drive over the crest of a hill without seeing what conditions are on the other side. Do not drive in reverse over a hill without the aid of an observer.

When climbing a steep slope or hill, start in a lower gear rather than downshifting to a lower gear from a higher gear once the ascent has started. This reduces strain on the engine and the possibility of stalling.

If you do stall out, do not try to turn around because you might roll over. It is better to back down to a safe location.

Apply just enough power to the wheels to climb the hill. Too much power will cause the tires to slip, spin or lose traction, resulting in loss of vehicle control.

Descend a hill in the same gear you would use to climb up the hill to avoid excessive brake application and brake overheating. Do not descend in neutral; instead, disengage overdrive or manually shift to a lower gear. When descending a steep hill, avoid sudden hard braking as you could lose control. When you brake hard, the front wheels can't turn and if they aren't turning, you won't be able to steer. The front wheels have to be turning in order to steer the vehicle. Rapid pumping of the brake pedal will help you slow the vehicle and still maintain steering control.

If your vehicle has anti-lock brakes, apply the brakes steadily. Do not "pump" the brakes.

### **Driving on snow and ice**

4WD vehicles have advantages over 2WD vehicles in snow and ice but can skid like any other vehicle.

Should you start to slide while driving on snowy or icy roads, turn the steering wheel in the direction of the slide until you regain control.

Avoid sudden applications of power and quick changes of direction on snow and ice. Apply the accelerator slowly and steadily when starting from a full stop.

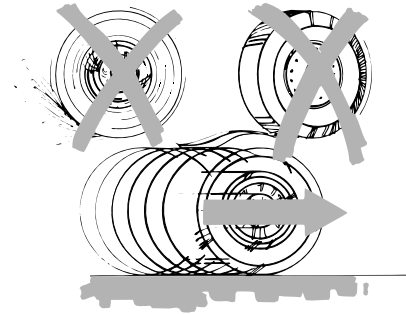
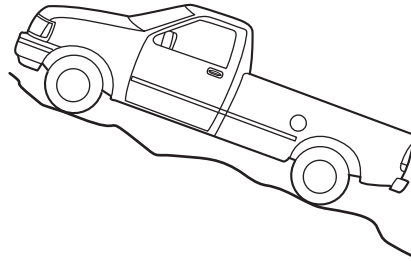

## Driving

Avoid sudden braking as well. Although a 4WD vehicle may accelerate better than a two-wheel drive vehicle in snow and ice, it won't stop any faster, because as in other vehicles, braking occurs at all four wheels. Do not become overconfident as to road conditions.

Make sure you allow sufficient distance between you and other vehicles for stopping. Drive slower than usual and consider using one of the lower gears. In emergency stopping situations, avoid locking of the wheels. Use a "squeeze" technique, push on the brake pedal with a steadily increasing force which allows the wheels to brake yet continue to roll so that you may steer in the direction you want to travel. If you lock the wheels, release the brake pedal and repeat the squeeze technique. If your vehicle is equipped with a Four Wheel Anti-Lock Brake System (ABS), apply the brake steadily. Do not "pump" the brakes. Refer to the *Brakes* section of this chapter for additional information on the operation of the anti-lock brake system.

Never drive with chains on the front tires of 4WD vehicles without also putting them on the rear tires. This could cause the rear to slide and swing around during braking.

### **Tires, Replacement Requirements**



Do not use a size and type of tire and wheel other than that originally provided by Ford Motor Company because it can affect the safety and performance of your vehicle, which could result in an increased risk of loss of vehicle control, vehicle rollover, and/or serious personal injury or death.

Make sure all tires and wheels on the vehicle are of the same size, type, tread design, brand and load-carrying capacity. If you have questions regarding tire replacement, see an authorized Ford or Lincoln/Mercury dealer.

If you nevertheless decide to equip your 4WD for off-road use with tires larger than what Ford Motor Company recommends, you should not use these tires for highway driving.

If you use any tire/wheel combination not recommended by Ford Motor Company, it may adversely affect vehicle handling and could cause steering, suspension, axle or transfer case failure as well as the increased risk of loss of vehicle control.

Do not use "aftermarket lift kits" or other suspension modifications, whether or not they are used with larger tires and wheels.

These "aftermarket lift kits" could adversely affect the vehicle's handling characteristics, which could lead to loss of vehicle control or rollover and serious injury.

## Driving

Tires can be damaged during off-road use. For your safety, tires that are damaged should not be used for highway driving because they are more likely to blow out or fail.

You should carefully observe the recommended tire inflation pressure found on the safety compliance certification label attached to the left front door lock facing or door latch post pillar. Failure to follow tire pressure recommendations can adversely affect the way your vehicle handles. Do not exceed the Ford Motor Company recommended pressure even if it is less than the maximum pressure allowed for the tire.

Each day before you drive, check your tires. If one looks lower than the others, use a tire gauge to check pressure of all tires, and adjust if required. Check tire pressure with a tire gauge every few weeks (including spare). Safe operation requires tires that are neither underinflated nor a vehicle which is overloaded.

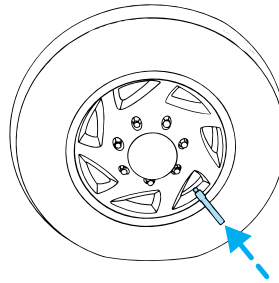

Periodically inspect the tire treads and remove stones, nails, glass or other objects that may be wedged in the tread grooves. Check for holes or cuts that may permit air leakage from the tire and make necessary repairs.

Inspect the tire side walls for cuts, bruises and other damage. If internal damage to the tire is suspected, have the tire demounted and inspected in case it needs to be repaired or replaced.

### **Maintenance and Modifications**

The suspension and steering systems on your vehicle have been designed and tested to provide predictable performance whether loaded or empty and durable load carrying capability. For this reason, Ford Motor Company strongly recommends that you do not make modifications such as adding or removing parts (such as lift kits or stabilizer bars) or by using replacement parts not equivalent to the original factory equipment.

Any modifications to a vehicle that raise the center of gravity can make it more likely the vehicle will roll over as a result of a loss of control. Ford Motor Company recommends that caution be used with any vehicle equipped with a high load or device (such as ladder racks or pickup box cover).

## Driving

Failure to maintain your vehicle properly may void the warranty, increase your repair cost, reduce vehicle performance and operational capabilities and adversely affect driver and passenger safety. Frequent inspection of vehicle chassis components is recommended if the vehicle is subjected to heavy off-road usage.

### **POWER TAKE OFF (PTO) CAPABILITY (IF EQUIPPED)**

Some vehicles are equipped with Power Take Off (PTO) capability. These vehicles have a special transmission case, internal components and calibration for PTO usage.

The PTO can be used during mobile and stationary continuous/intermittent applications.

#### **Gasoline engine:**

PTO operation is disabled while the vehicle is in Overdrive (the TCIL will not be illuminated), in N (Neutral), during engine cranking. Transmission upshift and downshift schedules will be reduced by about 15% and will have a firmer shift feel during PTO mobile applications.

The PTO cannot be disabled while the transmission is in D (Drive) (Overdrive position with Overdrive canceled), 2 (Second) or 1 (First).

Refer to the *Body Builder's Layout Book* for recommended electrical installation.

#### **Diesel engine:**

The Auxiliary Powertrain Control Module (APCM) will elevate the engine speed to 1,200 RPM when in PTO mode. PTO operation will be disabled in stationary drive idle conditions. For more information on the APCM and PTO operation with the Diesel engine, refer to the APCM manual supplied with your vehicle.

### **DRIVING THROUGH WATER**

If driving through deep or standing water is unavoidable, proceed very slowly especially if the depth is not known. Never drive through water that is higher than the bottom of the hubs (for trucks) or the bottom of the wheel rims (for cars). Traction or brake capability may be limited and your vehicle may stall. Water may also enter your engine's air intake and severely damage your engine.

Once through the water, always dry the brakes by moving your vehicle slowly while applying light pressure on the brake pedal. Wet brakes do not stop the vehicle as quickly as dry brakes. **Driving through deep water where the transmission vent tube is submerged may allow water into the transmission and cause internal transmission damage.**



### VEHICLE LOADING

Before loading a vehicle, familiarize yourself with the following terms:

- **Base Curb Weight:** Weight of the vehicle including any standard equipment, fluids, lubricants, etc. It does not include occupants or aftermarket equipment.
- **Payload:** Combined maximum allowable weight of cargo, occupants and optional equipment. The payload equals the gross vehicle weight rating minus base curb weight.
- **GVW (Gross Vehicle Weight):** Base curb weight plus payload weight.
- **GVWR (Gross Vehicle Weight Rating):** Maximum allowable total weight of the base vehicle, occupants, optional equipment and cargo. The GVWR is specific to each vehicle and is listed on the Safety Certification Label on the driver's door pillar.
- **GAWR (Gross Axle Weight Rating):** Carrying capacity for each axle system. The GAWR is specific to each vehicle and is listed on the Safety Certification Label on the driver's door pillar.
- **GCW (Gross Combined Weight):** The combined weight of the towing vehicle (including occupants and cargo) and the loaded trailer.
- **GCWR (Gross Combined Weight Rating):** Maximum allowable combined weight of towing vehicle (including occupants and cargo) and the loaded trailer.
- **Maximum Trailer Weight Rating:** Maximum weight of a trailer the vehicle is permitted to tow. The maximum trailer weight rating is determined by subtracting the vehicle curb weight for each engine/transmission combination, any required option weight for trailer towing and the weight of the driver from the GCWR for the towing vehicle.
- **Maximum Trailer Weight:** Maximum weight of a trailer the loaded vehicle (including occupants and cargo) is permitted to tow. It is determined by subtracting the weight of the loaded trailer towing vehicle from the GCWR for the towing vehicle.
- **Trailer Weight Range:** Specified range of trailer weight from zero to the maximum trailer weight rating.

Remember to figure in the tongue load of your loaded trailer when figuring the total weight.

The Safety Certification Label, located on the driver's door pillar, lists vehicle weight rating limitations. Before adding any additional equipment, refer to these limitations.

## Driving

Always ensure that the weight of occupants, cargo and equipment is within the weight limitations, including both gross vehicle weight and front and rear gross axle weight rating limits.

**Note:** Do not exceed the GVWR or the GAWR specified on the certification label.



Exceeding any vehicle weight rating limitation could result in serious damage to the vehicle, loss of vehicle control, vehicle rollover, and/or personal injury.

Do not use replacement tires with lower load carrying capacities than the originals because they may lower the vehicle's GVWR and GAWR limitations. Replacement tires with a higher limit than the originals do not increase the GVWR and GAWR limitations.

### **Special loading instructions for owners of pickup trucks and utility-type vehicles**



For important information regarding safe operation of this type of vehicle, see the **Preparing to drive your vehicle** section in this chapter.



Loaded vehicles may handle differently than unloaded vehicles. Extra precautions, such as slower speeds and increased stopping distance, should be taken when driving a heavily loaded vehicle.

Your vehicle can haul more cargo and people than most passenger cars. Depending upon the type and placement of the load, hauling cargo and people may raise the center of gravity of the vehicle.

### **Calculating the load your vehicle can carry/tow**

1. Use the appropriate maximum GCWR chart (in the *Trailer Towing* section in this chapter) for your type of engine and rear axle ratio.
2. Weigh your vehicle without cargo. To obtain correct weights, take your vehicle to a shipping company or an inspection station for trucks.
3. Subtract your loaded weight from the maximum GCWR in the chart. This is the maximum trailer weight your vehicle can tow. It must be below the maximum trailer weight shown in the chart.

### **TRAILER TOWING**

Your vehicle may tow a Conventional/Class IV trailer or fifth wheel trailer provided the maximum trailer weight is less than or equal to the maximum trailer weight listed for your engine and rear axle ratio on the following charts.

## Driving

2nd unit bodies are not included in maximum trailer weight ratings. The weight of the additional “body” must be subtracted from the maximum trailer weight.

Your vehicle’s load capacity is designated by weight, not by volume, so you cannot necessarily use all available space when loading a vehicle.

Towing a trailer places an additional load on your vehicle’s engine, transmission, axle, brakes, tires and suspension. Inspect these components carefully prior to and after any towing operation. The following trailer towing charts apply to vehicles equipped with gasoline engines; for Diesel engines, refer to the Diesel supplement.

**Note:** Do not exceed the GVWR or the GAWR specified on the certification label.



Towing trailers beyond the maximum recommended gross trailer weight exceeds the limit of the vehicle and could result in engine damage, transmission damage, structural damage, loss of vehicle control, vehicle rollover and personal injury.

Refer to *Transmission temperature gauge* in the *Instrument cluster* chapter for transmission fluid temperature information.

<b>F-250 Regular Cab Pickup</b>			
<b>Engine</b>	<b>Rear axle ratio</b>	<b>Maximum GCWR - kg (lbs.)</b>	<b>Maximum trailer weight - kg (lbs.)</b>
<b>4x2 with manual transmission</b>			
5.4L	3.73	6123 (13500)	3537 (7800)
5.4L	4.10	6804 (15000)	4217 (9300)
6.8L	3.73	7484 (16500)	4807 (10600)
6.8L (without fifth wheel)	4.30	9072 (20000)	5670 (12500)
6.8L (with fifth wheel)	4.30	9072 (20000)	6394 (14100)

## Driving

<b>F-250 Regular Cab Pickup</b>			
<b>Engine</b>	<b>Rear axle ratio</b>	<b>Maximum GCWR - kg (lbs.)</b>	<b>Maximum trailer weight - kg (lbs.)</b>
<b>4x2 with automatic transmission</b>			
5.4L	3.73	6123 (13500)	3537 (7800)
5.4L	4.10	6804 (15000)	4217 (9300)
6.8L	3.73	7711 (17000)	5079 (11200)
6.8L (without fifth wheel)	4.30	9072 (20000)	5670 (12500)
6.8L (with fifth wheel)	4.30	9072 (20000)	6439 (14200)
<b>4x4 with manual transmission</b>			
5.4L	3.73	6123 (13500)	3357 (7400)
5.4L	4.10	6804 (15000)	4037 (8900)
6.8L	3.73	7484 (16500)	4625 (10200)
6.8L (without fifth wheel)	4.30	9072 (20000)	5670 (12500)
6.8L (with fifth wheel)	4.30	9072 (20000)	6213 (13700)
<b>4x4 with automatic transmission</b>			
5.4L	3.73	6123 (13500)	3356 (7400)
5.4L	4.10	6804 (15000)	4036 (8900)
6.8L	3.73	7711 (17000)	4897 (10800)
6.8L (without fifth wheel)	4.30	9072 (20000)	5670 (12500)
6.8L (with fifth wheel)	4.30	9072 (20000)	6258 (13800)

## Driving

<b>F-250 SuperCab Pickup</b>			
<b>Engine</b>	<b>Rear axle ratio</b>	<b>Maximum GCWR - kg (lbs.)</b>	<b>Maximum trailer weight - kg (lbs.)</b>
<b>4x2 with manual transmission</b>			
5.4L	3.73	6123 (13500)	3356 (7400)
5.4L	4.10	6804 (15000)	4036 (8900)
6.8L	3.73	7484 (16500)	4672 (10300)
6.8L (without fifth wheel)	4.30	9072 (20000)	5670 (12500)
6.8L (with fifth wheel)	4.30	9072 (20000)	6260 (13800)
<b>4x2 with automatic transmission</b>			
5.4L	3.73	6123 (13500)	3402 (7500)
5.4L	4.10	6804 (15000)	4082 (9000)
6.8L	3.73	7711 (17000)	4944 (10900)
6.8L (without fifth wheel)	4.30	9072 (20000)	5670 (12500)
6.8L (with fifth wheel)	4.30	9072 (20000)	6260 (13800)
<b>4x4 with manual transmission</b>			
5.4L	3.73	6123 (13500)	3221 (7100)
5.4L	4.10	6804 (15000)	3901 (8600)
6.8L	3.73	7484 (16500)	4491 (9900)
6.8L (without fifth wheel)	4.30	9072 (20000)	5670 (12500)
6.8L (with fifth wheel)	4.30	9072 (20000)	6078 (13400)

## Driving

<b>F-250 SuperCab Pickup</b>			
<b>Engine</b>	<b>Rear axle ratio</b>	<b>Maximum GCWR - kg (lbs.)</b>	<b>Maximum trailer weight - kg (lbs.)</b>
<b>4x4 with automatic transmission</b>			
5.4L	3.73	6123 (13500)	3221 (7100)
5.4L	4.10	6804 (15000)	3901 (8600)
6.8L	3.73	7711 (17000)	4763 (10500)
6.8L (without fifth wheel)	4.30	9072 (20000)	5670 (12500)
6.8L (with fifth wheel)	4.30	9072 (20000)	6078 (13400)
<b>F-250 Crew Cab Pickup</b>			
<b>Engine</b>	<b>Rear axle ratio</b>	<b>Maximum GCWR - kg (lbs.)</b>	<b>Maximum trailer weight - kg (lbs.)</b>
<b>4x2 with manual transmission</b>			
5.4L	3.73	6123 (13500)	3266 (7200)
5.4L	4.10	6804 (15000)	3945 (8700)
6.8L	3.73	7484 (16500)	4581 (10100)
6.8L (without fifth wheel)	4.30	9072 (20000)	5670 (12500)
6.8L (with fifth wheel)	4.30	9072 (20000)	6169 (13600)
<b>4x2 with automatic transmission</b>			
5.4L	3.73	6123 (13500)	3266 (7200)
5.4L	4.10	6804 (15000)	3945 (8700)
6.8L	3.73	7711 (17000)	4807 (10600)
6.8L (without fifth wheel)	4.30	9072 (20000)	5670 (12500)
6.8L (with fifth wheel)	4.30	9072 (20000)	6169 (13600)

## Driving

<b>F-250 Crew Cab Pickup</b>			
<b>Engine</b>	<b>Rear axle ratio</b>	<b>Maximum GCWR - kg (lbs.)</b>	<b>Maximum trailer weight - kg (lbs.)</b>
<b>4x4 with manual transmission</b>			
5.4L	3.73	6123 (13500)	3083 (6800)
5.4L	4.10	6804 (15000)	3764 (8300)
6.8L	3.73	7484 (16500)	4400 (9700)
6.8L (without fifth wheel)	4.30	9072 (20000)	5670 (12500)
6.8L (with fifth wheel)	4.30	9072 (20000)	5987 (13200)
<b>4x4 with automatic transmission</b>			
5.4L	3.73	6123 (13500)	3130 (6900)
5.4L	4.10	6804 (15000)	3810 (8400)
6.8L	3.73	7711 (17000)	4625 (10200)
6.8L (without fifth wheel)	4.30	9072 (20000)	5670 (12500)
6.8L (with fifth wheel)	4.30	9072 (20000)	5957 (13200)
<b>F-350 Regular Cab Single Rear Wheel Pickup</b>			
<b>Engine</b>	<b>Rear axle ratio</b>	<b>Maximum GCWR - kg (lbs.)</b>	<b>Maximum trailer weight - kg (lbs.)</b>
<b>4x2 with manual transmission</b>			
5.4L	3.73	6123 (13500)	3538 (7800)
5.4L	4.10	6804 (15000)	4218 (9300)
6.8L	3.73	7484 (16500)	4807 (10600)
6.8L (without fifth wheel)	4.30	9072 (20000)	5670 (12500)
6.8L (with fifth wheel)	4.30	9072 (20000)	6394 (14100)

## Driving

<b>F-350 Regular Cab Single Rear Wheel Pickup</b>			
<b>Engine</b>	<b>Rear axle ratio</b>	<b>Maximum GCWR - kg (lbs.)</b>	<b>Maximum trailer weight - kg (lbs.)</b>
<b>4x2 with automatic transmission</b>			
5.4L	3.73	6123 (13500)	3537 (7800)
5.4L	4.10	6804 (15000)	4218 (9300)
6.8L	3.73	7711 (17000)	5080 (11200)
6.8L (without fifth wheel)	4.30	9072 (20000)	5670 (12500)
6.8L (with fifth wheel)	4.30	9072 (20000)	6441 (14200)
<b>4x4 with manual transmission</b>			
5.4L	3.73	6123 (13500)	3357 (7400)
5.4L	4.10	6804 (15000)	4037 (8900)
6.8L	3.73	7484 (16500)	4625 (10200)
6.8L (without fifth wheel)	4.30	9072 (20000)	5670 (12500)
6.8L (with fifth wheel)	4.30	9072 (20000)	6213 (13700)
<b>4x4 with automatic transmission</b>			
5.4L	3.73	6123 (13500)	3356 (7400)
5.4L	4.10	6804 (15000)	4036 (8900)
6.8L	3.73	7711 (17000)	4899 (10800)
6.8L (without fifth wheel)	4.30	9072 (20000)	5670 (12500)
6.8L (with fifth wheel)	4.30	9072 (20000)	6260 (13800)



## Driving

<b>F-350 Regular Cab Dual Rear Wheel Pickup</b>			
<b>Engine</b>	<b>Rear axle ratio</b>	<b>Maximum GCWR - kg (lbs.)</b>	<b>Maximum trailer weight - kg (lbs.)</b>
<b>4x2 with manual transmission</b>			
5.4L	3.73	6123 (13500)	3401 (7500)
5.4L	4.10	6804 (15000)	4081 (9000)
6.8L	3.73	7484 (16500)	4672 (10300)
6.8L	4.30	9072 (20000)	6260 (13800)
<b>4x2 with automatic transmission</b>			
5.4L	3.73	6123 (13500)	3447 (7600)
5.4L	4.10	6804 (15000)	4081 (9000)
6.8L	3.73	7711 (17000)	4944 (10900)
6.8L	4.30	9072 (20000)	6305 (13900)
<b>4x4 with manual transmission</b>			
5.4L	3.73	6123 (13500)	3221 (7100)
5.4L	4.10	6804 (15000)	3901 (8600)
6.8L	3.73	7484 (16500)	4491 (9900)
6.8L	4.30	9072 (20000)	6078 (13400)
<b>4x4 with automatic transmission</b>			
5.4L	3.73	6123 (13500)	3266 (7200)
5.4L	4.10	6804 (15000)	3946 (8700)
6.8L	3.73	7711 (17000)	4716 (10400)
6.8L	4.30	9072 (20000)	6078 (13400)

## Driving

<b>F-350 SuperCab Single Rear Wheel Pickup</b>			
<b>Engine</b>	<b>Rear axle ratio</b>	<b>Maximum GCWR - kg (lbs.)</b>	<b>Maximum trailer weight - kg (lbs.)</b>
<b>4x2 with manual transmission</b>			
5.4L	3.73	6123 (13500)	3356 (7400)
5.4L	4.10	6804 (15000)	4126 (8900)
6.8L	3.73	7484 (16500)	4672 (10300)
6.8L (without fifth wheel)	4.30	9072 (20000)	5670 (12500)
6.8L (with fifth wheel)	4.30	9072 (20000)	6260 (13800)
<b>4x2 with automatic transmission</b>			
5.4L	3.73	6123 (13500)	3402 (7500)
5.4L	4.10	6804 (15000)	4082 (9000)
6.8L	3.73	7711 (17000)	4897 (10800)
6.8L (without fifth wheel)	4.30	9072 (20000)	5670 (12500)
6.8L (with fifth wheel)	4.30	9072 (20000)	6260 (13800)
<b>4x4 with manual transmission</b>			
5.4L	3.73	6123 (13500)	3221 (7100)
5.4L	4.10	6804 (15000)	3901 (8600)
6.8L	3.73	7484 (16500)	4491 (9900)
6.8L (without fifth wheel)	4.30	9072 (20000)	5670 (12500)
6.8L (with fifth wheel)	4.30	9072 (20000)	6078 (13400)

## Driving

<b>F-350 SuperCab Single Rear Wheel Pickup</b>			
<b>Engine</b>	<b>Rear axle ratio</b>	<b>Maximum GCWR - kg (lbs.)</b>	<b>Maximum trailer weight - kg (lbs.)</b>
<b>4x4 with automatic transmission</b>			
5.4L	3.73	6123 (13500)	3221 (7100)
5.4L	4.10	6804 (15000)	3901 (8600)
6.8L	3.73	7711 (17000)	4716 (10400)
6.8L (without fifth wheel)	4.30	9072 (20000)	5670 (12500)
6.8L (with fifth wheel)	4.30	9072 (20000)	6078 (13400)
<b>F-350 SuperCab Dual Rear Wheel Pickup</b>			
<b>Engine</b>	<b>Rear axle ratio</b>	<b>Maximum GCWR - kg (lbs.)</b>	<b>Maximum trailer weight - kg (lbs.)</b>
<b>4x2 with manual transmission</b>			
5.4L	3.73	6123 (13500)	3266 (7200)
5.4L	4.10	6804 (15000)	3946 (8700)
6.8L	3.73	7484 (16500)	4536 (10000)
6.8L (without fifth wheel, with optional 14,000 lb. hitch)	4.30	9072 (20000)	6123 (13500)
6.8L (with fifth wheel)	4.30	9072 (20000)	6123 (13500)

## Driving

<b>F-350 SuperCab Dual Rear Wheel Pickup</b>			
<b>Engine</b>	<b>Rear axle ratio</b>	<b>Maximum GCWR - kg (lbs.)</b>	<b>Maximum trailer weight - kg (lbs.)</b>
<b>4x2 with automatic transmission</b>			
5.4L	3.73	6123 (13500)	3266 (7200)
5.4L	4.10	6804 (15000)	3946 (8700)
6.8L	3.73	7711 (17000)	4763 (10500)
6.8L (without fifth wheel, with optional 14,000 lb. hitch)	4.30	9072 (20000)	6123 (13500)
6.8L (with fifth wheel)	4.30	9072 (20000)	6123 (13500)
<b>4x4 with manual transmission</b>			
5.4L	3.73	6123 (13500)	3083 (6800)
5.4L	4.10	6804 (15000)	3764 (8300)
6.8L	3.73	7484 (16500)	4353 (9600)
6.8L (without fifth wheel, with optional 14,000 lb hitch)	4.30	9072 (20000)	5941 (13100)
6.8L (with fifth wheel)	4.30	9072 (20000)	5941 (13100)

## Driving

<b>F-350 SuperCab Dual Rear Wheel Pickup</b>			
<b>Engine</b>	<b>Rear axle ratio</b>	<b>Maximum GCWR - kg (lbs.)</b>	<b>Maximum trailer weight - kg (lbs.)</b>
<b>4x4 with automatic transmission</b>			
5.4L	3.73	6123 (13500)	3083 (6800)
5.4L	4.10	6804 (15000)	3764 (8300)
6.8L	3.73	7711 (17000)	4580 (10100)
6.8L (without fifth wheel, with optional 14,000 lb. hitch)	4.30	9072 (20000)	5941 (13100)
6.8L (with fifth wheel)	4.30	9072 (20000)	5941 (13100)
<b>F-350 Crew Cab Single Rear Wheel Pickup</b>			
<b>Engine</b>	<b>Rear axle ratio</b>	<b>Maximum GCWR - kg (lbs.)</b>	<b>Maximum trailer weight - kg (lbs.)</b>
<b>4x2 with manual transmission</b>			
5.4L	3.73	6123 (13500)	3266 (7200)
5.4L	4.10	6804 (15000)	3946 (8700)
6.8L	3.73	7484 (16500)	4581 (10100)
6.8L (without fifth wheel)	4.30	9072 (20000)	5670 (12500)
6.8L (with fifth wheel)	4.30	9072 (20000)	6169 (13600)
<b>4x2 with automatic transmission</b>			
5.4L	3.73	6123 (13500)	3265 (7200)
5.4L	4.10	6804 (15000)	3945 (8700)
6.8L	3.73	7711 (17000)	4808 (10600)
6.8L (without fifth wheel)	4.30	9072 (20000)	5670 (12500)
6.8L (with fifth wheel)	4.30	9072 (20000)	6169 (13600)

## Driving

<b>F-350 Crew Cab Single Rear Wheel Pickup</b>			
<b>Engine</b>	<b>Rear axle ratio</b>	<b>Maximum GCWR - kg (lbs.)</b>	<b>Maximum trailer weight - kg (lbs.)</b>
<b>4x4 with manual transmission</b>			
5.4L	3.73	6123 (13500)	3083 (6800)
5.4L	4.10	6804 (15000)	3764 (8300)
6.8L	3.73	7484 (16500)	4399 (9700)
6.8L (without fifth wheel)	4.30	9072 (20000)	5670 (12500)
6.8L (with fifth wheel)	4.30	9072 (20000)	5987 (13200)
<b>4x4 with automatic transmission</b>			
5.4L	3.73	6123 (13500)	3130 (6900)
5.4L	4.10	6804 (15000)	3810 (8400)
6.8L	3.73	7711 (17000)	4625 (10200)
6.8L (without fifth wheel)	4.30	9072 (20000)	5670 (12500)
6.8L (with fifth wheel)	4.30	9072 (20000)	5987 (13200)
<b>F-350 Crew Cab Dual Rear Wheel Pickup</b>			
<b>Engine</b>	<b>Rear axle ratio</b>	<b>Maximum GCWR - kg (lbs.)</b>	<b>Maximum trailer weight - kg (lbs.)</b>
<b>4x2 with manual transmission</b>			
6.8L	3.73	7484 (16500)	4445 (9800)
6.8L (without fifth wheel, with optional 14,000 lb. hitch)	4.30	9072 (20000)	6033 (13300)
6.8L (with fifth wheel)	4.30	9072 (20000)	6033 (13300)

## Driving

<b>F-350 Crew Cab Dual Rear Wheel Pickup</b>			
<b>Engine</b>	<b>Rear axle ratio</b>	<b>Maximum GCWR - kg (lbs.)</b>	<b>Maximum trailer weight - kg (lbs.)</b>
<b>4x2 with automatic transmission</b>			
6.8L	3.73	7711 (17000)	4672 (10300)
6.8L (without fifth wheel, with optional 14,000 lb. hitch)	4.30	9072 (20000)	6033 (13300)
6.8L (with fifth wheel)	4.30	9072 (20000)	6033 (13300)
<b>4x4 with manual transmission</b>			
6.8L	3.73	7484 (16500)	4263 (9400)
6.8L (without fifth wheel, with optional 14,000 lb. hitch)	4.30	9072 (20000)	5850 (12900)
6.8L (with fifth wheel)	4.30	9072 (20000)	5850 (12900)
<b>4x4 with automatic transmission</b>			
6.8L	3.73	7711 (17000)	4491 (9900)
6.8L (without fifth wheel, with optional 14,000 lb. hitch)	4.30	9072 (20000)	5850 (12900)
6.8L (with fifth wheel)	4.30	9072 (20000)	5851 (12900)

## Driving

<b>F-350 Regular Chassis Cab Single Rear Wheel (Fifth Wheel Towing)</b>			
<b>Engine</b>	<b>Rear axle ratio</b>	<b>Maximum GCWR - kg (lbs.)</b>	<b>Maximum trailer weight - kg (lbs.)</b>
<b>4x2 with manual transmission</b>			
5.4L	3.73	6123 (13500)	3266 (7200)
5.4L	4.10	6804 (15000)	3946 (8700)
6.8L	3.73	7484 (16500)	4581 (10100)
<b>4x2 with automatic transmission</b>			
5.4L	3.73	6123 (13500)	3311 (7300)
5.4L	4.10	6804 (15000)	3992 (8800)
6.8L	3.73	7711 (17000)	4808 (10600)
<b>4x4 with manual transmission</b>			
5.4L	3.73	6123 (13500)	3084 (6800)
5.4L	4.10	6804 (15000)	3765 (8300)
6.8L	3.73	7484 (16500)	4400 (9700)
<b>4x4 with automatic transmission</b>			
5.4L	3.73	6123 (13500)	3084 (6800)
5.4L	4.10	6804 (15000)	3765 (8300)
6.8L	3.73	7711 (17000)	4627 (10200)
<b>F-350 Regular Chassis Cab Dual Rear Wheel (Fifth Wheel Towing)</b>			
<b>Engine</b>	<b>Rear axle ratio</b>	<b>Maximum GCWR - kg (lbs.)</b>	<b>Maximum trailer weight - kg (lbs.)</b>
<b>4x2 with manual transmission</b>			
5.4L	3.73	6123 (13500)	3130 (6900)
5.4L	4.10	6804 (15000)	3810 (8400)
6.8L	3.73	7484 (16500)	4400 (9700)
6.8L	4.30	9072 (20000)	5987 (13200)



## Driving

<b>F-350 Regular Chassis Cab Dual Rear Wheel (Fifth Wheel Towing)</b>			
<b>Engine</b>	<b>Rear axle ratio</b>	<b>Maximum GCWR - kg (lbs.)</b>	<b>Maximum trailer weight - kg (lbs.)</b>
<b>4x2 with automatic transmission</b>			
5.4L	3.73	6123 (13500)	3175 (7000)
5.4L	4.10	6804 (15000)	3856 (8500)
6.8L	3.73	7711 (17000)	4672 (10300)
6.8L	4.30	9072 (20000)	6033 (13300)
<b>4x4 with manual transmission</b>			
5.4L	3.73	6123 (13500)	2903 (6400)
5.4L	4.10	6804 (15000)	3583 (7900)
6.8L	3.73	7484 (16500)	4172 (9200)
6.8L	4.30	9072 (20000)	5759 (12700)
<b>4x4 with automatic transmission</b>			
5.4L	3.73	6123 (13500)	2948 (6500)
5.4L	4.10	6804 (15000)	3629 (8000)
6.8L	3.73	7711 (17000)	4445 (9800)
6.8L	4.30	9072 (20000)	5806 (12800)
<b>F-350 SuperCab Chassis Cab Single Rear Wheel (Fifth Wheel Towing)</b>			
<b>Engine</b>	<b>Rear axle ratio</b>	<b>Maximum GCWR - kg (lbs.)</b>	<b>Maximum trailer weight - kg (lbs.)</b>
<b>4x2 with manual transmission</b>			
5.4L	3.73	6123 (13500)	3130 (6900)
5.4L	4.10	6804 (15000)	3810 (8400)
6.8L	3.73	7484 (16500)	4400 (9700)
<b>4x2 with automatic transmission</b>			
5.4L	3.73	6123 (13500)	3130 (6900)
5.4L	4.10	6804 (15000)	3810 (8400)
6.8L	3.73	7711 (17000)	4671 (10300)

## Driving

<b>F-350 SuperCab Chassis Cab Single Rear Wheel (Fifth Wheel Towing)</b>			
<b>Engine</b>	<b>Rear axle ratio</b>	<b>Maximum GCWR - kg (lbs.)</b>	<b>Maximum trailer weight - kg (lbs.)</b>
<b>4x4 with manual transmission</b>			
5.4L	3.73	6123 (13500)	2903 (6400)
5.4L	4.10	6804 (15000)	3583 (7900)
6.8L	3.73	7484 (16500)	4218 (9300)
<b>4x4 with automatic transmission</b>			
5.4L	3.73	6123 (13500)	2948 (6500)
5.4L	4.10	6804 (15000)	3629 (8000)
6.8L	3.73	7711 (17000)	4445 (9800)
<b>F-350 SuperCab Chassis Cab Dual Rear Wheel (Fifth Wheel Towing)</b>			
<b>Engine</b>	<b>Rear axle ratio</b>	<b>Maximum GCWR - kg (lbs.)</b>	<b>Maximum trailer weight - kg (lbs.)</b>
<b>4x2 with manual transmission</b>			
6.8L	3.73	7484 (16500)	4264 (9400)
6.8L	4.30	9072 (20000)	5851 (12900)
<b>4x2 with automatic transmission</b>			
6.8L	3.73	7711 (17000)	4491 (9900)
6.8L	4.30	9072 (20000)	5851 (12900)
<b>4x4 with manual transmission</b>			
6.8L	3.73	7484 (16500)	4082 (9000)
6.8L	4.30	9072 (20000)	5670 (12500)
<b>4x4 with automatic transmission</b>			
6.8L	3.73	7711 (17000)	4309 (9500)
6.8L	4.30	9072 (20000)	5670 (12500)

## Driving

<b>F-350 Crew Cab Chassis Cab Single Rear Wheel (Fifth Wheel Towing)</b>			
<b>Engine</b>	<b>Rear axle ratio</b>	<b>Maximum GCWR - kg (lbs.)</b>	<b>Maximum trailer weight - kg (lbs.)</b>
<b>4x2 with manual transmission</b>			
5.4L	3.73	6123 (13500)	3039 (6700)
5.4L	4.10	6804 (15000)	3719 (8200)
6.8L	3.73	7484 (16500)	4309 (9500)
<b>4x2 with automatic transmission</b>			
5.4L	3.73	6123 (13500)	3039 (6700)
5.4L	4.10	6804 (15000)	3719 (8200)
6.8L	3.73	7711 (17000)	4580 (10100)
<b>4x4 with manual transmission</b>			
5.4L	3.73	6123 (13500)	2812 (6200)
5.4L	4.10	6804 (15000)	3493 (7700)
6.8L	3.73	7484 (16500)	4128 (9100)
<b>4x4 with automatic transmission</b>			
5.4L	3.73	6123 (13500)	2858 (6300)
5.4L	4.10	6804 (15000)	3538 (7800)
6.8L	3.73	7711 (17000)	4354 (9600)
<b>F-350 Crew Cab Chassis Cab Dual Rear Wheel (Fifth Wheel Towing)</b>			
<b>Engine</b>	<b>Rear axle ratio</b>	<b>Maximum GCWR - kg (lbs.)</b>	<b>Maximum trailer weight - kg (lbs.)</b>
<b>4x2 with manual transmission</b>			
6.8L	3.73	7484 (16500)	4173 (9200)
6.8L	4.30	9072 (20000)	5761 (12700)
<b>4x2 with automatic transmission</b>			
6.8L	3.73	7711 (17000)	4400 (9700)
6.8L	4.30	9072 (20000)	5761 (12700)

## Driving

<b>F-350 Crew Cab Chassis Cab Dual Rear Wheel (Fifth Wheel Towing)</b>			
<b>Engine</b>	<b>Rear axle ratio</b>	<b>Maximum GCWR - kg (lbs.)</b>	<b>Maximum trailer weight - kg (lbs.)</b>
<b>4x4 with manual transmission</b>			
6.8L	3.73	7484 (16500)	3946 (8700)
6.8L	4.30	9072 (20000)	5534 (12200)
<b>4x4 with automatic transmission</b>			
6.8L	3.73	7711 (17000)	4172 (9200)
6.8L	4.30	9072 (20000)	5532 (12200)
<b>F-450 Regular Chassis Cab Dual Rear Wheel (Fifth Wheel Towing)</b>			
<b>Engine</b>	<b>Rear axle ratio</b>	<b>Maximum GCWR - kg (lbs.)</b>	<b>Maximum trailer weight - kg (lbs.)</b>
<b>4x2 with manual transmission</b>			
6.8L	4.88/5.38	9979 (22000)	6577 (14500)
<b>4x2 with automatic transmission</b>			
6.8L	4.88	10886 (24000)	7530 (16600)
6.8L	5.38	11793 (26000)	8437 (18600)
<b>4x4 with manual transmission</b>			
6.8L	4.88/5.38	9979 (22000)	6441 (14200)
<b>4x4 with automatic transmission</b>			
6.8L	4.88	10886 (24000)	7394 (16300)
6.8L	5.38	11793 (26000)	8301 (18300)

## Driving

<b>F-450 SuperCab Chassis Cab Dual Rear Wheel (Fifth Wheel Towing)</b>			
<b>Engine</b>	<b>Rear axle ratio</b>	<b>Maximum GCWR - kg (lbs.)</b>	<b>Maximum trailer weight - kg (lbs.)</b>
<b>4x2 with manual transmission</b>			
6.8L	4.88/5.38	9979 (22000)	6441 (14200)
<b>4x2 with automatic transmission</b>			
6.8L	4.88	10886 (24000)	7348 (16200)
6.8L	5.38	11793 (26000)	8255 (18200)
<b>4x4 with manual transmission</b>			
6.8L	4.88/5.38	9979 (22000)	6260 (13800)
<b>4x4 with automatic transmission</b>			
6.8L	4.88	10886 (24000)	7167 (15800)
6.8L	5.38	11793 (26000)	8074 (17800)
<b>F-450 Crew Cab Chassis Cab Dual Rear Wheel (Fifth Wheel Towing)</b>			
<b>Engine</b>	<b>Rear axle ratio</b>	<b>Maximum GCWR - kg (lbs.)</b>	<b>Maximum trailer weight - kg (lbs.)</b>
<b>4x2 with manual transmission</b>			
6.8L	4.88/5.38	9979 (22000)	6350 (14000)
<b>4x2 with automatic transmission</b>			
6.8L	4.88	10886 (24000)	7257 (16000)
6.8L	5.38	11793 (26000)	8165 (18000)
<b>4x4 with manual transmission</b>			
6.8L	4.88/5.38	9979 (22000)	6214 (13700)
<b>4x4 with automatic transmission</b>			
6.8L	4.88	10886 (24000)	7121 (15700)
6.8L	5.38	11793 (26000)	8029 (17700)

## Driving

<b>F-550 Regular Cab Chassis Cab Dual Rear Wheel (Fifth Wheel Towing)</b>			
<b>Engine</b>	<b>Rear axle ratio</b>	<b>Maximum GCWR - kg (lbs.)</b>	<b>Maximum trailer weight - kg (lbs.)</b>
<b>4x2 with automatic transmission</b>			
6.8L	4.88	10886 (24000)	7484 (16500)
6.8L	5.38	11793 (26000)	8391 (18500)
<b>4x4 with automatic transmission</b>			
6.8L	4.88	10886 (24000)	7348 (16200)
6.8L	5.38	11793 (26000)	8255 (18200)
<b>F-550 SuperCab Chassis Cab Dual Rear Wheel (Fifth Wheel Towing)</b>			
<b>Engine</b>	<b>Rear axle ratio</b>	<b>Maximum GCWR - kg (lbs.)</b>	<b>Maximum trailer weight - kg (lbs.)</b>
<b>4x2 with automatic transmission</b>			
6.8L	4.88	10886 (24000)	7348 (16200)
6.8L	5.38	11793 (26000)	8255 (18200)
<b>4x4 with automatic transmission</b>			
6.8L	4.88	10886 (24000)	7121 (15700)
6.8L	5.38	11793 (26000)	8029 (17700)
<b>F-550 Crew Cab Chassis Cab Dual Rear Wheel (Fifth Wheel Towing)</b>			
<b>Engine</b>	<b>Rear axle ratio</b>	<b>Maximum GCWR - kg (lbs.)</b>	<b>Maximum trailer weight - kg (lbs.)</b>
<b>4x2 with automatic transmission</b>			
6.8L	4.88	10886 (24000)	7212 (15900)
6.8L	5.38	11793 (26000)	8119 (17900)
<b>4x4 with automatic transmission</b>			
6.8L	4.88	10886 (24000)	7076 (15600)
6.8L	5.38	11793 (26000)	7983 (17600)

### Preparing to tow

Use the proper equipment for towing a trailer and make sure it is properly attached to your vehicle. See your dealer or a reliable trailer dealer if you require assistance.

### Hitches

Do not use hitches that clamp onto the vehicle's bumper or attach to the axle. You must distribute the load in your trailer so that 10%–15% of the total weight of the trailer is on the tongue.

### Load equalizing hitch

When hooking up a trailer using a load equalizing hitch, always use the following procedure:

1. Park the unloaded vehicle on a level surface. With the ignition on and all doors closed, allow the vehicle to stand for several minutes so that it can level.
2. Measure the height of a reference point on the front and rear bumpers at the center of the vehicle.
3. Attach the trailer to the vehicle and adjust the hitch equalizers so that the front bumper height is within 0–13 mm (0.5 in) of the reference point. After proper adjustment, the rear bumper should be no higher than in Step 2.

**Note:** Adjusting an equalizing hitch so the rear bumper of the vehicle is higher than it was unloaded will defeat the function of the load equalizing hitch and may cause unpredictable handling.

### Safety chains

Always connect the trailer's safety chains to the frame or hook retainers of the vehicle hitch. To connect the trailer's safety chains, cross the chains under the trailer tongue and allow slack for turning corners.

If you use a rental trailer, follow the instructions that the rental agency gives to you.

**Do not attach safety chains to the bumper.**

### Trailer brakes

Electric brakes and manual, automatic or surge-type trailer brakes are safe if installed properly and adjusted to the manufacturer's specifications. The trailer brakes must meet local and Federal regulations.

## Driving



Do not connect a trailer's hydraulic brake system directly to your vehicle's brake system. Your vehicle may not have enough braking power and your chances of having a collision greatly increase.

The braking system of the tow vehicle is rated for operation at the GVWR not GCWR.

### Trailer lamps

Trailer lamps are required on most towed vehicles. Make sure your trailer lamps conform to local and Federal regulations. See your dealer or trailer rental agency for proper instructions and equipment for hooking up trailer lamps.

### Using a step bumper (if equipped)

The rear bumper is equipped with an integral hitch and only requires a ball with a 25.4 mm (one inch) shank diameter. The bumper has a 2,270 kg (5,000 lb.) trailer weight and 227 kg (500 lb.) tongue weight capacity. If it is necessary to relocate the trailer hitch ball position, a frame-mounted trailer hitch must be installed.

### Driving while you tow

When towing a trailer:

- Turn off the speed control. The speed control may shut off automatically when you are towing on long, steep grades.
- Consult your local motor vehicle speed regulations for towing a trailer.
- **If your vehicle is equipped with a 4-speed automatic transmission:** To eliminate excessive transmission shifting, use a lower gear. This will also assist in transmission cooling. (For additional information, refer to the *Understanding the positions of the 4-speed automatic transmission* section in this chapter.
- **If your vehicle is equipped with a 5-speed automatic transmission:** To eliminate excessive transmission shifting, activate the Tow/Haul feature. This will also assist in transmission cooling. (For additional information, refer to the *Understanding the positions of the 5-speed automatic transmission* section in this chapter.
- Anticipate stops and brake gradually.
- Do not exceed the GCWR rating or transmission damage may occur.

### Servicing after towing

If you tow a trailer for long distances, your vehicle will require more frequent service intervals. Refer to your scheduled maintenance guide for more information.



### Trailer towing tips

- Practice turning, stopping and backing up before starting on a trip to get the feel of the vehicle trailer combination. When turning, make wider turns so the trailer wheels will clear curbs and other obstacles.
- Allow more distance for stopping with a trailer attached.
- The trailer tongue weight should be 10–15% of the loaded trailer weight.
- After you have traveled 80 km (50 miles), thoroughly check your hitch, electrical connections and trailer wheel lug nuts.
- To aid in engine/transmission cooling and A/C efficiency during hot weather while stopped in traffic, place the gearshift lever in P (Park) (automatic transmission) or N (Neutral) (manual transmissions).
- Vehicles with trailers should not be parked on a grade. If you must park on a grade, place wheel chocks under the trailer's wheels.

### Launching or retrieving a boat

When backing down a ramp during boat launching or retrieval,

- Do not allow the static water level to rise above the bottom edge of the rear bumper.
- Do not allow waves to break higher than 15 cm (6 inches) above the bottom edge of the rear bumper.
- Disconnect the trailer tow electrical connector to prevent blown fuses caused by water entering into your trailer's electrical wiring.

Exceeding these limits may allow water to enter critical vehicle components, adversely affecting driveability, emissions and reliability.

Replace front and rear axle lubricants any time the axles have been submerged in water. Axle lubricant quantities are not to be checked unless a leak is suspected.

### ALL REAR WHEEL DRIVE (RWD) VEHICLES

This applies to all cars and 4x2 trucks/sport utilities with rear wheel drive capability.

An example of recreational towing is towing your vehicle behind a motorhome. The following recreational towing guidelines are designed to ensure that your transmission is not damaged.

- Place the transmission in N (Neutral).

## Driving

- Maximum speed is 56 km/h (35 mph).
- Maximum distance is 80 km (50 miles).

If a distance of 80 km (50 miles) or a speed of 56 km/h (35 mph) must be exceeded, you must disconnect the driveshaft. Ford recommends the driveshaft be removed/installed only by a qualified technician. See your local dealer for driveshaft removal/installation.

**Improper removal/installation of the driveshaft can cause transmission fluid loss, damage to the driveshaft and internal transmission components.**

**RWD vehicles with 4x4 electronic shift transfer case or All Wheel Drive (AWD) vehicles with automatic transmissions:**

Regarding recreational towing or having your vehicle towed, 4x4 vehicles with electronic shift on the fly and AWD vehicles cannot be towed with any wheels on the ground (with the exception of moving it as a disabled vehicle off the road out of traffic).

### SNOWPLOWING

**Note:** Do not use your vehicle to snowplow until it has been driven at least 800 km (500 miles). Follow the severe duty schedule in your scheduled maintenance guide for engine oil and transmission fluid change intervals.

**Note:** Ford does not install snowplows.

For low speed snow removal, Ford offers a Snowplow Package Option on select 4x4 vehicles. To assist Ford dealers and equipment installers further prepare the vehicle for snowplowing, Ford includes instructions in the *Ford Truck Body Builders Layout Book* and *Ford Truck Source Book*. These instructions are available through your Ford dealer; they include the list of vehicle models recommended for snowplowing and snowplow weight limits. Use of the Snowplow Package Option, or its equivalent, along with these instructions will help avoid possible powertrain and chassis damage from snowplowing.

The front and rear GAWR, GVWR, Total Accessory Reserve Capacity (TARC) and tire inflation pressures are found on the Safety Compliance Certification Label located on one of the vehicle's door jambs. This label is applied to all vehicles completed by Ford Motor Company. Incomplete vehicles built by Ford Motor Company will have an Incomplete Vehicle Label in place of the Safety Compliance Label. The TARC does not apply to Incomplete Vehicles and will not be shown on the Incomplete Vehicle Label. The weight of the vehicle with occupants must never exceed the front and rear GAWR or the GVWR.

The TARC is the weight of the permanently attached equipment that can be added to the vehicle without violating the vehicle's Safety Compliance Certification. This includes the snowplow mounting hardware but does not include the removable portion of the snowplow assembly.

### Installing the snowplow

Read the following instructions before installing a snowplow:

- Front GAWR must not exceed 63% of the GVW. Add ballast weight to the back of the vehicle, if necessary. Refer to the Safety Compliance Certification Label to find your vehicle's front GAWR.
- The Front Axle Accessory Reserve Capacity and the TARC listed on the bottom right of the Safety Compliance Certification Label will determine whether or not the addition of a snowplow will overload your vehicle.
- The weight of the snowplow and supporting components distributed to the front axle must not exceed the Front Axle Accessory Reserve Capacity.
- The total weight of the snowplow and aftermarket equipment must not exceed the TARC.
- The weight of the installed snowplow and aftermarket equipment must not load the vehicle beyond the GAWR (front/rear) and GVWR listed on the Safety Compliance Certification Label.
- The total weight of the snowplow and aftermarket equipment must be considered part of the payload and must not exceed the GCWR for towing.
- Federal and most local regulations require additional exterior lamps for snowplow-equipped vehicles. Consult your dealer for additional information.
- Tires have their maximum inflation pressure and associated load rating imprinted on the tire sidewall. This pressure may or may not be the same as that shown as recommended on the vehicle. The vehicle operator may have to adjust the tire inflation pressure to accommodate the snowplow and payload. Consult your dealer or equipment installer for help with proper inflation pressures.
- Federal and some local regulations require additional exterior lamps for snowplow-equipped vehicles. Consult your dealer for additional information.
- After installing a snowplow to the vehicle, ensure the vehicle's front toe alignment and front ride height are within specification (reset if required). These specifications are located in the vehicle's Workshop Manual.

## Driving

**Note:** Do not exceed the GVWR or the GAWR specified on the certification label.

### Removing snowplow

After removing a snowplow from the vehicle, ensure the vehicle's front toe alignment and front ride height are within specification (reset if required).

### Snowplowing with your air bag-equipped vehicle

Your vehicle is equipped with a driver and passenger air bag Supplemental Restraint System (SRS). The SRS is designed to activate in certain frontal and offset frontal collisions when the vehicle sustains sufficient longitudinal deceleration.

Careless or high speed driving while plowing snow which results in sufficient vehicle decelerations can deploy the air bag. Such driving also increases the risk of accidents.



All occupants of the vehicle, including the driver, should always properly wear their safety belts, even when an air bag (SRS) is provided.

Never remove or defeat the “tripping mechanisms” designed into the snow removal equipment by its manufacturer. Doing so may cause damage to the vehicle and the snow removal equipment as well as possible air bag deployment.



Do not attempt to service, repair, or modify the Air Bag Supplemental Restraint System or its fuses. See your Ford or Lincoln Mercury dealer.



Additional equipment such as snowplow equipment may effect the performance of the air bag sensors increasing the risk of injury. Please refer to the Body Builders Layout Book for instructions about the appropriate installation of additional equipment.

### Engine temperature while plowing

When driving with a snowplow, your engine may run at a higher temperature than normal because the attached snowplow blade will restrict airflow to the radiator.

If you are driving more than 24 km (15 miles) at temperatures above freezing, angle the plow blade either full left or full right to provide maximum airflow to the radiator.

## Driving

If you are driving less than 24 km (15 miles) at speeds up to 64 km/h (40 mph) in cold weather, you will not need to worry about blade position to provide maximum airflow.

Refer to *Transmission temperature gauge* in the *Instrument cluster* chapter for transmission fluid temperature information.

### **4WD operation while plowing**

- Shift transfer case to 4x4 LOW (4WD Low) when plowing in small areas at speeds below 8 km/h (5 mph).
- Shift transfer case to 4x4 HIGH (4WD High) when plowing larger areas or light snow at higher speeds. Do not exceed 24 km/h (15 mph).
- Do not shift the transmission from a forward gear to R (Reverse) until the engine is at idle and the wheels are stopped.
- If the vehicle is stuck, shift the transmission in a steady motion between forward and reverse gears. Do not rock the vehicle for more than a few minutes. The transmission and tires may be damaged or the engine can overheat.

**It is the owner's responsibility to avoid engine overheating which can cause damage.**

Refer to *Transmission temperature gauge* in the *Instrument cluster* chapter for transmission fluid temperature information.



Do not spin the wheels at over 35 mph (55 km/h). The tires may fail and injure a passenger or bystander.

## Roadside Emergencies

### GETTING ROADSIDE ASSISTANCE

To fully assist you should you have a vehicle concern, Ford Motor Company offers a complimentary roadside assistance program. This program is separate from the New Vehicle Limited Warranty. The service is available:

- 24-hours, seven days a week
- for the New Vehicle Limited Warranty period of three years or 60,000 km (36,000 miles), whichever occurs first on Ford and Mercury vehicles, and four years or 80,000 km (50,000 miles) on Lincoln vehicles.

Roadside assistance will cover:

- changing a flat tire
- jump-starts
- lock-out assistance
- limited fuel delivery
- towing of your disabled vehicle to the nearest Ford Motor Company dealership, or your selling dealer if within 56.3 km (35 miles) of the nearest Ford Motor Company dealership (one tow per disablement). Even non-warranty related tows, like accidents or getting stuck in the mud or snow, are covered (some exclusions apply, such as impound towing or repossession).

### Canadian customers refer to your Owner Information Guide for information on:

- coverage period
- exact fuel amounts
- towing of your disabled vehicle
- emergency travel expense reimbursement
- travel planning benefits

### USING ROADSIDE ASSISTANCE

Complete the roadside assistance identification card and place it in your wallet for quick reference. In the United States, this card is found in the Owner Guide portfolio in the glove compartment in Ford vehicles and is mailed to you if you own a Mercury or Lincoln. In Canada, the card is found in the Owner Information Guide in the glove compartment.

U.S. Ford or Mercury vehicle customers who require roadside assistance, call 1-800-241-3673; Lincoln vehicle customers call 1-800-521-4140.

## Roadside Emergencies

Canadian customers who require roadside assistance, call 1-800-665-2006.

If you need to arrange roadside assistance for yourself, Ford Motor Company will reimburse a reasonable amount. To obtain reimbursement information, U.S. Ford or Mercury vehicles customers call 1-800-241-3673; Lincoln vehicle customers call 1-800-521-4140.

Canadian customers who need to obtain reimbursement information, call 1-800-665-2006.

### ROADSIDE COVERAGE BEYOND BASIC WARRANTY

In the United States, you may purchase additional roadside assistance coverage beyond this period through the Ford Auto Club by contacting your Ford or Lincoln Mercury dealer.

Similarly in Canada, for uninterrupted Roadside Assistance coverage, you may purchase extended coverage prior to your Basic Warranty's Roadside Assistance expiring. For more information and enrollment, contact 1-877-294-2582 or visit our website at [www.ford.ca](http://www.ford.ca).

### HAZARD FLASHER

The hazard flasher is located on the steering column, just behind the steering wheel. The hazard flashers will operate when the ignition is in any position.

Push in the flasher control and all front and rear direction signals will flash. Press the flasher control again to turn them off. Use it when your vehicle is disabled and is creating a safety hazard for other motorists.

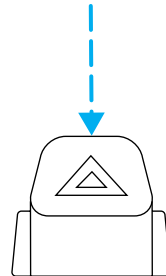

**Note:** With extended use, the flasher may run down your battery.

### FUEL PUMP SHUT-OFF SWITCH FUEL RESET

This device stops the electric fuel pump from sending fuel to the engine when your vehicle has had a substantial jolt.

After an accident, if the engine cranks but does not start, this switch may have been activated.

## Roadside Emergencies

This switch is located in the front passenger's footwell, by the kick panel access cover.

To reset the switch:

1. Turn the ignition OFF.
2. Check the fuel system for leaks.
3. If no leaks are apparent, reset the switch by pushing in on the reset button.
4. Turn the ignition ON.
5. Wait a few seconds and return the key to OFF.
6. Make another check of leaks.

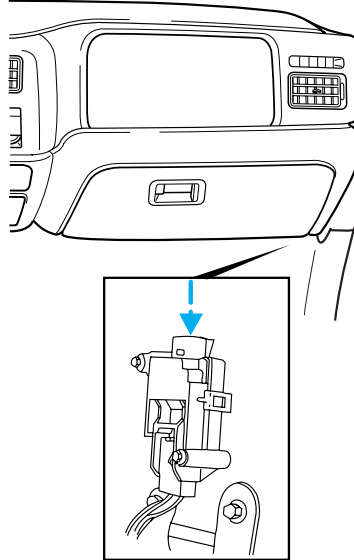

## FUSES AND RELAYS

### Fuses

If electrical components in the vehicle are not working, a fuse may have blown. Blown fuses are identified by a broken wire within the fuse. Check the appropriate fuses before replacing any electrical components.

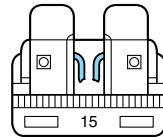

**Note:** Always replace a fuse with one that has the specified amperage rating. Using a fuse with a higher amperage rating can cause severe wire damage and could start a fire.



## Roadside Emergencies

### Standard fuse amperage rating and color

Fuse rating	COLOR				
	Mini fuses	Standard fuses	Maxi fuses	Cartridge maxi fuses	Fuse link cartridge
2A	Grey	Grey	—	—	—
3A	Violet	Violet	—	—	—
4A	Pink	Pink	—	—	—
5A	Tan	Tan	—	—	—
7.5A	Brown	Brown	—	—	—
10A	Red	Red	—	—	—
15A	Blue	Blue	—	—	—
20A	Yellow	Yellow	Yellow	Blue	Blue
25A	Natural	Natural	—	—	—
30A	Green	Green	Green	Pink	Pink
40A	—	—	Orange	Green	Green
50A	—	—	Red	Red	Red
60A	—	—	Blue	—	Yellow
70A	—	—	Tan	—	Brown
80A	—	—	Natural	—	Black

### Passenger compartment fuse panel / power distribution box

The fuse panel is located below and to the left of the steering wheel by the brake pedal. Remove the panel cover to access the fuses.

To remove the fuse panel cover, turn the panel fasteners counterclockwise.

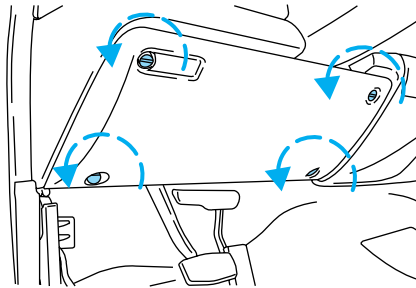

## Roadside Emergencies

To remove a fuse use the fuse puller tool provided on the fuse panel cover.

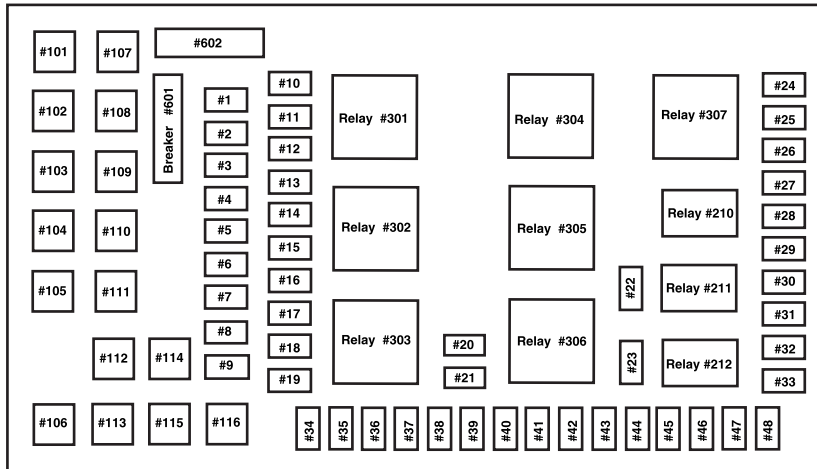
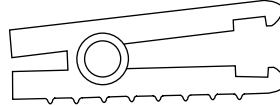

The fuses are coded as follows.

Fuse/Relay Location	Fuse Amp Rating	Passenger Compartment Fuse Panel Description
1	15A*	Adjustable pedals
2	—	Not used
3	—	Not used
4	20A*	Power point - instrument panel
5	—	Not used
6	20A*	Trailer tow turn/stop relay
7	30A*	High beam headlamps/Flash to pass
8	15A*	Backup lamps (Diesel engine only)
9	20A*	Heated mirrors
10	10A*	A/C clutch
11	20A*	Radio (main)

## Roadside Emergencies

Fuse/Relay Location	Fuse Amp Rating	Passenger Compartment Fuse Panel Description
12	20A*	Cigar lighter / OBD II
13	5A*	Power mirrors/switches
14	15A*	Daytime running lamps (DRL)
15	—	Not used
16	—	Not used
17	15A*	Exterior lamps
18	20A*	Turn lamps/Brake on-off switch (high)
19	10A*	Body security module/4x4 module
20	10A*	Fuel Injection Control Module (FICM) relay (Diesel engine only)
21	—	Not used
22	20A*	Engine control
23	20A*	Engine control (gasoline engine only), Climate control (Diesel engine only)
24	2A*	Brake pressure switch/Speed control
25	10A*	4-Wheel Anti-lock Brake System (4WABS) module, Variable Fan Control (VFC) (Diesel engine only)
26	10A*	Air bags
27	15A*	Ignition switch Run feed
28	10A*	EATC module/Front blower relay coil
29	10A*	Customer access
30	15A*	Highbeam headlamps
31	15A*	Clutch interlock switch (manual transmissions only), Transmission range sensor (automatic transmissions only) then to starter relay coil (all transmissions), 4x4

## Roadside Emergencies

Fuse/Relay Location	Fuse Amp Rating	Passenger Compartment Fuse Panel Description
32	5A*	Radio (start)
33	15A*	Front wiper
34	10A*	Brake on-off switch
35	10A*	Instrument cluster
36	10A*	PCM Memory
37	15A*	Horn
38	20A*	Trailer tow park lamps
39	15A*	Trailer tow back-up lamps
40	20A*	Fuel pump
41	10A*	Instrument cluster
42	15A*	Delayed accessory
43	10A*	Fog lamps
44	—	Not used
45	10A*	Ignition switch Run/Start feed
46	10A*	Left-hand lowbeam
47	10A*	Right-hand lowbeam
48	—	Not used
101	30A**	Trailer tow electric brake
102	30A**	Door locks/Body security module
103	50A**	Ignition switch (gasoline engine only), FICM power (Diesel engine only)
104	40A**	Heated backlight
105	30A**	Fuel heater (Diesel engine only)
106	30A**	Front wiper main
107	40A**	Front blower motor
108	—	Not used
109	30A**	Heated seats
110	50A**	Ignition switch
111	30A**	4WD/Shift on the fly
112	30A**	Left-hand power seats

## Roadside Emergencies

Fuse/Relay Location	Fuse Amp Rating	Passenger Compartment Fuse Panel Description
113	30A**	Starter motor
114	30A**	Right-hand power seats
115	20A**	Trailer tow battery charge
116	30A**	Ignition switch
601	30A CB***	Window motors, Moonroof
602	60A**	4WABS module
210	—	Not used
211	—	Backup lamps relay (Diesel engine only)
212	—	Not used
301	—	Front blower motor relay
302	—	Powertrain Control Module (PCM) relay
303	—	Fuel heater relay (Diesel engine only)
304	—	Heated backlight relay
305	—	Trailer tow battery charge relay
306	—	Delayed accessory relay
307	—	Starter relay

\* Mini Fuses \*\* Maxi Fuses \*\*\*Circuit Breaker

**Note: (Diesel engine only)** The Fuel Injection Control Module (FICM) logic 15A mini-fuse is located in the underhood relay block.

### CHANGING A FLAT TIRE

If you get a flat tire while driving:

- do not brake heavily.
- gradually decrease the vehicle's speed.
- hold the steering wheel firmly.
- slowly move to a safe place on the side of the road.



The use of tire sealants is not recommended and may compromise the integrity of your tires.

## Roadside Emergencies

### Spare tire information

Your vehicle may be equipped with a spare tire that can be used as either a spare or a regular tire. The spare tire is not equipped with wheel trim. The wheel trim from the original wheel/tire may be used on the spare.



If your vehicle is equipped with 4WD, a spare tire of a different size than the road tires should not be used. Use of such a tire could result in damage to driveline components and an increased risk of loss of vehicle control, vehicle rollover, personal injury or death.

### Location of the spare tire and tools

The spare tire and tools for your vehicle are stowed in the following locations:

Tool	Location
Spare tire (pick-up trucks only)	Under the vehicle, just forward of the rear bumper
Jack	Regular cab, crew cab and SuperCab without rear bench seat: Fastened to floor pan behind rearmost seat on passenger side
	SuperCab with rear bench seat: Under rear bench on passenger side
Jack handle and lug wrench	On top of the radiator support at the front of the engine compartment
Key, spare tire lock	In the glove box

## Roadside Emergencies

### Removing the spare tire (with spare tire carrier only)

1. The following tools are required to remove the spare tire:

- one handle extension and one typical extension. To assemble, align button with hole and slide parts together. To disconnect, depress button and pull apart.
- one wheel nut wrench. Slide over square end of jack handle.

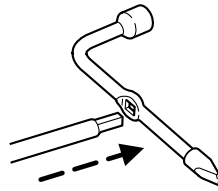
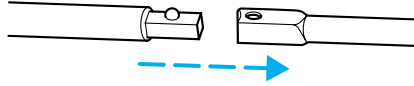

- **Vehicles equipped with dual rear wheels**, insert the lug wrench extension into the lug wrench to reach the lug nuts.

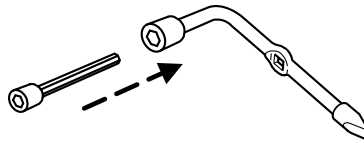

2. Attach the spare tire lock key (A) to the jack handle (B).

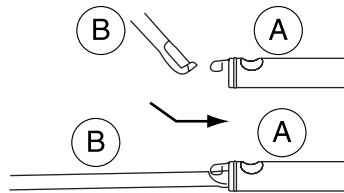

## Roadside Emergencies

3. Fully insert the jack handle through the bumper hole and into the guide tube. The key and lock will engage with a slight push and counterclockwise turn. Some resistance will be felt when turning the jack handle assembly.

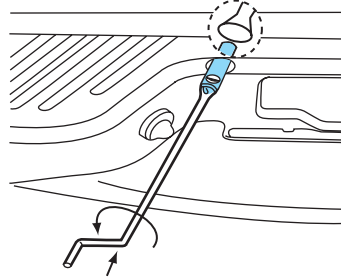

4. Turn the handle counterclockwise and lower the spare tire until you can slide the tire rearward and the cable is slack.

5. Remove the retainer through the center of the wheel.

### Tire change procedure

1. Park on a level surface, activate hazard flashers and set the parking brake.

- Automatic transmission: Place gearshift lever in P (Park).
- Manual transmission: Place gearshift lever in R (Reverse).
- Electronic Shift On the Fly 4WD: Place transfer case in any position.
- Manual shift transfer case 4WD: Place transfer case in 2H, 4H or 4L.

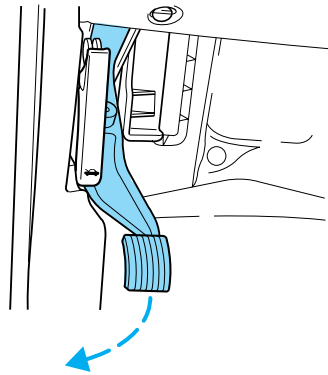

To prevent the vehicle from moving when you change a tire, be sure the parking brake is set, then block (in both directions) the wheel that is diagonally opposite (other side and end of the vehicle) to the tire being changed.

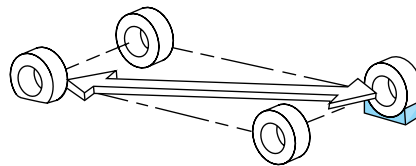



2. Turn engine off and block the diagonally opposite wheel (block not provided).

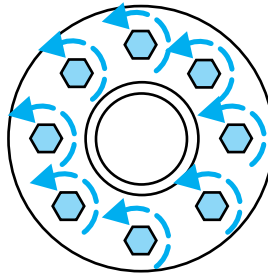

## Roadside Emergencies

3. Remove the jack, jack handle, lug wrench and spare tire from the stowage locations.
4. Use the tip of the lug wrench to remove any wheel trim.
5. Loosen each wheel lug nut one-half turn counterclockwise but do not remove them until the wheel is raised off the ground.



 When one of the rear wheels is off the ground, the transmission alone will not prevent the vehicle from moving or slipping off the jack, even if the transmission is in P (Park) (automatic transmission) or R (Reverse) (manual transmission). To prevent the vehicle from moving when you change the tire, be sure that the parking brake is set and the diagonally opposite wheel is blocked.

 If the vehicle slips off the jack, you or someone else could be seriously injured.

### The following steps apply to F250/F350 only:

6. Insert the hooked end of the jack handle into the jack and use the handle to slide the jack under the vehicle.
7. Position the jack according to the following guides:

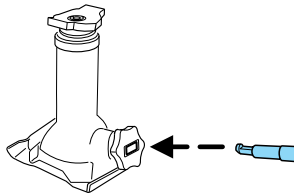

## Roadside Emergencies

- Front (4x2)

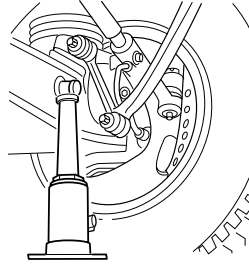

- Front passenger side (4x4)

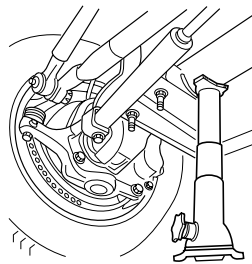

- Front driver side (4x4)

Make sure the jack fits into the notched area next to the differential housing.

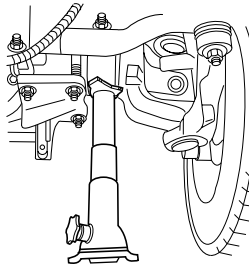

## Roadside Emergencies

- Rear

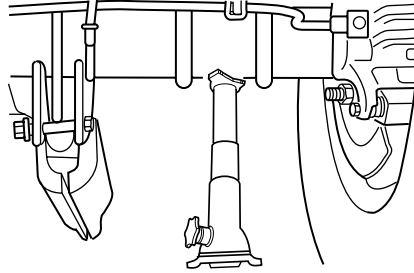

### Never use the front or rear differential as a jacking point.



To lessen the risk of personal injury, do not put any part of your body under the vehicle while changing a tire. Do not start the engine when your vehicle is on the jack. The jack is only meant for changing the tire.

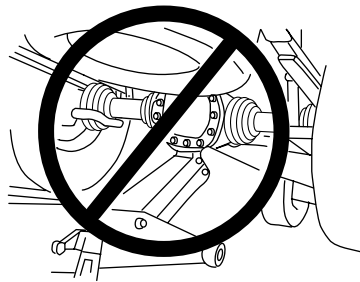

8. Turn the jack handle clockwise until the wheel is completely off the ground and high enough to install the spare tire.

9. Remove the lug nuts with the lug wrench.

10. Replace the flat tire with the spare tire, making sure the valve stem is facing outward for all front wheels and single rear wheel vehicles. If replacing an inboard rear tire on dual rear wheel vehicles, the valve stem must be facing outward. If replacing the outboard wheel, the valve stem must be facing inward. Reinstall the lug nuts until the wheel is snug against the hub. Do not fully tighten the lug nuts until the wheel has been lowered.

11. Lower the wheel by turning the jack handle counterclockwise.

Go to step 19.

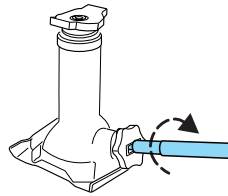

## Roadside Emergencies

The following steps apply to F350 Chassis Cab F450/F550 only:

12. Slide the notched end of the jack handle over the release valve and use the handle to slide the jack under the vehicle. Make sure the valve is closed by turning it clockwise.

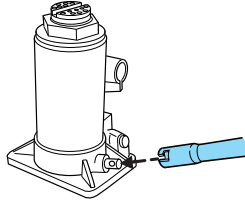

13. Position the jack according to the following guides:

- Front (4x2) F350

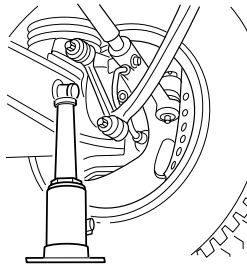

- Front (4x2) F450/550

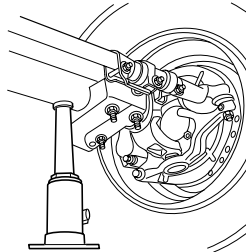

- Front driver side (4x4)

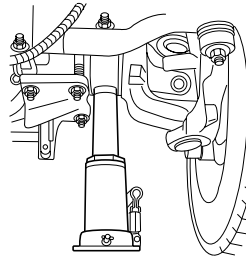

## Roadside Emergencies

- Front passenger side (4x4)

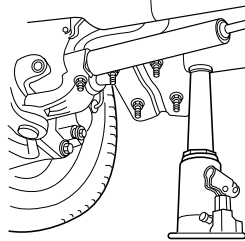

- Rear

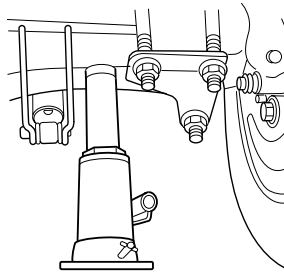

14. Insert the jack handle into the pump linkage.

15. Use an up-and-down motion with the jack handle to raise the wheel completely off the ground.

**Hydraulic jacks are equipped with a pressure release valve that prevents lifting loads which exceed the jack's rated capacity.**

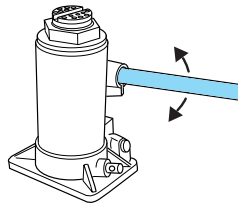

16. Remove the lug nuts with the lug wrench.

17. Replace the flat tire with the spare tire, making sure the valve stem is facing outward on all front and inboard rear wheels. If replacing the outboard wheel, the valve stem must be facing inward. Reinstall the lug nuts until the wheel is snug against the hub. Do not fully tighten the lug nuts until the wheel has been lowered.

18. Lower the wheel by slowly turning the release valve counterclockwise. Opening the release valve slowly will provide a more controlled rate of descent.

## Roadside Emergencies

### The following steps apply to all vehicles:

19. Remove the jack and fully tighten the lug nuts in the order shown.

20. Stow the flat tire. Refer to *Stowing the spare tire* if the vehicle is equipped with a spare tire carrier.

21. Stow the jack, jack handle and lug wrench. Make sure the jack is securely fastened so it does not rattle when driving.

22. Unblock the wheels.

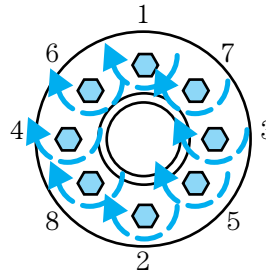

On vehicles equipped with single rear wheels, retighten the lug nuts to the specified torque at 800 km (500 miles) after any wheel disturbance (tire rotation, changing a flat tire, wheel removal, etc.).

On vehicles equipped with dual rear wheels, retighten the wheel lug nuts to the specified torque at 160 km (100 miles), and again at 800 km (500 miles) of new vehicle operation and after any wheel disturbance (tire rotation, changing a flat tire, wheel removal, etc.).

Bolt size	Wheel lug nut torque*	
	Nm	Lb-ft
M14 x 1.5	200-225	150-165

\* Torque specifications are for nut and bolt threads free of dirt and rust. Use only Ford recommended replacement fasteners.

On all two-piece flat wheel nuts, apply one drop of motor oil between the flat washer and the nut. Do not apply motor oil to the wheel nut threads or the wheel stud threads.

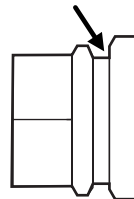

## Roadside Emergencies



When a wheel is installed, always remove any corrosion, dirt or foreign materials present on the mounting surfaces of the wheel or the surface of the front disc brake hub and rotor that contacts the wheel. Installing wheels without correct metal-to-metal contact at the wheel mounting surfaces can cause the wheel nuts to loosen and the wheel to come off while the vehicle is in motion, resulting in loss of control.

### **Stowing the flat/spare tire**

**Note:** Failure to follow spare tire stowage instructions may result in failure of cable or loss of spare tire.

1. Lay the tire on the ground with the valve stem facing in the direction specified on the Tire Changing Instructions located with the jack hardware.
2. Slide the wheel partially under the vehicle and install the retainer through the wheel center. Pull on the cable to align the components at the end of the cable.
3. Turn the jack handle clockwise until the tire is raised to its stowed position underneath the vehicle. The effort to turn the jack handle increases significantly and the spare tire carrier ratchets or slips when the tire is raised to the maximum tightness. Tighten to the best of your ability, to the point where the ratchet/slip occurs, if possible. The spare tire carrier will not allow you to overtighten. If the spare tire carrier ratchets or slips with little effort, take the vehicle to your dealer for assistance at your earliest convenience.
4. Check that the tire lies flat against the frame and is properly tightened. Try to push or pull, then turn the tire to be sure it will not move. Loosen and retighten, if necessary. Failure to properly stow the spare tire may result in failure of the winch cable and loss of the tire.
5. Repeat this tightness check procedure when servicing the spare tire pressure (every six months, per scheduled maintenance guide), or at any time that the spare tire is disturbed through service of other components.
6. If removed, install the spare tire lock (if equipped) into the bumper drive tube with the spare tire lock key (if equipped) and jack handle.

## Roadside Emergencies

### JUMP STARTING YOUR VEHICLE



The gases around the battery can explode if exposed to flames, sparks, or lit cigarettes. An explosion could result in injury or vehicle damage.



Batteries contain sulfuric acid which can burn skin, eyes and clothing, if contacted.

**Do not attempt to push-start your vehicle. Automatic transmissions do not have push-start capability; doing so may damage the catalytic converter.**

### Preparing your vehicle

When the battery is disconnected or a new battery is installed, the transmission must relearn its shift strategy. As a result, the transmission may have firm and/or soft shifts. This operation is considered normal and will not affect function or durability of the transmission. Over time, the adaptive learning process will fully update transmission operation.

1. **Use only a 12-volt supply to start your vehicle.**
2. Do not disconnect the battery of the disabled vehicle as this could damage the vehicle's electrical system.
3. Park the booster vehicle close to the hood of the disabled vehicle making sure the two vehicles **do not** touch. Set the parking brake on both vehicles and stay clear of the engine cooling fan and other moving parts.
4. Check all battery terminals and remove any excessive corrosion before you attach the battery cables. Ensure that vent caps are tight and level.
5. Turn the heater fan on in both vehicles to protect any electrical surges. Turn all other accessories off.



## Roadside Emergencies

### Connecting the jumper cables

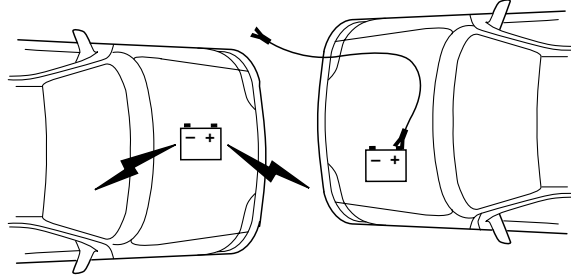

1. Connect the positive (+) jumper cable to the positive (+) terminal of the discharged battery.

**Note:** In the illustrations, *lightning bolts* are used to designate the assisting (boosting) battery.

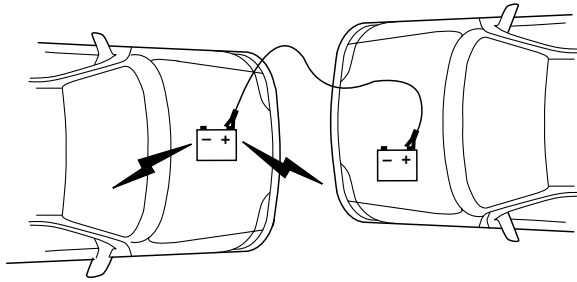

2. Connect the other end of the positive (+) cable to the positive (+) terminal of the assisting battery.

## Roadside Emergencies

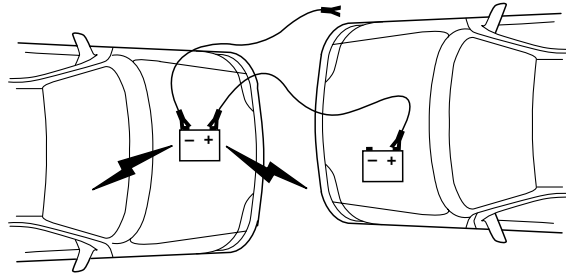

3. Connect the negative (-) cable to the negative (-) terminal of the assisting battery.

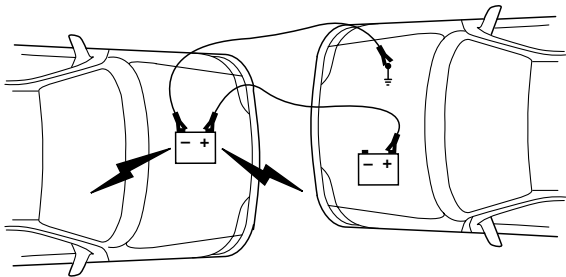

4. Make the final connection of the negative (-) cable to an exposed metal part of the stalled vehicle's engine, away from the battery and the carburetor/fuel injection system. **Do not** use fuel lines, engine rocker covers or the intake manifold as *grounding* points.



Do not connect the end of the second cable to the negative (-) terminal of the battery to be jumped. A spark may cause an explosion of the gases that surround the battery.

5. Ensure that the cables are clear of fan blades, belts, moving parts of both engines, or any fuel delivery system parts.

### Jump starting

1. Start the engine of the booster vehicle and run the engine at moderately increased speed.
2. Start the engine of the disabled vehicle.

## Roadside Emergencies

3. Once the disabled vehicle has been started, run both engines for an additional three minutes before disconnecting the jumper cables.

### Removing the jumper cables

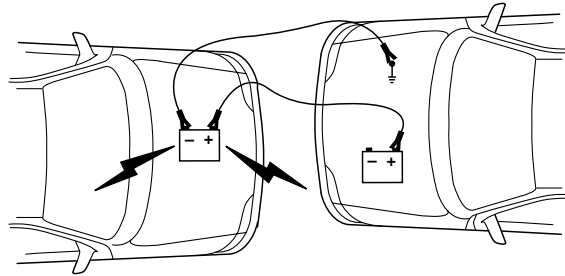

**Remove the jumper cables in the reverse order that they were connected.**

1. Remove the jumper cable from the *ground* metal surface.

**Note:** In the illustrations, *lightning bolts* are used to designate the assisting (boosting) battery.

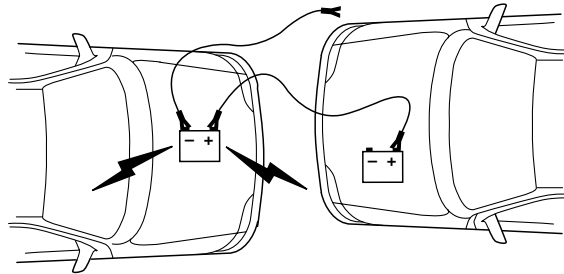

2. Remove the jumper cable on the negative (-) connection of the booster vehicle's battery.

## Roadside Emergencies

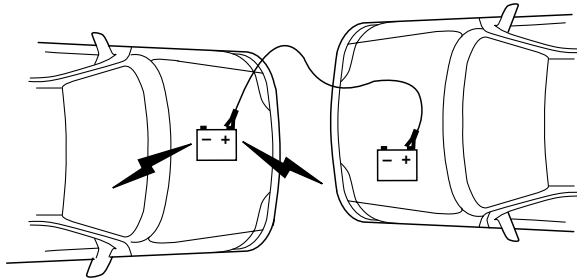

3. Remove the jumper cable from the positive (+) terminal of the booster vehicle's battery.

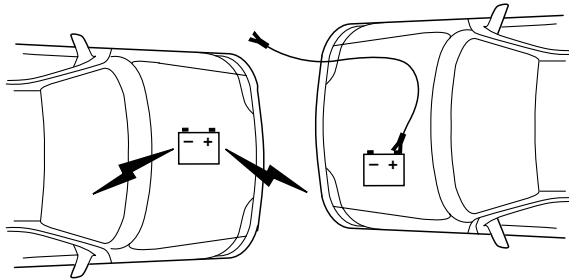

4. Remove the jumper cable from the positive (+) terminal of the disabled vehicle's battery.

After the disabled vehicle has been started and the jumper cables removed, allow it to idle for several minutes so the engine computer can *relearn* its idle conditions.

## Roadside Emergencies

### WRECKER TOWING

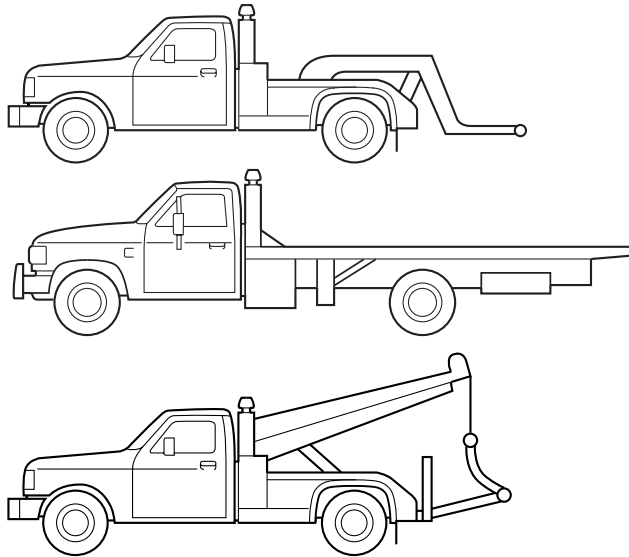

If you need to have your vehicle towed, contact a professional towing service or, if you are a member of a roadside assistance program, your roadside assistance service provider.

On 4x2 vehicles, it is acceptable to tow the vehicle with the front wheels on the ground and the rear wheels off the ground using a wheel lift or a slingbelt with T-hooks.

On 4x4 vehicles it is recommended that your vehicle be towed with flatbed equipment with all the wheels off the ground. However, a wheel lift or slingbelt may be used in conjunction with a wheel dolly so that all four wheels are off the ground.

## Roadside Emergencies

An alternative for towing a 4x4 vehicle (with gasoline engine only) with a **manual** 4WD system is to:

- put the transfer case in neutral, then put the 4WD shift lever in N (Neutral).
- unlock the front hub locks (refer to *Four wheel drive [4WD] Operation [if equipped]* in the *Driving* chapter).
- lift the rear wheels of the vehicle using a wheel lift or a sling belt with T-hooks.

**If the vehicle is towed by other means or incorrectly, vehicle damage may occur.**

Ford Motor Company produces a towing manual for all authorized tow truck operators. Have your tow truck operator refer to this manual for proper hook-up and towing procedures for your vehicle.

## Customer Assistance

### GETTING THE SERVICES YOU NEED

#### At home

Ford Motor Company and Ford of Canada have authorized dealerships to service your vehicle. It is preferred that you return to the authorized dealer where your vehicle was purchased when warranty repairs are needed. However, you may also take your vehicle to another Ford Motor Company or Ford of Canada dealership authorized for warranty repairs. Repairs can be made at Lincoln Mercury dealers, however Jaguar, Land Rover, Mazda, Volvo and Aston Martin dealers are not qualified to perform Superduty repairs. Certain warranty repairs require special training though, so not all dealers are authorized to perform all warranty repairs. That means that depending on the warranty repair needed, the vehicle may need to be taken to another dealer. If a particular dealership cannot assist you, then contact the Customer Relationship Center.

If you have questions or concerns, or are unsatisfied with the service you are receiving, follow these steps:

1. Contact your Sales Representative or Service Advisor at your selling/servicing dealership.
2. If your inquiry or concern remains unresolved, contact the Sales Manager or Service Manager at the dealership.
3. If the inquiry or concern cannot be resolved at the dealership level, please contact the Ford Customer Relationship Center.

#### Away from home

If you own a Ford or Mercury vehicle and are away from home when your vehicle needs service, or if you need more help than the dealership could provide, after following the steps described above, contact the Ford Customer Relationship Center to find an authorized dealership to help you.

In the United States:

Ford Motor Company  
Customer Relationship Center  
P.O. Box 6248  
Dearborn, Michigan 48121  
1-800-392-3673 (FORD)  
(TDD for the hearing impaired: 1-800-232-5952)  
[www.ford.com](http://www.ford.com), click on "contact us"

In Canada:

Customer Relationship Centre

## Customer Assistance

Ford Motor Company of Canada, Limited  
P.O. Box 2000  
Oakville, Ontario L6J 5E4  
1-800-565-3673 (FORD)  
www.ford.ca

If you own a Lincoln vehicle and are away from home when your vehicle needs service, or if you need more help than the dealership could provide, after following the steps described above, contact the Ford Customer Relationship Center to find an authorized dealership to help you.

In the United States:  
Ford Motor Company  
Customer Relationship Center  
P.O. Box 6248  
Dearborn, Michigan 48121  
1-800-521-4140  
(TDD for the hearing impaired: 1-800-232-5952)  
www.ford.com, click on “contact us”

In Canada:  
Lincoln Centre  
Ford Motor Company of Canada, Limited  
P.O. Box 2000  
Oakville, Ontario L6J 5E4  
1-800-387-9333  
www.lincolncanada.com

In order to help you service your Lincoln vehicle, please have the following information available when contacting the Lincoln Centre:

- Your telephone number (home and business)
- The name of the dealer and the city where the dealership is located
- The year and make of your vehicle
- The date of vehicle purchase
- The current odometer reading
- The vehicle identification number (VIN)

If you still have a complaint involving a warranty dispute, you may wish to contact the Dispute Settlement Board (U.S.).

In some states (in the U.S.) you must directly notify Ford in writing before pursuing remedies under your state’s warranty laws. Ford is also allowed a final repair attempt in some states.

200



## Customer Assistance

In the United States, a warranty dispute must be submitted to the Dispute Settlement Board before taking action under the Magnuson-Moss Warranty Act, or to the extent allowed by state law, before pursuing replacement or repurchase remedies provided by certain state laws. This dispute handling procedure is not required prior to enforcing state created rights or other rights which are independent of the Magnuson-Moss Warranty Act or state replacement or repurchase laws.

### **FORD EXTENDED SERVICE PLAN**

You can get more protection for your new car or light truck by purchasing Ford Extended Service Plan (Ford ESP) coverage. Ford ESP is an optional service contract which is backed by Ford Motor Company or Ford Motor Service Company (in the U.S.) and Ford of Canada (in Canada). It provides the following:

- Benefits during the warranty period depending on the plan you purchase (such as: reimbursement for rentals; coverage for certain maintenance and wear items).
- Protection against covered repair costs after your Bumper-to-Bumper Warranty expires.

You may purchase Ford ESP from any participating Ford and Lincoln Mercury and Ford of Canada dealer. There are several plans available in various time, distance and deductible combinations which can be tailored to fit your own driving needs. Ford ESP also offers reimbursement benefits for towing and rental coverage.

When you buy Ford ESP, you receive Peace-of-Mind protection throughout the United States and Canada, provided by a network of more than 5,000 participating Ford or Lincoln Mercury and Ford of Canada dealers.

If you did not take advantage of the Ford Extended Service Plan at the time of purchasing your vehicle, you may still be eligible. Since this information is subject to change, please ask your dealer for complete details about Ford Extended Service Plan coverage options, or visit the Ford ESP website at [www.ford-esp.com](http://www.ford-esp.com).

### **THE DISPUTE SETTLEMENT BOARD (U.S. ONLY)**

The Dispute Settlement Board is:

- an independent, third-party arbitration program for warranty disputes.
- available free to owners and lessees of qualifying Ford Motor Company vehicles.

## Customer Assistance

The Dispute Settlement Board may not be available in all states. Ford Motor Company reserves the right to change eligibility limitations, modify procedures and/or to discontinue this service without notice and without incurring obligations per applicable state law.

### What kinds of cases does the Board review?

Unresolved warranty repair concerns or vehicle performance concerns as on Ford and Lincoln Mercury cars and Ford and Lincoln Mercury light trucks which are within the terms of any applicable written new vehicle warranty are eligible for review, except those involving:

- a non-Ford product
- a non-Ford dealership
- sales disputes between customer and dealer except those associated with warranty repairs or concerns with the vehicle's performance as designed
- a request for reimbursement of consequential expenses unless a service or product concern is being reviewed
- items not covered by the New Vehicle Limited Warranty (including maintenance and wear items)
- alleged personal injury/property damage claims
- cases currently in litigation
- vehicles not used primarily for family, personal or household purposes (except in states where the Dispute Settlement Board is required to review commercial vehicles)
- vehicles with non-U.S. warranties

Concerns are ineligible for review if the New Vehicle Limited Warranty has expired at receipt of your application and, in certain states eligibility is dependent upon the customer's possession of the vehicle.

Eligibility may differ according to state law. For example, see the unique brochures for California, West Virginia, Georgia and Wisconsin purchasers/lessees.

### Board membership

The Board consists of:

- Three consumer representatives
- A Ford or Lincoln Mercury dealership representative

Consumer candidates for Board membership are recruited and trained by an independent consulting firm. The dealership Board member is chosen

202

## Customer Assistance

from Ford and Lincoln Mercury dealership management, recognized for their business leadership qualities.

### **What the Board needs**

To have your case reviewed you must complete the application in the DSB brochure and mail it to the address provided on the application form. Some states will require you to use certified mail, with return receipt requested.

Your application is reviewed and, if it is determined to be eligible, you will receive an acknowledgment indicating:

- The file number assigned to your application.
- The toll-free phone number of the DSB's independent administrator.

Your dealership and a Ford Motor Company representative will then be asked to submit statements.

To properly review your case, the Board needs the following information:

- Legible copies of all documents and maintenance or repair orders relevant to the case.
- The year, make, model, and Vehicle Identification Number (VIN) listed on your vehicle ownership license.
- The date of repair(s) and mileage at the time of occurrence(s).
- The current mileage.
- The name of the dealer(s) who sold or serviced the vehicle.
- A brief description of your unresolved concern.
- A brief summary of the action taken by the dealer(s) and Ford Motor Company.
- The names (if known) of all the people you contacted at the dealership(s).
- A description of the action you expect to resolve your concern.

You will receive a letter of explanation if your application does not qualify for Board review.

### **Oral presentations**

If you would like to make an oral presentation, indicate YES to question 6 on the application. While it is your right to make an oral presentation before the Board, this is not a requirement and the Board will decide the case whether or not an oral presentation is made. An oral presentation may be requested by the Board as well.

## Customer Assistance

### ***Making a decision***

Board members review all available information related to each complaint, including oral presentations, and arrive at a fair and impartial decision. Board review may be terminated at any time by either party.

Every effort is made to decide the case within 40 days of the date that all requested information is received by the Board. Since the Board generally meets once a month, it may take longer for the Board to consider some cases.

After a case is reviewed, the Board mails you a decision letter and a form on which to accept or reject the Board's decision. The decisions of the Board are binding on Ford (and, in some cases, on the dealer) but not on consumers who are free to pursue other remedies available to them under state or federal law.

### **To request a DSB Brochure/Application**

For a brochure/application, speak to your dealer or write/call to the Board at the following address/phone number:

Dispute Settlement Board  
P.O. Box 5120  
Southfield, MI 48086-5120  
1-800-428-3718

You may also contact the North American Customer Relationship Center at 1-800-392-3673 (Ford), TDD for the hearing impaired: 1-800-232-5952 or by writing to the Center at the following address:

Ford Motor Company  
Customer Relationship Center  
P.O. Box 6248  
Dearborn, Michigan 48121

### **UTILIZING THE MEDIATION/ARBITRATION PROGRAM (CANADA ONLY)**

In those cases where you continue to feel that the efforts by Ford and the dealer to resolve a factory-related vehicle service concern have been unsatisfactory, Ford of Canada participates in an impartial third party mediation/arbitration program administered by the Canadian Motor Vehicle Arbitration Plan (CAMVAP).

The CAMVAP program is a straight-forward and relatively speedy alternative to resolve a disagreement when all other efforts to produce a settlement have failed. This procedure is without cost to you and is designed to eliminate the need for lengthy and expensive legal proceedings.

204

## Customer Assistance

In the CAMVAP program, impartial third-party arbitrators conduct hearings at mutually convenient times and places in an informal environment. These impartial arbitrators review the positions of the parties, make decisions and, when appropriate, render awards to resolve disputes. CAMVAP decisions are fast, fair, and final; the arbitrator's award is binding both to you and Ford of Canada.

CAMVAP services are available in all territories and provinces. For more information, without charge or obligation, call your CAMVAP Provincial Administrator directly at 1-800-207-0685.

### **GETTING ASSISTANCE OUTSIDE THE U.S. AND CANADA**

Before exporting your vehicle to a foreign country, contact the appropriate foreign embassy or consulate. These officials can inform you of local vehicle registration regulations and where to find unleaded fuel.

If you cannot find unleaded fuel or can only get fuel with an anti-knock index lower than is recommended for your vehicle, contact a district or owner relations/customer relationship office.

The use of leaded fuel in your vehicle without proper conversion may damage the effectiveness of your emission control system and may cause engine knocking or serious engine damage. Ford Motor Company/Ford of Canada is not responsible for any damage caused by use of improper fuel.

In the United States, using leaded fuel may also result in difficulty importing your vehicle back into the U.S.

If your vehicle must be serviced while you are traveling or living in Central or South America, the Caribbean, or the Middle East, contact the nearest Ford dealership. If the dealership cannot help you, write or call:

FORD MOTOR COMPANY  
WORLDWIDE DIRECT MARKET OPERATIONS  
1555 Fairlane Drive  
Fairlane Business Park #3  
Allen Park, Michigan 48101  
U.S.A.  
Telephone: (313) 594-4857  
FAX: (313) 390-0804

If you are in another foreign country, contact the nearest Ford dealership. If the dealership employees cannot help you, they can direct you to the nearest Ford affiliate office.

If you buy your vehicle in North America and then relocate outside of the U.S. or Canada, register your vehicle identification number (VIN) and new address with Ford Motor Company Worldwide Direct Market Operations.

## Customer Assistance

### ORDERING ADDITIONAL OWNER'S LITERATURE

To order the publications in this portfolio, contact Helm, Incorporated at:

HELM, INCORPORATED  
P.O. Box 07150  
Detroit, Michigan 48207

Or call:

**For a free publication catalog, order toll free: 1-800-782-4356**

Monday-Friday 8:00 a.m. - 6:00 p.m. EST

Helm, Incorporated can also be reached by their website:  
[www.helminc.com](http://www.helminc.com).

*(Items in this catalog may be purchased by credit card, check or money order.)*

### Obtaining a French owner's guide

French Owner's Guides can be obtained from your dealer or by writing to Ford Motor Company of Canada, Limited, Service Publications, P.O. Box 1580, Station B, Mississauga, Ontario L4Y 4G3.

### IN CALIFORNIA (U.S. ONLY)

California Civil Code Section 1793.2(d) requires that, if a manufacturer or its representative is unable to repair a motor vehicle to conform to the vehicle's applicable express warranty after a reasonable number of attempts, the manufacturer shall be required to either replace the vehicle with one substantially identical or repurchase the vehicle and reimburse the buyer in an amount equal to the actual price paid or payable by the consumer (less a reasonable allowance for consumer use). The consumer has the right to choose whether to receive a refund or replacement vehicle.

California Civil Code Section 1793.22(b) presumes that the manufacturer has had a reasonable number of attempts to conform the vehicle to its applicable express warranties if, within the first 18 months of ownership of a new vehicle or the first 29,000 km (18,000 miles), whichever occurs first:

1. Two or more repair attempts are made on the same nonconformity likely to cause death or serious bodily injury OR
2. Four or more repair attempts are made on the same nonconformity (a defect or condition that substantially impairs the use, value or safety of the vehicle) OR

206

**2003 F250/350/450/550 (f23)**  
**Owners Guide (post-2002-fmt)**  
**USA English (fus)**

## Customer Assistance

3. The vehicle is out of service for repair of nonconformities for a total of more than 30 calendar days (not necessarily all at one time)

In the case of 1 or 2 above, the consumer must also notify the manufacturer of the need for the repair of the nonconformity at the following address:

Ford Motor Company  
16800 Executive Plaza Drive  
Mail Drop 3NE-B  
Dearborn, MI 48126

### REPORTING SAFETY DEFECTS (U.S. ONLY)

If you believe that your vehicle has a defect which could cause a crash or could cause injury or death, you should immediately inform the National Highway Traffic Safety

*Ford Motor Company*

Administration (NHTSA) in addition to notifying Ford Motor Company.

If NHTSA receives similar complaints, it may open an investigation, and if it finds that a safety defect exists in a group of vehicles, it may order a recall and remedy campaign. However, NHTSA cannot become involved in individual problems between you, your dealer, or Ford Motor Company.

To contact NHTSA, you may either call the Auto Safety Hotline toll-free at 1-800-424-9393 (or 366-0123 in the Washington D.C. area) or write to:

NHTSA  
400 Seventh Street  
U.S. Department of Transportation  
Washington, D.C. 20590

You can also obtain other information about motor vehicle safety from the Hotline.

## Cleaning

### WASHING THE EXTERIOR

Wash your vehicle regularly with cool or lukewarm water and a neutral Ph shampoo, such as Motorcraft Detail Wash (ZC-3-A), which is available from your dealer.

- Never use strong household detergents or soap, such as dish washing or laundry liquid. These products can discolor and spot painted surfaces.
- Never wash a vehicle that is “hot to the touch” or during exposure to strong, direct sunlight.
- Always use a clean sponge or carwash mitt with plenty of water for best results.
- Dry the vehicle with a chamois or soft terry cloth towel in order to eliminate water spotting.
- It is especially important to wash the vehicle regularly during the winter months, as dirt and road salt are difficult to remove and cause damage to the vehicle.
- Immediately remove items such as gasoline, diesel fuel, bird droppings and insect deposits because they can cause damage to the vehicle’s paintwork and trim over time.
- Remove any exterior accessories, such as antennas, before entering a car wash.
- **Suntan lotions and insect repellents can damage any painted surface; if these substances come in contact with your vehicle, wash off as soon as possible.**
- **If your vehicle is equipped with running boards, do not use rubber, plastic and vinyl protectant products on the running board surface, as the area may become slippery.**

### WAXING

Applying a polymer paint sealant to your vehicle every six months will assist in reducing minor scratches and paint damage.

- Wash the vehicle first.
- Do not use waxes that contain abrasives.
- Do not allow paint sealant to come in contact with any non-body (low-gloss black) colored trim, such as grained door handles, roof racks, bumpers, side moldings, mirror housings or the windshield cowl area. The paint sealant will “gray” or stain the parts over time.



### PAINT CHIPS

Your dealer has touch-up paint and sprays to match your vehicle's color. Take your color code (printed on a sticker in the driver's door jam) to your dealer to ensure you get the correct color.

- Remove particles such as bird droppings, tree sap, insect deposits, tar spots, road salt and industrial fallout before repairing paint chips.
- Always read the instructions before using the products.

### ALUMINUM WHEELS AND WHEEL COVERS

Aluminum wheels and wheel covers are coated with a clearcoat paint finish. In order to maintain their shine:

- Clean weekly with Motorcraft Wheel and Tire Cleaner (ZC-37-A), which is available from your dealer. Heavy dirt and brake dust accumulation may require agitation with a sponge. Rinse thoroughly with a strong stream of water.
- Never apply any cleaning chemical to hot or warm wheel rims or covers.
- Some automatic car washes may cause damage to the finish on your wheel rims or covers. Chemical-strength cleaners, or cleaning chemicals, in combination with brush agitation to remove brake dust and dirt, could wear away the clearcoat finish over time.
- Do not use hydrofluoric acid-based or high caustic-based wheel cleaners, steel wool, fuels or strong household detergent.
- To remove tar and grease, use Motorcraft Bug and Tar Remover (ZC-42), available from your dealer.

### ENGINE

Engines are more efficient when they are clean because grease and dirt buildup keep the engine warmer than normal. When washing:

- Take care when using a power washer to clean the engine. The high-pressure fluid could penetrate the sealed parts and cause damage.
- Do not spray a hot engine with cold water to avoid cracking the engine block or other engine components.
- Spray Motorcraft Engine Shampoo and Degreaser (ZC-20) on all parts that require cleaning and pressure rinse clean.
- Never wash or rinse the engine while it is running; water in the running engine may cause internal damage.

## Cleaning

- Cover the highlighted areas to prevent water damage when cleaning the engine.

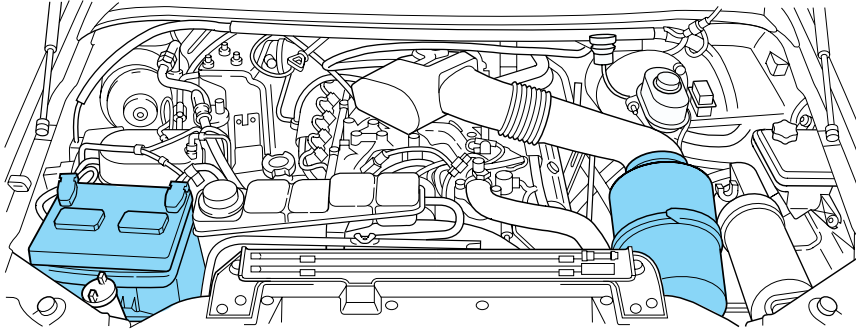

- **5.4L V8/6.8L V10 gasoline engines**

### **PLASTIC (NON-PAINTED) EXTERIOR PARTS**

Use only approved products to clean plastic parts. These products are available from your dealer.

- For routine cleaning, use Motorcraft Detail Wash (ZC-3-A).
- If tar or grease spots are present, use Motorcraft Bug and Tar Remover (ZC-42).

### **WINDOWS AND WIPER BLADES**

The windshield, rear window and wiper blades should be cleaned regularly. If the wiper does not wipe properly, substances on the windshield, rear window or the wiper blades may be the cause. These may include hot wax treatments used by commercial car washes, tree sap, or other organic contamination. To clean these items, please follow these tips:

- The windshield or rear window may be cleaned with a non-abrasive cleaner such as Motorcraft Ultra Clear Spray Glass Cleaner (ZC-23), available from your dealer.
- Do not use abrasives, as they may cause scratches.
- Do not use fuel, kerosene, or paint thinner to clean any parts.
- Wiper blades can be cleaned with isopropyl (rubbing) alcohol or windshield washer solution. Be sure to replace wiper blades when they appear worn or do not function properly.

## Cleaning

### INSTRUMENT PANEL AND CLUSTER LENS

Clean the instrument panel with a damp cloth, then dry with a dry cloth.

- Avoid cleaners or polish that increase the gloss of the upper portion of the instrument panel. The dull finish in this area helps protect the driver from undesirable windshield reflection.



Do not use chemical solvents or strong detergents when cleaning the steering wheel or instrument panel to avoid contamination of the air bag system.

- Be certain to wash or wipe your hands clean if you have been in contact with certain products such as insect repellent and suntan lotion in order to avoid possible damage to the interior painted surfaces.

### INTERIOR TRIM

- Clean the interior trim areas with a damp cloth, then dry by wiping with a dry, soft, clean cloth.
- Do not use household or glass cleaners as these may damage the finish.

### INTERIOR

For fabric, carpets, cloth seats and safety belts:

- Remove dust and loose dirt with a vacuum cleaner.
- Remove light stains and soil with Motorcraft Extra Strength Upholstery Cleaner (ZC-41).
- If grease or tar is present on the material, spot-clean the area first with Motorcraft Spot and Stain Remover (ZC-14).
- Never saturate the seat covers with cleaning solution.
- Do not use household cleaning products or glass cleaners, which can stain and discolor the fabric and affect the flame retardant abilities of the seat materials.



Do not use cleaning solvents, bleach or dye on the vehicle's seatbelts, as these actions may weaken the belt webbing.

## Cleaning

### **LEATHER SEATS (IF EQUIPPED, EXCEPT FOR THE KING RANCH F-250 AND F-350 CREWCAB)**

Your leather seating surfaces have a clear, protective coating over the leather.

**For King Ranch F-250 and F-350 CrewCab leather seats, refer to separate section in this chapter.**

- To clean, use a soft cloth with Motorcraft Deluxe Leather and Vinyl Cleaner (ZC-11-A). Dry the area with a soft cloth.
- To help maintain its resiliency and color, use the Motorcraft Deluxe Leather Care Kit (ZC-11-D), available from your authorized dealer.
- Do not use household cleaning products, alcohol solutions, solvents or cleaners intended for rubber, vinyl and plastics, or oil/petroleum-based leather conditioners. These products may cause premature wearing of the clear, protective coating on the seat.

### **LEATHER SEATS FOR THE KING RANCH F-250 AND F-350 CREWCAB ONLY (IF EQUIPPED)**

Your vehicle is equipped with seating covered in premium, top-grain leather which is extremely durable, but still requires special care and maintenance in order to ensure longevity and comfort.

Regular cleaning and conditioning will maintain the appearance of the leather. Failure to care for the leather can result in drying out and fading of the material.

#### **Cleaning**

For dirt, use a vacuum cleaner then use a clean, damp cloth or soft brush.

First use a damp cloth then wipe with a dry cloth. Allow the area to dry, then apply conditioner.

- Clean spills as quickly as possible.
- Test any cleaner or stain remover on an inconspicuous part of the leather as cleaners may darken the leather. For more specific cleaning information, contact the King Ranch Saddle Shop at 1-800-282-KING (5464).
- Do not spill coffee, ketchup, mustard, orange juice or oil-based products on the leather as they may permanently stain the leather.
- Do not use household cleaning products, alcohol solutions, solvents or cleaners intended for rubber, vinyl or plastics.

## Cleaning

### Scratches

In order to lessen the appearance of certain scratches and other wear marks, apply conditioner on the affected area following the same instructions as in the *Conditioning* section.

### Conditioning

Bottles of King Ranch Leather Conditioner are available at the King Ranch Saddle Shop. Visit the Web site at [www.krsaddleshop.com](http://www.krsaddleshop.com), or telephone (in the United States) 1-800-282-KING (5464). If you are unable to obtain King Ranch Leather Conditioner, use another premium leather conditioner.

- Apply your first conditioning treatment within six months of taking delivery of your vehicle. Condition twice yearly in order to replenish lost oils and revitalize the aroma, suppleness and resilience of the leather.
- Clean the surfaces using the steps outlined in the *Cleaning* section.
- Ensure the leather is dry then apply a nickel-sized amount of conditioner to a clean, dry cloth
- Rub the conditioner into leather until it disappears. Allow the conditioner to dry and repeat the process for the entire interior. If a film appears, wipe off film with a dry, clean cloth.

### UNDERBODY

Flush the complete underside of your vehicle frequently. Keep body and door drain holes free from packed dirt.

### FORD, LINCOLN AND MERCURY CAR CARE PRODUCTS

Your Ford, Lincoln or Mercury dealer has many quality products available to clean your vehicle and protect its finishes. These quality products have been specifically engineered to fulfill your automotive needs; they are custom designed to complement the style and appearance of your vehicle. Each product is made from high quality materials that meet or exceed rigid specifications. For best results, use the following products or products of equivalent quality:

Motorcraft Custom Clearcoat Polish (ZC-8-A)

Motorcraft Custom Vinyl Protectant (not available in Canada) (ZC-40-A)

Motorcraft Vinyl Cleaner (Canada only) (CXC-93)

Motorcraft Vinyl Conditioner (Canada only) (CXC-94)

Motorcraft Deluxe Leather and Vinyl Cleaner (not available in Canada) (ZC-11-A)

## Cleaning

Motorcraft Bug and Tar Remover (ZC-42)  
Motorcraft Extra Strength Upholstery Cleaner (not available in Canada)  
(ZC-41)  
Motorcraft Custom Bright Metal Cleaner (ZC-15)  
Motorcraft Wheel and Tire Cleaner (ZC-37-A)  
Motorcraft Dash and Vinyl Cleaner (ZC-38-A)  
Motorcraft Car Care Kit (ZC-26)  
Ford Premium Car Wash Concentrate (F2SZ-19523-WC)  
Motorcraft Carlite Glass Cleaner (Canada only) (CXC-100)  
Motorcraft Spot and Stain Remover (ZC-14)  
Motorcraft Detail Wash (ZC-3-A)  
Motorcraft Tire Clean and Shine (ZC-28)  
Motorcraft Triple Clean (ZC-13)  
Motorcraft Ultra-Clear Spray Glass Cleaner (not available in Canada)  
(ZC-23)  
Motorcraft Engine Shampoo and Degreaser (ZC-20)

## Maintenance and Specifications

### SERVICE RECOMMENDATIONS

To help you service your vehicle:

- We highlight do-it-yourself items in the engine compartment for easy location.
- We provide a scheduled maintenance guide which makes tracking routine service easy.

If your vehicle requires professional service, your dealership can provide the necessary parts and service. Check your *Warranty Guide/Owner Information Guide* to find out which parts and services are covered.

Use only recommended fuels, lubricants, fluids and service parts conforming to specifications. Motorcraft parts are designed and built to provide the best performance in your vehicle.

### PRECAUTIONS WHEN SERVICING YOUR VEHICLE

- Do not work on a hot engine.
- Make sure that nothing gets caught in moving parts.
- Do not work on a vehicle with the engine running in an enclosed space, unless you are sure you have enough ventilation.
- Keep all open flames and other burning (cigarettes) material away from the battery and all fuel related parts.

### Working with the engine off

- Automatic transmission:
  1. Set the parking brake and shift to P (Park).
  2. Turn off the engine and remove the key.
  3. Block the wheels.
- Manual transmission:
  1. Set the parking brake, depress the clutch and place the gearshift in 1 (First).
  2. Turn off the engine and remove the key.
  3. Block the wheels.

### Working with the engine on

- Automatic transmission:
  1. Set the parking brake and shift to P (Park).
  2. Block the wheels.

## Maintenance and Specifications

- Manual transmission:
  1. Set the parking brake, depress the clutch and place the gearshift in N (Neutral).
  2. Block the wheels.

**Note:** Do not start your engine with the air cleaner removed and do not remove it while the engine is running.

### OPENING THE HOOD

1. Inside the vehicle, pull the hood release handle located under the bottom left corner of the instrument panel.

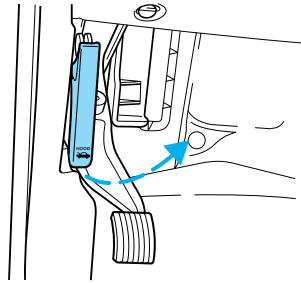

2. Go to the front of the vehicle and release the auxiliary latch located under the right center of the hood. Slide the handle to release the auxiliary latch.
3. Lift the hood until the lift cylinders hold it open.

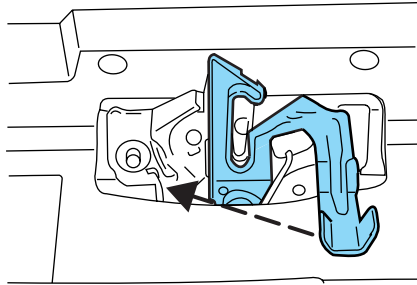



## Maintenance and Specifications

### IDENTIFYING COMPONENTS IN THE ENGINE COMPARTMENT

#### 5.4L V8/6.8L V10 gasoline engines

Refer to the *6.0 Liter Power Stroke Direct Injection Turbo Diesel Owner's Guide Supplement* for diesel engine component locations.

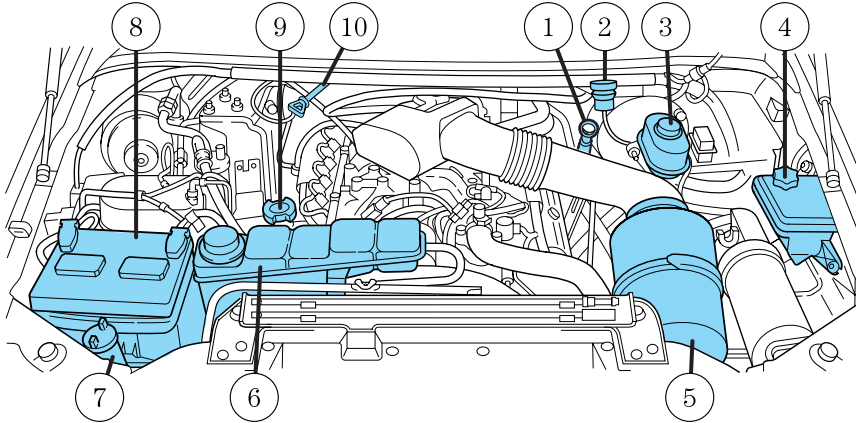

1. Engine oil dipstick
2. Clutch fluid reservoir (manual transmission)
3. Brake fluid reservoir
4. Power steering fluid reservoir
5. Air filter assembly
6. Engine coolant reservoir
7. Windshield washer fluid reservoir
8. Battery
9. Engine oil filler cap
10. Transmission fluid dipstick (automatic transmission)

## Maintenance and Specifications

### WINDSHIELD WASHER FLUID

Add fluid to fill the reservoir if the level is low. In very cold weather, do not fill the reservoir completely.

Only use a washer fluid that meets Ford specification WSB-M8B16-A2. Refer to *Lubricant specifications* in this chapter.

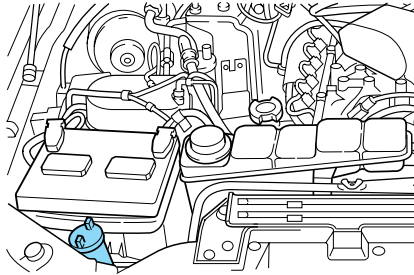

State or local regulations on volatile organic compounds may restrict the use of methanol, a common windshield washer antifreeze additive. Washer fluids containing non-methanol antifreeze agents should be used only if they provide cold weather protection without damaging the vehicle's paint finish, wiper blades or washer system.



If you operate your vehicle in temperatures below 4.5° C (40° F), use washer fluid with antifreeze protection. Failure to use washer fluid with antifreeze protection in cold weather could result in impaired windshield vision and increase the risk of injury or accident.

**Note:** Do not put washer fluid in the engine coolant reservoir. Washer fluid placed in the cooling system may harm engine and cooling system components.

### ENGINE OIL

#### Checking the engine oil

Refer to the scheduled maintenance guide for the appropriate intervals for checking the engine oil.

1. Make sure the vehicle is on level ground.
2. Turn the engine off and wait a few minutes for the oil to drain into the oil pan.
3. Set the parking brake and ensure the gearshift is securely latched in P (Park) (automatic transmission) or 1 (First) (manual transmission).
4. Open the hood. Protect yourself from engine heat.

## Maintenance and Specifications

5. Locate and carefully remove the engine oil level indicator (dipstick).

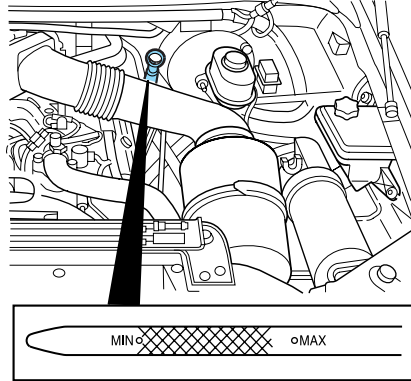

6. Wipe the indicator clean. Insert the indicator fully, then remove it again.

- If the oil level is **between the MIN and MAX marks**, the oil level is acceptable. **DO NOT ADD OIL.**
- If the oil level is below the MIN mark, add enough oil to raise the level within the MIN-MAX range.

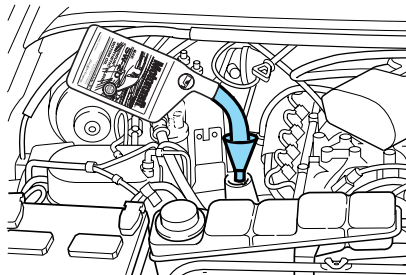

- Oil levels above the MAX mark may cause engine damage. Some oil must be removed from the engine by a service technician.

7. Put the indicator back in and ensure it is fully seated.

### Adding engine oil

1. Check the engine oil. For instructions, refer to *Checking the engine oil* in this chapter.
2. If the engine oil level is not within the normal range, add only certified engine oil of the recommended viscosity. Remove the engine oil filler cap and use a funnel to pour the engine oil into the opening.

## Maintenance and Specifications

3. Recheck the engine oil level. Make sure the oil level is not above the MAX mark on the engine oil level indicator (dipstick).
4. Install the indicator and ensure it is fully seated.
5. Fully install the engine oil filler cap by turning the filler cap clockwise 1/4 of a turn until three clicks are heard or until the cap is fully seated.

**To avoid possible oil loss, DO NOT operate the vehicle with the engine oil level indicator and/or the engine oil filler cap removed.**

### Engine oil and filter recommendations

Look for this certification trademark.

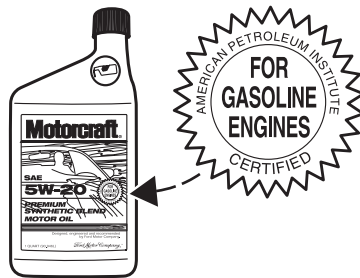

### **Use SAE 5W-20 engine oil.**

Only use oils “Certified For Gasoline Engines” by the American Petroleum Institute (API). To protect your engine’s warranty use Motorcraft SAE 5W-20 or an equivalent 5W-20 oil meeting Ford specification WSS-M2C153-H. **SAE 5W-20 oil provides optimum fuel economy and durability performance meeting all requirements for your vehicle’s engine.**

Do not use supplemental engine oil additives, cleaners or other engine treatments. They are unnecessary and could lead to engine damage that is not covered by Ford warranty.

Change your engine oil according to the appropriate schedule listed in the scheduled maintenance guide.

Ford production and aftermarket (Motorcraft) oil filters are designed for added engine protection and long life. If a replacement oil filter is used that does not meet Ford material and design specifications, start-up engine noises or knock may be experienced.

It is recommended you use the appropriate Motorcraft oil filter (or another brand meeting Ford specifications) for your engine application.

## Maintenance and Specifications

### BATTERY

Your vehicle is equipped with a Motorcraft maintenance-free battery which normally does not require additional water during its life of service.

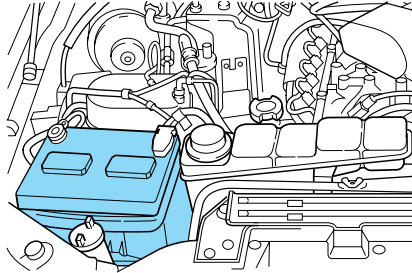

However, for severe usage or in high temperature climates, check the battery electrolyte level. Refer to the scheduled maintenance guide for the service interval schedules.

**Keep the electrolyte level in each cell up to the “level indicator”. Do not overfill the battery cells.**

If the electrolyte level in the battery is low, you can add plain tap water to the battery, as long as you do not use hard water (water with a high mineral or alkali content). If possible, however, try to only fill the battery cells with distilled water. If the battery needs water often, have the charging system checked.

**If your battery has a cover/shield, make sure it is reinstalled after the battery has been cleaned or replaced.**

For longer, trouble-free operation, keep the top of the battery clean and dry. Also, make certain the battery cables are always tightly fastened to the battery terminals.

If you see any corrosion on the battery or terminals, remove the cables from the terminals and clean with a wire brush. You can neutralize the acid with a solution of baking soda and water.

When the battery is disconnected or a new battery installed, the transmission must learn its adaptive strategy. As a result of this, the transmission may shift firmly. This operation is considered normal and will fully update transmission operation to its optimum shift feel.



Batteries normally produce explosive gases which can cause personal injury. Therefore, do not allow flames, sparks or lighted substances to come near the battery. When working near the battery, always shield your face and protect your eyes. Always provide proper ventilation.

## Maintenance and Specifications

 When lifting a plastic-cased battery, excessive pressure on the end walls could cause acid to flow through the vent caps, resulting in personal injury and/or damage to the vehicle or battery. Lift the battery with a battery carrier or with your hands on opposite corners.

 Keep batteries out of reach of children. Batteries contain sulfuric acid. Avoid contact with skin, eyes or clothing. Shield your eyes when working near the battery to protect against possible splashing of acid solution. In case of acid contact with skin or eyes, flush immediately with water for a minimum of 15 minutes and get prompt medical attention. If acid is swallowed, call a physician immediately.

 Battery posts, terminals and related accessories contain lead and lead compounds. **Wash hands after handling.**

For information on transmission operation after the battery has been disconnected see “Shift strategy” in the driving section.

Because your vehicle’s engine is also electronically controlled by a computer, some control conditions are maintained by power from the battery. When the battery is disconnected or a new battery is installed, the engine must relearn its idle and fuel trim strategy for optimum driveability and performance. To begin this process:

1. With the vehicle at a complete stop, set the parking brake.
2. Put the gearshift in P (Park) (automatic transmission) or the neutral position (manual transmission), turn off all accessories and start the engine.
3. Run the engine until it reaches normal operating temperature.
4. Allow the engine to idle for at least one minute.
5. Turn the A/C on and allow the engine to idle for at least one minute.
6. Drive the vehicle to complete the relearning process.
  - The vehicle may need to be driven 16 km (10 miles) or more to relearn the idle and fuel trim strategy.
  - **If you do not allow the engine to relearn its idle trim, the idle quality of your vehicle may be adversely affected until the idle trim is eventually relearned.**

If the battery has been disconnected or a new battery has been installed, the clock and the preset radio stations must be reset once the battery is reconnected.

## Maintenance and Specifications

- Always dispose of automotive batteries in a responsible manner. Follow your local authorized standards for disposal. Call your local authorized recycling center to find out more about recycling automotive batteries.

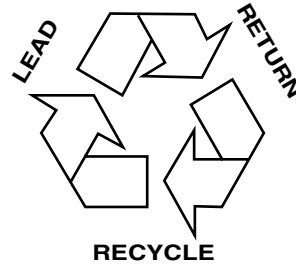

### ENGINE COOLANT

#### Checking engine coolant

The concentration and level of engine coolant should be checked at the mileage intervals listed in the scheduled maintenance guide. The coolant concentration should be maintained at 50/50 coolant and distilled water, which equates to a freeze point of  $-36^{\circ}\text{C}$  ( $-34^{\circ}\text{F}$ ). Coolant concentration testing is possible with a hydrometer or antifreeze tester (such as the Rotunda Battery and Antifreeze Tester, 014-R1060). The level of coolant should be maintained at the “cold full” or “cold fill range” level in the coolant reservoir. If the level falls below, add coolant per the instructions in the *Adding engine coolant* section.

Your vehicle was factory-filled with a 50/50 engine coolant and water concentration. If the concentration of coolant falls below 40% or above 60%, the engine parts could become damaged or not work properly. **A 50–50 mixture of coolant and water provides the following:**

- **Freeze protection down to  $-36^{\circ}\text{C}$  ( $-34^{\circ}\text{F}$ ).**
- **Boiling protection up to  $129^{\circ}\text{C}$  ( $265^{\circ}\text{F}$ ).**
- **Protection against rust and other forms of corrosion.**
- **Enables calibrated gauges to work properly.**

## Maintenance and Specifications

When the engine is cold, check the level of the engine coolant in the reservoir.

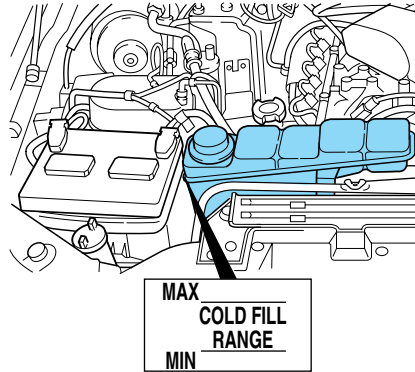

- The engine coolant should be at the “cold fill level” or within the “cold fill range” as listed on the engine coolant reservoir (depending upon application).
- Refer to the Scheduled Maintenance Guide for service interval schedules.
- Be sure to read and understand *Precautions when servicing your vehicle* in this chapter.

If the engine coolant has not been checked at the recommended interval, the engine coolant reservoir may become low or empty. If the reservoir is low or empty, add engine coolant to the reservoir. Refer to *Adding engine coolant* in this chapter.

**Note:** Automotive fluids are not interchangeable; do not use engine coolant, antifreeze or windshield washer fluid outside of its specified function and vehicle location.

### Adding engine coolant

When adding coolant, make sure it is a 50/50 mixture of engine coolant and distilled water. Add the mixture to the coolant reservoir, **when the engine is cool**, until the appropriate fill level is obtained.



Do not add engine coolant when the engine is hot. Steam and scalding liquids released from a hot cooling system can burn you badly. Also, you can be burned if you spill coolant on hot engine parts.



## Maintenance and Specifications



Do not put engine coolant in the windshield washer fluid container. If sprayed on the windshield, engine coolant could make it difficult to see through the windshield.

- **Add Motorcraft Premium Gold Engine Coolant (yellow-colored), VC-7-A (VC-7-B in Oregon), meeting Ford Specification WSS-M97B51-A1.**

**Note:** Use of Motorcraft Cooling System Stop Leak Pellets, VC-6, may darken the color of Motorcraft Premium Gold Engine Coolant from yellow to golden tan.

- **Do not add/mix an orange-colored, extended life coolant such as Motorcraft Speciality Orange Engine Coolant, VC-2 (US) or CXC-209 (Canada), meeting Ford specification WSS-M97B44-D with the factory-filled coolant.** Mixing Motorcraft Speciality Orange Engine Coolant or any orange-colored extended life product with your factory filled coolant can result in degraded corrosion protection.
- A large amount of water without engine coolant may be added, in case of emergency, to reach a vehicle service location. In this instance, the cooling system must be drained and refilled with a 50/50 mixture of engine coolant and distilled water as soon as possible. Water alone (without engine coolant) can cause engine damage from corrosion, overheating or freezing.
- **Do not use alcohol, methanol, brine or any engine coolants mixed with alcohol or methanol antifreeze (coolant).** Alcohol and other liquids can cause engine damage from overheating or freezing.
- **Do not add extra inhibitors or additives to the coolant.** These can be harmful and compromise the corrosion protection of the engine coolant.

For vehicles with overflow coolant systems with a non-pressurized cap on the coolant recovery system, add coolant to the coolant recovery reservoir when the engine is cool. Add the proper mixture of coolant and water to the “cold full” level. For all other vehicles, which have a coolant degas system with a pressurized cap, or if it is necessary to remove the coolant pressure relief cap on the radiator of a vehicle with an overflow system, follow these steps to add engine coolant.



To reduce the risk of personal injury, make sure the engine is cool before unscrewing the coolant pressure relief cap. The cooling system is under pressure; steam and hot liquid can come out forcefully when the cap is loosened slightly.

## Maintenance and Specifications

1. Before you begin, turn the engine off and let it cool.
2. When the engine is cool, wrap a thick cloth around the coolant pressure relief cap on the coolant reservoir (a translucent plastic bottle). Slowly turn cap counterclockwise (left) until pressure begins to release.
3. Step back while the pressure releases.
4. When you are sure that all the pressure has been released, use the cloth to turn it counterclockwise and remove the cap.
5. Fill the coolant reservoir slowly with the proper coolant mixture (see above), to within the “cold fill range” or the “cold full” level on the reservoir. If you removed the radiator cap in an overflow system, fill the radiator until the coolant is visible and radiator is almost full.
6. Replace the cap. Turn until tightly installed. (Cap must be tightly installed to prevent coolant loss.)

After any coolant has been added, check the coolant concentration, refer to *Checking Engine Coolant* section. If the concentration is not 50/50 (protection to  $-34^{\circ}\text{F}/-36^{\circ}\text{C}$ ), drain some coolant and adjust the concentration. It may take several drains and additions to obtain a 50/50 coolant concentration.

Whenever coolant has been added, the coolant level in the coolant reservoir should be checked the next few times you drive the vehicle. If necessary, add enough 50/50 concentration of engine coolant and distilled water to bring the liquid level to the proper level.

If you have to add more than 1.0 liter (1.0 quart) of engine coolant per month, have your dealer check the engine cooling system. Your cooling system may have a leak. Operating an engine with a low level of coolant can result in engine overheating and possible engine damage.

### Recycled engine coolant

Ford Motor Company does NOT recommend the use of recycled engine coolant in vehicles originally equipped with Motorcraft Premium Gold Engine Coolant since a Ford-approved recycling process is not yet available.



Used engine coolant should be disposed of in an appropriate manner. Follow your community's regulations and standards for recycling and disposing of automotive fluids.

### Coolant refill capacity

To find out how much fluid your vehicle's cooling system can hold, refer to *Refill capacities* in this chapter.

## Maintenance and Specifications

Fill your engine coolant reservoir as outlined in *Adding engine coolant* in this chapter.

### Severe climates

If you drive in extremely cold climates (less than  $-36^{\circ}\text{C}$  [ $-34^{\circ}\text{F}$ ):

- **It may be necessary to increase the coolant concentration above 50%.**
- **NEVER increase the coolant concentration above 60%.**
- **Increased engine coolant concentrations above 60% will decrease the overheat protection characteristics of the engine coolant and may cause engine damage.**
- **Refer to the chart on the coolant container to ensure the coolant concentration in your vehicle will provide adequate freeze protection at the temperatures in which you drive in the winter months.**

If you drive in extremely hot climates:

- **It is still necessary to maintain the coolant concentration above 40%.**
- **NEVER decrease the coolant concentration below 40%.**
- **Decreased engine coolant concentrations below 40% will decrease the corrosion protection characteristics of the engine coolant and may cause engine damage.**
- **Decreased engine coolant concentrations below 40% will decrease the freeze protection characteristics of the engine coolant and may cause engine damage.**
- **Refer to the chart on the coolant container to ensure the coolant concentration in your vehicle will provide adequate protection at the temperatures in which you drive.**

Vehicles driven year-round in non-extreme climates should use a 50/50 mixture of engine coolant and distilled water for optimum cooling system and engine protection.



### What you should know about fail-safe cooling (if equipped)

If the engine coolant supply is depleted, this feature allows the vehicle to be driven temporarily before incremental component damage is incurred. The “fail-safe” distance depends on ambient temperatures, vehicle load and terrain.

## Maintenance and Specifications

### How fail-safe cooling works

If the engine begins to overheat:

- The engine coolant temperature gauge will move to the red (hot) area.
- The  and  symbol will illuminate.
- The *Service Engine Soon* indicator light will illuminate.

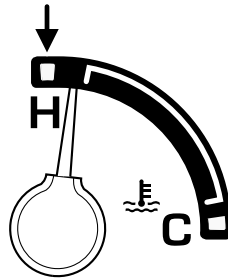

If the engine reaches a preset over-temperature condition, the engine will automatically switch to alternating cylinder operation. Each disabled cylinder acts as an air pump and cools the engine.

When this occurs the vehicle will still operate. However:

- The engine power will be limited.
- The air conditioning system will be disabled.

Continued operation will increase the engine temperature and the engine will completely shut down, causing steering and braking effort to increase.

Once the engine temperature cools, the engine can be re-started. Take your vehicle to a service facility as soon as possible to minimize engine damage.

### When fail-safe mode is activated

You have limited engine power when in the fail-safe mode, so drive the vehicle with caution. The vehicle will not be able to maintain high-speed operation and the engine will run rough. Remember that the engine is capable of completely shutting down automatically to prevent engine damage, therefore:

1. Pull off the road as soon as safely possible and turn off the engine.
2. Arrange for the vehicle to be taken to a service facility.
3. If this is not possible, wait a short period for the engine to cool.
4. Check the coolant level and replenish if low.



Never remove the coolant reservoir cap while the engine is running or hot.

## Maintenance and Specifications

5. Re-start the engine and take your vehicle to a service facility.

**Driving the vehicle without repairing the engine problem increases the chance of engine damage. Take your vehicle to a service facility as soon as possible.**

### WHAT YOU SHOULD KNOW ABOUT AUTOMOTIVE FUELS

#### Important safety precautions



Do not overfill the fuel tank. The pressure in an overfilled tank may cause leakage and lead to fuel spray and fire.



The fuel system may be under pressure. If the fuel filler cap is venting vapor or if you hear a hissing sound, wait until it stops before completely removing the fuel filler cap. Otherwise, fuel may spray out and injure you or others.



If you do not use the proper fuel filler cap, excessive pressure or vacuum in the fuel tank may damage the fuel system or cause the fuel cap to disengage in a collision, which may result in possible personal injury.



Automotive fuels can cause serious injury or death if misused or mishandled.



Gasoline may contain benzene, which is a cancer-causing agent.

Observe the following guidelines when handling automotive fuel:

- Extinguish all smoking materials and any open flames before fueling your vehicle.
- Always turn off the vehicle before fueling.
- Automotive fuels can be harmful or fatal if swallowed. Fuel such as gasoline is highly toxic and if swallowed can cause death or permanent injury. If fuel is swallowed, call a physician immediately, even if no symptoms are immediately apparent. The toxic effects of fuel may not be visible for hours.



## Maintenance and Specifications

- Avoid inhaling fuel vapors. Inhaling too much fuel vapor of any kind can lead to eye and respiratory tract irritation. In severe cases, excessive or prolonged breathing of fuel vapor can cause serious illness and permanent injury.
- Avoid getting fuel liquid in your eyes. If fuel is splashed in the eyes, remove contact lenses (if worn), flush with water for 15 minutes and seek medical attention. Failure to seek proper medical attention could lead to permanent injury.
- Fuels can also be harmful if absorbed through the skin. If fuel is splashed on the skin and/or clothing, promptly remove contaminated clothing and wash skin thoroughly with soap and water. Repeated or prolonged skin contact with fuel liquid or vapor causes skin irritation.
- Be particularly careful if you are taking “Antabuse” or other forms of disulfiram for the treatment of alcoholism. Breathing gasoline vapors, or skin contact could cause an adverse reaction. In sensitive individuals, serious personal injury or sickness may result. If fuel is splashed on the skin, promptly wash skin thoroughly with soap and water. Consult a physician immediately if you experience an adverse reaction.



When refueling always shut the engine off and never allow sparks or open flames near the filler neck. Never smoke while refueling. Fuel vapor is extremely hazardous under certain conditions. Care should be taken to avoid inhaling excess fumes.



The flow of fuel through a fuel pump nozzle can produce static electricity, which can cause a fire if fuel is pumped into an ungrounded fuel container.

Use the following guidelines to avoid static build-up when filling an ungrounded fuel container:

- Place approved fuel container on the ground.
- DO NOT fill a fuel container while it is in the vehicle (including the cargo area).
- Keep the fuel pump nozzle in contact with the fuel container while filling.
- DO NOT use a device that would hold the fuel pump handle in the fill position.

230

## Maintenance and Specifications

### Fuel Filler Cap

Your fuel tank filler cap has an indexed design with a 1/8 turn on/off feature.

When fueling your vehicle:

1. Turn the engine off.
2. Carefully turn the filler cap counterclockwise 1/8 of a turn until it stops.
3. Pull to remove the cap from the fuel filler pipe.
4. To install the cap, align the tabs on the cap with the notches on the filler pipe.
5. Turn the filler cap clockwise 1/8 of a turn until it stops.

If the “Service Engine Soon/Check Engine” indicator comes on and stays on after you start the engine, the fuel filler cap may not be properly installed. Turn off the engine, remove the fuel filler cap, align the cap properly and reinstall it.

**If you must replace the fuel filler cap, replace it with a fuel filler cap that is designed for your vehicle. The customer warranty may be void for any damage to the fuel tank or fuel system if the correct genuine Ford or Motorcraft fuel filler cap is not used.**



The fuel system may be under pressure. If the fuel filler cap is venting vapor or if you hear a hissing sound, wait until it stops before completely removing the fuel filler cap. Otherwise, fuel may spray out and injure you or others.



If you do not use the proper fuel filler cap, excessive pressure or vacuum in the fuel tank may damage the fuel system or cause the fuel cap to disengage in a collision, which may result in possible personal injury.

### Choosing the right fuel

Use only UNLEADED FUEL. The use of leaded fuel is prohibited by law and could damage your vehicle.

Do not use fuel containing methanol. It can damage critical fuel system components.

Your vehicle was not designed to use fuel or fuel additives with metallic compounds, including manganese-based additives.

## Maintenance and Specifications

Repairs to correct the effects of using a fuel for which your vehicle was not designed may not be covered by your warranty.

### Octane recommendations

Your vehicle is designed to use “Regular” unleaded gasoline with pump (R+M)/2 octane rating of 87. We do not recommend the use of gasolines labeled as “Regular” that are sold with octane ratings of 86 or lower in high altitude areas.

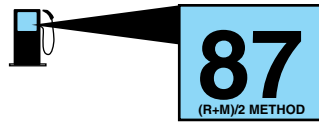

Do not be concerned if your engine sometimes knocks lightly. However, if it knocks heavily under most driving conditions while you are using fuel with the recommended octane rating, see your dealer or a qualified service technician to prevent any engine damage.

### Fuel quality

If you are experiencing starting, rough idle or hesitation driveability problems during a cold start, try a different brand of unleaded gasoline. “Premium” unleaded gasoline is not recommended for vehicles designed to use “Regular” unleaded gasoline because it may cause these problems to become more pronounced. If the problems persist, see your dealer or a qualified service technician.

It should not be necessary to add any aftermarket products to your fuel tank if you continue to use high quality fuel of the recommended octane rating. Aftermarket products could cause damage to the fuel system. Repairs to correct the effects of using an aftermarket product in your fuel may not be covered by your warranty.

Many of the world’s automakers approved the World-wide Fuel Charter that recommends gasoline specifications to provide improved performance and emission control system protection for your vehicle. Gasolines that meet the World-wide Fuel Charter should be used when available. Ask your fuel supplier about gasolines that meet the World-wide Fuel Charter.

### Cleaner air

Ford endorses the use of reformulated “cleaner-burning” gasolines to improve air quality.

### Running out of fuel

Avoid running out of fuel because this situation may have an adverse affect on powertrain components.

232



## Maintenance and Specifications

If you have run out of fuel:

- You may need to cycle the ignition from OFF to ON several times after refueling, to allow the fuel system to pump the fuel from the tank to the engine.
- Your “Service Engine Soon” indicator may come on. For more information on the “Service Engine Soon” indicator, refer to the *Instrument cluster* chapter.

### Fuel Filter

For fuel filter replacement, see your dealer or a qualified service technician. Refer to the scheduled maintenance guide for the appropriate intervals for changing the fuel filter.

**Replace the fuel filter with an authorized Motorcraft part. The customer warranty may be void for any damage to the fuel system if an authorized Motorcraft fuel filter is not used.**

## ESSENTIALS OF GOOD FUEL ECONOMY

### Measuring techniques

Your best source of information about actual fuel economy is you, the driver. You must gather information as accurately and consistently as possible. Fuel expense, frequency of fill-ups or fuel gauge readings are NOT accurate as a measure of fuel economy. We do not recommend taking fuel economy measurements during the first 1,600 km (1,000 miles) of driving (engine break-in period). You will get a more accurate measurement after 3,000 km–5,000 km (2,000 miles–3,000 miles).

### Filling the tank

The advertised fuel capacity of the fuel tank on your vehicle is equal to the rated refill capacity of the fuel tank as listed in the *Refill capacities* section of this chapter.

The advertised capacity is the amount of the indicated capacity and the empty reserve combined. Indicated capacity is the difference in the amount of fuel in a full tank and a tank when the fuel gauge indicates empty. Empty reserve is the small amount of fuel remaining in the fuel tank after the fuel gauge indicates empty.

**The amount of usable fuel in the empty reserve varies and should not be relied upon to increase driving range. When refueling your vehicle after the fuel gauge indicates empty, you might not be able to refuel the full amount of the advertised capacity of the fuel tank due to the empty reserve still present in the tank.**

## Maintenance and Specifications

For consistent results when filling the fuel tank:

- Turn the engine/ignition switch to the off position prior to refueling, an error in the reading will result if the engine is left running.
- Use the same filling rate setting (low — medium — high) each time the tank is filled.
- Allow no more than 2 automatic click-offs when filling.
- Always use fuel with the recommended octane rating.
- Use a known quality gasoline, preferably a national brand.
- Use the same side of the same pump and have the vehicle facing the same direction each time you fill up.
- Have the vehicle loading and distribution the same every time.

Your results will be most accurate if your filling method is consistent.

### Calculating fuel economy

1. Fill the fuel tank completely and record the initial odometer reading (in kilometers or miles).
2. Each time you fill the tank, record the amount of fuel added (in liters or gallons).
3. After at least three to five tank fill-ups, fill the fuel tank and record the current odometer reading.
4. Subtract your initial odometer reading from the current odometer reading.
5. Follow one of the simple calculations in order to determine fuel economy:

Calculation 1: **Multiply liters used by 100, then divide by total kilometers traveled.**

Calculation 2: **Divide total miles traveled by total gallons used.**

Keep a record for at least one month and record the type of driving (city or highway). This will provide an accurate estimate of the vehicle's fuel economy under current driving conditions. Additionally, keeping records during summer and winter will show how temperature impacts fuel economy. In general, lower temperatures give lower fuel economy.

### Driving style — good driving and fuel economy habits

Give consideration to the lists that follow and you may be able to change a number of variables and improve your fuel economy.

## Maintenance and Specifications

### **Habits**

- Smooth, moderate operation can yield up to 10% savings in fuel.
- Steady speeds without stopping will usually give the best fuel economy.
- Idling for long periods of time (greater than one minute) may waste fuel.
- Anticipate stopping; slowing down may eliminate the need to stop.
- Sudden or hard accelerations may reduce fuel economy.
- Slow down gradually.
- Driving at reasonable speeds (traveling at 88 km/h [55 mph] uses 15% less fuel than traveling at 105 km/h [65 mph]).
- Revving the engine before turning it off may reduce fuel economy.
- Using the air conditioner or defroster may reduce fuel economy.
- You may want to turn off the speed control in hilly terrain if unnecessary shifting between third and fourth gear occurs. Unnecessary shifting of this type could result in reduced fuel economy.
- Warming up a vehicle on cold mornings is not required and may reduce fuel economy.
- Resting your foot on the brake pedal while driving may reduce fuel economy.
- Combine errands and minimize stop-and-go driving.

### **Maintenance**

- Keep tires properly inflated and use only recommended size.
- Operating a vehicle with the wheels out of alignment will reduce fuel economy.
- Use recommended engine oil. Refer to *Lubricant specifications* in this chapter.
- Perform all regularly scheduled maintenance items. Follow the recommended maintenance schedule and owner maintenance checks found in your vehicle scheduled maintenance guide.

### **Conditions**

- Heavily loading a vehicle or towing a trailer may reduce fuel economy at any speed.
- Carrying unnecessary weight may reduce fuel economy (approximately 0.4 km/L [1 mpg] is lost for every 180 kg [400 lb] of weight carried).

## Maintenance and Specifications

- Adding certain accessories to your vehicle (for example bug deflectors, rollbars/light bars, running boards, ski/luggage racks) may reduce fuel economy.
- Using fuel blended with alcohol may lower fuel economy.
- Fuel economy may decrease with lower temperatures during the first 12–16 km (8–10 miles) of driving.
- Driving on flat terrain offers improved fuel economy as compared to driving on hilly terrain.
- Transmissions give their best fuel economy when operated in the top cruise gear and with steady pressure on the gas pedal.
- Four-wheel-drive operation (if equipped) is less fuel efficient than two-wheel-drive operation.
- Close windows for high speed driving.

### EPA window sticker

Every new vehicle should have the EPA window sticker. Contact your dealer if the window sticker is not supplied with your vehicle. The EPA window sticker should be your guide for the fuel economy comparisons with other vehicles.

It is important to note the box in the lower left corner of the window sticker. These numbers represent the Range of L/100 km (MPG) expected on the vehicle under optimum conditions. Your fuel economy may vary depending upon the method of operation and conditions.

### EMISSION CONTROL SYSTEM

Your vehicle is equipped with various emission control components and a catalytic converter which will enable your vehicle to comply with applicable exhaust emission standards. To make sure that the catalytic converter and other emission control components continue to work properly:

- Use only the specified fuel listed.
- Avoid running out of fuel.
- Do not turn off the ignition while your vehicle is moving, especially at high speeds.
- Have the items listed in your scheduled maintenance guide performed according to the specified schedule.

The scheduled maintenance items listed in the scheduled maintenance guide are essential to the life and performance of your vehicle and to its emissions system.

## Maintenance and Specifications

If other than Ford, Motorcraft or Ford-authorized parts are used for maintenance replacements or for service of components affecting emission control, such non-Ford parts should be equivalent to genuine Ford Motor Company parts in performance and durability.



Do not park, idle, or drive your vehicle in dry grass or other dry ground cover. The emission system heats up the engine compartment and exhaust system, which can start a fire.

Illumination of the “Service Engine Soon” light, charging system warning light or the temperature warning light, fluid leaks, strange odors, smoke or loss of engine power, could indicate that the emission control system is not working properly.



Exhaust leaks may result in entry of harmful and potentially lethal fumes into the passenger compartment.

Do not make any unauthorized changes to your vehicle or engine. By law, vehicle owners and anyone who manufactures, repairs, services, sells, leases, trades vehicles, or supervises a fleet of vehicles are not permitted to intentionally remove an emission control device or prevent it from working. Information about your vehicle’s emission system is on the Vehicle Emission Control Information Decal located on or near the engine. This decal identifies engine displacement and gives some tune up specifications.

Please consult your *Warranty Guide* for complete emission warranty information.

### On board diagnostics (OBD-II)

Your vehicle is equipped with a computer that monitors the engine’s emission control system. This system is commonly known as the On Board Diagnostics System (OBD-II). This OBD-II system protects the environment by ensuring that your vehicle continues to meet government emission standards. The OBD-II system also assists the service technician in properly servicing your vehicle. When the *Check Engine/Service Engine Soon* light illuminates, the OBD-II system has detected a malfunction. Temporary malfunctions may cause your *Check Engine/Service Engine Soon* light to illuminate. Examples are:

1. The vehicle has run out of fuel. (The engine may misfire or run poorly.)
2. Poor fuel quality or water in the fuel.

## Maintenance and Specifications

3. The fuel cap may not have been securely tightened.

These temporary malfunctions can be corrected by filling the fuel tank with good quality fuel and/or properly tightening the fuel cap. After three driving cycles without these or any other temporary malfunctions present, the *Check Engine/Service Engine Soon* light should turn off. (A driving cycle consists of a cold engine startup followed by mixed city/highway driving.) No additional vehicle service is required.

If the *Check Engine/Service Engine Soon* light remains on, have your vehicle serviced at the first available opportunity.

### Readiness for Inspection/Maintenance (I/M) testing

In some localities, it may be a legal requirement to pass an I/M test of the on-board diagnostics system. If your “Check Engine/Service Engine Soon” light is on, refer to the description in the *Warning lights and chimes* section of the *Instrument cluster* chapter. Your vehicle may not pass the I/M test with the “Check Engine/Service Engine Soon” light on.

If the vehicle’s powertrain system or its battery has just been serviced, the on-board diagnostics system is reset to a “not ready for I/M test” condition. To ready the on-board diagnostics system for I/M testing, a minimum of 30 minutes of city and highway driving is necessary as described below:

- First, at least 10 minutes of driving on an expressway or highway.
- Next, at least 20 minutes driving in stop-and-go, city-type traffic with at least four idle periods.

Allow the vehicle to sit for at least eight hours without starting the engine. Then, start the engine and complete the above driving cycle. The engine must warm up to its normal operating temperature. Once started, do not turn off the engine until the above driving cycle is complete.

## Maintenance and Specifications

### CHECKING AND ADDING POWER STEERING FLUID

Check the power steering fluid. Refer to the scheduled maintenance guide for the service interval schedules. If adding fluid is necessary, use only MERCON® ATF.

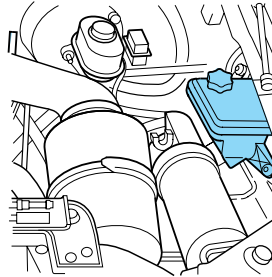

Check the fluid level when it is at ambient temperature, 20° – 80° F (-7° – 25° C):

1. Check the fluid level on the dipstick. It should be between the arrows in the FULL COLD range. Do not add fluid if the level is within this range.
2. If the fluid level is low, start the engine.
3. While the engine idles, turn the steering wheel left and right several times.
4. Turn the engine off.
5. Recheck the fluid level on the dipstick. Do not add fluid if the level is between the arrows in the FULL COLD range.
6. If the fluid is low, add fluid in small amounts, continuously checking the level until it reaches the FULL COLD range. Be sure to put the dipstick back in the reservoir.

### BRAKE FLUID RESERVOIR

The fluid level will drop slowly as the brakes wear, and will rise when the brake components are replaced. Fluid levels below the “MAX” line that do not trigger the brake system warning lamp are within the normal operating range, there is no need to add fluid. If the fluid levels are outside of the normal operating range, the performance of your brake system could be compromised, seek service from your dealer immediately.

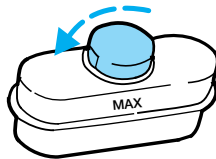

## Maintenance and Specifications

### CLUTCH FLUID (IF EQUIPPED)

Check the clutch fluid level. Refer to the scheduled maintenance guide for the service interval schedules.

Use only a DOT 3 brake fluid designed to meet Ford specification ESA-M6C25-A. Refer to *Lubricant Specifications* in this chapter.



Brake fluid is toxic. If brake fluid contacts the eyes, flush eyes with running water for 15 minutes. Seek medical attention if irritation persists. If taken internally, drink water and induce vomiting. Seek medical attention immediately.

During normal operation, the fluid level in the clutch reservoir should remain constant or rise slightly. If the fluid level drops, refill the fluid level to the step in the reservoir.

1. Clean the reservoir cap before removal to prevent dirt and water from entering the reservoir.
2. Remove cap and rubber diaphragm from reservoir.
3. Add fluid until the level reaches the step in the reservoir.
4. Reinstall rubber diaphragm and cap onto reservoir.

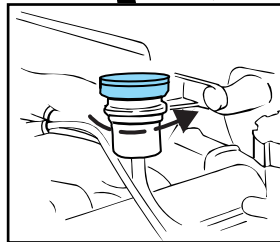
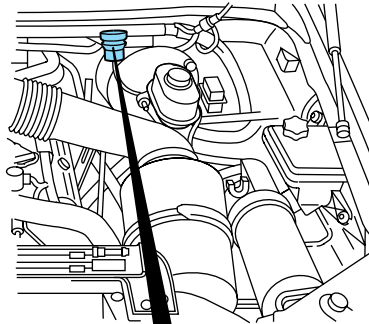



## Maintenance and Specifications

### TRANSMISSION FLUID

#### Checking automatic transmission fluid (if equipped)

Refer to your scheduled maintenance guide for scheduled intervals for fluid checks and changes. Your transmission does not consume fluid. However, the fluid level should be checked if the transmission is not working properly, i.e., if the transmission slips or shifts slowly or if you notice some sign of fluid leakage.

Automatic transmission fluid expands when warmed. To obtain an accurate fluid check, drive the vehicle until it is at normal operating temperature (approximately 30 km [20 miles]). If your vehicle has been operated for an extended period at high speeds, in city traffic during hot weather or pulling a trailer, the vehicle should be turned off for about 30 minutes to allow fluid to cool before checking.

1. Drive the vehicle 30 km (20 miles) or until it reaches normal operating temperature.
2. Park the vehicle on a level surface and engage the parking brake.
3. With the parking brake engaged and your foot on the brake pedal, start the engine and move the gearshift lever through all of the gear ranges. Allow sufficient time for each gear to engage.
4. Latch the gearshift lever in P (Park) and leave the engine running.
5. Remove the dipstick, wiping it clean with a clean, dry lint free rag. If necessary, refer to *Identifying components in the engine compartment* in this chapter for the location of the dipstick.
6. Install the dipstick making sure it is fully seated in the filler tube.
7. Remove the dipstick and inspect the fluid level. The fluid should be in the designated area for normal operating temperature or ambient temperature.

#### Low fluid level

Do not drive the vehicle if the fluid level is at the bottom of the dipstick and the ambient temperature is above 10°C (50°F).

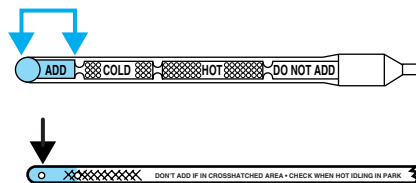

## Maintenance and Specifications

### Correct fluid level

The transmission fluid should be checked at normal operating temperature 66°C-77°C (150°F-170°F) on a level surface. The normal operating temperature can be reached after approximately 30 km (20 miles) of driving.

You can check the fluid without driving if the ambient temperature is above 10°C (50°F). However, if fluid is added at this time, an overfill condition could result when the vehicle reaches normal operating temperature.

The transmission fluid should be in this range if at normal operating temperature (66°C-77°C [150°F-170°F]).

The transmission fluid should be in this range if at ambient temperature (10°C-35°C [50°F-95°F]).

### High fluid level

Fluid levels above the safe range may result in transmission failure. An overfill condition of transmission fluid may cause shift and/or engagement concerns and/or possible damage.

High fluid levels can be caused by an overheating condition.

### Adjusting automatic transmission fluid levels

Before adding any fluid, make sure the correct type is used. The type of fluid used is normally indicated on the dipstick and also in the *Lubricant specifications* section in this chapter.

**Use of a non-approved automatic transmission fluid may cause internal transmission component damage.**

If necessary, add fluid in 250 ml (1/2 pint) increments through the filler tube until the level is correct.

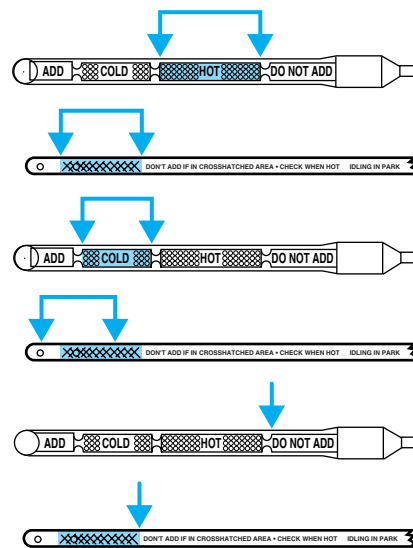

## Maintenance and Specifications

If an overfill occurs, excess fluid should be removed by a qualified technician.

**An overfill condition of transmission fluid may cause shift and/or engagement concerns and/or possible damage.**

Do not use supplemental transmission fluid additives, treatments or cleaning agents. The use of these materials may affect transmission operation and result in damage to internal transmission components.

### Automatic transmission fluid filter (if equipped)

The TorqShift automatic transmission is equipped with a serviceable external fluid filter mounted on the frame rail. Refer to the Scheduled Maintenance Guide for service intervals.

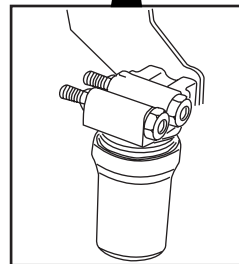
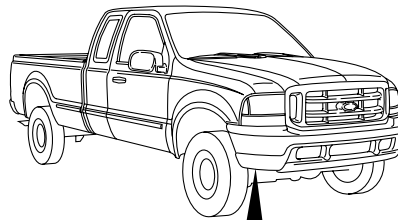
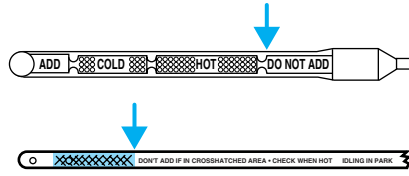

To replace the transmission filter:

1. Shut off the engine.
2. Unscrew filter housing.
3. Replace filter with a new authorized Motorcraft filter element. Refer to the *Motorcraft Part Numbers* chart in this chapter.
4. Reinstall housing and check transmission fluid level using procedure in this section.

## Maintenance and Specifications

### Checking and adding manual transmission fluid (if equipped)

1. Clean the filler plug.
2. Remove the filler plug and inspect the fluid level.

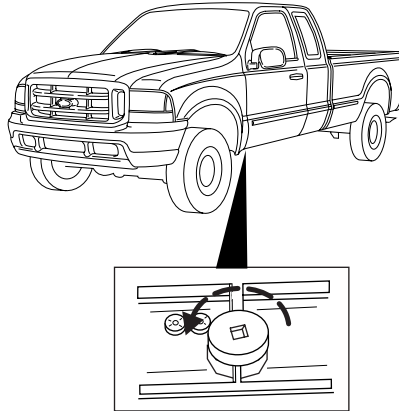

3. Fluid level should be at the bottom of the opening.
4. Add enough fluid through the filler opening so that the fluid level is at the bottom of the opening.
5. Install and tighten the fill plug securely.

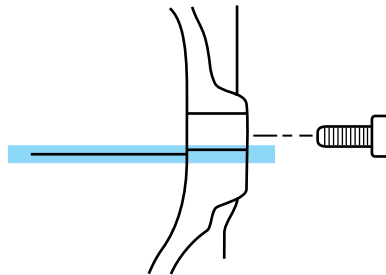

Use only fluid that meets Ford specifications. Refer to *Lubricant Specifications* in this chapter.

## Maintenance and Specifications

### Checking and adding transfer case fluid (if equipped)

1. Clean the filler plug.
2. Remove the filler plug and inspect the fluid level.

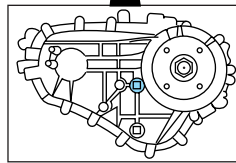
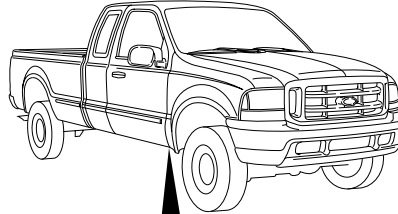

3. Add only enough fluid through the filler opening so that the fluid level is at the bottom of the opening.

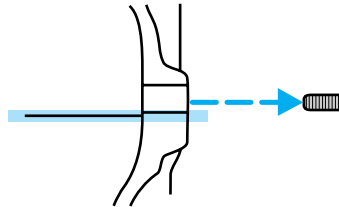

Use only fluid that meets Ford specifications. Refer to *Lubricant Specifications* in this chapter.

### DRIVELINE UNIVERSAL JOINT AND SLIP YOKE

Your vehicle may be equipped with universal joints that require lubrication. Refer to the scheduled maintenance guide for maintenance intervals. If the original universal joints are replaced with universal joints equipped with grease fittings, lubrication will also be necessary.

## Maintenance and Specifications

### AIR FILTER MAINTENANCE

Refer to the scheduled maintenance guide for the appropriate intervals for changing the air filter element.

When changing the air filter element, use only the Motorcraft air filter element listed. Refer to *Motorcraft Part Numbers*.

**Note:** Do not start your engine with the air cleaner removed and do not remove it while the engine is running.

#### Changing the air filter element

1. Loosen the clamp that secures the air filter element in place.

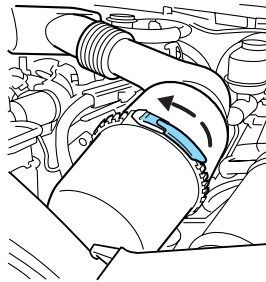

2. Carefully separate the two halves of the air filter housing.

3. Remove the air filter element from the open end of the air filter housing.

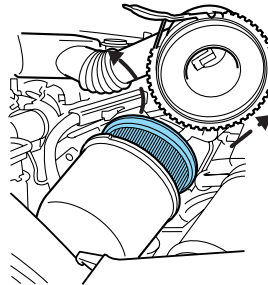

4. Install a new air filter element, ensuring the arrow on the top half of the air filter housing lines up with the notch on the bottom half of air filter housing. Be careful not to crimp the filter element edges between the air filter housing. This could cause filter damage and allow unmeasured air to enter the engine if not properly seated.

5. Replace the two halves of the air filter housing and secure the clamp.

## Maintenance and Specifications

### INFORMATION ABOUT UNIFORM TIRE QUALITY GRADING

New vehicles are fitted with tires that have a rating on them called Tire Quality Grades. The Quality grades can be found where applicable on the tire sidewall between tread shoulder and maximum section width. For example:

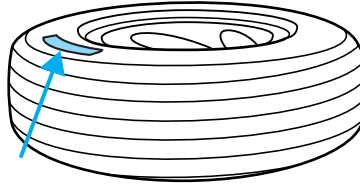

- **Treadwear 200 Traction AA Temperature A**

These Tire Quality Grades are determined by standards that the United States Department of Transportation has set.

Tire Quality Grades apply to new pneumatic tires for use on passenger cars. They do not apply to deep tread, winter-type snow tires, space-saver or temporary use spare tires, tires with nominal rim diameters of 10 to 12 inches or limited production tires as defined in Title 49 Code of Federal Regulations Part 575.104(c)(2).

**U.S. Department of Transportation-Tire quality grades:** The U.S. Department of Transportation requires Ford to give you the following information about tire grades exactly as the government has written it.

#### **Treadwear**

The treadwear grade is a comparative rating based on the wear rate of the tire when tested under controlled conditions on a specified government test course. For example, a tire graded 150 would wear one and one-half (1 1/2) times as well on the government course as a tire graded 100. The relative performance of tires depends upon the actual conditions of their use, however, and may depart significantly from the norm due to variations in driving habits, service practices, and differences in road characteristics and climate.

#### **Traction AA A B C**

The traction grades, from highest to lowest are AA, A, B, and C. The grades represent the tire's ability to stop on wet pavement as measured under controlled conditions on specified government test surfaces of asphalt and concrete. A tire marked C may have poor traction performance.

## Maintenance and Specifications



The traction grade assigned to this tire is based on straight-ahead braking traction tests, and does not include acceleration, cornering, hydroplaning or peak traction characteristics.

### Temperature A B C

The temperature grades are A (the highest), B and C, representing the tire's resistance to the generation of heat and its ability to dissipate heat when tested under controlled conditions on a specified indoor laboratory test wheel. Sustained high temperature can cause the material of the tire to degenerate and reduce tire life, and excessive temperature can lead to sudden tire failure. The grade C corresponds to a level of performance which all passenger car tires must meet under the Federal Motor Vehicle Safety Standard No. 109. Grades B and A represent higher levels of performance on the laboratory test wheel than the minimum required by law.



The temperature grade for this tire is established for a tire that is properly inflated and not overloaded. Excessive speed, underinflation, or excessive loading, either separately or in combination, can cause heat buildup and possible tire failure.

## SERVICING YOUR TIRES

### Checking the tire pressure

- Use an accurate tire pressure gauge.
- Check the tire pressure when tires are cold, after the vehicle has been parked for at least one hour or has been driven less than 5 km (3 miles).
- Adjust tire pressure to recommended specifications found on the Certification Label. Tire pressure information can also be found on the Tire Information label located on the inside of the fuel filler door.



Improperly inflated tires can affect vehicle handling and can fail suddenly, possibly resulting in loss of vehicle control, vehicle rollover and/or personal injury.





## Maintenance and Specifications

### **Tire inflation information**

All tires with Steel Carcass Plies (if equipped):

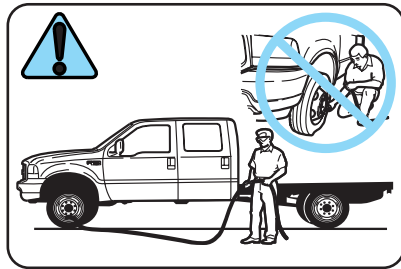
This type of tire utilizes steel cords in the sidewalls. As such, they cannot be treated like normal light truck tires. Tire service, including adjusting tire pressure, must be performed by personnel trained, supervised and equipped according to Federal Occupational Safety and Health Administration (OSHA) regulations. For example, during any procedure involving tire inflation, the technician or individual must utilize a remote inflation device, and insure that all persons are clear of the trajectory area.



 **WARNING** An inflated tire and rim can be very dangerous if improperly used, serviced or maintained. To avoid serious injury, never attempt to re-inflate a tire which has been run flat or seriously under-inflated without first removing the tire from the wheel assembly for inspection. Do not attempt to add air to tires or replace tires or wheels without first taking precautions to protect persons and property.

### **Tire rotation**

Because your vehicle's tires perform different jobs, they often wear differently. To make sure your tires wear evenly and last longer, rotate them as indicated in the scheduled maintenance guide. If you notice that the tires wear unevenly, have them checked.

The following procedure applies to vehicles equipped with single rear wheel.

## Maintenance and Specifications

- Four tire rotation

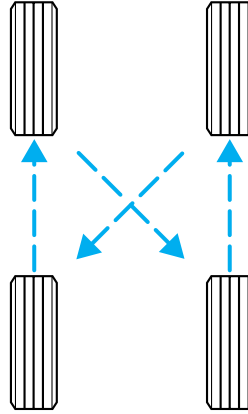

- Five tire rotation

Your vehicle may be equipped with a temporary or a conventional spare tire. If the spare tire is different in size (diameter and/or width), tread type (All-season or All-Terrain) or is from a different manufacturer other than the road tires on your vehicle, your spare tire is considered “temporary”.

If road tire replacement is necessary, replace it with a tire of the same size, tread, speed rating and load carrying capacity as soon as possible. Temporary spare tires should not be used in a five-tire rotation.

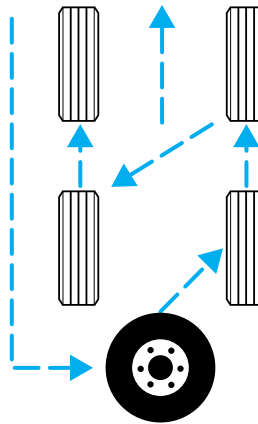

## Maintenance and Specifications

- DRW – Six tire rotation

If your vehicle is equipped with dual rear wheels it is recommended that front and rear tires (in pairs) be rotated only side to side, with the rear tires maintaining original vehicle position. After tire rotation, inflation pressures must be adjusted for the tires new positions in accordance with vehicle requirements.

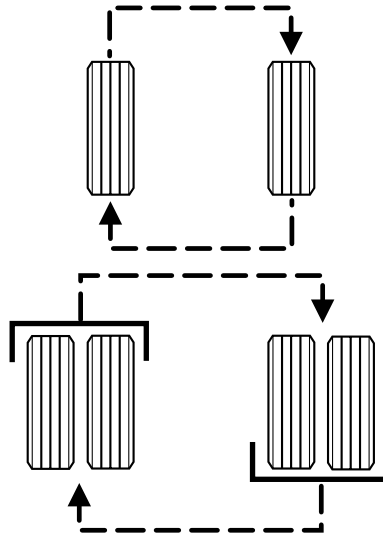

### Replacing the tires

Replace the tires when the wear band is visible through the tire treads. Due to exposure to the elements and exhaust you should replace the spare tire when you replace the other tires.

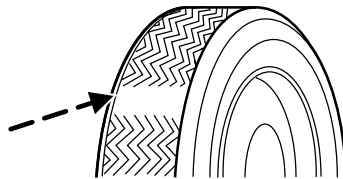

When replacing full size tires, never mix radial bias-belted, or bias-type tires. Use only the tire sizes that are listed on the Certification Label. Make sure that all tires are the same size, speed rating, and load-carrying capacity. Use only the tire combinations recommended on the label. If you do not follow these precautions, your vehicle handling may be affected which can lead to loss of vehicle control, vehicle rollover and/or personal injury.

## Maintenance and Specifications



Make sure that all replacement tires are of the same size, type, speed rating, load-carrying capacity and tread design (e.g., “All Terrain”, “Touring”, etc.), as originally offered by Ford.



Do not replace your tires with “high performance” tires or larger size tires.



Failure to follow these precautions may adversely affect the handling of the vehicle, and increase the risk of loss of vehicle control, vehicle rollover and/or personal injury.

Tires that are larger or smaller than your vehicle’s original tires may also affect the accuracy of your speedometer.

### SNOW TIRES AND CHAINS



Snow tires must be the same size and grade as the tires you currently have on your vehicle.

The tires on your vehicle have all weather treads to provide traction in rain and snow. However, in some climates, you may need to use snow tires and chains. If you need to use chains, it is recommended that steel wheels (of the same size and specifications) be used, as chains may chip aluminum wheels.

Follow these guidelines when using snow tires and chains:

- Use only SAE Class S chains.
- Install chains securely, verifying that the chains do not touch any wiring, brake lines or fuel lines.
- Drive cautiously. If you hear the chains rub or bang against your vehicle, stop and re-tighten the chains. If this does not work, remove the chains to prevent damage to your vehicle.
- If possible, avoid fully loading your vehicle.
- Remove the tire chains when they are no longer needed. Do not use tire chains on dry roads.
- The suspension insulation and bumpers will help prevent vehicle damage. Do not remove these components from your vehicle when using snow tires and chains.

## Maintenance and Specifications

### MOTORCRAFT PART NUMBERS

Component*	5.4L V8 engine	6.8L V10 engine
Air filter element	FA-1634	FA-1634
Fuel filter	FG-986B	FG-986B
Oil filter	FL-820-S	FL-820-S
PCV valve	EV-233	EV-233
Battery (Standard)	BXT-65-650	BXT-65-650
Battery (Optional)	BXT-65-750	BXT-65-750
Spark plugs-platinum**	AGSF-22W	AGSF-22W
Automatic Transmission Filter ***	—	—

\*Refer to the *6.0 Liter Power Stroke Direct Injection Turbo Diesel Owner's Guide Supplement* for Motorcraft diesel engine service part numbers.

\*\*Refer to Vehicle Emissions Control Information (VECI) decal for spark plug gap information.

\*\*\*Only available with 6.0L Diesel engine/TorqShift transmission. Part number is FT-145.

## Maintenance and Specifications

### REFILL CAPACITIES

Fluid	Ford Part Name	Application	Capacity
Front axle	Hypoid Gear Oil SAE 90	F-250/350 (Dana 60 axle)	2.7L (5.8 pints)
		F-350/450/550 (Dana 60 axle)	2.7L (5.8 pints)
Rear axle <sup>1,2</sup>	Motorcraft SAE 75W-140 Synthetic Rear Axle Lubricant	F-250 /350 (10.50 inch axle)	3.3L (6.9 pints)
	Motorcraft SAE 75W-90 Synthetic Rear Axle Lubricant	F-350/450 (DANA 80)	4.0L (8.5 pints)
	Motorcraft SAE 80W-90 Premium Rear Axle Lubricant	F-550 (Dana 135)	11.6L (24.5 pints)
Brake fluid (and clutch fluid-if equipped)	Motorcraft High Performance DOT 3 Motor Vehicle Brake Fluid	All	Fill to line or step (for clutch) on reservoir
Engine coolant <sup>3</sup>	Motorcraft Premium Gold Engine Coolant (yellow-colored)	5.4L V8 engine with A/C	25.0L (26.4 quarts)
		6.8L V10 engine	26.0L (27.5 quarts)
Engine oil (includes filter change)-Gas engines <sup>7</sup>	Motorcraft SAE 5W-20 Premium Synthetic Blend Motor Oil (US) Motorcraft SAE 5W-20 Super Premium Motor Oil (Canada)	5.4L V8 and 6.8L V10 engines	5.7L (6.0 quarts)
Engine oil (includes filter change)-Diesel engine	Refer to your 6.0L Diesel Supplement		

## Maintenance and Specifications

Fluid	Ford Part Name	Application	Capacity
Fuel tank	N/A	Mid-ship tank (optional on Chassis Cab)	71.9L (19.0 gallons)
		Right side saddle mounted tank (optional on Chassis Cab)	87.1L (23.0 gallons)
		Short box	109.8L (29.0 gallons)
		Long box	143.9L (38.0 gallons)
		Aft axle	151.4L (40.0 gallons)
Power steering fluid	Motorcraft MERCON® ATF	All	Fill to FULL COLD range on dipstick
Transfer case fluid	Motorcraft MERCON® ATF	4x4 vehicles	1.9L (2.0 quarts)
Manual transmission fluid	Motorcraft MERCON® ATF	6-speed manual	5.5L (5.8 quarts) <sup>5</sup>
Automatic transmission fluid <sup>4</sup>	Motorcraft MERCON® ATF	4R100 (4-speed)	16.7L (17.7 quarts) <sup>6</sup>
	Motorcraft MERCON® SP ATF	TorqShift (5-speed)	16.6L (17.5 quarts) <sup>6</sup> (includes remote filter element change)
Windshield washer fluid	Motorcraft Premium Windshield Washer Concentrate	All	4.0L (4.25 quarts)

## Maintenance and Specifications

<sup>1</sup>Your vehicle's rear axle(s) may be filled with a synthetic lubricant that may require a lubricant change. Refer to the scheduled maintenance guide. Axle lubricant quantities should not need to be checked unless a leak is suspected, service is required or the axle assembly has been submerged in water. The axle lubricant should be changed any time the rear axle has been submerged in water.

<sup>2</sup>Add 236 ml (8 oz.) of Additive Friction Modifier XL-3or equivalent meeting Ford Specification EST-M2C118-A for complete refill of Traction-Lok axles.

<sup>3</sup>Add the coolant type originally equipped in your vehicle.

<sup>4</sup>Ensure the correct automatic transmission fluid is used. Transmission fluid requirements are indicated on the end of the dipstick. Check the container to verify the fluid being added is of the correct type. Refer to your scheduled maintenance guide to determine the correct service interval.

Some transmission fluids may be labeled as dual usage, such as MERCON® and MERCON® V. These dual usage fluids are not to be used in an automatic transmission that requires use of the MERCON® type fluid. However, these dual usage fluids may be used in transmissions that require the MERCON® V type fluid.

**MERCON®, MERCON® V and MERCON® SP are not interchangeable. DO NOT mix MERCON®, MERCON® V and MERCON® SP. Use of dual usage fluids in an automatic transmission application requiring MERCON® SP may cause transmission damage. Use of a transmission fluid other than the recommended fluid may cause transmission damage.**

<sup>5</sup>Service refill capacity is determined by filling the transmission to the bottom of the filler hole with the vehicle on a level surface. The 6-speed manual transmission is equipped with an in-tank cooler. Verify the fluid level after operating vehicle to assure correct fluid level.

<sup>6</sup>Indicates only approximate dry-fill capacity. Some applications may vary based on cooler size and if equipped with an in-tank cooler. The amount of transmission fluid and fluid level should be set by the indication on the dipstick's normal operating range.

<sup>7</sup>Use of synthetic or synthetic blend motor oil is not mandatory. Engine oil need only meet the requirements of Ford specification WSS-M2C153-H and the API Certification mark.



## Maintenance and Specifications

### LUBRICANT SPECIFICATIONS

Item	Ford part name or equivalent	Ford part number	Ford specification
Spindle bearing	High Temperature 4X4 Front Axle and Wheel Bearing Grease	E8TZ-19590-A	ESA-M1C198-A
Front axle (4X4)	Hypoid Gear Oil SAE 90	C6AZ-19580-E	ESW-M2C105-A
Rear axle	Motorcraft SAE 75W-140 High Performance Synthetic Rear Axle Lube <sup>1</sup>	XY-75W140-QL	WSL-M2C192-A
	Motorcraft SAE 75W-90 Synthetic Rear Axle Lubricant	XY-75W90-GLS	—
	Motorcraft SAE 80W-90 Premium Rear Axle Lubricant (Dana 135 axles) <sup>1</sup>	XY-80W90-QL	WSP-M2C197-A
Brake fluid and clutch fluid (if equipped)	Motorcraft High Performance DOT 3 Motor Vehicle Brake Fluid	PM-1	ESA-M6C25-A and DOT 3
Engine coolant	Motorcraft Premium Gold Engine Coolant (yellow-colored)	VC-7-A	WSS-M97B51-A1

## Maintenance and Specifications

Item	Ford part name or equivalent	Ford part number	Ford specification
Engine oil	Motorcraft SAE 5W-20 Premium Synthetic Blend Motor Oil (US) Motorcraft SAE 5W-20 Super Premium Motor Oil (Canada)	XO-5W20-QSP (US) CXO-5W20-LSP12 (Canada)	WSS-M2C153-H and API Certification Mark
Hinges, latches, striker plates, fuel filler door hinge and seat tracks	Multi-Purpose Grease	XG-4 or XL-5	ESR-M1C159-A or ESB-M1C93-B
Lock cylinders	Motorcraft penetrating and lock lubricant	XL-1	none
Transmission /steering/parking brake linkages and pivots, brake and clutch pedal shaft (if equipped)	Motorcraft Premium Long-Life Grease	XG-1-C or XG-1-K	ESA-M1C75-B
Power steering fluid and transfer case fluid (if equipped)	Motorcraft MERCON® ATF	XT-2-QDX	MERCON®
Manual transmission (6-speed)	Motorcraft MERCON® ATF <sup>2</sup>	XT-2-QDX	MERCON®

## Maintenance and Specifications

Item	Ford part name or equivalent	Ford part number	Ford specification
Automatic transmission 4R100 (4-speed)	Motorcraft MERCON® ATF <sup>2</sup>	XT-2-QDX	MERCON®
Automatic transmission TorqShift (5-speed)	Motorcraft MERCON® SP ATF <sup>2</sup>	XT-6-QSP	MERCON® SP
Windshield washer fluid	Motorcraft Premium Windshield Washer Concentrate	ZC-32-A	WSB-M8B16-A2

<sup>1</sup>Add 236 ml (8 oz.) of Additive Friction Modifier XL-3 or equivalent meeting Ford specification EST-M2C118-A for complete refill of Traction-Lok axles. Ford design rear axles contain a synthetic lubricant that does not require changing unless the axle has been submerged in water. Dana rear axles also contain a synthetic lubricant but **do** require a change. Refer to your “Service Guide” for change intervals on Dana rear axles.

<sup>2</sup>Ensure the correct automatic transmission fluid is used. Transmission fluid requirements are indicated on the end of the dipstick. Check the container to verify the fluid being added is of the correct type. Refer to your scheduled maintenance guide to determine the correct service interval.

Some transmission fluids may be labeled as dual usage, such as MERCON® and MERCON® V. These dual usage fluids are not to be used in an automatic transmission that requires use of the MERCON® type fluid. However, these dual usage fluids may be used in transmissions that require the MERCON® V type fluid.

**MERCON®, MERCON® V and MERCON® SP are not interchangeable. DO NOT mix MERCON®, MERCON® V and MERCON® SP. Use of dual usage fluids in an automatic transmission application requiring MERCON® SP may cause transmission damage. Use of a transmission fluid other than the recommended fluid may cause transmission damage.**

## Maintenance and Specifications

### ENGINE DATA

Engine*	5.4L V8 engine	6.8L V10 engine
Cubic inches	330	415
Required fuel	87 octane	87 octane
Firing order	1-3-7-2-6-5-4-8	1-6-5-10-2-7-3-8-4-9
Spark plug gap	1.3-1.4 mm (0.052-0.056 inch)	1.3-1.4 mm (0.052-0.056 inch)
Ignition system	Coil on plug	Coil on plug
Compression ratio	9.0:1	9.0:1

\*Refer to the *6.0 Liter Power Stroke Direct Injection Turbo Diesel Owner's Guide Supplement* for Motorcraft diesel engine service part numbers.

### VEHICLE DIMENSIONS

#### F250—Regular and Super Cab

Dimension	Body style			
	Regular Cab 4x2	Regular Cab 4x4	Super Cab 4x2	Super Cab 4x4
(1) Overall height	1935 mm (76.2 in)	2005 mm (78.9 in)	1943 mm (76.5 in) <sup>b</sup>	2008 mm (79.0 in) <sup>b</sup>
(2) Track (Front / Rear)	1736 mm (68.3 in) / 1729 mm (68 in)	1736 mm (68.3 in) / 1729.3 mm (68 in)	1736 mm (68.3 in) / 1729.3 mm (68 in)	1736 mm (68.3 in) / 1729.3 mm (68 in)
(3) Overall width	2031 mm (79.9 in)	2031 mm (79.9 in)	2031 mm (79.9 in)	2031 mm (79.9 in)
(4) Wheelbase	3479.8 mm (137 in)	3479.8 mm (137 in)	3610.7 mm (141.8 in) <sup>a</sup> 4013.2 mm (158 in) <sup>b</sup>	3610.7 mm (141.8 in) <sup>a</sup> 4013.2 mm (158 in) <sup>b</sup>

## Maintenance and Specifications

Dimension	Body style			
	Regular Cab 4x2	Regular Cab 4x4	Super Cab 4x2	Super Cab 4x4
(5) Overall length	5756 mm (226.6 in)	5756 mm (226.6 in)	5878 mm (231.4 in) <sup>a</sup> 6289 mm (247.6 in) <sup>b</sup>	5878 mm (231.4 in) <sup>a</sup> 6289 mm (247.6 in) <sup>b</sup>
<sup>a</sup> Short Wheel Base (SWB)				
<sup>b</sup> Long wheel base (LWB)				

### F250-Crew Cab

Dimension	Body style			
	Crew Cab 4x2/ Short box	Crew Cab 4x4/ Short box	Crew Cab 4x2/ Long box	Crew Cab 4x4/ Long box
(1) Overall height	1960 mm (77.2 in)	2027 mm (79.8 in)	1957 mm (77.0 in)	2022 mm (76.6 in)
(2) Track (Front / Rear)	1736 mm (68.3 in) / 1729 mm (68.1 in)	1736 mm (68.3 in) / 1729 mm (68.1 in)	1736 mm (68.3 in) / 1729 mm (68.1 in)	1736 mm (68.3 in) / 1729 mm (68.1 in)
(3) Overall width	2031 mm (79.9 in)	2031 mm (79.9 in)	2031 mm (79.9 in)	2031 mm (79.9 in)
(4) Wheelbase	3967 mm (156.2 in)	3967 mm (156.2 in)	4379 mm (172.4 in)	4379 mm (172.4 in)
(5) Overall length	6243 mm (245.8 in)	6243 mm (245.8 in)	6654 mm (262 in)	6654 mm (262 in)

## Maintenance and Specifications

### F350—except Crew Cab

Dimension	Body style			
	Chassis Cab — Regular Cab	Chassis Cab — Super Cab	Regular Cab Style Side	Super Cab Style Side
(1) Overall height	1924 mm (75.7 in) <sup>a</sup> 1912 mm (75.2 in) <sup>b</sup> 2028 mm (79.8 in) <sup>c</sup> 2031 mm (80.0 in) <sup>d</sup>	1928 mm (75.9 in) <sup>a</sup> 1931 mm (76.0 in) <sup>b</sup> 2029 mm (79.9 in) <sup>c</sup> 2019 mm (79.5 in) <sup>d</sup>	1938 mm (76.3 in) <sup>a</sup> 1976 mm (77.8 in) <sup>b</sup> 2041 mm (80.3 in) <sup>c</sup> 2018 mm (79.4 in) <sup>d</sup>	1952 mm (76.8 in) <sup>a,e</sup> 1954 mm (76.9 in) <sup>a,f</sup> 1939 mm (76.3 in) <sup>b</sup> 2051 mm (80.7 in) <sup>c,e</sup> 2039 mm (80.3 in) <sup>c,f</sup> 2019 mm (79.5 in) <sup>d</sup>
(2a) Front Track	1736 mm (68.3 in) <sup>a,b</sup> / 1736 mm (68.4 in) <sup>c,d</sup>	1736 mm (68.3 in) <sup>a,b</sup> / 1736 mm (68.4 in) <sup>c,d</sup>	1736 mm (68.3 in) <sup>a,b</sup> / 1736 mm (68.4 in) <sup>c,d</sup>	1736 mm (68.3 in) <sup>a,b</sup> / 1736 mm (68.4 in) <sup>c,d</sup>
(2b) Rear Track	1729 mm (68.1 in) <sup>a,c</sup> / 1880 mm (74.0 in) <sup>b,d</sup>	1729 mm (68.1 in) <sup>a,c</sup> / 1880 mm (74.0 in) <sup>b,d</sup>	1729 mm (68.1 in) <sup>a,c</sup> / 1880 mm (74.0 in) <sup>b,d</sup>	1729 mm (68.1 in) <sup>a,c</sup> / 1880 mm (74.0 in) <sup>b,d</sup>
(3) Overall width	2031 mm (79.9 in) <sup>a,c</sup> / 2304 mm (90.7 in) <sup>b</sup> 2329 mm (91.7 in) <sup>d</sup>	2031 mm (79.9 in)	2031 mm (79.9 in) <sup>a,c</sup> 2426 mm (95.5 in) <sup>b,d</sup>	2031 mm (79.9 in) <sup>a,c</sup> 2426 mm (95.5 in) <sup>b,d</sup>

## Maintenance and Specifications

Dimension	Body style			
	Chassis Cab — Regular Cab	Chassis Cab — Super Cab	Regular Cab Style Side	Super Cab Style Side
(4) Wheelbase	3576 mm (140.8 in) 4186 mm (164.8 in)	4110 mm (161.8 in)	3480 mm (137.0 in)	3602 mm (141.8 in) <sup>e</sup> / 4014 mm (158.0 in) <sup>f</sup>
(5) Overall length	5733 mm (225.7 in) <sup>a,b,c,d</sup> / 6343 (249.7 in) <sup>b,d</sup>	6267 mm (246.7 in)	5756 mm (226.6 in)	5878 mm (231.4 in) <sup>e</sup> / 6289 mm (247.6 in) <sup>f</sup>
<sup>a</sup> 4x2 Single rear wheel (SRW) <sup>b</sup> 4x2 Dual rear wheel (DRW) <sup>c</sup> 4x4 Single rear wheel (SRW) <sup>d</sup> 4x4 Dual rear wheel (DRW) <sup>e</sup> Short box <sup>f</sup> Long box				

### F350-Crew Cab

Dimension	Body style		
	Crew chassis Cab	Crew cab-short box	Crew cab — long box
(1) Overall height	1 929 mm (75.9 in) <sup>a</sup> / 1 941 mm (76.4 in) <sup>b</sup> / 2 026 mm (79.8 in) <sup>c</sup> / 2 038 mm (80.2 in) <sup>d</sup>	1 955mm (77.0 in) <sup>a</sup> / 1998 mm (78.6 in) <sup>b</sup> / 1 958 mm (77.1 in) <sup>c</sup> / 2 033 mm (80.0 in) <sup>d</sup>	1 964 mm (77.3 in) <sup>a</sup> / 1991 mm (75.2 in) <sup>b</sup> / 1 957 mm (77.0 in) <sup>c</sup> / 2 031 mm (80.0 in) <sup>d</sup>
(2a) Track —Front	1 736 mm (68.3 in)	1 736 mm (68.3 in)	1 736 mm (68.3 in)

## Maintenance and Specifications

Dimension	Body style		
	Crew chassis Cab	Crew cab-short box	Crew cab — long box
(2b) Track — Rear	1 729 mm (68.1 in) <sup>a,c/</sup> 1 803 mm (74.0 in) <sup>b,d</sup>	1 729 mm (68.1 in) <sup>a,c/</sup> 1 880 mm (74.0 in) <sup>b,d</sup>	1 729 mm (68.1 in) <sup>a,c/</sup> 1 880 mm (74.0 in) <sup>b,d</sup>
(3) Overall width	2 031 mm (79.9 in) <sup>a,c/</sup> 2 304 mm (90.7 in) <sup>b/</sup> 2 329 mm (91.7 in) <sup>d</sup>	2 031 mm (79.9 in) <sup>a,c</sup> 2 426 mm (95.5 in) <sup>b,d</sup>	2 031 mm (79.9 in) <sup>a,c</sup> 2 426 mm (95.5 in) <sup>b,d</sup>
(4) Wheelbase	4 475 mm (176.2 in )	3 967 mm (156.2 in )	4 379 mm (172.4 in)
(5) Overall length	6 632 mm (261.1 in)	6 243 mm (245.8 in)	6 654 mm (262.0 in)
<sup>a</sup> 4x2 Single rear wheel (SRW) <sup>b</sup> 4x2 Dual rear wheel (DRW) <sup>c</sup> 4x4 Single rear wheel (SRW) <sup>d</sup> 4x4 Dual rear wheel (DRW)			

### F450

Dimension	Body style			
	Regular Cab Chassis 4x2	Regular Cab Chassis 4x4	Super Cab Chassis 4x2/4x4	Crew Cab Chassis 4x2/4x4
(1) Overall height	2 048 mm (80.6 in) <sup>a</sup> 2 044 mm (80.5 in) <sup>b,c</sup> 2 038 mm (80.2 in) <sup>d</sup>	2 051 mm (80.7 in) <sup>a</sup> 2 044 mm (80.5 in) <sup>b</sup> 2 033 mm (80.0 in) <sup>c,d</sup>	2 045 mm (80.5 in)	2 053 mm (80.8 in) - 4x2 2 056 mm (80.9 in) - 4x4



## Maintenance and Specifications

Dimension	Body style			
	Regular Cab Chassis 4x2	Regular Cab Chassis 4x4	Super Cab Chassis 4x2/4x4	Crew Cab Chassis 4x2/4x4
(2) Track (Front / Rear)	1 736 mm (68.4 in) / 1 880 mm (74.0 in)	1 736 mm (68.4 in) / 1 880 mm (74.0 in)	1 736 mm (68.4 in) / 1 889 mm (74.3 in)	1 736 mm (68.4 in) / 1 880 mm (74.0 in)
(3) Overall width	2 377 mm (93.6 in)	2 377 mm (93.6 in)	2 386 mm (93.9 in)	2 377 mm (93.6 in)
(4) Wheelbase	3 576 mm (140.8 in) 4 186 mm (164.8 in) 4 795 mm (188.8 in) 5 100 mm (200.8 in)	3 576 mm (140.8 in) 4 186 mm (164.8 in) 4 795 mm (188.8 in) 5 100 mm (200.8 in)	4 110 mm (161.8 in)	4 475 mm (176.2 in) 5 085 (200.2 in)
(5) Overall length	5 733 mm (225.7 in) <sup>a</sup> 6 343 mm (249.7 in) <sup>b</sup> 6 952 mm (273.7 in) <sup>c</sup> 7 257 mm (285.7 in) <sup>d</sup>	5 733 mm (225.7 in) <sup>a</sup> 6 343 mm (249.7 in) <sup>b</sup> 6 952 mm (273.7 in) <sup>c</sup> 7 257 mm (285.7 in) <sup>d</sup>	6 267 mm (246.7 in)	6 632 mm (261.1 in) <sup>e</sup> 7 241 mm (285.1 in) <sup>f</sup>
<sup>a</sup> 3 576 mm (140.8 in) wheel base <sup>b</sup> 4 186 mm (164.8 in) wheel base <sup>c</sup> 4 795 mm (188.8 in) wheel base <sup>d</sup> 5 100 mm (200.8 in) wheel base <sup>e</sup> 4 475 mm (176.2 in) wheel base <sup>f</sup> 5 085 mm (200.2 in) wheel base				

## Maintenance and Specifications

### F550

Dimension	Body style			
	Regular Cab Chassis Cab 4x2	Regular Cab Chassis Cab 4x4	Crew Cab Chassis Cab 4x2	Crew Cab Chassis Cab 4x4
(1) Overall height	2 076 mm (81.7 in) <sup>a</sup> 2 068 mm (81.4 in) <sup>b,c</sup> 2 059 mm (81.1 in) <sup>d</sup>	2 075 mm (81.7 in) <sup>a</sup> 2 063 mm (81.2 in) <sup>b</sup> 2 059 mm (81.1 in) <sup>c</sup> 2 049 mm (80.7 in) <sup>d</sup>	2 067 mm (81.4 in)	2 066 mm (81.3 in)
(2) Track (Front / Rear)	1 736 mm (68.4 in) / 1 880 mm (74.0 in)	1 736 mm (68.4 in) / 1 880 mm (74.0 in)	1 736 mm (68.4 in) / 1 880 mm (74.0 in)	1 736 mm (68.4 in) / 1 880 mm (74.0 in)
(3) Overall width	2 377 mm (93.6 in)	2 377 mm (93.6 in)	2 377 mm (93.6 in)	2 377 mm (93.6 in)
(4) Wheelbase	3 576 mm (140.8 in) 4 186 mm (164.8 in) 4 795 mm (188.8 in) 5 100 mm (200.8 in)	3 576 mm (140.8 in) 4 186 mm (164.8 in) 4 795 mm (188.8 in) 5 100 mm (200.8 in)	4 475 mm (176.2 in) 5 085 (200.2 in)	4 475 mm (176.2 in) 5 085 (200.2 in)

## Maintenance and Specifications

Dimension	Body style			
	Regular Cab Chassis Cab 4x2	Regular Cab Chassis Cab 4x4	Crew Cab Chassis Cab 4x2	Crew Cab Chassis Cab 4x4
(5) Overall length	5 733 mm (225.7 in) <sup>a</sup>	5 733 mm (225.7 in) <sup>a</sup>	6 632 mm (261.1 in) <sup>e</sup>	6 632 mm (261.1 in) <sup>e</sup>
	6 343 mm (249.7 in) <sup>b</sup>	6 343 mm (249.7 in) <sup>b</sup>	7 241 mm (285.1 in) <sup>f</sup>	7 241 mm (285.1 in) <sup>f</sup>
	6 952 mm (273.7 in) <sup>c</sup>	6 952 mm (273.7 in) <sup>c</sup>		
	7 257 mm (285.7 in) <sup>d</sup>	7 257 mm (285.7 in) <sup>d</sup>		
<sup>a</sup> 3 576 mm (140.8 in) wheel base <sup>b</sup> 4 186 mm (164.8 in) wheel base <sup>c</sup> 4 795 mm (188.8 in) wheel base <sup>d</sup> 5 100 mm (200.8 in) wheel base <sup>e</sup> 4 475 mm (176.2 in) wheel base <sup>f</sup> 5 085 mm (200.2 in) wheel base				

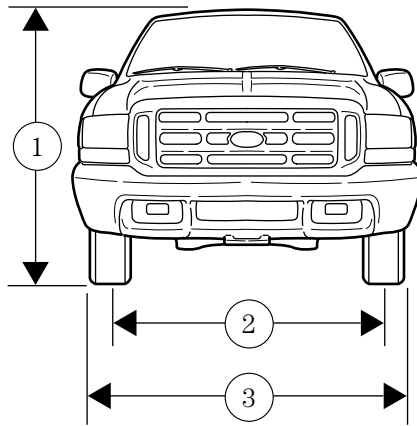

## Maintenance and Specifications

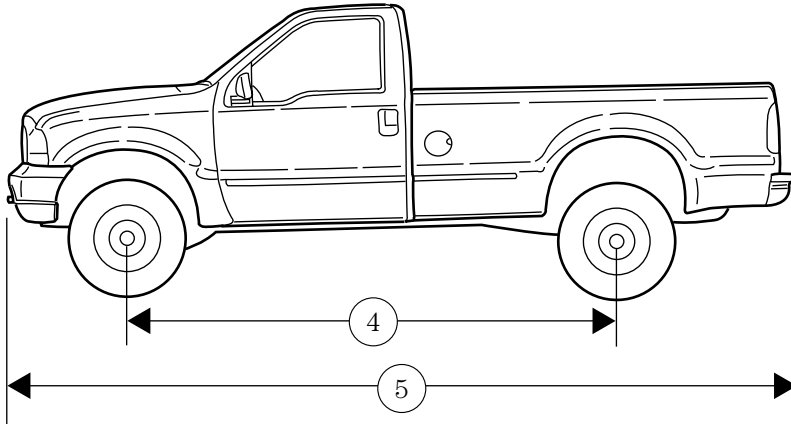

### IDENTIFYING YOUR VEHICLE

#### Certification label

The National Highway Traffic Safety Administration Regulations require that a Certification label be affixed to a vehicle and prescribe where the Certification label may be located. The Certification label is located on the front door latch pillar on the driver's side.

<b>MFD. BY FORD MOTOR CO. IN U.S.A.</b>			
DATE: XXXXX	GVWR: XXXXX LB/ XXXXX KG		
FGAWR: XXXXXX/XXXXXXXX	RGAWR: XXXXXX/XXXXXXXX		
THIS VEHICLE CONFORMS TO ALL APPLICABLE FEDERAL MOTOR VEHICLE SAFETY STANDARDS IN EFFECT ON THE DATE OF MANUFACTURE SHOWN ABOVE.			
VIN: XXXXXXXXXXXXXXXXX		TYPE: XXXXXXXXXXXXXXXXX	
MAXIMUM LOAD=OCCUPANTS + LUGGAGE=XXXKG/XXXLB			
OCCUPANTS: X TOTAL X FR X 2ND X RR OCCUPANTS LUGGAGE			
TIRE: XXXX/XXXXX XXX		XX XXXKG/XXXLB	X XXXKG/XXXLB
PRESSURE (FR) XXX kPa/ XX PSI COLD			
PRESSURE (RR) XXX kPa/ XX PSI COLD			
TRAILER TOWING - SEE OWNER GUIDE			
EXT PNT: XXXXXX XXXXXX	RC: XX	DSO: XXXX	F0000
BAR   INT TR   TP/PS   R	AXLE   TR   SPR	T0000	
X XX XXX X	XX X XXXX		
UTC VFOHT-15294A10-GA			

## Maintenance and Specifications

### Vehicle identification number (VIN)

The vehicle identification number is attached to a metal tag and is located on the driver side instrument panel. (Please note that in the graphic XXXX is representative of your vehicle identification number.)

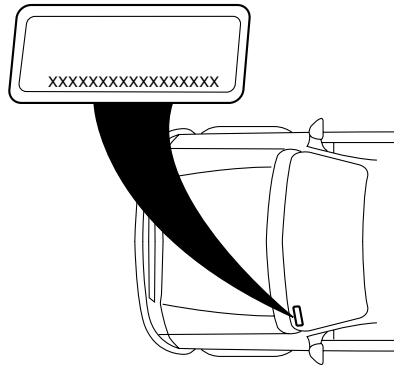

1. World manufacturer identifier
2. Brake type and gross vehicle weight rating (GVWR)
3. Vehicle line, series, body type
4. Engine type
5. Check digit
6. Model year
7. Assembly plant
8. Production sequence number

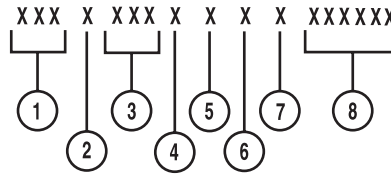

### Engine number

The engine number (the last eight numbers of the vehicle identification number) is stamped on the engine block, transmission, frame and transfer case (if equipped).

## Accessories

### FORD ACCESSORIES FOR YOUR VEHICLE

A wide selection of genuine Ford accessories are available for your vehicle through your local authorized Ford, Lincoln, Mercury or Ford of Canada dealer. These quality accessories have been specifically engineered to fulfill your automotive needs; they are custom designed to complement the style and aerodynamic appearance of your vehicle. In addition, each accessory is made from high quality materials and meets or exceeds Ford's rigorous engineering and safety specifications. Ford Motor Company will repair or replace any properly dealer-installed Ford accessory found to be defective in factory-supplied materials or workmanship during the warranty period, as well as any component damaged by the defective accessory. The accessory will be warranted for whichever provides you the greatest benefit:

- 12 months or 20,000 km (12,000 miles) (whichever occurs first), or
- the remainder of your new vehicle limited warranty.

This means that genuine Ford accessories purchased along with your new vehicle and installed by the dealer are covered for the full length of your New Vehicle's Limited Warranty — 3 years or 60,000 km (36,000 miles) (whichever occurs first). Contact your dealer for details and a copy of the warranty.

**Not all accessories are available for all models.**

#### Vehicle Security

Remote keyless entry

Styled wheel protector locks

Vehicle security systems

#### Comfort and convenience

Cargo organizers

Cargo storage bin

Cargo trays

Cell phone holder

Engine block heaters

Manual sliding rear window

Power sliding rear window

Tire step

270

## Accessories

### **Travel equipment**

Adjustable Towing System  
Auto headlamp system with Daytime Running Lights (DRL)  
Battery Warmer  
Bed Tent  
Box Aluminum Rack cargo storage systems (Trac Rac)  
Daytime running lights (DRL)  
Electrochromic inside mirror with compass  
Electrochromic inside mirror with compass and temperature display  
Fog lights  
Highway safety and first aid kit  
Off road lights  
Pickup box rails  
ROC2 hitch mounted bike courier  
Running boards and tubular running bars  
Running boards diamond plate  
Seatback organizer  
Speed control  
Towing mirrors  
Trailer hitch, Class IV &  
Trailer hitch bars and balls  
Trailer hitch mounted bike carrier  
Trailer hitch wiring adaptor  
Trailer wiring harness  
Trailgate table

### **Protection and appearance equipment**

Air bag anti-theft locks  
All weather vinyl floor mats  
Bed mat  
Bed hooks  
Bed mats

## Accessories

Bedliners  
Carpet floor mats  
Cap (hard, color keyed – Leer supplier branded)  
Cap (commercial – Leer supplier branded)  
Cleaners, waxes and polishes  
Diamond plate bed rail caps  
Diamond plate front box protection  
Diamond plate splash guards  
Diamond plate tool box  
Door edge guards  
Fender flares  
Flat splash guards  
Front end covers (full)  
Hood deflectors  
Leather wrap steering wheel  
Locking gas cap  
Lubricants and oils  
Molded splash guards  
Rear window deflector  
Side window air deflectors  
Spare tire lock  
Stainless steel grill insert  
Step bumpers  
Tailgate covers (Diamond plate)  
Tonneau cover (soft)  
Tonneau cover (hard, color keyed – Leer supplier branded)  
Touch-up paint  
Truck cover (full vehicle)  
Universal floor mats  
Wheels  
Wheel covers

272



## Accessories

Wood trim - interim applique

For maximum vehicle performance, keep the following information in mind when adding accessories or equipment to your vehicle:

- When adding accessories, equipment, passengers and luggage to your vehicle, do not exceed the total weight capacity of the vehicle or of the front or rear axle (GVWR or GAWR as indicated on the Safety compliance certification label). Consult your dealer for specific weight information.
- The Federal Communications Commission (FCC) and Canadian Radio Telecommunications Commission (CRTC) regulate the use of mobile communications systems - such as two-way radios, telephones and theft alarms - that are equipped with radio transmitters. Any such equipment installed in your vehicle should comply with FCC or CRTC regulations and should be installed only by a qualified service technician.
- Mobile communications systems may harm the operation of your vehicle, particularly if they are not properly designed for automotive use or are not properly installed. When operated, such systems may cause the engine to stumble or stall or cause the transmission to be damaged or operate improperly. In addition, such systems may be damaged or their performance may be affected by operating your vehicle. (Citizens band [CB] transceivers, garage door openers and other transmitters with outputs of five watts or less will not ordinarily affect your vehicle's operation.)
- Ford cannot assume responsibility for any adverse effects or damage that may result from the use of such equipment.



Vehicles with a higher center of gravity such as utility and four-wheel drive vehicles handle differently than vehicles with a lower center of gravity. Utility and four-wheel drive vehicles are **not** designed for cornering at speeds as high as passenger cars any more than low-slung sports cars are designed to perform satisfactorily under off-road conditions. Avoid sharp turns, excessive speed and abrupt maneuvers in these vehicles. Failure to drive cautiously could result in an increased risk of loss of vehicle control, vehicle rollover, personal injury and death.

## Index

### A

Accessory delay .....53  
Air bag supplemental restraint system .....90  
    and child safety seats .....92  
    description .....90  
    disposal .....94  
    driver air bag .....92  
    indicator light .....94  
    operation .....92  
    passenger air bag .....92  
    passenger deactivation switch .....95  
Air cleaner filter .....246, 253  
Ambulance packages .....8  
Antifreeze (see Engine coolant) .....223  
Anti-lock brake system (see Brakes) .....115  
Audio system  
    AM/FM .....19  
Audio system (see Radio) .....19, 21, 23, 27  
Automatic transmission .....118  
    driving an automatic  
    overdrive .....119, 122  
    fluid, adding .....241  
    fluid, checking .....241  
    fluid, refill capacities .....254  
    fluid, specification .....260  
Auxiliary power point .....52  
Axle  
    lubricant specifications ..257, 260  
    refill capacities .....254  
    traction lok .....117

### B

Battery .....221

274

acid, treating emergencies .....221  
    jumping a disabled battery ....192  
    maintenance-free .....221  
    replacement, specifications ..253  
    servicing .....221  
BeltMinder .....85  
Brakes .....115  
    anti-lock .....115  
    anti-lock brake system (ABS)  
    warning light .....115  
    fluid, checking and adding ....239  
    fluid, refill capacities .....254  
    fluid, specifications .....257, 260  
    lubricant specifications ..257, 260  
    parking .....116  
    shift interlock .....118  
Bulbs .....42

### C

Calculating load .....146  
Capacities for refilling fluids ....254  
Cassette tape player .....27  
CD changer .....31  
CD-single premium .....19, 21, 23  
Cell phone use .....59  
Certification Label .....268  
Child safety restraints .....99  
    child safety belts .....99  
Child safety seats .....102  
    attaching with tether straps ..106  
    in front seat .....104  
    in rear seat .....104  
Cleaning your vehicle  
    engine compartment .....209  
    instrument panel .....211  
    interior .....211  
    interior trim .....211

## Index

- plastic parts .....210
- safety belts .....211
- washing .....208
- waxing .....208
- wheels .....209
- wiper blades .....210
- Clock adjust
  - AM/FM .....19
- Clutch
  - fluid .....240
  - operation while driving .....124
  - recommended shift speeds ...125
- Compass, electronic .....61
  - calibration .....63
  - set zone adjustment .....62
- Console .....59
  - overhead .....50
- Coolant
  - checking and adding .....223
  - refill capacities .....226, 254
  - specifications .....257, 260
- Cruise control
  - (see Speed control) .....56
- Customer Assistance .....174
  - Ford accessories for your vehicle .....213
  - Ford Extended Service Plan .....201
  - Getting assistance outside the U.S. and Canada .....205
  - Getting roadside assistance ...174
  - Getting the service you need .....199
  - Ordering additional owner's literature .....206
  - The Dispute Settlement Board .....201
  - Utilizing the Mediation/Arbitration Program .....204
- D**
  - Daytime running lamps (see Lamps) .....39
  - Dipstick
    - automatic transmission fluid .....241
    - engine oil .....218
  - Doors
    - lubricant specifications .....257
  - Driveline universal joint and slip yoke .....245
  - Driving under special conditions .....124, 137, 140
    - sand .....139
    - snow and ice .....141
    - through water .....139, 144
- E**
  - Emergencies, roadside
    - jump-starting .....192
  - Emergency Flashers .....175
  - Emission control system .....236
  - Engine .....260
    - cleaning .....209
    - coolant .....223
    - diesel .....7
    - fail-safe coolant .....227
    - idle speed control .....221
    - lubrication
      - specifications .....257, 260
      - refill capacities .....254
      - service points .....217
      - starting after a collision .....175
  - Engine block heater .....114
  - Engine oil .....218
    - checking and adding .....218
    - dipstick .....218

## Index

- filter, specifications .....220, 253
- recommendations .....220
- refill capacities .....254
- specifications .....257, 260
- Exhaust fumes .....114
- F**
- Fail safe cooling .....227
- Fluid capacities .....254
- Foglamps .....39
- Four-Wheel Drive vehicles .....129
  - description .....133
  - driving off road .....135
  - electronic shift .....129, 133
  - indicator light .....130
  - lever operated shift .....130
  - manual locking hubs .....129
  - preparing to drive your vehicle .....117
- Fuel .....229
  - calculating fuel economy .....233
  - cap .....231
  - capacity .....254
  - choosing the right fuel .....231
  - comparisons with EPA fuel economy estimates .....236
  - detergent in fuel .....232
  - filling your vehicle
    - with fuel .....229, 231, 233
  - filter, specifications .....233, 253
  - fuel pump shut-off switch .....175
  - improving fuel economy .....233
  - octane rating .....232, 260
  - quality .....232
  - running out of fuel .....232
  - safety information relating to automotive fuels .....229
- Fuel pump shut-off switch .....175
- Fuses .....176–177
- G**
- Garage door opener .....50
- Gas cap (see Fuel cap) .....231
- Gas mileage (see Fuel economy) .....233
- Gauges .....15
  - transmission fluid
  - temperature gauge .....19
- GAWR (Gross Axle Weight Rating) .....145
  - calculating .....146
  - definition .....145
  - driving with a heavy load .....145
  - location .....145
- GVWR (Gross Vehicle Weight Rating) .....145
  - calculating .....145–146
  - definition .....145
  - driving with a heavy load .....145
  - location .....145
- H**
- Hazard flashers .....175
- Headlamps .....38
  - aiming .....40
  - autolamp system .....38
  - daytime running lights .....39
  - flash to pass .....40
  - high beam .....39
  - replacing bulbs .....43–44
  - turning on and off .....38
- Heating
  - heating and air conditioning system .....35–36
- Hood .....216
- I**
- Ignition .....110, 260

## Index

- Infant seats  
(see Safety seats) .....102
- Inspection/maintenance (I/M)  
testing .....238
- Instrument panel  
  cleaning .....211  
  cluster .....12  
  lighting up panel and  
  interior .....40
- J**
- Jump-starting your vehicle .....192
- K**
- Keyless entry system  
  autolock .....71
- Keys  
  positions of the ignition .....110
- L**
- Lamps  
  autolamp system .....38  
  bulb replacement  
  specifications chart .....42  
  cargo lamps .....40  
  daytime running light .....39  
  fog lamps .....39  
  headlamps .....38  
  headlamps, flash to pass .....40  
  instrument panel, dimming ....40  
  interior lamps .....41–42  
  replacing bulbs .....42–47
- Lane change indicator  
(see Turn signal) .....41
- Lights, warning and indicator ....12  
  anti-lock brakes (ABS) .....115  
  speed control .....58
- Load limits .....145
- GAWR .....145  
GVWR .....145  
trailer towing .....145
- Loading instructions .....146
- Locks  
  autolock .....71  
  childproof .....66
- Lubricant specifications ...257, 260
- Lumbar support, seats .....76
- M**
- Manual transmission .....124  
  fluid capacities .....254  
  lubricant specifications .....260  
  reverse .....126
- Message center .....59  
  english/metric button .....60  
  menu button .....60
- Mirrors .....50  
  fold away .....55  
  heated .....54  
  side view mirrors (power) .....53
- Moon roof .....51
- Motorcraft parts .....233, 253
- O**
- Octane rating .....232
- Oil (see Engine oil) .....218
- Overdrive .....49
- P**
- Parking brake .....116
- Parts (see Motorcraft parts) ....253
- Pedals (see Power adjustable  
foot pedals) .....56
- Power adjustable foot pedals ....56

## Index

- Power distribution box  
(see Fuses) .....177
- Power door locks .....65, 71
- Power point .....52
- Power steering .....117  
fluid, checking and adding ....239  
fluid, refill capacity .....254  
fluid, specifications .....257, 260
- Power Windows .....52
- Preparing to drive your  
vehicle .....117
- R**
- Radio .....19, 21, 23, 27  
AM/FM .....19
- Relays .....176
- Remote entry system .....67  
illuminated entry .....70  
locking/unlocking doors .....65
- Reverse sensing system .....127
- Roadside assistance .....174
- S**
- Safety Belt Maintenance .....89
- Safety belts (see Safety  
restraints) .....77, 79–81, 83
- Safety defects, reporting .....207
- Safety restraints .....77, 79–83  
belt minder .....85  
extension assembly .....89  
for adults .....79–81  
for children .....99  
lap belt .....84  
safety belt maintenance .....89  
warning light and chime .....85
- Safety seats for children .....102
- Seat belts (see Safety  
restraints) .....77
- Seats .....72  
child safety seats .....102  
cleaning .....212
- Servicing your vehicle .....215
- Snowplowing .....8, 170–172
- Spare tire  
(see Changing the Tire) .....182
- Spark plugs,  
specifications .....253, 260
- Special notice .....9  
ambulance conversions .....8  
diesel-powered vehicles .....7  
four-wheel drive vehicles 172–173  
utility-type vehicles .....7
- Specification chart,  
lubricants .....257, 260
- Speed control .....56
- Starting your vehicle .....110–111,  
113  
jump starting .....192
- Steering wheel  
tilting .....49
- Stereo  
AM/FM .....19
- T**
- Tailgate .....64
- Tilt steering wheel .....49
- Tires .....247–248  
changing .....182, 184  
checking the pressure .....248  
replacing .....251  
rotating .....249  
snow tires and chains .....252  
tire grades .....248  
treadwear .....247

## Index

- Towing .....146  
trailer towing .....146  
wrecker .....197
- Traction-lok rear axle .....117
- Transfer case  
fluid checking .....245
- Transmission  
automatic operation .....49, 118  
brake-shift interlock (BSI) ....118  
fluid, checking and adding  
(automatic) .....241  
fluid, checking and adding  
(manual) .....244  
fluid, refill capacities .....254  
lubricant specifications ..257, 260  
manual operation .....124
- Turn signal .....41
- V**
- Vehicle dimensions .....260
- Vehicle Identification Number  
(VIN) .....269
- Vehicle loading .....145
- Ventilating your vehicle .....114
- W**
- Warning lights (see Lights) .....12
- Washer fluid .....218
- Water, Driving through .....144
- Windows  
power .....52
- Windshield washer fluid and  
wipers .....48  
checking and adding fluid ....218  
replacing wiper blades .....48
- Wrecker towing .....197

