

## Table of Contents

|                                     |           |
|-------------------------------------|-----------|
| <b>Introduction</b>                 | <b>4</b>  |
| <b>Instrument Cluster</b>           | <b>12</b> |
| Warning and control lights          | 12        |
| Gauges                              | 15        |
| <b>Entertainment Systems</b>        | <b>20</b> |
| AM/FM stereo                        | 20        |
| AM/FM stereo with CD                | 22        |
| AM/FM stereo cassette with CD       | 25        |
| AM/FM stereo with in-dash six CD    | 28        |
| <b>Climate Controls</b>             | <b>33</b> |
| Heater only                         | 33        |
| Manual heating and air conditioning | 34        |
| Automatic temperature control       | 36        |
| <b>Lights</b>                       | <b>39</b> |
| Headlamps                           | 39        |
| Turn signal control                 | 44        |
| Bulb replacement                    | 45        |
| <b>Driver Controls</b>              | <b>54</b> |
| Windshield wiper/washer control     | 54        |
| Steering wheel adjustment           | 54        |
| Power windows                       | 57        |
| Mirrors                             | 58        |
| Speed control                       | 61        |
| Upfitter controls                   | 64        |
| Moon roof                           | 66        |
| Message center                      | 68        |
| <b>Locks and Security</b>           | <b>80</b> |
| Keys                                | 80        |
| Locks                               | 80        |

## Table of Contents

|                                      |            |
|--------------------------------------|------------|
| <b>Seating and Safety Restraints</b> | <b>90</b>  |
| Seating                              | 90         |
| Safety restraints                    | 97         |
| Airbags                              | 108        |
| Child restraints                     | 117        |
| <b>Tires, Wheels and Loading</b>     | <b>129</b> |
| Tire Information                     | 132        |
| Tire Inflation                       | 133        |
| Vehicle loading                      | 148        |
| Trailer towing                       | 155        |
| Trailer Brake Controller-Integrated  | 159        |
| Recreational towing                  | 165        |
| <b>Driving</b>                       | <b>167</b> |
| Starting                             | 167        |
| Brakes                               | 172        |
| Transmission operation               | 176        |
| <b>Roadside Emergencies</b>          | <b>202</b> |
| Getting roadside assistance          | 202        |
| Hazard flasher switch                | 204        |
| Fuel pump shut-off switch            | 204        |
| Fuses and relays                     | 205        |
| Changing tires                       | 214        |
| Lug Nut Torque                       | 225        |
| Jump starting                        | 226        |
| Wrecker towing                       | 232        |
| <b>Customer Assistance</b>           | <b>234</b> |
| Reporting safety defects (U.S. only) | 240        |
| <b>Cleaning</b>                      | <b>241</b> |

## Table of Contents

|                                       |            |
|---------------------------------------|------------|
| <b>Maintenance and Specifications</b> | <b>249</b> |
| Engine compartment                    | 251        |
| Engine oil                            | 254        |
| Battery                               | 258        |
| Engine Coolant                        | 260        |
| Fuel information                      | 266        |
| Air filter(s)                         | 284        |
| Part numbers                          | 286        |
| Refill capacities                     | 287        |
| Lubricant specifications              | 290        |
| <b>Accessories</b>                    | <b>302</b> |
| <b>Index</b>                          | <b>305</b> |

All rights reserved. Reproduction by any means, electronic or mechanical including photocopying, recording or by any information storage and retrieval system or translation in whole or part is not permitted without written authorization from Ford Motor Company. Ford may change the contents without notice and without incurring obligation.

Copyright © 2005 Ford Motor Company

## Introduction

### CALIFORNIA Proposition 65 Warning



**WARNING:** Engine exhaust, some of its constituents, and certain vehicle components contain or emit chemicals known to the State of California to cause cancer and birth defects or other reproductive harm. In addition, certain fluids contained in vehicles and certain products of component wear contain or emit chemicals known to the State of California to cause cancer and birth defects or other reproductive harm.

### CONGRATULATIONS

Congratulations on acquiring your new Ford. Please take the time to get well acquainted with your vehicle by reading this handbook. The more you know and understand about your vehicle, the greater the safety and pleasure you will derive from driving it.

For more information on Ford Motor Company and its products visit the following website:

- In the United States: [www.ford.com](http://www.ford.com)
- In Canada: [www.ford.ca](http://www.ford.ca)
- In Australia: [www.ford.com.au](http://www.ford.com.au)
- In Mexico: [www.ford.com.mx](http://www.ford.com.mx)

Additional owner information is given in separate publications.

This *Owner's Guide* describes every option and model variant available and therefore some of the items covered may not apply to your particular vehicle. Furthermore, due to printing cycles it may describe options before they are generally available.

Remember to pass on this *Owner's Guide* when reselling the vehicle. It is an integral part of the vehicle.



**Fuel pump shut-off switch:** In the event of an accident the safety switch will automatically cut off the fuel supply to the engine. The switch can also be activated through sudden vibration (e.g. collision when parking). To reset the switch, refer to the *Fuel pump shut-off switch* in the *Roadside Emergencies* chapter.

## Introduction

### SAFETY AND ENVIRONMENT PROTECTION

#### **Warning symbols in this guide**

How can you reduce the risk of personal injury to yourself or others? In this guide, answers to such questions are contained in comments highlighted by the warning triangle symbol. These comments should be read and observed.

#### **Warning symbols on your vehicle**

When you see this symbol, it is imperative that you consult the relevant section of this guide before touching or attempting adjustment of any kind.



#### **Protecting the environment**

We must all play our part in protecting the environment. Correct vehicle usage and the authorized disposal of waste, cleaning and lubrication materials are significant steps towards this aim. Information in this respect is highlighted in this guide with the tree symbol.



### BREAKING-IN YOUR VEHICLE

During the first 1,000 miles (1,600 km) of driving, maintain speeds below 70 mph (112 km/h) and vary speeds frequently. This is recommended to give the moving parts a chance to break-in.

Do not tow a trailer or use your vehicle to snowplow until it has been driven at least 500 miles (800 km). Refer to *Trailer towing* in the *Tires, Wheels and Loading* chapter for more information on towing a trailer and *Snowplowing* in the *Driving* chapter.

Do not add friction modifier compounds or special break-in oils during the first few thousand miles (kilometers) of operation, since these additives may prevent piston ring seating. See *Engine oil* in the *Maintenance and Specifications* chapter for more information on oil usage.

## Introduction

### SPECIAL NOTICES

#### **New Vehicle Limited Warranty**

For a detailed description of what is covered and what is not covered by your vehicle's New Vehicle Limited Warranty, refer to the *Warranty Guide* that is provided to you along with your *Owner's Guide*.

#### **Service Data Recording**

Service data recorders in your vehicle are capable of collecting and storing diagnostic information about your vehicle. This potentially includes information about the performance or status of various systems and modules in the vehicle, such as engine, throttle, steering or brake systems. In order to properly diagnose and service your vehicle, Ford Motor Company, Ford of Canada, Ford Motor Company, S.A. de C.V. and service and repair facilities may access vehicle diagnostic information through a direct connection to your vehicle when diagnosing or servicing your vehicle.

#### **Event Data Recording**

Other modules in your vehicle — event data recorders — are capable of collecting and storing data during a crash or near crash event. The recorded information may assist in the investigation of such an event. The modules may record information about both the vehicle and the occupants, potentially including information such as:

- how various systems in your vehicle were operating;
- whether or not the driver and passenger seatbelts were buckled;
- how far (if at all) the driver was depressing the accelerator and/or the brake pedal;
- how fast the vehicle was traveling; and
- where the driver was positioning the steering wheel.

To access this information, special equipment must be directly connected to the recording modules. Ford Motor Company, Ford of Canada and Ford Motor Company, S.A. de C.V. do not access event data recorder information without obtaining consent, unless pursuant to court order or where required by law enforcement, other government authorities or other third parties acting with lawful authority. Other parties may seek to access the information independently of Ford Motor Company, Ford of Canada and Ford Motor Company, S.A. de C.V.

## Introduction

### **Vehicle Modification Data Recording**

Some aftermarket products may cause severe engine and/or transmission damage; refer to the *What is not covered* section in *The new vehicle limited warranty for your vehicle* chapter of your vehicle's *Warranty Guide* for more information. Some vehicles are equipped with Powertrain Control Systems that can detect and store information about vehicle modifications that increase horsepower and torque output; this information cannot be erased and will stay in the system's memory even if the modification is removed. When a dealer or repair facility works on your vehicle, it may be necessary for them to access the information in the Powertrain Control System. This information will likely identify if any unauthorized modifications have been made to the system and may be used to determine if repairs will be covered by warranty.

### **Special instructions**

For your added safety, your vehicle is fitted with sophisticated electronic controls.



Please read the section *Supplemental restraint system (SRS)* in the *Seating and Safety Restraints* chapter. Failure to follow the specific warnings and instructions could result in personal injury.



Front seat mounted rear-facing child or infant seats should **NEVER** be placed in front of an active passenger airbag.

### **Cell phone use**

The use of Mobile Communications Equipment has become increasingly important in the conduct of business and personal affairs. However, drivers must not compromise their own or others' safety when using such equipment. Mobile Communications can enhance personal safety and security when appropriately used, particularly in emergency situations. Safety must be paramount when using mobile communications equipment to avoid negating these benefits.

Mobile Communication Equipment includes, but is not limited to cellular phones, pagers, portable email devices, in-vehicle communications systems, telematics devices and portable two-way radios.



A driver's first responsibility is the safe operation of the vehicle. The most important thing you can do to prevent a crash is to avoid distractions and pay attention to the road. Wait until it is safe to operate Mobile Communications Equipment.

## Introduction

### Notice to owners of diesel-powered vehicles

Read the *6.0 Liter Power Stroke Direct Injection Turbo Diesel Owner's Guide* Supplement for information regarding correct operation and maintenance of your Diesel-powered light truck.

### Notice to owners of pickup trucks and utility type vehicles



Utility vehicles have a significantly higher rollover rate than other types of vehicles.

Before you drive your vehicle, please read this *Owner's Guide* carefully. Your vehicle is not a passenger car. As with other vehicles of this type, failure to operate this vehicle correctly may result in loss of vehicle control, vehicle rollover, personal injury or death.

Be sure to read *Driving off road* in the *Driving* chapter.

### Using your vehicle with a snowplow

For more information and guidelines for using your vehicle with a snowplow, refer to the *Driving* chapter.

### Using your vehicle as an ambulance

If your light truck is equipped with the Ford Ambulance Preparation Package, it may be utilized as an ambulance. Ford urges ambulance manufacturers to follow the recommendations of the *Ford Incomplete Vehicle Manual*, *Ford Truck Body Builder's Layout Book* and the *Qualified Vehicle Modifiers (QVM) Guidelines* as well as pertinent supplements. For additional information, please contact the Truck Body Builders Advisory Service at 1-877-840-4338.

Use of your Ford light truck as an ambulance, without the Ford Ambulance Preparation Package voids the Ford New Vehicle Limited Warranty and may void the Emissions Warranties. In addition, ambulance usage without the preparation package could cause high underbody temperatures, overpressurized fuel and a risk of spraying fuel which could lead to fires.



## Introduction

If your vehicle is equipped with the Ford Ambulance Preparation Package, it will be indicated on the Safety Compliance Certification Label. The label is located on the driver's side door pillar or on the rear edge of the driver's door. You can determine whether the ambulance manufacturer followed Ford's recommendations by directly contacting that manufacturer. Ford Ambulance Preparation Package is only available on certain 6.0L Diesel engine equipped vehicles.

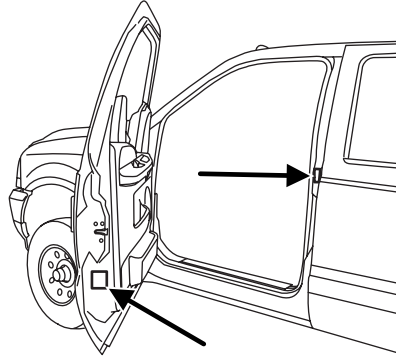

### Using your vehicle as a stationary power source (PTO)

Refer to the *Driving* chapter for more information and guidelines for operating a vehicle equipped with an aftermarket power take-off system.

### Middle East/North Africa vehicle specific information

For your particular global region, your vehicle may be equipped with features and options that are different from the ones that are described in this *Owner's Guide*; therefore, a supplement has been supplied that complements this book. By referring to the pages in the provided supplement, you can properly identify those features, recommendations and specifications that are unique to your vehicle. **Refer to this Owner's Guide for all other required information and warnings.**

## Introduction















These are some of the symbols you may see on your vehicle.

### Vehicle Symbol Glossary

|                                 |   |                                   |  |
|---------------------------------|---|-----------------------------------|--|
| Safety Alert                    |    | See Owner's Guide                 |    |
| Fasten Safety Belt              |    | Airbag-Front                      |    |
| Airbag-Side                     |    | Child Seat                        |    |
| Child Seat Installation Warning |    | Child Seat Lower Anchor           |    |
| Child Seat Tether Anchor        |    | Brake System                      |    |
| Anti-Lock Brake System          |   | Brake Fluid - Non-Petroleum Based |   |
| Powertrain Malfunction          |  | Speed Control                     |  |
| Master Lighting Switch          |  | Hazard Warning Flasher            |  |
| Fog Lamps-Front                 |  | Fuse Compartment                  |  |
| Fuel Pump Reset                 |  | Windshield Wash/Wipe              |  |
| Windshield Defrost/Demist       |  | Rear Window Defrost/Demist        |  |

## Introduction

### Vehicle Symbol Glossary

|                                  |   |   |  |
|----------------------------------|---|---|--|
| Power Windows Front/Rear         |    | Power Window Lockout                        |    |
| Child Safety Door Lock/Unlock    |    | Interior Luggage Compartment Release Symbol |    |
| Panic Alarm                      |    | Engine Oil                                  |    |
| Engine Coolant                   |    | Engine Coolant Temperature                  |    |
| Do Not Open When Hot             |    | Battery                                     |    |
| Avoid Smoking, Flames, or Sparks |    | Battery Acid                                |    |
| Explosive Gas                    |  | Fan Warning                                 |  |
| Power Steering Fluid             |  | Maintain Correct Fluid Level                |  |
| Emission System                  |  | Engine Air Filter                           |  |
| Passenger Compartment Air Filter |  | Jack  |  |
| Check Fuel Cap                   |  | Low Tire Pressure Warning                   |  |

## Instrument Cluster

### WARNING LIGHTS AND CHIMES

#### Standard instrument cluster (manual transmission)

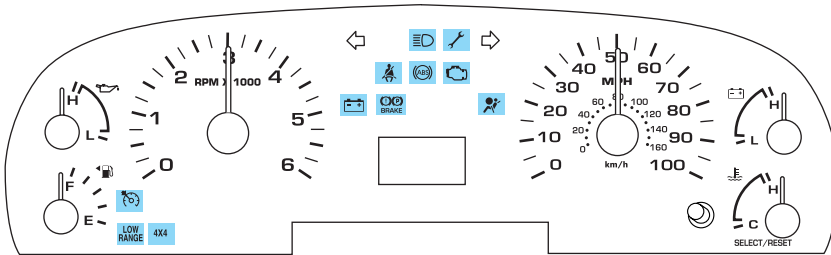

#### Standard instrument cluster (automatic transmission)

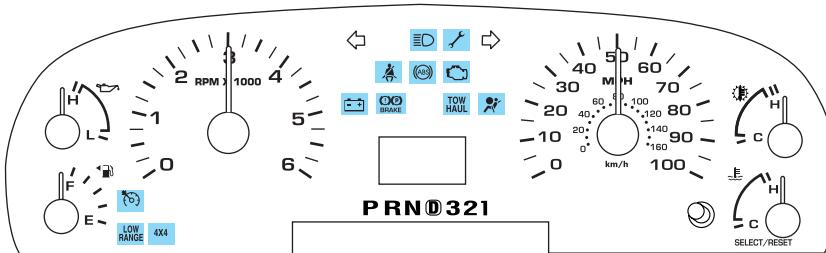

#### Amarillo instrument cluster

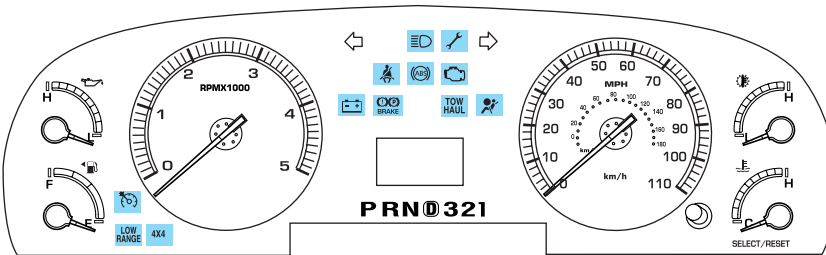

Warning lights and gauges can alert you to a vehicle condition that may become serious enough to cause expensive repairs. A warning light may illuminate when a problem exists with one of your vehicle's functions.

## Instrument Cluster

Many lights will illuminate when you start your vehicle to make sure the bulbs work. If any light remains on after starting the vehicle, have the respective system inspected immediately.

If your vehicle is equipped with a diesel engine, it has a unique cluster, refer to *Starting the engine* in your *6.0 Liter Power Stroke Direct Injection Turbo Diesel Owner's Guide Supplement*.

**Service engine soon:** The *Service engine soon* indicator light illuminates when the ignition is first turned to the ON position to check

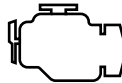

the bulb. Solid illumination after the engine is started indicates the On Board Diagnostics System (OBD-II) has detected a malfunction. Refer to *On board diagnostics (OBD-II)* in the *Maintenance and Specifications* chapter. If the light is blinking, engine misfire is occurring which could damage your catalytic converter. Drive in a moderate fashion (avoid heavy acceleration and deceleration) and have your vehicle serviced immediately.



Under engine misfire conditions, excessive exhaust temperatures could damage the catalytic converter, the fuel system, interior floor coverings or other vehicle components, possibly causing a fire.

**Electronic throttle control:**

Illuminates when the engine has defaulted to a 'limp-home' operation. Report the fault to an authorized dealer at the earliest opportunity.



On vehicles equipped with a message center, "ENGINE FAILSAFE MODE" will be displayed, refer to *Message Center* in the *Driver Controls* chapter.

**Brake system warning light:** To confirm the brake system warning light is functional, it will momentarily illuminate when the ignition is turned to the ON position when the engine



is not running, or in a position between ON and START, or by applying the parking brake when the ignition is turned to the ON position. If the brake system warning light does not illuminate at this time, seek service immediately from your authorized dealer. Illumination after releasing the parking brake indicates low brake fluid level and the brake system should be inspected immediately by your servicing authorized dealer.

## Instrument Cluster



Driving a vehicle with the brake system warning light on is dangerous. A significant decrease in braking performance may occur. It will take you longer to stop the vehicle. Have the vehicle checked by your authorized dealer immediately.

**Anti-lock brake system:** If the ABS light stays illuminated or continues to flash, a malfunction has been detected, have the system serviced immediately. Normal braking is still functional unless the brake warning light also is illuminated.



**Airbag readiness:** If this light fails to illuminate when ignition is turned to ON, continues to flash or remains on, have the system serviced immediately. A chime will also sound when a malfunction in the supplemental restraint system has been detected.



**Safety belt:** Reminds you to fasten your safety belt. A chime will also sound to remind you to fasten your safety belt.



**Charging system:** Illuminates when the battery is not charging properly.



**Transmission Tow/Haul Feature (automatic transmission):**

Illuminates when the Tow/Haul feature has been activated. Refer to the *Driving* chapter for transmission function and operation. If the light flashes steadily, have the system serviced immediately, damage to the transmission could occur.

TOW  
HAUL

**Four wheel drive low:** Illuminates when four-wheel drive low is engaged.

LOW  
RANGE

**Four wheel drive indicator:** Illuminates when four-wheel drive is engaged.

4x4

## Instrument Cluster

**Speed control:** Illuminates when the speed control is activated. Turns off when the speed control system is deactivated.



**Turn signal:** Illuminates when the left or right turn signal or the hazard lights are turned on. If the indicators stay on or flash faster, check for a burned out bulb.



**High beams:** Illuminates when the high beam headlamps are turned on.



**Key-in-ignition warning chime:** Sounds when the key is left in the ignition in the OFF, LOCK or ACCESSORY position and the driver's door is opened.

**Headlamps on warning chime:** Sounds when the headlamps or parking lamps are on, the ignition is off (the key is not in the ignition) and the driver's door is opened.

**Parking brake ON warning chime:** Sounds when the parking brake is set, the engine is running and the vehicle is driven more than 3 mph (5 km).

### GAUGES

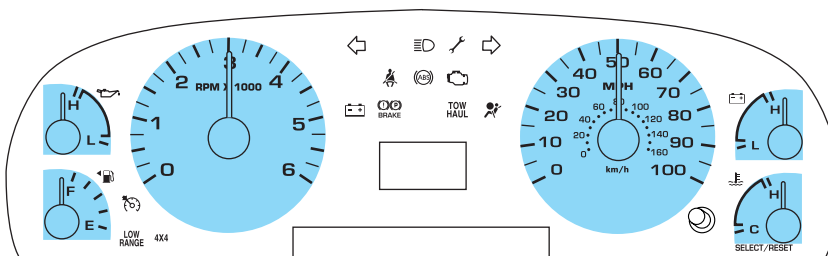

## Instrument Cluster

**Speedometer:** Indicates the current vehicle speed.

### Standard instrument cluster

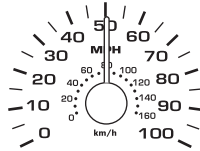

### Amarillo instrument cluster

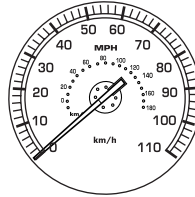

**Engine coolant temperature gauge:** Indicates engine coolant temperature. At normal operating temperature, the needle will be in the normal range (between “H” and “C”). **If it enters the red section, the engine is overheating. Stop the vehicle as soon as safely possible, switch off the engine and let the engine cool.**

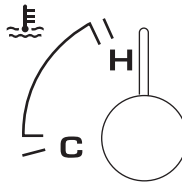

Never remove the coolant reservoir cap while the engine is running or hot.

**Odometer:** Registers the total miles (kilometers) of the vehicle.

- With Mini Message Center

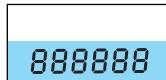

- With Full Message Center

Refer to *Message Center* in the *Drivers Controls* chapter on how to switch the display from Metric to English.

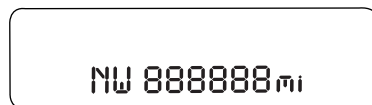



## Instrument Cluster

**Trip odometer:** Registers the miles (kilometers) of individual journeys.

- With Mini Message Center

Press and release the SELECT/RESET button on the cluster to toggle between odometer and trip odometer display. To reset, press and hold for less than 2 seconds.

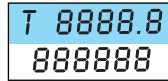

- With Full Message Center

Press and release the message center INFO button until TRIP mode appears in the display. Press the RESET button to reset.

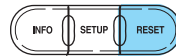
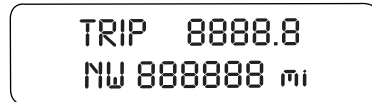

**Engine hour meter:** Registers the accumulated time the engine has been running.

- With Mini Message Center

Press the SELECT/RESET button until the engine hours display.

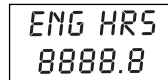

- With Full Message Center

Press and release the message center INFO button until ENG HRS XXXX.X appears in the display. Press the RESET button to reset.

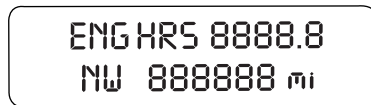

**Tachometer:** Indicates the engine speed in revolutions per minute. Driving with your tachometer pointer continuously at the top of the scale may damage the engine.

### Standard instrument cluster

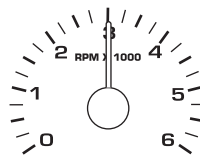

## Instrument Cluster

### Amarillo instrument cluster

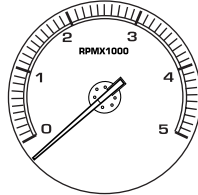

#### Engine oil pressure gauge:

Indicates engine oil pressure. The needle should stay in the normal operating range (between “L” and “H”). If the needle falls below the normal range, stop the vehicle, turn off the engine and check the engine oil level. Add oil if needed. If the oil level is correct, have your vehicle checked at your authorized dealer.

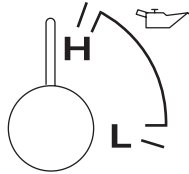

**Fuel gauge:** Indicates approximately how much fuel is left in the fuel tank (when the ignition is in the ON position). The fuel gauge may vary slightly when the vehicle is in motion or on a grade.

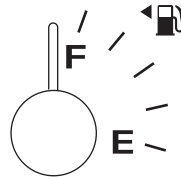

Refer to *Filling the tank* in the *Maintenance and Specifications* chapter for more information.

**Battery voltage gauge (manual transmission only):** Indicates the battery voltage when the ignition is in the ON position. If the pointer moves and stays outside the normal operating range, have the vehicle's electrical system checked as soon as possible.

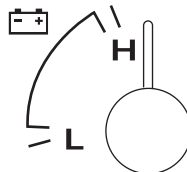

## Instrument Cluster

**Transmission fluid temperature gauge (automatic transmission only):** If the gauge is in the:

**Normal area** (normal) - the transmission fluid is within the normal operating temperature (between “H” and “C”).

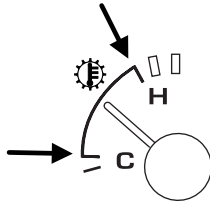

**Yellow area** (warning) — the transmission fluid is higher than normal operating temperature. This can be caused by special operation conditions (i.e. snowplowing, towing or off road use). Refer to *Special Operating Conditions* in the *scheduled maintenance information* for instructions. Operating the transmission for extended periods of time with the gauge in the yellow area may cause internal transmission damage.

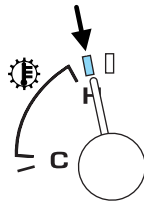

Altering the severity of the driving conditions is recommended to lower the transmission temperature into the normal range.

**Red area** (over temperature) — the transmission fluid is overheating. Stop the vehicle to allow the temperature to return to normal range.

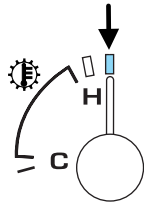

If the gauge is operating in the Yellow or Red area, stop the vehicle and verify the airflow is not restricted such as snow or debris blocking airflow through the grill. If the gauge continues to show high temperatures, see your authorized dealer.

## Entertainment Systems

### AUDIO SYSTEMS

#### AM/FM stereo system (if equipped)

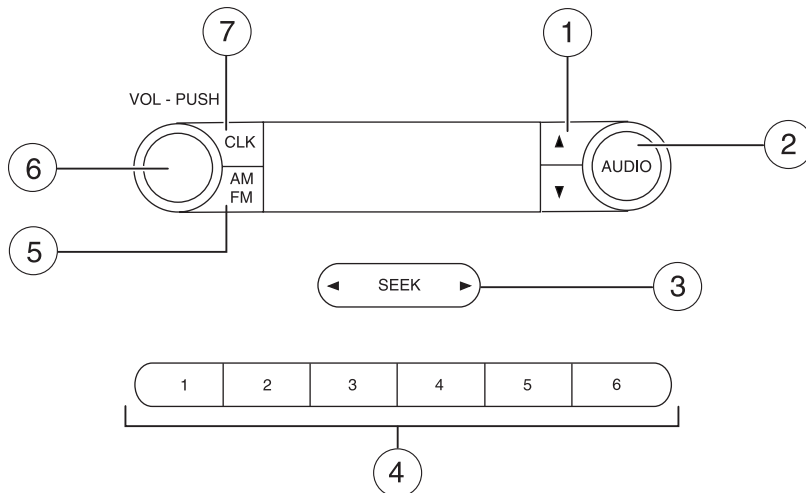

1. **▲ / ▼ Tuner:** Press to manually go up or down the radio frequency. Also use in menu mode to select various settings.



2. **Audio:** Press to access select various settings.



**Treble:** Press to adjust the treble setting. Use ▲ / ▼ / ◀ SEEK, SEEK ▶ .

**Bass:** Press to adjust the bass setting. Use ▲ / ▼ / ◀ SEEK, SEEK ▶ .

**Balance:** Press to adjust the audio between the left and right speakers. Use ▲ / ▼ / ◀ SEEK, SEEK ▶ .

**Fade:** Press to adjust the audio between the front and rear speakers. Use ▲ / ▼ / ◀ SEEK, SEEK ▶ .

## Entertainment Systems

3. **Seek:** Press to access the next/previous strong station or track.



4. **Memory presets:** To set a station: Select frequency band AM/FM; tune to a station, press and hold a preset button until sound returns.



5. **AM/FM:** Press to select AM/FM frequency band.



6. **ON/OFF/Volume:** Press to turn ON/OFF. Turn to increase/decrease volume.

VOL - PUSH



If the volume is set above a certain level and the ignition is turned off, the volume will come back on at a “nominal” listening level when the ignition switch is turned back on.

7. **CLK (Clock):** Press to toggle between the clock and radio display. To set the clock: Press and hold CLK until the hours begin to flash.



Press ▼ / ▲ to manually decrease / increase the hours. Press CLK again to set the minutes.

## Entertainment Systems

### AM/FM stereo/single CD sound system (if equipped)

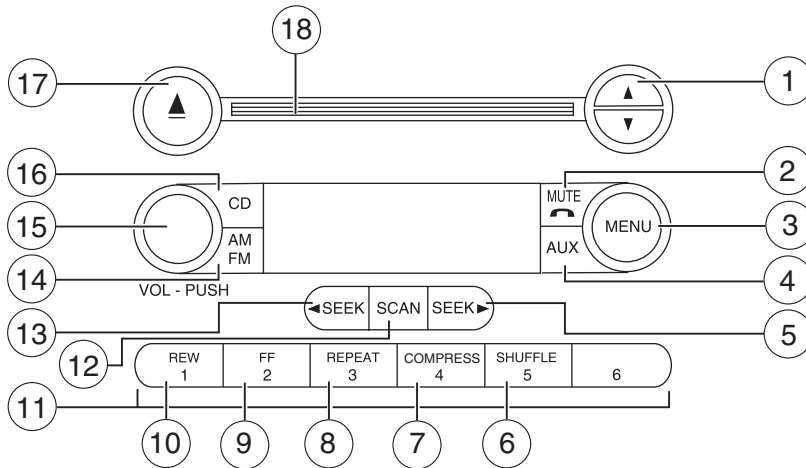

1. **▲ / ▼ Tuner:** Press to manually go up or down the radio frequency. Also use in menu mode to select various settings.



2. **Phone/mute:** Press to mute the playing media. Press again to return to the playing media.



3. **Menu:** Press to toggle through the following modes:



**Autoset:** Allows you to set the strongest local radio stations without losing your original manually set preset stations for AM/FM1/FM2 . Press MENU to access. Use ▲ / ▼ / ◀ SEEK ▶ to set.

When the six strongest stations are filled, the station stored in preset 1 will begin playing. If there are less than six strong stations, the system will store the last one in the remaining presets.

**Bass:** Press to adjust the bass setting. Use ▲ / ▼ / ◀ SEEK ▶ .

## Entertainment Systems

**Treble:** Press to adjust the treble setting. Use ▲ / ▼ / ◀ SEEK ▶ .

**Balance:** Press to adjust the audio between the left and right speakers. Use ▲ / ▼ / ◀ SEEK ▶ .

**Fade:** Press to adjust the audio between the front and rear speakers. Use ▲ / ▼ / ◀ SEEK ▶ .

**Speed sensitive volume (if equipped):** Radio volume automatically changes slightly with vehicle speed to compensate for road and wind noise. Press MENU to access and use ▲ / ▼ / ◀ SEEK ▶ to adjust.

**Setting the clock:** Press MENU until SELECT HOUR or SELECT MINS is displayed. Use ▲ / ▼ to manually increase/decrease Press MENU again to disengage clock mode.

4. **Aux:** Press to toggle between FES/DVD and AUX modes. If no auxiliary sources are available, NO AUX AUDIO will be displayed.



5. **Seek:** Press to access the next strong station or track.



6. **Shuffle:** Press to play tracks in random order.



7. **Comp (Compression):** In CD mode, brings soft and loud CD passages together for a more consistent listening level.



8. **Repeat:** Press to repeat the current CD track.



9. **Fast forward:** Press to manually advance in a CD track.



10. **Rewind:** Press to manually reverse in a CD track.



## Entertainment Systems

11. **Memory presets:** To set a station: Select frequency band AM/FM; tune to a station, press and hold a preset button until sound returns.



12. **Scan:** Press for a brief sampling of radio stations or CD tracks. Press again to stop.



13. **Seek:** Press to access the previous strong station or track.



14. **AM/FM:** Press to select AM/FM frequency band.



15. **ON/OFF/Volume:** Press to turn ON/OFF. Turn to increase/decrease volume.



VOL - PUSH

If the volume is set above a certain level and the ignition is turned off, the volume will come back on at a “nominal” listening level when the ignition switch is turned back on.

16. **CD:** Press to enter CD mode. If a CD is already loaded into the system, CD play will begin where it ended last.



17. **CD eject:** Press to eject a CD.



18. **CD slot:** Insert a CD label side up.





## Entertainment Systems

### AM/FM stereo cassette/single CD sound system (if equipped)

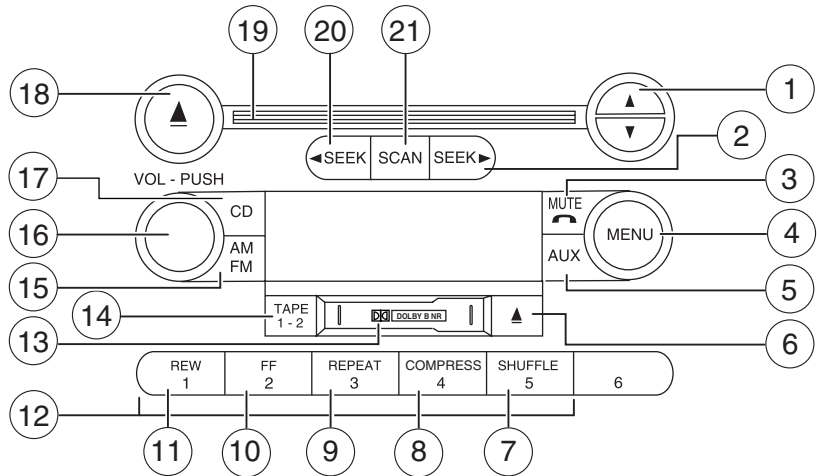

1. **▲ / ▼ Tuner:** Press to manually go up or down the radio frequency. Also use in menu mode to select various settings.



2. **Seek:** Press to access the next strong station or track.



3. **Phone/mute:** Press to mute the playing media. Press again to return to the playing media.



4. **Menu:** Press to toggle through the following modes:



**Treble:** Press to adjust the treble setting. Use ▲ / ▼ / ◀ SEEK ▶ .

**Bass:** Press to adjust the bass setting. Use ▲ / ▼ / ◀ SEEK ▶ .

**Balance:** Press to adjust the audio between the left and right speakers. Use ▲ / ▼ / ◀ SEEK ▶ .

## Entertainment Systems

**Fade:** Press to adjust the audio between the front and rear speakers. Use ▲ / ▼ / ◀ SEEK ▶ .

**Speed sensitive volume (if equipped):** Radio volume automatically changes slightly with vehicle speed to compensate for road and wind noise. Press MENU to access and use ▲ / ▼ / ◀ SEEK ▶ to adjust.

**Setting the clock:** Press MENU until SELECT HOUR or SELECT MINS is displayed. Press ▲ / ▼ / ◀ SEEK ▶ to adjust the hours/minutes.

**Autoset:** Allows you to set the strongest local radio stations without losing your original manually set preset stations for AM/FM1/FM2 . Press MENU to access. Use ▲ / ▼ / ◀ SEEK ▶ to set.

When the six strongest stations are filled, the station stored in preset 1 will begin playing. If there are less than six strong stations, the system will store the last one in the remaining presets.

**Dolby noise reduction:** In tape mode, this feature reduces tape noise and hiss. Press ▲ / ▼ / ◀ SEEK ▶ to cycle ON/OFF. The Dolby noise reduction system is manufactured under license from Dolby Laboratories Licensing Corporation. Dolby and double-D are registered trademarks of Dolby Laboratories Licensing Corporation.

5. **AUX:** Press to toggle between FES/DVD and AUX modes. If no auxiliary sources are available, NO AUX AUDIO will be displayed. To return to radio mode, press AM/FM.



6. **Tape eject:** Press to eject a tape.



7. **Shuffle:** Press to play CD tracks in random order.



8. **Compress (Compression):** In CD mode, brings soft and loud CD passages together for a more consistent listening level.



9. **Repeat:** Press to repeat the current CD track.



## Entertainment Systems

10. **Fast forward:** Press to manually advance in a CD track or cassette.



11. **Rewind:** Press to manually reverse in a CD track or cassette.



12. **Memory presets:** To set a station: Select frequency band AM/FM; tune to a station, press and hold a preset button until sound returns.



13. **Tape:** Insert a tape facing to the right.



14. **Tape direction:** Press to enter tape mode. Press while in play mode to change which side of the tape is playing.



15. **AM/FM:** Press to select AM/FM frequency band.



16. **ON/OFF/Volume:** Press to turn ON/OFF. Turn to increase/decrease volume.

If the volume is set above a certain level and the ignition is turned off, the volume will come back on at a “nominal” listening level when the ignition switch is turned back on.



17. **CD:** Press to enter CD mode. If a CD is already loaded into the system, CD play will begin where it ended last.



18. **CD eject:** Press to eject a CD.



19. **CD slot:** Insert a CD label side up.



## Entertainment Systems

20. **Seek:** Press to access the previous strong station or track.



21. **Scan:** Press for a brief sampling of radio stations or CD tracks. Press again to stop.



When this radio is used in cargo vans where no rear speakers are installed in the vehicle, fading to the rear speakers will result in no audio output.

### Premium in-dash six CD sound system (if equipped)

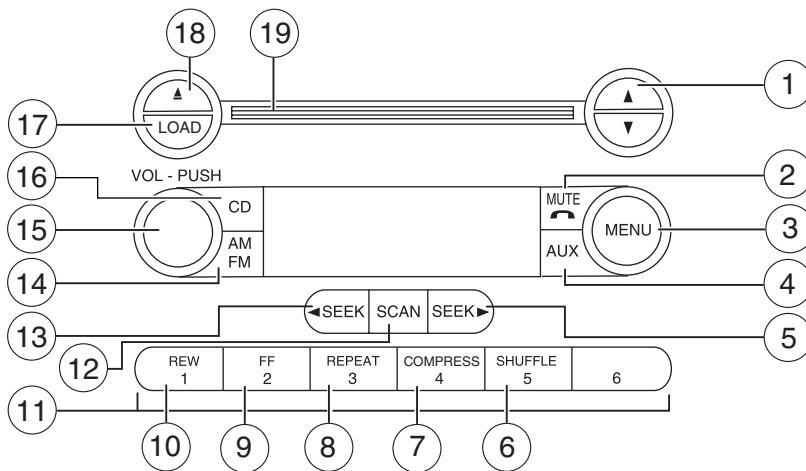

1. **▲ / ▼ Tuner:** Press to manually go up or down the radio frequency. Also use in menu mode to select various settings.



2. **Phone/mute:** Press to mute the playing media. Press again to return to the playing media.



## Entertainment Systems

3. **Menu:** Press to toggle through the following modes:



**Autoset:** Allows you to set the strongest local radio stations without losing your original manually set preset stations for AM/FM1/FM2 . Press MENU to access. Use ▲ /▼ /◀ SEEK ▶ to set.

When the six strongest stations are filled, the station stored in preset 1 will begin playing. If there are less than six strong stations, the system will store the last one in the remaining presets.

**Bass:** Press to adjust the bass setting. Use ▲ /▼ /◀ SEEK ▶ .

**Treble:** Press to adjust the treble setting. Use ▲ /▼ /◀ SEEK ▶ .

**Balance:** Press to adjust the audio between the left and right speakers. Use ▲ /▼ /◀ SEEK ▶ .

**Fade:** Press to adjust the audio between the front and rear speakers. Use ▲ /▼ /◀ SEEK ▶ .

**Speed sensitive volume (if equipped):** Radio volume automatically changes slightly with vehicle speed to compensate for road and wind noise. Press MENU to access and use ▲ /▼ /◀ SEEK ▶ to adjust.

**Setting the clock:** Press MENU until SELECT HOUR or SELECT MINS is displayed. Press ▲ /▼ /◀ SEEK ▶ to adjust the hours/minutes.

4. **Aux:** Press to toggle between FES/DVD and AUX modes. If no auxiliary sources are available, NO AUX AUDIO will be displayed.



5. **Seek:** Press to access the next strong station or track.



6. **Shuffle:** Press to play tracks in random order.



## Entertainment Systems

7. **Comp (Compression):** In CD mode, brings soft and loud CD passages together for a more consistent listening level.



8. **Repeat:** Press to repeat the current CD track.



9. **Fast forward:** Press to manually advance in a CD track.



10. **Rewind:** Press to manually reverse in a CD track.



11. **Memory presets:** To set a station: Select frequency band AM/FM; tune to a station, press and hold a preset button until sound returns.



12. **Scan:** Press for a brief sampling of radio stations or CD tracks. Press again to stop.



13. **Seek:** Press to access the previous strong station or track.



14. **AM/FM:** Press to select AM/FM frequency band.



15. **ON/OFF/Volume:** Press to turn ON/OFF. Turn to increase/decrease volume.

If the volume is set above a certain level and the ignition is turned off, the volume will come back on at a

"nominal" listening level when the ignition switch is turned back on.



16. **CD:** Press to enter CD mode. If a CD is already loaded into the system, CD play will begin where it ended last.



## Entertainment Systems

17. **LOAD:** Press to load a CD, then select a slot number using the radio presets 1 through 6. If you don't select a slot within 5 seconds, the radio shall choose the first available slot for you. Press and hold for 2 seconds to auto load up to six CDs.



18. **CD eject:** Press to eject a CD, then select the desired CD slot using the radio presets 1 through 6. If a slot is not selected within 5 seconds, the radio shall eject the current disc. Press and hold for 2 seconds to auto eject all CDs present in the radio mechanism.



19. **CD slot:** Insert a CD label side up.



### GENERAL AUDIO INFORMATION

#### Radio frequencies

AM and FM frequencies are established by the Federal Communications Commission (FCC) and the Canadian Radio and Telecommunications Commission (CRTC). Those frequencies are:

AM - 530, 540–1700, 1710 kHz

FM- 87.7, 87.9–107.7, 107.9 MHz

#### Radio reception factors

There are three factors that can affect radio reception:

- Distance/strength: The further you travel from an FM station, the weaker the signal and the weaker the reception.
- Terrain: Hills, mountains, tall buildings, power lines, electric fences, traffic lights and thunderstorms can interfere with your reception.
- Station overload: When you pass a broadcast tower, a stronger signal may overtake a weaker one and play while the weak station frequency is displayed.

#### Cassette/player care

Do:

- Use only cassettes that are 90 minutes long or less.
- Tighten very loose tapes by inserting a finger or pencil into the hole and turning the hub.

## Entertainment Systems

- Remove loose labels before inserting tapes.
- Allow tapes which have been subjected to extreme heat, humidity or cold to reach a moderate temperature before playing.
- Clean the cassette player head with a cassette cleaning cartridge after 10–12 hours of play to maintain good sound/operation.

Don't:

- Expose tapes to direct sunlight, extreme humidity, heat or cold.
- Leave tapes in the cassette player for a long time when not being played.

### CD/CD player care

Do:

- Handle discs by their edges only. Never touch the playing surface.
- Inspect discs before playing. Clean only with an approved CD cleaner and wipe from the center out.

Don't:

- Expose discs to direct sunlight or heat sources for extended periods of time.
- Insert more than one disc into each slot of the CD changer magazine.
- Clean using a circular motion.

**CD units are designed to play commercially pressed 4.75 in (12 cm) audio compact discs only. Due to technical incompatibility, certain recordable and re-recordable compact discs may not function correctly when used in Ford CD players. Irregular shaped CDs, CDs with a scratch protection film attached, and CDs with homemade paper (adhesive) labels should not be inserted into the CD player. The label may peel and cause the CD to become jammed. It is recommended that homemade CDs be identified with permanent felt tip marker rather than adhesive labels. Ballpoint pens may damage CDs. Please contact your authorized dealer for further information.**

### Audio system warranty and service

Refer to the *Warranty Guide* for audio system warranty information. If service is necessary, see your authorized dealer.



## Climate Controls

### HEATER ONLY SYSTEM (IF EQUIPPED)

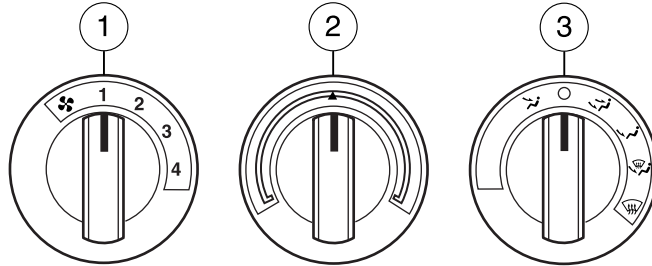

1. **Fan speed adjustment:** Controls the volume of air circulated in the vehicle.

2. **Temperature selection:** Controls the temperature of the airflow in the vehicle.

3. **Air flow selections:** Controls the direction of the airflow in the vehicle. See the following for a brief description on each control:

 : Distributes outside air through the instrument panel vents.

 : Distributes outside air through the instrument panel vents and the floor vents.

**O (OFF):** Outside air is shut out and the fan will not operate.

 : Distributes outside air through the floor vents.

 : Distributes outside air through the windshield defroster vents, floor vents and demister vents.

 : Distributes outside air through the windshield defroster vents and demister vents. Can be used to clear windshield of fog and thin ice.

#### Operating tips

- To reduce fog build up on the windshield during humid weather, place the air flow selector in the  position.
- To reduce humidity build up inside the vehicle during cold or warm weather, do not drive with the air flow selector in the O (OFF) position.
- Do not put objects under the front seats that will interfere with the air flow to the rear seats.
- Remove any snow, ice or leaves from the air intake area at the base of the windshield.

## Climate Controls

To aid in side window defogging/demisting in cold weather:

1. Select .
2. Modulate the temperature control to maintain comfort.
3. Set the fan speed to the highest setting.
4. Direct the outer instrument panel vents toward the side windows.

To increase airflow to the outer instrument panel vents, close the vents located in the middle of the instrument panel.



Do not place objects on top of the instrument panel as these objects may become projectiles in a collision or sudden stop.

### MANUAL HEATING AND AIR CONDITIONING SYSTEM (IF EQUIPPED)

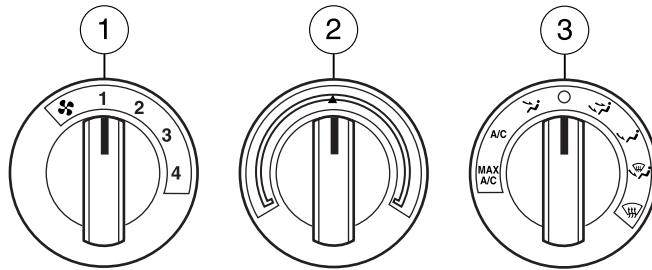

1. **Fan speed adjustment:** Controls the volume of air circulated in the vehicle.
2. **Temperature selection:** Controls the temperature of the airflow in the vehicle.
3. **Air flow selections:** Controls the direction of the airflow in the vehicle. See the following for a brief description on each control.

**MAX A/C:** Distributes recirculated air through the instrument panel vents and center console vents (if equipped) to cool the vehicle. This re-cooling of the interior air is more economical and efficient. Recirculated air may also help reduce undesirable odors from entering the vehicle. The temperature selection control will not adjust airflow temperature when in MAX A/C mode.

 : Distributes outside air through the instrument panel vents and center console vents (if equipped).

## Climate Controls

 : Distributes outside air through the instrument panel vents, floor vents and center console vents (if equipped).

**O (OFF):** Outside air is shut out and the climate system is turned off.

 : Distributes outside air through the floor vents.

 : Distributes outside air through the windshield defroster vents, floor vents and demister vents.

 : Distributes outside air through the windshield defroster vents and demister vents.

### Operating tips

- To reduce fog build up on the windshield during humid weather, place the air flow selector in the  position.
- To reduce humidity build up inside the vehicle, do not drive with the air flow selector in the O (OFF) position.
- Do not put objects under the front seats that will interfere with the airflow to the rear seats.
- Remove any snow, ice or leaves from the air intake area at the base of the windshield.
- To improve the A/C cool down, drive with the windows slightly open for 2–3 minutes after start up or until the vehicle has been “aired out.”

For maximum cooling performance (MAX A/C) in MAX A/C mode:

- Move the temperature control to the coolest setting.
- Set the fan to the highest speed initially, then adjust in order to maintain comfort.

To aid in side window defogging and demisting in cold weather:

1. Select .
2. Select A/C.
3. Set the temperature control to maintain comfort.
4. Set the fan speed to highest setting.
5. Direct the outer instrument panel vents towards the side windows.





Do not place objects on top of the instrument panel as these objects may become projectiles in a collision or sudden stop.

## Climate Controls

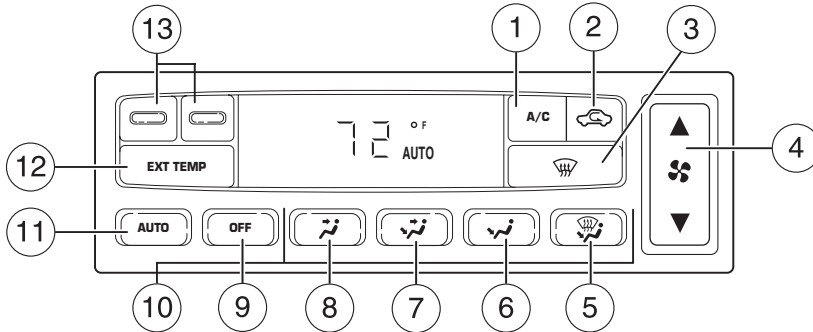
### AUTOMATIC TEMPERATURE CONTROL SYSTEM (IF EQUIPPED)



Press the AUTO and  (floor/defrost) controls at the same time and hold for one second to switch between Fahrenheit and Celsius.

1. **A/C:** Press to activate/deactivate air conditioning. Use with recirculated air to improve cooling performance and efficiency. Engages automatically in AUTO,  (defrost), and  (floor/defrost).



2. **Recirculated air:** Press to activate/deactivate air recirculation in cabin. Recirculated air may reduce the amount of time to cool down the interior of the vehicle and may also help reduce undesired odors from reaching the interior of the vehicle. Recirculation can be engaged manually in any other airflow selection except  (defrost). Recirculation may turn off automatically in all airflow selections.







3. **Defrost:**  Distributes outside air through the windshield defroster vents and demister vents. Can be used to clear windshield of fog and thin ice.



4. **Fan speed:** Press the respective control in order to manually increase or decrease the fan speed. To return to automatic fan operation, press AUTO.



## Climate Controls

5.  (Floor/defrost): Distributes air through the instrument panel vents, floor vents and demister vents.
6.  (Floor): Distributes air through the floor vents.
7.  (Panel/floor): Distributes air through the instrument panel vents, floor vents and center console vents (if equipped).
8.  (Panel): Distributes air through the instrument panel vents and center console vents (if equipped).

9. **OFF:** Outside air is shut out and the climate control system is turned off.



10. **Manual override controls:**

The manual override controls allow you to change the system operation. To return to full automatic control, press AUTO. Refer to controls 5–8 for a brief description of each mode.



11. **AUTO:** Press to engage full automatic operation, and select the desired temperature using the



temperature control. The system will automatically determine fan speed, airflow location, A/C on or off, and outside or recirculated air, to heat or cool the vehicle to reach the desired temperature.

12. **EXT Control (if equipped):**

Press **EXT TEMP** to display outside temperature. Press again to display cabin temperature settings.



13. **Temperature controls:** Press to increase or decrease the temperature in the vehicle cabin.



**Note:** The recommended vehicle cabin setting is between 72°F (22°C) and 75°F (24°C).

### Operating tips

- To reduce fog build up on the windshield during humid weather, place the air flow selector in the  position.
- To reduce humidity build up inside the vehicle, do not drive with the air flow selector in the OFF or with recirculated air engaged.
- Do not put objects under the front seats that will interfere with the airflow to the rear seats.

## Climate Controls

- Remove any snow, ice or leaves from the air intake area at the base of the windshield.
- To improve the A/C cool down, drive with the windows slightly open for 2–3 minutes after start up or until the vehicle has been “aired out.”

For maximum cooling performance in AUTO mode:

- Press AUTO control and set to desired temperature.

For maximum cooling performance using manual override modes:

- Press  (panel), A/C, with recirculated air. Set the temperature to 60°F (16°C) and the fan to the highest setting.

To aid in side window defogging and demisting in cold weather:

1. Select .
2. Select A/C.
3. Set the temperature control to maintain comfort.
4. Set the fan speed to highest setting.
5. Direct the outer instrument panel vents towards the side windows. To increase airflow to the outer instrument panel vents, close the vents located in the middle of the instrument panel.

To increase airflow to the outer instrument panel vents, close the vents located in the middle of the instrument panel.



Do not place objects on top of the instrument panel as these objects may become projectiles in a collision or sudden stop.

## Lights

### HEADLAMP CONTROL

- Turns the lamps off.
- P⊖ Turns on the parking lamps, instrument panel lamps, license plate lamps and tail lamps.
- ☰☽ Turns the headlamps on.

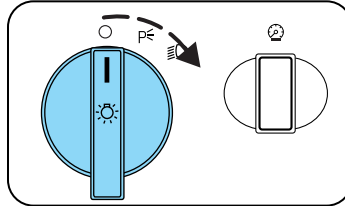

### Autolamp control (if equipped)

The autolamp system provides light sensitive automatic on-off control of the exterior lights normally controlled by the headlamp control.

The autolamp system also keeps the lights on for approximately 20 seconds after the ignition switch is turned to OFF.

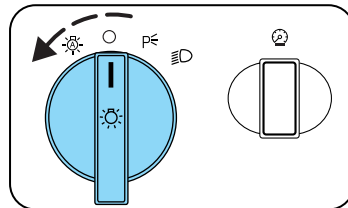

To change the delay time of the autolamp feature, do the following:

1. Start with the ignition in OFF and the autolamps selected.
2. Deselect the autolamps.
3. Put the ignition in 4 (ON).
4. Put the ignition in 3 (OFF).
5. Select the autolamps. Steps 2 through 5 must be performed within a 10 second period. At this point, the headlamps and parking lamps will turn on.
6. Deselect the autolamps after the desired autolamp delay time (maximum of 3 minutes). At this point, the headlamps and parking lamps will turn off.



## Lights

### Foglamp control (if equipped)

The headlamp control also operates the foglamps. The foglamps can be turned on only when the headlamp control is in the ,  or  position and the high beams are not turned on.

In autolamp mode, the foglamps won't be operational until lighting conditions warrant the activation of the headlamp/parklamp lighting.

Pull headlamp control towards you to turn foglamps on. The foglamp indicator light  will illuminate when the switch is pulled and the parklamps are on.

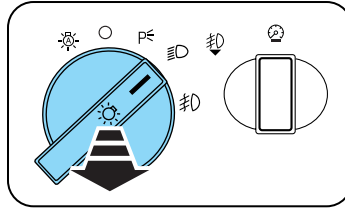

### Daytime running lamps (DRL) (if equipped)

Turns the headlamps on with a reduced output.

To activate:

- the ignition must be in the ON position,
- the headlamp control is in the OFF or parking lamp position and
- the parking brake must be disengaged.



Always remember to turn on your headlamps at dusk or during inclement weather. The Daytime Running Lamp (DRL) system does not activate the tail lamps and generally may not provide adequate lighting during these conditions. Failure to activate your headlamps under these conditions may result in a collision.



## Lights

### High beams

Push the lever toward the instrument panel to activate. Pull the lever towards you to deactivate.

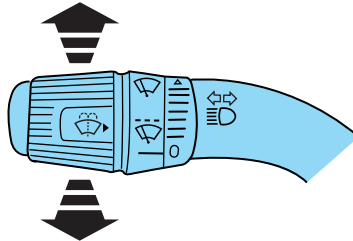

### Flash to pass

Pull toward you slightly to activate and release to deactivate.

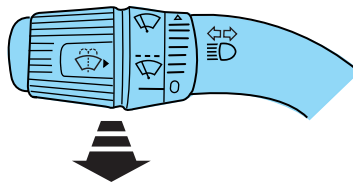

### PANEL DIMMER CONTROL

Use to adjust the brightness of the instrument panel and all applicable switches in the vehicle during headlamp and parklamp operation.

Move the control to the full upright position, past detent, to turn on the interior lamps.

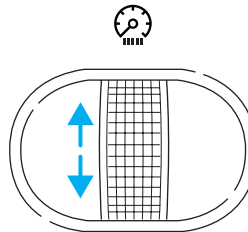

### AIMING THE HEADLAMPS

Your vehicle may be equipped with a sealed beam or aerodynamic headlamp system. Sealed beam headlamps may be aimed in the vertical (up/down) and the horizontal (left/right) directions using the procedures following. The aerodynamic headlamps can only be aimed in the vertical direction (up/down) using the following procedures. The headlamps on your vehicle are properly aimed at the assembly plant and should not normally need adjusting.

## Lights

### Vertical and horizontal aim adjustment (sealed beam headlamps)

The headlamps on your vehicle are intended to be aimed using mechanical aimers. If mechanical aimers are used and the cross-car sight line is in any way blocked, set the legs of the universal adaptor all to the same setting, such that the cross-car sight line is no longer blocked, per the instructions for the brand of mechanical aimer used. You can also aim the headlamps visually using the procedure below.

To adjust the headlamps:

1. Park your vehicle on a level surface about 25 feet (7.6 meters) away from a vertical plain surface (3). Check your headlamp alignment at night or in a dark area so that you can see the headlamp beam pattern.

- (1) 8 feet (2.4 meters)
- (2) Center height of lamp to ground
- (3) 25 feet (7.6 meters)
- (4) Horizontal reference line
- (5) Center of headlamps
- (6) Center line of the vehicle

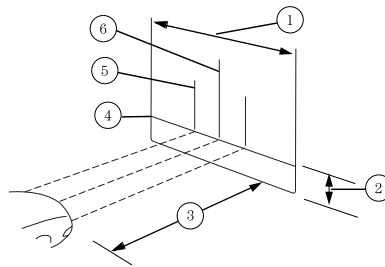

2. The center of the headlamp is marked either on the lens (a circle or cross marker) or on the bulb shield, internal to the lamp (mark or feature). Measure the height from the center of your headlamp to the ground (2) and mark an 8 foot (2.4 meter) long horizontal line on the wall or screen (1) at this height (masking tape works well).

3. Turn on the low beam headlamps and open the hood.

4. Locate the high intensity area of the beam pattern and place the top edge of the intensity zone even with the horizontal reference line (4). If the top edge of the high intensity area is not even with the horizontal line, follow the next step to adjust it.

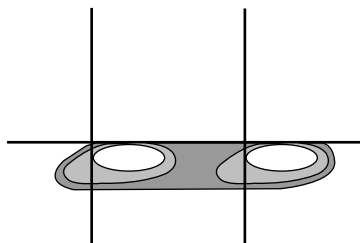

## Lights

5. Locate the vertical adjuster (2) for each headlamp. Adjust the aim by turning the adjuster control either clockwise (to adjust up) or counterclockwise (to adjust down).

6. In addition to the horizontal line marked in step 2, a pair of vertical lines (5) must be marked at the center line of the headlamps on the wall or screen.

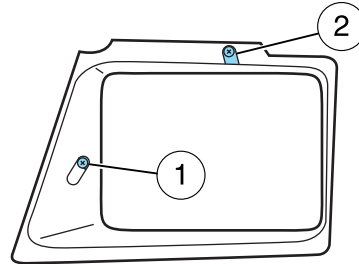

7. On the wall or screen, locate the high intensity area of the beam pattern. The left edge of the high intensity area should be even with the vertical line corresponding to the headlamp under adjustment. If the left edge of the high intensity area is not even with the vertical line, follow the next step to adjust it.

8. Locate the horizontal adjuster (1) for each headlamp. Turn it clockwise or counterclockwise, to place the left edge of the high intensity area even with the vertical line corresponding to the headlamp under adjustment.

### **Vertical aim adjustment (aerodynamic headlamps)**

The headlamps on your vehicle can only be vertically adjusted. Your vehicle does not require horizontal aim adjustments.

To adjust the headlamps:

1. Park the vehicle directly in front of a wall or screen on a level surface, approximately 25 feet (7.6 meters) away.

- (1) 8 feet (2.4 meters)
- (2) Center height of lamp to ground
- (3) 25 feet (7.6 meters)
- (4) Horizontal reference line

2. Measure the height from the center of your headlamp (indicated by a 3.0 mm circle on the lens) to the ground and mark an 8 foot (2.4 meter) horizontal reference line on the vertical wall or screen at this height (a piece of masking tape works well).

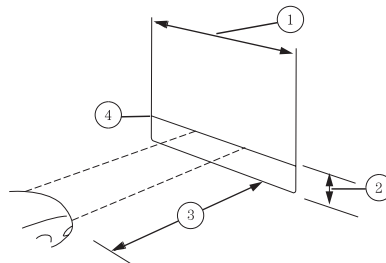

3. Turn on the low beam headlamps to illuminate the wall or screen and open the hood. Cover one of the headlamps so no light hits the wall.

## Lights

4. On the wall or screen you will observe a light pattern with a distinct horizontal edge towards the right. If this edge is not at the horizontal reference line, the beam will need to be adjusted so the edge is at the same height as the horizontal reference line.

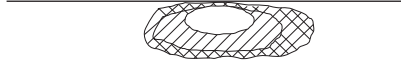

5. Locate the vertical adjuster on each headlamp, then use a E5 Torx socket to turn the adjuster either counterclockwise (to adjust down) or clockwise (to adjust up) aligning the upper edge of the light pattern up to the horizontal line.

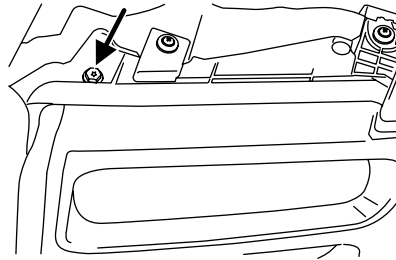

6. Repeat Steps 3–5 for the other headlamp.

7. Close the hood and turn off the lamps.

### TURN SIGNAL CONTROL

- Push down to activate the left turn signal.
- Push up to activate the right turn signal.

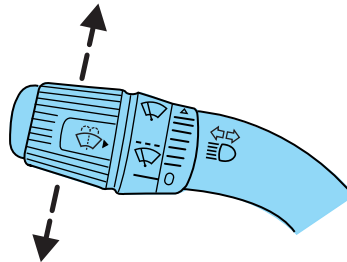

## Lights

### **COURTESY/READING LAMPS (IF EQUIPPED)**

The dome lamp illuminates when any door is not completely closed, the instrument panel switch is pushed past the detent and when any of the remote entry controls are pressed while the ignition is off.

The reading lamps can be turned on by pressing the rocker controls next to each lamp.

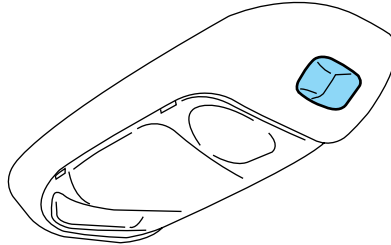

### **MAP LAMPS (IF EQUIPPED)**

To turn on the map lamps, press the control next to each lamp.

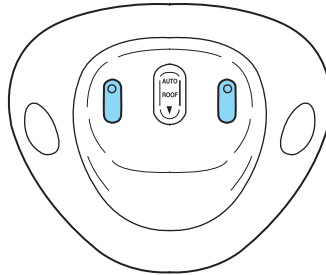

## **BULBS**

### **Headlamp condensation**

The headlamps are vented to equalize pressure. When moist air enters the headlamp(s) through the vents, there is a possibility that condensation can occur. This condensation is normal and will clear within 45 minutes of headlamp operation.

## Lights

### Replacing exterior bulbs

Check the operation of all the bulbs frequently.

| Function  | Number of bulbs | Trade number    |
|---|-----------------|-----------------|
| Headlamps (aerodynamic)   | 2               | H13/9008        |
| Headlamps (sealed beam)   | 2               | H6054           |
| Park lamp with aerodynamic headlamp                                 | 2               | 3157AK or 3157A |
| Park lamp with sealed beam headlamp                                 | 2               | 4157K/3157      |
| Sidemarker  | 2               | 194             |
| Tail/stop/turn/sidemarker   | 2               | 4157K/3157      |
| Backup  | 2               | 3156K or 3156   |
| High-mount stoplamp   | 1               | 922             |
| Foglamp   | 2               | 9145            |
| License plate lamp  | 2               | 194             |
| Cargo lamp  | 2               | 906             |
| Front clearance lamps (2) and Front identification lamps (3)        | 5               | 194             |
| Rear fender clearance*  | 4               | W5W             |
| Interior visor lamp (if equipped)                                   | 4               | 194             |
| Rear identification   | 3               | 194             |
| All replacement bulbs are clear in color except where noted.        |                 |                 |
| To replace all instrument panel lights - see your authorized dealer |                 |                 |
| * Dual rear wheels, or if equipped.                                 |                 |                 |

## Lights

### Replacing headlamp bulbs (aerodynamic)

1. Make sure that the headlamp control is in the OFF position and open the hood.

2. Remove the four screws from the top and bottom front of the headlamp assembly.

3. Press the retaining clip at the top of the headlamp assembly while pulling the assembly straight out.

If removing the lamp is difficult, removing the four screws along the top of the grill will help provide more clearance.

4. Disconnect the electrical connector by squeezing the release tab and pushing the connector forward and then pulling it rearward.

5. Remove the bulb assembly by turning it counterclockwise and pulling it straight out.

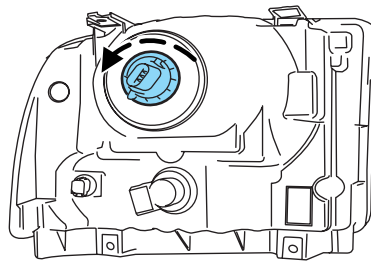
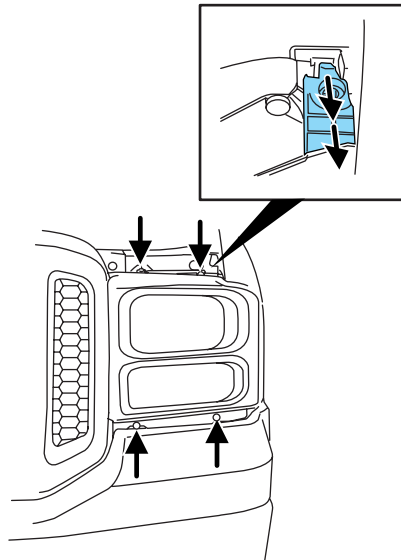

Handle a halogen headlamp bulb carefully and keep out of children's reach. Grasp the bulb only by its plastic base and do not touch the glass. The oil from your hand could cause the bulb to break the next time the headlamps are operated.

Install the new bulb(s) in reverse order.

## Lights

### **Replacing park/turn and sidemarker lamp bulbs (aerodynamic)**

1. Make sure that the headlamp control is in the OFF position and open the hood.

2. Remove the four screws from the top and bottom front of the headlamp assembly.

3. Press the retaining clip at the top of the headlamp assembly while pulling the assembly straight out.

If removing the lamp is difficult, removing the four screws along the top of the grill will help provide more clearance.

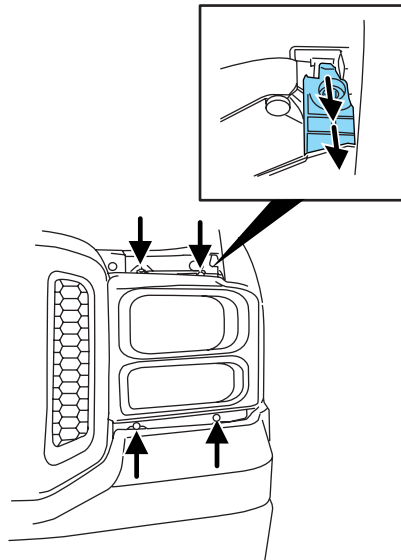

4. Remove the bulb assembly, (1) sidemarker or (2) park/turn by turning it counterclockwise and pulling it straight out.

5. Pull the old bulb out from the socket.

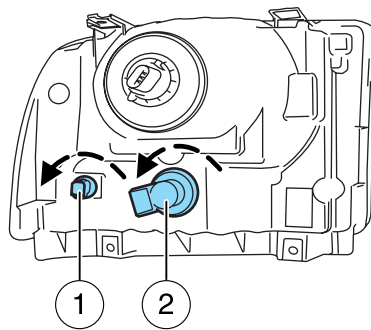

Install the new bulb(s) in reverse order.



## Lights

### **Replacing headlamp bulbs (sealed beam)**

1. Make sure that the headlamp control is in the OFF position and open the hood.

2. Remove the four screws from the top and bottom front of the headlamp assembly.

3. Press the retaining clip at the top of the headlamp assembly while pulling the assembly straight out.

If removing the lamp is difficult, removing the four screws along the top of the grill will help provide more clearance.

4. Disconnect the electrical connector from the park lamp/bezel.

5. Remove the four screws and the headlamp retaining ring from headlamp.

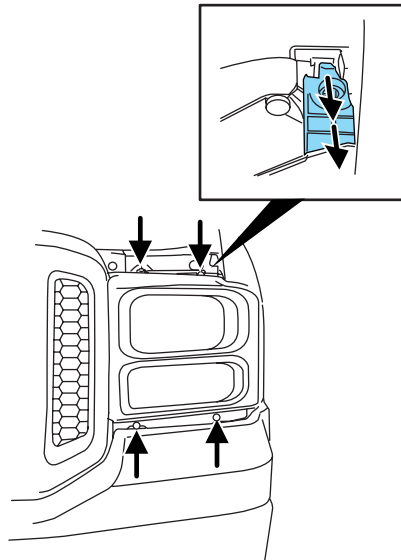

Install the new bulb(s) in reverse order.

## Lights

### **Replacing park/turn/sidemarkers bulbs (sealed beam)**

1. Make sure that the headlamp control is in the OFF position and open the hood.

2. Remove the four screws from the top and bottom front of the headlamp assembly.

3. Press the retaining clip at the top of the headlamp assembly while pulling the assembly straight out.

If removing the lamp is difficult, removing the four screws along the top of the grill will help provide more clearance.

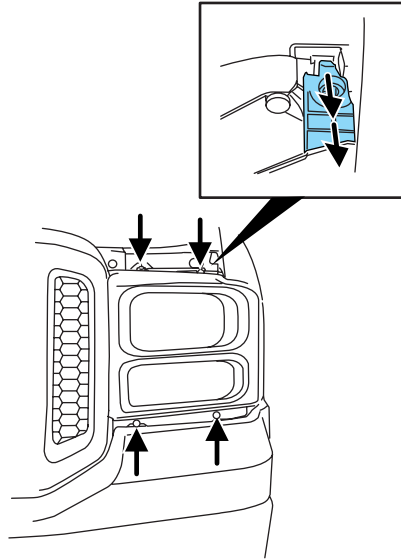

4. Remove the bulb assembly, (1) sidemarker or (2), park/turn by turning it counterclockwise.

5. Pull the old bulb out from the socket.

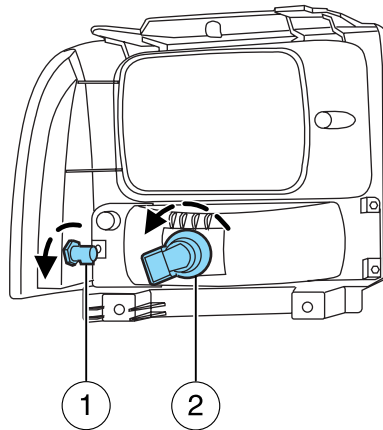

Install the new bulb(s) in reverse order.

## Lights

### **Replacing tail lamp/turn/backup lamp bulbs — F-250/F-350 only**

1. Make sure the headlamp switch is in the OFF position and then open the tailgate to expose the lamp assemblies.

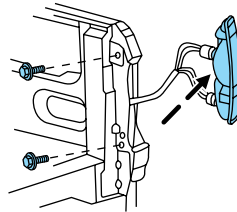

2. Remove the two bolts from the tail lamp assembly and carefully pull the lamp assembly from the tailgate pillar by releasing the two retaining tabs.

3. Rotate the bulb socket counterclockwise and remove from lamp assembly.

4. Pull the bulb straight out of the socket.

Install the new bulb(s) in reverse order.

### **Replacing brake/tail/backup lamp bulbs — F-450/F-550 only**

1. Make sure the headlamp switch is in the OFF position.

2. Remove the four screws and the lamp lens from lamp assembly.

3. Carefully pull the bulb straight out of the socket and push in the new bulb.

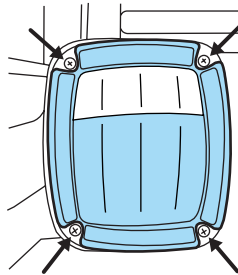

## Lights

### **Replacing cargo lamp and high-mount brakelamp bulbs**

1. Make sure the headlamp switch is in the OFF position.
2. Remove the two screws and lamp assembly from vehicle as wiring permits.
3. Remove the bulb socket by rotating counterclockwise.
4. Pull the bulb straight out of the socket.

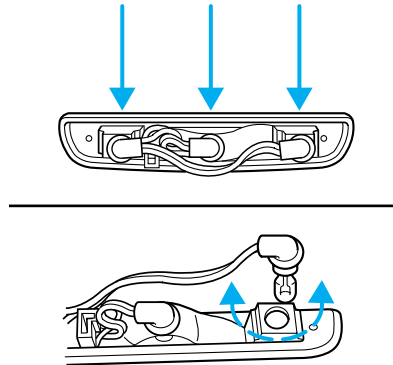

### **Front clearance and identification lamp bulbs**

1. Make sure the headlamp switch is in the OFF position.
2. Remove the screw and lens from the lamp assembly.
3. Pull the bulb straight out of the socket.

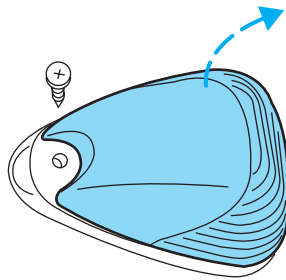

Install the bulb(s) in reverse order.

### **Replacing foglamp bulbs (if equipped)**

1. Make sure the headlamp switch is in the OFF position.
2. Remove the bulb socket from the foglamp by turning counterclockwise.
3. Disconnect the electrical connector from the foglamp bulb.

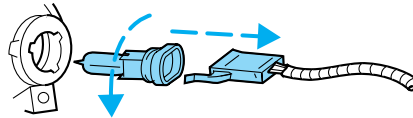

Install the new bulb(s) in reverse order.

### **Replacing license plate lamp bulbs**

The license plate bulbs are located behind the rear bumper. To change the license plate lamp bulbs:

1. Reach behind the rear bumper to locate the bulb.
2. Twist the bulb socket counterclockwise and carefully pull to remove it from the lamp assembly.
3. Pull out the old bulb from the socket and push in the new bulb.
4. Install the bulb socket in lamp assembly by turning it clockwise.

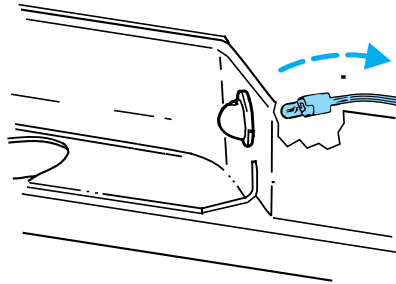

## Driver Controls

### MULTI-FUNCTION LEVER

**Windshield wiper:** Rotate the end of the control away from you to increase the speed of the wipers; rotate towards you to decrease the speed of the wipers.

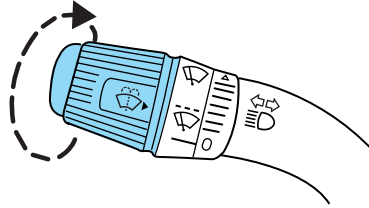

**Windshield washer:** Push the end of the stalk:

- briefly: causes a single swipe of the wipers without washer fluid.
- a quick push and hold: the wipers will swipe three times with washer fluid.
- a long push and hold: the wipers and washer fluid will be activated for up to ten seconds.

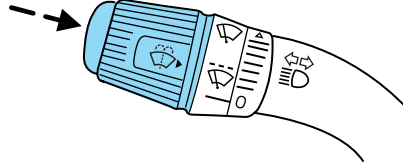

### TILT STEERING WHEEL (IF EQUIPPED)

To adjust the steering wheel:

1. Pull and hold the steering wheel release control toward you.
2. Move the steering wheel up or down until you find the desired location.
3. Release the steering wheel release control. This will lock the steering wheel in position.

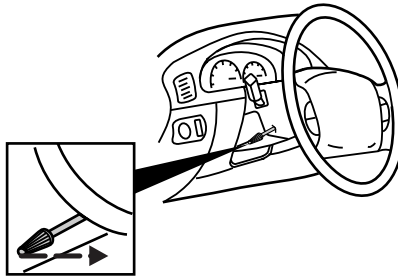

Never adjust the steering wheel when the vehicle is moving.

## Driver Controls

### TRANSMISSION CONTROL

#### Tow/Haul feature (5-speed automatic transmission) (if equipped)

To activate, press the transmission control switch (TCS) located on the gearshift. The TOW/HAUL indicator light will illuminate in the instrument cluster. The transmission will operate in all gears. Press the transmission control switch again to deactivate Tow/Haul mode. When you shut off and re-start your vehicle, the transmission will automatically return to normal mode with Tow/Haul feature deactivated, refer to the *Driving* chapter for more information.

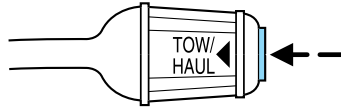

Do not use the Tow/Haul feature when driving in icy or slippery conditions as the increased engine braking can cause the rear wheels to slide and the vehicle to swing around with the possible loss of vehicle control..

#### ILLUMINATED VISOR MIRROR (IF EQUIPPED)

Lift the mirror cover to turn on the visor mirror lamps.

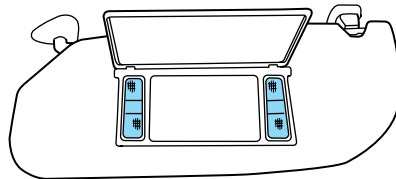

#### OVERHEAD CONSOLE (IF EQUIPPED)

The appearance of your vehicle's overhead console will vary according to your option package. If your vehicle is equipped with a moonroof, refer to *Moonroof* later in this chapter for information on its operation.

## Driver Controls

### Storage compartment (if equipped)

Press the release on the door to open the storage compartment.

The storage compartment may be used to secure sunglasses or a similar object and the front tab can be used for holding tickets, paper, envelopes, etc. The front bin may be used to store small objects.

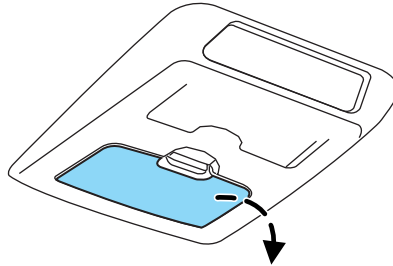

### AUXILIARY POWER POINT (12VDC)

**Power outlets are designed for accessory plugs only. Do not insert any other object in the power outlet for this will damage the outlet and blow the fuse. Do not hang any type of accessory or accessory bracket from the plug. Improper use of the power outlet can cause damage not covered by your warranty.**

The auxiliary power point is located on the instrument panel.

Do not use the power point for operating the cigarette lighter element (if equipped).

To prevent the fuse from being blown, do not use the power point(s) over the vehicle capacity of 12 VDC/180W.

To prevent the battery from being discharged, do not use the power point longer than necessary when the engine is not running.

Always keep the power point caps closed when not being used.

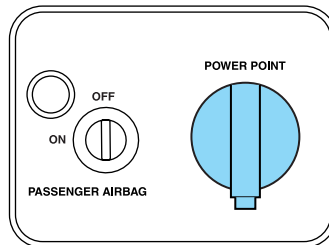

### Cigar lighter (if equipped)

Do not plug optional electrical accessories into the cigarette lighter socket.

Do not hold the lighter in with your hand while it is heating, this will damage the lighter element and socket. The lighter will be released from its heating position when it is ready to be used.

Improper use of the lighter can cause damage not covered by your warranty.



## Driver Controls

### POWER WINDOWS (IF EQUIPPED)

 Do not leave children unattended in the vehicle and do not let children play with the power windows. They may seriously injure themselves.

 When closing the power windows, you should verify they are free of obstructions and ensure that children and/or pets are not in the proximity of the window openings.

Press and hold the bottom part of the rocker switch to open the window. Press and hold the top part of the rocker switch to close the window.

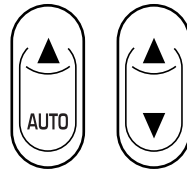

### One touch down

Allows the driver's window to open fully without holding the control down. Press completely down on AUTO and release quickly. Press again to stop.

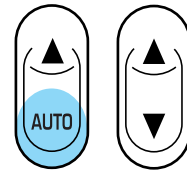

### Window lock (if equipped)

The window lock feature allows only the driver to operate the power windows.

To lock out all the window controls except for the driver's press the left side of the control. Press the right side to restore the window controls.

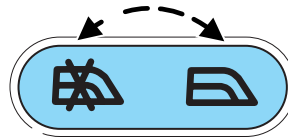

## Driver Controls

### Power rear slider window (if equipped)

- Press and hold the open arrow side of control to open window.
- Press and hold the closed arrow side of control to close window.

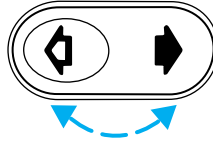

### Accessory delay (if equipped)

With accessory delay, the window switches may be used for up to ten minutes after the ignition switch is turned to the OFF position or until any door is opened.

### AUTOMATIC DIMMING INSIDE REAR VIEW MIRROR (IF EQUIPPED)

Your vehicle may be equipped with an inside rear view mirror with an auto-dimming function. The electronic day/night mirror will change from the normal state to the non-glare state when bright lights (glare) reach the mirror. When the mirror detects bright light from front or behind, it will automatically adjust to minimize glare.

Do not clean the housing or glass of any mirror with harsh abrasives, fuel or other petroleum-based cleaning products.

### POWER SIDE VIEW MIRRORS (IF EQUIPPED)

To adjust your mirrors:

1. Rotate the control clockwise to adjust the right mirror and rotate the control counterclockwise to adjust the left mirror.
2. Move the control in the direction you wish to tilt the mirror.
3. Return to the center position to lock mirrors in place.



## Driver Controls

### Heated outside mirrors (if equipped)

The main mirror glass is heated automatically to remove ice, mist and fog and activates when the vehicle is started.

**Note:** The mirrors may be **hot** to the touch but will not burn. This is a normal condition.

#### Type A

The mirror heating elements are designed to operate regardless of the geographic location of the vehicle. There is no switch to turn on, or other operator involvement required other than to start the vehicle.

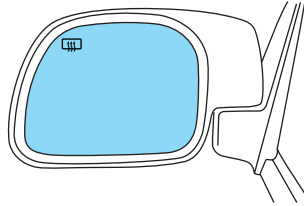

#### Type B

The spotter mirror, below the main mirror, is not heated and must be adjusted manually.

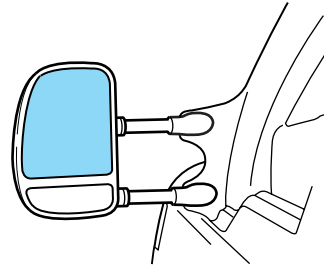

**Do not remove ice from the mirrors with a scraper or attempt to readjust the mirror glass if it is frozen in place. These actions could cause damage to the glass and mirrors.**

### Mirror mounted side turn signal indicator (if equipped)

When the vehicle turn signals are activated, the outer portion of the mirror housing will blink amber.

The turn signal feature can be seen by other drivers who may approach from the rear of the vehicle.

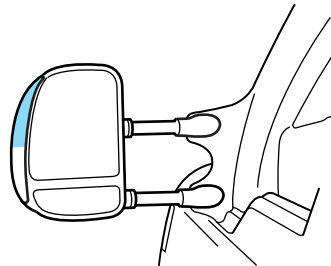

## Driver Controls

### Clearance lamps (if equipped)

Illuminates when the headlamps or parking lamps are switched on.

This provides additional visibility of your vehicle to other drivers on the road.

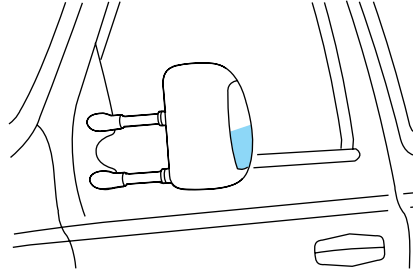

### Fold-away mirrors

The mirrors can be manually folded forward or backwards for narrow spaces like driving through an automatic car wash or backing out of a garage with the trailer tow mirror.

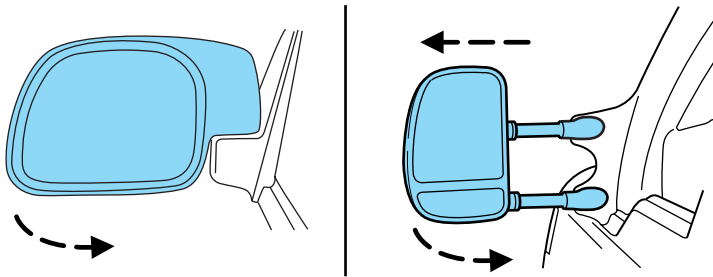

The telescoping feature (if equipped) allows the mirror to extend approximately 3.15 inches (80 mm). This feature is especially useful to the driver when towing a trailer.

## Driver Controls

### POWER ADJUSTABLE FOOT PEDALS (IF EQUIPPED)

The accelerator and brake pedal should only be adjusted when the vehicle is stopped and the gearshift lever is in the P (Park) position.

Press and hold the rocker control to adjust accelerator and brake pedal toward you or away from you.

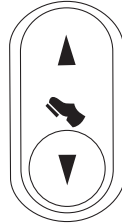

The adjustment allows for approximately 2.75 inches (70 mm) of maximum travel.



Never adjust the accelerator and brake pedal with feet on the pedals while the vehicle is moving.

### SPEED CONTROL (IF EQUIPPED)

With speed control set, you can maintain a speed of 30 mph (48 km/h) or more without keeping your foot on the accelerator pedal. Speed control does not work at speeds below 30 mph (48 km/h).



Do not use the speed control in heavy traffic or on roads that are winding, slippery or unpaved.

### Setting speed control

The controls for using your speed control are located on the steering wheel for your convenience.

1. Press the ON control and release it.
2. Accelerate to the desired speed.

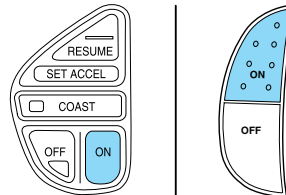

## Driver Controls

3. Press the SET ACCEL control and release it.
4. Take your foot off the accelerator pedal.
5. The indicator  light on the instrument cluster will turn on.

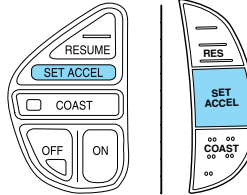

### Note:

- Vehicle speed may vary momentarily when driving up and down a steep hill.
- If the vehicle speed increases above the set speed on a downhill, you may want to apply the brakes to reduce the speed.
- If the vehicle speed decreases more than 10 mph (16 km/h) below your set speed on an uphill, your speed control will disengage.

### Resuming a set speed

Press the RES/RESUME control and release it. This will automatically return the vehicle to the previously set speed. The RES/RESUME control will not work if the vehicle speed is not faster than 30 mph (48 km/h).

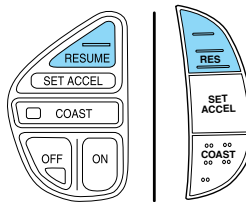

### Increasing speed while using speed control

There are two ways to set a higher speed:

- Press and hold the SET ACCEL control until you get to the desired speed, then release the control. You can also use the SET ACCEL control to operate the Tap-Up function. Press and release this control to increase the vehicle set speed in small amounts by 1 mph (1.6 km/h).
- Use the accelerator pedal to get to the desired speed. When the vehicle reaches that speed press and release the SET ACCEL control.

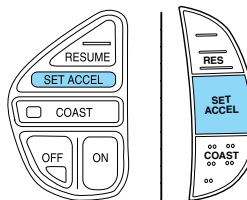

## Driver Controls

### Reducing speed while using speed control

There are two ways to reduce a set speed:

- Press and hold the COAST control until you get to the desired speed, then release the control. You can also use the COAST control to operate the Tap-Down function. Press and release this control to decrease the vehicle set speed in small amounts by 1 mph (1.6 km/h).
- Depress the brake pedal until the desired vehicle speed is reached, press the SET ACCEL control.

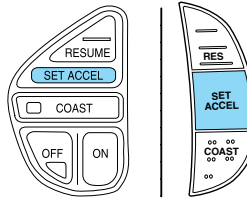
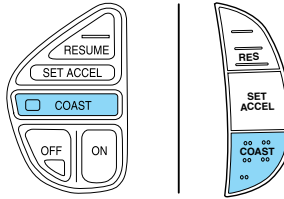

### Turning off speed control

There are two ways to turn off the speed control:

- Depress the brake pedal or the clutch pedal (if equipped). This will not erase your vehicle's previously set speed.
- Press the speed control OFF control.

**Note:** When you turn off the speed control or the ignition, your speed control set speed memory is erased.

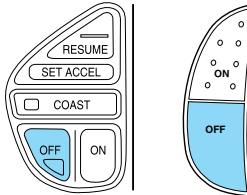

### Indicator light (if equipped)

This light comes on when either the SET ACCEL or RES controls are pressed. The vehicle speed must be at or above 48 km/h (30 mph). It turns off when the speed control OFF control is pressed, the brake or clutch is applied, or the ignition is turned to the OFF position.



## Driver Controls

### UPFITTER CONTROLS (IF EQUIPPED)

Your vehicle may be equipped with the Upfitter option package which will provide four switches, mounted in the center of the instrument panel, labeled AUX 1, AUX 2, AUX 3 and AUX 4. These switches will only operate while the ignition is in the 4 (ON) position, whether the engine is running or not. It is, however, recommended that the engine remain running to maintain battery charge when using the Upfitter switches for extended duration or higher current draws. (This is even more important for vehicles with diesel engines since the glow plugs are also draining battery power when the ignition key is in the 4 [ON] position.)

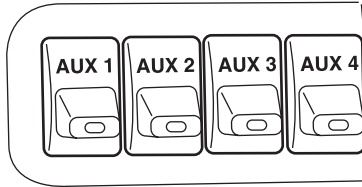

When switched on by the operator they provide 10 amps or 30 amps of electrical battery power for a variety of personal or commercial uses.

If your vehicle is equipped with this option, there will also be a relay box with a fuse located inside the glove box.

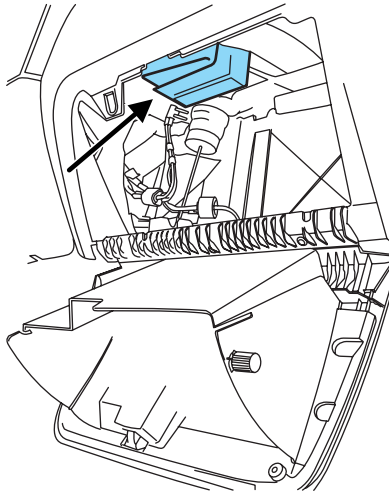



## Driver Controls

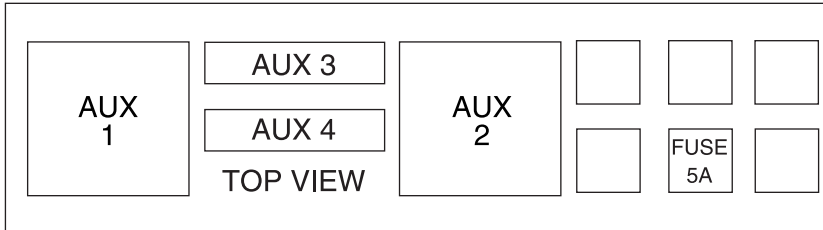

The relays and fuse in the glove box are coded as shown in the accompanying illustration.

There will also be one power lead for each switch found as a blunt-cut and sealed wire located behind the passenger compartment fuse panel.

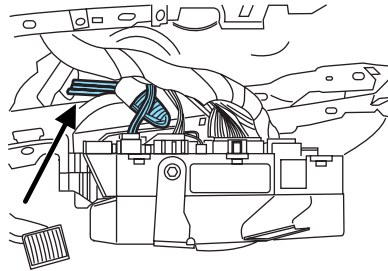

They are coded as follows:

| Switch | Circuit number | Wire color                    | Fuse |
|--------|----------------|-------------------------------|------|
| AUX 1  | 1936           | Orange with Light Green Trace | 30A  |
| AUX 2  | 1933           | Orange                        | 30A  |
| AUX 3  | 1934           | Orange with Yellow Trace      | 10A  |
| AUX 4  | 1935           | Orange with Light Blue Trace  | 10A  |

More detailed information about the Upfitter switches can be found in the *Electrical Wiring* section of the *Ford Truck Body Builders Layout Book*, found at [www.fleet.ford.com/truckbbas](http://www.fleet.ford.com/truckbbas).

## Driver Controls

### STEERING WHEEL CONTROLS (IF EQUIPPED)

These controls allow you to operate some radio and climate control features.

#### Radio control features

- Press MODE to select AM, FM1, FM2, TAPE or CD (if equipped).

In Radio mode:

- Press NEXT to seek/scan to the next strong station.

In Tape mode:

- Press NEXT to listen to the next selection on the tape.

In CD mode:

- Press NEXT to listen to the next track on the disc.

In any mode:

- Press VOL up or down to adjust the volume.

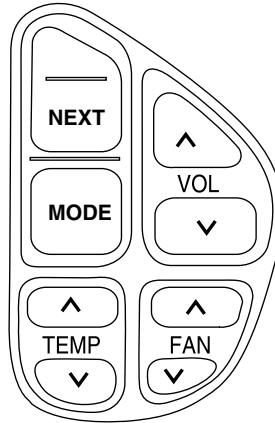

#### Climate control features

- Press TEMP up or down to adjust temperature.
- Press FAN up or down to adjust fan speed.

### ONE-TOUCH MOON ROOF (IF EQUIPPED)

The moon roof control is located on the overhead console.

**Note:** The moon roof will open to the “comfort” position first before opening all the way. The “comfort” position helps to alleviate rumbling wind noise which may happen in the vehicle with the roof fully opened.

**To open the moon roof:** The moon roof is equipped with a one-touch open feature. Press and release the AUTO control. The moon roof will open to the “comfort” position.

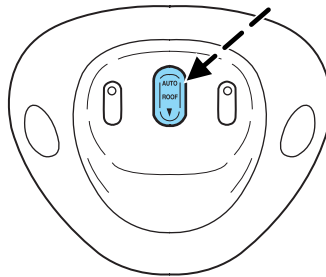

## Driver Controls

Press and release the control again to fully open. To stop the one-touch open feature press either the AUTO or ▼ control again.

**To close the moon roof:** Press and hold the ▼ control until the glass panel stops at the “comfort” position. Press and hold the control again until the glass stops moving. When fully closed, the rear portion of the glass panel will appear higher than the front portion.

**To vent the moon roof:** Press and hold the ▼ control. **The moon roof must be in the closed position in order to move it into the vent position.** To close, press and hold the AUTO control until the glass panel stops moving.

The moon roof has a built-in sliding shade that can be manually opened or closed when the glass panel is shut. To close the shade, pull it toward the front of the vehicle.



Do not let children play with the moon roof or leave children unattended in the vehicle. They may seriously hurt themselves.



When closing the moon roof, you should verify that it is free of obstructions and ensure that children and/or pets are not in the proximity of the moon roof opening.

### CENTER CONSOLE (IF EQUIPPED)

Your vehicle may be equipped with a variety of console features. These include:

- Utility compartment with cassette/CD holder
- Coin holder
- Pen holder
- Writing surface



Use only soft cups in the cupholder. Hard objects can injure you in a collision.

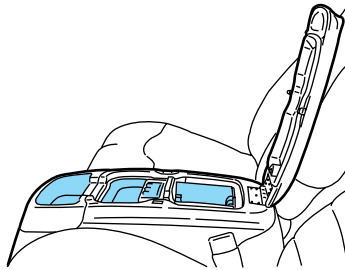

## Driver Controls

### MINI-MESSAGE CENTER (IF EQUIPPED)

With the ignition in the ON position, the mini message center, located on your instrument cluster, displays text messages that alert you to possible problems or malfunctions in your vehicle's operating systems.

**Note:** The following warning messages will reappear after an ignition OFF-ON cycle has been completed.

**Door ajar:** Displays when the ignition is in the ON position and any door is open.



DOOR  
AJAR

**Check fuel cap:** Displays when the fuel cap may not be properly installed. Continued driving with this display on may cause the Service engine soon warning light to come on. Refer to *Fuel filler cap* under the *Fuel Information* section in the *Maintenance and Specifications* chapter.



CHECK  
FUELCAP

**Trailer fault (if equipped):**

Displayed if there is a short circuit on the electric brake output wire or the trailer brakes are drawing too much current. Refer to *Integrated trailer brake controller* in the *Tires, Wheels and Loading* chapter for more information.



TRAILER  
FAULT

**TBC fault (if equipped):** Displays in response to faults sensed by the TBC. In the event this message is seen, please take your vehicle to an authorized dealer for diagnosis and repair. Refer to *Integrated trailer brake controller* in the *Tires, Wheels and Loading* chapter for more information.



TBC  
FAULT

**Note:** The following warning messages will reappear on the display every ten minutes.

**Low fuel:** Displays when the fuel level in the fuel tank is at or near empty (refer to *Fuel gauge* in this chapter).



LOW  
FUEL

## Driver Controls

**Check gauge:** Displays when any of the following conditions has occurred:

- The engine coolant temperature is high.
- The engine oil pressure is low.
- The fuel gauge is at or near empty.

A rectangular display box containing the text "CHECK GAUGES" in a stylized, blocky font.

**Check trailer (if equipped):**

Displayed when a trailer connection becomes disconnected, either intentionally or unintentionally, and has been sensed during a given ignition cycle. Refer to *Integrated trailer brake controller* in the *Tires, Wheels and Loading* chapter for more information.

A rectangular display box containing the text "CHECK TRAILER" in a stylized, blocky font.

### Language

The language options are English and French. The feature works as follows:

1. If present language is English, press and hold the SELECT/RESET button for 15 seconds or greater to convert the language selection to French. The word "FRENCH" will be displayed for 4 seconds as a confirmation that language has been changed.

A rectangular display box containing the text "FRENCH" in a stylized, blocky font.

2. If present language is French, press and hold the SELECT/RESET button for 15 seconds or greater to convert the language selection to English. The word "ENGLISH" will be displayed for 4 seconds as a confirmation that language has been changed.

A rectangular display box containing the text "ENGLISH" in a stylized, blocky font.

### MESSAGE CENTER (IF EQUIPPED)

With the ignition in the ON position, the message center, located on your instrument cluster, displays important vehicle information **through a constant monitor of vehicle systems.** You may select display

features on the message center for a display of status preceded by a brief indicator chime. The system will also notify you of potential vehicle problems with a display of system warnings followed by a long indicator chime.

A rounded rectangular display box containing the text "NW 888888mi" in a digital font.

## Driver Controls

### Selectable features

#### **Reset**

Press this control to select and reset functions shown in the INFO menu and SETUP menu.

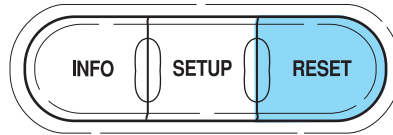

#### **Info menu**

This control displays the following control displays:

- Odometer/Compass
- Trip odometer/Odometer/Compass
- Distance to Empty/Odometer/Compass
- Average Fuel Economy/Odometer/Compass
- Engine hour meter/Odometer/Compass

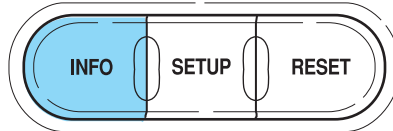

#### **Odometer/Trip odometer**

Refer to *Gauges* in the *Instrument Cluster* chapter.

#### **Compass display**

The compass heading is displayed as one of N, NE, E, SE, S, SW, W and NW in the message center display.

The compass reading may be affected when you drive near large buildings, bridges, power lines and powerful broadcast antenna. Magnetic or metallic objects placed in, on or near the vehicle may also affect compass accuracy.

Usually, when something affects the compass readings, the compass will correct itself after a few days of operating your vehicle in normal conditions. If the compass still appears to be inaccurate, a manual calibration may be necessary. Refer to *Compass zone/calibration adjustment*.

Most geographic areas (zones) have a magnetic north compass point that varies slightly from the northerly direction on maps. This variation is four degrees between adjacent zones and will become noticeable as the vehicle crosses multiple zones. A correct zone setting will eliminate this error. Refer to *Compass zone/calibration adjustment*.

## Driver Controls

### Compass zone/calibration adjustment

1. Determine your magnetic zone by referring to the zone map.
2. Turn ignition to the ON position.
3. Start the engine.

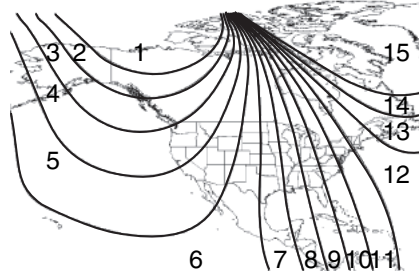

4. From Info menu, press and hold the SETUP and RESET controls simultaneously until the message center display changes to show the current zone setting (XX).
5. Press the SETUP control repeatedly until the correct zone setting for your geographic location is displayed on the message center. The range of zone values are from 01 to 15 and “wraps” back to 01.
6. To exit the zone, and to “lock in” your change, press and release the RESET control.

RESET FOR ZONE  
INFO TO EXIT

SETUP ZONE XX  
RESET IF DONE

RESET FOR CAL  
INFO TO EXIT

Perform compass calibration in an open area free from steel structures and high voltage lines. For optimum calibration, turn off all electrical accessories (heater/air conditioning, wipers, etc.) and make sure all vehicle doors are shut.

7. Press the RESET control to start the compass calibration function.

CIRCLE SLOWLY  
TO CALIBRATE

8. Slowly drive the vehicle in a circle (less than 3 mph [5 km/h]) until the CIRCLE SLOWLY TO CALIBRATE display changes to CALIBRATION COMPLETED. It will take up to five circles to complete calibration.

## Driver Controls

9. The compass is now calibrated.



CALIBRATION  
COMPLETED

### **Distance to empty (DTE)**

Selecting this function from the INFO menu estimates approximately how far you can drive with the fuel remaining in your tank under normal driving conditions.

Remember to turn the ignition OFF when refueling to allow this feature to correctly detect the added fuel.

The DTE function will display LOW FUEL LEVEL and sound a tone for one second when you have approximately 50 miles (80 km) to empty. If you RESET this warning message, this display and tone will return within 10 minutes.

DTE is calculated using a running average fuel economy, which is based on your recent driving history of 500 miles (800 km). This value is not the same as the average fuel economy display. The running average fuel economy is reinitialized to a factory default value if the battery is disconnected.



XXX MILES TO E  
NW 888888 mi

### **Average fuel economy (AFE)**

Select this function from the INFO menu to display your average fuel economy in miles/gallon or liters/100 km.

If you calculate your average fuel economy by dividing miles traveled since last fill-up by gallons of fuel used (multiply liters used by 100, then divide by kilometers traveled), your figure may be different than displayed for the following reasons:

- Your vehicle was not perfectly level during fill-up
- Differences in the automatic shut-off points on the fuel pumps at service stations
- Variations in top-off procedure from one fill-up to another
- Rounding of the displayed values to the nearest 0.1 gallon (liter)



XX.X MPG  
NW 888888 mi



## Driver Controls

1. Drive the vehicle at least 5 miles (8 km) with the speed control system engaged to display a stabilized average.
2. Record the highway fuel economy for future reference.

It is important to press the RESET control after setting the speed control to get accurate highway fuel economy readings.

### **Engine hour meter**

Select this function from the INFO menu to display the accumulated running time of the engine.

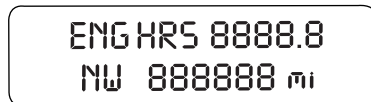

### **Setup menu**

Press this control for the following displays:

- System Check
- Units (English/Metric)
- Autolock
- Autolamp Delay
- Language

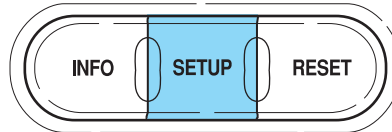

### **System check**

Selecting this function from the SETUP menu causes the message center to cycle through each of the systems being monitored. For each of the monitored systems, the message center will indicate either an OK message or a warning message for three seconds.

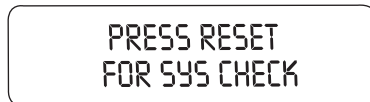

Pressing the RESET control cycles the message center through each of the systems being monitored.

The sequence of the system check report and how it appears in the message center is as follows:

1. ENGINE TEMP
2. TRANS TEMP
3. OIL PRESSURE
4. BRAKE FLUID LEVEL

## Driver Controls

5. DOOR AJAR
6. FUEL CAP (gasoline engine only)
7. AIR FILTER (diesel engine only)
8. FUEL LEVEL

### **Units (English/Metric)**

1. Select this function from the SETUP menu for the current units to be displayed.
2. Press the RESET control to change from English to Metric.

UNITS  
< ENG > METRIC

### **Autolocks**

This feature automatically locks all vehicle doors when the vehicle is shifted into any gear, putting the vehicle in motion.

1. To disable/enable the autolock feature, select this function from the SETUP control for the current display mode.
2. Press the RESET control to turn the autolocks ON or OFF.

AUTO LOCKS  
< ON > OFF

### **Autolamp delay**

This feature keeps your headlights on for up to three minutes after the ignition is switched off.

1. To disable/enable the autolamp delay feature, select this function from the SETUP control for the current display mode.
2. Press the RESET control to select the new Autolamp delay values of >0, >10, >20, >30, >60, >90, >120 or >180.

AUTOLAMP  
DELAY = XXX SEC

## Driver Controls

### Language

1. Select this function from the SETUP menu for the current language to be displayed.

ENGLISH  
RESET FOR NEW

2. Pressing the RESET control cycles the message center through each of the language choices.

FOR ENGLISH  
HOLD RESET

3. Press and hold the RESET control to set the language choice.

SET TO  
ENGLISH

### System warnings

System warnings alert you to possible problems or malfunctions in your vehicle's operating systems.

In the event of a multiple warning situation, the message center will cycle the display to show all warnings by displaying each one for 4 seconds.

The message center will display the last selected feature if there are no more warning messages. This allows you to use the full functionality of the message center after you acknowledge the warning by pressing the RESET control and clearing the warning message.

Warning messages that have been reset are divided into three categories:

- They will not disappear until a condition is changed.
- They will reappear on the display ten minutes from the reset.
- They will not reappear until an ignition OFF-ON cycle has been completed.

## Driver Controls

This acts as a reminder that these warning conditions still exist within the vehicle.

| Warning display                | Status   |
|--------------------------------|--|
| Reduced engine power           | Warning cannot be reset  |
| Stop engine safely             |  |
| Low fuel level                 | Warning returns after 10 minutes                                 |
| Low brake fluid level          |  |
| Low oil pressure               |  |
| Check engine temperature       |  |
| Trailer disconnected           |  |
| Water in fuel (diesel only)    |  |
| Check air filter (diesel only) |  |
| Door ajar                      | Warning returns after the ignition key is turned from OFF to ON. |
| Check fuel cap                 |  |
| Engine failsafe mode           |  |
| Check compass module           |  |
| Trailer fault                  |  |
| TBC fault                      |  |

**DOOR AJAR.** Displayed when a door is not completely closed.

**CHECK ENGINE TEMPERATURE.** Displayed when the engine coolant is overheating. Stop the vehicle as soon as safely possible, turn off the engine and let it cool. Check the coolant and coolant level. Refer to *Engine coolant* in the *Maintenance and Specifications* chapter. If the warning stays on or continues to come on, contact your authorized dealer as soon as possible.

**REDUCED ENGINE POWER.** Displayed when the engine is overheating. Stop the vehicle as soon as safely possible, turn off the engine. If the warning stays on followed by an indicator chime or continues to come on, contact your authorized dealer as soon as possible.

**STOP ENGINE SAFELY.** Displayed when the engine is overheating. Stop the vehicle as soon as safely possible, turn off the engine. If the warning stays on followed by an indicator chime or continues to come on, contact your authorized dealer as soon as possible.

**LOW FUEL LEVEL.** Displayed as an early reminder of a low fuel condition.

## Driver Controls

**LOW BRAKE FLUID LEVEL.** Indicates the brake fluid level is low and the brake system should be inspected immediately. Refer to *Checking and adding brake fluid* in the *Maintenance and Specifications* chapter.

**LOW OIL PRESSURE.** Displayed when the engine oil pressure is low. If this warning message is displayed, check the level of the engine oil. Refer to *Engine oil* in the *Maintenance and Specifications* chapter for information about adding engine oil. If the oil level is OK and this warning persists, shut down the engine immediately and contact your authorized dealer for service.

**CHECK FUEL CAP.** Displayed when the fuel filler cap is not properly installed. Check the fuel filler cap for proper installation. Refer to *Fuel filler cap* under the *Fuel Information* section in the *Maintenance and Specifications* chapter.

**ENGINE FAILSAFE MODE.** Displayed when the engine has defaulted to a 'limp-home' operation. If the warning stays on or continues to come on, contact your authorized dealer as soon as possible.

**CHECK COMPASS MODULE.** Displayed when the compass is not operating properly. If the warning stays on or continues to come on, contact your authorized dealer as soon as possible.

**TRAILER DISCONNECTED (if equipped):** Displayed when a trailer connection becomes disconnected, either intentionally or unintentionally, and has been sensed during a given ignition cycle. Refer to *Integrated trailer brake controller* in the *Tires, Wheels and Loading* chapter for more information.

**TRAILER FAULT (if equipped):** Displayed if there is a short circuit on the electric brake output wire or the trailer brakes are drawing too much current. Refer to *Integrated trailer brake controller* in the *Tires, Wheels and Loading* chapter for more information.

**TBC FAULT (if equipped):** Displayed in response to faults sensed by the TBC. In the event this message is seen, please take your vehicle to an authorized dealer for diagnosis and repair. Refer to *Integrated trailer brake controller* in the *Tires, Wheels and Loading* chapter for more information.

**WATER IN FUEL (diesel only):** Refer to *Instrumentation* in your *6.0 Liter Power Stroke Direct Injection Turbo Diesel Owner's Guide Supplement*.

**CHECK AIR FILTER (diesel only):** Refer to *Instrumentation* in your *6.0 Liter Power Stroke Direct Injection Turbo Diesel Owner's Guide Supplement*.

## Driver Controls

**DATA ERR.** These messages indicate improper operation of the vehicle network communication between electronic modules.

- Odometer
- Fuel flow
- Fuel level
- Trans temp
- Fuel cap
- Engine sensor
- Brake fluid
- Auto lock
- Auto lamp delay

Contact your authorized dealer as soon as possible if these messages occur on a regular basis.

### TAILGATE LOCK (IF EQUIPPED)

Your vehicle may be equipped with a tailgate lock designed to prevent theft of the tailgate.

- Insert ignition key and turn to the right to engage lock.
- Turn ignition key to the left to unlock.

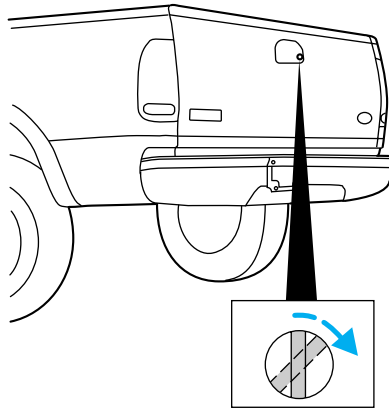

## Driver Controls

### Tailgate removal

Your tailgate is removable to allow more room for loading.

1. Lower the tailgate.
2. Use a screwdriver to pry the spring clip (on each connector) past the head of the support screw. Disconnect cable.
3. Disconnect the other cable.
4. Lift tailgate to a 45-degree angle.
5. Lift right side off of its hinge.
6. Lift left side off of its hinge.

To install, follow the removal procedures in reverse order.



## Locks and Security

### KEYS

The key operates all locks on your vehicle. You should always carry a second key with you in a safe place in case you require it in an emergency.

Your keys are programmed to your vehicle; using a non-programmed key will not permit your vehicle to start. If you lose your authorized dealer supplied keys, replacement keys are available through your authorized dealer.

### POWER DOOR LOCKS (IF EQUIPPED)

Press control to unlock all doors.

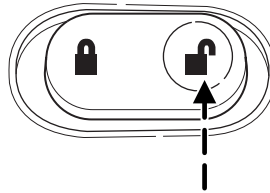

Press control to lock all doors.

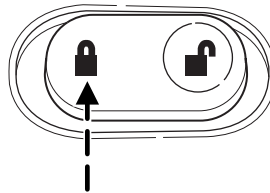

### Smart locks (if equipped)

This feature prevents you from locking yourself out of the vehicle if your key is still in the ignition.

When you open the driver's door and you lock the vehicle with the power door lock control, all the doors will lock, then the driver's door will automatically unlock reminding you that your key is still in the ignition.

The vehicle can still be locked, with the key in the ignition, using the manual lock button on the door, locking the driver's door with a key, by simultaneously pressing button 7 • 8 and the 9 • 0 controls on the remote entry keypad (if equipped), or using the lock button on the remote entry transmitter (if equipped).



## Locks and Security

### CHILDPROOF DOOR LOCKS (IF EQUIPPED)

- When these locks are set, the rear doors cannot be opened from the inside.
- The rear doors can be opened from the outside when the doors are unlocked.

The childproof locks are located on rear edge of each rear door and must be set separately for each door. Setting the lock for one door will not automatically set the lock for both doors.

- Move lock control up to engage the childproof lock.
- Move lock control down to disengage the childproof lock.

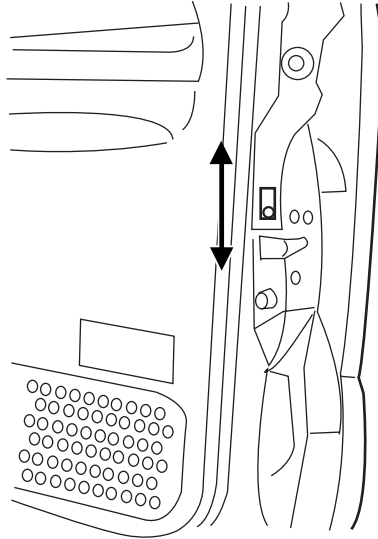

### REMOTE ENTRY SYSTEM (IF EQUIPPED)

This device complies with part 15 of the FCC rules and with RS-210 of Industry Canada. Operation is subject to the following two conditions: (1) This device may not cause harmful interference, and (2) This device must accept any interference received, including interference that may cause undesired operation.

**Changes or modifications not expressly approved by the party responsible for compliance could void the user's authority to operate the equipment.**

The typical operating range for your remote entry transmitter is approximately 33 feet (10 meters). A decrease in operating range could be caused by:

- weather conditions,
- nearby radio towers,
- structures around the vehicle, or
- other vehicles parked next to your vehicle.

## Locks and Security

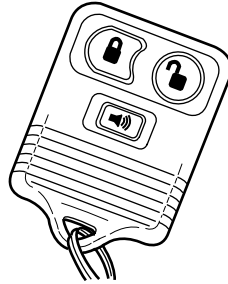

Your vehicle is equipped with a remote entry system which allows you to:

- unlock the vehicle doors without a key.
- lock all the vehicle doors without a key.
- activate the personal alarm.





If there are problems with the remote entry system, make sure to take **ALL remote entry transmitters** with you to the authorized dealer in order to aid in troubleshooting the problem.

### Unlocking the doors

1. Press  and release to unlock the driver's door. **Note:** The interior lamps will illuminate.
2. Press  and release again within three seconds to unlock all the doors.

### Locking the doors

1. Press  and release to lock all the doors. The parking lamps will flash if all the doors are closed and locked.
2. Press  and release again within three seconds to confirm that all the doors are closed and locked. **Note:** The doors will lock again, the horn will chirp once, and the parking lamps will flash once more.

If any of the doors are not properly closed the horn will make two quick chirps.

### Power door lock disable feature (if equipped)

The UNLOCK  feature on your power door locks will not work from inside the vehicle when:

- the ignition has been turned to the 3 (OFF) position, and
- 20 seconds elapse after all vehicle doors are closed and locked using the remote entry transmitter, or the power door lock control (while the accompanying door is open).

## Locks and Security

The UNLOCK  feature will work again after:

- a door has become ajar,
- the ignition is turned to the 4 (ON) position,
- unlocking the vehicle using the keyless entry keypad,
- or using the UNLOCK  control on your remote entry transmitter (if equipped).

This feature is initially deactivated, but may be activated by taking your vehicle to an authorized dealer.

### Sounding a panic alarm

Press  to activate the alarm. Press again or turn the ignition to 4 (ON) to deactivate.

**Note:** The panic alarm will only operate when the ignition is in the 2 (LOCK) or 3 (OFF) position.

### Replacing the battery

The remote entry transmitter uses one coin type three-volt lithium battery CR2032 or equivalent.

To replace the battery:

1. Twist a thin coin between the two halves of the remote entry transmitter near the key ring. DO NOT TAKE THE RUBBER COVER AND CIRCUIT BOARD OFF THE FRONT HOUSING OF THE REMOTE ENTRY TRANSMITTER.

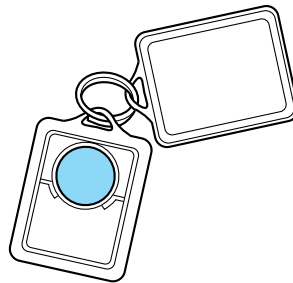

## Locks and Security

2. Do not wipe off any grease on the battery terminals on the back surface of the circuit board.

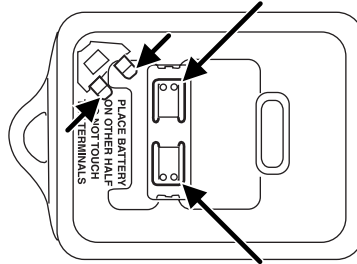

3. Remove the old battery. **Note:** Please refer to local regulations when disposing of transmitter batteries.

4. Insert the new battery. Refer to the diagram inside the remote entry transmitter for the correct orientation of the battery. Press the battery down to ensure that the battery is fully seated in the battery housing cavity.

5. Snap the two halves back together.

**Note:** Replacement of the battery will **not** cause the remote transmitter to become deprogrammed from your vehicle. The remote transmitter should operate normally after battery replacement.

### Replacing lost remote entry transmitters

If you would like to have your remote entry transmitter reprogrammed because you lost one, or would like to buy additional remote entry transmitters, you can either reprogram them yourself, or take **all remote entry transmitters** to your authorized dealer for reprogramming.

### *How to reprogram your remote entry transmitters*

You must have **all remote keyless entry keypads and remote entry transmitters** (maximum of four) available before beginning this procedure.

## Locks and Security

To program the keyless entry keypads remote entry transmitters yourself:

1. Ensure the vehicle is electronically unlocked.
2. Put the key in the ignition.
3. Turn the key from the 2 (LOCK) position to 3 (OFF).
4. Cycle eight times rapidly (within 10 seconds) between the 3 (OFF) position and 4 (ON). **Note:** The eighth turn must end in the 4 (ON) position.
5. The doors will lock, then unlock, to confirm that the programming mode has been activated.
6. Within 20 seconds, program the keyless entry keypad by pressing the 7 • 8 and the 9 • 0 controls at the same time.
7. The doors will lock, then unlock, to confirm that the keypad programming mode has been activated.
8. Within 20 seconds, program the remote entry transmitter by pressing any button on the transmitter. **Note:** If more than 20 seconds have passed you will need to start the procedure over again.
9. The doors will again lock, then unlock, to confirm that this remote entry transmitter has been programmed.
10. Repeat Step 8 to program each additional remote keypad or entry transmitter.
11. Turn the ignition to the 3 (OFF) position after you have finished programming all of the remote entry transmitters. **Note:** If more than 20 seconds have passed you will need to start the procedure over again.
12. The doors will once again lock, then unlock, to confirm that the programming mode has been exited.

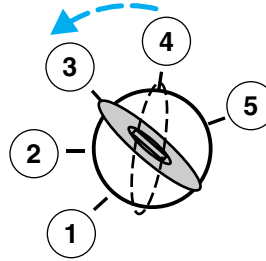

## Locks and Security

### Illuminated entry

The interior lamps illuminate when the remote entry system is used to unlock the door(s).

The illuminated entry system will turn off the interior lights if:

- the ignition switch is turned to the 4 (ON) position, or
- the remote transmitter lock control is pressed, or
- the 7 • 8 and the 9 • 0 controls on the keyless entry keypad are pressed, or
- after 25 seconds of illumination.

The dome lamp control (if equipped) must **not** be set to the off position for the illuminated entry system to operate.

The inside lights will not turn off if:

- they have been turned on with the dimmer control, or
- any door is open.

The battery saver will shut off the interior lamps 30 minutes after the ignition has been turned to the 3 (OFF) position, 10 minutes after if the dome lamp is off, and 30 minutes after if the dome lamp switch is left on.

### KEYLESS ENTRY SYSTEM

You can use the keyless entry keypad to lock or unlock the doors without using a key.



The keypad can be operated with the factory set 5-digit entry code; this code is located on the owner's wallet card in the glove box, is marked on the computer module, and is available from your authorized dealer. You can also create your own 5-digit personal entry code.

When pressing the controls on the keypad, press the middle of the controls to ensure a good activation.

### Programming a personal entry code

To create your own personal entry code:

1. Enter the factory set code.
2. Within five seconds press the 1 • 2 on the keypad.

## Locks and Security

3. Enter your personal 5-digit code. Each number must be entered within five seconds of each other.

4. The doors will again lock then unlock to confirm that your personal keycode has been programmed to the module.

### **Tips:**

- Do not set a code that uses five of the same number.
- Do not use five numbers in sequential order.
- The factory set code will work even if you have set your own personal code.
- If you set a second personal code it will erase your first personal code.

### **Erasing personal code**

1. Enter the factory set 5-digit code.

2. Within five seconds, press the 1 • 2 on the keypad and release.

3. Press and hold the 1 • 2 for two seconds. This must be done within five seconds of completing Step 2.

Your personal code is now erased and only the factory set 5-digit code will work.

### **Anti-scan feature**

If an incorrect code has been entered 7 times (35 consecutive button presses), the keypad will go into an anti-scan mode. This mode disables the keypad for one minute and the keypad lamp will flash during this time.

The anti-scan feature will turn off after:

- one minute of keypad inactivity.
- pressing the  control on the remote entry transmitter.
- the ignition is turned to the 4 (ON) position.

### **Unlocking and locking the doors using keyless entry**

**To unlock the driver's door**, enter the factory set 5-digit code or your personal code. Each number must be pressed within five seconds of each other. The interior lamps will illuminate after entering a valid keypad entry code.

**To unlock all doors**, press the 3 • 4 control within five seconds.

**To lock all doors**, press the 7 • 8 and the 9 • 0 at the same time. You **do not** need to enter the keypad code first. **Note:** The interior lamps will turn off.

## Locks and Security

### **Autolock (if equipped)**

This feature automatically locks all vehicle doors when the following conditions are met:

- the ignition key is in the 4 (ON) position,
- all the doors are closed,
- the brake is pressed before reaching 5 mph (8 km/h), and
- the vehicle is traveling more than 5 mph (8 km/h).

### **Relock**

The autolock feature repeats when the following conditions are met:

- the vehicle's speed is less than 5 mph (8 km/h),
- any door is opened then closed while the ignition is in the 4 (ON) position,
- the brake is pressed before reaching 5 mph (8 km/h), and
- the vehicle is traveling more than 5 mph (8 km/h).

### **To deactivate/reactivate the autolock feature using the keypad**

Your vehicle comes with the autolock feature activated. To deactivate/reactivate this feature:

1. Ensure that the anti-theft system is not armed.
2. Turn the ignition to the 3 (OFF) position.
3. Close all the doors, liftgate and cargo doors.
4. Enter the 5-digit entry code.
5. Press and hold the 7 • 8. While holding the 7 • 8, press and release the 3 • 4.
6. Release the 7 • 8.

The horn will chirp once when the system has been successfully deactivated.

The horn will chirp twice (one short and one long chirp) when the system has been successfully reactivated.



## Locks and Security

### ***To deactivate/reactivate the autolock feature using the power door unlock control***

You must complete Steps 1-7 within 30 seconds or the procedure will have to be repeated. If the procedure needs to be repeated, you must wait 30 seconds.

1. Insert the key and turn the ignition to the 4 (ON) position.
2. Press the power door unlock control three times.
3. Turn the ignition from the 4 (ON) position to the 3 (OFF) position.
4. Press the power door unlock control three times.
5. Turn the ignition back to the 4 (ON) position. The horn will chirp.
6. Press the unlock control, then press the lock control. The horn will chirp once if autolock was deactivated or twice (one short and one long chirp) if autolock was activated. **Note:** Pressing the power door UNLOCK/LOCK button again will toggle between activating and deactivating the autolock feature.
7. Turn the ignition to the 3 (OFF) position. The horn will chirp once to confirm the procedure is complete.

## Seating and Safety Restraints

### SEATING

#### Notes:



Reclining the seatback can cause an occupant to slide under the seat's safety belt, resulting in severe personal injuries in the event of a collision.



Do not pile cargo higher than the seatbacks to reduce the risk of injury in a collision or sudden stop.

### Head restraints

The purpose of these head restraints is to help limit head motion in the event of a rear collision. To properly adjust your head restraints, lift the head restraint so that it is located directly behind your head or as close to that position as possible.

The head restraints can be moved up and down. Lift the head restraint so that it is located directly or as close as possible behind your head.

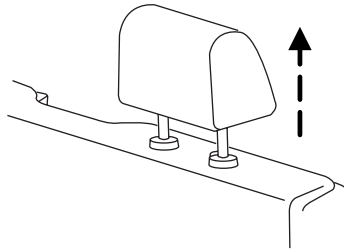

Push control to lower head restraint.

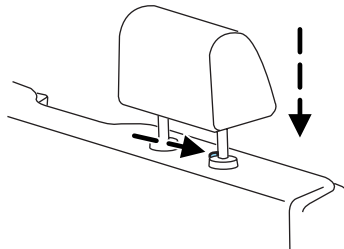

## Seating and Safety Restraints

### Full bench seat (if equipped)

- Lift the release bar to move the seat forward or backward. Ensure that the seat is related into place.
- Pull up on the lever located at the bottom of the seatback to quickly fold the seatback forward.
- Pull up on the lever located at the side of the seat cushion to recline the seatback and to return the seat to the upright position.

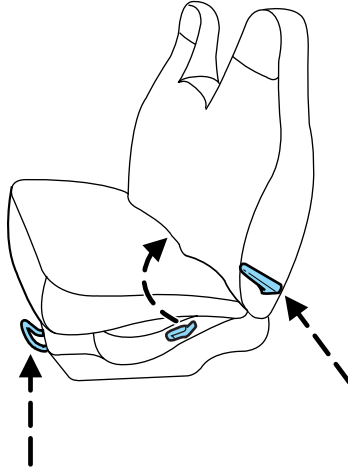

### 40/20/40 split bench seat (if equipped)

- Lift the track release bar to move the seat forward or backward. Ensure the seat is related into place.
- Pull the handle on the side of the seat up to recline the seat.
- Push down the lever located at the bottom of the seatback to quickly fold the seatback forward.

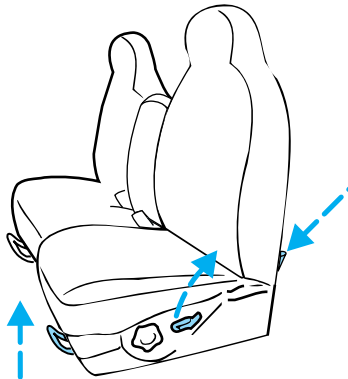

## Seating and Safety Restraints

### 40/20/40 front seat armrest and console (if equipped)

To release the armrest, pull forward on the strap and pull the armrest down.

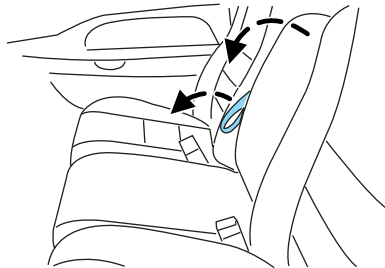

To gain access to the storage compartment in your armrest, lift the latch to open the lid. The lid cannot be opened in the upright position.

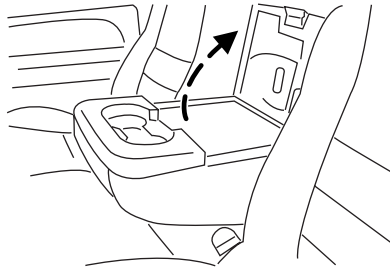

Lift up armrest to return it to a center seatback.

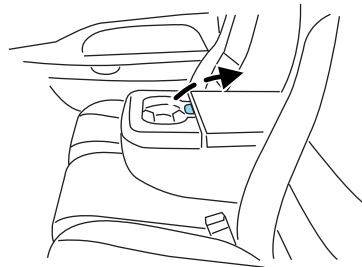

## Seating and Safety Restraints

### Captain's chair (if equipped)

- Lift the bar to move the seat forward or rearward. Make sure that the seat is related into place.
- To recline the seatback, pull the release lever handle located on the side of the seat up.
- Push down the lever (if equipped) located at the bottom of the seatback to quickly fold the seatback forward.

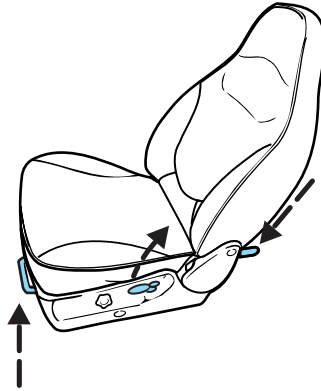

### Adjusting the front power seat (if equipped)

The control is located on the outboard side of the seat cushion.

Your vehicle will only be equipped with one of the two controls shown.

Press to raise or lower the front portion of the seat cushion.

- Type A

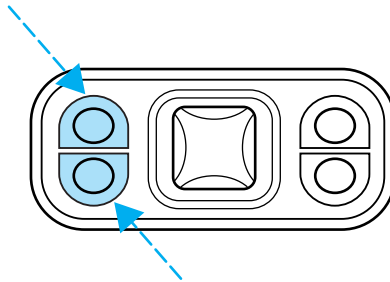

- Type B

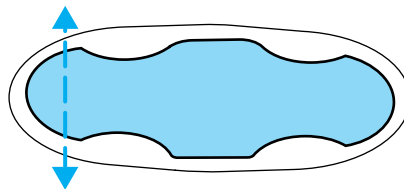

## Seating and Safety Restraints

Press to raise or lower the rear portion of the seat cushion.

- Type A

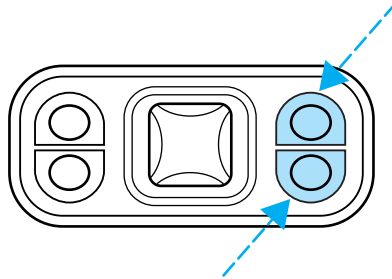

- Type B

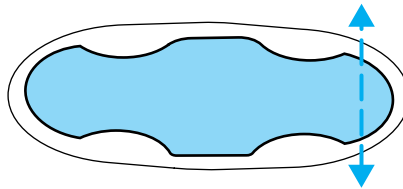

- Type A

Press the control to move the seat forward, backward, up or down.

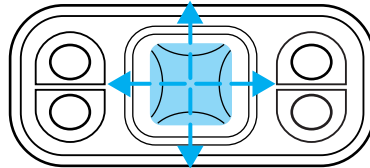

- Type B

Press the control to move the seat forward or backward.

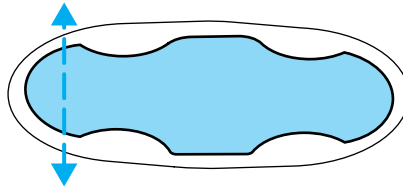

## Seating and Safety Restraints

### Using the manual lumbar support

For more lumbar support, turn the lumbar support control toward the front of vehicle.

For less lumbar support, turn the lumbar support control toward the rear of vehicle.

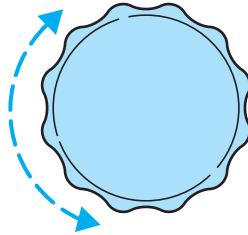

### Heated seats (if equipped)

To operate the heated seats, do the following:

- Push control to activate.
- Push again to deactivate.

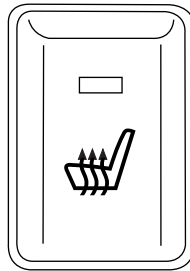

The indicator light on the control will illuminate when activated.

The system will not automatically shut off unless control is pushed to deactivate. If system is not manually terminated at last use, then system will remain active at next ignition key cycle.

## Seating and Safety Restraints

### REAR FOLDING SEAT SYSTEM WITH LOAD FLOOR (IF EQUIPPED)

The rear seatback has a split 60/40 seat. Each seat cushion can be flipped up into the seatback position.

1. Pull down the latch lever located on the bottom seat back to fold the seat back forward.

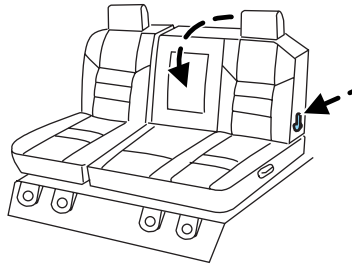

2. Pull up on the lever located on the side of the seat cushion to rotate the cushion up until it locks into a vertical storage position, gaining access to the grocery hook located on the underside of the driver-side seat cushion. The maximum load is 25 lb. (11 kg).

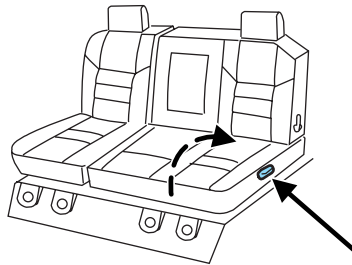

### Returning the seat to seating position

- Pull lever on the side of the seat to release seat cushion from storage position.
- Push seat cushion down until it locks into horizontal position.



Before returning the seatback to its original position, make sure that cargo or any objects are not trapped underneath the seatback. After returning the seatback to its original position, pull on the seatback to ensure that it has fully latched. An unlatched seat may become dangerous in the event of a sudden stop or collision.



## Seating and Safety Restraints

To gain access to the cupholders and tray, pull down on the armrest.

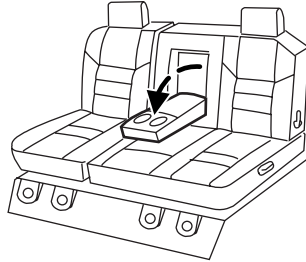

To gain access to the 60/40 load floor, store the cushion in the upright locked position. Pull up on the straps located at the sides of the load floor, and rotate forward until resting on the carpet.

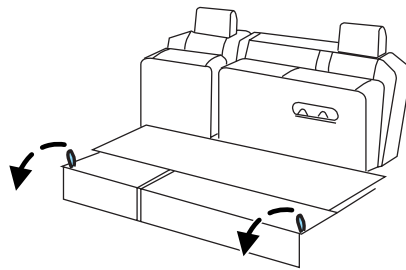

### SAFETY RESTRAINTS

#### Safety restraints precautions



Always drive and ride with your seatback upright and the lap belt snug and low across the hips.



To reduce the risk of injury, make sure children sit in the back seat where they can be properly restrained.





Never let a passenger hold a child on his or her lap while the vehicle is moving. The passenger cannot protect the child from injury in a collision.





All occupants of the vehicle, including the driver, should always properly wear their safety belts, even when an air bag supplemental restraint system (SRS) is provided.

## Seating and Safety Restraints

 It is extremely dangerous to ride in a cargo area, inside or outside of a vehicle. In a collision, people riding in these areas are more likely to be seriously injured or killed. Do not allow people to ride in any area of your vehicle that is not equipped with seats and safety belts. Be sure everyone in your vehicle is in a seat and using a safety belt properly.

 In a rollover crash, an unbelted person is significantly more likely to die than a person wearing a safety belt.

 Each seating position in your vehicle has a specific safety belt assembly which is made up of one buckle and one tongue that are designed to be used as a pair. 1) Use the shoulder belt on the outside shoulder only. Never wear the shoulder belt under the arm. 2) Never swing the safety belt around your neck over the inside shoulder. 3) Never use a single belt for more than one person.

 Always transport children 12 years old and under in the back seat and always properly use appropriate child restraints.

 Safety belts and seats can become hot in a vehicle that has been closed up in sunny weather; they could burn a small child. Check seat covers and buckles before you place a child anywhere near them.

### Combination lap and shoulder belts

1. Insert the belt tongue into the proper buckle (the buckle closest to the direction the tongue is coming from) until you hear a snap and feel it latch. Make sure the tongue is securely fastened in the buckle.

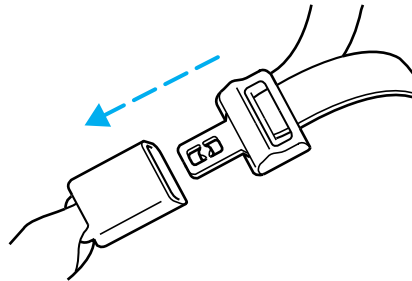

## Seating and Safety Restraints

2. To unfasten, push the release button and remove the tongue from the buckle.

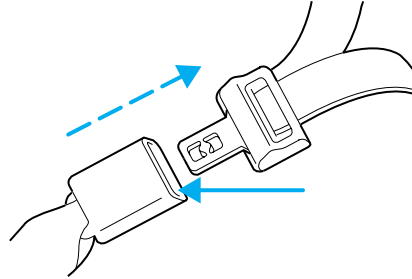

The front outboard and rear outboard safety restraints in the vehicle are combination lap and shoulder belts. The front outboard passenger and rear seat outboard safety belts have two types of locking modes described below:

### Vehicle sensitive mode

This is the normal retractor mode, which allows free shoulder belt length adjustment to your movements and locking in response to vehicle movement. For example, if the driver brakes suddenly or turns a corner sharply, or the vehicle receives an impact of approximately 5 mph (8 km/h) or more, the combination safety belts will lock to help reduce forward movement of the driver and passengers.

On SuperCab and Crew Cab models, the front seat belt system can also be made to lock manually by quickly pulling on the shoulder belt.

Rear seat belts (if equipped) cannot be made to lock up by pulling quickly on the belt.

### Automatic locking mode

#### ***When to use the automatic locking mode***

In this mode, the shoulder belt is automatically pre-locked. The belt will still retract to remove any slack in the shoulder belt. The automatic locking mode is not available on the driver safety belt.

This mode should be used **any time** a child safety seat is installed in a passenger front or outboard rear seating position (if equipped). Children 12 years old and under should be properly restrained in the rear seat whenever possible. Refer to *Safety restraints for children* or *Safety seats for children* later in this chapter.

## Seating and Safety Restraints

### **How to use the automatic locking mode**

- Buckle the combination lap and shoulder belt.

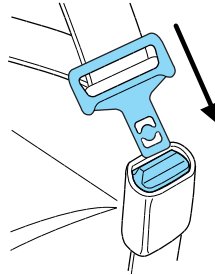

- Grasp the shoulder portion and pull downward until the entire belt is pulled out.



- Allow the belt to retract. As the belt retracts, you will hear a clicking sound. This indicates the safety belt is now in the automatic locking mode.

### **How to disengage the automatic locking mode**

Disconnect the combination lap/shoulder belt and allow it to retract completely to disengage the automatic locking mode and activate the vehicle sensitive (emergency) locking mode.

 After any vehicle collision, the front passenger and rear outboard seat belt systems must be checked by your authorized dealer to verify that the “automatic locking retractor” feature for child seats is still functioning properly. In addition, all seat belts should be checked for proper function.

## Seating and Safety Restraints



BELT AND RETRACTOR ASSEMBLY MUST BE REPLACED if the seat belt assembly “automatic locking retractor” feature or any other seat belt function is not operating properly when checked according to the procedures in the *Workshop Manual*. Failure to replace the belt and retractor assembly could increase the risk of injury in collisions.

### Energy Management Feature

- This vehicle has a seat belt system with an energy management feature at the front outboard seating positions to help further reduce the risk of injury in the event of a head-on collision.
- The front outboard seat belt systems have a retractor assembly that is designed to pay out webbing in a controlled manner. This feature is designed to help reduce the belt force acting on the occupant’s chest.

### Front safety belt height adjustment

The front outboard seats are equipped with belt height adjusters.

If your vehicle is equipped with seat integrated restraints (SIR), you will not have a safety belt height adjuster.

Adjust the height of the shoulder belt so the belt rests across the middle of your shoulder.

- Regular Cab and 4-door Crew Cab

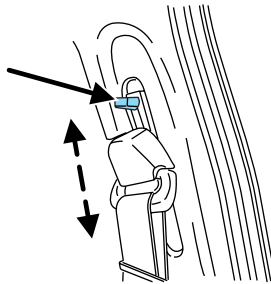

## Seating and Safety Restraints

- 4-door Super Cab

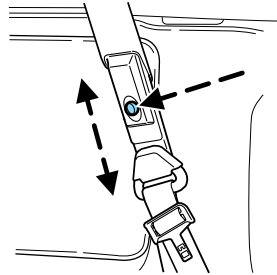

To adjust the shoulder belt height, push the button and slide the height adjuster up or down. Release the button and pull down on the height adjuster to make sure it is locked in place.



Position the safety belt height adjusters so that the belt rests across the middle of your shoulder. Failure to adjust the safety belt properly could reduce the effectiveness of the seat belt and increase the risk of injury in a collision.

### Lap belts

#### ***Adjusting the lap belt***



The lap belt should fit snugly and as low as possible around the hips, not across the waist.

- **1st row center seating position**

The lap belt does not adjust automatically.

## Seating and Safety Restraints

Insert the tongue into the correct buckle (the buckle closest to the direction the tongue is coming from). To lengthen the belt, turn the tongue at a right angle to the belt and pull across your lap until it reaches the buckle. To tighten the belt, pull the loose end of the belt through the tongue until it fits snugly across the hips.

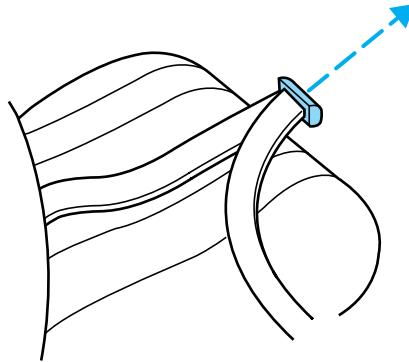

Shorten and fasten the belt when not in use.

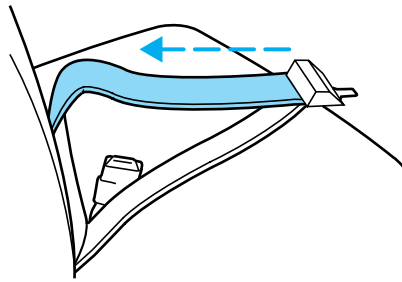

- **2nd row center seating position (if equipped)**

The lap belt will not adjust automatically. To fasten, grasp the tongue, and with a continuous motion, pull out enough webbing to buckle the tongue into the correct buckle. If you did not pull out enough webbing to reach the buckle, allow the tongue to retract fully before trying to pull it out again.

### **Safety belt warning light and indicator chime**

The safety belt warning light illuminates in the instrument cluster and a chime sounds to remind the occupants to fasten their safety belts.

## Seating and Safety Restraints

### Conditions of operation

| If...   | Then...   |
|---|---|
| The driver's safety belt is not buckled before the ignition switch is turned to the ON position...                | The safety belt warning light illuminates 1-2 minutes and the warning chime sounds 4-8 seconds. |
| The driver's safety belt is buckled while the indicator light is illuminated and the warning chime is sounding... | The safety belt warning light and warning chime turn off.                                       |
| The driver's safety belt is buckled before the ignition switch is turned to the ON position...                    | The safety belt warning light and indicator chime remain off.                                   |

### BeltMinder®

The BeltMinder® feature is a supplemental warning to the safety belt warning function. This feature provides additional reminders to the driver that the driver's safety belt is unbuckled by intermittently sounding a chime and illuminating the safety belt warning lamp in the instrument cluster.

| If...  | Then...  |
|--|--|
| The driver's safety belt is not buckled before the vehicle has reached at least 3 mph (5 km/h) and 1-2 minutes have elapsed since the ignition switch has been turned to ON... | The BeltMinder® feature is activated - the safety belt warning light illuminates and the warning chime sounds for 6 seconds every 30 seconds, repeating for approximately 5 minutes or until safety belt is buckled. |
| The driver's safety belt is buckled while the safety belt indicator light is illuminated and the safety belt warning chime is sounding...                                      | The BeltMinder® feature will not activate.   |
| The driver's safety belt is buckled before the ignition switch is turned to the ON position...   | The BeltMinder® feature will not activate.   |



## Seating and Safety Restraints

The following are reasons most often given for not wearing safety belts  
(All statistics based on U.S. data):

| Reasons given...                       | Consider...  |
|--|--|
| “Crashes are rare events”              | <b>36700 crashes occur every day.</b> The more we drive, the more we are exposed to “rare” events, even for good drivers. <i>1 in 4 of us will be seriously injured in a crash during our lifetime.</i>              |
| “I’m not going far”                    | <b>3 of 4</b> fatal crashes occur within <b>25</b> miles (40 km) of home.  |
| “Belts are uncomfortable”              | We design our safety belts to enhance comfort. If you are uncomfortable - try different positions for the safety belt upper anchorage and seatback which should be as upright as possible; this can improve comfort. |
| “I was in a hurry”                     | <b>Prime time for an accident.</b> BeltMinder® reminds us to take a few seconds to buckle up.  |
| “Safety belts don’t work”              | <b>Safety belts</b> , when used properly, <b>reduce risk of death</b> to front seat occupants by <b>45% in cars</b> , and by <b>60% in light trucks.</b>   |
| “Traffic is light”                     | <b>Nearly 1 of 2 deaths occur in single-vehicle crashes</b> , many when no other vehicles are around.  |
| “Belts wrinkle my clothes”             | Possibly, but a serious crash can do much more than wrinkle your clothes, particularly if you are unbelted.  |
| “The people I’m with don’t wear belts” | Set the example, teen deaths occur 4 times more often in vehicles with TWO or MORE people. Children and younger brothers/sisters imitate behavior they see.  |

## Seating and Safety Restraints

| Reasons given...             | Consider...  |
|------------------------------|--|
| "I have an airbag"           | Airbags offer greater protection when used with safety belts. Frontal airbags are not designed to inflate in rear and side crashes or rollovers.       |
| "I'd rather be thrown clear" | Not a good idea. <b>People</b> who are <b>ejected are 40 times more likely to DIE</b> . Safety belts help prevent ejection, WE CAN'T "PICK OUR CRASH". |



Do not sit on top of a buckled safety belt to avoid the BeltMinder® chime. Sitting on the safety belt will increase the risk of injury in an accident. To disable (one-time) or deactivate the BeltMinder® feature please follow the directions stated below.

### **One time disable**

Any time the safety belt is buckled and then unbuckled during an ignition ON cycle, the BeltMinder® will be disabled for that ignition cycle only.

### **Deactivating/activating the BeltMinder® feature**

*Read Steps 1 - 9 thoroughly before proceeding with the deactivation/activation programming procedure.*

The BeltMinder® feature can be deactivated/activated by performing the following procedure:

Before following the procedure, make sure that the following conditions are met:

- the parking brake is set
- the gearshift is in P (Park) (automatic transmission) or the neutral position (manual transmission)
- the ignition switch is in the OFF position
- all vehicle doors are closed
- the driver's safety belt is unbuckled
- the parklamps/headlamps are in the OFF position (If the vehicle is equipped with Autolamps, this will not affect the procedure)



To reduce the risk of injury, do not deactivate/activate the Belt Minder feature while driving the vehicle.

## Seating and Safety Restraints

### **BeltMinder® activation and deactivation procedure**

1. Turn the ignition switch to the RUN (or ON) position. (DO NOT START THE ENGINE)
2. Wait until the safety belt warning light turns off. (Approximately 1–2 minutes)
  - Step 3–5 must be completed within 60 seconds or the procedure will have to be repeated.
3. Buckle then unbuckle the safety belt three times, ending with the safety belt unbuckled. This can be done before or during the BeltMinder® warning activation.
4. Turn on the parklamps/headlamps, turn off the parklamps/headlamps.
5. Buckle then unbuckle the safety belt three times, ending with the safety belt unbuckled.
  - After Step 5, the safety belt warning light will be turned on for three seconds.
6. Within seven seconds of the safety belt warning light turning off, buckle then unbuckle the safety belt.
  - This will disable the BeltMinder® feature if it is currently enabled or enable the BeltMinder® feature if it is currently disabled.
7. Confirmation of disabling BeltMinder® is provided by the safety belt warning light flashing four times per second for three seconds.
8. Confirmation of enabling BeltMinder® is provided by:
  - The safety belt warning light flashing four times per second for three seconds.
  - Followed by three seconds with the safety belt warning light off.
  - Once again, the safety belt warning light will flash four times per second for three seconds.
9. After receiving confirmation, the deactivation/activation procedure is complete.

### **Safety belt extension assembly**

If the safety belt is too short when fully extended, there is a 8 inch (20 cm) safety belt extension assembly that can be added (part number 611C22). This assembly can be obtained from your authorized dealer.

Use only extensions manufactured by the same supplier as the safety belt. Manufacturer identification is located at the end of the webbing on

## Seating and Safety Restraints

the label. Also, use the safety belt extension only if the safety belt is too short for you when fully extended.



Do not use extensions to change the fit of the shoulder belt across the torso.

### Safety belt maintenance

Inspect the safety belt systems periodically to make sure they work properly and are not damaged. Inspect the safety belts to make sure there are no nicks, tears or cuts. Replace if necessary. All safety belt assemblies, including retractors, buckles, front seat belt buckle assemblies, buckle support assemblies (slide bar-if equipped), shoulder belt height adjusters (if equipped), shoulder belt guide on seatback (if equipped), child safety seat LATCH and tether anchors, and attaching hardware, should be inspected after a collision. Ford Motor Company recommends that all safety belt assemblies in use in vehicles involved in a collision be replaced. However, if the collision was minor and your authorized dealer finds that the belts do not show damage and continue to operate properly, they do not need to be replaced. Safety belt assemblies not in use during a collision should also be inspected and replaced if either damage or improper operation is noted.



Failure to inspect and if necessary replace the safety belt assembly under the above conditions could result in severe personal injuries in the event of a collision.

For proper care of soiled safety belts, refer to *Interior* in the *Cleaning* chapter.

### AIR BAG SUPPLEMENTAL RESTRAINT SYSTEM (SRS)

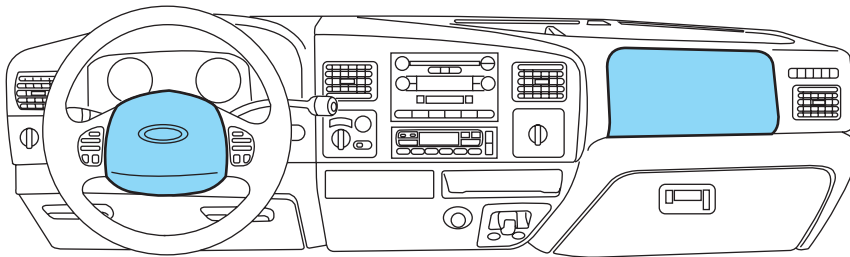



## Seating and Safety Restraints

### Important SRS precautions

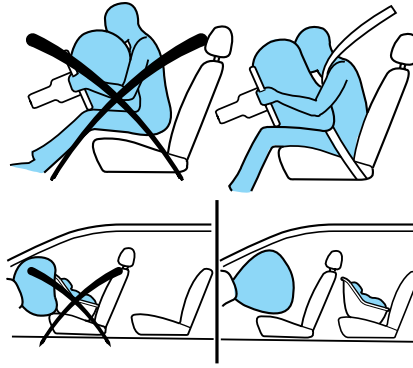
The SRS is designed to work with the safety belt to help protect the driver and right front passenger from certain upper body injuries. Airbags DO NOT inflate slowly; there is a risk of injury from a deploying airbag.



 All occupants of the vehicle, including the driver, should always properly wear their safety belts, even when an air bag supplemental restraint system (SRS) is provided.

 Always transport children 12 years old and under in the back seat and always properly use appropriate child restraints.

 The National Highway Traffic Safety Administration (NHTSA) recommends a minimum distance of at least 10 inches (25 cm) between an occupant's chest and the driver airbag module.

 Never place your arm over the air bag module as a deploying air bag can result in serious arm fractures or other injuries.

To properly position yourself away from the airbag:

- Move your seat to the rear as far as you can while still reaching the pedals comfortably.
- Recline the seat slightly one or two degrees from the upright position.

 Do not put anything on or over the air bag module. Placing objects on or over the air bag inflation area may cause those objects to be propelled by the air bag into your face and torso causing serious injury.

## Seating and Safety Restraints



Do not attempt to service, repair, or modify the airbag supplemental restraint systems or its fuses. See your authorized dealer.



The front passenger air bag is not designed to offer protection to an occupant in the center front seating position.



Modifying or adding equipment to the front end of the vehicle (including frame, bumper, front end body structure and tow hooks) may affect the performance of the airbag system, increasing the risk of injury. Do not modify the front end of the vehicle.



Additional equipment such as snowplow equipment may effect the performance of the airbag sensors increasing the risk of injury. Please refer to the *Body Builders Layout Book* for instructions about the appropriate installation of additional equipment.



Removing the blocker beam without installing snow plow attachment hardware may effect airbag deployment in a crash. Do not operate the truck unless either the blocker beam or snow plow attachment hardware is installed on the vehicle.

### Children and airbags

For additional important safety information, read all information on safety restraints in this guide.

Children must always be properly restrained. Failure to follow these instructions may increase the risk of injury in a collision.



An infant in a rear-facing seat faces a high risk of serious or fatal injuries from a deploying passenger airbag. Rear facing infant seats should NEVER be placed in the front seats, unless the passenger airbag is turned off. See *Passenger airbag ON/OFF switch*.

## Seating and Safety Restraints

### How does the airbag supplemental restraint system work?

The airbag SRS is designed to activate when the vehicle sustains sufficient longitudinal deceleration. The fact that the airbags did not inflate in a collision does not mean that something is wrong with the system. Rather, it means the forces were not of the type sufficient to cause activation. Airbags are designed to inflate in frontal and near-frontal collisions, not rollover, side-impact, or rear-impacts.

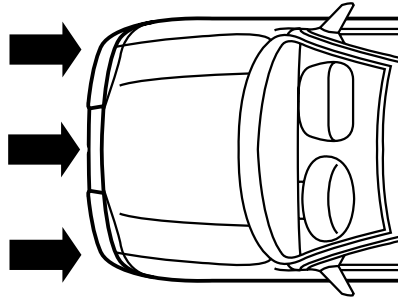

The airbags inflate and deflate rapidly upon activation. After airbag deployment, it is normal to notice a smoke-like, powdery residue or smell the burnt propellant. This may consist of cornstarch, talcum powder (to lubricate the bag) or sodium compounds (e.g., baking soda) that result from the combustion process that inflates the airbag. Small amounts of sodium hydroxide may be present which may irritate the skin and eyes, but none of the residue is toxic.



While the system is designed to help reduce serious injuries, it may also cause minor abrasions, swelling or temporary hearing loss. Because airbags must inflate rapidly and with considerable force, there is the risk of death or serious injuries such as fractures, facial and eye injuries or internal injuries, particularly to occupants who are not properly restrained or are otherwise out of position at the time of airbag deployment. Thus, it is extremely important that occupants be properly restrained as far away from the airbag module as possible while maintaining vehicle control.



Several air bag system components get hot after inflation. Do not touch them after inflation.

## Seating and Safety Restraints



If the air bag has deployed, **the air bag will not function again and must be replaced immediately.** If the air bag is not replaced, the unrepaired area will increase the risk of injury in a collision.

The SRS consists of:

- driver and passenger airbag modules (which include the inflators and airbags),
- one or more impact and safing sensors,
- a readiness light and tone
- and the electrical wiring which connects the components.

The diagnostic module monitors its own internal circuits and the supplemental airbag electrical system wiring (including the impact sensors), the system wiring, the airbag system readiness light, the airbag back up power and the airbag ignitors.

### Determining if the system is operational

The SRS uses a readiness light in the instrument cluster or a tone to indicate the condition of the system. Refer to *Airbag readiness* section in the *Instrument Cluster* chapter. Routine maintenance of the airbag is not required.

A difficulty with the system is indicated by one or more of the following:

- The readiness light will either flash or stay lit.
- The readiness light will not illuminate immediately after ignition is turned on.
- A series of five beeps will be heard. The tone pattern will repeat periodically until the problem and/or light are repaired.



If any of these things happen, even intermittently, have the SRS serviced at your authorized dealer immediately. Unless serviced, the system may not function properly in the event of a collision.

### Disposal of airbags and airbag equipped vehicles

See your local authorized dealer. Airbags **MUST BE** disposed of by qualified personnel.



## Seating and Safety Restraints

### Passenger airbag ON/OFF switch (if equipped)

 An airbag ON/OFF switch has been installed in this vehicle. Before driving, *always* look at the face of the switch to be sure the switch is in the proper position in accordance with these instructions and warnings. Failure to put the switch in a proper position can increase the risk of serious injury or death in a collision.

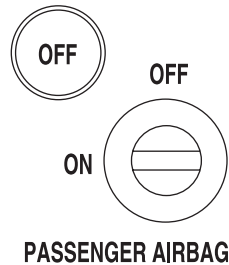

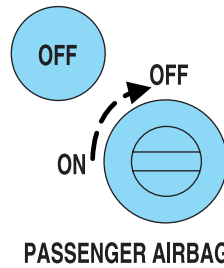

### Turning the passenger airbag off

1. Insert the ignition key, turn the switch to OFF position and hold in OFF position while removing the key.
2. When the ignition is turned to the ON position the OFF light illuminates briefly, momentarily shuts off and then turns back on. This indicates that the passenger airbag is deactivated.



 If the light fails to illuminate when the passenger air bag switch is in the OFF position and the ignition switch is in ON, have the passenger air bag switch serviced at your authorized dealer immediately.

 In order to avoid inadvertent activation of the switch, always remove the ignition key from the passenger air bag ON/OFF switch.

 An infant in a rear-facing seat faces a high risk of serious or fatal injuries from a deploying passenger airbag. Rear facing infant seats should NEVER be placed in the front seats, unless the passenger airbag is turned off.

## Seating and Safety Restraints

### Turning the passenger airbag back on

The passenger airbag remains OFF until you turn it back ON.

1. Insert the ignition key and turn the switch to ON.
2. The OFF light will briefly illuminate when the ignition is turned to On. This indicates that the passenger airbag is operational.

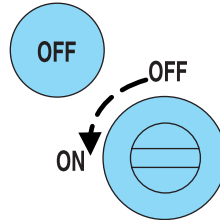

PASSENGER AIRBAG



If the OFF light is illuminated when the passenger airbag switch is in the ON position and the ignition switch is in ON, have the passenger airbag switch serviced at your authorized dealer immediately.

The passenger side airbag should always be ON (the airbag OFF light should *not* be illuminated) unless the passenger is a person who meets the requirements stated either in Category 1, 2 or 3 of the NHTSA/Transport Canada deactivation criteria which follows.



The safety belts for the driver and right front passenger seating positions have been specifically designed to function together with the airbags in certain types of crashes. When you turn OFF your airbag, you not only lose the protection of the airbag, you also may reduce the effectiveness of your safety belt system, which was designed to work with the airbag. If you are not a person who meets the requirements stated in the NHTSA/Transport Canada deactivation criteria turning OFF the airbag can increase the risk of serious injury or death in a collision.



If your vehicle has rear seats, always transport children who are 12 and younger in the rear seat. Always use safety belts and child restraints properly. If a child in a rear facing infant seat must be transported in front, the passenger airbag *must* be turned OFF. This is because the back of the infant seat is too close to the inflating airbag and the risk of a fatal injury to the infant when the airbag inflates is substantial.

## Seating and Safety Restraints

The vast majority of drivers and passengers are much safer with an airbag than without. To do their job and reduce the risk of life threatening injuries, airbags must open with great force, and this force can pose a potentially deadly risk in some situations, particularly when a front seat occupant is not properly buckled up. The most effective way to reduce the risk of unnecessary airbag injuries without reducing the overall safety of the vehicle is to make sure all occupants are properly restrained in the vehicle, especially in the front seat. This provides the protection of safety belts and permits the airbags to provide the additional protection they were designed to provide. If you choose to deactivate your airbag, you are losing the very significant risk reducing benefits of the airbag and you are also reducing the effectiveness of the safety belts, because safety belts in modern vehicles are designed to work as a safety system with the airbags.

Read all airbag warning labels in the vehicle as well as the other important airbag instructions and warnings in this Owner's Guide.

### ***NHTSA deactivation criteria (excluding Canada)***

1. **Infant.** An infant (less than 1 year old) must ride in the front seat because:
  - the vehicle has no rear seat;
  - the vehicle has a rear seat too small to accommodate a rear-facing infant seat; or
  - the infant has a medical condition which, according to the infant's physician, makes it necessary for the infant to ride in the front so that the driver can constantly monitor the child's condition.
2. **Child age 1 to 12.** A child age 1 to 12 must ride in the front seat because:
  - the vehicle has no rear seat;
  - although children ages 1 to 12 ride in the rear seat(s) whenever possible, children ages 1 to 12 sometimes must ride in the front because no space is available in the rear seat(s) of the vehicle; or
  - the child has a medical condition which, according to the child's physician, makes it necessary for the child to ride in the front seat so that the driver can constantly monitor the child's condition.
3. **Medical condition.** A passenger has a medical condition which, according to his or her physician:
  - causes the passenger airbag to pose a special risk for the passenger; and

## Seating and Safety Restraints

- makes the potential harm from the passenger airbag in a crash greater than the potential harm from turning OFF the airbag and allowing the passenger, even if belted, to hit the dashboard or windshield in a crash.



This vehicle has special energy management safety belts for the driver and right front passenger. These particular belts are specifically designed to work with airbags to help reduce the risk of injury in a collision. The energy management safety belt is designed to give or release additional belt webbing in some accidents to reduce concentration of force on an occupant's chest and reduce the risk of certain bone fractures and injuries to underlying organs. In a crash, if the airbag is turned OFF, this energy management safety belt might permit the person wearing the belt to move forward enough to incur a serious or fatal injury. The more severe the crash, and the heavier the occupant, the greater the risk is. Be sure the airbag is turned ON for any person who does not qualify under the NHTSA deactivation criteria.

### **Transport Canada deactivation criteria (Canada Only)**

1. **Infant:** An infant (less than 1 year old) must ride in the front seat because:
  - my vehicle has no rear seat;
  - the rear seat in my vehicle cannot accommodate a rear-facing infant seat; or
  - the infant has a medical condition which, according to the infant's physician, makes it necessary for the infant to ride in the front seat so that the driver can monitor the infant's condition.
2. **Child age 12 or under:** A child age 12 or under must ride in the front seat because:
  - my vehicle has no rear seat;
  - although children age 12 and under ride in the rear seat whenever possible, children age 12 and under have no option but to sometimes ride in the front seat because rear seat space is insufficient; or
  - the child has a medical condition that, according to the child's physician, makes it necessary for the child to ride in the front seat so that the driver can monitor the child's condition.
3. **Medical condition:** A passenger has a medical condition that, according to his or her physician:
  - poses a special risk for the passenger if the airbag deploys; and

## Seating and Safety Restraints

- makes the potential harm from the passenger airbag deployment greater than the potential harm from turning OFF the airbag and experiencing a crash without the protection offered by the airbag



This vehicle has special energy management safety belts for the driver and right front passenger. These particular belts are specifically designed to work with airbags to help reduce the risk of injury in a collision. The energy management safety belt is designed to give or release additional belt webbing in some accidents to reduce concentration of force on an occupant's chest and reduce the risk of certain bone fractures and injuries to underlying organs. In a crash, if the airbag is turned OFF, this energy management safety belt might permit the person wearing the belt to move forward enough to incur a serious or fatal injury. The more severe the crash, and the heavier the occupant, the greater the risk is. Be sure the airbag is turned ON for any person who does not qualify under the NHTSA deactivation criteria.

### SAFETY RESTRAINTS FOR CHILDREN

See the following sections for directions on how to properly use safety restraints for children. Also see *Airbag supplemental restraint system (SRS)* in this chapter for special instructions about using airbags.

#### Important child restraint precautions

You are required by law to use safety restraints for children in the U.S. and Canada. If small children (generally children who are four years old or younger and who weigh 40 lb. [18 kg] or less) ride in your vehicle, you must put them in safety seats made especially for children. Many states require that children use approved booster seats until they are eight years old. Check your local and state or provincial laws for specific requirements regarding the safety of children in your vehicle. When possible, always place children under age 12 in the rear seat of your vehicle. Accident statistics suggest that children are safer when properly restrained in the rear seating positions than in the front seating position.



Never let a passenger hold a child on his or her lap while the vehicle is moving. The passenger cannot protect the child from injury in a collision.

Always follow the instructions and warnings that come with any infant or child restraint you might use.

## Seating and Safety Restraints

### Children and safety belts

If the child is the proper size, restrain the child in a safety seat. Children who are too large for child safety seats (as specified by your child safety seat manufacturer) should always wear safety belts.

Follow all the important safety restraint and airbag precautions that apply to adult passengers in your vehicle.

If the shoulder belt portion of a combination lap and shoulder belt can be positioned so it does not cross or rest in front of the child's face or neck, the child should wear the lap and shoulder belt. Moving the child closer to the center of the vehicle may help provide a good shoulder belt fit.



Do not leave children, unreliable adults, or pets unattended in your vehicle.

### Child booster seats

Children outgrow a typical convertible or toddler seat when they weigh 40 lb. (18 kg) and are around 4 years of age. Although the lap/shoulder belt will provide some protection, these children are still too small for lap/shoulder belts to fit properly, which could increase the risk of serious injury.

To improve the fit of both the lap and shoulder belt on children who have outgrown child safety seats, Ford Motor Company recommends use of a belt-positioning booster.

Booster seats position a child so that safety belts fit better. They lift the child up so that the lap belt rests low across the hips and the knees bend comfortably. Booster seats also may make the shoulder belt fit better and more comfortably, but make sure that the belt is approximately centered on the shoulder.

### When children should use booster seats

Children need to use booster seats from the time they outgrow the toddler seat until they are big enough for the vehicle seat and lap/shoulder belt to fit properly. Generally this is when they weigh about 80 lb. (36 kg) (about 8 to 12 years old).

## Seating and Safety Restraints

Booster seats should be used until you can answer YES to ALL of these questions:

- Can the child sit all the way back against the vehicle seat back with knees bent comfortably at the edge of the seat without slouching?
- Does the lap belt rest low across the hips?
- Is the shoulder belt centered on the shoulder and chest?
- Can the child stay seated like this for the whole trip?

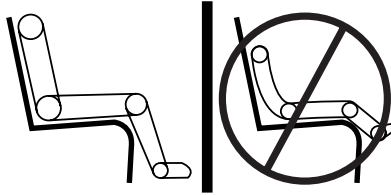

### **Types of booster seats**

There are two types of belt-positioning booster seats:

- Those that are backless.

If your backless booster seat has a removable shield, remove the shield and use the lap/shoulder belt. If a seating position has a low seat back and no head restraint, a backless booster seat may place your child's head (top of ear level) above the top of the seat. In this case, move the backless booster to another seating position with a higher seat back and lap/shoulder belts.



- Those with a high back.

If, with a backless booster seat, you cannot find a seating position that adequately supports your child's head, a high back booster seat would be a better choice.



Either type can be used at any seating position equipped with lap/shoulder belts if your child is over 40 lb. (18 kg).

## Seating and Safety Restraints

Children and booster seats vary widely in size and shape. Choose a booster that keeps the lap belt low and snug across the hips, never up across the stomach, and lets you adjust the shoulder belt to cross the chest and rest snugly near the center of the shoulder. The drawings below compare the ideal fit (center) to a shoulder belt uncomfortably close to the neck and a shoulder belt that could slip off the shoulder.

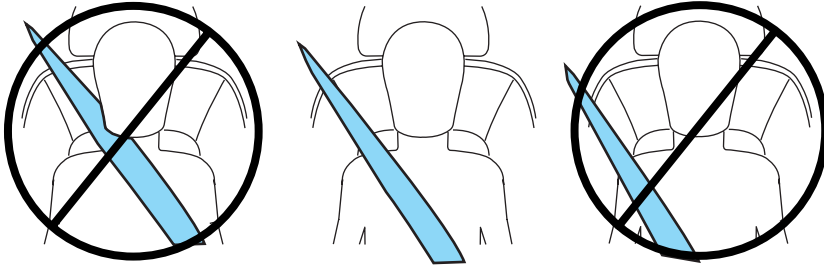

If the booster seat slides on the vehicle seat, placing a rubberized mesh sold as shelf or carpet liner under the booster seat may improve this condition.

### The importance of shoulder belts

Using a booster without a shoulder belt increases the risk of a child's head hitting a hard surface in a collision. For this reason, you should never use a booster seat with a lap belt only. It is best to use a booster seat with lap/shoulder belts in the back seat- the safest place for children to ride.



Move a child to a different seating location if the shoulder belt does not stay positioned on the shoulder during use.



Follow all instructions provided by the manufacturer of the booster seat.



Never put the shoulder belt under a child's arm or behind the back because it eliminates the protection for the upper part of the body and may increase the risk of injury or death in a collision.



Never use pillows, books, or towels to boost a child. They can slide around and increase the likelihood of injury or death in a collision.



## Seating and Safety Restraints

### SAFETY SEATS FOR CHILDREN

#### Child and infant or child safety seats

Use a safety seat that is recommended for the size and weight of the child. Carefully follow all of the manufacturer's instructions with the safety seat you put in your vehicle. If you do not install and use the safety seat properly, the child may be injured in a sudden stop or collision.

When installing a child safety seat:

- Review and follow the information presented in the *Airbag supplemental restraint system (SRS)* section in this chapter.
- Use the correct safety belt buckle for that seating position (the buckle closest to the direction the tongue is coming from).
- Insert the belt tongue into the proper buckle until you hear a snap and feel it latch. Make sure the tongue is securely fastened in the buckle.
- Keep the buckle release button pointing up and away from the safety seat, with the tongue between the child seat and the release button, to prevent accidental unbuckling.
- Place seat back in upright position.
- Put the safety belt in the automatic locking mode. Refer to *Automatic locking mode* (passenger side front and outboard rear seating positions) (if equipped) section in this chapter.
- LATCH lower anchors are recommended for use by children up to 48 pounds (22 kg) in a child restraint. Top tether anchors can be used for children up to 60 pounds (27 kg) in a child restraint, and to provide upper torso restraint for children up to 80 pounds (36 kg) using an upper torso harness and a belt-positioning booster.

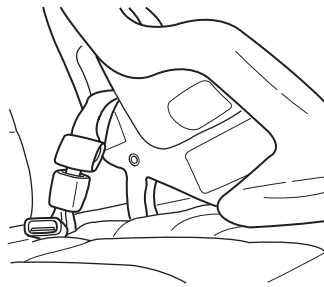

Ford recommends the use of a child safety seat having a top tether strap. Install the child safety seat in a seating position with a tether anchor. For more information on top tether straps and anchors, refer to *Attaching safety seats with tether straps* in this chapter.

## Seating and Safety Restraints

 Carefully follow all of the manufacturer's instructions included with the safety seat you put in your vehicle. If you do not install and use the safety seat properly, the child may be injured in a sudden stop or collision.

 Rear-facing child seats or infant carriers should never be placed in the front seats, unless the passenger airbag On/Off switch is turned off. See *Passenger airbag ON/OFF switch* in this chapter.

### Installing child safety seats with combination lap and shoulder belts

1. Position the child safety seat in a seat with a combination lap and shoulder belt.

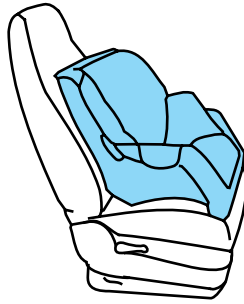

 An airbag can kill or injure a child in a child seat. Child seats should NEVER be placed in the front seats, unless the passenger airbag switch is turned off. See *Passenger airbag on/off switch*.

 Rear facing child seats should NEVER be placed in the front seats unless the passenger airbag switch is turned off.

## Seating and Safety Restraints

2. Pull down on the shoulder belt and then grasp the shoulder belt and lap belt together.

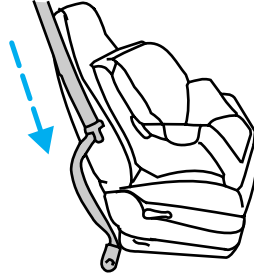

3. While holding the shoulder and lap belt portions together, route the tongue through the child seat according to the child seat manufacturer's instructions. Be sure the belt webbing is not twisted.

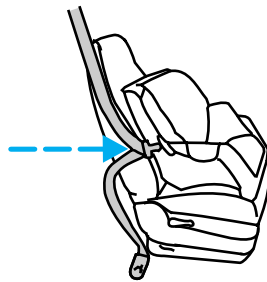

4. Insert the belt tongue into the proper buckle (the buckle closest to the direction the tongue is coming from) for that seating position until you hear and feel the latch engage. Make sure the tongue is latched securely by pulling on it.

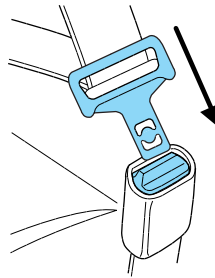

5. To put the retractor in the automatic locking mode, grasp the shoulder portion of the belt and pull downward until all of the belt is extracted and a click is heard.

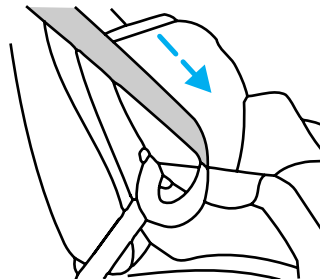

## Seating and Safety Restraints

6. Allow the belt to retract. The belt will click as it retracts to indicate it is in the automatic locking mode.

7. Pull the lap belt portion across the child seat toward the buckle and pull up on the shoulder belt while pushing down with knee on the child seat.

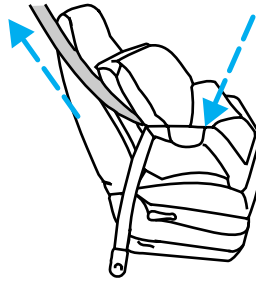

8. Allow the safety belt to retract to remove any slack in the belt.

9. Before placing the child in the seat, forcibly tilt the seat forward and back to make sure the seat is securely held in place. To check this, grab the seat at the belt path and attempt to move it side to side and forward. There should be no more than one inch of movement for proper installation.

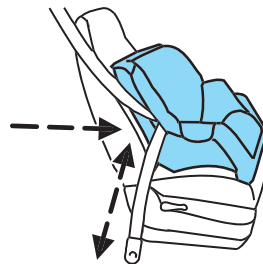

10. Try to pull the belt out of the retractor to make sure the retractor is in the automatic locking mode (you should not be able to pull more belt out). If the retractor is not locked, unbuckle the belt and repeat Steps two through nine.

Check to make sure the child seat is properly secured before each use.

### Attaching child safety seats with tether straps

Most new forward-facing child safety seats include a tether strap which goes over the back of the seat and hooks to an anchoring point. Tether straps are available as an accessory for many older safety seats. Contact the manufacturer of your child seat for information about ordering a tether strap.

The passenger seats of your vehicle may be equipped with built-in tether strap anchors located behind the seats as described below.

The tether anchors in your vehicle may be straps on the seatback or an anchor bracket on the rear edge of the seat cushion or an anchor bracket mounted to the body shell on the back panel.

## Seating and Safety Restraints

The SuperCab rear seat has three straps behind the top of the seat back that function as both routing loops for the tether straps and anchor loops.

The tether strap anchors in your vehicle are in the following positions (shown from top view):



Attach the tether strap only to the appropriate tether anchor as shown. The tether strap may not work properly if attached somewhere other than the correct tether anchor.

### • F-Series Regular Cab

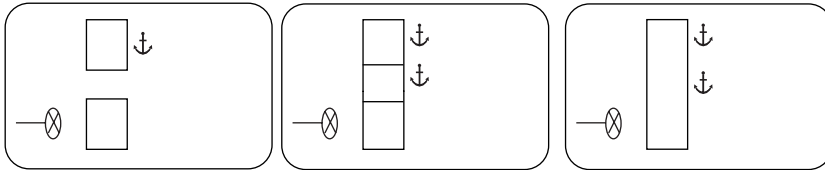

### • F-Series SuperCab

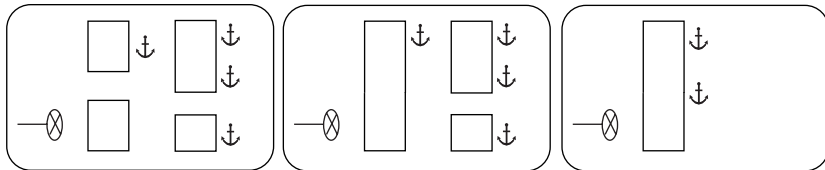

### • F-Series Crew Cab

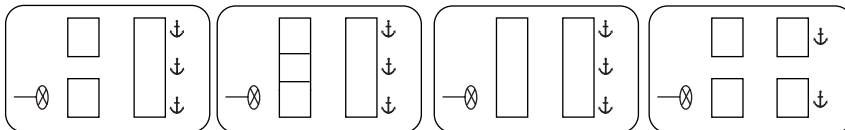

### Tether strap attachment

1. Position the child safety seat on the seat cushion.
2. Route the child safety seat tether strap over the back of the seat.
3. Locate the correct anchor for the selected seating position.

## Seating and Safety Restraints

4. You may need to pull the seatback forward to access the tether anchors. Make sure the seat is locked in the upright position before installing the child seat. Refer to the *Rear folding seat system with load floor* section in this chapter for information on how to operate the rear seats.

5. Clip the tether strap to the anchor as shown.

- Front seats (Regular Cab)

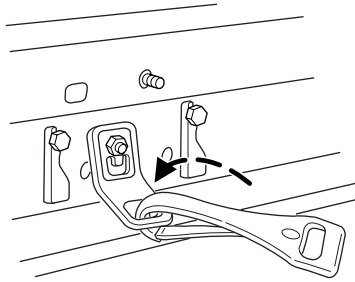

- Front seat (SuperCab)

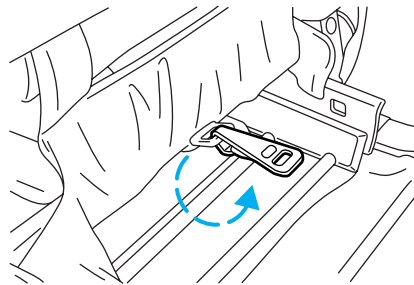

- Rear seats (Crew Cab)

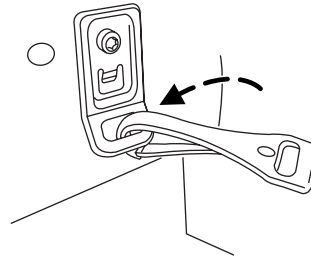

If the tether strap is clipped incorrectly, the child safety seat may not be retained properly in the event of a collision.

## Seating and Safety Restraints

6. Refer to the *Installing child safety seats in combination lap and shoulder belt seating positions* section of this chapter for further instructions to secure the child safety seat.
7. Tighten the child safety seat tether strap according to the manufacturer's instructions.



If the safety seat is not anchored properly, the risk of a child being injured in a collision greatly increases.

### ***Tether strap attachment (rear SuperCab only)***

There are three loops of webbing just above the back of the rear seat (along the bottom edge of the rear window) in the SuperCab. These loops are to be used as both routing loops and anchor loops for up to three child safety seat tether straps.

Many tether straps cannot be tightened if the tether strap is hooked to the loop directly behind the child seat. To provide a tight tether strap:

1. Route the tether strap through the loop directly behind the child seat.



2. Attach the strap hook onto the loop behind an adjacent seating position.

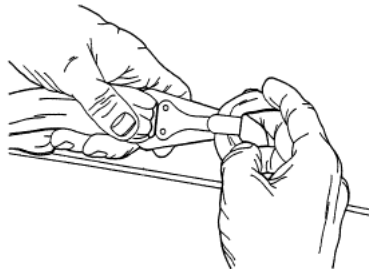

## Seating and Safety Restraints

3. Install the child safety seat tightly using the vehicle belts. Follow the instructions in this chapter.
4. Tighten the tether strap according to the child seat manufacturer's instructions.

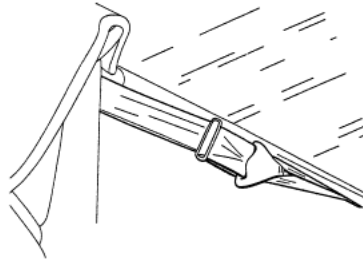

A single loop can be used to route and anchor more than one child seat. For example, the center loop can be used as a routing loop for a child safety seat in the center rear seat and as an anchoring loop for child seats installed in the outboard rear seats.



## Tires, Wheels and Loading

### NOTICE TO UTILITY VEHICLE AND TRUCK OWNERS

Utility vehicles and trucks handle differently than passenger cars in the various driving conditions that are encountered on streets, highways and off-road. Utility vehicles and trucks are not designed for cornering at speeds as high as passenger cars any more than low-slung sports cars are designed to perform satisfactorily under off-road conditions.

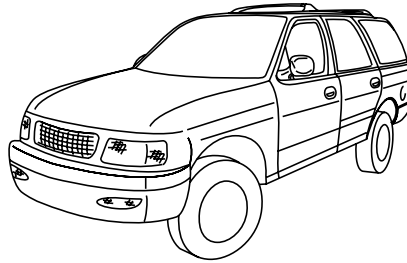

Utility vehicles have a significantly higher rollover rate than other types of vehicles. To reduce the risk of serious injury or death from a rollover or other crash you must:

- Avoid sharp turns and abrupt maneuvers;
- Drive at safe speeds for the conditions;
- Keep tires properly inflated;
- Never overload or improperly load your vehicle; and
- Make sure every passenger is properly restrained.



In a rollover crash, an unbelted person is significantly more likely to die than a person wearing a seat belt. All occupants must wear safety belts and children/infants must use appropriate restraints to minimize the risk of injury or ejection.

Study your *Owner's Guide* and any supplements for specific information about equipment features, instructions for safe driving and additional precautions to reduce the risk of an accident or serious injury.

### VEHICLE CHARACTERISTICS

#### 4WD and AWD Systems (if equipped)

A vehicle equipped with AWD or 4WD (when you select the 4WD mode) has the ability to use all four wheels to power itself. This increases traction which may enable you to safely drive over terrain and road conditions that a conventional two-wheel drive vehicle cannot.

## Tires, Wheels and Loading

Power is supplied to all four wheels through a transfer case or power transfer unit. 4WD vehicles allow you to select different drive modes as necessary. Information on shifting procedures and maintenance can be found in your *Owner's Guide*. You should become thoroughly familiar with this information before you operate your vehicle.

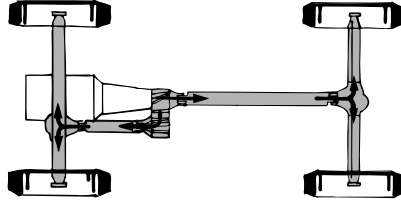

On some 4WD models, the initial shift from two-wheel drive to 4WD while the vehicle is moving can cause a momentary clunk and ratcheting sound. These sounds are normal as the front drivetrain comes up to speed and is not cause for concern.



Do not become overconfident in the ability of 4WD and AWD vehicles. Although a 4WD or AWD vehicle may accelerate better than two-wheel drive vehicle in low traction situations, it won't stop any faster than two-wheel drive vehicles. Always drive at a safe speed.

### How your vehicle differs from other vehicles

SUV and trucks can differ from some other vehicles in a few noticeable ways. Your vehicle may be:

- Higher – to allow higher load carrying capacity and to allow it to travel over rough terrain without getting hung up or damaging underbody components.
- Shorter – to give it the capability to approach inclines and drive over the crest of a hill without getting hung up or damaging underbody components. All other things held equal, a shorter wheelbase may make your vehicle quicker to respond to steering inputs than a vehicle with a longer wheelbase.

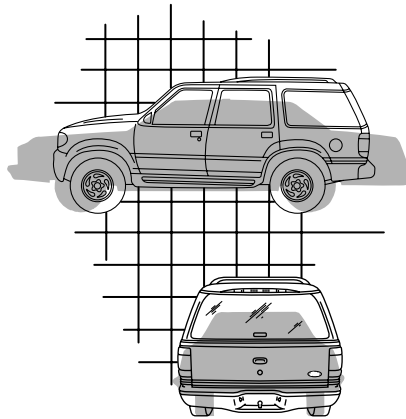

## Tires, Wheels and Loading

- Narrower — to provide greater maneuverability in tight spaces, particularly in off-road use.

As a result of the above dimensional differences, SUV's and trucks often will have a higher center of gravity and a greater difference in center of gravity between the loaded and unloaded condition.

These differences that make your vehicle so versatile also make it handle differently than an ordinary passenger car.

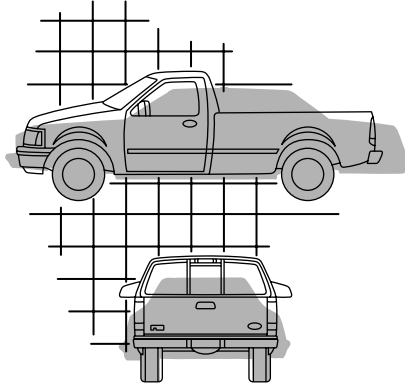

### INFORMATION ABOUT UNIFORM TIRE QUALITY GRADING

New vehicles are fitted with tires that have a rating on them called Tire Quality Grades. The Quality grades can be found where applicable on the tire sidewall between tread shoulder and maximum section width. For example:

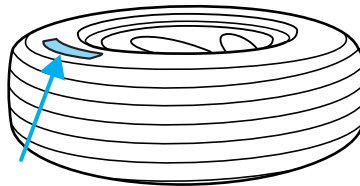

- **Treadwear 200 Traction AA Temperature A**

These Tire Quality Grades are determined by standards that the United States Department of Transportation has set.

Tire Quality Grades apply to new pneumatic tires for use on passenger cars. They do not apply to deep tread, winter-type snow tires, space-saver or temporary use spare tires, tires with nominal rim diameters of 10 to 12 inches or limited production tires as defined in Title 49 Code of Federal Regulations Part 575.104(c)(2).

**U.S. Department of Transportation-Tire quality grades:** The U.S. Department of Transportation requires Ford to give you the following information about tire grades exactly as the government has written it.

#### Treadwear

The treadwear grade is a comparative rating based on the wear rate of the tire when tested under controlled conditions on a specified government test course. For example, a tire graded 150 would wear one

## Tires, Wheels and Loading

and one-half (1½) times as well on the government course as a tire graded 100. The relative performance of tires depends upon the actual conditions of their use, however, and may depart significantly from the norm due to variations in driving habits, service practices, and differences in road characteristics and climate.

### Traction AA A B C

The traction grades, from highest to lowest are AA, A, B, and C. The grades represent the tire's ability to stop on wet pavement as measured under controlled conditions on specified government test surfaces of asphalt and concrete. A tire marked C may have poor traction performance.



The traction grade assigned to this tire is based on straight-ahead braking traction tests, and does not include acceleration, cornering, hydroplaning or peak traction characteristics.

### Temperature A B C

The temperature grades are A (the highest), B and C, representing the tire's resistance to the generation of heat and its ability to dissipate heat when tested under controlled conditions on a specified indoor laboratory test wheel. Sustained high temperature can cause the material of the tire to degenerate and reduce tire life, and excessive temperature can lead to sudden tire failure. The grade C corresponds to a level of performance which all passenger car tires must meet under the Federal Motor Vehicle Safety Standard No. 109. Grades B and A represent higher levels of performance on the laboratory test wheel than the minimum required by law.



The temperature grade for this tire is established for a tire that is properly inflated and not overloaded. Excessive speed, underinflation, or excessive loading, either separately or in combination, can cause heat buildup and possible tire failure.

## TIRES

Tires are designed to give many thousands of miles of service, but they must be maintained in order to get the maximum benefit from them.

### Glossary of tire terminology

- **Tire Label:** A label showing the OE (Original Equipment) tire sizes, recommended inflation pressure and the maximum weight the vehicle can carry.

## Tires, Wheels and Loading

- **Tire Identification Number (TIN):** A number on the sidewall of each tire providing information about the tire brand and manufacturing plant, tire size and date of manufacture. Also referred to as DOT code.
- **Inflation pressure:** A measure of the amount of air in a tire.
- **Standard load:** A class of P-metric or Metric tires designed to carry a maximum load at 35 psi [37 psi (2.5 bar) for Metric tires]. Increasing the inflation pressure beyond this pressure will not increase the tire's load carrying capability.
- **Extra load:** A class of P-metric or Metric tires designed to carry a heavier maximum load at 41 psi [43 psi (2.9 bar) for Metric tires]. Increasing the inflation pressure beyond this pressure will not increase the tire's load carrying capability.
- **kPa:** Kilopascal, a metric unit of air pressure.
- **PSI:** Pounds per square inch, a standard unit of air pressure.
- **Cold inflation pressure:** The tire pressure when the vehicle has been stationary and out of direct sunlight for an hour or more and prior to the vehicle being driven for 1 mile (1.6 km).
- **Recommended inflation pressure:** The cold inflation pressure found on the Tire Label or Safety Compliance Certification Label located on the B-Pillar or the edge of the driver's door.
- **B-pillar:** The structural member at the side of the vehicle behind the front door.
- **Bead area of the tire:** Area of the tire next to the rim.
- **Sidewall of the tire:** Area between the bead area and the tread.
- **Tread area of the tire:** Area of the perimeter of the tire that contacts the road when mounted on the vehicle.
- **Rim:** The metal support (wheel) for a tire or a tire and tube assembly upon which the tire beads are seated.

### INFLATING YOUR TIRES

Safe operation of your vehicle requires that your tires are properly inflated. Remember that a tire can lose up to half of its air pressure without appearing flat.

## Tires, Wheels and Loading

Every day before you drive, check your tires. If one looks lower than the others, use a tire gauge to check pressure of all tires and adjust if required.

At least once a month and before long trips, inspect each tire and check the tire pressure with a tire gauge (including spare, if equipped). Inflate all tires to the inflation pressure recommended by Ford Motor Company.

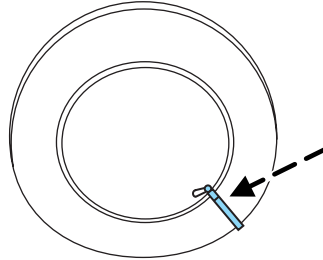

Use a tire gauge to check the tire inflation pressure, including the spare (if equipped), at least monthly and before long trips. You are strongly urged to buy a reliable tire pressure gauge, as automatic service station gauges may be inaccurate. Ford recommends the use of a digital or dial type tire pressure gauge rather than a stick type tire pressure gauge.

Use the recommended cold inflation pressure for optimum tire performance and wear. Under-inflation or over-inflation may cause uneven treadwear patterns.



Under-inflation is the most common cause of tire failures and may result in severe tire cracking, tread separation or "blowout", with unexpected loss of vehicle control and increased risk of injury. Under-inflation increases sidewall flexing and rolling resistance, resulting in heat buildup and internal damage to the tire. It also may result in unnecessary tire stress, irregular wear, loss of vehicle control and accidents. A tire can lose up to half of its air pressure and not appear to be flat!

Always inflate your tires to the Ford recommended inflation pressure even if it is less than the maximum inflation pressure information found on the tire. The Ford recommended tire inflation pressure is found on the Safety Compliance Certification Label or Tire Label which is located on the B-Pillar or the edge of the driver's door. Failure to follow the tire pressure recommendations can cause uneven treadwear patterns and adversely affect the way your vehicle handles.

**Maximum Permissible Inflation Pressure** is the tire manufacturer's maximum permissible pressure and/or the pressure at which the maximum load can be carried by the tire. This pressure is normally higher than the manufacturer's recommended cold inflation pressure

## Tires, Wheels and Loading

which can be found on the Safety Compliance Certification Label or Tire Label which is located on the B-Pillar or the edge of the driver's door. The cold inflation pressure should never be set lower than the recommended pressure on the Safety Compliance Certification Label or Tire Label.

When weather temperature changes occur, tire inflation pressures also change. A 10°F (6°C) temperature drop can cause a corresponding drop of 1 psi (7 kPa) in inflation pressure. Check your tire pressures frequently and adjust them to the proper pressure which can be found on the Safety Compliance Certification Label or the Tire Label.

If you are checking tire pressure when the tire is hot, (i.e. driven more than 1 mile [1.6 km]), never "bleed" or reduce air pressure. The tires are hot from driving and it is normal for pressures to increase above recommended cold pressures. A hot tire at or below recommended cold inflation pressure could be significantly under-inflated.

To check the pressure in your tire(s):

1. Make sure the tires are cool, meaning they are not hot from driving even a mile.

**Note:** If you have to drive a distance to get air for your tire(s), check and record the tire pressure first and add the appropriate air pressure when you get to the pump. It is normal for tires to heat up and the air pressure inside to go up as you drive. Never "bleed" or reduce air pressure when tires are hot.

2. Remove the cap from the valve on one tire, then firmly press the tire gauge onto the valve and measure the pressure with the tire gauge.

3. Add enough air to reach the recommended air pressure

**Note:** If you overfill the tire, release air by pushing on the metal stem in the center of the valve. Then recheck the pressure with your tire gauge.

4. Replace the valve cap.

5. Repeat this procedure for each tire, including the spare.

**Note:** Some spare tires operate at a higher inflation pressure than the other tires. For T-type/mini-spare tires (see *Dissimilar Spare Tire/Wheel Information* section for description): Store and maintain at 60 psi (4.15 bars). For Dissimilar spare tires and Full-size matching spare tires (see the *Dissimilar Spare Tire/Wheel Information* and *Full-size Matching Spare Tire/Wheel Information* sections for descriptions): Store and maintain at the higher of the front and rear inflation pressure as shown on the or Safety Compliance Certification Label or the Tire Label.

## Tires, Wheels and Loading

6. Visually inspect the tires to make sure there are no nails or other objects embedded that could poke a hole in the tire and cause an air leak.
7. Check the sidewalls to make sure there are no gouges, cuts or bulges.

### Tire inflation information

All tires with Steel Carcass Plies (if equipped):

This type of tire utilizes steel cords in the sidewalls. As such, they cannot be treated like normal light truck tires. Tire service, including adjusting the air pressure, must be performed by personnel trained, supervised and equipped according to Federal Occupational Safety and Health Administration (OSHA) regulations. For example, during any procedure involving tire inflation, the technician or individual must utilize a remote inflation device, and ensure that all persons are clear of the trajectory area.

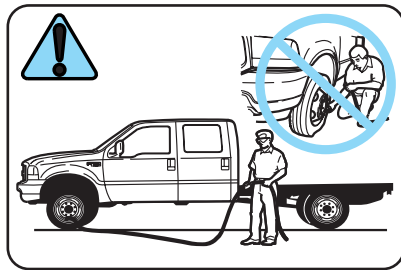

 **WARNING** An inflated tire and rim can be very dangerous if improperly used, serviced or maintained. To avoid serious injury, never attempt to re-inflate a tire which has been run flat or seriously under-inflated without first removing the tire from the wheel assembly for inspection. Do not attempt to add air to tires or replace tires or wheels without first taking precautions to protect persons and property.



## Tires, Wheels and Loading

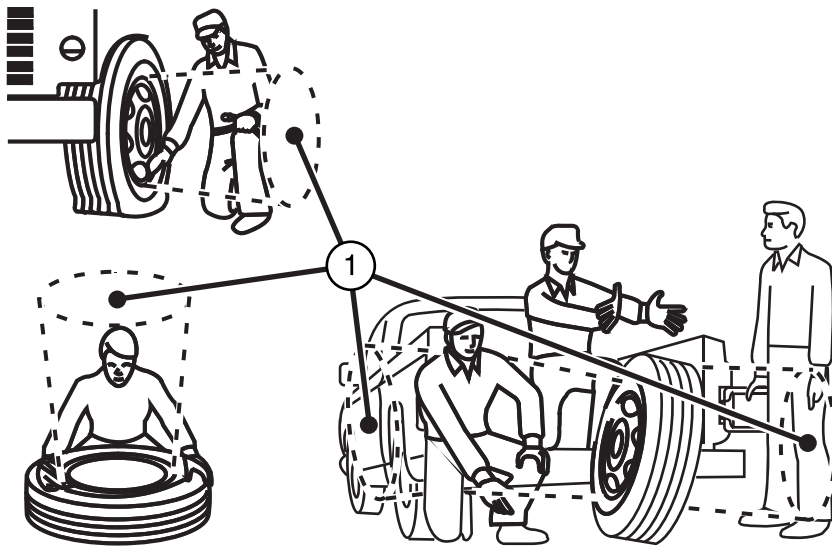

Stay out of the trajectory (1) as indicated in the illustration.

### TIRE CARE

#### Inspecting your tires

Periodically inspect the tire treads for uneven or excessive wear and remove objects such as stones, nails or glass that may be wedged in the tread grooves. Check for holes or cuts that may permit air leakage from the tire and make necessary repairs. Also inspect the tire sidewalls for cracking, cuts, bruises and other signs of damage or excessive wear. If internal damage to the tire is suspected, have the tire demounted and inspected in case it needs to be repaired or replaced. For your safety, tires that are damaged or show signs of excessive wear should not be used because they are more likely to blow out or fail.

## Tires, Wheels and Loading

Improper or inadequate vehicle maintenance can cause tires to wear abnormally. Inspect all your tires, including the spare, frequently, and replace them if one or more of the following conditions exist:

### Tire wear

When the tread is worn down to 1/16th of an inch (2 mm), tires must be replaced to help prevent your vehicle from skidding and hydroplaning. Built-in treadwear indicators, or “wear bars”, which look like narrow strips of smooth rubber across the tread will appear on the tire when the tread is worn down to 1/16th of an inch (2 mm). When the tire tread wears down to the same height as these “wear bars”, the tire is worn out and must be replaced.

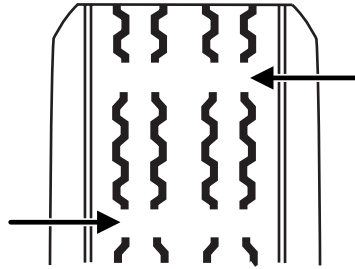

### Damage

Periodically inspect the tire treads and sidewalls for damage (such as bulges in the tread or sidewalls, cracks in the tread groove and separation in the tread or sidewall). If damage is observed or suspected have the tire inspected by a tire professional. Tires can be damaged during off-road use, so inspection after off-road use is also recommended.



### Age

Tires degrade over time, even when they are not being used. It is recommended that tires generally be replaced after 6 years of normal service. Heat caused by hot climates or frequent high loading conditions can accelerate the aging process. You should replace the spare tire when you replace the other road tires due to the aging of the spare tire.

### U.S. DOT Tire Identification Number (TIN)

U.S. and Canada Federal regulations require tire manufacturers to place standardized information on the sidewall of all tires. This information identifies and describes the fundamental characteristics of the tire and also provides a U.S. DOT Tire Identification Number for safety standard certification and in case of a recall.

## Tires, Wheels and Loading

This begins with the letters “DOT” and indicates that the tire meets all federal standards. The next two numbers or letters are the plant code designating where it was manufactured, the next two are the tire size code and the last four numbers represent the week and year the tire was built. For example, the numbers 317 mean the 31st week of 1997. After 2000 the numbers go to four digits. For example, 2501 means the 25th week of 2001. The numbers in between are identification codes used for traceability. This information is used to contact customers if a tire defect requires a recall.

### Tire Replacement Requirements

Your vehicle is equipped with tires designed to provide a safe ride and handling capability.



Only use replacement tires and wheels that are the same size and type (such as P-metric versus LT-metric or all-season versus all-terrain) as those originally provided by Ford. Use of any tire or wheel not recommended by Ford can affect the safety and performance of your vehicle, which could result in an increased risk of loss of vehicle control, vehicle rollover, personal injury and death. Additionally the use of non-recommended tires and wheels could cause steering, suspension, axle or transfer case/power transfer unit failure. If you have questions regarding tire replacement, see an authorized dealer.

**Important:** Remember to replace the wheel valve stems when the road tires are replaced on your vehicle.

It is recommended that the two front tires or two rear tires generally be replaced as a pair.

### Safety practices

Driving habits have a great deal to do with your tire mileage and safety.

- Observe posted speed limits
- Avoid fast starts, stops and turns
- Avoid potholes and objects on the road
- Do not run over curbs or hit the tire against a curb when parking

## Tires, Wheels and Loading



If your vehicle is stuck in snow, mud, sand, etc., **do not** rapidly spin the tires; spinning the tires can tear the tire and cause an explosion. A tire can explode in as little as three to five seconds.



Never spin the tires in excess of the 35 mph (55 km/h) point indicated on the speedometer.

### **Highway hazards**

No matter how carefully you drive there's always the possibility that you may eventually have a flat tire on the highway. Drive slowly to the closest safe area out of traffic. This may further damage the flat tire, but your safety is more important.

If you feel a sudden vibration or ride disturbance while driving, or you suspect your tire or vehicle has been damaged, immediately reduce your speed. Drive with caution until you can safely pull off the road. Stop and inspect the tires for damage. If a tire is under-inflated or damaged, deflate it, remove wheel and replace it with your spare tire and wheel. If you cannot detect a cause, have the vehicle towed to the nearest repair facility or tire dealer to have the vehicle inspected.

### **Tire and wheel alignment**

A bad jolt from hitting a curb or pothole can cause the front end of your vehicle to become misaligned or cause damage to your tires. If your vehicle seems to pull to one side when you're driving, the wheels may be out of alignment. Have your authorized dealer check the wheel alignment periodically.

Wheel misalignment in the front or the rear can cause uneven and rapid treadwear of your tires and should be corrected by your authorized dealer. Front wheel drive (FWD) vehicles and those with an independent rear suspension (if equipped) may require alignment of all four wheels.

The tires should also be balanced periodically. An unbalanced tire and wheel assembly may result in irregular tire wear.

## Tires, Wheels and Loading

### Tire rotation

Rotating your tires at the recommended interval (as indicated in the *scheduled maintenance information* that comes with your vehicle) will help your tires wear more evenly, providing better tire performance and longer tire life. Unless otherwise specified, rotate the tires approximately every 5,000 miles (8,000 km).

- Rear Wheel Drive (RWD) vehicles/Four Wheel Drive (4WD) (front tires at top of diagram)

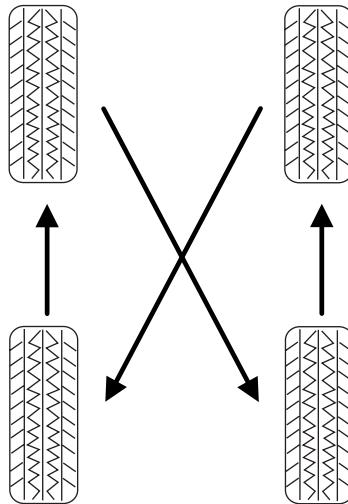

Sometimes irregular tire wear can be corrected by rotating the tires.

**Note:** If your tires show uneven wear ask your authorized dealer to check for and correct any wheel misalignment, tire imbalance or mechanical problem involved before tire rotation.

**Note:** Your vehicle may be equipped with a dissimilar spare tire/wheel. A dissimilar spare tire/wheel is defined as a spare tire and/or wheel that is different in brand, size or appearance from the road tires and wheels. If you have a dissimilar spare tire/wheel it is intended for temporary use only and should not be used in a tire rotation.

**Note:** After having your tires rotated, inflation pressure must be checked and adjusted to the vehicle requirements.

## Tires, Wheels and Loading

- DRW – Six tire rotation

If your vehicle is equipped with dual rear wheels it is recommended that the front and rear tires (in pairs) be rotated only side to side. We do not recommend splitting up the dual rear wheels. Rotate them side to side as a set/pair. After tire rotation, inflation pressures must be adjusted for the tires new positions in accordance with vehicle requirements.

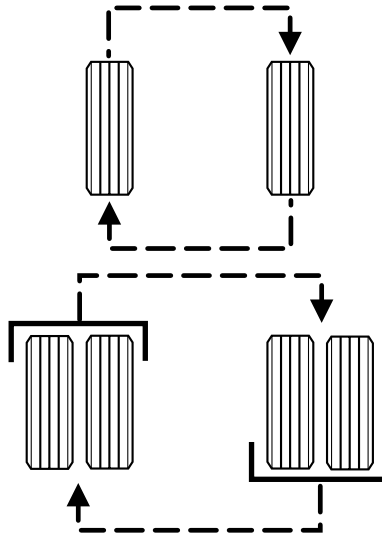

Sometimes irregular tire wear can be corrected by rotating the tires.

**Note:** If your tires show uneven wear ask your authorized dealer to check for and correct any wheel misalignment, tire imbalance or mechanical problem involved before tire rotation.

**Note:** Your vehicle may be equipped with a dissimilar spare tire/wheel. A dissimilar spare tire/wheel is defined as a spare tire and/or wheel that is different in brand, size or appearance from the road tires and wheels. If you have a dissimilar spare tire/wheel it is intended for temporary use only and should not be used in a tire rotation.

**Note:** After having your tires rotated, inflation pressure must be checked and adjusted to the vehicle requirements.

### INFORMATION CONTAINED ON THE TIRE SIDEWALL

U.S. and Canada Federal regulations require tire manufacturers to place standardized information on the sidewall of all tires. This information identifies and describes the fundamental characteristics of the tire and also provides a U.S. DOT Tire Identification Number for safety standard certification and in case of a recall.

## Tires, Wheels and Loading

### Information on “P” type tires

P215/65R15 95H is an example of a tire size, load index and speed rating. The definitions of these items are listed below. (Note that the tire size, load index and speed rating for your vehicle may be different from this example.)

1. **P:** Indicates a tire, designated by the Tire and Rim Association (T&RA), that may be used for service on cars, SUVs, minivans and light trucks.

**Note:** If your tire size does not begin with a letter this may mean it is designated by either ETRTO (European Tire and Rim Technical Organization) or JATMA (Japan Tire Manufacturing Association).

2. **215:** Indicates the nominal width of the tire in millimeters from sidewall edge to sidewall edge. In general, the larger the number, the wider the tire.

3. **65:** Indicates the aspect ratio which gives the tire’s ratio of height to width.

4. **R:** Indicates a “radial” type tire.

5. **15:** Indicates the wheel or rim diameter in inches. If you change your wheel size, you will have to purchase new tires to match the new wheel diameter.

6. **95:** Indicates the tire’s load index. It is an index that relates to how much weight a tire can carry. You may find this information in your *Owner’s Guide*. If not, contact a local tire dealer.

**Note:** You may not find this information on all tires because it is not required by federal law.

7. **H:** Indicates the tire’s speed rating. The speed rating denotes the speed at which a tire is designed to be driven for extended periods of time under a standard condition of load and inflation pressure. The tires on your vehicle may operate at different conditions for load and inflation pressure. These speed ratings may need to be adjusted for the difference in conditions. The ratings range from 81 mph (130 km/h) to 186 mph (299 km/h). These ratings are listed in the following chart.

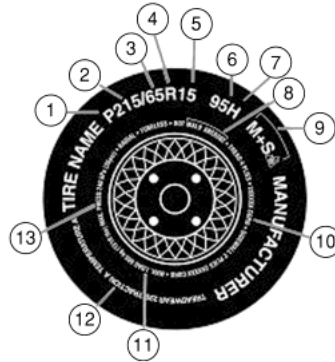

## Tires, Wheels and Loading

**Note:** You may not find this information on all tires because it is not required by federal law.

| Letter rating | Speed rating - mph (km/h) |
|---------------|---------------------------|
| M             | 81 mph (130 km/h)         |
| N             | 87 mph (140 km/h)         |
| Q             | 99 mph (159 km/h)         |
| R             | 106 mph (171 km/h)        |
| S             | 112 mph (180 km/h)        |
| T             | 118 mph (190 km/h)        |
| U             | 124 mph (200 km/h)        |
| H             | 130 mph (210 km/h)        |
| V             | 149 mph (240 km/h)        |
| W             | 168 mph (270 km/h)        |
| Y             | 186 mph (299 km/h)        |

**Note:** For tires with a maximum speed capability over 149 mph (240 km/h), tire manufacturers sometimes use the letters ZR. For those with a maximum speed capability over 186 mph (299 km/h), tire manufacturers always use the letters ZR.

**8. U.S. DOT Tire Identification Number (TIN):** This begins with the letters "DOT" and indicates that the tire meets all federal standards. The next two numbers or letters are the plant code designating where it was manufactured, the next two are the tire size code and the last four numbers represent the week and year the tire was built. For example, the numbers 317 mean the 31st week of 1997. After 2000 the numbers go to four digits. For example, 2501 means the 25th week of 2001. The numbers in between are identification codes used for traceability. This information is used to contact customers if a tire defect requires a recall.

**9. M+S or M/S:** Mud and Snow, or

**AT:** All Terrain, or

**AS:** All Season.

**10. Tire Ply Composition and Material Used:** Indicates the number of plies or the number of layers of rubber-coated fabric in the tire tread and sidewall. Tire manufacturers also must indicate the ply materials in the tire and the sidewall, which include steel, nylon, polyester, and others.



## Tires, Wheels and Loading

11. **Maximum Load:** Indicates the maximum load in kilograms and pounds that can be carried by the tire. Refer to the Tire Label or Safety Compliance Certification Label, which is located on the B-Pillar or the edge of the driver's door, for the correct tire pressure for your vehicle.

### 12. Treadwear, Traction and Temperature Grades

- **Treadwear:** The treadwear grade is a comparative rating based on the wear rate of the tire when tested under controlled conditions on a specified government test course. For example, a tire graded 150 would wear one and one-half (1½) times as well on the government course as a tire graded 100.
- **Traction:** The traction grades, from highest to lowest are AA, A, B, and C. The grades represent the tire's ability to stop on wet pavement as measured under controlled conditions on specified government test surfaces of asphalt and concrete. A tire marked C may have poor traction performance.
- **Temperature:** The temperature grades are A (the highest), B and C, representing the tire's resistance to the generation of heat and its ability to dissipate heat when tested under controlled conditions on a specified indoor laboratory test wheel.

13. **Maximum Permissible Inflation Pressure:** Indicates the tire manufacturers' maximum permissible pressure and/or the pressure at which the maximum load can be carried by the tire. This pressure is normally higher than the manufacturer's recommended cold inflation pressure which can be found on either the Tire Label or Safety Compliance Certification Label which is located on the B-Pillar or the edge of the driver's door. The cold inflation pressure should never be set lower than the recommended pressure on the vehicle label.

The tire suppliers may have additional markings, notes or warnings such as standard load, radial tubeless, etc.

## Tires, Wheels and Loading

### Additional information contained on the tire sidewall for “LT” type tires

“LT” type tires have some additional information beyond those of “P” type tires; these differences are described below:

1. **LT:** Indicates a tire, designated by the Tire and Rim Association (T&RA), that is intended for service on light trucks.

2. **Load Range/Load Inflation Limits:** Indicates the tire’s load-carrying capabilities and its inflation limits.

3. **Maximum Load Dual lb. (kg) at psi (kPa) cold:** Indicates the maximum load and tire pressure when the tire is used as a dual; defined as four tires on the rear axle (a total of six or more tires on the vehicle).

4. **Maximum Load Single lb. (kg) at psi (kPa) cold:** Indicates the maximum load and tire pressure when the tire is used as a single; defined as two tires (total) on the rear axle.

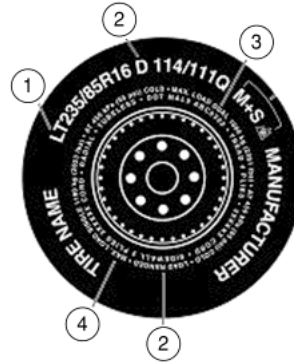

## Tires, Wheels and Loading

### Information on “T” type tires

“T” type tires have some additional information beyond those of “P” type tires; these differences are described below:

T145/80D16 is an example of a tire size.

**Note:** The temporary tire size for your vehicle may be different from this example.

1. **T:** Indicates a type of tire, designated by the Tire and Rim Association (T&RA), that is intended for temporary service on cars, SUVs, minivans and light trucks.

2. **145:** Indicates the nominal width of the tire in millimeters from sidewall edge to sidewall edge. In general, the larger the number, the wider the tire.

3. **80:** Indicates the aspect ratio which gives the tire’s ratio of height to width. Numbers of 70 or lower indicate a short sidewall.

4. **D:** Indicates a “diagonal” type tire.

**R:** Indicates a “radial” type tire.

5. **16:** Indicates the wheel or rim diameter in inches. If you change your wheel size, you will have to purchase new tires to match the new wheel diameter.

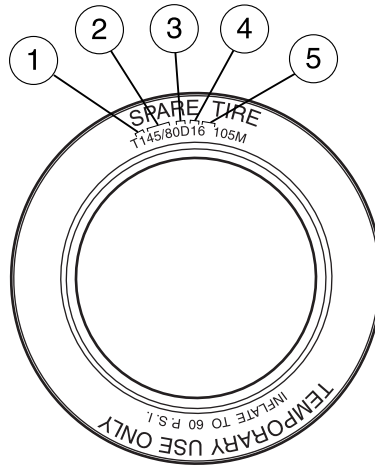

### Location of the Tire Label or Safety Compliance Certification Label

You will find a Tire Label or Safety Compliance Certification Label containing tire inflation pressure by tire size and other important information located on the B-Pillar or the edge of the driver’s door. Refer to the payload description and graphic in the *Vehicle loading — with and without a trailer* section.

## Tires, Wheels and Loading

### SNOW TIRES AND CHAINS



Snow tires must be the same size and grade as the tires you currently have on your vehicle.

**Note:** If your vehicle is equipped with 20" tires, do not use snow chains on the front tires.

The tires on your vehicle have all weather treads to provide traction in rain and snow. However, in some climates, you may need to use snow tires and chains. If you need to use chains, it is recommended that steel wheels (of the same size and specifications) be used, as chains may chip aluminum wheels.

Follow these guidelines when using snow tires and chains:

- Use only SAE Class S chains.
- Install chains securely, verifying that the chains do not touch any wiring, brake lines or fuel lines.
- Drive cautiously. If you hear the chains rub or bang against your vehicle, stop and re-tighten the chains. If this does not work, remove the chains to prevent damage to your vehicle.
- If possible, avoid fully loading your vehicle.
- Remove the tire chains when they are no longer needed. Do not use tire chains on dry roads.
- The suspension insulation and bumpers will help prevent vehicle damage. Do not remove these components from your vehicle when using snow tires and chains.

### VEHICLE LOADING – WITH AND WITHOUT A TRAILER

This section will guide you in the proper loading of your vehicle and/or trailer, to keep your loaded vehicle weight within its design rating capability, with or without a trailer. Properly loading your vehicle will provide maximum return of vehicle design performance. Before loading your vehicle, familiarize yourself with the following terms for determining your vehicle's weight ratings, with or without a trailer, from the vehicle's Tire Label or Safety Compliance Certification Label:

**Base Curb Weight** – is the weight of the vehicle including a full tank of fuel and all standard equipment. It does not include passengers, cargo, or optional equipment.

## Tires, Wheels and Loading

**Vehicle Curb Weight** – is the weight of your new vehicle when you picked it up from your authorized dealer plus any aftermarket equipment.

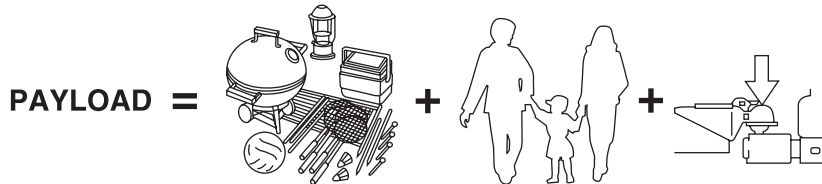

**Payload** – is the combined weight of cargo and passengers that the vehicle is carrying. The maximum payload for your vehicle can be found on the Tire Label (vehicles exported outside the U.S. and Canada may not have a Tire Label) on the B-Pillar or the edge of the driver's door. Look for **“THE COMBINED WEIGHT OF OCCUPANTS AND CARGO SHOULD NEVER EXCEED XXX kg OR XXX lb.”** for maximum payload. The payload listed on the Tire Label or Safety Compliance Certification Label is the maximum payload for the vehicle as built by the assembly plant. If any aftermarket or authorized dealer installed equipment has been installed on the vehicle, the weight of the equipment must be subtracted from the payload listed on the Tire Label or Safety Compliance Certification Label in order to determine the new payload.

 The appropriate loading capacity of your vehicle can be limited either by volume capacity (how much space is available) or by payload capacity (how much weight the vehicle should carry). Once you have reached the maximum payload of your vehicle, do not add more cargo, even if there is space available. Overloading or improperly loading your vehicle can contribute to loss of vehicle control and vehicle rollover.

## Tires, Wheels and Loading

Example only:

| TIRE AND LOADING INFORMATION   |                          |                                    |  |        |
|--|--------------------------|------------------------------------|--|--------|
| SEATING CAPACITY   |                          | TOTAL 5                            | FRONT 2                                      | REAR 3 |
| The combined weight of occupants and cargo should never exceed : <b>XXX kg or XXX lbs.</b> |                          |                                    |  |        |
| TIRE   | SIZE                     | COLD TIRE PRESSURE                 | SEE OWNERS MANUAL FOR ADDITIONAL INFORMATION |        |
| FRONT  | LT225/75R 16.5E          | 200 KPA, 29 PSI                    |  |        |
| REAR   | LT225/75R 16.5E          | 200 KPA, 29 PSI                    |  |        |
| SPARE  | T145/80D16<br>P225/60R17 | 420 KPA, 60 PSI<br>200 KPA, 29 PSI |  |        |

| TIRE AND LOAD INFORMATION   |                          |                                     |  |           |
|---|--------------------------|-------------------------------------|--|-----------|
| SEATING CAPACITY  |                          | TOTAL XX                            | FRONT XX   | REAR X    |
| NOMBRE DE PLACES  |                          | TOTAL XX                            | AVANT XX   | ARRIERE X |
| The combined weight of occupants and cargo should never exceed : <b>XXX kg.</b><br>La charge du véhicule (occupants et bagages) ne doit jamais dépasser : <b>XXX lbs.</b> |                          |                                     |  |           |
| TIRE PNEUS  | SIZE DIMENSIONS          | COLD TIRE PRESSURE PRESSION A FROID | SEE OWNERS MANUAL FOR ADDITIONAL INFORMATION<br>CONSULTER LE GUIDE DU PROPRIETAIRE POUR DE PLUS AMPLES RESEIGNEMENTS |           |
| FRONT/ AVANT  | LT225/75R 16.5E          | 200 KPA, 29 PSI                     |  |           |
| REAR/ ARRIERE   | LT225/75R 16.5E          | 200 KPA, 29 PSI                     |  |           |
| SPARE/ PNEU DE SECOURS  | T145/80D16<br>P225/60R17 | 420 KPA, 60 PSI<br>200 KPA, 29 PSI  |  |           |

CARGO

=



+

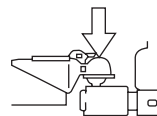

**Cargo Weight** – includes all weight added to the Base Curb Weight, including cargo and optional equipment. When towing, trailer tongue load or king pin weight is also part of cargo weight.

**GAW (Gross Axle Weight)** – is the total weight placed on each axle (front and rear) – including vehicle curb weight and all payload.

150

2006 F-250/350/450/550 (f23)  
Owners Guide (post-2002-fmt)  
USA (fus)

## Tires, Wheels and Loading

**GAWR (Gross Axle Weight Rating)** – is the maximum allowable weight that can be carried by a single axle (front or rear). **These numbers are shown on the Tire Label or Safety Compliance Certification Label located on the B-Pillar or the edge of the driver's door. The total load on each axle must never exceed its GAWR.**



Exceeding the Tire Label or Safety Compliance Certification Label axle weight rating limits could result in substandard vehicle handling or performance, engine, transmission and/or structural damage, serious damage to the vehicle, loss of control and personal injury.

**Note:** For trailer towing information refer to *Trailer towing* found in this chapter or the *RV and Trailer Towing Guide* provided by your authorized dealer.

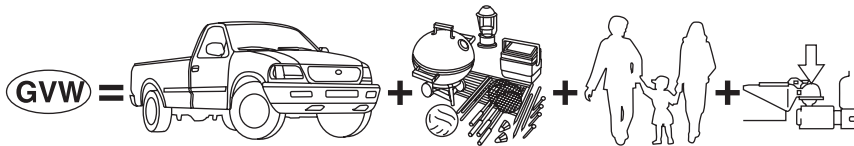

**GVW (Gross Vehicle Weight)** – is the Vehicle Curb Weight + cargo + passengers.

## Tires, Wheels and Loading

**GVWR (Gross Vehicle Weight Rating)** – is the maximum allowable weight of the fully loaded vehicle (including all options, equipment, passengers and cargo). **The GVWR is shown on the Tire Label or Safety Compliance Certification Label located on the B-Pillar or the edge of the driver's door. The GVW must never exceed the GVWR.**

| Sample Safety Compliance Certification Label<br><small>(Refer to actual label on your vehicle)</small>                           |                       |                              |                       |
|--|-----------------------|------------------------------|-----------------------|
| Front GAWR   | GVWR                  | Rear GAWR                    |                       |
| <b>MFD. BY FORD MOTOR CO. IN U.S.A.</b>  |                       |                              |                       |
| DATE: 06/95  | GVWR: 6250 LB/2834 KG |                              |                       |
| FRONT GAWR: 3450 LB<br>1584KG  | WITH<br>TIRES<br>RIMS | REAR GAWR: 3777 LB<br>1713KG | WITH<br>TIRES<br>RIMS |
| P265/75R15SL<br>15X7.5J  |                       | P265/75R15SL<br>15X7.5J      |                       |
| AT 30 PSI COLD   |                       | AT 30 PSI COLD               |                       |
| THIS VEHICLE CONFORMS TO ALL APPLICABLE FEDERAL MOTOR VEHICLE SAFETY STANDARDS IN EFFECT ON THE DATE OF MANUFACTURE SHOWN ABOVE. |                       |                              |                       |
| XXXXXXXXXXXX   |                       | F0018<br>TC183               |                       |
| VIN: 1FTEX14H 0 SKB 00000  |                       | TYPE: XXXXXXXXXXXXXXXXX      |                       |
|    |                       |                              |                       |
| EXT PNT: XXXXXX XXXXXX   |                       |                              | DSO:                  |
| WD   | TYPE:GVW              | BODY                         | TRANS                 |
| 155  | REM                   | E                            | HBB                   |
|  |                       |                              | TAPE                  |
|  |                       |                              | SPRINGS               |
|  |                       |                              | M4                    |

 Exceeding the Tire Label or Safety Compliance Certification Label vehicle weight rating limits could result in substandard vehicle handling or performance, engine, transmission and/or structural damage, serious damage to the vehicle, loss of control and personal injury.



**GCW (Gross Combined Weight)** – is the weight of the loaded vehicle (GVW) plus the weight of the fully loaded trailer.

**GCWR (Gross Combined Weight Rating)** – is the maximum allowable weight of the vehicle and the loaded trailer – including all cargo and passengers – that the vehicle can handle without risking damage. (Important: The towing vehicles' braking system is rated for operation at GVWR, not at GCWR. Separate functional brakes should be used for safe control of towed vehicles and for trailers where the GCW of the towing vehicle plus the trailer exceed the GVWR of the towing vehicle. **The GCW must never exceed the GCWR.**)



## Tires, Wheels and Loading

**Maximum Loaded Trailer Weight** – is the highest possible weight of a fully loaded trailer the vehicle can tow. It assumes a vehicle with only mandatory options, no cargo (internal or external), a tongue load of 10–15% (conventional trailer) or king pin weight of 15–25% (fifth wheel trailer), and driver only (150 lb. [68 kg]). **Consult your authorized dealer (or the *RV and Trailer Towing Guide* provided by your authorized dealer) for more detailed information.**

**Tongue Load or Fifth Wheel King Pin Weight** – refers to the amount of the weight that a trailer pushes down on a trailer hitch.

**Examples:** For a 5,000 lb. (2,268 kg) conventional trailer, multiply 5,000 by 0.10 and 0.15 to obtain a proper tongue load range of 500 to 750 lb. (227 to 340 kg). For an 11,500 lb. (5,216 kg) fifth wheel trailer, multiply by 0.15 and 0.25 to obtain a proper king pin load range of 1,725 to 2,875 lb. (782 to 1,304 kg)



Do not exceed the GVWR or the GAWR specified on the Tire Label or Safety Compliance Certification Label.



Do not use replacement tires with lower load carrying capacities than the originals because they may lower the vehicle's GVWR and GAWR limitations. Replacement tires with a higher limit than the originals do not increase the GVWR and GAWR limitations.



Exceeding any vehicle weight rating limitation could result in serious damage to the vehicle and/or personal injury.

### Steps for determining the correct load limit:

1. Locate the statement “The combined weight of occupants and cargo should never exceed XXX kg or XXX lbs.” on your vehicle's placard.
2. Determine the combined weight of the driver and passengers that will be riding in your vehicle.
3. Subtract the combined weight of the driver and passengers from XXX kg or XXX lbs.
4. The resulting figure equals the available amount of cargo and luggage load capacity. For example, if the “XXX” amount equals 1,400 lbs. and there will be five 150 lb. passengers in your vehicle, the amount of available cargo and luggage load capacity is 650 lbs. (1,400–750 (5 x 150) = 650 lb.). In metric units (635–340 (5 x 68) = 295 kg.)

## Tires, Wheels and Loading

5. Determine the combined weight of luggage and cargo being loaded on the vehicle. That weight may not safely exceed the available cargo and luggage load capacity calculated in Step 4.

6. If your vehicle will be towing a trailer, load from your trailer will be transferred to your vehicle. Consult this manual to determine how this reduces the available cargo and luggage load capacity of your vehicle.

The following gives you a few examples on how to calculate the available amount of cargo and luggage load capacity:

- Another example for your vehicle with 1,400 lb. (635 kg) of cargo and luggage capacity. You decide to go golfing. Is there enough load capacity to carry you, 4 of your friends and all the golf bags? You and four friends average 220 lb. (99 kg) each and the golf bags weigh approximately 30 lb. (13.5 kg) each. The calculation would be:  $1,400 - (5 \times 220) - (5 \times 30) = 1,400 - 1,100 - 150 = 150$  lb. Yes, you have enough load capacity in your vehicle to transport four friends and your golf bags. In metric units, the calculation would be:  $635 \text{ kg} - (5 \times 99 \text{ kg}) - (5 \times 13.5 \text{ kg}) = 635 - 495 - 67.5 = 72.5$  kg.
- A final example for your vehicle with 1,400 lb. (635 kg) of cargo and luggage capacity. You and one of your friends decide to pick up cement from the local home improvement store to finish that patio you have been planning for the past 2 years. Measuring the inside of the vehicle with the rear seat folded down, you have room for 12-100 lb. (45 kg) bags of cement. Do you have enough load capacity to transport the cement to your home? If you and your friend each weigh 220 lb. (99 kg), the calculation would be:  $1,400 - (2 \times 220) - (12 \times 100) = 1,400 - 440 - 1,200 = -240$  lb. No, you do not have enough cargo capacity to carry that much weight. In metric units, the calculation would be:  $635 \text{ kg} - (2 \times 99 \text{ kg}) - (12 \times 45 \text{ kg}) = 635 - 198 - 540 = -103$  kg. You will need to reduce the load weight by at least 240 lb. (104 kg). If you remove 3-100 lb. (45 kg) cement bags, then the load calculation would be:  
 $1,400 - (2 \times 220) - (9 \times 100) = 1,400 - 440 - 900 = 60$  lb. Now you have the load capacity to transport the cement and your friend home. In metric units, the calculation would be:  $635 \text{ kg} - (2 \times 99 \text{ kg}) - (9 \times 45 \text{ kg}) = 635 - 198 - 405 = 32$  kg.

The above calculations also assume that the loads are positioned in your vehicle in a manner that does not overload the Front or the Rear Gross Axle Weight Rating specified for your vehicle on the Tire Label or Safety Compliance Certification Label found on the edge of the driver's door.

## Tires, Wheels and Loading

### Special loading instructions for owners of pickup trucks and utility-type vehicles



For important information regarding safe operation of this type of vehicle, see the *Preparing to drive your vehicle* section in the *Driving* chapter of this owner guide.



Loaded vehicles may handle differently than unloaded vehicles. Extra precautions, such as slower speeds and increased stopping distance, should be taken when driving a heavily loaded vehicle.

Your vehicle can haul more cargo and people than most passenger cars. Depending upon the type and placement of the load, hauling cargo and people may raise the center of gravity of the vehicle.

### TRAILER TOWING

Your vehicle may tow a Conventional/Class IV trailer or fifth wheel trailer provided the maximum trailer weight is less than or equal to the maximum trailer weight listed for your engine and rear axle ratio on the following charts.

To calculate your maximum trailer weight:

**For pickup trucks:** Take curb weight, hitch hardware and the driver's weight, then subtract them from the GCWR listed for your vehicle series, engine, transmission and drive axle ratio (*refer to the chart/table in the following text*). This calculation will give you the maximum trailer weight possible for your vehicle.

**For chassis cabs and pickup trucks with aftermarket equipment:**

Weigh your vehicle at a certified scale and subtract this actual curb weight, hitch hardware, and the driver's weight from the GCWR listed for your vehicle series, engine, transmission and drive axle ratio (*refer to the chart/table in the following text*). This calculation will give you the maximum trailer weight possible for your vehicle.

The weight of all additional cargo and passengers must be subtracted from the maximum trailer weight calculated above.

Further trailer/hitch restrictions and limitations exist depending on the type of trailer and hitch used. These additional maximum trailer weight and tongue load limitations are listed in the chart/table that follows the listing of GCWRs.

## Tires, Wheels and Loading

Towing a trailer places an additional load on your vehicle's engine, transmission, axle, brakes, tires and suspension. Inspect these components carefully prior to and after any towing operation. Refer to *Transmission temperature gauge* in the *Instrument Cluster* chapter for the transmission fluid temperature information.

The following trailer towing charts apply to vehicles equipped with gasoline engines; for vehicles equipped with diesel engines, refer to your *6.0 Liter Power Stroke Direct Injection Turbo Diesel Owner's Guide Supplement*.

**Note:** Do not exceed the GCWR listed for your vehicle on the following chart/table, or the GVWR, GAWR or tire ratings specified on the Tire Label or Safety Compliance Certification Label.



Towing trailers beyond the maximum recommended trailer weight which exceeds the limit of the vehicle's GCWR, GVWR, GAWR or tire ratings could result in engine damage, transmission damage, structural damage, loss of vehicle control, vehicle rollover and personal injury.

| <b>Maximum GCWR - lb. (kg.)</b>            |                        |                            |                               |
|--|------------------------|----------------------------|-------------------------------|
| <b>Engine</b>                              | <b>Rear axle ratio</b> | <b>Manual transmission</b> | <b>Automatic transmission</b> |
| <b>F-250/F-350 Single Rear Wheel (SRW)</b> |                        |                            |                               |
| 5.4L                                       | 3.73                   | 15000 (6804)               | 16000 (7257)                  |
|  | 4.10                   | 17000 (7711)               | 18000 (8165)                  |
| 6.8L (F-250)                               | 4.10                   | 20000 (9072)               | 21000 (9525)                  |
|  | 4.30                   | 22000 (9979)               | 22500 (10206)                 |
| 6.8L (F-350)                               | 4.10                   | 20000 (9072)               | 21000 (9525)                  |
|  | 4.30                   | 22000 (9979)               | 23000 (10433)                 |
| <b>F-350 Dual Rear Wheel (DRW)</b>         |                        |                            |                               |
| 5.4L                                       | 3.73                   | 15000 (6804)               | 16500 (7484)                  |
|  | 4.10                   | 17500 (7938)               | 18500 (8391)                  |
| 6.8L                                       | 4.10                   | 20500 (9299)               | 21500 (9752)                  |
|  | 4.30                   | 22500 (10206)              | 23000 (10433)                 |
| <b>F-450/F-550</b>                         |                        |                            |                               |
| 6.8L                                       | 4.88/5.38              | 26000 (11793)              | 26000 (11793)                 |

## Tires, Wheels and Loading

### Preparing to tow

Use the proper equipment for towing a trailer and make sure it is properly attached to your vehicle. See your authorized dealer or a reliable trailer dealer if you require assistance.

### Hitches

Do not use hitches that clamp onto the vehicle's bumper or attach to the axle. You must distribute the load in your trailer so that 10%–15% for conventional towing or 15%-25% fifth-wheel towing of the total weight of the trailer is on the tongue.

### *Integrated hitch rating*

The standard integrated hitch has two ratings depending on mode of operation:

- **Weight carrying** - requires a draw bar and hitch ball. The draw bar supports all the vertical tongue load of the trailer.
- **Weight distributing** - requires an aftermarket weight distributing system which includes draw bar, hitch ball, spring bars and snap-up brackets. The vertical tongue load of the trailer is distributed between the truck and the trailer by this system.

|  | Hitch Type          | Maximum Gross Trailer Weight — lb. (kg) | Maximum Tongue Weight — lb. (kg) |
|--|---------------------|---|----------------------------------|
| 6.8L DRW Pickup<br>2.5" ID without<br>adapter (requires<br>2.5" drawbar) | Weight carrying     | 8000 (3629)                             | 800 (363)                        |
|  | Weight distributing | 15000 (6804)                            | 1500 (680)                       |
| 6.8L DRW Pickup<br>2.5" ID with<br>adapter (requires<br>2" drawbar)      | Weight carrying     | 6000 (2721)                             | 600 (272)                        |
|  | Weight distributing | 12500 (5670)                            | 1250 (567)                       |
| All SRW Pickups<br>and 5.4L DRW<br>Pickups<br>2" receiver                | Weight carrying     | 6000 (2721)                             | 600 (272)                        |
|  | Weight distributing | 12500 (5670)                            | 1250 (567)                       |

## Tires, Wheels and Loading



Towing trailers beyond the maximum tongue weight exceeds the limit of the towing system and could result in vehicle structural damage, loss of vehicle control and personal injury.

### Load equalizing hitch

When hooking up a trailer using a load equalizing hitch, always use the following procedure:

1. Park the unloaded vehicle on a level surface. With the ignition on and all doors closed, allow the vehicle to stand for several minutes so that it can level.
2. Measure the height of a reference point on the front and rear bumpers at the center of the vehicle.
3. Attach the trailer to the vehicle and adjust the hitch equalizers so that the front bumper height is within  $\frac{1}{2}$ " (13 mm) of the reference point. After proper adjustment, the rear bumper should be no higher than in Step 2.

**Note:** Adjusting an equalizing hitch so the rear bumper of the vehicle is higher than it was unloaded will defeat the function of the load equalizing hitch and may cause unpredictable handling.

### Safety chains

Always connect the trailer's safety chains to the frame or hook retainers of the vehicle hitch. To connect the trailer's safety chains, cross the chains under the trailer tongue and allow slack for turning corners.

If you use a rental trailer, follow the instructions that the rental agency gives to you.

**Do not attach safety chains to the bumper.**

### Trailer brakes

Electric brakes and manual, automatic or surge-type trailer brakes are safe if installed properly and adjusted to the manufacturer's specifications. The trailer brakes must meet local and Federal regulations.



If you own a trailer with a hydraulic brake system, do not connect the trailer's hydraulic brake system directly to your vehicle's brake system. The vehicle's brake system is only designed to carry the appropriate amount of brake fluid for the vehicle alone. Connecting a hydraulic trailer braking system could adversely affect your vehicle's braking performance.

## Tires, Wheels and Loading

The braking system of the tow vehicle is rated for operation at the GVWR not GCWR.

### **Integrated trailer brake controller (if equipped)**

Your vehicle may be equipped with a fully integrated electronic Trailer Brake Controller (TBC). When used properly, the TBC helps ensure smooth and effective trailer braking by powering the trailer's electric brakes with a proportional output based on the towing vehicle's brake pressure.

 The Ford TBC has only been verified to be compatible with trailers having electric-actuated drum brakes (one to four axles) and not hydraulic surge or electric-over-hydraulic types. It is the responsibility of the customer to ensure that the trailer brakes are adjusted appropriately, functioning normally and all electric connections are properly made.

The TBC user interface consists of the following:

1. **+/- (GAIN adjustment buttons):** Pressing these buttons will adjust the TBC's power output to the trailer brakes (in 0.5 increments). The GAIN setting can be increased to a maximum of 10.0 or decreased to a minimum of 0 (no trailer braking). Pressing and holding a button will raise or lower the setting continuously.

2. **Trailer connection indicator:** This lamp indicates trailer electrical connection status.

- When a successful trailer connection is detected, the indicator will be green.
- If the electrical connection is lost, the indicator will flash red. If the connection is lost while the vehicle is stationary, the indicator will turn off after 30 seconds. If the connection is lost while the vehicle is moving, the indicator will flash until the ignition is turned off, then on again.
- If no electrical connection is detected after the ignition is turned on, pressing a GAIN adjustment button will display the GAIN setting. Sliding the manual control will display the GAIN setting, OUTPUT bar graph and light the trailer indicator red.

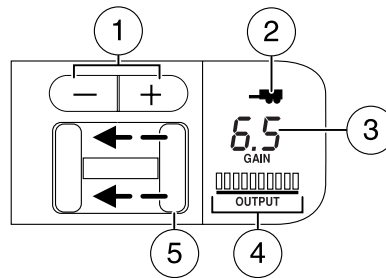

## Tires, Wheels and Loading

3. **GAIN setting display:** Shows the current GAIN setting. This will illuminate when a trailer is connected, flash if the trailer becomes disconnected, or remain off if no trailer is connected.
4. **OUTPUT bar graph:** When the vehicle's brake pedal is pushed, or when the manual control is activated, green bar indicators will illuminate to indicate the amount of power going to the trailer brakes relative to the brake pedal or manual control input.
5. **Manual control lever:** Slide the control lever to the left to activate power to the trailer's electric brakes independent of the tow vehicle's brakes (see the following *Procedure for adjusting GAIN* section for instructions on proper use of this feature). If the manual control is activated while the brake is also applied, the greater of the two inputs determines the power sent to the trailer brakes.
  - **Stop Lamps:** Activating the TBC manual control lever will illuminate both the trailer brake lamps and the tow vehicle brake lamps (presuming proper trailer electrical connection). Pressing the vehicle brake pedal will also illuminate both trailer and vehicle brake lamps.

### GAIN

The GAIN setting is used to set the TBC for the specific towing condition and should be changed as towing conditions change. Changes to towing conditions include trailer load, vehicle load, road conditions and weather.

The GAIN should be set to provide the maximum trailer braking assistance while ensuring the trailer wheels do not lock when braking. Locked trailer wheels may lead to trailer instability.

#### Procedure for adjusting GAIN:

**Note:** This should only be performed in a traffic free environment at speeds of approximately 20 – 25 mph (30 – 40 km/h).

1. Make sure the trailer brakes are in good working condition, functioning normally, and properly adjusted. See your trailer dealer if necessary.
2. Hook-up the trailer and make the electrical connections according to the trailer manufacturer's instructions.
3. When a trailer with electric brakes is plugged in, the trailer connection indicator will illuminate green on the TBC and the GAIN setting display will illuminate.
4. Use the GAIN adjustment (+/-) buttons to increase or decrease the GAIN setting to the desired starting point. (A GAIN setting of 6.0 is a good starting point for heavier loads.)



## Tires, Wheels and Loading

5. In a traffic-free environment, tow the trailer on a dry, level surface at a speed of 20 – 25 mph (30 – 40 km/h) and squeeze the manual control lever completely.

6. If the trailer wheels lock-up (indicated by squealing tires), reduce the GAIN setting; if the trailer wheels turn freely, increase the GAIN setting. Repeat Steps 5 and 6 until the GAIN setting is at a point just below trailer wheel lock-up. If towing a heavier trailer, trailer wheel lockup may not be attainable even with the maximum GAIN setting of 10.

### **Explanation of instrument cluster messages:**

The TBC interacts with the instrument cluster message center. These messages, accompanied by a single chime, will be displayed when the TBC determines a malfunction in the trailer connection, TBC system, or in the trailer. These messages are listed below:

**TRAILER DISCONNECTED (if equipped with message center) or CHECK TRAILER (if equipped with mini message center):** This message is displayed when a trailer connection was determined and then a disconnection, either intentionally or unintentionally, has been sensed during a given ignition cycle. It is also displayed if a trailer fault occurs causing the trailer to appear disconnected. This message is also displayed during manual activation without a trailer connected.

**TBC FAULT:** This message is displayed in response to faults sensed by the TBC. In the event this message is seen, please take your vehicle to an authorized dealer for diagnosis and repair. The TBC may still function, but performance may be degraded.

**TRAILER FAULT:** The TBC is capable of determining certain faults in the vehicle wiring and trailer wiring/brake system. These faults do not mean there is anything wrong with the TBC. This message is displayed when one of the following faults has occurred:

- *Short circuit on the electric brake output wire:* If the TRAILER FAULT message is displayed with no trailer connected, the problem is with the vehicle wiring from the TBC to the 7-pin connector in the bumper. If the message is only displayed with a trailer connected, the problem is related to the trailer wiring; consult your trailer dealer for assistance. This can be a short to ground (i.e., chaffed wire) or a short to voltage (i.e., pulled pin on trailer emergency break-away battery).
- *Trailer brake overload:* The trailer brakes are drawing too much current; consult your trailer dealer for assistance.

**Note:** Your TBC can be diagnosed by your authorized dealer to determine exactly which trailer fault has occurred; however, if the fault is with the trailer this diagnosis is **not** covered under your Ford warranty.

## Tires, Wheels and Loading

### Points to Remember:

- Remember to adjust gain setting before using the TBC for the first time.
- Readjust GAIN setting on the TBC (according to procedure above) whenever road, weather and trailer or vehicle loading conditions change from those that existed when the gain was initially set.
- The sliding lever on the TBC should be used only for manual activation of trailer brakes to assist with proper adjustment of the GAIN. Misuse, such as application during trailer sway, could cause instability of trailer and/or tow vehicle.
- Avoid towing in adverse weather conditions. The TBC does not provide anti-lock control of the trailer wheels. Trailer wheels can lock-up on slippery surfaces, resulting in reduced stability of trailer and tow vehicle.
- The TBC interacts with the brake system of the vehicle, including ABS, in order to reduce the likelihood of trailer wheel lockup. Therefore, if these systems are not functioning properly the TBC may not function at full performance.
- When the vehicle is turned off, the TBC Output is disabled and the display is shut down. Reactivation of the ignition from 3 (OFF) to 4 (ON) will awaken the TBC module.
- The TBC is only a factory or dealer installed item. Ford is not responsible for warranty or performance of the TBC due to misuse or customer installation.

### Trailer lamps

Trailer lamps are required on most towed vehicles. Make sure all running lights, brake lights, turn signals and hazard lights are working. See your authorized dealer or trailer rental agency for proper instructions and equipment for hooking up trailer lamps.

### Using a step bumper (if equipped)

The rear bumper is equipped with an integral hitch and only requires a ball with a one inch (25.4 mm) shank diameter. The bumper has a 5,000 lb. (2,270 kg) trailer weight and 500 lb. (227 kg) tongue weight capacity.

If it is necessary to relocate the trailer hitch ball position, a frame-mounted trailer hitch must be installed.

## Tires, Wheels and Loading

### Driving while you tow

When towing a trailer:

- Do not drive faster than 70 mph (112 km/h) during the first 500 miles (800 km) of trailer towing and don't make full-throttle starts.
- Turn off the speed control. The speed control may shut off automatically when you are towing on long, steep grades.
- Consult your local motor vehicle speed regulations for towing a trailer.
- To eliminate excessive transmission shifting, activate the Tow/Haul feature. This will also assist in transmission cooling. (For additional information, refer to the *Understanding the positions of the 5-speed automatic transmission* section in this chapter.
- Anticipate stops and brake gradually.
- Do not exceed the GCWR rating or transmission damage may occur.
- Your vehicle may be equipped with a temporary or conventional spare tire. If the spare tire is different in size (diameter and/or width), tread type (All-Season or All-Terrain) or is from a different manufacturer other than the road tires on your vehicle, your spare tire is considered "temporary". Consult information on the spare Tire Label or Safety Compliance Certification Label for limitations when using.

### Servicing after towing

If you tow a trailer for long distances, your vehicle will require more frequent service intervals. Refer to your *scheduled maintenance information* for more information.

### Trailer towing safety tips

#### General

- Ensure that the trailer, safety chains and 7-pin electrical connectors are securely fastened.
- Make sure the truck receiver, draw bar, and coupler are properly connected and adjusted.
- Check rear view and side mirrors for proper visibility especially when towing trailer wider than the truck.
- When towing, operate the vehicle at lower speeds than you would when not towing a trailer. The likelihood of trailer sway is greater at higher speeds.

## Tires, Wheels and Loading

- If you will be towing a trailer frequently in hot weather, hilly conditions, at GCW, or any combination of these factors, consider refilling your rear axle with synthetic gear lubricant if not already so equipped. Refer to *Lubricant Specifications* in the *Maintenance and specifications* chapter for the proper axle lubricant. Remember that regardless of the rear axle lubricant used, do not tow a trailer for the first 500 miles (800 km) of a new vehicle, and that the first 500 miles of towing be done at no faster than 70 mph (112 km/h) with no full-throttle starts.
- When turning make wide turns to allow trailer tires to properly clear any obstacles.
- Be prepared for trailer sway due to buffeting when larger vehicles pass in either direction.

### **Loading**

- Keep the center-of-gravity low for best handling.
- Trailer loads should be evenly distributed front to back and left to right.
- The load distribution within the trailer should be such that 10% – 15% of the trailer weight is on the hitch. (15% – 25% for 5th-wheel or gooseneck towing.)
- Never exceed truck, trailer, receiver, ball, tongue, tire or coupler loading recommendations.

### **Braking**

- The trailer brakes must be inspected and serviced at intervals specified by the manufacturer. This includes the shoes, drum and trailer brake magnets.
- Electric brakes also require periodic adjustment to keep the shoes properly spaced. If the brakes get hot when driving or if they will not hold, chances are that they need adjustment.
- Anticipate the need to stop; allow much more distance and time to stop than normal.
- Do not apply the trailer brakes for extended periods of time as they can overheat and lose effectiveness.

## Tires, Wheels and Loading

### **Backing up**

- Practice backing up, particularly if you are a novice. Turn the steering wheel to the right to move the trailer's rear end to the right.
- Sharp steering movements may cause the trailer to jackknife or go out of control.

### **Tires**

- All trailer tires should be of the same size, and construction.
- Select tires that meet the trailer loading requirements.
- Always check tow vehicle and trailer tire pressure before towing.

### **Launching or retrieving a boat**

When backing down a ramp during boat launching or retrieval,

- Do not allow the static water level to rise above the bottom edge of the rear bumper.
- Do not allow waves to break higher than 6 inches (15 cm) above the bottom edge of the rear bumper.
- Disconnect the trailer tow electrical connector to prevent blown fuses caused by water entering into your trailer's electrical wiring.

Exceeding these limits may allow water to enter critical vehicle components, adversely affecting driveability, emissions and reliability.

Replace front and rear axle lubricants any time the axles have been submerged in water. Axle lubricant quantities are not to be checked unless a leak is suspected.

### **RECREATIONAL TOWING**

This applies to all 4x2 trucks with rear wheel drive capability.

An example of recreational towing is towing your vehicle behind a motorhome. The following recreational towing guidelines are designed to ensure that your transmission is not damaged.

- Place the transmission in N (Neutral).
- Maximum speed is 35 mph (56 km/h).
- Maximum distance is 50 miles (80 km).

If a distance of 50 miles (80 km) or a speed of 35 mph (56 km/h) must be exceeded, you must disconnect the driveshaft. Ford recommends the driveshaft be removed/installed only by a qualified technician. See your local authorized dealer for driveshaft removal/installation.

## Tires, Wheels and Loading

**Improper removal/installation of the driveshaft can cause transmission fluid loss, damage to the driveshaft and internal transmission components.**

**4x4 with manual shift transfer case:**

- Place the transfer case in N (Neutral).
- Front hub locks are in the FREE position.

**4x4 electronic shift transfer case vehicles with automatic transmissions:**

Regarding recreational towing or having your vehicle towed, 4x4 vehicles with electronic shift on the fly cannot be towed with any wheels on the ground unless the rear driveshaft is removed and the front hub locks are in free mode (with the exception of moving it as a disabled vehicle off the road out of traffic). The hub locks can be set to free mode at any time by turning them from AUTO to LOCK and back to AUTO at least two times. Always make sure that both hub locks are set to the same position.

### STARTING

#### Positions of the ignition

1. ACCESSORY, allows the electrical accessories such as the radio to operate while the engine is not running.

2. LOCK, locks the steering wheel, automatic transmission gearshift lever and allows key removal. For vehicles equipped with a manual transmission, you must depress the ignition release lever to release the key.

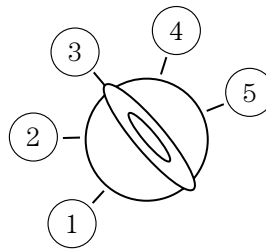

3. OFF, shuts off the engine and all accessories without locking the steering wheel. This position also allows the automatic transmission shift lever to be moved from the P (Park) position without the brake pedal being depressed.



When the key is in the ignition and in the OFF position, the automatic transmission shift lever can be moved from the P (Park) position without the brake pedal depressed. To avoid unwanted vehicle movement, always set the parking brake.

4. ON, all electrical circuits operational. Warning lights illuminated. Key position when driving.

5. START, cranks the engine. Release the key as soon as the engine starts.

#### Preparing to start your vehicle

Engine starting is controlled by the powertrain control system. This system meets all Canadian Interference-Causing Equipment standard requirements regulating the impulse electrical field strength of radio noise.

When starting a fuel-injected engine, don't press the accelerator before or during starting. Only use the accelerator when you have difficulty starting the engine. For more information on starting the vehicle, refer to *Starting the engine* in this chapter.

## Driving

 Extended idling at high engine speeds can produce very high temperatures in the engine and exhaust system, creating the risk of fire or other damage.

 Do not park, idle, or drive your vehicle in dry grass or other dry ground cover. The emission system heats up the engine compartment and exhaust system, which can start a fire.

 Do not start your vehicle in a closed garage or in other enclosed areas. Exhaust fumes can be toxic. Always open the garage door before you start the engine. See *Guarding against exhaust fumes* in this chapter for more instructions.

 If you smell exhaust fumes inside your vehicle, have your dealer inspect your vehicle immediately. Do not drive if you smell exhaust fumes.

### Important safety precautions

When the engine starts, the idle RPM runs faster to warm the engine. If the engine idle speed does not slow down automatically, have the vehicle checked. If your vehicle is operated in a heavy snow storm or blowing snow conditions, the engine air induction may become partially clogged with snow and/or ice. If this occurs, the engine may experience a significant reduction in power output. At the earliest opportunity, clear all the snow and/or ice away from the air induction inlet. The following starting instructions are for vehicles equipped with a gasoline engine; if your vehicle is equipped with a Diesel engine, refer to *Starting the engine* in your *6.0 Liter Power Stroke Direct Injection Turbo Diesel Owner's Guide Supplement*.

Before starting the vehicle:

1. Make sure all occupants buckle their safety belts. For more information on safety belts and their proper usage, refer to the *Seating and Safety Restraints* chapter.
2. Make sure the headlamps and electrical accessories are off.



## Driving

If starting a vehicle with an automatic transmission:

1. Make sure the parking brake is set.

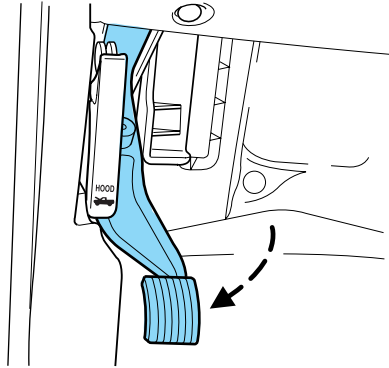

2. Make sure the gearshift is in P (Park).



If starting a vehicle with a manual transmission:

1. Make sure the parking brake is set.
2. Push the clutch pedal to the floor.

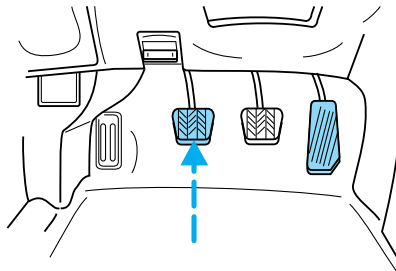

- Turn the key to 4 (ON) without turning the key to 5 (START).

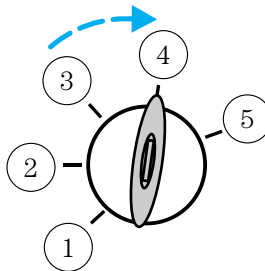

## Driving

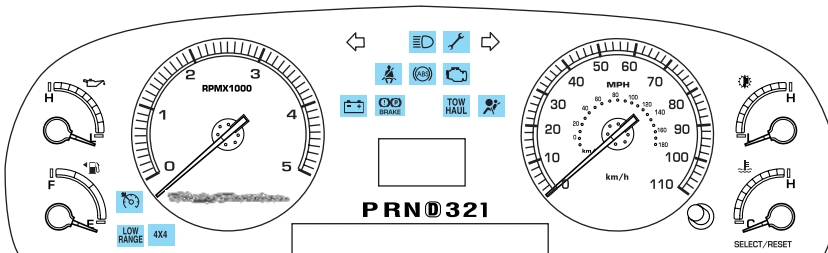
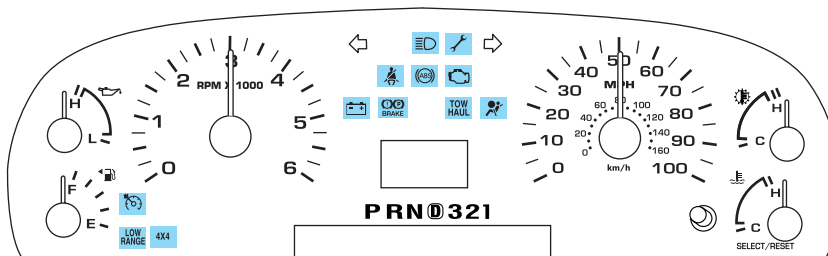
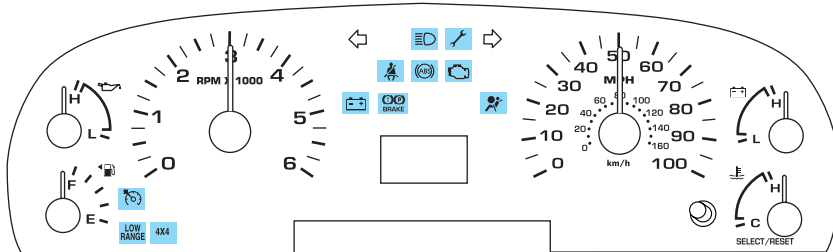

Make sure the corresponding lights illuminate or illuminate briefly. If a light fails to illuminate, have the vehicle serviced.

- If the driver's safety belt is fastened, the  light may not illuminate.

### Starting the engine

1. Turn the key to 4 (ON) without turning the key to 5 (START).
2. Turn the key to 5 (START), then release the key as soon as the engine starts. Excessive cranking could damage the starter.

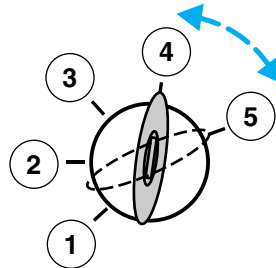

**Note:** If the engine does not start within five seconds on the first try, turn the key to 3 (OFF), wait 10 seconds and try again. If the engine still fails to start, press the accelerator to the floor and try again; this will allow the engine to crank with the fuel shut off in case the engine is flooded with fuel.

### Guarding against exhaust fumes

Carbon monoxide is present in exhaust fumes. Take precautions to avoid its dangerous effects.



If you smell exhaust fumes inside your vehicle, have your dealer inspect your vehicle immediately. Do not drive if you smell exhaust fumes.

### Important ventilating information

If the engine is idling while the vehicle is stopped for a long period of time, open the windows at least one inch (2.5 cm) or adjust the heating or air conditioning to bring in fresh air.

## Driving

### USING THE ENGINE BLOCK HEATER (IF EQUIPPED)

Use of an engine block heater is strongly recommended if you live in a region where temperatures reach  $-10^{\circ}\text{F}$  ( $-23^{\circ}\text{C}$ ) or below. For best results, plug the heater in at least three hours before starting the vehicle. The heater can be plugged in the night before starting the vehicle. The plug for the block heater is exposed in the front of the vehicle, beneath the grille. Vehicles

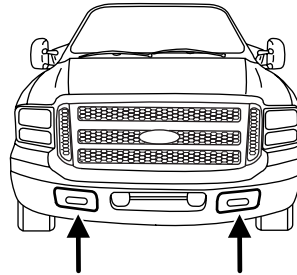

equipped with a gasoline engine have the plug exposed on the driver side of the vehicle; vehicles equipped with a Diesel engine have the plug exposed on the passenger side of the vehicle.



To reduce the risk of electrical shock, do not use your heater with ungrounded electrical systems or two-pronged (cheater) adapters.

### BRAKES

Occasional brake noise is normal. If a metal-to-metal, continuous grinding or continuous squeal sound is present, the brake linings may be worn-out and should be inspected by your authorized dealer. If the vehicle has continuous vibration or shudder in the steering wheel while braking, the vehicle should be inspected by your authorized dealer.

Refer to *Brake system warning light* in the *Instrument Cluster* chapter for information on the brake system warning light.



### Four-wheel anti-lock brake system (ABS)

Your vehicle is equipped with an Anti-lock Braking System (ABS). This system helps you maintain steering control during emergency stops by keeping the brakes from locking. Noise from the ABS pump motor and brake pedal pulsation may be observed during ABS braking and the brake pedal may suddenly travel a little farther as soon as ABS braking is done and normal brake operation resumes. These are normal characteristics of the ABS and should be no reason for concern.

**ABS warning lamp**

The ABS lamp in the instrument cluster momentarily illuminates when the ignition is turned on. If the light does not illuminate during start up, remains on or flashes, the ABS may be disabled and may need to be serviced.



Even when the ABS is disabled, normal braking is still effective. (If your BRAKE warning lamp illuminates with the parking brake released, have your brake system serviced immediately.)



**Using ABS**

When hard braking is required, apply continuous force on the brake pedal; do not pump the brake pedal since this will reduce the effectiveness of the ABS and will increase your vehicle's stopping distance. The ABS will be activated immediately, allowing you to retain full steering control during hard braking and on slippery surfaces. However, the ABS does not decrease stopping distance.

**Parking brake**

To set the parking brake, press the parking brake pedal down until the pedal stops.

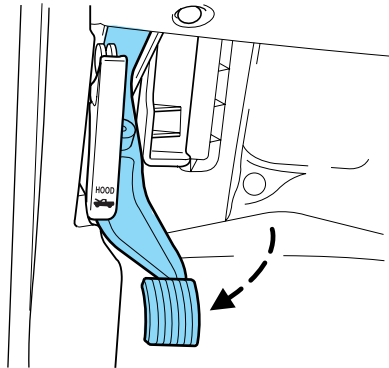

## Driving

The BRAKE warning lamp in the instrument cluster illuminates and remains illuminated until the parking brake is released.



Pull the right side of the release lever to release the parking brake; the release lever pulls at an angle toward the driver's door. To prevent the pedal from releasing too quickly, place your left foot on the parking brake pedal, then pull the release lever, making sure the pedal fully releases. You may want to pull the release lever again to make sure the parking brake is fully released.

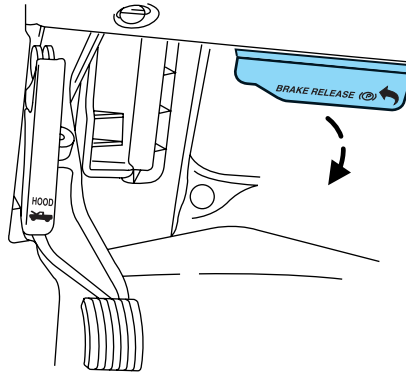

Always set the parking brake fully and make sure that the gearshift is securely latched in P (Park) (automatic transmission) or in 1 (First) (manual transmission).

**Note:** If your vehicle is equipped with a manual transmission, the engine may be required to run while power accessories operate and the parking brake is set. It is recommended that wheel chocks be used during this operation.

If you're parking your vehicle on a grade or with a trailer, press and hold the brake pedal down, then set the parking brake. There may be a little vehicle movement as the parking brake sets to hold the vehicle's weight. This is normal and should be no reason for concern. If needed, press and hold the service brake pedal down, then try reapplying the parking brake. Chock the wheels if required. If the parking brake cannot hold the weight of the vehicle, the parking brake may need to be serviced or the vehicle may be overloaded.

## STEERING

To prevent damage to the power steering system:

- Never hold the steering wheel at its furthest turning points (until it stops) for more than a few seconds when the engine is running.

## Driving

- Do not operate the vehicle with a low power steering pump fluid level (below the FULL COLD mark on the dipstick).

If the power steering system breaks down (or if the engine is turned off), you can steer the vehicle manually, but it takes more effort.

If the steering wanders or pulls, check for:

- an improperly inflated tire
- uneven tire wear
- loose or worn suspension components
- loose or worn steering components
- improper steering alignment

If any steering components are serviced or replaced, install new fasteners (many are coated with thread adhesive or have prevailing torque features which may not be re-used). Never re-use a bolt or nut. Torque fasteners to specifications in *Workshop Manual*.

A high crown in the road or high crosswinds may also make the steering seem to wander/pull.

### TRACTION-LOK AXLE (IF EQUIPPED)

This axle provides added traction on slippery surfaces, particularly when one wheel is on a poor traction surface. Under normal conditions, the Traction-Lok axle functions like a standard rear axle. The axle may exhibit a slight noise or vibration in tight turns with low vehicle speed. This is normal behavior and indicates the axle is working.

### PREPARING TO DRIVE YOUR VEHICLE



Utility vehicles have a significantly higher rollover rate than other types of vehicles.



In a rollover crash, an unbelted person is significantly more likely to die than a person wearing a safety belt.

Your vehicle has larger tires and increased ground clearance, giving the vehicle a higher center of gravity than a passenger car.

## Driving



Vehicles with a higher center of gravity such as utility and four-wheel drive vehicles handle differently than vehicles with a lower center of gravity. Utility and four-wheel drive vehicles are **not** designed for cornering at speeds as high as passenger cars any more than low-slung sports cars are designed to perform satisfactorily under off-road conditions. Avoid sharp turns, excessive speed and abrupt maneuvers in these vehicles. Failure to drive cautiously could result in an increased risk of loss of vehicle control, vehicle rollover, personal injury and death.



Loaded vehicles, with a higher center of gravity, may handle differently than unloaded vehicles. Extra precautions such as slower speeds and increased stopping distance should be taken when driving a heavily loaded vehicle.

### AUTOMATIC TRANSMISSION OPERATION (IF EQUIPPED)

#### Brake-shift interlock

This vehicle is equipped with a brake-shift interlock feature that prevents the gearshift lever from being moved from P (Park) when the ignition is in the 4 (ON) position unless brake pedal is depressed.

If you cannot move the gearshift lever out of P (Park) with ignition in the 4 (ON) position and the brake pedal depressed:

1. Apply the parking brake, turn ignition key to 2 (LOCK), then remove the key.
2. Insert the key and turn it to 3 (OFF). **Apply the brake pedal and shift to N (Neutral).**



When the key is in the ignition and in the OFF position, the automatic transmission shift lever can be moved from the P (Park) position without the brake pedal depressed. To avoid unwanted vehicle movement, always set the parking brake.

3. Start the vehicle.

If it is necessary to use the above procedure to move the gearshift lever, it is possible that a fuse has blown or the vehicle's brakelamps are not operating properly. Refer to *Fuses and relays* in the *Roadside Emergencies* chapter.



## Driving



Do not drive your vehicle until you verify that the brakelamps are working.



Always set the parking brake fully and make sure the gearshift is latched in P (Park). Turn the ignition to the LOCK position and remove the key whenever you leave your vehicle.



If the parking brake is fully released, but the brake warning lamp remains illuminated, the brakes may not be working properly. See your authorized dealer as soon as possible.

### Understanding the shift positions of the 5-speed automatic transmission



This vehicle is equipped with an adaptive Transmission Shift Strategy. Adaptive Shift Strategy offers the optimal transmission operation and shift quality. When the vehicle's battery has been disconnected for any type of service or repair, the transmission will need to relearn the normal shift strategy parameters, much like having to reset your radio stations when your vehicle battery has been disconnected. The Adaptive Transmission Strategy allows the transmission to relearn these operating parameters. This learning process could take several transmission upshifts and downshifts; during this learning process, slightly firmer shifts may occur. After this learning process, normal shift feel and shift scheduling will resume.

#### **P (Park)**

This position locks the transmission and prevents the rear wheels from turning.

To put your vehicle in gear:

- Start the engine
- Depress the brake pedal
- Move the gearshift lever into the desired gear

## Driving

To put your vehicle in P (Park):

- Come to a complete stop
- Move the gearshift lever and securely latch it in P (Park)



Always set the parking brake fully and make sure the gearshift is latched in P (Park). Turn the ignition to the LOCK position and remove the key whenever you leave your vehicle.

### **R (Reverse)**

With the gearshift lever in R (Reverse), the vehicle will move backward. Always come to a complete stop before shifting into and out of R (Reverse).

### **N (Neutral)**

With the gearshift lever in N (Neutral), the vehicle can be started and is free to roll. Hold the brake pedal down while in this position.

### **D (Overdrive) with Tow/Haul OFF**

D (Overdrive) with Tow/Haul OFF is the normal driving position for the best fuel economy. The overdrive function allows automatic upshifts and downshifts through gears one through five.

### **D (Overdrive) with Tow/Haul ON**

The Tow/Haul feature improves transmission operation when towing a trailer or a heavy load. All transmission gear ranges are available when using Tow/Haul.

To activate Tow/Haul, press the button on the end of the gearshift lever.

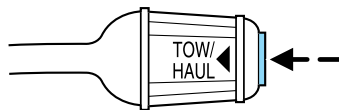

The TOW HAUL indicator light will illuminate in the instrument cluster.

**TOW  
HAUL**

Tow/Haul delays upshifts to reduce frequency of transmission shifting. Tow/Haul also provides engine braking in all forward gears when the transmission is in the D (Overdrive) position; this engine braking will slow the vehicle and assist the driver in controlling the vehicle when descending a grade. Depending on driving conditions and load conditions, the transmission may downshift, slow the vehicle and control the vehicle speed when descending a hill, without the accelerator pedal being pressed. The amount of downshift braking provided will vary based upon the amount the brake pedal is depressed.

## Driving

To deactivate the Tow/Haul feature and return to normal driving mode, press the button on the end of the gearshift lever. The TOW HAUL light will no longer be illuminated.

When you shut-off and restart the engine, the transmission will automatically return to normal D (Overdrive) mode (Tow/Haul OFF).



Do not use the Tow/Haul feature when driving in icy or slippery conditions as the increased engine braking can cause the rear wheels to slide and the vehicle to swing around with the possible loss of vehicle control.

### 3 (Third)

Transmission starts and operates in third gear only.

Used for improved traction on slippery roads. Selecting 3 (Third) provides engine braking.

### 2 (Second)

Use 2 (Second) to start-up on slippery roads or to provide additional engine braking on downgrades.

### 1 (First)

- Provides maximum engine braking.
- Allows upshifts by moving gearshift lever.
- The transmission will not downshift into 1 (First) at high speeds; it will downshift to a lower gear and then shift into 1 (First) when the vehicle reaches slower speeds.

### Forced downshifts

- Allowed in **D** (Overdrive) or Drive.
- Depress the accelerator to the floor.
- Allows transmission to select an appropriate gear.

### If your vehicle gets stuck in mud or snow

If your vehicle gets stuck in mud or snow, it may be rocked out by shifting between forward and reverse gears, stopping between shifts in a steady pattern. Press lightly on the accelerator in each gear.

**Do not rock the vehicle if the engine is not at normal operating temperature or damage to the transmission may occur.**

**Do not rock the vehicle for more than a minute or damage to the transmission and tires may occur, or the engine may overheat.**

## Driving

### MANUAL TRANSMISSION OPERATION (IF EQUIPPED)

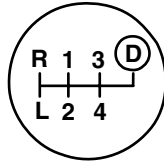

#### Using the clutch

The manual transmission has a starter interlock that prevents cranking the engine unless the clutch pedal is fully depressed.

To start the vehicle:

1. Make sure the parking brake is fully set.
2. Press the clutch pedal to the floor, then put the gearshift lever in the neutral position.
3. Start the engine, then press the brake pedal and release the parking brake.
4. Move the gearshift lever to 1 (First) gear, then slowly release the clutch pedal while slowly pressing on the accelerator.

During each shift, the clutch pedal must be fully depressed to the floor. Failure to fully depress the clutch pedal to the floor may cause increased shift efforts, prematurely wear transmission components or damage the transmission. Make sure the floor mat is properly positioned so it doesn't interfere with the full extension of the clutch pedal.

Do not drive with your foot resting on the clutch pedal or use the clutch pedal to hold your vehicle at a standstill while waiting on a hill. These actions will reduce the life of the clutch.

#### Recommended shift speeds

Do not overspeed the engine when going downhill or steep grades. If equipped, use the tachometer and do not allow engine speed to exceed the redline area. Operating the engine beyond the recommended speeds can cause severe engine damage.

## Driving

Shift according to the following shift speed charts:

| <b>Upshifts when accelerating (recommended for best fuel economy)</b> |   |                  |
|---|---|------------------|
| <b>6-speed transmission</b>   |   |                  |
| Shift from:   | Transfer case position <sup>1</sup> (if equipped) |                  |
|   | 2H or 4H  | 4L               |
| LO-1  | 5 mph (8 km/h)                                    | 2 mph (3 km/h)   |
| 1-2   | 15 mph (24 km/h)                                  | 6 mph (10 km/h)  |
| 2-3   | 22 mph (35 km/h)                                  | 9 mph (14 km/h)  |
| 3-4   | 30 mph (48 km/h)                                  | 12 mph (19 km/h) |
| 4   | 40 mph (64 km/h)                                  | 15 mph (24 km/h) |
| - <b>D</b> (Overdrive)  |   |                  |

| <b>Maximum downshift speeds<sup>1</sup></b>                               |   |                  |
|---|---|------------------|
| <b>6-speed transmission</b>   |   |                  |
| Shift from:   | Transfer case position (if equipped) <sup>2</sup> |                  |
|   | 2H or 4H  | 4L               |
| <b>D</b> (Overdrive) - 4  | 45 mph (72 km/h)                                  | 16 mph (26 km/h) |
| 4-3   | 35 mph (56 km/h)                                  | 12 mph (19 km/h) |
| 3-2   | 20 mph (32 km/h)                                  | 8 mph (13 km/h)  |
| 2-1   | 5 mph (8 km/h)                                    | 2 mph (3 km/h)   |
| 1-LO  | Only shift to LO when at a stop.                  |                  |
| <sup>1</sup> Use 2H or 4H for 4WD equipped vehicles.                      |   |                  |
| <sup>2</sup> Downshift at lower speeds when driving on slippery surfaces. |   |                  |

### Reverse

1. Make sure that your vehicle is at a complete stop before you shift into R (Reverse). Failure to do so may damage the transmission.
2. Move the gearshift lever into the neutral position and wait at least three seconds before shifting into R (Reverse).
  - The gearshift lever can only be moved into R (Reverse) by moving it from left of 3 (Third) and 4 (Fourth) before shifting into R (Reverse). This is a lockout feature that protects the transmission from accidentally being shifted into R (Reverse) from **D** (Overdrive).

## Driving

### Parking your vehicle

1. Apply the brake and shift into the neutral position.
2. Fully apply the parking brake, then shift into 1 (First).
3. Turn the ignition off.



Do not park your vehicle in Neutral, it may move unexpectedly and injure someone. Use 1 (First) gear and set the parking brake fully.

### Removing the key

Turn the ignition off, push the release lever (located above the ignition), then turn the key toward you and remove the key.



### REVERSE SENSING SYSTEM (IF EQUIPPED)

The Reverse Sensing System (RSS) sounds a tone to warn the driver of obstacles near the rear bumper when the R (Reverse) is selected and the vehicle is moving at speeds less than 3 mph (5 km/h). The system is not effective at speeds above 3 mph (5 km/h) and may not detect certain angular or moving objects.





To help avoid personal injury, please read and understand the limitations of the reverse sensing system as contained in this section. Reverse sensing is only an aid for some (generally large and fixed) objects when moving in reverse on a flat surface at “parking speeds”. Inclement weather may also affect the function of the RSS; this may include reduced performance or a false activation.



To help avoid personal injury, always use caution when in reverse and when using the RSS.

## Driving

 This system is not designed to prevent contact with small or moving objects. The system is designed to provide a warning to assist the driver in detecting large stationary objects to avoid damaging the vehicle. The system may not detect smaller objects, particularly those close to the ground.

 Certain add-on devices such as large trailer hitches, bike or surfboard racks and any device that may block the normal detection zone of the RSS system may create false beeps.

The RSS detects obstacles up to 6 feet (2 meters) from the rear bumper with a decreased coverage area at the outer corners of the bumper, (refer to the figures for approximate zone coverage areas). As you move closer to the obstacle, the rate of the tone increases. When the obstacle is less than 10 inches (25.0 cm) away, the tone will sound continuously. If the RSS detects a stationary or receding object further than 10 inches (25.0 cm) from the side of the vehicle, the tone will sound for only three seconds. Once the system detects an object approaching, the tone will sound again.

The RSS may have reduced performance or an increased chance of false detection if the tailgate is not locked and in the upright position. If the tailgate is down, the RSS tone may be heard intermittently or continuously. The tone may also be heard if items in the truck bed protrude rearward outside the bed.

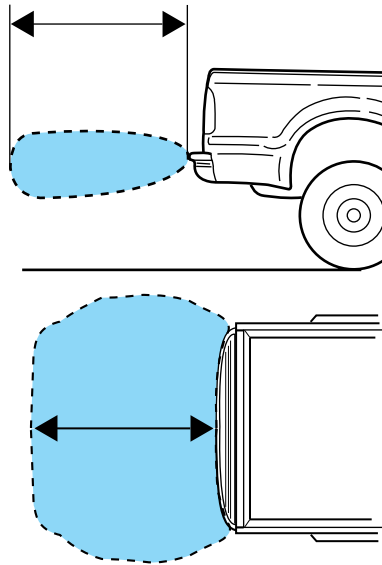

## Driving

The RSS automatically turns on when the gearshift lever is placed in R (Reverse) and the ignition is on. An RSS control allows the driver to turn the RSS on and off. To turn the RSS off, the ignition must be on, and the gear selector in R (Reverse). An indicator light on the control will illuminate when the system is turned off. If the indicator light illuminates when the RSS is not turned off, it may indicate a failure in the RSS. The RSS will remain off until either the RSS control is pushed again or the ignition switch is recycled.

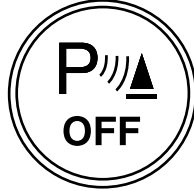

**Keep the RSS sensors (located on the rear bumper/fascia) free from snow, ice and large accumulations of dirt (do not clean the sensors with sharp objects). If the sensors are covered, it will affect the accuracy of the RSS.**

**If your vehicle sustains damage to the rear bumper/fascia, leaving it misaligned or bent, the sensing zone may be altered causing inaccurate measurement of obstacles or false alarms.**

### FOUR-WHEEL DRIVE (4WD) OPERATION (IF EQUIPPED)



For important information regarding safe operation of this type of vehicle, see **Preparing to drive your vehicle** in this chapter.

When four-wheel drive (4WD) is engaged, power is supplied to all four wheels through a transfer case. 4WD can be selected when additional driving power is desired.

4WD operation is not recommended on dry pavement. Doing so could result in difficult disengagement of the transfer case, increased tire wear and decreased fuel economy.



### Manual Shift On Stop (MSOS) 4x4 system (if equipped)

The 4WD system is engaged or disengaged by rotating the control for both front wheel hub locks from the FREE or LOCK position, then manually engaging or disengaging the transfer case with the floor-mounted shifter. For increased fuel economy in 2WD, rotate both hub locks to the FREE position.

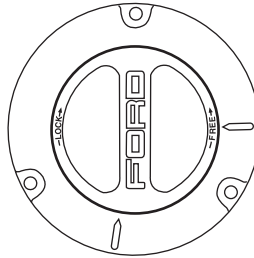

- **For proper operation, make sure that each hub is fully engaged and that both hub locks are set to the same position (both set to LOCK or both set to FREE). To engage LOCK, turn the hub locks completely clockwise; to disengage the hubs (FREE), turn the hub locks completely counterclockwise.**
- Some vehicles may be equipped with wheel ornaments that cover the 4x4 manual hub lock. These ornaments must be removed to access the manual hub locks.

### Electronic Shift On the Fly (ESOF) 4x4 system (if equipped)

If equipped with the electronic shift 4WD System, and the instrument panel control is moved to 4X4 LOW (4WD Low) while the vehicle is moving above 3 mph (5 km/h), the system will not engage and no damage will occur to the 4WD system. Before 4X4 LOW (4WD Low) can be engaged, the vehicle speed must be below 3 mph (5 km/h) with the brake pedal depressed and the transmission in N (Neutral). This vehicle is equipped with a non-synchronous low range gearset which will not allow the transfer case to shift into 4X4 LOW (4WD Low) if vehicle speed is above 3 mph (5 km/h). It is recommended that a shift to 4X4 LOW (4WD Low) is performed while the vehicle is moving at a speed below 3 mph (5 km/h).

The 4WD system:

- provides 4x4 High engagement and disengagement while the vehicle is moving.
- is operated by a rotary control located on the instrument panel that allows you select 2WD, 4x4 High or 4x4 Low operation.
- uses auto-manual hub locks that can be engaged and disengaged automatically based on the 4x4 mode selected.

## Driving

- auto-manual hub locks can be manually overridden by rotating the hub lock control from AUTO to LOCK if desired.
- **automatic operation of the hub locks is recommended**, and will increase fuel economy
- **For proper operation, make sure that each hub is fully engaged and that both hub locks are set to the same position (both set to LOCK or both set to AUTO). To engage LOCK, turn the hub locks completely clockwise; to engage AUTO, turn the hub locks completely counterclockwise.**

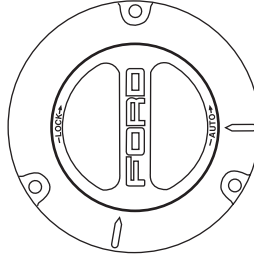

### 4WD system indicator lights

The 4WD system indicator lights illuminate only under the following conditions. If these lights illuminate when driving in 2WD, contact your authorized dealer as soon as possible.

- **4x4** - momentarily illuminates after the engine is started. Illuminates when 4H (4x4 High) or 4L (4x4 Low) is engaged.
- **LOW RANGE** - momentarily illuminates when the ignition is turned to the ON position. Illuminates when 4L (4x4 Low) is engaged.

4x4

LOW  
RANGE

### Using a Manual Shift On Stop (MSOS) 4WD system (if equipped)

**Note:** Some noise may be heard as the 4WD system shifts or engages. This is normal.

**2H (2WD High)** - For general on-road driving. Sends power to the rear wheels only.

**4H (4WD High)** - For winter and off-road conditions. Sends power to front and rear wheels.

**N (Neutral)** - Only used when towing the vehicle.

**4L (4WD Low)** - For low-speed off-road applications that require extra power such as steep grades, deep sand or pulling a boat out of the water. Sends power to front and rear wheels.

**Shifting from 2H (2WD High) to 4H (4WD High)**

Engage the locking hubs by rotating the hub lock control from FREE to LOCK, then move the transfer case lever from 2H (2WD High) to 4H (4WD High) at a vehicle speed below 3 mph (5 km/h).

- **For proper operation, make sure that both indicator arrows on the hub are aligned, and that both hubs are set to LOCK.**
- **Do not shift into 4H (4WD High) with the rear wheels slipping.**

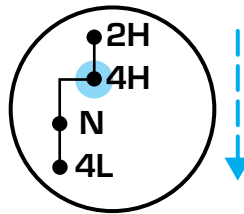
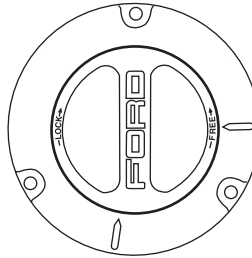

**Shifting from 4H (4WD High) to 2H (2WD High)**

Move the transfer case lever to 2H (2WD High) at a stop or a vehicle speed below 3 mph (5 km/h).

With the vehicle at complete stop, disengage the locking hubs (optional) by rotating the hub lock control from LOCK to FREE.

- **For proper operation, make sure that both indicator arrows on the hub are aligned, and that both hubs are set to FREE**

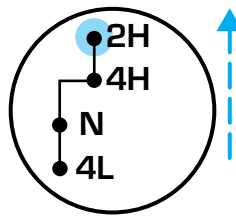

**Shifting from 4H (4WD High) to 4L (4WD Low)**

1. Bring the vehicle to a complete stop.
2. Place the gearshift lever in N (Neutral).

## Driving

3. Move the transfer case shift lever through N (Neutral) directly to 4L (4WD Low). If the shift lever does not, or only partially moves to the 4L (4WD Low) position, perform a shift with the transmission in N (Neutral) and the vehicle rolling at a speed below 3 mph (5 km/h). This will ensure the transfer case is fully engaged into 4L (4WD Low).

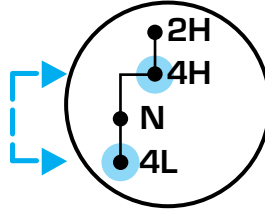

### **Shifting from 4L (4WD Low) to 4H (4WD High) or 2H (2WD High)**

1. Bring the vehicle to a speed below 3 mph (5 km/h).
2. Place the gearshift lever in N (Neutral).
3. Move the transfer case shift lever through N (Neutral) directly to 4H (4WD High) or 2H (2WD High).

4. If the transfer case **will not** engage into 4H (4WD High) or 2H (2WD High), let the vehicle creep at a speed above 1 mph (1.6 km/h), then repeat steps 2 and 3.

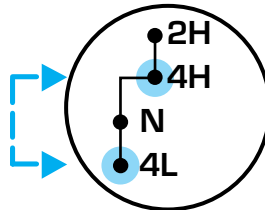

5. If shifting to 2H (2WD High) with the vehicle at a complete stop, disengage the locking hubs (optional) by rotating the hub lock control from LOCK to FREE.

### **Using the N (Neutral) position**

**The transfer case neutral position overrides the transmission and puts the vehicle in neutral regardless of transmission gearshift lever position. The vehicle can move forward or backwards.**

This position should only be used when towing the vehicle.

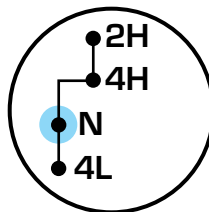

## Driving

 Do not leave the vehicle unattended with the transfer case in the N (Neutral) position. Always set the parking brake fully and turn off the ignition when leaving the vehicle.

### Using the Electronic Shift On the Fly (ESOF) 4WD system (if equipped)

#### *Positions of the electronic shift system*

The electronic shift 4WD system is designed to allow up to 45 seconds before a shift command is performed. In the event that conflicting shift commands are selected, allow up to 45 seconds for the shift command to be performed prior to reporting any shift concerns to your authorized dealer.

**Note:** Some noise may be heard as the 4WD system shifts or engages. This is normal.

**2H (2WD High)** – For general on-road driving. Sends power to the rear wheels only.

**4H (4WD High)** – For winter and off-road conditions. Sends power to front and rear wheels.

**4L (4WD Low)** – For low-speed off-road applications that require extra power such as steep grades, deep sand or pulling a boat out of the water. Sends power to front and rear wheels.

#### **Shifting from 2WD (2WD High) to 4x4 HIGH (4WD High)**

Rotate the 4WD control to the 4x4 HIGH position at speeds up to 55 mph (88 km/h).

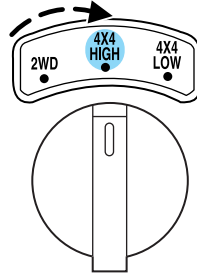

- **The electronic shift 4WD system is designed to engage 4x4 HIGH (4WD High) when the vehicle is moving. If shifted to 4x4 HIGH (4WD HIGH) while at complete stop, 4x4 may not engage and the 4x4 indicator may not illuminate until the vehicle is allowed to move at a speed above 1 mph (1.6 km/h).**
- **Do not shift into 4x4 HIGH with the rear wheels slipping.**

## Driving

### **Shifting from 4x4 HIGH (4WD High) to 2WD (2WD High)**

Rotate the 4WD control to 2WD at any forward speed. Disengagement of the transfer case and front hubs may be delayed due to torque bind which is caused by driving on dry hard surfaces or performing tight turns while using the 4WD system.

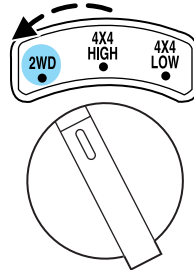

- You **do not** need to operate the vehicle in R (Reverse) to disengage your front hubs, but it will eliminate any torque bind and allow the system to immediately disengage.

### **Shifting from 4x4 HIGH (4WD High) to 4x4 LOW (4WD Low)**

1. Bring the vehicle to a complete stop.
2. Depress the brake.
3. Place the gearshift in N (Neutral).
4. Move the 4WD control to the 4x4 LOW position.
5. Hold the shift conditions until the LOW RANGE indicator light illuminates.
6. If the LOW RANGE indicator light **does not** illuminate within 15 seconds, let the vehicle creep at a speed above 1 mph (1.6 km/h), then repeat steps 3 through 5 before reporting any shift concerns to your authorized dealer.

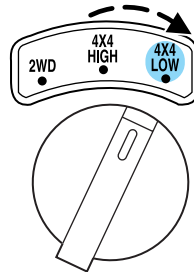

### **Shifting from 4x4 LOW (4WD Low) to 4x4 HIGH (4WD High) or 2WD (2WD High)**

1. Bring the vehicle to a complete stop.
2. Depress the brake.
3. Place the gearshift in N (Neutral).

4. Move the 4WD control to the 4x4 HIGH (4WD High) or 2WD (2WD High) position.

5. Hold the shift conditions until the LOW RANGE indicator light shuts off.

6. If the LOW RANGE indicator light **does not** shut off within 15 seconds, allow the vehicle to move at a speed above 1 mph (1.6 km/h), then repeat steps 3 through 5 before reporting any shift concerns to your authorized dealer.

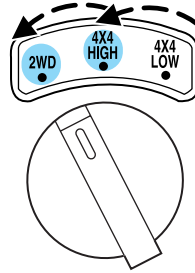

### Driving off-road with truck and utility vehicles

4WD vehicles are specially equipped for driving on sand, snow, mud and rough terrain and have operating characteristics that are somewhat different from conventional vehicles, both on and off the road.

#### **How your vehicle differs from other vehicles**

Truck and utility vehicles can differ from some other vehicles. Your vehicle may be higher to allow it to travel over rough terrain without getting hung up or damaging underbody components.

The differences that make your vehicle so versatile also make it handle differently than an ordinary passenger car.

Maintain steering wheel control at all times, especially in rough terrain. Since sudden changes in terrain can result in abrupt steering wheel motion, make sure you grip the steering wheel from the outside. Do not grip the spokes.

Drive cautiously to avoid vehicle damage from concealed objects such as rocks and stumps.

You should either know the terrain or examine maps of the area before driving. Map out your route before driving in the area. To maintain steering and braking control of your vehicle, you must have all four wheels on the ground and they must be rolling, not sliding or spinning.

#### **Basic operating principles**

- Do not use 4WD on dry, hard surfaced roads. Doing so will produce excessive noise, increase tire wear and may damage drive components. 4WD modes are only intended for consistently slippery or loose surfaces.

## Driving

- Drive slower in strong crosswinds which can affect the normal steering characteristics of your vehicle.
- Be extremely careful when driving on pavement made slippery by loose sand, water, gravel, snow or ice.

### ***If your vehicle goes off the edge of the pavement***

- If your vehicle goes off the edge of the pavement, slow down, but avoid severe brake application, ease the vehicle back onto the pavement only after reducing your speed. Do not turn the steering wheel too sharply while returning to the road surface.
- It may be safer to stay on the apron or shoulder of the road and slow down gradually before returning to the pavement. You may lose control if you do not slow down or if you turn the steering wheel too sharply or abruptly.
- It often may be less risky to strike small objects, such as highway reflectors, with minor damage to your vehicle rather than attempt a sudden return to the pavement which could cause the vehicle to slide sideways out of control or roll over. Remember, your safety and the safety of others should be your primary concern.



Vehicles with a higher center of gravity such as utility and four-wheel drive vehicles handle differently than vehicles with a lower center of gravity. Utility and four-wheel drive vehicles are **not** designed for cornering at speeds as high as passenger cars any more than low-slung sports cars are designed to perform satisfactorily under off-road conditions. Avoid sharp turns, excessive speed and abrupt maneuvers in these vehicles. Failure to drive cautiously could result in an increased risk of loss of vehicle control, vehicle rollover, personal injury and death.

### ***If your vehicle gets stuck***

If your vehicle gets stuck in mud or snow it may be rocked out by shifting between forward and reverse gears, stopping between shifts, in a steady pattern. Press lightly on the accelerator in each gear.

**Do not rock the vehicle if the engine is not at normal operating temperature or damage to the transmission may occur.**

**Do not rock the vehicle for more than a few minutes or damage to the transmission and tires may occur or the engine may overheat.**



## Driving



Do not spin the wheels at over 35 mph (56 km/h). The tires may fail and injure a passenger or bystander.

Refer to *Transmission temperature gauge* in the *Instrument Cluster* chapter for transmission fluid temperature information.

### Emergency maneuvers

- In an unavoidable emergency situation where a sudden sharp turn must be made, remember to avoid “over-driving” your vehicle, i.e., turn the steering wheel only as rapidly and as far as required to avoid the emergency. Excessive steering will result in less vehicle control, not more. Additionally, smooth variations of the accelerator and/or brake pedal pressure should be utilized if changes in vehicle speed are called for. Avoid abrupt steering, acceleration or braking which could result in an increased risk of loss of vehicle control, vehicle rollover and/or personal injury. Use all available road surface to return the vehicle to a safe direction of travel.
- In the event of an emergency stop, avoid skidding the tires and do not attempt any sharp steering wheel movements.



Vehicles with a higher center of gravity such as utility and four-wheel drive vehicles handle differently than vehicles with a lower center of gravity. Utility and four-wheel drive vehicles are **not** designed for cornering at speeds as high as passenger cars any more than low-slung sports cars are designed to perform satisfactorily under off-road conditions. Avoid sharp turns, excessive speed and abrupt maneuvers in these vehicles. Failure to drive cautiously could result in an increased risk of loss of vehicle control, vehicle rollover, personal injury and death.

- If the vehicle goes from one type of surface to another (i.e., from concrete to gravel) there will be a change in the way the vehicle responds to a maneuver (steering, acceleration or braking). Again, avoid these abrupt inputs.

### Parking

On some 4WD vehicles, when the transfer case is in the N (Neutral) position, the engine and transmission are disconnected from the rest of the driveline. Therefore, the vehicle is free to roll even if the automatic transmission is in P (Park) or the manual transmission is in gear. Do not leave the vehicle unattended with the transfer case in the N (Neutral) position. Always set the parking brake fully and turn off the ignition when leaving the vehicle.

## Driving

 Always set the parking brake fully and make sure the gearshift is latched in P (Park). Turn the ignition to the LOCK position and remove the key whenever you leave your vehicle.

 If the parking brake is fully released, but the brake warning lamp remains illuminated, the brakes may not be working properly. See your authorized dealer.

### 4WD Systems

4WD (when you select a 4WD mode), uses all four wheels to power the vehicle. This increases traction, enabling you to drive over terrain and road conditions that a conventional two-wheel drive vehicle cannot.

Power is supplied to all four wheels through a transfer case. On 4WD vehicles, the transfer case allows you to select 4WD when necessary. Information on transfer case operation and shifting procedures can be found in the *Driving* chapter. Information on transfer case maintenance can be found in the *Maintenance and Specifications* chapter. You should become thoroughly familiar with this information before you operate your vehicle.

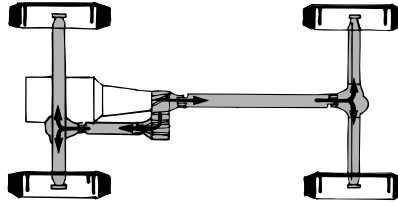

#### **Normal characteristics**

On some 4WD models, the initial shift from two-wheel drive to 4x4 while the vehicle is moving can cause some momentary clunk and ratcheting sounds. This is the front drivetrain coming up to speed and the automatic locking hubs engaging and is not cause for concern.

#### **Sand**

When driving over sand, try to keep all four wheels on the most solid area of the trail. Avoid reducing the tire pressures but shift to a lower gear and drive steadily through the terrain. Apply the accelerator slowly and avoid spinning the wheels.

Avoid excessive speed because vehicle momentum can work against you and cause the vehicle to become stuck to the point that assistance may be required from another vehicle. Remember, you may be able to back out the way you came if you proceed with caution.

### **Mud and water**

If you must drive through high water, drive slowly. Traction or brake capability may be limited.

When driving through water, determine the depth; avoid water higher than the bottom of the hubs (if possible) and proceed slowly. If the ignition system gets wet, the vehicle may stall.



Once through water, always try the brakes. Wet brakes do not stop the vehicle as effectively as dry brakes. Drying can be improved by moving your vehicle slowly while applying light pressure on the brake pedal.

Be cautious of sudden changes in vehicle speed or direction when you are driving in mud. Even 4WD vehicles can lose traction in slick mud. As when you are driving over sand, apply the accelerator slowly and avoid spinning your wheels. If the vehicle does slide, steer in the direction of the slide until you regain control of the vehicle.

If the transmission, transfer case or front axle are submerged in water, their fluids should be checked and changed, if necessary.

### **Driving through deep water may damage the transmission.**

Refer to *Transmission temperature gauge* in the *Instrument Cluster* chapter for transmission fluid temperature information.

If the front or rear axle is submerged in water, the axle lubricant should be replaced.

After driving through mud, clean off residue stuck to rotating driveshafts and tires. Excess mud stuck on tires and rotating driveshafts causes an imbalance that could damage drive components.

“Tread Lightly” is an educational program designed to increase public awareness of land-use regulations and responsibilities in our nation’s wilderness areas. Ford Motor



Company joins the U.S. Forest Service and the Bureau of Land Management in encouraging you to help preserve our national forest and other public and private lands by “treading lightly.”

## Driving

### ***Driving on hilly or sloping terrain***

Although natural obstacles may make it necessary to travel diagonally up or down a hill or steep incline, you should always try to drive straight up or straight down. **Avoid driving crosswise or turning on steep slopes or hills.** A danger lies in losing traction, slipping sideways and possibly rolling over. Whenever driving on a hill, determine beforehand the route you will use. Do not drive over the crest of a hill without seeing what conditions are on the other side. Do not drive in reverse over a hill without the aid of an observer.

When climbing a steep slope or hill, start in a lower gear rather than downshifting to a lower gear from a higher gear once the ascent has started. This reduces strain on the engine and the possibility of stalling.

If you do stall out, do not try to turn around because you might roll over. It is better to back down to a safe location.

Apply just enough power to the wheels to climb the hill. Too much power will cause the tires to slip, spin or lose traction, resulting in loss of vehicle control.

Descend a hill in the same gear you would use to climb up the hill to avoid excessive brake application and brake overheating. Do not descend in neutral; instead, manually shift to a lower gear. Your vehicle has anti-lock brakes, apply the brakes steadily. Do not “pump” the brakes.

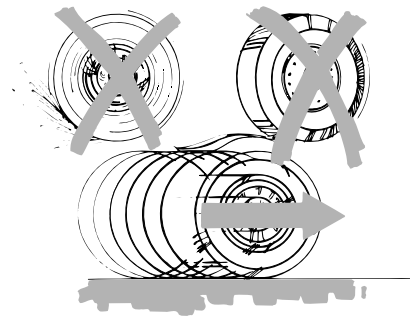
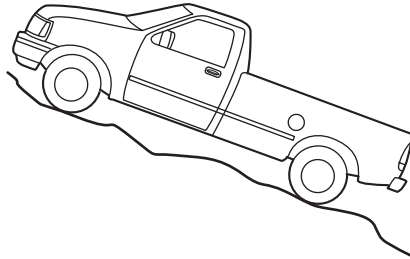

### ***Driving on snow and ice***

4WD vehicles have advantages over 2WD vehicles in snow and ice but can skid like any other vehicle.

## Driving

Should you start to slide while driving on snowy or icy roads, turn the steering wheel in the direction of the slide until you regain control.

Avoid sudden applications of power and quick changes of direction on snow and ice. Apply the accelerator slowly and steadily when starting from a full stop.

Avoid sudden braking as well. Although a 4WD vehicle may accelerate better than a two-wheel drive vehicle in snow and ice, it won't stop any faster, because as in other vehicles, braking occurs at all four wheels. Do not become overconfident as to road conditions.

Make sure you allow sufficient distance between you and other vehicles for stopping. Drive slower than usual and consider using one of the lower gears. In emergency stopping situations, avoid locking of the wheels. Use a "squeeze" technique, push on the brake pedal with a steadily increasing force which allows the wheels to brake yet continue to roll so that you may steer in the direction you want to travel. If you lock the wheels, release the brake pedal and repeat the squeeze technique. If your vehicle is equipped with a Four Wheel Anti-Lock Brake System (ABS), apply the brake steadily. Do not "pump" the brakes. Refer to the *Brakes* section of this chapter for additional information on the operation of the anti-lock brake system.

Never drive with chains on the front tires of 4WD vehicles without also putting them on the rear tires. This could cause the rear to slide and swing around during braking.

### **Maintenance and Modifications**

The suspension and steering systems on your vehicle have been designed and tested to provide predictable performance whether loaded or empty and durable load carrying capability. For this reason, Ford Motor Company strongly recommends that you do not make modifications such as adding or removing parts (such as lift kits or stabilizer bars) or by using replacement parts not equivalent to the original factory equipment.

Any modifications to a vehicle that raise the center of gravity can make it more likely the vehicle will roll over as a result of a loss of control. Ford Motor Company recommends that caution be used with any vehicle equipped with a high load or device (such as ladder racks or pickup box cover).

Failure to maintain your vehicle properly may void the warranty, increase your repair cost, reduce vehicle performance and operational capabilities and adversely affect driver and passenger safety. Frequent inspection of vehicle chassis components is recommended if the vehicle is subjected to heavy off-road usage.

## Driving

### VEHICLE USED AS A STATIONARY POWER SOURCE

Auxiliary equipment called power take-off, or PTO, is often added to the engine or transmission to operate utility equipment. Examples include a wheel-lift for tow trucks, tools for construction and cranes. PTO applications draw auxiliary horsepower from the powertrain, often while the vehicle is stationary. In this condition, there is limited cooling air flow through the radiator and around the vehicle that normally occurs when a vehicle is moving. Depending on the level and duration of auxiliary horsepower draw, vehicle conditions and surrounding environmental conditions and other factors, this can contribute to elevated transmission fluid temperatures and result in accelerated fluid deterioration, fuel vapor over-pressurization, and other concerns. Ford trucks are fully qualified for stationary PTO operation for 10 minutes or less of continuous operation. For stationary PTO operation of extended duration (beyond 10 minutes), diesel engine is recommended. Further consult your aftermarket PTO installer, since the duration of operation limit for the aftermarket PTO may be less than 10 minutes.

A more complete description of PTO operation is discussed in the Ford Truck Body Builders Layout Book, found at [www.fleet.ford.com/truckbbas](http://www.fleet.ford.com/truckbbas).

### DRIVING THROUGH WATER

If driving through deep or standing water is unavoidable, proceed very slowly especially when the depth is not known. Never drive through water that is higher than the bottom of the hubs (for trucks) or the bottom of the wheel rims (for cars). When driving through water, traction or brake capability may be limited. Also, water may enter your engine's air intake and severely damage your engine or your vehicle may stall. **Driving through deep water where the transmission vent tube is submerged may allow water into the transmission and cause internal transmission damage.**

**Once through the water, always dry the brakes by moving your vehicle slowly while applying light pressure on the brake pedal.** Wet brakes do not stop the vehicle as quickly as dry brakes.

### SNOWPLOWING

Ford recommends that the Super Duty F-Series used for snow removal include a snow plow package option.

#### Installing the snowplow

Weight limits and guidelines for selecting and installing the snowplow can be found in the *Ford Truck Body Builders Layout Book*, Snowplow section, found at [www.fleet.ford.com/truckbbas](http://www.fleet.ford.com/truckbbas). A typical installation affects the following:

- Certification to government safety laws such as occupant protection and airbag deployment, braking, and lighting. Look for an “Alterer’s Label” on the vehicle from the snowplow installer certifying that the installation meets all applicable Federal Motor Vehicle Safety Standards (FMVSS).
- The Total Accessory Reserve Capacity (TARC) is shown on the lower right side of the vehicle’s Safety Compliance Certification Label. This applies to Ford-completed vehicles of 10,000 lb. (4,536 kg) GVWR or less. This is the weight of permanently-attached auxiliary equipment, such as snowplow frame-mounting hardware, that can be added to the vehicle and satisfy Ford compliance certification to FMVSS. Exceeding this weight may require the auxiliary equipment installer additional safety certification responsibility. The Front Accessory Reserve Capacity (FARC) is added for customer convenience.
- Rear ballast weight behind the rear axle may be required to prevent exceeding the FGAWR, and provide front-to-rear weight balance for proper braking and steering.
- Front wheel toe may require re-adjustment to prevent premature uneven tire wear. Specifications are found in the *Ford Workshop Manual*.
- Headlight aim may require re-adjustment.
- Federal and some local regulations require additional exterior lamps for snowplow-equipped vehicles. Consult your authorized dealer for additional information.
- Snowplowing with vehicles equipped with a 6.0 Liter Power Stroke diesel engine may result in engine overheating under certain operating conditions unless equipped with the special engine cooling fan clutch that is included with a snow plow package option.

## Driving

### Operating the vehicle with the snowplow attached

Do not use your vehicle for snow removal until it has been driven at least 500 miles (800 km).

The attached snowplow blade restricts airflow to the radiator, and may cause the engine to run at a higher temperature:

- If you are driving more than 15 miles (24 km) where outside air temperatures are above freezing, then angle the plow blade to full left or right to maximize airflow to the radiator.
- If you are driving less than 15 miles (24 km) at speeds up to 40 mph (64 km/h) in cold weather you will not need to adjust blade position

Follow the severe duty schedule in your *scheduled maintenance information* for engine oil and transmission fluid change intervals.

### Snowplowing with your airbag-equipped vehicle

Your vehicle is equipped with a driver and passenger airbag Supplemental Restraint System (SRS). The SRS is designed to activate in certain frontal and offset frontal collisions when the vehicle sustains sufficient longitudinal deceleration.

Careless or high speed driving while plowing snow which results in sufficient vehicle decelerations can deploy the airbag. Such driving also increases the risk of accidents.



All occupants of the vehicle, including the driver, should always properly wear their safety belts, even when an air bag supplemental restraint system (SRS) is provided.

Never remove or defeat the “tripping mechanisms” designed into the snow removal equipment by its manufacturer. Doing so may cause damage to the vehicle and the snow removal equipment as well as possible airbag deployment.



Do not attempt to service, repair, or modify the air bag supplemental restraint system (SRS) or its fuses. See your Ford or Lincoln Mercury dealer.



Additional equipment such as snowplow equipment may effect the performance of the airbag sensors increasing the risk of injury. Please refer to the *Body Builders Layout Book* for instructions about the appropriate installation of additional equipment.



### **Transmission operation while plowing**

Operate the vehicle with the automatic transmission gearshift lever in the D (Overdrive) position and Tow/Haul OFF.

- Shift transfer case to 4x4 LOW (4WD Low) when plowing in small areas at speeds below 5 mph (8 km/h).
- Shift transfer case to 4x4 HIGH (4WD High) when plowing larger areas or light snow at higher speeds. Do not exceed 15 mph (24 km/h).
- Do not shift the transmission from a forward gear to R (Reverse) until the engine is at idle and the wheels are stopped.
- If the vehicle is stuck, shift the transmission in a steady motion between forward and reverse gears. Do not rock the vehicle for more than a few minutes. The transmission and tires may be damaged or the engine can overheat.

**Do not rock the vehicle if the engine is not at normal operating temperature. Do not rock the vehicle for more than a minute. The transmission and tires may be damaged or the engine may overheat.**

Refer to *Transmission temperature gauge* in the *Instrument Cluster* chapter for transmission fluid temperature information.



Do not spin the wheels at over 35 mph (55 km/h). The tires may fail and injure a passenger or bystander.

### **Removing the snowplow frame mount**

A metal crossmember is included below the front bumper on Super Duty vehicles called a “BlockerBeam”. Typical snowplow installations require removal of this BlockerBeam to install the snowplow mounting hardware to the vehicle frame.

**The BlockerBeam must be re-installed if the snowplow frame-mounting hardware is removed from the vehicle to ensure proper airbag deployment in a crash.**

## Roadside Emergencies

### ROADSIDE ASSISTANCE

#### Getting roadside assistance

To fully assist you should you have a vehicle concern, Ford Motor Company offers a complimentary roadside assistance program. This program is separate from the New Vehicle Limited Warranty. The service is available:

- 24-hours, seven days a week
- for the New Vehicle Limited Warranty period of three years or 36,000 miles (60,000 km), whichever occurs first on Ford and Mercury vehicles, and four years or 50,000 miles (80,000 km) on Lincoln vehicles.

Roadside assistance will cover:

- a flat tire change with a good spare (except Ford GT which has a tire inflation kit)
- battery jump start
- lock-out assistance (key replacement cost is the customer's responsibility)
- fuel delivery – Independent Service Contractors, if not prohibited by state, local or municipal law shall deliver up to 2.0 gallons (7.5L) of gasoline or 5 gallons (18.9L) of diesel fuel to a disabled vehicle.
- winch out – available within 100 feet (30.5 meters) of a paved or county maintained road, no recoveries.
- towing – Ford/Mercury/Lincoln eligible vehicle towed to an authorized dealer within 35 miles (56.3 km) of the disablement location or to the nearest authorized dealer. If a member requests to be towed to an authorized dealer more than 35 miles (56.3 km) from the disablement location, the member shall be responsible for any mileage costs in excess of 35 miles (56.3 km).

Trailers shall be covered up to \$100 if the disabled eligible vehicle requires service at the nearest authorized dealer. If the trailer is disabled, but the towing vehicle is operational, the trailer does not qualify for any roadside services.

## Roadside Emergencies

### **Canadian customers refer to your Owner Information Guide for information on:**

- coverage period
- exact fuel amounts
- towing of your disabled vehicle
- emergency travel expense reimbursement
- travel planning benefits

### **Using roadside assistance**

Complete the roadside assistance identification card and place it in your wallet for quick reference. In the United States, this card is found in the Owner Guide portfolio in the glove compartment. In Canada, the card is found in the *Owner Information Guide* in the glove compartment.

U.S. Ford or Mercury vehicle customers who require roadside assistance, call 1-800-241-3673; Lincoln vehicle customers call 1-800-521-4140.

Canadian customers who require roadside assistance, call 1-800-665-2006.

If you need to arrange roadside assistance for yourself, Ford Motor Company will reimburse a reasonable amount. To obtain reimbursement information, U.S. Ford or Mercury vehicles customers call 1-800-241-3673; Lincoln vehicle customers call 1-800-521-4140.

Canadian customers who need to obtain reimbursement information, call 1-800-665-2006.

### **Roadside coverage beyond basic warranty**

In the United States, you may purchase additional roadside assistance coverage beyond this period through the Ford Auto Club by contacting your authorized dealer.

Similarly in Canada, for uninterrupted Roadside Assistance coverage, you may purchase extended coverage prior to your Basic Warranty's Roadside Assistance expiring. For more information and enrollment, contact 1-877-294-2582 or visit our website at [www.ford.ca](http://www.ford.ca).

## Roadside Emergencies

### HAZARD FLASHER

The hazard flasher is located on the steering column, just behind the steering wheel. The hazard flashers will operate when the ignition is in any position or if the key is not in the ignition.

Push in the flasher control and all front and rear direction signals will flash. Press the flasher control again to turn them off. Use it when your vehicle is disabled and is creating a safety hazard for other motorists.

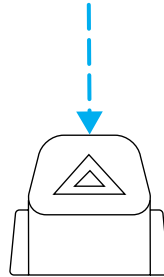

**Note:** With extended use, the flasher may run down your battery.

### FUEL PUMP SHUT-OFF SWITCH

This device stops the electric fuel pump from sending fuel to the engine when your vehicle has had a substantial jolt.

After an accident, if the engine cranks but does not start, this switch may have been activated.

## Roadside Emergencies

This switch is located in the front passenger's footwell, behind the kick panel access cover.

To reset the switch:

1. Turn the ignition off.
2. Check the fuel system for leaks.
3. If no leaks are apparent, reset the switch by pushing in on the reset button.
4. Turn the ignition on.
5. Wait a few seconds and return the key to off.
6. Make another check for leaks.

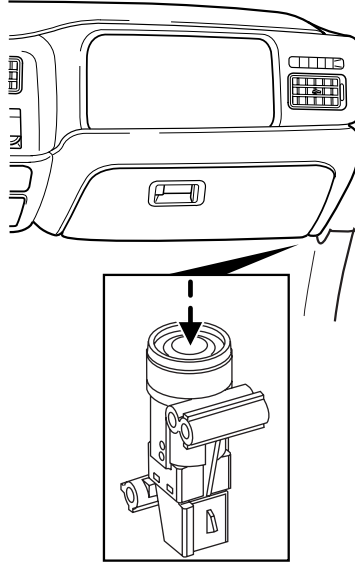

## FUSES AND RELAYS

### Fuses

If electrical components in the vehicle are not working, a fuse may have blown. Blown fuses are identified by a broken wire within the fuse. Check the appropriate fuses before replacing any electrical components.

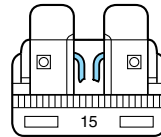

**Note:** Always replace a fuse with one that has the specified amperage rating. Using a fuse with a higher amperage rating can cause severe wire damage and could start a fire.

## Roadside Emergencies

### Standard fuse amperage rating and color

| Fuse rating | COLOR      |                |            |                      |                     |
|-------------|------------|----------------|------------|----------------------|---------------------|
|             | Mini fuses | Standard fuses | Maxi fuses | Cartridge maxi fuses | Fuse link cartridge |
| 2A          | Grey       | Grey           | —          | —                    | —                   |
| 3A          | Violet     | Violet         | —          | —                    | —                   |
| 4A          | Pink       | Pink           | —          | —                    | —                   |
| 5A          | Tan        | Tan            | —          | —                    | —                   |
| 7.5A        | Brown      | Brown          | —          | —                    | —                   |
| 10A         | Red        | Red            | —          | —                    | —                   |
| 15A         | Blue       | Blue           | —          | —                    | —                   |
| 20A         | Yellow     | Yellow         | Yellow     | Blue                 | Blue                |
| 25A         | Natural    | Natural        | —          | —                    | —                   |
| 30A         | Green      | Green          | Green      | Pink                 | Pink                |
| 40A         | —          | —              | Orange     | Green                | Green               |
| 50A         | —          | —              | Red        | Red                  | Red                 |
| 60A         | —          | —              | Blue       | —                    | Yellow              |
| 70A         | —          | —              | Tan        | —                    | Brown               |
| 80A         | —          | —              | Natural    | —                    | Black               |

### Passenger compartment fuse panel

The fuse panel is located below and to the left of the steering wheel by the brake pedal. Remove the panel cover to access the fuses.

To remove the fuse panel cover, pull the panel downward by the finger slots on top of the panel. When the top clips of the panel disengage, let the panel fall easily.

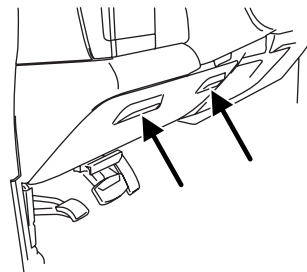

## Roadside Emergencies

To remove a fuse use the fuse puller tool provided on the fuse panel cover.

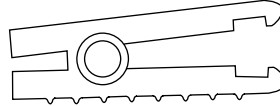

To reinstall the cover, align and engage the two hooked clips at the bottom of the cover onto the instrument panel, then lift the panel and press the top clips firmly into place.

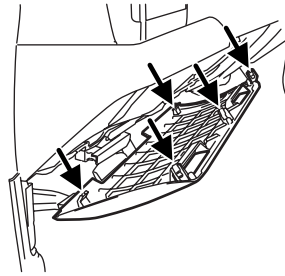

Always disconnect the battery before servicing high current fuses.

**Always replace the cover to the passenger compartment fuse panel before reconnecting the battery.**

If the battery has been disconnected and reconnected, refer to the *Battery* section of the *Maintenance and Specifications* chapter.

## Roadside Emergencies

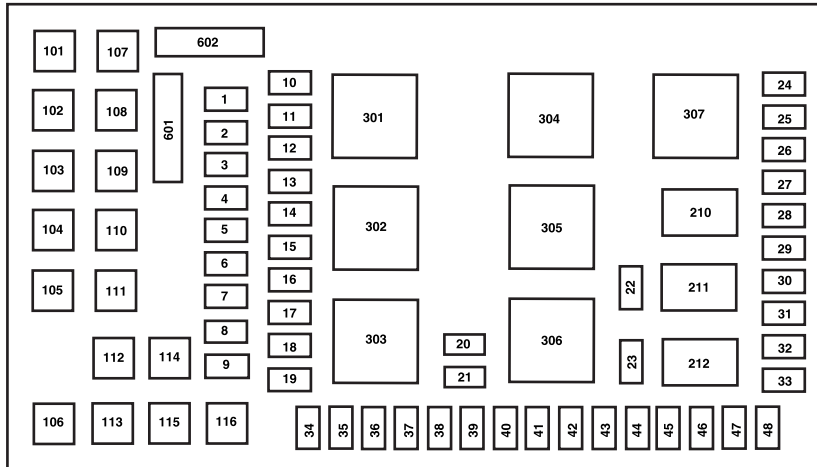

The fuses are coded as follows.

| Fuse/Relay Location | Fuse Amp Rating | Passenger Compartment Fuse Panel Description |
|---------------------|-----------------|--|
| 1                   | 15A*            | Adjustable pedals                            |
| 2                   | 10A*            | Cluster                                      |
| 3                   | 10A*            | Upfitter #3                                  |
| 4                   | 20A*            | Power point (Instrument panel)               |
| 5                   | 10A*            | Upfitter #4                                  |
| 6                   | —               | Not used                                     |
| 7                   | 30A*            | High beam headlamps, Flash-to-pass           |
| 8                   | 20A*            | Back-up lamps                                |
| 9                   | —               | Not used                                     |
| 10                  | —               | Not used                                     |
| 11                  | 20A*            | Radio (Main)                                 |
| 12                  | 20A*            | Cigar lighter, OBD II                        |
| 13                  | 5A*             | Power mirrors                                |
| 14                  | —               | Not used                                     |



## Roadside Emergencies

| Fuse/Relay Location | Fuse Amp Rating | Passenger Compartment Fuse Panel Description                               |
|---------------------|-----------------|--|
| 15                  | —               | Not used   |
| 16                  | —               | Not used   |
| 17                  | 15A*            | Exterior lamps   |
| 18                  | 20A*            | Flasher, Brake On-Off (BOO) lamps  |
| 19                  | 10A*            | Body Security Module (BSM) (Security)                                      |
| 20                  | 15A*            | Trailer tow Electric Brake Controller (EBC)                                |
| 21                  | 20A*            | Heated seats   |
| 22                  | 20A*            | Engine control   |
| 23                  | 20A*            | Engine control (gasoline engine only)/Climate control (Diesel engine only) |
| 24                  | 15A*            | Tow haul, Blower relay, Electronic Automatic Temperature Control (EATC)    |
| 25                  | —               | Not used   |
| 26                  | 10A*            | Airbags  |
| 27                  | 15A*            | Ignition switch RUN feed   |
| 28                  | 10A*            | Trailer tow EBC logic  |
| 29                  | 10A*            | Customer access  |
| 30                  | 15A*            | High beam headlamps  |
| 31                  | 15A*            | Starter relay  |
| 32                  | 5A*             | Radio (start)  |
| 33                  | 15A*            | Cluster, 4x4, Wipers   |
| 34                  | 10A*            | BOO switch (Low current)   |
| 35                  | 10A*            | Instrument cluster   |
| 36                  | —               | Not used   |
| 37                  | 15A*            | Horn   |
| 38                  | 20A*            | Trailer tow park lamps   |
| 39                  | 15A*            | Heated mirrors   |

## Roadside Emergencies

| Fuse/Relay Location | Fuse Amp Rating | Passenger Compartment Fuse Panel Description |
|---------------------|-----------------|--|
| 40                  | 20A*            | Fuel pump                                    |
| 41                  | 10A*            | Instrument cluster                           |
| 42                  | 15A*            | Delayed accessory                            |
| 43                  | 10A*            | Fog lamps                                    |
| 44                  | —               | Not used                                     |
| 45                  | 10A*            | Ignition switch RUN/START feed               |
| 46                  | 10A*            | Left-hand low beam headlamp                  |
| 47                  | 10A*            | Right-hand low beam headlamp                 |
| 48                  | —               | Not used                                     |
| 101                 | 30A**           | Trailer tow EBC                              |
| 102                 | 30A**           | BSM (Door locks)                             |
| 103                 | 30A**           | Ignition switch                              |
| 104                 | —               | Not used                                     |
| 105                 | —               | Not used                                     |
| 106                 | —               | Not used                                     |
| 107                 | 20A**           | Trailer tow battery charge                   |
| 108                 | 30A**           | Upfitter #1                                  |
| 109                 | 30A**           | Upfitter #2                                  |
| 110                 | 30A**           | Ignition switch                              |
| 111                 | —               | Not used                                     |
| 112                 | 30A**           | Power seat (Driver)                          |
| 113                 | 30A**           | Starter                                      |
| 114                 | 30A**           | Power seat (Passenger)                       |
| 115                 | 20A**           | Upfitter control                             |
| 116                 | 30A**           | Ignition switch                              |
| 210                 | —               | Not used                                     |
| 211                 | ½ ISO relay     | Back-up lamps                                |
| 212                 | —               | Not used                                     |
| 301                 | Full ISO relay  | Trailer tow battery charge                   |
| 302                 | Full ISO relay  | Powertrain Control Module (PCM)              |
| 303                 | —               | Not used                                     |

## Roadside Emergencies

| Fuse/Relay Location | Fuse Amp Rating     | Passenger Compartment Fuse Panel Description |
|---------------------|---------------------|--|
| 304                 | —                   | Not used                                     |
| 305                 | Full ISO relay      | Upfitter control                             |
| 306                 | Full ISO relay      | Delayed accessory                            |
| 307                 | Full ISO relay      | Starter                                      |
| 601                 | 30A circuit breaker | Delayed accessory, Power windows, Moonroof   |
| 602                 | —                   | Not used                                     |

\* Mini fuse \*\* Cartridge fuse

### Power distribution box

The power distribution box is located in the engine compartment. The power distribution box contains high-current fuses that protect your vehicle's main electrical systems from overloads.



Always disconnect the battery before servicing high current fuses.



To reduce risk of electrical shock, always replace the cover to the Power Distribution Box before reconnecting the battery or refilling fluid reservoirs.

If the battery has been disconnected and reconnected, refer to the *Battery* section of the *Maintenance and Specifications* chapter.

## Roadside Emergencies

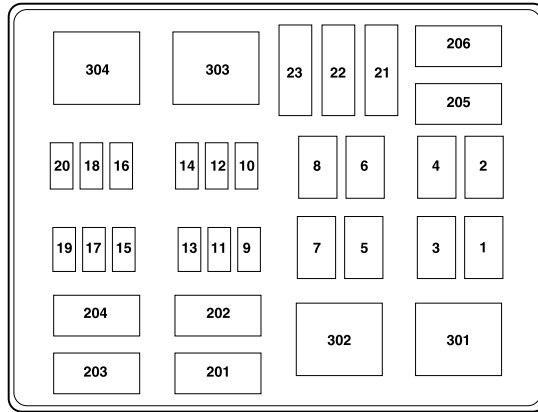

The high-current fuses and relays are coded as follows.

| Fuse/Relay Location | Fuse Amp Rating | Power Distribution Box Description  |
|---------------------|-----------------|---|
| 1                   | 30A*            | Wipers  |
| 2                   | 40A*            | Blower  |
| 3                   | 30A*            | Electronic Shift on the Fly (ESOF)  |
| 4                   | —               | Not used  |
| 5                   | 50A*            | Injector Driver Module (IDM) (Diesel engine only)   |
| 6                   | —               | Not used  |
| 7                   | 30A*            | Horizontal Fuel Conditioner Module (HFCM) (Diesel engine only)                                  |
| 8                   | —               | Shunt   |
| 9                   | 20A**           | Trailer tow turn signals  |
| 10                  | 10A**           | Powertrain Control Module (PCM) keep alive power, Canister vent solenoid (gasoline engine only) |
| 11                  | 10A**           | Anti-lock Brake System (ABS)  |

## Roadside Emergencies

| Fuse/Relay Location | Fuse Amp Rating    | Power Distribution Box Description      |
|---------------------|--------------------|---|
| 12                  | 2A**               | Brake pressure switch                   |
| 13                  | 15A**              | Daytime Running Lamps (DRL)             |
| 14                  | —                  | Not used                                |
| 15                  | 15A**              | IDM logic (Diesel engine only)          |
| 16                  | —                  | Not used                                |
| 17                  | 10A**              | A/C clutch                              |
| 18                  | 10A**              | IDM relay (Diesel engine only)          |
| 19                  | —                  | Not used                                |
| 20                  | 10A**              | Trailer tow back-up lamps               |
| 21                  | —                  | Not used                                |
| 22                  | 60A***             | ABS (Coils)                             |
| 23                  | 60A***             | ABS (Pump)                              |
| 201                 | ½ ISO relay        | Trailer tow right turn signal/stop lamp |
| 202                 | ½ ISO relay        | Trailer tow left turn signal/stop lamp  |
| 203                 | ½ ISO relay        | A/C clutch                              |
| 204                 | —                  | Not used                                |
| 205                 | ½ ISO relay        | DRL #1                                  |
| 206                 | ½ ISO relay        | DRL #2                                  |
| 301                 | Full ISO relay     | DRL #3                                  |
| 302                 | Full ISO relay     | HFCM                                    |
| 303                 | Full ISO relay     | Blower                                  |
| 304                 | High-current relay | IDM (Diesel engine only)                |

\* Cartridge Fuse \*\* Mini Fuses \*\*\* Maxi fuse

## Roadside Emergencies

### Relays

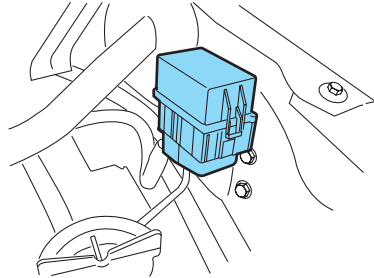

An auxiliary relay box is located in the left-hand front side of the engine compartment. This box contains relays for the Electronic Shift On the Fly (ESOF) system. Please see your authorized dealer for troubleshooting or service of these relays.

### CHANGING A FLAT TIRE

If you get a flat tire while driving:

- do not brake heavily.
- gradually decrease the vehicle's speed.
- hold the steering wheel firmly.
- slowly move to a safe place on the side of the road.



The use of tire sealants may damage your tires.

### Dissimilar spare tire/wheel information



Failure to follow these guidelines could result in an increased risk of loss of vehicle control, injury or death.

If you have a dissimilar spare tire/wheel, then it is intended for temporary use only. This means that if you need to use it, you should replace it as soon as possible with a road tire/wheel that is the same size and type as the road tires and wheels that were originally provided by Ford. If the dissimilar spare tire or wheel is damaged, it should be replaced rather than repaired.

## Roadside Emergencies

A dissimilar spare tire/wheel is defined as a spare tire and/or wheel that is different in brand, size or appearance from the road tires and wheels and can be one of three types:

1. **T-type mini-spare:** This spare tire begins with the letter “T” for tire size and may have “Temporary Use Only” molded in the sidewall
2. **Full-size dissimilar spare with label on wheel:** This spare tire has a label on the wheel that states: “THIS TIRE AND WHEEL FOR TEMPORARY USE ONLY”

When driving with one of the dissimilar spare tires listed above, **do not:**

- Exceed 50 mph (80 km/h) Load the vehicle beyond maximum vehicle load rating listed on the Safety Compliance Label
- Use snow chains on the end of the vehicle with the dissimilar spare tire
- Use more than one dissimilar spare tire at a time
- Use commercial car washing equipment
- Try to repair the dissimilar spare tire

Use of one of the dissimilar spare tires listed above at any one wheel location can lead to impairment of the following:

- Handling, stability and braking performance
- Comfort and noise
- Ground clearance and parking at curbs
- Winter weather driving capability
- Wet weather driving capability

It is not recommended that the vehicle be operated in 4WD modes with a temporary emergency spare tire. If 4WD operation is necessary, do not operate above speeds of 10 mph (16 km/h) or for distances above 50 miles (80 km).

### 3. Full-size dissimilar spare without label on wheel

When driving with the full-size dissimilar spare tire/wheel, **do not:**

- Exceed 70 mph (113 km/h)
- Use more than one dissimilar spare tire/wheel at a time
- Use commercial car washing equipment
- Use snow chains on the end of the vehicle with the dissimilar spare tire/wheel

## Roadside Emergencies

The usage of a full-size dissimilar spare tire/wheel can lead to impairment of the following:

- Handling, stability and braking performance
- Comfort and noise
- Ground clearance and parking at curbs
- Winter weather driving capability
- Wet weather driving capability
- All-Wheel driving capability (if applicable)
- Load leveling adjustment (if applicable)

When driving with the full-size dissimilar spare tire/wheel additional caution should be given to:

- Towing a trailer
- Driving vehicles equipped with a camper body
- Driving vehicles with a load on the cargo rack

Drive cautiously when using a full-size dissimilar spare tire/wheel and seek service as soon as possible.

### Full-size Matching Spare Tire/Wheel Information

This spare tire/wheel will match the road tire/wheel. When driving with the full size matching spare tire/wheel, do not exceed 70 mph (113 km/h). It is intended for temporary use only. This means if you need to use it, you should replace it as soon as possible.

### Location of the spare tire and tools

If your vehicle is equipped with a spare tire, jack and associated tools, refer to the following table for their locations:

| Tool                             | Location   |
|----------------------------------|--|
| Spare tire (pick-up trucks only) | Under the vehicle, just forward of the rear bumper   |
| Jack                             | Regular cab, Super Cab without rear bench seat and Crew Cab: Fastened to floor pan behind rearmost seat on passenger side<br>SuperCab with rear bench seat: Under rear bench on passenger side |



## Roadside Emergencies

| Tool                       | Location   |
|----------------------------|--|
| Jack handle and lug wrench | Regular cab: Fastened to floor behind front seat<br>Super Cab: Fastened to floor under rear seat<br>Crew Cab: Fastened to floor behind rear seat |
| Key, spare tire lock       | In the glove box   |

### **Removing the spare tire (with spare tire carrier only)**

1. The following tools are required to remove the spare tire:

- one handle extension and one typical extension. To assemble, align button with hole and slide parts together. To disconnect, depress button and pull apart.
- one wheel nut wrench. Slide over square end of jack handle.

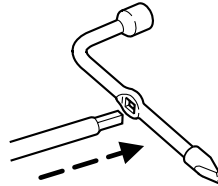
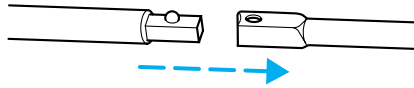

- **Vehicles equipped with dual rear wheels**, insert the lug wrench extension into the lug wrench to reach the lug nuts.

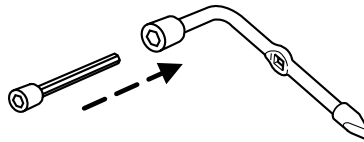

2. Attach the spare tire lock key (A) to the jack handle (B).

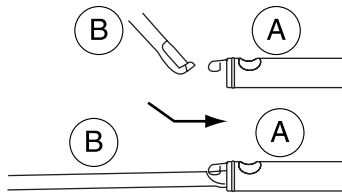

## Roadside Emergencies

3. Fully insert the jack handle through the bumper hole and into the guide tube. The key and lock will engage with a slight push and counterclockwise turn. Some resistance will be felt when turning the jack handle assembly.

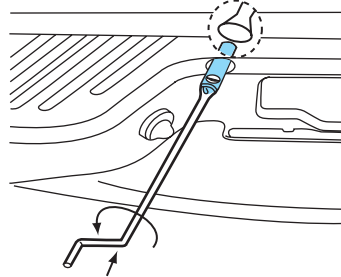

4. Turn the handle counterclockwise and lower the spare tire until you can slide the tire rearward and the cable is slack.

5. Remove the retainer through the center of the wheel.

### Tire change procedure

1. Park on a level surface, activate hazard flashers and set the parking brake.

- Automatic transmission: Place gearshift lever in P (Park).
- Manual transmission: Place gearshift lever in R (Reverse).
- Electronic Shift-On-the-Fly (ESOF) 4WD: Place transfer case in any position.
- Manual shift transfer case 4WD: Place transfer case in 2H, 4H or 4L.

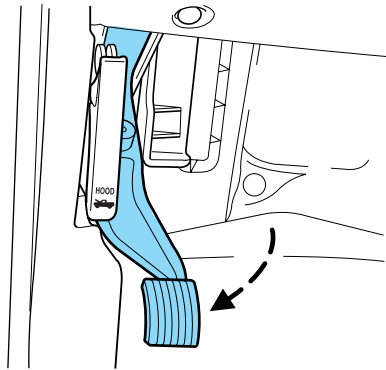

To help prevent the vehicle from moving when you change a tire, be sure the parking brake is set, then block (in both directions) the wheel that is diagonally opposite (other side and end of the vehicle) to the tire being changed.

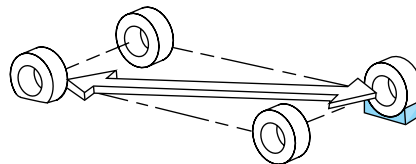

2. Turn engine off and block the diagonally opposite wheel (block not provided).

## Roadside Emergencies

3. Remove the jack, jack handle, lug wrench and spare tire from the stowage locations.
4. Use the tip of the lug wrench to remove any wheel trim.
5. Loosen each wheel lug nut one-half turn counterclockwise but do not remove them until the wheel is raised off the ground.

 When one of the rear wheels is off the ground, the transmission alone will not prevent the vehicle from moving or slipping off the jack, even if the transmission is in P (Park) (automatic transmission) or R (Reverse) (manual transmission). To prevent the vehicle from moving when you change the tire, be sure that the parking brake is set and the diagonally opposite wheel is blocked.

 If the vehicle slips off the jack, you or someone else could be seriously injured.

### The following steps apply to F-250/F-350 Single Rear Wheel (SRW) vehicles only (unless otherwise noted):

6. Insert the hooked end of the jack handle into the jack and use the handle to slide the jack under the vehicle.
7. Position the jack according to the following guides:

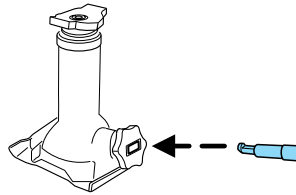

- Front (4x2)

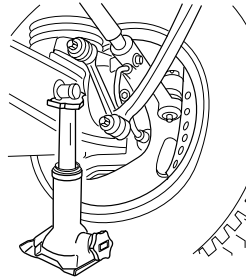

## Roadside Emergencies

- Front driver side (4x4)

**Note:** Make sure the jack fits onto the flat area on the outboard side of the differential.

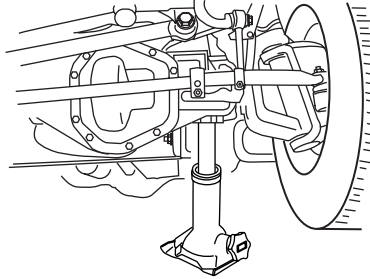

- Front passenger side (4x4)

**Note:** View shown from the rear of the vehicle to clearly identify the jack point. Place the jack directly under the axle.

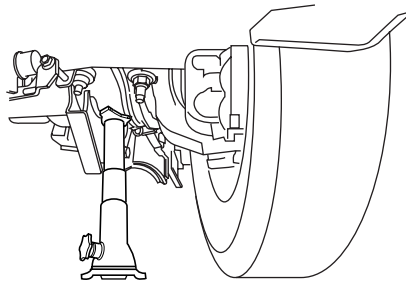

- Rear (including F-350 Dual Rear wheel [DRW] vehicles)

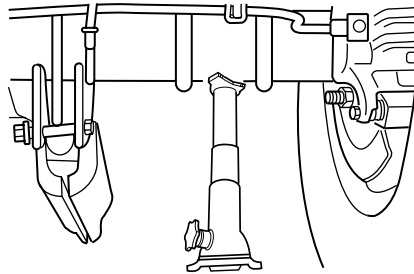

## Roadside Emergencies

**Never use the front or rear differential as a jacking point.**

 To lessen the risk of personal injury, do not put any part of your body under the vehicle while changing a tire. Do not start the engine when your vehicle is on the jack. The jack is only meant for changing the tire.

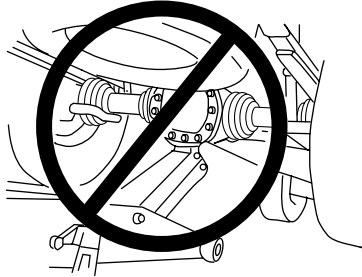

8. Turn the jack handle clockwise until the wheel is completely off the ground and high enough to install the spare tire.

9. Remove the lug nuts with the lug wrench.

10. Replace the flat tire with the spare tire, making sure the valve stem is facing outward for all front wheels and single rear wheel vehicles. If replacing an inboard rear tire on dual rear wheel vehicles, the valve stem must be facing outward. If replacing the outboard wheel, the valve stem must be facing inward. Reinstall the lug nuts until the wheel is snug against the hub. Do not fully tighten the lug nuts until the wheel has been lowered.

11. Lower the wheel by turning the jack handle counterclockwise.  
Go to step 19.

**The following steps apply to F-350 DRW and F-450/F-550 vehicles only:**

12. Slide the notched end of the jack handle over the release valve and use the handle to slide the jack under the vehicle. Make sure the valve is closed by turning it clockwise.

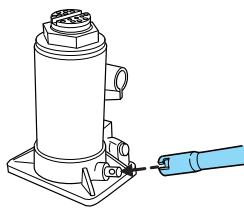
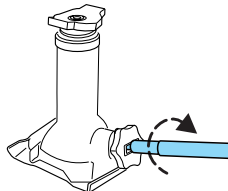

## Roadside Emergencies

13. Position the jack according to the following guides:

- Front (4x2): F-350 DRW

**Note:** Place jack directly under I-beam pin as shown in the illustration.

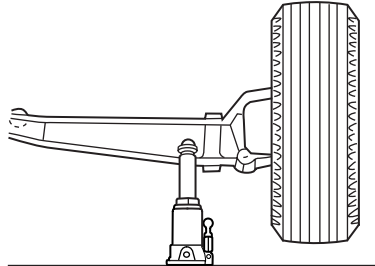

- Front driver side (4x4): F-350 DRW

**Note:** Make sure the jack fits onto the flat area on the outboard side of the differential housing.

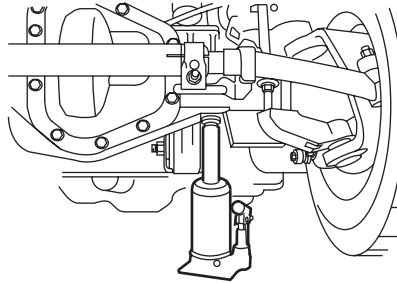

- Front passenger side (4x4): F-350 DRW

**Note:** View shown from the rear of the vehicle to clearly identify the jack point.

**Note:** Place the jack directly under axle and inboard of the radius arm so that the jack clears the radius arm.

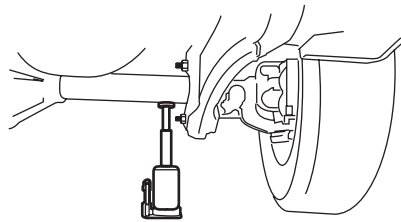

## Roadside Emergencies

- Front: F-450/F-550

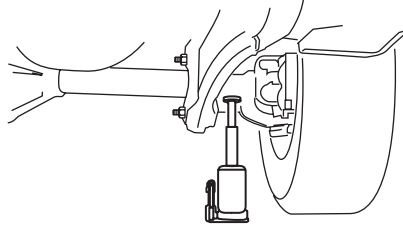

- Rear: F-450/F-550

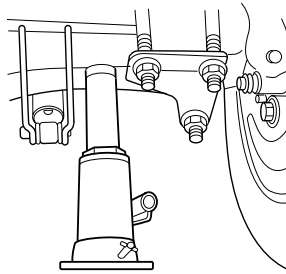

14. Insert the jack handle into the pump linkage.

15. Use an up-and-down motion with the jack handle to raise the wheel completely off the ground.

**Hydraulic jacks are equipped with a pressure release valve that prevents lifting loads which exceed the jack's rated capacity.**

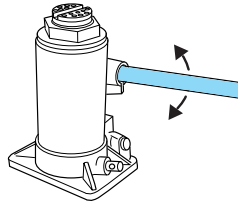

16. Remove the lug nuts with the lug wrench.

17. Replace the flat tire with the spare tire, making sure the valve stem is facing outward on all front and inboard rear wheels. If replacing the outboard wheel, the valve stem must be facing inward. Reinstall the lug nuts until the wheel is snug against the hub. Do not fully tighten the lug nuts until the wheel has been lowered.

18. Lower the wheel by slowly turning the release valve counterclockwise. Opening the release valve slowly will provide a more controlled rate of descent.

## Roadside Emergencies

### The following steps apply to all vehicles:

19. Remove the jack and fully tighten the lug nuts in the order shown. Refer to *Wheel lug nut torque specifications* later in this chapter for the proper lug nut torque specification.

#### 8-lug nut torque sequence

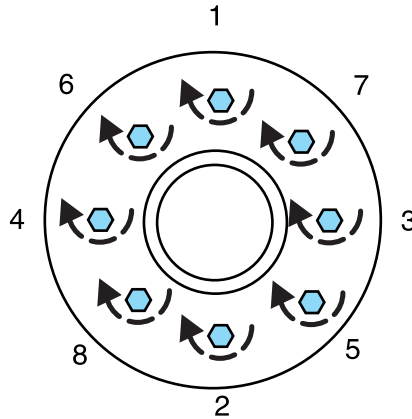

#### 10-lug nut torque sequence

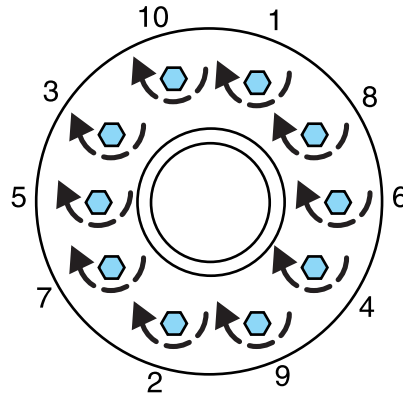

20. Stow the flat tire. Refer to *Stowing the spare tire* if the vehicle is equipped with a spare tire carrier.

**Note:** If your vehicle is equipped with 20" tires, do not stow the flat tire and wheel using the spare tire winch mechanism; store the flat in the bed of the truck.

21. Stow the jack, jack handle and lug wrench. Make sure the jack is securely fastened so it does not rattle when driving.

22. Unblock the wheels.

224



## Roadside Emergencies

### **Stowing the flat/spare tire**

**Note:** Failure to follow spare tire stowage instructions may result in failure of cable or loss of spare tire.

1. Lay the tire on the ground with the valve stem facing in the direction specified on the Tire Changing Instructions located with the jack hardware.
2. Slide the wheel partially under the vehicle and install the retainer through the wheel center. Pull on the cable to align the components at the end of the cable.
3. Turn the jack handle clockwise until the tire is raised to its stowed position underneath the vehicle. The effort to turn the jack handle increases significantly and the spare tire carrier ratchets or slips when the tire is raised to the maximum tightness. Tighten to the best of your ability, to the point where the ratchet/slip occurs, if possible. The spare tire carrier will not allow you to overtighten. If the spare tire carrier ratchets or slips with little effort, take the vehicle to your authorized dealer for assistance at your earliest convenience.
4. Check that the tire lies flat against the frame and is properly tightened. Try to push or pull, then turn the tire to be sure it will not move. Loosen and retighten, if necessary. Failure to properly stow the spare tire may result in failure of the winch cable and loss of the tire.
5. Repeat this tightness check procedure when servicing the spare tire pressure (every six months, per *scheduled maintenance information*), or at any time that the spare tire is disturbed through service of other components.
6. If removed, install the spare tire lock (if equipped) into the bumper drive tube with the spare tire lock key (if equipped) and jack handle.

### **WHEEL LUG NUT TORQUE SPECIFICATIONS**

On vehicles equipped with single rear wheels, retighten the lug nuts to the specified torque at 500 miles (800 km) after any wheel disturbance (tire rotation, changing a flat tire, wheel removal, etc.).

On vehicles equipped with dual rear wheels, retighten the wheel lug nuts to the specified torque at 100 miles (160 km), and again at 500 miles (800 km) of new vehicle operation and after any wheel disturbance (tire rotation, changing a flat tire, wheel removal, etc.).

## Roadside Emergencies

| Bolt size | Wheel lug nut torque* |     |
|-----------|-----------------------|-----|
|           | lb.ft.                | N•m |
| M14 x 1.5 | 150                   | 200 |

\* Torque specifications are for nut and bolt threads free of dirt and rust. Use only Ford recommended replacement fasteners.

On all two-piece flat wheel nuts, apply one drop of motor oil between the flat washer and the nut. Do not apply motor oil to the wheel nut threads or the wheel stud threads.

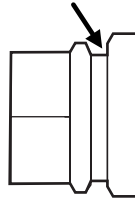

 When a wheel is installed, always remove any corrosion, dirt or foreign materials present on the mounting surfaces of the wheel or the surface of the front disc brake hub and rotor that contacts the wheel. Installing wheels without correct metal-to-metal contact at the wheel mounting surfaces can cause the wheel nuts to loosen and the wheel to come off while the vehicle is in motion, resulting in loss of control.

## JUMP STARTING YOUR VEHICLE

 The gases around the battery can explode if exposed to flames, sparks, or lit cigarettes. An explosion could result in injury or vehicle damage.

 Batteries contain sulfuric acid which can burn skin, eyes and clothing, if contacted.

**Do not attempt to push-start your vehicle. Automatic transmissions do not have push-start capability; doing so may damage the catalytic converter.**

## Roadside Emergencies

### Preparing your vehicle

When the battery is disconnected or a new battery is installed, the transmission must relearn its shift strategy. As a result, the transmission may have firm and/or soft shifts. This operation is considered normal and will not affect function or durability of the transmission. Over time, the adaptive learning process will fully update transmission operation.

1. **Use only a 12-volt supply to start your vehicle.**
2. Do not disconnect the battery of the disabled vehicle as this could damage the vehicle's electrical system.
3. Park the booster vehicle close to the hood of the disabled vehicle making sure the two vehicles **do not** touch. Set the parking brake on both vehicles and stay clear of the engine cooling fan and other moving parts.
4. Check all battery terminals and remove any excessive corrosion before you attach the battery cables. Ensure that vent caps are tight and level.
5. Turn the heater fan on in both vehicles to protect any electrical surges. Turn all other accessories off.

### Connecting the jumper cables

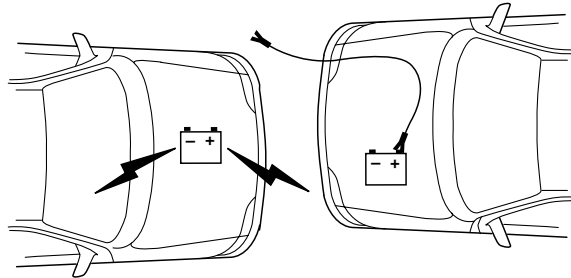

1. Connect the positive (+) jumper cable to the positive (+) terminal of the discharged battery.

**Note:** In the illustrations, *lightning bolts* are used to designate the assisting (boosting) battery.

## Roadside Emergencies

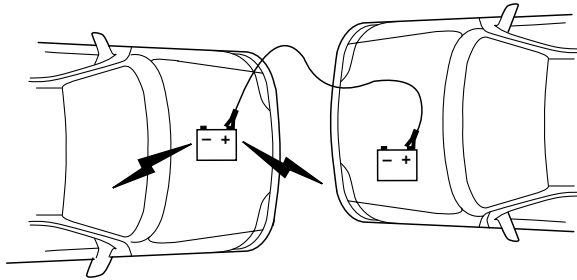

2. Connect the other end of the positive (+) cable to the positive (+) terminal of the assisting battery.

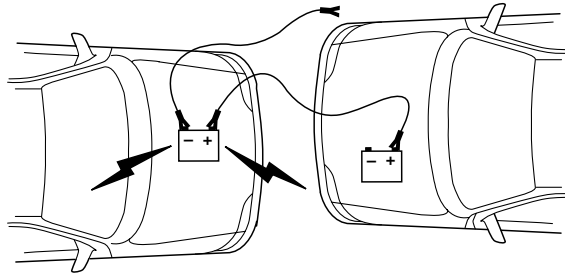

3. Connect the negative (-) cable to the negative (-) terminal of the assisting battery.

## Roadside Emergencies

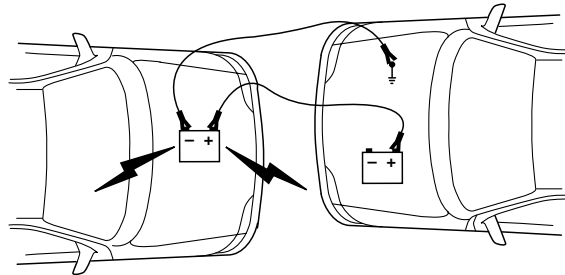

4. Make the final connection of the negative (-) cable to an exposed metal part of the stalled vehicle's engine, away from the battery and the carburetor/fuel injection system. **Do not** use fuel lines, engine rocker covers or the intake manifold as *grounding* points.



Do not connect the end of the second cable to the negative (-) terminal of the battery to be jumped. A spark may cause an explosion of the gases that surround the battery.

5. Ensure that the cables are clear of fan blades, belts, moving parts of both engines, or any fuel delivery system parts.

### Jump starting

1. Start the engine of the booster vehicle and run the engine at moderately increased speed.
2. Start the engine of the disabled vehicle.
3. Once the disabled vehicle has been started, run both engines for an additional three minutes before disconnecting the jumper cables.

## Roadside Emergencies

### Removing the jumper cables

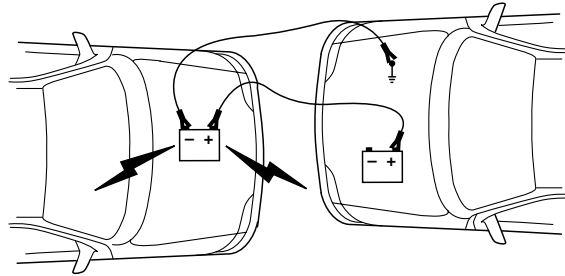

**Remove the jumper cables in the reverse order that they were connected.**

1. Remove the jumper cable from the *ground* metal surface.

**Note:** In the illustrations, *lightning bolts* are used to designate the assisting (boosting) battery.

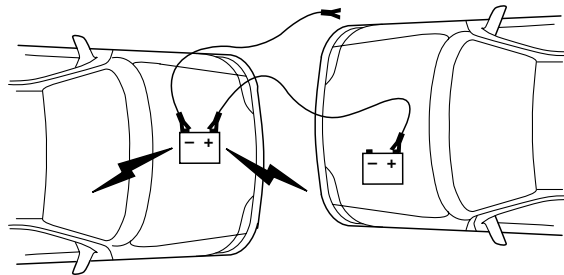

2. Remove the jumper cable on the negative (-) connection of the booster vehicle's battery.

## Roadside Emergencies

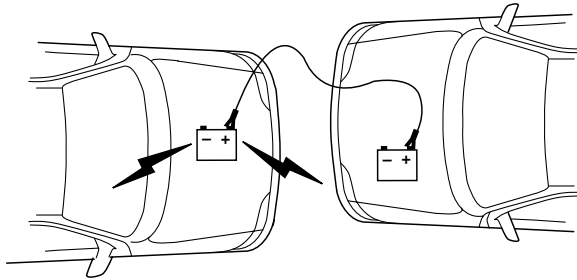

3. Remove the jumper cable from the positive (+) terminal of the booster vehicle's battery.

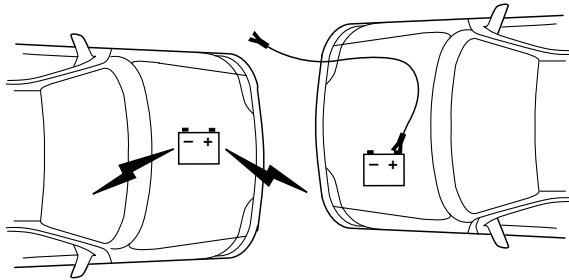

4. Remove the jumper cable from the positive (+) terminal of the disabled vehicle's battery.

After the disabled vehicle has been started and the jumper cables removed, allow it to idle for several minutes so the engine computer can *relearn* its idle conditions.

## Roadside Emergencies

### WRECKER TOWING

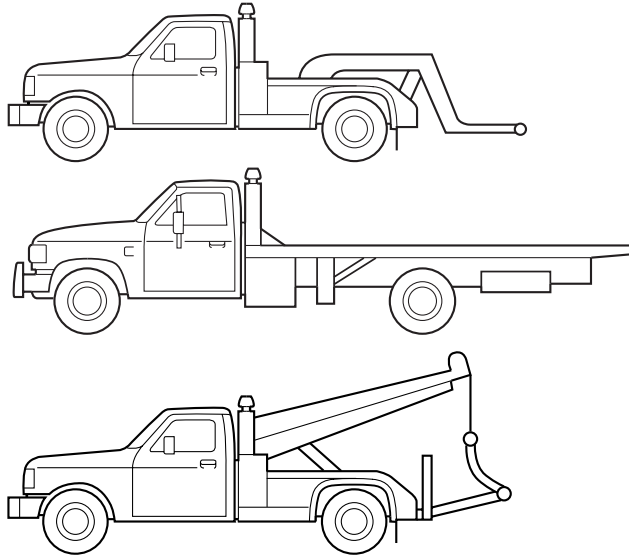

If you need to have your vehicle towed, contact a professional towing service or, if you are a member of a roadside assistance program, your roadside assistance service provider.

On 4x2 vehicles, it is acceptable to tow the vehicle with the front wheels on the ground and the rear wheels off the ground using a wheel lift

On 4x4 vehicles, it is recommended that your vehicle be towed using flatbed equipment with all the wheels off the ground. However, a wheel lift may be used to lift the rear of the vehicle so long as, depending on vehicle configurations, the following preparations are met:

- On Electronic Shift-On-the-Fly (ESOF) vehicles, the 4WD control is turned to the 2WD position prior to towing.
- On manual-shift transfer case vehicles, the front wheel hub locks are in the UNLOCKED position prior to towing.

**Note:** Towing an ESOF 4WD vehicle with the front wheels on the ground without disengaging the front hubs may cause damage to the automatic transmission.



## Roadside Emergencies

**Note:** Towing an a 4x2 or an ESOF 4WD vehicle with the rear wheels on the ground for more than 50 miles (80 km) and/or in excess of 35 mph (56 km/h) may cause damage to the automatic transmission.

**Note:** On Dual Rear Wheel (DRW) vehicles, an outer rear wheel must be removed prior to using a wheel lift wrecker.

**If the vehicle is towed by other means or incorrectly, vehicle damage may occur.**

Ford Motor Company produces a towing manual for all authorized tow truck operators. Have your tow truck operator refer to this manual for proper hook-up and towing procedures for your vehicle.

## Customer Assistance

### GETTING THE SERVICES YOU NEED

#### At home

You must take your Ford vehicle to an authorized dealer for warranty repairs. While any authorized dealer handling your vehicle line will provide warranty service, we recommend you return to your selling authorized dealer who wants to ensure your continued satisfaction. Please note that certain warranty repairs require special training and/or equipment, so not all authorized dealers are authorized to perform all warranty repairs. This means that, depending on the warranty repair needed, you may have to take your vehicle to another authorized dealer. A reasonable time must be allowed to perform a repair after taking your vehicle to the authorized dealer. Repairs will be made using Ford or Motorcraft parts, or remanufactured or other parts that are authorized by Ford.

If you have questions or concerns, or are unsatisfied with the service you are receiving, follow these steps:

1. Contact your Sales Representative or Service Advisor at your selling/servicing authorized dealer.
2. If your inquiry or concern remains unresolved, contact the Sales Manager, Service Manager or Customer Relations Manager.
3. If you require assistance or clarification on Ford Motor Company policies or procedures, please contact the Ford Customer Relationship Center at 1-800-392-3673 (FORD).

#### Away from home

If you own a Ford or Mercury vehicle and are away from home when your vehicle needs service, or if you need more help than the authorized dealer could provide, after following the steps described above, contact the Ford Customer Relationship Center to find an authorized dealer to help you.

In the United States:

Ford Motor Company  
Customer Relationship Center  
P.O. Box 6248  
Dearborn, MI 48121  
1-800-392-3673 (FORD)  
(TDD for the hearing impaired: 1-800-232-5952)  
[www.customersaskford.com](http://www.customersaskford.com)

234

## Customer Assistance

In Canada:  
Customer Relationship Centre  
Ford Motor Company of Canada, Limited  
P.O. Box 2000  
Oakville, Ontario L6J 5E4  
1-800-565-3673 (FORD)  
www.ford.ca

If you own a Lincoln vehicle and are away from home when your vehicle needs service, or if you need more help than the authorized dealer could provide, after following the steps described above, contact the Ford Customer Relationship Center to find an authorized dealer to help you.

In the United States:  
Ford Motor Company  
Customer Relationship Center  
P.O. Box 6248  
Dearborn, MI 48121  
1-800-521-4140  
(TDD for the hearing impaired: 1-800-232-5952)  
www.customersaskford.com

In Canada:  
Lincoln Centre  
Ford Motor Company of Canada, Limited  
P.O. Box 2000  
Oakville, Ontario L6J 5E4  
1-800-387-9333  
www.lincolncanada.com

In order to help you service your Lincoln vehicle, please have the following information available when contacting the Lincoln Centre:

- Your telephone number (home and business)
- The name of the authorized dealer and the city where the authorized dealer is located
- The year and make of your vehicle
- The date of vehicle purchase
- The current odometer reading
- The vehicle identification number (VIN)

### **Additional Assistance**

If you still have a complaint involving a warranty dispute, you may wish to contact the Dispute Settlement Board (U.S.).

## Customer Assistance

In some states (in the U.S.) you must directly notify Ford in writing before pursuing remedies under your state's warranty laws. Ford is also allowed a final repair attempt in some states.

In the United States, a warranty dispute must be submitted to the Dispute Settlement Board before taking action under the Magnuson-Moss Warranty Act, or to the extent allowed by state law, before pursuing replacement or repurchase remedies provided by certain state laws. This dispute handling procedure is not required prior to enforcing state created rights or other rights which are independent of the Magnuson-Moss Warranty Act or state replacement or repurchase laws.

### IN CALIFORNIA (U.S. ONLY)

California Civil Code Section 1793.2(d) requires that, if a manufacturer or its representative is unable to repair a motor vehicle to conform to the vehicle's applicable express warranty after a reasonable number of attempts, the manufacturer shall be required to either replace the vehicle with one substantially identical or repurchase the vehicle and reimburse the buyer in an amount equal to the actual price paid or payable by the consumer (less a reasonable allowance for consumer use). The consumer has the right to choose whether to receive a refund or replacement vehicle.

California Civil Code Section 1793.22(b) presumes that the manufacturer has had a reasonable number of attempts to conform the vehicle to its applicable express warranties if, within the first 18 months of ownership of a new vehicle or the first 18,000 miles (29,000 km), whichever occurs first:

1. Two or more repair attempts are made on the same non-conformity likely to cause death or serious bodily injury OR
2. Four or more repair attempts are made on the same nonconformity (a defect or condition that substantially impairs the use, value or safety of the vehicle) OR
3. The vehicle is out of service for repair of nonconformities for a total of more than 30 calendar days (not necessarily all at one time)

In the case of 1 or 2 above, the consumer must also notify the manufacturer of the need for the repair of the nonconformity at the following address:

Ford Motor Company  
16800 Executive Plaza Drive  
Mail Drop 3NE-B  
Dearborn, MI 48126

236

## Customer Assistance

### **THE BETTER BUSINESS BUREAU (BBB) AUTO LINE PROGRAM (U.S. ONLY)**

Your satisfaction is important to Ford Motor Company and to your dealer. Experience has shown that our customers have been very successful in achieving satisfaction by following the three-step procedure outlined on the front page of the Warranty Guide. However, if your warranty concern has not been resolved using the three-step procedure, you may be eligible to participate in the BBB AUTO LINE program.

The BBB AUTO LINE program consists of two parts – mediation and arbitration. Initially, the BBB will try to resolve your question or concern through mediation. Mediation is a process through which a representative of the BBB will contact the parties and explore options for settlement of your claim. If mediation is not successful, customers with eligible claims may participate in the BBB AUTO LINE arbitration process. An arbitration hearing will be scheduled so that you can present your case in an informal setting before an impartial person. The arbitrator will consider the testimony provided and make a decision after the hearing. You are not bound by the decision but may choose to accept it. If you choose to accept the BBB AUTO LINE decision then Ford must abide by the accepted decision as well. If the arbitrator has decided in your favor and you accept the decision, the BBB AUTO LINE program will contact you to ensure that Ford has complied with the decision in a timely manner. Disputes submitted to the BBB AUTO LINE program are usually decided within forty days after you file your claim with the BBB.

To file a claim with the BBB AUTO LINE, you will be asked for your name and address, information about your vehicle, information about your concerns and any steps you have already taken to try to resolve them.

You can get more information by calling BBB AUTO LINE at 1-800-428-3718, or writing to:

BBB AUTO LINE  
4200 Wilson Boulevard, Suite 800  
Arlington, Virginia 22203-1833

**Note:** Ford Motor Company reserves the right to change eligibility limitations, modify procedures, or to discontinue this process at any time without notice and without obligation.

## Customer Assistance

### **UTILIZING THE MEDIATION/ARBITRATION PROGRAM (CANADA ONLY)**

In those cases where you continue to feel that the efforts by Ford of Canada and the authorized dealer to resolve a factory-related vehicle service concern have been unsatisfactory, Ford of Canada participates in an impartial third party mediation/arbitration program administered by the Canadian Motor Vehicle Arbitration Plan (CAMVAP).

The CAMVAP program is a straight-forward and relatively speedy alternative to resolve a disagreement when all other efforts to produce a settlement have failed. This procedure is without cost to you and is designed to eliminate the need for lengthy and expensive legal proceedings.

In the CAMVAP program, impartial third-party arbitrators conduct hearings at mutually convenient times and places in an informal environment. These impartial arbitrators review the positions of the parties, make decisions and, when appropriate, render awards to resolve disputes. CAMVAP decisions are fast, fair, and final as the arbitrator's award is binding both to you and Ford of Canada.

CAMVAP services are available in all Canadian territories and provinces. For more information, without charge or obligation, call your CAMVAP Provincial Administrator directly at 1-800-207-0685.

### **FORD EXTENDED SERVICE PLAN**

You can get more protection for your new car or light truck by purchasing Ford Extended Service Plan (Ford ESP) coverage. It provides the following:

- Benefits during the warranty period depending on the plan you purchase (such as: reimbursement for rentals; coverage for certain maintenance and wear items).
- Protection against covered repair costs after your Bumper-to-Bumper Warranty expires.

You may purchase Ford ESP from any participating Ford and Lincoln Mercury and Ford of Canada authorized dealer. There are several plans available in various time, distance and deductible combinations which can be tailored to fit your own driving needs. Ford ESP also offers reimbursement benefits for towing and rental coverage.

When you buy Ford ESP, you receive Peace-of-Mind protection throughout the United States and Canada, provided by a network of more than 4,600 participating Ford or Lincoln Mercury and Ford of Canada authorized dealers.

## Customer Assistance

If you did not take advantage of the Ford Extended Service Plan at the time of purchasing your vehicle, you may still be eligible. Since this information is subject to change, please ask your authorized dealer for complete details about Ford Extended Service Plan coverage options, or visit the Ford ESP website at [www.ford-esp.com](http://www.ford-esp.com).

### **GETTING ASSISTANCE OUTSIDE THE U.S. AND CANADA**

Before exporting your vehicle to a foreign country, contact the appropriate foreign embassy or consulate. These officials can inform you of local vehicle registration regulations and where to find unleaded fuel.

If you cannot find unleaded fuel or can only get fuel with an anti-knock index lower than is recommended for your vehicle, contact a regional office or owner relations/customer relationship office.

The use of leaded fuel in your vehicle without proper conversion may damage the effectiveness of your emission control system and may cause engine knocking or serious engine damage. Ford Motor Company/Ford of Canada is not responsible for any damage caused by use of improper fuel. Using leaded fuel may also result in difficulty importing your vehicle back into the U.S.

If your vehicle must be serviced while you are traveling or living in Central or South America, the Caribbean, or the Middle East, contact the nearest authorized dealer. If the authorized dealer cannot help you, write or call:

FORD MOTOR COMPANY  
WORLDWIDE DIRECT MARKET OPERATIONS  
1555 Fairlane Drive  
Fairlane Business Park #3  
Allen Park, Michigan 48101  
U.S.A.  
Telephone: (313) 594-4857  
FAX: (313) 390-0804

If you are in another foreign country, contact the nearest authorized dealer. If the authorized dealer employees cannot help you, they can direct you to the nearest Ford affiliate office.

If you buy your vehicle in North America and then relocate outside of the U.S. or Canada, register your vehicle identification number (VIN) and new address with Ford Motor Company Worldwide Direct Market Operations.

## Customer Assistance

### ORDERING ADDITIONAL OWNER'S LITERATURE

To order the publications in this portfolio, contact Helm, Incorporated at:

HELM, INCORPORATED  
P.O. Box 07150  
Detroit, Michigan 48207

Or call:

**For a free publication catalog, order toll free: 1-800-782-4356**

Monday-Friday 8:00 a.m. - 6:00 p.m. EST

Helm, Incorporated can also be reached by their website:  
[www.helminc.com](http://www.helminc.com).

*(Items in this catalog may be purchased by credit card, check or money order.)*

### Obtaining a French owner's guide

French Owner's Guides can be obtained from your authorized dealer or by writing to Ford Motor Company of Canada, Limited, Service Publications, P.O. Box 1580, Station B, Mississauga, Ontario L4Y 4G3.

### REPORTING SAFETY DEFECTS (U.S. ONLY)

If you believe that your vehicle has a defect which could cause a crash or could cause injury or death, you should immediately inform the National Highway Traffic Safety Administration (NHTSA) in addition to notifying Ford Motor Company.



If NHTSA receives similar complaints, it may open an investigation, and if it finds that a safety defect exists in a group of vehicles, it may order a recall and remedy campaign. However, NHTSA cannot become involved in individual problems between you, your authorized dealer, or Ford Motor Company.

To contact NHTSA, you may either call the Auto Safety Hotline toll-free at 1-800-424-9393 (or 366-0123 in the Washington D.C. area) or write to:

NHTSA  
400 Seventh Street  
U.S. Department of Transportation  
Washington, D.C. 20590

You can also obtain other information about motor vehicle safety from the Hotline.

240

**2006 F-250/350/450/550 (f23)**  
**Owners Guide (post-2002-fmt)**  
**USA (fus)**



### WASHING THE EXTERIOR

Wash your vehicle regularly with cool or lukewarm water and a neutral pH shampoo, such as Motorcraft Detail Wash (ZC-3-A), which is available from your authorized dealer.

- Never use strong household detergents or soap, such as dish washing or laundry liquid. These products can discolor and spot painted surfaces.
- Never wash a vehicle that is “hot to the touch” or during exposure to strong, direct sunlight.
- Always use a clean sponge or car wash mitt with plenty of water for best results.
- Dry the vehicle with a chamois or soft terry cloth towel in order to eliminate water spotting.
- It is especially important to wash the vehicle regularly during the winter months, as dirt and road salt are difficult to remove and cause damage to the vehicle.
- Immediately remove items such as gasoline, diesel fuel, bird droppings and insect deposits because they can cause damage to the vehicle’s paintwork and trim over time.
- Remove any exterior accessories, such as antennas, before entering a car wash.
- **Suntan lotions and insect repellents can damage any painted surface; if these substances come in contact with your vehicle, wash off as soon as possible.**
- **If your vehicle is equipped with running boards, do not use rubber, plastic and vinyl protectant products on the running board surface, as the area may become slippery.**

### WAXING

Applying Motorcraft Paint Sealant (ZC-45) to your vehicle every six months will assist in reducing minor scratches and paint damage.

- Wash the vehicle first.
- Do not use waxes that contain abrasives. Use Motorcraft Premium Liquid Wax, ZC-53-A, which is available from your authorized dealer, or an equivalent quality product.

## Cleaning

- Do not allow paint sealant to come in contact with any non-body (low-gloss black) colored trim, such as grained door handles, roof racks, bumpers, side moldings, mirror housings or the windshield cowl area. The paint sealant will “gray” or stain the parts over time.

### PAINT CHIPS

Your authorized dealer has touch-up paint and sprays to match your vehicle’s color. Take your color code (printed on a sticker in the driver’s door jamb) to your authorized dealer to ensure you get the correct color.

- Remove particles such as bird droppings, tree sap, insect deposits, tar spots and industrial fallout before repairing paint chips.
- Always read the instructions before using the products.

### ALUMINUM WHEELS AND WHEEL COVERS

Aluminum wheels and wheel covers are coated with a clearcoat paint finish. In order to maintain their shine:

- Clean weekly with Motorcraft Wheel and Tire Cleaner (ZC-37-A), which is available from your authorized dealer. Heavy dirt and brake dust accumulation may require agitation with a sponge. Rinse thoroughly with a strong stream of water.
- Never apply any cleaning chemical to hot or warm wheel rims or covers.
- Some automatic car washes may cause damage to the finish on your wheel rims or covers. Chemical-strength cleaners, or cleaning chemicals, in combination with brush agitation to remove brake dust and dirt, could wear away the clearcoat finish over time.
- Do not use hydrofluoric acid-based or high caustic-based wheel cleaners, steel wool, fuels or strong household detergent.
- To remove tar and grease, use Motorcraft Bug and Tar Remover (ZC-42), available from your authorized dealer.

### ENGINE

Engines are more efficient when they are clean because grease and dirt buildup keep the engine warmer than normal. When washing:

- Take care when using a power washer to clean the engine. The high-pressure fluid could penetrate the sealed parts and cause damage.
- Do not spray a hot engine with cold water to avoid cracking the engine block or other engine components.

242

## Cleaning

- Spray Motorcraft Engine Shampoo and Degreaser (ZC-20) on all parts that require cleaning and pressure rinse clean.
- Never wash or rinse the engine while it is running; water in the running engine may cause internal damage.
- Cover the highlighted areas to prevent water damage when cleaning the engine.

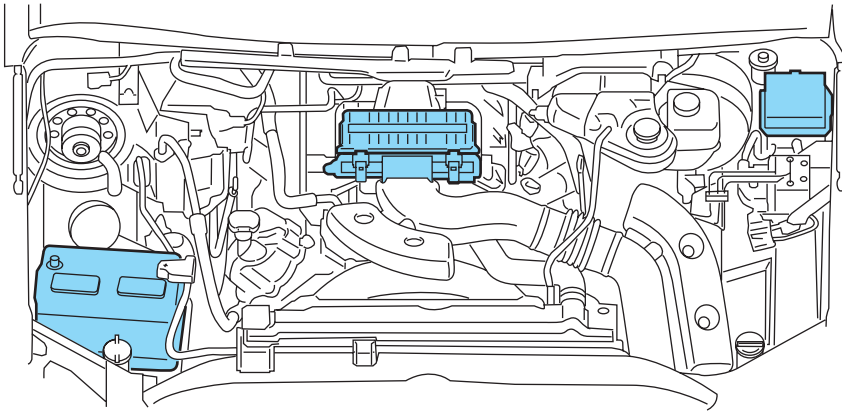

- **5.4L V8 gasoline engine**

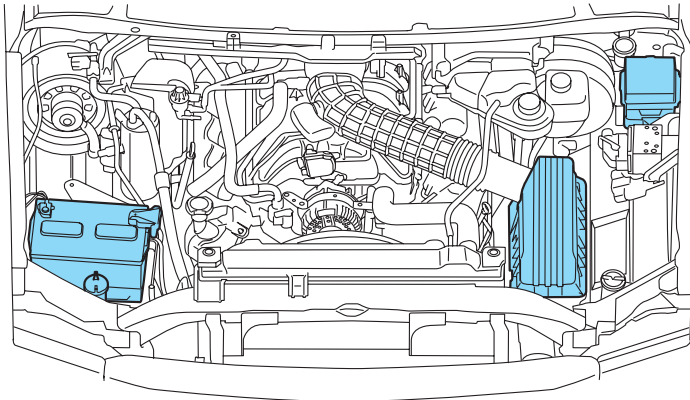

- **6.8L V10 gasoline engine**

## Cleaning

### PLASTIC (NON-PAINTED) EXTERIOR PARTS

Use only approved products to clean plastic parts. These products are available from your authorized dealer.

- For routine cleaning, use Motorcraft Detail Wash (ZC-3-A).
- If tar or grease spots are present, use Motorcraft Bug and Tar Remover (ZC-42).
- For plastic headlamp lenses, use Motorcraft Ultra Clear Spray Glass Cleaner (ZC-23).

### WINDOWS AND WIPER BLADES

The windshield, rear and side windows and the wiper blades should be cleaned regularly. If the wipers do not wipe properly, substances on the vehicle's glass or the wiper blades may be the cause. These may include hot wax treatments used by commercial car washes, water repellent coatings, tree sap, or other organic contamination; these contaminants may cause squeaking or chatter noise from the blades, and streaking and smearing of the windshield. To clean these items, follow these tips:

- The windshield, rear windows and side windows may be cleaned with a non-abrasive cleaner such as Motorcraft Ultra-Clear Spray Glass Cleaner (ZC-23), available from your authorized dealer.
- The wiper blades can be cleaned with isopropyl (rubbing) alcohol or Motorcraft Premium Windshield Washer Concentrate (ZC-32-A), available from your authorized dealer. This washer fluid contains special solution in addition to alcohol which helps to remove the hot wax deposited on the wiper blade and windshield from automated car wash facilities. Be sure to replace wiper blades when they appear worn or do not function properly.
- Do not use abrasives, as they may cause scratches.
- Do not use fuel, kerosene, or paint thinner to clean any parts.

### INSTRUMENT PANEL AND CLUSTER LENS

Clean the instrument panel with a damp cloth, then dry with a clean, dry cloth.

- Avoid cleaners or polish that increase the gloss of the upper portion of the instrument panel. The dull finish in this area helps protect the driver from undesirable windshield reflection.

## Cleaning



Do not use chemical solvents or strong detergents when cleaning the steering wheel or instrument panel to avoid contamination of the airbag system.

- Be certain to wash or wipe your hands clean if you have been in contact with certain products such as insect repellent and suntan lotion in order to avoid possible damage to the interior painted surfaces.

### INTERIOR TRIM

- Clean the interior trim areas with a damp cloth, then dry by wiping with a dry, soft, clean cloth.
- Do not use household or glass cleaners as these may damage the finish.

### INTERIOR

For fabric, carpets, cloth seats and safety belts:

- Remove dust and loose dirt with a vacuum cleaner.
- Remove light stains and soil with Motorcraft Professional Strength Carpet & Upholstery Cleaner (ZC-54).
- If grease or tar is present on the material, spot-clean the area first with Motorcraft Spot and Stain Remover (ZC-14).
- If a ring forms on the fabric after spot cleaning, clean the entire area immediately (but do not oversaturate) or the ring will set.
- Do not use household cleaning products or glass cleaners, which can stain and discolor the fabric and affect the flame retardant abilities of the seat materials.



Do not use cleaning solvents, bleach or dye on the vehicle's seatbelts, as these actions may weaken the belt webbing.

### LEATHER SEATS (IF EQUIPPED, EXCEPT FOR THE KING RANCH F-250 AND F-350 CREWCAB)

Your leather seating surfaces have a clear, protective coating over the leather.

**For King Ranch F-250 and F-350 CrewCab leather seats, refer to separate section in this chapter.**

- To clean, use a soft cloth with Motorcraft Deluxe Leather and Vinyl Cleaner (ZC-11-A). Dry the area with a soft cloth.

## Cleaning

- To help maintain its resiliency and color, use the Motorcraft Deluxe Leather Care Kit (ZC-11-D), available from your authorized dealer.
- Do not use household cleaning products, alcohol solutions, solvents or cleaners intended for rubber, vinyl and plastics, or oil/petroleum-based leather conditioners. These products may cause premature wearing of the clear, protective coating on the seat.

**Note:** In some instances, color or dye transfer can occur when wet clothing comes in contact with leather upholstery. If this occurs, the leather should be cleaned immediately to avoid permanent staining.

### **LEATHER SEATS FOR THE KING RANCH F-250 AND F-350 CREWCAB ONLY (IF EQUIPPED)**

Your vehicle is equipped with seating covered in premium, top-grain leather which is extremely durable, but still requires special care and maintenance in order to ensure longevity and comfort.

Regular cleaning and conditioning will maintain the appearance of the leather. Failure to care for the leather can result in drying out and fading of the material.

**Note:** In some instances, color or dye transfer can occur when wet clothing comes in contact with leather upholstery. If this occurs, the leather should be cleaned immediately to avoid permanent staining.

### **Cleaning**

For dirt, use a vacuum cleaner then use a clean, damp cloth or soft brush.

For routine cleaning, wipe the surface with a soft, damp cloth. For more thorough cleaning, wipe the surface with a mild soap. If the leather cannot be completely cleaned using a mild soap and water solution, the leather may be cleaned using a commercially available cleaning product “Tanners Preserve Leather Cleaner” and a 3M “Type T” scrubbing pad.

- Clean spills as quickly as possible.
- Test any cleaner or stain remover on an inconspicuous part of the leather as cleaners may darken the leather. For more specific cleaning information, contact the King Ranch Saddle Shop at 1-800-282-KING (5464).
- Do not spill coffee, ketchup, mustard, orange juice or oil-based products on the leather as they may permanently stain the leather.
- Do not use household cleaning products, alcohol solutions, solvents or cleaners intended for rubber, vinyl or plastics.

246

## Cleaning

### Scratches

Natural Markings - Because the leather in the seat comes from genuine steer hides, there will be evidence of naturally occurring markings, such as small scars. These markings give character to the seating covers and should be considered as proof of a genuine leather product.

In order to lessen the appearance of certain scratches and other wear marks, apply conditioner on the affected area following the same instructions as in the *Conditioning* section.

### Conditioning

Bottles of King Ranch Leather Conditioner are available at the King Ranch Saddle Shop. Visit the Web site at [www.krsaddleshop.com](http://www.krsaddleshop.com), or telephone (in the United States) 1-800-282-KING (5464). If you are unable to obtain King Ranch Leather Conditioner, use another premium leather conditioner.

- Apply your first conditioning treatment within six months of taking delivery of your vehicle. Condition twice yearly in order to replenish lost oils and revitalize the aroma, suppleness and resilience of the leather.
- Clean the surfaces using the steps outlined in the *Cleaning* section.
- Ensure the leather is dry then apply a nickel-sized amount of conditioner to a clean, dry cloth
- Rub the conditioner into leather until it disappears. Allow the conditioner to dry and repeat the process for the entire interior. If a film appears, wipe off film with a dry, clean cloth.

### UNDERBODY

Flush the complete underside of your vehicle frequently. Keep body and door drain holes free from packed dirt.

**Note:** Use care when using a power washer to clean the driveline, especially the driveshaft and interfacing components. The high-pressure fluid could penetrate the sealed parts and cause damage.

## Cleaning

### **FORD, LINCOLN AND MERCURY CAR CARE PRODUCTS**

Your authorized dealer has many quality products available to clean your vehicle and protect its finishes. These quality products have been specifically engineered to fulfill your automotive needs; they are custom designed to complement the style and appearance of your vehicle. Each product is made from high quality materials that meet or exceed rigid specifications. For best results, use the following products or products of equivalent quality:

- Motorcraft Bug and Tar Remover (ZC-42)
- Motorcraft Car Care Kit (ZC-26)
- Motorcraft Car Wash (Canada only) (CXC-21)
- Motorcraft Custom Bright Metal Cleaner (ZC-15)
- Motorcraft Custom Clear Coat Polish (ZC-8-A)
- Motorcraft Custom Vinyl Protectant (U.S. only) (ZC-40-A)
- Motorcraft Dash and Vinyl Cleaner (ZC-38-A)
- Motorcraft Deluxe Leather and Vinyl Cleaner (U.S. only) (ZC-11-A)
- Motorcraft Detail Wash (ZC-3-A)
- Motorcraft Dusting Cloth (ZC-24)
- Motorcraft Engine Shampoo and Degreaser (U.S. only) (ZC-20)
- Motorcraft Engine Shampoo (Canada only) (CXC-66-A)
- Motorcraft One Step Wash and Wax Concentrate (ZC-6-A)
- Motorcraft Paint Sealant (ZC-45)
- Motorcraft Premium Car Wash Concentrate (U.S. only) (ZC-17-B)
- Motorcraft Premium Glass Cleaner (Canada only) (CXC-100)
- Motorcraft Premium Liquid Wax (ZC-53-A)
- Motorcraft Professional Strength Carpet & Upholstery Cleaner (ZC-54)
- Motorcraft Spot and Stain Remover (U.S. only) (ZC-14)
- Motorcraft Tire Clean and Shine (ZC-28)
- Motorcraft Triple Clean (U.S. only) (ZC-13)
- Motorcraft Ultra-Clear Spray Glass Cleaner (ZC-23)
- Motorcraft Vinyl Cleaner (Canada only) (CXC-93)
- Motorcraft Vinyl Conditioner (Canada only) (CXC-94)
- Motorcraft Wheel and Tire Cleaner (ZC-37-A)

248



## Maintenance and Specifications

### SERVICE RECOMMENDATIONS

To help you service your vehicle:

- We highlight do-it-yourself items in the engine compartment for easy location.
- We provide a scheduled maintenance guide which makes tracking routine service easy.

If your vehicle requires professional service, your authorized dealer can provide the necessary parts and service. Check your *Warranty Guide/Owner Information Guide* to find out which parts and services are covered.

Use only recommended fuels, lubricants, fluids and service parts conforming to specifications. Motorcraft parts are designed and built to provide the best performance in your vehicle.

### PRECAUTIONS WHEN SERVICING YOUR VEHICLE

- Do not work on a hot engine.
- Make sure that nothing gets caught in moving parts.
- Do not work on a vehicle with the engine running in an enclosed space, unless you are sure you have enough ventilation.
- Keep all open flames and other burning (cigarettes) material away from the battery and all fuel related parts.

### Working with the engine off

- Automatic transmission:
  1. Set the parking brake and shift to P (Park).
  2. Turn off the engine and remove the key.
  3. Block the wheels.
- Manual transmission:
  1. Set the parking brake, depress the clutch and place the gearshift in 1 (First).
  2. Turn off the engine and remove the key.
  3. Block the wheels.

## Maintenance and Specifications

### Working with the engine on

- Automatic transmission:
  1. Set the parking brake and shift to P (Park).
  2. Block the wheels.
- Manual transmission:
  1. Set the parking brake, depress the clutch and place the gearshift in N (Neutral).
  2. Block the wheels.

**Note:** Do not start your engine with the air cleaner removed and do not remove it while the engine is running.

### OPENING THE HOOD

1. Inside the vehicle, pull the hood release handle located under the bottom left corner of the instrument panel.

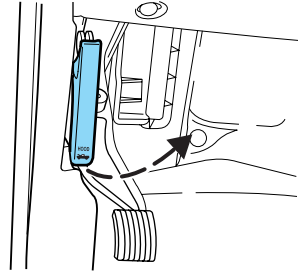

2. Go to the front of the vehicle and release the auxiliary latch located under the right center of the hood. Slide the handle to release the auxiliary latch.
3. Lift the hood until the lift cylinders hold it open.

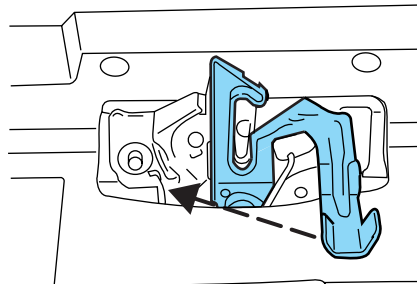

## Maintenance and Specifications

### IDENTIFYING COMPONENTS IN THE ENGINE COMPARTMENT

#### 5.4L V8 gasoline engines

Refer to the *6.0 Liter Power Stroke Direct Injection Turbo Diesel Owner's Guide Supplement* for diesel engine component locations.

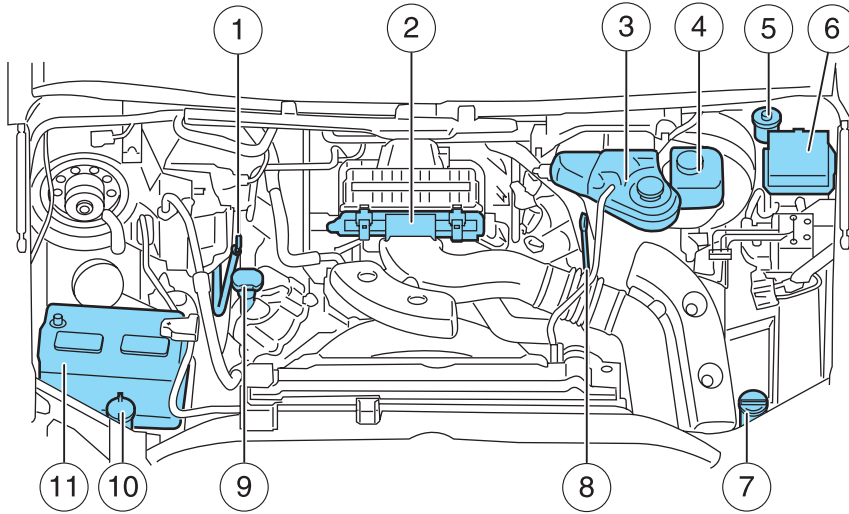

1. Transmission fluid dipstick (automatic transmission)
2. Air filter assembly
3. Engine coolant reservoir
4. Brake fluid reservoir
5. Clutch fluid reservoir (manual transmission)
6. Power distribution box
7. Power steering fluid reservoir
8. Engine oil dipstick
9. Engine oil filler cap
10. Windshield washer fluid reservoir
11. Battery

## Maintenance and Specifications

### 6.8L V10 gasoline engine

Refer to the *6.0 Liter Power Stroke Direct Injection Turbo Diesel Owner's Guide Supplement* for diesel engine component locations.

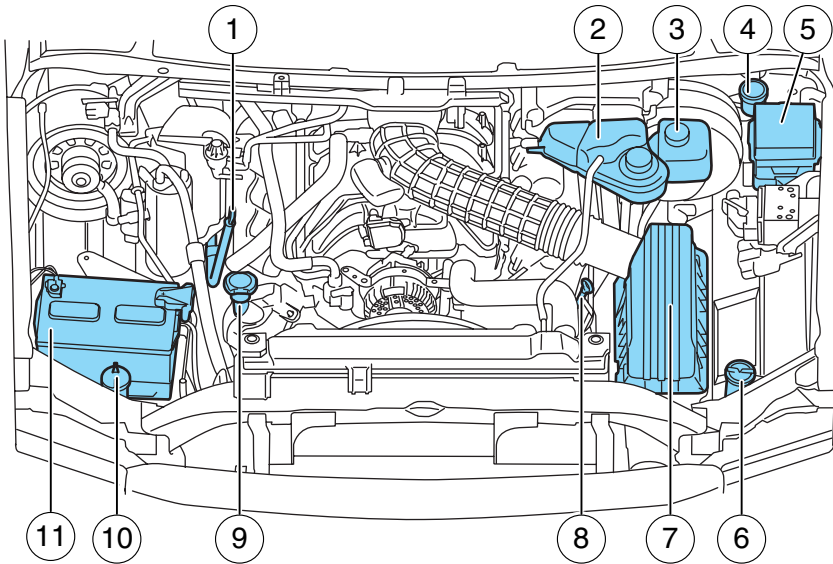

1. Transmission fluid dipstick (automatic transmission)
2. Engine coolant reservoir
3. Brake fluid reservoir
4. Clutch fluid reservoir (manual transmission)
5. Power distribution box
6. Power steering fluid reservoir
7. Air filter assembly
8. Engine oil dipstick
9. Engine oil filler cap
10. Windshield washer fluid reservoir
11. Battery

## Maintenance and Specifications

### WINDSHIELD WASHER FLUID

Add fluid to fill the reservoir if the level is low. In very cold weather, do not fill the reservoir completely.

Only use a washer fluid that meets Ford specification WSB-M8B16-A2. Do not use any special washer fluid such as windshield water repellent-type fluid or bug wash as this may cause a squeaking/chattering noise, streaking or smearing. Refer to *Lubricant specifications* in this chapter.

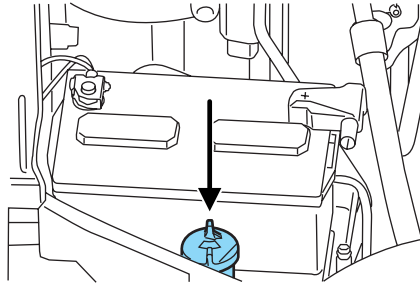

State or local regulations on volatile organic compounds may restrict the use of methanol, a common windshield washer antifreeze additive. Washer fluids containing non-methanol antifreeze agents should be used only if they provide cold weather protection without damaging the vehicle's paint finish, wiper blades or washer system.



If you operate your vehicle in temperatures below 40°F (4.5°C), use washer fluid with antifreeze protection. Failure to use washer fluid with antifreeze protection in cold weather could result in impaired windshield vision and increase the risk of injury or accident.

**Note:** Do not put washer fluid in the engine coolant reservoir. Washer fluid placed in the cooling system may harm engine and cooling system components.

## Maintenance and Specifications

### CHANGING THE WIPER BLADES

1. Pull the wiper arm away from the vehicle. Turn the blade at an angle from the wiper arm. Push the lock pin manually to release the blade and pull the wiper blade down toward the windshield to remove it from the arm.

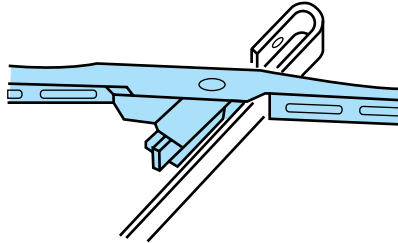

2. Attach the new wiper to the wiper arm and press it into place until a click is heard.

3. Replace wiper blades at least once per year for optimum performance.

4. Poor wiper quality can be improved by cleaning the wiper blades and the windshield; refer to *Windows and wiper blades* in the *Cleaning* chapter.

5. To prolong the life of the wiper blades, it is highly recommended to scrape off the ice on the windshield before turning on the wipers. The layer of ice has many sharp edges and can damage the micro edge of the wiper rubber element.

### ENGINE OIL

#### Checking the engine oil

Refer to the *scheduled maintenance information* for the appropriate intervals for checking the engine oil.

1. Make sure the vehicle is on level ground.
2. Turn the engine off and wait a few minutes for the oil to drain into the oil pan.
3. Set the parking brake and ensure the gearshift is securely latched in P (Park) (automatic transmission) or 1 (First) (manual transmission).
4. Open the hood. Protect yourself from engine heat.

## Maintenance and Specifications

5. Locate and carefully remove the engine oil level indicator (dipstick).

- 5.4L V8 engine

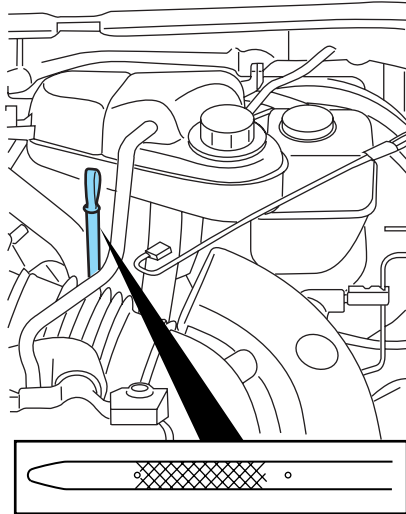

- 6.8L V10 engine

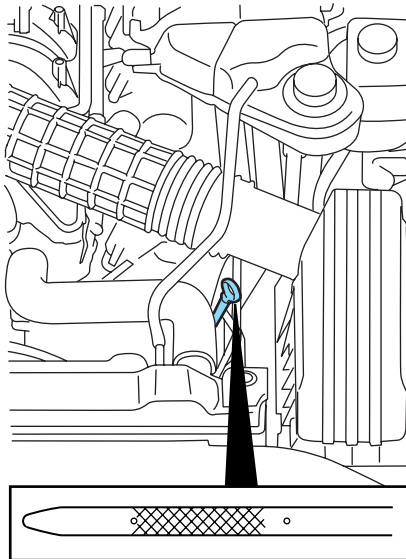

## Maintenance and Specifications

6. Wipe the indicator clean. Insert the indicator fully, then remove it again.

- If the oil level is **between the MIN and MAX marks**, the oil level is acceptable. **DO NOT ADD OIL.**
- If the oil level is below the MIN mark, add enough oil to raise the level within the MIN-MAX range.

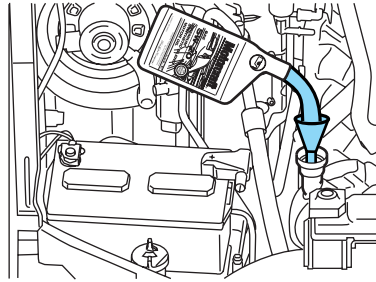

- Oil levels above the MAX mark may cause engine damage. Some oil must be removed from the engine by a service technician.

7. Put the indicator back in and ensure it is fully seated.

### Adding engine oil

1. Check the engine oil. For instructions, refer to *Checking the engine oil* in this chapter.
2. If the engine oil level is not within the normal range, add only certified engine oil of the recommended viscosity. Remove the engine oil filler cap and use a funnel to pour the engine oil into the opening.
3. Recheck the engine oil level. Make sure the oil level is not above the MAX mark on the engine oil level indicator (dipstick).
4. Install the indicator and ensure it is fully seated.
5. Fully install the engine oil filler cap by turning the filler cap clockwise 1/4 of a turn or until the cap is fully seated.

**To avoid possible oil loss, DO NOT operate the vehicle with the engine oil level indicator and/or the engine oil filler cap removed.**



## Maintenance and Specifications

### Engine oil and filter recommendations

Look for this certification trademark.



### **Use SAE 5W-20 engine oil.**

Only use oils “Certified For Gasoline Engines” by the American Petroleum Institute (API). An oil with this trademark symbol conforms to the current engine and emission system protection standards and fuel economy requirements of the International Lubricant Standardization and Approval Committee (ILSAC), comprised of U.S. and Japanese automobile manufacturers.

To protect your engine’s warranty use Motorcraft SAE 5W-20 or an equivalent 5W-20 oil meeting Ford specification WSS-M2C930-A. **SAE 5W-20 oil provides optimum fuel economy and durability performance meeting all requirements for your vehicle’s engine.**

Do not use supplemental engine oil additives, cleaners or other engine treatments. They are unnecessary and could lead to engine damage that is not covered by Ford warranty.

Change your engine oil and filter according to the appropriate schedule listed in the *scheduled maintenance information*.

Ford production and aftermarket (Motorcraft) oil filters are designed for added engine protection and long life. If a replacement oil filter is used that does not meet Ford material and design specifications, start-up engine noises or knock may be experienced.

It is recommended you use the appropriate Motorcraft oil filter (or another brand meeting Ford specifications) for your engine application.

## Maintenance and Specifications

### BATTERY

Your vehicle is equipped with a Motorcraft maintenance-free battery which normally does not require additional water during its life of service.

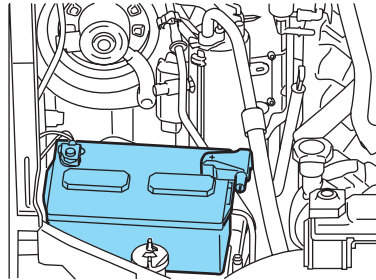

However, for severe usage or in high temperature climates, check the battery electrolyte level. Refer to the *scheduled maintenance information* for the service interval schedules.

**Keep the electrolyte level in each cell up to the “level indicator”. Do not overfill the battery cells.**

If the electrolyte level in the battery is low, you can add plain tap water to the battery, as long as you do not use hard water (water with a high mineral or alkali content). If possible, however, try to only fill the battery cells with distilled water. If the battery needs water often, have the charging system checked.

**If your battery has a cover/shield, make sure it is reinstalled after the battery has been cleaned or replaced.**

For longer, trouble-free operation, keep the top of the battery clean and dry. Also, make certain the battery cables are always tightly fastened to the battery terminals.

If you see any corrosion on the battery or terminals, remove the cables from the terminals and clean with a wire brush. You can neutralize the acid with a solution of baking soda and water.

When the battery is disconnected or a new battery installed, the transmission must learn its adaptive strategy. As a result of this, the transmission may shift firmly. This operation is considered normal and will fully update transmission operation to its optimum shift feel.

**Note: Electrical or electronic accessories or components added to the vehicle by the authorized dealer or the owner may adversely affect battery performance and durability.**

## Maintenance and Specifications

 Batteries normally produce explosive gases which can cause personal injury. Therefore, do not allow flames, sparks or lighted substances to come near the battery. When working near the battery, always shield your face and protect your eyes. Always provide proper ventilation.

 When lifting a plastic-cased battery, excessive pressure on the end walls could cause acid to flow through the vent caps, resulting in personal injury and/or damage to the vehicle or battery. Lift the battery with a battery carrier or with your hands on opposite corners.

 Keep batteries out of reach of children. Batteries contain sulfuric acid. Avoid contact with skin, eyes or clothing. Shield your eyes when working near the battery to protect against possible splashing of acid solution. In case of acid contact with skin or eyes, flush immediately with water for a minimum of 15 minutes and get prompt medical attention. If acid is swallowed, call a physician immediately.

 Battery posts, terminals and related accessories contain lead and lead compounds. **Wash hands after handling.**

For information on transmission operation after the battery has been disconnected, refer to *Shift strategy* in the *Driving* chapter.

Because your vehicle's engine is also electronically controlled by a computer, some control conditions are maintained by power from the battery. When the battery is disconnected or a new battery is installed, the engine must relearn its idle and fuel trim strategy for optimum driveability and performance. To begin this process:

1. With the vehicle at a complete stop, set the parking brake.
2. Put the gearshift in P (Park) (automatic transmission) or the neutral position (manual transmission), turn off all accessories and start the engine.
3. Run the engine until it reaches normal operating temperature.
4. Allow the engine to idle for at least one minute.
5. Turn the A/C on and allow the engine to idle for at least one minute.

## Maintenance and Specifications

6. Drive the vehicle to complete the relearning process.
  - The vehicle may need to be driven 10 miles (16 km) or more to relearn the idle and fuel trim strategy.
  - **If you do not allow the engine to relearn its idle trim, the idle quality of your vehicle may be adversely affected until the idle trim is eventually relearned.**

If the battery has been disconnected or a new battery has been installed, the clock and the preset radio stations must be reset once the battery is reconnected.

- Always dispose of automotive batteries in a responsible manner. Follow your local authorized standards for disposal. Call your local authorized recycling center to find out more about recycling automotive batteries.

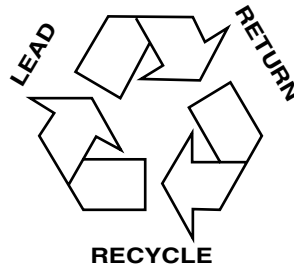

### ENGINE COOLANT

#### Checking engine coolant

The concentration and level of engine coolant should be checked at the mileage (kilometer) intervals listed in the *scheduled maintenance information*. The coolant concentration should be maintained at 50/50 coolant and distilled water, which equates to a freeze point of  $-34^{\circ}\text{F}$  ( $-36^{\circ}\text{C}$ ). Coolant concentration testing is possible with a hydrometer or antifreeze tester (such as the Rotunda Battery and Antifreeze Tester, 014-R1060). The level of coolant should be maintained at the "FULL COLD" level or within the "COLD FILL RANGE" in the coolant reservoir. If the level falls below, add coolant per the instructions in the *Adding engine coolant* section.

Your vehicle was factory-filled with a 50/50 engine coolant and water concentration. If the concentration of coolant falls below 40% or above 60%, the engine parts could become damaged or not work properly. **A 50/50 mixture of coolant and water provides the following:**

- **Freeze protection down to  $-34^{\circ}\text{F}$  ( $-36^{\circ}\text{C}$ ).**
- **Boiling protection up to  $265^{\circ}\text{F}$  ( $129^{\circ}\text{C}$ ).**
- **Protection against rust and other forms of corrosion.**

## Maintenance and Specifications

- Enables calibrated gauges to work properly.
- All engines

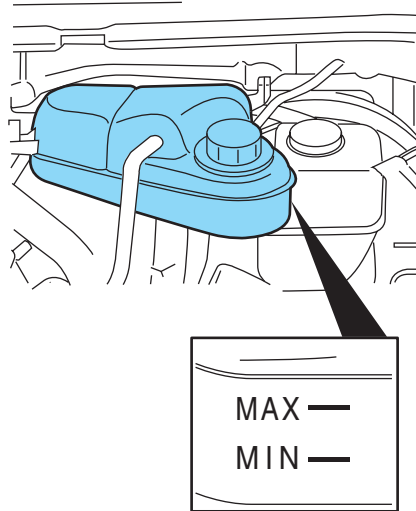

When the engine is cold, check the level of the engine coolant in the reservoir.

- The engine coolant should be at the “FULL COLD” level or within the “COLD FILL RANGE” as listed on the engine coolant reservoir (depending upon application).
- Refer to the *scheduled maintenance information* for service interval schedules.
- Be sure to read and understand *Precautions when servicing your vehicle* in this chapter.

If the engine coolant has not been checked at the recommended interval, the engine coolant reservoir may become low or empty. If the reservoir is low or empty, add engine coolant to the reservoir. Refer to *Adding engine coolant* in this chapter.

**Note:** Automotive fluids are not interchangeable; do not use engine coolant, antifreeze or windshield washer fluid outside of its specified function and vehicle location.

## Maintenance and Specifications

### Adding engine coolant

When adding coolant, make sure it is a 50/50 mixture of engine coolant and distilled water. Add the mixture to the coolant reservoir, **when the engine is cool**, until the appropriate fill level is obtained.



Do not add engine coolant when the engine is hot. Steam and scalding liquids released from a hot cooling system can burn you badly. Also, you can be burned if you spill coolant on hot engine parts.



Do not put engine coolant in the windshield washer fluid container. If sprayed on the windshield, engine coolant could make it difficult to see through the windshield.

- **Add Motorcraft Premium Gold Engine Coolant (yellow-colored), VC-7-A (U.S., except CA, OR and NM), VC-7-B (CA, OR and NM), meeting Ford Specification WSS-M97B51-A1.**

**Note:** Use of Motorcraft Cooling System Stop Leak Pellets, VC-6, may darken the color of Motorcraft Premium Gold Engine Coolant from yellow to golden tan.

- **Do not add/mix an orange-colored, extended life coolant such as Motorcraft Specialty Orange Engine Coolant, VC-2 (US) or CXC-209 (Canada), meeting Ford specification WSS-M97B44-D with the factory-filled coolant.** Mixing Motorcraft Specialty Orange Engine Coolant or any orange-colored extended life product with your factory filled coolant can result in degraded corrosion protection.
- A large amount of water without engine coolant may be added, in case of emergency, to reach a vehicle service location. In this instance, the cooling system must be drained and refilled with a 50/50 mixture of engine coolant and distilled water as soon as possible. Water alone (without engine coolant) can cause engine damage from corrosion, overheating or freezing.
- **Do not use alcohol, methanol, brine or any engine coolants mixed with alcohol or methanol antifreeze (coolant).** Alcohol and other liquids can cause engine damage from overheating or freezing.
- **Do not add extra inhibitors or additives to the coolant.** These can be harmful and compromise the corrosion protection of the engine coolant.

## Maintenance and Specifications

For vehicles with overflow coolant systems with a non-pressurized cap on the coolant recovery system, add coolant to the coolant recovery reservoir when the engine is cool. Add the proper mixture of coolant and water to the “FULL COLD” level. For all other vehicles which have a coolant degas system with a pressurized cap, or if it is necessary to remove the coolant pressure relief cap on the radiator of a vehicle with an overflow system, follow these steps to add engine coolant.



To reduce the risk of personal injury, make sure the engine is cool before unscrewing the coolant pressure relief cap. The cooling system is under pressure; steam and hot liquid can come out forcefully when the cap is loosened slightly.

1. Before you begin, turn the engine off and let it cool.
2. When the engine is cool, wrap a thick cloth around the coolant pressure relief cap on the coolant reservoir (a translucent plastic bottle). Slowly turn cap counterclockwise (left) until pressure begins to release.
3. Step back while the pressure releases.
4. When you are sure that all the pressure has been released, use the cloth to turn it counterclockwise and remove the cap.
5. Fill the coolant reservoir slowly with the proper coolant mixture (see above), to within the “COLD FILL RANGE” or the “FULL COLD” level on the reservoir. If you removed the radiator cap in an overflow system, fill the radiator until the coolant is visible and radiator is almost full.
6. Replace the cap. Turn until tightly installed. (Cap must be tightly installed to prevent coolant loss.)

After any coolant has been added, check the coolant concentration (refer to *Checking engine coolant*). If the concentration is not 50/50 (protection to  $-34^{\circ}\text{F}/-36^{\circ}\text{C}$ ), drain some coolant and adjust the concentration. It may take several drains and additions to obtain a 50/50 coolant concentration.

Whenever coolant has been added, the coolant level in the coolant reservoir should be checked the next few times you drive the vehicle. If necessary, add enough 50/50 concentration of engine coolant and distilled water to bring the liquid level to the proper level.

If you have to add more than 1.0 quart (1.0 liter) of engine coolant per month, have your authorized dealer check the engine cooling system. Your cooling system may have a leak. Operating an engine with a low level of coolant can result in engine overheating and possible engine damage.

## Maintenance and Specifications

### Recycled engine coolant

Ford Motor Company does NOT recommend the use of recycled engine coolant in vehicles originally equipped with Motorcraft Premium Gold Engine Coolant since a Ford-approved recycling process is not yet available.



Used engine coolant should be disposed of in an appropriate manner. Follow your community's regulations and standards for recycling and disposing of automotive fluids.

### Coolant refill capacity

To find out how much fluid your vehicle's cooling system can hold, refer to *Refill capacities* in this section. If your vehicle is equipped with a diesel engine, refer to the *Refill capacities* section of your *6.0 Liter Power Stroke Direct Injection Turbo Diesel Owner's Guide Supplement*.

Fill your engine coolant reservoir as outlined in *Adding engine coolant* in this section.

### Severe climates

If you drive in extremely cold climates (less than  $-34^{\circ}\text{F}$  [ $-36^{\circ}\text{C}$  ]):

- **It may be necessary to increase the coolant concentration above 50%.**
- **NEVER increase the coolant concentration above 60%.**
- **Increased engine coolant concentrations above 60% will decrease the overheat protection characteristics of the engine coolant and may cause engine damage.**
- **Refer to the chart on the coolant container to ensure the coolant concentration in your vehicle will provide adequate freeze protection at the temperatures in which you drive in the winter months.**

If you drive in extremely hot climates:

- **It is still necessary to maintain the coolant concentration above 40%.**
- **NEVER decrease the coolant concentration below 40%.**
- **Decreased engine coolant concentrations below 40% will decrease the corrosion protection characteristics of the engine coolant and may cause engine damage.**



## Maintenance and Specifications

- **Decreased engine coolant concentrations below 40% will decrease the freeze protection characteristics of the engine coolant and may cause engine damage.**
- **Refer to the chart on the coolant container to ensure the coolant concentration in your vehicle will provide adequate protection at the temperatures in which you drive.**

Vehicles driven year-round in non-extreme climates should use a 50/50 mixture of engine coolant and distilled water for optimum cooling system and engine protection.

### What you should know about fail-safe cooling (if equipped)

If the engine coolant supply is depleted, this feature allows the vehicle to be driven temporarily before incremental component damage is incurred. The “fail-safe” distance depends on ambient temperatures, vehicle load and terrain.

#### How fail-safe cooling works

If the engine begins to overheat:

- The engine coolant temperature gauge will move to the red (hot) area.
- The message center will indicate the engine is overheating.
- The *Service engine soon* indicator light will illuminate.

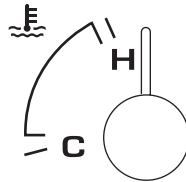

If the engine reaches a preset over-temperature condition, the engine will automatically switch to alternating cylinder operation. Each disabled cylinder acts as an air pump and cools the engine.

When this occurs the vehicle will still operate. However:

- The engine power will be limited.
- The air conditioning system will be disabled.

Continued operation will increase the engine temperature and the engine will completely shut down, causing steering and braking effort to increase.

Once the engine temperature cools, the engine can be re-started. Take your vehicle to a service facility as soon as possible to minimize engine damage.

## Maintenance and Specifications

### **When fail-safe mode is activated**

You have limited engine power when in the fail-safe mode, so drive the vehicle with caution. The vehicle will not be able to maintain high-speed operation and the engine will run rough. Remember that the engine is capable of completely shutting down automatically to prevent engine damage, therefore:

1. Pull off the road as soon as safely possible and turn off the engine.
2. Arrange for the vehicle to be taken to a service facility.
3. If this is not possible, wait a short period for the engine to cool.
4. Check the coolant level and replenish if low.



Never remove the coolant reservoir cap while the engine is running or hot.

5. Re-start the engine and take your vehicle to a service facility.

**Driving the vehicle without repairing the engine problem increases the chance of engine damage. Take your vehicle to a service facility as soon as possible.**

### **FUEL FILTER**

For fuel filter replacement, see your authorized dealer. Refer to the *scheduled maintenance information* for the appropriate intervals for changing the fuel filter.

**Replace the fuel filter with an authorized Motorcraft part. The customer warranty may be void for any damage to the fuel system if an authorized Motorcraft fuel filter is not used.**

### **WHAT YOU SHOULD KNOW ABOUT AUTOMOTIVE FUELS**

#### **Important safety precautions**





Do not overfill the fuel tank. The pressure in an overfilled tank may cause leakage and lead to fuel spray and fire.



The fuel system may be under pressure. If the fuel filler cap is venting vapor or if you hear a hissing sound, wait until it stops before completely removing the fuel filler cap. Otherwise, fuel may spray out and injure you or others.

## Maintenance and Specifications

 If you do not use the proper fuel filler cap, excessive pressure or vacuum in the fuel tank may damage the fuel system or cause the fuel cap to disengage in a collision, which may result in possible personal injury.

 Automotive fuels can cause serious injury or death if misused or mishandled.

 Gasoline may contain benzene, which is a cancer-causing agent.

Observe the following guidelines when handling automotive fuel:

- Extinguish all smoking materials and any open flames before refueling your vehicle.
- Always turn off the vehicle before refueling.
- Automotive fuels can be harmful or fatal if swallowed. Fuel such as gasoline is highly toxic and if swallowed can cause death or permanent injury. If fuel is swallowed, call a physician immediately, even if no symptoms are immediately apparent. The toxic effects of fuel may not be visible for hours.
- Avoid inhaling fuel vapors. Inhaling too much fuel vapor of any kind can lead to eye and respiratory tract irritation. In severe cases, excessive or prolonged breathing of fuel vapor can cause serious illness and permanent injury.
- Avoid getting fuel liquid in your eyes. If fuel is splashed in the eyes, remove contact lenses (if worn), flush with water for 15 minutes and seek medical attention. Failure to seek proper medical attention could lead to permanent injury.
- Fuels can also be harmful if absorbed through the skin. If fuel is splashed on the skin and/or clothing, promptly remove contaminated clothing and wash skin thoroughly with soap and water. Repeated or prolonged skin contact with fuel liquid or vapor causes skin irritation.



## Maintenance and Specifications

- Be particularly careful if you are taking “Antabuse” or other forms of disulfiram for the treatment of alcoholism. Breathing gasoline vapors, or skin contact could cause an adverse reaction. In sensitive individuals, serious personal injury or sickness may result. If fuel is splashed on the skin, promptly wash skin thoroughly with soap and water. Consult a physician immediately if you experience an adverse reaction.



When refueling always shut the engine off and never allow sparks or open flames near the filler neck. Never smoke while refueling. Fuel vapor is extremely hazardous under certain conditions. Care should be taken to avoid inhaling excess fumes.



The flow of fuel through a fuel pump nozzle can produce static electricity, which can cause a fire if fuel is pumped into an ungrounded fuel container.

Use the following guidelines to avoid static build-up when filling an ungrounded fuel container:

- Place approved fuel container on the ground.
- DO NOT fill a fuel container while it is in the vehicle (including the cargo area).
- Keep the fuel pump nozzle in contact with the fuel container while filling.
- DO NOT use a device that would hold the fuel pump handle in the fill position.

### Refueling



Fuel vapor burns violently and a fuel fire can cause bad injuries. To help avoid injuries to you and others:

- Read and follow all the instructions on the pump island;
- Turn off your engine when you are refueling;
- Do not smoke if you are near fuel or refueling your vehicle;
- Keep sparks, flames and smoking materials away from fuel;
- Stay outside your vehicle and do not leave the fuel pump unattended when refueling you vehicle — this is against the law in some places;
- Keep children away from the fuel pump; never let children pump fuel.

## Maintenance and Specifications

### Fuel filler cap

Your fuel tank filler cap has an indexed design with a 1/4 turn on/off feature.

When fueling your vehicle:

1. Turn the engine off.
2. Carefully turn the filler cap counterclockwise until it stops.
3. Pull to remove the cap from the fuel filler pipe.
4. To install the cap, align the tabs on the cap with the notches on the filler pipe.
5. Turn the filler cap clockwise until it clicks.

If the “Check Fuel Cap” indicator comes on and stays on after you start the engine, the fuel filler cap may not be properly installed. Turn off the engine, remove the fuel filler cap, align the cap properly and reinstall it.

**If you must replace the fuel filler cap, replace it with a fuel filler cap that is designed for your vehicle. The customer warranty may be void for any damage to the fuel tank or fuel system if the correct genuine Ford or Motorcraft fuel filler cap is not used.**



The fuel system may be under pressure. If the fuel filler cap is venting vapor or if you hear a hissing sound, wait until it stops before completely removing the fuel filler cap. Otherwise, fuel may spray out and injure you or others.



If you do not use the proper fuel filler cap, excessive pressure or vacuum in the fuel tank may damage the fuel system or cause the fuel cap to disengage in a collision, which may result in possible personal injury.

FORD RECOMMENDS BP



## Maintenance and Specifications

### Choosing the right fuel

Use only UNLEADED FUEL. The use of leaded fuel is prohibited by law and could damage your vehicle.

Your vehicle was not designed to use fuel or fuel additives with metallic compounds, including manganese-based additives. Studies indicate that these additives can cause your vehicle's emission control system to deteriorate more rapidly. In Canada, premium grade fuel generally contains more metallic additives than regular fuel. We recommend using regular grade fuel. In Canada, many fuels contain metallic additives, but fuels free of such additives may be available; check with your local fuel dealer.

Do not use fuel containing methanol. It can damage critical fuel system components.

Repairs to correct the effects of using a fuel for which your vehicle was not designed may not be covered by your warranty.

### Octane recommendations

Your vehicle is designed to use "Regular" unleaded gasoline with pump (R+M)/2 octane rating of 87.

We do not recommend the use of gasolines labeled as "Regular" that are sold with octane ratings of 86 or lower in high altitude areas.

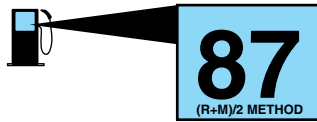

Do not be concerned if your engine sometimes knocks lightly. However, if it knocks heavily under most driving conditions while you are using fuel with the recommended octane rating, see your authorized dealer to prevent any engine damage.

### Fuel quality

If you are experiencing starting, rough idle or hesitation driveability problems, try a different brand of unleaded gasoline. "Premium" unleaded gasoline is not recommended for vehicles designed to use "Regular" unleaded gasoline because it may cause these problems to become more pronounced. If the problems persist, see your authorized dealer.

It should not be necessary to add any aftermarket products to your fuel tank if you continue to use high quality fuel of the recommended octane rating. Aftermarket products could cause damage to the fuel system. Repairs to correct the effects of using an aftermarket product in your fuel may not be covered by your warranty.

270

## Maintenance and Specifications

Many of the world's automakers approved the World-wide Fuel Charter that recommends gasoline specifications to provide improved performance and emission control system protection for your vehicle. Gasolines that meet the World-wide Fuel Charter should be used when available. Ask your fuel supplier about gasolines that meet the World-wide Fuel Charter.

### Cleaner air

Ford endorses the use of reformulated "cleaner-burning" gasolines to improve air quality.

### Running out of fuel

Avoid running out of fuel because this situation may have an adverse affect on powertrain components.

If you have run out of fuel:

- You may need to cycle the ignition from OFF to ON several times after refueling, to allow the fuel system to pump the fuel from the tank to the engine.
- The *Service engine soon* indicator () may come on. For more information on the *Service engine soon* indicator, refer to the *Instrument Cluster* chapter.

## ESSENTIALS OF GOOD FUEL ECONOMY

### Measuring techniques

Your best source of information about actual fuel economy is you, the driver. You must gather information as accurately and consistently as possible. Fuel expense, frequency of fill-ups or fuel gauge readings are NOT accurate as a measure of fuel economy. We do not recommend taking fuel economy measurements during the first 1,000 miles (1,600 km) of driving (engine break-in period). You will get a more accurate measurement after 2,000 miles-3,000 miles (3,000 km-5,000 km).

### Filling the tank

The advertised fuel capacity of the fuel tank on your vehicle is equal to the rated refill capacity of the fuel tank as listed in the *Refill capacities* section of this chapter.

## Maintenance and Specifications

The advertised capacity is the amount of the indicated capacity and the empty reserve combined. Indicated capacity is the difference in the amount of fuel in a full tank and a tank when the fuel gauge indicates empty. Empty reserve is the small amount of fuel remaining in the fuel tank after the fuel gauge indicates empty.

**The amount of usable fuel in the empty reserve varies and should not be relied upon to increase driving range. When refueling your vehicle after the fuel gauge indicates empty, you might not be able to refuel the full amount of the advertised capacity of the fuel tank due to the empty reserve still present in the tank.**

For consistent results when filling the fuel tank:

- Turn the engine/ignition off prior to refueling, an error in the reading will result if the engine is left running.
- Use the same filling rate setting (low-medium-high) each time the tank is filled.
- Allow no more than 2 automatic click-offs when filling.
- Always use fuel with the recommended octane rating.
- Use a known quality gasoline, preferably a national brand.
- Use the same side of the same pump and have the vehicle facing the same direction each time you fill up.
- Have the vehicle loading and distribution the same every time.

Your results will be most accurate if your filling method is consistent.

### Calculating fuel economy

1. Fill the fuel tank completely and record the initial odometer reading (in miles or kilometers).
2. Each time you fill the tank, record the amount of fuel added (in gallons or liters).
3. After at least three to five tank fill-ups, fill the fuel tank and record the current odometer reading.
4. Subtract your initial odometer reading from the current odometer reading.
5. Follow one of the simple calculations in order to determine fuel economy:

Calculation 1: **Divide total miles traveled by total gallons used.**

Calculation 2: **Multiply liters used by 100, then divide by total kilometers traveled.**



## Maintenance and Specifications

Keep a record for at least one month and record the type of driving (city or highway). This will provide an accurate estimate of the vehicle's fuel economy under current driving conditions. Additionally, keeping records during summer and winter will show how temperature impacts fuel economy. In general, lower temperatures give lower fuel economy.

### **Driving style — good driving and fuel economy habits**

Give consideration to the lists that follow and you may be able to change a number of variables and improve your fuel economy.

#### **Habits**

- Smooth, moderate operation can yield up to 10% savings in fuel.
- Steady speeds without stopping will usually give the best fuel economy.
- Idling for long periods of time (greater than one minute) may waste fuel.
- Anticipate stopping; slowing down may eliminate the need to stop.
- Sudden or hard accelerations may reduce fuel economy.
- Slow down gradually.
- Driving at reasonable speeds (traveling at 55 mph [88 km/h] uses 15% less fuel than traveling at 65 mph [105 km/h]).
- Revving the engine before turning it off may reduce fuel economy.
- Using the air conditioner or defroster may reduce fuel economy.
- You may want to turn off the speed control in hilly terrain if unnecessary shifting between third and fourth gear occurs. Unnecessary shifting of this type could result in reduced fuel economy.
- Warming up a vehicle on cold mornings is not required and may reduce fuel economy.
- Resting your foot on the brake pedal while driving may reduce fuel economy.
- Combine errands and minimize stop-and-go driving.

#### **Maintenance**

- Keep tires properly inflated and use only recommended size.
- Operating a vehicle with the wheels out of alignment will reduce fuel economy.
- Use recommended engine oil. Refer to *Lubricant specifications* in this chapter.

## Maintenance and Specifications

- Perform all regularly scheduled maintenance items. Follow the recommended maintenance schedule and owner maintenance checks found in your vehicle's *scheduled maintenance information*.

### **Conditions**

- Heavily loading a vehicle or towing a trailer may reduce fuel economy at any speed.
- Carrying unnecessary weight may reduce fuel economy (approximately 1 mpg [0.4 km/L] is lost for every 400 lb [180 kg] of weight carried).
- Adding certain accessories to your vehicle (for example bug deflectors, rollbars/light bars, running boards, ski/luggage racks) may reduce fuel economy.
- Using fuel blended with alcohol may lower fuel economy.
- Fuel economy may decrease with lower temperatures during the first 8–10 miles (12–16 km) of driving.
- Driving on flat terrain offers improved fuel economy as compared to driving on hilly terrain.
- Transmissions give their best fuel economy when operated in the top cruise gear and with steady pressure on the gas pedal.
- Four-wheel-drive operation (if equipped) is less fuel efficient than two-wheel-drive operation.
- Close windows for high speed driving.

### **EPA window sticker**

Every new vehicle should have the EPA window sticker. Contact your authorized dealer if the window sticker is not supplied with your vehicle. The EPA window sticker should be your guide for the fuel economy comparisons with other vehicles.

It is important to note the box in the lower left corner of the window sticker. These numbers represent the Range of MPG (L/100 km) expected on the vehicle under optimum conditions. Your fuel economy may vary depending upon the method of operation and conditions.

## Maintenance and Specifications

### EMISSION CONTROL SYSTEM

Your vehicle is equipped with various emission control components and a catalytic converter which will enable your vehicle to comply with applicable exhaust emission standards. To make sure that the catalytic converter and other emission control components continue to work properly:

- Use only the specified fuel listed.
- Avoid running out of fuel.
- Do not turn off the ignition while your vehicle is moving, especially at high speeds.
- Have the items listed in your *scheduled maintenance information* performed according to the specified schedule.

The scheduled maintenance items listed in the *scheduled maintenance information* are essential to the life and performance of your vehicle and to its emissions system.

If other than Ford, Motorcraft or Ford-authorized parts are used for maintenance replacements or for service of components affecting emission control, such non-Ford parts should be equivalent to genuine Ford Motor Company parts in performance and durability.



Do not park, idle, or drive your vehicle in dry grass or other dry ground cover. The emission system heats up the engine compartment and exhaust system, which can start a fire.

Illumination of the *Service engine soon* light () , charging system warning light or the temperature warning light, fluid leaks, strange odors, smoke or loss of engine power, could indicate that the emission control system is not working properly.





Exhaust leaks may result in entry of harmful and potentially lethal fumes into the passenger compartment.

Do not make any unauthorized changes to your vehicle or engine. By law, vehicle owners and anyone who manufactures, repairs, services, sells, leases, trades vehicles, or supervises a fleet of vehicles are not permitted to intentionally remove an emission control device or prevent it from working. Information about your vehicle's emission system is on the Vehicle Emission Control Information Decal located on or near the engine. This decal identifies engine displacement and gives some tune up specifications.

Please consult your *Warranty Guide* for complete emission warranty information.

## Maintenance and Specifications

### On board diagnostics (OBD-II)



Your vehicle is equipped with a computer that monitors the engine's emission control system. This system is commonly known as the On Board Diagnostics System (OBD-II). This OBD-II system protects the environment by ensuring that your vehicle continues to meet government emission standards. The OBD-II system also assists the service technician in properly servicing your vehicle. When the  light illuminates, the OBD-II system has detected a malfunction. Temporary malfunctions may cause your  light to illuminate. Examples are:

1. The vehicle has run out of fuel. (The engine may misfire or run poorly.)
2. Poor fuel quality or water in the fuel.
3. The fuel cap may not have been securely tightened.

These temporary malfunctions can be corrected by filling the fuel tank with good quality fuel and/or properly tightening the fuel cap. After three driving cycles without these or any other temporary malfunctions present, the  light should turn off. (A driving cycle consists of a cold engine startup followed by mixed city/highway driving.) No additional vehicle service is required.

If the  light remains on, have your vehicle serviced at the first available opportunity.

### Readiness for Inspection/Maintenance (I/M) testing

In some localities, it may be a legal requirement to pass an I/M test of the on-board diagnostics system. If your  light is on, refer to the description in the *Warning lights and chimes* section of the *Instrument Cluster* chapter. Your vehicle may not pass the I/M test with the  light on.

If the vehicle's powertrain system or its battery has just been serviced, the on-board diagnostics system is reset to a "not ready for I/M test" condition. To ready the on-board diagnostics system for I/M testing, a minimum of 30 minutes of city and highway driving is necessary as described below:

- First, at least 10 minutes of driving on an expressway or highway.
- Next, at least 20 minutes driving in stop-and-go, city-type traffic with at least four idle periods.

## Maintenance and Specifications

Allow the vehicle to sit for at least eight hours without starting the engine. Then, start the engine and complete the above driving cycle. The engine must warm up to its normal operating temperature. Once started, do not turn off the engine until the above driving cycle is complete.

### POWER STEERING FLUID

Check the power steering fluid.  
Refer to the scheduled maintenance guide for the service interval schedules. If adding fluid is necessary, use only MERCON® ATF.

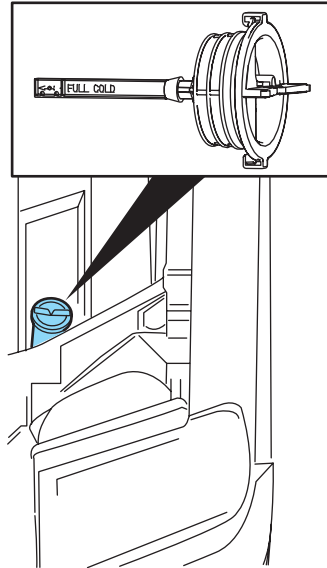

Check the fluid level when it is at ambient temperature, 20°F–80°F (-7°C–25°C):

1. Check the fluid level on the dipstick. It should be between the arrows in the FULL COLD range. Do not add fluid if the level is within this range.
2. If the fluid level is low. Add fluid to bring fluid level up to be between the arrows in the FULL COLD range.
3. Start the engine.
4. While the engine idles, turn the steering wheel left and right several times.
5. Turn the engine off.
6. Recheck the fluid level on the dipstick. Do not add fluid if the level is between the arrows in the FULL COLD range.

## Maintenance and Specifications

7. If the fluid is low, add fluid in small amounts, continuously checking the level until it reaches the FULL COLD range. Be sure to put the dipstick back in the reservoir.

### **BRAKE FLUID**

The fluid level will drop slowly as the brakes wear, and will rise when the brake components are replaced. Fluid levels between the “MIN” and “MAX” lines are within the normal operating range; there is no need to add fluid. If the fluid levels are outside of the normal operating range the performance of your brake system could be compromised; seek service from your authorized dealer immediately.

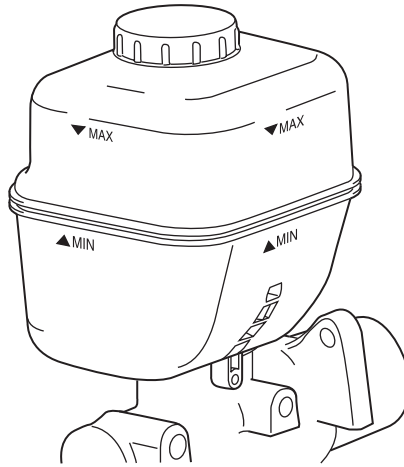

### **CLUTCH FLUID (IF EQUIPPED)**

Check the clutch fluid level. Refer to the *scheduled maintenance information* for the service interval schedules.

Use only a DOT 3 brake fluid designed to meet Ford specification ESA-M6C25-A. Refer to *Lubricant Specifications* in this chapter.



Brake fluid is toxic. If brake fluid contacts the eyes, flush eyes with running water for 15 minutes. Seek medical attention if irritation persists. If taken internally, drink water and induce vomiting. Seek medical attention immediately.

During normal operation, the fluid level in the clutch reservoir should remain constant or rise slightly. If the fluid level drops, refill the fluid level to the step in the reservoir.

## Maintenance and Specifications

1. Clean the reservoir cap before removal to prevent dirt and water from entering the reservoir.
2. Remove cap and rubber diaphragm from reservoir.
3. Add fluid until the level reaches the step in the reservoir.
4. Reinstall rubber diaphragm and cap onto reservoir.

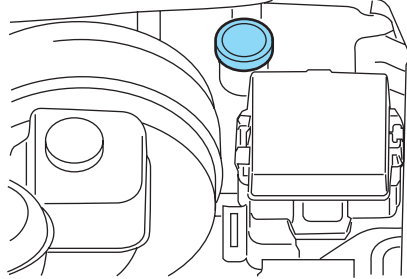

### TRANSMISSION FLUID

#### Checking automatic transmission fluid (if equipped)

Refer to your *scheduled maintenance information* for scheduled intervals for fluid checks and changes. Your transmission does not consume fluid. However, the fluid level should be checked if the transmission is not working properly, i.e., if the transmission slips or shifts slowly or if you notice some sign of fluid leakage.

Automatic transmission fluid expands when warmed. To obtain an accurate fluid check, drive the vehicle until it is at normal operating temperature (approximately 20 miles [30 km]). If your vehicle has been operated for an extended period at high speeds, in city traffic during hot weather or pulling a trailer, the vehicle should be turned off for about 30 minutes to allow fluid to cool before checking.

1. Drive the vehicle 20 miles (30 km) or until it reaches normal operating temperature.
2. Park the vehicle on a level surface and engage the parking brake.
3. With the parking brake engaged and your foot on the brake pedal, start the engine and move the gearshift lever through all of the gear ranges. Allow sufficient time for each gear to engage.
4. Latch the gearshift lever in P (Park) and leave the engine running.
5. Remove the dipstick, wiping it clean with a clean, dry lint free rag. If necessary, refer to *Identifying components in the engine compartment* in this chapter for the location of the dipstick.
6. Install the dipstick making sure it is fully seated in the filler tube.
7. Remove the dipstick and inspect the fluid level. The fluid should be in the designated area for normal operating temperature or ambient temperature.

## Maintenance and Specifications

### **Low fluid level**

Do not drive the vehicle if the fluid level is at the bottom of the dipstick and the ambient temperature is above 50°F (10°C).



### **Correct fluid level**

The transmission fluid should be checked at normal operating temperature 150°F-170°F (66°C-77°C) on a level surface. The normal operating temperature can be reached after approximately 20 miles (30 km) of driving.

You can check the fluid without driving if the ambient temperature is above 50°F (10°C). However, if fluid is added at this time, an overfill condition could result when the vehicle reaches normal operating temperature.

The transmission fluid should be in this range if at normal operating temperature (150°F-170°F [66°C-77°C]).

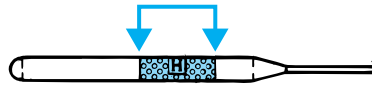

The transmission fluid should be in this range if at ambient temperature (50°F-95°F [10°C-35°C]).



### **High fluid level**

Fluid levels above the safe range may result in transmission failure. An overfill condition of transmission fluid may cause shift and/or engagement concerns and/or possible damage.

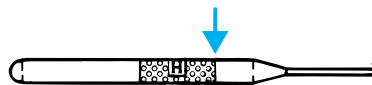

High fluid levels can be caused by an overheating condition.

### **Adjusting automatic transmission fluid levels**

Before adding any fluid, make sure the correct type is used. The type of fluid used is normally indicated on the dipstick handle and also in the *Lubricant specifications* section in this chapter.

**Use of a non-approved automatic transmission fluid may cause internal transmission component damage.**

If necessary, add fluid in 1/2 pint (250 ml) increments through the filler tube until the level is correct.



## Maintenance and Specifications

If an overfill occurs, excess fluid should be removed by a qualified technician.

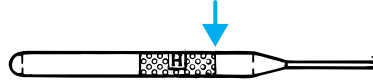

**An overfill condition of transmission fluid may cause shift and/or engagement concerns and/or possible damage.**

Do not use supplemental transmission fluid additives, treatments or cleaning agents. The use of these materials may affect transmission operation and result in damage to internal transmission components.

### Automatic transmission fluid filter (if equipped)

The TorqShift automatic transmission is equipped with a serviceable external fluid filter mounted on the frame rail. Refer to the *scheduled maintenance information* for service intervals.

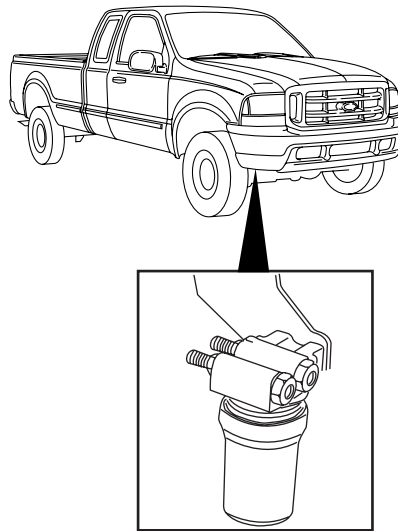

To replace the transmission filter:

1. Shut off the engine.
2. Unscrew filter housing.
3. Replace filter with a new authorized Motorcraft filter element. Refer to the *Motorcraft part numbers* chart in this chapter.
4. Reinstall housing and check transmission fluid level using procedure in this section.

## Maintenance and Specifications

### Checking and adding manual transmission fluid (if equipped)

1. Clean the filler plug.
2. Remove the filler plug and inspect the fluid level.

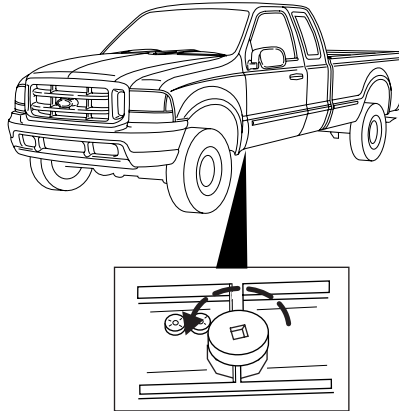

3. Fluid level should be at the bottom of the opening.
4. Add enough fluid through the filler opening so that the fluid level is at the bottom of the opening.
5. Install and tighten the fill plug securely.

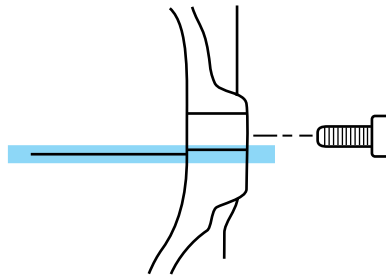

Use only fluid that meets Ford specifications. Refer to *Lubricant specifications* in this chapter.

## Maintenance and Specifications

### CHECKING AND ADDING TRANSFER CASE FLUID (IF EQUIPPED)

1. Clean the filler plug.
2. Remove the filler plug and inspect the fluid level.

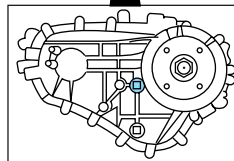
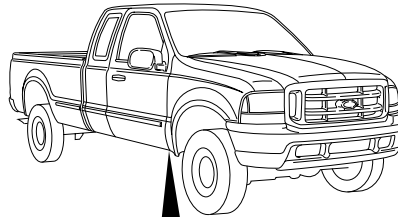

3. Add only enough fluid through the filler opening so that the fluid level is at the bottom of the opening.

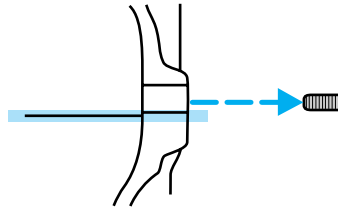

Use only fluid that meets Ford specifications. Refer to *Lubricant specifications* in this chapter.

### DRIVELINE UNIVERSAL JOINT AND SLIP YOKE

If the original universal joints are replaced with universal joints equipped with grease fittings, lubrication will be necessary. Refer to the *scheduled maintenance information* for maintenance intervals.

### AIR FILTER MAINTENANCE

Refer to the *scheduled maintenance information* for the appropriate intervals for changing the air filter element.

When changing the air filter element, use only the Motorcraft air filter element listed. Refer to *Motorcraft part numbers* in this chapter.

## Maintenance and Specifications

**Note:** Do not start your engine with the air cleaner removed and do not remove it while the engine is running.

### Changing the air filter element

- **5.4L Engine**

1. Release two retainer clamps.

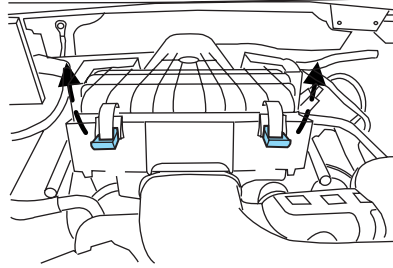

2. Pull air filter tray assembly out toward front of vehicle and lift air filter element up and out of housing.

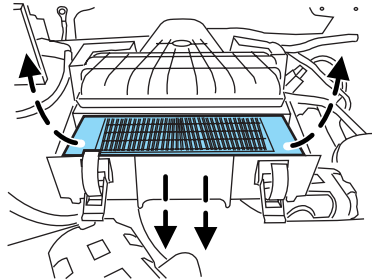

The air filter box needs to be free of any debris before installing a new air filter.

3. Install a new air filter element into the tray assembly.

4. Return air filter tray to original position by pressing firmly on the handle until all rearward movement stops and secure the two clamps.

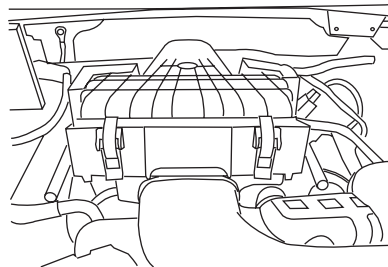

## Maintenance and Specifications

### • 6.8L Engine

1. Loosen the clamps that secure the air filter cover in place.

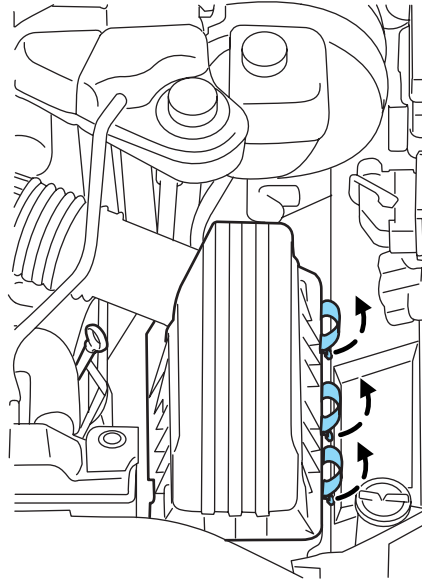

2. Carefully separate the two halves of the air filter housing.

3. Remove the air filter element from the air filter housing.

4. Install a new air filter element.

5. Reassemble the two halves of the air filter housing, aligning the notches and slots. Secure the clamps, making sure not to crimp the air filter edges between the two halves of the air filter housing. This could cause filter damage and allow unmetered air to enter the engine if not properly seated.

## Maintenance and Specifications

### MOTORCRAFT PART NUMBERS

| Component   | 5.4L V8 engine | 6.8L V10 engine |
|---|----------------|-----------------|
| Air filter element                                | FA-1754        | FA-1782         |
| Fuel filter                                       | FG-1011        | FG-1011         |
| Oil filter  | FL-820-S       | FL-820-S        |
| PCV valve   | 1              |                 |
| Battery (Standard)                                | BXT-65-650     | BXT-65-650      |
| Battery (Optional)                                | BXT-65-750     | BXT-65-750      |
| Spark plugs-platinum                              | 2              |                 |
| Remote Automatic Transmission Filter <sup>3</sup> | FT-145         | FT-145          |

<sup>1</sup>The PCV valve is a critical emission component. It is one of the items listed in the *scheduled maintenance information* and is essential to the life and performance of your vehicle and to its emissions system.

For PCV valve replacement, see your authorized dealer. Refer to the *scheduled maintenance information* for the appropriate intervals for changing the PCV valve.

**Replace the PCV valve with one that meets Ford material and design specifications for your vehicle, such as a Motorcraft or equivalent replacement part. The customer warranty may be void for any damage to the emissions system if such a PCV valve is not used.**

<sup>2</sup>For spark plug replacement, see your authorized dealer. Refer to the *scheduled maintenance information* for the appropriate intervals for changing the spark plugs.

**Replace the spark plugs with ones that meet Ford material and design specifications for your vehicle, such as Motorcraft or equivalent replacement parts. The customer warranty may be void for any damage to the engine if such spark plugs are not used.**

<sup>3</sup>Also available with 6.0L Diesel engine/TorqShift transmission. Part number is FT-145.

## Maintenance and Specifications

### REFILL CAPACITIES

| Fluid  | Ford Part Name   | Application  | Capacity                                       |
|--|--|--|--|
| Front axle   | Motorcraft SAE 80W-90 Premium Rear Axle Lubricant  | F-250/350 (Dana 60 axle)   | 5.8 pints (2.8L)                               |
|  |  | F-350/450/550 (Dana 60 axle)   | 5.8 pints (2.8L)                               |
| Rear axle  | Motorcraft SAE 75W-140 Synthetic Rear Axle Lubricant   | F-250 /350 (10.50 inch axle) <sup>1</sup>  | 6.9 pints (3.3L)                               |
|  | Motorcraft SAE 75W-90 Synthetic Rear Axle Lubricant  | F-350 (DANA 80) <sup>1</sup>   | 8.5 pints (4.0L)                               |
|  | Motorcraft SAE 75W-140 Synthetic Rear Axle Lubricant   | F-450/550 (Dana S110/S130) <sup>1</sup>  | 14.0 pints (6.6L)                              |
| Brake fluid (and clutch fluid-if equipped)                     | Motorcraft High Performance DOT 3 Motor Vehicle Brake Fluid  | All  | Fill to line or step (for clutch) on reservoir |
| Engine coolant - gas engines <sup>2</sup>                      | Motorcraft Premium Gold Engine Coolant (yellow-colored)  | 5.4L V8 engine with A/C  | 26.4 quarts (25.0L)                            |
|  |  | 6.8L V10 engine  | 27.5 quarts (26.0L)                            |
| Engine coolant - diesel engine <sup>2</sup>                    | Motorcraft Premium Gold Engine Coolant (yellow-colored)  | Refer to your <i>6.0 Liter Power Stroke Direct Injection Turbo Diesel Owner's Guide Supplement</i> |  |
| Engine oil (includes filter change) - gas engines <sup>6</sup> | Motorcraft SAE 5W-20 Premium Synthetic Blend Motor Oil (US)<br>Motorcraft SAE 5W-20 Super Premium Motor Oil (Canada) | 5.4L V8 and 6.8L V10 engines   | 7.0 quarts (6.6L)                              |

## Maintenance and Specifications

| Fluid   | Ford Part Name   | Application                             | Capacity   |
|---|--|---|--|
| Engine oil (includes filter change) - diesel engine | Refer to your <i>6.0 Liter Power Stroke Direct Injection Turbo Diesel Owner's Guide Supplement</i> |   |  |
| Fuel tank   | N/A  | Mid-ship tank (optional on Chassis Cab) | 19.0 gallons (71.9L)   |
|   |  | Short box                               | 30.5 gallons (115.5L)  |
|   |  | Long box                                | 38.0 gallons (143.9L)  |
|   |  | Aft axle                                | 40.0 gallons (151.4L)  |
| Power steering fluid                                | Motorcraft MERCON® ATF   | All                                     | Fill to FULL COLD range on dipstick                                      |
| Transfer case fluid                                 | Motorcraft MERCON® ATF   | 4x4 vehicles                            | 2.0 quarts (1.9L)  |
| Manual transmission fluid                           | Motorcraft MERCON® ATF   | 6-speed manual                          | 5.8 quarts (5.5L) <sup>4</sup>   |
| Automatic transmission fluid <sup>3</sup>           | Motorcraft MERCON® SP ATF  | TorqShift (5-speed)                     | 17.5 quarts (16.6L) <sup>5</sup> (includes remote filter element change) |
| Windshield washer fluid                             | Motorcraft Premium Windshield Washer Concentrate   | All                                     | 4.25 quarts (4.0L)   |

<sup>1</sup>Add 8 oz. (236 ml) of Additive Friction Modifier XL-3 or equivalent meeting Ford Specification EST-M2C118-A for complete refill of limited slip axles. Ford design rear axles contain a synthetic lubricant that does not require changing unless the axle has been submerged in water. Dana rear axles also contain a synthetic lubricant but do require a change. Refer to your *scheduled maintenance information* for change intervals on Dana rear axles.

<sup>2</sup>Add the coolant type originally equipped in your vehicle.



## Maintenance and Specifications

<sup>3</sup>Ensure the correct automatic transmission fluid is used. Transmission fluid requirements are indicated on the dipstick handle. Check the container to verify the fluid being added is of the correct type. Refer to your *scheduled maintenance information* to determine the correct service interval.

**MERCON<sup>®</sup>, MERCON<sup>®</sup> V and MERCON<sup>®</sup> SP are not interchangeable. DO NOT mix MERCON<sup>®</sup>, MERCON<sup>®</sup> V and MERCON<sup>®</sup> SP. Use of dual usage fluids in an automatic transmission application requiring MERCON<sup>®</sup> SP may cause transmission damage. Use of a transmission fluid other than the recommended fluid may cause transmission damage.**

<sup>4</sup>Service refill capacity is determined by filling the transmission to the bottom of the filler hole with the vehicle on a level surface. The 6-speed manual transmission is equipped with an in-tank cooler. Verify the fluid level after operating vehicle to ensure correct fluid level.

<sup>5</sup>Indicates only approximate dry-fill capacity. Some applications may vary based on cooler size and if equipped with an in-tank cooler. The amount of transmission fluid and fluid level should be set by the indication on the dipstick's normal operating range.

<sup>6</sup>Use of synthetic or synthetic blend motor oil is not mandatory. Engine oil need only meet the requirements of Ford specification WSS-M2C930-A and the API Certification mark.

## Maintenance and Specifications

### LUBRICANT SPECIFICATIONS

| Item                                       | Ford part name or equivalent   | Ford part number  | Ford specification         |
|--|--|---|----------------------------|
| Spindle bearing                            | High Temperature 4X4 Front Axle and Wheel Bearing Grease                                 | E8TZ-19590-A<br>XG-11 (FAD)                                 | ESA-M1C198-A               |
| Front axle (4X4)                           | Motorcraft SAE 80W-90 Premium Rear Axle Lubricant  | XY-80W-90-QL  | WSP-M2C197-A               |
| Rear axle                                  | Motorcraft SAE 75W-140 Synthetic Rear Axle Lubricant (10.5 inch) <sup>1</sup>            | XY-75W140-QL  | WSL-M2C192-A               |
|  | Motorcraft SAE 75W-90 Synthetic Rear Axle Lubricant (Dana 80) <sup>1</sup>               | XY-75W90-QLS  | WSS-M2C918-A               |
|  | Motorcraft SAE 75W-140 Synthetic Rear Axle Lubricant (Dana S110/S130 axles) <sup>1</sup> | XY-75W140-QL  | WSL-M2C192-A               |
| Brake fluid and clutch fluid (if equipped) | Motorcraft High Performance DOT 3 Motor Vehicle Brake Fluid                              | PM-1  | ESA-M6C25-A or WSS-M6C62-A |
| Engine coolant                             | Motorcraft Premium Gold Engine Coolant (yellow-colored)                                  | VC-7-A (U.S., except CA, OR and NM), VC-7-B (CA, OR and NM) | WSS-M97B51-A1              |

## Maintenance and Specifications

| Item  | Ford part name or equivalent   | Ford part number                            | Ford specification                      |
|---|--|---|---|
| Engine oil  | Motorcraft SAE 5W-20 Premium Synthetic Blend Motor Oil (US)<br>Motorcraft SAE 5W-20 Super Premium Motor Oil (Canada) | XO-5W20-QSP (US)<br>CXO-5W20-LSP12 (Canada) | WSS-M2C930-A and API Certification Mark |
| Hinges, latches, striker plates, fuel filler door hinge and seat tracks                     | Multi-Purpose Grease   | XG-4 or XL-5                                | ESB-M1C93-B                             |
| Lock cylinders  | Motorcraft Penetrating and Lock Lubricant  | XL-1  | none                                    |
| Transmission /parking brake linkages and pivots, brake and clutch pedal shaft (if equipped) | Motorcraft Premium Long-Life Grease  | XG-1-C or XG-1-K                            | ESA-M1C75-B                             |
| Steering linkage, knuckle ball joints (F-450/550) and trackbar ball joint (F-450/550)       | Motorcraft Premium Long-Life Grease  | XG-1-C or XG-1-K                            | WSD-M1C227-A                            |
| Power steering fluid and transfer case fluid (if equipped)                                  | Motorcraft MERCON® ATF   | XT-2-QDX                                    | MERCON®                                 |
| Manual transmission (6-speed)   | Motorcraft MERCON® ATF <sup>2</sup>  | XT-2-QDX                                    | MERCON®                                 |

## Maintenance and Specifications

| Item   | Ford part name or equivalent                                 | Ford part number | Ford specification |
|--|--|------------------|--------------------|
| Automatic transmission<br>TorqShift<br>(5-speed) | Motorcraft<br>MERCON® SP<br>ATF <sup>2</sup>                 | XT-6-QSP         | MERCON® SP         |
| Windshield washer fluid                          | Motorcraft<br>Premium<br>Windshield<br>Washer<br>Concentrate | ZC-32-A          | WSB-M8B16-A2       |

<sup>1</sup>Add 8 oz.(236 ml) of Additive Friction Modifier XL-3 or equivalent meeting Ford specification EST-M2C118-A for complete refill of limited slip axles. Ford design rear axles contain a synthetic lubricant that does not require changing unless the axle has been submerged in water. Dana rear axles also contain a synthetic lubricant but **do** require a change. Refer to your *scheduled maintenance information* for change intervals on Dana rear axles.

<sup>2</sup>Ensure the correct automatic transmission fluid is used. Transmission fluid requirements are indicated on the dipstick handle. Check the container to verify the fluid being added is of the correct type. Refer to your *scheduled maintenance information* to determine the correct service interval.

**MERCON®, MERCON® V and MERCON® SP are not interchangeable. DO NOT mix MERCON®, MERCON® V and MERCON® SP. Use of dual usage fluids in an automatic transmission application requiring MERCON® SP may cause transmission damage. Use of a transmission fluid other than the recommended fluid may cause transmission damage.**

## Maintenance and Specifications

### ENGINE DATA

| Engine            | 5.4L V8 engine                     | 6.8L V10 engine                    |
|-------------------|------------------------------------|------------------------------------|
| Cubic inches      | 330                                | 415                                |
| Required fuel     | 87 octane                          | 87 octane                          |
| Firing order      | 1-3-7-2-6-5-4-8                    | 1-6-5-10-2-7-3-8-4-9               |
| Spark plug gap    | 1.02–1.28mm<br>(0.040–0.050 inch)* | 1.02–1.28mm<br>(0.040–0.050 inch)* |
| Ignition system   | Coil on plug                       | Coil on plug                       |
| Compression ratio | 9.8:1                              | 9.2:1                              |

\*The 5.4L 3V and 6.8L 3V spark plug gap CANNOT be adjusted.

### VEHICLE DIMENSIONS

#### F–250 Regular Cab and SuperCab

| Dimension                                       | Body style                    |                               |  |  |
|---|-------------------------------|-------------------------------|--|--|
|   | Regular Cab 4x2 – inches (mm) | Regular Cab 4x4 – inches (mm) | SuperCab 4x2 – inches (mm)                             | SuperCab 4x4 – inches (mm)                             |
| (1) Overall height                              | 76.5 (1943)                   | 79.1 (2009)                   | 76.8 (1951) <sup>b</sup>                               | 79.4 (2017) <sup>b</sup>                               |
| (2) Track - Front/Rear                          | 68.3 (1734)/67.2 (1706)       | 68.3 (1736) / 67.2 (1706)     | 68.3 (1734) / 67.2 (1706)                              | 68.3 (1736) / 67.2 (1706)                              |
| (3) Overall width                               | 79.9 (2029)                   | 79.9 (2029)                   | 79.9 (2029)  | 79.9 (2029)  |
| (4) Wheelbase                                   | 137.0 (3480)                  | 137.0 (3480)                  | 141.8 (3602) <sup>a</sup><br>158.0 (4013) <sup>b</sup> | 141.8 (3602) <sup>a</sup><br>158.0 (4013) <sup>b</sup> |
| (5) Overall length                              | 226.4 (5751)                  | 226.4 (5751)                  | 231.2 (5872) <sup>a</sup><br>247.4 (6284) <sup>b</sup> | 231.2 (5872) <sup>a</sup><br>247.4 (6284) <sup>b</sup> |
| <sup>a</sup> Short Box<br><sup>b</sup> Long Box |                               |                               |  |  |

## Maintenance and Specifications

### F-250 Crew Cab

| Dimension                 | Body style  |  |   |   |
|---------------------------|---|--|---|---|
|                           | Crew Cab<br>4x2, Short<br>box -<br>inches<br>(mm) | Crew Cab<br>4x4, Short<br>box - inches<br>(mm) | Crew Cab<br>4x2, Long<br>box - inches<br>(mm) | Crew Cab<br>4x4, Long<br>box - inches<br>(mm) |
| (1) Overall height        | 77.5 (1969)                                       | 80.0 (2032)                                    | 77.3 (1963)                                   | 79.9 (2029)                                   |
| (2) Track -<br>Front/Rear | 68.3<br>(1734)/<br>67.2 (1706)                    | 68.3 (1736)/<br>67.2 (1706)                    | 68.3 (1734)/<br>67.2 (1706)                   | 68.3 (1736)/<br>67.2 (1706)                   |
| (3) Overall width         | 79.9 (2029)                                       | 79.9 (2029)                                    | 79.9 (2029)                                   | 79.9 (2029)                                   |
| (4) Wheelbase             | 156.2<br>(3967)                                   | 156.2 (3967)                                   | 172.4 (4379)                                  | 172.4 (4379)                                  |
| (5) Overall length        | 245.6<br>(6238)                                   | 245.6 (6238)                                   | 261.8 (6650)                                  | 261.8 (6650)                                  |

## Maintenance and Specifications

### F-350 (except Crew Cab)

| Dimension   | Body style   |  |  |  |
|---|--|--|--|--|
|   | Regular Cab Chassis Cab - inches (mm)  | SuperCab Chassis Cab - inches (mm)   | Regular Cab Style Side - inches (mm)   | SuperCab Style Side - inches (mm)  |
| (1) Overall height  | 76.9 (1953) <sup>a</sup><br>77.1 (1958) <sup>b</sup><br>81.6 (2073) <sup>c</sup><br>80.0 (2032) <sup>d</sup>       | 77.4 (1966) <sup>a</sup><br>77.4 (1966) <sup>b</sup><br>81.5 (2070) <sup>c</sup><br>80.2 (2037) <sup>d</sup>       | 76.8 (1951) <sup>a</sup><br>76.7 (1948) <sup>b</sup><br>80.8 (2052) <sup>c</sup><br>79.6 (2022) <sup>d</sup>       | 77.3 (1963) <sup>a,e</sup><br>77.1 (1958) <sup>a,f</sup><br>77.0 (1956) <sup>b</sup><br>81.4 (2068) <sup>c,e</sup><br>81.2 (2062) <sup>c,f</sup><br>79.6 (2022) <sup>d</sup> |
| (2a) Track - Front  | 68.3 (1734) <sup>a</sup> /<br>68.9 (1751) <sup>b</sup> /<br>68.3 (1736) <sup>c</sup> /<br>69.0 (1753) <sup>d</sup> | 68.3 (1734) <sup>a</sup> /<br>68.9 (1751) <sup>b</sup> /<br>68.3 (1736) <sup>c</sup> /<br>69.0 (1753) <sup>d</sup> | 68.3 (1734) <sup>a</sup> /<br>68.9 (1751) <sup>b</sup> /<br>68.3 (1736) <sup>c</sup> /<br>69.0 (1753) <sup>d</sup> | 68.3 (1734) <sup>a</sup> /<br>68.9 (1751) <sup>b</sup> /<br>68.3 (1736) <sup>c</sup> /<br>69.0 (1753) <sup>d</sup>   |
| (2b) Track - Rear   | 68.1 (1730) <sup>a, c</sup> /<br>71.0 (1803) <sup>b, d</sup>   | 68.1 (1730) <sup>a, c</sup> /<br>71.0 (1803) <sup>b, d</sup>   | 67.2 (1706) <sup>a, c</sup> /<br>74.6 (1896) <sup>b, d</sup>   | 67.2 (1706) <sup>a, c</sup> /<br>74.6 (1896) <sup>b, d</sup>   |
| (3) Overall width   | 79.9 (2029) <sup>a,c</sup> /<br>92.2 (2342) <sup>b, d</sup>  | 79.9 (2029) <sup>a,c</sup> /<br>92.2 (2342) <sup>b, d</sup>  | 79.9 (2029) <sup>a,c</sup> /<br>95.5 (2426) <sup>b, d</sup>  | 79.9 (2029) <sup>a,c</sup> /<br>95.5 (2426) <sup>b, d</sup>  |
| (4) Wheelbase   | 140.8 (3576)<br>164.8 (4186)   | 161.8 (4110)   | 137.0 (3480)   | 141.8 (3602) <sup>e</sup> /<br>158.0 (4013) <sup>f</sup>   |
| (5) Overall length  | 225.6 (5730) <sup>a,b,c,d</sup> /<br>249.6 (6340) <sup>b,d</sup>   | 246.6 (6264)   | 226.4 (5751)   | 231.2 (5872) <sup>e</sup> /<br>247.4 (6284) <sup>f</sup>   |
| <sup>a</sup> 4x2 Single rear wheel (SRW)<br><sup>b</sup> 4x2 Dual rear wheel (DRW)<br><sup>c</sup> 4x4 Single rear wheel (SRW)<br><sup>d</sup> 4x4 Dual rear wheel (DRW)<br><sup>e</sup> Short box<br><sup>f</sup> Long box |  |  |  |  |

## Maintenance and Specifications

### F-350 Crew Cab

| Dimension  | Body style   |  |  |
|--|--|--|--|
|  | Crew Cab<br>Chassis Cab -<br>inches (mm)   | Crew Cab,<br>Short box -<br>inches (mm)  | Crew Cab,<br>Long box -<br>inches (mm)   |
| (1) Overall height   | 77.9 (1979) <sup>a/</sup><br>77.9 (1979) <sup>b/</sup><br>81.8 (2078) <sup>c/</sup><br>80.8 (2052) <sup>d</sup>    | 77.8 (1976) <sup>a/</sup><br>77.6 (1971) <sup>b/</sup><br>81.8 (2078) <sup>c/</sup><br>80.1 (2035) <sup>d</sup>    | 77.6 (1971) <sup>a/</sup><br>77.4 (1966) <sup>b/</sup><br>81.7 (2075) <sup>c/</sup><br>80.0 (2032) <sup>d</sup>    |
| (2a) Track - Front   | 68.3 (1734) <sup>a</sup> /<br>68.9 (1751) <sup>b</sup> /<br>68.3 (1736) <sup>c</sup> /<br>69.0 (1753) <sup>d</sup> | 68.3 (1734) <sup>a</sup> /<br>68.9 (1751) <sup>b</sup> /<br>68.3 (1736) <sup>c</sup> /<br>69.0 (1753) <sup>d</sup> | 68.3 (1734) <sup>a</sup> /<br>68.9 (1751) <sup>b</sup> /<br>68.3 (1736) <sup>c</sup> /<br>69.0 (1753) <sup>d</sup> |
| (2b) Track - Rear  | 68.1 (1730) <sup>a,c/</sup><br>71.0 (1803) <sup>b,d</sup>  | 67.2 (1706) <sup>a,c/</sup><br>74.6 (1896) <sup>b,d</sup>  | 67.2 (1706) <sup>a,c/</sup><br>74.6 (1896) <sup>b,d</sup>  |
| (3) Overall width  | 79.9 (2029) <sup>a,c/</sup><br>92.2 (2342) <sup>b, d</sup>   | 79.9 (2029) <sup>a,c/</sup><br>95.5 (2426) <sup>b, d</sup>   | 79.9 (2029) <sup>a,c</sup><br>95.5 (2426) <sup>b,d</sup>   |
| (4) Wheelbase  | 176.2 (4475)   | 156.2 (3967)   | 172.4 (4379)   |
| (5) Overall length   | 261.0 (6629)   | 245.6 (6238)   | 261.8 (6650)   |
| <sup>a</sup> 4x2 Single Rear Wheel (SRW)<br><sup>b</sup> 4x2 Dual Rear Wheel (DRW)<br><sup>c</sup> 4x4 Single Rear Wheel (SRW)<br><sup>d</sup> 4x4 Dual Rear Wheel (DRW) |  |  |  |



## Maintenance and Specifications

### F-450

| Dimension  | Body style   |  |  |  |
|--|--|--|--|--|
|  | Regular Cab Chassis 4x2 - inches (mm)  | Regular Cab Chassis 4x4 - inches (mm)  | SuperCab Chassis 4x2/4x4 - inches (mm) | Crew Cab Chassis 4x2/4x4 - inches (mm)                 |
| (1) Overall height   | 80.6 (2047) <sup>a</sup><br>80.5 (2045) <sup>b,c</sup><br>80.2 (2037) <sup>d</sup>                               | 80.7 (2050) <sup>a</sup><br>80.5 (2045) <sup>b</sup><br>80.0 (2032) <sup>c,d</sup>                               | 80.5 (2045)                            | 80.8 (2052) - 4x2<br>80.9 (2055) - 4x4                 |
| (2) Track - Front / Rear   | 74.8 (1900) / 74.0 (1880)  | 74.8 (1900) / 74.0 (1880)  | 74.8 (1900) / 74.0 (1880)              | 74.8 (1900) / 74.0 (1880)                              |
| (3) Overall width  | 93.6 (2377)  | 93.6 (2377)  | 93.6 (2377)                            | 93.6 (2377)  |
| (4) Wheelbase  | 140.8 (3576)<br>164.8 (4186)<br>188.8 (4796)<br>200.8 (5100)   | 140.8 (3576)<br>164.8 (4186)<br>188.8 (4796)<br>200.8 (5100)   | 161.8 (4110)                           | 176.2 (4475)<br>200.2 (5085)                           |
| (5) Overall length   | 225.6 (5730) <sup>a</sup><br>249.6 (6340) <sup>b</sup><br>273.6 (6949) <sup>c</sup><br>285.6 (7254) <sup>d</sup> | 225.6 (5730) <sup>a</sup><br>249.6 (6340) <sup>b</sup><br>273.6 (6949) <sup>c</sup><br>285.6 (7254) <sup>d</sup> | 246.6 (6264)                           | 261.0 (6629) <sup>e</sup><br>285.0 (7239) <sup>f</sup> |
| <sup>a</sup> 140.8" (3576 mm) wheel base<br><sup>b</sup> 164.8" (4186 mm) wheel base<br><sup>c</sup> 188.8" (4795 mm) wheel base<br><sup>d</sup> 200.8" (5100 mm) wheel base<br><sup>e</sup> 176.2" (4475 mm) wheel base<br><sup>f</sup> 200.2" (5085 mm) wheel base |  |  |  |  |

## Maintenance and Specifications

### F-550

| Dimension  | Body style   |  |  |  |
|--|--|--|--|--|
|  | Regular Cab Chassis Cab 4x2 – inches (mm)  | Regular Cab Chassis Cab 4x4 – inches (mm)  | Crew Cab Chassis Cab 4x2 – inches (mm) | Crew Cab Chassis Cab 4x4 – inches (mm)                 |
| (1) Overall height   | 81.7 (2075) <sup>a</sup><br>81.4 (2068) <sup>b,c</sup><br>81.1 (2060) <sup>d</sup>                               | 81.7 (2075) <sup>a</sup><br>81.2 (2062) <sup>b</sup><br>81.1 (2060) <sup>c</sup><br>80.7 (2050) <sup>d</sup>     | 81.5 (2070)                            | 81.4 (2068)  |
| (2) Track - Front / Rear   | 74.8 (1900) / 74.0 (1880)  | 74.8 (1900) / 74.0 (1880)  | 74.8 (1900) / 74.0 (1880)              | 74.8 (1900) / 74.0 (1880)                              |
| (3) Overall width  | 93.6 (2377)  | 93.6 (2377)  | 93.6 (2377)                            | 93.6 (2377)  |
| (4) Wheelbase  | 140.8 (3576)<br>164.8 (4186)<br>188.8 (4796)<br>200.8 (5100)   | 140.8 (3576)<br>164.8 (4186)<br>188.8 (4796)<br>200.8 (5100)   | 161.8 (4110)                           | 176.2 (4475)<br>200.2 (5085)                           |
| (5) Overall length   | 225.6 (5730) <sup>a</sup><br>249.6 (6340) <sup>b</sup><br>273.6 (6949) <sup>c</sup><br>285.6 (7254) <sup>d</sup> | 225.6 (5730) <sup>a</sup><br>249.6 (6340) <sup>b</sup><br>273.6 (6949) <sup>c</sup><br>285.6 (7254) <sup>d</sup> | 246.6 (6264)                           | 261.0 (6629) <sup>e</sup><br>285.0 (7239) <sup>f</sup> |
| <sup>a</sup> 140.8" (3576 mm) wheel base<br><sup>b</sup> 164.8" (4186 mm) wheel base<br><sup>c</sup> 188.8" (4795 mm) wheel base<br><sup>d</sup> 200.8" (5100 mm) wheel base<br><sup>e</sup> 176.2" (4475 mm) wheel base<br><sup>f</sup> 200.2" (5085 mm) wheel base |  |  |  |  |

## Maintenance and Specifications

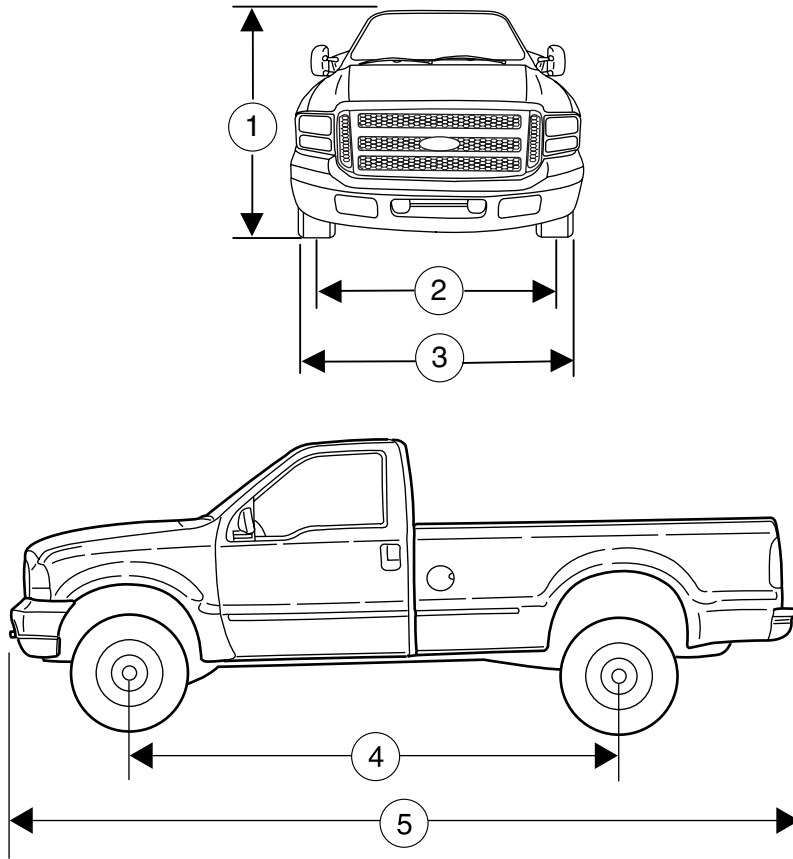

## Maintenance and Specifications

### IDENTIFYING YOUR VEHICLE

#### Safety Compliance Certification Label

The National Highway Traffic Safety Administration Regulations require that a Safety Compliance Certification Label be affixed to a vehicle and prescribe where the Safety Compliance Certification Label may be located. The Safety Compliance Certification Label is located on the structure by the trailing edge of the driver's door or the edge of the driver's door.

|  |                            |
|--|----------------------------|
| <b>MFD. BY FORD MOTOR CO. IN U.S.A.</b>  |                            |
| DATE: XXXXX  | GVWR: XXXXX LB/ XXXXX KG   |
| FGAWR: XXXXXX/XXXXXXXX   | RGAWR: XXXXXX/XXXXXXXX     |
| THIS VEHICLE CONFORMS TO ALL APPLICABLE FEDERAL MOTOR VEHICLE SAFETY STANDARDS IN EFFECT ON THE DATE OF MANUFACTURE SHOWN ABOVE. |                            |
| VIN: XXXXXXXXXXXXXXXXX   | TYPE: XXXXXXXXXXXXXXXXX    |
|    |                            |
| MAXIMUM LOAD=OCCUPANTS + LUGGAGE=XXXKG/XXXLB   |                            |
| OCCUPANTS: X TOTAL X FR X 2ND X RR OCCUPANTS LUGGAGE   |                            |
| TIRE: XXXX/XXXXX XXX XX XXXKG/XXXLB  |                            |
| PRESSURE (FR) XXX kPa/ XX PSI COLD X XXXKG/XXXLB   |                            |
| PRESSURE (RR) XXX kPa/ XX PSI COLD X XXXKG/XXXLB   |                            |
| TRAILER TOWING - SEE OWNER GUIDE   |                            |
| EXT PNT: XXXXX XXXXX   | RC: XX   DSC: XXXX   F0000 |
| BAR   INT TR   TP/PS   R   | AXLE   TR   SPR   T0000    |
| X XX XXX X   | XX X XXXX                  |
| UTC VF0HT-15294A10-GA  |                            |

#### Vehicle identification number (VIN)

The vehicle identification number is attached to a metal tag and is located on the driver side instrument panel. (Please note that in the graphic XXXX is representative of your vehicle identification number.)

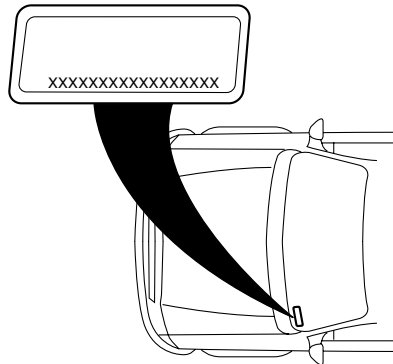

## Maintenance and Specifications

1. World manufacturer identifier
2. Brake type and gross vehicle weight rating (GVWR)
3. Vehicle line, series, body type
4. Engine type
5. Check digit
6. Model year
7. Assembly plant
8. Production sequence number

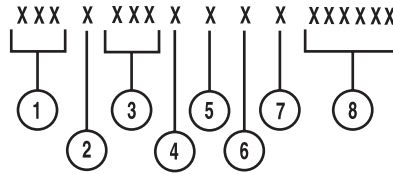

### TRANSMISSION/TRANSAXLE CODE DESIGNATIONS

**MFD. BY FORD MOTOR CO. IN U.S.A.**

DATE: XX/XX      GVWR: XXXXXLB/ XXXXXKG  
 FRONT GAWR: XXXXL      REAR GAWR: XXXXLB  
 XXXXKG      WITH      XXXXKG      WITH  
 XXXX/XXXXXXXXX      TIRES      XXXX/XXXXXXXXX      TIRES  
 XXXX.XX      RIMS      XXXX.XX      RIMS  
 AT XXX kPa/XX      PSI COLD      AT XXX kPa/XX      PSI COLD

THIS VEHICLE CONFORMS TO ALL APPLICABLE FEDERAL MOTOR VEHICLE SAFETY AND THEFT PREVENTION STANDARDS IN EFFECT ON THE DATE OF MANUFACTURE SHOWN ABOVE.

VIN: XXXXXXXXXXXXXXXXXXXX      XXXXX  
 TYPE: XXX      XXXXX



EXT PNT: XX      RC: XX      DSO:      XXXXX  
 WB ' BRK ' INT TR ' TP/PS ' R ' AXLE ' TR ' SPR ' XXXXX  
 XXX X      XX      X      XX      X      XX      XXX

XXXXXXXXXXXXXXXXX UTC      \*2USA-1520472-AA

You can find a transmission/transaxle code on the vehicle Safety Compliance Certification Label. The following table tells you which transmission or transaxle each code represents.

| Code | Description                                     |
|------|---|
| 5    | Six-speed manual, Dana (ZF S6-650)              |
| 7    | Six-speed manual, Dana (ZF M6HD-W)              |
| T    | Five-speed automatic, TorqShift (gas engines)   |
| B    | Five-speed automatic, TorqShift (diesel engine) |

## Accessories

### **GENUINE FORD ACCESSORIES FOR YOUR VEHICLE**

A wide selection of Genuine Ford Accessories are available for your vehicle through your local authorized Ford or Ford of Canada authorized dealer. These quality accessories have been specifically engineered to fulfill your automotive needs; they are custom designed to complement the style and aerodynamic appearance of your vehicle. In addition, each accessory is made from high quality materials and meets or exceeds Ford's rigorous engineering and safety specifications. Ford Motor Company will repair or replace any properly authorized dealer-installed Genuine Ford Accessory found to be defective in factory-supplied materials or workmanship during the warranty period, as well as any component damaged by the defective accessory. The accessory will be warranted for whichever provides you the greatest benefit:

- 12 months or 12,000 miles (20,000 km) (whichever occurs first), or
- the remainder of your new vehicle limited warranty.

This means that Genuine Ford Accessories purchased along with your new vehicle and installed by the authorized dealer are covered for the full length of your New Vehicle's Limited Warranty — 3 years or 36,000 miles (60,000 km) (whichever occurs first). Contact your authorized dealer for details and a copy of the warranty.

### **Not all accessories are available for all models.**

The following is a list of several Genuine Ford Accessory products for your vehicle. Not all accessories are available for all models. For a complete listing of the accessories that are available for your vehicle, please contact your authorized dealer or visit our online store at: [www.fordaccessoriesstore.com](http://www.fordaccessoriesstore.com).

### **Exterior style**

Bug shields

Chrome exhaust tip

Daytime Running Lamps (DRLs)

Deflectors

Front end covers

Running boards

Sliding rear windows - manual and power

Splash guards

Step bars

302

## Accessories

Tonneau covers

Wheels

### Interior style

Electrochromatic compass/temperature interior mirrors

Floor mats

Speed control

### Lifestyle

Bedliners and bedmats

Bed tents

Bike racks

Sport Liner™

Toolboxes

Towing mirrors

Trailer hitches, wiring harnesses and accessories

### Peace of mind

First aid and highway safety kits

Full vehicle covers

Keyless entry

Locking gas cap

Mobile-Ease™ hand-free communication system

Remote start

Vehicle security systems

For maximum vehicle performance, keep the following information in mind when adding accessories or equipment to your vehicle:

- When adding accessories, equipment, passengers and luggage to your vehicle, do not exceed the total weight capacity of the vehicle or of the front or rear axle (GVWR or GAWR as indicated on the Safety Compliance Certification Label). Consult your authorized dealer for specific weight information.

## Accessories

- The Federal Communications Commission (FCC) and Canadian Radio Telecommunications Commission (CRTC) regulate the use of mobile communications systems — such as two-way radios, telephones and theft alarms - that are equipped with radio transmitters. Any such equipment installed in your vehicle should comply with FCC or CRTC regulations and should be installed only by your authorized dealer.
- Mobile communications systems may harm the operation of your vehicle, particularly if they are not properly designed for automotive use.
- To avoid interference with other vehicle functions, such as anti-lock braking systems, amateur radio users who install radios and antennas onto their vehicle should not locate the Amateur Radio Antennas in the area of the driver's side hood.
- Electrical or electronic accessories or components that are added to the vehicle by the authorized dealer or the owner may adversely affect battery performance and durability.



## Index

### A

Accessory delay .....58  
Air cleaner filter .....283–284, 286  
Air conditioning .....36  
Airbag supplemental restraint system .....108–109  
    and child safety seats .....110  
    description .....109  
    disposal .....112  
    driver airbag .....111  
    indicator light .....112  
    operation .....111  
    passenger airbag .....111  
    passenger deactivation switch .....113  
Ambulance packages .....8  
Antifreeze  
    (see Engine coolant) .....260  
Anti-lock brake system  
    (see Brakes) .....172–173  
Audio system  
    (see Radio) .....20, 22, 25, 28  
Automatic transmission .....176  
    driving an automatic  
    overdrive .....177  
    fluid, adding .....279  
    fluid, checking .....279  
    fluid, refill capacities .....287  
Auxiliary power point .....56  
Axle  
    lubricant specifications .....290  
    refill capacities .....287  
    traction lok .....175

### B

Battery .....258  
    acid, treating emergencies .....258

    jumping a disabled battery ....226  
    maintenance-free .....258  
    replacement, specifications ...286  
    servicing .....258

BeltMinder .....104

Brakes .....172

    anti-lock .....172–173

    anti-lock brake system (ABS)

        warning light .....173

        fluid, checking and adding ....278

        fluid, refill capacities .....287

        fluid, specifications .....290

        lubricant specifications .....290

        parking .....173

        shift interlock .....176

        trailer .....159

Break-in period .....5

Bulbs .....45

### C

Capacities for refilling fluids ....287

Cassette tape player .....20, 22, 25

Cell phone use .....7

Child safety restraints .....118

    child safety belts .....118

Child safety seats .....121

    attaching with tether straps ..124

    in front seat .....122

    in rear seat .....122

Cleaning your vehicle

    engine compartment .....242

    instrument panel .....244

    interior .....245

    interior trim .....245

    plastic parts .....244

    safety belts .....245

    washing .....241

    waxing .....241

## Index

- wheels .....242
- wiper blades .....244
- Climate control (see Air conditioning or Heating) .....36
- Clutch
  - fluid .....278
  - operation while driving .....180
  - recommended shift speeds ....180
- Compass, electronic
  - set zone adjustment .....71
- Console .....67
  - overhead .....55–56
- Controls
  - steering column .....66
- Coolant
  - checking and adding .....260
  - refill capacities .....264, 287
  - specifications .....290
- Cruise control  
(see Speed control) .....61
- Customer Assistance .....202
  - Ford accessories for your vehicle .....248
  - Ford Extended Service Plan .....238
  - Getting assistance outside the U.S. and Canada .....239
  - Getting roadside assistance ...202
  - Getting the service you need .....234
  - Ordering additional owner's literature .....240
  - Utilizing the Mediation/Arbitration Program .....238
- D**
- Daytime running lamps  
(see Lamps) .....40
- Dipstick
  - automatic transmission fluid .....279
  - engine oil .....254
- Doors
  - lubricant specifications .....290
- Driveline universal joint and slip yoke .....283
- Driving under special conditions .....179, 192, 196
  - sand .....194
  - snow and ice .....196
  - through water .....195, 198
- E**
- Electronic message center ...68–69
- Emergencies, roadside
  - jump-starting .....226
- Emergency Flashers .....204
- Emission control system .....275
- Engine .....293
  - cleaning .....242
  - coolant .....260
  - diesel .....8
  - fail-safe cooling .....265
  - idle speed control .....258
  - lubrication specifications .....290
  - refill capacities .....287
  - service points .....251–252
  - starting after a collision .....204
- Engine block heater .....172
- Engine oil .....254
  - checking and adding .....254
  - dipstick .....254
  - filter, specifications .....257, 286
  - recommendations .....257
  - refill capacities .....287
  - specifications .....290

306

## Index

- Exhaust fumes .....171
- F**
- Fail safe cooling .....265
- Fluid capacities .....287
- Foglamps .....40
- Four-Wheel Drive vehicles .....184
- description .....189
- driving off road .....191
- electronic shift .....185, 189
- indicator light .....186
- lever operated shift .....186
- manual locking hubs .....185
- preparing to drive your vehicle .....175
- Fuel .....266
- calculating fuel
- economy .....72, 271
- cap .....269
- capacity .....287
- choosing the right fuel .....270
- comparisons with EPA fuel
- economy estimates .....274
- detergent in fuel .....271
- filling your vehicle with
- fuel .....266, 269, 271
- filter, specifications .....266, 286
- fuel pump shut-off switch .....204
- improving fuel economy .....271
- octane rating .....270, 293
- quality .....270
- running out of fuel .....271
- safety information relating to
- automotive fuels .....266
- Fuel pump shut-off switch .....204
- Fuses .....205–206
- G**
- Gas cap (see Fuel cap) .....269
- Gas mileage
- (see Fuel economy) .....271
- Gauges .....15
- transmission fluid
- temperature gauge .....20
- H**
- Hazard flashers .....204
- Head restraints .....90
- Headlamps .....39
- aiming .....41, 43
- autolamp system .....39
- daytime running lights .....40
- flash to pass .....41
- high beam .....41
- replacing bulbs .....47–50
- turning on and off .....39
- Heating
- heating and air conditioning
- system .....33–34, 36
- Hood .....250
- I**
- Ignition .....167, 293
- Infant seats
- (see Safety seats) .....121
- Inspection/maintenance (I/M)
- testing .....276
- Instrument panel
- cleaning .....244
- cluster .....12
- lighting up panel and
- interior .....41
- J**
- Jump-starting your vehicle .....226

## Index

### K

- Keyless entry system .....86
- Keys
  - positions of the ignition .....167

### L

- Lamps
    - autolamp system .....39
    - daytime running light .....40
    - fog lamps .....40
    - headlamps .....39
    - headlamps, flash to pass .....41
    - instrument panel, dimming ....41
    - interior lamps .....45
    - replacing bulbs .....45–53
  - Lane change indicator  
(see Turn signal) .....44
  - Lights, warning and indicator ....12
    - anti-lock brakes (ABS) .....173
    - speed control .....63
  - Load limits .....148
  - Loading instructions .....155
  - Locks
    - childproof .....81
  - Lubricant specifications .....290
  - Lug nuts .....225
  - Lumbar support, seats .....95
- ### M
- Manual transmission .....180
    - fluid capacities .....287
    - reverse .....181
  - Message center .....68–70
    - english/metric button .....74
    - system check button .....73
    - warning messages .....75

- Mirrors .....55
  - automatic dimming rearview
  - mirror .....58
  - fold away .....60
  - heated .....59
  - side view mirrors (power) .....58
  - signal .....59

- Moon roof .....66

- Motorcraft parts .....266, 286

### O

- Octane rating .....270
- Oil (see Engine oil) .....254
- Overdrive .....55

### P

- Parking brake .....173
- Parts (see Motorcraft parts) ....286
- Pedals (see Power adjustable  
foot pedals) .....61
- Power adjustable foot pedals ....61
- Power distribution box  
(see Fuses) .....211
- Power door locks .....80
- Power mirrors .....58
- Power point .....56
- Power steering .....174
  - fluid, checking and adding ....277
  - fluid, refill capacity .....287
  - fluid, specifications .....290
- Power Windows .....57
- Preparing to drive your  
vehicle .....175

### R

- Radio .....20, 22, 25, 28

## Index

- Relays .....205
- Remote entry system .....82  
  illuminated entry .....86  
  locking/unlocking doors .....80
- Reverse sensing system .....182
- Roadside assistance .....202
- S**
- Safety Belt Maintenance .....108
- Safety belts  
(see Safety restraints) .....97–101
- Safety defects, reporting .....240
- Safety restraints .....97–101  
  belt minder .....104  
  extension assembly .....107  
  for adults .....98–101  
  for children .....117–118  
  lap belt .....102  
  safety belt maintenance .....108  
  warning light and  
  chime .....103–104
- Safety seats for children .....121
- Safety Compliance  
  Certification Label .....300
- Seat belts  
(see Safety restraints) .....97
- Seats .....90  
  child safety seats .....121  
  cleaning .....246
- Servicing your vehicle .....249
- Snowplowing .....8, 199–201
- Spark plugs,  
  specifications .....286, 293
- Special notice .....9  
  ambulance conversions .....8  
  diesel-powered vehicles .....8
- utility-type vehicles .....8
- Specification chart,  
  lubricants .....290
- Speed control .....61
- Starting your vehicle .....167–168,  
  171  
  jump starting .....226
- Steering wheel  
  controls .....66  
  tilting .....54
- T**
- Tailgate .....78–79
- Tilt steering wheel .....54
- Tires .....131–132  
  alignment .....140  
  care .....137  
  changing .....218  
  checking the pressure .....136  
  inspecting and inflating .....133  
  label .....147  
  replacing .....139  
  rotating .....141  
  safety practices .....139  
  sidewall information .....142  
  snow tires and chains .....148  
  spare tire .....214, 216  
  terminology .....132  
  tire grades .....132  
  treadwear .....131, 138
- Towing .....155  
  Trailer Brake  
  Controller-Integrated .....159  
  trailer towing .....155  
  wrecker .....232
- Traction-lok rear axle .....175
- Trailer Brake  
  Controller-Integrated .....159

## Index

- Transfer case  
fluid checking .....283
- Transmission  
automatic operation .....55, 176  
brake-shift interlock (BSI) ....176  
fluid, checking and adding  
(automatic) .....279  
fluid, checking and adding  
(manual) .....282  
fluid, refill capacities .....287  
lubricant specifications .....290  
manual operation .....180
- Turn signal .....44
- U**
- Upfitter controls .....64
- V**
- Vehicle dimensions .....293
- Vehicle Identification Number  
(VIN) .....300
- Vehicle loading .....148
- Ventilating your vehicle .....171
- W**
- Warning lights (see Lights) .....12
- Washer fluid .....253
- Water, Driving through .....198
- Windows  
power .....57
- Windshield washer fluid and  
wipers .....54  
checking and adding fluid ....253  
replacing wiper blades .....254
- Wrecker towing .....232



