

FORD **FUSION** Owner's Manual

The information contained in this publication was correct at the time of going to print. In the interest of development the right is reserved to change specifications, design or equipment at any time without notice and without incurring any obligations. This publication, or part thereof, may not be reproduced nor translated without our approval. Errors and omissions excepted.

© Ford Motor Company 2011

All rights reserved.

Part Number: (CG3441en) 03/2011 20110408104927

Table of Contents

Introduction

About This Manual.....	5
Symbols Glossary.....	5
Parts and Accessories.....	5

At a Glance

At a Glance.....	8
------------------	---

Child Safety

Child Seats.....	15
Booster Seats.....	16
Child Seat Positioning.....	17
Child Safety Locks.....	19

Occupant protection

Principle of Operation.....	20
Fastening the seat belts.....	22
Seat belt height adjustment.....	22
Using seat belts during pregnancy.....	23
Disabling the passenger airbag.....	23

Keys and Remote Controls

General Information on Radio Frequencies.....	25
Programming the remote control.....	25
Changing the remote control battery.....	26

Locks

Locking and Unlocking.....	27
----------------------------	----

Engine immobiliser

Principle of Operation.....	29
Coded keys.....	29
Arming the engine immobiliser.....	29
Disarming the engine immobiliser.....	29

Alarm

Arming the alarm.....	30
Disarming the alarm.....	30

Steering Wheel

Adjusting the Steering Wheel.....	31
Audio Control.....	31

Wipers and Washers

Windscreen Wipers.....	33
Windscreen Washers.....	34
Rear Window Wiper and Washers.....	34
Checking the Wiper Blades.....	35
Changing the Wiper Blades.....	35

Lighting

Lighting Control.....	37
Front Fog Lamps.....	38
Rear Fog Lamps.....	38
Headlamp Levelling.....	39
Hazard Warning Flashers.....	39
Direction Indicators.....	40
Interior Lamps.....	40
Removing a Headlamp.....	41
Changing a Bulb.....	42
Bulb Specification Chart.....	46

Windows and Mirrors

Power Windows.....	47
Exterior Mirrors.....	47
Electric exterior mirrors.....	47

Instrument Cluster

Gauges.....	49
Warning Lamps and Indicators.....	50

Information Displays

General Information.....	53
Personalised Settings.....	54
Information Messages.....	55

Climate Control

Principle of Operation.....	58
-----------------------------	----

Table of Contents

Air Vents.....	58
Manual Climate Control.....	58
Automatic Climate Control.....	60
Heated Windows and Mirrors.....	62
Auxiliary Heater.....	62
Sunroof.....	62

Seats

Sitting in the Correct Position.....	64
Manual Seats.....	64
Rear Seats.....	65
Head Restraints.....	66
Heated Seats.....	67
Front Seat Armrest.....	68

Convenience features

Cigar Lighter.....	69
Glove Box.....	69
Storage compartments.....	69
Rear Seat Armrest.....	71
Floor Mats.....	71

Starting and Stopping the Engine

General Information.....	72
Ignition Switch.....	72
Starting a Petrol Engine.....	72
Starting a Diesel Engine.....	73
Switching Off the Engine.....	74

Fuel and Refuelling

Safety Precautions.....	75
Fuel Quality - Petrol.....	75
Fuel Quality - Diesel.....	75
Catalytic Converter.....	75
Fuel filler flap.....	76
Refuelling.....	76
Fuel Consumption.....	76
Technical Specifications.....	76

Transmission

Manual Transmission.....	78
Automatic Transmission - Vehicles With: 4-Speed Automatic Transmission (4F27E).....	79

Brakes

Principle of Operation.....	82
Hints on Driving With Anti-Lock Brakes.....	82
Parking Brake.....	82

Stability Control

Principle of Operation.....	83
Using Stability Control.....	83

Parking Aids

Principle of Operation.....	84
Using the Parking Aid.....	84

Load Carrying

General Information.....	86
Luggage Covers.....	86
Roof Racks and Load Carriers.....	86

Towing

Towing a Trailer.....	88
Tow Ball.....	88

Driving Hints

General Driving Points.....	92
Running-In.....	92
Cold Weather Precautions.....	92
Driving Through Water.....	92

Roadside Emergencies

First Aid Kit.....	93
Warning Triangle.....	93

Table of Contents

Status after a collision

Fuel Cut-Off Switch.....94

Fuses

Changing a Fuse.....96

Fuse Labels.....96

Fuse Box Locations.....98

Vehicle recovery

Towing Points.....99

Towing the Vehicle on Four Wheels.....99

Maintenance

General Information.....100

Opening and Closing the Bonnet.....101

Under Bonnet Overview - 1.25L

Duratec-16V (Sigma)/1.4L

Duratec-16V (Sigma)/1.6L

Duratec-16V (Sigma).....102

Under Bonnet Overview - 1.4L

Duratorq-TDCi (DV) Diesel.....104

Under Bonnet Overview - 1.6L

Duratorq-TDCi (DV) Diesel.....105

Engine Oil Dipstick - 1.25L Duratec-16V

(Sigma)/1.4L Duratec-16V

(Sigma)/1.6L Duratec-16V

(Sigma).....106

Engine Oil Dipstick - 1.4L Duratorq-TDCi

(DV) Diesel.....106

Engine Oil Dipstick - 1.6L Duratorq-TDCi

(DV) Diesel.....107

Engine Oil Check.....107

Engine Coolant Check.....107

Power Steering Fluid Check.....108

Brake and Clutch Fluid Check.....108

Washer Fluid Check.....109

Technical Specifications.....109

Vehicle care

Cleaning the Exterior.....112

Cleaning the Interior.....112

Repairing Minor Paint Damage.....113

Vehicle battery

Jump-Starting the Vehicle.....114

Wheels and Tyres

General Information.....116

Changing a Road Wheel.....116

Tyre Repair Kit.....121

Tyre Care.....124

Using Winter Tyres.....124

Using Snow Chains.....124

Technical Specifications.....125

Vehicle identification

Vehicle Identification Plate.....126

Vehicle Identification Number.....126

Engine number.....126

Capacities and Specifications

Dimensions.....127

Audio introduction

Important audio information.....131

Audio unit overview

Audio unit overview.....132

Audio system security

Security code.....136

Lost security code.....136

Entering a security code.....136

Incorrect security code.....136

Audio unit clock and date displays

Setting the clock and date on the audio unit.....137

Audio unit operation

On/off control.....138

Table of Contents

Bass/treble control.....	138
Balance/fade control.....	138
Audio menu control.....	138
Station preset buttons.....	141
Waveband button.....	141
Autostore control.....	141
Traffic information control.....	141
Station tuning control.....	143

Audio unit menus

Automatic volume control.....	145
Digital signal processing (DSP).....	145
Audio distortion reduction (CLIP).....	145
Alternative frequencies.....	146
Regional mode (REG).....	146
News broadcasts.....	147

Compact disc player

Loading compact discs.....	148
Track selection.....	148
Compact disc playback.....	149
Compact disc selection.....	149
Fast forward/reverse.....	149
Shuffle/random.....	149
Compact disc track compression.....	150
Compact disc track scanning.....	150
Ejecting compact discs.....	150
Repeat compact disc tracks.....	151
Ending compact disc playback.....	151
Ejecting multiple compact discs	151

Auxiliary input (AUX IN) socket

Auxiliary input (AUX IN) socket.....	152
--------------------------------------	-----

Audio troubleshooting

Audio troubleshooting.....	153
----------------------------	-----

Telephone

General Information.....	155
Telephone setup.....	155
Bluetooth setup.....	156
Telephone controls.....	157
Using the telephone - Vehicles Without: Navigation System.....	158
Using the telephone - Vehicles With: Travel Pilot EX.....	161

Voice control

Principle of Operation.....	163
Using voice control.....	163
Audio unit commands.....	164
Telephone commands.....	168
Navigation system commands.....	173
Climate control commands.....	173

Appendices

Electromagnetic compatibility.....	176
Type approvals.....	177

Introduction

ABOUT THIS MANUAL

Thank you for choosing Ford. We recommend that you take some time to get to know your vehicle by reading this manual. The more that you know about it, the greater the safety and pleasure you will get from driving it.

WARNING



Always drive with due care and attention when using and operating the controls and features on your vehicle.

Note: *This manual describes product features and options available throughout the range, sometimes even before they are generally available. It may describe options not fitted to your vehicle.*

Note: *Some of the illustrations in this manual may be used for different models, so may appear different to your vehicle. However, the essential information in the illustrations is always correct.*

Note: *Always use and operate your vehicle in line with all applicable laws and regulations.*

Note: *Pass on this manual when selling your vehicle. It is an integral part of the vehicle.*

This vehicle has received the endorsement of TÜV, the accredited international testing organisation, for its allergy-friendly properties.

All materials used in the manufacture of the interior of this vehicle meet strict requirements of the TÜV TOXPROOF Criteria Catalogue for Vehicle Interiors by TÜV Produkt and Umwelt GmbH and are designed to minimize the risk of allergic reactions.

Additionally an efficient pollen filter protects the passengers against allergen particles in the outdoor air.

For more information, contact TÜV at www.tuv.com.

SYMBOLS GLOSSARY

Symbols in this handbook

WARNING



You risk death or serious injury to yourself and others if you do not follow the instructions highlighted by the warning symbol.

CAUTION



You risk damaging your vehicle if you do not follow the instructions highlighted by the caution symbol.

Symbols on your vehicle



When you see these symbols, read and follow the relevant instructions in this handbook before touching or attempting adjustment of any kind.

PARTS AND ACCESSORIES

Now you can be sure that your Ford parts are Ford parts

Your Ford has been built to the highest standards using high quality Ford Original Parts. As a result, you can enjoy driving it for many years.

Introduction

Should the unexpected occur and a major part needs replacing, we recommend that you accept nothing less than Ford Original Parts.

The use of Ford Original Parts ensures that your vehicle is repaired to its pre-accident condition and maintains its maximum residual value.

Ford Original Parts match Ford's stringent safety requirements and high standards of fit, finish and reliability. Quite simply, they represent the best overall repair value, including parts and labour costs.

Now it is easier to tell if you have really been given Ford Original Parts. The Ford logo is clearly visible on the following parts if they are Ford Original Parts. If your vehicle has to be repaired, look for the clearly visible Ford branding and make sure that only Ford Original Parts have been used.

Look for the Ford logo on the following parts

Sheet metal

- Bonnet
- Wings
- Doors
- Tailgate



E89937

Bumper and radiator grille

- Radiator grille
- Front and rear bumper

Glass

- Rear window
- Side glass
- Windscreen

Introduction



E89939

Lighting

- Rear lamps
- Headlamp



E89940

At a Glance

AT A GLANCE

Instrument panel overview

Left-hand drive

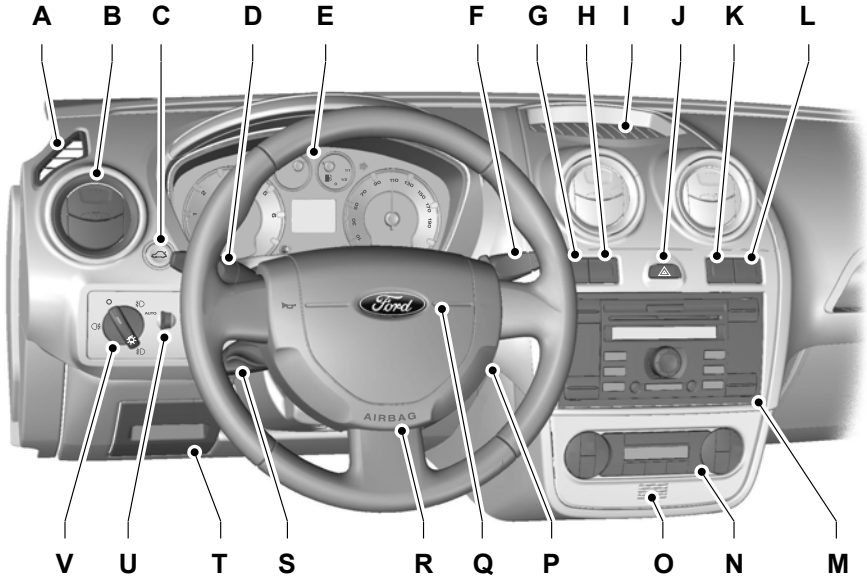

E89017

At a Glance

Right-hand drive

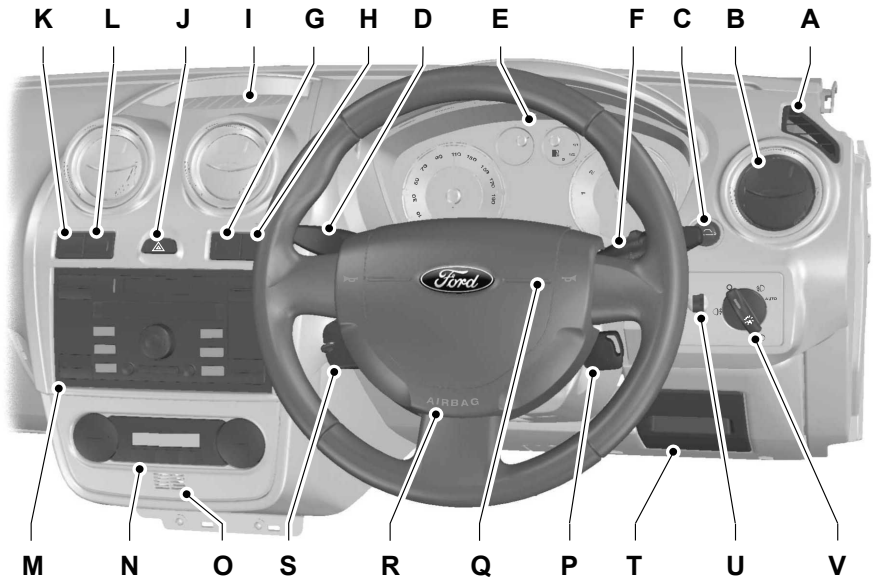

E102295

- A Window demister.
- B Air vent. See **Air Vents** (page 58).
- C Luggage compartment release.
- D Main beam, direction indicators, headlamp flasher and information display controls. See **Lighting Control** (page 37). See **General Information** (page 53).
- E Instrument cluster. See **Gauges** (page 49).
- F Wiper lever. See **Wipers and Washers** (page 33).
- G Heated windscreen switch. See **Heated Windows and Mirrors** (page 62).
- H Heater rear window switch. See **Heated Windows and Mirrors** (page 62).
- I Storage tray.
- J Hazard warning flasher switch. See **Hazard Warning Flashers** (page 39).
- K Stability control switch or coin holder. See **Stability Control** (page 83).

At a Glance

- L Airbag deactivated warning lamp or coin holder. See **Disabling the passenger airbag** (page 23).
- M Audio or navigation unit. See separate handbook.
- N Climate controls. See **Climate Control** (page 58).
- O Interior temperature sensor.
- P Ignition switch. See **Ignition Switch** (page 72).
- Q Horn.
- R Steering wheel adjustment lever. See **Adjusting the Steering Wheel** (page 31).
- S Audio controls. See **Audio Control** (page 31).
- T Storage compartment.
- U Headlamp levelling control. See **Headlamp Levelling** (page 39).
- V Lighting controls. See **Lighting** (page 37).

Adjusting the steering wheel

WARNING



Never adjust the steering wheel when the vehicle is moving.

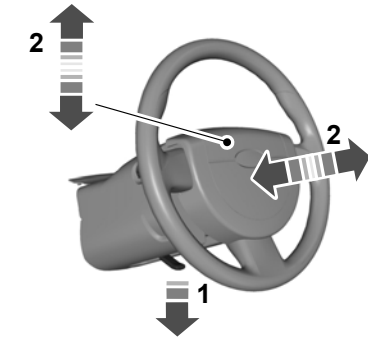

E95178

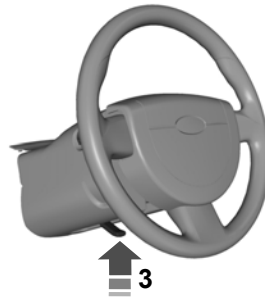

E95179

See **Adjusting the Steering Wheel** (page 31).

Engine idle speed after starting

The engine may idle at a higher speed than normal immediately after starting from cold.

See **Starting and Stopping the Engine** (page 72).

At a Glance

Information displays

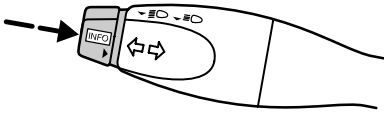

E70436

Press the button to scroll through the displays and hold the button to reset, select a submenu or change a setting. The information display will tell you whether a short press of the button or long press of the button is required for the various options.

See **Information Displays** (page 53).

Manual climate control

Recommended settings for cooling

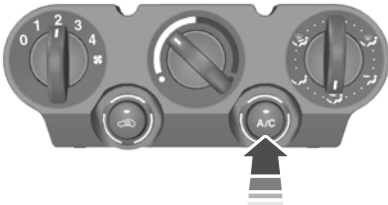

E116251

Open the centre and side air vents.

Direct the centre air vents upwards and the side air vents toward the side windows.

Recommended settings for heating



E116252

Close the centre air vents and open the side air vents.

Direct the side air vents toward the side windows.

See **Manual Climate Control** (page 58).

Automatic climate control

Recommended settings for cooling

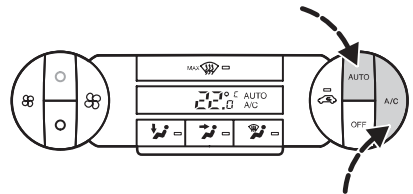

E116173

Set the temperature to 22°C (72°F).

Open the centre and side air vents.

Direct the centre air vents upwards and the side air vents toward the side windows.

At a Glance

Recommended settings for heating

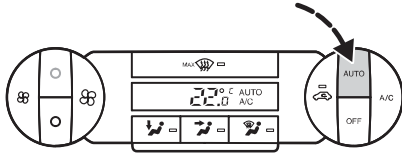

E72153

Set the temperature to 22°C (72°F).

Open the centre and side air vents.

Direct the centre air vents upwards and the side air vents toward the side windows.

See **Automatic Climate Control** (page 60).

Locking and unlocking the doors with the remote control

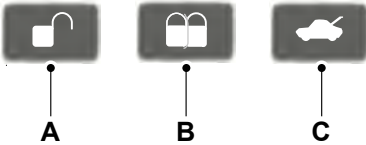

E87379

- A Unlock
- B Lock
- C Luggage compartment lid unlock

Locking the doors

Press button **B once**.

Double locking the doors

Press button **B twice** within three seconds.

Unlocking the luggage compartment lid

Press button **C twice** within three seconds.

See **Locking and Unlocking** (page 27).

Audio unit

Automatic volume control (AVC)

When available, automatic volume control (AVC) adjusts the volume level to compensate for engine noise and road speed noise.

1. Press the MENU button repeatedly until an AVC display appears.
2. Use the left or right arrow button, to adjust the AVC setting.

Changing the date and time

1. Press the **CLOCK** button to display the date and time.
2. Use the left or right arrow button to select the date or time value that you wish to change. The selected value will flash in the display.
3. Turn the volume control to change the selected date or time value.
4. Use the left or right arrow button to select additional date or time values that you wish to change.
5. Turn the volume control to change the selected date or time value.
6. Press the **CLOCK** button to exit and save the new date and time.

At a Glance

Autolamps

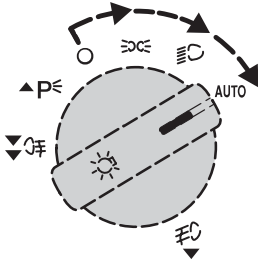

E72162

Note: If you have switched autolamps on, you can only switch the main beam on when autolamps has switched the headlamps on.

The headlamps will come on and go off automatically depending on the ambient light.

See **Lighting** (page 37).

Home safe lighting

Vehicles without autolamps

Switch the headlamps on and then switch them off within two seconds.

Vehicles with autolamps

- Switch autolamps on and then switch them off within two seconds.
- Switch autolamps off and then switch them on within two seconds.

See **Lighting** (page 37).

Welcome lighting

The side and tail lamps will come on when you unlock the doors with the remote control. They will switch off automatically after a short time.

See **Lighting** (page 37).

Autowipers

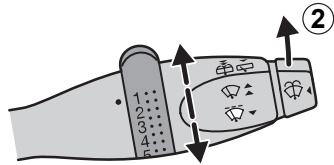

E72173

- High sensitivity
- Low sensitivity

See **Windscreen Wipers** (page 33).

Electric folding mirrors



E72184

Automatic folding

The mirrors will fold automatically when you lock the vehicle with the remote control. The mirrors will unfold when you unlock the vehicle with the key or the remote control.

See **Electric exterior mirrors** (page 47).

At a Glance

Creating a level load floor

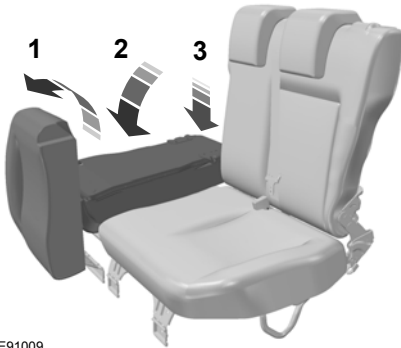

E91009

1. Lift the seat cushion.
2. Pull the locking lever and push the seatback forwards.
3. Press the rear of the seatback downwards.

See **Rear Seats** (page 65).

Child Safety

CHILD SEATS







E133140





E68916

WARNINGS

-  Secure children that are less than 150 centimetres (59 inches) tall in a suitable, approved child restraint, in the rear seat.
-  **Extreme Hazard!** Do not use a rearward facing child restraint on a seat protected by an air bag in front of it!
-  Read and follow the manufacturer's instructions when you are fitting a child restraint.
-  Do not modify child restraints in any way.
-  Do not hold a child on your lap when the vehicle is moving.

WARNINGS

-  Do not leave unattended children in your vehicle.
-  If your vehicle has been involved in an accident, have the child restraints checked by properly trained technicians.

Note: *Mandatory use of child restraints varies from country to country.*

Only child restraints certified to ECE-R44.03 (or later) have been tested and approved for use in your vehicle. A choice of these are available from your Dealer.

Child restraints for different mass groups

Use the correct child restraint as follows:

Baby safety seat



E68918

Secure children that weigh less than 13 kilograms (29 pounds) in a rearward facing baby safety seat (Group 0+) in the rear seat.

Child Safety

Child safety seat



E68920

Secure children that weigh between 13 and 18 kilograms (29 and 40 pounds) in a child safety seat (Group 1) in the rear seat.

BOOSTER SEATS

WARNINGS

-  Do not install a booster seat or a booster cushion with only the lap strap of the seat belt.
-  Do not install a booster seat or a booster cushion with a seat belt that is slack or twisted.
-  Do not put the seat belt under your child's arm or behind its back.
-  Do not use pillows, books or towels to boost your child's height.
-  Make sure that your children sit in an upright position.
-  Secure children that weigh more than 15 kilograms (33 pounds) but are less than 150 centimetres (59 inches) tall in a booster seat or a booster cushion.

CAUTION

-  When using a child seat on a rear seat, make sure that the child seat rests tightly against the vehicle seat. It may be necessary to lift or remove the head restraint. See **Head Restraints** (page 66).

Booster seat (Group 2)



E70710

We recommend that you use a booster seat that combines a cushion with a backrest instead of a booster cushion only. The raised seating position will allow you to position the shoulder strap of the adult seat belt over the centre of your child's shoulder and the lap strap tightly across its hips.

Child Safety

Booster cushion (Group 3)



E68924

CHILD SEAT POSITIONING

WARNINGS



Please consult your Dealer for the latest details relating to Ford recommended child seats.

WARNINGS



Original text according to ECE R94.01: Extreme Hazard! Do not use a rearward facing child restraint on a seat protected by an air bag in front of it!



When using a child seat with a support leg, the support leg must rest securely on the floor.



When using a child seat with a seat belt, make sure that the seat belt is not slack or twisted.

CAUTION



The child seat must rest tightly against the vehicle seat. It may be necessary to lift or remove the head restraint. See **Head Restraints** (page 66).

Note: *When using a child seat on a front seat, always adjust the front passenger seat to its fully rearwards position. If it proves difficult to tighten the lap section of the seat belt without slack remaining, adjust the seatback to the fully upright position and raise the height of the seat. See Manual Seats (page 64).*

Seating positions	Mass group categories				
	0	0+	1	2	3
	Up to 10 kg	Up to 13 kg	9 - 18 kg	15 - 25 kg	22 - 36 kg
Front passenger seat with airbag ON	X	X	UF ¹	UF ¹	UF ¹
Front passenger seat with airbag OFF	U ¹	U ¹	U ¹	U ¹	U ¹
Rear seats	U	U	U	U	U

X Not suitable for children in this mass group.

U Suitable for universal category child seats approved for use in this mass group.

Child Safety

U¹ Suitable for universal category child seats approved for use in this mass group. However, we recommend that you secure children in a government approved child seat, in the rear seat.

UF¹ Suitable for universal category forward facing child seats approved for use in this mass group. However, we recommend that you secure children in a government approved child seat, in the rear seat.

Child Safety

CHILD SAFETY LOCKS

WARNING



You cannot open the doors from inside if you have put the child safety locks on.

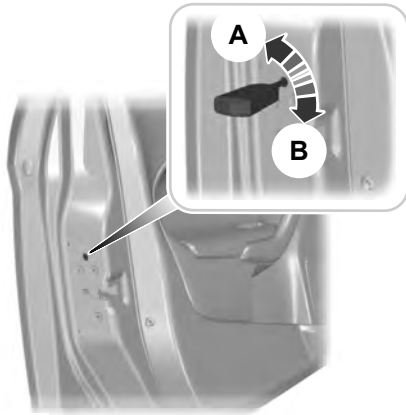

E73697

- A Lock
- B Unlock

Occupant protection

PRINCIPLE OF OPERATION

Airbags

WARNINGS

 Do not modify the front of your vehicle in any way. This could adversely affect deployment of the airbags.

 Original text according to ECE R94.01: Extreme Hazard! Do not use a rearward facing child restraint on a seat protected by an airbag in front of it!

 Wear a seat belt and keep sufficient distance between yourself and the steering wheel. Only when you use the seat belt properly, can it hold you in a position that allows the airbag to achieve its optimum effect. See **Sitting in the Correct Position** (page 64).

 Have repairs to the steering wheel, steering column, seats, airbags and seat belts carried out by properly trained technicians.

 Keep the areas in front of the airbags free from obstruction. Do not affix anything to or over the airbag covers.

 Do not poke sharp objects into areas where airbags are fitted. This could damage and adversely affect deployment of the airbags.

 Use seat covers designed for seats with side airbags. Have these fitted by properly trained technicians.

Note: You will hear a loud bang and see a cloud of harmless powdery residue if an airbag deploys. This is normal.

Note: Only wipe airbag covers with a damp cloth.

The restraint system comprises:

- a driver airbag
- a front passenger airbag

- side airbags
- curtain airbags
- a driver seat belt pretensioner
- a front passenger seat belt pretensioner
- crash sensors
- an airbag warning lamp
- a seat belt reminder
- an electronic control and diagnostic unit.

You can also have your vehicle fitted with:

- an airbag deactivation switch
- an airbag deactivation warning lamp.

Driver and front passenger airbags

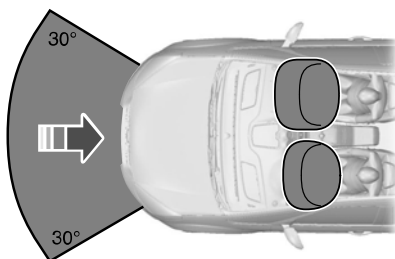

E74302

The driver and front passenger airbags will deploy during significant frontal collisions or collisions that are up to 30 degrees from the left or the right. The airbags will inflate within a few thousandths of a second and deflate on contact with the occupants, thus cushioning forward body movement. During minor frontal collisions, overturns, rear collisions and side collisions, the driver and front passenger airbags will not deploy.

Occupant protection

Side airbags



E72658

Side airbags are fitted inside the seatback of the front seats. A label indicates that side airbags are fitted to your vehicle.

The side airbags will deploy during significant lateral collisions. Only the airbag on the side affected by the collision will deploy. The airbags will inflate within a few thousandths of a second and deflate on contact with the occupants, thus providing protection for the chest and shoulder areas. During minor lateral collisions, overturns, front collisions and rear collisions, the side airbags will not deploy.

Curtain airbags

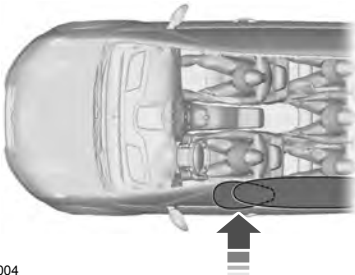







E75004

Curtain airbags are fitted inside the trim panels over the front and rear side windows. Moulded badges in the B-pillar trim panels indicate that curtain airbags are fitted to your vehicle.

The curtain airbags will deploy during significant lateral collisions. Only the airbag on the side affected by the collision will deploy. The airbag will inflate within a few thousandths of a second and deflate on contact with the occupants, thus providing protection for the head. During minor lateral collisions, front collisions, rear collisions, or overturns the curtain airbags will not deploy.

Seat belts

WARNINGS

-  Wear a seat belt and keep sufficient distance between yourself and the steering wheel. Only when you use the seat belt properly, can it hold you in a position to achieve its optimum effect. See **Sitting in the Correct Position** (page 64).
-  Never use a seat belt for more than one person.
-  Use the correct buckle for each seat belt.
-  Do not use a seat belt that is slack or twisted.
-  Do not wear thick clothing. The seat belt must fit tightly around your body to achieve its optimum effect.
-  Position the shoulder strap of the seat belt over the centre of your shoulder and position the lap strap tightly across your hips.

The driver and front passenger seat belt retractors are fitted with a seat belt pretensioner. Seat belt pretensioners have a lower deployment threshold than the airbags. During minor collisions, it is possible that only the seat belt pretensioners will deploy.

Occupant protection

Status after a collision

WARNING



Seat belts subjected to strain, as a result of an accident, should be renewed and the anchorages checked by a properly trained technician.

FASTENING THE SEAT BELTS

WARNING



Insert the tongue into the buckle until you hear a distinct click. You have not fastened the seat belt properly if you do not hear a click.



E74124

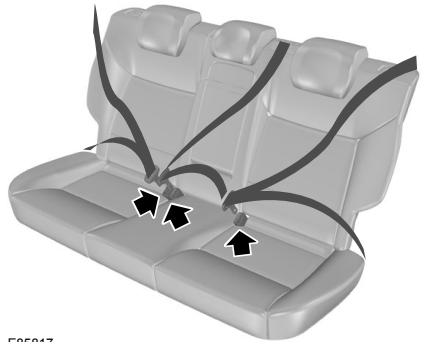

E85817

Pull the belt out steadily. It may lock if you pull it sharply or if the vehicle is on a slope.

Press the red button on the buckle to release the belt. Let it retract completely and smoothly.

SEAT BELT HEIGHT ADJUSTMENT



E87511

Note: *Lifting the slider slightly while pressing the locking button makes it easier to release the locking mechanism.*

To raise or lower, press the locking button on the adjuster and move as necessary.

Occupant protection

USING SEAT BELTS DURING PREGNANCY

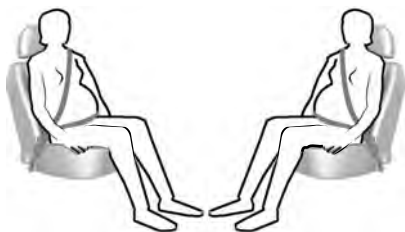

E68587

WARNING

 Position the seat belt correctly for your safety and that of your unborn child. Do not use only the lap strap or the shoulder strap.

Position the lap strap comfortably across your hips and low beneath your pregnant abdomen. Position the shoulder strap between your breasts, above and to the side of your pregnant abdomen.

DISABLING THE PASSENGER AIRBAG

WARNING

 Make sure that the passenger airbag is disabled when using a rearward facing child restraint on the front passenger seat.



E71313

Fitting the passenger airbag deactivation switch

WARNING

 If you need to fit a child restraint on a seat protected by an operational airbag in front of it, have a passenger airbag deactivation switch fitted. Ask your dealer for further information.

Note: The key switch is located in the glove compartment with an airbag deactivation lamp in the instrument panel.

If the airbag warning lamp illuminates or flashes when you are driving, this indicates a malfunction. See **Warning Lamps and Indicators** (page 50). Remove the child restraint and have the system checked immediately.

Disabling the passenger airbag

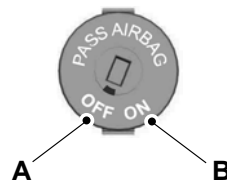

E71312

- A Disabled
- B Enabled

Occupant protection

Turn the switch to position **A**.

When you switch the ignition on, check that the passenger airbag deactivation warning lamp illuminates.

Enabling the passenger airbag

WARNING



Make sure that the passenger airbag is enabled when you are **not** using a child restraint on the front passenger seat.

Turn the switch to position **B**.

Keys and Remote Controls

GENERAL INFORMATION ON RADIO FREQUENCIES

CAUTIONS

! The radio frequency used by your remote control can also be used by other short distance radio transmissions (e.g. amateur radios, medical equipment, wireless headphones, remote controls and alarm systems). If the frequencies are jammed, you will not be able to use your remote control. You can lock and unlock the doors with the key.

! Check your vehicle is locked before leaving it unattended. This will safeguard against any potential malicious frequency blocking.

Note: You could unlock the doors if you press the buttons on the remote control unintentionally.

The operating range between your remote control and your vehicle varies depending on the environment.

PROGRAMMING THE REMOTE CONTROL

A maximum of four remote controls (including the ones supplied with the vehicle) can be programmed.

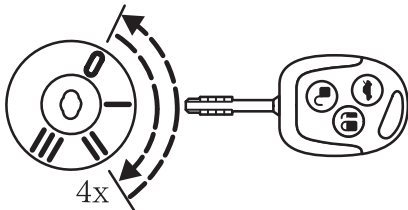

E72191

To programme a new remote control:

- Turn the ignition key to position II four times within six seconds.
- Switch off the ignition. A tone sounds to indicate that it is now possible to programme a new remote control.
- Press any button on a new remote control. A tone will sound as confirmation. Repeat this last step for all of your remote controls, including the original.
- Switch the ignition back on or wait for ten seconds without programming another remote control to end remote control programming. Only the remote controls which you have just programmed are now able to lock and unlock your vehicle.

Re-programming the unlocking function

You can change the unlocking function so that pressing the unlock button once deactivates the central locking or double locking, disarms the anti-theft alarm system and unlocks the driver's door. Pressing the unlock button twice within three seconds also unlocks the passengers' doors.

If you want the tailgate to be locked while driving, press the locking button on the driver's door to activate central locking.

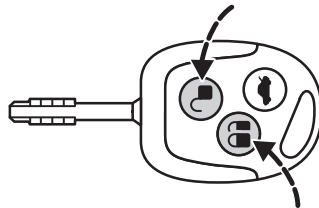

E72190

Keys and Remote Controls

In order to re-programme the function, press and hold the unlock and lock buttons simultaneously for at least four seconds with the ignition switched off. The direction indicators will flash twice to indicate that the unlocking function has been successfully re-programmed.

Pressing and holding both buttons simultaneously for at least four seconds again will change the function back.

CHANGING THE REMOTE CONTROL BATTERY



Make sure that you dispose of old batteries in an environmentally friendly way. Seek advice from your local authority regarding recycling.

If the range of the transmitter in the key decreases gradually, the battery (type 3V CR 2032) should be replaced.

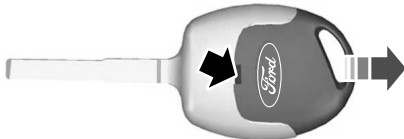

E68726

- Carefully separate the transmitter unit from the key using a flat object (e.g. a screwdriver) at the recess on the back.
- Carefully prise out the battery with the flat object. Fit the new battery between the contacts with the + sign facing downwards. Reassemble the transmitter unit in reverse order.

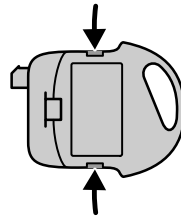

E68727

- Open the transmitter unit by separating the retaining clips on the sides with the flat object.

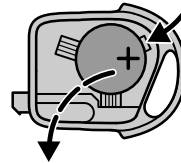

E68729

- Carefully prise out the battery with the flat object. Fit the new battery between the contacts with the + sign facing downwards. Reassemble the transmitter unit in reverse order.

Locks

LOCKING AND UNLOCKING

Central locking

You can only centrally lock the doors if they are all closed.

Double locking

WARNINGS



Do not activate double locking when persons or animals are inside the vehicle.



You will not be able to unlock the doors from the inside if you have double locked them.

Double locking is a theft protection feature that prevents someone from opening the doors from the inside. You can only double lock the doors if they are all closed.

Locking and unlocking confirmation

When you unlock the doors, the direction indicators will flash once.

When you lock the doors, the direction indicators will flash twice.

Note: *If your vehicle has double locking, the direction indicators will only flash twice once you have activated double locking.*

Locking and unlocking the doors with the key

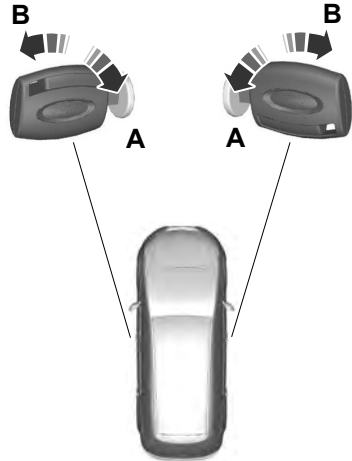

E71962

- A Unlock
- B Lock

Double locking the doors with the key

Turn the key to the unlock position and then the lock position within two seconds.

Locks

Locking and unlocking the doors with the remote control

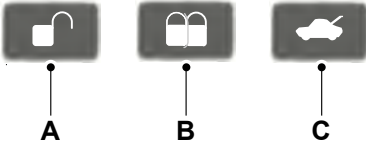

E87379

- A Unlock
- B Lock
- C Luggage compartment lid unlock

Locking the doors with the remote control

Press button **B** once.

Double locking the doors with the remote control

Press button **B** twice within three seconds.

Unlocking the luggage compartment lid

Press button **C** twice within three seconds.

Automatic relocking

The doors will relock automatically if you do not open a door within 45 seconds of unlocking the doors with the remote control. The door locks and the alarm will return to their previous state.

Reprogramming the unlocking function

You can reprogram the unlocking function so that only the driver's door is unlocked or all doors are unlocked. Press the lock and unlock buttons on the remote control at the same time for four seconds with the ignition switched off. The direction indicators will flash twice as confirmation.

Engine immobiliser

PRINCIPLE OF OPERATION

The engine immobiliser is a theft protection system that prevents someone from starting the engine with an incorrectly coded key.

CODED KEYS

Note: *Do not shield your keys with metal objects. This may prevent the receiver from recognising your key as a valid one.*

Note: *Have all of your remaining keys erased and recoded if you lose a key. Ask your dealer for further information. Have replacement keys recoded together with your existing keys.*

If you lose a key, you can obtain a replacement from your Ford Dealer. If possible, provide them with the key number from the tag provided with the original keys. You can also obtain additional keys from your Ford Dealer.

ARMING THE ENGINE IMMOBILISER

The engine immobiliser is armed automatically a short time after you have switched the ignition off.

The indicator in the instrument cluster will flash to confirm that the system is operating.

DISARMING THE ENGINE IMMOBILISER

Switching on the ignition disarms the system if the correct code is recognised. The indicator **illuminates** for approximately three seconds and then **extinguishes**.

If the indicator illuminates constantly for one minute or flashes for approximately one minute and then repeatedly at irregular intervals, the system did not recognise the key code or a system fault is present. Remove the key and try again.

If the engine does not start, a system malfunction has occurred. Have the system checked by an expert immediately.

Alarm

ARMING THE ALARM

The system is armed as soon as the vehicle is locked and acts as a deterrent to unauthorised persons who attempt to open the doors, bonnet or luggage compartment, or remove the audio system.

Automatic arming delay

The 20 seconds arming delay begins when the bonnet, luggage compartment and all doors are closed and locked.

Alarm

The alarm sounds for 30 seconds if an unauthorised person opens a door, the load compartment or the bonnet. The hazard warning flashers will flash for five minutes.

Any attempt to start the engine or to remove the audio system sounds the alarm again.

DISARMING THE ALARM

Disarm and silence the alarm by unlocking either of the front doors or luggage compartment with the key.

Steering Wheel

ADJUSTING THE STEERING WHEEL

WARNING



Never adjust the steering wheel when the vehicle is moving.

Note: Make sure that you are sitting in the correct position. See *Sitting in the Correct Position* (page 64).

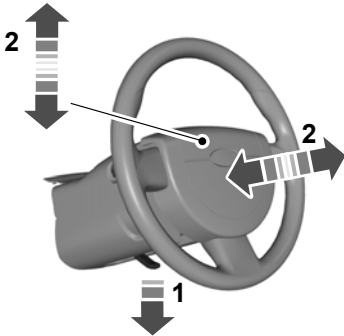

E95178



E95179

WARNING



Make sure that you fully engage the locking lever when returning it to its original position.

AUDIO CONTROL

Select radio, CD or cassette mode on the audio unit.

The following functions can be operated with the remote control:

Volume

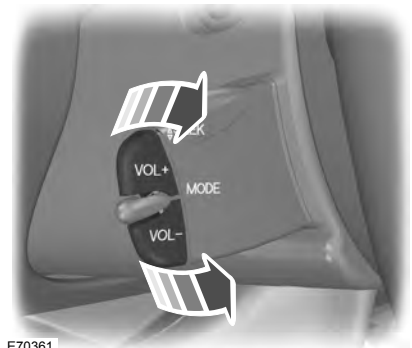

E70361

Volume up: Pull the **VOL+** switch towards the steering wheel.

Volume down: Pull the **VOL-** switch towards the steering wheel.

Steering Wheel

Seek

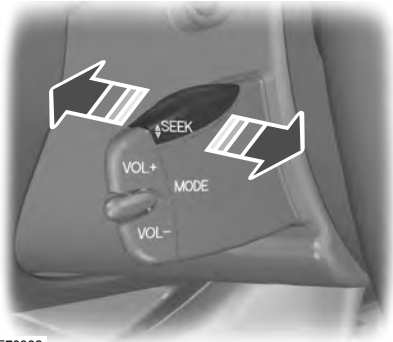

E70362

Move the **SEEK** switch towards the steering wheel or the instrument panel:

- In **radio mode**, this will locate the next radio station up or down the frequency band.
- In **CD mode**, it will select the next or previous track.

Mode

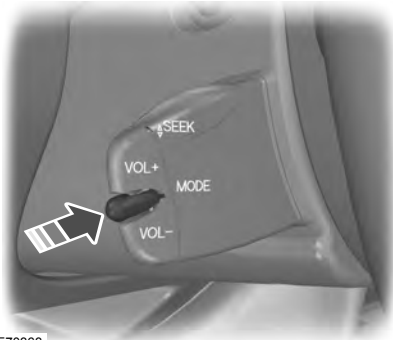

E70363

Briefly press the button on the side:

- In **radio mode**, this will locate the next pre-set radio station.
- In **CD mode**, this will select the next CD if a CD changer is fitted.
- In **all modes** to abort a traffic message during broadcasting.

Press and hold the button on the side:

- In **radio mode**, to change the waveband.

Wipers and Washers

WINDSCREEN WIPERS

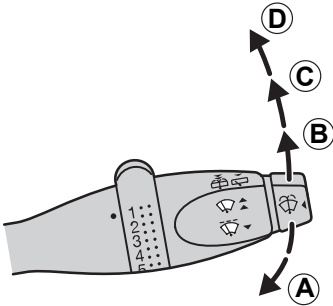

E72172

- A Single wipe
- B Intermittent wiping or autowipers
- C Normal wiping
- D High speed wiping

Intermittent wiping

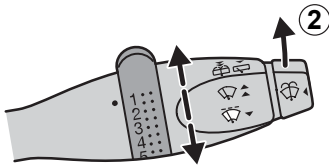



E72173

Select wipe interval with rotary switch: **1** = Short time interval. **6** = Extended time interval.

Autowipers

WARNINGS

-  In icy conditions, make sure that the windscreen has been fully defrosted before selecting autowipers.
-  Switch off the autowipers feature before entering a car wash.
-  Replace the wiper blades as soon as they begin to leave bands of water and smears or when they do not completely remove water from the windscreen. If the blades are not replaced, the rain sensor will continue to detect water on the windscreen. This will result in the wipers continuing to operate although the majority of the windscreen is dry.

Note: The autowipers feature is intended for use during wet weather conditions only and is very sensitive to anything which touches the windscreen near to the rain sensor. Objects such as dirt, mist or flies hitting the windscreen in this location may cause the wipers to wipe even though the windscreen is mostly dry.

Note: The autowipers feature should not be selected when it is snowing, foggy or when the roads have been salted. In these weather conditions, select an alternative position if necessary.

When autowipers is selected, the wipers will cycle once regardless of whether the windscreen is wet or dry. Thereafter, or when the ignition is switched on with autowipers selected, the wipers will not cycle until water is detected on the windscreen. Alternatively, move the lever to another position and then select autowipers, or operate the washer.

Wipers and Washers

The rain sensor will continuously measure the amount of water on the windscreen and adjust the speed of the front wipers automatically (single wipe, intermittent, normal or high speed wiping).

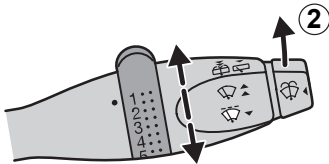

E72173

The sensitivity of the rain sensor is set using the rotary control:

1 = High sensitivity: The wipers will wipe even if only a small amount of water is detected on the windscreen.

6 = Low sensitivity: The wipers will only wipe when a larger amount of water is detected on the windscreen.

WINDSCREEN WASHERS

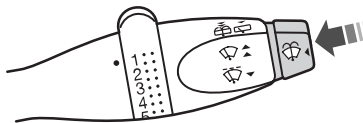

E72174

WARNING



Do not operate the windscreen washer for more than 10 seconds or when the reservoir is empty.

REAR WINDOW WIPER AND WASHERS

Intermittent wiping

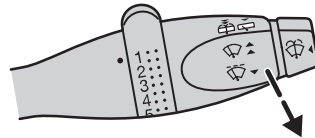

E72175

Pull the lever towards the steering wheel.

Reverse gear wipe

The rear wiper will be activated automatically when selecting reverse gear, if

- the rear wiper is not already switched on,
- the wiper lever is in position **C**, or **D**
- in position **B** and the front wipers are operating.

The rear wiper will follow the front wiper interval (at intermittent or normal speed).

Wipers and Washers

Washer

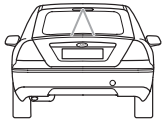
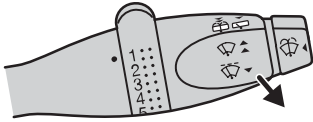

E72176

WARNING



Do not operate the washer for more than 10 seconds at a time, and never when the reservoir is empty.

Pull the lever fully towards the steering wheel and hold it to operate the washer.

The washer will operate in conjunction with the wipers.

The washer jet for the rear window is located on the roof above the rear window.

CHECKING THE WIPER BLADES

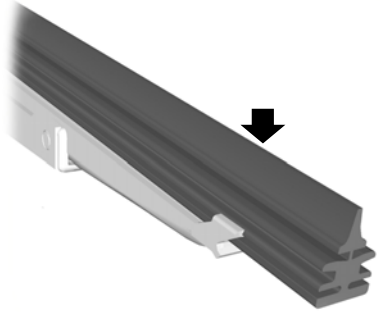

E66644

Run the tip of your fingers over the edge of the blade to check for roughness.

Clean the wiper blade lips with water applied with a soft sponge.

CHANGING THE WIPER BLADES

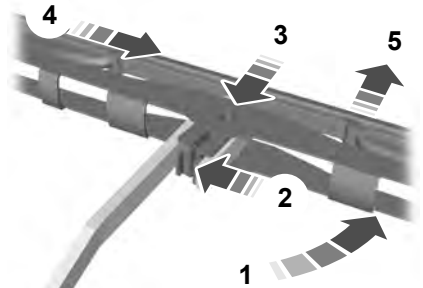

E66645

Wipers and Washers

Lift the wiper arm and position the wiper blade at a right angle to the wiper arm. To remove, press the retaining clip in the direction of the arrow, disengage the wiper blade and pull it off the arm in the opposite direction.

Lighting

LIGHTING CONTROL

Lighting control positions

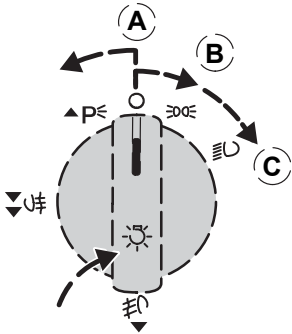

E72161

- A Off
- B Side and tail lamps
- C Headlamps

Autolamps

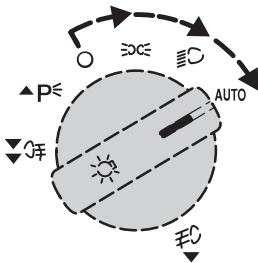

E72162

Note: If you have switched autolamps on, you can only switch the main beam on when autolamps has switched the headlamps on.

The headlamps will come on and go off automatically depending on the ambient light.

Home safe lighting

You can switch home safe lighting on up to 10 minutes after you have switched the ignition off.

Vehicles without autolamps

Switch the headlamps on and then switch them off within two seconds.

Vehicles with autolamps

- a. Switch autolamps **on** and then switch them **off** within two seconds.
- b. Switch autolamps **off** and then switch them **on** within two seconds.

Welcome lighting

The side and tail lamps will come on when you unlock the doors with the remote control. They will switch off automatically after a short time.

Main/dipped beam

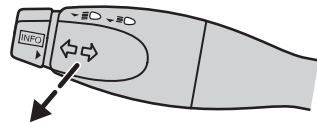

E72168

Pull the lever fully towards the steering wheel to switch between main and dipped beam.

Lighting

Headlamp flasher

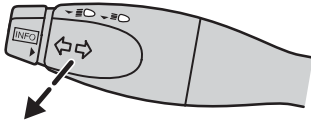

E72168

Pull the lever slightly towards the steering wheel.

FRONT FOG LAMPS

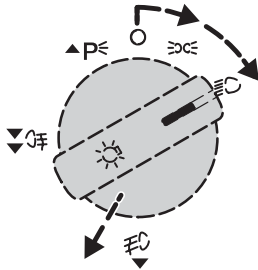

E72163

Note: It is not possible to switch on the front fog lamps when the lighting switch is set to AUTO. To switch on the front fog lamps, switch off the autolamps feature.

Switch on the headlamps **1** and pull out the control switch one position **2**.

The front fog lamps should be used only when visibility is considerably restricted by fog, snow or rain.

REAR FOG LAMPS

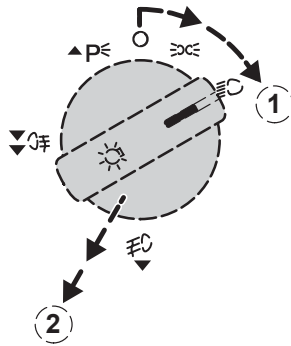

E72164

WARNING

 The rear fog lamps may only be used when visibility is restricted to less than 50 m and must not be used when it is raining or snowing.

Note: On vehicles not equipped with front fog lamps the control switch can be pulled out only one position.

Note: It is not possible to switch on the rear fog lamps when the lighting switch is set to AUTO. To switch on the rear fog lamps, switch off the autolamps feature.

Switch on the exterior lamps **1** and pull out the control two positions **2**.

Lighting

HEADLAMP LEVELLING

You can adjust the level of the headlamp beams according to the vehicle load.

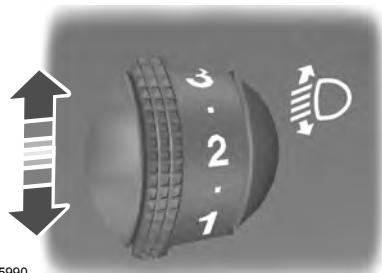

E65990

Recommended headlamp levelling switch positions

Load		Load in luggage compartment	Switch position
Front seats	Second row seats		
1-2	-	-	0
1-2	3	-	1
1-2	3	Max ¹	1.5
1	-	Max ¹	2

¹ See **Vehicle Identification Plate** (page 126).

HAZARD WARNING FLASHERS

Note: Depending on applicable laws and regulations in the country for which your vehicle was originally built, the hazard warning flashers may flash if you brake heavily.



For item location: See **At a Glance** (page 8).

Lighting

DIRECTION INDICATORS

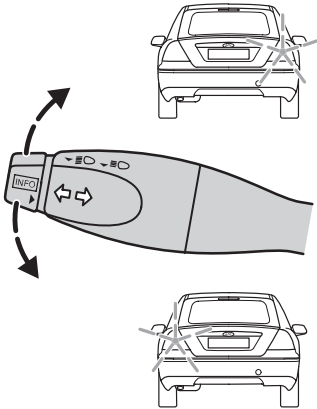

E72167

Briefly tap the lever up or down and the direction indicators will flash three times.

INTERIOR LAMPS

Courtesy lamp

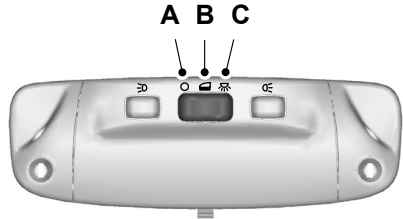

E71945

- A Off
- B Door contact
- C On

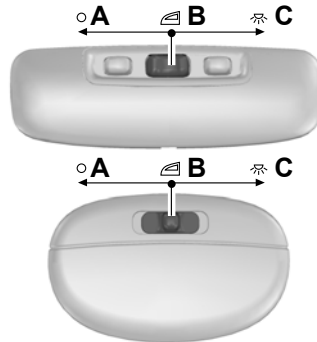

E91006

- A Off
- B Door contact
- C On

Lighting

If you set the switch to position **B**, the courtesy lamp will come on when you unlock or open a door or the tailgate. If you leave a door open with the ignition switch off, the courtesy lamp will go off automatically after some time to prevent the vehicle battery from discharging. To switch it back on, switch on the ignition for a short time.

The courtesy lamp will also come on when you switch off the ignition. It will go off automatically after a short time or when you start or restart the engine.

If you set the switch to position **C** with the ignition switch off, the courtesy lamp will come on. It will go off automatically after a short time to prevent the vehicle battery from discharging. To switch it back on, switch on the ignition for a short time.

Reading lamps

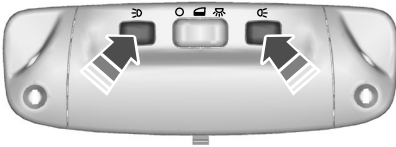

E71946

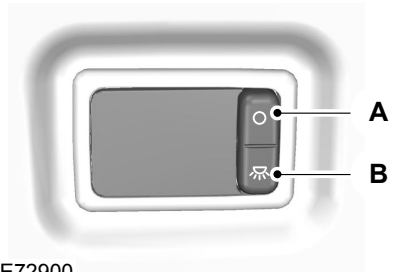

E72900

- A Off
- B On

REMOVING A HEADLAMP

1. Open the bonnet. See **Opening and Closing the Bonnet** (page 101).

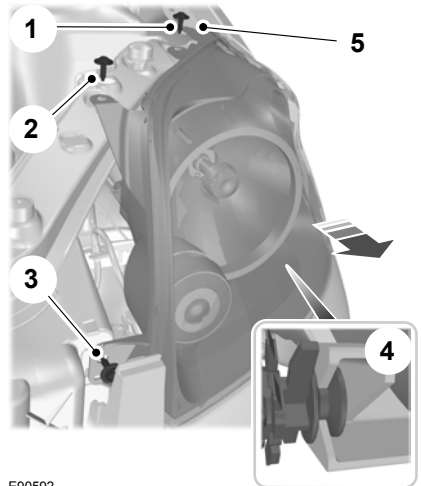

E90592

2. Remove the screws.

Lighting

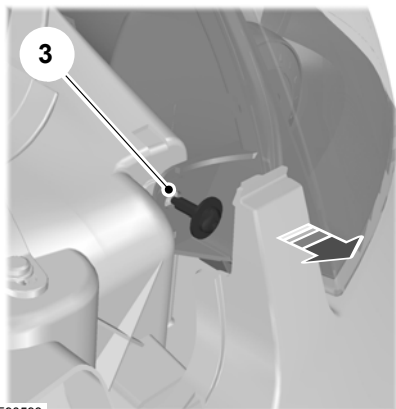

E90593

CAUTION

- ! Do not pull the bumper more than 10 mm from its original position.

- Carefully pull the bumper towards the front of the vehicle and remove the screw.
- Disconnect the electrical connector and remove the headlamp.

CAUTION

- ! When fitting the headlamp, take care not to damage the locating points.

Note: When fitting the headlamp, make sure that you fully engage the headlamp in the fixing points.

CHANGING A BULB

WARNINGS

- ! Switch the lights and the ignition off.
- ! Let the bulb cool down before removing it.

CAUTIONS

- ! Do not touch the glass of the bulb.
- ! Only fit bulbs of the correct specification. See **Bulb Specification Chart** (page 46).

Note: The following instructions describe how to remove the bulbs. Fit replacement in the reverse order unless otherwise stated.

Headlamp main and dipped beam

- Remove the headlamp. See **Removing a Headlamp** (page 41).

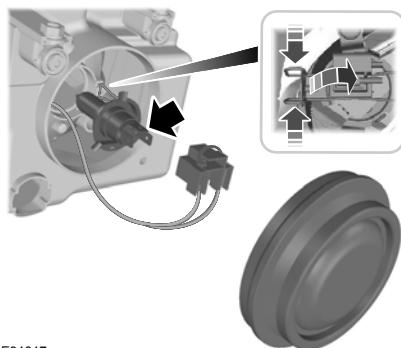

E91017

- Remove the cover.
- Disconnect the electrical connector.
- Release the clip and remove the bulb.

Side lamps

- Remove the headlamp. See **Removing a Headlamp** (page 41).

Lighting

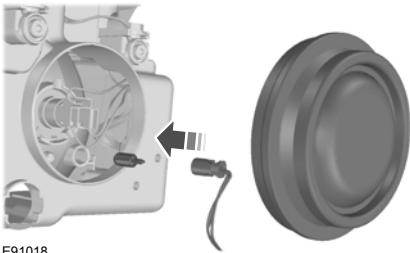

E91018

2. Remove the cover.
3. Carefully prise out the bulb holder.
4. Remove the bulb.

Front direction indicators

1. Remove the headlamp. See **Removing a Headlamp** (page 41).

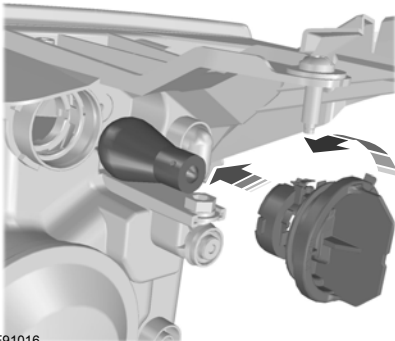

E91016

2. Turn the bulb holder anticlockwise and remove it.
3. Gently press the bulb into the bulb holder, turn it anticlockwise and remove it.

Side repeaters

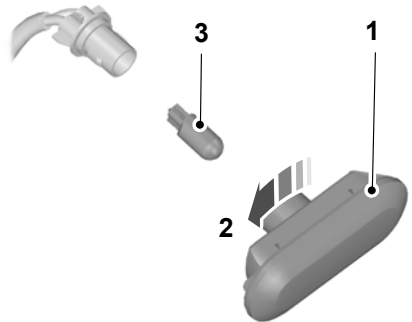

E78869

1. Carefully remove the side repeater.
2. Hold the bulb holder, turn the housing anticlockwise and remove it.
3. Remove the bulb.

Front fog lamps

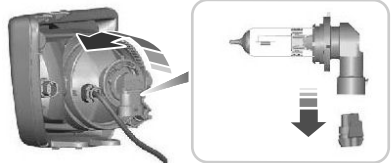

E91019

1. Disconnect the electrical connector.
2. Turn the bulb holder anticlockwise and remove it.

Rear lamps

1. Open the tailgate.

Lighting

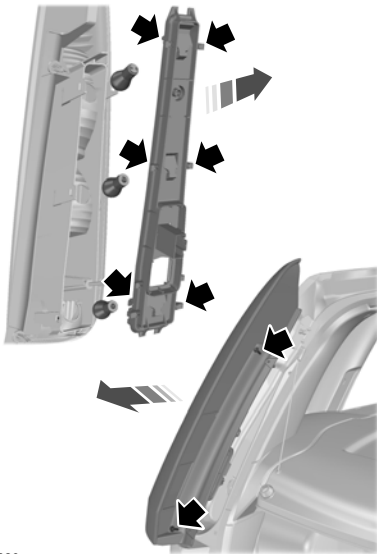

E91020

2. From inside the luggage compartment, remove the wing nut on the back of the rear lamp.
3. Remove the screws and remove the rear lamp assembly.
4. Release the clips and remove the bulb holder.

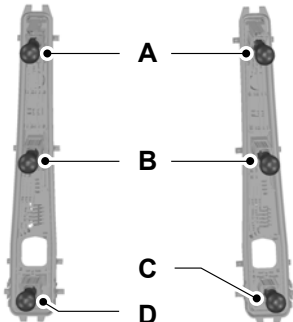

E91021

5. Gently press the bulbs into the bulb holder, turn them anticlockwise and remove them.

Central high mounted stop lamp

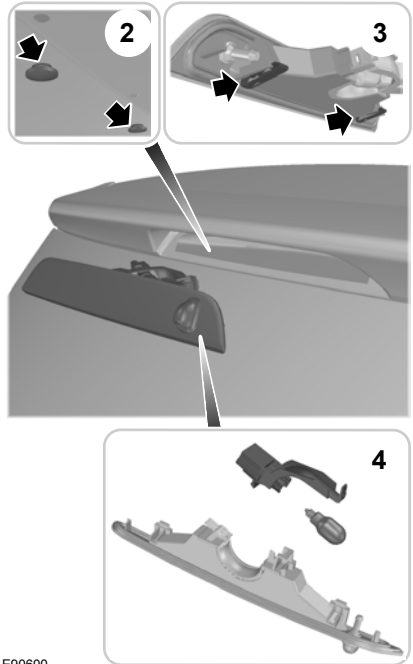

E90600

1. Open the tailgate.
2. Remove the rubber grommet.
3. Release the clips using a flat-bladed screwdriver and remove the lamp.
4. Unclip the bulb holder and remove the bulb.

Lighting

Number plate lamp

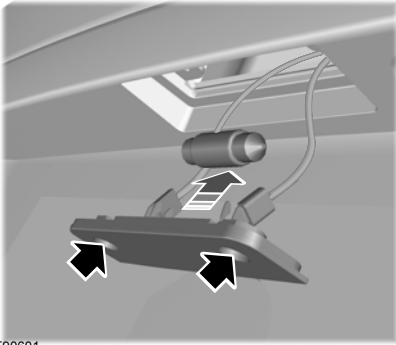

E90601

1. Loosen the screws and remove the lamp.
2. Remove the bulb.

Interior lamp

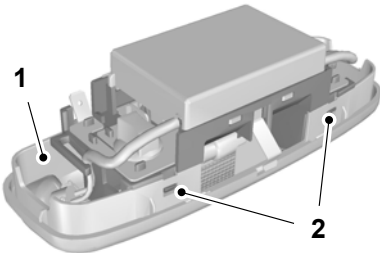

E73091

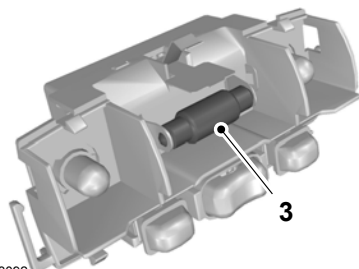

E73092

1. Carefully prise out the lamp.
2. Remove the lens.
3. Remove the bulb.

Reading lamps

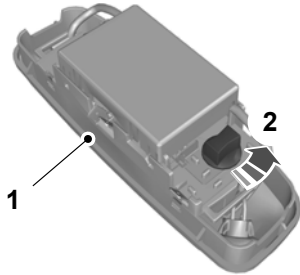

E73938

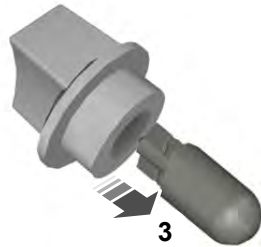

E73939

1. Carefully prise out the lamp.
2. Turn the bulb holder anticlockwise and remove it.
3. Remove the bulb.

Lighting

Luggage compartment lamp

1. Carefully prise out the lamp.
2. Remove the bulb.



E72784

BULB SPECIFICATION CHART

Bulb	Specification	Rating (watt)
Front direction indicator	PY21W	21
Side lamp		5
Headlamp	H4	55/60
Side repeater		5
Front fog lamp	H11	55
Brake and tail lamp	P21/5W	5
Rear direction indicator	P21W	21
Reversing lamp	P21W	21
Rear fog lamp	P21W	21
Central high mounted stop lamp		16
Number plate lamp	ZW5	5
Interior lamp		10
Reading lamp		5
Luggage compartment lamp		5

Windows and Mirrors

POWER WINDOWS

WARNING



Do not operate the electric windows unless they are free from obstruction.

Note: *If you operate the switches often during a short period of time, the system might become inoperable for a certain time to prevent damage due to overheating.*

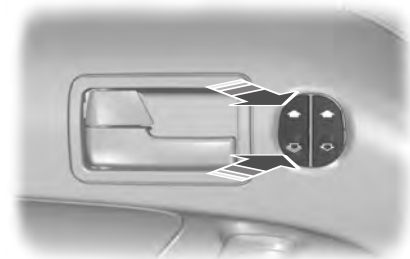

E93505

Switch on the ignition to operate the electric windows.

To open the driver's window automatically

Press the switch to the second action point and release it. Press it again to stop the window.

EXTERIOR MIRRORS

WARNING



Do not overestimate the distance of the objects that you see in the convex mirror. Objects seen in convex mirrors will appear smaller and further away than they actually are.

Manual folding mirrors

Folding

Push the mirror towards the door window glass.

Unfolding

Make sure that you fully engage the mirror in its support when returning it to its original position.

ELECTRIC EXTERIOR MIRRORS

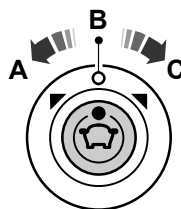

E66485

- A Left-hand mirror
- B Off
- C Right-hand mirror

Electric exterior mirrors are fitted with a heating element that will defrost or demist the mirror glass. They will switch on automatically when you switch the heated rear window on.

Windows and Mirrors

Mirror tilting positions

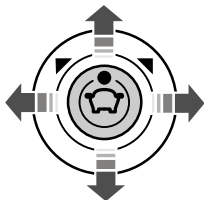

E66486

- A up
- B right
- C down
- D left

Electric folding mirrors

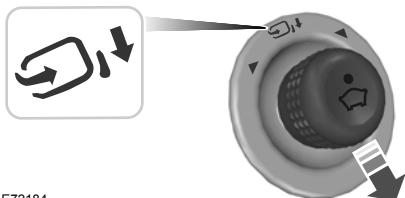

E72184

Automatic folding

The mirrors will fold automatically when you lock the vehicle with the remote control. The mirrors will unfold when you unlock the vehicle with the key or the remote control.

Instrument Cluster

GAUGES

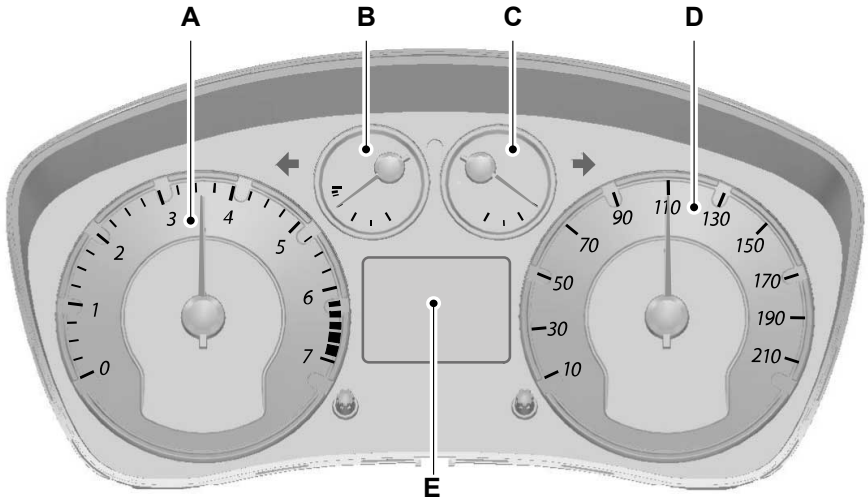

E89015

- A Tachometer
- B Engine coolant temperature gauge
- C Fuel gauge
- D Speedometer
- E Information display

Engine coolant temperature gauge

All vehicles

Shows the temperature of the engine coolant. At normal operating temperature, the needle will remain in the centre section.

CAUTION

- ! Do not restart the engine until the cause of overheating has been resolved.

If the needle enters the red section, the engine is overheating. Stop the engine, switch the ignition off and determine the cause **once the engine has cooled down**.

Instrument Cluster

Vehicles with an information display

In addition, a warning message will appear in the display.

Fuel gauge

The arrow adjacent to the fuel pump symbol tells you on which side of your vehicle the fuel filler cap is located.

WARNING LAMPS AND INDICATORS

The following warning lamps and indicators illuminate when the ignition is switched on:

- ABS
- Airbag
- Brake system
- Door open
- Engine
- Frost
- Ignition
- Oil pressure
- Power steering
- Powertrain
- Stability control (ESP).

If a warning or indicator lamp does not illuminate when the ignition is switched on, it indicates a malfunction. Have the system checked by properly trained technician.

ABS warning lamp



If it illuminates when you are driving, this indicates a malfunction. You will continue to have normal braking (without ABS). Have the system checked by a properly trained technician as soon as possible.

Airbag warning lamp



If it illuminates when you are driving, this indicates a malfunction. Have the system checked by a properly trained technician.

Brake system lamp



It illuminates when the parking brake is engaged.

WARNING



Reduce your speed gradually and stop your vehicle as soon as it is safe to do so. Use your brakes with care.

If it illuminates when you are driving, check that the parking brake is not engaged. If the parking brake is not engaged, this indicates a malfunction. Have the system checked by a properly trained technician immediately.

Direction indicator



Flashes during operation. A sudden increase in the rate of flashing warns of a failed indicator bulb. See **Changing a Bulb** (page 42).

Door open warning lamp



Illuminates when the ignition is switched on and remains on if any door, the bonnet or the luggage compartment is not closed properly.

Instrument Cluster

Engine warning lamp



If it illuminates with the engine running, this indicates a malfunction. If it flashes when you are driving, **reduce the speed of your vehicle immediately**. If it continues to flash, avoid heavy acceleration or deceleration. Have the system checked by a properly trained technician immediately.

Front fog lamp indicator



It will illuminate when you switch the front fog lamps on.

Frost warning lamp



It will illuminate and glow amber when the outside air temperature is between 4°C (39°F) and 1°C (34°F). It will glow red when the temperature is below 1°C (34°F).

Glow plug indicator



See **Starting a Diesel Engine** (page 73).

Headlamp indicator



It will illuminate when you switch the headlamp dipped beam or the side and tail lamps on.

Ignition warning lamp



If it illuminates when you are driving, this indicates a malfunction. Switch off all unnecessary electrical equipment. Have the system checked by a properly trained technician immediately.

Low fuel level warning lamp



If it illuminates, refuel as soon as possible.

Main beam indicator



It will illuminate when you switch the headlamp main beam on. It will flash when you use the headlamp flasher.

Oil pressure warning lamp

CAUTION



Do not resume your journey if it illuminates despite the level being correct. Have the system checked by a properly trained technician immediately.



If it stays on after starting or illuminates when driving, this indicates a malfunction. Stop your vehicle as soon as it is safe to do so and switch the engine off. Check the engine oil level. See **Engine Oil Check** (page 107).

Overdrive indicator



It will illuminate when you switch overdrive off.

Power steering warning lamp



Illuminates to indicate a malfunction of the power steering system. Full steering will be maintained but you will need to exert greater force on the steering wheel. Have the system checked by a properly trained technician as soon as possible.

Instrument Cluster

Powertrain warning lamp

Vehicles with an automatic transmission



If the powertrain warning lamp comes on when the engine is running, this indicates either a malfunction or a high transmission temperature. Stop your vehicle as soon as it is safe to do so and carry out the following:

1. Select **P** or **N** and allow the engine to idle for 10 minutes.
2. Switch the ignition off and restart the engine.

If the powertrain warning lamp comes on, switch the ignition off and have the transmission checked before continuing your journey.

If the powertrain warning lamp does not come on, continue your journey and have the transmission checked as soon as possible.

Vehicles with a 5-speed manual transmission or Durashift EST



If the powertrain warning lamp comes on when the engine is running, this indicates a malfunction. The engine will continue to run but it will have limited power. Have this checked as soon as possible.

If the powertrain warning lamp flashes when the engine is running, this indicates a malfunction. Stop your vehicle as soon as it is safe to do so. Have this checked before continuing your journey.

Rear fog lamp indicator



It will illuminate when you switch the rear fog lamps on.

Stability control (ESP) warning lamp



While driving, it flashes during activation of the system. After switching on the ignition, if it does not illuminate or illuminates continuously while driving, this indicates a malfunction. During a malfunction, the system switches off. Have the system checked by a properly trained technician as soon as possible.

If you switch ESP off, the warning lamp will illuminate. The lamp will go out when you switch the system back on or when you switch the ignition off.

Information Displays

GENERAL INFORMATION

WARNING



Do not operate the information display controls when the vehicle is moving.

Note: The information display will remain on for several minutes after you switch off the ignition.

Note: If *Sh on* or *SHIP ON* is displayed, the vehicle shipping mode is switched on. Have your dealer switch off the vehicle shipping mode.

Type 1 information display



E

E91003

- A Distance to empty or clock
- B Tripmeter
- C Odometer
- D Select button
- E Reset button

Press the select button to scroll through the displays.

Setting the time



E91004

Note: You can only set the time through the audio unit on some vehicles. See *Setting the clock and date on the audio unit* (page 137).

1. Press the select button until the time flashes in the display.
2. Press the select button to set the time.

Type 2 information display



F

E91005

- A Selected gear
- B Clock, radio station or CD track
- C Outside air temperature
- D Tripmeter

Information Displays

- E Odometer
- F Message indicator

You can change the settings of various functions through the information display. The information display also provides information messages.

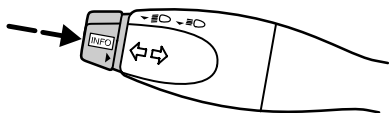

E70436

Press the button to scroll through the displays and hold the button to rest, select a submenu or change a setting. The information display will tell you whether a short press of the button or long press of the button is required for the various options.

Message indicator

The message indicator will come on to supplement some messages. It will be red or amber depending on the severity of the message and will remain on until the cause of the message has been rectified.

Display definitions

Distance to empty

Indicates the approximate distance that your vehicle will travel on the fuel in the fuel tank.

Average speed

Indicates the average speed of your vehicle since the last reset.

Average fuel

Indicates the average fuel consumption of your vehicle since the last reset.

Fuel economy

Indicates the current fuel consumption of your vehicle.

PERSONALISED SETTINGS

You can change the settings of various functions through the information display.

Unlocking the doors with the remote control

You can set the unlocking function to unlock the driver side front door only or to unlock all of the doors.

Direction indicators

You can set the direction indicators to flash only three times when you tap the direction indicator level.

Audio display

You can set the information display to display certain audio unit information.

Hazard warning flashers

You can set the hazard warning flashers to flash automatically when you brake heavily.

Audible warnings

You can switch off some of the audible warnings.

Language

You can set the display to your preferred language.

Information Displays

INFORMATION MESSAGES

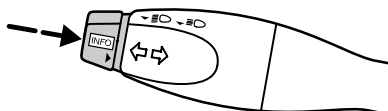

Press the button to acknowledge and remove some messages from the information display. Other messages will be removed automatically after a short time. Messages will remain active until the cause has been rectified.

E70436

Message	Message indicator	Meaning
LOW BRAKE FLUID LEVEL	Red	This indicates a malfunction in one of the brake circuits. Check the brake fluid level. See Brake and Clutch Fluid Check (page 108). If the ABS warning lamp or the stability control warning lamp also come on, this indicates a malfunction. Stop your vehicle as soon as it is safe to do so and have this checked before continuing you journey.
HIGH ENGINE TEMPERATURE	Red	The engine is overheating. Stop the engine, switch the ignition off and determine the cause once the engine has cooled down .
TRANSMISSION MALFUNCTION	Red	The transmission system has malfunctioned. Vehicles with an automatic transmission: Stop your vehicle as soon as it is safe to do so. Select P or N and let the engine idle for 10 minutes. Switch the ignition off and then restart the engine. If the message is still displayed, switch the ignition off and have this checked before continuing your journey. If the message is no longer displayed, you can continue your journey and have this checked as soon as possible. Vehicles with a Durashift EST transmission: Stop your vehicle as soon as it is safe to do so. Switch the ignition off and have this checked before continuing your journey.

Information Displays

Message	Message indicator	Meaning
TRANSMISSION MALFUNCTION	Amber	The transmission system has malfunctioned. Avoid heavy acceleration or deceleration. The transmission will continue to operate but you will notice some unusual conditions. Have this checked as soon as possible.
STEERING ASSIST FAILURE	Red	The power steering system has malfunctioned. You will need to use greater force to turn the steering wheel. Have this checked as soon as possible.
ENGINE SYSTEM FAULT	Red	The engine system has malfunctioned. Stop your vehicle as soon as it is safe to do so. Switch the ignition off and have this checked before continuing your journey.
ENGINE SYSTEM FAULT	Amber	The engine system has malfunctioned. Avoid heavy acceleration or deceleration. The engine will continue to run but it will have limited power. Have this checked as soon as possible.
LOW OUTSIDE TEMPERATURE	Red	The outside air temperature is below 1°C (34°F).
LOW OUTSIDE TEMPERATURE	Amber	The outside air temperature is between 4°C and 1°C (39°F and 34°F).
TRANSMISSION HOT MODE	Amber	Vehicles with an automatic transmission: The transmission is overheating. Stop your vehicle as soon as it is safe to do so. Select P or N and let the engine idle for 10 minutes. Switch the ignition off and then restart the engine. If the message is still displayed, switch the ignition off and have this checked before continuing your journey. If the message is no longer displayed, you can continue your journey and have this checked as soon as possible.
LEFT INDICATOR BULB FAILURE	Amber	A left-hand side indicator bulb has failed.
RIGHT INDICATOR BULB FAILURE	Amber	A right-hand side indicator bulb has failed.

Information Displays

Message	Message indicator	Meaning
DRIVER DOOR OPEN	Amber	The driver side front door is open.
DRIVER SIDE REAR DOOR OPEN	Amber	The driver side rear door is open.
PASSENGER DOOR OPEN	Amber	The passenger side front door is open.
PASSENGER SIDE REAR DOOR OPEN	Amber	The passenger side rear door is open.
BOOT OPEN	Amber	The tailgate is open.
BONNET OPEN	Amber	The bonnet is open.
REMOTE KEY BATTERY LOW	Amber	The remote control battery is low. Have this checked as soon as possible.
FAILURE AUTO LAMP/WIPER		Autolamps or autowipers have malfunctioned. Have this checked as soon as possible.

Climate Control

PRINCIPLE OF OPERATION

Outside air

Keep the air intakes forward of the windscreen free from obstruction (snow, leaves etc.) to allow the climate control system to function effectively.

Recirculated air

CAUTION

 Prolonged use of recirculated air may cause the windows to mist up. If the windows mist up, follow the settings for defrosting and demisting the windscreen.

The air currently in the passenger compartment will be recirculated. Outside air will not enter the vehicle.

Heating

Heating performance depends on the temperature of the engine coolant.

Air conditioning

Note: The air conditioning operates only when the temperature is above 4°C (39°F).

Note: If you use the air conditioning, the fuel consumption of your vehicle will be higher.

Air is directed through the evaporator where it is cooled. Humidity is extracted from the air to help keep the windows free of mist. The resulting condensation is directed to the outside of the vehicle and it is therefore normal if you see a small pool of water under your vehicle.

General information on controlling the interior climate

Fully close all the windows.

Warming the interior

Direct the air towards your feet. In cold or humid weather conditions, direct some of the air towards the windscreen and the door windows.

Cooling the interior

Direct the air towards your face.

AIR VENTS



E71942

MANUAL CLIMATE CONTROL

Blower



E90444

A Off

Note: If you switch the blower off, the windscreen may mist up.

Climate Control

Temperature control

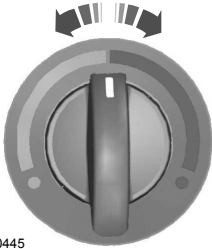

E90445

Blue Cold
Red Warm

Air distribution control

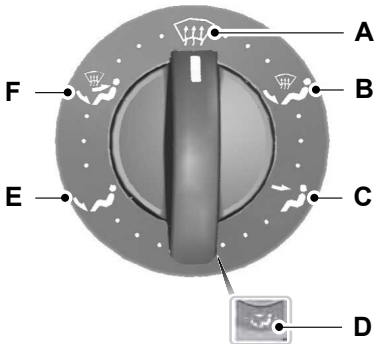

E90446

- A Windscreen
- B Footwell and windscreen
- C Face level
- D Face level and footwell
- E Footwell
- F Face level, windscreen and footwell

You can set the air distribution control to any position between the symbols.

A small amount of air is always directed towards the windscreen.

Defrosting and demisting the windscreen

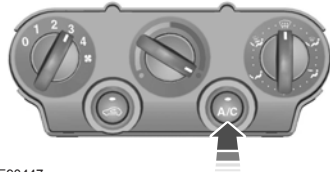

E90447

If necessary, switch the heated windows on. See **Heated Windows and Mirrors** (page 62).

Ventilation



E90448

Heating the interior quickly



E90449

Switching the air conditioning on and off



Climate Control

If you turn the blower off, the air conditioning will turn off. When you turn the blower on again, the air conditioning will come on automatically.

Recirculated air



Cooling with outside air

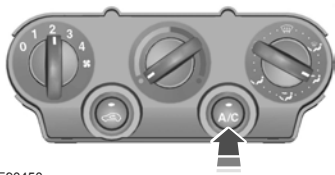

E90450

Cooling the interior quickly

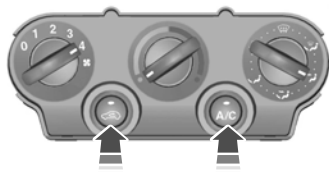

E90451

Reducing interior air humidity

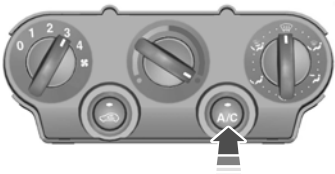

E90452

AUTOMATIC CLIMATE CONTROL

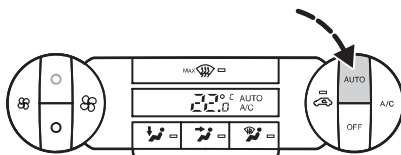

E72153

The system controls the temperature, amount and distribution of the air flow automatically and adjusts them according to the driving and weather conditions. Pressing the **AUTO** button once switches on the auto mode.

Note: Avoid adjusting the settings when the vehicle interior is extremely hot or cold. The automatic climate control adjusts to the current circumstances automatically. For the system to function properly, the side and centre vents should be fully open.

Note: The sunload sensor is located on top of the instrument panel. Do not cover the sensor with any objects.

Note: At low outside temperatures, when the system is in auto mode, the air stream will be directed to the windscreen and the side windows as long as the engine is cold.

Climate Control

Setting the temperature

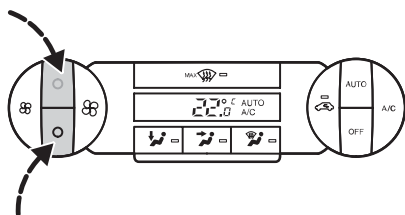

E72154

- Blue Reduces temperature
- Red Increases temperature

You can set the temperature between 16°C (61°F) and 28°C (82°F) in steps of 0.5°C (1°F). In position **LO**, 16°C (61°F), the system will switch to permanent cooling. In position **HI**, 28°C (82°F), the system will switch to permanent heating.

Blower

 Use the buttons to adjust the blower speed. The blower setting is indicated in the display. To return to auto mode, press the **AUTO** button.

Air distribution

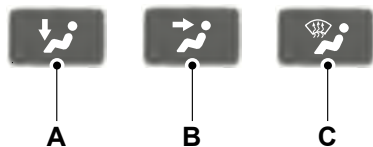

E70308

- A Footwell
- B Face level
- C Windscreen

Note: When you select windscreen defrosting and demisting, A, B and C switch off automatically and the air conditioning switches on. Outside air will flow into the vehicle. You cannot select recirculated air.

Windscreen defrosting and demisting

 Press the windscreen defrosting and demisting button. Outside air will flow into the vehicle. Air conditioning is automatically selected. As long as the air distribution is set to this position, you cannot select recirculated air.

The blower speed and the temperature control operate automatically and cannot be adjusted manually. The blower is set to high speed and the temperature to **HI**.

When you select windscreen defrosting and demisting, the heated screens switch on automatically and switch off after a short time.

Press the windscreen defrosting and demisting button again to return to the previous settings.

Switching the air conditioning on and off

 Press the **A/C** button to turn the air conditioning on and off.

Recirculated air

 Press the recirculated air button to toggle between outside air and recirculated air.

Note: When the system is in auto mode and the interior and exterior temperatures are quite hot, the system selects recirculated air automatically to maximise cooling of the interior. Once the selected temperature is reached, the system will reselect outside air automatically.

Climate Control

Switching the automatic climate control on and off

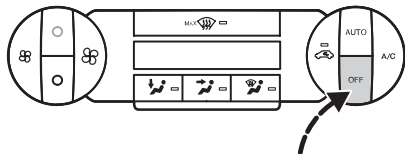

E72157

Press the **OFF** button.

When switched off, the heating, ventilation and air conditioning system is switched off and recirculated air is selected.

HEATED WINDOWS AND MIRRORS

Heated windows

Use the heated windows to defrost or demist the windscreen or rear window.

Note: *The heated windows operate only when the engine is running.*

Heated windscreen



Heated rear window



Heated exterior mirrors

Electric exterior mirrors are fitted with a heating element that will defrost or demist the mirror glass. They will switch on automatically when you switch the heated rear window on.

AUXILIARY HEATER

Diesel auxiliary heater (depending on country)

The diesel auxiliary heater (PTC electrical heater) aids in warming the engine and the interior compartment on vehicles with diesel engines. It is switched on or off automatically depending on the outside temperature, the coolant temperature and the alternator load.

SUNROOF

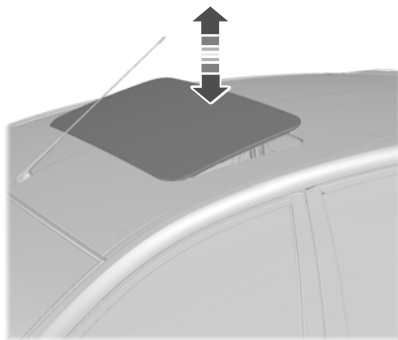

E90558

Climate Control

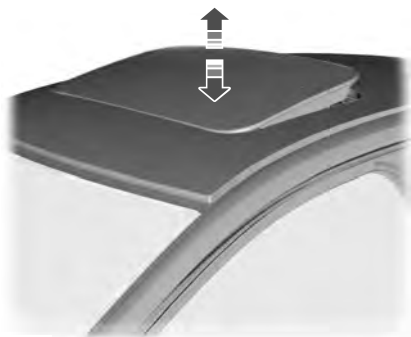

E72189

Seats

SITTING IN THE CORRECT POSITION

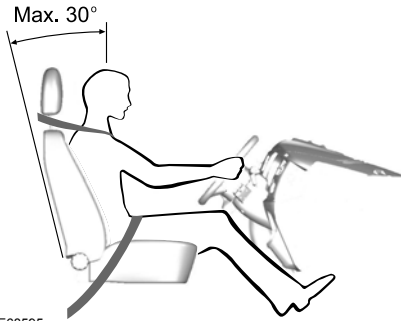

E68595

WARNINGS

- ⚠ Do not adjust the seats when the vehicle is moving.
- ⚠ Only when you use the seat belt properly, can it hold you in a position that allows the airbag to achieve its optimum effect.

When you use them properly, the seat, head restraint, seat belt and airbags will provide optimum protection in the event of a collision. We recommend that you:

- sit in an upright position with the base of your spine as far back as possible.
- do not recline the seatback more than 30 degrees.
- adjust the head restraint so that the top of it is level with the top of your head and as far forwards as possible, remaining comfortable.
- keep sufficient distance between yourself and the steering wheel. We recommend a minimum of 250 millimetres (10 inches) between your breastbone and the airbag cover.
- hold the steering wheel with your arms slightly bent.

- bend your legs slightly so that you can press the pedals fully.
- position the shoulder strap of the seat belt over the centre of your shoulder and position the lap strap tightly across your hips.

Make sure that your driving position is comfortable and that you can maintain full control of your vehicle.

MANUAL SEATS

Moving the seats backwards and forwards



E74816

WARNING

- ⚠ Rock the seat backwards and forwards after releasing the lever to make sure that it is fully engaged in its catch.

Seats

Adjusting the height of the driver's seat

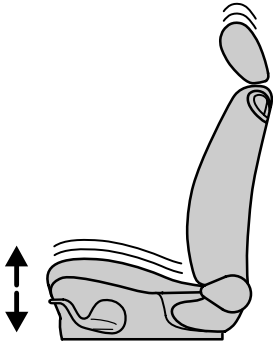

E68895

Adjusting the angle of the seatback



E74819

Folding the passenger seat forwards

WARNINGS



Do not drive with the passenger seat folded forwards if the rear seat directly behind it is occupied.



Do not drive with items on the folded seatback.

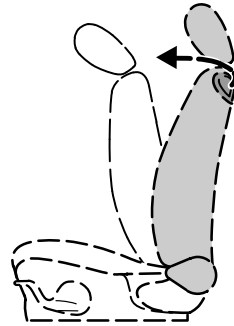

E68896

1. Fold the seat forwards.

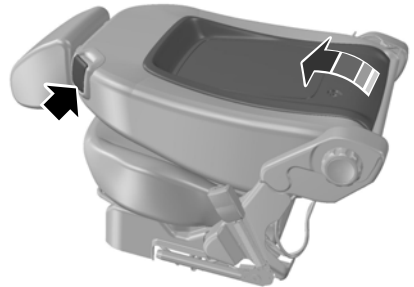

E91008

2. Turn the wheel until the seatback is horizontal.

Pull the locking lever to return the seatback to the vertical position. Make sure that the seatback is securely latched in position.

REAR SEATS

WARNINGS



Make sure that the seats and the seatbacks are secure and fully engaged in their catches.

Seats

WARNINGS

 When folding the seatbacks down, take care not to get your fingers caught between the seatback and seat frame.

 When folding the seatbacks up, make sure that the belts are visible to an occupant and not caught behind the seat.

CAUTION

 Lower the head restraints.

Folding the seatbacks down



E86611

1. Pull the unlock levers.
2. Push the seatback forwards.

Creating a level load floor

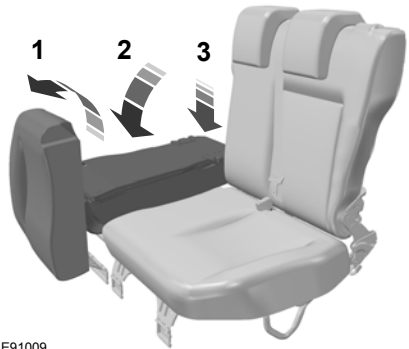

E91009

1. Lift the seat cushion.
2. Pull the locking lever and push the seatback forwards.
3. Press the rear of the seatback downwards.

HEAD RESTRAINTS



E75767

Seats



E81584

Adjusting the head restraint

WARNING



Raise rear head restraint when the rear seat is occupied by a passenger or a child restraint.

Adjust the head restraint so that the top of it is level with the top of your head.

Removing the head restraint

Press the locking buttons and remove the head restraint.

HEATED SEATS

Driver side

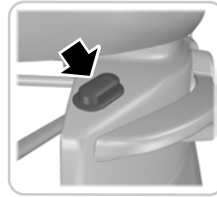

E90906

Passenger side

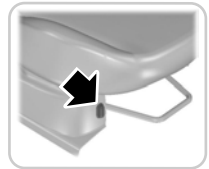

E90907

CAUTION



Operating the heated seats with the engine off will drain the battery.

The heated seats will operate when the ignition switch is in position **II**.

Seats

FRONT SEAT ARMREST

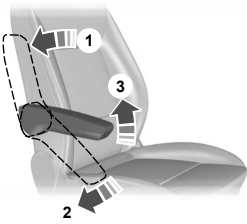

E95256

Convenience features

CIGAR LIGHTER

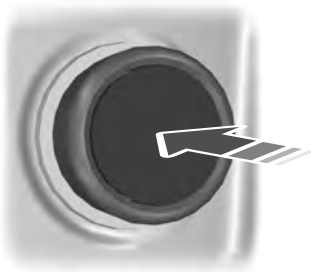

E78055

WARNING



Never hold the lighter in as this will result in damage. Always remove the lighter as a precaution when children are left alone in the vehicle.

To use the lighter, press it in and wait until it pops out automatically. The lighter will also operate when the ignition is switched off.

Other appliances can be connected to the cigar lighter power point.

When connecting appliances, use only specified connectors from the Ford Accessory range or connectors for use with SAE standard sockets.

GLOVE BOX

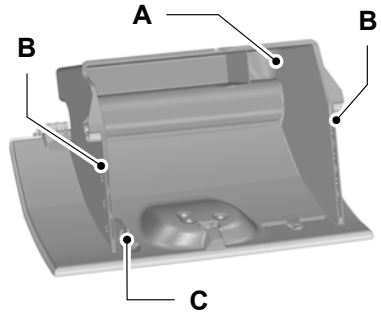

E91002

- A Card holder
- B Coin holders
- C Pen or pencil clip

STORAGE COMPARTMENTS

Storage box

A storage box is located under the passenger seat cushion.

Convenience features

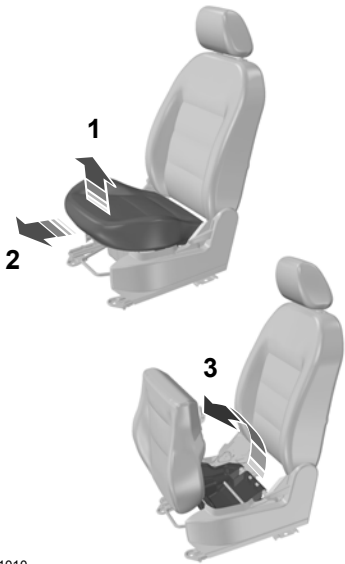

E91010

Storage pockets

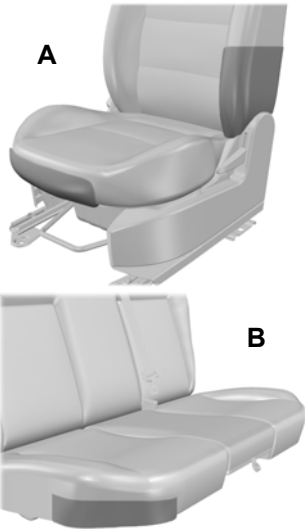

E91011

- A Driver seat
- B Rear seat

Convenience features

REAR SEAT ARMREST

Activity console

Installing the activity console

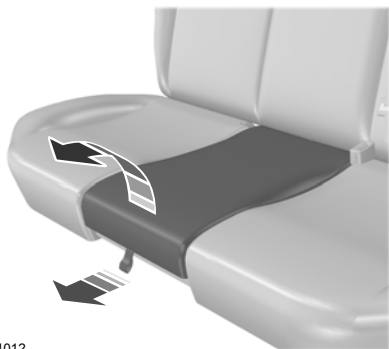

E91012

1. Remove the centre seat cushion.

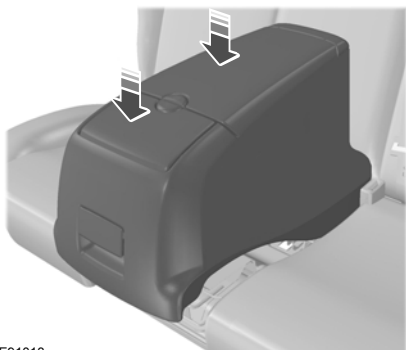

E91013

2. Install the activity console.

Removing the activity console

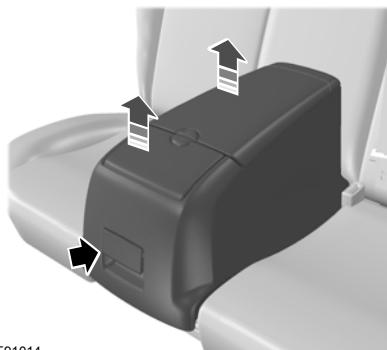

E91014

1. Pull the handle and remove the activity console.

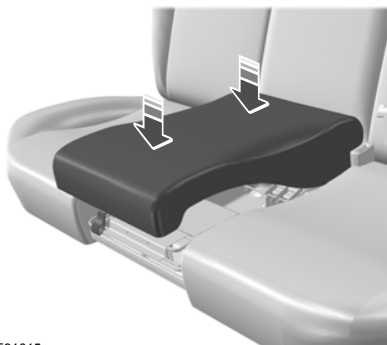

E91015

2. Install the centre seat cushion.

FLOOR MATS

WARNING



When using the floor mats, always make sure the floor mat is properly secured using the appropriate fixings and positioned so that it does not interfere with the operation of the pedals.

Starting and Stopping the Engine

GENERAL INFORMATION

General points on starting

If the battery has been disconnected the vehicle may exhibit some unusual driving characteristics for approx. 8 kilometres (5 miles) after reconnecting the battery.

This is because the engine management system must realign itself with the engine. Any unusual driving characteristics during this period may be disregarded.

Starting the engine by towing or pushing

WARNING



To prevent damage you must not push or tow start your vehicle. Use booster cables and a booster battery.

See **Jump-Starting the Vehicle** (page 114).

IGNITION SWITCH

WARNING



Never return the key to position **0** or **I** when the vehicle is in motion.



E72128

0 The ignition is off.

I The ignition and all main electrical circuits are disabled.

Note: Do not leave the ignition key in this position for too long to avoid discharging the battery.

II The ignition is switched on. All electrical circuits are operational. Warning lamps and indicators illuminate. This is the key position when driving. You must also select it when being towed.

III The starter motor is activated. Release the key as soon as the engine starts.

STARTING A PETROL ENGINE

Note: You can only operate the starter for a maximum of 30 seconds at a time.

Cold or hot engine

All vehicles

CAUTION



When the temperature is below -20°C (-4°F), switch the ignition on for at least one second before starting the engine. This will make sure that the maximum fuel pressure is established for starting the engine.

Vehicles with manual transmission

Note: Do not touch the accelerator pedal.

1. Fully depress the clutch pedal.
2. Start the engine.
3. If the engine does not start, fully depress the brake and clutch pedals and try again.

Vehicles with automatic transmission

Note: Do not touch the accelerator pedal.

1. Select park or neutral.
2. Fully depress the brake pedal.
3. Start the engine.

All vehicles

If the engine does not start within 15 seconds, wait for a short period and try again.

Starting and Stopping the Engine

If the engine does not start after **three** attempts, wait 10 seconds and follow the **Flooded engine** procedure.

If you have difficulty starting the engine when the temperature is below -25°C (-13°F), press the accelerator pedal between $\frac{1}{4}$ to $\frac{1}{2}$ of its travel and try again.

Flooded engine

Vehicles with manual transmission

1. Fully depress the clutch pedal.
2. Fully depress the accelerator pedal and hold it there.
3. Start the engine.

Vehicles with automatic transmission

1. Select park or neutral.
2. Fully depress the accelerator pedal and hold it there.
3. Fully depress the brake pedal.
4. Start the engine.

All vehicles

If the engine does not start, repeat the **Cold or hot engine** procedure.

Engine idle speed after starting

The speed at which the engine idles immediately after starting will vary depending on the engine temperature.

If the engine is cold then the idle speed will automatically be increased in order to heat the catalytic converter as quickly as possible. This makes sure that vehicle emissions are kept to an absolute minimum.

The idle speed will slowly decrease to the normal level as the catalytic converter warms up.

STARTING A DIESEL ENGINE

Cold or hot engine

All vehicles

Note: When the temperature is below -15°C (5°F), you may need to crank the engine for up to 25 seconds. If you consistently operate the vehicle in such temperatures, we recommend that you have an engine block heater fitted.

Note: Continue cranking the engine until it starts.

Note: You can only operate the starter for a maximum of 30 seconds at a time.



Switch the ignition on and wait until the glow plug indicator goes off.

Vehicles with manual transmission

Note: Do not touch the accelerator pedal.

1. Fully depress the clutch pedal.
2. Start the engine.
3. If the engine does not start, fully depress the brake and clutch pedals and try again.

Vehicles with automatic transmission

1. Select park or neutral.
2. Fully depress the brake pedal.
3. Start the engine.

Starting and Stopping the Engine

SWITCHING OFF THE ENGINE

Vehicles with a turbocharger

CAUTION



Do not switch the engine off when it is running at high speed. If you do, the turbocharger will continue running after the engine oil pressure has dropped to zero. This will lead to premature turbocharger bearing wear.

Release the accelerator pedal. Wait until the engine has reached idle speed and then switch it off.

Fuel and Refuelling

SAFETY PRECAUTIONS

WARNINGS



Stop refuelling after the fuel nozzle stops the second time. Additional fuel will fill the expansion space in the fuel tank which could lead to fuel overflowing. Fuel spillage could be hazardous to other road users.



Do not use any kind of flames or heat near the fuel system. The fuel system is under pressure. There is a risk of injury if the fuel system is leaking.

FUEL QUALITY - PETROL

CAUTION



Do not use leaded petrol or petrol with additives containing other metallic compounds (e.g. manganese-based). They could damage the emission system.

Note: We recommend that you use only high quality fuel without additives or other engine treatments.

Use **minimum 95 octane unleaded** petrol that meets the specification defined by **EN 228**, or equivalent.

FUEL QUALITY - DIESEL

WARNING



Do not mix diesel with oil, petrol or other liquids. This could cause a chemical reaction.

CAUTIONS



Do not add kerosene, paraffin or petrol to diesel. This could cause damage to the fuel system.

CAUTIONS



Use diesel that meets the specification defined by **EN 590**, or the relevant national specification.

Note: We recommend that you use only high quality fuel.

Note: The use of additives or other engine treatments not approved by Ford is not recommended.

Note: We do not recommend the prolonged use of additives intended to prevent fuel waxing.

Long-term storage

Most diesel fuels contain bio-diesel, it is recommended to fill the tank with purely mineral diesel (where available) or add an anti-oxidant prior to long-term storage of your vehicle exceeding two months. Your dealer can help you with a suitable anti-oxidant.

CATALYTIC CONVERTER

WARNING



Do not park or idle your vehicle over dry leaves, dry grass or other combustible materials. The exhaust will radiate a considerable amount of heat during use, and after you have switched the engine off. This is a potential fire hazard.

Driving with a catalytic converter

CAUTIONS



Avoid running out of fuel.



Do not crank the engine for long periods.



Do not run the engine when a spark plug lead is disconnected.

Fuel and Refuelling

CAUTIONS

- ⚠ Do not push-start or tow-start your vehicle. Use booster cables. See **Jump-Starting the Vehicle** (page 114).
- ⚠ Do not switch the ignition off when driving.

REFUELLING

CAUTION

- ⚠ Do not attempt to start the engine if you have filled the fuel tank with the incorrect fuel. This could damage the engine. Have the system checked by a properly trained technician immediately.

FUEL FILLER FLAP

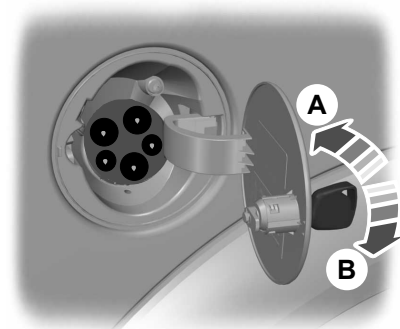

E75775

FUEL CONSUMPTION

The CO₂ and fuel consumption figures are derived from laboratory tests according to EEC Directive 80/1268/EEC and subsequent amendments and are carried out by all vehicle manufacturers.

They are intended as a comparison between makes and models of vehicles. They are not intended to represent the real world fuel consumption you may get from your vehicle. Real world fuel consumption is governed by many factors including; driving style, high speed driving, stop/start driving, air conditioning usage, the accessories fitted and towing etc.

Your Ford dealer can give you advice on improving your fuel consumption.

TECHNICAL SPECIFICATIONS

Fuel Consumption Figures

Variant	Urban	Extra-Urban	Combined	CO ₂ Emissions
	l/100 km (mpg)	l/100 km (mpg)	l/100 km (mpg)	g/km
1.25L Duratec-16V (Sigma) (55kW/75PS) Stage IV, 5-speed manual transmission	8.6 (32.8)	5.1 (55.4)	6.4 (44.1)	152
1.4L Duratec-16V (Sigma) (59kW/80PS) Stage IV, 5-speed manual transmission	8.5 (33.2)	5.3 (53.3)	6.5 (43.3)	154

Fuel and Refuelling

Variant	Urban	Extra-Urban	Combined	CO2 Emissions
	l/100 km (mpg)	l/100 km (mpg)	l/100 km (mpg)	g/km
1.4L Duratec-16V (Sigma) (59kW/80PS) Stage V, 5-speed manual transmission	8.8 (32.1)	5.4 (52.3)	6.6 (42.8)	154
1.4L Duratec-16V (Sigma) (59kW/80PS) Stage IV, Durashift EST	8.5 (33.2)	5 (56.5)	6.3 (44.8)	149
1.6L Duratec-16V (Sigma) (74kW/100PS) Stage IV, 5-speed manual transmission	8.9 (31.7)	5.3 (53.3)	6.6 (42.8)	157
1.6L Duratec-16V (Sigma) (74kW/100PS) Stage V, 5-speed manual transmission	9.1 (31)	5.4 (52.3)	6.7 (42.2)	157
1.6L Duratec-16V (Sigma) (74kW/100PS) Stage IV, automatic transmission	10.2 (27.7)	6 (47.1)	7.5 (37.7)	179
1.4L Duratorq-TDCi (DV) (50kW/68PS) Stage IV, 5-speed manual transmission,	5.7 (49.6)	3.9 (72.4)	4.5 (62.8)	120
1.6L Duratorq-TDCi (DV) (66kW/90PS) Stage IV, 5-speed manual transmission,	5.5 (51.4)	4 (70.6)	4.5 (62.8)	119

Transmission

MANUAL TRANSMISSION

5-speed manual transmission

CAUTION

⚠ Do not apply any undue lateral force to the gear lever when changing from 5th to 4th gear. This could lead to the inadvertent selection of 2nd gear and can cause damage to the transmission.

Selecting reverse gear

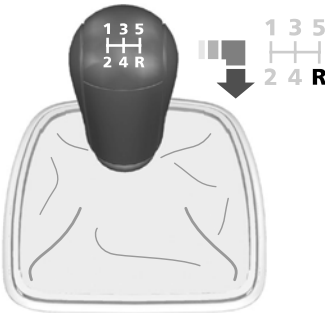

E75050

CAUTION

⚠ Do not engage reverse gear when the vehicle is moving. This can cause damage to the transmission.

Note: Fully depress the clutch pedal and wait for three seconds before you select reverse gear.

Durashift EST

Selector lever positions



E90581

- R Reverse
- N Neutral
- D Drive (automated)
- +/- Drive (manual)
- A Drive mode

WARNINGS

- ⚠ Apply the brakes before moving the selector lever and keep them applied until you are ready to move off.
- ⚠ Select reverse only when your vehicle is stationary and the engine is at idle speed.

Note: A cold engine has a higher idle speed. This will increase the tendency for your vehicle to creep when you have selected a drive gear.

The selected gear will be shown in the information display. If it flashes, apply the brakes or press the accelerator pedal to move off.

Push the lever to the left (drive mode) to select manual drive or automated drive.

Moving off

1. Release the parking brake.

Transmission

2. Release the brake pedal and press the accelerator pedal.

Stopping

1. Release the accelerator pedal and press the brake pedal.
2. Apply the parking brake.

Kickdown

Press the accelerator pedal fully to select the next highest gear for optimum performance. Release the accelerator pedal when you no longer require kickdown.

AUTOMATIC TRANSMISSION - VEHICLES WITH: 4-SPEED AUTOMATIC TRANSMISSION (4F27E)

Selector lever positions



E83164

- | | |
|---|---------|
| P | Park |
| R | Reverse |
| N | Neutral |
| D | Drive |

- | | |
|---|----------|
| 2 | 2nd Gear |
| 1 | 1st Gear |

WARNING



Apply the brakes before moving the selector lever and keep them applied until you are ready to move off.

Note: A cold engine has a higher idle speed. This will increase the tendency for your vehicle to creep when you have selected a drive gear.

Press the button on the selector lever to select reverse and park.

The selector lever position will be shown in the information display.

Park

WARNINGS



Select park only when your vehicle is stationary.



Apply the parking brake and select park before leaving your vehicle. Make sure that the selector lever is latched in position.

Note: An audible warning will sound if you open the drivers door and you have not selected park.

In this position, power is not transmitted to the drive wheels and the transmission is locked. You can start the engine with the selector lever in this position.

Reverse

WARNING



Select reverse only when your vehicle is stationary and the engine is at idle speed.

Transmission

Neutral

In this position, power is not transmitted to the drive wheels but the transmission is not locked. You can start the engine with the selector lever in this position.

Drive

Select drive to shift automatically through the forward gears.

2nd Gear

Select 2, the transmission will automatically shift between 2nd and 1st gears only.

1st Gear

Select 1, the transmission will select 1st gear only.

Hints on driving with an automatic transmission

Moving off

1. Release the parking brake.
2. Release the brake pedal and press the accelerator pedal.

Stopping

1. Release the accelerator pedal and press the brake pedal.
2. Apply the parking brake.

Kickdown

Press the accelerator pedal fully with the selector lever in the drive position to select the next highest gear for optimum performance. Release the accelerator pedal when you no longer require kickdown.

Overdrive

Note: The transmission is normally in overdrive when drive is selected.

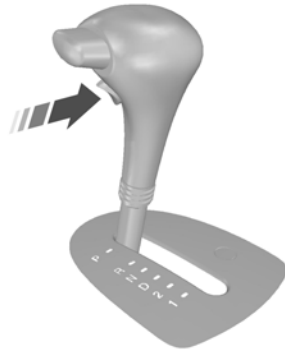

E83165

When you are travelling in slow moving traffic or climbing steep gradients there may be a tendency for the transmission to continually shift between 4th and 3rd gears. If this condition should arise switch the overdrive function off.

Note: The transmission will only select between 1st, 2nd and 3rd gears if the overdrive function has been switched off.

Drive modes

The transmission will select the appropriate gear for optimum performance based on ambient temperature, road gradient, vehicle load and driver input.

Emergency park position release lever

Use the lever to move the selector lever from the park position in the event of an electrical malfunction or if your vehicle has a flat battery.

Transmission

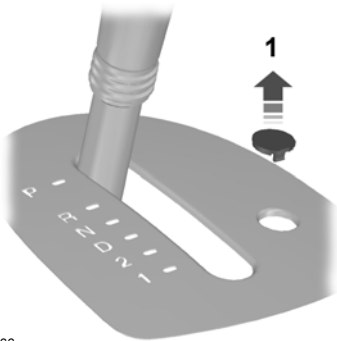

E83166

1. Remove the cover.
2. Insert a flat-bladed screwdriver into the slot.
3. Push downwards on the screwdriver to release the lever and move the selector lever from the park position.
4. Install the cover.

Brakes

PRINCIPLE OF OPERATION

Disc brakes

Wet brake discs result in reduced braking efficiency. Dab the brake pedal when driving from a car wash to remove the film of water.

ABS

WARNING



The ABS does not relieve you of your responsibility to drive with due care and attention.

The ABS helps you to maintain full steering and directional stability when you brake heavily in an emergency, by preventing the road wheels from locking.

HINTS ON DRIVING WITH ANTI-LOCK BRAKES

When the ABS is operating, the brake pedal will pulse. This is normal. Maintain pressure on the brake pedal.

The ABS will not eliminate the dangers inherent when:

- you drive too close to the vehicle in front of you.
- the vehicle is aquaplaning.
- you take corners too fast.
- the road surface is poor.

PARKING BRAKE

Applying the parking brake

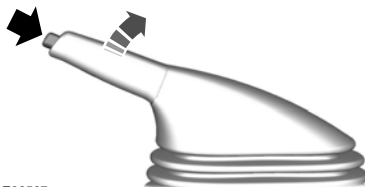

E66567

WARNING



Make sure that the parking brake is applied before you release the lever.

Note: Do not press the release button when you apply the parking brake.

1. Press the brake pedal firmly.
2. Pull the parking brake lever upwards to its fullest extent.

Parking on a hill

If you have to park facing uphill, select first gear and turn the front wheels away from the kerb. If you have to park facing downhill, select reverse gear and turn the front wheels towards the kerb.

Releasing the parking brake

1. Press the brake pedal firmly.
2. Pull the parking brake lever upwards slightly, press the release button and push the lever downwards.

Stability Control

PRINCIPLE OF OPERATION

Electronic stability programme (ESP)

WARNING



The system does not relieve you of your responsibility to drive with due care and attention.

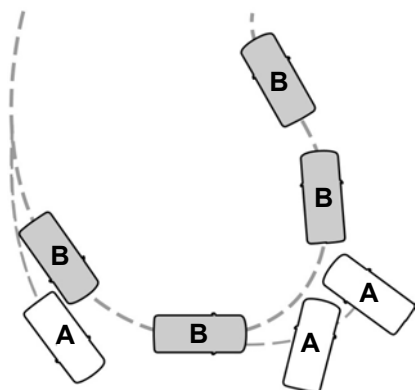

E72903

- A Without ESP
- B With ESP

The system supports stability when the vehicle starts to slide away from your intended path. This is performed by braking individual wheels and reducing engine torque as needed.

The system also provides an enhanced traction control function by reducing engine torque if the wheels spin when you accelerate. This improves your ability to pull away on slippery roads or loose surfaces, and improves comfort by limiting wheel spin in hairpin bends.

Stability control (ESP) warning lamp

While driving, it flashes during activation of the system. See **Warning Lamps and Indicators** (page 50).

Emergency brake assist

WARNING



The system does not relieve you of your responsibility to drive with due care and attention.

The system will detect when you brake heavily by measuring the rate at which you press the brake pedal. It will provide maximum braking efficiency as long as you press the pedal. The system can reduce stopping distances in critical situations.

USING STABILITY CONTROL

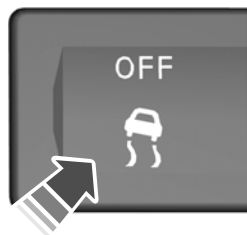

E94885

Press and hold the switch for one second. The switch will illuminate.

Press the switch again to turn the system on. The system will be switched on automatically every time you switch the ignition on.

For item location: See **At a Glance** (page 8).

Parking Aids

PRINCIPLE OF OPERATION

WARNING



The parking aid does not relieve you of your responsibility to drive with due care and attention.

CAUTIONS



Vehicles fitted with a trailer tow module not approved by us may not correctly detect obstacles.



The sensors may not detect objects in heavy rain or other conditions that cause disruptive reflections.



The sensors may not detect objects with surfaces that absorb ultrasonic waves.



The parking aid does not detect obstacles moving away from the vehicle. They will only be detected shortly after they start to move towards the vehicle again.



Take particular care when reversing with a tow ball arm or rear fitted accessories e.g. a bicycle carrier, as the rear parking aid will only indicate the distance from the bumper to the obstacle.



If you use a high pressure spray to wash your vehicle, only spray the sensors briefly from a distance not less than 20 centimetres (8 inches).

Note: On vehicles fitted with a tow ball arm, the parking aid is deactivated automatically when any trailer lamps (or lighting boards) are connected to the 13-pin socket via a trailer tow module we have approved.

Note: Keep the sensors free from dirt, ice and snow. Do not clean with sharp objects.

Note: The parking aid may emit false tones if it detects a signal using the same frequency as the sensors or if the vehicle is fully laden.

Note: The outer sensors may detect the side walls of a garage. If the distance between the outer sensor and the side wall remains constant for three seconds, the tone will switch off. As you continue, the inner sensors will detect rearward objects.

USING THE PARKING AID

Switching the parking aid on and off

Note: The parking aid switches off automatically when you start the engine or when you exceed 16 km/h (10 mph).

Note: The front and rear sensors are always activated or deactivated together.

The parking aid is per default off. To switch the parking aid on, press the switch in the instrument panel or select reverse gear.

The light in the switch illuminates when the parking aid is activated.

To turn it off, press the switch again.

Manoeuvring with the parking aid

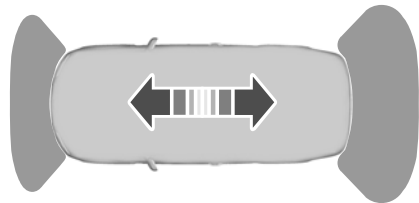

E72902

Note: If a high pitch warning tone sounds for three seconds and the light in the switch is flashing, it indicates a malfunction. The system will be disabled. Have the system checked by properly trained technicians.

Parking Aids





You will hear an intermittent tone at a distance of up to approximately 150 centimetres (59 inches) between the obstacle and rear bumper, 80 centimetres (31 inches) between the obstacle and front bumper and 50 centimetres (20 inches) to the side. Decreasing the distance accelerates the intermittent tone. A continuous tone will start at a distance of less than 30 centimetres (12 inches).

You will hear an alternating tone from the front and rear if obstacles are closer than 30 centimetres (12 inches) to the front and rear bumpers.



Load Carrying

GENERAL INFORMATION

WARNINGS

-  Use load securing straps to an approved standard, e.g. DIN.
-  Make sure that you secure all loose items properly.
-  Place luggage and other loads as low and as far forward as possible within the luggage or loadspace.
-  Do not drive with the tailgate or rear door open. Exhaust fumes may enter the vehicle.
-  Do not exceed the maximum front and rear axle loads for your vehicle. See **Vehicle identification** (page 126).

CAUTIONS

-  Do not allow items to contact the rear windows.
-  Do not use any abrasive materials to clean the interior of the rear windows.
-  Do not install stickers or labels to the interior of the rear windows.

LUGGAGE COVERS

CAUTION

-  Do not place objects on the luggage cover.

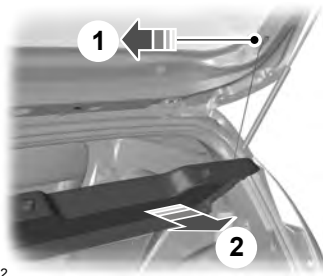





E72512

ROOF RACKS AND LOAD CARRIERS

Roof rack

WARNINGS

-  If you use a roof rack, the fuel consumption of your vehicle will be higher and you may experience different driving characteristics.
-  Read and follow the manufacturer's instructions when you are fitting a roof rack.
-  Switch stability control (ESP) on. See **Using Stability Control** (page 83).
-  Inflate the tyres to the full load pressures. See **Technical Specifications** (page 125).

CAUTION

-  Do not exceed the maximum permissible roof load. See **Vehicle Identification Plate** (page 126).

Check the security of the roof rack and tighten its fittings as follows:

Load Carrying

- before starting
- after driving 50 kilometres (30 miles)
- at 1000 kilometres (600 miles) intervals.

Towing

TOWING A TRAILER

WARNINGS



Do not exceed 100 km/h (62 mph).



The rear tyre pressures must be increased by 0.2 bar (3 psi) above specification. See **Technical Specifications** (page 125).



Do not exceed the maximum gross train weight stated on the vehicle identification plate. See **Vehicle Identification Plate** (page 126).

CAUTION



Do not exceed the maximum permissible nose weight, i.e. vertical weight on the tow ball, of 50 kilogrammes (110 pounds).

Note: *Not all vehicles are suitable or approved to have tow bars fitted. Check with your dealer first.*

Place loads as low and central to the axle(s) of the trailer as possible. If you are towing with an unladen vehicle, the load in the trailer should be placed toward the nose, within the maximum nose load, as this gives the best stability.

Note: *The maximum trailer nose weight can be found in the original vehicle documents (confirmation of conformity). Alternatively refer to your dealer.*

The stability of the vehicle to trailer combination is very much dependant on the quality of the trailer.

In high altitude regions above 1000 metres (3281 feet), the stipulated maximum permitted gross train weight must be reduced by 10% for every additional 1000 metres (3281 feet).

Steep gradients

WARNING



The overrun brake on a trailer is not controlled by ABS.

Change down a gear before you reach a steep downhill gradient.

TOW BALL

WARNINGS



Never leave the detached tow ball arm unsecured inside the vehicle. This would increase the risk of injury in an accident.



Take special care when fitting the tow ball arm as the safety of the vehicle and the trailer depends on this.

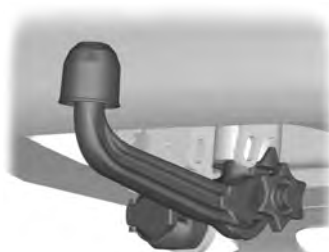

E71328

A 13-pin trailer socket and the tow ball arm are provided underneath the rear bumper. Turn the trailer socket down through 90 degrees until it engages in the end position.

When not in use, always transport the tow ball arm securely fastened in the luggage compartment. Insert the plug into its seat.

Towing

Unlocking the tow ball arm mechanism

WARNING

 Do not use any tools for mounting or dismounting the tow ball arm. Do not modify the trailer coupling. Do not disassemble or repair the tow ball arm.

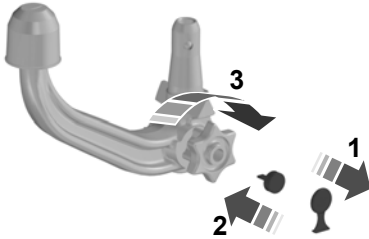

E71329

1. Remove the protecting cap. Insert the key and turn clockwise to unlock.
2. Hold the tow ball arm. Pull the handwheel out and turn it clockwise until it clicks.
3. The red mark on the handwheel must align with the green mark on the tow ball.
4. Release the handwheel. The tow ball arm is unlocked.

Inserting the tow ball arm

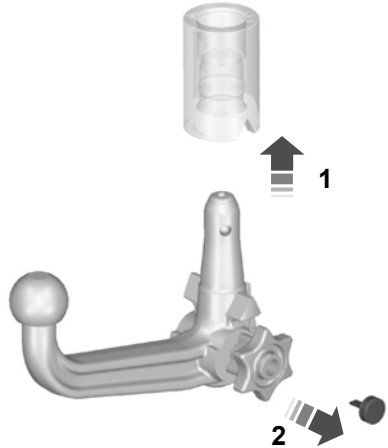

E71330

WARNING

 The tow ball arm may only be inserted when completely unlocked.

1. Pull out the plug.
2. Insert the tow ball arm vertically and press it upwards until it engages (1). Do not hold your hand near the handwheel.
3. The green mark on the handwheel must align with the green mark on the tow ball.
4. To lock, turn the key anticlockwise and remove the key (2).
5. Pull the protecting cap from the key bow and press it onto the lock.

Towing

Driving with a trailer

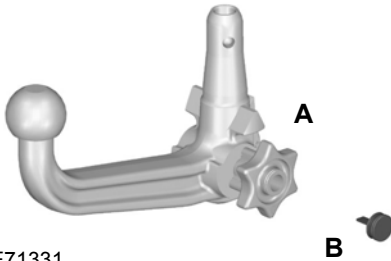

E71331

WARNING



If any of the below conditions cannot be met, do not use the tow bar and have it inspected by an expert.

Before starting your journey, ensure the tow ball arm is properly locked. Check that:

- the green marks are aligned
- the handwheel (**A**) is correctly fitted to the tow ball arm.
- you have removed the key (**B**).
- the tow ball arm is securely positioned. It must not move when jerked.

Removing the tow ball arm

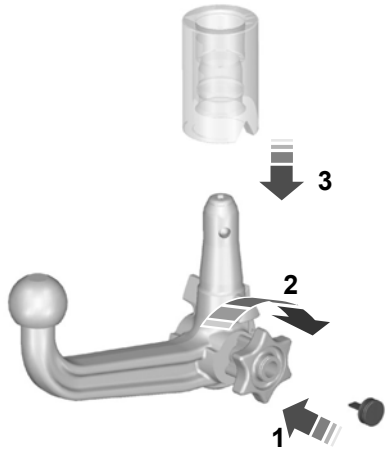

E71332

Note: *Unhitch the trailer.*

1. Remove the protecting cap. Press the cap into the key bow. Insert the key and unlock.
2. Hold the tow ball arm. Pull the handwheel out and turn it clockwise against the stop.
3. Remove the tow ball arm.
4. Release the handwheel.

When unlocked in this way, the tow ball arm can be reinserted at any time.

Driving without a trailer

WARNING



To avoid risk of injury, never unlock the tow ball arm with the trailer attached.

1. Remove the tow ball arm.
2. Insert the plug into its seat.

Towing

Maintenance

WARNING



Remove the tow ball arm and protect the seat with the plug before steam cleaning your vehicle.

Keep the system clean. Periodically lubricate bearings, sliding surfaces, and locking balls with resin-free grease or oil and the lock with graphite.

Keep a note of the key number. In case of loss, replacement keys are available from the manufacturer by stating the 4-digit key number.

Driving Hints

GENERAL DRIVING POINTS

Vehicles with a diesel engine

If the low fuel level warning lamp comes on, refuel as soon as possible. If you continue driving without refuelling, the engine will start to run unevenly. This indicates that you are about to run out of fuel. Refuel immediately.

RUNNING-IN

Tyres

WARNING



New tyres need to be run-in for approximately 500 kilometres (300 miles). During this time, you may experience different driving characteristics.

Brakes and clutch

WARNING



Avoid heavy use of the brakes and clutch if possible for the first 150 kilometres (100 miles) in town and for the first 1500 kilometres (1000 miles) on motorways.

Engine

CAUTION



Avoid driving too fast during the first 1500 kilometres (1000 miles). Vary your speed frequently and change up through the gears early. Do not labour the engine.

COLD WEATHER PRECAUTIONS

The functional operation of some components and systems can be affected at temperatures below -30°C (-22°F).

DRIVING THROUGH WATER

Driving through water

CAUTIONS



Drive through water in an emergency only, and not as part of normal driving.



Engine damage can occur if water enters the air filter.

In an emergency, the vehicle can be driven through water to a maximum depth of 200 mm and at a maximum speed of 10 km/h (6 mph). Extra caution should be exercised when driving through flowing water.

When driving in water, maintain a low speed and do not stop the vehicle. After driving through water, and as soon as it is safe to do so:

- Depress the brake pedal lightly and check that full brake function is achieved.
- Check that the horn works.
- Check that the vehicle's lights are fully operational.
- Check the power assistance of the steering system.

Roadside Emergencies

FIRST AID KIT

Space is provided in the luggage compartment.

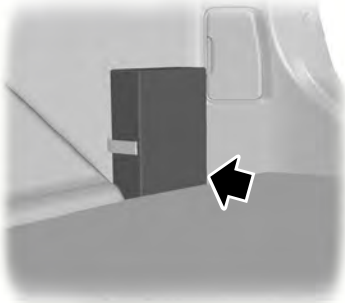

E87654

WARNING TRIANGLE

Space is provided in the spare wheel well.

Status after a collision

FUEL CUT-OFF SWITCH

Vehicles with a Duratec engine

Left-hand drive

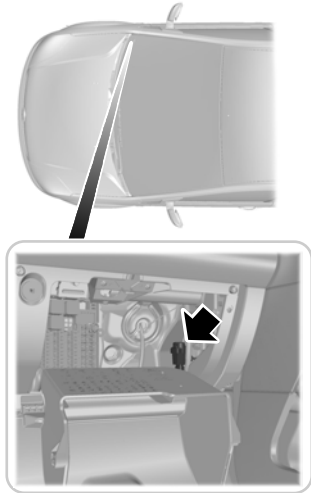

E90981

Right-hand drive

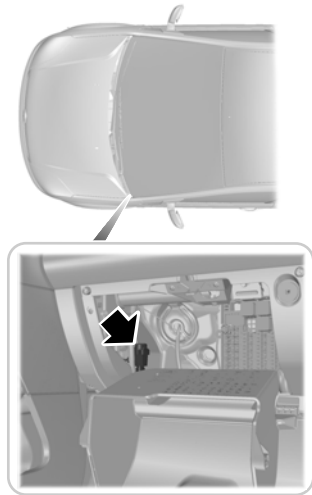

E90982

The fuel supply may be cut off as a result of an accident or sudden vibrations (e.g. collision when parking).

The switch is located behind the glove box. Open the glove box and empty the contents. Press the sides inwards and swivel the glove box downwards.

Resetting the switch

WARNING



Do not reset the fuel cut-off switch if you see or smell leaking fuel.

1. Turn the ignition switch to position **0**.
2. Check fuel system for leaks.
3. If no fuel leak is apparent, reset the switch by pushing in the button.
4. Turn the ignition switch to position **II**. After a few seconds return the key to position **I**.

Status after a collision

5. Make a further check for leaks in the fuel system.

Fuses

CHANGING A FUSE

WARNINGS



Do not modify the electrical system of your vehicle in any way. Have repairs to the electrical system and the replacement of relays and high current fuses carried out by a properly trained technician.



Switch the ignition and all electrical equipment off before touching or attempting to change a fuse.

CAUTION



Fit a replacement fuse with the same rating as the one you have removed.

Note: You can identify a blown fuse by a break in the filament.

Note: All fuses, except high current fuses, are a push fit.

Note: A fuse puller is located in the engine compartment fuse box.

FUSE LABELS

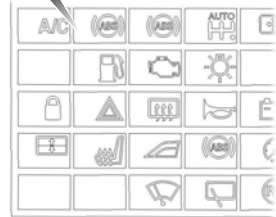
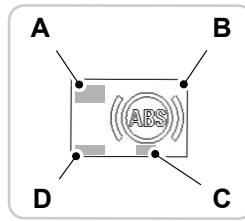

E90985

- A Fuse number
- B Circuits protected
- C Location (**L** = left and **R** = right)
- D Fuse rating (Amperes)



See Owner's handbook



Airbag



ABS



Headlamp dipped beam



Headlamp main beam

Fuses



Fog lamps



Lighting control



Windscreen wipers



Rear window wiper



Heated windscreen



Heated rear window



Heated exterior mirrors



Electric exterior mirrors



Electric windows



Not used



Heated seats



Blower motor



Air conditioning



Cigar lighter



Horn



Daytime running lamps



Automatic transmission or Durashift EST



Engine management (diesel) or catalytic converter



Starter motor



Audio system and diagnostic connector



Engine management or electronic module



Fuel pump



Auxiliary heater, glow plugs and fuel injection pump relay



Battery and charging system



Instrument cluster, battery saver, number plate lamp, generic electronic module (GEM)



Side and tail lamps



Central locking and alarm horn



Hazard warning flashers and direction indicators



Ignition

Fuses



Trailer towing module



Durashift EST



Brake lamps



Reversing lamp

FUSE BOX LOCATIONS

Central fuse box

The central fuse box is located behind the glove box. Open the glove box and empty the contents. Press the sides inwards and swivel the glove box downwards.

Vehicle recovery

TOWING POINTS

Front towing eye



E87280

The screw-in towing eye is attached to the vehicle jack in the luggage compartment. Keep the towing eye with the vehicle at all times.

CAUTION

- ! The screw-in towing eye has a **left-hand thread**. Turn it **anticlockwise** to install it.

Prise off the cover and install the towing eye.

TOWING THE VEHICLE ON FOUR WHEELS

All vehicles

WARNINGS

- ! Switch the ignition on when your vehicle is being towed. The steering lock will engage and the direction indicators and brake lamps will not work if you do not.

WARNINGS

- ! The brake servo and the power steering pump do not operate unless the engine is running. Press the brake pedal harder and allow for increased stopping distances and heavier steering.

CAUTIONS

- ! Too much tension in the tow rope could cause damage to your vehicle or the vehicle that is towing.
- ! Do not use a rigid tow bar on the front towing eye.

Drive off slowly and smoothly without jerking the vehicle that is towing.

Vehicles with a Durashift EST

CAUTION

- ! Select neutral when your vehicle is being towed.

Vehicles with an automatic transmission

CAUTIONS

- ! Do not tow your vehicle faster than 50 km/h (30 mph) or further than 50 kilometres (30 miles).
- ! If a speed of 50 km/h (30 mph) and a distance of 50 kilometres (30 miles) is to be exceeded the drive wheels must be lifted clear of the ground.
- ! In the event of a mechanical failure of the transmission the drive wheels must be lifted clear of the ground.
- ! Do not tow your vehicle backwards.
- ! Select neutral when your vehicle is being towed.

Maintenance

GENERAL INFORMATION

Have your vehicle serviced regularly to help maintain its roadworthiness and resale value. There is a large network of Ford Authorised Repairers that are there to help you with their professional servicing expertise. We believe that their specially trained technicians are best qualified to service your vehicle properly and expertly. They are supported by a wide range of highly specialised tools developed specifically for servicing your vehicle.

In addition to regular servicing, we recommend that you carry out the following additional checks.

WARNINGS



Switch the ignition off before touching or attempting adjustment of any kind.



Do not touch the electronic ignition system parts after you have switched the ignition on or when the engine is running. The system operates at high voltage.



Keep your hands and clothing clear of the engine cooling fan. Under certain conditions, the fan may continue to run for several minutes after you have switched the engine off.

CAUTION



When carrying out maintenance checks, make sure that filler caps are fitted securely.

Daily checks

- Exterior lamps.
- Interior lamps.
- Warning lamps and indicators.

Check when refuelling

- Engine oil level. See **Engine Oil Check** (page 107).
- Brake fluid level. See **Brake and Clutch Fluid Check** (page 108).
- Washer fluid level. See **Washer Fluid Check** (page 109).
- Tyre pressures (when cold). See **Technical Specifications** (page 125).
- Tyre condition. See **Tyre Care** (page 124).

Monthly checks

- Engine coolant level (engine cold). See **Engine Coolant Check** (page 107).
- Pipes, hoses and reservoirs for leaks.
- Power steering fluid level. See **Power Steering Fluid Check** (page 108).
- Air conditioning operation.
- Parking brake operation.
- Horn operation.
- Tightness of wheel nuts. See **Technical Specifications** (page 125).

Maintenance

OPENING AND CLOSING THE BONNET

Opening the bonnet

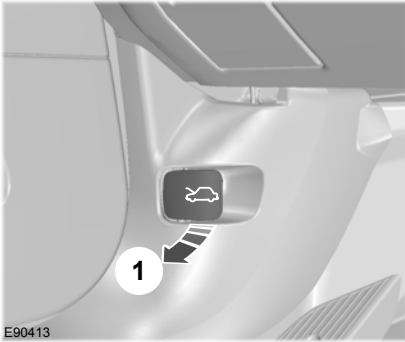

1. Pull the lever.

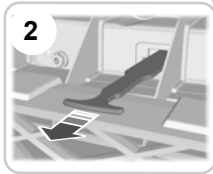
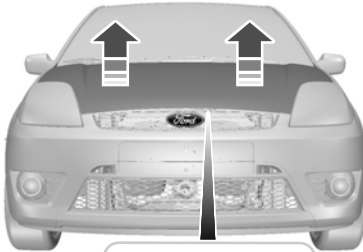

E90414

2. Raise the bonnet slightly and pull the catch towards you.

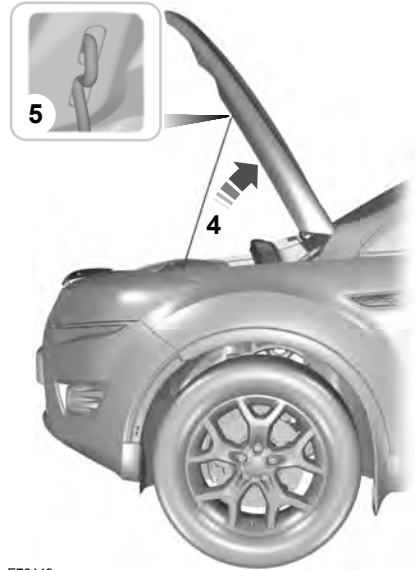

E78143

3. Open the bonnet and support it with the strut.

Closing the bonnet

Note: Make sure that the bonnet is closed properly.

Lower the bonnet and allow it to drop from under its own weight for the last 20 – 30 centimetres.

Maintenance

UNDERBONNET OVERVIEW -1.25L DURATEC-16V (SIGMA)/1.4L DURATEC-16V (SIGMA)/1.6L DURATEC-16V (SIGMA)

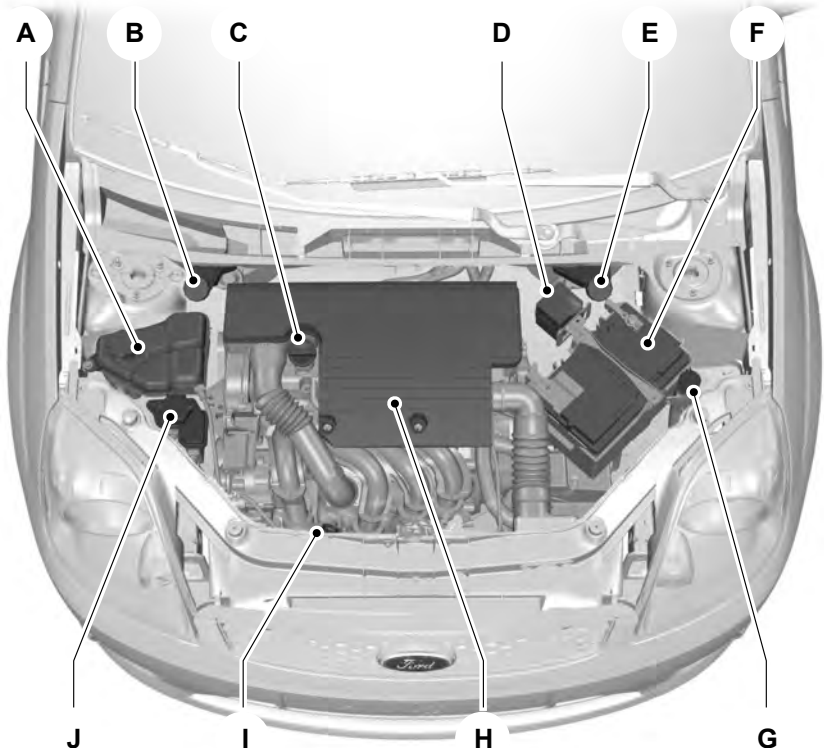

E90583

- A Engine coolant reservoir* : See **Engine Coolant Check** (page 107).
- B Brake and clutch fluid reservoir (right-hand drive)* : See **Brake and Clutch Fluid Check** (page 108).
- C Engine oil filler cap* : See **Engine Oil Check** (page 107).
- D Engine compartment fuse box. See **Fuses** (page 96).

Maintenance

- E Brake and clutch fluid reservoir (left-hand drive)* : See **Brake and Clutch Fluid Check** (page 108).
- F Battery: No maintenance necessary.
- G Windscreen and rear window washer fluid reservoir: See **Washer Fluid Check** (page 109).
- H Air cleaner: No maintenance necessary.
- I Engine oil dipstick* : See **Engine Oil Check** (page 107).
- J Power steering fluid reservoir: See **Power Steering Fluid Check** (page 108).

* The filler caps and the engine oil dipstick are coloured for easy identification.

Maintenance

UNDER BONNET OVERVIEW - 1.4L DURATORQ-TDCI (DV) DIESEL

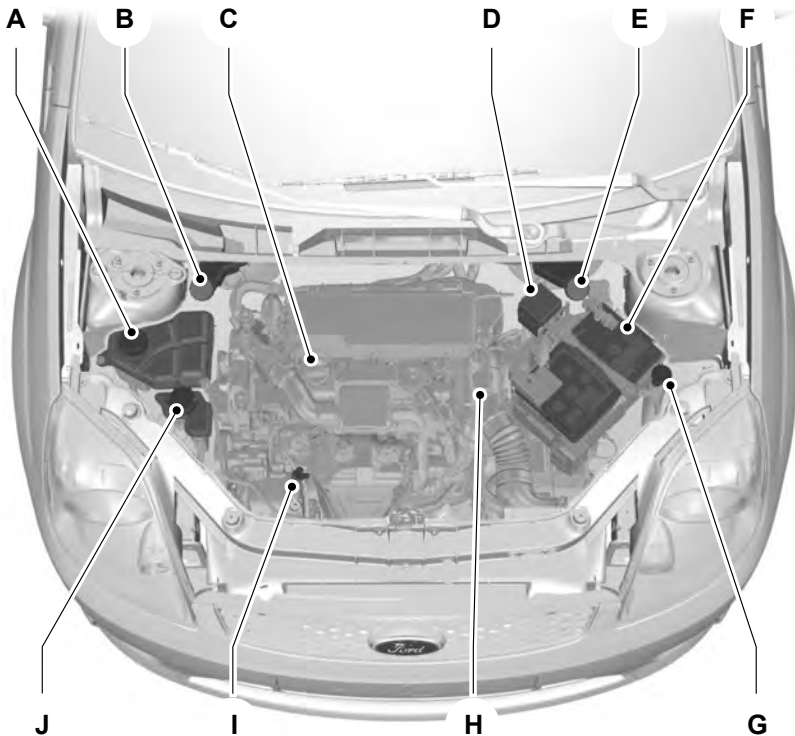

E90585

- A Engine coolant reservoir^{*}: See **Engine Coolant Check** (page 107).
- B Brake and clutch fluid reservoir (right-hand drive)^{*}: See **Brake and Clutch Fluid Check** (page 108).
- C Engine oil filler cap^{*}: See **Engine Oil Check** (page 107).
- D Engine compartment fuse box. See **Fuses** (page 96).
- E Brake and clutch fluid reservoir (left-hand drive)^{*}: See **Brake and Clutch Fluid Check** (page 108).
- F Battery: No maintenance necessary.

Maintenance

- G Windscreen and rear window washer fluid reservoir: See **Washer Fluid Check** (page 109).
- H Air cleaner: No maintenance necessary.
- I Engine oil dipstick* : See **Engine Oil Check** (page 107).
- J Power steering fluid reservoir: See **Power Steering Fluid Check** (page 108).

* The filler caps and the engine oil dipstick are coloured for easy identification.

UNDER BONNET OVERVIEW - 1.6L DURATORQ-TDCI (DV) DIESEL

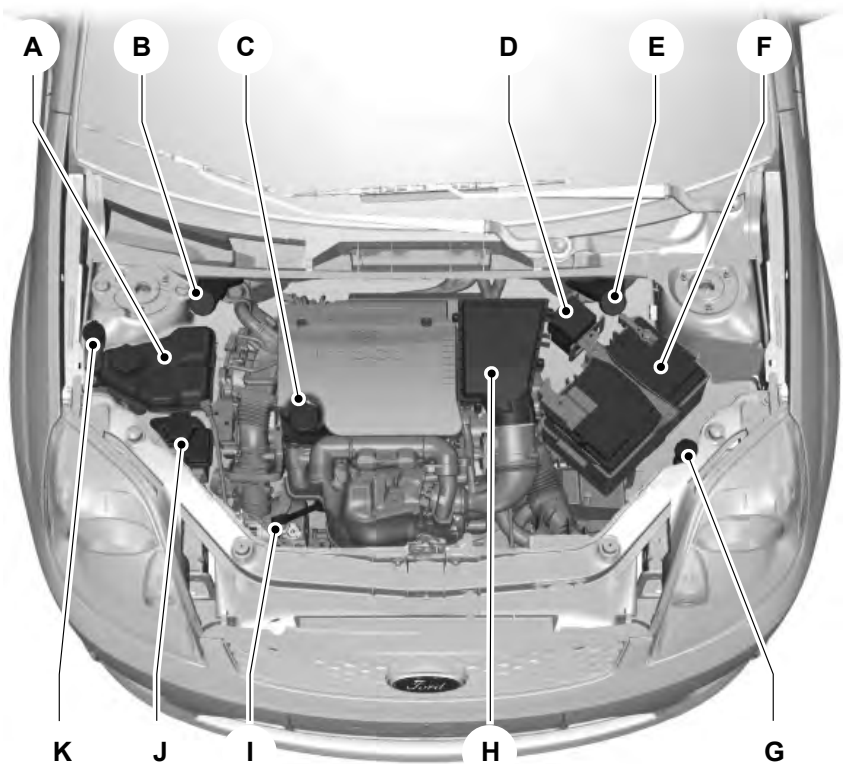

E90586

Maintenance

- A Engine coolant reservoir*: See **Engine Coolant Check** (page 107).
- B Brake and clutch fluid reservoir (right-hand drive)*: See **Brake and Clutch Fluid Check** (page 108).
- C Engine oil filler cap*: See **Engine Oil Check** (page 107).
- D Engine compartment fuse box. See **Fuses** (page 96).
- E Brake and clutch fluid reservoir (left-hand drive)*: See **Brake and Clutch Fluid Check** (page 108).
- F Battery: No maintenance necessary.
- G Windscreen and rear window washer fluid reservoir (left-hand drive): See **Washer Fluid Check** (page 109).
- H Air cleaner: No maintenance necessary.
- I Engine oil dipstick*: See **Engine Oil Check** (page 107).
- J Power steering fluid reservoir: See **Power Steering Fluid Check** (page 108).
- K Windscreen and rear window washer fluid reservoir (right-hand drive): See **Washer Fluid Check** (page 109).

* The filler caps and the engine oil dipstick are coloured for easy identification.

ENGINE OIL DIPSTICK - 1.25L DURATEC-16V (SIGMA)/1.4L DURATEC-16V (SIGMA)/1.6L DURATEC-16V (SIGMA)

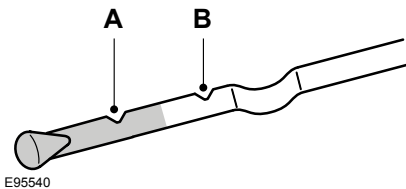

- A MIN
- B MAX

ENGINE OIL DIPSTICK - 1.4L DURATORQ-TDCI (DV) DIESEL

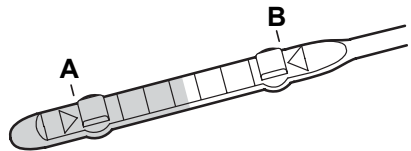

- A MIN
- B MAX

Maintenance

ENGINE OIL DIPSTICK - 1.6L DURATORQ-TDCI (DV) DIESEL

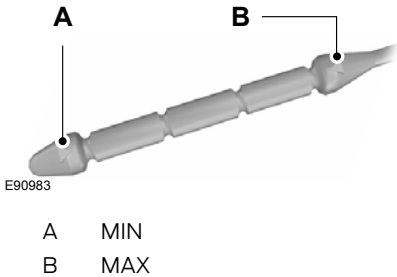

ENGINE OIL CHECK

CAUTION

! Do not use oil additives or other engine treatments. Under certain conditions, they could damage the engine.

Note: The oil consumption of new engines reaches its normal level after approximately 5000 kilometres (3000 miles).

Checking the oil level

CAUTION

! Make sure that the level is between the **MIN** and the **MAX** marks.

Note: Check the level before starting the engine.

Note: Make sure that your vehicle is on level ground.

Note: Oil expands when it is hot. The level may therefore extend a few millimetres beyond the **MAX** mark.

Remove the dipstick and wipe it with a clean, lint free cloth. Replace the dipstick and remove it again to check the oil level.

If the level is at the **MIN** mark, top up immediately.

Topping up

WARNINGS

! Only top up when the engine is cold. If the engine is hot, wait 10 minutes for the engine to cool down.

! Do not remove the filler cap when the engine is running.

Remove the filler cap.

CAUTION

! Do not top up further than the **MAX** mark.

Top up with fluid that meets the Ford specification. See **Technical Specifications** (page 109).

Replace the filler cap. Turn it until you feel a strong resistance.

ENGINE COOLANT CHECK

Checking the coolant level

WARNING

! Do not allow the fluid to touch your skin or eyes. If this happens, rinse the affected areas immediately with plenty of water and contact your doctor.

CAUTION

! Make sure that the level is between the **MIN** and the **MAX** marks.

Maintenance

Note: *Coolant expands when it is hot. The level may therefore extend beyond the MAX mark.*

If the level is at the **MIN** mark, top up immediately.

Topping up

WARNINGS

 Only top up when the engine is cold. If the engine is hot, wait 10 minutes for the engine to cool down.

 Do not remove the filler cap when the engine is running.

 Do not remove the filler cap when the engine is hot. Wait for the engine to cool down.

 Undiluted coolant is flammable and may ignite if spilt on a hot exhaust.

CAUTIONS

 In an emergency, you can add just water to the cooling system to reach a vehicle service station. Have the system checked by a properly trained technician as soon as possible.

 Prolonged use of incorrect dilution of the coolant can cause engine damage from corrosion, overheating or freezing.

Unscrew the cap **slowly**. Any pressure will escape slowly as you unscrew the cap.

CAUTION

 Do not top up further than the **MAX** mark.

Top up with a 50/50 mixture of coolant and water using fluid that meets the Ford specification. See **Technical Specifications** (page 109).

POWER STEERING FLUID CHECK

WARNING

 Do not allow the fluid to touch your skin or eyes. If this happens, rinse the affected areas immediately with plenty of water and contact your doctor.

CAUTION

 Make sure that the level is between the **MIN** and the **MAX** marks.

If the level is at the **MIN** mark, top up immediately.

Topping up

Remove the filler cap.

CAUTION

 Do not top up further than the **MAX** mark.

Top up with fluid that meets the Ford specification. See **Technical Specifications** (page 109).

BRAKE AND CLUTCH FLUID CHECK

WARNINGS

 Do not allow the fluid to touch your skin or eyes. If this happens, rinse the affected areas immediately with plenty of water and contact your doctor.

 If the level is at the **MIN** mark, have the system checked by a properly trained technician as soon as possible.

Maintenance

Note: Contamination with dirt, water, petroleum products or other materials may result in brake failure or costly repairs.

Note: The brake and the clutch systems are supplied from the same reservoir.

Top up with fluid that meets the Ford specification. See **Technical Specifications** (page 109).

WASHER FLUID CHECK

Note: The front and rear washer systems are supplied from the same reservoir.

When topping up, use a mixture of washer fluid and water to help prevent freezing in cold weather and improve the cleaning capability. We recommend that you use only high quality washer fluid.

For information on fluid dilution, refer to the product instructions.

TECHNICAL SPECIFICATIONS

Vehicle fluids

Item	Specification	Recommended fluid
Engine oil	WSS-M2C913-C	Castrol Engine Oil*
Power steering fluid	WSS-M2C204-A2	Ford or Motorcraft Power Steering Fluid
Antifreeze	WSS-M97B44-D	Motorcraft SuperPlus Anti-freeze
Brake fluid	WSS-M6C57-A2	Ford or Motorcraft Super DOT 4 Brake Fluid

* Providing it meets the specification defined by **WSS-M2C913-C**, you can also use Ford Engine Oil or an alternative engine oil.

Topping up the oil: If you are unable to find an oil that meets the specification defined by **WSS-M2C913-C**, you must use **SAE 5W-30** (preferred), **SAE 5W-40** (except vehicles with E85 fuel) or **SAE 10W-40** that meets the specification defined by either **ACEA A5/B5** (preferred) or **ACEA A3/B3**. Using these oils can result in longer engine cranking periods, reduced engine performance, reduced fuel economy and increased emission levels.

CAUTION



Do not use oils which do not meet the specifications or requirements. Use of unsuitable oil may lead to engine damage which is not covered by the Ford Warranty.

Note: If you operate your vehicle in temperatures below -20°C (68°F), you must not use SAE 10W-40 engine oil.

Castrol engine oil recommended.

Maintenance



Capacities

Variant	Item	Capacity in Litres (gallons)
All	Power steering system	MAX mark
All	Windscreen and rear window washer system	2.5 (0.5)
Petrol	Fuel tank	45 (9.9)
Diesel	Fuel tank	43 (9.5)
1.25L Duratec	Engine lubrication system - including the oil filter (EFL500)	3.75 (0.8)
1.25L Duratec	Engine lubrication system - including the oil filter (EFL10)	3.8 (0.8)
1.25L Duratec	Engine lubrication system - excluding the oil filter	3.5 (0.8)
1.25L Duratec	Engine cooling system	5 (1.1)
1.4L Duratec	Engine lubrication system - including the oil filter (EFL500)	3.75 (0.8)
1.4L Duratec	Engine lubrication system - including the oil filter (EFL10)	3.8 (0.8)
1.4L Duratec	Engine lubrication system - excluding the oil filter	3.5 (0.8)
1.4L Duratec	Engine cooling system	5 (1.1)
1.6L Duratec	Engine lubrication system - including the oil filter (EFL10)	4.1 (0.9)
1.6L Duratec	Engine lubrication system - including the oil filter (EFL600)	4.25 (0.9)

Maintenance

Variant	Item	Capacity in Litres (gallons)
1.6L Duratec	Engine lubrication system - excluding the oil filter	3.75 (0.8)
1.6L Duratec	Engine cooling system	5 (1.1)
1.4L Duratorq-TDCi	Engine lubrication system - including the oil filter	3.8 (0.8)
1.4L Duratorq-TDCi	Engine lubrication system - excluding the oil filter	3.4 (0.8)
1.4L Duratorq-TDCi	Engine cooling system	5.5 (1.2)
1.6L Duratorq-TDCi	Engine lubrication system - including the oil filter	3.85 (0.8)
1.6L Duratorq-TDCi	Engine lubrication system - excluding the oil filter	3.45 (0.8)
1.6L Duratorq-TDCi	Engine cooling system	6 (1.3)





Vehicle care

CLEANING THE EXTERIOR

WARNING

-  If you use a car wash with a waxing cycle, make sure that you remove the wax from the windscreen.
-



CAUTIONS

-  Prior to using a car wash facility check the suitability of it for your vehicle.
 -  Some car wash installations use water at high pressure. This could damage certain parts of your vehicle.
 -  Remove the aerial before using an automatic car wash.
 -  Switch the heater blower off to prevent contamination of the fresh air filter.
-

We recommend that you wash your vehicle with a sponge and lukewarm water containing a car shampoo.

Cleaning the headlamps

CAUTIONS

-  Do not scrape the headlamp lenses or use abrasives, alcoholic solvents or chemical solvents to clean them.
 -  Do not wipe the headlamps when they are dry.
-

Cleaning the rear window

CAUTION

-  Do not scrape the inside of the rear window or use abrasives or chemical solvents to clean it.
-

Use a clean, lint free cloth or a damp chamois leather to clean the inside of the rear window.



Cleaning the chrome trim

CAUTION

-  Do not use abrasives or chemical solvents. Use soapy water.
-

Body paintwork preservation

CAUTIONS



-  Do not polish your vehicle in strong sunshine.
 -  Do not allow polish to touch plastic surfaces. It could be difficult to remove.
 -  Do not apply polish to the windscreen or rear window. This could cause the wipers to become noisy and they may not clear the window properly.
-

We recommend that you wax the paintwork once or twice a year.

CLEANING THE INTERIOR

Seat belts

WARNINGS

-  Do not use abrasives, or chemical solvents to clean them.
 -  Do not allow moisture to penetrate the seat belt retractor mechanism.
-

Clean the seat belts with interior cleaner or water applied with a soft sponge. Let the seat belts dry naturally, away from artificial heat.

Vehicle care

Instrument cluster screens, LCD screens, radio screens

WARNING



Do not use abrasives, alcoholic solvents or chemical solvents to clean them.

Rear windows

CAUTIONS



Do not use any abrasive materials to clean the interior of the rear windows.



Do not install stickers or labels to the interior of the rear windows.

REPAIRING MINOR PAINT DAMAGE

CAUTION



Remove apparently harmless looking substances from the paintwork immediately (e.g. bird droppings, tree resins, insect remains, tar spots, road salt and industrial fall out).

You should repair paintwork damage caused by stones from the road or minor scratches as soon as possible. A choice of products is available from your Ford Dealer. Read and follow the manufacturer's instructions.

Vehicle battery

JUMP-STARTING THE VEHICLE

CAUTIONS

- ⚠ Connect batteries with only the same nominal voltage.
- ⚠ Always use booster cables with insulated clamps and adequate size cable.
- ⚠ Do not disconnect the battery from the vehicle's electrical system.

To connect the booster cables

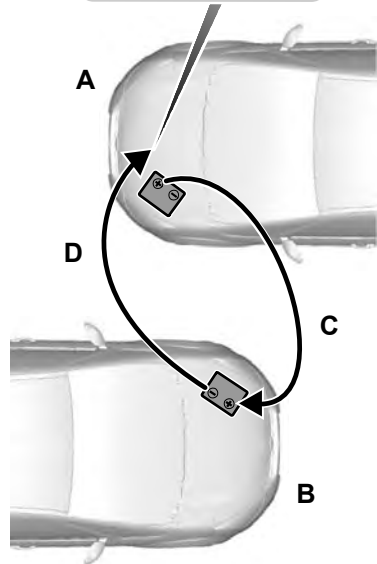

E90587

- A Flat battery vehicle
- B Booster battery vehicle
- C Positive connection cable
- D Negative connection cable

Vehicle battery

Vehicles with a petrol engine

CAUTIONS

 **Do not connect to the negative (-) terminal of the flat battery.**

 Make sure that the jump leads are clear of any moving parts.

1. Position the vehicles so that they do not touch one another.
2. Switch off the engine and any electrical equipment.
3. Connect the positive (+) terminal of vehicle **A** with the positive (+) terminal of vehicle **B** (cable **C**).
4. Connect the negative (-) terminal of vehicle **B** to the engine block or engine mount of vehicle **A** (cable **D**), as far from the battery as possible.

Vehicles with a diesel engine

CAUTIONS

 **Do not connect to the negative (-) terminal of the flat battery.**

 Make sure that the jump leads are clear of any moving parts.

1. Position the vehicles so that they do not touch one another.
2. Switch off the engine and any electrical equipment.
3. Connect the positive (+) terminal of vehicle **A** with the positive (+) terminal of vehicle **B** (cable **C**).
4. Connect the negative (-) terminal of vehicle **B** to the turbocharger of vehicle **A** (cable **D**).

To start the engine

1. Run the engine of vehicle **B** at moderately high speed.
2. Start the engine of vehicle **A**.

3. Run both vehicles for a minimum of three minutes before disconnecting the leads.

CAUTION

 Do not switch on the headlamps when disconnecting the cables. The peak voltage could blow the bulbs.

Disconnect the cables in the reverse order.

Wheels and Tyres

GENERAL INFORMATION

CAUTIONS

 Use only approved wheel and tyre sizes. Using other sizes could damage the vehicle and will make the National Type Approval invalid.

 If you change the diameter of the tyres from that fitted at the factory, the speedometer may not display the correct speed. Take the vehicle to your dealer to have the engine management system reprogrammed.

A decal with tyre pressure data is located in the driver's door opening at the B-pillar.

Check and set the tyre pressure at the ambient temperature in which you are intending to drive the vehicle and when the tyres are cold.

Tyre pressures

WARNING

 If the vehicle is used with a roof load or is fully laden the tyres must be set to the full load tyre pressure settings.

Driving at normal tyre pressures will improve ride comfort; however it will alter the driving characteristics and fuel consumption of the vehicle.

For optimum dynamic performance the recommended tyre pressure setting is 2.4 bar (35 psi) front and 2.2 bar (32 psi) rear.

CHANGING A ROAD WHEEL

Locking wheel nuts

You can obtain a replacement locking wheel nut key and replacement locking wheel nuts from your dealer using the reference number certificate.

Vehicles with a temporary spare wheel

WARNINGS

 If the spare wheel differs from the other fitted wheels, these rules must be followed:

 Do not exceed 80 km/h (50 mph).

 Drive the shortest possible distances.

 Do not fit more than one spare wheel on your vehicle at any one time.

 Do not use snow chains on this type of wheel.

Note: *Your vehicle may exhibit some unusual driving characteristics.*

Vehicle jack

WARNINGS

 The vehicle jack supplied with your vehicle should only be used when changing a wheel in emergency situations.

 Before using the vehicle jack, check that it is not damaged or deformed and that the thread is lubricated and free from foreign matter.

 Never place anything between the jack and the ground, or the jack and the vehicle.

Note: *Vehicles with a tyre repair kit are not equipped with a vehicle jack or a wheel brace.*

It is recommended to use a workshop type hydraulic jack for changing between summer and winter tyres.

Wheels and Tyres

Note: Use a jack with a minimum lifting capacity of 1.5 tonnes and a lifting plate with a minimum diameter of 80 millimetres (3.1 inches).

Your vehicle jack, wheel brace, screw-in towing eye and wheel trim remover are located in the spare wheel well.

Jacking and lifting points

CAUTION

! Use only the specified jacking points. If you use other positions, you may damage the body, steering, suspension, engine, braking system or the fuel lines.

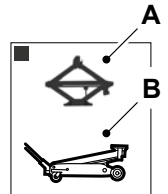
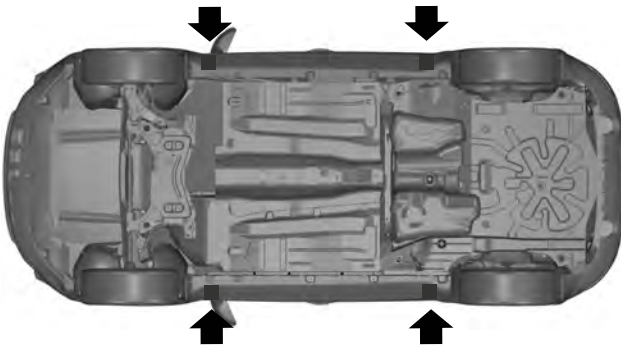
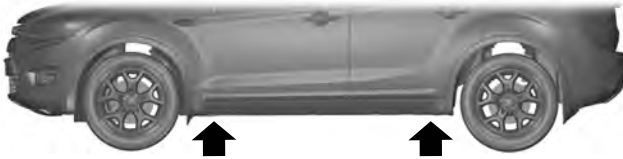

E92658

- A Emergency use only
- B Maintenance

Wheels and Tyres

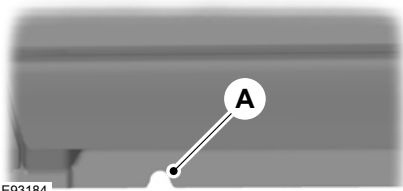

Indentations in the sills **A** show the location of the jacking points.

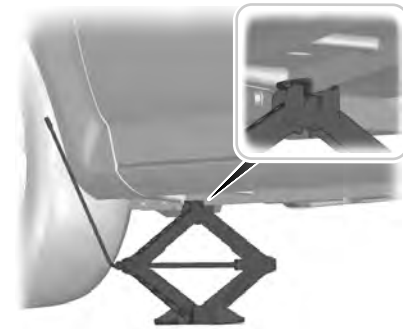

E92932



Note: If your vehicle is fitted with side skirts, remove the cover before positioning the vehicle jack.

Assembling the wheel brace

Type one

WARNING



When returning the wheel brace extension to its original position, take care not to get your fingers caught.

Note: Make sure that the wheel brace is fully extended.



E122546

Extend the wheel brace.

Type two

CAUTION



The screw-in towing eye has a **left-hand thread**. Turn it anti-clockwise to install it. Make sure that the towing eye is fully tightened.

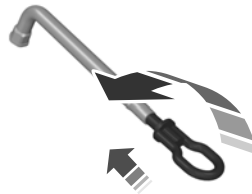

E122502

Insert the screw-in towing eye into the wheel brace.

Wheels and Tyres

Removing the wheel trim

Type one

Insert the flat end of the wheel brace between the rim and the trim and carefully remove the trim.

Type two

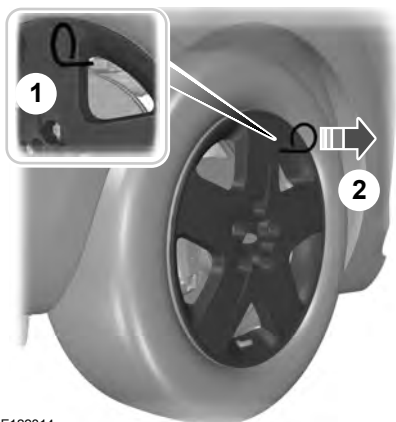





E122314

1. Insert the wheel trim remover.
2. Remove the wheel trim.







Note: Make sure that you pull the wheel trim remover at right angles to the trim.

Removing a road wheel

WARNINGS

-  Park your vehicle in such a position that neither the traffic nor you are hindered or endangered.
-  Set up a warning triangle.
-  Make sure that the vehicle is on firm, level ground with the wheels pointing straight ahead.
-  Switch off the ignition and apply the parking brake.

WARNINGS

-  If your vehicle has a manual transmission, select first or reverse gear. If it has an automatic transmission, select park.
-  If your vehicle is fitted with a Durashift EST transmission, select a gear before switching off the ignition.
-  Have the passengers leave the vehicle.
-  Secure the diagonally opposite wheel with an appropriate block or wheel chock.
-  Make sure that the arrows on directional tyres point in the direction of rotation when the vehicle is moving forwards. If you have to fit a spare wheel with the arrows pointing in the opposite direction, have the tyre refitted in the correct direction by a properly trained technician.
-  Do not work underneath the vehicle when it is supported only by a jack.
-  Make sure the jack base is flat on the ground and vertically below the jacking point.

CAUTION

-  Do not lay alloy wheels face down on the ground, this will damage the paint.

Note: The spare wheel is located under the floor cover in the luggage compartment.

Wheels and Tyres



E121887



1. Install the locking wheel nut key.
2. Slacken the wheel nuts.
3. Install the jack to the flange.
4. Extend the jack until the base of the jack is flat on the ground, vertically below the jacking point.
5. Jack up the vehicle until the tyre is clear of the ground.
6. Remove the wheel nuts and the wheel.

Installing a road wheel

WARNINGS

-  Use only approved wheel and tyre sizes. Using other sizes could damage the vehicle and will make the National Type Approval invalid. See **Technical Specifications** (page 125).

WARNINGS

-  Do not fit run flat tyres on vehicles that were not originally fitted with them. Please contact your dealer for more details regarding compatibility.
-  Make sure that the arrows on directional tyres point in the direction of rotation when the vehicle is moving forwards. If you have to fit a spare wheel with the arrows pointing in the opposite direction, have the tyre refitted in the correct direction by a properly trained technician.

CAUTION

-  Do not install alloy wheels using wheel nuts designed for use with steel wheels.

Note: Make sure the wheel and hub contact surfaces are free from foreign matter.

Note: Make sure that the cones on the wheel nuts are against the wheel.

1. Install the wheel.
2. Install the wheel nuts finger tight.
3. Install the locking wheel nut key.

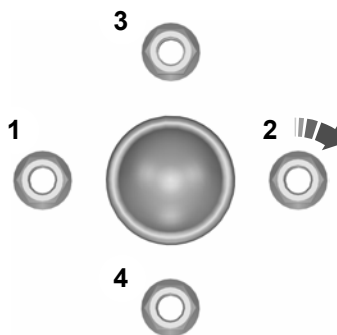

E90589

4. Partially tighten the wheel nuts in the sequence shown.

Wheels and Tyres

5. Lower the vehicle and remove the jack.
6. Fully tighten the wheel nuts in the sequence shown. See **Technical Specifications** (page 125).
7. Install the wheel trim using the ball of your hand.

TYRE REPAIR KIT

Your vehicle may not have a spare tyre. In this case it will have an emergency tyre repair kit that can be used to repair **one** flat tyre.

The tyre repair kit is located in the spare wheel well.

General information

WARNINGS



Depending on the type and extent of tyre damage, some tyres can only be partially sealed or not sealed at all.

Loss of tyre pressure can affect vehicle handling, leading to loss of vehicle control.



Do not use the tyre repair kit if the tyre has already been damaged as a result of being driven under inflated.



Do not use the tyre repair kit on run flat tyres.



Do not try to seal damage other than that located within the visible tread of the tyre.



Do not try to seal damage to the tyre's sidewall.

The tyre repair kit seals most tyre punctures [with a diameter of up to six millimetres (1/4 inch)] to temporarily restore mobility.

Observe the following rules when using the kit:

- **Drive with caution and avoid making sudden steering or driving manoeuvres**, especially if the vehicle is heavily loaded or you are towing a trailer.
- The kit will provide you with an emergency temporary repair, enabling you to continue your journey to the next vehicle or tyre dealer, or to drive a maximum distance of 200 kilometres (125 miles).
- Do not exceed a **maximum speed of 80 km/h (50 mph)**.
- Keep the kit out of the reach of children.
- Only use the kit when the ambient temperature is between -30°C (-22°F) and $+70^{\circ}\text{C}$ ($+158^{\circ}\text{F}$).

Using the tyre repair kit

WARNINGS



Compressed air can act as an explosive or propellant.



Never leave the tyre repair kit unattended while in use.

CAUTION



Do not keep the compressor operating for more than 10 minutes.

Note: Use the tyre repair kit only for the vehicle with which it was supplied.





- Park your vehicle at the roadside so that you do not obstruct the flow of traffic and so that you are able to use the kit without being in danger.
- Apply the parking brake, even if you have parked on a level road, to make sure that the vehicle will not move.
- Do not attempt to remove foreign objects like nails or screws penetrating the tyre.

Wheels and Tyres

- Leave the engine running while the kit is in use, but not if the vehicle is in an enclosed or poorly ventilated area (for example, inside a building). In these circumstances, switch the compressor on with the engine turned off.
- Replace the sealant bottle with a new one before the expiry date (see top of bottle) is reached.
- Inform all other users of the vehicle that the tyre has been temporarily sealed with the tyre repair kit and make them aware of the special driving conditions to be observed.

Inflating the tyre

WARNINGS

-  Check the sidewall of the tyre prior to inflation. If there are any cracks, bumps or similar damage, do not attempt to inflate the tyre.
-  Do not stand directly beside the tyre while the compressor is pumping.
-  Watch the sidewall of the tyre. If any cracks, bumps or similar damage appear, turn off the compressor and let the air out by means of the pressure relief valve **I**. Do not continue driving with this tyre.
-  The sealant contains natural rubber latex. Avoid contact with skin and clothing. If this happens, rinse the affected areas immediately with plenty of water and contact your doctor.
-  If the tyre inflation pressure does not reach 1.8 bar (26 psi) within 10 minutes, the tyre may have suffered excessive damage, making a temporary repair impossible. In this case, do not continue driving with this tyre.

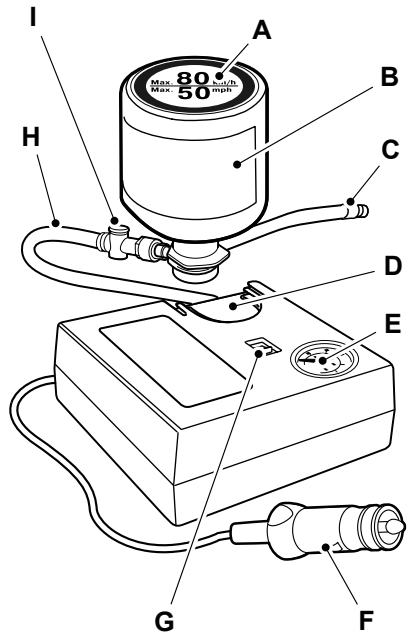

E102881

- A Label
- B Sealant bottle
- C Sealant bottle hose
- D Bottle holder
- E Pressure gauge
- F Power plug with cable
- G Compressor switch
- H Repair kit hose
- I Pressure relief valve

1. Remove the tyre repair kit from the wrapping.

Wheels and Tyres

2. Peel off the label **A** showing the maximum permissible speed of 80 km/h (50 mph) from the sealant bottle and attach it to the instrument panel in the driver's field of view. Make sure the label does not obscure anything important.
 3. Take the hose **H** with the pressure relieve valve **I** and the power plug with cable **F** out of the kit.
 4. Connect the hose **H** with the pressure relieve valve **I** to the sealant bottle **B**.
 5. Engage the sealant bottle **B** into the bottle holder **D**.
 6. Remove the valve cap from the damaged tyre.
 7. Screw the sealant bottle hose **C** firmly onto the valve of the damaged tyre.
 8. Make sure that the compressor switch **G** is in position **O**.
 9. Insert the power plug **F** into the cigar lighter socket or auxiliary power socket. See **Cigar Lighter** (page 69).
 10. Start the engine.
 11. Move the compressor switch **G** to position **1**.
 12. Inflate the tyre for no longer than 10 minutes to an inflation pressure of minimum 1.8 bar (26 psi) and a maximum of 3.5 bar (51 psi). Move the compressor switch **G** to position **O** and check the current tyre pressure with pressure gauge **E**.
- Note:** If a tyre pressure of 1.8 bar (26 psi) is not reached do not continue.
- Note:** When pumping in the sealant through the tyre valve, the pressure may rise up to 6 bar (87 psi) but will drop again after about 30 seconds.
13. Remove the power plug **F** from the cigar lighter socket or auxiliary power socket.
 14. Quickly unscrew the hose **C** from the tyre valve. Fasten the valve cap again.
 15. Leave the sealant bottle **B** in the bottle holder **D**.
 16. Make sure the kit is stored safely, but still easily accessible in the vehicle. The kit will be required again when you check the tyre pressure.
 17. Immediately drive approximately three kilometres (two miles) so that the sealant can seal the damaged area.

WARNING



If you experience heavy vibrations, unsteady steering behaviour or noises while driving, reduce your speed and drive with caution to a place where it is safe for you to stop the vehicle. Recheck the tyre and its pressure. If the tyre pressure is less than 1 bar (14.7 psi) or if there are any cracks, bumps or similar damage visible, do not continue driving with this tyre.

18. Stop the vehicle after driving approximately three kilometres (two miles). Check, and where necessary, adjust the pressure of the damaged tyre.
19. Attach the kit and read the tyre pressure from the pressure gauge **E**.
20. Adjust it to the specified pressure. See **Technical Specifications** (page 125).
21. Once you have inflated the tyre to its correct tyre pressure, move the compressor switch **G** to position **O**, remove the power plug **F** from the socket, unscrew the hose **C** and fasten the valve cap.
22. Leave hose **C** and **H** connected to the sealant bottle **B** and store the kit away safely.

Wheels and Tyres

23. Drive to the nearest tyre specialist to get the damaged tyre replaced. Before the tyre is removed from the rim, inform your tyre dealer that the tyre contains sealant. Renew the sealant bottle **B** and hose **C** as soon as possible after they have been used.

Note: Remember that emergency roadside tyre repair kits only provide temporary mobility. Regulations concerning tyre repair after usage of tyre repair kit may differ from country to country. You should consult a tyre specialist for advice.

WARNING



Before driving, make sure the tyre is adjusted to the recommended inflation pressure. See **Technical Specifications** (page 125). Monitor the tyre pressure until the sealed tyre is replaced.

Empty sealant bottles can be disposed of together with normal household waste. Return remains of sealant to your dealer or dispose of it in compliance with local waste disposal regulations.

TYRE CARE



E70415

To make sure the front and rear tyres of your vehicle wear evenly and last longer, we recommend that you swap the tyres from front to rear and vice versa at regular intervals of between 5000 and 10000 kilometres (3000 and 6000 miles).

CAUTION



Do not scrub the sidewalls of the tyres when you are parking.

If you have to mount a kerb, do so slowly and approach it with the wheels at right-angles to the kerb.

Examine the tyres regularly for cuts, foreign objects and uneven wear of the tread. Uneven wear could mean that the wheel alignment is outside specification.

Check the tyre pressures (including the spare) when cold, every two weeks.

USING WINTER TYRES

CAUTION



Make sure that you use the correct wheel nuts for the type of wheel the winter tyres are fitted to.

If winter tyres are used, make sure that the tyre pressures are correct. See **Technical Specifications** (page 125).

USING SNOW CHAINS

WARNINGS



Do not exceed 50 km/h (30 mph).



Do not use snow chains on snow-free roads.



Only fit snow chains to specified tyres. See **Technical Specifications** (page 125).

Wheels and Tyres

CAUTION

 If your vehicle is fitted with wheel trims, remove them before fitting snow chains.

Only use snow chains on the front wheels.

Vehicles with stability control (ESP)

Vehicles with stability control (ESP) may exhibit some unusual driving characteristics which can be avoided by switching the system off. See **Using Stability Control** (page 83).

Note: *The ABS will continue to operate normally.*

Only use small link snow chains.

TECHNICAL SPECIFICATIONS

Wheel nut torque

Variant	Specification Nm (lb-ft)
All	110 (81)

Tyre pressures (cold tyres)

Up to 80 km/h (50 mph)

Variant	Tyre size	Normal load		Full load	
		Front	Rear	Front	Rear
		bar (lbf/in ²)	bar (lbf/in ²)	bar (lbf/in ²)	bar (lbf/in ²)
All	175/65 R14	3 (44)	3 (44)	3 (44)	3 (44)

All speeds

Variant	Tyre size	Normal load		Full load	
		Front	Rear	Front	Rear
		bar (lbf/in ²)	bar (lbf/in ²)	bar (lbf/in ²)	bar (lbf/in ²)
All	185/60 R 14*	2.4 (35)	2.2 (32)	2.5 (36)	2.8 (41)
All	195/60 R 15	2.4 (35)	2.2 (32)	2.5 (36)	2.8 (41)
All	195/55 R 16	2.4 (35)	2.2 (32)	2.5 (36)	2.8 (41)

* Only fit snow chains to specified tyres.

Vehicle identification

VEHICLE IDENTIFICATION PLATE

Note: The vehicle identification plate design may vary to that shown.

Note: The information shown on the vehicle identification plate is dependant upon market requirements.

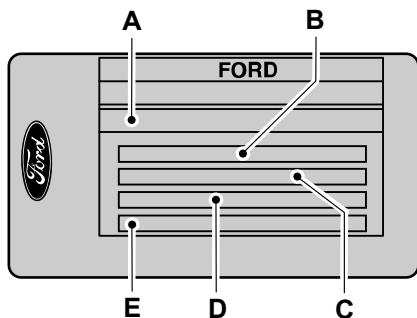

E85610

- A Vehicle identification number
- B Gross vehicle weight
- C Gross train weight
- D Maximum front axle weight
- E Maximum rear axle weight

The vehicle identification number and maximum weights are shown on a plate located on the lock side of the right-hand front door aperture at the bottom.

VEHICLE IDENTIFICATION NUMBER

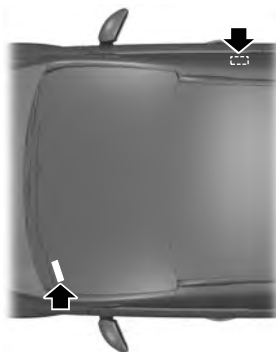

E87496

The vehicle identification number is stamped into the floor panel on the right-hand side, beside the front seat. It is also shown on the left-hand side of the instrument panel.

ENGINE NUMBER

The engine number is stamped on the engine block near the gearbox on the front left-hand side facing the radiator.

Capacities and Specifications

DIMENSIONS

Vehicle dimensions

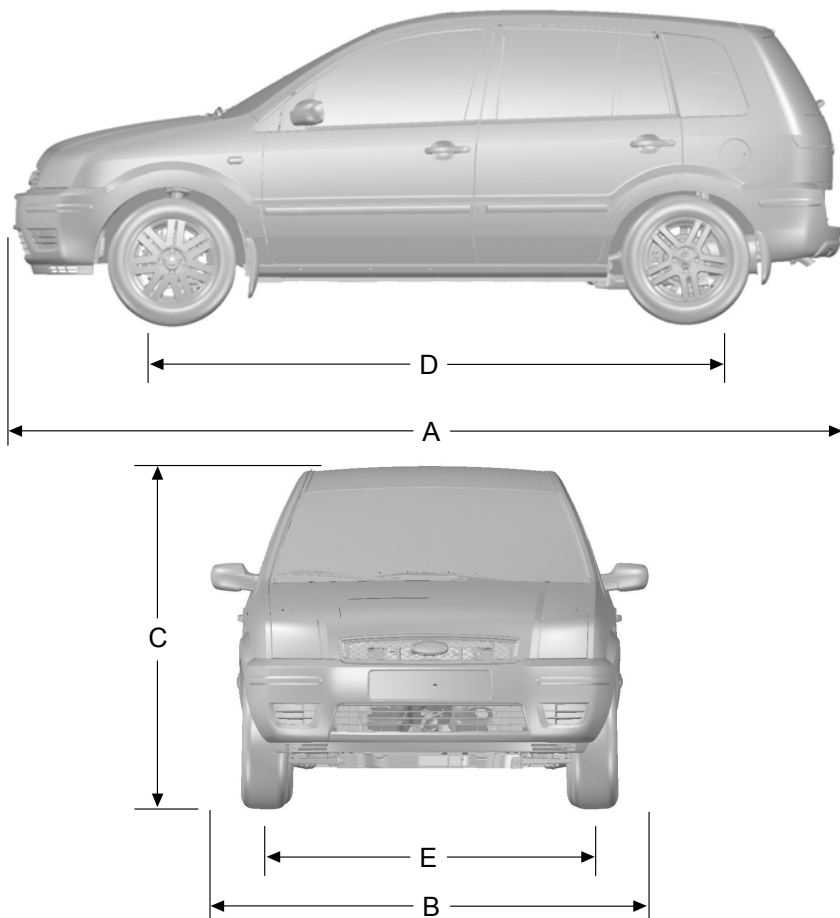

E91022

Capacities and Specifications

Item	Dimension Description	Dimension in mm (inches)
A	Maximum length	4013 (158)
B	Overall width including exterior mirrors	1950 or 1963* (76.8 or 77.3*)
C	Overall height at EC kerb weight	1512 - 1543 (59.5 - 60.7)
D	Wheelbase	2486 (97.9)
E	Front track	1477 - 1487 (58.1 - 58.5)
E	Rear track	1435 - 1445 (56.5 - 56.9)
* Vehicles with electric exterior mirrors		

Capacities and Specifications

Towing equipment dimensions

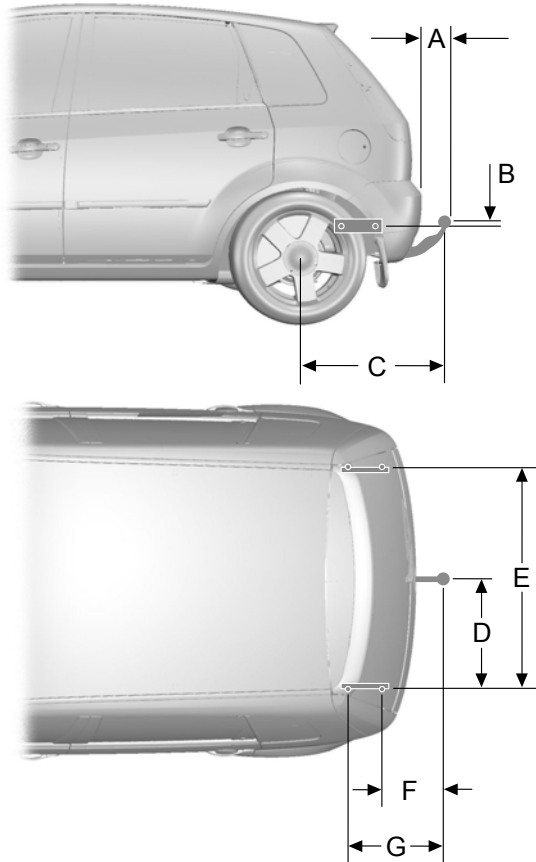

E90357

Item	Dimension Description	Dimension in mm (inches)
A	Bumper – end of tow ball	133 (5.2)
B	Attachment point – centre of tow ball	12 (0.5)





Capacities and Specifications

Item	Dimension Description	Dimension in mm (inches)
C	Wheel centre – centre of tow ball	869 (34.2)
D	Centre of tow ball – side member	493 (19.4)
E	Inner side of side member	986 (38.8)
F	Centre of tow ball - centre 1. attachment point	436 (17.2)
G	Centre of tow ball - centre 2. attachment point	721 (28.4)

Audio introduction

IMPORTANT AUDIO INFORMATION

WARNINGS

-  Due to technical incompatibility, recordable (CD-R) and rewritable (CD-RW) discs may not function correctly.
-  These units will play compact discs that conform to the International Red Book standard audio specification. Copy protected CDs from some manufacturers do not conform to this standard and playback cannot be guaranteed.
-  Dual format, dual sided discs (DVD Plus, CD-DVD format), adopted by the music industry, are thicker than normal CDs and consequently playback cannot be guaranteed, and jamming could occur. Irregular shaped CDs and CDs with a scratch protection film or self adhesive labels attached should not be used. Warranty claims, where this type of disc is found to be inside an audio unit returned for repair, will not be accepted.
-  All units except Sony CD (but not the 6CD) are designed to play commercially pressed 12 cm audio compact discs only. The Sony CD unit will play 8 cm discs with a Sony approved adaptor fitted (CSA-8).
-  The audio unit may be damaged if unsuitable items like credit cards or coins are pushed inside the CD aperture.

Audio unit labels

CLASS 1
LASER PRODUCT

CAUTION—INVISIBLE LASER RADIATION WHEN OPEN
DO NOT STARE INTO BEAM OR
VIEW DIRECTLY WITH OPTICAL INSTRUMENTS

Disc labels

Audio CD



MP3



Audio unit overview

AUDIO UNIT OVERVIEW

6000CD

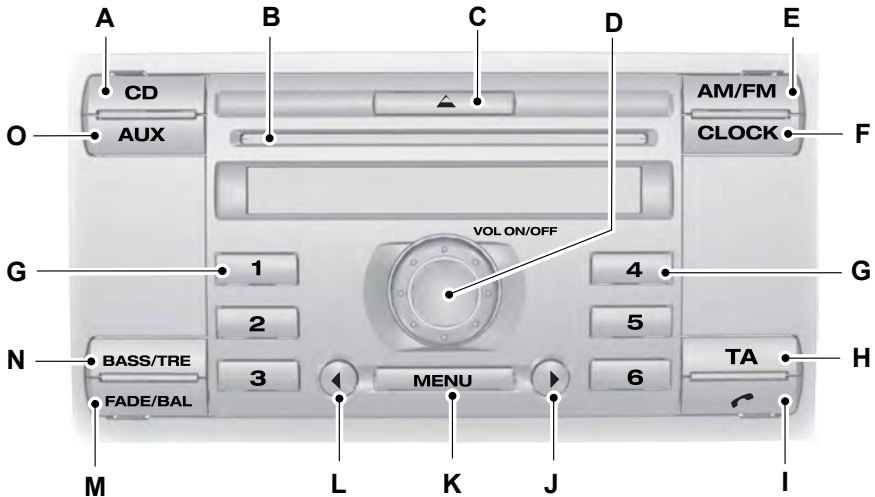

E138367

- A CD select. See **Compact disc player** (page 148).
- B CD aperture. See **Loading compact discs** (page 148).
- C CD eject. See **Ejecting compact discs** (page 150). See **Ejecting multiple compact discs** (page 151).
- D On, off and volume control. See **On/off control** (page 138).
- E Waveband select. See **Waveband button** (page 141).
- F Clock. See **Setting the clock and date on the audio unit** (page 137).
- G Station presets. See **Station preset buttons** (page 141).
- H Traffic announcement. See **Traffic information control** (page 141).
- I Accept call and phone menu. See **Telephone** (page 155).
- J Seek up. See **Station tuning control** (page 143).
- K Menu. See **Audio menu control** (page 138).
- L Seek down. See **Station tuning control** (page 143).
- M Balance and fade control. See **Balance/fade control** (page 138).

Audio unit overview

- N Base and treble control. See **Bass/treble control** (page 138).
- O Auxiliary select. See **Auxiliary input (AUX IN) socket** (page 152).

6006CDC

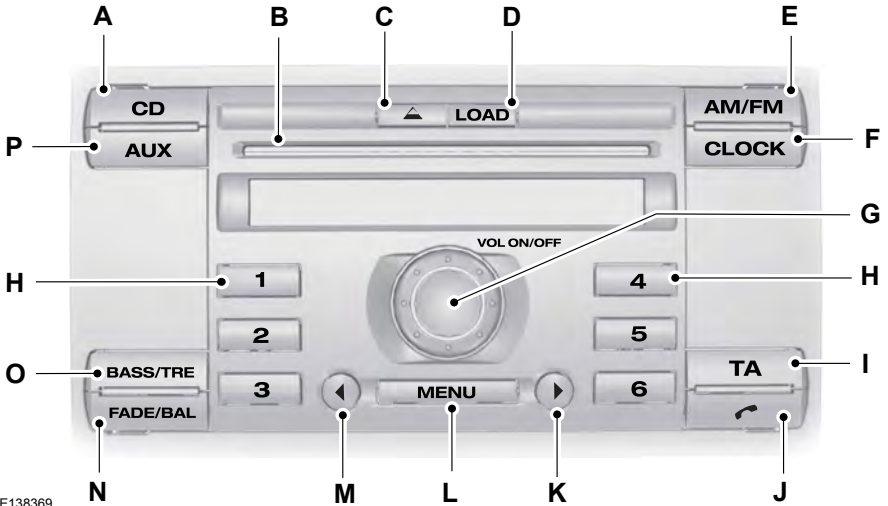

E138369

- A CD select. See **Compact disc player** (page 148).
- B CD aperture. See **Loading compact discs** (page 148).
- C CD eject. See **Ejecting compact discs** (page 150). See **Ejecting multiple compact discs** (page 151).
- D CD load. See **Loading compact discs** (page 148).
- E Waveband select. See **Waveband button** (page 141).
- F Clock. See **Setting the clock and date on the audio unit** (page 137).
- G On, off and volume control. See **On/off control** (page 138).
- H Station presets. See **Station preset buttons** (page 141).
- I Traffic announcement. See **Traffic information control** (page 141).
- J Accept call and phone menu. See **Telephone** (page 155).
- K Seek up. See **Station tuning control** (page 143).
- L Menu. See **Audio menu control** (page 138).

Audio unit overview

- M Seek down. See **Station tuning control** (page 143).
- N Balance and fade control. See **Balance/fade control** (page 138).
- O Base and treble control. See **Bass/treble control** (page 138).
- P Auxiliary select. See **Auxiliary input (AUX IN) socket** (page 152).

Sony CD

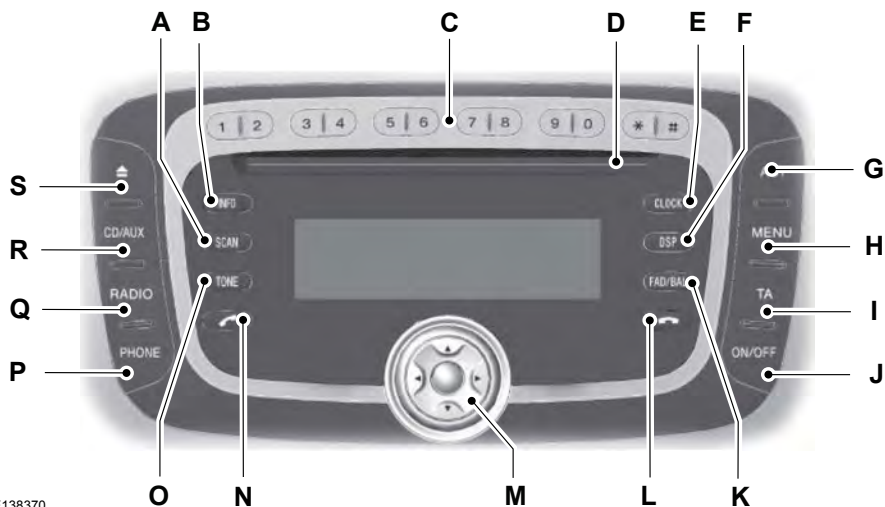

E138370

- A Scan. See **Station tuning control** (page 143). See **Compact disc track scanning** (page 150).
- B Information. See **Audio unit operation** (page 138). See **Audio unit menus** (page 145). See **Compact disc player** (page 148). See **Audio troubleshooting** (page 153).
- C Station presets. See **Station preset buttons** (page 141).
- D CD aperture. See **Loading compact discs** (page 148).
- E Clock. See **Setting the clock and date on the audio unit** (page 137).
- F DSP select. See **Digital signal processing (DSP)** (page 145).
- G Autostore. See **Autostore control** (page 141).
- H Menu. See **Audio menu control** (page 138).
- I Traffic announcement. See **Traffic information control** (page 141).

Audio unit overview

- J On and off control. See **On/off control** (page 138).
- K Balance and fade control. See **Balance/fade control** (page 138).
- L End call. See **Telephone** (page 155).
- M Volume control, navigation buttons and select button.
- N Accept call. See **Telephone** (page 155).
- O Tone. See **Bass/treble control** (page 138).
- P Phone menu. See **Telephone** (page 155).
- Q Radio and waveband select. See **Waveband button** (page 141).
- R Auxiliary and CD select. See **Auxiliary input (AUX IN) socket** (page 152). See **Compact disc player** (page 148).
- S CD eject. See **Ejecting compact discs** (page 150). See **Ejecting multiple compact discs** (page 151).

Audio system security

SECURITY CODE

Each unit incorporates a unique code that must be entered before the unit will operate.

If the battery is disconnected or if the unit has been removed from the vehicle, the code must be re-entered before the unit will operate.

LOST SECURITY CODE

If you lose the unique code, contact your dealer and supply details of your audio unit along with some proof of identity.

ENTERING A SECURITY CODE

If **CODE ----**, **CODE 0000** or **ENTER KEYCODE** appears in the display when you switch on the audio unit, you must enter the unique code using the station preset buttons.

6000CD and 6006CDC

1. Press preset button **1** repeatedly until the first digit of the unique code is shown in the display.
2. Press preset buttons **2**, **3** and **4** in the same way for remaining three digits.
3. Make sure that the complete code is correct before pressing preset button **5** to confirm your selection.

Sony CD

1. Using the station preset buttons enter the unique code.
2. If you make a mistake entering the code, re-enter the digits by continuing to select buttons 0-9. The display will advance from digit position 1 to 4 and then back again.
3. Make sure that the complete code is correct before pressing either the ***** preset button or the button between the navigation buttons to confirm your selection.

INCORRECT SECURITY CODE

Up to a maximum of 10 unique code entry attempts are allowed with various consequences if you get it wrong.

The number of attempts will be shown in the display.

If the display reverts to **CODE** another entry attempt may be made immediately.

If the display shows **WAIT 30**, the unit will be locked for 30 minutes. Wait until the timer counts down to zero. When **CODE** is shown in the display, enter the correct code.

Note: *After 10 incorrect attempts the unit will be permanently inoperative and LOCKED will be shown in the display. See your dealer.*

Audio unit clock and date displays

SETTING THE CLOCK AND DATE ON THE AUDIO UNIT

6000CD and 6006CDC

Changing the date and time

Press the **CLOCK** button to display the date and time.

Note: *If you do not press another button within 30 seconds of pressing the CLOCK button, the display will return to its previous setting.*

1. Using the seek up or seek down button select the date or time value that you wish to change. The selected value will flash in the display.
2. Rotate the volume control to change the selected date or time value.
3. Using the seek up or seek down button select additional date or time values that you wish to change.
4. Rotate the volume control to change the selected date or time value.
5. Press the **CLOCK** button to exit and save your settings.

Note: *If you do not press the CLOCK button within 30 seconds of changing a date or time value, the display will exit and save the new values automatically.*

Note: *Press and hold the CLOCK button for more than two seconds to automatically select the hour value for winter or summer time adjustment.*

12/24 hour format

1. Press the **MENU** button repeatedly until the 12/24 icon is shown in the display.
2. Using the seek up or seek down button select your required setting.
3. Press the **MENU** button repeatedly or allow the system to time out to confirm your selection.

Sony CD

Changing the date and time

1. Press the **CLOCK** button.
2. Press the left or right navigation button until the date or time value that you wish to change flashes in the display.
3. Using the up or down navigation button change the selected date or time value.
4. Using the left and right navigation buttons select additional date or time values that you wish to change. The selected value will flash in the display.
5. Repeat steps three and four as necessary.
6. Press the **CLOCK** button or the button between the navigation buttons to exit and save your settings.

12/24 hour format

1. Press the **MENU** button.
2. Press the up or down navigation button until the 12/24 icon is shown in the display.
3. Using the left or right navigation button select the required setting.
4. Press the **MENU** button or the button between the navigation buttons to confirm your selection.

Audio unit operation

ON/OFF CONTROL

Press the on/off control. This will also operate the unit for up to one hour with the ignition turned off.

The radio will switch off automatically after one hour.

BASS/TREBLE CONTROL

The bass function is used to adjust the low-frequency response of the audio unit.

The treble function is used to adjust the high-frequency response of the audio unit.

6000CD and 6006CDC

Note: *The selected level will be shown in the display.*

1. Press the **BASS/TRE** button once for bass or twice for treble.
2. Use the volume control or on some units the seek up or seek down button to make the necessary adjustment.

Sony CD

Note: *You can adjust these settings separately for CD, Radio and Aux.*

Note: *The selected level will be shown in the display.*

1. Press the **TONE** button once for bass or twice for treble.
2. Use the up and down navigation buttons to make the necessary adjustment.

BALANCE/FADE CONTROL

The balance function is used to adjust the sound distribution between the left and right speakers.

The fade function is used to adjust the sound distribution from front to rear in vehicles fitted with rear speakers.

6000CD and 6006CDC

1. Press the **FADE/BAL** button once for fade or twice for balance.
2. Use the volume control or on some units the seek up or seek down button to make the necessary adjustment.

Sony CD

1. Press the **FAD/BAL** button once for fade or twice for balance.
2. Use the up and down navigation buttons for fade adjustment, and the left and right navigation buttons for balance adjustment.

The selected level will be shown in the display.

AUDIO MENU CONTROL

Use the **MENU** button to access functions that cannot be selected directly via one of the control buttons. Press the **MENU** button for first level functions, or press and hold the **MENU** button for other second level functions (not available on Sony or Sony DAB audio units).

Audio unit operation

6000CD and 6006CDC

Menu functions			
First level			Second level
During radio reception	During tape playback	During CD playback	During all functions
Manual tuning	12/24 hour	Scan	Traffic local or distant
Scan tuning	AVC*	Shuffle	AF**
12/24 hour	ADV menu	Repeat	REG
AVC*	-	Comp	News
ADV menu	-	12/24 hour	CLIP
-	-	AVC*	VID
-	-	ADV menu	Bluetooth enable/disable

Note: The sequence in which functions appear may vary for different audio units and vehicles.

Note: Second level functions (advanced) can also be entered by selecting ADV menu from the first level menu.

* Automatic volume control.

** Alternative frequencies.

Sony CD

Menu functions	
During radio reception	During CD playback
12/24 hour	12/24 hour
CLIP ON/OFF	CLIP ON/OFF
News ON/OFF	News ON/OFF
AVC ¹	AVC ¹
AF ²	AF ²

Audio unit operation

Menu functions	
During radio reception	During CD playback
TA ³ volume	TA ³ volume
Traffic local or distant	Traffic local or distant
Regional ON/OFF	Shuffle
-	Repeat
-	Comp ON/OFF

Note: *The sequence in which functions appear may vary for different audio units and vehicles.*

¹Automatic volume control.

²Alternative frequencies.

³Traffic announcement.

Audio unit operation

STATION PRESET BUTTONS

This feature allows you to store your favourite stations so that they can be recalled by selecting the appropriate waveband and pressing one of the preset buttons.

1. Select a waveband.
2. Tune to the station required.
3. Press and hold one of the preset buttons. The audio unit will mute. When sound returns the station has been stored.

This can be repeated on each waveband and for each preset button.

Note: *When you drive to another part of the country, FM RDS (radio data system) stations that broadcast on alternative frequencies are stored on the preset buttons.*

WAVEBAND BUTTON

Note: *The AM/FM or RADIO button can also be used to return to radio reception when you have been listening to another source.*

6000CD and 6006CDC

Press the **AM/FM** button to select from the wavebands available.

Sony CD

Press the **RADIO** button to select from the wavebands available.

AUTOSTORE CONTROL

Note: *This function will overwrite the previously stored autostore preset stations.*

Note: *This function can also be used to store stations manually in the same way as other wavebands.*

Note: *The strongest signals available on the selected waveband will be stored.*

The sound is muted and AUTOSTORE will be shown in the display while the unit searches through the frequencies.

When the search is complete, sound is restored and the strongest signals are stored on the autostore presets.

6000CD and 6006CDC

Press and hold the **AM/FM** button.

Sony CD

Press and hold the **AST** or **RADIO** button.

TRAFFIC INFORMATION CONTROL

Many stations that broadcast on the FM waveband have a TP code to signify that they carry traffic programme information.

Activating traffic announcements

Before you can receive traffic announcements, you must press the **TA** button. Either TA-D or TA-L will be shown in the display to indicate that the feature is switched on.

If you are already tuned to a station that broadcasts traffic information, TP will also be shown in the display. Otherwise the unit will search for a traffic programme and display TP SEEK while doing so. If it cannot locate such a station, NOT FOUND will be shown in the display.

TP will be shown within a box in the display when you are tuned to a station providing traffic information from a linked RDS (radio data system) or EON (enhanced other network) station.

Audio unit operation

When traffic information is broadcast, it will automatically interrupt normal radio, tape or CD playback and TRAFFIC or NEWS will be shown in the display.

If the traffic signal weakens, TP will flash in the display. Press the seek up or seek down button (the left or right navigation button on Sony or Sony DAB audio units) to find another station.

Note: *If this happens during CD or AUX playback or, on certain models, with the radio volume set to zero, the unit will retune automatically if the station is not available.*

If a non-traffic station is selected or recalled using a preset button, the audio unit will remain on that station unless **TA** is turned off, then on again.

Note: *If TA is on and you select a preset or manual tune to a non TA station no traffic announcement will be heard.*

Local or distant traffic

The number of RDS or EON traffic announcements may become excessive in some areas so there is an option to select between local traffic information and all available information.

6000CD and 6006CDC

1. Press and hold the **MENU** button until the display changes.
2. Press the **MENU** button repeatedly until TA is shown in the display.
3. Press the seek up or seek down button to select either local (TA LOCAL) or distant (TA DIST) traffic announcements.
4. Press the **MENU** button or allow the menu to time out to confirm your selection.

Note: *Either TA-L or TA-D will be shown in the display.*

Sony CD

1. Press the **MENU** button and use the up or down navigation button to select the TA display.
2. Press the left or right navigation button to select your required setting.
3. Press the **MENU** button to confirm your selection.

Traffic announcement volume

Traffic announcements interrupt normal broadcasts at a preset minimum level that is usually louder than normal listening volumes.

To adjust the preset volume

6000CD and 6006CDC

1. Press and hold the **TA** button.
2. Rotate the volume control to make the necessary adjustment.

Note: *The selected level will be shown in the display.*

Sony CD

1. Press and hold the **TA** button.
2. Press the left or right navigation button to make the necessary adjustment.

Note: *The selected level will be shown in the display.*

Ending traffic announcements

The audio unit will return to normal operation at the end of each traffic announcement. To end the announcement prematurely, press **TA** during the announcement.

Note: *If you press TA at any other time it will switch all announcements off.*

Audio unit operation

STATION TUNING CONTROL

DAB service linking

Note: *The DAB service linking is as per default off.*

Note: *Service linking allows cross-referencing to other corresponding frequencies of the same station, for example FM and other DAB ensembles.*

Note: *The system will automatically change to another corresponding station if the current one becomes unavailable, for example when leaving the coverage area.*

Switching DAB service linking on

1. Press the **MENU** button.
2. Using the up or down navigation button scroll through the display until DIGITAL RADIO SERVICE LINK is shown in the display.
3. Using the left or right navigation button select AUTO.
4. Press the **MENU** button or the button between the navigation buttons to confirm your selection.

Switching DAB service linking off

1. Press the **MENU** button.
2. Using the up or down navigation button scroll through the display until DIGITAL RADIO SERVICE LINK is shown in the display.
3. Using the left or right navigation button select OFF.
4. Press the **MENU** button or the button between the navigation buttons to confirm your selection.

Seek tuning

6000CD and 6006CDC

Select a waveband and briefly press the seek up or seek down button. The unit will stop at the first station it finds in the direction you have chosen.

Sony CD

Select a waveband and briefly press the up or down navigation button. The unit will stop at the first station it finds in the direction you have chosen.

Manual tuning

6000CD and 6006CDC

1. Select a waveband and press the **MENU** button until MAN is shown in the display.
2. Press the seek up or seek down button to tune up or down the waveband in small increments or press and hold to increment quickly, until you find a station you want to listen to.

Sony CD

Select a waveband and briefly press the up or down navigation button to tune up or down the waveband in small increments. The display shows the frequency selected.

Scan tuning

The scan function allows you to listen to 10 seconds of each station detected.

Audio unit operation

6000CD and 6006CDC

1. Press the **MENU** button repeatedly until SCAN is shown in the display.
2. Press the seek up or seek down button to scan up or down the selected waveband.
3. Depending on the audio unit, press the seek up or seek down button or the **MENU** button to continue listening to a station.

Sony CD

1. Press the **SCAN** button. SCAN flashes or SCANNING is shown in the display.
2. Press the left or right navigation button to scan within a waveband.
3. Press the **SCAN** button to continue listening to a station.

Audio unit menus

AUTOMATIC VOLUME CONTROL

This function adjusts the volume level to compensate for engine and road speed noise.

6000CD and 6006CDC

1. Press the **MENU** button repeatedly until AVC is shown in the display.
2. Use the seek up or seek down button to adjust the setting.
3. Press the **MENU** button or allow the system to time out to confirm your selection.

Sony CD

1. Press the **MENU** button.
2. Using the up or down navigation button scroll through the display until AVC is shown in the display.
3. Press the **MENU** button or allow the system to time out to confirm your selection.

DIGITAL SIGNAL PROCESSING (DSP)

DSP occupancy

This feature takes into account the differences in distance from the various speakers in the vehicle to each seat. Select the sitting position for which the audio is to be correctly enhanced.

DSP equaliser

Select the music category that most suits your listening preference. The audio output will change to enhance the particular style of music chosen.

Changing the DSP settings

1. Press the **DSP** button once for occupancy and twice for equaliser.
2. Use the up and down navigation buttons to select the required setting.
3. Press the button between the navigation buttons to confirm your selection.

AUDIO DISTORTION REDUCTION (CLIP)

This function automatically detects sound distortion and reduces the volume level until the distortion has been eliminated. This means that whilst the display might change numerically when you raise the volume manually with the control, there may be no actual increase in sound.

6000CD and 6006CDC

1. Press and hold the **MENU** button until the display changes.
2. Press the **MENU** button repeatedly until CLIP is shown in the display.
3. Using the seek up or seek down button turn the function on or off.
4. Press the **MENU** button or allow the system to time out to confirm your selection.

Sony CD

1. Press the **MENU** button briefly.
2. Using the up or down navigation button scroll through the display until CLIP is shown in the display.
3. Press the **MENU** button or allow the system to time out to confirm your selection.

Audio unit menus

ALTERNATIVE FREQUENCIES

Many programmes broadcast on the FM waveband have a PI (programme identification) code, which can be recognised by audio units.

If your radio has AF (alternative frequencies) tuning switched on and you move from one transmission area to another, this function will search for and switch to a stronger station signal, if one can be found.

Under certain conditions, however, AF tuning may temporarily disrupt normal reception.

When selected, the unit continually evaluates signal strength and, if a better signal becomes available, the unit will switch to that alternative. It mutes while it checks a list of alternative frequencies and, if necessary, it will search once across the selected waveband for a genuine alternative frequency.

It will restore radio reception when it finds one or, if one is not found, the unit will return to the original stored frequency. On certain units, NOT FOUND will be shown in the display.

With AF-MAN selected, the unit operates in a similar way to AF-AUTO or AF-ON, but only searches for an alternative frequency when prompted by pressing a preset button.

With AF-OFF selected, the original stored frequency remains selected. In this mode, AF-OFF will be displayed every time the unit is turned on.

6000CD and 6006CDC

1. Press and hold the **MENU** button until the display changes.
2. Press the **MENU** button repeatedly until AF is shown in the display.

3. Using the seek up or seek down button select the required setting.
4. Press the **MENU** button or allow the system to time out to confirm your selection.

Sony CD

1. Press the **MENU** button briefly.
2. Using the left or right navigation button scroll through the display until the required setting is shown in the display.
3. Press the **MENU** button to confirm your selection.

REGIONAL MODE (REG)

The function REG (regional mode) controls the behaviour of AF switching between regionally related networks of a parent broadcaster. A broadcaster may run a fairly large network across a large part of the country. At various times of the day this large network may be broken down into a number of smaller regional networks, typically centred on major towns or cities. When the network is not split into regional variants, the whole network carries the same programming.

Regional mode ON: This prevents random AF switches when neighbouring regional networks are not carrying the same programming.

Regional mode OFF: This allows a larger coverage area if neighbouring regional networks are carrying the same programming, but can cause random AF switches if they are not.

6000CD and 6006CDC

1. Press and hold the **MENU** button until the display changes.
2. Press the **MENU** button repeatedly until REG is shown in the display.

Audio unit menus

3. Using the seek up or seek down button turn the function on or off.
4. Press the **MENU** button or allow the system to time out to confirm your selection.
3. Press the button between the navigation buttons to make your selection.
4. Using the left or right navigation button turn the function on or off.

Sony CD

1. Press the **MENU** button briefly.
2. Using the up or down navigation button scroll through the display until REGIONAL is shown in the display.
3. Press the **MENU** button or allow the system to time out to confirm your selection.

5. Press the **MENU** button or the button between the navigation buttons to confirm your selection.

NEWS BROADCASTS

Some audio units interrupt normal reception to broadcast news bulletins from stations on the FM waveband linked stations, in the same way as traffic information is provided.

During news broadcasts, the display alternates between the station name and NEWS. News interrupts are broadcast at the same preset volume level as traffic announcements.

6000CD and 6006CDC

1. Press and hold the **MENU** button until NEWS is shown in the display.
2. Using the seek up or seek down button turn the function on or off.
3. Press the **MENU** button to confirm your selection.

Sony CD

1. Press the **MENU** button.
2. Using the up or down navigation button scroll through the display until NEWS is shown in the display.

Compact disc player

LOADING COMPACT DISCS

6000CD

Always check that the CD aperture is empty before inserting a CD.

Insert a CD, label side up, into the audio unit.

6006CDC

To load a single CD

Press and release the **LOAD** button or press a preset button. **WAIT** will be shown in the display.

When the message changes to **LOAD CD**, and lights flash in the CD aperture, insert a CD, label side up, into the audio unit.

To load more than one CD

WARNING



If the power to the audio unit has been disconnected, then reconnected, the unit will automatically check for the presence of discs. This will take approximately 25 seconds. During this time all functions except Keypcode entry will be locked out.

1. Press and hold the **LOAD** button until **LOAD ALL** is shown in the display.
2. When the message changes to **LOAD CD**, and lights flash in the CD aperture, insert a CD, label side up, into the audio unit.
3. A numbered disc icon will flash in the display and **LOAD** will be shown in the display. When the disc is loaded, a number in one of the disc icons will indicate its location.

4. When the message changes to **WAIT** and then to **LOAD CD** you can load another CD.
5. Repeat the last step to load more CDs or allow the unit to time out if you have finished loading your discs.

Note: Do not try to insert a CD when **WAIT** is shown in the display.

Note: Do not insert two CDs in a figure of eight fashion with edges overlapping.

Note: You can only load a maximum of six CDs.

Note: If the **LOAD** button is pressed again, **CDC FULL** will be shown in the display.

Sony CD

Always check that the CD aperture is empty before inserting a CD.

Insert a CD, label side up, into the audio unit.

LOADING, READING CD and **AUDIO CD** or **MP3 CD** will be shown in the display, and playback will start automatically.

TRACK SELECTION

6000CD and 6006CDC

Press the seek up button once to move to the next track or press it repeatedly to access later tracks.

Press the seek down button once to replay the current track. If pressed within two seconds of the start of a track, the previous track will be selected.

Press the seek down button repeatedly to select previous tracks.

Sony CD

Press the up navigation button once to move to the next track or press it repeatedly to access later tracks.

Compact disc player

Press the down navigation button once to replay the current track. If pressed within two seconds of the start of a track, the previous track will be selected.

Press the down navigation button repeatedly to select previous tracks.

COMPACT DISC PLAYBACK

Note: During playback, the display indicates the disc, track and time that has elapsed since the start of the track.

Note: On CD changer audio units, if two or more CD's are loaded one after the other, playback will start with the last CD loaded.

6000CD and 6006CDC

During radio reception, press the **CD** button once to start CD playback.

Playback will start immediately after a disc is loaded.

Sony CD

During radio reception, press the **CD/AUX** button once to start CD playback.

Playback will start immediately after a disc is loaded.

COMPACT DISC SELECTION

6006CDC

On multiple CD units, CD's are normally played sequentially in ascending order.

You can, however, switch to a CD of your choice by pressing the preset button, which has the number corresponding to the disc you want to play. The display will show which CD is selected.

The unit remembers which CD's are available so it will not select a CD that it knows to be missing. If you select a missing CD using the preset buttons, **NO CD** will be shown in the display and playback will continue from the current disc.

Note: If a selected CD is damaged or upside down, the warning **CD ERROR** flashes and the CD number is displayed. The unit then selects the next available CD.

FAST FORWARD/REVERSE

6000CD and 6006CDC

Press and hold the seek up or the seek down button to search forwards or backwards within the tracks on the disc.

Sony CD

Press and hold the left or right navigation button to search forwards or backwards within the tracks on the disc.

SHUFFLE/RANDOM

Random track playback, also known as shuffle, plays all tracks on a CD in random order.

6000CD and 6006CDC

Note: When **SHUFF CD** is selected only the tracks on the current CD will be shuffled. When **SHUF ALL** is selected the tracks on all the CD's will be shuffled.

1. Press the **MENU** button repeatedly until **SHUF** is shown in the display.
2. Using the seek up or seek down button scroll through the display until **SHUF ALL** or **SHUFF CD** is shown in the display.
3. Using the seek up or seek down button select the next track to shuffle if required.

Compact disc player

Note: With the function on, *SHUFFLE* will be shown in the display as each new track is selected.

Sony CD

1. Press the **MENU** button.
2. Using the up or down navigation button scroll through the display until *SHUFFLE* is shown in the display.
3. Use the left or right navigation button to switch the function on and off.

COMPACT DISC TRACK COMPRESSION

6000CD and 6006CDC

1. Press **MENU** repeatedly until *COMP* is shown in the display.
2. Using the seek up or seek down button turn the function on or off.
3. Press the **MENU** button to confirm your selection.

Sony CD

1. Press the **MENU** button.
2. Using the up or down navigation button scroll through the display until *COMP* is shown in the display.
3. Press the button between the navigation buttons to make your selection.
4. Using the left or right navigation button turn the function on or off.
5. Press the **MENU** button or the button between the navigation buttons to confirm your selection.

COMPACT DISC TRACK SCANNING

The *SCAN* function allows you to preview each track for approximately 10 seconds.

6000CD and 6006CDC

Note: When selected, *SCAN* will be shown briefly in the display at the start of each track.

1. Press the **MENU** button repeatedly until **SCAN** is shown in the display.
2. Using the seek up or seek down button select either **SCAN CD** or **SCAN ALL**.
3. Press the seek up or seek down button again to continue listening to a track.

Sony CD

1. Press the **SCAN** button once to scan each track.
2. Press the **SCAN** button again to select **SCAN OFF**.

EJECTING COMPACT DISCS

Note: *Radio reception is restored automatically when the EJECT button is pressed.*

Note: *If the EJECT button is pressed in error, press the button again to cancel.*

Note: *If the CD is not removed it will be pulled back into the audio unit.*

6000CD

Press the **EJECT** button at any time and remove the CD.

6006CDC

Press the **EJECT** button at any time and remove the CD being played or use a preset button to select the CD you want to remove. **SELECT** or **SELECT CD** followed by **REMOVE CD** will be shown in the display.

Compact disc player

Sony CD

Note: If no CD is loaded when the **EJECT** button is pressed, **NO CD** will be shown in the display.

Press the **EJECT** button at any time and remove the CD. **EJECTING** and **PLEASE REMOVE** will be shown in the display.

REPEAT COMPACT DISC TRACKS

6000CD

1. Press the **MENU** button repeatedly until **REPEAT** is shown in the display.
2. Using the seek up or seek down button choose between **OFF** and **TRK**.

6006CDC

1. Press the **MENU** button repeatedly until **REPEAT** is shown in the display.
2. Using the seek up or seek down button choose between **ALL** (default), **CD** and **TRK**.

Sony CD

1. Press the **MENU** button.
2. Using the up or down navigation buttons scroll through the display until **REPEAT** is shown in the display.
3. Using the left or right navigation buttons select **REPEAT TRACK** or **REPEAT OFF**.
4. Press the **MENU** button to confirm your selection.

ENDING COMPACT DISC PLAYBACK

6000CD and 6006CDC

Press the **AM/FM** or **AUX** button.

Note: This will not eject the CD; the disc will merely pause at the point where radio reception was restored.

To resume CD playback, press the **CD** button again.

Sony CD

Press the **RADIO** or **CD/AUX** button.

Note: This will not eject the CD; the disc will merely pause at the point where radio reception was restored.

To resume CD playback, press the **CD/AUX** button.

EJECTING MULTIPLE COMPACT DISCS

6006CD

Press and hold the **EJECT** button until **EJECT ALL** is shown in the display.

The display will alternate between **REMOVE** and **WAIT**.

When **REMOVE** is displayed, remove a disc from the unit. This routine repeats until all discs have been removed.

Auxiliary input (AUX IN) socket

AUXILIARY INPUT (AUX IN) SOCKET

Note: *For optimum performance when using any auxiliary device set the volume on the device high. This will reduce audio interference when charging the device via the vehicle power supply socket.*

When fitted the Auxiliary input (AUX IN) socket permits an auxiliary device, such as an MP3 player, to be linked into the vehicle audio system. Output can be played through the vehicle speakers.

To connect an auxiliary device, plug it into the AUX IN socket using a 3.5 mm conventional audio jack connector.

Select the auxiliary input via the **AUX** button and playback will be heard through the vehicle speakers. AUX will be shown in the display. Volume, treble and bass can be adjusted on the audio unit as normal.

The audio unit buttons can also be used to restore playback from the audio unit, while the auxiliary device remains connected.

Audio troubleshooting

AUDIO TROUBLESHOOTING

Audio unit display	Rectification
CD ERROR PLEASE CHECK CD CDC ERROR	General error message for CD fault conditions, for example cannot read the CD, data-CD inserted. May also indicate a audio unit malfunction. Make sure that the disc is correctly loaded, clean and re- load the CD or replace the CD with a known music CD. See Ejecting compact discs (page 150). See Ejecting multiple compact discs (page 151). See Loading compact discs (page 148). If error continues. See your dealer.
NO CD NO CDS NO CD #	Message to indicate that the audio unit or CD changer is empty. Insert a CD. See Loading compact discs (page 148).
HIGH TEMP CD DRIVE HIGH TEMP	Ambient temperature too hot – unit will not work until it has cooled down.
SLOT FULL	Message to indicate that the CD slot is already loaded. Eject the CD from selected slot before attempting load operation or select another slot location. See Loading compact discs (page 148).
CDC FULL	Message to indicate that the audio unit is full. See Ejecting compact discs (page 150). See Ejecting multiple compact discs (page 151).
DATA CD	An incompatible CD has been inserted, for example not an audio CD. See Ejecting compact discs (page 150). See Ejecting multiple compact discs (page 151).
CODE ----	Message to prompt you for the Keycode. See Entering a security code (page 136).
WAIT	Message to inform you to wait until the next keycode entry attempt can be made. See Incorrect security code (page 136).
TRIES	Message indicates the number of incorrect input attempts. See Incorrect security code (page 136).
LOCKED	Message to inform you that audio unit security system has locked the unit after repeated incorrect keycode entries. See your dealer.
KEYCODE.... ENTER KEYCODE....	Message to prompt you for the Keycode. See Entering a security code (page 136).

Audio troubleshooting

Audio unit display	Rectification
INCORRECT	Message to inform you that the entered keycode is incorrect. See Incorrect security code (page 136).

Telephone

GENERAL INFORMATION

This section describes the functions and features of the Bluetooth mobile phone and voice control system.

The section covers the following variations:

- a mobile phone with a mobile phone cradle without voice control
- a Bluetooth and voice control system with a mobile phone cradle
- a Bluetooth and voice control system without a mobile phone cradle.

The Bluetooth mobile phone part of the system provides interaction with the audio or navigation system and your mobile phone. It allows you to use the audio or navigation system to make and receive calls without having to use your mobile phone.

The voice control part of the system can be used to control:

- mobile phone calls
- audio system functions
- vehicle climate control functions.

Note: *The mobile phone does not switch off immediately after the ignition key is turned off; the power down delay is preset to 10 minutes. The time period can be adjusted to between 0 and 60 minutes. This, depending on your mobile phone, can be achieved by creating a phonebook entry on your mobile phone with the name Timer and the required delay as it's number.*

If the Bluetooth and voice control is used for an extended period of time when the vehicle is stationary, make sure that the engine is running to avoid draining the battery

TELEPHONE SETUP

Requirements for cradle connection

Your phone must be fitted in a mobile phone holder before it can be used as a cradle phone with your handsfree/voice control system. You will be able to purchase the correct holder for your phone from your dealer.

Placing your phone in the cradle

Note: *Your phone must be fitted in a mobile phone holder to allow you to connect the phone to the cradle.*

Connect your phone to the cradle.

1. Place the base of the phone in the cradle connection.

Note: *Make sure that the phone is pushed fully rearwards in the cradle.*

2. Push the phone downwards until a click is heard.

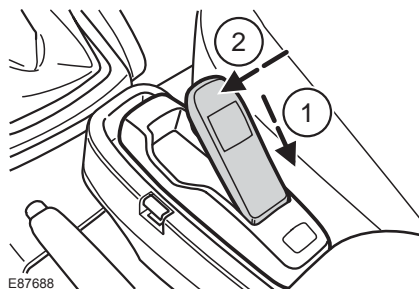

Note: *The connection to the system will be displayed on your phone.*

Phonebook

After start up access to the phonebook can be delayed for up to two minutes.

Telephone

Phonebook categories

Depending on your phonebook entry, different categories can be displayed in the audio or navigation unit.

For example:

M	Mobile
O	Office
H	Home
F	Fax

Note: *Entries may be displayed without a category attachment.*

The category can also be indicated as an icon:



Phone



Mobile



Home



Office



Fax

Making a phone an active phone

When using the system for the first time, no phone is connected to the system.

After switching on the ignition the cradle phone and the Bluetooth phone are recognized differently by the system.

Bluetooth phone

After bonding a Bluetooth phone to the system, this becomes the active phone. For further information refer to the phone menu.

However, in some cases the Bluetooth phone has to be activated by pressing the appropriate station button on the audio or navigation unit.

Turning the ignition back on again, the last active phone is picked up by the system.

Bond another Bluetooth phone

Note: *Before another Bluetooth phone can be bonded, the existing active Bluetooth connection has to be deactivated by the mobile phone.*

Bond a new Bluetooth phone as described in the requirements for a Bluetooth connection.

Phones stored in the system are accessible by using the phone list on the audio or navigation unit.

Note: *If six (five Bluetooth phones for cradle phone system) Bluetooth phones have been bonded, one of these has to be deleted in order to bond a new phone.*

Cradle phone

With your phone fitted in the mobile phone cradle this does not automatically become the active phone.

In these cases refer to **Changing the active phone** in the appropriate section which describes the system fitted to your vehicle.

BLUETOOTH SETUP

Before you can use your telephone with your vehicle it must be bonded to the vehicle telephone system.

Telephone

Handling of phones

A phone can be connected to the vehicle system by using either a cradle connection or a Bluetooth connection.

On vehicles with a mobile phone cradle, up to five Bluetooth phones can be bonded to the vehicle system.

On vehicles without a mobile phone cradle, up to six Bluetooth phones can be bonded to the vehicle system.

Note: *If there is an ongoing call when the phone in use is selected as the new active phone, the call is transferred to the vehicle audio system.*

Note: *Even if connected to the car system, your phone can still be used in the usual way.*

Requirements for Bluetooth connection

The following are required before a Bluetooth phone connection can be made.

1. The Bluetooth feature must be activated on the phone and on the audio unit. For additional information, refer to your phone user guide
2. The private mode must not be activated on the Bluetooth phone.
3. Search for audio device.
4. Select **Ford Audio**.
5. The Bluetooth PIN number 0000 must be entered on the phone keypad.

Note: *A phone call will be disconnected if the audio/navigation system is switched off. If the ignition key is turned to the off position the phone call will remain in progress.*

Compatibility of phones

CAUTION



As no common agreement exists, mobile phone manufacturers are able to implement a variety of profiles in their Bluetooth devices. Because of this, an incompatibility can occur between the phone and hands-free system, which in some cases may significantly degrade the system performance. To avoid this situation, only recommended phones should be used. Please contact your dealer for more details regarding the current compatibility list.

Phones with Symbian operating system

Note: *Certain phones require a special file to be installed to enable full phonebook access via Bluetooth. This is referred to as a SIS file and will be available via the Ford website. Please consult your dealer for full details.*

TELEPHONE CONTROLS

Ending or rejecting calls

By pressing one of several function buttons on the audio or navigation unit (example: AM/FM,CD/AUX) active calls can be ended or incoming calls can be rejected.

Remote control

One of several different types of remote control may be fitted to your vehicle:

Telephone

Voice and mode button

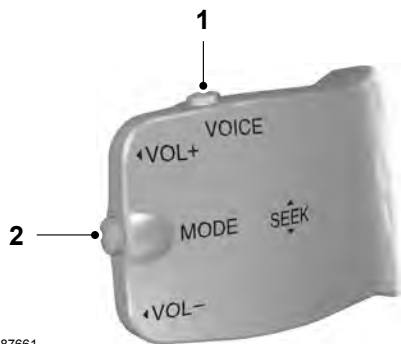

E87661

- 1 Voice button
- 2 Mode button

Incoming calls can be accepted by pressing the MODE button once or ended by pressing twice.

Voice and accept/reject button

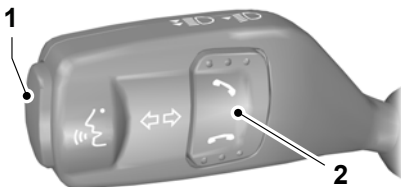

E87662

- 1 Voice button
- 2 Accept/Reject button

The VOICE button is used to activate or switch off the Voice control.

On vehicles with an accept/reject button, phone calls can be accepted and rejected by pressing the appropriate button.

Note: Some audio units have the accept/reject buttons on the front bezel. These operate in the same way.

Mode button on the steering wheel



E87663

Mode button only

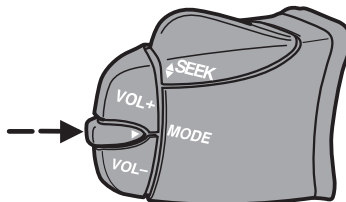

E87664

On vehicles without a VOICE button, the MODE button on the remote control is used to activate or switch off the voice control.

Note: You will not be able to use the MODE button to activate the voice control during an incoming or active call.

You will not be able to use the MODE button to control the audio system.

USING THE TELEPHONE - VEHICLES WITHOUT: NAVIGATION SYSTEM

This chapter describes the phone functions of the audio unit.

Telephone

Note: Refer to your audio guide for details of the controls.

An active phone must be present.

Even if connected to the audio unit, your phone can still be used in the usual way.

Note: You can exit the phone menu by pressing any source button **CD**, **AM/FM** or **AUX**.

Making a call

Dialling a number

You can access your phone address book either with the phone docked in the cradle or via Bluetooth. The entries will appear in the audio unit display.

1. Press the **PHONE** or the call accept button.
2. Press the **MENU** button.
3. Keep pressing the **MENU** button until **PHONEBOOK** appears.
4. Press the seek buttons to select the desired phone number.

Note: Press and hold the seek button to skip to the next letter in the alphabet.

5. Press the **PHONE** or the call accept button to dial the selected phone number.

If you have an audio unit with a telephone keypad (buttons 0-9, * and #), you can also direct dial by entering the number on the radio display via the keypad and pressing the call accept button:

1. Press the call accept button.
2. Dial the number using the telephone keypad on the audio unit.
3. Press the call accept button.

Note: If you enter an incorrect digit whilst entering a phone number, press the seek down button to erase the last digit. A long press will erase the complete string of digits.

Press and hold 0 to enter a + digit.

Ending a call

Calls can be ended by either:

- pressing one of the following buttons on the audio unit: **PHONE**, **CD**, **AM/FM** or **ON/OFF**
- pressing the **MODE** button on the remote control
- pressing the call reject button.

Note: If you have an audio unit with a telephone keypad you can end a call only with the call reject button.

Redialling a number

1. Press the **PHONE** or the call accept button.
2. Press the **MENU** button.
3. Select the **CALL OUT** list or the **CALL IN** list.

Note: If the active phone does not provide a call out list, the last outgoing call number/entry is displayed.

4. Press the seek button on the audio unit.
5. Press the **PHONE** or the call accept button to dial the desired phone number.

Redialling the last dialled number

Note: This applies to only audio units with a telephone keypad

1. Press the call accept button.
2. Press the call accept button again to display the last dialled number.
3. Press the call accept button a third time to dial the number.

Receiving an incoming call

Accepting an incoming call

Incoming calls can be accepted by either:

Telephone

- pressing the **PHONE** button
- pressing the **MODE** button on the remote control
- pressing the call accept button.

Rejecting an incoming call

Incoming calls can be rejected by either:

- pressing the call reject button
- pressing the **CD** button
- pressing the **AM/FM** button.

Note: *If you have an audio unit with a telephone keypad you can only reject a call with the call reject button.*

Note: *You cannot reject an incoming call using the remote control.*

Handling a second incoming call

Note: *The second incoming call function must be activated in your phone.*

If there is an incoming call whilst there is an ongoing call, a beep will be heard and you will have the option to end the active call and to accept the incoming call.

Accepting a second incoming call

Second incoming calls can be accepted by either:

- pressing the call accept button
- pressing the **MODE** button on the remote control
- pressing the **PHONE** button.

Note: *This will cancel the ongoing call.*

Rejecting a second incoming call

Second incoming calls can be rejected by pressing either:

- pressing the call reject button
- pressing the **CD** button
- pressing the **AM/FM** button.

Note: *If you have an audio unit with a telephone keypad you can only reject a call with the call reject button.*

Changing the active phone

Note: *Phones must be bonded to the system before they can be made active.*

Using the station storage button

1. Press the **PHONE** button on the audio unit.
2. Press the preset number required (using the station preset buttons 1 – 6).

Note: *This process is only for audio units without a telephone keypad.*

Using the audio unit menu

1. Press the **PHONE** or call accept button.
2. Press the **MENU** button on the audio unit.
3. Select the **ACTIVE PHONE** option on the audio unit.
4. Scroll through the different stored phones by using the seek buttons to display the bonded phones.
5. Press the **MENU** button to select the phone which is to be the active phone.

Note: *After bonding a Bluetooth phone to the system, this becomes the active phone.*

Debonding a bonded phone

A bonded phone can be deleted from the system at any time, unless a phone call is in progress.

1. Press the **PHONE** or call accept button.
2. Press the **MENU** button on the audio unit.
3. Select the **DEBOND** option on the audio unit.

Telephone

4. Scroll through the different phones by using the seek buttons and display the phone to be debonded.
5. Press the **MENU** button to select the phone which is to be debonded.

USING THE TELEPHONE - VEHICLES WITH: TRAVEL PILOT EX

This chapter describes the phone functions of the Navigation System TravelPilot EX.

Note: Refer to your Navigation System TravelPilot EX guide for details of the controls.

An active phone must be present.

Even if connected to the Navigation System TravelPilot EX, your phone can still be used in the usual way.

Making a call

Dialling a number - cradle phone

Using the cradle phone allows you to access your mobile phone address book. The entries will appear in the TravelPilot EX display.

1. Press the PHONE button on the audio unit.
2. Using the **PHONEBOOK** option in the menu.
3. Choose one of the letter areas.
4. Turning the right rotary entry control, select the desired phone number.
5. By pressing the INFO button the details of the phonebook entry can be displayed.
6. Press the right rotary entry control button.

Dialling a number - Bluetooth phone

Using the Bluetooth phone, phone numbers can be dialled using voice control, refer to the **Voice control** chapter.

Ending a call

Calls can be ended by either:

- pressing the reject button
- pressing the MODE button on the remote switch
- pressing the off button on the navigation system
- pressing the right rotary entry control button.

Redialling a number - cradle phone

1. Press the PHONE button on the audio unit.
2. Press the MENU button.
3. Select the **CALL OUT** list, **CALL IN** list or **REDIAL**.
4. Press the PHONE button on the audio unit to dial the desired phone number.

Redialling a number - Bluetooth phone

1. Press the PHONE button on the audio unit.
2. Press the MENU button.
3. Select **REDIAL**.
4. Press the PHONE button on the audio unit to dial the phone number.

Handling an incoming call

Accepting an incoming call

Incoming calls can be accepted by either:

- pressing the accept button
- pressing the MODE button on the remote control

Telephone

- pressing the PHONE button on the audio unit
- using the **ACCEPT** option in the menu.

Rejecting an incoming call

Incoming calls can be rejected by either:

- pressing the reject button
- pressing one of the following buttons on the audio unit: CD, AM/FM
- using the **REJECT** option in the menu.

Note: *You cannot reject an incoming call using the remote control MODE button.*

Handling a second incoming call

Note: *The second incoming call function must be activated in your phone.*

If there is an incoming call, whilst there is an ongoing call, a beep will be heard and you will have the option to end the active call and to accept the incoming call.

Accepting a second incoming call

Second incoming calls can be accepted by either:

- Pressing the accept button.
- Pressing the MODE button on the remote control.
- Pressing the PHONE button on the audio unit.
- Using the **ACCEPT** option in the menu.

Note: *This will cancel the ongoing call.*

Rejecting a second incoming call

Second incoming calls can be rejected by pressing either:

- The reject button
- one of the following buttons on the audio unit: CD, AM/FM.

Changing the active phone

Note: *Phones must be bonded to the system before they can be made active.*

1. Press the PHONE button on the audio unit.
2. Using the **ACTIVE PHONE** option in the menu, select the active phone from the list using the preset buttons.

Debonding a bonded phone

A bonded phone can be deleted from the system at any time, unless a phone call is in progress.

1. Press the PHONE button on the audio unit.
2. Select the **DEBOND** option in the menu.
3. Select the phone from the list by using the preset buttons.

Note: *After bonding a Bluetooth phone to the system, this becomes the active phone.*

However, in some cases the Bluetooth phone has to be activated by pressing the appropriate station button on the audio or navigation unit.

Voice control

PRINCIPLE OF OPERATION

Voice recognition enables operation of the audio system without the need to divert your attention from the road ahead in order to change settings, or receive feedback from the system.

Whenever you issue one of the defined commands with the system active, the voice recognition system converts your command into a control signal for the audio system. Your inputs take the form of dialogues or commands. You are guided through these dialogues by announcements or questions.

Please familiarise yourself with the functions of the audio system before using voice recognition.

Note: *If the Bluetooth and voice control is used for an extended period of time when the vehicle is stationary, make sure that the engine is running to avoid draining the battery.*

Supported commands

The voice control system allows you to control the following vehicle functions:

- phone
- radio
- CD Player
- climate control
- navigation system.

Note: *The voice control system is language specific. If you require the system to operate in another language please consult your dealer.*

System response

As you work through a voice session the system will prompt you with a beep tone each time the system is ready to proceed.

Do not try to give any commands until the beep tone has been heard. The voice control system will repeat each spoken command back to you.

If you are not sure how to continue say "HELP" for assistance or "CANCEL" if you do not wish to continue.

The "HELP" function provides only a subset of the available voice commands. Detailed explanations of all possible voice commands can be found on the following pages.

Voice commands

All voice commands should be given using a natural speaking voice, as if speaking to a passenger or on the phone. Your voice level should be dependant on the surrounding noise level inside or outside the vehicle but do not shout.

Name tag

The name tag functionality can support the phone, audio and navigation features by using the "STORE NAME" function.

- Store up to 20 name tags per function.
- The average recording time for each name tag is approximately 2-3 seconds.

USING VOICE CONTROL

System operation

The order and content of the voice controls are given in the following lists. The tables show the sequence of user voice commands and system responses for each available function.

< > indicates a number or stored name tag to be inserted by the user.

Voice control

Short cuts

There are a number of voice command short cuts available, which allow you to control some vehicle features without having to follow the complete command menu. These are:

- phone: "MOBILE NAME"¹, "DIAL NUMBER", "DIAL NAME" and "REDIAL"
- CD player: "DISC" and "TRACK"
- climate control: "TEMPERATURE", "FAN", "AUTO MODE", "DEFROSTING/DEMISTING ON" and "DEFROSTING/DEMISTING OFF"
- radio: "TUNE NAME"
- navigation: "ZOOM" and "ROUTE SETTING".

1) Only when the mobile phone is fitted with Bluetooth and voice control

Start communicating with the system

Before you can start talking to the system you first have to press the **VOICE** or **MODE** button for each operation and wait until the system answers with a beep.

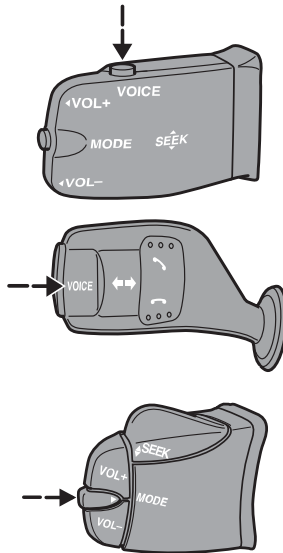

E87665

AUDIO UNIT COMMANDS

CD Player/CD Changer

You can choose a disc or track directly by voice control.

Overview

The overview below shows the available voice commands for operating your CD player. The following lists will give further information about the complete command menu.

"CD"
"HELP"
"DISC" ^a

Voice control

"CD"
"TRACK" ^b

- a) Can only be used with a CD changer.
- b) Can be used as a shortcut.

Disc

If you have a CD changer you can choose the disc number.

Steps	User says	System answer
1	"CD"	"CD"
2	"DISC" ^a	"DISC NUMBER PLEASE"
3	"<a number between 1 and 6>"	"DISC <number>"

- a) Can be used as a shortcut.

Track

You can also choose a track on your CD directly.

Steps	User says	System answer
1	"CD"	"CD"
2	"TRACK" ^a	"TRACK NUMBER PLEASE"
3	"<a number between 1 and 99>"	"TRACK <number>"

- a) Can be used as a shortcut.

Radio

The radio voice commands support the functionality of the radio and allow you to tune radio stations by voice control.

Overview

The overview below shows the available voice commands for operating your radio. The following lists will give further information about the complete command menu.

Voice control

"RADIO"
"HELP"
"AM"
"FM"
"TUNE NAME" ^a
"DELETE NAME"
"DELETE DIRECTORY"
"PLAY DIRECTORY"
"STORE NAME"

a) Can be used as a shortcut.

Tune frequency

This function allows you to tune your radio by voice commands.

Steps	User says	System answer
1	"RADIO"	"RADIO"
2	"AM"	"FREQUENCY PLEASE"
	"FM"	"FREQUENCY PLEASE"
3	"<frequency>"	"TUNE <frequency>"

Store name

If you have tuned a radio station, you can store it with a name in the directory.

Steps	User says	System answer
1	"RADIO"	"RADIO"
2	"STORE NAME"	"STORE NAME" "NAME PLEASE"
3	"<name>"	"REPEAT NAME PLEASE"

Voice control

Steps	User says	System answer
4	"<name>"	"STORING NAME" "<name> STORED"

Tune name

This function allows you to call up a stored radio station.

Steps	User says	System answer
1	"RADIO"	"RADIO"
2	"TUNE NAME" ^a	"NAME PLEASE"
3	"<name>"	"TUNE <name>"

a) Can be used as a shortcut.

Delete name

This function allows you to delete a stored radio station.

Steps	User says	System answer
1	"RADIO"	"RADIO"
2	"DELETE NAME"	"NAME PLEASE"
3	"<name>"	"DELETE <name>" "CONFIRM YES OR NO"
4	"YES"	"DELETED"
	"NO"	"COMMAND CANCELLED"

Play directory

This function allows you to let the system tell you all of the stored radio stations.

Steps	User says	System answer
1	"RADIO"	"RADIO"

Voice control

Steps	User says	System answer
2	"PLAY DIRECTORY"	"PLAY <DIRECTORY>"

Delete directory

This function allows you to delete all stored radio stations at once.

Steps	User says	System answer
1	"RADIO"	"RADIO"
2	"DELETE DIRECTORY"	"DELETE DIRECTORY" "CONFIRM YES OR NO"
3	"YES"	"RADIO DIRECTORY DELETED"
	"NO"	"COMMAND CANCELLED"

TELEPHONE COMMANDS

Phone

Your phone system allows you to create an additional phonebook. The stored entries can be dialled by voice control. Phone numbers stored by using voice control are stored on the vehicle system and not in your phone.

Overview

The overview below shows the available voice commands of the phone system. The following lists will give further information about the complete command menu.

"PHONE"
"HELP"
"MOBILE NAME" ^{a, b}
"DIAL NUMBER" ^a
"DIAL NAME" ^a
"DELETE NAME"
"DELETE DIRECTORY"
"PLAY DIRECTORY"

Voice control

"PHONE"
"STORE NAME"
"REDIAL" ^a
"ACCEPT CALLS"
"REJECT CALLS"

a) Can be used as a shortcut.

b) Only possible on mobiles which are connected by Bluetooth and fitted with voice control and stored name tags.

Create a phonebook

Store name

New entries can be stored with the "STORE NAME" command. This feature can be used to dial a number by calling up the name instead of the full phone number.

Steps	User says	System answer
1	"PHONE"	"PHONE"
2	"STORE NAME"	"STORE NAME" "NAME PLEASE"
3	"<name>"	"REPEAT NAME PLEASE"
4	"<name>"	"STORING NAME" "<name> STORED" "NUMBER PLEASE"
5	"<phone number>"	"<phone number>"
6	"STORE"	"STORING NUMBER" "<phone number>" "NUMBER STORED"

Delete name

Stored names can also be deleted from the directory.

Voice control

Steps	User says	System answer
1	"PHONE"	"PHONE"
2	"DELETE NAME"	"NAME PLEASE"
3	"<name>"	"DELETE <name>" "CONFIRM YES OR NO"
4	"YES"	"<name> DELETED"
	"NO"	"COMMAND CANCELLED"

Play directory

Use this function to let the system tell you all stored entries.

Steps	User says	System answer
1	"PHONE"	"PHONE"
2	"PLAY DIRECTORY"	"PLAY DIRECTORY"

Delete directory

This function allows you to delete all entries in one go.

Steps	User says	System answer
1	"PHONE"	"PHONE"
2	"DELETE DIRECTORY"	"DELETE DIRECTORY" "CONFIRM YES OR NO"
3	"YES"	"PHONE DIRECTORY DELETED"
	"NO"	"COMMAND CANCELLED"

Phone functions

Mobile name

This function allows you to access phone numbers stored with a name tag in your mobile phone.

Voice control

Steps	User says	System answer
1	"PHONE"	"PHONE"
2	"MOBILE NAME" ^{a, b}	"MOBILE NAME" "<phone dependent dialogue>"

a) Can be used as a shortcut.

b) Only when the mobile phone is fitted with Bluetooth and voice control (dependant on the mobile phone).

Dial number

Phone numbers can be dialled after giving the name tag voice command.

Steps	User says	System answer
1	"PHONE"	"PHONE"
2	"DIAL NUMBER" ^a	"NUMBER PLEASE"
3	"<phone number>"	"<phone number> CONTINUE?"
4	"DIAL"	"DIALLING"
	"CORRECTION"	"<repeat last part of number> CONTINUE?"

a) Can be used as a shortcut.

Dial name

Phone numbers can be dialled after giving the name tag voice command.

Steps	User says	System answer
1	"PHONE"	"PHONE"
2	"DIAL NAME" ^a	"NAME PLEASE"
3	"<name>"	"DIAL <name>" "CONFIRM YES OR NO"
4	"YES"	"DIALLING"

Voice control

Steps	User says	System answer
	"NO"	"COMMAND CANCELLED"

a) Can be used as a shortcut.

Redial

This function allows you to redial the last dialled phone number.

Steps	User says	System answer
1	"PHONE"	"PHONE"
2	"REDIAL" ^a	"REDIAL" "CONFIRM YES OR NO"
3	"YES"	"DIALLING"
	"NO"	"COMMAND CANCELLED"

a) Can be used as a shortcut.

DTMF (Tone dialling)

This function transfers spoken numbers into DTMF tones, i.e. to make a remote enquiry to your home answering machine.

Note: DTMF can only be used during an ongoing call. Press the VOICE button or the MODE button and wait for the system prompt.

Steps	User says	System answer
1		"NUMBER PLEASE"
2	"<numbers 1 to 9, zero, hash, star>"	

Main settings

Accept and reject calls

Calls can be accepted or rejected using the Voice Control.

Steps	User says	System answer
1	"PHONE"	"PHONE"
2	"ACCEPT CALLS"	"ACCEPT CALLS"

Voice control

Steps	User says	System answer
	"REJECT CALLS"	"REJECT CALLS"

NAVIGATION SYSTEM COMMANDS

Please refer to your separate Navigation manual for details of the command menus.

CLIMATE CONTROL COMMANDS

Climate

The climate voice commands supports the functionality of the fan speed, temperature and mode settings. Not all functions are available on all vehicles.

Overview

The overview below shows the available voice commands for operating your climate control system. The following lists will give further information about the complete command menu.

"CLIMATE"
"HELP"
"FAN" ^a
"DEFROSTING/DEMISTING ON" ^a
"DEFROSTING/DEMISTING OFF" ^a
"TEMPERATURE" ^a
"AUTO MODE" ^a

a) Can be used as a shortcut. On vehicles fitted with an English language module the "FAN" shortcut is not available.

Fan

This function allows you to adjust the fan speed.

Voice control

Steps	User says	System answer
1	"CLIMATE"	"CLIMATE"
2	"FAN" ^a	"FAN SPEED PLEASE"
3	"MINIMUM"	"FAN MINIMUM"
	"<a number between 1 and 7>"	"FAN <number>"
	"MAXIMUM"	"FAN MAXIMUM"

a) Can be used as a shortcut. On vehicles fitted with an English language module the "FAN" shortcut is not available.

Defrosting/Demisting

Steps	User says	System answer
1	"CLIMATE"	"CLIMATE"
2	"DEFROSTING/DEMISTING ON" ^a	"DEFROSTING/DEMISTING ON"
	"DEFROSTING/DEMISTING OFF" ^a	"DEFROSTING/DEMISTING OFF"

a) Can be used as a shortcut.

Temperature

This function allows you to adjust the temperature.

Steps	User says	System answer
1	"CLIMATE"	"CLIMATE"
2	"TEMPERATURE" ^a	"TEMPERATURE PLEASE"
3	"MINIMUM"	"TEMPERATURE MINIMUM"
	"<a number between 15 and 29 °C with 0.5 increments>" or "<a number between 59 and 84 °F>"	"TEMPERATURE <number>"
	"MAXIMUM"	"TEMPERATURE MAXIMUM"

a) Can be used as a shortcut.

Voice control

Auto mode

Steps	User says	System answer
1	"CLIMATE"	"CLIMATE"
2	"AUTO MODE" ^a	"AUTO MODE"

a) Can be used as a shortcut. Can be deactivated by selecting a different temperature or fan speed.





Appendices

ELECTROMAGNETIC COMPATIBILITY

WARNINGS

 Your vehicle has been tested and certified to legislations relating to electromagnetic compatibility (72/245/EEC, UN ECE Regulation 10 or other applicable local requirements). It is your responsibility to ensure that any equipment you have fitted complies with applicable local legislations. Have any equipment fitted by properly trained technicians.

WARNINGS

-  The RF (radio frequency) transmitter equipment (e.g. cellular telephones, amateur radio transmitters etc.) may only be fitted to your vehicle if they comply with the parameters shown in the table below. There are no special provisions or conditions for installations or use.
-  Do not mount any transceiver, microphones, speakers, or any other item in the deployment path of the airbag system.
-  Do not fasten antenna cables to original vehicle wiring, fuel pipes and brake pipes.
-  Keep antenna and power cables at least 10 centimetres (4 inches) from any electronic modules and airbags.

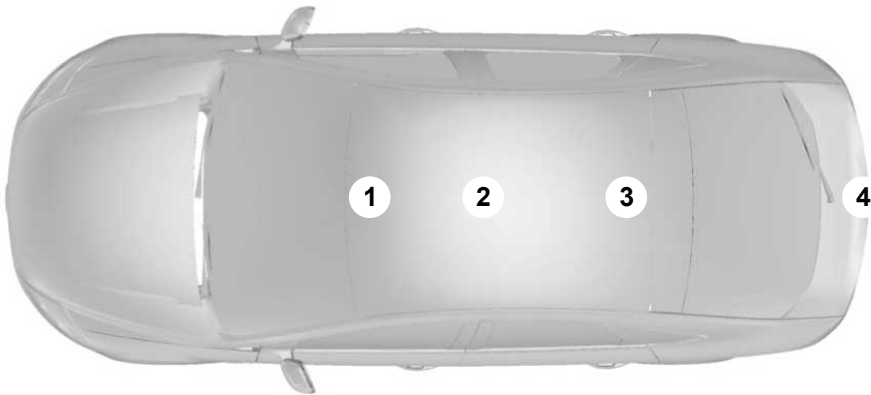

E85998

Frequency Band MHz	Maximum output power Watt (Peak RMS)	Antenna Positions
1 – 30	50 W	3, 4
30 – 54	50 W	1, 2, 3
68 – 87.5	50 W	1, 2, 3

Appendices

Frequency Band MHz	Maximum output power Watt (Peak RMS)	Antenna Positions
142 – 176	50 W	1, 2, 3
380 – 512	50 W	1, 2, 3
806 – 940	10 W	1, 2, 3
1200 – 1400	10 W	1, 2, 3
1710 – 1885	10 W	1, 2, 3
1885 – 2025	10 W	1, 2, 3

Note: After the installation of RF transmitters, check for disturbances from and to all electrical equipment in the vehicle, both in the standby and transmit modes.

Check all electrical equipment:

- with the ignition **ON**
- with the engine running
- during a road test at various speeds.

Check that electromagnetic fields generated inside the vehicle cabin by the transmitter installed do not exceed applicable human exposure requirements.

TYPE APPROVALS

FCC/INDUSTRY CANADA NOTICE

This device complies with Part 15 of the FCC Rules. Operation is subject to the following two conditions: (1) this device may not cause harmful interference, and (2) this device must accept any interference received, including interference that may cause undesired operation.

FCC ID: WJLRX-42

IC: 7847A-RX42

Changes or modifications to your device not expressly approved by the party responsible for compliance can void the user's authority to operate the equipment.

RX-42 - declaration of conformity

We, the party responsible for compliance, declare under our sole responsibility that the Handset Integration product RX-42 is in conformity with the provisions of the following Council Directive: 1999/5/EC. A copy of the Declaration of Conformity can be found at:

www.novero.com/declaration_of_conformity

The Bluetooth word mark and logos are owned by the Bluetooth SIG, Inc. and any use of such marks by Ford Motor Company is under license. Other trademarks and trade names are those of their respective owners.

Index

A

- A/C
See: Climate Control.....58
- About This Manual.....5
- ABS
See: Brakes.....82
- ABS driving hints
See: Hints on Driving With Anti-Lock Brakes.....82
- Accessories
See: Parts and Accessories.....5
- Adjusting the Steering Wheel.....31
- Air Conditioning
See: Climate Control.....58
- Air Vents.....58
- Alarm.....30
- Alternative frequencies.....146
6000CD and 6006CDC.....146
Sony CD.....146
- Appendices.....176
- Arming the alarm.....30
Alarm.....30
Automatic arming delay.....30
- Arming the engine immobiliser.....29
- At a Glance.....8
Adjusting the steering wheel.....10
Audio unit.....12
Autolamps.....13
Automatic climate control.....11
Autowipers.....13
Creating a level load floor.....14
Electric folding mirrors.....13
Engine idle speed after starting.....10
Home safe lighting.....13
Information displays.....11
Instrument panel overview.....8
Locking and unlocking the doors with the remote control.....12
Manual climate control.....11
Welcome lighting.....13
- Audio Control.....31
Mode.....32
Seek.....32
Volume.....31
- Audio distortion reduction (CLIP).....145
6000CD and 6006CDC.....145
Sony CD.....145
- Audio introduction.....131
- Audio menu control.....138
- Audio system security.....136
- Audio troubleshooting.....153
- Audio unit clock and date displays.....137
- Audio unit commands.....164
CD Player/CD Changer.....164
Radio.....165
- Audio unit menus.....145
- Audio unit operation.....138
- Audio unit overview.....132
- Automatic Climate Control.....60
Air distribution.....61
Blower.....61
Recirculated air.....61
Setting the temperature.....61
Switching the air conditioning on and off.....61
Switching the automatic climate control on and off.....62
Windscreen defrosting and demisting.....61
- Automatic Transmission - Vehicles With: 4-Speed Automatic Transmission (4F27E).....79
Drive modes.....80
Emergency park position release lever.....80
Hints on driving with an automatic transmission.....80
Selector lever positions.....79
- Automatic volume control.....145
6000CD and 6006CDC.....145
Sony CD.....145
- Autostore control.....141
6000CD and 6006CDC.....141
Sony CD.....141
- Auxiliary Heater.....62
Diesel auxiliary heater (depending on country).....62
- Auxiliary input (AUX IN) socket.....152

B

- Balance/fade control.....138
6000CD and 6006CDC.....138
Sony CD.....138

Index

Bass/treble control.....	138	Changing a Road Wheel.....	116
6000CD and 6006CDC.....	138	Assembling the wheel brace.....	118
Sony CD.....	138	Installing a road wheel.....	120
Bluetooth setup.....	156	Jacking and lifting points.....	117
Compatibility of phones.....	157	Locking wheel nuts.....	116
Handling of phones.....	157	Removing a road wheel.....	119
Requirements for Bluetooth		Removing the wheel trim.....	119
connection.....	157	Vehicle jack.....	116
Bonnet Lock		Vehicles with a temporary spare	
See: Opening and Closing the Bonnet.....	101	wheel.....	116
Booster cables		Changing the remote control	
See: Jump-Starting the Vehicle.....	114	battery.....	26
Booster Seats.....	16	Changing the Wiper Blades.....	35
Booster cushion (Group 3).....	17	Checking the Wiper Blades.....	35
Booster seat (Group 2).....	16	Child Safety.....	15
Brake and Clutch Fluid Check.....	108	Child Safety Locks.....	19
Brakes.....	82	Child Seat Positioning.....	17
Principle of Operation.....	82	Child Seats.....	15
Bulb changing		Child restraints for different mass	
See: Changing a Bulb.....	42	groups.....	15
Bulb Specification Chart.....	46	Cigar Lighter.....	69
C		Cleaning the Exterior.....	112
Capacities and Specifications.....	127	Body paintwork preservation.....	112
Car Wash		Cleaning the chrome trim.....	112
See: Cleaning the Exterior.....	112	Cleaning the headlamps.....	112
Catalytic Converter.....	75	Cleaning the rear window.....	112
Driving with a catalytic converter.....	75	Cleaning the Interior.....	112
Changing a Bulb.....	42	Instrument cluster screens, LCD screens,	
Central high mounted stop lamp.....	44	radio screens.....	113
Front direction indicators.....	43	Rear windows.....	113
Front fog lamps.....	43	Seat belts.....	112
Headlamp main and dipped beam.....	42	Climate Control.....	58
Interior lamp.....	45	Principle of Operation.....	58
Luggage compartment lamp.....	46	Climate control commands.....	173
Number plate lamp.....	45	Climate.....	173
Reading lamps.....	45	Coded keys.....	29
Rear lamps.....	43	Cold Weather Precautions.....	92
Side lamps.....	42	Compact disc playback.....	149
Side repeaters.....	43	6000CD and 6006CDC.....	149
Changing a Fuse.....	96	Sony CD.....	149
		Compact disc player.....	148
		Compact disc selection.....	149
		6006CDC.....	149
		Compact disc track compression.....	150
		6000CD and 6006CDC.....	150
		Sony CD.....	150

Index

Compact disc track scanning.....	150	Engine number.....	126
6000CD and 6006CDC.....	150	Engine Oil Check.....	107
Sony CD.....	150	Checking the oil level.....	107
Convenience features.....	69	Topping up.....	107
Coolant Check		Engine Oil Dipstick - 1.25L Duratec-16V	
See: Engine Coolant Check.....	107	(Sigma)/1.4L Duratec-16V	
D		(Sigma)/1.6L Duratec-16V	
Digital signal processing (DSP).....	145	(Sigma).....	106
Changing the DSP settings.....	145	Engine Oil Dipstick - 1.4L Duratorq-TDCi	
DSP equaliser.....	145	(DV) Diesel.....	106
DSP occupancy.....	145	Engine Oil Dipstick - 1.6L Duratorq-TDCi	
Dimensions.....	127	(DV) Diesel.....	107
Towing equipment dimensions.....	129	Entering a security code.....	136
Vehicle dimensions.....	127	6000CD and 6006CDC.....	136
Direction Indicators.....	40	Sony CD.....	136
Disabling the passenger airbag.....	23	Exterior Mirrors.....	47
Disabling the passenger airbag.....	23	Manual folding mirrors.....	47
Enabling the passenger airbag.....	24	F	
Fitting the passenger airbag deactivation		Fastening the seat belts.....	22
switch.....	23	Fast forward/reverse.....	149
Disarming the alarm.....	30	6000CD and 6006CDC.....	149
Disarming the engine immobiliser.....	29	Sony CD.....	149
Driving Hints.....	92	First Aid Kit.....	93
Driving Through Water.....	92	Floor Mats.....	71
Driving through water	92	Fog Lamps - Front	
E		See: Front Fog Lamps.....	38
Ejecting compact discs.....	150	Fog Lamps - Rear	
6000CD.....	150	See: Rear Fog Lamps.....	38
6006CDC.....	150	Front Fog Lamps.....	38
Sony CD.....	151	Front Seat Armrest.....	68
Ejecting multiple compact discs	151	Fuel and Refuelling.....	75
6006CD.....	151	Technical Specifications.....	76
Electric exterior mirrors.....	47	Fuel Burning Heater	
Electric folding mirrors.....	48	See: Auxiliary Heater.....	62
Mirror tilting positions.....	48	Fuel Consumption.....	76
Electromagnetic compatibility.....	176	Fuel Consumption	
Ending compact disc playback.....	151	See: Technical Specifications.....	76
6000CD and 6006CDC.....	151	Fuel Cut-Off Switch.....	94
Sony CD.....	151	Vehicles with a Duratec engine.....	94
Engine Coolant Check.....	107	Fuel filler flap.....	76
Checking the coolant level.....	107	Fuel Quality - Diesel.....	75
Topping up.....	108	Long-term storage.....	75
Engine immobiliser.....	29	Fuel Quality - Petrol.....	75
Principle of Operation.....	29	Fuse Box Locations.....	98
		Central fuse box.....	98
		Fuse Labels.....	96

Index

Fuses.....	96	Interior Lamps.....	40
G		Courtesy lamp.....	40
Gauges.....	49	Reading lamps.....	41
Engine coolant temperature gauge.....	49	Introduction.....	5
Fuel gauge.....	50	J	
Gearbox		Jump starting	
See: Transmission.....	78	See: Jump-Starting the Vehicle.....	114
General Driving Points.....	92	Jump-Starting the Vehicle.....	114
Vehicles with a diesel engine.....	92	To connect the booster cables.....	114
General Information on Radio		To start the engine.....	115
Frequencies.....	25	K	
Glove Box.....	69	Keys and Remote Controls.....	25
H		L	
Handbrake		Lighting Control.....	37
See: Parking Brake.....	82	Autolamps.....	37
Hazard Warning Flashers.....	39	Headlamp flasher.....	38
Headlamp Levelling.....	39	Home safe lighting.....	37
Recommended headlamp levelling switch		Main/dipped beam.....	37
positions.....	39	Welcome lighting.....	37
Head Restraints.....	66	Lighting.....	37
Adjusting the head restraint.....	67	Load Carriers	
Removing the head restraint.....	67	See: Roof Racks and Load Carriers.....	86
Heated Seats.....	67	Load Carrying.....	86
Heated Windows and Mirrors.....	62	General Information.....	86
Heated exterior mirrors.....	62	Loading compact discs.....	148
Heated windows.....	62	6000CD.....	148
Heating		6006CDC.....	148
See: Climate Control.....	58	Sony CD.....	148
Hints on Driving With Anti-Lock		Locking and Unlocking.....	27
Brakes.....	82	Automatic relocking.....	28
I		Central locking.....	27
Ignition Switch.....	72	Double locking.....	27
Immobiliser		Locking and unlocking confirmation.....	27
See: Engine immobiliser.....	29	Locking and unlocking the doors with the	
Important audio information.....	131	key.....	27
Audio unit labels.....	131	Locking and unlocking the doors with the	
Disc labels.....	131	remote control.....	28
Incorrect security code.....	136	Reprogramming the unlocking	
Information Displays.....	53	function.....	28
General Information.....	53	Locks.....	27
Information Messages.....	55	Lost security code.....	136
Instrument Cluster.....	49	Luggage Covers.....	86

Index

M

Maintenance.....	100
General Information.....	100
Technical Specifications.....	109
Manual Climate Control.....	58
Air distribution control.....	59
Blower.....	58
Cooling the interior quickly.....	60
Cooling with outside air.....	60
Defrosting and demisting the windscreen.....	59
Heating the interior quickly.....	59
Recirculated air.....	60
Reducing interior air humidity.....	60
Switching the air conditioning on and off.....	59
Temperature control.....	59
Ventilation.....	59
Manual Seats.....	64
Adjusting the angle of the seatback.....	65
Adjusting the height of the driver's seat.....	65
Folding the passenger seat forwards.....	65
Moving the seats backwards and forwards.....	64
Manual Transmission.....	78
5-speed manual transmission.....	78
Durashift EST.....	78
Message Centre	
See: Information Displays.....	53
Mirrors	
See: Heated Windows and Mirrors.....	62
See: Windows and Mirrors.....	47

N

Navigation system commands.....	173
News broadcasts.....	147
6000CD and 6006CDC.....	147
Sony CD.....	147

O

Occupant protection.....	20
Principle of Operation.....	20
Oil Check	
See: Engine Oil Check.....	107

On/off control.....	138
Opening and Closing the Bonnet.....	101
Closing the bonnet.....	101
Opening the bonnet.....	101

P

Parking Aids.....	84
Principle of Operation.....	84
Parking Brake.....	82
Applying the parking brake.....	82
Parking on a hill.....	82
Releasing the parking brake.....	82
Parts and Accessories.....	5
Look for the Ford logo on the following parts.....	6
Now you can be sure that your Ford parts are Ford parts.....	5
Personalised Settings.....	54
Audible warnings.....	54
Audio display.....	54
Direction indicators.....	54
Hazard warning flashers.....	54
Language.....	54
Unlocking the doors with the remote control.....	54
Power Door Locks	
See: Locking and Unlocking.....	27
Power Steering Fluid Check.....	108
Topping up.....	108
Power Windows.....	47
To open the driver's window automatically.....	47
Programming the remote control.....	25
Re-programming the unlocking function.....	25

R

Rear Fog Lamps.....	38
Rear Seat Armrest.....	71
Activity console.....	71
Rear Seats.....	65
Creating a level load floor.....	66
Folding the seatbacks down.....	66

Index

Rear Window Wiper and Washers.....	34
Intermittent wiping.....	34
Reverse gear wipe.....	34
Washer.....	35
Refuelling.....	76
Regional mode (REG).....	146
6000CD and 6006CDC.....	146
Sony CD.....	147
Remote control battery	
See: Changing the remote control battery.....	26
Remote control programming	
See: Programming the remote control.....	25
Removing a Headlamp.....	41
Repairing Minor Paint Damage.....	113
Repeat compact disc tracks.....	151
6000CD.....	151
6006CDC.....	151
Sony CD.....	151
Roadside Emergencies.....	93
Roof Racks and Load Carriers.....	86
Roof rack.....	86
Running-In.....	92
Brakes and clutch.....	92
Engine.....	92
Tyres.....	92

S

Safety Precautions.....	75
Seat belt height adjustment.....	22
Seat belts	
See: Fastening the seat belts.....	22
Seats.....	64
Security code.....	136
Setting the clock and date on the audio unit.....	137
6000CD and 6006CDC.....	137
Sony CD.....	137
Shuffle/random.....	149
6000CD and 6006CDC.....	149
Sony CD.....	150
Sitting in the Correct Position.....	64
Snow Chains	
See: Using Snow Chains.....	124
Stability Control.....	83
Principle of Operation.....	83

Starter Switch	
See: Ignition Switch.....	72
Starting a Diesel Engine.....	73
Cold or hot engine.....	73
Starting and Stopping the Engine.....	72
General Information.....	72
Starting a Petrol Engine.....	72
Cold or hot engine.....	72
Engine idle speed after starting.....	73
Flooded engine.....	73
Station preset buttons.....	141
Station tuning control.....	143
DAB service linking.....	143
Manual tuning.....	143
Scan tuning.....	143
Seek tuning.....	143
Status after a collision.....	94
Steering Wheel.....	31
Storage compartments.....	69
Storage box.....	69
Storage pockets.....	70
Sunroof.....	62
Switching Off the Engine.....	74
Vehicles with a turbocharger.....	74
Symbols Glossary.....	5
Symbols in this handbook.....	5
Symbols on your vehicle.....	5

T

Technical Specifications	
See: Capacities and Specifications.....	127
Telephone commands.....	168
Create a phonebook.....	169
Main settings.....	172
Phone.....	168
Phone functions.....	170
Telephone controls.....	157
Ending or rejecting calls.....	157
Remote control.....	157
Telephone setup.....	155
Bond another Bluetooth phone.....	156
Making a phone an active phone.....	156
Phonebook.....	155
Phonebook categories.....	156
Placing your phone in the cradle.....	155
Requirements for cradle connection.....	155

Index

Telephone.....	155
General Information.....	155
Telephone	
See: Using the telephone - Vehicles With:	
Travel Pilot EX.....	161
See: Using the telephone - Vehicles Without:	
Navigation System.....	158
Tow Ball.....	88
Driving with a trailer.....	90
Driving without a trailer.....	90
Inserting the tow ball arm.....	89
Maintenance.....	91
Removing the tow ball arm.....	90
Unlocking the tow ball arm	
mechanism.....	89
Towing a Trailer.....	88
Steep gradients.....	88
Towing Points.....	99
Front towing eye.....	99
Towing the Vehicle on Four Wheels.....	99
All vehicles.....	99
Vehicles with a Durashift EST.....	99
Vehicles with an automatic	
transmission.....	99
Towing.....	88
Track selection.....	148
6000CD and 6006CDC.....	148
Sony CD.....	148
Traffic information control.....	141
Activating traffic announcements.....	141
Ending traffic announcements.....	142
Local or distant traffic.....	142
To adjust the preset volume.....	142
Traffic announcement volume.....	142
Transmission.....	78
Type approvals.....	177
FCC/INDUSTRY CANADA NOTICE.....	177
RX-42 - declaration of conformity.....	177
Tyre Care.....	124
Tyre Pressures	
See: Technical Specifications.....	125
Tyre Repair Kit.....	121
General information.....	121
Inflating the tyre.....	122
Using the tyre repair kit.....	121
Tyres	
See: Wheels and Tyres.....	116

U

Under Bonnet Overview - 1.25L	
Duratec-16V (Sigma)/1.4L Duratec-16V	
(Sigma)/1.6L Duratec-16V	
(Sigma).....	102
Under Bonnet Overview - 1.4L	
Duratorq-TDCi (DV) Diesel.....	104
Under Bonnet Overview - 1.6L	
Duratorq-TDCi (DV) Diesel.....	105
Using seat belts during pregnancy.....	23
Using Snow Chains.....	124
Vehicles with stability control (ESP).....	125
Using Stability Control.....	83
Using the Parking Aid.....	84
Manoeuvring with the parking aid.....	84
Switching the parking aid on and off.....	84
Using the telephone - Vehicles With:	
Travel Pilot EX.....	161
Changing the active phone.....	162
Debonding a bonded phone.....	162
Handling an incoming call.....	161
Handling a second incoming call.....	162
Making a call.....	161
Using the telephone - Vehicles Without:	
Navigation System.....	158
Changing the active phone.....	160
Debonding a bonded phone.....	160
Handling a second incoming call.....	160
Making a call.....	159
Receiving an incoming call.....	159
Using voice control.....	163
System operation.....	163
Using Winter Tyres.....	124

V

Vehicle battery.....	114
Vehicle care.....	112
Vehicle Identification Number.....	126
Vehicle Identification Plate.....	126
Vehicle identification.....	126
Vehicle recovery.....	99
Ventilation	
See: Climate Control.....	58
Vents	
See: Air Vents.....	58

Index

VIN	
See: Vehicle Identification Number.....	126
Voice control.....	163
Principle of Operation.....	163

W

Warning Lamps and Indicators.....	50
ABS warning lamp.....	50
Airbag warning lamp.....	50
Brake system lamp.....	50
Direction indicator.....	50
Door open warning lamp.....	50
Engine warning lamp.....	51
Front fog lamp indicator.....	51
Frost warning lamp.....	51
Glow plug indicator.....	51
Headlamp indicator.....	51
Ignition warning lamp.....	51
Low fuel level warning lamp.....	51
Main beam indicator.....	51
Oil pressure warning lamp.....	51
Overdrive indicator.....	51
Power steering warning lamp.....	51
Powertrain warning lamp.....	52
Rear fog lamp indicator.....	52
Stability control (ESP) warning lamp.....	52
Warning Triangle.....	93
Washer Fluid Check.....	109
Washers	
See: Wipers and Washers.....	33
Washing	
See: Cleaning the Exterior.....	112
Waveband button.....	141
6000CD and 6006CDC	141
Sony CD.....	141
Wheels and Tyres.....	116
General Information.....	116
Technical Specifications.....	125
Windows and Mirrors.....	47
Windscreen Washers.....	34
Windscreen Wipers.....	33
Autowipers.....	33
Intermittent wiping.....	33
Winter Tyres	
See: Using Winter Tyres.....	124
Wipers and Washers.....	33

(CG3441en)