

Table of Contents

Introduction	4
Instrument Cluster	10
Warning lights and chimes	10
Gauges	13
Entertainment Systems	15
AM/FM stereo cassette	15
AM/FM stereo with CD	18
CD changer	20
Climate Controls	23
Manual heating and air conditioning	23
Automatic temperature control	25
Rear window defroster	27
Lights	29
Headlamps	29
Turn signal control	32
Bulb replacement	34
Driver Controls	41
Windshield wiper/washer control	41
Steering wheel adjustment	41
Power windows	43
Mirrors	45
Speed control	45
Moon roof	48
Message center	53
Locks and Security	63
Keys	63
Locks	63
Anti-theft system	72

Table of Contents

Seating and Safety Restraints	77
Seating	77
Safety restraints	81
Airbags	97
Child restraints	107
Tires, Wheels and Loading	120
Tire Information	120
Tire Inflation	122
Vehicle loading	134
Trailer towing	140
Recreational towing	143
Driving	144
Starting	144
Brakes	148
Traction control	150
Transmission operation	152
Roadside Emergencies	157
Getting roadside assistance	157
Hazard flasher switch	159
Fuel pump shut-off switch	159
Fuses and relays	160
Changing tires	166
Lug Nut Torque	171
Jump starting	172
Wrecker towing	177
Customer Assistance	178
Reporting safety defects (U.S. only)	184
Cleaning	185

Table of Contents

Maintenance and Specifications	191
Engine compartment	193
Engine oil	195
Battery	198
Engine Coolant	200
Fuel information	205
Part numbers	218
Maintenance product specifications and capacities	220
Engine data	222
Accessories	225
Index	227

All rights reserved. Reproduction by any means, electronic or mechanical including photocopying, recording or by any information storage and retrieval system or translation in whole or part is not permitted without written authorization from Ford Motor Company. Ford may change the contents without notice and without incurring obligation.

Copyright © 2006 Ford Motor Company

Introduction

CALIFORNIA Proposition 65 Warning



WARNING: Engine exhaust, some of its constituents, and certain vehicle components contain or emit chemicals known to the State of California to cause cancer and birth defects or other reproductive harm. In addition, certain fluids contained in vehicles and certain products of component wear contain or emit chemicals known to the State of California to cause cancer and birth defects or other reproductive harm.

CONGRATULATIONS

Congratulations on acquiring your new Ford Motor Company product. Please take the time to get well acquainted with your vehicle by reading this handbook. The more you know and understand about your vehicle, the greater the safety and pleasure you will derive from driving it.

For more information on Ford Motor Company and its products visit the following website:

- In the United States: www.ford.com
- In Canada: www.ford.ca
- In Mexico: www.ford.com.mx
- In Australia: www.ford.com.au

Additional owner information is given in separate publications.

This vehicle's *Owner's Guide* describes every option and model variant available and therefore some of the items covered may not apply to your particular vehicle. Furthermore, due to printing cycles it may describe options before they are generally available.

Remember to pass on this vehicle's *Owner's Guide* when reselling the vehicle. It is an integral part of the vehicle.



Fuel pump shut-off switch: In the event of an accident the safety switch will automatically cut off the fuel supply to the engine. The switch can also be activated through sudden vibration (e.g. collision when parking). To reset the switch, refer to the *Fuel pump shut-off switch* in the *Roadside Emergencies* chapter.

SAFETY AND ENVIRONMENT PROTECTION



Warning symbols in this guide

How can you reduce the risk of personal injury to yourself or others? In this guide, answers to such questions are contained in comments highlighted by the warning triangle symbol. These comments should be read and observed.

Introduction

Warning symbols on your vehicle

When you see this symbol, it is imperative that you consult the relevant section of this guide before touching or attempting adjustment of any kind.



Protecting the environment

We must all play our part in protecting the environment. Correct vehicle usage and the authorized disposal of waste, cleaning and lubrication materials are significant steps towards this aim. Information in this respect is highlighted in this guide with the tree symbol.



BREAKING-IN YOUR VEHICLE

Your vehicle does not need an extensive break-in. Try not to drive continuously at the same speed for the first 1,000 miles (1,600 km) of new vehicle operation. Vary your speed frequently in order to give the moving parts a chance to break in.

Drive your new vehicle at least 500 miles (800 km) before towing a trailer. For more detailed information about towing a trailer, refer to *Trailer towing* in the *Tires, Wheels and Loading* chapter.

Do not add friction modifier compounds or special break-in oils since these additives may prevent piston ring seating. See *Engine oil* in the *Maintenance and Specifications* chapter for more information on oil usage.

SPECIAL NOTICES

New Vehicle Limited Warranty

For a detailed description of what is covered and what is not covered by your vehicle's New Vehicle Limited Warranty, refer to the *Warranty Guide* that is provided to you along with your *Owner's Guide*.

Special instructions

For your added safety, your vehicle is fitted with sophisticated electronic controls.

Introduction

 Please read the section *Supplemental restraint system (SRS)* in the *Seating and Safety Restraints* chapter. Failure to follow the specific warnings and instructions could result in personal injury.

 Front seat mounted rear-facing child or infant seats should **NEVER** be placed in front of an active passenger airbag.

Service Data Recording

Service data recorders in your vehicle are capable of collecting and storing diagnostic information about your vehicle. This potentially includes information about the performance or status of various systems and modules in the vehicle, such as engine, throttle, steering or brake systems. In order to properly diagnose and service your vehicle, Ford Motor Company, Ford of Canada, and service and repair facilities may access vehicle diagnostic information through a direct connection to your vehicle when diagnosing or servicing your vehicle.

Event Data Recording

Other modules in your vehicle — event data recorders — are capable of collecting and storing data during a crash or near crash event. The recorded information may assist in the investigation of such an event. The modules may record information about both the vehicle and the occupants, potentially including information such as:

- how various systems in your vehicle were operating;
- whether or not the driver and passenger seatbelts were buckled;
- how far (if at all) the driver was depressing the accelerator and/or the brake pedal;
- how fast the vehicle was traveling; and
- where the driver was positioning the steering wheel.

To access this information, special equipment must be directly connected to the recording modules. Ford Motor Company and Ford of Canada do not access event data recorder information without obtaining consent, unless pursuant to court order or where required by law enforcement, other government authorities or other third parties acting with lawful authority. Other parties may seek to access the information independently of Ford Motor Company and Ford of Canada.

Introduction

Cell phone use

The use of Mobile Communications Equipment has become increasingly important in the conduct of business and personal affairs. However, drivers must not compromise their own or others' safety when using such equipment. Mobile Communications can enhance personal safety and security when appropriately used, particularly in emergency situations. Safety must be paramount when using mobile communications equipment to avoid negating these benefits.

Mobile Communication Equipment includes, but is not limited to cellular phones, pagers, portable email devices, in-vehicle communications systems, telematics devices and portable two-way radios.



A driver's first responsibility is the safe operation of the vehicle. The most important thing you can do to prevent a crash is to avoid distractions and pay attention to the road. Wait until it is safe to operate Mobile Communications Equipment.







Middle East/North Africa vehicle specific information

For your particular global region, your vehicle may be equipped with features and options that are different from the ones that are described in this *Owner's Guide*; therefore, a supplement has been supplied that complements this book. By referring to the pages in the provided supplement, you can properly identify those features, recommendations and specifications that are unique to your vehicle. **Refer to this Owner's Guide for all other required information and warnings.**

Introduction























These are some of the symbols you may see on your vehicle.

Vehicle Symbol Glossary

Safety Alert		See Owner's Guide	
Fasten Safety Belt		Airbag - Front	
Airbag - Side		Child Seat	
Child Seat Installation Warning		Child Seat Lower Anchor	
Child Seat Tether Anchor		Brake System	
Anti-Lock Brake System		Brake Fluid - Non-Petroleum Based	
Powertrain Malfunction		Speed Control	
Master Lighting Switch		Hazard Warning Flasher	
Fog Lamps-Front		Fuse Compartment	
Fuel Pump Reset		Windshield Wash/Wipe	
Windshield Defrost/Demist		Rear Window Defrost/Demist	

Introduction

Vehicle Symbol Glossary

Power Windows Front/Rear		Power Window Lockout	
Child Safety Door Lock/Unlock		Interior Luggage Compartment Release Symbol	
Panic Alarm		Engine Oil	
Engine Coolant		Engine Coolant Temperature	
Do Not Open When Hot		Battery	
Avoid Smoking, Flames, or Sparks		Battery Acid	
Explosive Gas		Fan Warning	
Power Steering Fluid		Maintain Correct Fluid Level	
Emission System		Engine Air Filter	
Passenger Compartment Air Filter		Jack	
Check Fuel Cap		Low Tire Pressure Warning	

Instrument Cluster

WARNING LIGHTS AND CHIMES

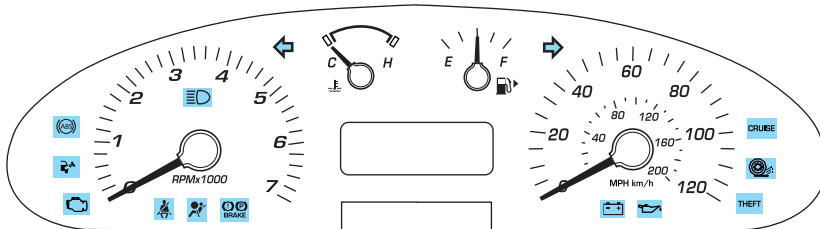

Warning lights and gauges can alert you to a vehicle condition that may become serious enough to cause expensive repairs. A warning light may illuminate when a problem exists with one of your vehicle's functions. Many lights will illuminate when you start your vehicle to make sure the bulb works. If any light remains on after starting the vehicle, refer to the respective system warning light for additional information.

Service engine soon: The *Service engine soon* indicator light illuminates when the ignition is first turned to the ON position to check the bulb. Solid illumination after the engine is started indicates the On Board Diagnostics System (OBD-II) has detected a malfunction. Refer to *On board diagnostics (OBD-II)* in the *Maintenance and Specifications* chapter. If the light is blinking, engine misfire is occurring which could damage your catalytic converter. Drive in a moderate fashion (avoid heavy acceleration and deceleration) and have your vehicle serviced immediately by your authorized dealer.



 Under engine misfire conditions, excessive exhaust temperatures could damage the catalytic converter, the fuel system, interior floor coverings or other vehicle components, possibly causing a fire.

Check fuel cap: Illuminates when the fuel cap may not be properly installed. Continued driving with this light on may cause the Service engine soon warning light to come on. Refer to *Fuel filler cap* in the *Maintenance and Specifications* chapter.



Instrument Cluster

Brake system warning light: To confirm the brake system warning light is functional, it will momentarily illuminate when the ignition is turned to the ON position when the engine is not running, or in a position between ON and START, or by applying the parking brake when the ignition is turned to the ON position. If the brake system warning light does not illuminate at this time, seek service immediately from your authorized dealer. Illumination after releasing the parking brake indicates low brake fluid level and the brake system should be inspected immediately by your authorized dealer.



 Driving a vehicle with the brake system warning light on is dangerous. A significant decrease in braking performance may occur. It will take you longer to stop the vehicle. Have the vehicle checked by your authorized dealer.

Anti-lock brake system (if equipped): If the ABS light stays illuminated or continues to flash, a malfunction has been detected, have the system serviced immediately by your authorized dealer. Normal braking is still functional unless the brake warning light also is illuminated.



Airbag readiness: If this light fails to illuminate when ignition is turned to ON, continues to flash or remains on, have the system serviced immediately by your authorized dealer. A chime will also sound when a malfunction in the supplemental restraint system has been detected.



Safety belt: Reminds you to fasten your safety belt. A chime will also sound to remind you to fasten your safety belt.



Charging system: Illuminates when the battery is not charging properly.



Instrument Cluster

Engine oil pressure: Illuminates when the oil pressure falls below the normal range, refer to *Engine oil* in the *Maintenance and Specifications* chapter.

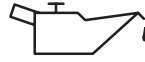

Traction Control™ active (if equipped): Flashes when the Traction Control™ is active. If the light remains on a malfunction has been detected; have the system serviced immediately, refer to the *Driving* chapter for more information.



Speed control: Illuminates when the speed control is activated. Turns off when the speed control system is deactivated.

CRUISE

SecuriLock™ Anti-theft system: Flashes when the SecuriLock™ Passive Anti-theft System has been activated. Refer to *SecuriLock™ Passive Anti-theft System* in the *Locks and Security* chapter.

THEFT

Turn signal: Illuminates when the left or right turn signal or the hazard lights are turned on. If the indicators stay on or flash faster, check for a burned out bulb.



High beams: Illuminates when the high beam headlamps are turned on.



Key-in-ignition warning chime: Sounds when the key is left in the ignition in the OFF/LOCK or ACCESSORY position and the driver's door is opened.

Headlamps on warning chime: Sounds when the headlamps or parking lamps are on, the ignition is off (the key is not in the ignition) and the driver's door is opened.

Instrument Cluster

GAUGES

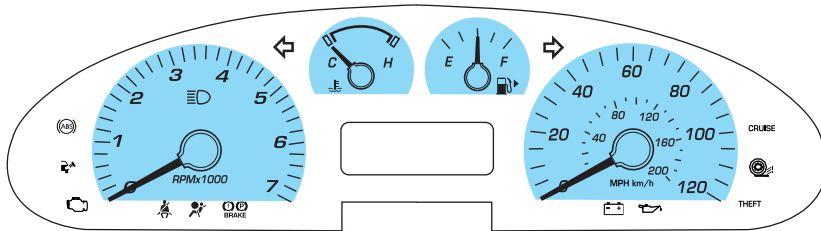

Speedometer: Indicates the current vehicle speed.

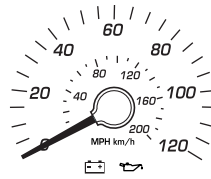

Engine coolant temperature gauge: Indicates engine coolant temperature. At normal operating temperature, the needle will be in the normal range (between “H” and “C”). **If it enters the red section, the engine is overheating. Stop the vehicle as soon as safely possible, switch off the engine and let the engine cool.**

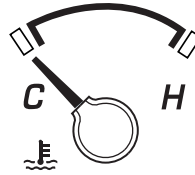

Never remove the coolant reservoir cap while the engine is running or hot.

Instrument Cluster

Tachometer: Indicates the engine speed in revolutions per minute. Driving with your tachometer pointer continuously at the top of the scale may damage the engine.

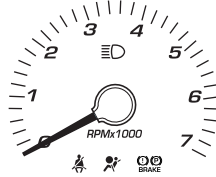

Fuel gauge: Indicates approximately how much fuel is left in the fuel tank (when the ignition is in the ON position). The fuel gauge may vary slightly when the vehicle is in motion or on a grade.

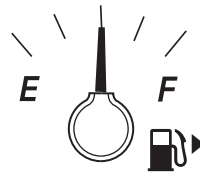

The FUEL icon and arrow indicates which side of the vehicle the fuel filler door is located.

Refer to *Filling the tank* in the *Maintenance and Specifications* chapter for more information.

Odometer: Registers the total miles (kilometers) of the vehicle. Note: When the odometer shows over 10,000 miles the tenths drop off the display.

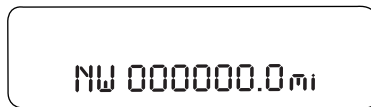

Refer to *Message Center* in the *Drivers Controls* chapter on how to switch the display from Metric to English.

Trip odometer: Registers the miles (kilometers) of individual journeys. Press and release the message center INFO button until "TRIP" appears in the display (this represents the trip mode). Press

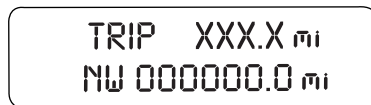

and hold the RESET button for three seconds to reset.

Entertainment Systems

AUDIO SYSTEMS

AM/FM stereo cassette/MACH® AUDIO SYSTEM with AM/FM stereo cassette (if equipped)

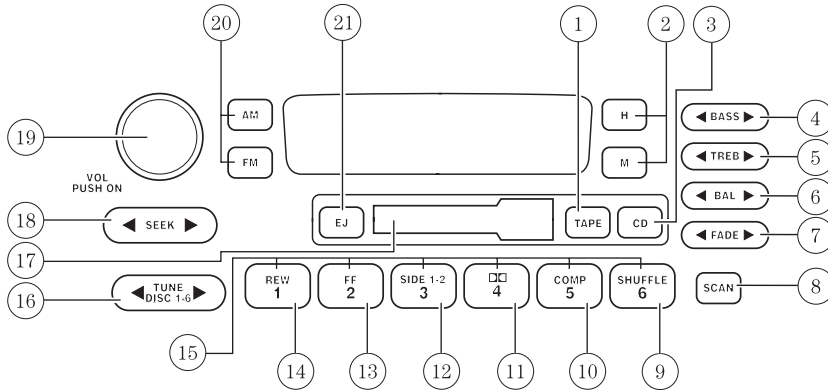

1. **Tape:** Insert the cassette with the opening to the right. If a tape is already inserted into the system, press **TAPE** to begin tape play.



2. **Clock:** To set the hour, press and hold the H control. When the desired hour appears, release the control.



To set the minute, press and hold the M control. When the desired minute appears, release the control.



3. **CD:** Press to play the CD (if equipped).



Note: This system is CDDJ compatible, but CDDJ is an option with limited availability as defined in the order guide.

4. **Bass:** Press ◀ / ▶ to decrease/increase the bass output.



Entertainment Systems

5. **Treble:** Press ◀ / ▶ to decrease/increase the treble output.



6. **Balance:** Press ◀ / ▶ to shift sound to the left/right speakers.



7. **Fade:** Press ◀ / ▶ to shift sound to the rear/front speakers.



8. **Scan:** Press SCAN to hear a brief sampling of all listenable radio stations, tape or CD selections. Press again to stop.



9. **Shuffle:** Press to play CD tracks in random order.



10. **COMP (compression):** While playing a CD, press to bring soft and loud passages together for a more consistent listening level.



11. **Dolby® noise reduction:** Reduces tape noise and hiss while playing a tape, press to activate/deactivate.



12. **Side 1-2:** Press to change tape direction.



13. **FF (fast forward):** Press to advance the tape or CD.



14. **REW (rewind):** Press to rewind the tape or reverse the CD.



15. **Memory preset buttons:** To set a station: Select frequency band AM/FM1/FM2; tune to a station, press and hold a preset button until sound returns.



Entertainment Systems

16. **Tune:** Works in radio mode or CD mode. Press ◀ / ▶ to change frequency down/up or previous/next disc.



17. **Cassette door:** Insert a cassette into the cassette door.



18. **Seek:** Press and release ◀ / ▶ for previous/next listenable radio station, tape selection or CD track.



19. **Power/volume:** Press to turn ON/OFF; turn to increase or decrease volume levels.

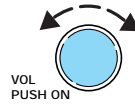

20. **AM/FM:** Press to choose a frequency band in radio mode (AM/FM1/FM2).



21. **EJ (Eject):** Press to eject a tape.



Entertainment Systems

Audio System with AM/FM Stereo/Single CD Player (if equipped)

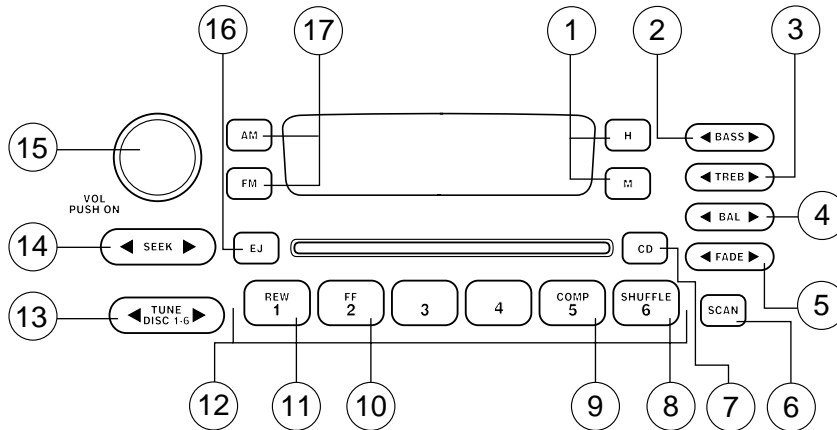

1. **Clock:** To set the hour, press and hold the H control. When the desired hour appears, release the control.

To set the minute, press and hold the M control. When the desired minute appears, release the control.

2. **Bass:** Press ◀ / ▶ to decrease/increase the bass output.

3. **Treble:** Press ◀ / ▶ to decrease/increase the treble output.

4. **Balance:** Press ◀ / ▶ to shift sound to the left/right speakers.

5. **Fade:** Press ◀ / ▶ to shift sound to the rear/front speakers.



Entertainment Systems

6. **Scan:** Press to hear a brief sampling of all listenable radio stations or CD tracks. Press again to stop.



7. **CD:** Press to play a CD. Press again to toggle between single CD mode and CD Changer mode (if equipped).



8. **Shuffle:** Press to play CD tracks in random order.



9. **COMP (compression):** Press to bring soft and loud passages together for a more consistent listening level.



10. **FF (fast forward):** Press and hold until desired selection is reached.



11. **REW (rewind):** Press and hold until desired selection is reached.



12. **Memory preset buttons:** To set a station: Select frequency band AM/FM; tune to a station, press and hold a preset button until sound returns.



13. **Tune:** Press ◀ / ▶ to change radio frequency down/up. With CD changer (if equipped), press to select the previous/next CD.



14. **Seek:** Press and release ◀ / ▶ for previous/next listenable radio station or previous/next CD track.



15. **Power/volume:** Press to turn ON/OFF; turn to increase or decrease volume levels.

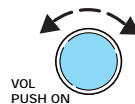

Entertainment Systems

16. **EJ (Eject):** Press to eject a CD.



17. **AM/FM:** Press to choose a frequency band (AM/FM1/FM2).



CD changer (if equipped)

Your CD changer is either located in the trunk or the center console.

1. Slide the door to access the CD changer magazine.
2. Press  to eject the magazine.

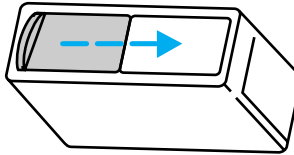

3. Turn the magazine (A) over.
4. Using the disc holder release knob (C), pull the disc holder (B) out of the magazine.

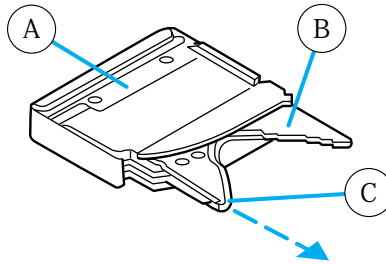

Do not pull too hard on the disc holder as the disc holder may come completely out of the magazine. If this happens, reinsert the disc holder back into the magazine while pressing on the lever.

Entertainment Systems

- Line up the CD with the groove of the disc holder. Ensure that the label on the CD faces downwards.
- Press the disc holder until it locks securely into the magazine.

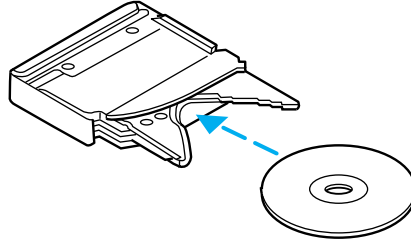

Ensure that the disc holder is evenly inserted and at the same level as the magazine (A). The unit will not operate if the disc holder is not inserted at the same level (B).

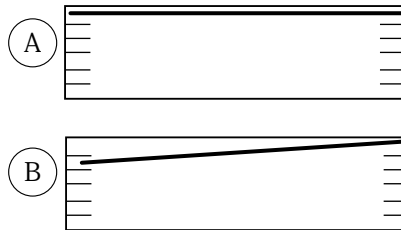

GENERAL AUDIO INFORMATION

Radio frequencies: AM and FM frequencies are established by the Federal Communications Commission (FCC) and the Canadian Radio and Telecommunications Commission (CRTC). Those frequencies are:

AM - 530, 540–1700, 1710 kHz

FM- 87.7, 87.9–107.7, 107.9 MHz

Radio reception factors: There are three factors that can affect radio reception:

- Distance/strength: The further you travel from a station, the weaker the signal and the weaker the reception.
- Terrain: Hills, mountains, tall buildings, power lines, electric fences, traffic lights and thunderstorms can interfere with your reception.
- Station overload: When you pass a broadcast tower, a stronger signal may overtake a weaker one and play while the weak station frequency is displayed.

Cassette/player care:

Do:

- Use only cassettes that are 90 minutes long or less.
- Tighten very loose tapes by inserting a finger or pencil into the hole and turning the hub.

Entertainment Systems

- Remove loose labels before inserting tapes.
- Allow tapes which have been subjected to extreme heat, humidity or cold to reach a moderate temperature before playing.
- Clean the cassette player head with a cassette cleaning cartridge after 10–12 hours of play to maintain good sound/operation.

Don't:

- Expose tapes to direct sunlight, extreme humidity, heat or cold.
- Leave tapes in the cassette player for a long time when not being played.

CD/CD player care:

Do:

- Handle discs by their edges only. Never touch the playing surface.
- Inspect discs before playing. Clean only with an approved CD cleaner and wipe from the center out.

Don't:

- Expose discs to direct sunlight or heat sources for extended periods of time.
- Clean using a circular motion.

CD units are designed to play commercially pressed 4.75 in (12 cm) audio compact discs only. Due to technical incompatibility, certain recordable and re-recordable compact discs may not function correctly when used in Ford CD players. Dirty, warped or damaged CDs, irregular shaped CDs, CDs with a scratch protection film attached, and CDs with homemade paper (adhesive) labels should not be inserted into the CD player. The label may peel and cause the CD to become jammed. It is recommended that homemade CDs be identified with permanent felt tip marker rather than adhesive labels. Ballpoint pens may damage CDs. Please contact your authorized dealer for further information.

Audio system warranty and service: Refer to the *Warranty Guide* for audio system warranty information. If service is necessary, see your dealer or qualified technician.

Climate Controls

MANUAL HEATING AND AIR CONDITIONING SYSTEM (IF EQUIPPED)

1. Temperature selection:

Controls the temperature of the airflow in the vehicle.

2. Passenger airbag indicator

light: Refer to *Front passenger sensing system* in the *Seating and Safety Restraints* chapter.

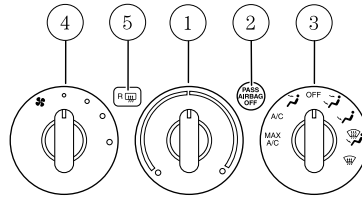

3. Air flow selections:

Controls the direction of the airflow in the vehicle. See the following for a brief description on each control.

MAX A/C: Distributes recirculated air through the instrument panel registers to cool the vehicle. This re-cooling of the interior air is more economical and efficient. Recirculated air may also help reduce undesirable odors from entering the vehicle.

A/C: Distributes outside air through the instrument panel vents to cool the vehicle.

 : Distributes outside air through the instrument panel vents.

OFF: Outside air is shut out and the climate system is turned off.

 : Distributes air through the instrument panel and floor vents.

 : Distributes air through the floor vents.

 : Distributes air through the windshield defroster vents and floor vents.

 : Distributes outside air through the windshield defroster vents. Can be used to clear the windshield of fog and thin ice.

4. **Fan speed adjustment:** Controls the volume of air circulated in the vehicle.

5. **Rear defroster control:** Press



to activate/deactivate the rear

window defroster. For more

information, refer to *Rear window defroster* later in this chapter.

Climate Controls

Operating tips

- To reduce fog build up on the windshield during humid weather, place the air flow selector in the  position.
- To reduce humidity buildup within the cabin, do not drive with the selector in the OFF or MAX A/C position when outside temperature is below 40°F (3°C).
- To improve A/C cool down, drive with the windows slightly open for the first 2–3 minutes after starting the vehicle or until the vehicle has “aired out.”
- Do not put objects under the front seats that will interfere with the airflow to the back seats.
- Remove any snow, ice or leaves from the air intake area at the base of the windshield.
- For best cooling results when using the MAX A/C mode, move the temperature control to full cold and initially set the fan to highest speed, then adjust the temperature and fan to maintain comfort.

To aid in side window defogging/demisting in cold weather:

1. Select .
2. Adjust the temperature control to maintain comfort.
3. Set the fan speed to the highest setting.
4. Direct the outer instrument panel vents towards the side windows.

To increase airflow to the outer instrument panel vents, close the vents located in the middle of the instrument panel.



Do not place objects on top of the instrument panel as these objects may become projectiles in a collision or sudden stop.

Climate Controls

AUTOMATIC TEMPERATURE CONTROL SYSTEM (IF EQUIPPED)

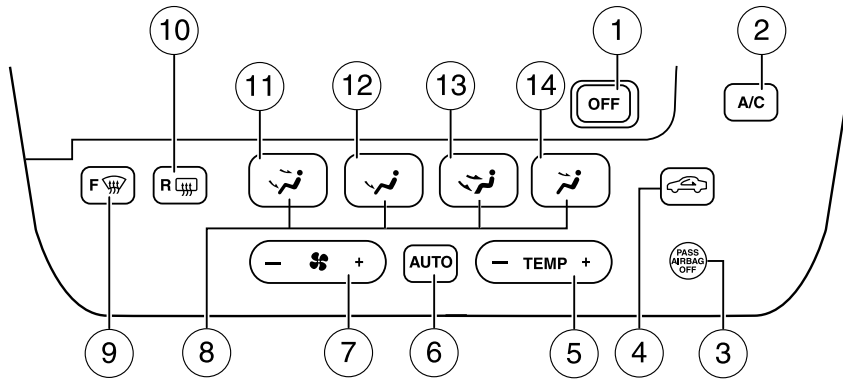

1. **OFF:** Outside air is shut out and the climate control system is turned off.



2. **A/C:** Press to activate/deactivate air conditioning. Use with the recirculated air to improve cooling performance and efficiency. Engages automatically in the AUTO, **F** (defrost) and (floor/defrost) modes.

3. **Passenger airbag off:** Refer to *Front passenger sensing system* in the *Seating and Safety Restraints* chapter.

4. **Recirculated air:** Press to activate/deactivate air circulation in cabin. Recirculated air may reduce the amount of time to cool down the vehicle and may also help reduce undesired odors from reaching the interior of the vehicle. Recirculation can be engaged manually in any airflow selection except **F** (defrost). Recirculation may turn off automatically in all airflow selections.

5. **Temperature control:** Press to increase or decrease the temperature in the cabin. **Note:** The recommended vehicle cabin setting is between 72°F (22°C) and 75°F (24°C).



Climate Controls

6. **AUTO:** Press to engage full automatic operation, and select the desired temperature using the temperature control. The system will automatically determine fan speed, airflow location, A/C on or off, and outside or recirculated air, to heat or cool the vehicle to reach the desired temperature.



7. **Fan Speed:** Press to manually increase/decrease fan speed. To return to automatic fan operation, select AUTO.



8. **Manual override controls:** Allows you to change the system operation. To return to full automatic control, press AUTO.

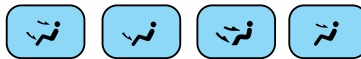

9. **F** : Distributes outside air through the windshield defroster vents. Can be used to clear thin ice or fog from the windshield.



10. **R** (**Rear defroster**): Press to activate/deactivate rear window defroster. For more information, refer to *Rear window defroster* in this chapter.



11. : Distributes air through the windshield defroster vents and floor vents.

12. : Distributes air through the floor and rear seat floor vents (if equipped).

13. : Distributes air through the instrument panel registers and the front and rear seat floor vents.





14. : Distributes air through the instrument panel registers.

Fahrenheit/Celsius temperature: Press A/C and **F** controls at the same time, to toggle between Fahrenheit and Celsius temperature. The set point temperatures in Celsius will be displayed in one degree increments.

Operating tips

- To reduce fog build up on the windshield during humid weather, place the air flow selector in the position.

Climate Controls

- To reduce humidity build up inside the vehicle, **do not** drive with the airflow selector in the OFF position, or with  (recirculated air) engaged without A/C engaged as well.
- Do not put objects under the front seats that will interfere with the airflow to the back seats.
- Remove any snow, ice or leaves from the air intake area at the base of the windshield.
- For maximum cooling in the AUTO mode, press AUTO and set to desired temperature; do not press A/C or  (recirculated air). In the manual override mode, press ,  and A/C, then set the temperature to 60°F (16°C) and the fan to the highest setting.
- To improve the A/C cool down of the vehicle cabin, drive with the windows slightly open for the first 2-3 minutes after starting the vehicle or until the vehicle has “aired out.”

To aid in side window defogging/demisting in cold weather:

1. Select .
2. Select A/C.
3. Adjust the temperature control to maintain comfort.
4. Set the fan speed to the highest setting.
5. Direct the outer instrument panel vents towards the side windows.

To increase airflow to the outer instrument panel vents, close the vents located in the middle of the instrument panel.



Do not place objects on top of the instrument panel as these objects may become projectiles in a collision or sudden stop.

REAR WINDOW DEFROSTER

The rear defroster control is located on the instrument panel.

Press the rear defroster control to clear the rear window of thin ice and fog.

- A small LED will illuminate when the rear defroster is activated.

The ignition must be in the ON position to operate the rear window defroster.

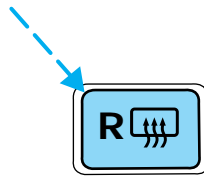

Climate Controls

The defroster turns off automatically after 10 minutes or when the ignition is turned to the OFF position. To manually turn off the defroster before 10 minutes have passed, push the control again.

Do not use razor blades or other sharp objects to clean the inside of the rear window or to remove decals from the inside of the rear window. This may cause damage to the heated grid lines and will not be covered by your warranty.

Activating the rear window defroster will also activate the heated mirrors (if equipped). For more information refer to *Heated outside mirrors* in the *Driver Controls* chapter.

CABIN AIR FILTER

Your vehicle is equipped with a cabin air filter. The particulate air filtration system is designed to reduce the concentration of airborne particles such as dust, spores and pollen in the air being supplied to the interior of the vehicle. The particulate filtration system gives the following benefits to customers:

- Improves the customer's driving comfort by reducing particle concentration.
- Improves the interior compartment cleanliness.
- Protects the climate control components from particle deposits.

The filter is located just in front of the windshield under the cowl grille on the passenger side of the vehicle.

For replacement intervals regarding your Cabin Air Filter, see your Scheduled Maintenance Guide. For more information regarding your filter, see your Ford or Lincoln Mercury dealer.

Lights

HEADLAMP CONTROL ☀

- Turns the lamps off.
- P☀ Turns on the parking lamps, instrument panel lamps, license plate lamps and tail lamps.
- ☀ Turns the headlamps on.

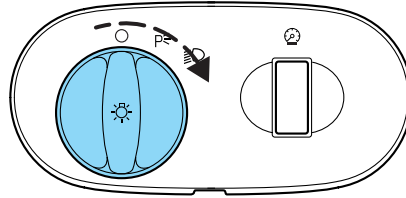

Autolamp control (if equipped) ☀

The autolamp system provides light sensitive automatic on-off control of the exterior lights normally controlled by the headlamp control. The autolamp system also keeps the lights on for a fixed period of time after the ignition switch is turned to OFF.

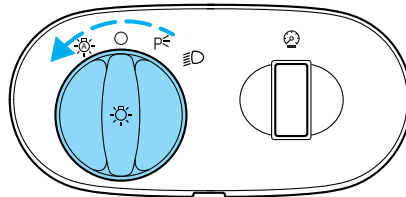

- To turn autolamps on, rotate the control counterclockwise to ☀.
- To turn autolamps off, rotate the control clockwise to ○.

High beams ☀

Push the lever toward the instrument panel to activate. Pull the lever towards you to deactivate.

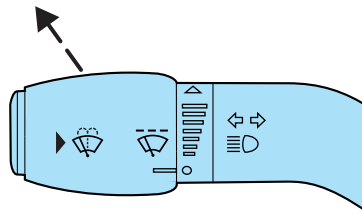

Lights

Flash to pass

Pull toward you slightly to activate and release to deactivate.

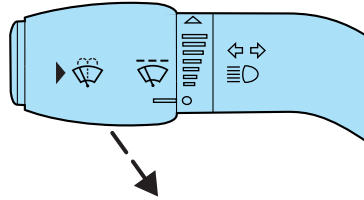

Daytime running lamps (DRL) (if equipped)

Turns the headlamps on with a reduced output.

To activate:

- the ignition must be in the ON position,
- the headlamp control is in the OFF or parking lamp position and
- the parking brake must be disengaged.

 Always remember to turn on your headlamps at dusk or during inclement weather. The Daytime Running Lamp (DRL) system does not activate the tail lamps and generally may not provide adequate lighting during these conditions. Failure to activate your headlamps under these conditions may result in a collision.

PANEL DIMMER CONTROL

Use to adjust the brightness of the instrument panel and all applicable switches in the vehicle during headlamp and parklamp operation.

Move the control to the full upright position, past detent, to turn on the interior lamps.

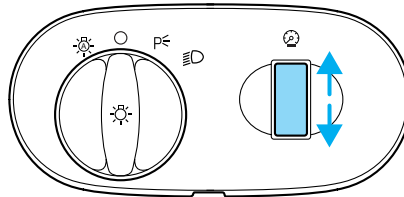

AIMING THE HEADLAMPS

The headlamps on your vehicle are properly aimed at the assembly plant. If your vehicle has been in an accident the alignment of your headlamps should be checked by your authorized dealer.

Vertical aim adjustment

1. Park the vehicle directly in front of a wall or screen on a level surface, approximately 25 feet (7.6 meters) away.

- (1) 8 feet (2.4 meters)
- (2) Center height of lamp to ground
- (3) 25 feet (7.6 meters)
- (4) Horizontal reference line

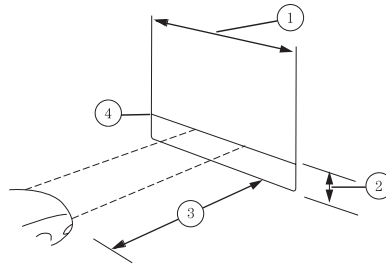

2. Measure the height of the headlamp bulb center from the ground and mark an 8 foot (2.4 meter) horizontal reference line on the vertical wall or screen at this height (a piece of masking tape works well).

3. Turn on the low beam headlamps to illuminate the wall or screen and open the hood.

4. On the wall or screen you will observe an area of high intensity light. The top of the high intensity area should touch the horizontal reference line, if not, the beam will need to be adjusted.

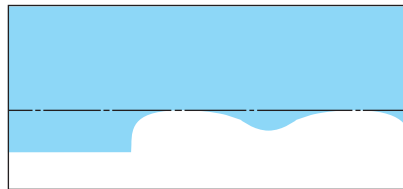

Lights

To see a clearer light pattern for adjusting, you may want to block the light from one headlamp while adjusting the other.

5. Locate the vertical adjuster on each headlamp. Using a 4 mm wrench, turn the adjuster either clockwise (to adjust down) or counterclockwise (to adjust up). The horizontal edge of the brighter light should touch the horizontal reference line.

6. HORIZONTAL AIM IS NOT REQUIRED FOR THIS VEHICLE AND IS NON-ADJUSTABLE.

7. Close the hood and turn off the lamps.

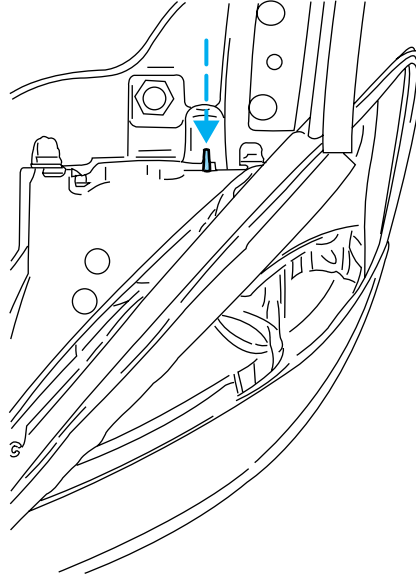

TURN SIGNAL CONTROL ⇄

- Push down to activate the left turn signal.
- Push up to activate the right turn signal.

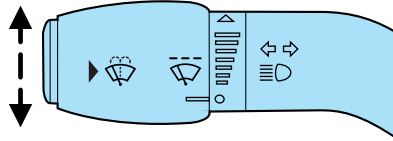

INTERIOR LAMPS

Map lamps/dome lamp

The map lamp controls are located on the dome lamp. Press the controls on either side of each lens on each map lamp to activate the lamps.

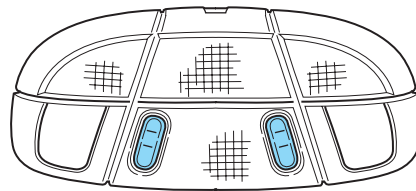



Lights

The dome lamp will illuminate whenever any door is opened, and the lamp will remain on for 25 seconds after the door is shut. If any other door has been opened from the inside, the lamp will shut off immediately after the door is closed.

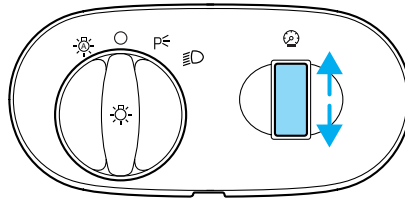
To turn on the dome lamp manually, move the panel dimmer control to the full upright position, past detent.



Dome lamp (with moon roof)

- ON or  : The dome light will stay on.
- DOOR or middle position: The dome light will only come on if a door is opened.
- OFF or  : The lamp will not come on at all.

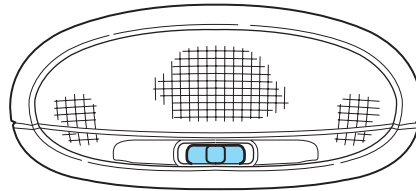

With the control in the middle position, the dome lamp will illuminate whenever a front door is opened. If either front door has been opened from the outside, the lamp will remain on for 25 seconds after the door is shut. If any other door has been opened from the inside, the lamp will shut off immediately after the door is closed.

Map lamps (with moon roof)

The map lamps are located on the moon roof control panel. Press the controls on either side of each map lamp to activate the lamps. The map lamps will illuminate whenever any door is opened, and the lamp will remain on for 25 seconds after the door is shut.

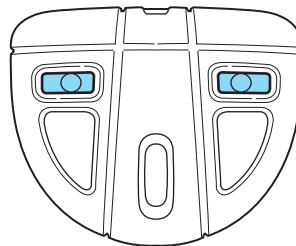

Lights

BULB REPLACEMENT

Headlamp Condensation

The headlamps are vented to equalize pressure. When moist air enters the headlamp(s) through the vents, there is a possibility that condensation can occur. This condensation is normal and will clear within 45 minutes of headlamp operation.

Using the right bulbs

Replacement bulbs are specified in the chart below. Headlamp bulbs must be marked with an authorized "D.O.T." for North America and an "E" for Europe to ensure lamp performance, light brightness and pattern and safe visibility. The correct bulbs will not damage the lamp assembly or void the lamp assembly warranty and will provide quality bulb burn time.

Function	Number of bulbs	Trade number
Front park/turn lamp	2	3457 AK (amber)
Headlamp	2	9007 QL (9007 LL optional)
Tail lamp/brake/turn lamp	2	3157K
Backup lamp	2	921
License plate lamp	2	168
High-mount brake lamp	Must replace the hi-mount brake lamp assembly	
Dome lamp	1	12V6W
Dome/map lamp	3	578
Visor vanity lamp (passenger/driver)	2	DE 3021
Luggage compartment lamp	1	212-2
Ashtray lamp	1	161
Glove box lamp	1	161
All replacement bulbs are clear in color except where noted.		
To replace all instrument panel lights - see your authorized dealer.		

Replacing the interior bulbs

Check the operation of all bulbs frequently.

Replacing exterior bulbs

Check the operation of all the bulbs frequently.

Replacing headlamp bulbs

To remove the headlamp bulb:

1. Make sure headlamp switch is in OFF position and open the hood.
2. Remove the bolt (1) from the headlamp housing.
3. At the back of the headlamp, pry up and remove the two retainer pins to release the headlamp assembly from the vehicle and pull headlamp forward.

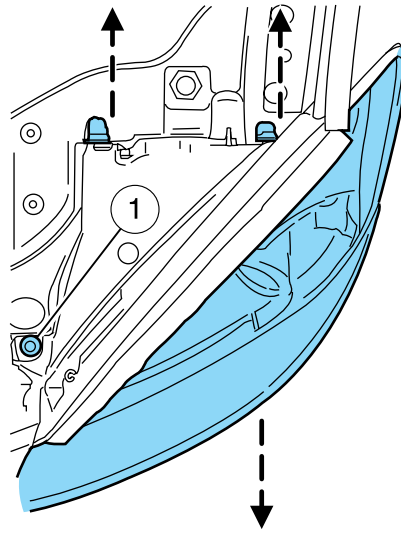

4. Remove the protective dust shield from the housing by turning the dust shield counterclockwise (when viewed from the rear).

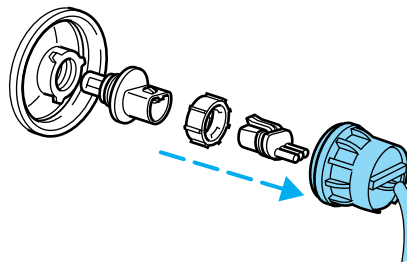

Lights

5. Disconnect the electrical connector from the bulb by pulling rearward.

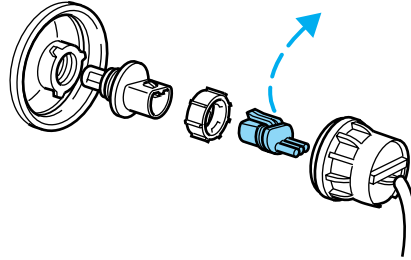

6. Remove the bulb retaining ring by rotating it counterclockwise.

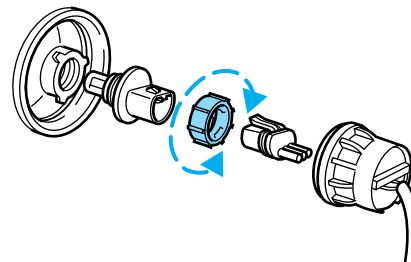

7. Remove the old bulb from the lamp assembly by pulling it straight out of the lamp assembly.

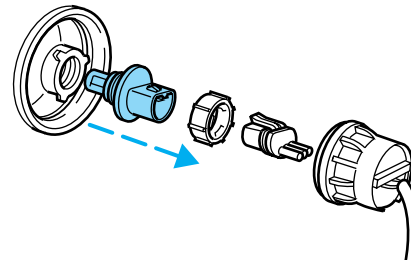

To install the new bulb:

 Handle a halogen headlamp bulb carefully and keep out of children's reach. Grasp the bulb only by its plastic base and do not touch the glass. The oil from your hand could cause the bulb to break the next time the headlamps are operated.

1. Install the new bulb in lamp assembly by pushing straight in with the flat surface of the bulb's plastic base facing upward. You may need to turn the bulb slightly to align the grooves in the plastic base with the tabs in the lamp assembly.

Lights

2. Install the bulb retaining ring over the plastic base and lock the ring by rotating clockwise until it snaps into place.
3. Connect the electrical connector to the bulb.
4. Install the protective dust shield and lock the shield by rotating it clockwise until it locks into position.
5. Carefully position the headlamp assembly onto the vehicle.
6. Hold the headlamp assembly snugly against the vehicle and install the retainer pins straight down to lock the lamp into place.
7. Before reinstalling the bolt, make sure the retainer pins are fully seated, and install bolt on headlamp housing.
8. Turn the headlamps on and make sure they work properly. If the headlamp was correctly aligned before you changed the bulb, you should not need to align it again.

Replacing front parking lamp/turn signal/cornering lamp bulbs

1. Make sure the headlamp control is in the OFF position and open the hood.
2. Remove the bolt (1) from the headlamp housing.
3. At the back of the headlamp, pry up and remove the two retainer pins to release the headlamp assembly from the vehicle and pull headlamp forward.
4. Rotate the bulb socket counterclockwise and remove it from the lamp assembly.

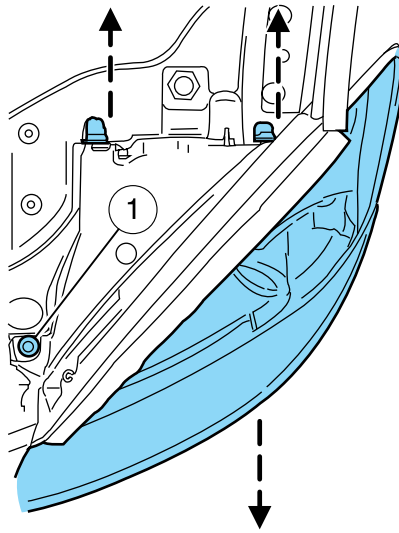

Lights

5. Carefully pull bulb straight out of the socket and push in the new bulb.

6. Install the bulb socket into the lamp assembly by rotating it clockwise.

7. Carefully position the headlamp assembly onto the vehicle.

8. Hold the headlamp assembly snugly against the vehicle and install the retainer pins straight down to lock the lamp into place.

9. Before reinstalling the bolt, make sure the retainer pins are fully seated, and install bolt on headlamp housing.

10. Turn the headlamps on and make sure they work properly. If the headlamp was correctly aligned before you changed the bulb, you should not need to align it again.

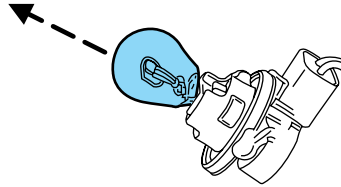

Replacing high-mount brakelamp assembly

To change the high-mount brake lamp assembly:

1. Pry the light assembly away from its housing and push rearward to disengage it from the retaining clips.

2. Lift the front of the light assembly from the parcel shelf.

3. Disconnect the light assembly wiring and replace the light assembly.

4. To complete installation, follow the removal procedure in reverse order.

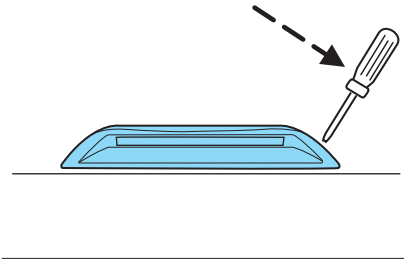

Replacing high-mount brakelamp bulbs — Decklid spoiler

Your vehicle may be equipped with a decklid spoiler that has a high mount stop lamp module containing integral multiple light emitting diodes (LED). If one or more LEDs burn out, the complete lamp module has to be replaced. See your dealer for the replacement LED module.

Lights

To replace the LED module:

1. Remove the two outboard grommets from the inside of the decklid.
2. On the inside of the decklid, remove the three nuts that hold the spoiler on and remove the spoiler.

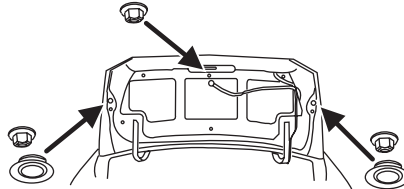

3. On the underside of the spoiler, remove the two decorative screw covers (on the LED module).
4. Remove the two screws that are holding the LED module in place.
5. Remove the wiring harness grommet and disengage the electrical connector.
6. Replace the LED module.
7. To complete installation, follow the removal procedure in reverse order.

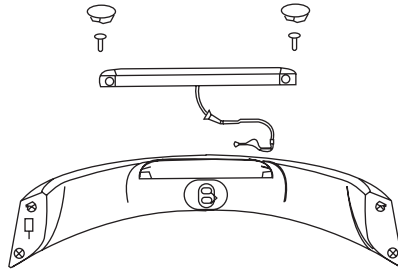

Replacing license plate lamp bulbs

1. Make sure headlamp switch is in OFF position and open trunk lid.
2. Carefully twist and pull the socket from the lamp housing.
3. Carefully pull the bulb from the socket and push in the new bulb.
4. Reinstall the socket in the lamp housing and twist to secure.

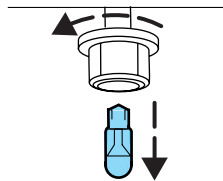

Lights

Replacing tail/brake/turn signal/backup lamp bulbs

The tail lamp, brake lamp, turn signal lamp and backup lamp bulbs are located in the same portion of the tail lamp assembly. Follow the same steps to replace any bulb.

1. Make sure headlamp switch is in OFF position and open trunk and remove two plastic mushroom nuts, five push pins and the plastic cover from inside the trunk to access the lamp assembly.
2. Carefully pull the carpet away to expose the lamp assembly hardware.
3. Remove three nut and washer assemblies and the lamp assembly from the vehicle.

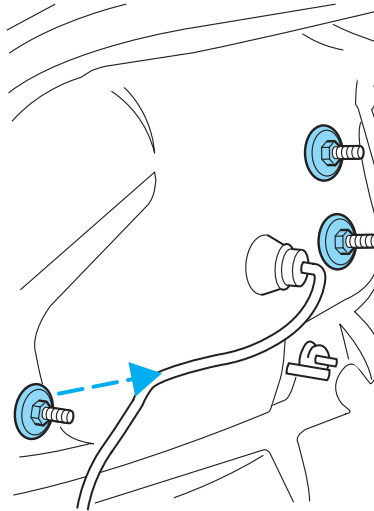

4. Remove the bulb socket by rotating it counterclockwise, then pulling it out of the lamp assembly.
5. Pull the bulb from the socket and push in the new bulb.
6. Install the bulb socket into the lamp assembly by rotating it clockwise.

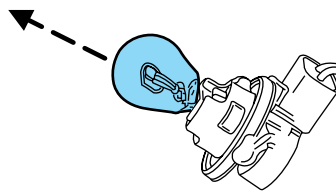

7. Install the lamp assembly on the vehicle with three nut and washer assemblies ensuring the washers on the nuts are flush with the body to prevent water from entering the trunk.
8. Carefully push the carpet back in to place and install the plastic cover inside the trunk with five push pins and two plastic mushroom nuts.

Driver Controls

MULTI-FUNCTION LEVER

Windshield wiper: Rotate the end of the control away from you to increase the speed of the wipers; rotate towards you to decrease the speed of the wipers.

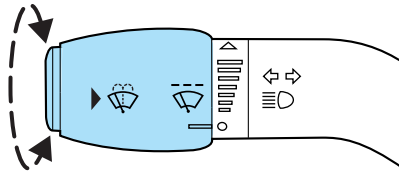

Windshield washer: Push the end of the stalk:

- briefly: causes a single swipe of the wipers without washer fluid.
- a quick push and hold: the wipers will swipe three times with washer fluid.
- a long push and hold: the wipers and washer fluid will be activated for up to ten seconds.

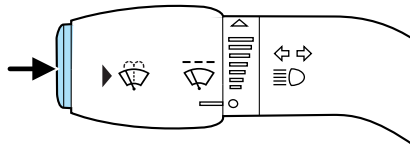

TILT STEERING WHEEL

To adjust the steering wheel:

1. Pull and hold the steering wheel release control toward you.
2. Move the steering wheel up or down until you find the desired location.
3. Release the steering wheel release control. This will lock the steering wheel in position.

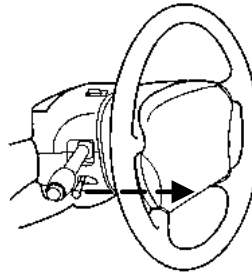

Never adjust the steering wheel when the vehicle is moving.

Driver Controls

ILLUMINATED VISOR MIRROR (IF EQUIPPED)

Lift the mirror cover to turn on the visor mirror lamp.

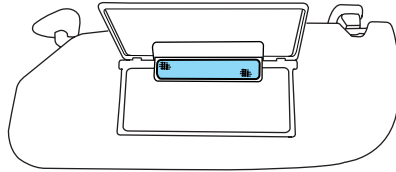

CENTER CONSOLE

Your vehicle may be equipped with a variety of console features. These include:

- Utility compartment
- Bin mat (snap-in)
- Cupholders (front and rear)
- Coin holder slots
- Compact disc changer (if equipped)
- Tissue holder
- Rear ashtray (see your authorized dealer to obtain rear ashtray)



Use only soft cups in the cupholder. Hard objects can injure you in a collision.

If your vehicle is equipped with the column shift and a bench seat, it has a center console in the center front seating position.

The center console has similar features as the full console. To open the storage compartment, raise the armrest and pull the strap on the seat up and toward the front of the vehicle. The rear seat area is provided with dual cupholders.

AUXILIARY POWER POINT (12VDC)

Power outlets are designed for accessory plugs only. Do not insert any other object in the power outlet as this will damage the outlet and blow the fuse. Do not hang any type of accessory or accessory bracket from the plug. Improper use of the power outlet can cause damage not covered by your warranty.

The auxiliary power point is located on the instrument panel below the optional cigarette lighter (if equipped).

Driver Controls

Do not use the power point for operating the cigarette lighter element (if equipped).

To prevent the fuse from being blown, do not use the power point(s) over the vehicle capacity of 12 VDC/180W.

To prevent the battery from being discharged, do not use the power point longer than necessary when the engine is not running.

Always keep the power point caps closed when not being used.

Cigar/Cigarette lighter (if equipped)

Do not plug optional electrical accessories into the cigarette lighter socket.

Do not hold the lighter in with your hand while it is heating, this will damage the lighter element and socket. The lighter will be released from its heating position when it is ready to be used.

Improper use of the lighter can cause damage not covered by your warranty.

POWER WINDOWS



Do not leave children unattended in the vehicle and do not let children play with the power windows. They may seriously injure themselves.



When closing the power windows, you should verify they are free of obstructions and ensure that children and/or pets are not in the proximity of the window openings.

Press and hold the bottom part of the rocker switch to open the window. Press and hold the top part of the rocker switch to close the window.

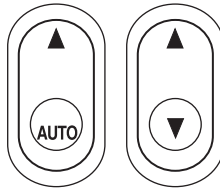

Driver Controls

One touch down

Allows the driver's window to open fully without holding the control down. Press completely down on AUTO and release quickly. Press again to stop.

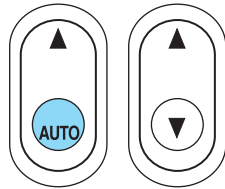

Window lock

The window lock feature allows only the driver to operate the power windows.

To lock out all the window controls except for the driver's press the left side of the control. Press the right side to restore the window controls.

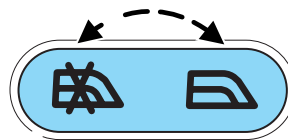

Accessory delay

With accessory delay, the window switches may be used for up to ten minutes after the ignition switch is turned to the OFF position or until the driver's door is opened.

AUTOMATIC DIMMING INSIDE REAR VIEW MIRROR (IF EQUIPPED)

Your vehicle may be equipped with an inside rear view mirror with an auto-dimming function. The electronic day/night mirror will change from the normal (high reflective) state to the non-glare (darkened) state when bright lights (glare) reach the mirror. When the mirror detects bright light from behind the vehicle, it will automatically adjust (darken) to minimize glare.

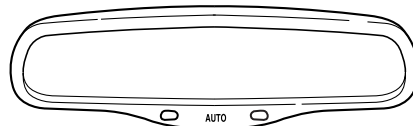

The mirror will automatically return to the normal state whenever the vehicle is placed in R (Reverse) to ensure a bright clear view when backing up.

Do not block the sensor on the backside of the inside rear view mirror since this may impair proper mirror performance.

Driver Controls

EXTERIOR MIRRORS

Power side view mirrors

To adjust your mirrors:

1. Select **L** to adjust the left mirror or **R** to adjust the right mirror.
2. Move the control in the direction you wish to tilt the mirror.
3. Return to the center position to disable the adjust function.



Heated outside mirrors (if equipped)

Both mirrors are heated automatically to remove ice, mist and fog when the rear window defrost is activated.

Do not remove ice from the mirrors with a scraper or attempt to readjust the mirror glass if it is frozen in place. These actions could cause damage to the glass and mirrors.

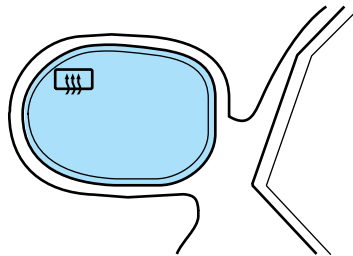

SPEED CONTROL

With speed control set, you can maintain a speed of 30 mph (48 km/h) or more without keeping your foot on the accelerator pedal. Speed control does not work at speeds below 30 mph (48 km/h).



Do not use the speed control in heavy traffic or on roads that are winding, slippery or unpaved.

Driver Controls

Setting speed control

The controls for using your speed control are located on the steering wheel for your convenience.

1. Press the ON control and release it.
2. Accelerate to the desired speed.
3. Press the SET ACC control and release it.
4. Take your foot off the accelerator pedal.
5. The **CRUISE** indicator light on the instrument cluster will turn on.

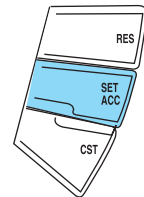
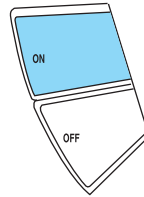

Note:

- Vehicle speed may vary momentarily when driving up and down a steep hill.
- If the vehicle speed increases above the set speed on a downhill, you may want to apply the brakes to reduce the speed.
- If the vehicle speed decreases more than 10 mph (16 km/h) below your set speed on an uphill, your speed control will disengage.
- If the vehicle speed decreases to 30 mph (48 km/h) or less, your speed control will disengage.

Disengaging speed control

To disengage the speed control:

- Depress the brake pedal

Disengaging the speed control will not erase previous set speed.

Driver Controls

Resuming a set speed

Press the RES (resume) control and release it. This will automatically return the vehicle to the previously set speed. The RES control will not work if the vehicle speed is not faster than 30 mph (48 km/h).

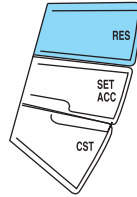

Increasing speed while using speed control

There are three ways to set a higher speed:

- Press and hold the SET ACC control until you get to the desired speed, then release the control.
- Press and release the SET ACC control to operate the Tap-Up function. Each tap will increase the set speed by 1 mph (1.6 km/h).
- Use the accelerator pedal to get to the desired speed. When the vehicle reaches that speed press and release the SET ACC control.

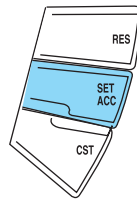

Reducing speed while using speed control

There are three ways to reduce a set speed:

- Press and hold the CST control until you get to the desired speed, then release the control.
- Press and release the CST control to operate the Tap-Down function. Each tap will decrease the set speed by 1 mph (1.6 km/h).

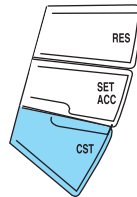

Driver Controls

- Depress the brake pedal until the desired vehicle speed is reached, press the SET ACC control.

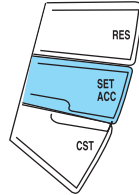

Turning off speed control

There are two ways to turn off the speed control:

- Depress the brake pedal. This will not erase your vehicle's previously set speed.
- Press the speed control OFF control.

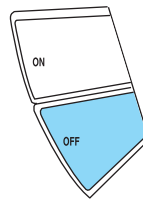

Note: When you turn off the speed control or the ignition, your speed control set speed memory is erased.

MOON ROOF (IF EQUIPPED)

You can move the glass panel of the moon roof back to open or tilt up to ventilate the vehicle.

To open the moon roof:

The moon roof is equipped with an automatic, one-touch, express opening feature. Press and release the rear portion of the control.

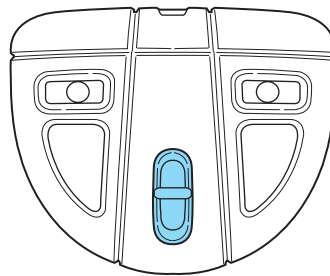

To close:

Press and hold the front portion of the control.

To vent:

To tilt the moon roof into the vent position (when the glass panel is closed), press and hold the front portion of the control. To close from the vent position, press and hold the rear portion of the control until the glass panel stops moving.

The moon roof has a sliding shade that can be opened or closed when the glass panel is shut. To close the shade, pull it toward the front of the vehicle.

Driver Controls

 Before operating the moonroof you should verify that it is free of obstructions and ensure that children and/or pets are not in the proximity of moon roof opening.

 Do not let children play with the moon roof or leave children unattended in the vehicle. They may seriously hurt themselves.

HOMELINK® WIRELESS CONTROL SYSTEM (IF EQUIPPED)

The HomeLink® Wireless Control System, located on the driver's visor, provides a convenient way to replace up to three hand-held transmitters with a single built-in device. This feature will learn the radio frequency codes of most transmitters to operate garage doors, entry gate operators, security systems, entry door locks, and home or office lighting.

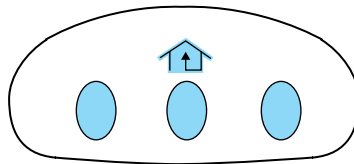

 When programming your HomeLink® Wireless Control System to a garage door or gate, be sure that people and objects are out of the way to prevent potential harm or damage.

Do not use the HomeLink® Wireless Control System with any garage door opener that lacks safety stop and reverse features as required by U.S. federal safety standards (this includes any garage door opener model manufactured before April 1, 1982). A garage door which cannot detect an object, signaling the door to stop and reverse, does not meet current U.S. federal safety standards. For more information, contact HomeLink® at: **www.homelink.com** or **1-800-355-3515**.

Retain the original transmitter for use in other vehicles as well as for future programming procedures (i.e. new HomeLink® equipped vehicle purchase). It is also suggested that upon the sale of the vehicle, the programmed Homelink® buttons be erased for security purposes, refer to *Programming* in this section.

Driver Controls

Programming

Do not program HomeLink® with the vehicle parked in the garage.

Note: Your vehicle may require the ignition switch to be turned to the ACC position for programming and/or operation of the HomeLink®. It is also recommended that a new battery be placed in the hand-held transmitter of the device being programmed to HomeLink® for quicker training and accurate transmission of the radio-frequency signal.

1. Press and hold the two outside buttons releasing only when the indicator light begins to flash after 20 seconds. **Do not** repeat Step 1 to program additional hand-held transmitters to the remaining two HomeLink® buttons. This will erase previously programmed hand-held transmitter signals into HomeLink®.

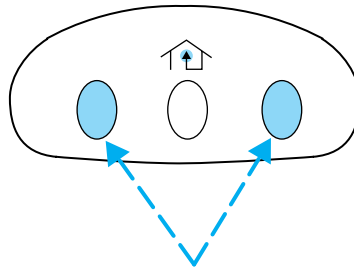

2. Position the end of your hand-held transmitter 1-3 inches (2-8 cm) away from the HomeLink® button you wish to program (located on your visor) while keeping the indicator light in view.

3. Simultaneously press and hold both the HomeLink® and hand-held transmitter button. **Do not release the buttons until Step 4 has been completed.**

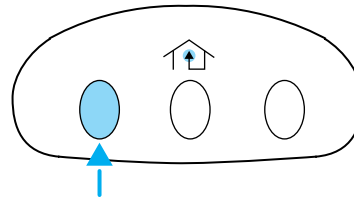

Some entry gates and garage door openers may require you to replace Step 3 with procedures noted in the “Gate Operator and Canadian Programming” in this section for Canadian residents.

4. The indicator light will flash slowly and then rapidly. Release both buttons when the indicator light flashes rapidly. (The rapid flashing light indicates acceptance of the hand-held transmitters’ radio frequency signals.)

5. Press and hold the just-trained HomeLink® button and observe the indicator light. If the light is constant, programming is complete and your device should activate when the HomeLink® button is pressed and released. **Note:** To program the remaining two HomeLink® buttons, begin with Step 2 in the “Programming” section — **do not** repeat Step 1.

Driver Controls

Note: If the indicator light blinks rapidly for two seconds and then turns to a continuous red, proceed with Steps 6 through 8 to complete programming of a rolling code equipped device.

6. At the garage door opener receiver (motor-head unit) in the garage, locate the “learn” or “smart” button (usually near where the hanging antenna wire is attached to the unit).

7. Press and release the “learn” or “smart” button. (The name and color of the button may vary by manufacturer.)

Note: There are 30 seconds in which to initiate Step 8.

8. Return to the vehicle and firmly press, hold for two seconds and release the HomeLink® button. Repeat the press/hold/release sequence again, and, depending on the brand of the garage door opener (or other rolling code equipped device), repeat this sequence a third time to complete the programming.

HomeLink® should now activate your rolling code equipped device. To program additional HomeLink® buttons begin with Step 2 in the “Programming” section. For questions or comments, please contact HomeLink at www.homelink.com or 1-800-355-3515.

Gate Operator & Canadian Programming

During programming, your hand-held transmitter may automatically stop transmitting — not allowing enough time for HomeLink® to accept the signal from the hand-held transmitter.

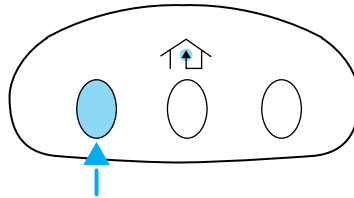

After completing Steps 1 and 2 outlined in the “Programming” section, replace Step 3 with the following:

Note: If programming a garage door opener or gate operator, it is advised to unplug the device during the “cycling” process to prevent overheating.

- Continue to press and hold the HomeLink® button (note Step 3 in the “Programming” section) while you press and release — **every two seconds** (“cycle”) your hand-held transmitter until the frequency signal has been accepted by the HomeLink®. The indicator light will flash slowly and then rapidly after HomeLink® accepts the radio frequency signal.
- Proceed with Step 4 in the “Programming” section.

Driver Controls

Operating the HomeLink® Wireless Control System

To operate, simply press and release the appropriate HomeLink® button. Activation will now occur for the trained product (garage door, gate operator, security system, entry door lock, or home or office lighting etc.). For convenience, the hand-held transmitter of the device may also be used at any time. In the event that there are still programming difficulties, contact HomeLink® at www.homelink.com or **1-800-355-3515**.

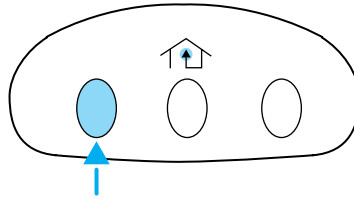

Erasing HomeLink® buttons

To erase the three programmed buttons (individual buttons cannot be erased):

- Press and hold the two outer HomeLink® buttons until the indicator light begins to flash-after 20 seconds. Release both buttons. Do not hold for longer than 30 seconds.

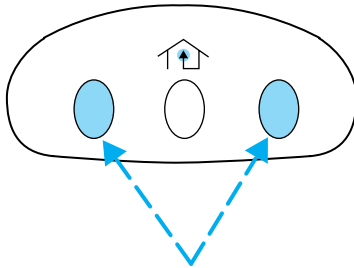

HomeLink® is now in the train (or learning) mode and can be programmed at any time beginning with Step 2 in the “Programming” section.

Reprogramming a single HomeLink® button

To program a device to HomeLink® using a HomeLink® button previously trained, follow these steps:

1. Press and hold the desired HomeLink® button. **Do NOT** release the button.
2. The indicator light will begin to flash after 20 seconds. Without releasing the HomeLink® button, follow Step 2 in the “Programming” section.

For questions or comments, contact HomeLink® at www.homelink.com or **1-800-355-3515**.

Driver Controls

MESSAGE CENTER

With the ignition in the ON position, the message center, located on your instrument cluster, displays important vehicle information

through a constant monitor of vehicle systems. You may select

display features on the message center for a display of status preceded by a brief indicator chime. The system will also notify you of potential vehicle problems with a display of system warnings followed by a long indicator chime.



Selectable features

Reset

Press this control to select and reset functions shown in the INFO menu and SETUP menu.

Info menu

This control displays the following control displays:

- Odometer
- Distance to Empty
- Average Fuel Economy
- Trip odometer
- Trip Elapsed Drive Time
- Outside air temperature (if equipped)
- Compass (if equipped)

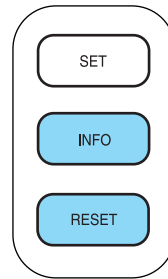

Odometer/Trip odometer

Refer to *Gauges* in the *Instrument Cluster* chapter.

Distance to empty (DTE)

Selecting this function from the INFO menu estimates approximately how far you can drive with the fuel remaining in your tank under normal driving conditions.

Remember to turn the ignition OFF

when refueling to allow this feature to correctly detect the added fuel.



Driver Controls

The DTE function will display LOW FUEL LEVEL and sound a tone for one second when you have approximately 25 miles (40 km) to empty. If you RESET this warning message, this display and tone will return within 10 minutes.

DTE is calculated using a running average fuel economy, which is based on your recent driving history of 500 miles (800 km). This value is not the same as the average fuel economy display. The running average fuel economy is reinitialized to a factory default value if the battery is disconnected.

Average fuel economy (AFE)

Select this function from the INFO menu to display your average fuel economy in liters/100 km or miles/U.S. gallon.



XX AVE MPG
NW 000000.0 mi

If you calculate your average fuel economy by dividing gallons of fuel used by 100 miles traveled (kilometers traveled by liters used), your figure may be different than displayed for the following reasons:

- Your vehicle was not perfectly level during fill-up
- Differences in the automatic shut-off points on the fuel pumps at service stations
- Variations in top-off procedure from one fill-up to another
- Rounding of the displayed values to the nearest 0.1 gallon (liter)

1. Drive the vehicle at least 8 km (5 miles) with the speed control system engaged to display a stabilized average.

2. Record the highway fuel economy for future reference.

It is important to press the RESET control after setting the speed control to get accurate highway fuel economy readings.

Distance to empty/Average fuel economy for FFV-equipped vehicles

Upon refueling, your vehicle must determine the percentage of Ethanol in the fuel. Until the percent of Ethanol is determined, DTE/AFE may not display the current values. The correct DTE/AFE will appear after driving a few miles.

Driver Controls

Trip elapsed drive time

Select this function from the INFO menu to display a timer.

To operate the Trip Elapsed Drive Time perform the following:

1. Press and release RESET in order to start the timer.
2. Press and release RESET to pause the timer.
3. Press and hold RESET for 2 seconds in order to reset the timer.



TIME XX:XX:XX
NW 000000.0 mi

Outside air temperature (if equipped)

Press and hold the INFO button for 2 seconds to display the outside temperature. To switch from a blank display to the temperature display, hold the INFO button for 2 seconds until the temperature is seen in the display. To switch the temperature display to compass display, hold the INFO button again for 2 seconds until the compass heading is seen in the display.



73°F 000000.0 mi

To turn the display off or change the display from English to metric see your authorized dealer.

Compass display (if equipped)

Select this function from the INFO menu. Press and hold the INFO button for 2 seconds to switch from temperature display to compass display. To switch from a blank display, press and hold the INFO button for 2 seconds until temperature is displayed. Press and hold the INFO button again to switch from temperature to compass display.

The compass reading may be affected when you drive near large buildings, bridges, power lines and powerful broadcast antenna. Magnetic or metallic objects placed in, on or near the vehicle may also affect compass accuracy.

Usually, when something affects the compass readings, the compass will correct itself after a few days of operating your vehicle in normal conditions. If the compass still appears to be inaccurate, a manual calibration may be necessary. Refer to *Compass zone/calibration adjustment*.

Driver Controls

Most geographic areas (zones) have a magnetic north compass point that varies slightly from the northerly direction on maps. This variation is four degrees between adjacent zones and will become noticeable as the vehicle crosses multiple zones. A correct zone setting will eliminate this error. Refer to *Compass zone/calibration adjustment*.

Compass zone/calibration adjustment

Perform this adjustment in an open area free from steel structures and high voltage lines.

For optimum calibration, turn off all electrical accessories (heater/air conditioning, wipers, etc.) and make sure all vehicle doors are shut.

1. Turn ignition to the ON position.
2. Start the engine.
3. Press and hold the INFO button for 2 seconds to select the Compass/Odometer function. (Do not select Trip, DTE, or AFE. **The top of the message center must be blank**).

Note: If the compass displays "CAL 000000.0 mi" instead of heading information, the compass will need to be calibrated. Slowly drive the vehicle in a circle (less than 3 mph [5 km/h]) until the "CAL" indicator changes to display compass heading. This may take up to 3 circles to complete calibration.

4. Determine your magnetic zone by referring to the zone map.

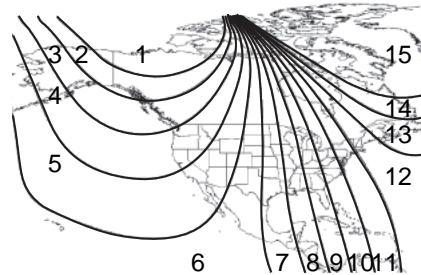

5. Press and hold the RESET until the message center display changes to show the current zone setting.

RESET FOR ZONE
INFO TO EXIT

Driver Controls

6. Release the RESET control, then slowly press RESET down again.

SETUP ZONE XX
RESET IF DONE

7. Press the SET control repeatedly until the correct zone setting for your geographic location is displayed on the message center. To exit the zone setting mode press and release the RESET control.

8. Press the RESET control to start the compass calibration function.

RESET FOR CAL
INFO TO EXIT

9. Slowly drive the vehicle in a circle (less than 3 mph [5 km/h]) until the CIRCLE SLOWLY TO CALIBRATE indicator changes to CALIBRATION COMPLETED. This will take up to three circles to complete calibration.

CIRCLE SLOWLY
TO CALIBRATE

10. The compass is now calibrated.

Setup menu

Press this control for the following displays:

- Language
- Units (English/Metric)
- System Check

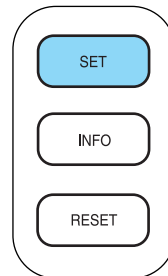

Language

1. Select this function from the SETUP menu for the current language to be displayed.

ENGLISH
RESET FOR NEW

Driver Controls

2. Pressing the RESET control cycles the message center through each of the language choices.

FOR ENGLISH
HOLD RESET

3. Press and hold the RESET control to set the language choice.

SET TO
ENGLISH

Units (English/Metric)

1. Select this function from the SETUP menu for the current units to be displayed.

UNITS
> ENG METRIC

2. Press and hold the RESET control to change from English to Metric.

System check

Selecting this function from the SETUP menu causes the message center to cycle through each of the systems being monitored. For each of the monitored systems, the message center will indicate either an OK message or a warning message for two to four seconds.

PRESS RESET
FOR SYS CHECK

Pressing the RESET control cycles the message center through each of the systems being monitored.

The sequence of the system check report is as follows:

1. OIL PRESSURE
2. CHARGING SYSTEM
3. BRAKE FLUID LEVEL
4. FUEL LEVEL
5. DOORS CLOSED (If RESET control is pressed PLEASE CLOSE DOOR will be displayed).
6. PARK BRAKE STATUS
7. ENGINE TEMP
8. BRAKE SYSTEM
9. TRACTION CONTROL (if equipped)

Driver Controls

System warnings

System warnings alert you to possible problems or malfunctions in your vehicle's operating systems.

In the event of a multiple warning situation, the message center will cycle the display to show all warnings by displaying each one for several seconds.

The message center will display the last selected feature if there are no more warning messages. This allows you to use the full functionality of the message center after you acknowledge the warning by pressing the RESET control and clearing the warning message.

Warning messages that have been reset are divided into three categories:

- They will not disappear until a condition is changed.
- They will reappear on the display ten minutes from the reset.
- They will not reappear until an ignition OFF-ON cycle has been completed.

This acts as a reminder that these warning conditions still exist within the vehicle.

Warnings	Status
Driver's door ajar	Warning cannot be reset (CLOSE DOOR TO RESET) will be displayed
Passenger door ajar	
Left rear door ajar	
Right rear door ajar	
Park brake engaged	RELEASE PARK BRAKE will be displayed
Check engine temp	Warning returns after 10 minutes
Transmission overheated	
Check transmission	
Low fuel level	
Check fuel cap	
Check charging system	
Oil pressure low	
Check brake system	Warning returns after the ignition key is turned from OFF to RUN
Low brake fluid	
Check Traction Control (if equipped)	
Data error	

Driver Controls

DRIVER'S DOOR AJAR. Displayed when the driver's door is not completely closed.

PASSENGER DOOR AJAR. Displayed when the passenger side door is not completely closed.

LEFT REAR DOOR AJAR. Displayed when the left rear door is not completely closed.

RIGHT REAR DOOR AJAR. Displayed when the right rear door is not completely closed.

PARK BRAKE ENGAGED. Displayed when the park brake is engaged. If the warning stays on after the park brake is off, contact your authorized dealer as soon as possible.

CHECK ENGINE TEMPERATURE. Displayed when the engine coolant is overheating. Stop the vehicle as soon as safely possible, turn off the engine and let it cool. Check the coolant and coolant level. Refer to *Engine coolant* in the *Maintenance and Specifications* chapter. If the warning stays on or continues to come on, contact your authorized dealer as soon as possible.



Never remove the coolant reservoir cap while the engine is running or hot.

TRANSMISSION OVERHEATED. Indicates the transmission is overheating. This warning may appear when towing heavy loads or when driving in a low gear at a high speed for an extended period of time. Stop the vehicle as soon as safely possible, turn off the engine and let it cool. Refer to *Transmission fluid* in the *Maintenance and Specifications* chapter. If the warning stays on or continues to come on, contact your authorized dealer for transmission service as soon as possible.

CHECK TRANSMISSION. Indicates the transmission is not operating properly. If this warning stays on, contact your authorized dealer as soon as possible.

LOW FUEL LEVEL. Displayed as an early reminder of a low fuel condition.

CHECK FUEL CAP. Displayed when the fuel filler cap is not properly installed. Check the fuel filler cap for proper installation. Refer to *Fuel filler cap* in the *Maintenance and Specifications* chapter.

CHECK CHARGING SYSTEM. Displayed when the electrical system is not maintaining proper voltage. If you are operating electrical accessories

Driver Controls

when the engine is idling at a low speed, turn off as many of the electrical loads as possible. If the warning stays on or comes on when the engine is operating at normal speeds, have the electrical system checked as soon as possible.

OIL PRESSURE LOW. Displayed when the engine oil level is low. If this warning message is displayed, check the level of the engine oil. Refer to *Engine oil* in the *Maintenance and Specifications* chapter for information about adding engine oil.

CHECK BRAKE SYSTEM. Displayed when the brake system needs servicing. If the warning stays on or continues to come on, contact your authorized dealer as soon as possible.

LOW BRAKE FLUID. Indicates the brake fluid level is low and the brake system should be inspected immediately. Refer to *Brake fluid reservoir* in the *Maintenance and Specifications* chapter.

CHECK TRACTION CONTROL (if equipped). Displayed when the Traction Control[™] system is not operating properly. If this warning stays on, contact your authorized dealer for service as soon as possible. For further information, refer to *Traction control[™]* in the *Driving* chapter.

DATA ERR. These messages indicate improper operation of the vehicle network communication between electronic modules.

- Fuel computer
- Charging system
- Coolant system
- Traction control (if equipped)
- Door sensor
- Brake fluid
- Compass (if equipped)
- Outside temperature (if equipped)
- Engine sensor
- Transmission sensor
- Fuel cap sensor
- Seat belt sensor
- Park brake
- Oil pressure sensor

Contact your authorized dealer as soon as possible if these messages occur on a regular basis.

Driver Controls

POSITIVE RETENTION FLOOR MAT

 Do not install additional floor mats on top of the factory installed floor mats as they may interfere with the accelerator or the brake pedals.

Position the driver floor mat so that the eyelet is over the pointed end of the retention post and rotate forward to lock in. Make sure that the mat does not interfere with the operation of the accelerator or the brake pedal. To remove the floor mat, reverse the installation procedure.

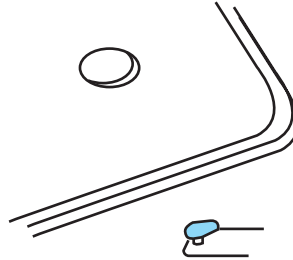

INTERIOR TRUNK CONTROL

Press the remote trunk release control on the instrument panel to the left of the steering wheel.

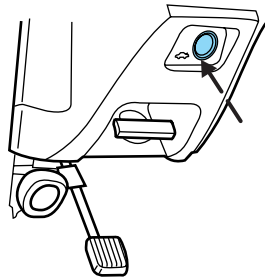

CARGO AREA FEATURES

Cargo utility hooks

The utility hooks located inside the trunk can be used to attach a cargo net to secure lightweight objects or hang small items on. Do not hang more than 20 lbs (12 kg) on the hooks.

 The hooks are not designed to restrain objects during a collision.

Locks and Security

KEYS

The key operates all locks on your vehicle. In case of loss, replacement keys are available from your dealer.

You should always carry a second key with you in a safe place in case you require it in an emergency.

Refer to the *SecuriLock[™] passive anti-theft system* section in this chapter for more information.

POWER DOOR LOCKS

Press control to unlock or lock all doors.

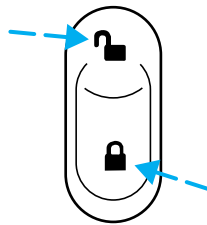

Autolock (if equipped)

This feature automatically locks all vehicle doors when the following conditions are met:

- all the doors are closed,
- the engine is running,
- you shift into gear, putting the vehicle in motion, and,
- the vehicle's speed is greater than 3 mph (5 km/h).

Relock

The autolock feature repeats when the following conditions are met:

- any door is opened then closed while the engine is running, and
- you shift into gear, putting the vehicle in motion, and
- the vehicle's speed is greater than 3 mph (5 km/h).

To deactivate/reactivate the autolock feature using the power door unlock control

You must complete Steps 1-4 within 30 seconds or the procedure will have to be repeated. If the procedure needs to be repeated, you must wait 30 seconds. **Note:** All doors must be closed and remain closed throughout the process.

Locks and Security

1. Turn the ignition to the 4 (ON) position, then press the power door UNLOCK control 3 times.

2. Turn the ignition to the 3 (OFF) position, then press the power door UNLOCK control 3 times.

3. Turn the ignition to the 4 (ON) position. The horn will chirp one time as confirmation that the programming mode is staged.

4. Within 5 seconds, press the power door UNLOCK control and then press the power door LOCK control. **Note:** The horn will chirp once if autolock was deactivated or chirp once then honk (one short and one long chirp) if autolock was activated.

5. Turn the ignition to the 3 (OFF) position. The horn will chirp once to confirm the procedure is complete.

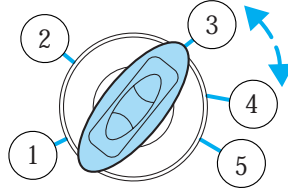

Smart unlocking feature

The smart unlocking feature helps prevent you from locking yourself out of the vehicle. With the key in any ignition position, the driver's door will automatically unlock if it is locked using the power lock control on the driver's door panel while the driver's door is open.

CHILDPROOF DOOR LOCKS

- When these locks are set, the rear doors cannot be opened from the inside.
- The rear doors can be opened from the outside when the doors are unlocked.

The childproof locks are located on rear edge of each rear door and must be set separately for each door. Setting the lock for one door will not automatically set the lock for both doors.

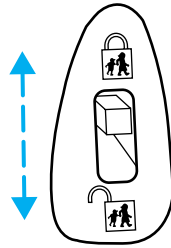

- Move lock control up to engage the childproof lock.
- Move control down to disengage childproof locks.

Locks and Security

INTERIOR LUGGAGE COMPARTMENT RELEASE

Your vehicle is equipped with a mechanical interior luggage compartment release handle that provides a means of escape for children and adults in the event they become locked inside the luggage compartment.

Adults are advised to familiarize themselves with the operation and location of the release handle.

To open the luggage compartment door (lid) from within the luggage compartment, pull the illuminated “T” shaped handle and push up on the trunk lid. The handle is composed of a material that will glow for hours in darkness following brief exposure to ambient light.

The “T” shaped handle will be located either on the luggage compartment door (lid) or inside the luggage compartment near the tail lamps.

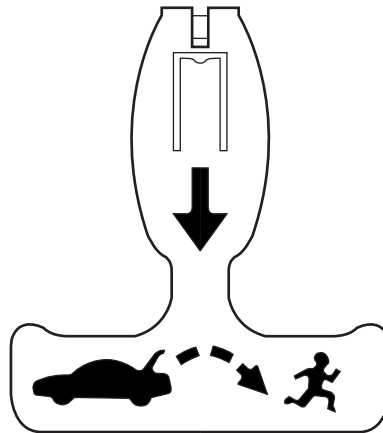

Keep vehicle doors and luggage compartment locked and keep keys and remote transmitters out of a child's reach. Unsupervised children could lock themselves in the trunk and risk injury. Children should be taught not to play in vehicles.

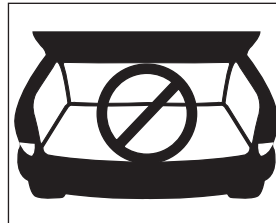

On hot days, the temperature in the trunk or vehicle interior can rise very quickly. Exposure of people or animals to these high temperatures for even a short time can cause death or serious heat-related injuries, including brain damage. Small children are particularly at risk.

Locks and Security

REMOTE ENTRY SYSTEM (IF EQUIPPED)

This device complies with part 15 of the FCC rules and with RSS-210 of Industry Canada. Operation is subject to the following two conditions: (1) This device may not cause harmful interference, and (2) This device must accept any interference received, including interference that may cause undesired operation.

Changes or modifications not expressly approved by the party responsible for compliance could void the user's authority to operate the equipment.

The typical operating range for your remote entry transmitter is approximately 33 feet (10 meters). A decrease in operating range could be caused by:

- weather conditions,
- nearby radio towers,
- structures around the vehicle, or
- other vehicles parked next to your vehicle.



The remote entry system allows you to:

- lock or unlock all vehicle doors,
- open the trunk, and
- sound the panic alarm.

If there are problems with the remote entry system, make sure to take **ALL remote entry transmitters** with you to the authorized dealer in order to aid in troubleshooting the problem.



Unlocking the doors

1. Press  and release to unlock the driver's door. **Note:** The headlamps, parking lamps and interior lamps will illuminate.
2. Press  and release again within three seconds to unlock all the doors.

The remote entry system comes with an illuminated entry feature. This feature turns on the interior lamps for 25 seconds or until the ignition is turned to the 4 (ON) position. If the dome lamp control is in the **off** position the illuminated entry feature will not work.



Locks and Security

The inside lights will not turn off if:

- they have been turned on using the dimmer control or
- any door is open.

The battery saver feature will turn off the interior lamps 10 minutes after the ignition is turned to the 3 (OFF) position.

Locking the doors

1. Press  and release to lock all the doors, turn off the interior lamps (if they were on) and arm the anti-theft system. **Note:** The parklamps will flash once if all doors are closed.
2. Press  and release again within three seconds to confirm that all the doors are closed and locked. **Note:** The doors will lock again, the horn will chirp once, and the parklamps will flash once.

If any of the doors are not properly closed the horn will make two quick chirps, and the parklamps will not flash. As soon as all vehicle doors are closed, the parklamps will flash once to confirm that all doors are closed.

Opening the trunk

Press  once to release the trunk.

Sounding a panic alarm

Press  to activate the alarm. Both the horn will sound and the parklamps will flash for a maximum of 30 seconds. Press again or turn the ignition to the 4 (ON) position to deactivate, or wait for the alarm to timeout in 3 minutes.

Note: The panic alarm will only operate when the ignition is in the , 2 (LOCK) or 3 (OFF) position.

Replacing the battery

The remote entry transmitter uses one coin type three-volt lithium battery CR2032 or equivalent.

Locks and Security

To replace the battery:

1. Twist a thin coin between the two halves of the remote entry transmitter near the key ring. **DO NOT TAKE THE RUBBER COVER AND CIRCUIT BOARD OFF THE FRONT HOUSING OF THE REMOTE ENTRY TRANSMITTER.**

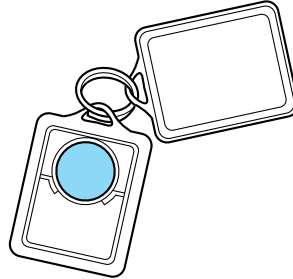

2. Do not wipe off any grease on the battery terminals on the back surface of the circuit board.

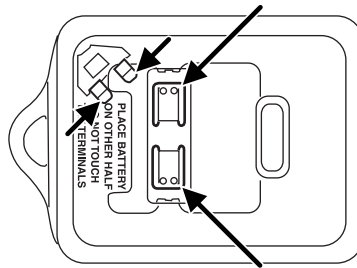

3. Remove the old battery. **Note:** Please refer to local regulations when disposing of transmitter batteries.

4. Insert the new battery. Refer to the diagram inside the remote entry transmitter for the correct orientation of the battery. Press the battery down to ensure that the battery is fully seated in the battery housing cavity.

5. Snap the two halves back together.

Note: Replacement of the battery will **not** cause the remote transmitter to become deprogrammed from your vehicle. The remote transmitter should operate normally after battery replacement.

Replacing lost remote entry transmitters

If you would like to have your remote entry transmitter reprogrammed because you lost one, or would like to buy additional remote entry transmitters, you can either reprogram them yourself, or take **all remote entry transmitters** to your authorized dealer for reprogramming.

How to reprogram your remote entry transmitters

You must have **all remote entry transmitters** (maximum of four) available before beginning this procedure.

Locks and Security

To reprogram the remote entry transmitters:

1. Ensure the vehicle is electronically unlocked.
2. Put the key in the ignition.
3. Turn the key from the 2 (LOCK) position to 3 (OFF).
4. Cycle eight times rapidly (within 10 seconds) between the 3 (OFF) position and 4 (ON). **Note:** The eighth turn must end in the 4 (ON) position.
5. The doors will lock, then unlock, to confirm that the programming mode has been activated.
6. Within 20 seconds press any button on the remote entry transmitter. **Note:** If more than 20 seconds have passed you will need to start the procedure over again.
7. The doors will lock, then unlock, to confirm that this remote entry transmitter has been programmed.
8. Repeat Step 6 to program each additional remote entry transmitter.
9. Turn the ignition to the 3 (OFF) position after you have finished programming all of the remote entry transmitters. **Note:** After 20 seconds, you will automatically exit the programming mode.
10. The doors will lock, then unlock, to confirm that the programming mode has been exited.

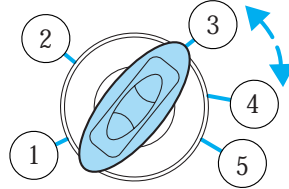

Illuminated entry

The interior lamps illuminate when the remote entry system is used to unlock the door(s) or sound the personal alarm.

The illuminated entry system will turn off the interior lights if:

- the ignition is turned to the 4 (ON) position, or
- the remote transmitter lock control is pressed, or
- the vehicle is locked using the keyless entry keypad (if equipped), or
- after 25 seconds of illumination.

The dome lamp control (if equipped) must **not** be set to the off position for the illuminated entry system to operate.

The inside lights will not turn off if:

- they have been turned on with the dimmer control, or

Locks and Security

- any door is open.

The battery saver will shut off the interior lamps 10 minutes after the ignition has been turned to the 3 (OFF) position.

Perimeter lamps illuminated entry

On vehicles equipped with the remote entry system, the following items will illuminate:

- Puddle lamps (if equipped)
- Head lamps
- Park lamps
- Tail lamps

The system will automatically turn off:

- if the ignition switch is turned to the 4 (ON) position, or
- the remote entry transmitter lock control is pressed, or
- the vehicle is locked using the keyless entry keypad (if equipped), or
- after 25 seconds of illumination.

Deactivating/activating perimeter lamps

You may enable/disable this feature by having your vehicle serviced by your authorized dealer.

You may also perform the following power door lock sequence to enable/disable the perimeter lamps feature (**Note:** All doors must be closed and remain closed throughout the process.):

1. Turn the ignition to the 4 (ON) position, and then press the power door unlock control 3 times.
2. Turn the ignition to the 3 (OFF) position, then press the power door unlock control 3 times.
3. Turn the ignition to the 4 (ON) position. The horn will chirp one time as confirmation that the programming mode is staged.

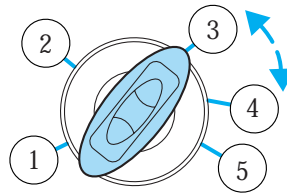

4. Press the power door unlock control twice within 5 seconds. **Note:** The horn will chirp twice to indicate the perimeter lighting feature has been deactivated or activated
5. Turn the ignition to the 3 (OFF) position to exit the procedure. **Note:** The horn will chirp once to confirm the procedure is complete.

Locks and Security

Note: The puddle lamps (if equipped) cannot be deactivated; performing this procedure will only deactivate the head, park and tail lamps.

KEYLESS ENTRY SYSTEM (IF EQUIPPED)

You can use the keyless entry keypad to:

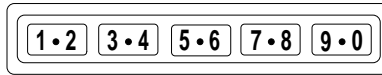

- lock or unlock the doors without using a key,
- open the trunk, or
- activate or deactivate the autolock feature.

The keypad can be operated with the factory set 5-digit entry code; this code is located on the owner's wallet card in the glove box, is marked on the computer module, and is available from your authorized dealer. You can also create your own 5-digit personal entry code.

When pressing the controls on the keypad, press the middle of the controls to ensure a good activation.

Programming a personal entry code

To create your own personal entry code:

1. Enter the factory set code. **Note:** The keyless entry keypad and interior lights will illuminate and the driver's door will unlock.
2. Within five seconds press the 1 • 2 on the keypad.
3. Enter your personal 5-digit code. Each number must be entered within five seconds of each other.
4. The doors will again lock then unlock, to confirm that your personal keycode has been programmed to the module.

Tips:

- Do not set a code that uses five of the same number.
- Do not use five numbers in sequential order.
- The factory set code will work even if you have set your own personal code.
- If you set a second personal code it will erase your first personal code.

Note: To exit programming mode, either wait 5 seconds after pressing 1 • 2 on the keypad, or press the 7 • 8 and 9 • 0 pads simultaneously to lock all vehicle doors and end programming mode.

Erasing personal codes

1. Enter the factory set 5-digit code. The keyless entry keypad and interior lights will illuminate and the driver's door will unlock.

Locks and Security

2. Press and release the 1 • 2 within five seconds of completing Step 1.
3. Press and hold the 1 • 2 for two seconds to erase the customer programmed codes.

All personal codes are now erased and only the factory set 5-digit code will work.

Note: To exit programming mode, either wait 5 seconds after pressing 1 • 2 on the keypad, or press the 7 • 8 and 9 • 0 pads simultaneously to lock all vehicle doors and end programming mode.

Unlocking and locking the doors using keyless entry

To unlock the driver's door, enter the factory set 5-digit code or your personal code. Each number must be pressed within five seconds of each other. The headlamps, parking lamps and interior lamps will illuminate.

To unlock all doors, enter the factory set code or your personal code, then press the 3 • 4 control within five seconds.

To unlock the trunk, enter the factory set code or your personal code, then press the 5 • 6 control within five seconds.

To lock all doors, press the 7 • 8 and the 9 • 0 at the same time. You **do not** need to enter the keypad code first.

SECURILOCK™ PASSIVE ANTI-THEFT SYSTEM

SecuriLock™ passive anti-theft system is an engine immobilization system. This system is designed to help prevent the engine from being started unless a **coded key programmed to your vehicle** is used. The use of the wrong type of coded key may lead to a “no-start” condition.

Your vehicle comes with two coded keys; additional coded keys may be purchased from your authorized dealer. The authorized dealer can program your spare keys to your vehicle or you can program the keys yourself. Refer to *Programming spare keys* for instructions on how to program the coded key.

Note: The SecuriLock™ passive anti-theft system is not compatible with non-Ford aftermarket remote start systems. Use of these systems may result in vehicle starting problems and a loss of security protection.

Note: Large metallic objects, electronic devices that are used to purchase gasoline or similar items, or a second coded key on the same key chain may cause vehicle starting issues. You need to prevent these objects from touching the coded key while starting the engine. These objects will not cause damage to the coded key, but may cause a momentary issue if they are too close to the key when starting the

Locks and Security

engine. If a problem occurs, turn the ignition off, remove all objects on the key chain away from the coded key and restart the engine.

Anti-theft indicator

The anti-theft indicator is located in the instrument cluster.

- When the ignition is in the 2 (LOCK) position, the indicator will flash once every 2 seconds to indicate the SecuriLock™ system is functioning as a theft deterrent.
- When the ignition is in the 4 (ON) position, the indicator will glow for 3 seconds, then turn off to indicate normal system functionality.

If a problem occurs with the SecuriLock™ system, the indicator will flash rapidly or glow steadily when the ignition is in the 4 (ON) position. If this occurs, the vehicle should be taken to an authorized dealer for service.

Automatic arming

The vehicle is armed immediately after switching the ignition to the 3 (OFF) position.

The **THEFT** indicator will flash every two seconds when the vehicle is armed.

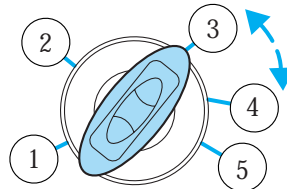

Automatic disarming

Switching the ignition to the 4 (ON) position with a **coded key** disarms the vehicle.

- The **THEFT** indicator will illuminate for three seconds and then go out.
- If the **THEFT** indicator stays on for an extended period of time or flashes rapidly, have the system serviced by your authorized dealer.

Replacement keys

If your keys are lost or stolen and you don't have an extra coded key, you will need to have your vehicle towed to an authorized dealer. The key codes need to be erased from your vehicle and new coded keys will need to be programmed.

Replacing coded keys can be very costly. Store an extra programmed key away from the vehicle in a safe place to help prevent any inconveniences. Please visit an authorized dealer to purchase additional spare or replacement keys.

Locks and Security

Programming spare keys

You can program your own coded keys to your vehicle. Please read and understand the entire procedure before you begin.

Tips:

- A maximum of eight keys can be coded to your vehicle.
- Only use Securilock™ keys.
- You must have two previously programmed coded keys (keys that already operate your vehicle's engine) and the new unprogrammed key(s) readily accessible.
- If no previously programmed coded keys are available, you must take your vehicle to your authorized dealer to have the spare key(s) programmed.

1. Insert a previously programmed coded key into the ignition.
2. Turn the ignition from the 3 (OFF) position to the 4 (ON) position. Keep the ignition in the 4 (ON) position for at least one second, but no more than 10 seconds.

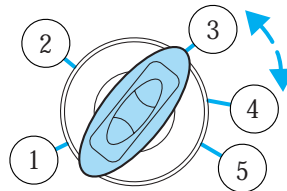

3. Turn the ignition to the 3 (OFF) position, and remove the coded key from the ignition.
4. Within ten seconds of removing the previously programmed coded key, insert the other previously programmed coded key into the ignition.
5. Turn the ignition from the 3 (OFF) position to the 4 (ON) position. Keep the ignition in the 4 (ON) position for at least one second but not more than 10 seconds.
6. Turn the ignition to the 3 (OFF) position, and remove the second key from the ignition.
7. Within twenty seconds of removing the previously programmed coded key, insert the unprogrammed key (new/valet key) into the ignition.
8. Turn the ignition from the 3 (OFF) position to the 4 (ON) position. Keep the ignition in the 4 (ON) position for at least one second.
9. Your new unprogrammed key is now programmed.

Locks and Security

If the key has been successfully programmed it will start the vehicle's engine and the theft indicator light will illuminate for three seconds and then go out. If the key was not successfully programmed, it will not start your vehicle's engine and the theft indicator light will flash on and off rapidly. If failure repeats, bring your vehicle to your authorized dealer to have the new key(s) programmed.

To program additional new unprogrammed key(s), repeat this procedure from Step 1 for each additional key.

PERIMETER ALARM SYSTEM (IF EQUIPPED)

The perimeter anti-theft system will warn you in the event of an unauthorized entry to your vehicle.

If there is any potential perimeter anti-theft problem with your vehicle, ensure **ALL remote entry transmitters** are taken to the authorized dealer to aid in troubleshooting.

Arming the system

When armed, this system will respond if unauthorized entry is attempted. When unauthorized entry occurs, the system will flash the headlamps and/or parking lamps and will sound the horn.

The system is ready to arm whenever key is removed from the ignition. Either of the following actions will prearm the alarm system:

- Press the  control on the remote entry transmitter.
- Press the 7 • 8 and the 9 • 0 on the keyless entry keypad (if equipped) at the same time.
- Open a door and press the power door lock control to lock all the doors.

Note: The hood and each door arm individually, and if any of them are open, they must be closed in order to be armed.



When you press the  control on the remote entry transmitter twice within three seconds:

- the horn will chirp once to indicate the hood and each door are closed.
- the horn will chirp twice to indicate that either the hood or a door is still open.

Locks and Security

Disarming the system

You can disarm the system by any of the following actions:

- Unlock the doors by pressing the  control on your remote entry transmitter.
- Unlock the doors by using the keyless entry pad.
- Unlock the doors with a key. Turn the key full travel (toward the front of the vehicle) to ensure the alarm disarms.
- Turn the ignition to the 4 (ON) position.
- Press the  control on the remote entry transmitter. This will only shut the horn off when the alarm is sounding; the alarm system will still be armed.

Triggering the anti-theft system

The armed system will be triggered if:

- Any door or the hood is opened without using the key or the remote entry transmitter.
- The trunk key cylinder is forced.

Seating and Safety Restraints

SEATING

Notes:



Reclining the seatback can cause an occupant to slide under the seat's safety belt, resulting in severe personal injuries in the event of a collision.



Do not pile cargo higher than the seatbacks to reduce the risk of injury in a collision or sudden stop.



Before returning the seatback to its original position, make sure that cargo or any objects are not trapped behind the seatback. After returning the seatback to its original position, pull on the seatback to ensure that it has fully latched. An unlatched seat may become dangerous in the event of a sudden stop or collision.

Adjustable head restraints (front seats)

Head restraints help to limit head motion in the event of a rear collision. The front seats in your vehicle have adjustable head restraints. Adjust your head restraint so that it is located directly or as close as possible behind your head.

Raise the head restraint by pulling it upward.

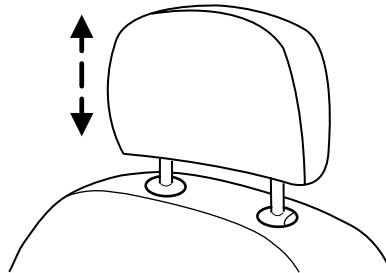

Seating and Safety Restraints

To lower the head restraint:

- Push the release control.
- Push down on the head restraint.

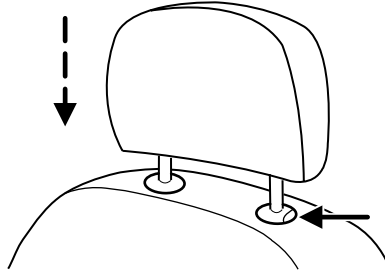

Using the manual lumbar support (if equipped)

The lumbar control is located on the front of the seat cushion.

Turn to adjust lumbar support.

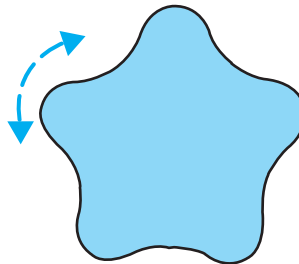

Adjusting the front manual seat (if equipped)



Never adjust the driver's seat or seatback when the vehicle is moving.



Always drive and ride with your seatback upright and the lap belt snug and low across the hips.

Lift handle to move seat forward or backward.

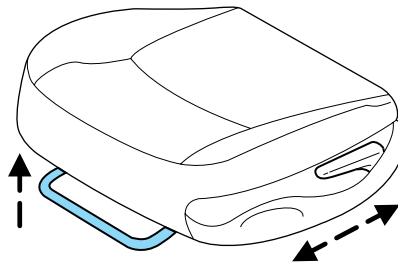

Seating and Safety Restraints

Pull lever up to adjust seatback.

 Before returning the seatback to its original position, make sure that cargo or any objects are not trapped behind the seatback. After returning the seatback to its original position, pull on the seatback to ensure that it has fully latched. An unlatched seat may become dangerous in the event of a sudden stop or collision.

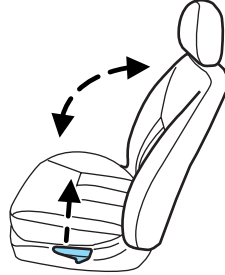



Adjusting the front power seat (if equipped)

 Never adjust the driver's seat or seatback when the vehicle is moving.

 Do not pile cargo higher than the seatbacks to avoid injuring people in a collision or sudden stop.

 Always drive and ride with your seatback upright and the lap belt snug and low across the hips.

 Reclining the seatback can cause an occupant to slide under the seat's safety belt, resulting in severe personal injuries in the event of a collision.

 Sitting improperly out of position or with the seat back reclined too far can take off weight from the seat cushion and affect the decision of the passenger sensing system, resulting in serious injury or death in a crash. Always sit upright against your seatback, with your feet on the floor.

Seating and Safety Restraints

 To reduce the risk of possible serious injury: Do not hang objects off seat back or stow objects in the seatback map pocket (if equipped) when a child is in the front passenger seat. Do not place objects underneath the front passenger seat or between the seat and the center console (if equipped). Check the “passenger airbag off” or “pass airbag off” indicator lamp for proper airbag status. Refer to *Front passenger sensing system* section for additional details. Failure to follow these instructions may interfere with the front passenger seat sensing system.

The control is located on the outboard side of the seat cushion.

Press to raise or lower the front portion of the seat cushion.

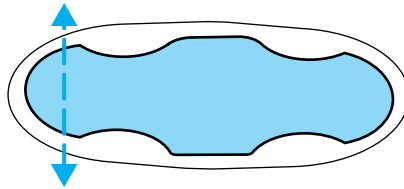

Press to raise or lower the rear portion of the seat cushion.

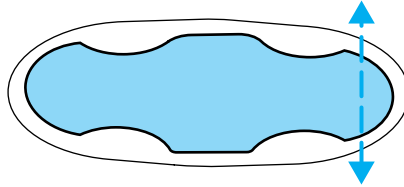

Press the control to move the seat forward, backward, up or down.

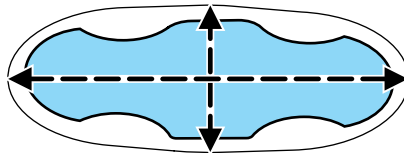

Seating and Safety Restraints

REAR SEATS

2nd seat/split-folding rear seat (if equipped)

Pull the loop forward to release the seatback and then fold the seatback down.

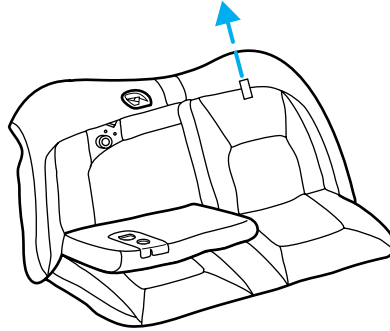

When raising the seatback(s), make sure you hear the seat latch into place.

Make sure that the safety belt for the rear center passenger is properly routed over the rear seatback.



Before returning the seatback to its original position, make sure that cargo or any objects are not trapped behind the seatback. After returning the seatback to its original position, pull on the seatback to ensure that it has fully latched. An unlatched seat may become dangerous in the event of a sudden stop or collision.

SAFETY RESTRAINTS

Personal Safety System™

The Personal Safety System™ provides an improved overall level of frontal crash protection to front seat occupants and is designed to help further reduce the risk of airbag-related injuries. The system is able to analyze different occupant classifications and conditions and crash severity before activating the appropriate safety devices to help better protect a range of occupants in a variety of frontal crash situations.

Your vehicle's Personal Safety System™ consists of:

- Driver and passenger dual-stage airbag supplemental restraints.
- Front safety belts with pretensioners, energy management retractors, and safety belt usage sensors.

Seating and Safety Restraints

- Driver's seat position sensor.
- Front crash severity sensor.
- Front passenger sensing system
- "Passenger airbag off" or "pass airbag off" indicator lamp
- Restraints Control Module (RCM) with impact and safing sensors.
- Restraint system warning light and back-up tone.
- The electrical wiring for the airbags, crash sensor(s), safety belt pretensioners, front safety belt usage sensors, driver seat position sensor, front passenger sensing system, and indicator lights.

How does the Personal Safety System™ work?

The Personal Safety System™ can adapt the deployment strategy of your vehicle's safety devices according to crash severity and occupant classification and conditions. A collection of crash and occupant sensors provides information to the Restraints Control Module (RCM). During a crash, the RCM activates the safety belt pretensioners and/or either none, one, or both stages of the dual-stage airbag supplemental restraints based on crash severity and occupant classification and conditions.

The fact that the pretensioners or airbags did not activate for both front seat occupants in a collision does not mean that something is wrong with the system. Rather, it means the Personal Safety System™ determined the accident conditions (crash severity, belt usage, etc.) were not appropriate to activate these safety devices. Front airbags are designed to activate in frontal and near-frontal collisions (not rollovers, side impacts or rear impacts) unless the collision causes sufficient longitudinal deceleration. The pretensioners are designed to activate in frontal and near-frontal collisions, and in side collisions when the vehicle is equipped with side airbags.

Driver and passenger dual-stage airbag supplemental restraints

The dual-stage airbags offer the capability to tailor the level of airbag inflation energy. A lower, less forceful energy level is provided for more common, moderate-severity impacts. A higher energy level is used for the most severe impacts. Refer to *Airbag Supplemental Restraints* section in this chapter.

Front crash severity sensor

The front crash severity sensor enhances the ability to detect the severity of an impact. Positioned up front, it provides valuable information early in the crash event on the severity of the impact. This

Seating and Safety Restraints

allows your Personal Safety System[™] to distinguish between different levels of crash severity and modify the deployment strategy of the dual-stage airbags and safety belt pretensioners.

Driver's seat position sensor

The driver's seat position sensor allows your Personal Safety System[™] to tailor the deployment level of the driver dual-stage airbag based on seat position. The system is designed to help protect smaller drivers sitting close to the driver airbag by providing a lower airbag output level.

Front passenger sensing system

For airbags to do their job they must inflate with great force, and this force can pose a potentially deadly risk to occupants that are very close to the airbag when it begins to inflate. For some occupants, like infants in rear-facing child seats, this occurs because they are initially sitting very close to the airbag. For other occupants, this occurs when the occupant is not properly restrained by safety belts or child safety seats and they move forward during pre-crash braking. The most effective way to reduce the risk of unnecessary injuries is to make sure all occupants are properly restrained. Accident statistics suggest that children are much safer when properly restrained in the rear seating positions than in the front.



Air bags can kill or injure a child in a child seat. **NEVER** place a rear-facing child seat in front of an active air bag. If you must use a forward-facing child seat in the front seat, move the seat all the way back.



Always transport children 12 years old and under in the back seat and always properly use appropriate child restraints.

The front passenger sensing system can automatically turn off the passenger front airbag. The system is designed to help protect small (child size) occupants from airbag deployments when they are improperly seated or restrained in the front passenger seat contrary to proper child-seating or restraint usage recommendations. Even with this technology, parents are **STRONGLY** encouraged to always properly restrain children in the rear seat. The sensor also turns off the airbag when the passenger seat is empty to prevent unnecessary replacement of airbag(s) after a collision.

When the front passenger seat is occupied and the sensing system has turned off the passenger's frontal airbag, the "pass airbag off" indicator

Seating and Safety Restraints

will light and stay lit to remind you that the front passenger frontal airbag is off. See *Front passenger sensing system* in the airbags section of this chapter.

Front safety belt usage sensors

The front safety belt usage sensors detect whether or not the driver and front outboard passenger safety belts are fastened. This information allows your Personal Safety System™ to tailor the airbag deployment and safety belt pretensioner activation depending upon safety belt usage. Refer to *Safety Belt* section in this chapter.

Front safety belt pretensioners

The safety belt pretensioners are designed to tighten the front outboard safety belts firmly against the occupant's body during a collision. This maximizes the effectiveness of the safety belt and removes any slack from the safety belt to improve protection. The safety belt pretensioners can be either activated alone or, if the collision is of sufficient severity, together with the airbags.

Front safety belt energy management retractors

The front outboard safety belt energy management retractors allow webbing to be pulled out of the retractor in a gradual and controlled manner in response to the occupant's forward momentum. This helps reduce the risk of force-related injuries to the occupant's chest by limiting the load on the occupant. Refer to *Safety Belt* section in this chapter.

Determining if the Personal Safety System™ is operational

The Personal Safety System™ uses a warning light in the instrument cluster or a back-up tone to indicate the condition of the system. Refer to the *Warning lights and chimes* section in the *Instrument Cluster* chapter. Routine maintenance of the Personal Safety System™ is not required.

The Restraints Control Module (RCM) monitors its own internal circuits and the circuits for the airbag supplemental restraints, crash sensor(s), safety belt pretensioners, front safety belt buckle sensors, and the driver seat position sensor. In addition, the RCM also monitors the restraints warning light in the instrument cluster. A difficulty with the system is indicated by one or more of the following.

- The warning light will either flash or stay lit.
- The warning light will not illuminate immediately after ignition is turned on.

Seating and Safety Restraints

- A series of five beeps will be heard. The tone pattern will repeat periodically until the problem and warning light are repaired. If any of these things happen, even intermittently, have the Personal Safety System[™] serviced at an authorized dealer immediately. Unless serviced, the system may not function properly in the event of a collision.

Safety belt precautions



Always drive and ride with your seatback upright and the lap belt snug and low across the hips.



To reduce the risk of injury, make sure children sit where they can be properly restrained.



Never let a passenger hold a child on his or her lap while the vehicle is moving. The passenger cannot protect the child from injury in a collision.



All occupants of the vehicle, including the driver, should always properly wear their safety belts, even when an air bag supplemental restraint system (SRS) is provided.



It is extremely dangerous to ride in a cargo area, inside or outside of a vehicle. In a collision, people riding in these areas are more likely to be seriously injured or killed. Do not allow people to ride in any area of your vehicle that is not equipped with seats and safety belts. Be sure everyone in your vehicle is in a seat and using a safety belt properly.



In a rollover crash, an unbelted person is significantly more likely to die than a person wearing a seat belt.



Each seating position in your vehicle has a specific safety belt assembly which is made up of one buckle and one tongue that are designed to be used as a pair. 1) Use the shoulder belt on the outside shoulder only. Never wear the shoulder belt under the arm. 2) Never swing the safety belt around your neck over the inside shoulder. 3) Never use a single belt for more than one person.

Seating and Safety Restraints



Always transport children 12 years old and under in the back seat and always properly use appropriate child restraints.

Combination lap and shoulder belts

1. Insert the belt tongue into the proper buckle (the buckle closest to the direction the tongue is coming from) until you hear a snap and feel it latch. Make sure the tongue is securely fastened in the buckle.

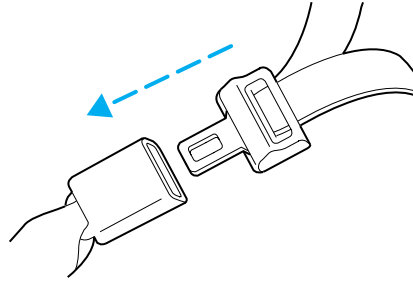

2. To unfasten, push the release button and remove the tongue from the buckle.

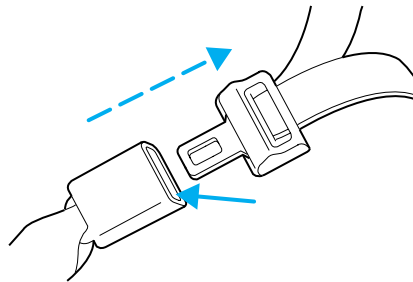

Energy management retractors

Your vehicle has a safety belt system equipped with energy management retractors at the driver and front outboard passenger seating positions.

An energy management retractor is a device which pays out webbing in a controlled manner. This feature is designed to help further reduce the risk of force-related injuries to the occupant.

Safety belt systems equipped with an energy management retractor must be replaced if they were in use during a frontal collision which resulted in deployment of the frontal airbags. Refer to the *Safety belt maintenance* section in this chapter.

The front and rear safety restraints in the vehicle are combination lap and shoulder belts. The front passenger outboard and rear outboard seat safety belts have two types of locking modes described below:

Seating and Safety Restraints

Vehicle sensitive mode

This is the normal retractor mode, which allows free shoulder belt length adjustment to your movements and locking in response to vehicle movement. For example, if the driver brakes suddenly or turns a corner sharply, or the vehicle receives an impact of approximately 5 mph (8 km/h) or more, the combination safety belts will lock to help reduce forward movement of the driver and passengers.

Automatic locking mode

In this mode, the shoulder belt is automatically pre-locked. The belt will still retract to remove any slack in the shoulder belt. The automatic locking mode is not available on the driver safety belt.

This mode should be used **any time** a child safety seat (except a booster) is installed in the vehicle. Children 12 years old and under should be properly restrained in the rear seat whenever possible. Refer to *Safety restraints for children* or *Safety seats for children* later in this chapter.

How to use the automatic locking mode

- Buckle the combination lap and shoulder belt.

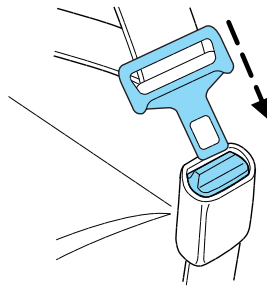

- Grasp the shoulder portion and pull downward until the entire belt is pulled out.

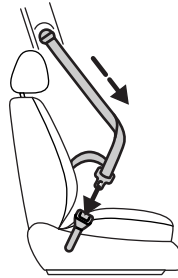

- Allow the belt to retract. As the belt retracts, you will hear a clicking sound. This indicates the safety belt is now in the automatic locking mode.

Seating and Safety Restraints

How to disengage the automatic locking mode

 Ford Motor Company recommends that all safety belt assemblies and attaching hardware should be inspected by an authorized dealer after any collision. Safety belt assemblies not in use during a collision should also be inspected and replaced if either damage or improper operation is noted.

Disconnect the combination lap/shoulder belt and allow it to retract completely to disengage the automatic locking mode and activate the vehicle sensitive (emergency) locking mode.

 After any vehicle collision, the safety belt system at all outboard seating positions (except driver, which has no “automatic locking retractor” feature) must be checked by an authorized dealer to verify that the “automatic locking retractor” feature for child seats is still functioning properly. In addition, all safety belts should be checked for proper function.

 BELT AND RETRACTOR ASSEMBLY MUST BE REPLACED if the safety belt assembly “automatic locking retractor” feature or any other safety belt function is not operating properly when checked by an authorized dealer.

 Failure to replace the Belt and Retractor assembly could increase the risk of injury in collisions.

Safety belt pretensioner

Your vehicle is equipped with safety belt pretensioners at the driver and front outboard passenger seating positions.

The safety belt pretensioners are designed to activate when the safety belt is fastened during certain frontal or near-frontal collisions, or in certain side collisions that result in side airbag activation (if the vehicle is equipped with side airbags). A safety belt pretensioner is a device which tightens the webbing of the lap and shoulder belts in such a way that they fit more snugly against the body.

When the front airbags are activated, the safety belt pretensioners for the driver and right front passenger seating positions will be activated when the respective safety belt is properly buckled. If a side airbag is

Seating and Safety Restraints

activated, the safety belt pretensioner for that seating position will be activated if the safety belt is properly buckled.

The driver and front outboard passenger safety belt system (including retractors, buckles and height adjusters) must be replaced if the vehicle is involved in a collision that results in the activation of the safety belt pretensioners. Refer to the *Safety belt maintenance* section in this chapter.

 The driver and the right front passenger safety belt system (including retractors, buckles and height adjusters) must be replaced if the vehicle is involved in a collision that results in deployment of front airbags or side airbags and safety belt pretensioners.

Safety belt usage sensors

The driver and front outboard passenger safety belt buckles are equipped with sensors that detect if the safety belts are fastened. The sensors provide information to the Personal Safety System which can then adapt the airbag deployment or safety belt pretensioner activation based upon safety belt usage.

 The Personal Safety System provides the most benefit to belted occupants. The system monitors and tailors the air bag deployment based upon safety belt usage. Failure to properly wear your safety belt will increase your risk of injury.

Front safety belt height adjustment

Your vehicle has safety belt height adjustments for the driver and front passenger. Adjust the height of the shoulder belt so the belt rests across the middle of your shoulder.

To lower the shoulder belt height, pull the control down and slide the height adjuster down. To raise the height of the shoulder belt, slide the height adjuster up. To raise the height of the shoulder belt from its lowest position, pull the control down and slide the height adjuster up. Pull down on the height adjuster to make sure it is locked in place.

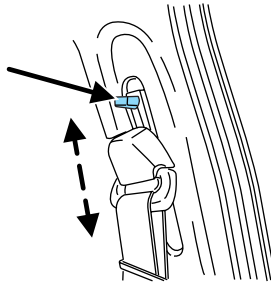

Seating and Safety Restraints

 Position the safety belt height adjusters so that the belt rests across the middle of your shoulder. Failure to adjust the safety belt properly could reduce the effectiveness of the seat belt and increase the risk of injury in a collision.

Lap belts

Adjusting the center front lap belt

The center front lap belt does not adjust automatically.

 The lap belt should fit snugly and as low as possible around the hips, not across the waist.

Insert the tongue into the correct buckle (the buckle closest to the direction the tongue is coming from). To lengthen the belt, turn the tongue at a right angle to the belt and pull across your lap until it reaches the buckle. To tighten the belt, pull the loose end of the belt through the tongue until it fits snugly across the hips.

Shorten and fasten the belt when not in use.

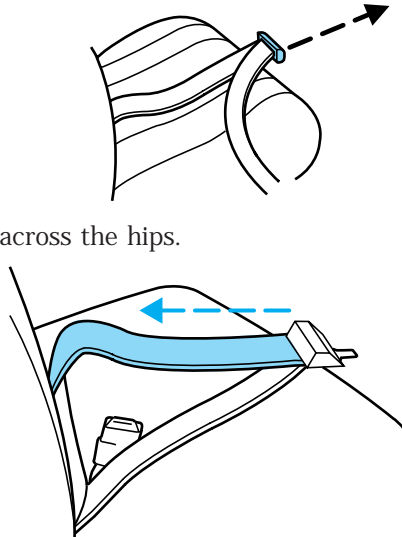

Safety belt extension assembly

If the safety belt is too short when fully extended, there is a 8 inch (20 cm) safety belt extension assembly that can be added (part number 611C22). This assembly can be obtained from an authorized dealer.

Use only extensions manufactured by the same supplier as the safety belt. Manufacturer identification is located at the end of the webbing on the label. Also, use the safety belt extension only if the safety belt is too short for you when fully extended.

Seating and Safety Restraints



Do not use extensions to change the fit of the shoulder belt across the torso.

Safety belt maintenance

Inspect the safety belt systems periodically to make sure they work properly and are not damaged. Inspect the safety belts to make sure there are no nicks, tears or cuts. Replace if necessary. All safety belt assemblies, including retractors, buckles, front safety belt buckle assemblies, buckle support assemblies (slide bar-if equipped), shoulder belt height adjusters (if equipped), shoulder belt guide on seatback (if equipped), child safety seat LATCH and tether anchors, and attaching hardware, should be inspected after a collision. Ford Motor Company recommends that all safety belt assemblies in use in vehicles involved in a collision be replaced. However, if the collision was minor and an authorized dealer finds that the belts do not show damage and continue to operate properly, they do not need to be replaced. Safety belt assemblies not in use during a collision should also be inspected and replaced if either damage or improper operation is noted.



Failure to inspect and if necessary replace the safety belt assembly under the above conditions could result in severe personal injuries in the event of a collision.

For proper care of soiled safety belts, refer to *Interior* in the *Cleaning* chapter.

Safety belt warning light and indicator chime

The safety belt warning light illuminates in the instrument cluster and a chime sounds to remind the occupants to fasten their safety belts.

Seating and Safety Restraints

Conditions of operation

If...	Then...
The driver's safety belt is not buckled before the ignition switch is turned to the ON position...	The safety belt warning light illuminates 1-2 minutes and the warning chime sounds 4-8 seconds.
The driver's safety belt is buckled while the indicator light is illuminated and the warning chime is sounding...	The safety belt warning light and warning chime turn off.
The driver's safety belt is buckled before the ignition switch is turned to the ON position...	The safety belt warning light and indicator chime remain off.

BeltMinder®

The BeltMinder® feature is a supplemental warning to the safety belt warning function. This feature provides additional reminders by intermittently sounding a chime and illuminating the safety belt warning light in the instrument cluster when the driver's and front passenger's safety belt is unbuckled.

The BeltMinder® feature uses information from the front passenger sensing system to determine if a front seat passenger is present and therefore potentially in need of a warning. To avoid activating the BeltMinder® feature for objects placed in the front passenger seat, warnings will only be given to large front seat occupants as determined by the front passenger sensing system.

Both the driver's and passenger's safety belt usages are monitored and either may activate the BeltMinder® feature. The warnings are the same for the driver and the front passenger. If the BeltMinder® warnings have expired (warnings for approximately 5 minutes) for one occupant (driver or front passenger), the other occupant can still activate the BeltMinder® feature.

Seating and Safety Restraints

If...	Then...
The driver's and front passenger's safety belts are buckled before the ignition switch is turned to the ON position or less than 1-2 minutes have elapsed since the ignition switch has been turned ON...	The BeltMinder® feature will not activate.
The driver's or front passenger's safety belt is not buckled when the vehicle has reached at least 3 mph (5 km/h) and 1-2 minutes have elapsed since the ignition switch has been turned to ON...	The BeltMinder® feature is activated - the safety belt warning light illuminates and the warning chime sounds for 6 seconds every 30 seconds, repeating for approximately 5 minutes or until the safety belts are buckled.
The driver's or front passenger's safety belt becomes unbuckled for approximately 1 minute while the vehicle is traveling at least 3 mph (5 km/h) and more than 1-2 minutes have elapsed since the ignition switch has been turned to ON...	The BeltMinder® feature is activated - the safety belt warning light illuminates and the warning chime sounds for 6 seconds every 30 seconds, repeating for approximately 5 minutes or until the safety belts are buckled.

Seating and Safety Restraints

The following are reasons most often given for not wearing safety belts
(All statistics based on U.S. data):

Reasons given...	Consider...
"Crashes are rare events"	36700 crashes occur every day. The more we drive, the more we are exposed to "rare" events, even for good drivers. <i>1 in 4 of us will be seriously injured in a crash during our lifetime.</i>
"I'm not going far"	3 of 4 fatal crashes occur within 25 miles (40 km) of home.
"Belts are uncomfortable"	We design our safety belts to enhance comfort. If you are uncomfortable - try different positions for the safety belt upper anchorage and seatback which should be as upright as possible; this can improve comfort.
"I was in a hurry"	Prime time for an accident. BeltMinder® reminds us to take a few seconds to buckle up.
"Safety belts don't work"	Safety belts , when used properly, reduce risk of death to front seat occupants by 45% in cars , and by 60% in light trucks .
"Traffic is light"	Nearly 1 of 2 deaths occur in single-vehicle crashes , many when no other vehicles are around.
"Belts wrinkle my clothes"	Possibly, but a serious crash can do much more than wrinkle your clothes, particularly if you are unbelted.
"The people I'm with don't wear belts"	Set the example, teen deaths occur 4 times more often in vehicles with TWO or MORE people. Children and younger brothers/sisters imitate behavior they see.

Seating and Safety Restraints

Reasons given...	Consider...
"I have an airbag"	Airbags offer greater protection when used with safety belts. Frontal airbags are not designed to inflate in rear and side crashes or rollovers.
"I'd rather be thrown clear"	Not a good idea. People who are ejected are 40 times more likely to DIE. Safety belts help prevent ejection, WE CAN'T "PICK OUR CRASH".

 Do not sit on top of a buckled safety belt to avoid the BeltMinder® chime. Sitting on the safety belt will increase the risk of injury in an accident. To disable (one-time) or deactivate the BeltMinder® feature please follow the directions stated below.

One time disable

If at any time the driver/front passenger quickly buckles then unbuckles the safety belt for that seating position, the BeltMinder® is disabled for the current ignition cycle. The BeltMinder® feature will enable during the same ignition cycle if the occupant buckles and remains buckled for approximately 30 seconds. Confirmation is not given for the one time disable.

Deactivating/activating the BeltMinder® feature

The driver and front passenger BeltMinder® are deactivated/activated independently. When deactivating/activating one seating position, do not buckle the other position as this will terminate the process.

Read Steps 1 - 4 thoroughly before proceeding with the deactivation/activation programming procedure.

Note: The driver and front passenger BeltMinder® features must be disabled/enabled separately. Both cannot be disabled/enabled during the same key cycle.

Seating and Safety Restraints

The driver and front passenger BeltMinder® features can be deactivated/activated by performing the following procedure:

Before following the procedure, make sure that:

- The parking brake is set
- The gearshift is in P (Park) (automatic transmission)
- The ignition switch is in the OFF position
- The driver and front passenger safety belts are unbuckled



To reduce the risk of injury, do not deactivate/activate the BeltMinder® feature while driving the vehicle.

1. Turn the ignition switch to the RUN (or ON) position. (DO NOT START THE ENGINE)
2. Wait until the safety belt warning light turns off. (Approximately 1 minute)
 - Step 3 must be completed within 50 seconds after the safety belt warning light turns off.
3. For the seating position being disabled, at a moderate speed, buckle then unbuckle the safety belt 9 times, ending in the unbuckled state. (Step 3 must be completed within 50 seconds after the safety belt warning light turns off.)
 - After Step 3, the restraint system warning light (airbag light) will be turned on for three seconds.
4. Within 10 seconds of the light turning on, at a moderate speed, buckle then unbuckle the safety belt.
 - This will disable the BeltMinder® feature for that seating position if it is currently enabled. As confirmation, the restraint system warning light will flash 4 times per second for 3 seconds.
 - This will enable the BeltMinder® feature for that seating position if it is currently disabled. As confirmation, the restraint system warning light will flash 4 times per second for 3 seconds, followed by 3 seconds with the light off, then followed by the restraint system warning light flashing 4 times per second for 3 seconds again.

Seating and Safety Restraints

AIRBAG SUPPLEMENTAL RESTRAINT SYSTEM (SRS)

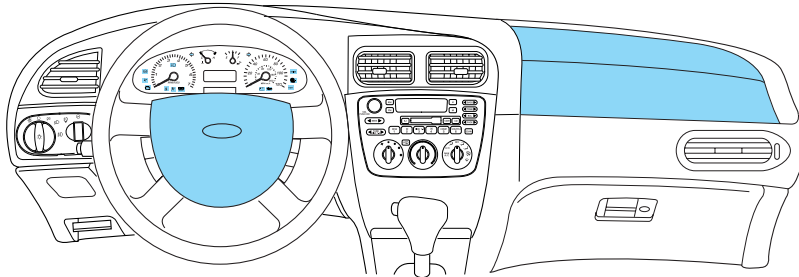

The airbag supplemental restraint system (SRS) is designed to work in conjunction with the safety belts to help protect the driver and front outboard passenger from certain upper body injuries. The term “supplemental restraint” means the airbags are intended as a supplement to the safety belts. Airbags alone cannot protect as well as airbags plus safety belts in impacts for which the airbags are designed to deploy, and airbags do not offer any protection in crashes for which they do not deploy.

The airbag supplemental restraint system consists of:

- driver and passenger dual stage airbag modules (which include the inflators and airbags).
- side airbags (if equipped). Refer to *Side airbag system* later in this chapter.
- one or more impact and safing sensors.
- the same indicator light, RCM (restraints control module) and diagnostic unit used for the Personal safety system.
- Front passenger sensing system. Refer to *Front passenger sensing system* later in this chapter.
- “Passenger airbag off” or “pass airbag off” indicator lamp. Refer to *Front passenger sensing system* later in this chapter.

The airbag supplemental restraints are an integral part of the Personal Safety System. They are designed to be deployed in cases where the Personal Safety System has determined the occupant conditions and crash severity are appropriate to activate these devices. Refer to the *Personal Safety System* section in this chapter.

Seating and Safety Restraints

Important supplemental restraint system precautions

Airbags DO NOT inflate slowly or gently and the risk of injury from a deploying airbag is greatest close to the trim covering the airbag module.

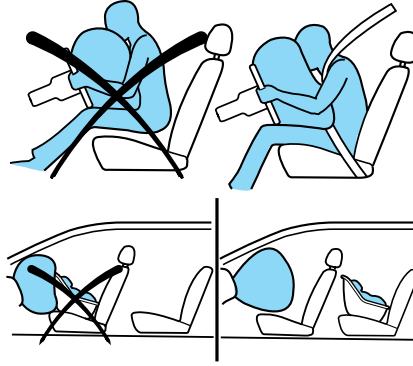

 All occupants of the vehicle, including the driver, should always properly wear their safety belts, even when an air bag supplemental restraint system (SRS) is provided.

 Always transport children 12 years old and under in the back seat and always properly use appropriate child restraints.

 National Highway Traffic Safety Administration (NHTSA) recommends a minimum distance of at least 10 inches (25 cm) between an occupant's chest and the driver airbag module.

 Never place your arm over the airbag module as a deploying airbag can result in serious arm fractures or other injuries.

Steps you can take to properly position yourself away from the airbag:

- Move your seat to the rear as far as you can while still reaching the pedals comfortably.
- Recline the seat slightly (one or two degrees) from the upright position.

 Do not put anything on or over the airbag module. Placing objects on or over the airbag inflation area may cause those objects to be propelled by the airbag into your face and torso causing serious injury.

Seating and Safety Restraints

 Do not attempt to service, repair, or modify the airbag supplemental restraint system (SRS) or its fuses. See your authorized dealer.

 The front passenger airbag is not designed to offer protection to an occupant in the center front seating position.

 Modifying or adding equipment to the front end of the vehicle (including frame, bumper, front end body structure and tow hooks) may affect the performance of the airbag system, increasing the risk of injury. Do not modify the front end of the vehicle.

Children and airbags

Children must always be properly restrained. Accident statistics suggest that children are safer when properly restrained in the rear seating positions than in the front seating position. Failure to follow these instructions may increase the risk of injury in a collision.

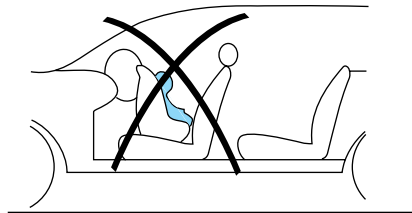

 Airbags can kill or injure a child in a child seat. **NEVER** place a rear-facing child seat in front of an active airbag. If you must use a forward-facing child seat in the front seat, move the seat all the way back.

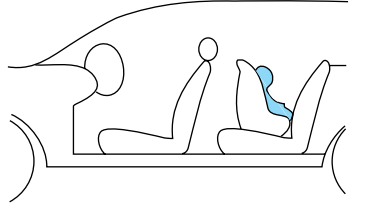

Seating and Safety Restraints

How do the airbag supplemental restraints work?

The airbags inflate and deflate rapidly upon activation. After airbag deployment, it is normal to notice a smoke-like, powdery residue or smell the burnt propellant. This may consist of cornstarch, talcum powder (to lubricate the bag) or sodium compounds (e.g., baking soda) that result from the combustion process that inflates the airbag. Small amounts of sodium hydroxide may be present which may irritate the skin and eyes, but none of the residue is toxic.



While the system is designed to help reduce serious injuries, contact with a deploying airbag may also cause abrasions, swelling or temporary hearing loss. Because airbags must inflate rapidly and with considerable force, there is the risk of death or serious injuries such as fractures, facial and eye injuries or internal injuries, particularly to occupants who are not properly restrained or are otherwise out of position at the time of airbag deployment. Thus, it is extremely important that occupants be properly restrained as far away from the airbag module as possible while maintaining vehicle control.



Several air bag system components get hot after inflation. Do not touch them after inflation.



If the air bag has deployed, **the air bag will not function again and must be replaced immediately.** If the air bag is not replaced, the unrepaired area will increase the risk of injury in a collision.

Front passenger sensing system

The front passenger sensing system is designed to meet the regulatory requirements of Federal Motor Vehicle Safety Standard (FMVSS) 208 and is designed to disable (will not inflate) the front passenger's frontal airbag under certain conditions.

100

Seating and Safety Restraints

The front passenger sensing system works with sensors that are part of the front passenger's seat and safety belt. The sensors are designed to detect the presence of a properly seated occupant and determine if the front passenger's frontal airbag should be enabled (may inflate) or disabled (will not inflate).

The front passenger sensing system will disable (will not inflate) the front passenger's frontal airbag if:

- the front passenger seat is unoccupied, or has small/medium objects in the front seat,
- the system determines that an infant is present in a rear-facing infant seat that is installed according to the manufacturer's instructions,
- the system determines that a small child is present in a forward-facing child restraint that is installed according to the manufacturer's instructions,
- the system determines that a small child is present in a booster seat,
- a front passenger takes his/her weight off of the seat for a period of time,
- a child or a small person occupies the front passenger seat.

For side airbag equipped vehicles, the front passenger sensing system will turn off the passenger seat side airbag if:

- the seat is empty and safety belt is unbuckled.

The front passenger sensing system uses a "passenger airbag off" or "pass airbag off" indicator which will illuminate and stay lit to remind you that the front passenger frontal airbag is disabled. The indicator



lamp is located next to the climate controls on the bottom right corner of the center stack of the instrument panel.

Note: The indicator lamp will illuminate for a short period of time when the ignition is turned to the ON position to confirm it is functional.

When the front passenger seat is not occupied (empty seat) or in the event that the front passenger frontal airbag is enabled (may inflate), the indicator lamp will be unlit.

The front passenger sensing system is designed to disable (will not inflate) the front passenger's frontal airbag when a rear facing infant seat, a forward-facing child restraint, or a booster seat is detected.

Seating and Safety Restraints

- When the front passenger sensing system disables (will not inflate) the front passenger frontal airbag, the indicator lamp will illuminate and stay lit to remind you that the front passenger frontal airbag is disabled.
- If the child restraint has been installed and the indicator lamp is not lit, then turn the vehicle off, remove the child restraint from the vehicle and reinstall the restraint following the child restraint manufacturer's instructions.

The front passenger sensing system is designed to enable (may inflate) the front passenger's frontal airbag anytime the system senses that a person of adult size is sitting properly in the front passenger seat.

- When the front passenger sensing system enables the front passenger frontal airbag (may inflate), the indicator will be unlit and stay unlit.

If a person of adult size is sitting in the front passenger's seat, but the "passenger airbag off" or "pass airbag off" indicator lamp is lit, it is possible that the person isn't sitting properly in the seat. If this happens:

- Turn the vehicle off and ask the person to place the seatback in the full upright position.
- Have the person sit upright in the seat, centered on the seat cushion, with the person's legs comfortably extended.
- Restart the vehicle and have the person remain in this position for about two minutes. This will allow the system to detect that person and enable the passenger's frontal airbag.
- If the indicator lamp remains lit even after this, the person should be advised to ride in the rear seat.

Occupant	Pass Airbag Off Indicator Lamp	Passenger Airbag
Empty seat	Unlit	Disabled
Small child in child safety seat or booster	Lit	Disabled
Small child with safety belt buckled or unbuckled	Lit	Disabled
Adult	Unlit	Enabled



Even with Advanced Restraints Systems, children 12 and under should be properly restrained in the back seat.

Seating and Safety Restraints

After all occupants have adjusted their seats and put on safety belts, it's very important that they continue to sit properly. A properly seated occupant sits upright, leaning against the seat back, and centered on the seat cushion, with their feet comfortably extended on the floor. Sitting improperly can increase the chance of injury in a crash event. For example, if an occupant slouches, lies down, turns sideways, sits forward, leans forward or sideways, or puts one or both feet up, the chance of injury during a crash is greatly increased.



Sitting improperly out of position or with the seat back reclined too far can take off weight from the seat cushion and affect the decision of the front passenger sensing system, resulting in serious injury or death in a crash.

Always sit upright against your seatback, with your feet on the floor.

The front passenger sensing system may detect small or medium objects placed on the seat cushion. For most objects that are in the front passenger seat, the passenger airbag will be disabled. Even though the passenger airbag is disabled, the "pass airbag off" lamp may or may not be illuminated according to the table below.

Objects	Pass Airbag Off Indicator Lamp	Passenger Airbag
Small (i.e. 3 ring binder, small purse, bottled water)	Unlit	Disabled
Medium (i.e. heavy briefcase, fully packed luggage)	Lit	Disabled
Empty seat, or small to medium object with safety belt buckled	Lit	Disabled

If you think that the status of the passenger airbag off indicator lamp is incorrect, check for the following:

- Objects lodged underneath the seat
- Objects between the seat cushion and the center console (if equipped)
- Objects hanging off the seat back
- Objects stowed in the seatback map pocket (if equipped)

Seating and Safety Restraints

- Objects placed on the occupant's lap
- Cargo interference with the seat
- Other passengers pushing or pulling on the seat
- Rear passenger feet and knees resting or pushing on the seat

The conditions listed above may cause the weight of a properly seated occupant to be incorrectly interpreted by the passenger sensing system. The person in the front passenger seat may appear heavier or lighter due to the conditions described in the list above.



To reduce the risk of possible serious injury:

Do not stow objects in seat back map pocket (if equipped) or hang objects off seat back if a child is in the front passenger seat. Do not place objects underneath the front passenger seat or between the seat and the center console (if equipped). Check the "passenger airbag off" or "pass airbag off" indicator lamp for proper airbag Status. Failure to follow these instructions may interfere with the front passenger seat sensing system.

In case there is a problem with the front passenger sensing system, the airbag readiness lamp in the instrument cluster will stay lit.



If the airbag readiness lamp is lit, do the following:

The driver and/or adult passengers should check for any objects that may be lodged underneath the front passenger seat or cargo interfering with the seat.

If objects are lodged and/or cargo is interfering with the seat; please take the following steps to remove the obstruction:

- Pull the vehicle over.
- Turn the vehicle off.
- Driver and/or adult passengers should check for any objects lodged underneath the front passenger seat or cargo interfering with the seat.
- Remove the obstruction(s) (if found).
- Restart the vehicle.
- Wait at least 2 minutes and verify that the airbag readiness lamp is no longer illuminated

Seating and Safety Restraints

- If the airbag readiness lamp remains illuminated, this may or may/not be a problem due to the front passenger sensing system.

DO NOT attempt to repair or service the system; take your vehicle immediately to an authorized dealer.



The front passenger airbag is not designed to offer protection to an occupant in the center seating position.



An out of position front center occupant could affect the decision of the front passenger sensing system.

If it is necessary to modify an advanced front airbag system to accommodate a person with disabilities, contact the Ford Customer Relationship Center at the phone number shown in the *Customer Assistance* section of this *Owner's Guide*.



Any alteration/modification to the front passenger seat may affect the performance of the front passenger sensing system.

Determining if the system is operational

The supplemental restraint system uses a warning indicator light in the instrument cluster or a back-up tone to indicate the condition of the system. Refer to the *Warning lights and chimes* section in the *Instrument Cluster* chapter. Routine maintenance of the airbag is not required.

A difficulty with the system is indicated by one or more of the following:

- The readiness light (same light for front and side airbag system) will either flash or stay lit.
- The readiness light will not illuminate immediately after ignition is turned on.
- A series of five beeps will be heard. The tone pattern will repeat periodically until the problem and/or light are repaired.



If any of these things happen, even intermittently, have the supplemental restraint system serviced at an authorized dealer immediately. Unless serviced, the system may not function properly in the event of a collision.

Seating and Safety Restraints

Seat-mounted side airbag system (if equipped)

 Do not place objects or mount equipment on or near the airbag cover on the side of the seatbacks of the front seats or in front seat areas that may come into contact with a deploying airbag. Failure to follow these instructions may increase the risk of personal injury in the event of a collision.

 Do not use accessory seat covers. The use of accessory seat covers may prevent the deployment of the side airbags and increase the risk of injury in an accident.

 Do not lean your head on the door. The side airbag could injure you as it deploys from the side of the seatback.

 Do not attempt to service, repair, or modify the airbag SRS, its fuses or the seat cover on a seat containing an airbag. See your authorized dealer.

 All occupants of the vehicle should always wear their safety belts even when an airbag SRS is provided.

How does the side airbag system work?

The side airbag system consists of the following:

- An inflatable nylon bag (airbag) with a gas generator concealed behind the outboard bolster of the driver and front passenger seatbacks.
- A special seat cover designed to allow airbag deployment.
- The same warning light, electronic control and diagnostic unit as used for the front airbags.
- Two crash sensors located on the pillars between the front and rear doors (one on each side of the vehicle).

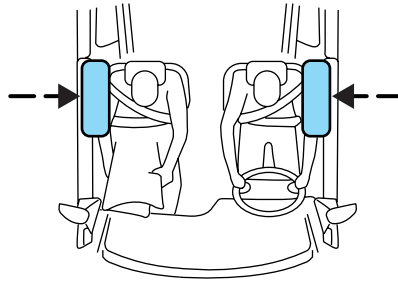

Side airbags, in combination with safety belts, can help reduce the risk of severe injuries in the event of a significant side impact collision.

Seating and Safety Restraints

The side airbags are fitted on the outboard side of the seatbacks of the front seats. In certain lateral collisions, the airbag on the side affected by the collision will be inflated, even if the respective seat is not occupied. The airbag was designed to inflate between the door panel and occupant to further enhance the protection provided occupants in side impact collisions.

The airbag SRS is designed to activate when the vehicle sustains lateral deceleration sufficient to cause the sensors to close an electrical circuit that initiates airbag inflation.

The fact that the airbags did not inflate in a collision does not mean that something is wrong with the system. Rather, it means the forces were not of the type sufficient to cause activation. Side airbags are designed to inflate in side-impact collisions, not roll-over, rear-impact, frontal or near-frontal collisions, unless the collision causes sufficient lateral deceleration.



Several air bag system components get hot after inflation. Do not touch them after inflation.



If the side airbag has deployed, **the airbag will not function again. The side airbag system (including the seat) must be inspected and serviced by an authorized dealer.** If the airbag is not replaced, the unrepaired area will increase the risk of injury in a collision.

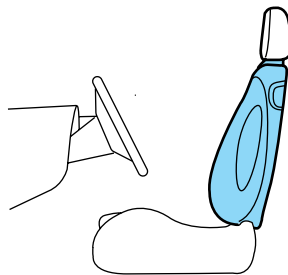

Disposal of airbags and airbag equipped vehicles

For disposal of airbags or airbag equipped vehicles, see your authorized dealer . Airbags **MUST BE** disposed of by qualified personnel.

SAFETY RESTRAINTS FOR CHILDREN

See the following sections for directions on how to properly use safety restraints for children. Also see *Airbag supplemental restraint system (SRS)* in this chapter for special instructions about using airbags.

Seating and Safety Restraints

Important child restraint precautions

You are required by law to use safety restraints for children in the U.S. and Canada. If small children (generally children who are four years old or younger and who weigh 40 lb. [18 kg] or less) ride in your vehicle, you must put them in safety seats made especially for children. Many states require that children use approved booster seats until they are eight years old. Check your local and state or provincial laws for specific requirements regarding the safety of children in your vehicle. When possible, always place children under age 12 in the rear seat of your vehicle. Accident statistics suggest that children are safer when properly restrained in the rear seating positions than in the front seating position.



Never let a passenger hold a child on his or her lap while the vehicle is moving. The passenger cannot protect the child from injury in a collision.

Always follow the instructions and warnings that come with any infant or child restraint you might use.

Children and safety belts

If the child is the proper size, restrain the child in a safety seat. Children who are too large for child safety seats (as specified by your child safety seat manufacturer) should always wear safety belts.

Follow all the important safety restraint and airbag precautions that apply to adult passengers in your vehicle.

If the shoulder belt portion of a combination lap and shoulder belt can be positioned so it does not cross or rest in front of the child's face or neck, the child should wear the lap and shoulder belt. Moving the child closer to the center of the vehicle may help provide a good shoulder belt fit.



Do not leave children, unreliable adults, or pets unattended in your vehicle.

Seating and Safety Restraints

Child booster seats

Children outgrow a typical convertible or toddler seat when they weigh 40 lb. (18 kg) and are around 4 years of age. Although the lap/shoulder belt will provide some protection, these children are still too small for lap/shoulder belts to fit properly, which could increase the risk of serious injury in a crash.

To improve the fit of both the lap and shoulder belt on children who have outgrown child safety seats, Ford Motor Company recommends use of a belt-positioning booster.

Booster seats position a child so that safety belts fit better. They lift the child up so that the lap belt rests low across the hips and the knees bend comfortably. Booster seats may also make the shoulder belt fit better and more comfortably. Try to keep the belt near the middle of the shoulder.

When children should use booster seats

Children need to use booster seats from the time they outgrow the toddler seat until they are big enough for the vehicle seat and lap/shoulder belt to fit properly. Generally this is when they weigh about 80 lb. (36 kg) (about 8 to 12 years old).

Booster seats should be used until you can answer YES to ALL of these questions:

- Can the child sit all the way back against the vehicle seat back with knees bent comfortably at the edge of the seat without slouching?

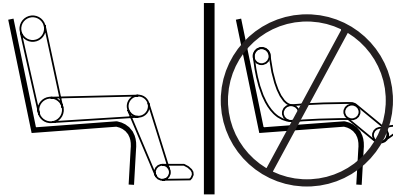

- Does the lap belt rest low across the hips?
- Is the shoulder belt centered on the shoulder and chest?
- Can the child stay seated like this for the whole trip?

Seating and Safety Restraints

Types of booster seats

There are two types of belt-positioning booster seats:

- Those that are backless.

If your backless booster seat has a removable shield, remove the shield and use the lap/shoulder belt. If a seating position has a low seat back and no head restraint, a backless booster seat may place your child's head (top of ear level) above the top of the seat. In this case, move the backless booster to another seating position with a higher seat back and lap/shoulder belts.



- Those with a high back.

If, with a backless booster seat, you cannot find a seating position that adequately supports your child's head, a high back booster seat would be a better choice.



Either type can be used at any seating position equipped with lap/shoulder belts if your child is over 40 lb. (18 kg).

Seating and Safety Restraints

Children and booster seats vary widely in size and shape. Choose a booster that keeps the lap belt low and snug across the hips, never up across the stomach, and lets you adjust the shoulder belt to cross the chest and rest snugly near the center of the shoulder. The drawings below compare the ideal fit (center) to a shoulder belt uncomfortably close to the neck and a shoulder belt that could slip off the shoulder.

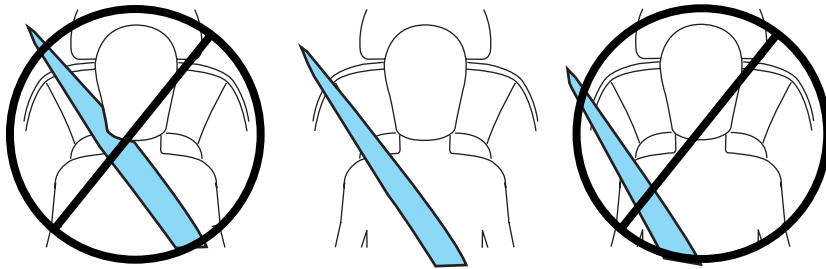

If the booster seat slides on the vehicle seat, placing a rubberized mesh sold as shelf or carpet liner under the booster seat may improve this condition.

The importance of shoulder belts

Using a booster without a shoulder belt increases the risk of a child's head hitting a hard surface in a collision. For this reason, you should never use a booster seat with a lap belt only. It is best to use a booster seat with lap/shoulder belts in the back seat- the safest place for children to ride.



Move a child to a different seating location if the shoulder belt does not stay positioned on the shoulder during use.



Follow all instructions provided by the manufacturer of the booster seat.



Never put the shoulder belt under a child's arm or behind the back because it eliminates the protection for the upper part of the body and may increase the risk of injury or death in a collision.

Seating and Safety Restraints



Never use pillows, books, or towels to boost a child. They can slide around and increase the likelihood of injury or death in a collision.

SAFETY SEATS FOR CHILDREN

Child and infant or child safety seats

Use a safety seat that is recommended for the size and weight of the child. Carefully follow all of the manufacturer's instructions with the safety seat you put in your vehicle. If you do not install and use the safety seat properly, the child may be injured in a sudden stop or collision.

When installing a child safety seat:

- Review and follow the information presented in the *Airbag Supplemental Restraint System* section in this chapter.
- Use the correct safety belt buckle for that seating position.
- Insert the belt tongue into the proper buckle until you hear a snap and feel it latch. Make sure the tongue is securely fastened in the buckle.
- Keep the buckle release button pointing up and away from the safety seat, with the tongue between the child seat and the release button, to prevent accidental unbuckling.
- Place seat back in upright position.
- Put the safety belt in the automatic locking mode. Refer to *Automatic locking mode*.
- LATCH lower anchors are recommended for use by children up to 48 lb (22 kg) in a child restraint. Top tether anchors can be used for children up to 60 lb (27 kg) in a child restraint, and to provide upper torso restraint for children up to 80 lb (36 kg) using an upper torso harness and a belt-positioning booster.

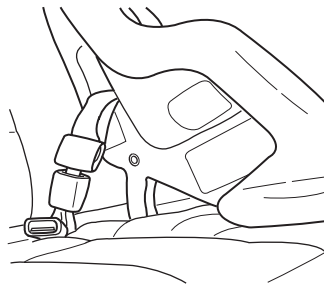

Ford Motor Company recommends the use of a child safety seat having a top tether strap. Install the child safety seat in a seating position with LATCH and tether anchors. For more information on top tether straps

Seating and Safety Restraints

and anchors, refer to *Attaching safety seats with tether straps* in this chapter. For more information of LATCH anchors refer to *Attaching safety seats with LATCH (Lower Anchors and Tethers for Children) attachments* in this chapter.

 Carefully follow all of the manufacturer's instructions included with the safety seat you put in your vehicle. If you do not install and use the safety seat properly, the child may be injured in a sudden stop or collision.

 Rear-facing child seats or infant carriers should never be placed in front of an active passenger airbag.

Installing child safety seats with combination lap and shoulder belts

 Airbags can kill or injure a child in a child seat. **NEVER** place a rear-facing child seat in front of an active airbag. If you must use a forward-facing child seat in the front seat, move the seat all the way back.

 Children 12 and under should be properly restrained in the rear seat whenever possible.

1. Position the child safety seat in a seat with a combination lap and shoulder belt.

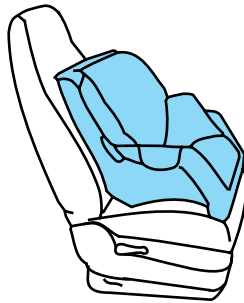

Seating and Safety Restraints

2. Pull down on the shoulder belt and then grasp the shoulder belt and lap belt together.

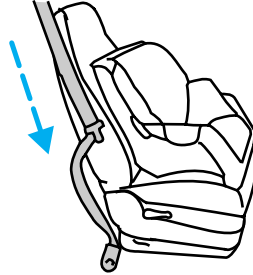

3. While holding the shoulder and lap belt portions together, route the tongue through the child seat according to the child seat manufacturer's instructions. Be sure the belt webbing is not twisted.

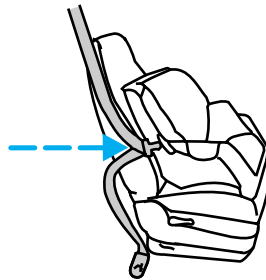

4. Insert the belt tongue into the proper buckle (the buckle closest to the direction the tongue is coming from) for that seating position until you hear a snap and feel the latch engage. Make sure the tongue is latched securely by pulling on it.

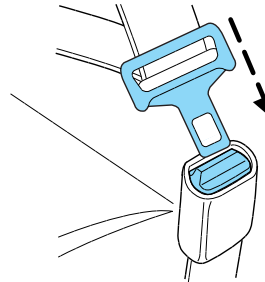

Seating and Safety Restraints

5. To put the retractor in the automatic locking mode, grasp the shoulder portion of the belt and pull downward until all of the belt is pulled out and a click is heard.

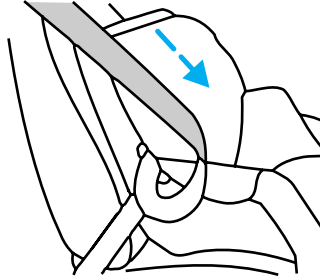

6. Allow the belt to retract. The belt will click as it retracts to indicate it is in the automatic locking mode.

7. Pull the lap belt portion across the child seat toward the buckle and pull up on the shoulder belt while pushing down with your knee on the child seat.

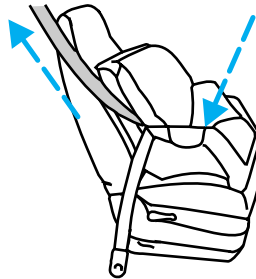

8. Allow the safety belt to retract to remove any slack in the belt.

9. Before placing the child in the seat, forcibly move the seat forward and back to make sure the seat is securely held in place. To check this, grab the seat at the belt path and attempt to move it side to side and forward. There should be no more than one inch of movement for proper installation.

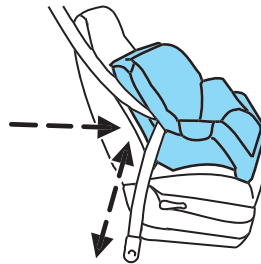

10. Try to pull the belt out of the retractor to make sure the retractor is in the automatic locking mode (you should not be able to pull more belt out). If the retractor is not locked, unbuckle the belt and repeat Steps 2 through 9.

Check to make sure the child seat is properly secured before each use.

Seating and Safety Restraints

Installing child safety seats in the center lap belt seating position

1. Lengthen the lap belt. To lengthen the belt, hold the tongue so that its bottom is perpendicular to the direction of webbing while sliding the tongue up the webbing.
2. Place the child safety seat in the center seating position.
3. Route the tongue and webbing through the child seat according to the child seat manufacturer's instructions.
4. Insert the belt tongue into the proper buckle for the center seating position until you hear a snap and feel it latch. Make sure the tongue is securely fastened to the buckle by pulling on tongue.
5. Push down on the child seat while pulling on the loose end of the lap belt webbing to tighten the belt.
6. Before placing the child into the child seat, forcibly tilt the child seat from side to side and in forward direction to make sure that the seat is securely held in place. To check this, grab the seat at the belt path and attempt to move it side to side and forward and back. There should be no more than one inch of movement for proper installation.

Attaching child safety seats with tether straps

Most new forward-facing child safety seats include a tether strap which goes over the back of the seat and hooks to an anchoring point. Tether straps are available as an accessory for many older safety seats. Contact the manufacturer of your child seat for information about ordering a tether strap.

The rear seats of your vehicle are equipped with built-in tether strap anchors located behind the seats as described below.

The tether anchors in your vehicle are located under a cover marked with the tether anchor symbol (shown with title).

The tether strap anchors in your vehicle are in the following positions (shown from top view):

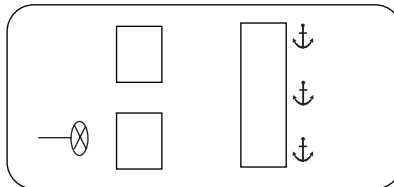

Attach the tether strap only to the appropriate tether anchor as shown. The tether strap may not work properly if attached somewhere other than the correct tether anchor.

Seating and Safety Restraints

1. Position the child safety seat on the seat cushion.
2. Route the child safety seat tether strap over the back of the seat.
For vehicles with adjustable head restraints, route the tether strap under the head restraint and between the head restraint posts, otherwise route the tether strap over the top of the seatback.
3. Locate the correct anchor for the selected seating position.



4. Open the tether anchor cover.



5. Clip the tether strap to the anchor as shown.

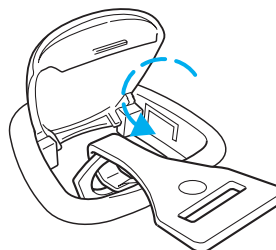

If the tether strap is clipped incorrectly, the child safety seat may not be retained properly in the event of a collision.

6. Install the child safety seat tightly using the LATCH anchors or safety belts. Follow the instructions in this chapter.
7. Tighten the child safety seat tether strap according to the manufacturer's instructions.



If the safety seat is not anchored properly, the risk of a child being injured in a collision greatly increases.

Seating and Safety Restraints

Attaching safety seats with LATCH (Lower Anchors and Tethers for Children) attachments for child seat anchors

Some child safety seats have two rigid or webbing mounted attachments that connect to two anchors at certain seating positions in your vehicle. This type of child seat eliminates the need to use safety belts to attach the child seat. For forward-facing child seats, the tether strap must also be attached to the proper tether anchor. See *Attaching safety seats with tether straps* in this chapter.

Your vehicle has LATCH anchors for child seat installation at the seating positions marked with the child seat symbol.

All the LATCH lower anchors are equally spaced, so that a single LATCH child seat can be installed at any rear seating position. **If two child safety seats are installed using the LATCH lower anchors, they must be placed in the outboard seating positions only.**

If three child safety seats are installed, use the LATCH lower anchors for the center child safety seat; however, you must use child safety seats with lap/shoulder belts and tether anchors for the outboard child seats.

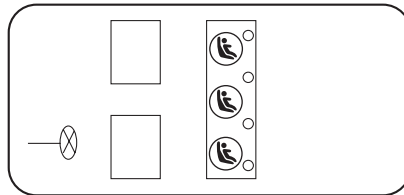

Never attach two LATCH child safety seats to the same anchor.

In a crash, one anchor may not be strong enough to hold two child safety seat attachments and may break, causing serious injury or death.

The lower anchors for child seat installation are located at the rear section of the rear seat between the cushion and seat back. The LATCH anchors are below the locator symbols on the seat back.

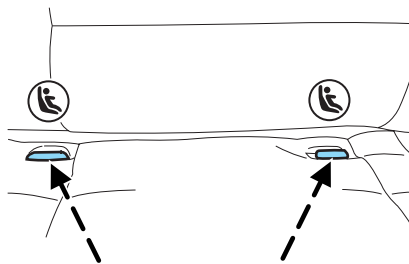

Follow the child seat manufacturer's instructions to properly install a child seat with LATCH attachments.

Seating and Safety Restraints



Attach LATCH lower attachments of the child seat only to the anchors shown.

If you install a child seat with rigid LATCH attachments, do not tighten the tether strap enough to lift the child seat off the vehicle seat cushion when the child is seated in it. Keep the tether strap just snug without lifting the front of the child seat. Keeping the child seat just touching the vehicle seat gives the best protection in a severe crash.

Each time you use the safety seat, check that the seat is properly attached to the lower anchors and tether anchor. Try to tilt the child seat from side to side. Also try to tug the seat forward. Check to see if the anchors hold the seat in place.



If the safety seat is not anchored properly, the risk of a child being injured in a crash greatly increases.

Tires, Wheels and Loading

INFORMATION ABOUT UNIFORM TIRE QUALITY GRADING

New vehicles are fitted with tires that have a rating on them called Tire Quality Grades. The Quality grades can be found where applicable on the tire sidewall between tread shoulder and maximum section width. For example:

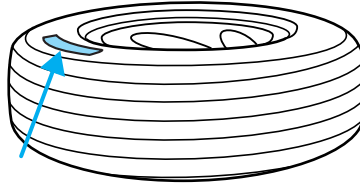

- **Treadwear 200 Traction AA Temperature A**

These Tire Quality Grades are determined by standards that the United States Department of Transportation has set.

Tire Quality Grades apply to new pneumatic tires for use on passenger cars. They do not apply to deep tread, winter-type snow tires, space-saver or temporary use spare tires, tires with nominal rim diameters of 10 to 12 inches or limited production tires as defined in Title 49 Code of Federal Regulations Part 575.104(c)(2).

U.S. Department of Transportation-Tire quality grades: The U.S. Department of Transportation requires Ford Motor Company to give you the following information about tire grades exactly as the government has written it.

Treadwear

The treadwear grade is a comparative rating based on the wear rate of the tire when tested under controlled conditions on a specified government test course. For example, a tire graded 150 would wear one and one-half (1 1/2) times as well on the government course as a tire graded 100. The relative performance of tires depends upon the actual conditions of their use, however, and may depart significantly from the norm due to variations in driving habits, service practices, and differences in road characteristics and climate.

Traction AA A B C

The traction grades, from highest to lowest are AA, A, B, and C. The grades represent the tire's ability to stop on wet pavement as measured under controlled conditions on specified government test surfaces of asphalt and concrete. A tire marked C may have poor traction performance.

120

Tires, Wheels and Loading



The traction grade assigned to this tire is based on straight-ahead braking traction tests, and does not include acceleration, cornering, hydroplaning or peak traction characteristics.

Temperature A B C

The temperature grades are A (the highest), B and C, representing the tire's resistance to the generation of heat and its ability to dissipate heat when tested under controlled conditions on a specified indoor laboratory test wheel. Sustained high temperature can cause the material of the tire to degenerate and reduce tire life, and excessive temperature can lead to sudden tire failure. The grade C corresponds to a level of performance which all passenger car tires must meet under the Federal Motor Vehicle Safety Standard No. 109. Grades B and A represent higher levels of performance on the laboratory test wheel than the minimum required by law.



The temperature grade for this tire is established for a tire that is properly inflated and not overloaded. Excessive speed, underinflation, or excessive loading, either separately or in combination, can cause heat buildup and possible tire failure.

TIRES

Tires are designed to give many thousands of miles of service, but they must be maintained in order to get the maximum benefit from them.

Glossary of tire terminology

- **Tire label:** A label showing the OE (Original Equipment) tire sizes, recommended inflation pressure and the maximum weight the vehicle can carry.
- **Tire Identification Number (TIN):** A number on the sidewall of each tire providing information about the tire brand and manufacturing plant, tire size and date of manufacture. Also referred to as DOT code.
- **Inflation pressure:** A measure of the amount of air in a tire.
- **Standard load:** A class of P-metric or Metric tires designed to carry a maximum load at 35 psi [37 psi (2.5 bar) for Metric tires]. Increasing the inflation pressure beyond this pressure will not increase the tire's load carrying capability.
- **Extra load:** A class of P-metric or Metric tires designed to carry a heavier maximum load at 41 psi [43 psi (2.9 bar) for Metric tires].

Tires, Wheels and Loading

Increasing the inflation pressure beyond this pressure will not increase the tire's load carrying capability.

- **kPa:** Kilopascal, a metric unit of air pressure.
- **PSI:** Pounds per square inch, a standard unit of air pressure.
- **Cold inflation pressure:** The tire pressure when the vehicle has been stationary and out of direct sunlight for an hour or more and prior to the vehicle being driven for 1 mile (1.6 km).
- **Recommended inflation pressure:** The cold inflation pressure found on the Safety Compliance Certification Label or Tire Label located on the B-Pillar or the edge of the driver's door.
- **B-pillar:** The structural member at the side of the vehicle behind the front door.
- **Bead area of the tire:** Area of the tire next to the rim.
- **Sidewall of the tire:** Area between the bead area and the tread.
- **Tread area of the tire:** Area of the perimeter of the tire that contacts the road when mounted on the vehicle.
- **Rim:** The metal support (wheel) for a tire or a tire and tube assembly upon which the tire beads are seated.

INFLATING YOUR TIRES

Safe operation of your vehicle requires that your tires are properly inflated. Remember that a tire can lose up to half of its air pressure without appearing flat.

Every day before you drive, check your tires. If one looks lower than the others, use a tire gauge to check pressure of all tires and adjust if required.

At least once a month and before long trips, inspect each tire and check the tire pressure with a tire gauge (including spare, if equipped). Inflate all tires to the inflation pressure recommended by Ford Motor Company.

Use a tire gauge to check the tire inflation pressure, including the spare (if equipped), at least monthly and before long trips. You are strongly urged to buy a reliable tire pressure gauge, as automatic service station

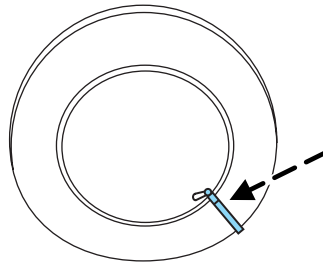

Tires, Wheels and Loading

gauges may be inaccurate. Ford Motor Company recommends the use of a digital or dial-type tire pressure gauge rather than a stick-type tire pressure gauge.

Use the recommended cold inflation pressure for optimum tire performance and wear. Under-inflation or over-inflation may cause uneven treadwear patterns.



Under-inflation is the most common cause of tire failures and may result in severe tire cracking, tread separation or "blowout", with unexpected loss of vehicle control and increased risk of injury. Under-inflation increases sidewall flexing and rolling resistance, resulting in heat buildup and internal damage to the tire. It also may result in unnecessary tire stress, irregular wear, loss of vehicle control and accidents. A tire can lose up to half of its air pressure and not appear to be flat!

Always inflate your tires to the Ford recommended inflation pressure even if it is less than the maximum inflation pressure information found on the tire. The Ford recommended tire inflation pressure is found on the Safety Compliance Certification Label or Tire Label which is located on the B-Pillar or the edge of the driver's door. Failure to follow the tire pressure recommendations can cause uneven treadwear patterns and adversely affect the way your vehicle handles.

Maximum Permissible Inflation Pressure is the tire manufacturer's maximum permissible pressure and/or the pressure at which the maximum load can be carried by the tire. This pressure is normally higher than the manufacturer's recommended cold inflation pressure which can be found on the Safety Compliance Certification Label or Tire Label which is located on the B-Pillar or the edge of the driver's door. The cold inflation pressure should never be set lower than the recommended pressure on the Safety Compliance Certification Label or Tire Label.

When weather temperature changes occur, tire inflation pressures also change. A 10° F (6° C) temperature drop can cause a corresponding drop of 1 psi (7 kPa) in inflation pressure. Check your tire pressures frequently and adjust them to the proper pressure which can be found on the Safety Compliance Certification Label or Tire Label.

If you are checking tire pressure when the tire is hot, (i.e. driven more than 1 mile [1.6 km]), never "bleed" or reduce air pressure. The tires are hot from driving and it is normal for pressures to increase above recommended cold pressures. A hot tire at or below recommended cold inflation pressure could be significantly under-inflated.

Tires, Wheels and Loading

To check the pressure in your tire(s):

1. Make sure the tires are cool, meaning they are not hot from driving even a mile.

Note: If you have to drive a distance to get air for your tire(s), check and record the tire pressure first and add the appropriate air pressure when you get to the pump. It is normal for tires to heat up and the air pressure inside to go up as you drive. Never “bleed” or reduce air pressure when tires are hot.

2. Remove the cap from the valve on one tire, then firmly press the tire gauge onto the valve and measure the pressure with the tire gauge.

3. Add enough air to reach the recommended air pressure.

Note: If you overfill the tire, release air by pushing on the metal stem in the center of the valve. Then recheck the pressure with your tire gauge.

4. Replace the valve cap.

5. Repeat this procedure for each tire, including the spare.

Note: Some spare tires operate at a higher inflation pressure than the other tires. For T-type/mini-spare tires (see *T-Type/Mini-Spare Tire Information* section for description): Store and maintain at 60psi (4.15 bars). For Full Size and Dissimilar spare tires (see *Dissimilar Spare Tire/Wheel Information* section for description): Store and maintain at the higher of the front and rear inflation pressure as shown on the Safety Compliance Certification Label or the Tire Label.

6. Visually inspect the tires to make sure there are no nails or other objects embedded that could poke a hole in the tire and cause an air leak.

7. Check the sidewalls to make sure there are no gouges, cuts or bulges.

TIRE CARE

Inspecting your tires

Periodically inspect the tire treads for uneven or excessive wear and remove objects such as stones, nails or glass that may be wedged in the tread grooves. Check for holes or cuts that may permit air leakage from the tire and make necessary repairs. Also inspect the tire sidewalls for cracking, cuts, bruises and other signs of damage or excessive wear. If internal damage to the tire is suspected, have the tire demounted and inspected in case it needs to be repaired or replaced. For your safety, tires that are damaged or show signs of excessive wear should not be used because they are more likely to blow out or fail.

Tires, Wheels and Loading

Improper or inadequate vehicle maintenance can cause tires to wear abnormally. Inspect all your tires, including the spare, frequently, and replace them if one or more of the following conditions exist:

Tire wear

When the tread is worn down to 1/16th of an inch (2 mm), tires must be replaced to help prevent your vehicle from skidding and hydroplaning. Built-in treadwear indicators, or “wear bars”, which look like narrow strips of smooth rubber across the tread will appear on the tire when the tread is worn down to 1/16th of an inch (2 mm).

When the tire tread wears down to the same height as these “wear bars”, the tire is worn out and must be replaced.

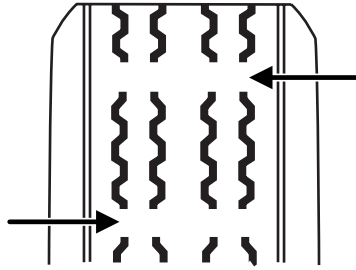

Damage

Periodically inspect the tire treads and sidewalls for damage (such as bulges in the tread or sidewalls, cracks in the tread groove and separation in the tread or sidewall). If damage is observed or suspected have the tire inspected by a tire professional. Tires can be damaged during off-road use, so inspection after off-road use is also recommended.



Age

Tires degrade over time, even when they are not being used. It is recommended that tires generally be replaced after 6 years of normal service. Heat caused by hot climates or frequent high loading conditions can accelerate the aging process.

You should replace the spare tire when you replace the other road tires due to the aging of the spare tire.

U.S. DOT Tire Identification Number (TIN)

Both U.S. and Canada Federal regulations require tire manufacturers to place standardized information on the sidewall of all tires. This information identifies and describes the fundamental characteristics of the tire and also provides a U.S. DOT Tire Identification Number for safety standard certification and in case of a recall.

Tires, Wheels and Loading

This begins with the letters "DOT" and indicates that the tire meets all federal standards. The next two numbers or letters are the plant code designating where it was manufactured, the next two are the tire size code and the last four numbers represent the week and year the tire was built. For example, the numbers 317 mean the 31st week of 1997. After 2000 the numbers go to four digits. For example, 2501 means the 25th week of 2001. The numbers in between are identification codes used for traceability. This information is used to contact customers if a tire defect requires a recall.

Tire Replacement Requirements

Your vehicle is equipped with tires designed to provide a safe ride and handling capability.



Only use replacement tires and wheels that are the same size and type (such as P-metric versus LT-metric or all-season versus all-terrain) as those originally provided by Ford. Use of any tire or wheel not recommended by Ford can affect the safety and performance of your vehicle, which could result in an increased risk of loss of vehicle control, vehicle rollover, personal injury and death. Additionally the use of non-recommended tires and wheels could cause steering, suspension, axle or transfer case/power transfer unit failure. If you have questions regarding tire replacement, see an authorized dealer.

Important: Remember to replace the wheel valve stems when the road tires are replaced on your vehicle.

It is recommended that the two front tires or two rear tires generally be replaced as a pair.

Safety practices

Driving habits have a great deal to do with your tire mileage and safety.

- Observe posted speed limits
- Avoid fast starts, stops and turns
- Avoid potholes and objects on the road
- Do not run over curbs or hit the tire against a curb when parking



If your vehicle is stuck in snow, mud, sand, etc., **do not** rapidly spin the tires; spinning the tires can tear the tire and cause an explosion. A tire can explode in as little as three to five seconds.

Tires, Wheels and Loading



Do not spin the wheels at over 35 mph (56 km/h). The tires may fail and injure a passenger or bystander.

Highway hazards

No matter how carefully you drive there's always the possibility that you may eventually have a flat tire on the highway. Drive slowly to the closest safe area out of traffic. This may further damage the flat tire, but your safety is more important.

If you feel a sudden vibration or ride disturbance while driving, or you suspect your tire or vehicle has been damaged, immediately reduce your speed. Drive with caution until you can safely pull off the road. Stop and inspect the tires for damage. If a tire is under-inflated or damaged, deflate it, remove wheel and replace it with your spare tire and wheel. If you cannot detect a cause, have the vehicle towed to the nearest repair facility or tire dealer to have the vehicle inspected.

Tire and wheel alignment

A bad jolt from hitting a curb or pothole can cause the front end of your vehicle to become misaligned or cause damage to your tires. If your vehicle seems to pull to one side when you're driving, the wheels may be out of alignment. Have an authorized dealer check the wheel alignment periodically.

Wheel misalignment in the front or the rear can cause uneven and rapid treadwear of your tires and should be corrected by an authorized dealer. Front wheel drive (FWD) vehicles and those with an independent rear suspension (if equipped) may require alignment of all four wheels.

The tires should also be balanced periodically. An unbalanced tire and wheel assembly may result in irregular tire wear.

Tire rotation

Rotating your tires at the recommended interval (as indicated in the *scheduled maintenance information* that comes with your vehicle) will help your tires wear more evenly, providing better tire performance and longer tire life. Unless otherwise specified, rotate the tires approximately every 5,000 miles (8,000 km).

Tires, Wheels and Loading

- Front Wheel Drive (FWD) vehicles (front tires at top of diagram)

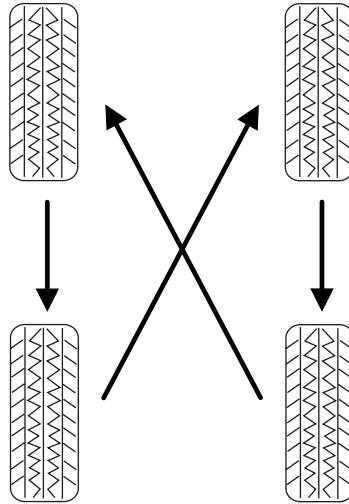

Sometimes irregular tire wear can be corrected by rotating the tires.

Note: If your tires show uneven wear ask an authorized dealer to check for and correct any wheel misalignment, tire imbalance or mechanical problem involved before tire rotation.

Note: Your vehicle may be equipped with a dissimilar spare tire/wheel. A dissimilar spare tire/wheel is defined as a spare tire and/or wheel that is different in brand, size or appearance from the road tires and wheels. If you have a dissimilar spare tire/wheel it is intended for temporary use only and should not be used in a tire rotation.

Note: After having your tires rotated, inflation pressure must be checked and adjusted to the vehicle requirements.

INFORMATION CONTAINED ON THE TIRE SIDEWALL

Both U.S. and Canada Federal regulations require tire manufacturers to place standardized information on the sidewall of all tires. This information identifies and describes the fundamental characteristics of the tire and also provides a U.S. DOT Tire Identification Number for safety standard certification and in case of a recall.

128

Tires, Wheels and Loading

Information on “P” type tires

P215/65R15 95H is an example of a tire size, load index and speed rating. The definitions of these items are listed below. (Note that the tire size, load index and speed rating for your vehicle may be different from this example.)

1. **P:** Indicates a tire, designated by the Tire and Rim Association (T&RA), that may be used for service on cars, SUVs, minivans and light trucks.

Note: If your tire size does not begin with a letter this may mean it is designated by either ETRTO (European Tire and Rim Technical Organization) or JATMA (Japan Tire Manufacturing Association).

2. **215:** Indicates the nominal width of the tire in millimeters from sidewall edge to sidewall edge. In general, the larger the number, the wider the tire.

3. **65:** Indicates the aspect ratio which gives the tire’s ratio of height to width.

4. **R:** Indicates a “radial” type tire.

5. **15:** Indicates the wheel or rim diameter in inches. If you change your wheel size, you will have to purchase new tires to match the new wheel diameter.

6. **95:** Indicates the tire’s load index. It is an index that relates to how much weight a tire can carry. You may find this information in your *Owner’s Guide*. If not, contact a local tire dealer.

Note: You may not find this information on all tires because it is not required by federal law.

7. **H:** Indicates the tire’s speed rating. The speed rating denotes the speed at which a tire is designed to be driven for extended periods of time under a standard condition of load and inflation pressure. The tires on your vehicle may operate at different conditions for load and inflation pressure. These speed ratings may need to be adjusted for the difference in conditions. The ratings range from 81 mph (130 km/h) to 186 mph (299 km/h). These ratings are listed in the following chart.

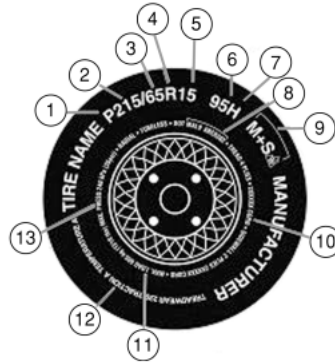

Tires, Wheels and Loading

Note: You may not find this information on all tires because it is not required by federal law.

Letter rating	Speed rating - mph (km/h)
M	81 mph (130 km/h)
N	87 mph (140 km/h)
Q	99 mph (159 km/h)
R	106 mph (171 km/h)
S	112 mph (180 km/h)
T	118 mph (190 km/h)
U	124 mph (200 km/h)
H	130 mph (210 km/h)
V	149 mph (240 km/h)
W	168 mph (270 km/h)
Y	186 mph (299 km/h)

Note: For tires with a maximum speed capability over 149 mph (240 km/h), tire manufacturers sometimes use the letters ZR. For those with a maximum speed capability over 186 mph (299 km/h), tire manufacturers always use the letters ZR.

8. U.S. DOT Tire Identification Number (TIN): This begins with the letters "DOT" and indicates that the tire meets all federal standards. The next two numbers or letters are the plant code designating where it was manufactured, the next two are the tire size code and the last four numbers represent the week and year the tire was built. For example, the numbers 317 mean the 31st week of 1997. After 2000 the numbers go to four digits. For example, 2501 means the 25th week of 2001. The numbers in between are identification codes used for traceability. This information is used to contact customers if a tire defect requires a recall.

9. M+S or M/S: Mud and Snow, or

AT: All Terrain, or

AS: All Season.

10. Tire Ply Composition and Material Used: Indicates the number of plies or the number of layers of rubber-coated fabric in the tire tread and sidewall. Tire manufacturers also must indicate the ply materials in the tire and the sidewall, which include steel, nylon, polyester, and others.

11. Maximum Load: Indicates the maximum load in kilograms and pounds that can be carried by the tire. Refer to the Safety Compliance Certification Label, which is located on the B-Pillar or the edge of the driver's door, for the correct tire pressure for your vehicle.

Tires, Wheels and Loading

12. Treadwear, Traction and Temperature Grades

- **Treadwear:** The treadwear grade is a comparative rating based on the wear rate of the tire when tested under controlled conditions on a specified government test course. For example, a tire graded 150 would wear one and one-half (1½) times as well on the government course as a tire graded 100.
- **Traction:** The traction grades, from highest to lowest are AA, A, B, and C. The grades represent the tire's ability to stop on wet pavement as measured under controlled conditions on specified government test surfaces of asphalt and concrete. A tire marked C may have poor traction performance.
- **Temperature:** The temperature grades are A (the highest), B and C, representing the tire's resistance to the generation of heat and its ability to dissipate heat when tested under controlled conditions on a specified indoor laboratory test wheel.

13. **Maximum Permissible Inflation Pressure:** Indicates the tire manufacturers' maximum permissible pressure and/or the pressure at which the maximum load can be carried by the tire. This pressure is normally higher than the manufacturer's recommended cold inflation pressure which can be found on the Safety Compliance Certification Label or Tire Label which is located on the B-Pillar or the edge of the driver's door. The cold inflation pressure should never be set lower than the recommended pressure on the vehicle label.

The tire suppliers may have additional markings, notes or warnings such as standard load, radial tubeless, etc.

Tires, Wheels and Loading

Additional information contained on the tire sidewall for “LT” type tires

“LT” type tires have some additional information beyond those of “P” type tires; these differences are described below:

1. **LT:** Indicates a tire, designated by the Tire and Rim Association (T&RA), that is intended for service on light trucks.

2. **Load Range/Load Inflation Limits:** Indicates the tire’s load-carrying capabilities and its inflation limits.

3. **Maximum Load Dual lb. (kg) at psi (kPa) cold:** Indicates the maximum load and tire pressure when the tire is used as a dual; defined as four tires on the rear axle (a total of six or more tires on the vehicle).

4. **Maximum Load Single lb. (kg) at psi (kPa) cold:** Indicates the maximum load and tire pressure when the tire is used as a single; defined as two tires (total) on the rear axle.

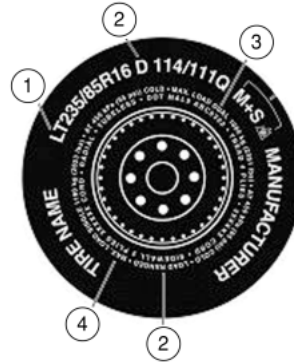

Tires, Wheels and Loading

Information on “T” type tires

“T” type tires have some additional information beyond those of “P” type tires; these differences are described below:

T145/80D16 is an example of a tire size.

Note: The temporary tire size for your vehicle may be different from this example.

1. **T:** Indicates a type of tire, designated by the Tire and Rim Association (T&RA), that is intended for temporary service on cars, SUVs, minivans and light trucks.

2. **145:** Indicates the nominal width of the tire in millimeters from sidewall edge to sidewall edge. In general, the larger the number, the wider the tire.

3. **80:** Indicates the aspect ratio which gives the tire’s ratio of height to width. Numbers of 70 or lower indicate a short sidewall.

4. **D:** Indicates a “diagonal” type tire.

R: Indicates a “radial” type tire.

5. **16:** Indicates the wheel or rim diameter in inches. If you change your wheel size, you will have to purchase new tires to match the new wheel diameter.

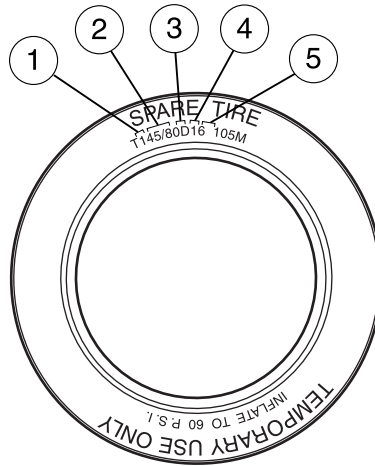

Location of the tire label

You will find a Tire Label containing tire inflation pressure by tire size and other important information located on the B-Pillar or the edge of the driver’s door. Refer to the payload description and graphic in the *Vehicle loading — with and without a trailer* section.

Tires, Wheels and Loading

SNOW TIRES AND CHAINS



Snow tires must be the same size and grade as the tires you currently have on your vehicle.

The tires on your vehicle have all weather treads to provide traction in rain and snow. However, in some climates, you may need to use snow tires and chains. If you need to use snow tires and chains, it is recommended that steel wheels are used of the same size and specifications as those originally installed.

Follow these guidelines when using snow tires and chains:

- Use only cable type chains. SAE class “S” or other conventional link type chains may cause damage to the vehicle’s wheel house and/or body.
- Install cable chains securely, verifying that the cables do not touch any wiring, brake lines or fuel lines.
- Drive cautiously. If you hear the cables rub or bang against your vehicle, stop and re-tighten the cables. If this does not work, remove the cables to prevent damage to your vehicle.
- If possible, avoid fully loading your vehicle.
- Remove the tire cables when they are no longer needed. Do not use tire cables on dry roads.
- The suspension insulation and bumpers will help prevent vehicle damage. Do not remove these components from your vehicle when using snow tires and cables.
- Do not exceed 30 mph (48 km/h) with tire cables on your vehicle.

VEHICLE LOADING – WITH AND WITHOUT A TRAILER

This section will guide you in the proper loading of your vehicle and/or trailer, to keep your loaded vehicle weight within its design rating capability, with or without a trailer. Properly loading your vehicle will provide maximum return of vehicle design performance. Before loading your vehicle, familiarize yourself with the following terms for determining your vehicle’s weight ratings, with or without a trailer, from the vehicle’s Tire Label or Safety Compliance Certification Label:

Base Curb Weight – is the weight of the vehicle including a full tank of fuel and all standard equipment. It does not include passengers, cargo, or optional equipment.

Tires, Wheels and Loading

Vehicle Curb Weight – is the weight of your new vehicle when you picked it up from your authorized dealer plus any aftermarket equipment.

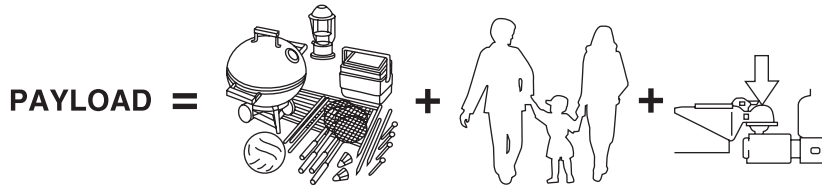

Payload – is the combined weight of cargo and passengers that the vehicle is carrying. The maximum payload for your vehicle can be found on the Tire Label on the B-Pillar or the edge of the driver's door (vehicles exported outside the US and Canada may not have a Tire Label). Look for **“THE COMBINED WEIGHT OF OCCUPANTS AND CARGO SHOULD NEVER EXCEED XXX kg OR XXX lb.”** for maximum payload. The payload listed on the Tire Label is the maximum payload for the vehicle as built by the assembly plant. If any aftermarket or authorized-dealer installed equipment has been installed on the vehicle, the weight of the equipment must be subtracted from the payload listed on the Tire Label in order to determine the new payload.

 The appropriate loading capacity of your vehicle can be limited either by volume capacity (how much space is available) or by payload capacity (how much weight the vehicle should carry). Once you have reached the maximum payload of your vehicle, do not add more cargo, even if there is space available. Overloading or improperly loading your vehicle can contribute to loss of vehicle control and vehicle rollover.

Tires, Wheels and Loading

Example only:

TIRE AND LOADING INFORMATION				
SEATING CAPACITY		TOTAL 5	FRONT 2	REAR 3
The combined weight of occupants and cargo should never exceed : XXX kg or XXX lbs.				
TIRE	SIZE	COLD TIRE PRESSURE	SEE OWNERS MANUAL FOR ADDITIONAL INFORMATION	
FRONT	LT225/75R 16.5E	200 KPA, 29 PSI		
REAR	LT225/75R 16.5E	200 KPA, 29 PSI		
SPARE	T145/80D16 P225/60R17	420 KPA, 60 PSI 200 KPA, 29 PSI		

TIRE AND LOAD INFORMATION				
RENSEIGNEMENTS RELATIFS AUX PNEUS ET À LA CHARGE				
SEATING CAPACITY		TOTAL XX	FRONT XX	REAR X
NOMBRE DE PLACES		TOTAL	AVANT	ARRIÈRE
The combined weight of occupants and cargo should never exceed : XXX kg. La charge du véhicule (occupants et bagages) ne doit jamais dépasser : XXX lbs.				
TIRE PNEUS	SIZE DIMENSIONS	COLD TIRE PRESSURE PRESSION À FROID	SEE OWNERS MANUAL FOR ADDITIONAL INFORMATION CONSULTER LE GUIDE DU PROPRIÉTAIRE POUR DE PLUS AMPLES RESEIGNEMENTS	
FRONT/ AVANT	LT225/75R 16.5E	200 KPA, 29 PSI		
REAR/ ARRIÈRE	LT225/75R 16.5E	200 KPA, 29 PSI		
SPARE/ PNEU DE SECOURS	T145/80D16 P225/60R17	420 KPA, 60 PSI 200 KPA, 29 PSI		

CARGO

=



+

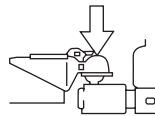

Cargo Weight – includes all weight added to the Base Curb Weight, including cargo and optional equipment. When towing, trailer tongue load or king pin weight is also part of cargo weight.

GAW (Gross Axle Weight) – is the total weight placed on each axle (front and rear) – including vehicle curb weight and all payload.

Tires, Wheels and Loading

GAWR (Gross Axle Weight Rating) – is the maximum allowable weight that can be carried by a single axle (front or rear). **These numbers are shown on the Safety Compliance Certification Label located on the B-Pillar or the edge of the driver's door. The total load on each axle must never exceed its GAWR.**

 Exceeding the Safety Compliance Certification Label axle weight rating limits could result in substandard vehicle handling or performance, engine, transmission and/or structural damage, serious damage to the vehicle, loss of control and personal injury.

Note: For trailer towing information refer to *Trailer towing* found in this chapter or the *RV and Trailer Towing Guide* provided by your authorized dealer.

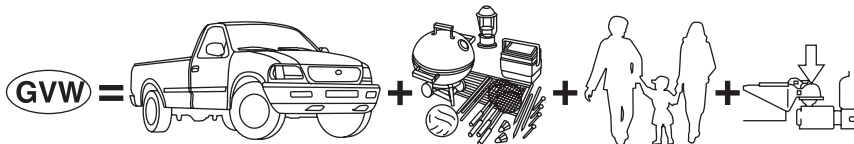

GVW (Gross Vehicle Weight) – is the Vehicle Curb Weight + cargo + passengers.

GVWR (Gross Vehicle Weight Rating) – is the maximum allowable weight of the fully loaded vehicle (including all options, equipment, passengers and cargo). **The GVWR is shown on the Safety Compliance Certification Label located on the B-Pillar or the edge of the driver's door. The GVW must never exceed the GVWR.**

MFD. BY FORD MOTOR CO.					
DATE: XX/XX	GVWR: XXXXXLB/ XXXXXKG				
FRONT GAWR: XXXXL	REAR GAWR: XXXXLB				
XXXXKG	WITH	XXXXKG	WITH		
XXXX/XXXXXXX	TIRES	XXXX/XXXXXXX	TIRES		
XXXX.XX	RIMS	XXXX.XX	RIMS		
AT XXX kPa/XX	PSI COLD	AT XXX kPa/XX	PSI COLD		
THIS VEHICLE CONFORMS TO ALL APPLICABLE FEDERAL MOTOR VEHICLE SAFETY AND THEFT PREVENTION STANDARDS IN EFFECT ON THE DATE OF MANUFACTURE SHOWN ABOVE.					
VIN: XXXXXXXXXXXXXXXXX	XXXXX				
TYPE: XXX	XXXXX				
					
EXT PNT: XX	RC: XX	DSO:			
WB ¹ BRK ²	INT TR ³	TP/PS ⁴	R ⁵	AXLE ⁶	TR ⁷ SPR ⁸
XXX X	XX	X	XX	X XX	XXX
XXXXXXXXXXXXX XXX XXXX-XXXXXX-XX					

Tires, Wheels and Loading

 Exceeding the Safety Compliance Certification Label vehicle weight rating limits could result in substandard vehicle handling or performance, engine, transmission and/or structural damage, serious damage to the vehicle, loss of control and personal injury.

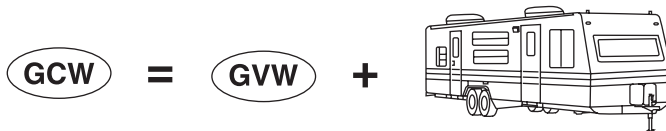
$$\text{GCW} = \text{GVW} + \text{Trailer}$$



GCW (Gross Combined Weight) – is the weight of the loaded vehicle (GVW) plus the weight of the fully loaded trailer.

GCWR (Gross Combined Weight Rating) – is the maximum allowable weight of the vehicle and the loaded trailer – including all cargo and passengers – that the vehicle can handle without risking damage.

(Important: The towing vehicles' braking system is rated for operation at GVWR, not at GCWR. Separate functional brakes should be used for safe control of towed vehicles and for trailers where the GCW of the towing vehicle plus the trailer exceed the GVWR of the towing vehicle. **The GCW must never exceed the GCWR.**

Maximum Loaded Trailer Weight – is the highest possible weight of a fully loaded trailer the vehicle can tow. It assumes a vehicle with only mandatory options, no cargo (internal or external), a tongue load of 10–15% (conventional trailer) or king pin weight of 15–25% (fifth wheel trailer), and driver only (150 lb. [68 kg]). **Consult your authorized dealer (or the *RV and Trailer Towing Guide* provided by your authorized dealer) for more detailed information.**

 Do not exceed the GVWR or the GAWR specified on the Safety Compliance Certification Label.

 Do not use replacement tires with lower load carrying capacities than the originals because they may lower the vehicle's GVWR and GAWR limitations. Replacement tires with a higher limit than the originals do not increase the GVWR and GAWR limitations.

Tires, Wheels and Loading



Exceeding any vehicle weight rating limitation could result in serious damage to the vehicle and/or personal injury.

Steps for determining the correct load limit:

1. Locate the statement “The combined weight of occupants and cargo should never exceed XXX kg or XXX lbs.” on your vehicle’s placard.
2. Determine the combined weight of the driver and passengers that will be riding in your vehicle.
3. Subtract the combined weight of the driver and passengers from XXX kg or XXX lbs.
4. The resulting figure equals the available amount of cargo and luggage load capacity. For example, if the “XXX” amount equals 1,400 lbs. and there will be five 150 lb. passengers in your vehicle, the amount of available cargo and luggage load capacity is 650 lbs. ($1400 - 750 (5 \times 150) = 650 \text{ lb.}$). In metric units ($635 - 340 (5 \times 68) = 295 \text{ kg.}$)
5. Determine the combined weight of luggage and cargo being loaded on the vehicle. That weight may not safely exceed the available cargo and luggage load capacity calculated in Step 4.
6. If your vehicle will be towing a trailer, load from your trailer will be transferred to your vehicle. Consult this manual to determine how this reduces the available cargo and luggage load capacity of your vehicle.

The following gives you a few examples on how to calculate the available amount of cargo and luggage load capacity:

- Another example for your vehicle with 1400 lb. (635 kg) of cargo and luggage capacity. You decide to go golfing. Is there enough load capacity to carry you, 4 of your friends and all the golf bags? You and four friends average 220 lb. (99 kg) each and the golf bags weigh approximately 30 lb. (13.5 kg) each. The calculation would be: $1400 - (5 \times 220) - (5 \times 30) = 1400 - 1100 - 150 = 150 \text{ lb.}$ Yes, you have enough load capacity in your vehicle to transport four friends and your golf bags. In metric units, the calculation would be: $635 \text{ kg} - (5 \times 99 \text{ kg}) - (5 \times 13.5 \text{ kg}) = 635 - 495 - 67.5 = 72.5 \text{ kg.}$
- A final example for your vehicle with 1400 lb. (635 kg) of cargo and luggage capacity. You and one of your friends decide to pick up cement from the local home improvement store to finish that patio you have been planning for the past 2 years. Measuring the inside of the vehicle with the rear seat folded down, you have room for 12-100 lb. (45 kg) bags of cement. Do you have enough load capacity to

Tires, Wheels and Loading

transport the cement to your home? If you and your friend each weigh 220 lb. (99 kg), the calculation would be: $1400 - (2 \times 220) - (12 \times 100) = 1400 - 440 - 1200 = -240$ lb. No, you do not have enough cargo capacity to carry that much weight. In metric units, the calculation would be: $635 \text{ kg} - (2 \times 99 \text{ kg}) - (12 \times 45 \text{ kg}) = 635 - 198 - 540 = -103$ kg. You will need to reduce the load weight by at least 240 lb. (104 kg). If you remove 3-100 lb. (45 kg) cement bags, then the load calculation would be:

$1400 - (2 \times 220) - (9 \times 100) = 1400 - 440 - 900 = 60$ lb. Now you have the load capacity to transport the cement and your friend home. In metric units, the calculation would be: $635 \text{ kg} - (2 \times 99 \text{ kg}) - (9 \times 45 \text{ kg}) = 635 - 198 - 405 = 32$ kg.

The above calculations also assume that the loads are positioned in your vehicle in a manner that does not overload the Front or the Rear Gross Axle Weight Rating specified for your vehicle on the Safety Compliance Certification Label found on the edge of the driver's door.

TRAILER TOWING

Your vehicle is classified as a light duty towing vehicle. Your vehicle does not come from the factory fully equipped to tow. No towing packages are available through authorized dealers. Do not tow a trailer until your vehicle has been driven at least 800 km (500 miles).

Towing a trailer places an additional load on your vehicle's engine, transaxle, brakes, tires and suspension. Inspect these components carefully after towing.

Passenger Load - #/lb. (kg)	Luggage Load - lb. (kg)	Max Trailer Wt. - lb. (kg)
5 /750 (340)	0	800 (365)
4/600 (270)	150 (70)	800 (365)
2/300 (135)	150 (70)	1100 (500)
2/300 (135)	0	1250 (565)

The above chart is based on the specified vehicle at a maximum GCW (Vehicle weight + Trailer weight) equal to 4,950 lb. (2,245 kg).



Do not exceed the GVWR or the GAWR specified on the certification label.

Tires, Wheels and Loading



Towing trailers beyond the maximum recommended gross trailer weight exceeds the limit of the vehicle and could result in engine damage, transaxle damage, structural damage, loss of control, and personal injury.

Preparing to tow

Use the proper equipment for towing a trailer and make sure it is properly attached to your vehicle. See your authorized dealer or a reliable trailer dealer if you require assistance.

Hitches

Do not use hitches that clamp onto the vehicle bumper. Use a load carrying hitch. You must distribute the load in your trailer so that 10–15% of the total weight of the trailer is on the tongue.

Safety chains

Always connect the trailer's safety chains to the frame or hook retainers of the vehicle hitch. To connect the trailer's safety chains, cross the chains under the trailer tongue and allow slack for turning corners.

If you use a rental trailer, follow the instructions that the rental agency gives to you.

Do not attach safety chains to the bumper.

Trailer brakes

Electric brakes and manual, automatic or surge-type trailer brakes are safe if installed properly and adjusted to the manufacturer's specifications. The trailer brakes must meet local and Federal regulations.



Do not connect a trailer's hydraulic brake system directly to your vehicle's brake system. Your vehicle may not have enough braking power and your chances of having a collision greatly increase.

The braking system of the tow vehicle is rated for operation at the GVWR not GCWR.

Tires, Wheels and Loading

Trailer lamps

Trailer lamps are required on most towed vehicles. Make sure all running lights, brake lights, turn signals and hazard lights are working. See your authorized dealer or trailer rental agency for proper instructions and equipment for hooking up trailer lamps.

Driving while you tow

When towing a trailer:

- Turn off the speed control. The speed control may shut off automatically when you are towing on long, steep grades.
- Consult your local motor vehicle speed regulations for towing a trailer.
- To eliminate excessive shifting, use a lower gear. This will also assist in transaxle cooling.
- Anticipate stops and brake gradually.

Servicing after towing

If you tow a trailer for long distances, your vehicle will require more frequent service intervals. Refer to your *scheduled maintenance information* for more information.

Trailer towing tips

- Practice turning, stopping and backing up before starting on a trip to get the feel of the vehicle trailer combination. When turning, make wider turns so the trailer wheels will clear curbs and other obstacles.
- Allow more distance for stopping with a trailer attached.
- If you are driving down a long or steep hill, shift to a lower gear. Do not apply the brakes continuously, as they may overheat and become less effective.
- The trailer tongue weight should be 10–15% of the loaded trailer weight.
- After you have traveled 50 miles (80 km), thoroughly check your hitch, electrical connections and trailer wheel lug nuts.
- To aid in engine/transmission cooling and A/C efficiency during hot weather while stopped in traffic, place the gearshift lever in P (Park).
- Vehicles with trailers should not be parked on a grade. If you must park on a grade, place wheel chocks under the trailer's wheels.

Tires, Wheels and Loading

RECREATIONAL TOWING

Follow these guidelines for your specific powertrain combination to tow your vehicle with all four wheels on the ground (such as behind a recreational vehicle).

These guidelines are designed to ensure that your transmission is not damaged due to insufficient lubrication.

All Front Wheel Drive (FWD) vehicles:

It is not recommended to tow front wheel drive vehicles with the front drive wheels on the ground. It is recommended to tow your vehicle with the drive wheels on a dolly or two wheel car hauling trailer.

In case of a roadside emergency with a disabled vehicle (without access to wheel dollies, car hauling trailer or flatbed transport vehicle) your vehicle can be flat towed (all wheels on the ground) under the following conditions:

- Place the transmission in N (Neutral).
- Maximum speed is 35 mph (56 km/h).
- Maximum distance is 50 miles (80 km).

Driving

STARTING

Positions of the ignition

1. ACCESSORY, allows the electrical accessories such as the radio to operate while the engine is not running.

2. LOCK, locks the automatic transmission gearshift lever and allows key removal.

3. OFF, shuts off the engine without locking the steering wheel. This position also allows the automatic transmission shift lever to be moved from the P (Park) position without the brake pedal being depressed.

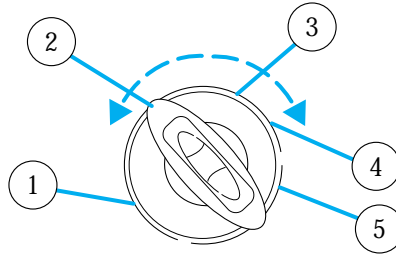

 When the key is in the ignition and in the OFF position, the automatic transmission shift lever can be moved from the P (Park) position without the brake pedal depressed. To avoid unwanted vehicle movement, always set the parking brake.

4. ON, all electrical circuits operational. Warning lights illuminated with engine off. Key position when driving.

5. START, cranks the engine. Release the key as soon as the engine starts.

Preparing to start your vehicle

Engine starting is controlled by the powertrain control system. This system meets all Canadian Interference-Causing Equipment standard requirements regulating the impulse electrical field strength of radio noise.

When starting a fuel-injected engine, don't press the accelerator before or during starting. Only use the accelerator when you have difficulty starting the engine. For more information on starting the vehicle, refer to *Starting the engine* in this chapter.

 Extended idling at high engine speeds can produce very high temperatures in the engine and exhaust system, creating the risk of fire or other damage.

Driving



Do not park, idle, or drive your vehicle in dry grass or other dry ground cover. The emission system heats up the engine compartment and exhaust system, which can start a fire.



Do not start your vehicle in a closed garage or in other enclosed areas. Exhaust fumes can be toxic. Always open the garage door before you start the engine. See *Guarding against exhaust fumes* in this chapter for more instructions.



If you smell exhaust fumes inside your vehicle, have your dealer inspect your vehicle immediately. Do not drive if you smell exhaust fumes.

Important safety precautions

A computer system controls the engine's idle revolutions per minute (RPM). When the engine starts, the idle RPM runs higher than normal in order to warm the engine. If the engine idle speed does not slow down automatically, have the vehicle checked. Do not allow the vehicle to idle for more than 10 minutes at the higher engine RPM.

Before starting the vehicle:

1. Make sure all occupants buckle their safety belts. For more information on safety belts and their proper usage, refer to the *Seating and Safety Restraints* chapter.
2. Make sure the headlamps and electrical accessories are off.

Driving

- Make sure the parking brake is set.

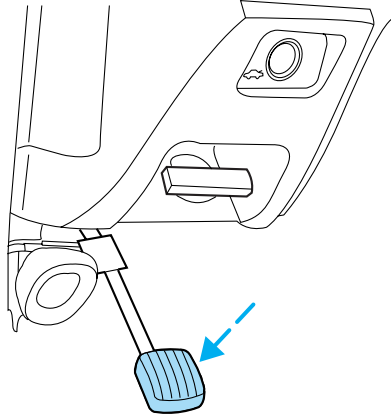

- Make sure the gearshift is in P (Park).
- Turn the key to 4 (ON) without turning the key to 5 (START).

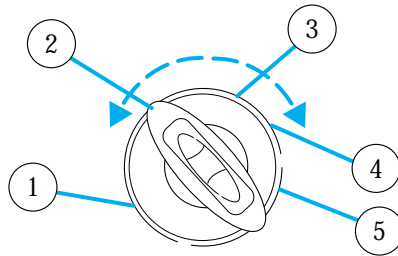

Some warning lights will briefly illuminate. See *Warning lights and chimes* in the *Instrument Cluster* chapter for more information regarding the warning lights.

Starting the engine

1. Turn the key to 4 (ON) without turning the key to 5 (START).
2. Turn the key to 5 (START), then release the key as soon as the engine starts. Excessive cranking could damage the starter.

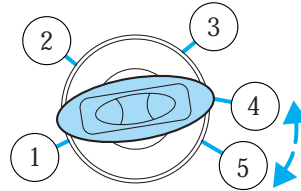

Note: If the engine does not start within five seconds on the first try, turn the key to OFF, wait 10 seconds and try again. If the engine still fails to start, press the accelerator to the floor and try again; this will allow the engine to crank with the fuel shut off in case the engine is flooded with fuel.

Cold weather starting (flexible fuel vehicles only)

In cold weather, ethanol fuel distributors should supply winter grade (E_d85) ethanol. If summer grade (E_d85) ethanol is used in cold weather, you may experience increased cranking times, rough idle or hesitation until the engine has warmed up. Consult your fuel distributor for the availability of winter grade (E_d85) ethanol. High-quality blends of winter grade (E_d85) ethanol will produce satisfactory cold weather starting and driving results.

Cold starting performance can also be improved by using an engine block heater. Engine block heaters are available as an option and can be obtained from your authorized dealer. Consult the engine block heater section for proper use of the engine block heater.

If you experience cold weather starting problems on (E_d85) ethanol, and neither an alternative brand of (E_d85) ethanol nor an engine block heater is available, adding unleaded gasoline to your tank will improve cold starting performance. Your vehicle is designed to operate on (E_d85) ethanol, unleaded gasoline alone, or any mixture of the two.

If the engine fails to start using the preceding instructions (flexible fuel vehicles only)

1. Press and hold down the accelerator 1/3 to 1/2 way to floor, then crank the engine.
2. When the engine starts, release the key, then gradually release the accelerator pedal as the engine speeds up. If the engine still fails to start, repeat Step 1.

Guarding against exhaust fumes

Carbon monoxide is present in exhaust fumes. Take precautions to avoid its dangerous effects.

Driving



If you smell exhaust fumes inside your vehicle, have your dealer inspect your vehicle immediately. Do not drive if you smell exhaust fumes.

Important ventilating information

If the engine is idling while the vehicle is stopped for a long period of time, open the windows at least one inch (2.5 cm) or adjust the heating or air conditioning to bring in fresh air.

ENGINE BLOCK HEATER (IF EQUIPPED)

An engine block heater warms the engine coolant which aids in starting and heater/defroster performance. Use of an engine block heater is strongly recommended if you live in a region where temperatures reach -10°F (-23°C) or below. For best results, plug the heater in at least three hours before starting the vehicle. The heater can be plugged in the night before starting the vehicle.



To reduce the risk of electrical shock, do not use your heater with ungrounded electrical systems or two-pronged (cheater) adapters.

BRAKES

Your service brakes are self-adjusting. Refer to the Scheduled Maintenance Guide for maintenance recommendations.

Occasional brake noise is normal and often does not indicate a performance concern with the vehicle's brake system. In normal operation, automotive brake systems may emit occasional or intermittent squeal or groan noises when the brakes are applied. Such noises are usually heard during the first few brake applications in the morning; however, they may be heard at any time while braking and can be aggravated by environmental conditions such as cold, heat, moisture, road dust, salt or mud. If a "metal-to-metal," "continuous grinding" or "continuous squeal" sound is present while braking, the brake linings may be worn-out and should be inspected by an authorized dealer.

If the vehicle has continuous vibration or shudder in the steering wheel while braking, the vehicle should be inspected by an authorized dealer.

148

Refer to *Brake system warning light* in the *Instrument Cluster* chapter for information on the brake system warning light.



Four-wheel anti-lock brake system (ABS) (if equipped)

On vehicles equipped with an anti-lock braking system (ABS), a noise from the hydraulic pump motor and pulsation in the pedal may be observed during ABS braking events. Pedal pulsation coupled with noise while braking under panic conditions or on loose gravel, bumps, wet or snowy roads is normal and indicates proper functioning of the vehicle's anti-lock brake system. The ABS performs a self-check after you start the engine and begin to drive away. A brief mechanical noise may be heard during this test. This is normal. If a malfunction is found, the ABS warning light will come on.

The ABS operates by detecting the onset of wheel lockup during brake applications and compensates for this tendency. The wheels are prevented from locking even when the brakes are firmly applied.

Using ABS

- In an emergency or when maximum efficiency from the four-wheel ABS is required, apply continuous force on the brake. The four wheel ABS will be activated immediately, thus allowing you to retain steering control of your vehicle and, providing there is sufficient space, will enable you to avoid obstacles and bring the vehicle to a controlled stop.
- The anti-lock system does not reduce stopping distance. Always leave enough room between your vehicle and the vehicle in front of you to stop.
- We recommend that you familiarize yourself with this braking technique. However, avoid taking any unnecessary risks.

ABS warning lamp

The ABS lamp in the instrument cluster momentarily illuminates when the ignition is turned on. If the light does not illuminate during start up, remains on or flashes, the ABS may be disabled and may need to be serviced.



Driving

Even when the ABS is disabled, normal braking is still effective. (If your BRAKE warning lamp illuminates with the parking brake released, have your brake system serviced immediately.)

Parking brake

To set the parking brake (1), press the parking brake pedal down until the pedal stops.

To release, pull the lever (2).

 Always set the parking brake fully and make sure that the gearshift is securely latched in P (Park).

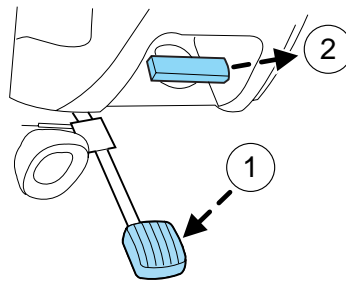

The BRAKE warning lamp will illuminate and will remain illuminated until the parking brake is released.



The parking brake is not recommended to stop a moving vehicle. However, if the normal brakes fail, the parking brake can be used to stop your vehicle in an emergency. Since the parking brake applies only the rear brakes, the vehicle's stopping distance will increase greatly and the handling of your vehicle will be adversely affected.

Park brake warning chime

Sounds when the parking brake is set, the engine is running, the vehicle speed is greater than 3 mph (5 km/h), and the transaxle is not in P (Park) or N (Neutral). The chime will shut off when the parking brake is disengaged.

TRACTION CONTROL™ (IF EQUIPPED)

Your vehicle may be equipped with a Traction Control™ system. This system helps you maintain the stability and steerability of your vehicle, especially on slippery road surfaces such as snow- or ice-covered roads and gravel roads. The system will allow your vehicle to make better use of available traction in these conditions.

Driving

During Traction Control[™] operation, the traction control active light will illuminate, you may hear an electric motor type of sound coming from the engine compartment and the engine will not “rev-up” when you push further on the accelerator. This is normal system behavior and should be no reason for concern.



 Aggressive driving in any road conditions can cause you to lose control of your vehicle increasing the risk of severe personal injury or property damage. The occurrence of a Traction Control[™] event is an indication that at least some of the tires have exceeded their ability to grip the road; this may lead to an increased risk of loss of vehicle control, vehicle rollover, personal injury and death. If you experience a severe road event, SLOW DOWN.

The Traction Control[™] switch, located on the right-hand side of the instrument cluster, has an indicator light that illuminates when the system is off. The Traction Control[™] system will automatically turn on every time the ignition is turned off and on. The Traction Control[™] system should normally be left on.

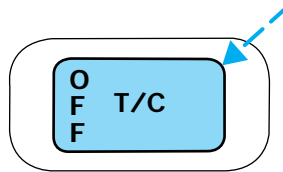

If you should become stuck in snow or ice or on a very slippery road surface, try switching the Traction Control[™] system off. This may allow excess wheel spin to “dig” the vehicle out and enable a successful “rocking” maneuver.

If a system fault is detected, the traction control active light will illuminate, the Traction Control[™] button will not turn the system on or off and your vehicle should be serviced by an authorized dealer.

STEERING

To help prevent damage to the power steering system, never hold the steering wheel at its furthest turning points (until it stops) for more than a few seconds when the engine is running.

It is also important to maintain a proper power steering fluid level in the power steering fluid reservoir:

- Do not operate the vehicle with a low power steering pump fluid level. See *Checking and adding power steering fluid* in the *Maintenance and Specifications* chapter.

Driving

- Some noise is normal during operation. If the noise is excessive, check for low power steering pump fluid level before seeking service by your authorized dealer.
- Heavy or uneven steering efforts may be caused by low power steering pump fluid level. Check for low power steering pump fluid level before seeking service by your authorized dealer.
- Do not fill the power steering pump reservoir above the maximum level, as this may result in leaks from the reservoir. See *Checking and adding power steering fluid* in the *Maintenance and Specifications* chapter.

If the power steering system breaks down (or if the engine is turned off), you can steer the vehicle manually, but it takes more effort.

If the steering wanders or pulls, check for:

- an improperly inflated tire
- uneven tire wear
- loose or worn suspension components
- loose or worn steering components
- improper steering alignment

AUTOMATIC TRANSAXLE OPERATION

Brake-shift interlock

This vehicle is equipped with a brake-shift interlock feature that prevents the gearshift lever from being moved from P (Park) when the ignition is in the ON position unless brake pedal is depressed.

If you cannot move the gearshift lever out of P (Park) with ignition in the ON position and the brake pedal depressed:

1. Apply the parking brake, turn ignition key to LOCK, then remove the key.
2. Insert the key and turn it to OFF. **Apply the brake pedal and shift to N (Neutral).**



When the key is in the ignition and in the OFF position, the automatic transmission shift lever can be moved from the P (Park) position without the brake pedal depressed. To avoid unwanted vehicle movement, always set the parking brake.

3. Start the vehicle.

Driving

If it is necessary to use the above procedure to move the gearshift lever, it is possible that a fuse has blown or the vehicle's brakelamps are not operating properly. Refer to *Fuses and relays* in the *Roadside Emergencies* chapter.



Do not drive your vehicle until you verify that the brakelamps are working.



Always set the parking brake fully and make sure the gearshift is latched in P (Park). Turn the ignition to the LOCK position and remove the key whenever you leave your vehicle.



If the parking brake is fully released, but the brake warning lamp remains illuminated, the brakes may not be working properly. See your authorized dealer.

Driving with an automatic overdrive transaxle

Your automatic overdrive transaxle provides fully automatic operation in either **D** (Overdrive) or D (Drive). Driving with the gearshift lever in **D** (Overdrive) gives the best fuel economy for normal driving conditions. For manual control, start in 1 (First) and then shift manually.

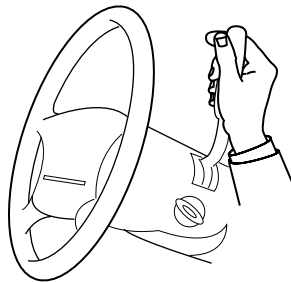

If your vehicle is equipped with a console-mounted gearshift lever, you must press the thumb button on the side of the gearshift lever to move the gearshift lever from P (Park).

To put your vehicle in gear, start the engine, depress the brake pedal, then move the gearshift lever out of P (Park).

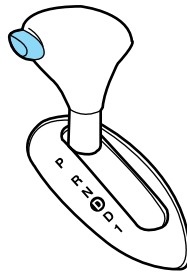

Driving

 Hold the brake pedal down while you move the gearshift lever from P (Park) to another position. If you do not hold the brake pedal down, your vehicle may move unexpectedly and injure someone.

Understanding the gearshift positions of the 4-speed automatic transaxle

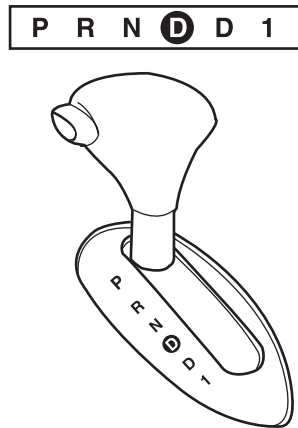

This vehicle is equipped with an adaptive Transmission Shift Strategy. Adaptive Shift Strategy offers the optimal transmission operation and shift quality. When the vehicle's battery has been disconnected for any type of service or repair, the transmission will need to relearn the normal shift strategy parameters, much like having to reset your radio stations when your vehicle battery has been disconnected. The Adaptive Transmission Strategy allows the transmission to relearn these operating parameters. This learning process could take several transmission upshifts and downshifts; during this learning process, slightly firmer shifts may occur. After this learning process, normal shift feel and shift scheduling will resume.

P (Park)

This position locks the transaxle and prevents the front wheels from turning.

To put your vehicle in gear:

- Start the engine

Driving

- Depress the brake pedal
- Move the gearshift lever into the desired gear

To put your vehicle in P (Park):

- Come to a complete stop
- Move the gearshift lever and securely latch it in P (Park)



Always set the parking brake fully and make sure the gearshift is latched in P (Park). Turn the ignition to the LOCK position and remove the key whenever you leave your vehicle.

R (Reverse)

With the gearshift lever in R (Reverse), the vehicle will move backward. Always come to a complete stop before shifting into and out of R (Reverse).

N (Neutral)

With the gearshift lever in N (Neutral), the vehicle can be started and is free to roll. Hold the brake pedal down while in this position.

D (Overdrive)

The normal driving position for the best fuel economy. The transaxle operates in gears one through four.

D (Drive)

- This position allows for all forward gears except overdrive.
- Provides more engine braking than **D (Overdrive)**.
- Use when driving conditions cause excessive shifting from O/D to other gears. Examples: city traffic, hilly terrain, heavy loads, trailer towing and when engine braking is required.

1 (First)

- Provides maximum engine braking.
- Allows upshifts by moving gearshift lever.
- Will not downshift into 1 (First) at high speeds; allows for 1 (First) when vehicle reaches slower speeds.



When parking, do not use the gearshift in place of the parking brake. Always set the parking brake fully and make sure that the gearshift is securely latched in P (Park). Turn off the ignition whenever you leave your vehicle. Never leave your vehicle unattended while it is running. If you do not take these precautions, your vehicle may move unexpectedly and injure someone.

Driving

If your vehicle gets stuck in mud or snow

If your vehicle gets stuck in mud or snow, it may be rocked out by shifting between forward and reverse gears, stopping between shifts in a steady pattern. Press lightly on the accelerator in each gear.

If necessary, try turning the Traction Control[™] system off. This will allow the wheels to spin, which may help to free your stuck vehicle. For more information, refer to *Traction Control[™] (if equipped)* in this chapter.

Do not rock the vehicle if the engine is not at normal operating temperature or damage to the transmission may occur.

Do not rock the vehicle for more than a minute or damage to the transmission and tires may occur, or the engine may overheat.

DRIVING THROUGH WATER

If driving through deep or standing water is unavoidable, proceed very slowly especially when the depth is not known. Never drive through water that is higher than the bottom of the wheel rims (for cars) or the bottom of the hubs (for trucks).

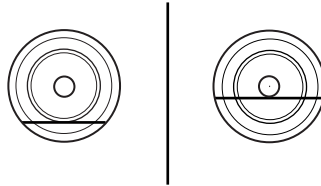

When driving through water, traction or brake capability may be limited. Also, water may enter your engine's air intake and severely damage your engine or your vehicle may stall. **Driving through deep water where the transmission vent tube is submerged may allow water into the transmission and cause internal transmission damage.**

Once through the water, always dry the brakes by moving your vehicle slowly while applying light pressure on the brake pedal.

Wet brakes do not stop the vehicle as quickly as dry brakes.

Roadside Emergencies

ROADSIDE ASSISTANCE

Getting roadside assistance

To fully assist you should you have a vehicle concern, Ford Motor Company offers a complimentary roadside assistance program. This program is separate from the New Vehicle Limited Warranty. The service is available:

- 24-hours, seven days a week
- for the New Vehicle Limited Warranty period of three years or 36,000 miles (60,000 km), whichever occurs first on Ford and Mercury vehicles, and four years or 50,000 miles (80,000 km) on Lincoln vehicles.

Roadside assistance will cover:

- a flat tire change with a good spare (except Ford GT which has a tire inflation kit)
- battery jump start
- lock-out assistance (key replacement cost is the customer's responsibility)
- fuel delivery – Independent Service Contractors, if not prohibited by state, local or municipal law shall deliver up to 2.0 gallons (7.5L) of gasoline or 5 gallons (18.9L) of diesel fuel to a disabled vehicle. Fuel delivery service is limited to two no-charge occurrences within a 12-month period.
- winch out – available within 100 feet (30.5 meters) of a paved or county maintained road, no recoveries.
- towing – Ford/Mercury/Lincoln eligible vehicle towed to an authorized dealer within 35 miles (56.3 km) of the disablement location or to the nearest authorized dealer. If a member requests to be towed to an authorized dealer more than 35 miles (56.3 km) from the disablement location, the member shall be responsible for any mileage costs in excess of 35 miles (56.3 km).

Trailers shall be covered up to \$100 if the disabled eligible vehicle requires service at the nearest authorized dealer. If the trailer is disabled, but the towing vehicle is operational, the trailer does not qualify for any roadside services.

Roadside Emergencies

Canadian customers refer to your Owner Information Guide for information on:

- coverage period
- exact fuel amounts
- towing of your disabled vehicle
- emergency travel expense reimbursement
- travel planning benefits

Using roadside assistance

Complete the roadside assistance identification card and place it in your wallet for quick reference. In the United States, this card is found in the Owner Guide portfolio in the glove compartment. In Canada, the card is found in the *Owner Information Guide* in the glove compartment.

U.S. Ford or Mercury vehicle customers who require roadside assistance, call 1-800-241-3673; Lincoln vehicle customers call 1-800-521-4140.

Canadian customers who require roadside assistance, call 1-800-665-2006.

If you need to arrange roadside assistance for yourself, Ford Motor Company will reimburse a reasonable amount. To obtain reimbursement information, U.S. Ford or Mercury vehicles customers call 1-800-241-3673; Lincoln vehicle customers call 1-800-521-4140.

Canadian customers who need to obtain reimbursement information, call 1-800-665-2006.

Roadside coverage beyond basic warranty

In the United States, you may purchase additional roadside assistance coverage beyond this period through the Ford Auto Club by contacting your authorized dealer.

Similarly in Canada, for uninterrupted Roadside Assistance coverage, you may purchase extended coverage prior to your Basic Warranty's Roadside Assistance expiring. For more information and enrollment, contact 1-877-294-2582 or visit our website at www.ford.ca.

Roadside Emergencies

HAZARD FLASHER

The hazard flasher is located on the steering column, just behind the steering wheel. The hazard flashers will operate when the ignition is in any position or if the key is not in the ignition.

Push in the flasher control and all front and rear direction signals will flash. Press the flasher control again to turn them off. Use it when your vehicle is disabled and is creating a safety hazard for other motorists.

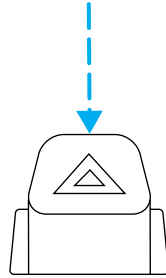

Note: With extended use, the flasher may run down your battery.

FUEL PUMP SHUT-OFF SWITCH

The fuel pump shut-off switch is a device intended to stop the electric fuel pump when your vehicle has been involved in a substantial jolt.

After a collision, if the engine cranks but does not start, the fuel pump shut-off switch may have been activated.

The fuel pump shut-off switch is located on the right side of the trunk behind the trunk liner.

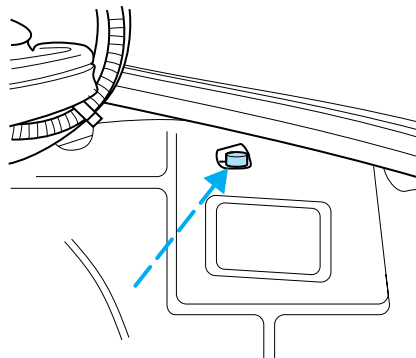

Use the following procedure to reset the fuel pump shut-off switch.

1. Turn the ignition to the OFF position.
2. Check the fuel system for leaks.

Roadside Emergencies

3. If no fuel leak is apparent, reset the fuel pump shut-off switch by pushing down on the reset button.
4. Turn the ignition to the ON position. Pause for a few seconds and return the key to the OFF position.
5. Make a further check for leaks in the fuel system.

FUSES AND RELAYS

Fuses

If electrical components in the vehicle are not working, a fuse may have blown. Blown fuses are identified by a broken wire within the fuse. Check the appropriate fuses before replacing any electrical components.

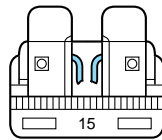

Note: Always replace a fuse with one that has the specified amperage rating. Using a fuse with a higher amperage rating can cause severe wire damage and could start a fire.

Standard fuse amperage rating and color

COLOR					
Fuse rating	Mini fuses	Standard fuses	Maxi fuses	Cartridge Maxi fuses	Fuse link cartridge
2A	Grey	Grey	—	—	—
3A	Violet	Violet	—	—	—
4A	Pink	Pink	—	—	—
5A	Tan	Tan	—	—	—
7.5A	Brown	Brown	—	—	—
10A	Red	Red	—	—	—
15A	Blue	Blue	—	—	—
20A	Yellow	Yellow	Yellow	Blue	Blue
25A	Natural	Natural	—	—	—
30A	Green	Green	Green	Pink	Pink
40A	—	—	Amber	Green	Green

Roadside Emergencies

COLOR					
Fuse rating	Mini fuses	Standard fuses	Maxi fuses	Cartridge Maxi fuses	Fuse link cartridge
50A	—	—	Red	Red	Red
60A	—	—	Blue	—	Yellow
70A	—	—	Tan	—	Brown
80A	—	—	Natural	—	Black

Passenger compartment fuse panel

The fuse panel is located below and to the left of the steering wheel by the brake pedal. Remove the panel cover to access the fuses.

To remove a fuse use the fuse puller tool provided on the fuse panel cover.

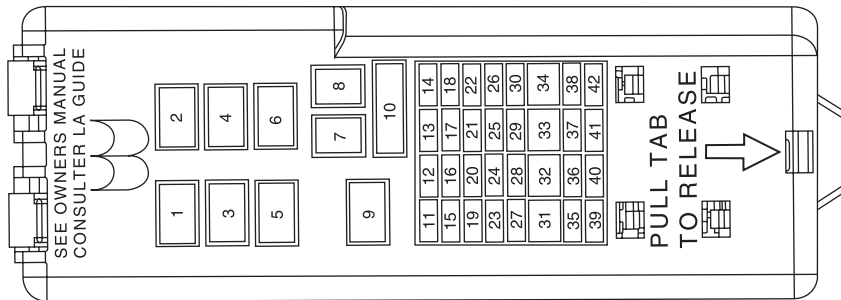

The fuses are coded as follows.

Fuse/relay location	Fuse amp rating	Passenger compartment fuse panel description
1	—	Accessory delay relay
2	—	Driver one touch down relay
3	—	Blower motor relay
4	—	Flasher relay
5	—	Not used
6	—	Not used

Roadside Emergencies

Fuse/relay location	Fuse amp rating	Passenger compartment fuse panel description
7	20A	Rear defrost relay coil feed
8	40A	Blower motor
9	—	Rear defrost relay
10	30A CB	Power seats, Delayed accessory
11	10A	Left headlamp
12	15A	Highbeam headlamps
13	—	Not used
14	—	Not used
15	10A	Right headlamp
16	10A	Not used (spare)
17	15A	Stop lamp, Speed control deactivation switch
18	15A	Parklamps, PWM (backlighting), Autolamps
19	10A	Heated mirrors, Rear defrost switch indicator
20	10A	Restraints (air bag module/OCS module)
21	15A	Transmission range sensor (transmission position switch)
22	15A	Front washer pump, Cluster (RUN/ACC), Integrated Control Panel (ICP) logic, Electrochromatic mirror
23	30A	Front wiper motor
24	—	Not used
25	20A	Power point
26	20A	Power locks, Trunk release
27	10A	Anti-lock Brake System (ABS), Speed control, Traction control, Brake-shift interlock, A/C function switch (manual A/C only), Temperature blend door (manual A/C only), Defrost coil

Roadside Emergencies

Fuse/relay location	Fuse amp rating	Passenger compartment fuse panel description
28	15A	Turn signals, Back-up lamps
29	20A	Cigar lighter
30	10A	Courtesy lighting, Battery saver, Power mirrors, Decklid lamp, Glove box lamp
31	10A	Blower motor relay coil, Electronic Automatic Temperature Control (EATC) logic
32	10A	Cluster, Flex fuel module, ICP logic, Passive anti-theft module (GEM power), Compass
33	15A	Hazard flasher, Cluster power, ICP power, EATC
34	5A	GEM logic
35	10A	Backlighting, Ashtray light
36	2A	Powertrain Control Module (PCM) relay, Fuel pump relay, A/C clutch
37	25A	Autolamp, Daytime Running Lamps (DRL), Flash-to-pass, Headlamp switch
38	15A	Horn, Diagnostic connector (OBD II)
39	—	Not used
40	—	Not used
41	—	Not used
42	—	Not used
CB - Circuit Breaker		

Roadside Emergencies

Power distribution box

The power distribution box is located in the engine compartment. The power distribution box contains high-current fuses that protect your vehicle's main electrical systems from overloads.

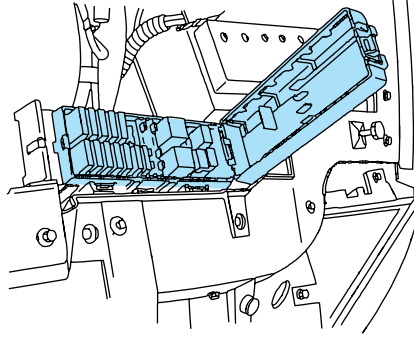

Always disconnect the battery before servicing high current fuses.



To reduce risk of electrical shock, always replace the cover to the Power Distribution Box before reconnecting the battery or refilling fluid reservoirs.

If the battery has been disconnected and reconnected, refer to the *Battery* section of the *Maintenance and Specifications* chapter.

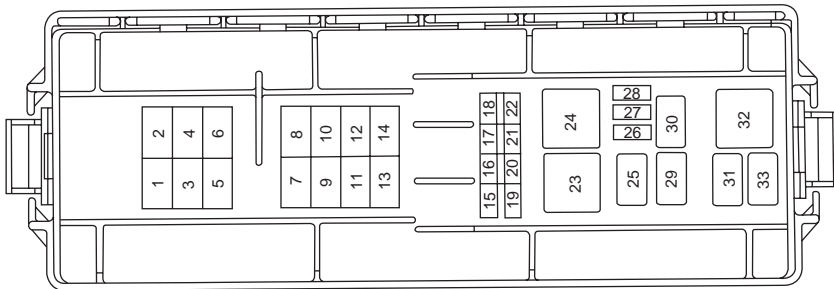

Roadside Emergencies

The high-current fuses are coded as follows.

Fuse/relay location	Fuse amp rating	Power distribution box description
1	60A**	Fuse junction panel
2	30A**	Powertrain Control Module (PCM)
3	60A**	Fuse junction panel
4	10A CB	Low speed cooling fan
5	40A**	Cooling fan (main)
6	—	Not used
7	40A**	Starter relay, Ignition switch
8	—	Not used
9	20A**	Cooling fan (passenger side)
10	20A**	Cooling fan (driver side)
11	50A**	Rear defrost
12	—	Not used
13	40A**	Anti-lock Brake System (ABS) module pump feed
14	—	Not used
15	20A*	ABS module valve solenoid
16	20A*	Fuel pump relay
17	20A*	CD
18	10A*	A/C clutch relay, PCM keep alive power
19	—	Not used
20	—	Not used
21	—	Not used
22	5A*	Heated PCV valve
23	—	Starter motor relay
24	—	Fan relay
25	—	Wiper speed relay
26	10A*	Alternator
27	5A*	Rear control unit

Roadside Emergencies

Fuse/relay location	Fuse amp rating	Power distribution box description
28	15A*	HEGO sensor, Transmission shift solenoid, A/C clutch relay, Canister vent
29	—	Wiper park relay
30	—	Fuel pump relay
31	—	PCM power relay
32	—	Fan relay
33	—	A/C clutch relay

* - Mini Fuses ** - Maxi Fuses CB - Circuit breaker

Relays

Relays are located in the power distribution box and should be replaced by an authorized dealer.

CHANGING THE TIRES

If you get a flat tire while driving:

- do not brake heavily.
- gradually decrease the vehicle's speed.
- hold the steering wheel firmly.
- slowly move to a safe place on the side of the road.



The use of tire sealants is not recommended and may damage your tires.

Dissimilar spare tire/wheel information



Failure to follow these guidelines could result in an increased risk of loss of vehicle control, injury or death.

If you have a dissimilar spare tire/wheel, then it is intended for temporary use only. This means that if you need to use it, you should replace it as soon as possible with a road tire/wheel that is the same size and type as the road tires and wheels that were originally provided by Ford. If the dissimilar spare tire or wheel is damaged, it should be replaced rather than repaired.

Roadside Emergencies

A dissimilar spare tire/wheel is defined as a spare tire and/or wheel that is different in brand, size or appearance from the road tires and wheels and can be one of three types:

1. **T-type mini-spares:** This spare tire begins with the letter “T” for tire size and may have “Temporary Use Only” molded in the sidewall
2. **Full-size dissimilar spare with label on wheel:** This spare tire has a label on the wheel that states: “THIS TIRE AND WHEEL FOR TEMPORARY USE ONLY”

When driving with one of the dissimilar spare tires listed above, **do not:**

- Exceed 50 mph (80 km/h)
- Load the vehicle beyond maximum vehicle load rating listed on the Safety Compliance Label
- Tow a trailer
- Use snow chains on the end of the vehicle with the dissimilar spare tire
- Use more than one dissimilar spare tire at a time
- Use commercial car washing equipment
- Try to repair the dissimilar spare tire

Use of one of the dissimilar spare tires listed above at any one wheel location can lead to impairment of the following:

- Handling, stability and braking performance
- Comfort and noise
- Ground clearance and parking at curbs
- Winter weather driving capability
- Wet weather driving capability

For vehicles equipped with 4WD, it is not recommended that the vehicle be operated in 4WD modes with a temporary emergency spare tire. If 4WD operation is necessary, do not operate above speeds of 10 mph (16 km/h) or for distances above 50 miles (80 km).

3. Full-size dissimilar spare without label on wheel

When driving with the full-size dissimilar spare tire/wheel, **do not:**

- Exceed 70 mph (113 km/h)
- Use more than one dissimilar spare tire/wheel at a time
- Use commercial car washing equipment

Roadside Emergencies

- Use snow chains on the end of the vehicle with the dissimilar spare tire/wheel

The usage of a full-size dissimilar spare tire/wheel can lead to impairment of the following:

- Handling, stability and braking performance
- Comfort and noise
- Ground clearance and parking at curbs
- Winter weather driving capability
- Wet weather driving capability
- All-Wheel driving capability (if applicable)
- Load leveling adjustment (if applicable)

When driving with the full-size dissimilar spare tire/wheel additional caution should be given to:

- Towing a trailer
- Driving vehicles equipped with a camper body
- Driving vehicles with a load on the cargo rack

Drive cautiously when using a full-size dissimilar spare tire/wheel and seek service as soon as possible.

Tire change procedure

1. Park on a level surface, activate hazard flashers and set parking brake.



When one of the front wheels is off the ground, the transaxle alone will not prevent the vehicle from moving or slipping off the jack, even if the vehicle is in P (Park).



To help prevent the vehicle from moving when you change a tire, be sure the parking brake is set, then block (in both directions) the wheel that is diagonally opposite (other side and end of the vehicle) to the tire being changed.



If the vehicle slips off the jack, you or someone else could be seriously injured.

Roadside Emergencies

2. Place gearshift lever in P (Park), turn engine OFF, block the diagonally opposite wheel, then remove the spare tire, jack and lug wrench.

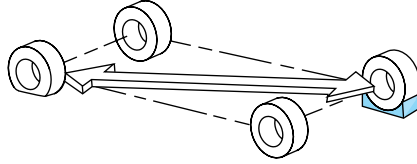

- These are located in the trunk cargo area storage compartment.

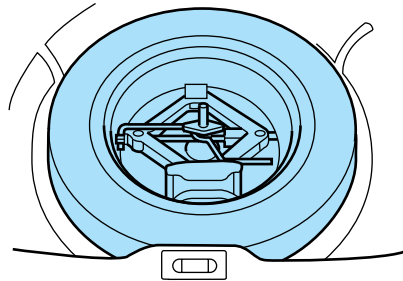

3. If equipped with a wheel cover that's bolted on, loosen the five plastic nuts with the lug nut wrench.

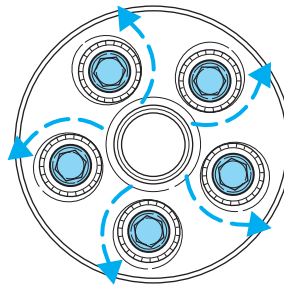

4. Remove the center ornament or wheel cover from the wheel with the tapered end of the wheel lug nut wrench that came with your vehicle. Insert and twist the handle, then pry against the wheel.

Roadside Emergencies

5. Loosen each wheel lug nut one-half turn counterclockwise but do not remove them until the wheel is raised off the ground.

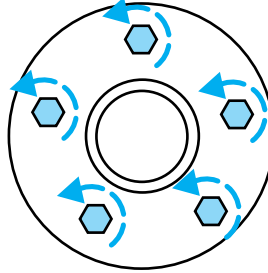

6. Put the jack in the jack notch next to the door of the tire you are changing. Turn the jack handle clockwise until the wheel is completely off the ground.

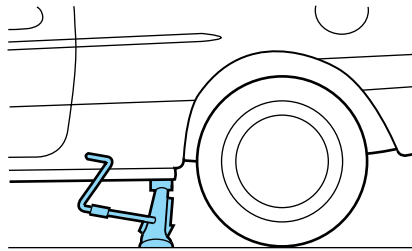

7. Remove the lug nuts with the lug nut wrench.

8. Replace the flat tire with the spare tire, making sure the valve stem is facing outward. Reinstall lug nuts until the wheel is snug against the hub. Do not fully tighten the lug nuts until the wheel has been lowered.

9. Lower the wheel by turning the jack handle counterclockwise.

10. Remove the jack and fully tighten the lug nuts in the order shown. Refer to *Wheel lug nut torque specifications* later in this chapter for the proper lug nut torque specification.

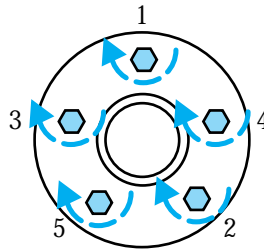

Roadside Emergencies

11. Return the flat tire, jack and lug wrench to their proper storage locations. Make sure the jack is fastened so it does not rattle when you drive.

12. Unblock the wheels.

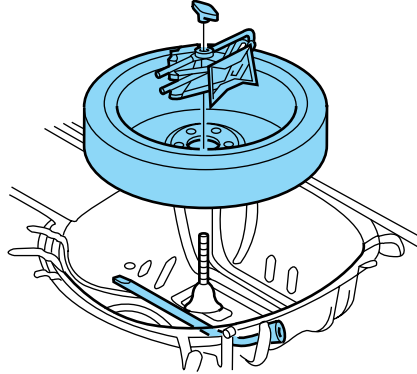

WHEEL LUG NUT TORQUE SPECIFICATIONS

Retighten the lug nuts to the specified torque at 500 miles (800 km) after any wheel disturbance (tire rotation, changing a flat tire, wheel removal, etc.).

Bolt size	Wheel lug nut torque*	
	lb. ft.	N•m
M12 x 1.5	100	135

* Torque specifications are for nut and bolt threads free of dirt and rust. Use only Ford recommended replacement fasteners.



When a wheel is installed, always remove any corrosion, dirt or foreign materials present on the mounting surfaces of the wheel or the surface of the wheel hub, brake drum or brake disc that contacts the wheel. Ensure that any fasteners that attach the rotor to the hub are secured so they do not interfere with the mounting surfaces of the wheel. Installing wheels without correct metal-to-metal contact at the wheel mounting surfaces can cause the wheel nuts to loosen and the wheel to come off while the vehicle is in motion, resulting in loss of control.

Roadside Emergencies

JUMP STARTING



The gases around the battery can explode if exposed to flames, sparks, or lit cigarettes. An explosion could result in injury or vehicle damage.



Batteries contain sulfuric acid which can burn skin, eyes and clothing, if contacted.

Do not attempt to push-start your automatic transmission vehicle. Automatic transmissions do not have push-start capability. Attempting to push-start a vehicle with an automatic transmission may cause transmission damage.

Preparing your vehicle

When the battery is disconnected or a new battery is installed, the transmission must relearn its shift strategy. As a result, the transmission may have firm and/or soft shifts. This operation is considered normal and will not affect function or durability of the transmission. Over time, the adaptive learning process will fully update transmission operation.

1. **Use only a 12-volt supply to start your vehicle.**
2. Do not disconnect the battery of the disabled vehicle as this could damage the vehicle's electrical system.
3. Park the booster vehicle close to the hood of the disabled vehicle making sure the two vehicles **do not** touch. Set the parking brake on both vehicles and stay clear of the engine cooling fan and other moving parts.
4. Check all battery terminals and remove any excessive corrosion before you attach the battery cables. Ensure that vent caps are tight and level.
5. Turn the heater fan on in both vehicles to protect any electrical surges. Turn all other accessories off.

Roadside Emergencies

Connecting the jumper cables

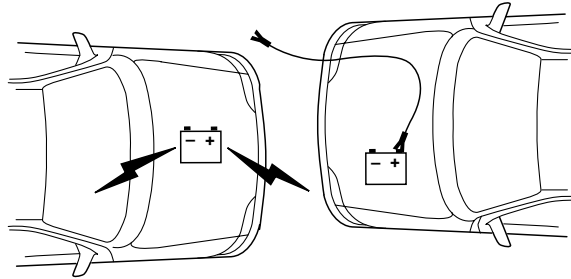

1. Connect the positive (+) jumper cable to the positive (+) terminal of the discharged battery.

Note: In the illustrations, *lightning bolts* are used to designate the assisting (boosting) battery.

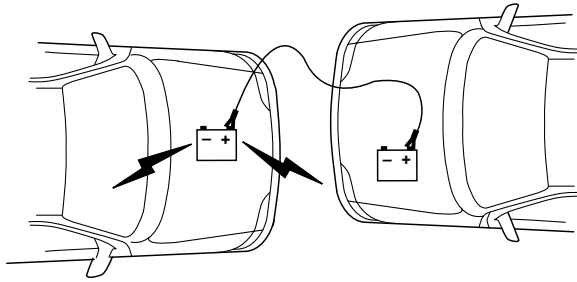

2. Connect the other end of the positive (+) cable to the positive (+) terminal of the assisting battery.

Roadside Emergencies

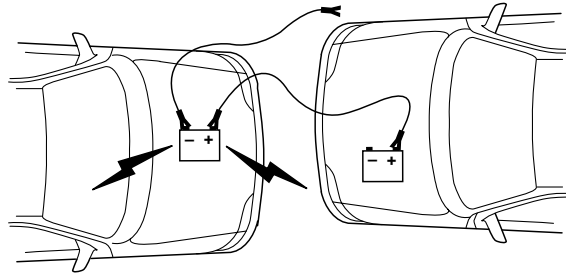

3. Connect the negative (-) cable to the negative (-) terminal of the assisting battery.

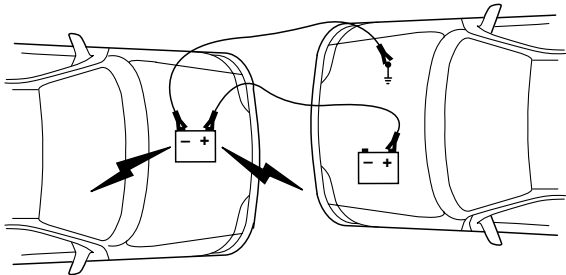

4. Make the final connection of the negative (-) cable. Make the connection to an exposed metal part of the stalled vehicle's engine, away from the battery and the fuel injection system. **Do not** use fuel lines, engine rocker covers or the intake manifold as *grounding* points.



Do not connect the end of the second cable to the negative (-) terminal of the battery to be jumped. A spark may cause an explosion of the gases that surround the battery.

5. Ensure that the cables are clear of fan blades, belts, moving parts of both engines, or any fuel delivery system parts.

Roadside Emergencies

Jump starting

1. Start the engine of the booster vehicle and run the engine at moderately increased speed.
2. Start the engine of the disabled vehicle.
3. Once the disabled vehicle has been started, run both engines for an additional three minutes before disconnecting the jumper cables.

Removing the jumper cables

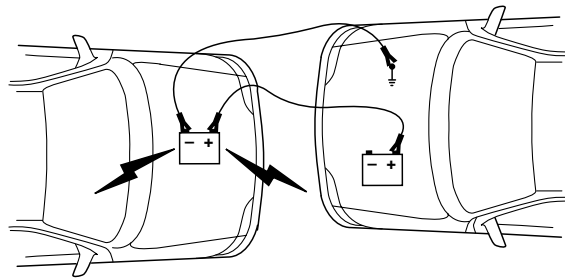

Remove the jumper cables in the reverse order that they were connected.

1. Remove the jumper cable from the *ground* metal surface.

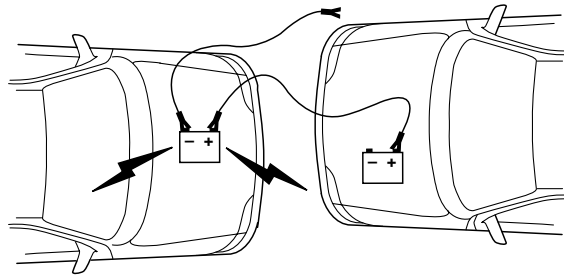

2. Remove the jumper cable on the negative (-) connection of the booster vehicle's battery.

Roadside Emergencies

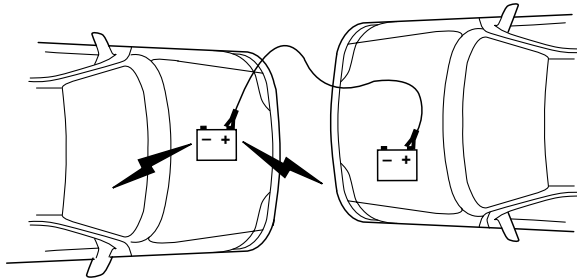

3. Remove the jumper cable from the positive (+) terminal of the booster vehicle's battery.

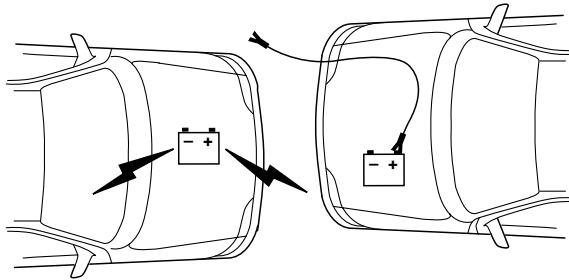

4. Remove the jumper cable from the positive (+) terminal of the disabled vehicle's battery.

After the disabled vehicle has been started and the jumper cables removed, allow it to idle for several minutes so the engine computer can *relearn* its idle conditions.

Roadside Emergencies

WRECKER TOWING

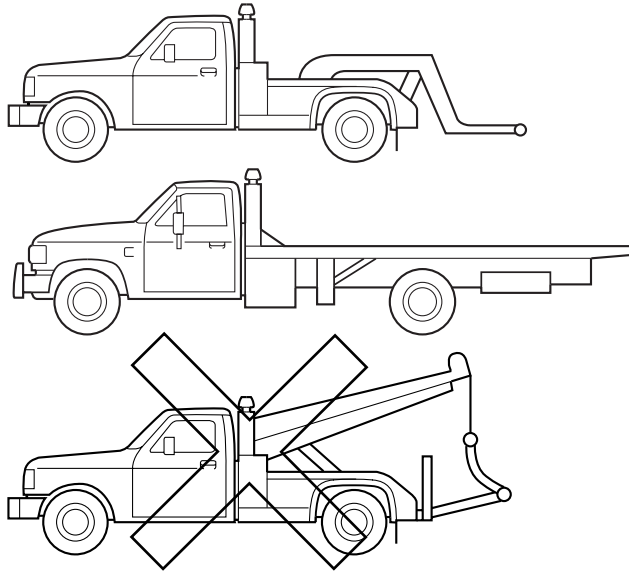

If you need to have your vehicle towed, contact a professional towing service or, if you are a member of a roadside assistance program, your roadside assistance service provider.

It is recommended that your vehicle be towed with a wheel lift or flatbed equipment. Do not tow with a slingbelt. Ford Motor Company has not approved a slingbelt towing procedure.

If your vehicle is to be towed from the rear using wheel lift equipment, it is recommended that the front wheels (drive wheels) be placed on a dolly to prevent damage to the transaxle.

If your vehicle must be towed with the drive wheels on the ground:

- Place the transaxle in N (Neutral).
- DO NOT exceed the distance of 50 miles (80 km).
- DO NOT exceed the speed of 35 mph (56 km/h).

If the vehicle is towed by other means or incorrectly, vehicle damage may occur.

Ford Motor Company produces a towing manual for all authorized tow truck operators. Have your tow truck operator refer to this manual for proper hook-up and towing procedures for your vehicle.

Customer Assistance

GETTING THE SERVICES YOU NEED

At home

You must take your Ford vehicle to an authorized dealer for warranty repairs. While any authorized dealer handling your vehicle line will provide warranty service, we recommend you return to your selling authorized dealer who wants to ensure your continued satisfaction. Please note that certain warranty repairs require special training and/or equipment, so not all authorized dealers are authorized to perform all warranty repairs. This means that, depending on the warranty repair needed, you may have to take your vehicle to another authorized dealer. A reasonable time must be allowed to perform a repair after taking your vehicle to the authorized dealer. Repairs will be made using Ford or Motorcraft parts, or remanufactured or other parts that are authorized by Ford.

If you have questions or concerns, or are unsatisfied with the service you are receiving, follow these steps:

1. Contact your Sales Representative or Service Advisor at your selling/servicing authorized dealer.
2. If your inquiry or concern remains unresolved, contact the Sales Manager, Service Manager or Customer Relations Manager.
3. If you require assistance or clarification on Ford Motor Company policies or procedures, please contact the Ford Customer Relationship Center at 1-800-392-3673 (FORD).

Away from home

If you own a Ford or Mercury vehicle and are away from home when your vehicle needs service, or if you need more help than the authorized dealer could provide, after following the steps described above, contact the Ford Customer Relationship Center to find an authorized dealer to help you.

In the United States:

Ford Motor Company
Customer Relationship Center
P.O. Box 6248
Dearborn, MI 48121
1-800-392-3673 (FORD)
(TDD for the hearing impaired: 1-800-232-5952)
www.customersaskford.com

178

Customer Assistance

In Canada:
Customer Relationship Centre
Ford Motor Company of Canada, Limited
P.O. Box 2000
Oakville, Ontario L6J 5E4
1-800-565-3673 (FORD)
www.ford.ca

If you own a Lincoln vehicle and are away from home when your vehicle needs service, or if you need more help than the authorized dealer could provide, after following the steps described above, contact the Ford Customer Relationship Center to find an authorized dealer to help you.

In the United States:
Ford Motor Company
Customer Relationship Center
P.O. Box 6248
Dearborn, MI 48121
1-800-521-4140
(TDD for the hearing impaired: 1-800-232-5952)
www.customersaskford.com

In Canada:
Lincoln Centre
Ford Motor Company of Canada, Limited
P.O. Box 2000
Oakville, Ontario L6J 5E4
1-800-387-9333
www.lincolncanada.com

In order to help you service your Lincoln vehicle, please have the following information available when contacting the Lincoln Centre:

- Your telephone number (home and business)
- The name of the authorized dealer and the city where the authorized dealer is located
- The year and make of your vehicle
- The date of vehicle purchase
- The current odometer reading
- The vehicle identification number (VIN)

Additional Assistance

If you still have a complaint involving a warranty dispute, you may wish to contact the Better Business Bureau (BBB) AUTO LINE program (U.S. only).

Customer Assistance

In some states (in the U.S.) you must directly notify Ford in writing before pursuing remedies under your state's warranty laws. Ford is also allowed a final repair attempt in some states.

In the United States, a warranty dispute must be submitted to the BBB AUTO LINE before taking action under the Magnuson-Moss Warranty Act, or to the extent allowed by state law, before pursuing replacement or repurchase remedies provided by certain state laws. This dispute handling procedure is not required prior to enforcing state created rights or other rights which are independent of the Magnuson-Moss Warranty Act or state replacement or repurchase laws.

IN CALIFORNIA (U.S. ONLY)

California Civil Code Section 1793.2(d) requires that, if a manufacturer or its representative is unable to repair a motor vehicle to conform to the vehicle's applicable express warranty after a reasonable number of attempts, the manufacturer shall be required to either replace the vehicle with one substantially identical or repurchase the vehicle and reimburse the buyer in an amount equal to the actual price paid or payable by the consumer (less a reasonable allowance for consumer use). The consumer has the right to choose whether to receive a refund or replacement vehicle.

California Civil Code Section 1793.22(b) presumes that the manufacturer has had a reasonable number of attempts to conform the vehicle to its applicable express warranties if, within the first 18 months of ownership of a new vehicle or the first 18,000 miles (29,000 km), whichever occurs first:

1. Two or more repair attempts are made on the same non-conformity likely to cause death or serious bodily injury OR
2. Four or more repair attempts are made on the same nonconformity (a defect or condition that substantially impairs the use, value or safety of the vehicle) OR
3. The vehicle is out of service for repair of nonconformities for a total of more than 30 calendar days (not necessarily all at one time)

In the case of 1 or 2 above, the consumer must also notify the manufacturer of the need for the repair of the nonconformity at the following address:

Ford Motor Company
16800 Executive Plaza Drive
Mail Drop 3NE-B
Dearborn, MI 48126

180

Customer Assistance

THE BETTER BUSINESS BUREAU (BBB) AUTO LINE PROGRAM (U.S. ONLY)

Your satisfaction is important to Ford Motor Company and to your dealer. Experience has shown that our customers have been very successful in achieving satisfaction by following the three-step procedure outlined on the front page of the Warranty Guide. However, if your warranty concern has not been resolved using the three-step procedure, you may be eligible to participate in the BBB AUTO LINE program.

The BBB AUTO LINE program consists of two parts – mediation and arbitration. Initially, the BBB will try to resolve your question or concern through mediation. Mediation is a process through which a representative of the BBB will contact the parties and explore options for settlement of your claim. If mediation is not successful, customers with eligible claims may participate in the BBB AUTO LINE arbitration process. An arbitration hearing will be scheduled so that you can present your case in an informal setting before an impartial person. The arbitrator will consider the testimony provided and make a decision after the hearing. You are not bound by the decision but may choose to accept it. If you choose to accept the BBB AUTO LINE decision then Ford must abide by the accepted decision as well. If the arbitrator has decided in your favor and you accept the decision, the BBB AUTO LINE program will contact you to ensure that Ford has complied with the decision in a timely manner. Disputes submitted to the BBB AUTO LINE program are usually decided within forty days after you file your claim with the BBB.

To file a claim with the BBB AUTO LINE, you will be asked for your name and address, information about your vehicle, information about your concerns and any steps you have already taken to try to resolve them.

You can get more information by calling BBB AUTO LINE at 1-800-955-5100, or writing to:

BBB AUTO LINE
4200 Wilson Boulevard, Suite 800
Arlington, Virginia 22203-1833

Note: Ford Motor Company reserves the right to change eligibility limitations, modify procedures, or to discontinue this process at any time without notice and without obligation.

UTILIZING THE MEDIATION/ARBITRATION PROGRAM (CANADA ONLY)

For vehicles delivered to authorized Canadian dealers. In those cases where you continue to feel that the efforts by Ford of Canada and the

Customer Assistance

authorized dealer to resolve a factory-related vehicle service concern have been unsatisfactory, Ford of Canada participates in an impartial third party mediation/arbitration program administered by the Canadian Motor Vehicle Arbitration Plan (CAMVAP).

The CAMVAP program is a straight-forward and relatively speedy alternative to resolve a disagreement when all other efforts to produce a settlement have failed. This procedure is without cost to you and is designed to eliminate the need for lengthy and expensive legal proceedings.

In the CAMVAP program, impartial third-party arbitrators conduct hearings at mutually convenient times and places in an informal environment. These impartial arbitrators review the positions of the parties, make decisions and, when appropriate, render awards to resolve disputes. CAMVAP decisions are fast, fair, and final as the arbitrator's award is binding both to you and Ford of Canada.

CAMVAP services are available in all territories and provinces. For more information, without charge or obligation, call your CAMVAP Provincial Administrator directly at 1-800-207-0685.

FORD EXTENDED SERVICE PLAN

You can get more protection for your new car or light truck by purchasing Ford Extended Service Plan (Ford ESP) coverage. It provides the following:

- Benefits during the warranty period depending on the plan you purchase (such as: reimbursement for rentals; coverage for certain maintenance and wear items).
- Protection against covered repair costs after your Bumper-to-Bumper Warranty expires.

You may purchase Ford ESP from any participating authorized dealer. There are several plans available in various time, distance and deductible combinations which can be tailored to fit your own driving needs. Ford ESP also offers reimbursement benefits for towing and rental coverage.

When you buy Ford ESP, you receive Peace-of-Mind protection throughout the United States and Canada, provided by a network of more than 4,600 participating authorized dealers.

If you did not take advantage of the Ford Extended Service Plan at the time of purchasing your vehicle, you may still be eligible. Since this information is subject to change, please ask your authorized dealer for complete details about Ford Extended Service Plan coverage options, or visit the Ford ESP website at www.ford-esp.com.

Customer Assistance

GETTING ASSISTANCE OUTSIDE THE U.S. AND CANADA

Before exporting your vehicle to a foreign country, contact the appropriate foreign embassy or consulate. These officials can inform you of local vehicle registration regulations and where to find unleaded fuel.

If you cannot find unleaded fuel or can only get fuel with an anti-knock index lower than is recommended for your vehicle, contact a regional office or owner relations/customer relationship office.

The use of leaded fuel in your vehicle without proper conversion may damage the effectiveness of your emission control system and may cause engine knocking or serious engine damage. Ford Motor Company/Ford of Canada is not responsible for any damage caused by use of improper fuel. Using leaded fuel may also result in difficulty importing your vehicle back into the U.S.

If your vehicle must be serviced while you are traveling or living in Central America, the Caribbean, or the Middle East, contact the nearest authorized dealer. If the authorized dealer cannot help you, write or call:

FORD MOTOR COMPANY
WORLDWIDE DIRECT MARKET OPERATIONS
1555 Fairlane Drive
Fairlane Business Park #3
Allen Park, Michigan 48101
U.S.A.
Telephone: (313) 594-4857
FAX: (313) 390-0804

If you are in another foreign country, contact the nearest authorized dealer. If the authorized dealer employees cannot help you, they can direct you to the nearest Ford affiliate office.

If you buy your vehicle in North America and then relocate outside of the U.S. or Canada, register your vehicle identification number (VIN) and new address with Ford Motor Company Worldwide Direct Market Operations.

Customers in the U.S. should call 1-800-392-3673.

Customer Assistance

ORDERING ADDITIONAL OWNER'S LITERATURE

To order the publications in this portfolio, contact Helm, Incorporated at:

HELM, INCORPORATED
P.O. Box 07150
Detroit, Michigan 48207

Or call:

For a free publication catalog, order toll free: 1-800-782-4356

Monday-Friday 8:00 a.m. - 6:00 p.m. EST

Helm, Incorporated can also be reached by their website:
www.helminc.com.

(Items in this catalog may be purchased by credit card, check or money order.)

Obtaining a French owner's guide

French Owner's Guides can be obtained from your authorized dealer or by writing to Ford Motor Company of Canada, Limited, Service Publications, P.O. Box 1580, Station B, Mississauga, Ontario L4Y 4G3.

REPORTING SAFETY DEFECTS (U.S. ONLY)

If you believe that your vehicle has a defect which could cause a crash or could cause injury or death, you should immediately inform the National Highway Traffic Safety



Administration (NHTSA) in addition to notifying Ford Motor Company.

If NHTSA receives similar complaints, it may open an investigation, and if it finds that a safety defect exists in a group of vehicles, it may order a recall and remedy campaign. However, NHTSA cannot become involved in individual problems between you, your dealer, or Ford Motor Company.

To contact NHTSA, you may call the Vehicle Safety Hotline toll-free at 1-888-327-4236 (TTY: 1-800-424-9153); go to <http://www.safercar.gov>; or write to:

Administrator
NHTSA
400 Seventh Street, SW
Washington, D.C. 20590

You can also obtain other information about motor vehicle safety from <http://www.safercar.gov>.

184

2007 Taurus (tau)
Owners Guide (post-2002-fmt)
USA (fus)

WASHING THE EXTERIOR

Wash your vehicle regularly with cool or lukewarm water and a neutral pH shampoo, such as Motorcraft Detail Wash (ZC-3-A), which is available from your authorized dealer.

- Never use strong household detergents or soap, such as dish washing or laundry liquid. These products can discolor and spot painted surfaces.
- Never wash a vehicle that is “hot to the touch” or during exposure to strong, direct sunlight.
- Always use a clean sponge or car wash mitt with plenty of water for best results.
- Dry the vehicle with a chamois or soft terry cloth towel in order to eliminate water spotting.
- It is especially important to wash the vehicle regularly during the winter months, as dirt and road salt are difficult to remove and cause damage to the vehicle.
- Immediately remove items such as gasoline, diesel fuel, bird droppings and insect deposits because they can cause damage to the vehicle’s paintwork and trim over time.
- Remove any exterior accessories, such as antennas, before entering a car wash.
- **Suntan lotions and insect repellents can damage any painted surface; if these substances come in contact with your vehicle, wash off as soon as possible.**

Exterior chrome

- Wash the vehicle first, using cool or lukewarm water and a neutral pH shampoo, such as Motorcraft Detail Wash (ZC-3-A).
- Use Custom Brite Metal Cleaner (ZC-15), available from your authorized dealer. Apply the product as you would a wax to clean bumpers and other chrome parts; allow the cleaner to dry for a few minutes, then wipe off the haze with a clean, dry rag.
- **Never use abrasive materials such as steel wool or plastic pads as they can scratch the chrome surface.**

WAXING

Applying Motorcraft Paint Sealant (ZC-45) to your vehicle every six months will assist in reducing minor scratches and paint damage.

- Wash the vehicle first.
- Do not use waxes that contain abrasives; use Motorcraft Premium Liquid Wax (ZC-53-A), which is available from your authorized dealer, or an equivalent quality product.

Cleaning

- Do not allow paint sealant to come in contact with any non-body (low-gloss black) colored trim, such as grained door handles, roof racks, bumpers, side moldings, mirror housings or the windshield cowl area. The paint sealant will “gray” or stain the parts over time.

PAINT CHIPS

Your authorized dealer has touch-up paint and sprays to match your vehicle's color. Take your color code (printed on a sticker in the driver's door jamb) to your authorized dealer to ensure you get the correct color.

- Remove particles such as bird droppings, tree sap, insect deposits, tar spots, road salt and industrial fallout before repairing paint chips.
- Always read the instructions before using the products.

ALUMINUM WHEELS AND WHEEL COVERS

Aluminum wheels and wheel covers are coated with a clearcoat paint finish. In order to maintain their shine:

- Clean weekly with Motorcraft Wheel and Tire Cleaner (ZC-37-A), which is available from your authorized dealer. Heavy dirt and brake dust accumulation may require agitation with a sponge. Rinse thoroughly with a strong stream of water.
- Never apply any cleaning chemical to hot or warm wheel rims or covers.
- Some automatic car washes may cause damage to the finish on your wheel rims or covers. Chemical-strength cleaners, or cleaning chemicals, in combination with brush agitation to remove brake dust and dirt, could wear away the clearcoat finish over time.
- Do not use hydrofluoric acid-based or high caustic-based wheel cleaners, steel wool, fuels or strong household detergent.
- To remove tar and grease, use Motorcraft Bug and Tar Remover (ZC-42), available from your authorized dealer.

ENGINE

Engines are more efficient when they are clean because grease and dirt buildup keep the engine warmer than normal. When washing:

- Take care when using a power washer to clean the engine. The high-pressure fluid could penetrate the sealed parts and cause damage.
- Do not spray a hot engine with cold water to avoid cracking the engine block or other engine components.

186

Cleaning

- Spray Motorcraft Engine Shampoo and Degreaser (ZC-20) on all parts that require cleaning and pressure rinse clean.
- Cover the highlighted areas to prevent water damage when cleaning the engine.

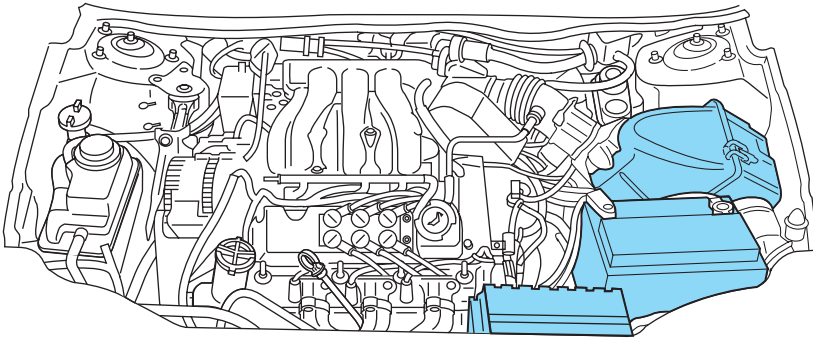

- **3.0L Vulcan engine**
- Never wash or rinse the engine while it is running; water in the running engine may cause internal damage.

PLASTIC (NON-PAINTED) EXTERIOR PARTS

Use only approved products to clean plastic parts. These products are available from your authorized dealer.

- For routine cleaning, use Motorcraft Detail Wash (ZC-3-A).
- If tar or grease spots are present, use Motorcraft Bug and Tar Remover (ZC-42).
- For plastic headlamp lenses, use Motorcraft Ultra Clear Spray Glass Cleaner (ZC-23).

WINDOWS AND WIPER BLADES

The windshield, rear and side windows and the wiper blades should be cleaned regularly. If the wipers do not wipe properly, substances on the vehicle's glass or the wiper blades may be the cause. These may include hot wax treatments used by commercial car washes, water repellent coatings, tree sap, or other organic contamination; these contaminants may cause squeaking or chatter noise from the blades, and streaking and smearing of the windshield. To clean these items, follow these tips:

- The windshield, rear windows and side windows may be cleaned with a non-abrasive cleaner such as Motorcraft Ultra-Clear Spray Glass Cleaner (ZC-23), available from your authorized dealer.

Cleaning

- The wiper blades can be cleaned with isopropyl (rubbing) alcohol or Motorcraft Premium Windshield Washer Concentrate (ZC-32-A), available from your authorized dealer. This washer fluid contains special solution in addition to alcohol which helps to remove the hot wax deposited on the wiper blade and windshield from automated car wash facilities. Be sure to replace wiper blades when they appear worn or do not function properly.
- Do not use abrasives, as they may cause scratches.
- Do not use fuel, kerosene, or paint thinner to clean any parts.

Do not use sharp objects, such as a razor blade, to clean the inside of the rear window or to remove decals, as it may cause damage to the rear window defroster's heated grid lines.

INSTRUMENT PANEL AND CLUSTER LENS

Clean the instrument panel with a damp cloth, then with a clean, dry cloth, or use Motorcraft Dash & Vinyl Cleaner (ZC-38-A).

- Avoid cleaners or polish that increase the gloss of the upper portion of the instrument panel. The dull finish in this area helps protect the driver from undesirable windshield reflection.



Do not use chemical solvents or strong detergents when cleaning the steering wheel or instrument panel to avoid contamination of the airbag system.

- Be certain to wash or wipe your hands clean if you have been in contact with certain products such as insect repellent and suntan lotion in order to avoid possible damage to the interior painted surfaces.

INTERIOR TRIM

- Clean the interior trim areas with a damp cloth, then with a clean, dry cloth; you may also use Motorcraft Dash & Vinyl Cleaner (ZC-38-A).
- Do not use household or glass cleaners as these may damage the finish.

INTERIOR

For fabric, carpets, cloth seats, safety belts and seats equipped with side airbags:

- Remove dust and loose dirt with a vacuum cleaner.

188

Cleaning

- Remove light stains and soil with Motorcraft Professional Strength Carpet & Upholstery Cleaner (ZC-54).
- If grease or tar is present on the material, spot-clean the area first with Motorcraft Spot and Stain Remover (ZC-14).
- If a ring forms on the fabric after spot cleaning, clean the entire area immediately (but do not oversaturate) or the ring will set.
- Do not use household cleaning products or glass cleaners, which can stain and discolor the fabric and affect the flame retardant abilities of the seat materials.



Do not use cleaning solvents, bleach or dye on the vehicle's safety belts, as these actions may weaken the belt webbing.



Do not use chemical solvents or strong detergents when cleaning the seat-mounted side airbag (if equipped). Such products could contaminate the side airbag system and affect performance of the side airbag in a collision.

LEATHER SEATS (IF EQUIPPED)

Your leather seating surfaces have a clear, protective coating over the leather.

- To clean, use a soft cloth with Motorcraft Deluxe Leather and Vinyl Cleaner (ZC-11-A). Dry the area with a soft cloth.
- To help maintain its resiliency and color, use the Motorcraft Deluxe Leather Care Kit (ZC-11-D), available from your authorized dealer.
- Do not use household cleaning products, alcohol solutions, solvents or cleaners intended for rubber, vinyl and plastics, or oil/petroleum-based leather conditioners. These products may cause premature wearing of the clear, protective coating.

Note: In some instances, color or dye transfer can occur when wet clothing comes in contact with leather upholstery. If this occurs, the leather should be cleaned immediately to avoid permanent staining.

UNDERBODY

Flush the complete underside of your vehicle frequently. Keep body and door drain holes free from packed dirt.

Cleaning

FORD AND LINCOLN MERCURY CAR CARE PRODUCTS

Your Ford or Lincoln Mercury authorized dealer has many quality products available to clean your vehicle and protect its finishes. These quality products have been specifically engineered to fulfill your automotive needs; they are custom designed to complement the style and appearance of your vehicle. Each product is made from high quality materials that meet or exceed rigid specifications. For best results, use the following products or products of equivalent quality:

- Motorcraft Bug and Tar Remover (ZC-42)
- Motorcraft Car Care Kit (ZC-26)
- Motorcraft Car Wash (Canada only) (CXC-21)
- Motorcraft Custom Bright Metal Cleaner (ZC-15)
- Motorcraft Custom Clear Coat Polish (ZC-8-A)
- Motorcraft Custom Vinyl Protectant (U.S. only) (ZC-40-A)
- Motorcraft Dash and Vinyl Cleaner (ZC-38-A)
- Motorcraft Deluxe Leather and Vinyl Cleaner (U.S. only) (ZC-11-A)
- Motorcraft Detail Wash (ZC-3-A)
- Motorcraft Dusting Cloth (ZC-24)
- Motorcraft Engine Shampoo and Degreaser (U.S. only) (ZC-20)
- Motorcraft Engine Shampoo (Canada only) (CXC-66-A)
- Motorcraft One Step Wash and Wax Concentrate (ZC-6-A)
- Motorcraft Paint Sealant (ZC-45)
- Motorcraft Premium Car Wash Concentrate (U.S. only) (ZC-17-B)
- Motorcraft Premium Glass Cleaner (Canada only) (CXC-100)
- Motorcraft Premium Liquid Wax (ZC-53-A)
- Motorcraft Premium Windshield Washer Concentrate (ZC-32-A)
- Motorcraft Professional Strength Carpet & Upholstery Cleaner (ZC-54)
- Motorcraft Spot and Stain Remover (U.S. only) (ZC-14)
- Motorcraft Tire Clean and Shine (ZC-28)
- Motorcraft Triple Clean (U.S. only) (ZC-13)
- Motorcraft Ultra-Clear Spray Glass Cleaner (ZC-23)
- Motorcraft Vinyl Cleaner (Canada only) (CXC-93)
- Motorcraft Wheel and Tire Cleaner (ZC-37-A)

Maintenance and Specifications

SERVICE RECOMMENDATIONS

To help you service your vehicle:

- We highlight do-it-yourself items in the engine compartment for easy location.
- We provide *scheduled maintenance information* which makes tracking routine service easy.

If your vehicle requires professional service, your authorized dealer can provide the necessary parts and service. Check your *Warranty Guide/Owner Information Guide* to find out which parts and services are covered.

Use only recommended fuels, lubricants, fluids and service parts conforming to specifications. Motorcraft parts are designed and built to provide the best performance in your vehicle.

PRECAUTIONS WHEN SERVICING YOUR VEHICLE

- Do not work on a hot engine.
- Make sure that nothing gets caught in moving parts.
- Do not work on a vehicle with the engine running in an enclosed space, unless you are sure you have enough ventilation.
- Keep all open flames and other burning (cigarettes) material away from the battery and all fuel related parts.

Working with the engine off

1. Set the parking brake and shift to P (Park).
2. Turn off the engine and remove the key.
3. Block the wheels.

Working with the engine on

1. Set the parking brake and ensure the gearshift is securely latched in P (Park).
2. Block the wheels to prevent the vehicle from moving unexpectedly.



To reduce the risk of vehicle damage and/or personal burn injuries do not start your engine with the air cleaner removed and do not remove it while the engine is running.

Maintenance and Specifications

OPENING THE HOOD

1. Inside the vehicle, pull the hood release handle located under the bottom of the instrument panel.
2. Go to the front of the vehicle and release the auxiliary latch located in the center between the hood and the grille.
3. Lift the hood until the lift cylinders hold it open.

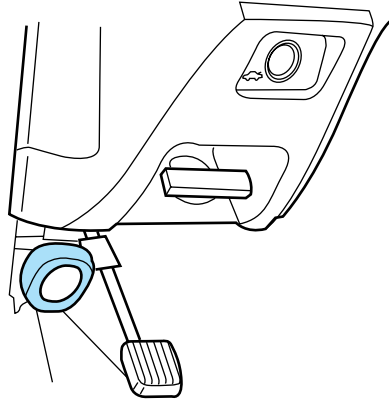

Maintenance and Specifications

IDENTIFYING COMPONENTS IN THE ENGINE COMPARTMENT

3.0L V6 Vulcan engine

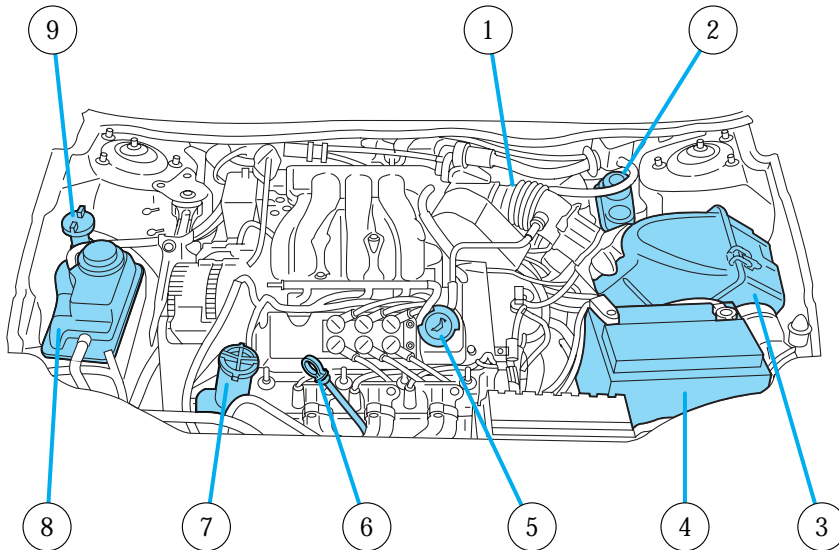

1. Automatic transmission fluid dipstick
2. Brake fluid reservoir
3. Air filter assembly
4. Battery
5. Engine oil filler cap
6. Engine oil dipstick
7. Power steering fluid reservoir
8. Engine coolant reservoir
9. Windshield washer fluid reservoir

Maintenance and Specifications

WINDSHIELD WASHER FLUID

Add fluid to fill the reservoir if the level is low. In very cold weather, do not fill the reservoir completely.

Only use a washer fluid that meets Ford specification WSB-M8B16-A2. Do not use any special washer fluid such as windshield water repellent type fluid or bug wash. They may cause squeaking, chatter noise, streaking and smearing. Refer to the *Maintenance product specifications and capacities* section in this chapter.

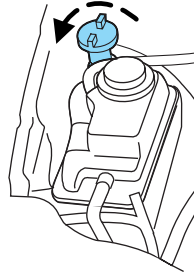

State or local regulations on volatile organic compounds may restrict the use of methanol, a common windshield washer antifreeze additive. Washer fluids containing non-methanol antifreeze agents should be used only if they provide cold weather protection without damaging the vehicle's paint finish, wiper blades or washer system.



If you operate your vehicle in temperatures below 40° F (4.5°C), use washer fluid with antifreeze protection. Failure to use washer fluid with antifreeze protection in cold weather could result in impaired windshield vision and increase the risk of injury or accident.

Note: Do not put washer fluid in the engine coolant reservoir. Washer fluid placed in the cooling system may harm engine and cooling system components.

Maintenance and Specifications

CHANGING THE WIPER BLADES

1. Pull the wiper arm away from the vehicle. Turn the blade at an angle from the wiper arm. Push the lock pin manually to release the blade and pull the wiper blade down toward the windshield to remove it from the arm.

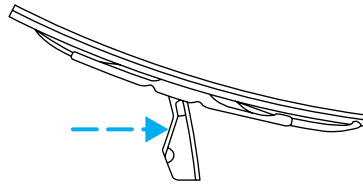

2. Attach the new wiper to the wiper arm and press it into place until a click is heard.

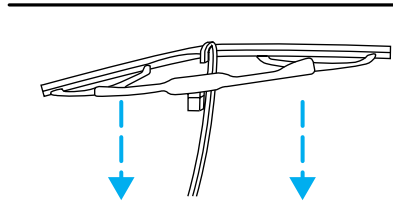

Replace wiper blades at least once per year for optimum performance.

Poor wiper quality can be improved by cleaning the wiper blades and the windshield, refer to *Windows and wiper blades* in the *Cleaning* chapter.

To prolong the life of the wiper blades, it is highly recommended to scrape off the ice on the windshield before turning on the wipers. The layer of ice has many sharp edges and can damage the micro edge of the wiper rubber element.

ENGINE OIL

Checking the engine oil

Refer to the *scheduled maintenance information* for the appropriate intervals for checking the engine oil.

1. Make sure the vehicle is on level ground.
2. Turn the engine off and wait a few minutes for the oil to drain into the oil pan.
3. Set the parking brake and ensure the gearshift is securely latched in P.
4. Open the hood. Protect yourself from engine heat.
5. Locate and carefully remove the engine oil indicator (dipstick).

Maintenance and Specifications

- 3.0L Vulcan engine

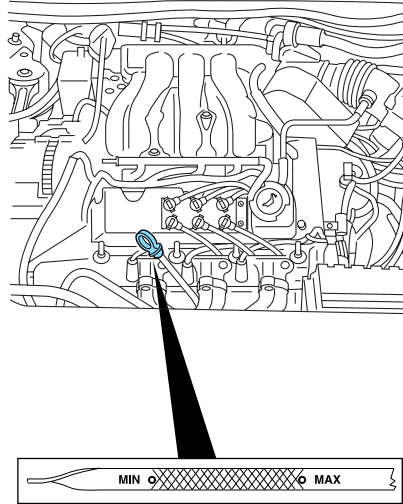

6. Wipe the indicator clean. Insert the indicator fully, then remove it again.

- If the oil level is **between the two holes or between the MIN and MAX marks (depending on application)**, the oil level is acceptable. **DO NOT ADD OIL.**
- If the oil level is at or below the lower hole or the MIN mark, add enough oil to raise the level within the two holes or within the MIN-MAX range (depending on application).
- 3.0L Vulcan engine

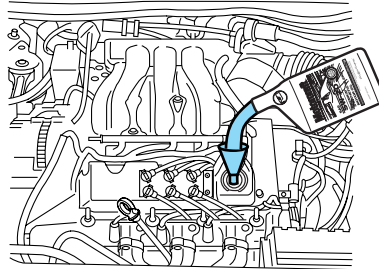

- Oil levels above the upper hole or above the MAX mark, may cause engine damage. Some oil must be removed from the engine by an authorized dealer.

196

Maintenance and Specifications

7. Put the indicator back in and ensure it is fully seated.

Adding engine oil

1. Check the engine oil. For instructions, refer to *Checking the engine oil* in this chapter.
2. If the engine oil level is not within the normal range, add only certified engine oil of the recommended viscosity. Remove the engine oil filler cap and use a funnel to pour the engine oil into the opening.
3. Recheck the engine oil level. Make sure the oil level is not above the upper hole or MAX mark on the engine oil level indicator (dipstick).
4. Install the indicator and ensure it is fully seated.
5. Fully install the engine oil filler cap by turning the filler cap clockwise until it stops.

To avoid possible oil loss, DO NOT operate the vehicle with the engine oil level indicator and/or the engine oil filler cap removed.

Engine oil and filter recommendations

Look for this certification trademark.

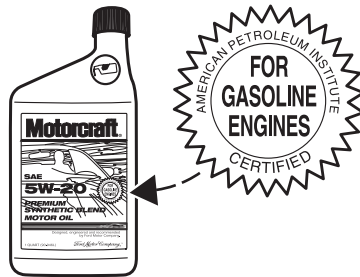

Use SAE 5W-20 engine oil.

Only use oils “Certified For Gasoline Engines” by the American Petroleum Institute (API). An oil with this trademark symbol conforms to the current engine and emission system protection standards and fuel economy requirements of the International Lubricant Standardization and Approval Committee (ILSAC), comprised of U.S. and Japanese automobile manufacturers.

To protect your engine’s warranty use Motorcraft SAE 5W-20 or an equivalent SAE 5W-20 oil meeting Ford specification WSS-M2C930-A.

SAE 5W-20 oil provides optimum fuel economy and durability performance meeting all requirements for your vehicle’s engine.

Maintenance and Specifications

Do not use supplemental engine oil additives, cleaners or other engine treatments. They are unnecessary and could lead to engine damage that is not covered by Ford warranty.

Change your engine oil and filter according to the appropriate schedule listed in *scheduled maintenance information*.

Ford production and aftermarket (Motorcraft) oil filters are designed for added engine protection and long life. If a replacement oil filter is used that does not meet Ford material and design specifications, start-up engine noises or knock may be experienced.

It is recommended you use the appropriate Motorcraft oil filter (or another brand meeting Ford specifications) for your engine application.

BATTERY

Your vehicle is equipped with a Motorcraft maintenance-free battery which normally does not require additional water during its life of service.

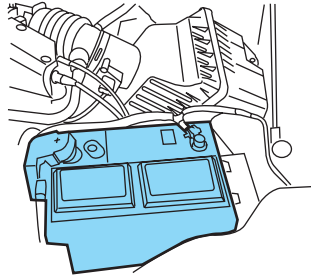

If your battery has a cover/shield, make sure it is reinstalled after the battery has been cleaned or replaced.

For longer, trouble-free operation, keep the top of the battery clean and dry. Also, make certain the battery cables are always tightly fastened to the battery terminals.

If you see any corrosion on the battery or terminals, remove the cables from the terminals and clean with a wire brush. You can neutralize the acid with a solution of baking soda and water.



Batteries normally produce explosive gases which can cause personal injury. Therefore, do not allow flames, sparks or lighted substances to come near the battery. When working near the battery, always shield your face and protect your eyes. Always provide proper ventilation.

Maintenance and Specifications

 When lifting a plastic-cased battery, excessive pressure on the end walls could cause acid to flow through the vent caps, resulting in personal injury and/or damage to the vehicle or battery. Lift the battery with a battery carrier or with your hands on opposite corners.

 Keep batteries out of reach of children. Batteries contain sulfuric acid. Avoid contact with skin, eyes or clothing. Shield your eyes when working near the battery to protect against possible splashing of acid solution. In case of acid contact with skin or eyes, flush immediately with water for a minimum of 15 minutes and get prompt medical attention. If acid is swallowed, call a physician immediately.

 Battery posts, terminals and related accessories contain lead and lead compounds. **Wash hands after handling.**

Because your vehicle's engine is electronically controlled by a computer, some control conditions are maintained by power from the battery. When the battery is disconnected or a new battery is installed, the engine must relearn its idle and fuel trim strategy for optimum driveability and performance. To begin this process:

1. With the vehicle at a complete stop, set the parking brake.
2. Put the gearshift in P (Park), turn off all accessories and start the engine.
3. Run the engine until it reaches normal operating temperature.
4. Allow the engine to idle for at least one minute.
5. Turn the A/C on and allow the engine to idle for at least one minute.
6. Release the parking brake. With your foot on the brake pedal and with the A/C on, put the vehicle in D (Drive) and allow the engine to idle for at least one minute.
7. Drive the vehicle to complete the relearning process.
 - The vehicle may need to be driven 10 miles (16 km) or more to relearn the idle and fuel trim strategy.
 - **If you do not allow the engine to relearn its idle trim, the idle quality of your vehicle may be adversely affected until the idle trim is eventually relearned.**

If the battery has been disconnected or a new battery has been installed, the clock and radio settings must be reset once the battery is reconnected.

Maintenance and Specifications

- Always dispose of automotive batteries in a responsible manner. Follow your local authorized standards for disposal. Call your local authorized recycling center to find out more about recycling automotive batteries.

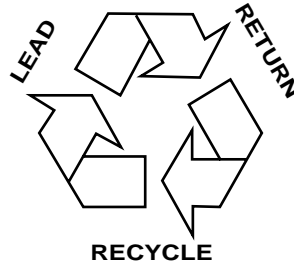

ENGINE COOLANT

Checking engine coolant

The concentration and level of engine coolant should be checked at the intervals listed in *scheduled maintenance information*. The coolant concentration should be maintained at 50/50 coolant and distilled water, which equates to a freeze point of -34°F (-36°C). Coolant concentration testing is possible with a hydrometer or antifreeze tester (such as the Rotunda Battery and Antifreeze Tester, 014-R1060). The level of coolant should be maintained at the "FULL COLD" level or within the "COLD FILL RANGE" in the coolant reservoir. If the level falls below, add coolant per the instructions in the *Adding engine coolant* section.

Your vehicle was factory-filled with a 50/50 engine coolant and water concentration. If the concentration of coolant falls below 40% or above 60%, the engine parts could become damaged or not work properly. **A 50-50 mixture of coolant and water provides the following:**

- **Freeze protection down to -34°F (-36°C).**
- **Boiling protection up to 265°F (129°C).**
- **Protection against rust and other forms of corrosion.**
- **Enables calibrated gauges to work properly.**

Maintenance and Specifications

When the engine is cold, check the level of the engine coolant in the reservoir.

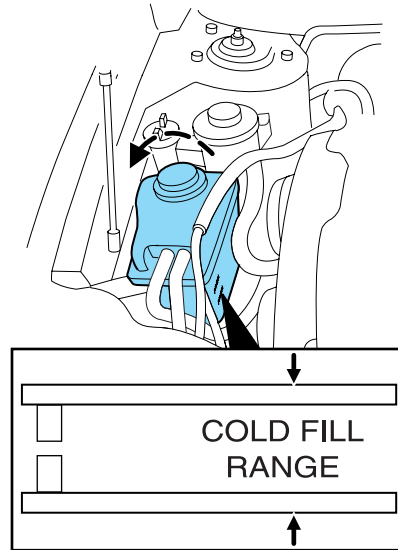

- The engine coolant should be at the “FULL COLD” level or within the “COLD FILL RANGE” as listed on the engine coolant reservoir (depending upon application).
- Refer to *scheduled maintenance information* for service interval schedules.
- Be sure to read and understand *Precautions when servicing your vehicle* in this chapter.

If the engine coolant has not been checked at the recommended interval, the engine coolant reservoir may become low or empty. If the reservoir is low or empty, add engine coolant to the reservoir. Refer to *Adding engine coolant* in this chapter.

Note: Automotive fluids are not interchangeable; do not use engine coolant, antifreeze or windshield washer fluid outside of its specified function and vehicle location.

Adding engine coolant

When adding coolant, make sure it is a 50/50 mixture of engine coolant and distilled water. Add the mixture to the coolant reservoir, **when the engine is cool**, until the appropriate fill level is obtained.

Maintenance and Specifications



Do not add engine coolant when the engine is hot. Steam and scalding liquids released from a hot cooling system can burn you badly. Also, you can be burned if you spill coolant on hot engine parts.



Do not put engine coolant in the windshield washer fluid container. If sprayed on the windshield, engine coolant could make it difficult to see through the windshield.

- **Add Motorcraft Premium Gold Engine Coolant or equivalent meeting Ford specification WSS-M97B51-A1.** Refer to *Maintenance product specifications and capacities* in this chapter.

Note: Use of Motorcraft Cooling System Stop Leak Pellets or an equivalent product meeting Ford specification WSS-M99B37-B6, may darken the color of Motorcraft Premium Gold Engine Coolant from yellow to golden tan.

- **Do not add/mix an orange-colored, extended life coolant such as Motorcraft Specialty Orange Engine Coolant, meeting Ford specification WSS-M97B44-D, with the factory-filled coolant.** Mixing Motorcraft Specialty Orange Engine Coolant or any orange-colored extended life product with your factory filled coolant can result in degraded corrosion protection.
- A large amount of water without engine coolant may be added, in case of emergency, to reach a vehicle service location. In this instance, the cooling system must be drained and refilled with a 50/50 mixture of engine coolant and distilled water as soon as possible. Water alone (without engine coolant) can cause engine damage from corrosion, overheating or freezing.
- **Do not use alcohol, methanol, brine or any engine coolants mixed with alcohol or methanol antifreeze (coolant).** Alcohol and other liquids can cause engine damage from overheating or freezing.
- **Do not add extra inhibitors or additives to the coolant.** These can be harmful and compromise the corrosion protection of the engine coolant.

For vehicles with overflow coolant systems with a non-pressurized cap on the coolant recovery system, add coolant to the coolant recovery reservoir when the engine is cool. Add the proper mixture of coolant and water to the "FULL COLD" level. For all other vehicles which have a coolant degas system with a pressurized cap, or if it is necessary to

Maintenance and Specifications

remove the coolant pressure relief cap on the radiator of a vehicle with an overflow system, follow these steps to add engine coolant.



To reduce the risk of personal injury, make sure the engine is cool before unscrewing the coolant pressure relief cap. The cooling system is under pressure; steam and hot liquid can come out forcefully when the cap is loosened slightly.

1. Before you begin, turn the engine off and let it cool.
2. When the engine is cool, wrap a thick cloth around the coolant pressure relief cap on the coolant reservoir (a translucent plastic bottle). Slowly turn cap counterclockwise (left) until pressure begins to release.
3. Step back while the pressure releases.
4. When you are sure that all the pressure has been released, use the cloth to turn it counterclockwise and remove the cap.
5. Fill the coolant reservoir slowly with the proper coolant mixture (see above), to within the "COLD FILL RANGE" or the "FULL COLD" level on the reservoir. If you removed the radiator cap in an overflow system, fill the radiator until the coolant is visible and radiator is almost full.
6. Replace the cap. Turn until tightly installed. (Cap must be tightly installed to prevent coolant loss.)

After any coolant has been added, check the coolant concentration (refer to *Checking engine coolant*). If the concentration is not 50/50 (protection to -34° F/ -36° C), drain some coolant and adjust the concentration. It may take several drains and additions to obtain a 50/50 coolant concentration.

Whenever coolant has been added, the coolant level in the coolant reservoir should be checked the next few times you drive the vehicle. If necessary, add enough 50/50 concentration of engine coolant and distilled water to bring the liquid level to the proper level.

If you have to add more than 1.0 quart (1.0 liter) of engine coolant per month, have your authorized dealer check the engine cooling system. Your cooling system may have a leak. Operating an engine with a low level of coolant can result in engine overheating and possible engine damage.

Recycled engine coolant

Ford Motor Company does NOT recommend the use of recycled engine coolant in vehicles originally equipped with Motorcraft Premium Gold Engine Coolant since a Ford-approved recycling process is not yet available.

Maintenance and Specifications



Used engine coolant should be disposed of in an appropriate manner. Follow your community's regulations and standards for recycling and disposing of automotive fluids.

Coolant refill capacity

To find out how much fluid your vehicle's cooling system can hold, refer to *Maintenance product specifications and capacities* in this chapter.

Fill your engine coolant reservoir as outlined in *Adding engine coolant* in this section.

Severe climates

If you drive in extremely cold climates (less than -34°F [-36°C]):

- **It may be necessary to increase the coolant concentration above 50%.**
- **NEVER increase the coolant concentration above 60%.**
- **Increased engine coolant concentrations above 60% will decrease the overheat protection characteristics of the engine coolant and may cause engine damage.**
- **Refer to the chart on the coolant container to ensure the coolant concentration in your vehicle will provide adequate freeze protection at the temperatures in which you drive in the winter months.**

If you drive in extremely hot climates:

- **It is still necessary to maintain the coolant concentration above 40%.**
- **NEVER decrease the coolant concentration below 40%.**
- **Decreased engine coolant concentrations below 40% will decrease the corrosion protection characteristics of the engine coolant and may cause engine damage.**
- **Decreased engine coolant concentrations below 40% will decrease the freeze protection characteristics of the engine coolant and may cause engine damage.**
- **Refer to the chart on the coolant container to ensure the coolant concentration in your vehicle will provide adequate protection at the temperatures in which you drive.**

Vehicles driven year-round in non-extreme climates should use a 50/50 mixture of engine coolant and distilled water for optimum cooling system and engine protection.

Maintenance and Specifications

WHAT YOU SHOULD KNOW ABOUT AUTOMOTIVE FUELS

Important safety precautions



Do not overfill the fuel tank. The pressure in an overfilled tank may cause leakage and lead to fuel spray and fire.



The fuel system may be under pressure. If the fuel filler cap is venting vapor or if you hear a hissing sound, wait until it stops before completely removing the fuel filler cap. Otherwise, fuel may spray out and injure you or others.



If you do not use the proper fuel filler cap, excessive vacuum in the fuel tank may damage the fuel system or cause the fuel cap to disengage in a collision, which may result in possible personal injury.



Automotive fuels can cause serious injury or death if misused or mishandled.



Gasoline may contain benzene, which is a cancer-causing agent.

Observe the following guidelines when handling automotive fuel:

- Extinguish all smoking materials and any open flames before refueling your vehicle.
- Always turn off the vehicle before refueling.
- Automotive fuels can be harmful or fatal if swallowed. Fuel such as gasoline is highly toxic and if swallowed can cause death or permanent injury. If fuel is swallowed, call a physician immediately, even if no symptoms are immediately apparent. The toxic effects of fuel may not be visible for hours.
- Avoid inhaling fuel vapors. Inhaling too much fuel vapor of any kind can lead to eye and respiratory tract irritation. In severe cases, excessive or prolonged breathing of fuel vapor can cause serious illness and permanent injury.



Maintenance and Specifications

- Avoid getting fuel liquid in your eyes. If fuel is splashed in the eyes, remove contact lenses (if worn), flush with water for 15 minutes and seek medical attention. Failure to seek proper medical attention could lead to permanent injury.
- Fuels can also be harmful if absorbed through the skin. If fuel is splashed on the skin and/or clothing, promptly remove contaminated clothing and wash skin thoroughly with soap and water. Repeated or prolonged skin contact with fuel liquid or vapor causes skin irritation.
- Be particularly careful if you are taking “Antabuse” or other forms of disulfiram for the treatment of alcoholism. Breathing gasoline vapors, or skin contact could cause an adverse reaction. In sensitive individuals, serious personal injury or sickness may result. If fuel is splashed on the skin, promptly wash skin thoroughly with soap and water. Consult a physician immediately if you experience an adverse reaction.

 When refueling always shut the engine off and never allow sparks or open flames near the filler neck. Never smoke while refueling. Fuel vapor is extremely hazardous under certain conditions. Care should be taken to avoid inhaling excess fumes.

 The flow of fuel through a fuel pump nozzle can produce static electricity, which can cause a fire if fuel is pumped into an ungrounded fuel container.

Refueling

-  Fuel vapor burns violently and a fuel fire can cause severe injuries. To help avoid injuries to you and others:
- Read and follow all the instructions on the pump island;
 - Turn off your engine when you are refueling;
 - Do not smoke if you are near fuel or refueling your vehicle;
 - Keep sparks, flames and smoking materials away from fuel;
 - Stay outside your vehicle and do not leave the fuel pump unattended when refueling your vehicle — this is against the law in some places;
 - Keep children away from the fuel pump; never let children pump fuel.

Maintenance and Specifications

Use the following guidelines to avoid electrostatic charge build-up when filling an ungrounded fuel container:

- Place approved fuel container on the ground.
- DO NOT fill a fuel container while it is in the vehicle (including the cargo area).
- Keep the fuel pump nozzle in contact with the fuel container while filling.
- DO NOT use a device that would hold the fuel pump handle in the fill position.

Fuel Filler Cap

Your fuel tank filler cap has an indexed design with a 1/4 turn on/off feature.

When fueling your vehicle:

1. Turn the engine off.
2. Carefully turn the filler cap counterclockwise 1/4 of a turn until it stops.
3. Pull to remove the cap from the fuel filler pipe.
4. To install the cap, align the tabs on the cap with the notches on the filler pipe.
5. Turn the filler cap clockwise 1/4 of a turn until it clicks at least once.

If the “Check Fuel Cap”  indicator comes on or if “Service Engine Soon/Check Engine” indicator comes on and stays on when you start the engine, the fuel filler cap may not be properly installed. Turn off the engine, remove the fuel filler cap, align the cap properly and reinstall it.

If you must replace the fuel filler cap, replace it with a fuel filler cap that is designed for your vehicle. The customer warranty may be void for any damage to the fuel tank or fuel system if the correct genuine Ford or Motorcraft fuel filler cap is not used.



The fuel system may be under pressure. If the fuel filler cap is venting vapor or if you hear a hissing sound, wait until it stops before completely removing the fuel filler cap. Otherwise, fuel may spray out and injure you or others.

Maintenance and Specifications

 If you do not use the proper fuel filler cap, excessive vacuum in the fuel tank may damage the fuel system or cause the fuel cap to disengage in a collision, which may result in possible personal injury.

FORD RECOMMENDS BP



Choosing the right fuel

Use only UNLEADED FUEL. The use of leaded fuel is prohibited by law and could damage your vehicle.

Your vehicle was not designed to use fuel or fuel additives with metallic compounds, including manganese-based additives. Studies indicate that these additives can cause your vehicle's emission control system to deteriorate more rapidly. In Canada, premium grade fuel generally contains more metallic additives than regular grade fuel. We recommend using regular grade fuel. In Canada, many fuels contain metallic additives, but fuels free of such additives may be available; check with your local fuel dealer.

Do not use fuel containing methanol. It can damage critical fuel system components.

Repairs to correct the effects of using a fuel for which your vehicle was not designed may not be covered by your warranty.

Octane recommendations

Your vehicle is designed to use "Regular" unleaded gasoline with pump (R+M)/2 octane rating of 87. We do not recommend the use of gasolines labeled as "Regular" that are sold with octane ratings of 86 or lower in high altitude areas.

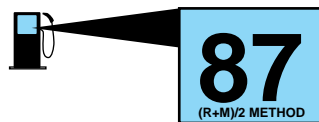

208

Maintenance and Specifications

Do not be concerned if your engine sometimes knocks lightly. However, if it knocks heavily under most driving conditions while you are using fuel with the recommended octane rating, see your authorized dealer to prevent any engine damage.

Fuel quality

If you are experiencing starting, rough idle or hesitation driveability problems, try a different brand of unleaded gasoline. “Premium” unleaded gasoline is not recommended for vehicles designed to use “Regular” unleaded gasoline because it may cause these problems to become more pronounced. If the problems persist, see your authorized dealer.

It should not be necessary to add any aftermarket products to your fuel tank if you continue to use high quality fuel of the recommended octane rating. Aftermarket products could cause damage to the fuel system. Repairs to correct the effects of using an aftermarket product in your fuel may not be covered by your warranty.

Many of the world’s automakers approved the World-wide Fuel Charter that recommends gasoline specifications to provide improved performance and emission control system protection for your vehicle. Gasolines that meet the World-wide Fuel Charter should be used when available. Ask your fuel supplier about gasolines that meet the World-wide Fuel Charter.

Cleaner air

Ford endorses the use of reformulated “cleaner-burning” gasolines to improve air quality.

Running out of fuel

Avoid running out of fuel because this situation may have an adverse effect on powertrain components.

If you have run out of fuel:

- You may need to cycle the ignition from off to on several times after refueling, to allow the fuel system to pump the fuel from the tank to the engine.
- The  indicator may come on. For more information on the “check engine” or the “service engine soon” indicator, refer to *Warning lights and chimes* in the *Instrument Cluster* chapter.

FUEL FILTER

For fuel filter replacement, see your authorized dealer. Refer to *scheduled maintenance information* for the appropriate intervals for changing the fuel filter.

Maintenance and Specifications

Replace the fuel filter with an authorized Motorcraft part. The customer warranty may be void for any damage to the fuel system if an authorized Motorcraft fuel filter is not used.

ESSENTIALS OF GOOD FUEL ECONOMY

Measuring techniques

Your best source of information about actual fuel economy is you, the driver. You must gather information as accurately and consistently as possible. Fuel expense, frequency of fill-ups or fuel gauge readings are NOT accurate as a measure of fuel economy. We do not recommend taking fuel economy measurements during the first 1,000 miles (1,600 km) of driving (engine break-in period). You will get a more accurate measurement after 2,000 miles-3,000 miles (3,000 km-5,000 km).

Filling the tank

The advertised fuel capacity of the fuel tank on your vehicle is equal to the rated refill capacity of the fuel tank as listed in the *Maintenance product specifications and capacities* section of this chapter.

The advertised capacity is the amount of the indicated capacity and the empty reserve combined. Indicated capacity is the difference in the amount of fuel in a full tank and a tank when the fuel gauge indicates empty. Empty reserve is the small amount of fuel remaining in the fuel tank after the fuel gauge indicates empty.

The amount of usable fuel in the empty reserve varies and should not be relied upon to increase driving range. When refueling your vehicle after the fuel gauge indicates empty, you might not be able to refuel the full amount of the advertised capacity of the fuel tank due to the empty reserve still present in the tank.

For consistent results when filling the fuel tank:

- Turn the engine/ignition switch to the off position prior to refueling, an error in the reading will result if the engine is left running.
- Use the same filling rate setting (low — medium — high) each time the tank is filled.
- Allow no more than two automatic click-offs when filling.
- Always use fuel with the recommended octane rating.
- Use a known quality gasoline, preferably a national brand.
- Use the same side of the same pump and have the vehicle facing the same direction each time you fill up.

Maintenance and Specifications

- Have the vehicle loading and distribution the same every time.
- Your results will be most accurate if your filling method is consistent.

Calculating fuel economy

1. Fill the fuel tank completely and record the initial odometer reading (in miles or kilometers).
2. Each time you fill the tank, record the amount of fuel added (in gallons or liters).
3. After at least three to five tank fill-ups, fill the fuel tank and record the current odometer reading.
4. Subtract your initial odometer reading from the current odometer reading.
5. Follow one of the simple calculations in order to determine fuel economy:

Calculation 1: **Divide total miles traveled by total gallons used.**

Calculation 2: **Multiply liters used by 100, then divide by total kilometers traveled.**

Keep a record for at least one month and record the type of driving (city or highway). This will provide an accurate estimate of the vehicle's fuel economy under current driving conditions. Additionally, keeping records during summer and winter will show how temperature impacts fuel economy. In general, lower temperatures give lower fuel economy.

Driving style — good driving and fuel economy habits

Give consideration to the lists that follow and you may be able to change a number of variables and improve your fuel economy.

Habits

- Smooth, moderate operation can yield up to 10% savings in fuel.
- Steady speeds without stopping will usually give the best fuel economy.
- Idling for long periods of time (greater than one minute) may waste fuel.
- Anticipate stopping; slowing down may eliminate the need to stop.
- Sudden or hard accelerations may reduce fuel economy.
- Slow down gradually.
- Driving at reasonable speeds (traveling at 55 mph [88 km/h] uses 15% less fuel than traveling at 65 mph [105 km/h]).

Maintenance and Specifications

- Revving the engine before turning it off may reduce fuel economy.
- Using the air conditioner or defroster may reduce fuel economy.
- You may want to turn off the speed control in hilly terrain if unnecessary shifting between third and fourth gear occurs. Unnecessary shifting of this type could result in reduced fuel economy.
- Warming up a vehicle on cold mornings is not required and may reduce fuel economy.
- Resting your foot on the brake pedal while driving may reduce fuel economy.
- Combine errands and minimize stop-and-go driving.

Maintenance

- Keep tires properly inflated and use only recommended size.
- Operating a vehicle with the wheels out of alignment will reduce fuel economy.
- Use recommended engine oil. Refer to *Lubricant specifications* in this chapter.
- Perform all regularly scheduled maintenance items. Follow the recommended maintenance schedule and owner maintenance checks found in *scheduled maintenance information*.

Conditions

- Heavily loading a vehicle or towing a trailer may reduce fuel economy at any speed.
- Carrying unnecessary weight may reduce fuel economy (approximately 1 mpg [0.4 km/L] is lost for every 400 lb [180 kg] of weight carried).
- Adding certain accessories to your vehicle (for example bug deflectors, rollbars/light bars, running boards, ski/luggage racks) may reduce fuel economy.
- Using fuel blended with alcohol may lower fuel economy.
- Fuel economy may decrease with lower temperatures during the first 8–10 miles (12–16 km) of driving.
- Driving on flat terrain offers improved fuel economy as compared to driving on hilly terrain.
- Transmissions give their best fuel economy when operated in the top cruise gear and with steady pressure on the gas pedal.

Maintenance and Specifications

- Close windows for high speed driving.

EPA window sticker

Every new vehicle should have the EPA window sticker. Contact your authorized dealer if the window sticker is not supplied with your vehicle. The EPA window sticker should be your guide for the fuel economy comparisons with other vehicles.

It is important to note the box in the lower left corner of the window sticker. These numbers represent the Range of MPG (L/100 km) expected on the vehicle under optimum conditions. Your fuel economy may vary depending upon the method of operation and conditions.

EMISSION CONTROL SYSTEM

Your vehicle is equipped with various emission control components and a catalytic converter which will enable your vehicle to comply with applicable exhaust emission standards. To make sure that the catalytic converter and other emission control components continue to work properly:

- Use only the specified fuel listed.
- Avoid running out of fuel.
- Do not turn off the ignition while your vehicle is moving, especially at high speeds.
- Have the items listed in *scheduled maintenance information* performed according to the specified schedule.

The scheduled maintenance items listed in *scheduled maintenance information* are essential to the life and performance of your vehicle and to its emissions system.

If other than Ford, Motorcraft or Ford-authorized parts are used for maintenance replacements or for service of components affecting emission control, such non-Ford parts should be equivalent to genuine Ford Motor Company parts in performance and durability.



Do not park, idle, or drive your vehicle in dry grass or other dry ground cover. The emission system heats up the engine compartment and exhaust system, which can start a fire.

Illumination of the  indicator, charging system warning light or the temperature warning light, fluid leaks, strange odors, smoke or loss of engine power could indicate that the emission control system is not working properly.

Maintenance and Specifications





Exhaust leaks may result in entry of harmful and potentially lethal fumes into the passenger compartment.

Do not make any unauthorized changes to your vehicle or engine. By law, vehicle owners and anyone who manufactures, repairs, services, sells, leases, trades vehicles, or supervises a fleet of vehicles are not permitted to intentionally remove an emission control device or prevent it from working. Information about your vehicle's emission system is on the Vehicle Emission Control Information Decal located on or near the engine. This decal identifies engine displacement and gives some tune up specifications.

Please consult your *Warranty Guide* for complete emission warranty information.

On board diagnostics (OBD-II)

Your vehicle is equipped with a computer that monitors the engine's emission control system. This system is commonly known as the On Board Diagnostics System (OBD-II). This OBD-II system protects the environment by ensuring that your vehicle continues to meet government emission standards. The OBD-II system also assists your authorized dealer in properly servicing your vehicle. When the  indicator illuminates, the OBD-II system has detected a malfunction. Temporary malfunctions may cause the  indicator to illuminate. Examples are:



1. The vehicle has run out of fuel—the engine may misfire or run poorly.
2. Poor fuel quality or water in the fuel.
3. The fuel cap may not have been securely tightened. See *Fuel filler cap* in this chapter.

These temporary malfunctions can be corrected by filling the fuel tank with good quality fuel and/or properly tightening the fuel cap. After three driving cycles without these or any other temporary malfunctions present, the  indicator should turn off—A driving cycle consists of a cold engine startup followed by mixed city/highway driving. No additional vehicle service is required.

If the  indicator remains on, have your vehicle serviced at the first available opportunity.

Maintenance and Specifications

Readiness for Inspection/Maintenance (I/M) testing

In some localities, it may be a legal requirement to pass an I/M test of the on-board diagnostics system. If the  indicator is on, refer to the description in the *Warning lights and chimes* section of the *Instrument Cluster* chapter. Your vehicle may not pass the I/M test with the  indicator on.

If the vehicle's powertrain system or its battery has just been serviced, the on-board diagnostics system is reset to a "not ready for I/M test" condition. To ready the on-board diagnostics system for I/M testing, a minimum of 30 minutes of city and highway driving is necessary as described below:

- First, at least 10 minutes of driving on an expressway or highway.
- Next, at least 20 minutes driving in stop-and-go, city-type traffic with at least four idle periods.

Allow the vehicle to sit for at least eight hours without starting the engine. Then, start the engine and complete the above driving cycle. The engine must warm up to its normal operating temperature. Once started, do not turn off the engine until the above driving cycle is complete.

POWER STEERING FLUID

Check the power steering fluid. Refer to the *scheduled maintenance information* for the service interval schedules. If adding fluid is necessary, use only MERCON® ATF.

1. Start the engine and let it run until it reaches normal operating temperature (the engine coolant temperature gauge indicator will be near the center of the normal area between H and C).
2. While the engine idles, turn the steering wheel left and right several times.
3. Turn the engine off.

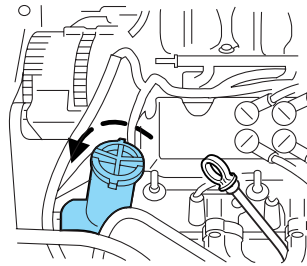

Maintenance and Specifications

4. Check the fluid level on the dipstick. It should be between the arrows in the FULL HOT range. Do not add fluid if the level is within this range.

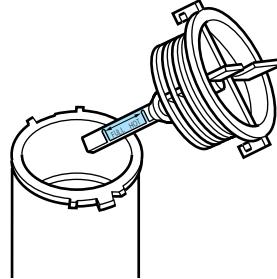

5. If the fluid is low, add fluid in small amounts, continuously checking the level until it reaches the FULL HOT range. Be sure to put the dipstick back in the reservoir.

BRAKE FLUID

The fluid level will drop slowly as the brakes wear, and will rise when the brake components are replaced. Fluid levels below the “MAX” line that do not trigger the brake system warning lamp are within the normal operating range, there is no need to add fluid. If the fluid levels are outside of the normal operating range, the performance of your brake system could be compromised, seek service from your authorized dealer immediately.

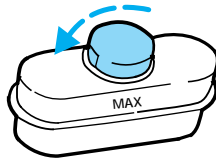

TRANSMISSION FLUID

Checking automatic transmission fluid

Refer to your *scheduled maintenance information* for scheduled intervals for fluid checks and changes. Your transaxle does not consume fluid. However, the fluid level should be checked if the transaxle is not working properly, i.e., if the transaxle slips or shifts slowly or if you notice some sign of fluid leakage.

Automatic transmission fluid expands when warmed. To obtain an accurate fluid check, drive the vehicle until it is warmed up (approximately 20 miles [30 km]). If your vehicle has been operated for an extended period at high speeds, in city traffic during hot weather or pulling a trailer, the vehicle should be turned off for about 30 minutes to allow fluid to cool before checking.

Maintenance and Specifications

1. Drive the vehicle 20 miles (30 km) or until it reaches normal operating temperature.
2. Park the vehicle on a level surface and engage the parking brake.
3. With the parking brake engaged and your foot on the brake pedal, start the engine and move the gearshift lever through all of the gear ranges. Allow sufficient time for each gear to engage.
4. Latch the gearshift lever in P (Park) and leave the engine running.
5. Remove the dipstick, wiping it clean with a clean, dry lint free rag. If necessary, refer to *Identifying components in the engine compartment* in this chapter for the location of the dipstick.
6. Install the dipstick making sure it is fully seated in the filler tube.
7. Remove the dipstick and inspect the fluid level. The fluid should be in the designated areas for normal operating temperature.

Low fluid level

Do not drive the vehicle if the fluid level is at the bottom of the dipstick and the outside temperatures are above 50°F (10°C).



Correct fluid level

The transmission fluid should be checked at normal operating temperatures 150°F-170°F (66°C-77°C) on a level surface. The normal operating temperature can be reached after approximately 20 miles (30 km) of driving.

The transmission fluid should be in this range if at normal operating temperature (150°F-170°F [66°C-77°C]).



High fluid level

Fluid levels above the safe range may result in transaxle failure. An overfill condition of transmission fluid may cause shift and/or engagement concerns and/or possible damage.



High fluid levels can be caused by an overheating condition.

Maintenance and Specifications

Adjusting automatic transmission fluid levels

Before adding any fluid, make sure the correct type is used. The type of fluid used is normally indicated on the dipstick. Refer to *Maintenance product specifications and capacities* in this chapter.

Use of a non-approved automatic transmission fluid may cause internal transaxle component damage.

If necessary, add fluid in 1/2 pint (250 mL) increments through the filler tube until the level is correct.

If an overfill occurs, excess fluid should be removed by a qualified technician.



An overfill condition of transmission fluid may cause shift and/or engagement concerns and/or possible damage.

Do not use supplemental transmission fluid additives, treatments or cleaning agents. The use of these materials may affect transmission operation and result in damage to internal transmission components.

MOTORCRAFT PART NUMBERS

Component	3.0L V6 Vulcan engine	3.0L FFV V6 Vulcan engine
Air filter element ¹	FA-1683	FA-1683
Fuel filter	FG-1060	FG-1060
Battery	BXT-36R	BXT-36R
Oil filter	FL-400-S	FL-400-S
PCV valve	²	
Spark plugs	³	

¹Do not use oil-impregnated air filter elements. Failure to use the correct air filter element may result in severe engine damage. The customer warranty may be void for any damage to the engine if the correct air filter element is not used.

²The PCV valve is a critical emission component. It is one of the items listed in *scheduled maintenance information* and is essential to the life and performance of your vehicle and to its emissions system.

For PCV valve replacement, see your authorized dealer. Refer to the *scheduled maintenance information* for the appropriate intervals for changing the PCV valve.

Maintenance and Specifications

Replace the PCV valve with one that meets Ford material and design specifications for your vehicle, such as a Motorcraft or equivalent replacement part. The customer warranty may be void for any damage to the emissions system if such a PCV valve is not used.

³For spark plug replacement, see your authorized dealer. Refer to *scheduled maintenance information* for the appropriate intervals for changing the spark plugs.

Replace the spark plugs with ones that meet Ford material and design specifications for your vehicle, such as Motorcraft or equivalent replacement parts. The customer warranty may be void for any damage to the engine if such spark plugs are not used.

Maintenance and Specifications

MAINTENANCE PRODUCT SPECIFICATIONS AND CAPACITIES

Items	Capacity	Ford Part Name or equivalent	Ford Part Number / Ford Specification
Brake fluid	Between MAX and MIN on reservoir	Motorcraft High Performance DOT 3 Motor Vehicle Brake Fluid	PM-1 or PM-1-C / ESA-M6C25-A or WSS-M6C62-A
Door latch, hood latch, auxiliary hood latch, seat tracks, and trunk latches	—	Multi-Purpose Grease	XG-4 or XL-5 / ESA-M1C93-B
Lock cylinders	—	Motorcraft Penetrating and Lock Lubricant	XL-1 / None
Automatic transaxle fluid (4F50N)	13.5 quarts (12.8L)	Motorcraft MERCON [®] V ATF ¹	XT-5-QM / MERCON [®] V
Engine oil ²	4.5 quarts (4.25L)	Motorcraft SAE 5W-20 Premium Synthetic Blend Motor Oil (US) Motorcraft SAE 5W-20 Super Premium Motor Oil (Canada)	XO-5W20-QSP (US) CXO-5W20-LSP12 (Canada) / WSS-M2C930-A and API Certification Mark
Engine coolant	11.6 quarts (11.0L)	Motorcraft Premium Gold Engine Coolant (yellow-colored) ³	VC-7-B / WSS-M97B51-A1
Cooling system stop leak pellets	—	Motorcraft Cooling System Stop Leak Pellets	VC-6 / WSS-M99B37-B6

Maintenance and Specifications

Items	Capacity	Ford Part Name or equivalent	Ford Part Number / Ford Specification
Power steering fluid	Fill to line on dipstick	Motorcraft MERCON® ATF	XT-2-QDX / MERCON®
Windshield washer fluid	94.7 oz (2.8L)	Motorcraft Premium Windshield Washer Concentrate	ZC-32-A / WSB-M8B16-A2

¹Ensure the correct automatic transmission fluid is used. Transmission fluid requirements are indicated on the dipstick or on the dipstick handle. Check the container to verify the fluid being added is of the correct type. Refer to scheduled maintenance information to determine the correct service interval.

Some transmission fluids may be labeled as dual usage, such as MERCON® and MERCON® V. These dual usage fluids are not to be used in an automatic transmission that requires use of the MERCON® type fluid. However, these dual usage fluids may be used in transmissions that require the MERCON® V type fluid.

MERCON® and MERCON® V type fluids are not interchangeable. DO NOT mix MERCON® and MERCON® V. Use of a transmission fluid that indicates dual usage (MERCON® and MERCON® V) in an automatic transmission application requiring MERCON® may cause transmission damage. Use of any fluid other than the recommended fluid may cause transmission damage.

²Use of synthetic or synthetic blend motor oil is not mandatory. Engine oil need only meet the requirements of Ford specification WSS-M2C930-A and the API Certification mark.

³Add the coolant type originally equipped in your vehicle.

Maintenance and Specifications

ENGINE DATA

Engine	3.0L V6 Vulcan engine	3.0L FFV V6 Vulcan engine
Cubic inches	182	182
Required fuel	87 octane	87 octane or Ethanol (E 85)
Firing order	1-4-2-5-3-6	1-4-2-5-3-6
Ignition system	EDIS	EDIS
Spark plug gap	0.042–0.046 inch (1.1–1.2mm)	0.042–0.046 inch (1.1–1.2mm)
Compression ratio	9.7:1	9.7:1

Engine drivebelt routing

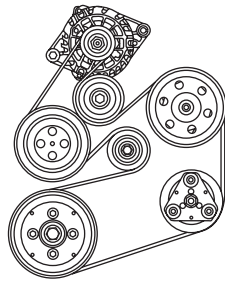

- 3.0L V6 Engine (all)

Maintenance and Specifications

IDENTIFYING YOUR VEHICLE

Safety Compliance Certification Label

The National Highway Traffic Safety Administration Regulations require that a Safety Compliance Certification Label be affixed to a vehicle and prescribe where the Safety Compliance Certification Label may be located. The Safety Compliance Certification Label is located on the structure (B-Pillar) by the trailing edge of the driver's door or the edge of the driver's door.

MFD. BY FORD MOTOR CO.					
DATE: XX/XX	GVWR: XXXXLB/ XXXXKG				
FRONT GAWR: XXXXL	REAR GAWR: XXXXLB				
XXXXKG	WITH	XXXXKG	WITH		
XXXX/XXXXXXX	TIRES	XXXX/XXXXXXX	TIRES		
XXXX.XX	RIMS	XXXX.XX	RIMS		
AT XXX kPa/XX	PSI COLD	AT XXX kPa/XX	PSI COLD		
THIS VEHICLE CONFORMS TO ALL APPLICABLE FEDERAL MOTOR VEHICLE SAFETY AND THEFT PREVENTION STANDARDS IN EFFECT ON THE DATE OF MANUFACTURE SHOWN ABOVE.					
VIN: XXXXXXXXXXXXXXXXX	XXXXX		XXXXX		
TYPE: XXX					
					
EXT PNT: XX	RC: XX	DSO:			
WB ¹ BRK ²	INT TR ³	TP/PS ⁴	R ⁵	AXLE ⁶	TR SPR ⁷ XXXXX
XXX X	XX	X	XX	X XX	XXX
XXXXXXXXXXXXX XXX XXXX-XXXXXX-XX					

Vehicle identification number (VIN)

The vehicle identification number is attached to a metal tag and is located on the driver side instrument panel.

Please note that in the graphic, XXXX is representative of your vehicle identification number.

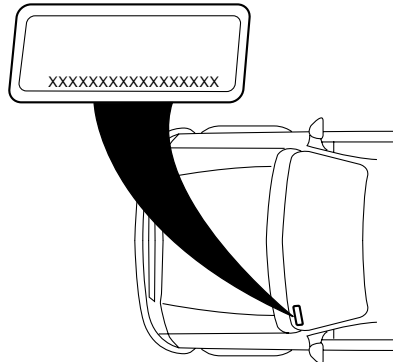

Maintenance and Specifications

The Vehicle Identification Number (VIN) contains the following information:

1. World manufacturer identifier
2. Brake system / Gross Vehicle Weight Rating (GVWR) / Restraint System
3. Vehicle line, series, body type
4. Engine type
5. Check digit
6. Model year
7. Assembly plant
8. Production sequence number

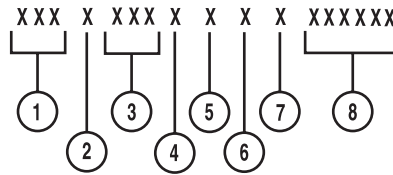

TRANSMISSION/TRANSAXLE CODE DESIGNATIONS

You can find a transmission/transaxle code on the Safety Compliance Certification Label. The following table tells you which transmission or transaxle each code represents.

MFD. BY FORD MOTOR CO.	
DATE: XX/XX	GVWR: XXXXLB/ XXXXKKG
FRONT GAWR: XXXL	REAR GAWR: XXXLB
XXXXKG	WITH XXXXKG
XXXX/XXXXXXXX	TIRES: XXXX/XXXXXXXX
XXXX.XX	RIMS: XXXX.XX
AT XXX kPa/XX	PSI COLD
AT XXX kPa/XX	PSI COLD
THIS VEHICLE CONFORMS TO ALL APPLICABLE FEDERAL MOTOR VEHICLE SAFETY AND THEFT PREVENTION STANDARDS IN EFFECT ON THE DATE OF MANUFACTURE SHOWN ABOVE.	
VIN: XXXXXXXXXXXXXXXXX	XXXXX
TYPE: XXX	XXXXX
EXT PNT: XX	RC: XX
DSO: XXXX	
WB ' BRK ' INT TR ' TP/PS ' R ' AXLE ' TR ' SPR ' XXXXX	
XXX X XX X XX X XX	
XXXXXXXXXXXXXX XX XXXX-XXXXXX-XX	

Description	Code
Automatic overdrive	N

Accessories

GENUINE FORD ACCESSORIES FOR YOUR VEHICLE

A wide selection of Genuine Ford Accessories are available for your vehicle through your local Ford or Ford of Canada dealer. These quality accessories have been specifically engineered to fulfill your automotive needs; they are custom designed to complement the style and aerodynamic appearance of your vehicle. In addition, each accessory is made from high quality materials and meets or exceeds Ford's rigorous engineering and safety specifications. Ford Motor Company will repair or replace any properly dealer-installed Genuine Ford Accessories found to be defective in factory-supplied materials or workmanship during the warranty period, as well as any component damaged by the defective accessory. The accessories will be warranted for whichever provides you the greatest benefit:

- 12 months or 12,000 miles (20,000 km) (whichever occurs first), or
- the remainder of your new vehicle limited warranty.

This means that Genuine Ford Accessories purchased along with your new vehicle and installed by a dealer are covered for the full length of your New Vehicle's Limited Warranty — 3 years or 36,000 miles (60,000 km) (whichever occurs first). Contact your dealer for details and a copy of the warranty.

Not all accessories are available for all models.

The following is a list of several Genuine Ford Accessories. Not all accessories are available for all models. For a complete listing of the accessories that are available for your vehicle, please contact your dealer or visit our online store at: www.fordaccessoriesstore.com.

Exterior style

Bug shields
Deflectors
Splash guards
Spoiler

Interior style

Electrochromatic compass/temperature interior mirrors
Floor mats

Lifestyle

Ash cup / smoker's package
Cargo organization and management

Accessories

Peace of mind

Remote start

Vehicle security systems

Wheel locks

For maximum vehicle performance, keep the following information in mind when adding accessories or equipment to your vehicle:

- When adding accessories, equipment, passengers and luggage to your vehicle, do not exceed the total weight capacity of the vehicle or of the front or rear axle (GVWR or GAWR as indicated on the Safety Compliance Certification label). Consult your authorized dealer for specific weight information.
- The Federal Communications Commission (FCC) and Canadian Radio Telecommunications Commission (CRTC) regulate the use of mobile communications systems — such as two-way radios, telephones and theft alarms - that are equipped with radio transmitters. Any such equipment installed in your vehicle should comply with FCC or CRTC regulations and should be installed only by a qualified service technician.
- Mobile communications systems may harm the operation of your vehicle, particularly if they are not properly designed for automotive use.
- To avoid interference with other vehicle functions, such as anti-lock braking systems, amateur radio users who install radios and antennas onto their vehicle should not locate the Amateur Radio Antennas in the area of the driver's side hood.
- Electrical or electronic accessories or components that are added to the vehicle by the authorized dealer or the owner may adversely affect battery performance and durability.

Index

A

- Accessory delay44
- Air cleaner filter218
- Air conditioning25
- Airbag supplemental restraint system97-98, 106
 - and child safety seats99
 - description98, 106
 - disposal107
 - driver airbag98, 100, 106
 - indicator light105
 - operation98, 100, 106
 - passenger airbag98, 100, 106
 - side airbag106
- Antifreeze
(see Engine coolant)200
- Anti-lock brake system
(see Brakes)149
- Anti-theft system72, 75
 - arming the system75
 - disarming a triggered system ..76
 - triggering76
- Audio system (see Radio) ...15, 18
- Automatic transaxle
 - fluid, adding216
 - fluid, checking216
 - fluid, refill capacities220
 - fluid, specification220
- Automatic transmission
 - driving an automatic
overdrive154
- Auxiliary power point42

B

- Battery198
 - acid, treating emergencies198
 - jumping a disabled battery172

- maintenance-free198
- replacement, specifications ...218
- servicing198
- BeltMinder92
- Brakes148
 - anti-lock149
 - anti-lock brake system (ABS)
 - warning light149
 - fluid, checking and adding216
 - fluid, refill capacities220
 - fluid, specifications220
 - lubricant specifications220
 - parking150
 - shift interlock152
- Bulbs34

C

- Capacities for refilling fluids220
- CD changer20
- CD-single premium15, 18
- Cell phone use7
- Changing a tire166
- Child safety restraints108
 - child safety belts108
- Child safety seats112
 - attaching with tether straps ..116
 - in front seat113
 - in rear seat113, 116
- Cleaning your vehicle
 - engine compartment186
 - instrument panel188
 - interior188
 - interior trim188
 - plastic parts187
 - washing185
 - waxing185
 - wheels186
 - wiper blades187

Index

- Climate control (see Air conditioning or Heating)25
- Clock adjust
AM/FM/Cassette15
AM/FM/CD18
- Compass
zone/calibration adjustment56
- Compass Display55
- Console42
- Controls
power seat79
- Coolant
checking and adding200
refill capacities204, 220
specifications220
- Cruise control
(see Speed control)45
- Customer Assistance157
Ford Extended Service
Plan182
Getting assistance outside the
U.S. and Canada183
Getting roadside assistance ...157
Getting the service you need 178
Ordering additional owner's
literature184
Utilizing the
Mediation/Arbitration
Program181
- D**
- Daytime running lamps
(see Lamps)30
- Defrost
rear window27
- Dipstick
automatic transmission
fluid216
- engine oil195
- Driving under special
conditions156
through water156
- E**
- Electronic message center53
- Emergencies, roadside
jump-starting172
- Emergency Flashers159
- Emission control system213
- Engine222
cleaning186
coolant200
idle speed control198
lubrication specifications220
refill capacities220
service points193
starting after a collision159
- Engine block heater148
- Engine oil195
checking and adding195
dipstick195
filter, specifications197, 218
recommendations197
refill capacities220
specifications220
- Exhaust fumes147
- F**
- Floor mats62
- Fluid capacities220
- Fuel205
calculating fuel
economy54, 210
cap207
capacity220

228

Index

- choosing the right fuel208
comparisons with EPA fuel
economy estimates213
detergent in fuel209
filling your vehicle with
fuel205, 207, 210
filter, specifications209, 218
fuel pump shut-off switch159
improving fuel economy210
octane rating208, 222
quality209
running out of fuel209
safety information relating to
automotive fuels205
- Fuses160–161
- G**
- Gas cap (see Fuel cap)207
Gas mileage
(see Fuel economy)210
Gauges13
- H**
- Hazard flashers159
Headlamps29
aiming31
autolamp system29
bulb specifications34
daytime running lights30
flash to pass30
high beam29
replacing bulbs35
turning on and off29
- Heating
heating and air conditioning
system23, 25
Homelink wireless control
system49
- Hood192
- I**
- Ignition144, 222
Illuminated visor mirror42
Infant seats
(see Safety seats)112
Inspection/maintenance (I/M)
testing215
Instrument panel
cleaning188
cluster10
lighting up panel and
interior30
- J**
- Jack166
positioning166
storage166
Jump-starting your vehicle172
- K**
- Keyless entry system71
keypad71
locking and unlocking doors72
programming entry code71
Keys63, 73
positions of the ignition144
- L**
- Lamps
autolamp system29
bulb replacement
specifications chart34
daytime running light30
headlamps29

Index

- headlamps, flash to pass30
- instrument panel, dimming30
- interior lamps32–33, 35
- replacing bulbs35
- Lane change indicator
(see Turn signal)32
- Lights, warning and indicator10
 - anti-lock brakes (ABS)149
- Load limits134
- Locks
 - childproof64
 - doors63
- Lubricant specifications220
- Lug nuts171
- Lumbar support, seats78
- M**
- Message center53
 - english/metric button58
 - system check button58
 - warning messages59
- Mirrors45
 - automatic dimming rearview
 - mirror44
 - heated45
 - side view mirrors (power)45
- Moon roof48
- Motorcraft parts190, 209, 218
- O**
- Octane rating208
- Oil (see Engine oil)195
- Overdrive153
- P**
- Parking brake150
- Parts (see Motorcraft parts)218
- Passenger Occupant
Classification Sensor83
- Power distribution box
(see Fuses)164
- Power door locks63
- Power mirrors45
- Power point42
- Power steering151
 - fluid, checking and adding215
 - fluid, refill capacity220
 - fluid, specifications220
- Power Windows43
- R**
- Radio15, 18
- Rear window defroster27
- Relays160, 166
- Remote entry system66
 - illuminated entry69
 - locking/unlocking doors66–67
 - opening the trunk67
 - panic alarm67
 - replacing the batteries67
- Roadside assistance157
- S**
- Safety Belt Maintenance91
- Safety belts (see Safety
restraints)81, 85–89
- Safety defects, reporting184
- Safety restraints81, 85–89
 - belt minder92
 - extension assembly90
 - for adults86–88

Index

- for children107–108
- lap belt90
- Occupant Classification
- Sensor83
- safety belt maintenance91
- warning light and chime91–92
- Safety seats for children112
- Safety Compliance
- Certification Label223
- Seat belts
- (see Safety restraints)81
- Seats77
- child safety seats112
- front seats78
- SecuriLock passive anti-theft
- system72
- Servicing your vehicle191
- Setting the clock
- AM/FM/Cassette15
- AM/FM/CD18
- Spark plugs,
- specifications218, 222
- Specification chart,
- lubricants220
- Speed control45
- Starting a flex fuel vehicle147
- Starting your
- vehicle144–145, 147
- jump starting172
- Steering wheel
- tilting41
- T**
- Tail lamps
- bulb replacement40
- Tilt steering wheel41
- Tires120–121, 166
- alignment127
- care124
- changing166, 168
- checking the pressure124
- inflating122
- label133
- replacing126
- rotating127
- safety practices126
- sidewall information128
- snow tires and chains134
- spare tire166
- terminology121
- tire grades121
- treadwear120, 125
- Towing140
- recreational towing143
- trailer towing140
- wrecker177
- Traction control150
- Transaxle
- fluid, refill capacities220
- lubricant specifications220
- Transmission152
- brake-shift interlock (BSI)152
- fluid, checking and adding
- (automatic)216
- Trunk62, 65
- remote release62, 67
- Turn signal32
- V**
- Vehicle Identification Number
- (VIN)223
- Vehicle loading134
- Ventilating your vehicle148
- W**
- Warning lights (see Lights)10

Index

Washer fluid	194	Windshield washer fluid and	
Water, Driving through	156	wipers	41
Windows		checking and adding fluid	194
power	43	replacing wiper blades	195
		Wrecker towing	177