



fordowner.com



ford.ca

2013 **SUPER DUTY** Owner's Manual



Table of Contents 1

| | |
|---|-----------|
| Introduction | 9 |
| Child Safety | 18 |
| Child seats | .20 |
| Child seat positioning | .20 |
| Booster seats | .22 |
| Installing child safety seats | .25 |
| Child safety locks | .35 |
| Safety Belts | 36 |
| Fastening the safety belts | .38 |
| Safety belt height adjustment | .42 |
| Safety belt warning light and indicator chime | .43 |
| Safety belt-minder | .43 |
| Child restraint and safety belt maintenance | .45 |
| Supplementary Restraints System | 46 |
| Driver and passenger airbags | .48 |
| Side airbags | .56 |
| Safety canopy curtain airbags | .57 |
| Crash sensors and airbag indicator | .59 |
| Airbag disposal | .60 |
| Keys and Remote Control | 61 |
| General information on radio frequencies | .61 |
| Remote control | .62 |
| Keys | .62 |
| Replacing a lost key or remote control | .66 |
| MyKey | 67 |
| Settings, MyKey | .67 |
| Creating | .68 |
| Clearing | .69 |
| System status | .70 |
| Remote start, MyKey | .70 |
| Troubleshooting, MyKey | .71 |

| | |
|---|-----------|
| Locks | 72 |
| Locking and unlocking | .72 |
| SecuriCode™ keyless entry keypad | .75 |
| Security | 77 |
| SecuriLock® passive anti-theft system | .77 |
| Anti-theft alarm | .79 |
| Steering Wheel | 80 |
| Adjusting the steering wheel | .80 |
| Steering wheel controls | .80 |
| Pedals | 83 |
| Adjustable pedals | .83 |
| Wipers and Washers | 84 |
| Windshield wipers | .84 |
| Windshield washers | .84 |
| Lighting | 85 |
| Lighting control | .85 |
| Autolamps | .86 |
| Instrument lighting dimmer | .87 |
| Daytime running lamps | .87 |
| Front fog lamps | .88 |
| Direction indicators | .88 |
| Interior lamps | .89 |
| Windows and Mirrors | 90 |
| Power windows | .90 |
| Exterior mirrors | .92 |
| Interior mirrors | .94 |
| Sun visors | .95 |
| Moonroof | .96 |

Table of Contents 3

| | |
|---|------------|
| Instrument Cluster | 97 |
| Gauges | .97 |
| Warning lamps and indicators | .99 |
| Audible warnings and indicators | .103 |
| Information Displays | 104 |
| Controls | .104 |
| Information messages | .119 |
| Audio System | 134 |
| AM/FM stereo | .136 |
| AM/FM/CD with SYNC | .137 |
| Auxiliary input jack | .141 |
| USB port | .142 |
| Satellite radio information | .143 |
| Climate Control | 146 |
| Manual heating and air conditioning | .146 |
| Dual automatic temperature control | .148 |
| Rear window defroster | .152 |
| Seats | 154 |
| Sitting in the correct position | .154 |
| Head restraints | .155 |
| Manual seats | .157 |
| Power seats | .159 |
| Memory function | .160 |
| Rear seats | .161 |
| Heated and cooled seats | .165 |
| Universal Garage Door Opener (If Equipped) | 168 |
| Car2U® home automation system | .168 |
| HomeLink® wireless control system | .173 |

| | |
|--|------------|
| Auxiliary Power Points | 178 |
| Storage Compartments | 181 |
| Overhead console | 181 |
| Starting and Stopping the Engine | 182 |
| Ignition switch | 183 |
| Engine block heater | 186 |
| Fuel and Refueling | 188 |
| Fuel quality | 190 |
| Refueling | 193 |
| Fuel consumption | 194 |
| Transmission | 199 |
| Transmission operation | 199 |
| Hill start assist | 208 |
| Four-Wheel Drive (If Equipped) | 209 |
| Four wheel drive | 209 |
| Brakes | 223 |
| Brakes | 223 |
| Hints on driving with anti-lock brakes | 224 |
| Parking brake | 224 |
| Traction Control | 225 |
| Traction Control™ | 225 |
| Stability Control | 227 |
| AdvanceTrac® | 228 |
| Terrain Response | 230 |
| Hill descent control | 230 |
| Parking Aids | 232 |
| Sensing system | 232 |
| Rear-view camera system | 234 |

Table of Contents **5**

| | |
|--|------------|
| Cruise Control | 238 |
| Driving Aids | 240 |
| Load Carrying | 241 |
| Vehicle loading | .241 |
| Tailgate | .248 |
| Towing | 253 |
| Trailer towing | .253 |
| Trailer brake controller-integrated | .259 |
| Wrecker towing | .266 |
| Recreational towing | .268 |
| Driving Hints | 269 |
| Economical driving | .269 |
| Floor mats | .271 |
| Roadside Emergencies | 276 |
| Getting roadside assistance | .276 |
| Hazard flasher control | .278 |
| Fuel cut-off switch | .278 |
| Jump-starting the vehicle | .279 |
| Customer Assistance | 282 |
| Reporting safety defects (U.S. only) | .289 |
| Reporting safety defects (Canada only) | .289 |
| Fuses | 290 |
| Changing a fuse | .290 |
| Fuse specification chart | .291 |
| Upfitter controls | .300 |

| | |
|---|------------|
| Maintenance | 302 |
| General information | .302 |
| Opening and closing the hood | .303 |
| Under hood overview | .304 |
| Engine oil dipstick | .306 |
| Engine oil check | .306 |
| Engine coolant check | .307 |
| Automatic transmission fluid check | .313 |
| Brake fluid check | .317 |
| Power steering fluid check | .317 |
| Fuel filter | .317 |
| Washer fluid check | .318 |
| Changing the vehicle battery | .318 |
| Checking the wiper blades | .321 |
| Air filter(s) | .323 |
| Adjusting the headlamps | .325 |
| Changing a bulb | .326 |
| Bulb specification chart | .331 |
| Vehicle Care | 332 |
| Cleaning products | .332 |
| Cleaning the exterior | .332 |
| Waxing | .334 |
| Repairing minor paint damage | .334 |
| Cleaning the engine | .334 |
| Cleaning the windows and wiper blades | .335 |
| Cleaning the interior | .335 |
| Cleaning the instrument panel and instrument cluster lens | .336 |
| Cleaning the alloy wheels | .340 |
| Vehicle storage | .340 |

Table of Contents

7

| | |
|--|------------|
| Wheels and Tires | 343 |
| Tire care | .345 |
| Tire Pressure Monitoring System (TPMS) | .364 |
| Changing a road wheel | .371 |
| Technical specifications | .387 |
| Wheel lug nut torque | .387 |
| Capacities and Specifications | 389 |
| Engine specifications | .389 |
| Engine drivebelt | .389 |
| Part numbers | .395 |
| Vehicle identification number | .395 |
| Vehicle certification label | .396 |
| Transmission code designation | .397 |
| Accessories | 398 |
| Accessories | .398 |
| Ford Extended Service Plan | 400 |
| Scheduled Maintenance | 403 |
| Normal scheduled maintenance and log | .408 |
| SYNC® | 420 |
| Pairing your phone for the first time | .426 |
| 911 Assist™ | .441 |
| Vehicle Health Report | .443 |

8 Table of Contents

| | |
|------------------------------------|------------|
| MyFord Touch® (If Equipped) | 466 |
| Privacy Information | .472 |
| Voice recognition | .472 |
| Listening to music | .478 |
| Phone features | .500 |
| Information Menu | .508 |
| Settings | .520 |
| Climate features | .534 |
| Navigation system. | .537 |
| Appendices | 549 |
| Index | 569 |

The information contained in this publication was correct at the time of going to print. In the interest of continuous development, we reserve the right to change specifications, design or equipment at any time without notice or obligation. No part of this publication may be reproduced, transmitted, stored in a retrieval system or translated into any language in any form by any means without our written permission. Errors and omissions excepted.

© Ford Motor Company 2013

ABOUT THIS MANUAL

Thank you for choosing Ford. We recommend that you take some time to get to know your vehicle by reading this manual. The more that you know about it, the greater the safety and pleasure you will get from driving it.



WARNING: Always drive with due care and attention when using and operating the controls and features on your vehicle.

Note: This manual describes a range of product features and options, sometimes before they are generally available. Therefore, you may find options in this manual that are not found on your vehicle.

Note: Some of the illustrations in this manual may be used for different models, so they may appear different than your vehicle. However, the essential information in the illustrations is always correct.

Note: Always use and operate your vehicle in line with all applicable laws and regulations.

Note: Pass on this manual when selling your vehicle. It is an integral part of the vehicle.

This manual may qualify the location of a component as left-hand side or right-hand side. The side is determined when facing forward in the seat.

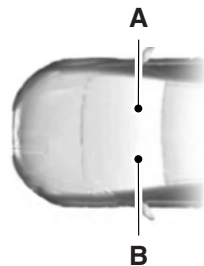

A. Right-hand side

B. Left-hand side



















Protecting the Environment

You must play your part in protecting the environment. Correct vehicle usage and the authorized disposal of waste, cleaning and lubrication materials are significant steps toward this aim.

SYMBOL GLOSSARY





















 **WARNING:** You risk death or serious injury to yourself and others if you do not follow the instruction highlighted by the warning symbol.

These are some of the symbols you may see on your vehicle.

| Symbol | Description | Symbol | Description | Symbol | Description |
|---|----------------------------------|---|-----------------------------------|--|----------------------------|
|  | Safety alert |  | See Owner's Manual |  | Anti-lock braking system |
|  | Avoid smoking, flames, or sparks |  | Battery |  | Battery acid |
|  | Brake fluid – non petroleum base |  | Brake system |  | Cabin air filter |
|  | Check fuel cap |  | Child Safety Door Lock and Unlock |  | Child seat lower anchor |
|  | Child seat tether anchor |  | Cruise control |  | Do not open when hot |
|  | Engine air filter |  | Engine coolant |  | Engine coolant temperature |
|  | Engine oil |  | Explosive gas |  | Fan warning |
|  | Fasten safety belt |  | Front airbag |  | Front fog lamps |

Introduction

11

| Symbol | Description | Symbol | Description | Symbol | Description |
|---|-------------------------------|---|--------------------------------------|--|------------------------------|
|  | Fuel pump reset |  | Fuse compartment |  | Hazard warning flasher |
|  | Heated rear window |  | Interior luggage compartment release |  | Jack |
|  | Lighting control |  | Low tire pressure warning |  | Maintain correct fluid level |
|  | Panic alarm |  | Parking aid system |  | Parking brake system |
|  | Power steering fluid |  | Power windows front and rear |  | Power window lockout |
|  | Service engine soon |  | Side airbag |  | Stability control |
|  | Windshield defrost and demist |  | Windshield washer and wiper | | |

DATA RECORDING**Service Data Recording**

Service data recorders in your vehicle are capable of collecting and storing diagnostic information about your vehicle. This potentially includes information about the performance or status of various systems and modules in the vehicle, such as engine, throttle, steering or brake systems. In order to properly diagnose and service your vehicle, Ford Motor Company, Ford of Canada, and service and repair facilities may access or share among them vehicle diagnostic information received through a direct connection to your vehicle when diagnosing or servicing your vehicle. Additionally, when your vehicle is in for service or repair, Ford Motor Company, Ford of Canada, and service and repair facilities may access or share among them data for vehicle improvement purposes. For U.S. only (if equipped), if you choose to use the SYNC® Vehicle Health Report, you consent that certain diagnostic information may also be accessed electronically by Ford Motor Company and Ford authorized service facilities, and that the diagnostic information may be used for any purpose. See the *SYNC®* chapter for more information.

Event Data Recording

This vehicle is equipped with an event data recorder (EDR). The main purpose of an EDR is to record, in certain crash or near crash-like situations, such as an airbag deployment or hitting a road obstacle; this data will assist in understanding how a vehicle's systems performed. The EDR is designed to record data related to vehicle dynamics and safety systems for a short period of time, typically 30 seconds or less. The EDR in this vehicle is designed to record such data as:

- **How various systems in your vehicle were operating;**
- **Whether or not the driver and passenger safety belts were buckled/fastened;**
- **How far (if at all) the driver was depressing the accelerator and/or the brake pedal;**
- **How fast the vehicle was travelling;**
- **Where the driver was positioning the steering wheel.**

This data can help provide a better understanding of the circumstances in which crashes and injuries occur.

Note: EDR data is recorded by your vehicle only if a non-trivial crash situation occurs; no data is recorded by the EDR under normal driving conditions and no personal data or information (e.g., name, gender, age, and crash location) is recorded (see limitations regarding 911 Assist and Traffic, Directions and Information privacy below). However, parties, such as law enforcement, could combine the EDR data with the type of personally identifying data routinely acquired during a crash investigation.

To read data recorded by an EDR, special equipment is required, and access to the vehicle or the EDR is needed. In addition to the vehicle manufacturer, other parties, such as law enforcement, that have such special equipment, can read the information if they have access to the vehicle or the EDR. Ford Motor Company and Ford of Canada do not access event data recorder information without obtaining consent, unless pursuant to court order or where required by law enforcement, other government authorities or other third parties acting with lawful authority. Other parties may seek to access the information independently of Ford Motor Company and Ford of Canada.

Note: Including to the extent that any law pertaining to Event Data Recorders applies to SYNC® or its features, please note the following: Once 911 Assist (if equipped) is enabled (set ON), 911 Assist may, through any paired and connected cell phone, disclose to emergency services that the vehicle has been in a crash involving the deployment of an airbag or, in certain vehicles, the activation of the fuel pump shut-off. Certain versions or updates to 911 Assist may also be capable of being used to electronically or verbally provide to 911 operators the vehicle location (such as latitude and longitude), and/or other details about the vehicle or crash or personal information about the occupants to assist 911 operators to provide the most appropriate emergency services. If you do not want to disclose this information, do not activate the 911 Assist feature. See your SYNC® chapter for more information.

Additionally, when you connect to Traffic, Directions and Information (if equipped, U.S. only), the service uses GPS technology and advanced vehicle sensors to collect the vehicle's current location, travel direction, and speed ("vehicle travel information"), only to help provide you with the directions, traffic reports, or business searches that you request. If you do not want Ford or its vendors to receive this information, do not activate the service. Ford Motor Company and the vendors it uses to provide you with this information do not store your vehicle travel information. For more information, see Traffic, Directions and Information, Terms and Conditions. See your SYNC® chapter for more information.

CALIFORNIA PROPOSITION 65



WARNING: Some constituents of engine exhaust, certain vehicle components, certain fluids contained in vehicles and certain products of component wear contain or emit chemicals known to the State of California to cause cancer and birth defects or other reproductive harm.

PERCHLORATE MATERIAL

Note: Certain components in your vehicle, such as airbag modules, safety belt pretensioners, and remote control batteries, may contain perchlorate material. Special handling may apply for service or vehicle end of life disposal. See www.dtsc.ca.gov/hazardouswaste/perchlorate for more information.

FORD CREDIT (U.S. ONLY)

Ford Credit offers a full range of financing and lease plans to help you acquire your vehicle. If you have financed or leased your vehicle through Ford Credit, thank you for your business.

For your convenience, we offer a number of ways to contact us, as well as help manage your account.

Phone: 1-800-727-7000

For more information regarding Ford Credit, as well as access to Account Manager, please go to www.fordcredit.com.

REPLACEMENT PARTS RECOMMENDATION

Your vehicle has been built to the highest standards using quality parts. We recommend that you demand the use of genuine Ford and Motorcraft parts whenever your vehicle requires scheduled maintenance or repair. You can clearly identify genuine Ford and Motorcraft parts by looking for the Ford, FoMoCo or Motorcraft branding on the parts or their packaging.

Scheduled Maintenance and Mechanical Repairs

One of the best ways for you to make sure that your vehicle provides years of service is to have it maintained in line with our recommendations using parts that conform to the specifications detailed in this owner's manual. Genuine Ford and Motorcraft parts meet or exceed these specifications.

Collision Repairs

We hope that you never experience a collision, but accidents do happen. Genuine Ford replacement collision parts meet our stringent requirements for fit, finish, structural integrity, corrosion protection and dent resistance. During vehicle development, we validate that these parts deliver the intended level of protection as a whole system. A great way to know for sure you are getting this level of protection is to use genuine Ford replacement collision parts.

Warranty on Replacement Parts

Genuine Ford and Motorcraft replacement parts are the only replacement parts that benefit from a Ford Warranty. Damage caused to your vehicle as a result of the failure of non-Ford parts may not be covered by the Ford Warranty. For additional information, see the terms and conditions of the Ford Warranty.

SPECIAL NOTICES**New Vehicle Limited Warranty**

For a detailed description of what is covered and what is not covered by your vehicle's New Vehicle Limited Warranty, see the warranty information that is provided to you along with your owner's manual.

Special Instructions

For your added safety, your vehicle is fitted with sophisticated electronic controls.



WARNING: Please read the *Supplementary Restraints System* chapter. Failure to follow the specific warnings and instructions could result in personal injury.



WARNING: Front seat mounted rear-facing child or infant seats should **NEVER** be placed in front of an active passenger airbag.

Using your vehicle with a snowplow

For more information and guidelines for using your vehicle with a snowplow, refer to the *Snowplow* section in the *Driving Hints* chapter.

Using your vehicle as an ambulance

If your light truck is equipped with the Ford Ambulance Preparation Package, it may be utilized as an ambulance. Ford urges ambulance manufacturers to follow the recommendations of the *Ford Incomplete Vehicle Manual*, *Ford Truck Body Builder's Layout Book* and the *Qualified Vehicle Modifiers (QVM) Guidelines* as well as pertinent supplements. For additional information, please contact the Truck Body Builders Advisory Service at <http://www.fleet.ford.com/truckbbas/> and then by selecting "Contact Us" or by phone at 1-877-840-4338.

Use of your Ford light truck as an ambulance, without the Ford Ambulance Preparation Package voids the Ford New Vehicle Limited Warranty and may void the Emissions Warranties. In addition, ambulance usage without the preparation package could cause high underbody temperatures, overpressurized fuel and a risk of spraying fuel which could lead to fires.

If your vehicle is equipped with the Ford Ambulance Preparation Package, it will be indicated on the Safety Compliance Certification Label. The label is located on the driver's side door pillar or on the rear edge of the driver's door. You can determine whether the ambulance manufacturer followed Ford's recommendations by directly contacting that manufacturer. Ford Ambulance Preparation Package is only available on certain Diesel engine equipped vehicles.

Using your vehicle as a stationary power source (PTO)

Refer to the *Driving Hints* chapter for more information and guidelines for operating a vehicle equipped with an aftermarket power take-off system.

MOBILE COMMUNICATIONS EQUIPMENT

Using mobile communications equipment is becoming increasingly important in the conduct of business and personal affairs. However, you must not compromise your own or others' safety when using such equipment. Mobile communications can enhance personal safety and security when appropriately used, particularly in emergency situations. Safety must be paramount when using mobile communications equipment to avoid negating these benefits.

Mobile communication equipment includes, but is not limited to, cellular phones, pagers, portable email devices, text messaging devices and portable two-way radios.



WARNING: Driving while distracted can result in loss of vehicle control, accident and injury. Ford strongly recommends that you use extreme caution when using any device or feature that may take your focus off the road. Your primary responsibility is the safe operation of your vehicle. We recommend against the use of any handheld device while driving, encourage the use of voice operated systems when possible and that you become aware of applicable state and local laws that may affect use of electronic devices while driving.

EXPORT UNIQUE (NON-UNITED STATES/CANADA) VEHICLE SPECIFIC INFORMATION

For your particular global region, your vehicle may be equipped with features and options that are different from the features and options that are described in this owner's manual. A market unique supplement may be supplied that complements this book. By referring to the market unique supplement, if provided, you can properly identify those features, recommendations and specifications that are unique to your vehicle. This owner's manual is written primarily for the U.S. and Canadian Markets. Features or equipment listed as standard may be different on units built for Export. **See this owner's manual for all other required information and warnings.**

GENERAL INFORMATION

See the following sections for directions on how to properly use safety restraints for children.



WARNING: Always make sure your child is secured properly in a device that is appropriate for their height, age and weight. Child safety restraints must be bought separately from your vehicle. Failure to follow these instructions and guidelines may result in an increased risk of serious injury or death to your child.



WARNING: All children are shaped differently. The recommendations for safety restraints are based on probable child height, age and weight thresholds from NHTSA and other safety organizations, or are the minimum requirements of law. Ford recommends checking with a NHTSA Certified Child Passenger Safety Technician (CPST) and consulting your pediatrician to make sure your child seat is appropriate for your child, and is compatible with and properly installed in your vehicle. To locate a child seat fitting station and CPST, contact the NHTSA toll free at 1-888-327-4236 or on the internet at <http://www.nhtsa.dot.gov>. In Canada, check with your local St. John Ambulance office for referral to a CPST or for further information, contact your provincial ministry of transportation, or locate your local St. John Ambulance office by searching for St. John Ambulance on the internet, or Transport Canada at 1-800-333-0371 (<http://www.tc.gc.ca>). Failure to properly restrain children in safety seats made especially for their height, age, and weight may result in an increased risk of serious injury or death to your child.

| Recommendations for Safety Restraints for Children | | |
|---|--|--|
| | Child size, height, weight, or age | Recommended restraint type |
| Infants or toddlers | Children weighing 40 lb (18 kg) or less (generally age four or younger). | Use a child safety seat (sometimes called an infant carrier, convertible seat, or toddler seat). |

| Recommendations for Safety Restraints for Children | | |
|---|--|--|
| | Child size, height, weight, or age | Recommended restraint type |
| Small children | Children who have outgrown or no longer properly fit in a child safety seat (generally children who are less than 4 ft. 9 in. (1.45 m) tall, are greater than age four (4) and less than age twelve (12), and between 40 lb (18 kg) and 80 lb (36 kg) and upward to 100 lb (45 kg) if recommended by your child restraint manufacturer). | Use a belt-positioning booster seat. |
| Larger children | Children who have outgrown or no longer properly fit in a belt-positioning booster seat (generally children who are at least 4 ft. 9 in. (1.45 m) tall or greater than 80 lb (36 kg) or 100 lb (45 kg) if recommended by child restraint manufacturer). | Use a vehicle safety belt having the lap belt snug and low across the hips, shoulder belt centered across the shoulder and chest, and seat back upright. |

- You are required by law to properly use safety seats for infants and toddlers in the U.S. and Canada.
- Many states and provinces require that small children use approved booster seats until they reach age eight, a height of 4 feet 9 inches (1.45 meters) tall, or 80 pounds (36 kilograms). Check your local and state or provincial laws for specific requirements about the safety of children in your vehicle.
- When possible, always properly restrain children twelve (12) years of age and under in a rear seating position of your vehicle. Accident statistics suggest that children are safer when properly restrained in the rear seating positions than in a front seating position.

CHILD SEATS

Use a child safety seat (sometimes called an infant carrier, convertible seat, or toddler seat) for infants, toddlers or children weighing 40 pounds (18 kilograms) or less (generally age four or younger).

CHILD SEAT POSITIONING

! **WARNING:** Airbags can kill or injure a child in a child seat. NEVER place a rear-facing child seat in front of an active airbag. If you must use a forward-facing child seat in the front seat, move the vehicle seat upon which the child seat is installed all the way back. When possible, all children age 12 and under should be properly restrained in a rear seating position. If all children cannot be seated and restrained properly in a rear seating position, properly restrain the largest child in the front seat.

! **WARNING:** Always carefully follow the instructions and warnings provided by the manufacturer of any child restraint to determine if the restraint device is appropriate for your child's size, height, weight, or age. Follow the child restraint manufacturer's instructions and warnings provided for installation and use in conjunction with the instructions and warnings provided by your vehicle manufacturer. A safety seat that is improperly installed or utilized, is inappropriate for your child's height, age, or weight or does not properly fit the child may increase the risk of serious injury or death.

! **WARNING:** Never let a passenger hold a child on his or her lap while your vehicle is moving. The passenger cannot protect the child from injury in a crash, which may result in serious injury or death.

! **WARNING:** Never use pillows, books, or towels to boost a child. They can slide around and increase the likelihood of injury or death in a crash.

 **WARNING:** Always restrain an unoccupied child seat or booster seat. These objects may become projectiles in a crash or sudden stop, which may increase the risk of serious injury.

 **WARNING:** Never place, or allow a child to place, the shoulder belt under a child's arm or behind the back because it reduces the protection for the upper part of the body and may increase the risk of injury or death in a crash.

 **WARNING:** Do not leave children or pets unattended in your vehicle.

| Restraint Type | Child Weight | Use any attachment method as indicated below by X. | | | | |
|---------------------------|---------------------|--|----------------------------|-----------------------------------|---|------------------|
| | | LATCH (lower anchors and top tether anchor) | LATCH (lower anchors only) | Safety belt and top tether anchor | Safety belt and LATCH (lower anchors and top tether anchor) | Safety belt only |
| Rear-facing child seat | Up to 48 lb (21 kg) | | | | | X |
| Forward-facing child seat | Up to 48 lb (21 kg) | | | X | | |
| Forward-facing child seat | Over 48 lb (21 kg) | | | X | | |

Note: The child seat must rest tightly against the vehicle seat upon which it is installed. It may be necessary to lift or remove the head restraint. See the *Seats* chapter for information on head restraints.

BOOSTER SEATS

WARNING: Never place, or allow a child to place, the shoulder belt under a child's arm or behind the back because it reduces the protection for the upper part of the body and may increase the risk of injury or death in a crash.

Use a belt-positioning booster seat for children who have outgrown or no longer properly fit in a child safety seat (generally children who are less than 4 feet 9 inches (1.45 meters) tall, are greater than age four (4) and less than age twelve (12), and between 40 pounds (18 kilograms) and 80 pounds (36 kilograms) and upward to 100 pounds (45 kilograms) if recommended by your child restraint manufacturer). Many state and provincial laws require that children use approved booster seats until they reach age eight (8), a height of 4 feet 9 inches (1.45 meters) tall, or 80 pounds (36 kilograms).

Booster seats should be used until you can answer YES to ALL of these questions when the child is seated without a booster seat.

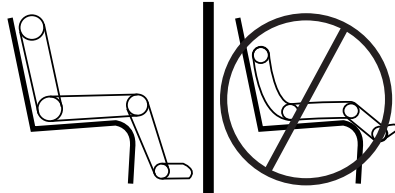

- Can the child sit all the way back against their vehicle seat with knees bent comfortably at the edge of the seat cushion?
- Can the child sit without slouching?
- Does the lap belt rest low across the hips?
- Is the shoulder belt centered on the shoulder and chest?
- Can the child stay seated like this for the whole trip?

Always use booster seats in conjunction with your vehicle lap and shoulder belt.

Types of Booster Seats



- Backless booster seats

If your backless booster seat has a removable shield, remove the shield. If a vehicle seating position has a low seat back or no head restraint, a backless booster seat may place your child's head (as measured at the tops of the ears) above the top of the seat. In this case, move the backless booster to another seating position with a higher seat back or head restraint and lap and shoulder belts, or consider using a high back booster seat.



- High back booster seats

If, with a backless booster seat, you cannot find a seating position that adequately supports your child's head, a high back booster seat would be a better choice.

Children and booster seats vary in size and shape. Choose a booster that keeps the lap belt low and snug across the hips, never up across the stomach, and lets you adjust the shoulder belt to cross the chest and rest snugly near the center of the shoulder. The following drawings compare the ideal fit (center) to a shoulder belt uncomfortably close to the neck and a shoulder belt that could slip off the shoulder. The drawings also show how the lap belt should be low and snug across the child's hips.

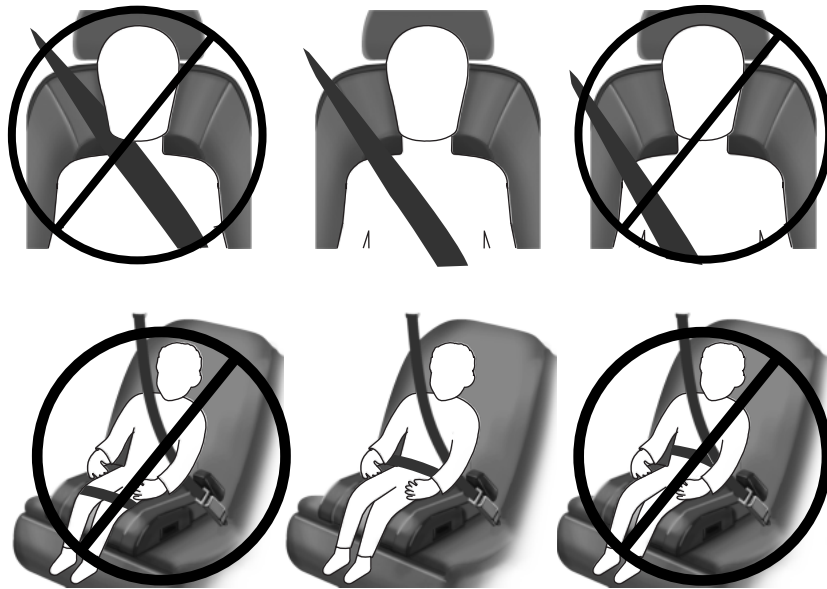

If the booster seat slides on the vehicle seat upon which it is being used, placing a rubberized mesh sold as shelf or carpet liner under the booster seat may improve this condition. Do not introduce any item thicker than this under the booster seat. Check with the booster seat manufacturer's instructions.

INSTALLING CHILD SEATS**Using Lap and Shoulder Belts**

WARNING: Airbags can kill or injure a child in a child seat. **NEVER** place a rear-facing child seat in front of an active airbag. If you must use a forward-facing child seat in the front seat, move the seat all the way back.



WARNING: Children 12 and under should be properly restrained in the rear seat whenever possible.



WARNING: Depending on where you secure a child restraint, and depending on the child restraint design, you may block access to certain safety belt buckle assemblies or LATCH lower anchors, rendering those features potentially unusable. To avoid risk of injury, occupants should only use seating positions where they are able to be properly restrained.

When installing a child safety seat with combination lap/shoulder belts:

- Use the correct safety belt buckle for that seating position.
- Insert the belt tongue into the proper buckle until you hear a snap and feel it latch. Make sure the tongue is securely fastened in the buckle.
- Keep the buckle release button pointing up and away from the safety seat, with the tongue between the child seat and the release button, to prevent accidental unbuckling.
- Place the vehicle seat upon which the child seat will be installed in the upright position.
- This vehicle does not require the use of a locking clip.

Perform the following steps when installing the child seat with combination lap and shoulder belts:

Note: Although the child seat illustrated is a forward facing child seat, the steps are the same for installing a rear facing child seat.



1. Position the child safety seat in a seat with a combination lap and shoulder belt.

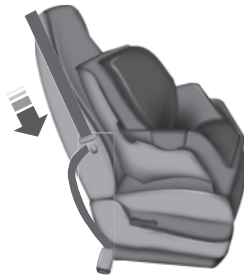

2. Pull down on the shoulder belt and then grasp the shoulder belt and lap belt together.

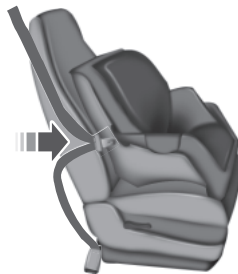

3. While holding the shoulder and lap belt portions together, route the tongue through the child seat according to the child seat manufacturer's instructions. Be sure the belt webbing is not twisted.

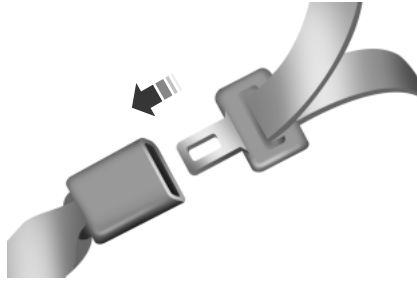

4. Insert the belt tongue into the proper buckle (the buckle closest to the direction the tongue is coming from) for that seating position until you hear a snap and feel the latch engage. Make sure the tongue is latched securely by pulling on it.



5. To put the retractor in the automatic locking mode, grasp the shoulder portion of the belt and pull downward until all of the belt is pulled out.

6. Allow the belt to retract to remove slack. The belt will click as it retracts to indicate it is in the automatic locking mode.

7. Try to pull the belt out of the retractor to make sure the retractor is in the automatic locking mode (you should not be able to pull more belt out). If the retractor is not locked, unbuckle the belt and repeat Steps 5 and 6.

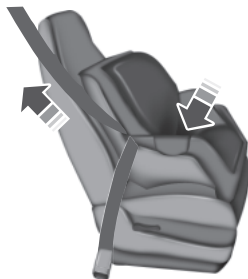

8. Remove remaining slack from the belt. Force the seat down with extra weight, for example, by pressing down or kneeling on the child restraint while pulling up on the shoulder belt in order to force slack from the belt.

This is necessary to remove the remaining slack that will exist once the extra weight of the child is added to the child restraint. It also helps to achieve the proper snugness of the child seat to your vehicle. Sometimes, a slight lean toward the buckle will additionally help to remove remaining slack from the belt.

9. Attach the tether strap (if the child seat is equipped). See *Using Tether Straps* in this chapter.

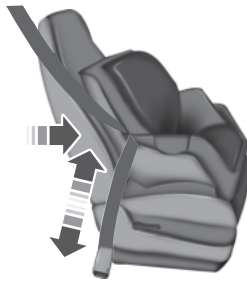

10. Before placing the child in the seat, forcibly move the seat forward and back to make sure the seat is securely held in place.

To check this, grab the seat at the belt path and attempt to move it side to side and forward and back. There should be no more than 1 inch (2.5 centimeters) of movement for proper installation.

Ford recommends checking with a NHTSA Certified Child Passenger Safety Technician to make certain the child restraint is properly installed. In Canada, check with your local St. John Ambulance office for referral to a Child Passenger Safety Technician.

Using Cinch Tongue Lap and Shoulder Belts (All Front Center and Super/Crew Cab Rear Center Positions)



WARNING: Airbags can kill or injure a child in a child seat.

If you must use a forward-facing child seat in the front seat, move seat all the way back.



WARNING: Rear facing child seats should never be placed in front of an active airbag.



WARNING: Always use both lap and shoulder safety belt in the Regular Cab center seating position if applicable.

The belt webbing below the tongue is the lap portion of the combination lap and shoulder belt, and the belt webbing above the tongue is the shoulder belt portion of the combination lap and shoulder belt.



1. Position the child safety seat in the center front seat.



2. Slide the tongue up the webbing.

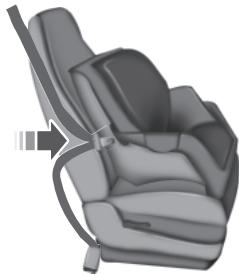

3. While holding both shoulder and lap portions next to the tongue, route the tongue and webbing through the child seat according to the child seat manufacturer's instructions. Be sure that the belt webbing is not twisted.

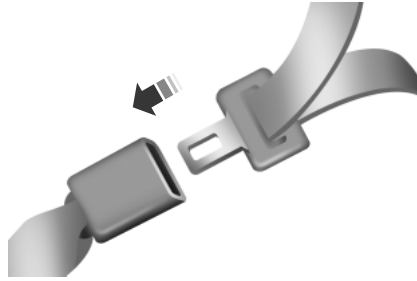

4. Insert the belt tongue into the proper buckle (the buckle closest to the direction the tongue is coming from) for that seating position until you hear a snap and feel the latch engage. Make sure the tongue is latched securely by pulling on it.

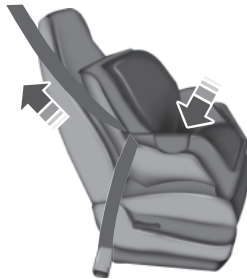

5. While pushing down with your knee on the child seat pull up on the shoulder belt portion to tighten the lap belt portion of the combination lap and shoulder belt.

6. Allow the safety belt to retract and remove any slack in the belt to securely tighten the child safety seat in the vehicle.

7. Attach the tether strap (if the child seat is equipped). See *Using Tether Straps* in this chapter.

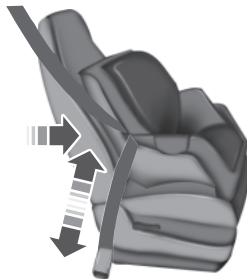

8. Before placing the child into the child seat, forcibly pull the child seat forward and back to make sure that the seat is held securely in place. To check this, grab the seat at the belt path and attempt to move it side to side and forward and back. There should be no more than 1 inch (2.5 centimeters) of movement for proper installation.

9. Check from time to time to be sure that there is no slack in the lap and shoulder belt. The shoulder belt must be snug to keep the lap belt tight during a collision.

Ford recommends checking with a NHTSA Certified Child Passenger Safety Technician to make certain the child restraint is properly installed. In Canada, check with your local St. John Ambulance office for referral to a Child Passenger Safety Technician.

Using Lower Anchors and Tethers for Children (LATCH)

The LATCH system is composed of three vehicle anchor points: two lower anchors located where the vehicle seat back and seat cushion meet (called the seat bight) and one top tether anchor located behind that seating position. Your vehicle is not equipped with the lower anchor points in the seat bight. For this vehicle, use the vehicle safety belt and upper tether to secure a child seat. See *Using Tether Straps* and *Recommendations for Safety Restraints for Children* in this chapter for more information.

Using Tether Straps

Many forward-facing child safety seats include a tether strap which extends from the back of the child safety seat and hooks to an anchoring point called the top tether anchor. Tether straps are available as an accessory for many older safety seats. Contact the manufacturer of your child seat for information about ordering a tether strap, or to obtain a longer tether strap if the tether strap on your safety seat does not reach the appropriate top tether anchor in the vehicle.

The passenger seats of your vehicle may be equipped with built-in tether strap anchors located behind the seats as described below.

The tether anchors in your vehicle may be straps on the seat back or an anchor bracket mounted to the body shell on the back panel.

The SuperCab rear seat has three straps behind the top of the seat back that function as both routing loops for the tether straps and anchor loops.

The tether strap anchors in your vehicle are in the following positions (shown from top view):

- **F-Series Regular Cab**

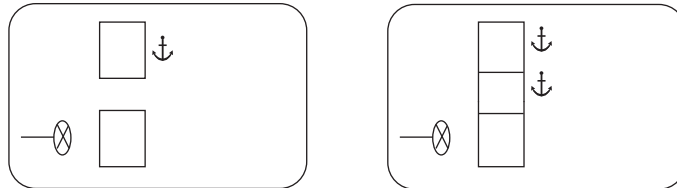

- **F-Series SuperCab**

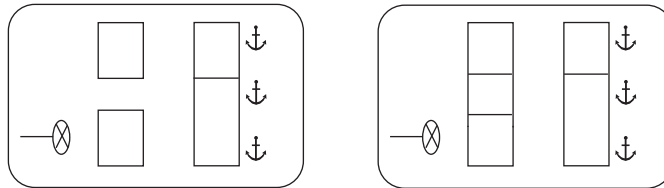

- **F-Series Crew Cab**

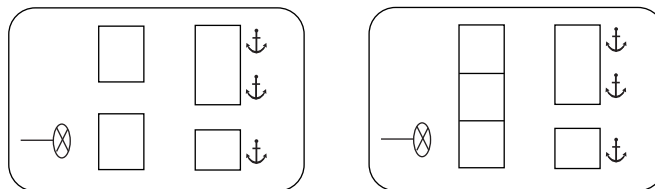

Attach the tether strap only to the appropriate tether anchor as shown. The tether strap may not work properly if attached somewhere other than the correct tether anchor.

Once the child safety seat has been installed using the safety belt, you can attach the top tether strap.

Tether Strap Attachment

1. Route the child safety seat tether strap over the back of the seat.

For vehicles with adjustable head restraints, route the tether strap under the head restraint and between the head restraint posts, otherwise route the tether strap over the top of the seat back. If the top of the safety seat hits the head restraint, raise the head restraint to let the child seat fit further rearward.

2. Locate the correct anchor for the selected seating position.

3. You may need to pull the seat back forward to access the tether anchors. Make sure the seat is locked in the upright position before installing the child seat.

4. Remove the tether cover.

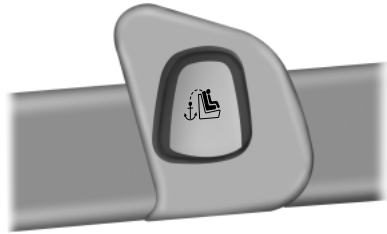

5. Clip the tether strap to the anchor as shown.

- Front seats (Regular Cab)/Rear seats (Crew Cab)

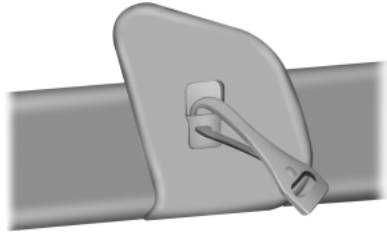

If the tether strap is clipped incorrectly, the child safety seat may not be retained properly in the event of a crash.

6. Tighten the child safety seat tether strap according to the manufacturer's instructions.

If the safety seat is not anchored properly, the risk of a child being injured in a crash greatly increases.

If your child restraint system is equipped with a tether strap, and the child restraint manufacturer recommends its use, Ford also recommends its use.

Tether Strap Attachment (Rear SuperCab Only)

There are three loops of webbing just above the back of the rear seat (along the bottom edge of the rear window) in the SuperCab. These loops are to be used as both routing loops and anchor loops for up to three child safety seat tether straps.

These straps may be secured below the back of the seat with rubber bands. To access, reach below the back of the seat and pull tether loop out of the rubber band securing it.

Many tether straps cannot be tightened if the tether strap is hooked to the loop directly behind the child seat. To provide a tight tether strap:

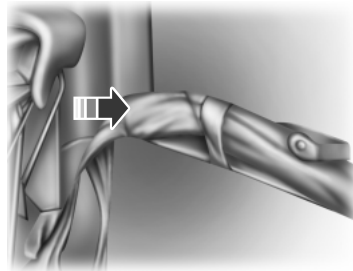

1. Route the tether strap through the loop directly behind the child seat.

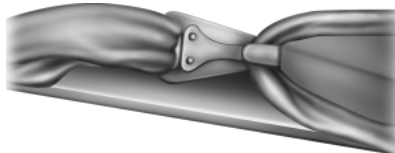

2. Attach the strap hook onto the loop behind an adjacent seating position.

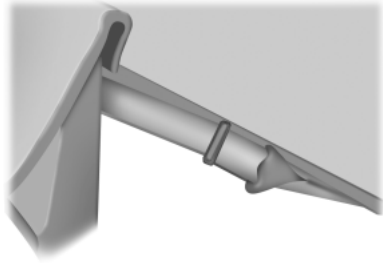

3. Install the child safety seat tightly using the vehicle belts. Follow the instructions in this chapter.

4. Tighten the tether strap according to the child seat manufacturer's instructions.

A single loop can be used to route and anchor more than one child seat. For example, the center loop can be used as a routing loop for a child safety seat in the center rear seat and as an anchoring loop for child seats installed in the outboard rear seats.

CHILD SAFETY LOCKS (IF EQUIPPED)

When these locks are set, the rear doors cannot be opened from the inside.



The childproof locks are located on the rear edge of each rear door and must be set separately for each door.

Move the lock control up or down to engage or disengage the childproof lock.

PRINCIPLES OF OPERATION

WARNING: Always drive and ride with your seat back upright and the lap belt snug and low across the hips.



WARNING: To reduce the risk of injury, make sure children sit where they can be properly restrained.



WARNING: Never let a passenger hold a child on his or her lap while the vehicle is moving. The passenger cannot protect the child from injury in a crash.



WARNING: All occupants of the vehicle, including the driver, should always properly wear their safety belts, even when an airbag supplemental restraint system is provided. Failure to properly wear your safety belt could seriously increase the risk of injury or death.



WARNING: It is extremely dangerous to ride in a cargo area, inside or outside of a vehicle. In a crash, people riding in these areas are more likely to be seriously injured or killed. Do not allow people to ride in any area of your vehicle that is not equipped with seats and safety belts. Be sure everyone in your vehicle is in a seat and using a safety belt properly.



WARNING: In a rollover crash, an unbelted person is significantly more likely to die than a person wearing a safety belt.



WARNING: Each seating position in your vehicle has a specific safety belt assembly which is made up of one buckle and one tongue that are designed to be used as a pair. 1) Use the shoulder belt on the outside shoulder only. Never wear the shoulder belt under the arm. 2) Never swing the safety belt around your neck over the inside shoulder. 3) Never use a single belt for more than one person.



WARNING: When possible, all children 12 years old and under should be properly restrained in a rear seating position. Failure to follow this could seriously increase the risk of injury or death.





WARNING: Safety belts and seats can become hot in a vehicle that has been closed up in sunny weather; they could burn a small child. Check seat covers and buckles before you place a child anywhere near them.



WARNING: Front and rear seat occupants, including pregnant women, should wear safety belts for optimum protection in an accident.

All seating positions in this vehicle have lap and shoulder safety belts. All occupants of the vehicle should always properly wear their safety belts, even when an airbag supplemental restraint system is provided.

The safety belt system consists of:

- lap and shoulder safety belts.
- shoulder safety belt with automatic locking mode, (except driver safety belt).
- height adjuster at the front outboard seating positions
- safety belt pretensioner at the front outboard seating positions.
- 
 - Safety belt warning light and chime. See *Safety Belt Warning Light and Indicator Chime* later in this chapter.
- 
 - Crash sensors and monitoring system with readiness indicator. See *Crash Sensors and Airbag Indicator* in the *Supplemental Restraints System* chapter.

The safety belt pretensioners are designed to activate in frontal, near-frontal and side crashes, and in rollovers. The safety belt pretensioners at the front seating positions are designed to tighten the safety belts firmly against the occupant's body when activated. This helps increase the effectiveness of the safety belts. In frontal crashes, the safety belt pretensioners can be activated alone or, if the crash is of sufficient severity, together with the front airbags.

FASTENING THE SAFETY BELTS

The front outboard and rear safety restraints in your vehicle are combination lap and shoulder belts.

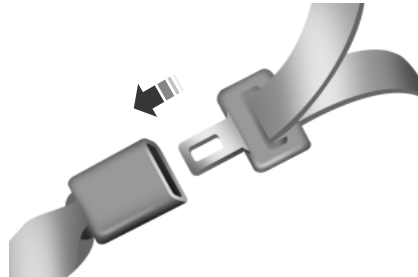

1. Insert the belt tongue into the proper buckle (the buckle closest to the direction the tongue is coming from) until you hear a snap and feel it latch. Make sure the tongue is securely fastened in the buckle.

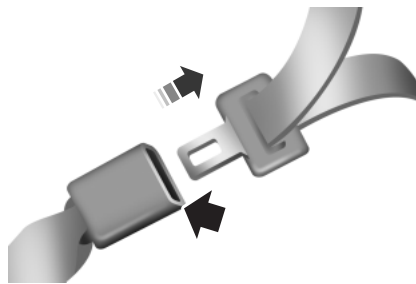

2. To unfasten, press the release button and remove the tongue from the buckle.

Using the Safety Belt with Cinch Tongue (Front Center and Rear Center Seats Only)

The cinch tongue will slide up and down the belt webbing when the belt is stowed or while putting safety belts on. When the lap and shoulder safety belt is buckled, the cinch tongue will allow the lap portion to be shortened, but pinches the webbing to keep the lap portion from getting longer. The cinch tongue is designed to slip during a crash, so always wear the shoulder belt properly and don't allow any slack in either the lap or shoulder portions.

Before you can reach and latch a lap and shoulder belt having a cinch tongue into the buckle, you may have to lengthen the lap belt portion of it.



1. To lengthen the lap belt, pull some webbing out of the shoulder belt retractor.
2. While holding the webbing below the tongue, grasp the tip (metal portion) of the tongue so that it is parallel to the webbing and slide the tongue upward.

3. Provide enough lap belt length so that the tongue can reach the buckle.

Fastening the Cinch Tongue



WARNING: The lap belt should fit snugly and as low as possible around the hips, not across the waist.

1. Pull the lap and shoulder belt from the retractor so that the shoulder belt portion of the safety belt crosses your shoulder and chest.
2. Be sure the belt is not twisted. If the belt is twisted, remove the twist.
3. Insert the belt tongue into the proper buckle for your seating position until you hear a snap and feel it latch.
4. Make sure the tongue is securely fastened to the buckle by pulling on the tongue.

While you are fastened in the safety belt, the lap and shoulder belt with a cinch tongue adjusts to your movement. However, if you brake hard, turn hard, or if your vehicle receives an impact of 5 mph (8 km/h) or more, the safety belt will become locked and help reduce your forward movement.

Restraint of Pregnant Women

 **WARNING:** Always ride and drive with your seat back upright and the safety belt properly fastened. The lap portion of the safety belt should fit snug and be positioned low across the hips. The shoulder portion of the safety belt should be positioned across the chest. Pregnant women should also follow this practice. See the following figure.

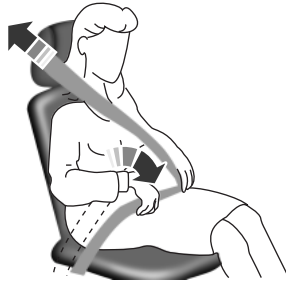

Pregnant women should always wear their safety belts. The lap belt portion of a combination lap and shoulder belt should be positioned low across the hips below the belly and worn as tight as comfort will allow. The shoulder belt should be positioned to cross the middle of the shoulder and the center of the chest.

Safety Belt Locking Modes

 **WARNING:** After any vehicle crash, the safety belt system at all passenger seating positions must be checked by an authorized dealer to verify that the automatic locking retractor feature for child seats is still functioning properly. In addition, all safety belts should be checked for proper function.

 **WARNING:** BELT AND RETRACTOR ASSEMBLY MUST BE REPLACED if the safety belt assembly automatic locking retractor feature or any other safety belt function is not operating properly when checked by an authorized dealer. Failure to replace the belt and retractor assembly could increase the risk of injury in crashes.

All safety restraints in the vehicle are combination lap and shoulder belts. The driver safety belt has the first type of locking mode, and the front outboard passenger and rear seat safety belts have both types of locking modes described as follows:

Vehicle Sensitive Mode

This is the normal retractor mode, which allows free shoulder belt length adjustment to your movements and locking in response to vehicle movement. For example, if the driver brakes suddenly or turns a corner sharply, or the vehicle receives an impact of about 5 mph (8 km/h) or more, the combination safety belts will lock to help reduce forward movement of the driver and passengers.

In addition, the retractor is designed to lock if the webbing is pulled out too quickly. If this occurs, let the belt retract slightly and pull webbing out again in a slow and controlled manner.

Automatic Locking Mode

In this mode, the shoulder belt is automatically pre-locked. The belt will still retract to remove any slack in the shoulder belt. The automatic locking mode is not available on the driver safety belt.

When to Use the Automatic Locking Mode

This mode should be used any time a child safety seat, except a booster, is installed in passenger front or rear seating positions. Children 12 years old and under should be properly restrained in a rear seating position whenever possible. See the *Child Safety* chapter.

How to Use the Automatic Locking Mode

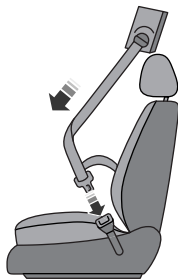

1. Buckle the combination lap and shoulder belt.
2. Grasp the shoulder portion and pull downward until the entire belt is pulled out.
3. Allow the belt to retract. As the belt retracts, you will hear a clicking sound. This indicates the safety belt is now in the automatic locking mode.

How to Disengage the Automatic Locking Mode

Unbuckle the combination lap and shoulder belt and allow it to retract completely to disengage the automatic locking mode and activate the vehicle sensitive (emergency) locking mode.

Safety Belt Extension Assembly

WARNING: Do not use extensions to change the fit of the shoulder belt across the torso.

If the safety belt is too short when fully extended, you can obtain a safety belt extension assembly from an authorized dealer.

Use only extensions manufactured by the same supplier as the safety belt. Manufacturer identification is located at the end of the webbing on the label. Also, use the safety belt extension only if the safety belt is too short for you when fully extended.

SAFETY BELT HEIGHT ADJUSTMENT

WARNING: Position the safety belt height adjusters so that the belt rests across the middle of your shoulder. Failure to adjust the safety belt properly could reduce the effectiveness of the safety belt and increase the risk of injury in a crash.

Adjust the height of the shoulder belt so the belt rests across the middle of your shoulder.

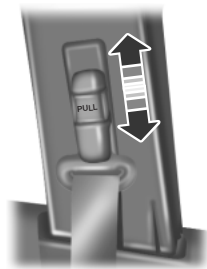

To adjust the shoulder belt height:

1. Pull on the center button and slide the height adjuster up or down.
2. Release the button and pull down on the height adjuster to make sure it is locked in place.

SAFETY BELT WARNING LIGHT AND INDICATOR CHIME



This lamp illuminates and an audible warning will sound if the driver's safety belt has not been fastened when the vehicle's ignition is turned on.

Conditions of Operation

| If... | Then... |
|---|---|
| The driver's safety belt is not buckled before the ignition switch is turned to the on position... | The safety belt warning light illuminates 1-2 minutes and the warning chime sounds 4-8 seconds. |
| The driver's safety belt is buckled while the indicator light is illuminated and the warning chime is sounding... | The safety belt warning light and warning chime turn off. |
| The driver's safety belt is buckled before the ignition switch is turned to the on position... | The safety belt warning light and indicator chime remain off. |

SAFETY BELT-MINDER®

This feature supplements the safety belt warning function by providing additional reminders by intermittently sounding a chime and illuminating the safety belt warning light when the driver's seat is occupied and the safety belt is unbuckled.

| If... | Then... |
|--|---|
| The driver's safety belt is buckled before the ignition switch is turned to the on position or less than 1-2 minutes have elapsed since the ignition switch has been turned to on... | The Belt-Minder feature will not activate. |
| The driver's safety belt is not buckled when the vehicle has reached at least 6 mph (9.7 km/h) and 1-2 minutes have elapsed since the ignition switch has been turned to on... | The Belt-Minder feature is activated - the safety belt warning light illuminates and the warning chime sounds for six seconds every 25 seconds, repeating for about five minutes or until the safety belts are buckled. |

| If... | Then... |
|--|---|
| The driver's safety belt becomes unbuckled for about one minute while the vehicle is traveling at least 6 mph (9.7 km/h) and more than 1-2 minutes have elapsed since the ignition switch has been turned to on... | The Belt-Minder feature is activated - the safety belt warning light illuminates and the warning chime sounds for six seconds every 25 seconds, repeating for about five minutes or until the safety belts are buckled. |

Deactivating and Activating the Belt-Minder® Feature (Driver Only)



WARNING: While the design allows you to deactivate your Belt-Minder, this system is designed to improve your chances of being safely belted and surviving an accident. We recommend you leave the Belt-Minder system activated for yourself and others who may use the vehicle. To reduce the risk of injury, do not deactivate or activate the Belt-Minder feature while driving the vehicle.

Note: If you are using MyKey®, the Belt-Minder cannot be disabled. Also, if the Belt-Minder has been previously disabled, it will be re-enabled during the use of MyKey®. See the *MyKey®* chapter.

Read Steps 1 - 4 thoroughly before proceeding with the programming procedure.

Before following the procedure, make sure that:

- the parking brake is set
 - the transmission selector lever is in position **P**
 - the ignition is off
 - all vehicle doors are closed
 - the driver's safety belt is unbuckled
 - the parking lamps and headlamps are off.
1. Turn the ignition on. DO NOT START THE ENGINE.
 2. Wait until the safety belt warning light turns off (about one minute).
- Step 3 must be completed within 30 seconds after the safety belt warning light turns off.

3. Buckle then unbuckle the safety belt three times at a moderate speed, ending with the safety belt in the unbuckled state.

- After Step 3 is complete, the safety belt warning light will be turned on for three seconds.

4. Within seven seconds of the light turning on, buckle then unbuckle the safety belt.

- This will disable the Belt-Minder feature if it is currently enabled.
- This will enable the Belt-Minder feature if it is currently disabled.

CHILD RESTRAINT AND SAFETY BELT MAINTENANCE

Inspect the vehicle safety belts and child safety seat systems periodically to make sure they work properly and are not damaged. Inspect the vehicle and child seat safety belts to make sure there are no nicks, tears or cuts. Replace if necessary. All vehicle safety belt assemblies, including retractors, buckles, front safety belt buckle assemblies, buckle support assemblies (slide bar-if equipped), shoulder belt height adjusters (if equipped), shoulder belt guide on seat back (if equipped), child safety seat LATCH and tether anchors, and attaching hardware, should be inspected after a crash. Read the child restraint manufacturer's instructions for additional inspection and maintenance information specific to the child restraint.

Ford Motor Company recommends that all safety belt assemblies in use in vehicles involved in a crash be replaced. However, if the crash was minor and an authorized dealer finds that the belts do not show damage and continue to operate properly, they do not need to be replaced. Safety belt assemblies not in use during a crash should also be inspected and replaced if either damage or improper operation is noted.

For proper care of soiled safety belts, see *Cleaning the Interior* in the *Vehicle Care* chapter.

PRINCIPLES OF OPERATION

WARNING: Airbags do not inflate slowly or gently, and the risk of injury from a deploying airbag is the greatest close to the trim covering the airbag module.



WARNING: All occupants of your vehicle, including the driver, should always properly wear their safety belts, even when an airbag supplemental restraint system is provided.



WARNING: Always transport children 12 years old and under in the back seat and always properly use appropriate child restraints.



WARNING: Never place your arm over the airbag module as a deploying airbag can result in serious arm fractures or other injuries.



WARNING: Airbags can kill or injure a child in a child seat. NEVER place a rear-facing child seat in front of an active airbag. If you must use a forward-facing child seat in the front seat, move the seat all the way back.



WARNING: Do not attempt to service, repair, or modify the airbag supplemental restraint systems or its fuses. Contact your authorized dealer as soon as possible.



WARNING: Several airbag system components get hot after inflation. Do not touch them after inflation.



WARNING: If the airbag has deployed, the airbag will not function again and must be replaced immediately. If the airbag is not replaced, the unrepaired area will increase the risk of injury in a crash.

The airbags are a supplemental restraint system and are designed to work with the safety belts to help protect the driver and right front passenger from certain upper body injuries. Airbags do not inflate slowly; there is a risk of injury from a deploying airbag.

Note: You will hear a loud bang and see a cloud of harmless powdery residue if an airbag deploys. This is normal.

The airbags inflate and deflate rapidly upon activation. After airbag deployment, it is normal to notice a smoke-like, powdery residue or smell the burnt propellant. This may consist of cornstarch, talcum powder (to lubricate the bag) or sodium compounds (for example, baking soda) that result from the combustion process that inflates the airbag. Small amounts of sodium hydroxide may be present which may irritate the skin and eyes, but none of the residue is toxic. While the system is designed to help reduce serious injuries, contact with a deploying airbag may also cause abrasions or swelling. Temporary hearing loss is also a possibility as a result of the noise associated with a deploying airbag. Because airbags must inflate rapidly and with considerable force, there is the risk of death or serious injuries, such as fractures, facial and eye injuries or internal injuries, particularly to occupants who are not properly restrained or are otherwise out of position at the time of airbag deployment. Thus, it is extremely important that occupants be properly restrained as far away from the airbag module as possible while maintaining vehicle control.

Routine maintenance of the airbags is not required.

SOS POST-CRASH ALERT SYSTEM™

The system flashes the turn signal lamps and sounds the horn (intermittently) in the event of a serious impact that deploys an airbag equipped on your vehicle, such as front, side, side curtain or Safety Canopy®.

The horn and lamps will turn off when:

- the hazard control button is pressed
- the panic button (if equipped) is pressed on the remote entry transmitter, or
- your vehicle runs out of power.

48 Supplementary Restraints System

DRIVER AND PASSENGER AIRBAGS

 **WARNING:** Never place your arm or any objects over an airbag module. Placing your arm over a deploying airbag can result in serious arm fractures or other injuries. Objects placed on or over the airbag inflation area may cause those objects to be propelled by the airbag into your face and torso causing serious injury.

 **WARNING:** Airbags can kill or injure a child in a child seat. Never place a rear-facing child seat in front of an active airbag. If you must use a forward-facing child seat in the front seat, move the seat all the way back.

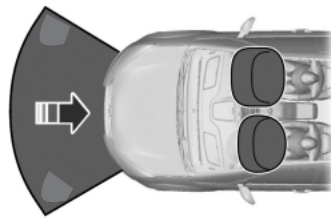

The driver and front passenger airbags will deploy during significant frontal and near frontal crashes.

The driver and passenger front airbag system consists of:

- driver and passenger airbag modules
-  • crash sensors and monitoring system with readiness indicator. See *Crash Sensors and Airbag Indicator* later in this chapter.

Proper Driver and Front Passenger Seating Adjustment

 **WARNING:** The National Highway Traffic Safety Administration recommends a minimum distance of at least 10 inches (25 centimeters) between an occupant's chest and the driver airbag module.

To properly position yourself away from the airbag:

- Move your seat to the rear as far as you can while still reaching the pedals comfortably.
- Recline the seat slightly (one or two degrees) from the upright position.

After all occupants have adjusted their seats and put on safety belts, it is very important that they continue to sit properly. Properly seated occupants sit upright, lean against the seat back, and center themselves on the seat cushion, with their feet comfortably extended on the floor. Sitting improperly can increase the chance of injury in a crash event. For example, if an occupant slouches, lies down, turns sideways, sits forward, leans forward or sideways, or puts one or both feet up, the chance of injury during a crash is greatly increased.

Children and Airbags

 **WARNING:** Airbags can kill or injure a child in a child seat. Never place a rear-facing child seat in front of an active airbag. If you must use a forward-facing child seat in the front seat, move the seat all the way back.



Children must always be properly restrained. Accident statistics suggest that children are safer when properly restrained in the rear seating positions than in the front seating position. Failure to follow these instructions may increase the risk of injury in a crash.

50 Supplementary Restraints System

If two adults and a child occupy a Regular Cab, properly restrain the child in the center front unless doing so would interfere with driving your vehicle. This provides lap and shoulder belt protection for all occupants, and airbag protection for the adults. A child or infant properly restrained in the center front seat should not incur risk of serious injury from the airbags.

FRONT PASSENGER SENSING SYSTEM



WARNING: Even with Advanced Restraints Systems, children 12 and under should be properly restrained in a rear seating position.



WARNING: The front passenger airbag is not designed to offer protection to an occupant in the center seating position.

High-series vehicles (if equipped)



The front passenger sensing system uses a passenger airbag status indicator that will illuminate, indicating that the front passenger frontal airbag is either **ON** (enabled) or **OFF** (disabled). The indicator lamp is located by the radio.

Note: The passenger airbag status indicator **OFF** and **ON** lamps will illuminate for a short period of time when the ignition is first turned on to confirm it is functional.

| Switch position | Passenger Airbag Status Indicator | Passenger Airbag |
|-----------------|-----------------------------------|------------------|
| Off | OFF: Lit | Disabled |
| | ON: Unlit | |
| On | OFF: Unlit | Enabled |
| | ON: Lit | |

Low-series vehicles (if equipped)

The front passenger sensing system uses a pass airbag off indicator which will illuminate and stay lit to remind you that the front passenger frontal airbag is disabled. The indicator lamp is located by the radio.

Note: The indicator lamp will illuminate for a short period of time when the ignition is first turned on to confirm it is functional.

Passenger Airbag ON/OFF Switch (if equipped)

 **WARNING:** An airbag ON/OFF switch may be installed in this vehicle. Before driving, always look at the face of the switch to be sure the switch is in the proper position in accordance with these instructions and warnings. Failure to put the switch in a proper position can increase the risk of serious injury or death in a collision.

Turning the Passenger Airbag Off

 **WARNING:** If the light fails to illuminate when the passenger air bag switch is off and the ignition is on, have the passenger air bag switch serviced at your authorized dealer immediately.

 **WARNING:** In order to avoid inadvertent activation of the switch, always remove the ignition key from the passenger air bag ON/OFF switch.

 **WARNING:** An infant in a rear-facing seat faces a high risk of serious or fatal injuries from a deploying passenger airbag. Rear facing infant seats should NEVER be placed in the front seats, unless the passenger airbag is turned off.

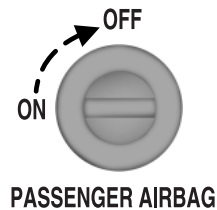

1. Insert the ignition key, turn the switch off and hold in off while removing the key.
2. When the ignition is turned on, the pass airbag off light illuminates briefly, momentarily shuts off and then turns back on. This indicates that the passenger airbag is deactivated.

Turning the Passenger Airbag Back On

 **WARNING:** The safety belts for the driver and right front passenger seating positions have been specifically designed to function together with the airbags in certain types of crashes. When you turn OFF your airbag, you not only lose the protection of the airbag, you also may reduce the effectiveness of your safety belt system, which was designed to work with the airbag. If you are not a person who meets the requirements stated in the NHTSA/Transport Canada deactivation criteria turning OFF the airbag can increase the risk of serious injury or death in a collision.

 **WARNING:** If your vehicle has rear seats, always transport children who are 12 and younger in the rear seat. Always use safety belts and child restraints properly. DO NOT place a child in a rear facing infant seat in the front seat unless your vehicle is equipped with an airbag ON/OFF switch and the passenger airbag is turned OFF. This is because the back of the infant seat is too close to the inflating airbag and the risk of a fatal injury to the infant when the airbag inflates is substantial.

 **WARNING:** If the pass airbag off light is illuminated when the passenger airbag switch is on and the ignition is on, have the passenger airbag switch serviced at your authorized dealer immediately.

The passenger airbag remains off until you turn it back on.

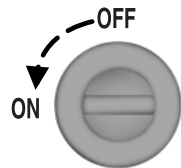

PASSENGER AIRBAG

1. Insert the ignition key and turn the ignition on.
2. The pass airbag off light will briefly illuminate when the ignition is turned to on. This indicates that the passenger airbag is operational.

The passenger side airbag should always be ON (the pass airbag off light should not be illuminated) unless the passenger is a person who meets the requirements stated either in Category 1, 2 or 3 of the NHTSA/Transport Canada deactivation criteria which follows.

The vast majority of drivers and passengers are much safer with an airbag than without. To do their job and reduce the risk of life threatening injuries, airbags must open with great force, and this force can pose a potentially deadly risk in some situations, particularly when a front seat occupant is not properly buckled up. The most effective way to reduce the risk of unnecessary airbag injuries without reducing the overall safety of the vehicle is to make sure all occupants are properly restrained in the vehicle, especially in the front seat. This provides the protection of safety belts and permits the airbags to provide the additional protection they were designed to provide. If you choose to deactivate your airbag, you are losing the very significant risk reducing benefits of the airbag and you are also reducing the effectiveness of the safety belts, because safety belts in modern vehicles are designed to work as a safety system with the airbags.

NHTSA Deactivation Criteria (Excluding Canada)



WARNING: This vehicle has special energy management safety belts for the driver and right front passenger. These particular belts are specifically designed to work with airbags to help reduce the risk of injury in a collision. The energy management safety belt is designed to give or release additional belt webbing in some accidents to reduce concentration of force on an occupant's chest and reduce the risk of certain bone fractures and injuries to underlying organs. In a crash, if the airbag is turned OFF, this energy management safety belt might permit the person wearing the belt to move forward enough to incur a serious or fatal injury. The more severe the crash, and the heavier the occupant, the greater the risk is. Be sure the airbag is turned ON for any person who does not qualify under the NHTSA deactivation criteria.

1. **Infant.** An infant (less than 1 year old) must ride in the front seat because:
 - the vehicle has no rear seat;
 - the vehicle has a rear seat too small to accommodate a rear-facing infant seat; or
 - the infant has a medical condition which, according to the infant's physician, makes it necessary for the infant to ride in the front so that the driver can constantly monitor the child's condition.
2. **Child age 1 to 12.** A child age 1 to 12 must ride in the front seat because:
 - the vehicle has no rear seat;
 - although children ages 1 to 12 ride in the rear seat(s) whenever possible, children ages 1 to 12 sometimes must ride in the front because no space is available in the rear seat(s) of the vehicle; or
 - the child has a medical condition which, according to the child's physician, makes it necessary for the child to ride in the front seat so that the driver can constantly monitor the child's condition.

3. **Medical condition.** A passenger has a medical condition which, according to his or her physician:

- causes the passenger airbag to pose a special risk for the passenger; and
- makes the potential harm from the passenger airbag in a crash greater than the potential harm from turning OFF the airbag and allowing the passenger, even if belted, to hit the dashboard or windshield in a crash.

Transport Canada Deactivation Criteria (Canada Only)



WARNING: This vehicle has special energy management safety belts for the driver and right front passenger. These particular belts are specifically designed to work with airbags to help reduce the risk of injury in a collision. The energy management safety belt is designed to give or release additional belt webbing in some accidents to reduce concentration of force on an occupant's chest and reduce the risk of certain bone fractures and injuries to underlying organs. In a crash, if the airbag is turned OFF, this energy management safety belt might permit the person wearing the belt to move forward enough to incur a serious or fatal injury. The more severe the crash, and the heavier the occupant, the greater the risk is. Be sure the airbag is turned ON for any person who does not qualify under the NHTSA deactivation criteria.

1. **Infant:** An infant (less than 1 year old) must ride in the front seat because:

- my vehicle has no rear seat;
- the rear seat in my vehicle cannot accommodate a rear-facing infant seat; or
- the infant has a medical condition which, according to the infant's physician, makes it necessary for the infant to ride in the front seat so that the driver can monitor the infant's condition.

2. **Child age 12 or under:** A child age 12 or under must ride in the front seat because:

- my vehicle has no rear seat;
- although children age 12 and under ride in the rear seat whenever possible, children age 12 and under have no option but to sometimes ride in the front seat because rear seat space is insufficient; or

56 Supplementary Restraints System

- the child has a medical condition that, according to the child's physician, makes it necessary for the child to ride in the front seat so that the driver can monitor the child's condition.
3. **Medical condition:** A passenger has a medical condition that, according to his or her physician:
- poses a special risk for the passenger if the airbag deploys; and
 - makes the potential harm from the passenger airbag deployment greater than the potential harm from turning OFF the airbag and experiencing a crash without the protection offered by the airbag

SIDE AIRBAGS



WARNING: Do not place objects or mount equipment on or near the airbag cover, on the side of the seat backs (of the front seats), or in front seat areas that may come into contact with a deploying airbag. Failure to follow these instructions may increase the risk of personal injury in the event of a crash.



WARNING: Do not use accessory seat covers. The use of accessory seat covers may prevent the deployment of the side airbags and increase the risk of injury in an accident.



WARNING: Do not lean your head on the door. The side airbag could injure you as it deploys from the side of the seat back.



WARNING: Do not attempt to service, repair, or modify the airbag, its fuses or the seat cover on a seat containing an airbag, as you could be seriously injured or killed. Contact your authorized dealer as soon as possible.



WARNING: If the side airbag has deployed, the airbag will not function again. The side airbag system (including the seat) must be inspected and serviced by an authorized dealer. If the airbag is not replaced, the unrepaired area will increase the risk of injury in a crash.

The side airbags are located on the outboard side of the seat backs of the front seats. In certain sideways crashes, the airbag on the side affected by the crash will be inflated. The airbag was designed to inflate between the door panel and occupant to further enhance the protection provided occupants in side impact crashes.



The system consists of the following:

- a label or embossed side panel indicating that side airbags are found on your vehicle
- side airbags located inside the seat back of the driver and front passenger seats



- crash sensors and monitoring system with readiness indicator. See *Crash Sensors and Airbag Indicator* later in this chapter.

The design and development of the side airbag system included recommended testing procedures that were developed by a group of automotive safety experts known as the Side Airbag Technical Working Group. These recommended testing procedures help reduce the risk of injuries related to the deployment of side airbags.

SAFETY CANOPY® CURTAIN AIRBAGS



WARNING: Do not place objects or mount equipment on or near the headliner at the siderail that may come into contact with a deploying curtain airbag. Failure to follow these instructions may increase the risk of personal injury in the event of a crash.





WARNING: Do not lean your head on the door. The curtain airbag could injure you as it deploys from the headliner.



WARNING: Do not attempt to service, repair, or modify the curtain airbags, its fuses, the A, B, or C pillar trim, or the headliner on a vehicle containing curtain airbags, as you could be seriously injured or killed. Contact your authorized dealer as soon as possible.

58 Supplementary Restraints System

 **WARNING:** All occupants of your vehicle including the driver should always wear their safety belts even when an airbag supplemental restraint system and curtain airbag is provided. Failure to properly wear your safety belt could seriously increase the risk of injury or death.

 **WARNING:** To reduce risk of injury, do not obstruct or place objects in the deployment path of the curtain airbag.

 **WARNING:** If the curtain airbags have deployed, the curtain airbags will not function again. The curtain airbags (including the A, B and C pillar trim and headliner) must be inspected and serviced by an authorized dealer. If the curtain airbag is not replaced, the unrepaired area will increase the risk of injury in a crash.

The Safety Canopy will deploy during significant side crashes or when a certain likelihood of a rollover event is detected by the rollover sensor. The Safety Canopy is mounted to the roof side-rail sheet metal, behind the headliner, above each row of seats. In certain sideways crashes or rollover events, the Safety Canopy will be activated, regardless of which seats are occupied. The Safety Canopy is designed to inflate between the side window area and occupants to further enhance protection provided in side impact crashes and rollover events.

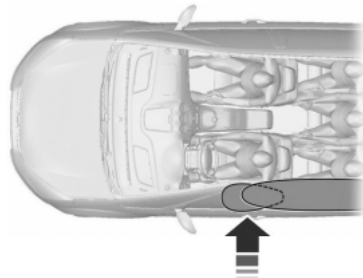

The system consists of:

- safety canopy curtain airbags located above the trim panels over the front and rear side windows identified by wording on the B-pillar trim.
- a flexible headliner which opens above the side doors to allow air curtain deployment.
-  crash sensors and monitoring system with readiness indicator. See *Crash Sensors and Airbag Indicator* in this chapter.

Children 12 years old and under should always be properly restrained in the rear seats. The Safety Canopy will not interfere with children restrained using a properly installed child or booster seat because it is designed to inflate downward from the headliner above the doors along the side window opening.

The design and development of the Safety Canopy included recommended testing procedures that were developed by a group of automotive safety experts known as the Side Airbag Technical Working Group. These recommended testing procedures help reduce the risk of injuries related to the deployment of side airbags (including the Safety Canopy).

CRASH SENSORS AND AIRBAG INDICATOR



WARNING: Modifying or adding equipment to the front end of your vehicle (including frame, bumper, front end body structure and tow hooks) may affect the performance of the airbag system, increasing the risk of injury. Do not modify the front end of your vehicle.

Your vehicle has a collection of crash and occupant sensors which provide information to the restraints control module which deploys (activates) the front safety belt pretensioners, driver airbag, passenger airbag, seat mounted side airbags, and the Safety Canopy. Based on the type of accident (frontal impact, side impact or rollover) the restraints control module will deploy the appropriate safety devices.

The restraints control module also monitors the readiness of the above safety devices plus the crash and occupant sensors. The readiness of the safety system is indicated by a warning indicator light in the instrument cluster or by a backup tone if the warning light is not working. See the *Instrument Cluster* chapter. Routine maintenance of the airbag is not required.

A difficulty with the system is indicated by one or more of the following:



- The readiness light will either flash or stay lit.
- The readiness light will not illuminate immediately after the ignition is turned on.
- A series of five beeps will be heard. The tone pattern will repeat periodically until the problem or light are repaired.

60 **Supplementary Restraints System**

If any of these things happen, even intermittently, have the supplemental restraint system serviced at an authorized dealer immediately. Unless serviced, the system may not function properly in the event of a crash.

The safety belt pretensioners and the airbag supplemental restraint system are designed to activate when the vehicle sustains frontal or sideways deceleration sufficient to cause the restraints control module to deploy a safety device or when a certain likelihood of a rollover event is detected by the rollover sensor.

The fact that the safety belt pretensioners or airbags did not activate for both front seat occupants in a crash does not mean that something is wrong with the system. Rather, it means the restraints control module determined the accident conditions (such as crash severity, belt usage) were not appropriate to activate these safety devices.

- The design of the front airbags is to activate only in frontal and near-frontal crashes (not rollovers, side impacts or rear impacts) unless the crash causes sufficient frontal deceleration.
- The design of the safety belt pretensioners is to activate in frontal, near-frontal and side crashes, and in rollovers.
- The design of the side airbags is to inflate in certain side impact crashes. Side airbags may activate in other types of crashes if the vehicle experiences sufficient sideways motion or deformation.
- The design of the Safety Canopy is to inflate in certain side impact crashes or rollover events. The Safety Canopy may activate in other types of crashes if the vehicle experiences sufficient sideways motion or deformation, or a certain likelihood of rollover.

AIRBAG DISPOSAL

Contact your authorized dealer as soon as possible. Airbags **MUST BE** disposed of by qualified personnel.

GENERAL INFORMATION ON RADIO FREQUENCIES

This device complies with part 15 of the FCC Rules and with Industry Canada license-exempt RSS standard(s). Operation is subject to the following two conditions: (1) This device may not cause harmful interference, and (2) This device must accept any interference received, including interference that may cause undesired operation.

Note: Changes or modifications not expressly approved by the party responsible for compliance could void the user's authority to operate the equipment. The term **IC** before the radio certification number only signifies that Industry Canada technical specifications were met.

The typical operating range for your transmitter is approximately 33 feet (10 meters). Vehicles with the remote start feature will have a greater range. A decrease in operating range could be caused by:

- weather conditions
- nearby radio towers
- structures around your vehicle
- other vehicles parked next to your vehicle.

The radio frequency used by your remote control can also be used by other short-distance radio transmissions, for example amateur radios, medical equipment, wireless headphones, remote controls and alarm systems. If the frequencies are jammed, you will not be able to use your remote control. You can lock and unlock the doors with the key.

Note: Make sure your vehicle is locked before leaving it unattended.

Note: If you are in range, the remote control will operate if you press any button unintentionally.

REMOTE CONTROL

Integrated Keyhead Transmitters (IKTs) (If Equipped)



Your vehicle may be equipped with two integrated keyhead transmitters. Use the key blade to start your vehicle and unlock or lock the driver door from outside the vehicle. The transmitter portion functions as the remote control.



Note: Your vehicle's keys came with a security label that provides important key cut information. Keep the label in a safe place for future reference.

Replacing the Battery

Note: Refer to local regulations when disposing of transmitter batteries.

Note: Do not wipe off any grease on the battery terminals or on the back surface of the circuit board.

Note: Replacing the battery will not delete the transmitter from the vehicle. The transmitter should operate normally.

The remote control uses one coin-type three-volt lithium battery CR2032 or equivalent.

Integrated Keyhead Transmitter

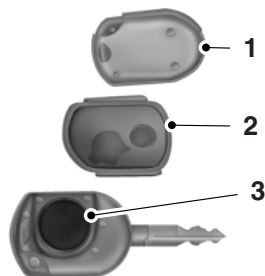

1. Twist a thin coin in the slot near the key ring to remove the battery cover (1).

2. Carefully peel up the rubber gasket (2) from the transmitter if it does not come off with the battery cover.

3. Remove the old battery (3).

4. Insert the new battery. Refer to the instructions inside the integrated keyhead transmitter for the correct orientation of the battery. Press the battery down to ensure that the battery is fully seated in the battery housing cavity.
5. Reinstall the rubber gasket.
6. Snap the battery cover back onto the key.

Memory Feature (If Equipped)

The feature allows the remote control to recall the driver seat, power mirrors and power adjustable foot pedals (if equipped) memory positions.

Press the unlock button on the remote control to recall the memory positions. If the easy entry and exit feature is enabled, the seat will move to the easy entry position. The seat will move to the driver memory position when the key is put in the ignition.

Programming Memory to the Transmitter

1. Move the memory features to the desired positions using the associated controls.



2. Press and hold memory button **1** on the driver door for five seconds. A tone will sound after about two seconds. Continue to hold until a second tone is heard.
 3. Within three seconds press the lock button on the remote control.
 4. Wait 10 seconds, then press the unlock button on the remote control.
- Repeat this procedure for memory button **2** and a second remote control if desired.

Deactivating Memory from the Transmitter

1. Press and hold the desired memory button for five seconds. A tone will sound after about two seconds. Continue to hold until a second tone is heard.
 2. Within three seconds press the unlock button on the remote control.
- Repeat this procedure for each additional transmitter if desired.

Car Finder

Press the button twice within three seconds. The horn will sound and the turn signals will flash. We recommend you use this method to locate your vehicle, rather than using the panic alarm.

Sounding a Panic Alarm

Press the button to activate the alarm. Press the button again or switch the ignition on to deactivate.

Note: The panic alarm will only operate when the ignition is off.

Remote Start (If Equipped)

WARNING: To avoid exhaust fumes, do not use remote start if your vehicle is parked indoors or areas that are not well ventilated.

Note: Do not use remote start if your vehicle is low on fuel.



The remote start button is on the transmitter.

This feature allows you to start your vehicle from outside your vehicle. The transmitter has an extended operating range.

Vehicles with automatic climate control can be configured to operate when the vehicle is remote started. See the *Climate Control* chapter for more information. A manual climate control system will run at the setting it was set to when your vehicle was last turned off.

Many states and provinces have restrictions for the use of remote start. Check your local and state or provincial laws for specific requirements regarding remote start systems.

The remote start system will not work if:

- the ignition is on
- the alarm system is triggered
- you disable the feature
- the hood is not closed
- the transmission is not in **P**
- the vehicle battery voltage is too low
- the service engine soon light is on.

Remote Starting the Vehicle

Note: You must press each button within three seconds of each other. Your vehicle will not remote start and the horn will not chirp if you do not follow this sequence.

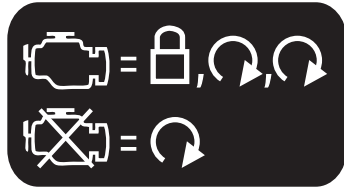

The label on your transmitter details the starting procedure.

To remote start your vehicle:

1. Press the lock button to lock all the doors.
2. Press the remote start button twice. The exterior lamps will flash twice.

The horn will chirp if the system fails to start.

Note: If you remote start your vehicle with an integrated keyhead transmitter, you must switch the ignition on before driving your vehicle. If you remote start your vehicle with an intelligent access transmitter, you must have a programmed intelligent access key inside your vehicle and press the **START/STOP** button on the instrument panel once while applying the brake pedal before driving your vehicle.

The power windows will be inhibited during the remote start and the radio will not turn on automatically.

The parking lamps will remain on and your vehicle will run for 5, 10, or 15 minutes, depending on the setting. See the *Information Displays* chapter to select the duration of the remote start system.

Extending the Vehicle Run Time

Repeat Steps 1 and 2 with your vehicle still running to extend the run time for another remote start duration. If the duration is set to last 10 minutes, the duration will extend by another 10 minutes beginning after what is left of the first activation time. For example, if your vehicle had been running from the first remote start for five minutes, your vehicle will continue to run now for a total of 15 minutes.

Wait at least five seconds before remote starting after a vehicle shutdown.

Turning the Vehicle Off After Remote Starting

Press the button once. The parking lamps will turn off.

You may have to be closer to your vehicle than when starting due to ground reflection and the added noise of the running vehicle.

You can disable or enable the remote start system through the information display. See the *Information Display* chapter.

REPLACING A LOST KEY OR REMOTE CONTROL

You can purchase replacement or additional keys or remote controls from an authorized dealer. A dealer can program the transmitters to your vehicle or you may be able to program them yourself. See the *Security* chapter for information on programming your transmitters.

PRINCIPLES OF OPERATION

MyKey allows you to program keys with restricted driving modes to promote good driving habits. All but one of the keys programmed to the vehicle can be activated with these restricted modes.

Any keys that have not been programmed are referred to as administrator keys or admin keys. These can be used to:

- create a MyKey
- program configurable MyKey settings
- clear all MyKey features.

When you have programmed a MyKey, you can access the following information using the information display:

- How many admin keys and MyKeys are programmed to your vehicle.
- The total distance your vehicle has traveled using a MyKey.

Note: All MyKeys are programmed to the same settings. You cannot program them individually.

Note: For vehicles with intelligent access key (push-button start) keyless start, when both a MyKey and an admin intelligent access key (fob) are present, the admin fob will be recognized by the vehicle to start the engine.

Standard Settings

These settings activate automatically with a programmed MyKey:

- Belt-Minder. The audible safety belt warning tones continue and do not time out after approximately five minutes. The audio system also mutes until drivers and front passengers fasten their safety belts. (Not available in vehicles equipped with AM/FM only audio systems.)
- Early low fuel. The low-fuel warning activates earlier, giving MyKey drivers more time to refuel.
- Driver assist features, if equipped, remain on and active: Parking aid, Blind Spot Information System (BLIS) with Cross Traffic Alert and the Collision Warning System.

Optional Settings

You can configure these settings while programming a MyKey or change them while using an admin key:

- 80 mph (130 km/h) vehicle speed limit. Drivers receive visual warnings and an audible tone when they reach 80 mph (130 km/h).
- 45, 55 or 65 mph (75, 90, or 105 km/h) vehicle speed warning. Drivers receive visual warnings and an audible tone when they exceed the preselected vehicle speed.
- 45% of the maximum audio system output. The audio system displays a message when drivers attempt to exceed the volume limits.
- AdvanceTrac. Program the system to Always-on and these features, if your vehicle is equipped, cannot be turned off when drivers use a programmed MyKey.

CREATING A MYKEY

Use the information display to create a MyKey.

For Type 1 information displays:

1. Insert the key you want to program into the ignition.
2. Switch the ignition on.
3. Access the main menu within the information display, and press **SETUP** using the information display button until **PRESS RESET TO CREATE MYKEY** displays.
4. Press and release the **RESET** button. The message **HOLD RESET TO CONFIRM MYKEY** will display.
5. Press and hold the **RESET** button for two seconds until **MARK THIS AS RESTRICTED** displays. Wait until **KEY RESTRICTED AT NEXT START** displays, confirming that your key is successfully created.

Make sure you label your key so you can distinguish it from the admin keys.

For Type 2 information display controls:

1. Insert the key you want to program into the ignition.
2. Switch the ignition on.
3. From the main menu within the information display, use the right arrow key **>** or **OK** to select **SETTING** and then **MYKEY**.
4. Press **>** or **OK** to select **CREATE MYKEY**.
5. Hold **OK** as prompted until you see **MARK THIS KEY AS RESTRICTED** in the information display screen.

The key is successfully created. Make sure you label it so you can distinguish it from the admin keys.

You can also program configurable settings for the key(s). Refer to the *Programming/Changing Optional Settings* section.

Programming/Changing Configurable Settings

Use the information display to access your configurable MyKey settings.

1. Switch the ignition on with an admin key.
2. Access the main menu on the information display controls, and select **Settings**, then **MyKey** by pressing **OK** or **>** button.
3. Use the arrow buttons to get to a feature.
4. Press **OK** or **>** to make a selection.

Note: You can clear or change your MyKey settings at any time during the same key cycle as you created the MyKey. Once you have switched the engine off, however, you will need an admin key to change or clear your MyKey settings.

CLEARING ALL MYKEYS

You can clear all MyKeys within the same key cycle as you created the MyKey. If you switch your ignition off, however, you will need to use an admin key to clear your MyKeys.

Note: When you clear your MyKeys, you remove all restrictions and return all MyKeys to their original admin key status at once.

To clear all MyKeys of all MyKey settings, use the information display to do the following:

For Type 1 information display settings:

1. Access the main menu of your information display and press **SETUP** until **PRESS RESET TO CLEAR MYKEY** displays.
2. Press and release the **RESET** button. The display will show **HOLD RESET TO CONFIRM CLEAR**.
3. Press and hold the **RESET** button for two seconds until **ALL MYKEYS CLEARED** displays.

For Type 2 information display settings:

1. Access main menu of your information display and select **Settings**, then **MyKey**.
2. Scroll to **Clear All** and press the **OK** button.
3. Hold the **OK** button until **ALL MYKEYS CLEARED** displays .

CHECKING MYKEY SYSTEM STATUS

You can find information about your programmed MyKeys by using the information display.

MYKEY DISTANCE

Tracks the distance when drivers use a MyKey. The only way to delete the accumulated distance is by using an admin key to clear your MyKey. If the distance does not accumulate as expected, then the intended user is not using the MyKey, or an admin key user recently cleared and then recreated a MyKey.

NUMBER OF MYKEY(S)

Indicates the number of MyKeys programmed to your vehicle. Use this feature to detect how many MyKeys you have for your vehicle and determine when a MyKey has been deleted.

NUMBER OF ADMIN KEY(S)

Indicates how many admin keys are programmed to your vehicle. Use this feature to determine how many unrestricted keys you have for your vehicle, and detect if an additional MyKey has been programmed.

USING MYKEY WITH REMOTE START SYSTEMS

MyKey is not compatible with non-Ford-approved aftermarket remote start systems. If you choose to install a remote start system, please see your Ford authorized dealer for a Ford-approved remote start system.

MYKEY TROUBLESHOOTING

| Condition | Potential causes |
|--|---|
| I cannot create a MyKey. | <ul style="list-style-type: none"> • The key or fob used to start the vehicle does not have admin privileges. • The key or fob used to start the vehicle is the only admin key (there always has to be at least one admin key). • Vehicles with push-button start: The intelligent access key is not in the backup slot. The backup slot location information is in another chapter. See <i>Starting and Stopping the Vehicle</i>. • SecuriLock passive anti-theft system is disabled or in unlimited mode. |
| I cannot program the configurable settings. | <ul style="list-style-type: none"> • The key or fob used to start the vehicle does not have admin privileges. • No MyKeys are created. See <i>Creating a MyKey</i>. |
| I cannot clear the MyKeys. | <ul style="list-style-type: none"> • The key or fob used to start the vehicle does not have admin privileges. • No MyKeys are created. Refer to <i>Creating a MyKey</i>. |
| I lost the only admin key. | <ul style="list-style-type: none"> • Purchase a new key from your authorized dealer. |
| I lost a key. | <ul style="list-style-type: none"> • Program a spare key. See <i>SecuriLock</i> in the <i>Security</i>. |
| No MyKey functions with intelligent access key (push- button start). | <ul style="list-style-type: none"> • An admin fob is present at engine start. • No MyKey has been created. See <i>Creating a MyKey</i>. |
| MyKey distances do not accumulate. | <ul style="list-style-type: none"> • The MyKey user is not using the MyKey. • An admin key holder cleared the MyKeys and created new MyKeys. • The key system has been reset. |

LOCKING AND UNLOCKING

You can use the power door lock control or the remote control to lock and unlock the vehicle.

Power Door Locks (If Equipped)

The power door lock control is located on the driver and front passenger door panels.



A. Unlock

B. Lock

Remote Control

You can use the remote control anytime the vehicle is not running.

Unlocking the Doors (Two-Stage Unlock)

Press the button to unlock the driver's door.

Press the button again within three seconds to unlock all doors. The turn signals will flash.

Press and hold both the lock and unlock buttons on the remote control for four seconds to disable or enable two-stage unlocking. Disabling two-stage unlocking allows all vehicle doors to unlock with one press of the button. The turn signals will flash twice to indicate the unlocking mode was changed. The unlocking mode will be applied to the remote control and keyless entry keypad (if equipped).

Locking the Doors

Press the button to lock all the doors. The turn signals will illuminate.

Press the button again within three seconds to confirm that all the doors are closed. The doors will lock again, the horn will chirp and the turn signals will illuminate if all the doors are closed.

Note: If any door is not closed, or if the hood is not closed on vehicles equipped with an anti-theft alarm or remote start, the horn will chirp twice and the lamps will not illuminate.

Smart Unlocks (If Equipped)

This feature helps to prevent you from locking yourself out of your vehicle if your key is still in the ignition.

When you open the driver door and lock your vehicle with the power door lock control, all the doors will lock then unlock if your key is still in the ignition.

Your vehicle can still be locked with the key in the ignition by:

- using the manual lock button on the door
- locking the driver door with a key
- using the keyless entry keypad (if equipped)
- using the lock button on the remote control (if equipped).

Autolock and Unlock (If Equipped)

The autolock feature will lock all the doors when:

- all doors are closed,
- the ignition is on,
- you shift into any gear putting the vehicle in motion, and
- the vehicle attains a speed greater than 12 mph (20 km/h).

If the vehicle was autolocked, the autounlock feature will unlock all doors when the driver's door is opened within 10 minutes of switching the ignition off.

Enabling or Disabling Autolock and Autounlock

These features can be enabled or disabled:

- by your authorized dealer
- through the information display
- using the power door lock procedure.

To enable or disable using the power door locks, do the following:

Note: You will have 30 seconds to complete the procedure.

1. Switch the ignition on.
2. Press the power door unlock button three times.
3. Switch the ignition off.
4. Press the power door unlock button three times.
5. Switch the ignition on. The horn will chirp indicating the programming mode has been entered.

Autolock: Once in programming mode, press the power door unlock button then the lock button. The horn will chirp once if autolock was deactivated or twice (one short and one long chirp) if autolock was activated.

Autounlock: Once in programming mode, press the power door lock button then the unlock button. The horn will chirp once if autounlock was deactivated or twice (one short and one long chirp) if autounlock was activated.

6. Turn the ignition off. The horn will chirp once to confirm the procedure is complete.

Note: The autounlock feature can be enabled or disabled independently of the autolock feature.

Illuminated Entry

The interior lamps and parking lamps illuminate when the remote entry system is used to unlock the door(s).

The system will turn off the lights if:

- the ignition is turned on
- the lock button on the remote control is pressed
- the vehicle is locked using the keyless entry keypad
- after 25 seconds of illumination.

The dome lamp control (if equipped) must not be set to the off position for the illuminated entry system to operate.

The lights will not turn off if:

- they have been turned on with the dimmer control
- any door is open.

Battery Saver

The battery saver shuts off the interior lamps 30 minutes after you switch the ignition off if you leave a door open and leave the dome lamp switch on. It shuts off the interior lamps after 10 minutes if you leave the dome lamp switch off.

SECURICODE™ KEYLESS ENTRY KEYPAD (IF EQUIPPED)

You can use the keyless entry keypad to lock or unlock the doors without using a key.

The keypad can be operated with the factory-set 5-digit entry code; this code is located on the owner's wallet card in the glove box and is available from your authorized dealer. You can also create up to five of your own 5-digit personal entry codes.

Programming a Personal Entry Code

To create your own personal entry code:

1. Enter the factory-set code.
2. Press the **1•2** on the keypad within five seconds.
3. Enter your personal 5-digit code. You must enter each number within five seconds of each other.
4. For memory recall feature, enter the sixth digit **1•2** to store driver 1 settings or **3•4** to store driver 2 settings.

Note: Pressing **5•6**, **7•8**, or **9•0** keypad numbers as a sixth digit will not recall a driver memory setting.

Note: The factory-set code cannot be associated with a memory setting.

5. The doors will lock and then unlock to confirm that programming is complete.

You may also program a personal entry code through the MyFord Touch or MyLincoln Touch system. Refer to the *MyFord Touch* or *MyLincoln Touch* chapter.

Tips:

- Do not set a code that uses five of the same number.
- Do not use five numbers in sequential order.
- The factory-set code will work even if you have set your own personal code.

Erasing a Personal Code

1. Enter the factory-set 5-digit code.
2. Press and release the **1•2** on the keypad within five seconds.
3. Press and hold the **1•2** for two seconds. This must be done within five seconds of completing Step 2.

All personal codes are now erased and only the factory-set 5-digit code will work.

Anti-Scan Feature

The keypad will go into an anti-scan mode if you enter the wrong code seven times (35 consecutive button presses). This mode disables the keypad for one minute and the keypad lamp will flash.

The anti-scan feature will turn off after:

- one minute of keypad inactivity
- pressing the unlock button on the remote control
- the ignition is turned on.

Unlocking and Locking the Doors

To unlock the driver door: Enter the factory-set 5-digit code or your personal code. You must press each number within five seconds of each other. The interior lamps will illuminate. **Note:** All doors will unlock if the two-stage unlocking feature is disabled. Refer to *Locking and Unlocking* earlier in this chapter.

To unlock all doors: Enter the factory-set code or your personal code, then press the **3•4** control within five seconds.

To lock all doors: Press and hold **7•8** and **9•0** at the same time with the driver door closed. You do not need to enter the keypad code first.

Displaying the Factory Set Code

Note: You will need to have two programmed passive anti-theft keys for this procedure.

To display the factory set code in the information display:

1. Insert a key into the ignition and turn the ignition on for a few seconds.
2. Turn the ignition off and remove the key.
3. Insert the second key into the ignition and turn the ignition on.

The factory set code will display for a few seconds.

Note: The code may not display until after any other warning messages first display.

SECURILOCK® PASSIVE ANTI-THEFT SYSTEM (IF EQUIPPED)

Note: The system is not compatible with non-Ford aftermarket remote start systems. Use of these systems may result in vehicle starting problems and a loss of security protection.

Note: Metallic objects, electronic devices or a second coded key on the same key chain may cause vehicle starting issues if they are too close to the key when starting the engine. Prevent these objects from touching the coded key while starting the engine. Switch the ignition off, move all objects on the key chain away from the coded key and restart the engine if a problem occurs.

Note: Do not leave a duplicate coded key in the vehicle. Always take your keys and lock all doors when leaving the vehicle.

The system is an engine immobilization system. It helps prevent the engine from starting unless a coded key programmed to your vehicle is used. Using the wrong key may prevent the engine from starting. A message may appear in the information display.

If you are unable to start the engine with a correctly coded key, a malfunction has happened and a message may appear in the information display.

Automatic Arming

Your vehicle arms immediately after you switch the ignition off.

Automatic Disarming

Your vehicle disarms when you switch the ignition on with a coded key.

Replacement Keys

Note: Your vehicle may come with two integrated keyhead transmitters. The integrated keyhead transmitter functions as a programmed ignition key that operates all the locks and starts the vehicle, as well as a remote control.

If your programmed transmitters or standard SecuriLock coded keys are lost or stolen and you do not have an extra coded key, you will need to have your vehicle towed to an authorized dealer. The key codes need to be erased from your vehicle and new coded keys will need to be programmed.

Store an extra programmed key away from the vehicle in a safe place to help prevent any inconveniences. See an authorized dealer to purchase additional spare or replacement keys.

Programming a Spare Key

Note: A maximum of eight coded keys can be programmed to your vehicle. Only four of these eight can be integrated keyhead transmitters.

You can program your own integrated keyhead transmitters or standard SecuriLock coded keys to your vehicle. This procedure will program both the engine immobilizer key code and the remote entry portion of the remote control to your vehicle.

Only use integrated keyhead transmitters or standard SecuriLock keys.

You must have two previously programmed coded keys and the new unprogrammed key readily accessible. See your authorized dealer to have the spare key programmed if two previously programmed coded keys are not available.

Read and understand the entire procedure before you begin.

1. Insert the first previously programmed coded key into the ignition.
2. Turn the ignition from off to on. Keep the ignition on for at least three seconds, but no more than 10 seconds.
3. Turn the ignition off and remove the first coded key from the ignition.
4. After three seconds but within 10 seconds of removing the first coded key, insert the second previously coded key into the ignition.
5. Turn the ignition from off to on. Keep the ignition on for at least one second, but no more than 10 seconds.
6. Turn the ignition off and remove the second previously programmed coded key from the ignition.
7. After three seconds but within 10 seconds of turning the ignition off and removing the previously programmed coded key, insert the new unprogrammed key into the ignition.
8. Turn the ignition from off to on. Keep the ignition on for at least one second, but no more than 10 seconds.
9. Remove the newly programmed coded key from the ignition.

The key will start the vehicle's engine and will operate the remote entry system (if the new key is an integrated keyhead transmitter) if it has been successfully programmed.

If the key was not successfully programmed, wait 20 seconds and repeat Steps 1 through 8. Take your vehicle to your authorized dealer to have the new key programmed if you are still unsuccessful.

Wait 20 seconds and then repeat this procedure from Step 1 to program an additional key.

ANTI-THEFT ALARM (IF EQUIPPED)

The system will warn you of unauthorized entry to your vehicle.

The turn signal lamps will flash and the horn will sound when:

- any door or the hood is opened without using the key or the remote control
- the ignition is turned on with an invalid key.

Take all keys and remote controls to your authorized dealer if there is any potential alarm problem with your vehicle.

Arming the Alarm

The system is ready to arm whenever the ignition is off. Lock the vehicle to arm the alarm.

The turn signal lamps will flash once after locking the vehicle to indicate the alarm is in the pre-armed mode and will become fully armed in 20 seconds.

Disarming the Alarm

To disarm the alarm, do any of the following:

- Press the power door unlock button within the 20-second pre-armed mode.
- Press the unlock button on the remote control.
- Unlock the doors with the keyless entry pad.
- Turn the ignition on with a valid key.
- Press the panic button on the remote control. The alarm system will still be armed, but this shuts off the horn and turn lamps when the alarm is sounding.

Note: If the driver's door is unlocked with a key, a chime will sound when you open the door. You will have 12 seconds to disarm the alarm using any of the actions above, otherwise the alarm will trigger.

ADJUSTING THE STEERING WHEEL

WARNING: Do not adjust the steering wheel when your vehicle is moving.

Note: Make sure that you are sitting in the correct position. See *Sitting in the Correct Position* in the *Seats* chapter.

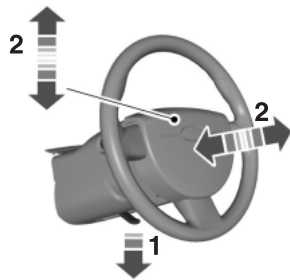

1. Unlock the steering column.
2. Adjust the steering wheel to the desired position.

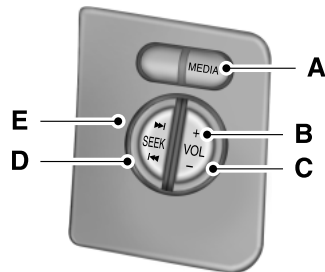

3. Lock the steering column.

AUDIO CONTROL (IF EQUIPPED)

- A. Media
- B. Volume up
- C. Volume down
- D. Seek down or previous
- E. Seek up or next

Media

Press the media button repeatedly to scroll through available audio modes.

Seek, Next or Previous

Press the seek button to:

- tune the radio to the next or previous stored preset
- play the next or previous track.

Press and hold the seek button to:

- tune the radio to the next station up or down the frequency band
- seek through a track.

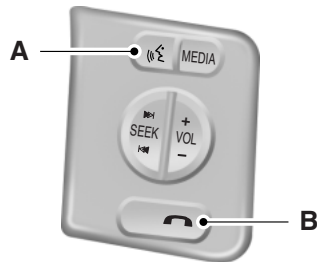
VOICE CONTROL (IF EQUIPPED)

A. Voice recognition

B. Phone mode

See the *SYNC* or *MyFord Touch* chapter.

CRUISE CONTROL (IF EQUIPPED)

See the *Cruise Control* chapter.

INFORMATION DISPLAY CONTROL**Type 1****Type 2**

See the *Information Displays* chapter.

HEATED STEERING WHEEL (IF EQUIPPED)

See the *MyFord Touch* chapter.

ADJUSTABLE PEDALS (IF EQUIPPED)

WARNING: Never adjust the accelerator and brake pedal with feet on the pedals while the vehicle is moving.

The control is located on the left side of the steering column. Press and hold the appropriate control to move the pedals.

- A. Farther
- B. Closer

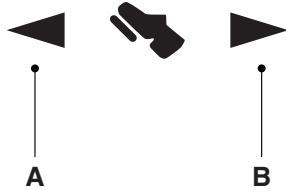

The pedal positions are saved and recalled with the memory feature (if equipped). Refer to the *Seats* chapter.

The pedals should only be adjusted when the vehicle is parked.

WINDSHIELD WIPERS

Note: Fully defrost the windshield in icy conditions before turning on the windshield wipers.

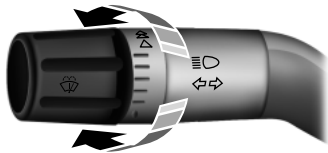

Rotate the end of the control away from you to increase the speed of the wipers. Rotate toward you to decrease the speed of the wipers.

Speed Dependent Wipers

When your vehicle speed increases, the interval between wiper blades will decrease when intermittent wiper is selected.

WINDSHIELD WASHERS

Note: Do not operate the wipers on a dry windshield. This may scratch the glass, damage the wiper blades or cause the wiper motor to burn out. Always use the windshield washer before wiping a dry windshield.

Note: Do not operate the washer when the washer reservoir is empty. This may cause the washer pump to overheat.



Press the end of the stalk to activate the washer.

- A brief press causes a single wipe without washer fluid.
- A quick press and hold causes the wipers to swipe three times with washer fluid.
- A long press and hold will activate the wipers and washer fluid for up to 10 seconds.

A wipe will occur a few seconds after washing to clear any remaining washer fluid. This feature can be turned on and off in the information display.

LIGHTING CONTROL

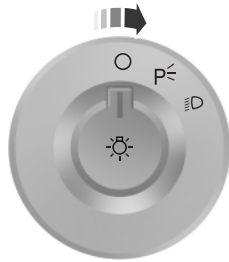

- Rotate the headlamp control clockwise to the first position to turn on the parking lamps.
- Rotate clockwise to the second position to also turn on the headlamps.

High Beams

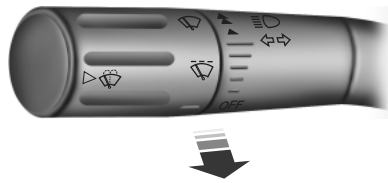

Pull the lever fully past the detent to switch the high beams on.
Pull the lever fully again switch the high beams off.

Headlamp Flasher

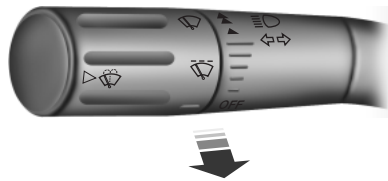

Pull the lever toward you slightly and release it to flash the headlamps.

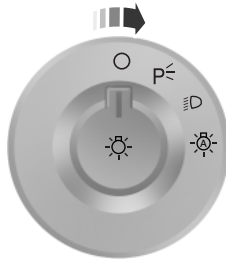
AUTOLAMPS (IF EQUIPPED)

The autolamp system provides light sensitive automatic on-off control of the exterior lights normally controlled by the headlamp control.

- To turn autolamps on, rotate the control to the fourth position.
- To turn autolamps off, rotate the control to the first, second, or third position.

Note: If the vehicle is equipped with autolamps, it will have the headlamps on with windshield wipers feature. If the windshield wipers are turned on, the exterior lamps will turn on with the headlamp control in the autolamp position.

The autolamp system also keeps the lights on for a predetermined amount of time after the ignition switch is turned to off. You can change the amount of time the lamps stay on by using the programming procedure that follows:

Autolamps - Programmable Exit Delay

Programmable exit delay allows the length of the autolamp exit delay to be changed.

To program the auto lamp exit time delay:

1. Start with the ignition in the off position and the headlamp control in the autolamp position.
2. Turn the headlamp control to off.
3. Turn the ignition switch to on and then back to off.
4. Turn the headlamp control to the autolamp position. The headlamps will turn on.
5. Wait the desired amount of time for the exit delay you want (up to three minutes), then turn the headlamps off.

INSTRUMENT LIGHTING DIMMER

Use to adjust the brightness of the instrument panel and all applicable lit components in the vehicle during headlamp and parking lamp operation.

- Tap the top or bottom of the control to brighten/dim all interior lit components incrementally, or
- Press and hold at the first position the top or bottom of the control until the desired lighting level is reached.
- Press and hold the top of the control to the full on position to activate the “dome on” feature. This will turn on the interior courtesy lights. The lights will remain on until the bottom of the control is pressed.

DAYTIME RUNNING LAMPS (DRL) (IF EQUIPPED)

WARNING: Always remember to switch your headlamps on in low light situations or during inclement weather. The system does not activate the tail lamps and may not provide adequate lighting during these conditions. Failure to activate your headlamps under these conditions may result in a collision.

The system switches the headlamps on with a reduced output in daylight conditions.

To switch the system on:

1. Switch the ignition on.
2. Switch the lighting control to the off or parking lamp position.
3. Disengage the parking brake.
4. Make sure the transmission selector lever is not in position P.

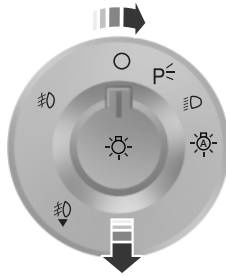
FRONT FOG LAMPS (IF EQUIPPED)

The headlamp control also operates the fog lamps. The fog lamps can be turned on only when the headlamp control is in the parking lamp (second) position, headlamps on (third) position, or autolamp (fourth) position, and the high beams are not turned on.

Pull headlamp control towards you to turn fog lamps on. The fog lamp indicator light will illuminate.

DIRECTION INDICATORS

The turn signal lever does not mechanically lock in the upward or downward position when activated. The turn signal control activation and cancellation is electronic.



- To operate the left turn signal, push the lever down until it stops and release.
- To operate the right turn signal, push the lever up until it stops and release.
- To manually cancel turn signal operation, push the lever again in either direction.

Lane Change

To indicate a left or right lane change:

- Push the lever up/down to the first stop position and release. The turn signals will flash three times and stop.
- Push the lever up/down to the first stop position and hold. The turn signals will flash for as long as the lever is held in this position.

INTERIOR LAMPS**Front Map Lamps (If Equipped)**

The map lamps are located on the overhead console. Press the controls on either side of each map lamp to turn on the lamps. The map lamps also light when:

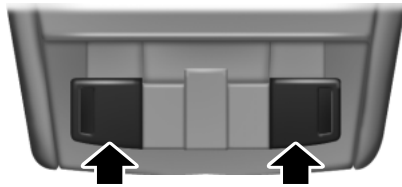

- any door is opened,
- the instrument panel dimmer switch is rotated up until the courtesy lamps come on, and
- any of the remote entry controls are pressed and the ignition is off.

Rear Dome and Map Lamps

Your vehicle may have map lamps within the rear dome lamp. Press the switches on either side of the dome lamp to turn the lamps on.

POWER WINDOWS (IF EQUIPPED)

WARNING: Do not leave children unattended in your vehicle and do not let them play with the power windows. They may seriously injure themselves.



WARNING: When closing the power windows, you should verify they are free of obstructions and make sure that children and pets are not in the proximity of the window openings.

Note: You may hear a rumbling noise when one or both of the rear windows are open. Lower a front window slightly to reduce this noise.

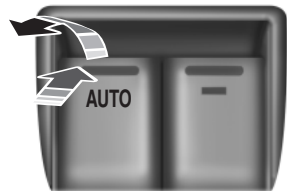

Press the switch to open the window.

Lift the switch to close the window.

One-Touch Up or Down (Front Windows)

Note: The window may be disabled for up to five minutes if it is cycled up and down repeatedly. This helps prevent damage to the motor. Normal operation will resume once the motor cools.

This feature automatically opens or closes the window.

Press or lift the switch completely and release. The window will fully open or close. Press or lift it again to stop the window.

Restoring the One-Touch Up Functionality

Note: Perform one-touch up re-calibration with the door closed. Calibrating with the door open will cause the window to continuously bounce back.

Functionality may be lost under low battery power conditions.

To reset this function after restoring full battery power:

1. Pull the switch to the one-touch up position.
2. Hold the switch until the glass reaches the stall position and continue to hold for two seconds.
3. Press the switch down and operate the window to the full down position. One-touch up will now be functional.

Bounce-Back (One-Touch Up or Down Windows Only)

The window will stop automatically while closing and reverse some distance if there is an obstacle in the way.

Overriding the Bounce-Back Feature

WARNING: When you override the bounce-back feature the window will not reverse if it detects an obstacle. Take care when closing the windows to avoid personal injury.

Pull up the window switch and hold within two seconds of the window reaching the bounce-back position. The window will travel up with no bounce-back protection. The window will stop if you release the switch before the window is fully closed.

Global Open Windows (If Equipped)

Note: The ignition must be off and the accessory delay feature must not be activated in order for this feature to operate.

Note: This feature can be disabled or enabled by your authorized dealer or through the information display. Refer to *Information Displays* chapter.

Press and hold the unlock button on the remote control to begin opening the windows.

Press the lock or unlock button on the remote control to stop motion.

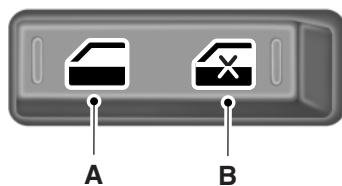
Window Lock

A. Unlock

B. Lock

Press the control to lock or unlock the rear window controls.

Power Sliding Back Window (If Equipped)

 **WARNING:** When operating the power sliding back window you must ensure all rear seat occupants and/or cargo are not in the proximity of the back window.

 **WARNING:** Do not leave children unattended in the vehicle and do not let children play with the power sliding back window. They may seriously injure themselves.

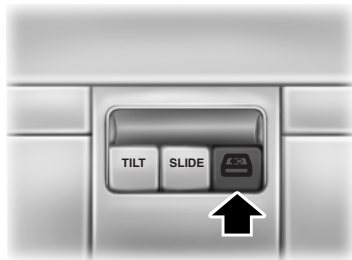

The control is located on the overhead console.

Press and hold the control to open the window. Pull and hold the control to close the window.

Accessory Delay

You can use the window switches for several minutes after you switch the ignition off, or until you open either front door.

EXTERIOR MIRRORS**Power Exterior Mirrors (If Equipped)**

 **WARNING:** Do not adjust the mirror while your vehicle is in motion.

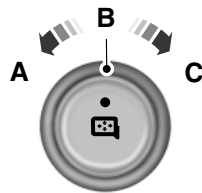

- A. Left mirror
- B. Off
- C. Right mirror

To adjust your mirrors:

1. Select the mirror you want to adjust.
2. Move the control in the direction you want to tilt the mirror.
3. Return the control to the center position to lock mirrors in place.

Fold-Away Exterior Mirrors

Push the mirror toward the door window glass. Make sure that you fully engage the mirror in its support when returning it to its original position.

Power-Folding Mirrors (If Equipped)

Note: Activating the mirrors 10 or more times within one minute, or repeated folding and unfolding of the mirrors while holding the control down during full travel, may disable the system to protect motors from overheating. Wait approximately three minutes with the vehicle running, and up to 10 minutes with the vehicle off, for the system to reset and for function to return to normal.



Pull the control back to fold the mirrors in or out.

Loose Mirror

A mirror may also be manually folded by pulling it toward the door window glass. This may cause the mirror to appear loose and it will need to be re-synchronized. Pull and hold the control to fold the mirrors in until movement stops. A click will be heard indicating re-synchronization. If the click is not heard, use the control to fold the mirrors all the way out, then in again. Once the click is heard the mirrors will operate normally until they are again manually folded.

Heated Exterior Mirror (If Equipped)

The heated exterior mirrors switch on with the heated rear window. See *Heated Windows and Mirrors* in the *Climate Control* chapter.

Memory Mirrors (If Equipped)

You can save and recall the mirror positions through the memory function. See *Memory function* in the *Seats* chapter.

Signal Indicator Mirrors (If Equipped)

The outer portion of the appropriate mirror housing blinks when you activate the turn signal.

Clearance Lamps (If Equipped)

The lower, outer portion of the mirror housings illuminates when the headlamps or parking lamps are switched on.

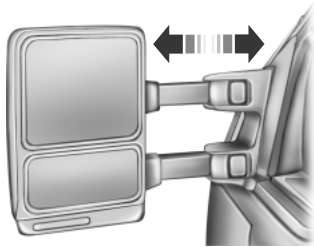
Telescoping Mirrors (If Equipped)

This feature allows the mirror to extend approximately 3 inches (75 millimeters). It is especially useful when towing a trailer. The mirrors can be manually pulled out or pushed in to the desired position.

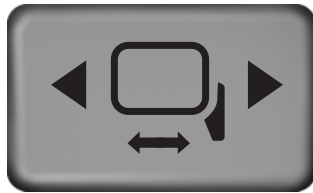
PowerScope® Power Telescoping Mirrors (If Equipped)

This feature lets you position both mirrors at the same time. The switch is on the door trim panel.

To telescope the mirrors out, press and hold the left side of the switch. When the mirrors are fully extended, it is normal to hear the telescoping motors running as long as you continue to hold the switch.

To telescope the mirrors in, press and hold the right side of the switch.

INTERIOR MIRROR

WARNING: Do not adjust the mirror when your vehicle is moving.

Note: Do not clean the housing or glass of any mirror with harsh abrasives, fuel or other petroleum or ammonia based cleaning products.

You can adjust the interior mirror to your preference. Some mirrors also have a second pivot point. This lets you move the mirror head up or down and from side to side.

Pull the tab below the mirror toward you to reduce glare at night.

Auto-Dimming Mirror (If Equipped)

Note: Do not block the sensors on the front and back of the mirror. Mirror performance may be affected. A rear center passenger or raised rear center head restraint may also block light from reaching the sensor. The mirror will dim automatically to reduce glare when bright lights are detected from behind your vehicle. It will automatically return to normal reflection when you select reverse gear to make sure you have a clear view when backing up.

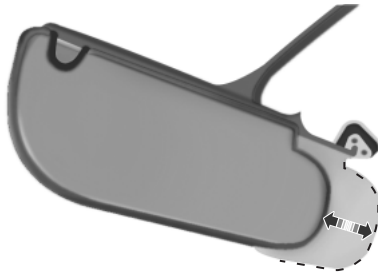
SUN VISORS**Slide-On-Rod (If Equipped)**

Rotate the visor toward the side window and extend it rearward for extra sunlight coverage.

Retract the visor before moving it back toward the windshield and storing it.

Illuminated Visor Vanity Mirror (If Equipped)

Lift the cover to switch on the lamp.

MOONROOF (IF EQUIPPED)

WARNING: Do not let children play with the moonroof or leave children unattended in the vehicle. They may seriously hurt themselves.



WARNING: When closing the moonroof, you should verify that it is free of obstructions and ensure that children and/or pets are not in the proximity of the moonroof opening.

The sliding shade can be manually opened or closed when the moonroof is closed. Pull the shade toward the front of the vehicle to close it.

The moonroof control is located on the overhead console.

The moonroof has a one-touch open and close feature. To stop its motion during the one-touch operation, press the control a second time.

Opening and Closing the Moonroof

Press and release the **SLIDE** control to open the moonroof. The moonroof will stop short of the fully opened position.

Note: This position helps to reduce rumbling wind noise which may happen with the moonroof fully open. Press and release the control again to fully open the moonroof.

Pull and release the **SLIDE** control to close the moonroof.

Bounce-Back

The moonroof will stop automatically while closing and reverse some distance if there is an obstacle detected.

Pull and hold the **SLIDE** control within two seconds of a bounce-back event to override the function. While bounce-back is active, the closing force increases for each of the next three times the moonroof is closed.

Venting the Moonroof

Press and release the **TILT** control to move the moonroof to the vent position. Pull and hold the **TILT** control to close the moonroof.

GAUGES

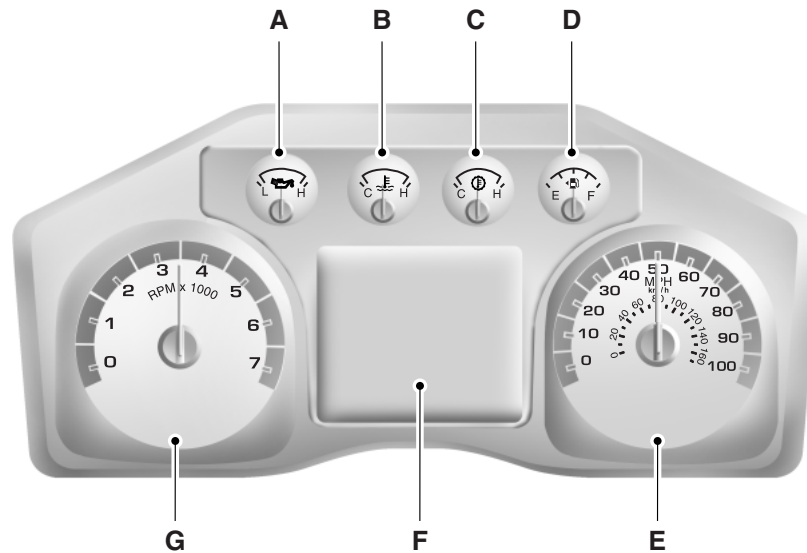

Cluster shown in standard measure. Metric similar.

- A. Engine oil pressure gauge
- B. Engine coolant temperature gauge
- C. Transmission fluid temperature gauge
- D. Fuel gauge
- E. Speedometer
- F. Information display. See *Information displays* for more information.
- G. Tachometer

Engine Oil Pressure Gauge

Indicates engine oil pressure. The needle should stay in the normal operating range. If the needle falls below the normal range, stop the vehicle, turn off the engine and check the engine oil level. Add oil if needed. If the oil level is correct, have your vehicle checked at your authorized dealer.

Engine Coolant Temperature Gauge

Indicates engine coolant temperature. At normal operating temperature, the level indicator will be in the normal range. If the engine coolant temperature exceeds the normal range, stop the vehicle as soon as safely possible, switch off the engine and let the engine cool.



WARNING: Never remove the coolant reservoir cap while the engine is running or hot.

Transmission Fluid Temperature Gauge

Indicates transmission fluid temperature. At normal operating temperature, the level indicator will be in the normal range. If the transmission fluid temperature exceeds the normal range, stop the vehicle as soon as safely possible and verify the airflow is not restricted such as snow or debris blocking airflow through the grill. Also, higher than normal operating temperature can be caused by special operation conditions (i.e. snowplowing, towing or off-road use). Refer to *Special operating conditions in the scheduled maintenance information* for instructions. Operating the transmission for extended periods of time with the gauge in the higher than normal area may cause internal transmission damage. Altering the severity of the driving conditions is recommended to lower the transmission temperature into the normal range. If the gauge continues to show high temperatures, see your authorized dealer.

Fuel Gauge

Indicates approximately how much fuel is left in the fuel tank (when the ignition is on). The fuel gauge may vary slightly when the vehicle is in motion or on a grade. The fuel icon and arrow indicates which side of the vehicle the fuel filler door is located.

Information Display**Odometer**

Located in the bottom of the information display Registers the accumulated distance your vehicle has travelled.

Trip Computer

See *Trip A/B* in *Information Displays*.

Vehicle Settings and Personalization

See *Information Displays*.

WARNING LAMPS AND INDICATORS

The following warning lamps and indicators will alert you to a vehicle condition that may become serious. Some lamps will illuminate when you start your vehicle to make sure they work. If any lamps remain on after starting your vehicle, refer to the respective system warning lamp for further information.

Note: Some warning indicators appear in the information display and function the same as a warning lamp but do not display when you start your vehicle.

Airbag – Front

If it fails to illuminate on startup, continues to flash or remains on, it indicates a malfunction. Have the system checked by your authorized dealer. A chime will sound when there is a malfunction in the indicator light.

Anti-Lock Braking System

If it illuminates when you are driving, this indicates a malfunction. You will continue to have the normal braking system (without ABS) unless the brake warning lamp is also illuminated. Have the system checked by your authorized dealer.

Battery

If it illuminates while driving, it indicates a malfunction. Switch off all unnecessary electrical equipment and have the system checked by your authorized dealer.

Brake System

It will illuminate when the parking brake is engaged and the ignition is on.

If it illuminates when you are driving, check that the parking brake is not engaged. If the parking brake is not engaged, this indicates low brake fluid level or a brake system malfunction. Have the system checked immediately by your authorized dealer.



WARNING: Driving a vehicle with the brake system warning light on is dangerous. A significant decrease in braking performance may occur. It will take you longer to stop the vehicle. Have the vehicle checked by your authorized dealer as soon as possible. Driving extended distances with the parking brake engaged can cause brake failure and the risk of personal injury.

Charging System

It will illuminate when the 12-volt battery is not charging properly. Contact your authorized dealer as soon as possible. This indicates a problem with the electrical system or a related component.

Check Fuel Cap

It will illuminate when the fuel cap may not be properly installed. Continued driving with this light on may cause the Service engine soon warning indicator to come on.

Cruise Control (if equipped)

It will illuminate when you switch this feature on.

Direction Indicator

Illuminates when the left or right turn signal or the hazard warning flasher is switched on. If the indicators stay on or flash faster, check for a burned out bulb.

Door Ajar

Displays when the ignition is on and any door is not completely closed.

Electronic Locking Differential

Displays when using the electronic locking differential.

Engine Oil

If it illuminates with the engine running or when you are driving, this indicates a malfunction. Stop your vehicle as soon as it is safe to do so and switch the engine off. Check the engine oil level.

Note: Do not resume your journey if it illuminates despite the level being correct. Have the system checked by your authorized dealer.

Engine Coolant Temperature

Illuminates when the engine coolant temperature is high. Stop the vehicle as soon as possible, switch off the engine and let cool.

Fasten Safety belt

It will illuminate and a chime will sound to remind you to fasten your safety belt.

High Beam

It will illuminate when the headlamp high beam is switched on.

It will flash when you use the headlamp flasher.

Hill Descent (if equipped)

Illuminates when hill descent is turned on.

Low Fuel Level

It will illuminate when the fuel level is low or near empty. Refuel as soon as possible.

Low Tire Pressure Warning

It will illuminate when your tire pressure is low. If the lamp remains on with the engine running or when driving, check your tire pressure as soon as possible.

The lamp also illuminates momentarily when you switch the ignition on to confirm the lamp is functional. If it does not illuminate when you switch the ignition on, or begins to flash at any time, have the system checked by your authorized dealer.

Powertrain Malfunction/Reduced Power/Electronic Throttle Control

Illuminates when a powertrain fault has been detected. Contact your authorized dealer as soon as possible.

Service Engine Soon

The *service engine soon* indicator light illuminates when the ignition is first turned to the on position to check the bulb and to indicate whether the vehicle is ready for Inspection/Maintenance (I/M) testing. Normally, the “service engine soon” light will stay on until the engine is cranked, then turn itself off if no malfunctions are present. However, if after 15 seconds the “service engine soon” light blinks eight times, it means that the vehicle is not ready for I/M testing. See the *Readiness for inspection/maintenance (I/M) testing* in the *Fuel and Refueling* chapter.

Solid illumination after the engine is started indicates the on-board diagnostics system (OBD-II) has detected a malfunction. Refer to *On-board diagnostics (OBD-II)* in the *Fuel and Refueling* chapter. If the light is blinking, engine misfire is occurring which could damage your catalytic converter. Drive in a moderate fashion (avoid heavy acceleration and deceleration) and have your vehicle serviced immediately by your authorized dealer.



WARNING: Under engine misfire conditions, excessive exhaust temperatures could damage the catalytic converter, the fuel system, interior floor coverings or other vehicle components, possibly causing a fire.

Stability Control System

Displays when the AdvanceTrac®/Traction control is active. If the light remains on, have the system serviced immediately.

Stability Control System Off

Illuminates when AdvanceTrac®/Traction control has been disabled by the driver.

Transmission Tow/Haul

Illuminates when the Tow/Haul feature has been activated. Refer to the *Transmission* chapter for transmission function and operation. If the light flashes steadily, have the system serviced immediately, damage to the transmission could occur.

4X2**4x2**

Illuminates momentarily when two-wheel drive high is selected. If the light fails to display when the ignition is turned on, or remains on, have the system serviced immediately by your authorized dealer.

4X4 LOW**4x4
LOW**

Illuminates when four-wheel drive low is engaged. If the light fails to display when the ignition is turned on, or remains on, have the system serviced immediately by your authorized dealer.

4X4 HIGH**4x4
HIGH**

Illuminates when four-wheel drive high is engaged. If the light fails to display when the ignition is turned on, or remains on, have the system serviced immediately by your authorized dealer.

Diesel Warning Lights: If your vehicle is equipped with a diesel engine, it has some unique warning lights; refer to the *Instrument Cluster* in your diesel supplement for detailed information on their function.



- Glow plug pre-heat



- Water in fuel



- Diesel exhaust fluid

AUDIBLE WARNINGS AND INDICATORS**Key In Ignition Warning Chime**

Sounds when the key is left in the ignition in the off or accessory position and the driver's door is opened.

Keyless Warning Alert (If Equipped)

Sounds when the keyless vehicle is in RUN and the driver's door is opened.

Headlamps On Warning Chime

Sounds when the headlamps or parking lamps are on, the ignition is off (the key is not in the ignition) and the driver's door is opened.

Parking Brake On Warning Chime

Sounds when you have left the parking brake on and drive your vehicle. If the warning chime remains on after you have released the parking brake, have the system checked by your authorized dealer immediately.

GENERAL INFORMATION

WARNING: Driving while distracted can result in loss of vehicle control, accident and injury. Ford strongly recommends that drivers use extreme caution when using any device or feature that may take their focus off the road. Your primary responsibility is the safe operation of the vehicle. We recommend against the use of any handheld device while driving and that you comply with all applicable laws.

Various systems on your vehicle can be controlled using the information display controls on the steering wheel. Corresponding information is displayed in the information display.

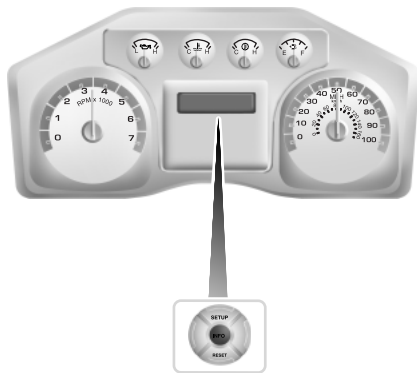
Information Display Controls (Type 1)

- Press the INFO button to scroll through trip, outside temperature, fuel usage, trailer gain and MyKey® information.
- Press the SETUP button to scroll through various vehicle feature settings.
- Press the RESET button to choose settings, reset information and confirm messages.

Info

Press the INFO button repeatedly to cycle through the following features:

Note: Some options may appear slightly different or not at all if the items are optional.

| INFO |
|----------------------------------|
| TRIP A/B |
| XXX° (if equipped) |
| MYKEY MILES (km) (if programmed) |
| XXX MILES (km) TO E |
| XX.X AVG MPG (L/100km) |
| MPG (L/km) |
| TIMER |
| TBC GAIN (if equipped) |
| EXHAUST FILTER (diesel only) |

- TRIP A/B: Registers the distance of individual journeys. Press and release the INFO button until TRIP A/B appears in the display (this represents the trip mode). Press and hold the RESET button to reset. Refer to *UNITS* later in this section to switch the display from metric to English.
- XXX° (outside air temperature) (if equipped): This displays the outside temperature.
- MYKEY MILES (km) (if programmed): For more information, refer to the *MyKey*® chapter.
- XXX MILES (km) TO E: This displays an estimate of approximately how far you can drive with the fuel remaining in your tank under normal driving conditions. Remember to turn the ignition off when refueling to allow this feature to correctly detect the added fuel. Distance to empty is calculated using a running average fuel economy, which is based on your recent driving history of 500 miles (800 km). This value is not the same as the average fuel economy display. The running average fuel economy is re-initialized to a factory default value if the battery is disconnected.
- XX.X AVG MPG (L/100km): Average fuel economy displays your average fuel economy in miles/gallon or liters/100 km.
- MPG (L/km): This displays instantaneous fuel economy as a bar graph. Your vehicle must be moving to calculate instantaneous fuel economy. Instantaneous fuel economy cannot be reset.

- **TIMER:** Displays the trip elapsed drive time. Press and release RESET to pause the timer. Press and hold RESET to reset the timer.
- **TBC GAIN** (if equipped): Displays the level of trailer brake gain or if the trailer is not connected.
- **EXHAUST FILTER** (Diesel only): For more information, refer to the *Diesel exhaust system: oxidation catalyst/diesel particulate filter system* in your diesel supplement for more information.

System Check and Vehicle Feature Customization

Press the SETUP button repeatedly to cycle the message center through the following features:

Note: Some options may appear slightly different or not at all if the items are optional.

Note: When returning to the SETUP menu and a non-English language has been selected, HOLD RESET FOR ENGLISH will be displayed to change back to English. Press and hold the RESET button to change back to English.

| SETUP | | |
|------------------------|------------------------|--------------------------------------|
| RESET FOR SYSTEM CHECK | press the RESET button | OIL LIFE |
| | | EXHAUST FLUID LEVEL (Diesel only) |
| | | ENGINE HOURS |
| | | ENGINE IDLE HOURS |
| | | CHARGING SYSTEM |
| | | DOOR |
| | | BRAKE SYSTEM |
| | | TBC GAIN = XX.X |
| | | FUEL LEVEL |
| | | MYKEY DISTANCE |
| | | MYKEY(S) PROGRAMMED |
| | | ADMIN KEYS PROGRAMMED |

| SETUP | | | |
|--|---------------------------|----------------------------|------------|
| OIL LIFE | | | |
| UNITS | press the RESET button | Distance | English |
| | | | Metric |
| | | Temperature | Fahrenheit |
| | | | Celsius |
| AUTOLAMP (SEC) | | 0 to 180 seconds | |
| AUTOLOCK | | On or Off | |
| AUTOUNLOCK | | On or Off | |
| COURTESY WIPE | | On or Off | |
| REMOTE WINDOW OPEN | | On or Off | |
| CREATE MYKEY / MYKEY SETUP / CLEAR MYKEY | | | |
| RESET FOR ZONE SETTING (if equipped) | | | |
| ZONE XX RESET = CHANGE (if equipped) | | | |
| RESET FOR CALIBRATION (if equipped) | | | |
| RESET FOR REMOTE START (if equipped) | press the RESET button | On or Off | |
| | | 5, 10, 15 minutes | |
| TBC MODE (if equipped) | | Electric or EOH | |
| TRAILER SWAY (if equipped) | | On or Off | |
| LANGUAGE = ENGLISH / SPANISH / FRENCH | | English / Spanish / French | |

- **RESET FOR SYSTEM CHECK:** The message center will begin to cycle through the vehicle systems and provide a status of the item if needed. Some systems show a message only if a condition is present.
- **OIL LIFE:** This displays the remaining oil life. An oil change is required whenever indicated by the message center and according to the recommended maintenance schedule. **USE ONLY RECOMMENDED ENGINE OILS.**

To reset the oil monitoring system to 100% after each oil change, perform the following:

1. Press and release the SETUP button to display OIL LIFE XXX% HOLD RESET = NEW.
2. Press and hold the RESET button for two seconds and release to reset the oil life to 100%.

Note: To change oil life 100% value (if equipped with this feature) to another value, proceed to Step 3.

3. Once OIL LIFE SET TO XXX% is displayed, release and press the RESET button to change the Oil Life Start Value. Each release and press will reduce the value by 10%.

- UNITS: Displays the current units in English or Metric.
- AUTOLAMP (SEC): This feature keeps your headlights on for up to three minutes after the ignition is switched off.
- AUTOLOCK: This feature automatically locks all vehicle doors when the vehicle is shifted into any gear, putting the vehicle in motion.
- AUTOUNLOCK: This feature automatically unlocks all vehicle doors when the driver's door is opened within 10 minutes of the ignition being turned off.
- COURTESY WIPE: This feature allows for an extra swipe of the wipers after a wipe/wash cycle.
- REMOTE WINDOW OPEN: This feature allows for all windows to be opened remotely.
- CREATE MYKEY / MYKEY SETUP / CLEAR MYKEY: For more information refer to *MyKey®* in the *Locks and Security* chapter.
- RESET FOR ZONE SETTING (if equipped): This feature changes the compass zone setting.

Most geographic areas (zones) have a magnetic north compass point that varies slightly from the northerly direction on maps. This variation is four degrees between adjacent zones and will become noticeable as the vehicle crosses multiple zones. A correct zone setting will eliminate this error.

Refer to *Compass zone/calibration adjustment*.

- ZONE XX RESET = CHANGE (if equipped): The compass heading is displayed as one of N, NE, E, SE, S, SW, W and NW in the message center display.

Refer to *Compass zone/calibration adjustment*.

- **RESET FOR CALIBRATION** (if equipped): This feature calibrates the compass.

The compass reading may be affected when you drive near large buildings, bridges, power lines and powerful broadcast antenna. Magnetic or metallic objects placed in, on or near the vehicle may also affect compass accuracy. If the compass appears to be inaccurate, a manual calibration may be necessary.

Refer to *Compass zone/calibration adjustment*.

Compass zone adjustment

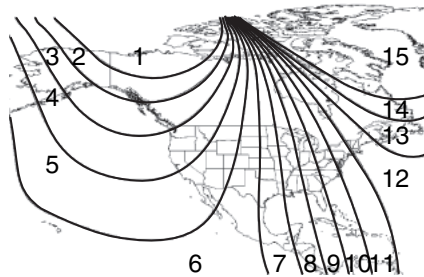

1. Determine which magnetic zone you are in for your geographic location by referring to the zone map.
2. Start the engine.
3. From the SETUP menu, press and release the RESET button until the message center display changes to show the current zone setting ZONE XX RESET = CHANGE.

4. Press and release the RESET button repeatedly until the correct zone setting for your geographic location is displayed on the information display.

5. Press and release SETUP, press INFO or allow the setup timer to expire to exit the procedure.

Compass calibration adjustment

Note: For optimum calibration, drive to an open, level location away from large metallic objects or structures. Switch off all non-essential electrical accessories (heated rear window, heater, A/C, map lamps, wiper, etc.) and make sure all the doors are closed

Note: If the RESET button is pressed or three minutes has expired, the display will go back to the INFO menu and will show CAL instead of the compass heading until the compass is calibrated.

1. Press the RESET button until the display reads RESET FOR CALIBRATION to start the compass calibration function.
2. Slowly drive the vehicle in a circle (less than 3 mph [5 km/h]) until the CIRCLE SLOWLY TO CALIBRATE display changes to CALIBRATION COMPLETED. It will take up to five circles to complete calibration.

3. The compass is now calibrated.

- RESET FOR REMOTE START (if equipped)
- REAR PARK AID (if equipped): This feature sounds a warning tone to warn the driver of obstacles near the rear bumper, and functions only when R (Reverse) gear is selected.
- TBC MODE (if equipped): Allows you to choose the trailer brake mode.
- TRAILER SWAY (if equipped): This feature uses the electronic stability control to mitigate trailer sway.
- LANGUAGE = ENGLISH / SPANISH / FRENCH: Allows you to choose which language the message center will display in.

Waiting four seconds or pressing the RESET button cycles the message center through each of the language choices.

Press the RESET button to set the language choice.

Information Display Controls (Type 2)



- Press the up and down arrow buttons to scroll through and highlight the options within a menu.
- Press the right arrow button to enter a sub-menu.
- Press the left arrow button to exit a menu.
- Press the OK button to choose and confirm a setting/messages.

Main menu

You can access the menus using the information display control.



- Gauge Mode



- Trip A/B



- Fuel Economy



- Truck Apps (If Equipped)



- Settings



- Information

Gauge Mode



Use the arrow buttons to choose between the following gauge options.

| Gauge Mode | | |
|---------------|--|---|
| Gauges Detail | Engine Oil Temperature (Diesel only) | |
| | Transmission Temperature | |
| | Compass | The compass orientation can be changed between fixed north or rotating north. To change the modes, press OK when the compass display is shown. Use the right arrow to choose the mode. Press and hold OK to set the mode. |
| | Exhaust Filter (diesel only). Refer to <i>Diesel exhaust system: oxidation catalyst/diesel particulate filter system</i> in your diesel supplement for more information. | |
| | Blank | |

Trip A/ B

Use the arrow buttons to choose between the following trip options.

| Trip A/ B | |
|-------------------|--|
| Trip time | |
| Trip distance | |
| Fuel used | |
| Avg MPG (L/100km) | |
| Odometer | |

Press OK to pause the Trip A or B screen/press again to un-pause.

Press and hold OK to reset the currently displayed trip information.

- Trip time: shows the elapsed trip time. This timer will stop when the vehicle is turned off and will restart when the vehicle is restarted.
- Trip distance: Registers the mileage of individual journeys.
- Fuel used: Shows the amount of fuel used for a given trip.
- Average MPG: Shows the average distance traveled per unit of fuel used for a given trip.

Fuel Economy

Use the arrow buttons to choose the desired fuel economy display.

| Fuel Economy | |
|--|---|
| Fuel Econ. | Instant MPG (L/100km) |
| | Miles (kilometers) to Empty |
| | AVG MPG (L/100km) |
| Fuel Hist.: shows fuel usage as a bar graph based on time. The duration time can be changed. | Duration: 5 Minutes, 10 Minutes, 30 Minutes, Last 5 Resets. The graph is updated each minute with the fuel economy that was achieved during the prior 5, 10, 30 minutes of driving. |

- Instant MPG: shows instantaneous fuel usage.
- Miles to empty: shows the approximate distance the vehicle can travel before running out of fuel.
- Average MPG: shows the average fuel usage based on time. See Fuel Hist. to change the time interval. Press and hold OK to reset this value.

Truck Apps



In this mode, off-road information depicted with graphics and trailer towing application options are available.

Note: Some items are optional and may not appear.

| Truck Apps | |
|------------|--|
| Off Road | Pitch and bank angle (in degrees): Displays the pitch angle (front to rear) and bank angle (side to side) of the road surface. |
| | Steering angle (in degrees): Displays the steering angle of the front wheels after the vehicle has been driven for a period of time. |
| | Differential lock/unlock: Displays the state (locked or unlocked) of the electronic locking differential. |
| | Energy flow: Displays the operating mode of the transfer case: 4X2, 4X4 High or 4X4 Low. |
| | Press OK for Info |
| | ELD (Electronic Locking Differential) |
| | Hill Descent Control |
| | 4X4 System |
| | Traction Control |
| | AdvanceTrac® + RSC |

| Truck Apps (cont'd) | | | |
|---------------------|--|---|---|
| Trailer (cont'd) | Active trailer name or default trailer | | |
| | Accumulated trailer distance | | |
| | Trailer gain and output | | |
| | Trailer disconnected. Disregard this status if your vehicle is not equipped with a factory installed trailer brake controller. This message may appear when an aftermarket TBC is used even when the trailer is connected. | | |
| | Press OK for options | Options | |
| | | Change Active Trailer | When this is highlighted, press the right arrow key to change the currently selected trailer. Use the up and down arrows to select a trailer and press the OK button to choose the highlighted trailer. |
| | | Adding a new trailer– Use the up/down arrows to highlight New Trailer and press the right arrow key to enter the New Trailer input screen. Use the up/down arrow keys to choose alpha, numeric and symbol characters and then press the right arrow to move the character space over. Continue adding characters as needed. Press the left arrow to go back and change a previously selected character. When finished with the new trailer name, press OK to accept the new trailer name. | |

| Truck Apps (cont'd) | | | |
|----------------------------|-------------------------|---|---|
| Trailer (cont'd) | Press OK for options | Connection Checklist (if equipped) | Conventional, Fifth Wheel and Gooseneck. Use the up/down arrows to highlight one of these choices and press OK to display the connection checklist. Follow the on-screen instructions to go through the connections list. |
| | | Delete Trailer | Use the up/down arrows to highlight the trailer you want to delete and press OK to delete. Follow the on-screen prompts to exit or confirm delete. |
| | | Information Screen | Tow Haul mode, Trailer Brake Controller. |
| | | Rename Trailer | Use the up/down buttons to highlight a trailer and press OK to select it. Use the up/down arrow buttons to change the characters as needed. When done, press OK to accept the change. |
| | | Reset Trailer Mileage / Kilometers (if equipped) | Use the up/down buttons to select a trailer, then press and hold OK to reset the trailer mileage (kilometers). |

Settings

In this mode, you can configure different driver setting choices.

Note: Some items are optional and may not appear.

| Settings | | | |
|---------------|----------------------|-----------------------------------|--------|
| Driver Assist | Rear Park Aid | On/Off | |
| | Rear Video Camera | Camera Delay | On/Off |
| | Trailer Brake Mode | Electric or Elect. Over Hydraulic | |
| | Trailer Sway Control | On/Off | |

| Settings (cont'd) | | | |
|-------------------|-------------------------------------|--|--|
| Vehicle | Autolamp Delay | Off or XXX seconds | |
| | Compass | Zone Setting (1–15) See the diagram below to determine your magnetic zone. Calibration (When choosing Calibration, follow the on-screen directions to calibrate the compass) | |
| | Easy Entry/Exit | On/Off | |
| | DTE Calculation (distance to empty) | Normal History Used | |
| | | Towing History Used | |
| | Locks | Autolock | On/Off |
| | | Autounlock | On/Off |
| | | Unlocking | One Stage or Two Stage |
| | Maintenance | Coolant (if equipped) | Hold OK if coolant maintenance performed |
| | | Fuel Filter (diesel only) | Hold OK if Fuel Filter Changed |
| | Menu Control | Standard: with standard set, pressing the up/down arrows from a lower level menu will escape to the main menu. Memory On: with memory on set, pressing the up/down arrows will navigate to the previous lower level menu. | |
| | Oil Life Reset | Set to XXX% (Hold OK to Reset) | |
| | Remote Start | Duration | 5, 10 or 15 minutes |
| | | System | Enable/Disable |
| Windows | Remote Open | On/Off | |
| Wiper Control | On/Off | | |

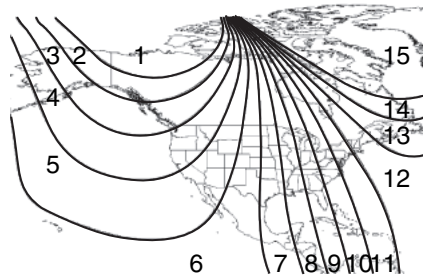
Compass (if equipped):

Determine which magnetic zone you are in for your geographic location by referring to the zone map.

| Settings (cont'd) | | |
|-------------------|----------------------------|--|
| MyKey | Create MyKey | Hold OK to create MyKey |
| | AdvanceTrac | Always On / Selectable |
| | MAX Speed | 80 MPH (130 km/h) or Off |
| | Speed Warning | 45, 55 or 65 MPH (75, 90 or 105 km/h), Off |
| | Volume Limiter | On/Off |
| | Clear MyKey | Hold OK to Clear MyKey |
| Language | English, Español, Français | |
| Units | Distance | English |
| | | Metric |
| | Temperature | Fahrenheit |
| | | Celsius |

Information

In this mode, you can view different vehicle system information and perform a system check.

| Information | |
|-------------|---|
| MyKey | Admin Keys (Number of admin keys) |
| | MyKeys (Number of MyKeys programmed) |
| | MyKey Miles (km) (Distance traveled using a programmed MyKey) |

| Information | |
|--------------|---|
| System Check | Some items will only display during a system check if a problem has been detected. If an issue exists on one of the monitored systems, the number of warnings that need immediate attention will display in red and the number of informational warnings will display in amber. Use the up/down arrow buttons to scroll through the list; press the right arrow button to display specific information on the highlighted warning |

Compass/Transmission indicator display (if equipped)

The compass heading will display in the upper right corner of the information display; the transmission gear indicator displays in the right side of the information display when using the SelectShift Automatic™ transmission feature. These displays will not be shown in all screen modes. For example: when programming certain vehicle features or in certain information menus.

INFORMATION MESSAGES

Note: Depending on the vehicle options equipped with your vehicle, not all of the messages will display or be available. Certain messages may be abbreviated or shortened depending upon which cluster type you have.

Press the RESET button for Type 1 displays or the OK button for Type 2 displays to acknowledge and remove some messages from the information display. Other messages will be removed automatically after a short time. Certain messages need to be confirmed before you can access the menus.

| AdvanceTrac® / Traction Control Messages | Action / Description |
|--|--|
| SERVICE ADVANCETRAC | Displayed when the AdvanceTrac® system has detected a condition that requires service. Contact your authorized dealer as soon as possible. |
| ADVANCETRAC OFF | Displayed when the AdvanceTrac® system has been disabled by the driver. |

| AdvanceTrac® / Traction Control Messages | Action / Description |
|---|---|
| TRACTION CONTROL OFF | Displayed when the traction control has been disabled by the driver. Refer to the <i>Traction Control</i> chapter for more information. |
| Alarm/Security Messages | Action / Description |
| TO STOP ALARM START VEHICLE | Displayed when the perimeter alarm system is armed and the vehicle is entered using the key on the driver's side door. In order to prevent the perimeter alarm system from triggering, the ignition must be turned to start or on before the 12 second chime expires. |
| SECURITY SYSTEM FAULT | Displayed when the security system has detected a fault. See your authorized dealer for service. |
| Brake System Messages | Action / Description |
| BRAKE FLUID LEVEL LOW | Indicates the brake fluid level is low and the brake system should be inspected immediately. Refer to <i>Brake fluid</i> in the <i>Maintenance</i> chapter. |
| CHECK BRAKE SYSTEM | Displayed when the brake system needs servicing. If the warning stays on or continues to come on, contact your authorized dealer as soon as possible. |
| PARK BRAKE ENGAGED | Displayed when the parking brake is set and the vehicle is in motion. |



WARNING: When the CLEANING EXHAUST FILTER message appears in the message center, do not park near flammable materials, vapors or structures until filter cleaning is complete.

| Diesel Messages | Action / Description |
|--------------------------------------|---|
| CHECK COOLANT ADDITIVE | Displayed when the coolant additive needs to be checked. Refer to your diesel supplement for more information. |
| CLEANING EXHAUST FILTER | Displayed when the vehicle has entered the cleaning mode. Various engine actions will raise the exhaust temperature in the Diesel Particulate Filter (DPF) system to burn off the particles (exhaust soot). After the particles are burned off, the exhaust temperature will fall back to normal levels. This message is NORMAL. Refer to your diesel supplement for more information. |
| DRIVE TO CLEAN EXHAUST SYSTEM | Displayed when the Diesel Particulate Filter (DPF) is full of particles (exhaust soot) and the vehicle is not being operated in a manner to allow normal cleaning. This message will stay on until the exhaust filter cleaning has begun, at which time the CLEANING EXHAUST FILTER message will be displayed. It is recommended the vehicle operator drive the vehicle above 30 mph (48 km/h) until the CLEANING EXHAUST FILTER message turns off. This message is NORMAL. Refer to your diesel supplement for more information. Note: If this message is ignored, your vehicle will continue to fill the Diesel Particulate Filter (DPF) with particles (exhaust soot). If cleaning is not permitted, the light will illuminate and engine power may be limited. If the vehicle is still not operated in a manner to allow cleaning, the service engine soon light will illuminate and engine power will be further limited. Dealer service will then be required to restore your vehicle to full-power operation. |

| Diesel Messages | Action / Description |
|---------------------------------------|---|
| STOP SAFELY NOW | Displayed and a chime sounds when the vehicle exhaust system temperature exceeds intended operating range. If this warning occurs, engine power is reduced and the engine will shut down when the vehicle speed is below 3 mph (5 km/h). Stop the vehicle as soon as safely possible and contact your authorized dealer. Depending on the severity of the over-temperature condition, the vehicle may not restart after cycling the ignition off. If the vehicle restarts, there may be limited power. If the exhaust over-temperature condition reoccurs, the message center will display STOP SAFELY NOW, the chime will sound, and engine power will be reduced again and shut down below 3 mph (5 km/h). Refer to your diesel supplement for more information. |
| ENGINE OIL DILUTED | Displays once the engine oil has become diluted and needs to be changed. See Changing the engine oil and oil filter in your diesel supplement. |
| ENGINE TURNS OFF IN 1 SECOND | Displayed when the vehicle is in the final second of a countdown to where the engine will intentionally be turned off by the PCM. The diesel engine shutdown is a (regulatory) requirement which may be required of a particular diesel vehicle for sale in states requiring this feature. Refer to your diesel supplement for more information. |
| ENGINE TURNS OFF IN XX SECONDS | Displayed when the vehicle is in the final 30 seconds of a countdown to where the engine will intentionally be turned off by the PCM. The diesel engine shutdown for extended idling is an optional feature. Refer to your diesel supplement for more information. |
| ENGINE TURNED OFF | Displayed after the 30 second countdown. Refer to your diesel supplement for more information. |

| Diesel Messages | Action / Description |
|---|---|
| ENGINE WARMING PLEASE WAIT | Displayed in extremely cold weather, typically below -15°F (-26°C), if the engine block heater is not utilized. The engine will not respond to accelerator pedal movement for 30 seconds; this is done so the engine oil can be properly circulated to avoid engine damage from lack of lubrication. A timer will begin a countdown from 30 seconds. Once the counter has reached 0 seconds, OK TO DRIVE will be displayed and the engine will respond to accelerator pedal movement. Refer to your diesel supplement for more information. |
| EXHAUST FILTER DRIVE COMPLETE | Displayed when the Diesel Particulate Filter (DPF) has been adequately cleaned after the DRIVE TO CLEAN EXHAUST FILTER followed by CLEANING EXHAUST FILTER messages have been displayed. This message is NORMAL. Refer to your diesel supplement for more information. |
| EXHAUST FILTER CLEANED | Displayed when the Diesel Particulate Filter (DPF) has been adequately cleaned by the manual regeneration process (OCR). Refer to your diesel supplement for more information. |
| EXHAUST CLEAN STOPPED | Displayed when the Diesel Particulate Filter (DPF) manual regeneration process (OCR) has been stopped. Refer to your diesel supplement for more information. |
| EXHAUST FLUID RANGE XXX MI | Displays the distance you can travel before depleting the remaining diesel exhaust fluid. Refer to your diesel supplement for more information. |
| IN XX MILES, SPEED LIMITED TO XX MPH EXHAUST FLUID EMPTY | Displayed when the diesel exhaust fluid is nearing empty. The vehicle's top speed will become limited in the displayed distance. The diesel exhaust fluid must be replenished to resume normal operation of the vehicle. Refer to your diesel supplement for more information. |

| Diesel Messages | Action / Description |
|--|---|
| SPEED LIMITED TO XX MPH UPON RESTART EXHAUST FLUID EMPTY | Displayed when the remaining diesel exhaust fluid level is depleted. Speed will be limited upon restart. The diesel exhaust fluid must be replenished to resume normal operation of the vehicle. Refer to your diesel supplement for more information. |
| SPEED LIMITED TO XX MPH EXHAUST FLUID EMPTY | Displayed when the diesel exhaust fluid is empty. The diesel exhaust fluid must be replenished to resume normal operation of the vehicle. Refer to your diesel supplement for more information. |
| ENGINE IDLED SOON EXHAUST FLUID EMPTY | Displayed when the SCR system detects low exhaust fluid. The engine will eventually enter into an idle only mode. The diesel exhaust fluid must be replenished to resume normal operation of the vehicle. Refer to your diesel supplement for more information. |
| ENGINE IDLED - SEE OWNER'S MANUAL EXHAUST FLUID EMPTY | Displayed when a problem exists with the SCR system. The vehicle will enter into an idle-only mode. If the exhaust fluid is empty, it must be replenished to resume normal operation of the vehicle. Refer to your diesel supplement for more information. |
| IN XX MILES, SPEED LIMITED TO 50 MPH EXHAUST FLUID SYSTEM FAULT | Displayed when the SCR system detects a fault. The vehicle's top speed will become limited in the displayed distance starting at 50 miles (80 km) and count down from this point. Refer to your diesel supplement for more information. Contact your authorized dealer as soon as possible. |
| SPEED LIMITED TO 50 MPH UPON RESTART EXHAUST FLUID SYSTEM FAULT | Displayed when the SCR system detects a fault. The vehicle's top speed will become limited upon restarting. Refer to your diesel supplement for more information. Contact your authorized dealer as soon as possible. |

| Diesel Messages | Action / Description |
|---|--|
| SPEED LIMITED TO 50 MPH EXHAUST FLUID SYSTEM FAULT | Displayed when the SCR system detects a fault. The vehicle's top speed is limited. Refer to your diesel supplement for more information. Contact your authorized dealer as soon as possible. |
| ENGINE IDLED SOON EXHAUST FLUID SYSTEM FAULT SEE MANUAL | Displayed when the SCR system detects a fault. The engine will enter into an idle only mode. Refer to your diesel supplement for more information. Contact your authorized dealer as soon as possible. |
| ENGINE IDLED - SEE OWNER'S MANUAL EXHAUST FLUID SYSTEM FAULT | Displayed when the SCR system detects a fault. The engine will eventually enter into an idle-only mode. Press OK to override the idle mode. Refer to your diesel supplement for more information. Contact your authorized dealer as soon as possible. |
| FUEL FILTER CHANGE REQUIRED | Displayed when a fuel filter change is required. Refer to the <i>scheduled maintenance information</i> . |
| REDUCED ENGINE POWER | Displayed approximately two hours after the DRIVE TO CLEAN EXHAUST SYSTEM message has displayed and the vehicle operator has not driven the vehicle above 30 mph (48 km/h) for at least 20 minutes to clean the DPF. At this point the vehicle must be serviced by an authorized dealer. This message is normal. Refer to your diesel supplement for more information. |
| WATER IN FUEL DRAIN FILTER SEE MANUAL | Displayed when the water separator has reached a predetermined capacity and needs to be drained. Refer to your diesel supplement for more information. |

| Diesel Messages | Action / Description |
|---------------------------------|---|
| <p>LOW FUEL PRESSURE</p> | <p>If this message appears during a cold start or during cold operation 32°F (0°C) up to 10 minutes after the initial cold start; monitor the message center and if it disappears and does not re-appear after the engine has fully warmed up, the low fuel pressure message is most likely caused by waxed or gelled fuel. To prevent this, use an anti-gel additive. Refer to your diesel supplement for more information. The customer warranty may be void from using additives that do not meet or exceed Ford specifications. If the low fuel pressure message persistently appears after re-fueling during the cold start and cold operation conditions defined previously and then disappear when the engine has fully warmed up, consider different fuel sources.</p> <p>Low Fuel Operation: If the message appears when the vehicle is warm and during low fuel tank level operation, i.e. the tank level is at or very near empty, refuel the vehicle and operate the vehicle. If the message reappears after fueling, see below. If the message does not come back, the low fuel pressure condition was due to low fuel levels in the fuel tank.</p> <p>Normal Operation: If the message appears during normal operation when the vehicle / engine is fully warm, and fuel level is not low, the fuel filters must be changed regardless of the maintenance schedule interval. If replacement of the fuel filter does not remedy the low fuel pressure message during normal operation as defined above, please take the vehicle to your authorized dealer.</p> |

| Door Messages | Action / Description |
|---|--|
| X DOOR AJAR | Displayed when the corresponding door is not completely closed. |
| Drivetrain Messages | Action / Description |
| LOCKING DIFFERENTIAL ENGAGED/ DISENGAGED | Displayed when the electronic locking differential is engaged. |
| LOCKING DIFFERENTIAL DISENGAGED | Displayed when the electronic locking differential is disengaged. |
| TO ENGAGE LOCKING DIFFERENTIAL SLOW TO XX MPH/KM/H | Displayed when the electronic locking differential requests a certain speed requirement to engage. |
| TO ENGAGE LOCKING DIFFERENTIAL RELEASE ACCELERATOR PEDAL | Displayed when the electronic locking differential request the accelerator to be released in order to engage. |
| SLOW VEHICLE TO XX KM/H FOR ELD | Displayed when the vehicle speed requirement for the electronic locking differential mode has not been met. |
| SLOW VEHICLE TO XX MPH FOR ELD | Displayed when the vehicle speed requirement for the electronic locking differential mode has not been met. |
| CHECK LOCKING DIFFERENTIAL | Displayed when an electronic locking differential (ELD) system fault is present. For more information, refer to the <i>Four-Wheel Drive</i> chapter. |
| SHIFT TO PARK | Displays as a reminder to shift into park. |

| Engine Messages | Action / Description |
|---|---|
| TRANSPORT MODE CONTACT DEALER | Displayed when the vehicle is set to transport mode. The transport mode is used to disable certain vehicle functions to prevent battery discharge when the vehicle is in the transport/inventory phase and is not driven long enough to maintain the battery's charge. This mode can be disabled by doing the following: Turn the ignition on, without starting the engine. Press and release the brake pedal fully five times and press the hazard button four times (on, off, on, off) within 10 seconds. |
| POWER REDUCED TO LOWER ENGINE TEMP | Displayed when the engine temperature gauge needle moves to H. You may notice reduced engine power. Refer to <i>Engine coolant</i> in the <i>Maintenance</i> chapter for more information. |
| Fuel Messages | Action / Description |
| CHECK FUEL CAP | Displayed when the fuel cap may not be properly closed. |
| FUEL LEVEL LOW | Displayed as an early reminder of a low fuel condition. |
| Key Messages | Action / Description |
| COULD NOT PROGRAM INTEGRATED KEY | Displayed when an attempt is made to program a fifth integrated key. For more information, refer to the <i>Security</i> chapter. |
| TO DRIVE: TURN KEY TO ON | Displayed when the factory equipped remote start is activated. |
| Maintenance Messages | Action / Description |
| ENGINE OIL CHANGE SOON | Displayed when the engine oil life is nearing its end. |
| OIL CHANGE REQUIRED | Displayed when the oil life left reaches 0%. |

| Maintenance Messages | Action / Description |
|--|--|
| SERVICE POWER STEERING | The power steering system has detected a condition that requires service. See your authorized dealer. |
| SERVICE POWER STEERING NOW | The power steering system has detected a condition within the power steering system that requires service immediately. See your authorized dealer. |
| POWER STEERING ASSIST FAULT | The power steering system has disabled power steering assist due to a system error. See your authorized dealer. |
| MyKey® Messages | Action / Description |
| MYKEY ACTIVE DRIVE SAFELY | Displayed when MyKey® is active. |
| ADVANCETRAC ALWAYS ON - MYKEY SETTING | Displayed when a MyKey® is in use and the ESC cannot be deactivated. |
| VEHICLE NEAR TOP SPEED | Displayed when a MyKey® is in use and the MyKey speed limit is on and the vehicle speed is approaching 80 mph (130 km/h). |
| VEHICLE AT TOP SPEED - MYKEY SETTING | Displayed when a MyKey® is in use and the MyKey speed limit is on and the vehicle speed is 80 mph (130 km/h). |
| SPEED LIMITED TO 80 MPH | Displayed when starting the vehicle and MyKey® is in use and the MyKey speed limit is on. |
| SPEED LIMITED TO 130 KM/H | Displayed when starting the vehicle and MyKey® is in use and the MyKey speed limit is on. |
| CHECK SPEED DRIVE SAFELY | Displayed when a MyKey® is in use and the optional setting is on and the vehicle exceeds a preselected speed. |

Information Displays

| MyKey® Messages | Action / Description |
|--|---|
| BUCKLE UP TO UNMUTE AUDIO | Displayed when a MyKey® is in use and Belt-Minder® is activated. |
| MYKEY COULD NOT PROGRAM | Displayed when an attempt is made to program a spare key using two existing MyKeys. |
| Park Aid Messages | Action / Description |
| CHECK REAR PARK AID | Displayed when the transmission is in R (Reverse) and the park aid is disabled. |
| REAR PARK AID OFF | Displayed when the rear park aid is disabled by the driver. |
| REAR PARK AID ON | Displayed when the rear park aid is enabled. |
| Off Road Messages | Action / Description |
| HILL DESCENT CONTROL OFF | Displayed when hill descent control mode becomes inactive. |
| FOR HILL DESCENT REDUCE SPEED | Displayed when the vehicle speed requirement for off-road mode entry has not been met. |
| FOR HILL DESCENT SELECT GEAR | Displayed when the driver is able to select a transmission gear for hill descent mode. |
| HILL DESCENT - DRIVER RESUME CONTROL | Displayed when hill descent control mode is deactivated and the driver must resume control. |
| HILL DESCENT CONTROL FAULT | Displayed when a hill descent system fault is present. |
| HILL DESCENT CONTROL OFF SYSTEM COOLING | Displayed when the hill descent system is cooling due to overuse. |
| HILL DESCENT CONTROL READY | Displayed when the hill descent control switch is turned on. |

| Tire Messages | Action / Description |
|--|--|
| LOW TIRE PRESSURE | Displays when one or more tires on your vehicle have low tire pressure. |
| TIRE PRESSURE MONITOR FAULT | Displays when the tire pressure monitoring system is malfunctioning. If the warning stays on or continues to come on, contact your authorized dealer. |
| TIRE PRESSURE SENSOR FAULT | Displayed when a tire pressure sensor is malfunctioning, or your spare tire is in use. For more information on how the system operates under these conditions refer to the <i>Wheels and Tires</i> chapter. If the warning stays on or continues to come on, contact your authorized dealer as soon as possible. |
| TIRES NOT TRAINED - REPEAT | Displayed when an error occurs while training the TPMS. Refer to the <i>Wheels and Tires</i> chapter for more information. |
| TRAIN LEFT FRONT TIRE | Displayed when training the TPMS. |
| TRAIN LEFT REAR TIRE | Displayed when training the TPMS. |
| TRAIN RIGHT FRONT TIRE | Displayed when training the TPMS. |
| TRAIN RIGHT REAR TIRE | Displayed when training the TPMS. |
| TRAINING COMPLETE | Displayed when training of the TPMS system is complete. |
| Trailer Messages | Action / Description |
| TRAILER BRAKE GAIN: XX.X [OUTPUT] | Displays the current gain setting for the trailer brake. |
| TRAILER BRAKE GAIN: XX.X NO TRAILER | Displays the current gain setting for the trailer brake when a trailer is not connected. |

| Trailer Messages | Action / Description |
|-----------------------------------|--|
| TRAILER BRAKE MODULE FAULT | Displayed and accompanied by a single chime, in response to faults sensed by the TBC. Refer to the <i>Towing</i> chapter for more information. |
| TRAILER CONNECTED | Displayed when a correct trailer connection (a trailer with electric trailer brakes) is sensed during a given ignition cycle. |
| TRAILER DISCONNECTED | Displayed when a trailer connection becomes disconnected, either intentionally or unintentionally, and has been sensed during a given ignition cycle. Disregard this status if your vehicle is not equipped with a factory installed trailer brake controller. This message may appear when an aftermarket TBC is used even when the trailer is connected. |
| TRAILER SWAY REDUCE SPEED | Displayed when the trailer sway control has detected trailer sway. |
| WIRING FAULT ON TRAILER | Displayed if there are certain faults in the vehicle wiring and trailer wiring/brake system. Refer to the <i>Towing</i> chapter for more information. |
| 4WD Messages | Action / Description |
| CHECK 4X4 | Displayed when a 4X4 system fault is present. For more information, refer to <i>Four-wheel drive</i> chapter. |
| 4X4 SHIFT IN PROGRESS | Displayed when the 4X4 system is making a shift. |
| FOR 4X4 LOW APPLY BRAKE | Displayed when trying to select 4X4 LOW. |

| 4WD Messages | Action / Description |
|---|--|
| FOR 4X4 LOW SHIFT TO N | Displayed when 4X4 LOW is selected and the vehicle is stopped. |
| FOR 4X4 LOW SLOW TO 3 MPH | Displayed when 4X4 LOW is selected while the vehicle is moving. |
| TO EXIT 4X4 LOW APPLY BRAKE | Displayed when 2WD is selected from 4X4 LOW mode. |
| TO EXIT 4X4 LOW SHIFT TO N | Displayed when 2WD is selected while the vehicle has been stopped in 4X4 LOW. |
| TO EXIT 4X4 LOW SLOW TO 3 MPH | Displayed when 2WD is selected while the vehicle is operating in 4X4 LOW. |
| SHIFT DELAYED PULL FORWARD | May display when shifting to or from 4X4 LOW. |
| REDUCE ACCELERATOR TO PREVENT WHEEL SLIP | Displayed when the vehicle senses that torque to the drive wheels has overcome the available traction. |

GENERAL INFORMATION**Radio Frequencies and Reception Factors**

AM and FM frequencies are established by the Federal Communications Commission (FCC) and the Canadian Radio and Telecommunications Commission (CRTC). Those frequencies are:

AM: 530, 540–1700, 1710 kHz

FM: 87.9–107.7, 107.9 MHz

| Radio reception factors | |
|--------------------------------|---|
| Distance and strength | The further you travel from an FM station, the weaker the signal and the weaker the reception. |
| Terrain | Hills, mountains, tall buildings, bridges, tunnels, freeway overpasses, parking garages, dense tree foliage and thunderstorms can interfere with the reception. |
| Station overload | When you pass a ground-based broadcast repeating tower, a stronger signal may overtake a weaker one and result in the audio system muting. |

CD and CD Player Information

Note: CD units play commercially pressed 4.75-inch (12 centimeter) audio compact discs only. Due to technical incompatibility, certain recordable and re-recordable compact discs may not function correctly when used in Ford CD players.

Note: Do not insert CDs with homemade paper (adhesive) labels into the CD player as the label may peel and cause the CD to become jammed. You should use a permanent felt tip marker rather than adhesive labels on your homemade CDs. Ballpoint pens may damage CDs. Please contact your authorized dealer for further information.

Note: Do not use any irregularly shaped discs or discs with a scratch protection film attached.

Always handle discs by their edges only. Clean the disc with an approved CD cleaner only. Wipe it from the center of the disc toward the edge. Do not clean in a circular motion.

Do not expose discs to direct sunlight or heat sources for extended periods.

MP3 Track and Folder Structure

Audio systems capable of recognizing and playing MP3 individual tracks and folder structures work as follows:

- There are two different modes for MP3 disc playback: MP3 track mode (system default) and MP3 folder mode.
- MP3 track mode ignores any folder structure on the MP3 disc. The player numbers each MP3 track on the disc (noted by the .mp3 file extension) from T001 to a maximum of T255. **Note:** The maximum number of playable MP3 files may be less depending on the structure of the CD and exact model of radio present.
- MP3 folder mode represents a folder structure consisting of one level of folders. The CD player numbers all MP3 tracks on the disc (noted by the .mp3 file extension) and all folders containing MP3 files, from F001 (folder) T001 (track) to F253 T255.
- Creating discs with only one level of folders helps with navigation through the disc files.

If you are burning your own MP3 discs, it is important to understand how the system reads the structures you create. While various files may be present, (files with extensions other than mp3), only files with the .mp3 extension are played; other files are ignored by the system. This enables you to use the same MP3 disc for a variety of tasks on your work computer, home computer and your in-vehicle system.

In track mode, the system displays and plays the structure as if it were only one level deep (all .mp3 files play, regardless of being in a specific folder). In folder mode, the system only plays the .mp3 files in the current folder.

AM/FM

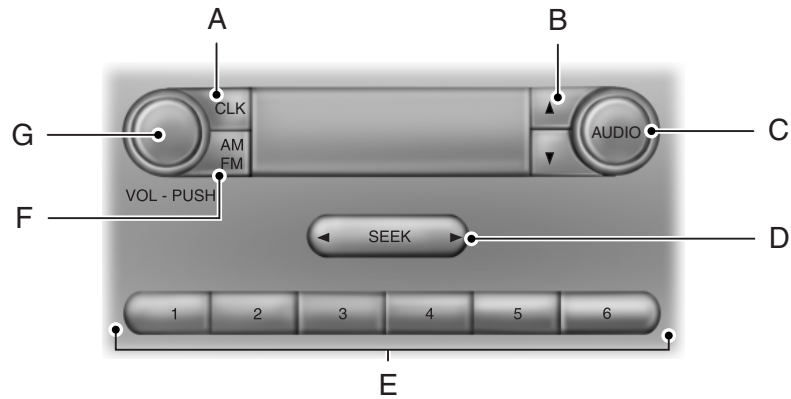

WARNING: Driving while distracted can result in loss of vehicle control, crash and injury. We strongly recommend that you use extreme caution when using any device that may take your focus off the road. Your primary responsibility is the safe operation of your vehicle. We recommend against the use of any hand-held device while driving and encourage the use of voice-operated systems when possible. Make sure you are aware of all applicable local laws that may affect the use of electronic devices while driving.

- A. **CLK:** Press this button to switch the display between the clock and radio frequency. To set the time:
1. Press and hold **CLK** until the hours start to flash.
 2. Press the arrow buttons to adjust the hours. Repeat Steps 1 and 2 to set the minutes.
 3. Press **CLK** again to exit clock mode.
- B. **Tune:** Press these arrow buttons to manually search through the radio frequency band. Press and hold for a fast search. In AUDIO mode, press the buttons to adjust different sound settings.
- C. **AUDIO:** Press this button to access settings for Treble, Middle, Bass, Fade and Balance.
- D. **SEEK:** Press this button to go to the previous or next strong station on the frequency band.

E. **Memory presets:** Store your favorite radio stations. To store a radio station, tune to the station, then press and hold a preset button until sound returns.

F. **AM/FM:** Press this button to select a frequency band.

G. **VOL-PUSH:**

- Press this button to switch the system off and on.
- Turn the control to adjust the volume.

AM/FM/CD WITH SYNC®

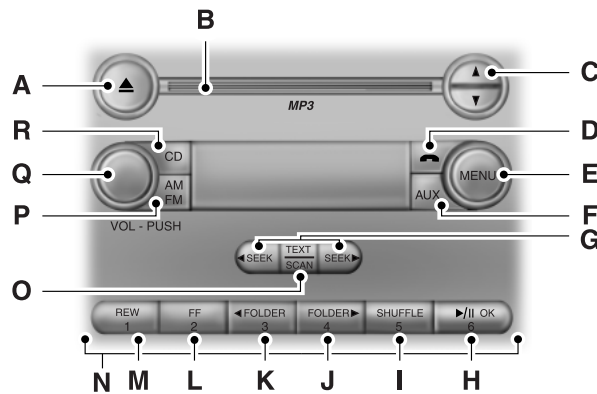

! WARNING: Driving while distracted can result in loss of vehicle control, crash and injury. We strongly recommend that you use extreme caution when using any device that may take your focus off the road. Your primary responsibility is the safe operation of your vehicle. We recommend against the use of any hand-held device while driving and encourage the use of voice-operated systems when possible. Make sure you are aware of all applicable local laws that may affect the use of electronic devices while driving.

A. **Eject:** Press this button to eject a CD.

B. **CD slot:** Insert a CD.

C. **Tune:** Press this button to manually search through the radio frequency band. Press and hold for a fast search.

D. **Phone:** Press this button to access the phone features of the SYNC® system. See the *SYNC®* chapter for more information.

- E. **MENU:** Press this button to access different audio system features.
- If your vehicle is equipped with satellite radio, you can access different menus by pressing **OK**.
 - Set the time by pressing **MENU** until **SET HOURS** or **SET MINUTES** appears and using the arrow buttons to adjust the time.
 - Set the strongest stations on the radio frequency by pressing **MENU** until **AUTOSET** appears. **AUTOSET** does not override your original presets.
 - **RBDS** displays text transmitted by certain radio stations and searches for music categories. To search for music categories, turn on RBDS (by using the **SEEK** buttons when **RBDS ON/OFF** appears). Press the up and down arrow buttons to scroll through categories, then use the **SEEK** buttons to begin the search.
 - **SPEEDVOL** (speed compensated volume) allows you to adjust radio volume to compensate for noise levels when vehicle speed increases.
 - **Track/Folder** is only available on MP3 files when in CD mode. In track mode, pressing the **SEEK** arrows allows you to scroll through all the tracks on the disc. In folder mode, pressing the **SEEK** arrows allows you to scroll through all the tracks within the selected folder. Press the **FOLDER** buttons to access other folders.
 - **COMPRESS** (Compression) is only available in CD and MP3 modes. Switching compression on brings the soft and loud passages together for a more consistent listening level. Use the **SEEK** buttons and up and down arrow buttons to switch it on and off.
- F. **AUX:** Press this button to access the media features of the SYNC® system. See the *SYNC®* chapter for more information.
- G. **SEEK:**
- In radio mode, press and release these buttons to go to the next (or previous) preset radio station or disc track.
 - In CD and MP3 modes, press these buttons to select the next (or previous) track, or press and hold to advance (or reverse) within the same track.

H. Play, Pause and OK:

- Play and Pause allow you to play or pause a track when listening to a CD.
- **OK** allows you to confirm commands with phone and media features of the SYNC system. See the *SYNC*® chapter for more information.

I. **SHUFFLE:** Play music on the selected CD or MP3 folder in random order.

J. **Folder:** Press this button to access the next folder on an MP3 disc.

K. **Folder:** Press this button to access the previous folder on an MP3 disc.

L. **FF:** Press this button to manually fast forward in a CD track or MP3 file.

M. **REW:** Press this button to manually rewind in a CD track or MP3 file.

N. **Memory presets:** Store your favorite radio stations. To store a radio station, tune to the station, then press and hold a preset button until sound returns.

O. TEXT/SCAN:

- In radio, CD and MP3 modes, press and hold to hear a brief sampling of radio stations, CD tracks or MP3 files.
- In CD and MP3 modes, press and release to display track title, artist name and disc title.

Note: In text mode, sometimes the display requires additional text to show. When the < / > indicator is on, press TEXT and then use the SEEK buttons to view the additional display text.

P. **AM/FM:** Press this button to select a frequency band.

Q. VOL-PUSH:

- Press this button to switch the system off and on.
- Turn it to adjust the volume.

R. **CD:** Press this button to enter CD or MP3 mode.

AM/FM/CD SONY AUDIO SYSTEM

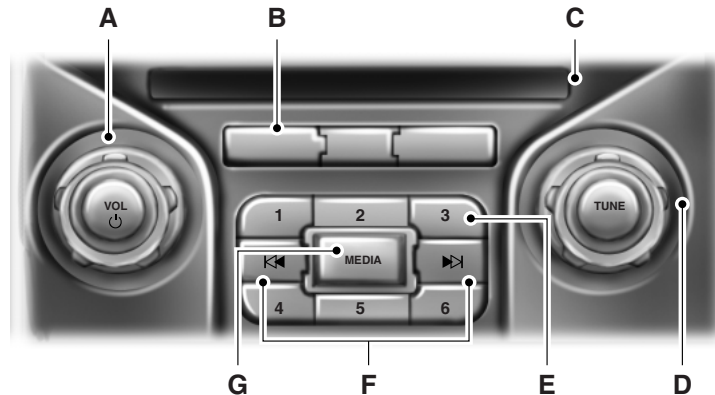

WARNING: Driving while distracted can result in loss of vehicle control, crash and injury. We strongly recommend that you use extreme caution when using any device that may take your focus off the road. Your primary responsibility is the safe operation of your vehicle. We recommend against the use of any hand-held device while driving and encourage the use of voice-operated systems when possible. Make sure you are aware of all applicable local laws that may affect the use of electronic devices while driving.

Note: The MyFord Touch system controls most of the audio features. See the *MyFord Touch* chapter for more information.

A. VOL and Power:

- Press this button to switch the system off and on.
- Turn it to adjust the volume.

B. Eject: Press this button to eject a CD.

C. CD Slot: Insert a CD.

D. TUNE: Turn this control to manually search through the radio frequency band.

E. Memory presets: Store your favorite radio stations. To store a radio station, tune to the station, then press and hold a preset button until sound returns.

F. Seek, Reverse and Fast Forward:

- In radio mode, select a frequency band and press one of these buttons. The system stops at the first station it finds in that direction.
- In SIRIUS mode, press these buttons to select the previous or next channel. If a specific category is selected (such as Jazz, Rock or News), use these buttons to find the previous or next channel in the selected category.
- In CD mode, press these buttons to select the previous or next track.

G. **MEDIA:** Press this button to access different audio modes, such as AM, FM and A/V Input.

AUXILIARY INPUT JACK

WARNING: Driving while distracted can result in loss of vehicle control, crash and injury. We strongly recommend that you use extreme caution when using any device that may take your focus off the road. Your primary responsibility is the safe operation of your vehicle. We recommend against the use of any hand-held device while driving and encourage the use of voice-operated systems when possible. Make sure you are aware of all applicable local laws that may affect the use of electronic devices while driving.



WARNING: For safety reasons, do not connect or adjust the settings on your portable music player while your vehicle is moving.



WARNING: Store the portable music player in a secure location, such as the center console or the glove box, when your vehicle is moving. Hard objects may become projectiles in a crash or sudden stop, which may increase the risk of serious injury. The audio extension cable must be long enough to allow the portable music player to be safely stored while your vehicle is moving.

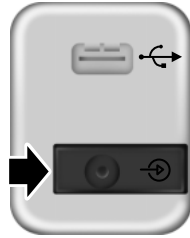

The auxiliary input jack allows you to connect and play music from your portable music player through your vehicle speakers. You can use any portable music player designed for use with headphones. Your audio extension cable must have male 1/8-inch (3.5 millimeter) connectors at each end.

1. Switch off the engine, radio and portable music player. Set the parking brake and put the transmission in position **P**.
2. Plug the extension cable from the portable music player into the auxiliary input jack.
3. Switch the radio on. Select either a tuned FM station or a CD.
4. Adjust the volume as desired.
5. Switch your portable music player on and adjust its volume to half its maximum level.
6. Press **AUX** until **LINE** or **LINE IN** appears in the display. You should hear music from your device even if it is low.
7. Adjust the volume on your portable music player until it reaches the volume level of the FM station or CD. Do this by switching back and forth between the AUX and FM or CD controls.

USB PORT (IF EQUIPPED)

 **WARNING:** Driving while distracted can result in loss of vehicle control, crash and injury. We strongly recommend that you use extreme caution when using any device that may take your focus off the road. Your primary responsibility is the safe operation of your vehicle. We recommend against the use of any hand-held device while driving and encourage the use of voice-operated systems when possible. Make sure you are aware of all applicable local laws that may affect the use of electronic devices while driving.



The USB port allows you to plug in media playing devices, memory sticks and charge devices (if supported). See the *SYNC* chapter for more information.

MEDIA HUB (IF EQUIPPED)

The media hub is located in a compartment on top of the instrument panel. Push down on the top of the compartment to access the media hub.

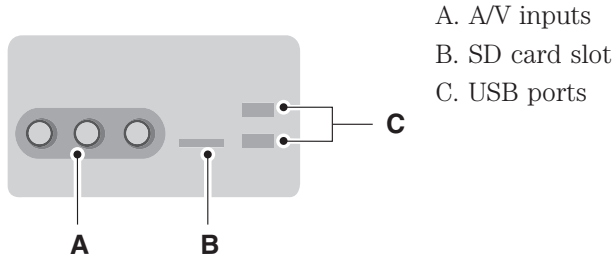

For more information, see the *MyFord Touch* chapter.

SATELLITE RADIO INFORMATION (IF EQUIPPED)

Satellite Radio Channels

SIRIUS broadcasts a variety of music, news, sports, weather, traffic and entertainment satellite radio channels. For more information and a complete list of SIRIUS satellite radio channels, visit www.siriusxm.com in the United States, www.sirius.ca in Canada, or call SIRIUS at 1-888-539-7474.

Note: This receiver includes the eCos real-time operating system. eCos is published under the eCos License.

Satellite Radio Reception Factors

| Potential satellite radio reception issues | |
|--|--|
| Antenna obstructions | For optimal reception performance, keep the antenna clear of snow and ice build-up and keep luggage and other material as far away from the antenna as possible. |
| Terrain | Hills, mountains, tall buildings, bridges, tunnels, freeway overpasses, parking garages, dense tree foliage and thunderstorms can interfere with your reception. |

| Potential satellite radio reception issues | |
|--|--|
| Station overload | When you pass a ground-based broadcast-repeating tower, a stronger signal may overtake a weaker one and the audio system may mute. |
| Satellite radio signal interference | Your display may show ACQUIRING . . . to indicate the interference and the audio system may mute. |

SIRIUS Satellite Radio Service

Note: SIRIUS reserves the unrestricted right to change, rearrange, add or delete programming including canceling, moving or adding particular channels, and its prices, at any time, with or without notice to you. Ford Motor Company shall not be responsible for any such programming changes.



SIRIUS satellite radio is a subscription-based satellite radio service that broadcasts a variety of music, sports, news, weather, traffic and entertainment programming. Your factory-installed SIRIUS satellite radio system includes

hardware and a limited subscription term which begins on the date of sale or lease of your vehicle. See an authorized dealer for availability.

For more information on extended subscription terms (a service fee is required), the online media player and a complete list of SIRIUS satellite radio channels, and other features, please visit www.siriusxm.com in the United States, www.sirius.ca in Canada, or call SIRIUS at 1-888-539-7474.

Satellite Radio Electronic Serial Number (ESN)

You need your ESN to activate, modify or track your satellite radio account. When in satellite radio mode, you can view this number by pressing **SIRIUS** and memory preset 1 at the same time. To access your ESN, press the bottom left corner of the touchscreen, then **SIRIUS > Options.**

Troubleshooting

| Radio display | Condition | Possible action |
|----------------------------------|---|--|
| Acquiring | Radio requires more than two seconds to produce audio for the selected channel. | No action required. This message should disappear shortly. |
| Sat Fault/SIRIUS system failure | There is an internal module or system failure present. | If this message does not clear shortly, or with an ignition key cycle, your receiver may have a fault. See an authorized dealer for service. |
| Invalid Channel | The channel is no longer available. | Tune to another channel or choose another preset. |
| Unsubscribed Channel | Your subscription does not include this channel. | Contact SIRIUS at 1-888-539-7474 to subscribe to the channel, or tune to another channel. |
| No Signal | The signal is lost from the SIRIUS satellite or SIRIUS tower to your vehicle antenna. | The signal is blocked. When you move into an open area, the signal should return. |
| Updating | Update of channel programming in progress. | No action required. The process may take up to three minutes. |
| Call SIRIUS 1-888-539-7474 | Your satellite service is no longer available. | Call SIRIUS at 1-888-539-7474 to resolve subscription issues. |
| None Found. Check Channel Guide. | All the channels in the selected category are either skipped or locked. | Use the channel guide to turn off the Lock or Skip function on that station. |
| Subscription Updated | SIRIUS has updated the channels available for your vehicle. | No action required. |

MANUAL CLIMATE SYSTEM

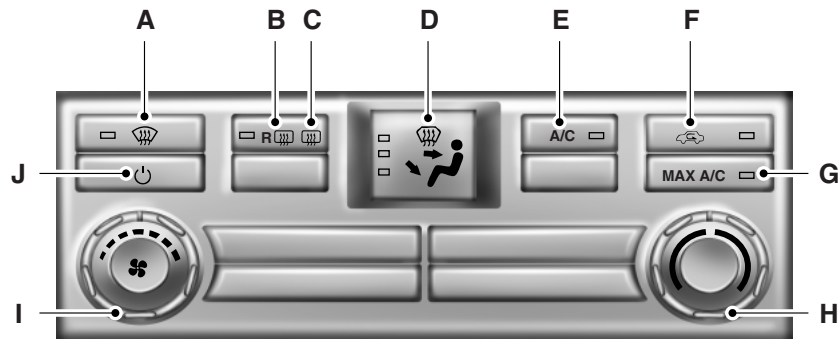

A. Defrost: Distributes air through the windshield defroster vents and demister vents. This setting can also be used to defog and clear the windshield of a thin covering of ice.

B. Rear defrost and heated mirrors: Turns the heated rear window and heated mirrors off and on. See *Heated windows and mirrors* later in this chapter for more information.

C. Heated mirrors: Turns the heated mirrors off and on (if equipped with heated mirrors, but not a heated rear window). See *Heated windows and mirrors* later in this chapter for more information.

D. Air distribution control: Press to set the air distribution to a position listed below:



Distributes air through the windshield defroster vents, demister vents and floor vents.



Distributes air through the instrument panel vents.



Distributes air through the instrument panel vents, floor vents, and demister vents.



Distributes air through the floor vents.

E. **A/C:** Press to turn air conditioning off and on. Air conditioning cools the vehicle using outside air. To improve air conditioning when starting your vehicle, drive with the windows slightly open for two to three minutes.

F. **Recirculated air:** Press to switch between outside air and recirculated air. When the LED on the button is lit, the air currently in the passenger compartment is being recirculated. Using recirculated air can reduce the time needed to cool the interior and reduce unwanted odors from entering your vehicle.

G. **MAX A/C:** Distributes recirculated air through the instrument panel vents to cool the vehicle. This position is more economical and efficient than normal A/C.

H. **Temperature control:** Controls the temperature of the air circulated in your vehicle. Turn to select the desired temperature.

I. **Fan speed control:** Controls the volume of air circulated in your vehicle. Turn to select the desired fan speed or switch off. If you switch the fan off, the windshield may fog up.

J. **Power:** Press to turn the system off and on. When the system is off, outside air cannot enter the vehicle.

DUAL AUTOMATIC TEMPERATURE CONTROL SYSTEM

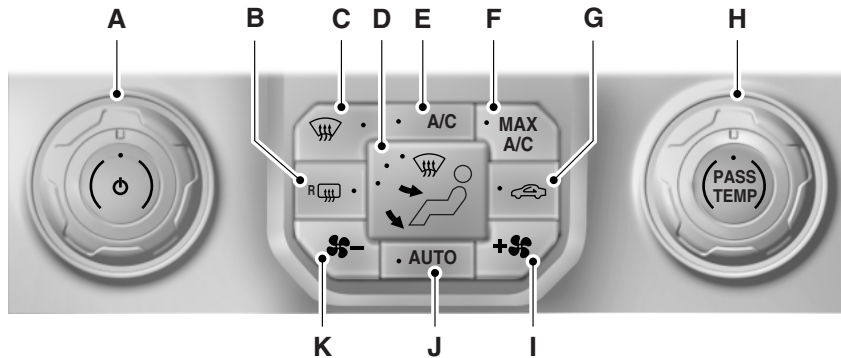

Note: You can switch temperature units between Fahrenheit and Celsius. See *Menu features* in the *MyFord Touch* or *MyLincoln Touch* chapter.

A. Power/Driver temperature control: Press to turn the climate control system off and on. When the system is off, outside air cannot enter the vehicle.

Turn to increase or decrease the air temperature for the driver side of the vehicle.

This control also adjusts the passenger side temperature when dual zone operation is disengaged.

B. Rear defrost: Turns the heated windows and mirrors off and on.

See *Heated windows and mirrors* later in this chapter for more information. If your vehicle is equipped with heated mirrors, this button turns them on also.

C. Defrost: Distributes air through the windshield defroster vents and demister vents. This setting can also be used to defog and clear the windshield of a thin covering of ice.

D. **Air distribution control:** Press to set the air distribution to a position listed below:



Distributes air through the windshield defroster vents, demister vents and floor vents.



Distributes air through the instrument panel vents.



Distributes air through the instrument panel vents and floor vents.



Distributes air through the floor vents.

E. **A/C:** Press to turn air conditioning off and on. Air conditioning cools the vehicle using outside air. To improve air conditioning when starting your vehicle, drive with the windows slightly open for two to three minutes. Use A/C with recirculated air to improve cooling performance and efficiency.

Note: A/C turns on automatically in MAX A/C, Defrost and Floor/Defrost.

F. **MAX A/C:** Distributes recirculated air through the instrument panel vents to cool the vehicle. This position is more economical and efficient than normal A/C.

G. **Recirculated air:** Press to switch between outside air and recirculated air. When the LED on the button is lit, the air currently in the passenger compartment is being recirculated. Using recirculated air can reduce the time needed to cool the interior and reduce unwanted odors from entering your vehicle. Even when this button is not selected, air may still recirculate in some instances in order to reduce vehicle warm-up time in cold conditions or to cool down time in hot conditions.

Note: Recirculated air engages automatically when MAX A/C is selected or can be turned on manually in any airflow mode except Defrost.

Note: You may notice changes in sound between recirculated mode and other airflow modes.

Note: For better cooling in hot conditions, recirculated air automatically engages when the air distribution control is in panel or panel/floor modes and the air conditioning is on. You can switch to fresh air by pressing the recirculated air button again.

H. **PASS TEMP:** Press to switch between single and dual zone. Turn to increase or decrease the air temperature on the passenger side of the vehicle.

I. **Fan speed control +**: Press to increase the volume of air circulated in your vehicle.

J. **AUTO**: Press to turn on fully automatic operation. Select the desired temperature using the temperature control. The system automatically determines fan speed, air distribution, A/C operation, and outside or recirculated air, to heat or cool the vehicle to maintain the selected temperature.

K. **Fan speed control -** : Press to decrease the volume of air circulated in your vehicle.

GENERAL OPERATING TIPS

Manual Heating and Air Conditioning System

- To reduce fog build-up on the windshield during humid weather, select Defrost. Temperature and fan speed can also be increased to improve clearing.
- To reduce humidity build-up inside the vehicle, do not drive with the system off or with recirculated air engaged.
- Do not put objects under the front seats that will interfere with the airflow to the back seats.
- Remove any snow, ice or leaves from the air intake area at the base of the windshield.
- To improve the A/C cool down, drive with the windows slightly open for 2-3 minutes after start-up or until the vehicle has been aired out.
- A small amount of air may be felt from the floor vent regardless of the air distribution setting that is selected.

During extreme high ambient temperatures when idling stationary for extended periods of time in gear, it is recommended to run the A/C in the MAX A/C mode, adjust the blower fan speed to the lowest setting and put the vehicle's transmission into position **P** to continue to receive cool air from your A/C system.

For maximum cooling performance in AUTO or panel mode, press **MAX A/C**.

For maximum cooling performance in panel/floor mode:

1. Move temperature control to the coolest setting.
2. Select A/C and recirculated air to provide colder airflow.
3. Set the fan to the highest speed initially, then adjust to maintain comfort.

To aid in side window defogging and demisting in cold or humid weather:

1. Select Floor/Panel.
2. Select A/C.
3. Adjust the temperature control to maintain comfort.
4. Set the fan speed to the highest setting.
5. Direct the outer instrument panel vents toward the side windows.
6. To increase airflow to the outer instrument panel vents, close the vents located in the middle of the instrument panel.

Dual Zone Automatic Temperature Control

- To reduce fog build-up on the windshield during humid weather, select Defrost. Temperature and fan speed can also be increased to improve clearing.
- To reduce humidity build-up inside the vehicle, do not drive with the system off or with recirculated air engaged.
- Do not put objects under the front seats that will interfere with the airflow to the back seats.
- Remove any snow, ice or leaves from the air intake area at the base of the windshield.
- To improve the A/C cool down, drive with the windows slightly open for 2-3 minutes after start-up or until the vehicle has been aired out.
- A small amount of air may be felt from the floor vent regardless of the air distribution setting that is selected.

During extreme high ambient temperatures when idling stationary for extended periods of time in gear, it is recommended to run the A/C in the MAX A/C mode, adjust the blower fan speed to the lowest setting and put the vehicle's transmission into position **P** to continue to receive cool air from your A/C system.

For maximum cooling performance in AUTO or panel mode, press **MAX A/C**.

For maximum cooling performance in panel/floor mode:

1. Choose the A/C and recirc buttons.
2. Set the temperature to LO.
3. Set the fan to the highest blower setting.

To aid in side window defogging and demisting in cold or humid weather:

1. Select Floor/Panel.
2. Select A/C.
3. Adjust the temperature control to maintain comfort.
4. Set the fan speed to the highest setting.

5. Direct the outer instrument panel vents toward the side windows.
6. To increase airflow to the outer instrument panel vents, close the vents located in the middle of the instrument panel.

HEATED WINDOWS AND MIRRORS (IF EQUIPPED)

Heated Rear Window

Note: The engine must be running to use this feature.

Note: If your vehicle is equipped with a sliding rear window, the feature still operates when the window is opened.

Press the button to clear the rear window of thin ice and fog. Press the button again within 10 minutes to switch it off. It switches off automatically after 10 minutes, or when you switch the ignition off.

Do not use razor blades or other sharp objects to clean the inside of the rear window or to remove decals from the inside of the rear window. This may cause damage to the heated grid lines. Your warranty does not cover this damage.

Heated Exterior Mirror (If Equipped)

Note: Do not remove ice from the mirrors with a scraper or attempt to readjust the mirror glass that has frozen in place. These actions could cause damage to the glass and mirrors.

Note: Do not clean the housing or glass of any mirror with harsh abrasives, fuel or other petroleum-based cleaning products.

Both mirrors heat to remove ice, mist and fog when you turn the rear window defroster on.

REMOTE START CLIMATE OPERATION (IF EQUIPPED)

The climate control system adjusts the cabin temperature during remote start.

You cannot adjust the system during remote start operation. Turn the ignition on to return the system to its previous settings. You can now make adjustments. You will need to turn certain vehicle-dependent features back on, such as:

- heated seats
- cooled seats
- heated steering wheel
- heated mirrors
- heated rear window.

Manual Climate Systems

In hot weather, the climate control system is set to MAX A/C.

In moderate weather, the system either heats or cools (based on previous settings). The rear defroster and heated mirrors are not automatically turned on.

In cold weather, maximum heat is provided in floor/defrost mode. The rear defroster and heated mirrors are automatically turned on. If your vehicle is equipped with a diesel engine and a supplemental heater, the supplemental heater also turns on.

Automatic Climate Systems***Automatic Settings***

The climate control system automatically sets the interior temperature to 72°F (22°C).

In hot weather, the system is set to 72°F (22°C). Cooled seats are set to high (if available, and selected to AUTO in the information display).

In moderate weather, the system either heats or cools (based on previous settings). The rear defroster, heated mirrors and heated/cooled seats are not automatically turned on.

In cold weather, the system is set to 72°F (22°C). The heated seats and heated steering wheel (if equipped) are set to high. The rear defroster and heated mirrors are automatically turned on.

Heated and Cooled Devices

The climate control system controls other heated and cooled devices inside the vehicle. These devices (if equipped) may also be switched on during remote start. Heated devices are typically switched on during cold weather, and cooled devices during hot weather. If your vehicle is equipped with a diesel engine and a supplemental heater, the supplemental heater also turns on.

SITTING IN THE CORRECT POSITION

 **WARNING:** Sitting improperly out of position or with the seat back reclined too far can take off weight from the seat cushion and affect the passenger sensing system, resulting in serious injury or death in a crash. Always sit upright against your seat back, with your feet on the floor.

 **WARNING:** Do not recline the seat back as this can cause the occupant to slide under the seat's safety belt, resulting in severe personal injury in the event of a crash.

 **WARNING:** Do not place objects higher than the seat backs to reduce the risk of injury in a crash or during heavy braking or when stopping suddenly.

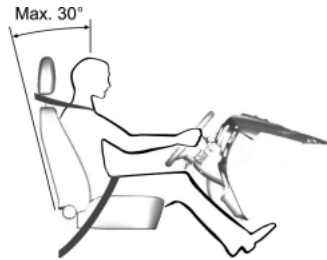



When you use them properly, the seat, head restraint, safety belt and airbags will provide optimum protection in the event of a crash. We recommend that you follow these guidelines:

- Do not recline the seat back more than 30 degrees from vertical.
- Sit in an upright position with the base of your spine as far back as possible.
- Adjust the head restraint so that the top of it is level with the top of your head and as far forward as possible, remaining comfortable.
- Keep sufficient distance between yourself and the steering wheel. We recommend a minimum of 10 inches (250 millimeters) between your breastbone and the airbag cover.
- Hold the steering wheel with your arms slightly bent.
- Bend your legs slightly so that you can press the pedals fully.
- Position the shoulder strap of the safety belt over the center of your shoulder and position the lap strap tightly across your hips.

Make sure that your driving position is comfortable and that you can maintain full control of your vehicle.

HEAD RESTRAINTS

 **WARNING:** To minimize the risk of neck injury in the event of a crash, you and the passenger occupants should not sit in or operate the vehicle, until the head restraint is placed in its proper position. Never adjust the head restraint while the vehicle is in motion.

 **WARNING:** The adjustable head restraint is a safety device. Whenever possible it should be installed and properly adjusted when the seat is occupied.

 **WARNING:** Install the head restraint properly to minimize the risk of neck injury in the event of a crash.

Note: Adjust the seat back to an upright driving or riding position before adjusting any head restraint. Properly adjust the head restraint so that the top of the head restraint is even with the top of your head and positioned as close as possible to the back of your head. For occupants of extremely tall stature, adjust the head restraint to its full up position.

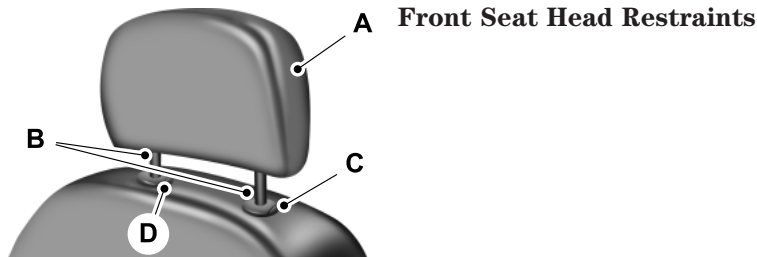

The head restraints consist of :

- A. an energy absorbing head restraint
- B. two steel stems
- C. guide sleeve adjust and release button
- D. guide sleeve unlock and remove button

Adjusting the Head Restraint

Raise: Pull up the head restraint.

Lower:

1. Press and hold button C.
2. Push down on the head restraint.

Remove:

1. Pull up the head restraint until it reaches the highest adjustment position.
2. Press and hold buttons C and D.
3. Pull up the head restraint.

Reinstall: Align the steel stems into the guide sleeves and push the head restraint down until it locks.

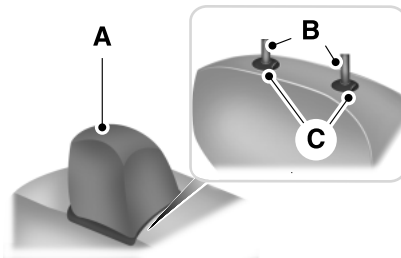

Front Row Center, Outboard (Crew Cab), and Rear Seat Center (Crew Cab) Head Restraints

Note: The SuperCab has rear outboard head restraints that are not removable and are bolted to the back wall.

Your vehicle may be equipped with head restraints that are non-adjustable.

The non-adjustable head restraints consist of :

- A. an energy absorbing head restraint
- B. two steel stems
- C. guide sleeve unlock and remove button

Remove:

1. Press and hold buttons C.
2. Pull up the head restraint.

Reinstall: Align the steel stems into the guide sleeves and push the head restraint down until it locks.

Tilting Head Restraints (If Equipped)

The front head restraints may have a tilting feature for extra comfort. To tilt the head restraint, do the following:



1. Adjust the seat back to an upright driving or riding position.
2. Tilt the head restraint forward by gently pulling the top of the head restraint.

Once it is in its forward-most position, tilt it forward once more to release it to the upright position.

Note: Do not attempt to force the head restraint backward after it is tilted. Instead, continue tilting it forward until the head restraint releases to the upright position.

MANUAL SEATS**Moving the Seats Backward and Forward**

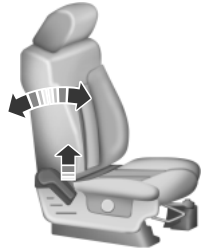
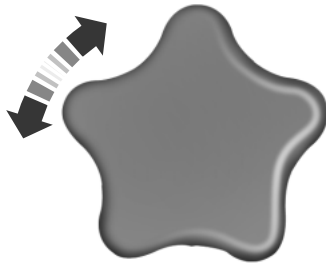
Recline Adjustment**Manual Lumbar (If Equipped)**

The lumbar support control is located on the outboard side of the seat. Turn the control to adjust your support.

POWER SEATS (IF EQUIPPED)

 **WARNING:** Before returning the seat back to its original position, make sure that cargo or any objects are not trapped behind the seat back.

 **WARNING:** Never adjust the driver's seat or seat back when the vehicle is moving.

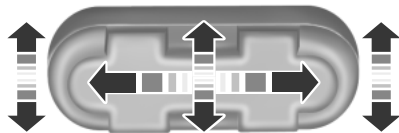

The control is located on the outboard side of the seat. Move the switch in the direction of the arrow to raise or lower the seat cushion or to move the seat forward, backward, up or down.

Power Recline (if equipped)



Move the switch to recline the seat back forward or rearward.

Power Lumbar (if equipped)



The control is located on the outboard side of the seat. Press the forward or rearward side of the control for more or less support.

MEMORY FUNCTION (IF EQUIPPED)

This system allows automatic positioning of the driver seat, power mirrors, and adjustable pedals to two programmable positions.



The memory control is located on the driver's door.

- To program position 1, move the memory features to the desired positions using the associated controls. Press and hold button 1 for at least two seconds. A chime will sound confirming that a memory position has been set.
- To program position 2, repeat the previous procedure using button 2.

A memory position may be programmed at any time.

To program the memory feature to a remote entry transmitter, see *Remote entry system* in the *Locks* chapter.

A programmed memory position can be recalled:

- in any gearshift position if the ignition is not on.
- only in position **P** or **N** if the ignition is on.

The memory positions are also recalled when you press your remote entry transmitter unlock control (if the transmitter is programmed to a memory position) or, when you enter a valid personal entry code that is programmed to a memory position. The mirrors will move to the programmed position and the seat will move to the easy entry position. The seat will move to the final position when the key is in the ignition (if easy entry feature is enabled).

Easy Entry and Exit Feature (If Equipped)

If the easy entry and exit feature is enabled, this feature automatically moves the driver's seat rearward 2 inches (5 centimeters) when the transmission selector lever is in position **P** and the key is removed from the ignition.

If the seat is located less than 2 inches (5 centimeters) from the rear of the seat track, the seat travel will be less than 2 inches (5 centimeters) rearward.

The driver's seat will return to the previous position when the key is put in the ignition.

This feature is enabled or disabled through the information display. See the *Information Displays* chapter for more information.

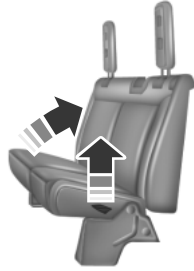
REAR SEATS**Folding Up the Rear Seats (SuperCab)**

1. Pull the control to release the seat cushion.
2. Rotate the seat cushion up until it locks into the vertical storage position.

Returning the Seat to the Seating Position

WARNING: Make sure that cargo or any objects are not trapped underneath the seat cushion before returning the seat cushion to its original position, and that the seat cushion locks into place. Failure to do so may prevent the seat from operating properly in the event of a crash, which could increase the risk of serious injury.

1. Pull the control on the side of the seat to release the seat cushion from the storage position.
2. Push the seat cushion down until it locks into the horizontal position.

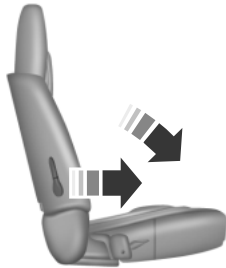
Folding the Rear Seat Back (Crew Cab)

1. Pull forward on the control to fold down the seatback.
2. Pull down on the handle and lift up on the seatback to return it to the original position.

Folding up the Rear Seat Cushion

1. Pull the control to release the seat cushion.
2. Rotate the seat cushion up until it locks into the vertical storage position.

Returning the Seat to the Seating Position

 **WARNING:** Make sure that cargo or any objects are not trapped underneath the seat cushion before returning the seat cushion to its original position, and that the seat cushion locks into place. Failure to do so may prevent the seat from operating properly in the event of a crash, which could increase the risk of serious injury.

1. Pull the control on the side of the seat to release the seat cushion from the storage position.
2. Push the seat cushion down until it locks into the horizontal position.

Rear Under Seat Storage (If Equipped) (Crew Cab)

The rear seat has storage space located under the seat cushion.

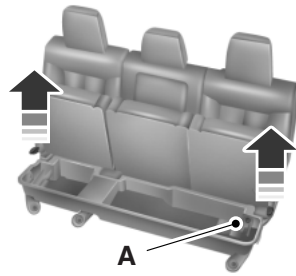

Lift up the lever and flip up the seat cushion to access the storage space and the power point (A).

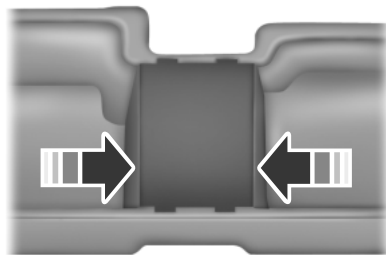

To remove the storage space divider, squeeze the sides and lift it from the storage tub.

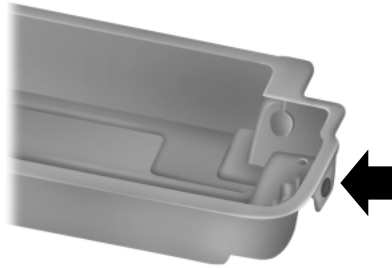

Use your vehicle key to lock the storage space.

Rear Heated Seats (If Equipped)



WARNING: Persons who are unable to feel pain to the skin because of advanced age, chronic illness, diabetes, spinal cord injury, medication, alcohol use, exhaustion, or other physical conditions, must exercise care when using the seat heater. The seat heater may cause burns even at low temperatures, especially if used for long periods of time. Do not place anything on the seat that insulates against heat, such as a blanket or cushion, because this may cause the seat heater to overheat. Do not puncture the seat with pins, needles, or other pointed objects because this may damage the heating element which may cause the seat heater to overheat. An overheated seat may cause serious personal injury.

Note: Do not do the following:

- Place heavy objects on the seat
- Operate the seat heater if water or any other liquid is spilled on the seat. Allow the seat to dry thoroughly.

The rear seat heat controls are located on the rear door armrest.

To operate the heated seats:



- Push the indicated side of the control for maximum heat.
- Push again to deactivate.



- Push the indicated side of the control for minimum heat.
- Push again to deactivate.

The heated seat module resets at every ignition run cycle. While the ignition is in the on position, activate the high or low heated seat switch to enable heating mode. When activated, they will turn off automatically when the engine is turned off.

The indicator light will illuminate when the heated seats have been activated.

REAR SEAT ARMREST (IF EQUIPPED)



To use the armrest, rotate it forward from the seat back.

HEATED AND COOLED SEATS (IF EQUIPPED)**Heated Seats**

WARNING: Persons who are unable to feel pain to the skin because of advanced age, chronic illness, diabetes, spinal cord injury, medication, alcohol use, exhaustion, or other physical conditions, must exercise care when using the seat heater. The seat heater may cause burns even at low temperatures, especially if used for long periods of time. Do not place anything on the seat that insulates against heat, such as a blanket or cushion, because this may cause the seat heater to overheat. Do not puncture the seat with pins, needles, or other pointed objects because this may damage the heating element which may cause the seat heater to overheat. An overheated seat may cause serious personal injury.

- Do not place heavy objects on the seat.
- Do not operate the seat heater if water or any other liquid is spilled on the seat. Allow the seat to dry thoroughly.

The heated seats will only function when the engine is running.

To operate the heated seats:



Press the heated seat button/symbol to cycle through the various heat settings and off. Warmer settings are indicated by more indicator lights.

Cooled Seats

The cooled seats will only function when the engine is running.

To operate the cooled seats:



Press the cooled seat button/symbol to cycle through the various cooling settings and off. Cooler settings are indicated by more indicator lights.

If the engine falls below 350 rpm while the cooled seats are on, the feature will turn itself off and will need to be reactivated.

Heated and Cooled Seats Air Filter Replacement (If Equipped)

The heated and cooled seat system includes air filters. They must be replaced periodically. See *scheduled maintenance information*.

The filter is located under each front seat. Access the filter from the second row foot-well area. Move the front seats all the way to the full front and full up positions to ease access.

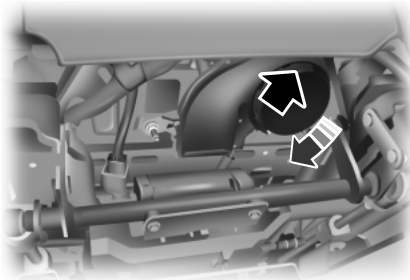

To remove a filter:

1. Turn the vehicle off.
2. Push up on the outside rigid edge of the filter until the tabs are released, then remove the filter.

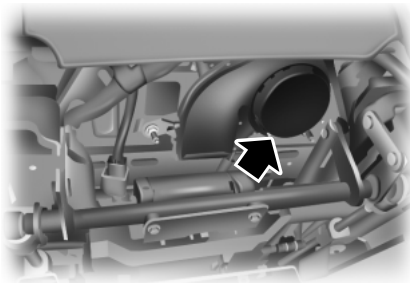

To install a filter:

1. First, position the filter in its housing making sure that the far forward end is all the way up in the housing.
2. Push in on the center of the outside edge of the filter and rotate clockwise into the housing until it clips into position.

FRONT SEAT ARMREST (IF EQUIPPED)



To release the armrest and gain access to the cupholders and seat back storage bin, press the button on the right-hand side of the seat and pull the seat back down.

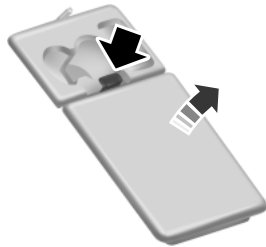

Pull up on the tab to open the storage bin.

Lift up on the seat back to return it to the upright position.



To gain access to the under-seat storage compartment (if equipped) in your seat cushion, lift the latch to open the lid. The lid cannot be opened when the armrest is down.



The under-seat storage compartment (if equipped) has a programmable lock. Use the ignition key to program the lock to the compartment. Electronics may be powered or charged using the under-seat storage compartment auxiliary power point. See the *Auxiliary Power Points* chapter.

168 Universal Garage Door Opener (If Equipped)

UNIVERSAL GARAGE DOOR OPENER

The appearance of your vehicle's universal garage door opener will vary according to your option package. Before programming, make sure you identify which transmitter you have by comparing it to the graphics below.

HomeLink®



Car2U® Home Automation System

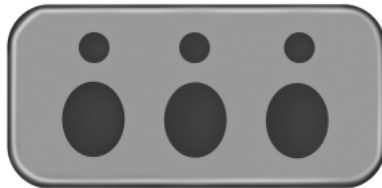

Note: The programming of the two types of universal garage door openers are different and have different instructions. Identify your package and refer to the instructions listed in this chapter.

CAR2U® HOME AUTOMATION SYSTEM (IF EQUIPPED)



WARNING: Make sure that the garage door and security device are free from obstruction when you are programming. Do not program the system with the vehicle in the garage.



WARNING: Do not use the system with any garage door opener that does not have the safety stop and reverse feature as required by U.S. Federal Safety Standards (this includes any garage door opener manufactured before April 1, 1982).

Universal Garage Door Opener (If Equipped) 169

Note: Before you begin the programming process, park your vehicle in front of the garage door opener motor or other device you want to program.

Note: Make sure you keep the original remote control transmitter for use in other vehicles as well as for future system programming.

Note: We recommend that upon the sale or lease termination of your vehicle, you erase the programmed function buttons for security reasons. See *Erasing the Function Button Codes* later in this section.

Note: You can program a maximum of three devices. To change or replace any of the three devices after it has been initially programmed, you must first erase the current settings. See *Erasing the Function Button Codes* later in this section.

Note: Programming the system to a community gate will require a unique set of instructions depending on the gate system model. Contact the help line at 1-866-572-2728 for further information.

Note: If you accidentally enter the program mode by pressing and releasing the outer two buttons or all three buttons simultaneously, do not press any button until the module times out after a few seconds and resets to normal mode. When the module has timed out, all three LED lamps will flash rapidly for a few seconds then turn off. Any settings should remain as previously set.

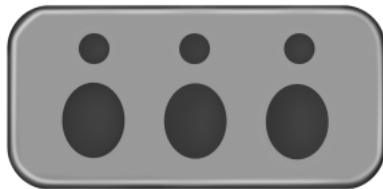

The universal garage door opener replaces the common hand-held garage door opener with a three-button transmitter that is integrated into the driver's sun visor.

The system includes two primary features, a garage door opener and a platform for remote activation of devices with the home. As well as being programmed for garage doors, the system transmitter can be programmed to operate security devices and home lighting systems.

Additional system information can be found on-line at www.learcar2U.com or by calling the toll-free help line 1-866-572-2728.

170 Universal Garage Door Opener (If Equipped)

Rolling Code Programming

Note: If you do not follow the time-sensitive instructions, the device will time out and you will have to repeat the complete procedure.

Note: It may be helpful to have another person assist you in programming the transmitter.

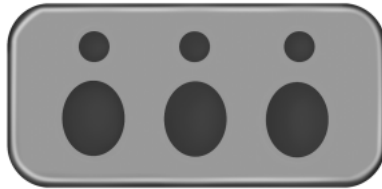
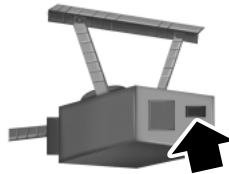
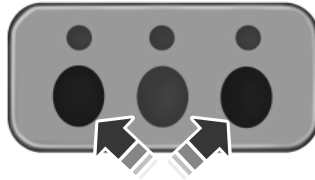

1. Switch the ignition on.
2. Press and hold the outer two buttons for 1–2 seconds, then release.

Note: You may need a ladder to reach the unit and you may need to remove the cover or lamp lens.

Note: If you cannot locate the learn button, see the Owner's Manual for your garage door opener or call the toll-free help line at 1-866-572-2728.

3. Press the learn button on the garage door opener motor.

Note: You will have 10–30 seconds to complete the following steps.

4. Return to your car.
5. Press and hold the function button you would like to use to control the garage door. You may need to hold the button from 5–20 seconds, during which time

the selected button LED lamp will flash slowly.

6. When the garage door moves, release the button **within one second**. The LED lamp will flash rapidly until programming is complete.

7. Press and release the button again. The garage door should move, confirming that programming is successful. If your garage door does not operate, repeat the previous steps.

The LED lamp above the selected button will illuminate to confirm that the system is responding to the button command.

To program another rolling code device, repeat Steps 1 through 6, substituting a different function button in Step 5.

Universal Garage Door Opener (If Equipped) 171

Fixed Code Programming

Note: It may be helpful to have another person assist you in programming the transmitter.



To program units with fixed code DIP switches, you will need the garage door hand-held transmitter, paper and a pen or pencil.

1. Switch the ignition on.
2. Open the battery cover and note all the switch settings from left to right.

When the switch is in the up, on, or + position, mark down “left button”.

When the switch is in the middle, neutral, or 0 position, mark down “middle button”.

When the switch is in the down, off, or – position, mark down “right button”.

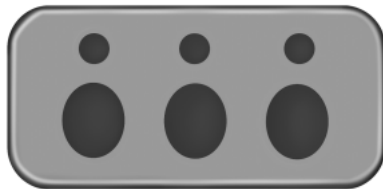

3. Press all three function buttons simultaneously for a few seconds and then release. The LED lamps will flash slowly.

Note: The following step must be completed within 2.5 minutes.

4. Enter the corresponding DIP switch settings from left to right into the system by pressing and releasing the buttons corresponding to the settings you noted.

5. Simultaneously press and release all three function buttons. The LED lamps will illuminate.

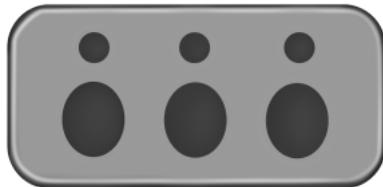

6. Press and hold the function button you would like to use to control the garage door.

Note: You may need to hold the button from 5–55 seconds before observing movement of the garage door.

172 Universal Garage Door Opener (If Equipped)

7. When the garage door moves, release the button within one second. When the button is released, the LED lamp will flash slowly.

8. The LED lamp will begin to flash rapidly until programming is complete. If your garage door does not operate, repeat the previous steps. Otherwise, call the toll-free help line at 1-866-572-2728.

The LED lamp above the selected button will illuminate to confirm that the system is responding to the button command.

Erasing the Function Button Codes

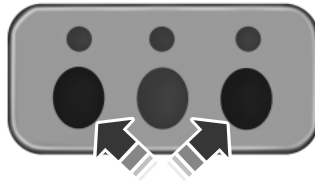

Note: You cannot erase individual buttons.

1. Press and hold the outer two function buttons simultaneously for approximately 20 seconds until the LED lamps above the buttons flash rapidly.

2. When the LED lamps flash, release the buttons. The codes for all buttons are erased.

FCC and RSS-210 Industry Canada Compliance

This device complies with Part 15 of the FCC Rules and with RSS-210 of Industry Canada. Operation is subject to the following two conditions: (1) this device may not cause harmful interference, and (2) this device must accept any interference received, including interference that may cause undesired operation.

Changes or modifications to your device not expressly approved by the party responsible for compliance can void the user's authority to operate the equipment.

HOMELINK® WIRELESS CONTROL SYSTEM (IF EQUIPPED)



WARNING: Make sure that the garage door and security device are free from obstruction when you are programming. Do not program the system with the vehicle in the garage.



WARNING: Do not use the system with any garage door opener that does not have the safety stop and reverse feature as required by U.S. Federal Safety Standards (this includes any garage door opener manufactured before April 1, 1982).

Universal Garage Door Opener (If Equipped) 173

Note: Make sure you keep the original remote control transmitter for use in other vehicles as well as for future system programming.

Note: We recommend that upon the sale or lease termination of your vehicle, you erase the programmed function buttons for security reasons. See *Erasing the function button codes* later in this section.

Note: You can program a maximum of three devices. To change or replace any of the three devices after it has been initially programmed, you must first erase the current settings. See *Erasing the function button codes* later in this section.

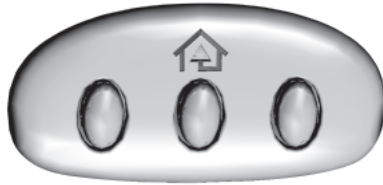

The universal garage door opener replaces the common hand-held garage door opener with a three-button transmitter that is integrated into the driver's sun visor.

The system includes two primary features, a garage door opener and a platform for remote activation of devices with the home. As well as being programmed for garage doors, the system transmitter can be programmed to operate entry gate operators, security systems, entry door locks, and home or office lighting.

Additional system information can be found online at www.homelink.com or by calling the toll-free help line on 1-800-355-3515.

Programming

Note: Put a new battery in the hand-held transmitter. This will ensure quicker training and accurate transmission of the radio-frequency signal.

1. With your vehicle parked outside of the garage and your key in the ignition, turn the key so that the ignition is in the on position.

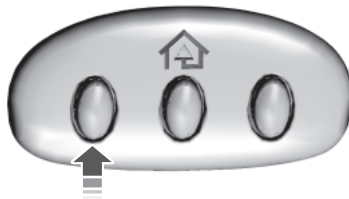

2. Hold your hand-held, garage door transmitter 1–3 inches (2–8 centimeters) away from the HomeLink button you want to program.

3. Using both hands, simultaneously press and hold the desired HomeLink button and the hand-held transmitter button. DO NOT release either one until the HomeLink

indicator light flashes slowly and then rapidly. When the indicator light flashes rapidly, both buttons may be released. The rapid flashing indicates successful training.

174 Universal Garage Door Opener (If Equipped)

4. Press and hold the HomeLink button you programmed for five seconds, then release. You may need to do this twice to activate the door. If your garage door does not operate, watch the HomeLink indicator light.

If the indicator light stays on, the programming is complete. Press and release the programmed HomeLink button, and then begin programming your garage door opener. See below for Steps 5 – 7.

If the indicator light flashes rapidly for two seconds and then turns to a constant light, the HomeLink button is not programmed yet. Do the following:

Press and hold the HomeLink button while you press and release the hand-held transmitter button every two seconds. The HomeLink indicator light will flash slowly and then rapidly once the HomeLink function button recognizes and accepts the hand-held transmitter's radio frequency signal.

After programming the HomeLink button, follow Steps 5 – 7 as listed below to program your garage door opener.



Note: You may need a ladder to reach the unit and you may need to remove the cover or lamp lens on your garage door opener.

5. Press the learn button on the garage door opener motor, and then you have 30 seconds to complete the next step.

6. Return to your car.

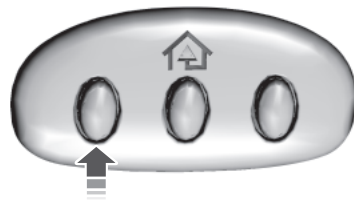

7. Press and hold the function button you want to program for two seconds, then release. Repeat this step. Depending on your brand of garage door opener, you may need to repeat this sequence a third time.

To program additional buttons, repeat Steps 1 – 4.

For questions or comments, please contact HomeLink® at www.homelink.com or 1-800-355-3515.

Universal Garage Door Opener (If Equipped) 175

Erasing the Function Button Codes

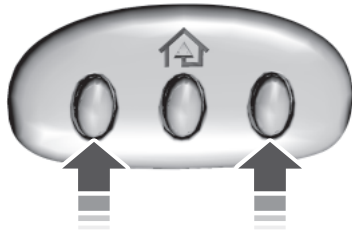

Note: You cannot erase individual buttons.

1. Press and hold the outer two function buttons simultaneously for approximately 20 seconds until the indicator lights above the buttons flash rapidly.
2. When the indicator lights flash, release the buttons. The codes for all buttons are erased.

Reprogramming a single button

To program a device to a previously trained button, follow these steps:

1. Press and hold the desired button. **Do NOT** release the button.
2. The indicator light will begin to flash after 20 seconds. Without releasing the button, follow Step 1 in the *Programming* section.

For questions or comments, contact HomeLink® at www.homelink.com or 1-800-355-3515.

Programming HomeLink to a Genie Intellicode 2 garage door opener

Note: The Genie Intellicode 2 transmitter must already be programmed to operate with the garage door opener.

Programming the transmitters

To program HomeLink to the transmitter you must first put the transmitter into programming mode. To do this:

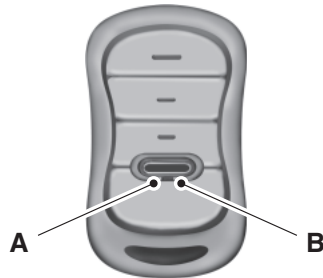

- A. Red LED
- B. Green LED

176 Universal Garage Door Opener (If Equipped)

1. Press and hold one of the buttons on the hand-held transmitter for 10 seconds. The LED light will change from green to green and red.
2. Press the same button twice to confirm the change to Programming mode. If done properly the LED light will appear red.
3. Hold the transmitter within 1–3 inches (2–8 centimeters) of the button on the sun visor you want to program.
4. Press and hold both the programmed Genie button on the hand-held transmitter and the button on the sun visor you want to program. The indicator light on the sun visor will flash rapidly when the programming is successful.

Note: the Genie transmitter will transmit for up to 30 seconds. If HomeLink does not program within 30 seconds the Genie transmitter will need to be pressed again. If the Genie transmitter LED displays green and red, release the button until the LED turns off before pressing the button again.

Once HomeLink has been programmed successfully, the Genie transmitter must be changed out of program mode. To do this:

1. Press and hold the previously programmed Genie button on the hand-held transmitter for 10 seconds. The indicator light will change from red to red and green.
2. Press the same button twice to confirm the change. If done correctly the LED will turn green.

Programming HomeLink to the Genie Intellicode garage door opener motor

Note: You may need a ladder to access the garage door opener motor.

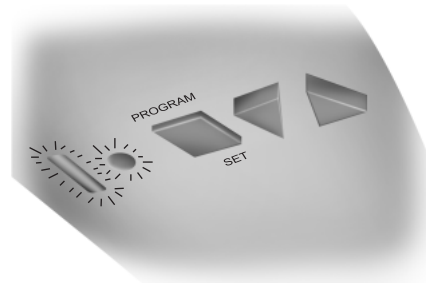

To program HomeLink to the garage door opener motor:

1. Press and hold the PROGRAM button on the garage door opener motor until both blue LED's turn on.
2. Release the PROGRAM button. Only the smaller round LED should be on.

Universal Garage Door Opener (If Equipped) 177

3. Press and release the program button. The larger purple LED will flash

Note: The next two steps must be completed in 30 seconds.

4. Press and release the Genie Intellicode 2 hand-held transmitter's previously programmed button. Both indicator lights on the garage door opener motor unit should now flash purple.

5. Press and hold the previously programmed button on the sun visor for two seconds. Repeat this step up to 3 times until the garage door moves. Programming is now complete.

Clearing a HomeLink device

To erase programming from the three HomeLink buttons, press and hold the two outer HomeLink buttons until the indicator light begins to flash. The LED will begin flashing in 10 to 20 seconds, at which time both buttons should be released. Programming has now been erased, and the LED should blink slowly to indicate the device is in train mode when any one of the three HomeLink buttons is pressed.

FCC and RSS-210 Industry Canada Compliance

This device complies with Part 15 of the FCC Rules and with RSS-210 of Industry Canada. Operation is subject to the following two conditions: (1) this device may not cause harmful interference, and (2) this device must accept any interference received, including interference that may cause undesired operation.

Changes or modifications to your device not expressly approved by the party responsible for compliance can void the user's authority to operate the equipment.

AUXILIARY POWER POINTS

WARNING: Do not plug optional electrical accessories into the cigarette lighter socket (if equipped). Improper use of the lighter can cause damage not covered by your warranty, and can result in fire or serious injury.

Note: If used when the engine is not running, the battery will discharge. There may be insufficient power to restart your engine.

Note: Do not insert objects other than an accessory plug into the power point. This will damage the outlet and blow the fuse.

Note: Do not hang any type of accessory or accessory bracket from the plug.

Note: Do not use the power point over the vehicle capacity of 12-volt DC 180 watts or a fuse may blow.

Note: Do not use the power point for operating a cigarette lighter element.

Note: Improper use of the power outlet can cause damage not covered by your warranty.

Note: Always keep the power point caps closed when not in use.

Run the engine for full capacity use of the power point. To prevent the battery from being discharged:

- Do not use the power point longer than necessary when the engine is not running.
- Do not leave devices plugged in overnight or when the vehicle is parked for extended periods.

Locations

Power points may be found:

- on the instrument panel (two locations).
- inside the center console storage compartment (if equipped).
- on the rear of the center console (if equipped).
- inside the 20-percent front seat console (if equipped).
- inside the rear under seat storage compartment (if equipped).

110 Volt AC Power Points (If Equipped)



WARNING: Do not keep electrical devices plugged in the power point whenever the device is not in use. Do not use any extension cord with the 110-volt AC power point since it will defeat the safety protection design. Do not power multiple devices from your power point. Doing so may cause the power point to overload and could result in fire or serious injury.

Note: Always close the protective cap after using the power point outlets.

Note: The power points will turn off after 13 minutes if the ignition is on without the engine running. Keep the engine running to use the power points.

Your 110-volt AC power point outlets are used for powering electrical devices that require up to 150 watts. Exceeding the 150-watt limit will cause the power points to cut off the power temporarily to provide overload protection.



Your vehicle may have more than one power point, located:

- on the back of the center console
- on the instrument panel.

Your power points are not designed for the following electric appliances and may prevent the appliances from working properly:

- Cathode ray tube type televisions
- Motor loads, such as vacuum cleaners, electric saws and other electric power tools, compressor-driven refrigerators, etc.
- Measuring devices, which process precise data, such as medical equipment, measuring equipment, etc.
- Other appliances requiring an extremely stable power supply: microcomputer-controlled electric blankets, touch sensor lamps, etc.

Power points can switch to a fault mode when overloaded, overheated or shorted. Unplug your device and turn the ignition off then on for overloading and shorting conditions. Let the system cool off, then turn the ignition off then on for an overheating condition.

Power points can provide power whenever the ignition is on and the indicator lights are on. Each indicator light is located in the top left corner of the power point.

When the indicator light is:

- on — power point is ready to supply power
- off — power point power supply is off; ignition is not on
- blinking — power point is in fault mode.

CENTER CONSOLE (IF EQUIPPED)

Stow items in the cupholder carefully as items may become loose during hard braking, acceleration or collisions, including hot drinks which may spill.

Available console features include:

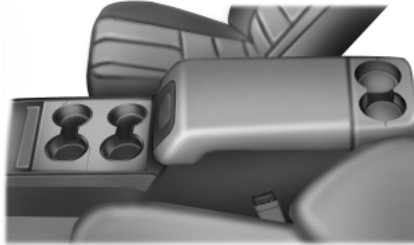

- Locking storage compartment with hanging file folder supports
- Storage for laptop computer, binder or book between the hanging file folder support and the passenger side of the console bin
- One 12-volt power point inside the storage compartment and one on the rear of the console
- 110-volt AC power point outlet on the rear of the console

- Rear cupholders

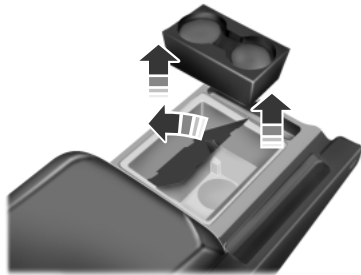

- Two removable front cupholder modules
- Removable false bottom tray for accessing hidden storage compartment (also has space for a large cup)

OVERHEAD CONSOLE (IF EQUIPPED)

The appearance of the overhead console will vary according to your option package.

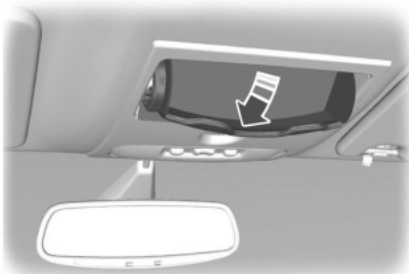

Press near the rear edge of the door to open it.

182 Starting and Stopping the Engine

GENERAL INFORMATION



WARNING: Extended idling at high engine speeds can produce very high temperatures in the engine and exhaust system, creating the risk of fire or other damage.



WARNING: Do not park, idle, or drive your vehicle on dry grass or other dry ground cover. The emission system heats up the engine compartment and exhaust system, which can start a fire.



WARNING: Do not start your vehicle in a closed garage or in other enclosed areas. Exhaust fumes can be toxic. Always open the garage door before you start the engine.



WARNING: If you smell exhaust fumes inside your vehicle, have your vehicle checked by an authorized dealer immediately. Do not drive if you smell exhaust fumes.

If you disconnect the battery, your vehicle may exhibit some unusual driving characteristics for approximately 5 miles (8 kilometers) after you connect it. This is because the engine management system must realign itself with the engine. You may disregard any unusual driving characteristics during this period.

The powertrain control system meets all Canadian interference-causing equipment standard requirements regulating the impulse electrical field strength of radio noise.

When starting your vehicle, avoid pressing the accelerator pedal before and during operation. Only use the accelerator pedal when you have difficulty starting the engine.

If your vehicle is operated in a heavy snow storm or blowing snow conditions, the engine air induction may become partially clogged with snow and/or ice. If this occurs, the engine may experience a significant reduction in power output. At the earliest opportunity, clear all the snow and/or ice away from the air induction inlet. The following starting instructions are for vehicles equipped with a gasoline engine; if your vehicle is equipped with a diesel engine, refer to *Starting the engine* in your diesel supplement.

IGNITION SWITCH

Note: To switch the engine off when your vehicle is moving, move the transmission selector lever to position **N**. Use the brakes to bring your vehicle to a safe stop. After your vehicle has stopped, switch the engine off and move the transmission selector lever to position **P**. Turn the key to the accessory or off position.

Note: Do not store the key in the ignition after the vehicle is turned off and you have left the vehicle. This could cause a drain on the battery.

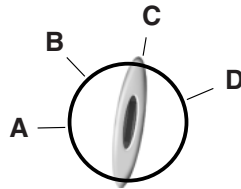

A. **Off:** The ignition is off.

B. **Accessory:** Allows the electrical accessories, such as the radio, to operate while the engine is not running.

C. **On:** All the electrical circuits are operational. Warning lights are illuminated. This is the key position when driving.

D. **Start:** Cranks the engine. Release the key as soon as the engine starts.

STARTING A GASOLINE ENGINE

When you start the engine, the idle speed increases, this helps to warm up the engine. If the engine idle speed does not slow down automatically, have your vehicle checked by an authorized dealer.

Before starting the engine:

- Make sure all occupants have fastened their safety belts.
- Make sure the headlamps and electrical accessories are off.
- Make sure the parking brake is on.
- Move the transmission selector lever to position **P**.
- Turn the ignition key to the on position.

184 Starting and Stopping the Engine

Some warning lights briefly illuminate.

Note: Do not touch the accelerator pedal.

1. Fully press the brake pedal.
2. Turn the key to the start position to start the engine. Release the key when the engine starts.

Note: The engine may continue cranking for up to 15 seconds or until it starts.

Note: If you cannot start the engine on the first try, wait for a short period and try again.

If you have difficulty starting the engine when the temperature is below -13°F (-25°C), press the accelerator pedal slightly and try again.

Failure to Start

If you cannot start the engine after three attempts, wait 10 seconds and follow this procedure:

1. Fully press the brake pedal.
2. Fully press the accelerator pedal and hold it there.
3. Start the engine.

Stopping the Engine When Your Vehicle is Stationary

1. Move the transmission selector lever to position **P**.
2. Turn the key to the off position.

Stopping the Engine When Your Vehicle is Moving



WARNING: When you switch off the engine when your vehicle is still moving, this results in a loss of brake and steering assistance. The steering does not lock, but higher effort is required. When you switch off the ignition, some electrical circuits, warning lamps and indicators may also be off.

1. Move the transmission selector lever to position **N** and use the brakes to bring your vehicle to a safe stop.
2. When your vehicle has stopped, move the transmission selector lever to position **P** and turn the key to the off position.

Cold Weather Starting (Flexible Fuel Vehicles Only)

The starting characteristics of all grades of E-85 ethanol make it unsuitable for use when ambient temperatures fall below 0°F (-18°C). Consult your fuel distributor for the availability of winter grade ethanol. As the outside temperature approaches freezing, ethanol fuel distributors should supply winter grade ethanol (same as with unleaded gasoline). If summer grade ethanol is used in cold weather conditions, 0°F to 32°F (-18°C to 0°C), you may experience increased cranking times, rough idle or hesitation until the engine has warmed up.

You may experience a decrease in peak performance when the engine is cold when operating on E-85 ethanol.

Do not crank the engine for more than 10 seconds at a time as starter damage may occur. If the engine fails to start, turn the key to off and wait 30 seconds before trying again.

Do not use starting fluid such as ether in the air intake system. Such fluid could cause immediate explosive damage to the engine and possible personal injury.

If you should experience cold weather starting problems on E-85 ethanol, and neither an alternative brand of E-85 ethanol nor an engine block heater is available, the addition of unleaded gasoline to your tank improves cold starting performance. Your vehicle is designed to operate on E-85 ethanol alone, unleaded gasoline alone, or any mixture of the two.

If the Engine Fails to Start Using the Preceding Instructions (Flexible Fuel Vehicles Only)

1. Press and hold down the accelerator 1/3 to 1/2 way to floor, then crank the engine.
2. When the engine starts, release the key, then gradually release the accelerator pedal as the engine speeds up. If the engine still fails to start, repeat Step 1.

Guarding Against Exhaust Fumes



WARNING: If you smell exhaust fumes inside your vehicle, have this checked immediately. Do not drive your vehicle if you smell exhaust fumes. Carbon monoxide is present in exhaust fumes. Take precautions to avoid its dangerous effects.

186 Starting and Stopping the Engine

Important Ventilating Information

If you stop your vehicle and leave the engine idling for long periods of time, we recommend that you do one of the following:

- Open the windows at least 1 inch (2.5 centimeters).
- Set your climate control to outside air.

ENGINE BLOCK HEATER (IF EQUIPPED)



WARNING: Failure to follow engine block heater instructions could result in property damage or physical injury.



WARNING: Do not use your heater with ungrounded electrical systems or two-pronged (cheater) adapters. There is a risk of electrical shock.

Note: The heater is most effective when outdoor temperatures are below 0°F (-18°C).

The heater acts as a starting aid by warming the engine coolant. This allows the climate control system to respond quickly. The equipment includes a heater element (installed in the engine block) and a wire harness. You can connect the system to a grounded 120-volt A/C electrical source.

We recommend that you do the following for safe and correct operation:

- Use a 16-gauge outdoor extension cord that is product certified by Underwriter's Laboratory or Canadian Standards Association. This extension cord must be suitable for use outdoors, in cold temperatures, and be clearly marked *Suitable for Use with Outdoor Appliances*. Never use an indoor extension cord outdoors; it could result in an electric shock or become a fire hazard.
- Use as short an extension cord as possible.
- Do not use multiple extension cords.

- Make sure that when in operation, the extension cord plug and the heater cord plug connections are free and clear of water. This could cause an electric shock or fire.
- Make sure your vehicle is parked in a clean area, clear of combustibles.
- Make sure the heater, heater cord and extension cord are firmly connected.
- Check for heat anywhere in the electrical hookup once the system has been operating for approximately 30 minutes.
- Make sure the system is unplugged and properly stowed before driving your vehicle. Make sure the protective cover seals the prongs of the block heater cord plug when not in use.
- Keep plug terminals clean and free of dirt and corrosion.
- Make sure the heater system is checked for proper operation before winter.

Using the Engine Block Heater

Make sure the receptacle terminals are clean and dry prior to use. Clean them with a dry cloth, if necessary.

The heater uses 0.4 to 1.0 kilowatt-hours of energy per hour of use. The system does not have a thermostat. It achieves maximum temperature after approximately three hours of operation. Using the heater longer than three hours does not improve system performance and unnecessarily uses electricity.

IMPORTANT SAFETY PRECAUTIONS

WARNING: Do not overfill the fuel tank. The pressure in an overfilled tank may cause leakage and lead to fuel spray and fire.



WARNING: The fuel system may be under pressure. If the fuel filler cap is venting vapor or if you hear a hissing sound, wait until it stops before completely removing the fuel filler cap. Otherwise, fuel may spray out and injure you or others.



WARNING: If you do not use the proper fuel filler cap, excessive vacuum in the fuel tank may damage the fuel system or cause the fuel cap to disengage in a collision, which may result in serious personal injury.



WARNING: Automotive fuels can cause serious injury or death if misused or mishandled.



WARNING: Fuel ethanol and gasoline may contain benzene, which is a cancer-causing agent.



WARNING: When refueling always shut the engine off and never allow sparks or open flames near the filler neck. Never smoke while refueling. Fuel vapor is extremely hazardous under certain conditions. Care should be taken to avoid inhaling excess fumes.



WARNING: The flow of fuel through a fuel pump nozzle can produce static electricity, which can cause a fire if fuel is pumped into an ungrounded fuel container.



WARNING: Flexible fuel components and standard unleaded gasoline fuel components are not interchangeable. If your vehicle is not serviced in accordance with flexible fuel vehicles procedures, damage may occur and your warranty may be invalidated.

Observe the following guidelines when handling automotive fuel:

- Extinguish all smoking materials and any open flames before fueling your vehicle.
- Always turn off the vehicle before fueling.
- Automotive fuels can be harmful or fatal if swallowed. Fuels such as gasoline and ethanol are highly toxic and if swallowed can cause death or permanent injury. If fuel is swallowed, call a physician immediately, even if no symptoms are immediately apparent. The toxic effects of fuel may not be visible for hours.
- Avoid inhaling fuel vapors. Inhaling too much fuel vapor of any kind can lead to eye and respiratory tract irritation. In severe cases, excessive or prolonged breathing of fuel vapor can cause serious illness and permanent injury.
- Avoid getting fuel liquid in your eyes. If fuel is splashed in the eyes, remove contact lenses (if worn), flush with water for 15 minutes and seek medical attention. Failure to seek proper medical attention could lead to permanent injury.
- Fuels can also be harmful if absorbed through the skin. If fuel is splashed on the skin and/or clothing, promptly remove contaminated clothing and wash skin thoroughly with soap and water. Repeated or prolonged skin contact with fuel liquid or vapor causes skin irritation.
- Be particularly careful if you are taking “Antabuse” or other forms of disulfiram for the treatment of alcoholism. Breathing gasoline and/or ethanol vapors, or skin contact could cause an adverse reaction. In sensitive individuals, serious personal injury or sickness may result. If fuel is splashed on the skin, promptly wash skin thoroughly with soap and water. Consult a physician immediately if you experience an adverse reaction.
- FFV fuel tanks may contain zero to 85% ethanol. Any fuel blends containing gasoline and ethanol should be treated the same as “Fuel Ethanol.” To identify if your vehicle is an FFV, it may be equipped with a yellow fuel cap with the text “E85/Gasoline”, or check if there is a label on the fuel filler door.

Pure ethanol is the alcohol which is the intoxicating agent in liquor, beer and wine. It is distilled from the fermentation of plants such as field corn and sugar cane. When ethanol is produced for use in motor fuels, a small amount of gasoline is added to make it unfit for beverage use. The resulting ethanol blend is called denatured fuel ethanol meaning that it is denatured with 2% to 5% gasoline and is suitable for automotive use.

During the summer season, fuel ethanol may contain a maximum of 85% denatured ethanol (Ed85) and 15% unleaded gasoline. The fuel ethanol has a higher octane rating than unleaded regular or premium gasoline and this allows the design of engines with greater efficiency and power.

Winter blends may contain up to 75% denatured ethanol (Ed75) and up to 25% unleaded gasoline to enhance cold engine starts. Severely cold weather may require additional measures for reliable starting. Refer to the Starting chapter

Ethanol is more chemically active than gasoline. It corrodes some metals and causes some plastic and rubber components to swell, break down or become brittle and crack, especially when mixed with gasoline. Special materials and procedures have been developed for flexible fuel vehicles and the dispensers used by ethanol fuel providers.

FUEL QUALITY

Note: Use of any fuel other than those recommended may cause powertrain damage and a loss of vehicle performance; repairs may not be covered under warranty.

Your vehicle was not designed to use fuel or fuel additives with metallic compounds, including manganese-based additives.

Choosing the Right Fuel

Use only UNLEADED fuel or UNLEADED fuel blended with a maximum of 15% ethanol. Do not use fuel ethanol (E85), diesel fuel, fuel-methanol, leaded fuel or any other fuel because it could damage or impair the emission control system.

Your vehicle was not designed to use fuel or fuel additives with metallic compounds, including manganese-based additives. The use of leaded fuel is prohibited by law.

Diesel engine (if equipped)

Refer to the diesel supplement for information regarding diesel fuel recommendations and requirements of your diesel-powered truck.

Choosing the Right Fuel With a Flex Fuel Vehicle (If Equipped)

Note: If your vehicle is FFV capable, it will have a yellow colored fuel cap.

Flex fuel vehicles are designed to use only ethanol fuel blends which contains 51 to 83% ethanol and UNLEADED FUEL Regular unleaded gasoline or any mixture of the two fuels.

It is best not to alternate repeatedly between gasoline and E85. If you do switch fuels, it is recommended that you add as much fuel as possible—at least half a tank. Do not add less than five gallons (18.9 liters) when refueling. You should drive the vehicle immediately after refueling for at least 5 miles (8 kilometers) to allow the vehicle to adapt to the change in ethanol concentration. If you exclusively use E85 fuel, it is recommended to fill the fuel tank with regular unleaded gasoline at each scheduled oil change.

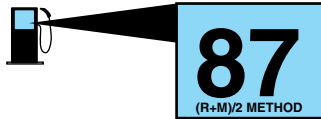
Octane Recommendations

Regular unleaded gasoline with a pump (R+M)/2 octane rating of 87 is recommended. Some stations offer fuels posted as Regular with an octane rating below 87, particularly

in high altitude areas. Fuels with octane levels below 87 are not recommended.

Regular unleaded gasoline with a pump (R+M)/2 octane rating of 87 is recommended. Some stations offer fuels posted as “Regular” with an octane rating below 87, particularly in high altitude areas. Fuels with octane levels below 87 are not recommended.

Do not be concerned if your engine sometimes knocks lightly. However, if it knocks heavily under most driving conditions while you are using fuel with the recommended octane rating, see your authorized dealer to prevent any engine damage.

RUNNING OUT OF FUEL

Avoid running out of fuel because this situation may have an adverse effect on powertrain components.

If you have run out of fuel:

- You may need to cycle the ignition from off to on several times after refueling to allow the fuel system to pump the fuel from the tank to the engine. On restarting, cranking time will take a few seconds longer than normal.
- Normally, adding 1 gallon (3.8L) of fuel is enough to restart the engine. If the vehicle is out of fuel and on a steep grade, more than 1 gallon (3.8L) may be required.
- The service engine soon indicator may come on. For more information on the service engine soon indicator, refer to the *Instrument Cluster* chapter.

See *Settings* in the *Instrument Cluster* chapter for information on calculating DTE (Distance to empty).

Refilling With a Portable Fuel Container

WARNING: Do not insert the nozzle of portable fuel containers or aftermarket funnels the fuel system. This could damage the fuel system and its seal, and may cause fuel to run onto the ground instead of filling the tank, which could result in serious personal injury.



WARNING: Do not try to pry open or push open the fuel system with foreign objects. This could damage the fuel system and its seal and cause injury to you or others.

Use the following directions when filling from a portable fuel container:

1. Remove the fuel cap by rotating it counter clockwise.
2. Slowly insert the portable fuel container into the fuel filler opening.
3. Fill the vehicle with fuel from the portable fuel container.
4. When done, remove the portable fuel container nozzle and reinstall fuel cap. Insert fuel cap into fuel filler opening and turn clockwise until a click is heard.

REFUELING

WARNING: Fuel vapor burns violently and a fuel fire can cause severe injuries. To help avoid injuries to you and others:

- Read and follow all the instructions on the pump island.
- Turn off your engine when you are refueling.
- Do not smoke if you are near fuel or refueling your vehicle.
- Keep sparks, flames and smoking materials away from fuel.
- Stay outside your vehicle and do not leave the fuel pump unattended when refueling your vehicle - this is against the law in some places.
- Keep children away from the fuel pump; never let children pump fuel.
- Do not use personal electronic devices while refueling.

Use the following guidelines to avoid electrostatic charge build-up when filling an ungrounded fuel container:

- Place approved fuel container on the ground.
- DO NOT fill a fuel container while it is in the vehicle (including the cargo area).
- Keep the fuel pump nozzle in contact with the fuel container while filling.
- DO NOT use a device that would hold the fuel pump handle in the fill position.

Fuel Filler Cap

WARNING: The fuel system may be under pressure. If the fuel filler cap is venting vapor or if you hear a hissing sound, wait until it stops before completely removing the fuel filler cap. Otherwise, fuel may spray out and injure you or others.



WARNING: If you do not use the proper fuel filler cap, excessive pressure or vacuum in the fuel tank may damage the fuel system or cause the fuel cap to disengage in a collision, which may result in possible personal injury.

Note: If you must replace the fuel filler cap, replace it with a fuel filler cap that is designed for your vehicle. The customer warranty may be void for any damage to the fuel tank or fuel system if the correct genuine Ford, Motorcraft® or other certified fuel filler cap is not used.

Your fuel tank filler cap has an indexed design with a 1/4th turn on and off feature. When fueling your vehicle:

1. Turn the engine off.
2. Carefully turn the filler cap counterclockwise until it spins off.
3. Pull to remove the cap from the fuel filler pipe.
4. To install the cap, align the tabs on the cap with the notches on the filler pipe.
5. Turn the filler cap clockwise 1/4 of a turn clockwise until it clicks at least once.

If the Check Fuel Cap light or a Check Fuel Cap message appears in the instrument cluster and stays on after you start the engine, the fuel filler cap may not be properly installed.

If the fuel cap light remains on, at the next opportunity, safely pull off of the road, remove the fuel filler cap, align the cap properly and reinstall it. The check fuel cap light or Check fuel cap message may not reset immediately; it may take several driving cycles for the indicators to turn off. A driving cycle consists of an engine start-up (after four or more hours with the engine off) followed by normal city and highway driving.

FUEL CONSUMPTION

Filling the Tank

The advertised capacity is the indicated capacity and the empty reserve combined. Indicated capacity is the difference in the amount of fuel in a full tank and a tank when the fuel gauge indicates empty. Empty reserve is the amount of fuel in the tank after the fuel gauge indicates empty.

Note: The amount of usable fuel in the empty reserve varies and should not be relied upon to increase driving range. When refueling your vehicle after the fuel gauge indicates empty, you might not be able to refuel the full amount of the advertised capacity of the fuel tank due to the empty reserve still present in the tank.

For consistent results when filling the fuel tank:

- Turn the ignition off before fueling; an inaccurate reading results if the engine is left running.
- Use the same fill rate (low–medium–high) each time the tank is filled.
- Allow no more than two automatic click–offs when filling.

Results are most accurate when the filling method is consistent.

Calculating Fuel Economy

Do not measure fuel economy during the first 1000 miles (1600 kilometers) of driving (this is your engine's break-in period); a more accurate measurement is obtained after 2000 miles–3000 miles (3200 kilometers–4800 kilometers). Also, fuel expense, frequency of fill-ups or fuel gauge readings are not accurate ways to measure fuel economy.

1. Fill the fuel tank completely and record the initial odometer reading.
2. Each time you fill the tank, record the amount of fuel added.
3. After at least three to five tank fill-ups, fill the fuel tank and record the current odometer reading.
4. Subtract your initial odometer reading from the current odometer reading.
5. Calculate fuel economy as follows:

Standard: Divide miles traveled by gallons used.

Metric: Multiply liters used by 100, then divide by kilometers traveled.

Keep a record for at least one month and record the type of driving (city or highway). This provides an accurate estimate of the vehicle's fuel economy under current driving conditions. Additionally, keeping records during summer and winter show how temperature impacts fuel economy. In general, lower temperatures mean lower fuel economy.

EMISSION CONTROL SYSTEM



WARNING: Do not park, idle, or drive your vehicle in dry grass or other dry ground cover. The emission system heats up the engine compartment and exhaust system, which can start a fire.



WARNING: Exhaust leaks may result in entry of harmful and potentially lethal fumes into the passenger compartment. If you smell exhaust fumes inside your vehicle, have your dealer inspect your vehicle immediately. Do not drive if you smell exhaust fumes.

Your vehicle is equipped with various emission control components and a catalytic converter which will enable your vehicle to comply with applicable exhaust emission standards. To make sure that the catalytic converter and other emission control components continue to work properly:

- Use only the specified fuel listed.
- Avoid running out of fuel.
- Do not turn off the ignition while your vehicle is moving, especially at high speeds.
- Have the items listed in *Scheduled Maintenance Information* performed according to the specified schedule.

The scheduled maintenance items listed in *Scheduled Maintenance Information* are essential to the life and performance of your vehicle and to its emissions system.

If other than Ford, Motorcraft® or Ford-authorized parts are used for maintenance replacements or for service of components affecting emission control, such non-Ford parts should be equivalent to genuine Ford Motor Company parts in performance and durability.

Illumination of the service engine soon indicator, charging system warning light or the temperature warning light, fluid leaks, strange odors, smoke or loss of engine power could indicate that the emission control system is not working properly.

An improperly operating or damaged exhaust system may allow exhaust to enter the vehicle. Have a damaged or improperly operating exhaust system inspected and repaired immediately.

Do not make any unauthorized changes to your vehicle or engine. By law, vehicle owners and anyone who manufactures, repairs, services, sells, leases, trades vehicles, or supervises a fleet of vehicles are not permitted to intentionally remove an emission control device or prevent it from working. Information about your vehicle's emission system is on the Vehicle Emission Control Information Decal located on or near the engine. This decal also lists engine displacement.

Please consult your warranty information for complete emission warranty information.

On-board Diagnostics (OBD-II)

Your vehicle is equipped with a computer that monitors the engine's emission control system. This system is commonly known as the on-board diagnostics system (OBD-II). The OBD-II system protects the environment by ensuring that your vehicle continues to meet government emission standards. The OBD-II system also assists your authorized dealer in properly servicing your vehicle.



When the service engine soon indicator illuminates, the OBD-II system has detected a malfunction. Temporary malfunctions may cause the service engine soon indicator to illuminate.

Examples are:

1. The vehicle has run out of fuel—the engine may misfire or run poorly.
2. Poor fuel quality or water in the fuel—the engine may misfire or run poorly.
3. The fuel cap may not have been securely tightened. See *Fuel filler cap* in this chapter.
4. Driving through deep water—the electrical system may be wet.

These temporary malfunctions can be corrected by filling the fuel tank with good quality fuel, properly closing the fuel fill inlet or letting the electrical system dry out. After three driving cycles without these or any other temporary malfunctions present, the service engine soon indicator should stay off the next time the engine is started. A driving cycle consists of a cold engine startup followed by mixed city/highway driving. No additional vehicle service is required.

If the service engine soon indicator remains on, have your vehicle serviced at the first available opportunity. Although some malfunctions detected by the OBD-II may not have symptoms that are apparent, continued driving with the service engine soon indicator on can result in increased emissions, lower fuel economy, reduced engine and transmission smoothness, and lead to more costly repairs.

Readiness for Inspection/Maintenance (I/M) Testing

Some state, provincial and local governments may have Inspection/Maintenance (I/M) programs to inspect the emission control equipment on your vehicle. Failure to pass this inspection could prevent you from getting a vehicle registration.



If the service engine soon indicator is on or the bulb does not work, the vehicle may need to be serviced. See *On-board Diagnostics (OBD-II)* in this chapter.

Your vehicle may not pass the I/M test if the service engine soon indicator is on or not working properly (bulb is burned out), or if the OBD-II system has determined that some of the emission control systems have not been properly checked. In this case, the vehicle is considered not ready for I/M testing.

If the vehicle's engine or transmission has just been serviced, or the battery has recently run down or been replaced, the OBD-II system may indicate that the vehicle is not ready for I/M testing. To determine if the vehicle is ready for I/M testing, turn the ignition key to the on position for 15 seconds without cranking the engine. If the service engine soon indicator blinks eight times, it means that the vehicle is not ready for I/M testing; if the service engine soon indicator stays on solid, it means that the vehicle is ready for I/M testing.

The OBD-II system is designed to check the emission control system during normal driving. A complete check may take several days. If the vehicle is not ready for I/M testing, the following driving cycle consisting of mixed city and highway driving may be performed:

15 minutes of steady driving on an expressway or highway followed by 20 minutes of stop-and-go driving with at least four 30-second idle periods.

Allow the vehicle to sit for at least eight hours without starting the engine. Then, start the engine and complete the above driving cycle. The engine must warm up to its normal operating temperature. Once the engine is started, do not turn off the engine until the above driving cycle is complete. If the vehicle is still not ready for I/M testing, the above driving cycle will have to be repeated.

AUTOMATIC TRANSMISSION OPERATION**Understanding the Shift Positions of the 5-Speed Automatic Transmission (If Equipped)**

WARNING: Do not use the tow/haul feature when driving in icy or slippery conditions as the increased engine braking can cause the rear wheels to slide and the vehicle to swing around with the possible loss of vehicle control.



WARNING: Always set the parking brake fully and make sure the gearshift is latched in P (Park). Turn the ignition to the off position and remove the key whenever you leave your vehicle.

P R N D 3 2 1**P (Park)**

This position locks the transmission and prevents the rear wheels from turning.

To put your vehicle in gear:

- Start the engine
- Press the brake pedal
- Move the gearshift lever into the desired gear

To put your vehicle in P (Park):

- Come to a complete stop
- Move the gearshift lever and securely latch it in P (Park)

R (Reverse)

With the gearshift lever in R (Reverse), the vehicle will move backward. Always come to a complete stop before shifting into and out of R (Reverse).

N (Neutral)

With the gearshift lever in N (Neutral), the vehicle can be started and is free to roll. Hold the brake pedal down while in this position.

D (Overdrive) with Tow/Haul Off

D (Overdrive) with tow/haul off is the normal driving position for the best fuel economy. The overdrive function allows automatic upshifts and downshifts through gears one through five.

D (Overdrive) with Tow/Haul On

The tow/haul feature improves transmission operation when towing a trailer or a heavy load. All transmission gear ranges are available when using tow/haul.



To activate tow/haul, press the button on the end of the gearshift lever.



The TOW HAUL indicator light will illuminate in the instrument cluster.

Tow/haul delays upshifts to reduce frequency of transmission shifting. Tow/haul also provides engine braking in all forward gears when the transmission is in the D (Overdrive) position; this engine braking will slow the vehicle and assist the driver in controlling the vehicle when descending a grade. Depending on driving conditions and load conditions, the transmission may downshift, slow the vehicle and control the vehicle speed when descending a hill, without the pedals being pressed. The amount of downshift braking provided will vary based upon the amount the pedal is depressed.

To deactivate the tow/haul feature and return to normal driving mode, press the button on the end of the gearshift lever. The TOW HAUL light will no longer be illuminated.

When you shut-off and restart the engine, the transmission will automatically return to normal D (Overdrive) mode (Tow/Haul OFF).

3 (Third)

Transmission starts and operates in third gear only.

Used for improved traction on slippery roads. Selecting 3 (Third) provides engine braking.

2 (Second)

Use 2 (Second) to start-up on slippery roads or to provide additional engine braking on downgrades.

1 (First)

- Provides maximum engine braking.
- Allows upshifts by moving gearshift lever.
- The transmission will not downshift into 1 (First) at high speeds; it will downshift to a lower gear and then shift into 1 (First) when the vehicle reaches slower speeds.

Forced downshifts

- Allowed in D (Overdrive) or D (Drive).
- Press the accelerator to the floor.
- Allows transmission to select an appropriate gear.

Understanding the Shift Positions of a 6-Speed Automatic Transmission (If Equipped)

WARNING: Always set the parking brake fully and make sure the gearshift is latched in P (Park). Turn the ignition to the off position and remove the key whenever you leave your vehicle.

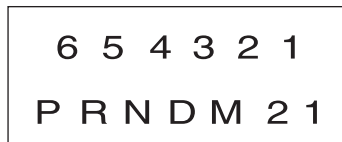

WARNING: Do not use the tow/haul feature when driving in icy or slippery conditions as the increased engine braking can cause the rear wheels to slide and the vehicle to swing around with the possible loss of vehicle control.

**P (Park)**

This position locks the transmission and prevents the rear wheels from turning.

To put your vehicle in gear:

1. Start the engine
2. Press the brake pedal
3. Move the gearshift lever into the desired gear

To put your vehicle in P (Park):

1. Come to a complete stop
2. Move the gearshift lever and securely latch it in P (Park)

R (Reverse)

With the gearshift lever in R (Reverse), the vehicle will move backward. Always come to a complete stop before shifting into and out of R (Reverse).

N (Neutral)

With the gearshift lever in N (Neutral), the vehicle can be started and is free to roll. Hold the brake pedal down while in this position.

D (Overdrive) with Tow/Haul Off

D (Overdrive) with tow/haul off is the normal driving position for the best fuel economy. The overdrive function allows automatic upshifts and downshifts through gears one through six.

D (Overdrive) with Tow/Haul On

The tow/haul feature improves transmission operation when towing a trailer or a heavy load. All transmission gear ranges are available when using tow/haul.

To activate tow/haul, press the button on the end of the gearshift lever.



The TOW HAUL indicator light will illuminate in the instrument cluster.

Tow/haul delays upshifts to reduce frequency of transmission shifting. Tow/haul also provides engine braking in all forward gears when the transmission is in the D (Overdrive) position; this engine braking will slow the vehicle and assist the driver in controlling the vehicle when descending a grade. Depending on driving conditions and load conditions, the transmission may downshift, slow the vehicle and control the vehicle speed when descending a hill, without the pedals being pressed. The amount of downshift braking provided will vary based upon the amount the brake pedal is pressed.

Tow/haul may be automatically activated (without pressing the tow/haul button). This provides engine braking to assist the vehicles braking system when going downhill and repetitive braking is sensed. Once the tow/haul mode has been automatically activated it will not automatically deactivate.

To deactivate the tow/haul feature and return to normal driving mode, press the button on the end of the gearshift lever. The tow/haul light will no longer be illuminated.

Tow/haul will also deactivate when the vehicle is powered down for a few minutes.

M (Manual) without Overdrive

With the gearshift lever in M (Manual), the driver can change gears up or down as desired. This is called SelectShift Automatic™ transmission (SST) mode. By moving the gearshift lever from drive position D (Overdrive) to M (Manual) you now have control of selecting the gear you desire using buttons on the shift lever.

To return to normal D (Overdrive) position, move the shift lever back from M to D.

- The transmission will operate in gears one through six.

2 (Second)

Use 2 (Second) to start-up on slippery roads or to provide additional engine braking on downgrades.

1 (First)

- Provides maximum engine braking.
- Allows upshifts by moving gearshift lever.
- The transmission will not downshift into 1 (First) at high speeds; it will downshift to a lower gear and then shift into 1 (First) when the vehicle reaches slower speeds.

Forced downshifts

- Allowed in D (Overdrive).
- Press the accelerator to the floor.
- Allows transmission to select an appropriate gear.

Understanding your SelectShift Automatic® transmission

This vehicle is equipped with a SelectShift Automatic™ transmission gearshift lever. SelectShift Automatic™ transmission gives you the ability to change gears up or down (without a clutch) as desired.



Use the buttons on the shifter to lock or unlock gears and manually select gears. Press the + button to upshift or the – button to downshift.



With the gearshift lever in D (Drive), press the – button to activate SelectShift. The available and selected gears will be indicated on the instrument cluster.

All available gears will be displayed with the current gear indicated. Press the – button again to lock out gears beginning with the highest gear. Example: press the – button twice to lock out 6th and 5th gears. Only the available gears will be displayed and the transmission will automatically shift between the available gears. Press the + button to unlock gears.

By moving the gearshift lever from the D (Drive) position to the M (Manual) position you may now manually select the gear you desire. Only the current gear will be displayed. Press the + button or the – button to upshift or downshift. If the – button is pressed at a vehicle speed that would cause an engine overspeed, the requested gear will flash then disappear and the transmission will remain in the current gear.

Recommended shift speeds

Upshift according to the following chart:

| Upshifts when accelerating (recommended for best fuel economy) | | |
|---|-------------------------|-----------------------|
| Shift from: | Gasoline engines | Diesel engines |
| 1 – 2 | 15 mph (24 km/h) | 12 mph (19 km/h) |
| 2 – 3 | 25 mph (40 km/h) | 19 mph (31 km/h) |
| 3 – 4 | 40 mph (64 km/h) | 26 mph (42 km/h) |
| 4 – 5 | 45 mph (72 km/h) | 34 mph (55 km/h) |
| 5 – 6 | 50 mph (80 km/h) | 46 mph (74 km/h) |

In order to prevent the engine from running at too low an RPM, which may cause it to stall, SelectShift will still automatically make some downshifts if it has determined that you have not downshifted in time. Although SelectShift will make some downshifts for you, it will still allow you to downshift at any time as long as the SelectShift determines that the engine will not be damaged from over-revving.

SelectShift will not automatically upshift, even if the engine is approaching the RPM limit. It must be shifted manually by pressing the + button.

Engine damage may occur if excessive engine revving is held without shifting.

Automatic Transmission Adaptive Learning

This feature is designed to increase durability and provide consistent shift feel over the life of the vehicle. A new vehicle or transmission may have firm shifts, soft shifts or both. This operation is considered normal and will not affect function or durability of the transmission. Over time, the adaptive learning process will fully update transmission operation. Additionally, whenever the battery is disconnected or a new battery installed, the strategy must be relearned.

Brake-shift interlock

WARNING: Do not drive your vehicle until you verify that the brake lamps are working.



WARNING: When doing this procedure, you will be taking the vehicle out of park which means the vehicle can roll freely. To avoid unwanted vehicle movement, always fully set the parking brake prior to doing this procedure. Use wheel chocks if appropriate.



WARNING: If the parking brake is fully released, but the brake warning lamp remains illuminated, the brakes may not be working properly. See your authorized dealer as soon as possible.

This vehicle is equipped with a brake-shift interlock feature that prevents the gearshift lever from being moved from P (Park) when the ignition is in the 3 (on) position and the brake pedal is not pressed.

If you cannot move the gearshift lever out of P (Park) with ignition in the on position and the brake pedal pressed, it is possible that a fuse has blown or the vehicle's brake lamps are not operating properly. Refer to the *Fuses* chapter.

If the fuse is not blown and the brake lamps are working properly, the following procedure will allow you to move the gearshift lever from P (Park):

1. Apply the parking brake. Turn the ignition key to 1 (off), then remove the key.
2. Move the steering column to the full down and full rearward position (toward the driver's seat).
3. Remove the gearshift lever boot.
4. Place fingers into hole where the gearshift lever boot was removed from and pull top half of shroud up and forward to separate it from the lower half of the shroud. There is a hinge at the forward edge of the top shroud. Roll the top half of the shroud upward on the hinge point to clear the hazard flasher button, then pull straight rearward toward the driver's seat to remove.
5. Remove the top half of the shroud.

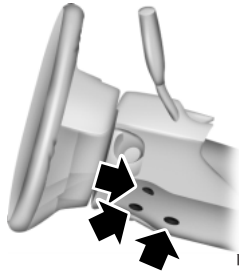

6. Remove the three fasteners under the column that secure the lower shroud half to the column.

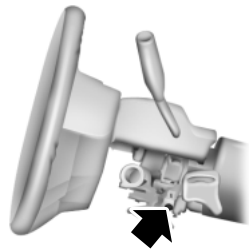

7. Pull the lock lever into the full unlocked position and remove the lower shroud cover by pulling the lever handle through the slot in the cover.

8. Apply the brake and move the gearshift lever into N (Neutral).

9. Start the vehicle.

Perform Steps 4 through 8 in reverse order, making sure to engage the hinge pivots between the upper and lower halves of the shroud. Keep slight pressure in the forward direction as the halves are rotated together.

If Your Vehicle Gets Stuck in Mud or Snow

Note: Do not rock the vehicle if the engine is not at normal operating temperature or damage to the transmission may occur.

Note: Do not rock the vehicle for more than a minute or damage to the transmission and tires may occur, or the engine may overheat.

If your vehicle gets stuck in mud or snow, it may be rocked out by shifting between forward and reverse gears, stopping between shifts in a steady pattern. Press lightly on the accelerator in each gear.

HILL START ASSIST

WARNING: The hill start assist feature does not replace the parking brake. When you leave the vehicle, always apply the parking brake and shift the transmission into P (Park).



WARNING: You must remain in the vehicle once you have activated the hill start assist feature.



WARNING: During all times, you are responsible for controlling the vehicle, supervising the hill start assist system and intervening, if required.



WARNING: If the engine is revved excessively, or if a malfunction is detected when the hill start assist feature is active, the hill start assist feature will be deactivated.

Hill start assist keeps your vehicle stationary long enough to move your foot from the brake pedal to the accelerator pedal when your vehicle is on a slope.

The brakes are released automatically once the engine has developed sufficient drive to prevent the vehicle from rolling down the slope. This is an advantage when pulling away on a slope, (for example from a car park ramp, traffic lights or when reversing uphill into a parking space).

Using Hill Start Assist

1. Press the brake pedal to bring the vehicle to a complete standstill. Keep the brake pedal pressed.
2. If the sensors detect that the vehicle is on a slope, the hill start assist feature will be activated automatically.
3. When you remove your foot from the brake pedal, the vehicle will remain on the slope without rolling away for approximately two or three seconds. This hold time will automatically be extended if you are in the process of driving off.
4. Drive off in the normal manner. The brakes will be released automatically.

USING FOUR-WHEEL DRIVE (4WD) (IF EQUIPPED)



WARNING: For important information regarding safe operation of this type of vehicle, see *General Information* in the *Wheels and Tires* chapter.

Note: Do not use 4X4 mode on dry, hard surfaced roads. Doing so will produce excessive noise, increase tire wear and may damage drive components. 4X4 mode is only intended for consistently slippery or loose surfaces.

Note: If 4X4 low is selected while the vehicle is moving above 3 mph (5 km/h), the 4WD system will not perform a shift. This is normal and should be no reason for concern. Refer to *Shifting to/from 4L (4X4 Low)* for proper operation.

Manual Shift On Stop (MSOS) 4WD system (if equipped)

Note: Some vehicles may be equipped with wheel ornaments that cover the 4x4 manual hub lock. These ornaments must be removed to access the manual hub locks.

Note: The vehicle should not be driven in 4X4 High or 4X4 Low modes with the hub locks set to FREE as this condition may damage driveline system components.



The 4WD system is engaged or disengaged by rotating the control for both front wheel hub locks from the FREE or LOCK position, then manually engaging or disengaging the transfer case with the floor-mounted shifter. For increased fuel economy in 2WD, rotate both hub locks to the FREE position.

Electronic Shift-On-the-Fly (ESOF) 4WD system (if equipped)

Note: If 4X4 Low is selected while the vehicle is moving above 3 mph (5 km/h), the 4WD system will not perform a shift. This is normal and should be no reason for concern. Refer to *Shifting to/from 4L (4X4 Low)* for proper system operation.

Note: Auto-manual hub locks can be manually overridden by rotating the hub lock control from AUTO to LOCK.



For proper operation, make sure that each hub is fully engaged and that both hub locks are set to the same position (both set to LOCK or both set to AUTO). To engage LOCK, turn the hub locks completely clockwise; to engage AUTO, turn the hub locks completely counterclockwise.

The ESOF 4WD system:

- provides 4x4 High engagement and disengagement while the vehicle is moving.
- is operated by a rotary control located on the instrument panel that allows you select 4x2, 4x4 High or 4x4 Low operation.
- uses auto-manual hub locks that can be engaged and disengaged automatically based on the 4x4 mode selected.
- will increase fuel economy when used in the recommended AUTO lock mode.

4WD Indicator Lights

The indicator lights illuminate in the message center in the reconfigurable telltale (RTT) location under the following conditions. Refer to *Warning Lamps and Indicators* in the *Instrument Cluster* chapter.

Note: When a 4X4 system fault is present, the system will typically remain in whichever 4X4 mode was selected prior to the fault condition occurring. It will not default to 4X2 in all circumstances. When this warning is displayed, have your vehicle serviced by an authorized dealer.

4x2

4X2 - Momentarily illuminates when 2H is selected.

**4x4
HIGH**

4X4 HIGH - Continuously illuminates when 4H is selected.



4X4 LOW - Continuously illuminates when 4L is selected.



CHECK 4X4 - Displays when a 4X4 fault is present.

Using a Manual Shift On Stop (MSOS) 4wd system (if equipped)

Note: High shift efforts may be encountered when attempting to shift into and out of 4x4 modes. It is recommended to allow the vehicle to roll at a speed below 3 mph (5 km/h) when shifting between modes.

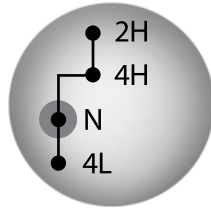

- **2H (2WD):** For general on-road driving. Sends power to the rear wheels only and should be used for street and highway driving. Provides optimal smoothness and fuel economy at high speeds.
- **4H (4x4 High):** Used for extra traction such as in snow or icy roads or in off road situations. **This mode is not intended for use on dry pavement.**
- **N (Neutral):** Only used when towing the vehicle. No power to front or rear wheels.
- **4L (4x4 Low):** Uses extra gearing to provide maximum power to all four wheels at reduced speeds. Intended only for off road applications such as deep sand, steep grades or pulling heavy objects.

Shifting between system modes

Note: Do not perform these operations if the rear wheels are slipping.

Note: Some noise may be heard as the 4x4 system shifts or engages. This is normal. In order to reduce engagement noise, it is recommended that all shifts be performed at speeds below 3 mph (5 km/h).

Note: The vehicle should not be driven in 4X4 High with the hub locks disengaged as this condition may damage driveline system components.

- Engage the locking hubs by rotating the hub lock control from FREE to LOCK, then move the transfer case lever from 2H (2WD) to 4H (4x4 High) at a stop or a vehicle speed below 3 mph (5 km/h).

212 Four-Wheel Drive (If Equipped)

- Move the transfer case lever from 4H (4x4 High) to 2H (2WD) at a stop or a vehicle speed below 3 mph (5 km/h), then disengage the locking hubs (optional) by rotating the hub lock control from LOCK to FREE.
- For proper operation, make sure that both indicator arrows on the hub are aligned, and that both hubs are set to either FREE or LOCK.

Shifting to/from 4L (4x4 Low)

1. Bring the vehicle to a stop or a speed below 3 mph (5 km/h).
2. Place the transmission in N (Neutral).
3. Move the transfer case shift lever through N (Neutral) directly to the desired position.
4. If the transfer case does not, or only partially moves to the desired position, perform a shift with the transmission in N (Neutral) and the vehicle rolling at a speed below 3 mph (5 km/h).
5. If shifting to 2H (2WD) with the vehicle at a complete stop, disengage the locking hubs (optional) by rotating the hub lock control from LOCK to FREE.

Using the N (Neutral) position



WARNING: Do not leave the vehicle unattended with the transfer case in the N (Neutral) position. Always set the parking brake fully and turn off the ignition when leaving the vehicle.

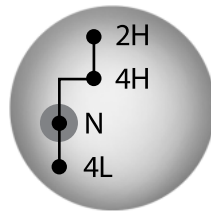

The transfer case neutral position overrides the transmission and puts the vehicle in neutral regardless of transmission gearshift lever position. The vehicle can move forward or backwards.

This position should only be used when towing the vehicle.

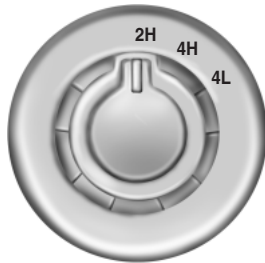
Using the Electronic Shift on the Fly 4WD system (If Equipped)

2H (2WD) - For general on-road driving. Sends power to the rear wheels only and should be used for street and highway driving. Provides optimal smoothness and fuel economy at high speeds.

4H (4X4 HIGH) - Used for extra traction such as in snow or icy roads or in off road situations. This mode is not intended for use on dry pavement.

4L (4X4 LOW) - Uses extra gearing to provide maximum power to all four wheels at reduced speeds. Intended only for off-road applications such as deep sand, steep grades, or pulling heavy objects. 4L (4x4 low) will not engage while the vehicle is moving above 3 mph (5 km/h); this is normal and should be no reason for concern. Refer to *Shifting to/from 4L (4x4 low)* for proper operation.

Shifting between system modes

Note: Momentarily releasing the accelerator pedal while performing a shift will improve engagement/disengagement times.

Note: Do not perform this operation if the rear wheels are slipping.

Note: Some noise may be heard as the system shifts or engages; this is normal.

Note: 4X4 high mode is not intended for use on dry pavement.

You can move the control from 2H or 4H at a stop or while driving. The information display may display a message indicating a 4X4 shift is in progress. Once the shift is complete the message center will then display the system mode selected.

If **SHIFT DELAYED PULL FORWARD** is displayed in the information display during the mode shift, transfer case gear tooth blockage is present. To alleviate this condition, place the transmission in a forward gear and move the vehicle forward approximately 5 feet (2 meters) to allow the transfer case to complete the mode shift.

214 **Four-Wheel Drive (If Equipped)**

Shifting to/from 4L (4X4 low)

Note: Some noise may be heard as the system shifts or engages; this is normal.

Note: 4x4 low mode is not intended for use on dry pavement.

1. Bring the vehicle to a speed of 3 mph (5 km/h) or less.
2. Place the transmission in N (Neutral).
3. Move the 4WD control to the desired position.

The information display will display a message indicating a 4X4 shift is in progress. The information display will then display the system mode selected. If any of the above shift conditions are not met, the shift will not occur and the information display will display information guiding the driver through the proper shifting procedures.

If **SHIFT DELAYED PULL FORWARD** is displayed in the information display, transfer case gear tooth blockage is present. To alleviate this condition, place the transmission in a forward gear, move the vehicle forward approximately 5 feet (1.5 m), and shift the transmission back to neutral to allow the transfer case to complete the range shift.

Electronic Locking Differential (ELD) (If Equipped)

Note: The ELD is designed for off-road use only and is not intended for use on dry pavement. Using the ELD on dry pavement will result in increased tire wear, noise and vibration.

The electronic locking differential (ELD) is a device housed in the rear axle which allows both rear wheels to turn at the same speed. It provides added traction on slippery and/or off road surfaces, particularly when one wheel is on a poor traction surface. The ELD may be locked or unlocked by the vehicle operator and can be engaged or disengaged on the fly. When the axle is unlocked it will function like a standard rear axle. When the axle is locked it will not allow the rear wheels to rotate at different speeds when turning.

The ELD is affected by the following conditions:

- On 2WD vehicles and 4WD vehicles in 2H (4X2) or 4H (4X4 High), the ELD will not engage if the vehicle speed is above 20 mph (32 km/h).
- On 2WD vehicles and 4WD vehicles in 2H (4X2) or 4H (4X4 High), the ELD will automatically disengage at speeds above 25 mph (40 km/h) and will automatically reengage at speeds below 20 mph (32 km/h).
- On 4WD vehicles in 4L (4X4 Low), the ELD can be engaged at any speed and will not automatically disengage.

Activating the Electronic Locking Differential (ELD)

Note: The ELD may have difficulty disengaging either by operator command or automatically if the driveline is under torque. If driving conditions allow, releasing the accelerator pedal or turning the steering wheel in the opposite direction may assist in disengagement.

Note: The ELD is designed for off-road use only and is not intended for use on dry pavement.

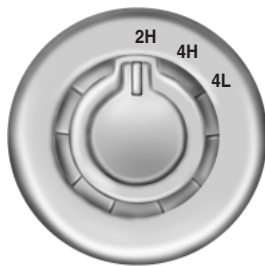
**For vehicles equipped with an electronic shift 4WD system:**

Pull the 4WD control knob toward you.

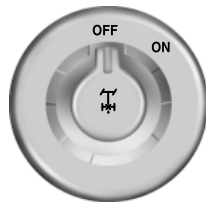
**For 2WD vehicles and vehicles equipped with a manual shift 4WD system:**

Turn the control to ON.



Once the indicator light is displayed in the information display, both rear wheel axle shafts will be locked together providing added traction.

If the indicator does not come on, or the indicator turns off while driving, one of the following has occurred:

- The vehicle speed is too high.
- The left and right rear wheel speed difference is too high during an engagement attempt.
- The system has malfunctioned and will be accompanied by a message in the information display. See your authorized Ford dealer for assistance.

How Your Vehicle Differs From Other Vehicles

WARNING: Vehicles with a higher center of gravity such as utility and four-wheel drive vehicles handle differently than vehicles with a lower center of gravity. Utility and four-wheel drive vehicles are **not** designed for cornering at speeds as high as passenger cars any more than low-slung sports cars are designed to perform satisfactorily under off-road conditions. Avoid sharp turns, excessive speed and abrupt maneuvers in these vehicles. Failure to drive cautiously could result in an increased risk of loss of vehicle control, vehicle rollover, personal injury and death.

Truck and utility vehicles can differ from some other vehicles. Your vehicle may be higher to allow it to travel over rough terrain without getting hung up or damaging underbody components.

The differences that make your vehicle so versatile also make it handle differently than an ordinary passenger car.

Maintain steering wheel control at all times, especially in rough terrain. Since sudden changes in terrain can result in abrupt steering wheel motion, make sure you grip the steering wheel from the outside. Do not grip the spokes.

Drive cautiously to avoid vehicle damage from concealed objects such as rocks and stumps.

You should either know the terrain or examine maps of the area before driving. Map out your route before driving in the area. To maintain steering and braking control of your vehicle, you must have all four wheels on the ground and they must be rolling, not sliding or spinning.

Driving Off-Road With Truck and Utility Vehicles

Note: On some models, the initial shift from two-wheel drive to four-wheel drive while the vehicle is moving can cause some momentary clunk and ratcheting sounds. This is the front drivetrain coming up to speed and the automatic locking hubs engaging and is not cause for concern.

Note: Your vehicle may be equipped with a front air dam that can become damaged (due to reduced ground clearance) when taking your vehicle off-road. This air dam can be taken off by removing two bolts.

4WD vehicles are specially equipped for driving on sand, snow, mud and rough terrain and have operating characteristics that are somewhat different from conventional vehicles, both on and off the road.

Power is supplied to all four wheels through a transfer case. On 4WD vehicles, the transfer case allows you to select 4WD when necessary. Information on transfer case operation and shifting procedures can be found in this chapter. Information on transfer case maintenance can be found in the *Maintenance* chapter. You should become thoroughly familiar with this information before you operate your vehicle.

4WD (when you select a 4WD mode) uses all four wheels to power the vehicle. This increases traction, enabling you to drive over terrain and road conditions that a conventional two-wheel drive vehicle cannot.

Basic Operating Principles In Special Conditions

- Do not use 4WD on dry, hard surfaced roads. Doing so will produce excessive noise, increase tire wear and may damage drive components. 4WD modes are only intended for consistently slippery or loose surfaces.
- Drive slower in strong crosswinds which can affect the normal steering characteristics of your vehicle.
- Be extremely careful when driving on pavement made slippery by loose sand, water, gravel, snow or ice.

If your vehicle goes off the edge of the pavement

- If your vehicle goes off the edge of the pavement, slow down, but avoid severe brake application, ease the vehicle back onto the pavement only after reducing your speed. Do not turn the steering wheel too sharply while returning to the road surface.
- It may be safer to stay on the apron or shoulder of the road and slow down gradually before returning to the pavement. You may lose control if you do not slow down or if you turn the steering wheel too sharply or abruptly.
- It often may be less risky to strike small objects, such as highway reflectors, with minor damage to your vehicle rather than attempt a sudden return to the pavement which could cause the vehicle to slide sideways out of control or roll over. Remember, your safety and the safety of others should be your primary concern.

218 Four-Wheel Drive (If Equipped)

If your vehicle gets stuck



WARNING: Do not spin the wheels at over 35 mph (56 km/h).
The tires may fail and injure a passenger or bystander.

Note: Do not rock the vehicle if the engine is not at normal operating temperature or damage to the transmission may occur.

Note: Do not rock the vehicle for more than a few minutes or damage to the transmission and tires may occur or the engine may overheat.

If your vehicle gets stuck in mud or snow it may be rocked out by shifting between forward and reverse gears, stopping between shifts, in a steady pattern. Press lightly on the accelerator in each gear.

Emergency maneuvers

- In an unavoidable emergency situation where a sudden sharp turn must be made, remember to avoid over-driving your vehicle, i.e., turn the steering wheel only as rapidly and as far as required to avoid the emergency. Excessive steering will result in less vehicle control, not more. Additionally, smooth variations of the accelerator and/or brake pedal pressure should be utilized if changes in vehicle speed are called for. Avoid abrupt steering, acceleration or braking which could result in an increased risk of loss of vehicle control, vehicle rollover and/or personal injury. Use all available road surface to return the vehicle to a safe direction of travel.
- In the event of an emergency stop, avoid skidding the tires and do not attempt any sharp steering wheel movements.
- If the vehicle goes from one type of surface to another (i.e., from concrete to gravel) there will be a change in the way the vehicle responds to a maneuver (steering, acceleration or braking). Again, avoid these abrupt inputs.

Sand

When driving over sand, try to keep all four wheels on the most solid area of the trail. Avoid reducing the tire pressures but shift to a lower gear and drive steadily through the terrain. Apply the accelerator slowly and avoid spinning the wheels.

Avoid excessive speed because vehicle momentum can work against you and cause the vehicle to become stuck to the point that assistance may be required from another vehicle. Remember, you may be able to back out the way you came if you proceed with caution.

Mud and water

Note: Driving through deep water may damage the vehicle.

If you must drive through high water, drive slowly. Traction or brake capability may be limited.

When driving through water, determine the depth; avoid water higher than the bottom of the hubs (if possible) and proceed slowly. If the ignition system gets wet, the vehicle may stall.

Once through water, always try the brakes. Wet brakes do not stop the vehicle as effectively as dry brakes. Drying can be improved by moving your vehicle slowly while applying light pressure on the brake pedal.

Be cautious of sudden changes in vehicle speed or direction when you are driving in mud. Even 4WD vehicles can lose traction in slick mud. As when you are driving over sand, apply the accelerator slowly and avoid spinning your wheels. If the vehicle does slide, steer in the direction of the slide until you regain control of the vehicle.

If the transmission, transfer case or front axle are submerged in water, their fluids should be checked and changed, if necessary.

If the front or rear axle is submerged in water, the axle lubricant should be replaced.

After driving through mud, clean off residue stuck to rotating driveshafts and tires. Excess mud stuck on tires and rotating driveshafts causes an imbalance that could damage drive components.



Tread Lightly is an educational program designed to increase public awareness of land-use regulations and responsibilities in our nations wilderness areas. Ford Motor Company joins the U.S. Forest

Service and the Bureau of Land Management in encouraging you to help preserve our national forest and other public and private lands by treading lightly.

Driving on hilly or sloping terrain

Note: Avoid driving crosswise or turning on steep slopes or hills.

Although natural obstacles may make it necessary to travel diagonally up or down a hill or steep incline, you should always try to drive straight up or straight down. A danger lies in losing traction, slipping sideways and possibly rolling over. Whenever driving on a hill, determine beforehand the route you will use. Do not drive over the crest of a hill without seeing what conditions are on the other side. Do not drive in reverse over a hill without the aid of an observer.

When climbing a steep slope or hill, start in a lower gear rather than downshifting to a lower gear from a higher gear once the ascent has started. This reduces strain on the engine and the possibility of stalling.

If you do stall out, do not try to turn around because you might roll over. It is better to back down to a safe location.

Apply just enough power to the wheels to climb the hill. Too much power will cause the tires to slip, spin or lose traction, resulting in loss of vehicle control.

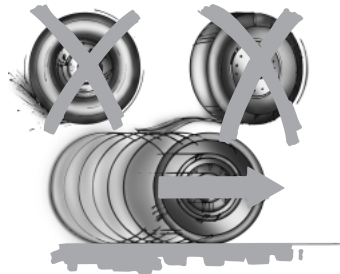

Descend a hill in the same gear you would use to climb up the hill to avoid excessive brake application and brake overheating. Do not descend in neutral; instead, disengage overdrive or manually shift to a lower gear. When descending a steep hill, avoid sudden hard braking as you could lose control. When you brake hard, the front wheels can't turn and if they aren't turning, you won't be able

to steer. The front wheels have to be turning in order to steer the vehicle.

If your vehicle has anti-lock brakes, apply the brakes steadily. Do not pump the brakes.

Driving on snow and ice

WARNING: If you are driving in slippery conditions that require tire chains or cables, then it is critical that you drive cautiously. Keep speeds down, allow for longer stopping distances and avoid aggressive steering to reduce the chances of a loss of vehicle control which can lead to serious injury or death. If the rear end of the vehicle slides while cornering, steer in the direction of the slide until you regain control of the vehicle.

4WD vehicles have advantages over 2WD vehicles in snow and ice but can skid like any other vehicle.

Should you start to slide while driving on snowy or icy roads, turn the steering wheel in the direction of the slide until you regain control.

Avoid sudden applications of power and quick changes of direction on snow and ice. Apply the accelerator slowly and steadily when starting from a full stop.

Avoid sudden braking as well. Although a 4WD vehicle may accelerate better than a two-wheel drive vehicle in snow and ice, it won't stop any faster, because as in other vehicles, braking occurs at all four wheels. Do not become overconfident as to road conditions.

Make sure you allow sufficient distance between you and other vehicles for stopping. Drive slower than usual and consider using one of the lower gears. In emergency stopping situations, apply the brake steadily. Do not pump the brakes. Refer to the *Brakes* section of this chapter for additional information on the operation of the Anti-lock Brake System (ABS).

Parking

WARNING: If the parking brake is fully released, but the brake warning lamp remains illuminated, the brakes may not be working properly. See your authorized dealer.



WARNING: Always set the parking brake fully and make sure the gearshift is latched in P (Park). Turn the ignition to the off position and remove the key whenever you leave your vehicle.

On some 4WD vehicles, when the transfer case is in the N (Neutral) position, the engine and transmission are disconnected from the rest of the driveline. Therefore, the vehicle is free to roll even if the automatic transmission is in P (Park) or the manual transmission is in gear. Do not leave the vehicle unattended with the transfer case in the N (Neutral) position. Always set the parking brake fully and turn off the ignition when leaving the vehicle.

Maintenance and modifications

The suspension and steering systems on your vehicle have been designed and tested to provide predictable performance whether loaded or empty and durable load carrying capability. For this reason, Ford Motor Company strongly recommends that you do not make modifications such as adding or removing parts (such as lift kits or stabilizer bars) or by using replacement parts not equivalent to the original factory equipment.

Any modifications to a vehicle that raise the center of gravity can make it more likely the vehicle will roll over as a result of a loss of control. Ford Motor Company recommends that caution be used with any vehicle equipped with a high load or device (such as ladder racks or pickup box cover).

Failure to maintain your vehicle properly may void the warranty, increase your repair cost, reduce vehicle performance and operational capabilities and adversely affect driver and passenger safety. Frequent inspection of vehicle chassis components is recommended if the vehicle is subjected to heavy off-road usage.

GENERAL INFORMATION

Note: Occasional brake noise is normal. If a metal-to-metal, continuous grinding or continuous squeal sound is present, the brake linings may be worn out and should be inspected by an authorized dealer. If your vehicle has continuous vibration or shudder in the steering wheel while braking, you should take it to an authorized dealer for inspection.

Note: Brake dust may accumulate on the wheels, even under normal driving conditions. Some dust is inevitable as the brakes wear and does not contribute to brake noise. See the *Vehicle Care* chapter for wheel cleaning instructions.



See the *Instrument Cluster* chapter for information on the brake system warning light.

Wet brakes result in reduced braking efficiency. Gently press the brake pedal a few times when driving from a car wash or standing water to dry the brakes.

Brake Over Accelerator

In the event the accelerator pedal becomes stuck or entrapped, apply steady and firm pressure to the brake pedal to slow your vehicle and reduce engine power. If you experience this condition, apply the brakes and bring your vehicle to a safe stop. Turn the engine off, shift to position **P** and apply the parking brake, then inspect the accelerator pedal for any interferences. If none are found and the condition persists, have your vehicle towed to the nearest authorized dealer.

Brake Assist

Brake assist detects when you brake heavily by measuring the rate at which you press the brake pedal. It provides maximum braking efficiency as long as you press the pedal. Brake assist can reduce stopping distances in critical situations.

Anti-Lock Brake System

This system helps you maintain steering control during emergency stops by keeping the brakes from locking.



The anti-lock brake system lamp momentarily illuminates when the ignition is turned on. If the light does not illuminate during start-up, remains on or flashes, the anti-lock brake system may be disabled and may need to be serviced.



If the anti-lock brake system is disabled, normal braking is still effective. If the brake warning lamp illuminates with the parking brake released, have your brake system serviced immediately.

HINTS ON DRIVING WITH ANTI-LOCK BRAKES

When the system is operating, the brake pedal will pulse and may travel further. Maintain pressure on the brake pedal. You may also hear a noise from the system. This is normal.

The anti-lock braking system will not eliminate the dangers inherent when:

- you drive too closely to the vehicle in front of you.
- your vehicle is hydroplaning.
- you take corners too fast.
- the road surface is poor.

PARKING BRAKE



WARNING: Always set the parking brake fully and make sure that the transmission selector lever is securely latched in position **P**.

To set the parking brake, press the parking brake pedal down until the pedal stops.

The BRAKE warning lamp in the instrument cluster will illuminate and remains illuminated until the parking brake is released.

To release, pull the brake release lever located at the lower left side of the instrument panel.

If you are parking your vehicle on a grade or with a trailer, press and hold the brake pedal down, then set the parking brake. There may be a little vehicle movement as the parking brake sets to hold the vehicle's weight. This is normal and should be no reason for concern. If needed, press and hold the service brake pedal down, then try reapplying the parking brake. Chock the wheels if required. If the parking brake cannot hold the weight of the vehicle, the parking brake may need to be serviced or the vehicle may be overloaded.

PRINCIPLES OF OPERATION

The traction control system helps avoid drive wheel spin and loss of traction.

If your vehicle begins to slide, the system applies the brakes to individual wheels and, when needed, reduces engine power at the same time. If the wheels spin when accelerating on slippery or loose surfaces, the system reduces engine power in order to increase traction.

USING TRACTION CONTROL**(Dual rear wheel vehicles only)**

In certain situations (for example, stuck in snow or mud), turning the traction control off may be beneficial as this allows the wheels to spin with full engine power.

TCS OFF Turn the traction control system off by pressing the stability control button located on the instrument panel.

If the system cannot be turned off, see the *MyKey* chapter for more information.

If traction control is on when your vehicle is put into four-wheel drive mode (if equipped), the traction control system will be automatically disabled. Traction control operation will resume when your vehicle is placed back into two-wheel drive mode.

| Engine Only Traction Control (Dual rear wheel vehicles only) | | |
|---|--------------------------|------------|
| Button functions | TCS OFF indicator | TCS |
| Default at start-up | Not illuminated | Enabled |
| Button pressed momentarily | Illuminated | Disabled |
| Button pressed again after deactivation | Not illuminated | Enabled |
| Transfer case switched to 4WD ¹ | Illuminated | Disabled |

¹Engaging 4WD automatically disables TCS.

System indicator lights and messages

WARNING: If a failure has been detected within the Traction Control System, the stability control light will illuminate steadily. Verify that the Traction Control System was not manually disabled using the stability control button. If the stability control light still illuminates steadily, have the system serviced by an authorized dealer immediately. Operating your vehicle with Traction Control disabled could lead to an increased risk of loss of vehicle control, vehicle rollover, personal injury and death.



The stability control light temporarily illuminates on engine start-up and flashes when a driving condition activates the stability system.



The stability control off light temporarily illuminates on engine start-up and stays on when the traction control system is turned off or if a problem occurs in the stability system.

PRINCIPLES OF OPERATION



WARNING: Vehicle modifications involving braking system, aftermarket roof racks, suspension, steering system, tire construction or wheel and tire size may change the handling characteristics of the vehicle and may adversely affect the performance of the AdvanceTrac® system. In addition, installing any stereo loudspeakers may interfere with and adversely affect the AdvanceTrac® system. Install any aftermarket stereo loudspeaker as far as possible from the front center console, the tunnel, and the front seats in order to minimize the risk of interfering with the AdvanceTrac® sensors. Reducing the effectiveness of the AdvanceTrac® system could lead to an increased risk of loss of vehicle control, vehicle rollover, personal injury and death.



WARNING: Remember that even advanced technology cannot defy the laws of physics. It's always possible to lose control of a vehicle due to inappropriate driver input for the conditions. Aggressive driving on any road condition can cause you to lose control of your vehicle increasing the risk of personal injury or property damage. Activation of the AdvanceTrac® system is an indication that at least some of the tires have exceeded their ability to grip the road; this could reduce the operator's ability to control the vehicle potentially resulting in a loss of vehicle control, vehicle rollover, personal injury and death. If your AdvanceTrac® system activates, SLOW DOWN.

The AdvanceTrac® with Roll Stability Control™ system helps you keep control of your vehicle when on a slippery surface. The electronic stability control portion of the system helps avoid skids and lateral slides and roll stability control helps avoid a vehicle rollover. The traction control system helps avoid drive wheel spin and loss of traction. See the *Traction Control* chapter for details on traction control system operation.

A Vehicle without AdvanceTrac® with RSC® skidding off its intended route.

B Vehicle with AdvanceTrac® with RSC® maintaining control on a slippery surface.

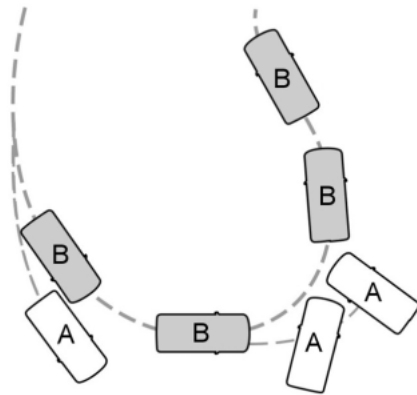

USING ADVANCETRAC® WITH RSC®

(Single rear wheel vehicles only)

The system automatically activates when you start your engine. The electronic stability control and roll stability control portions of the system can be turned off below 35 mph (56 km/h) and are disabled when the transmission is in position **R**.

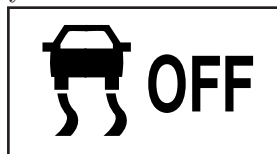

Turn off the traction control system by pressing the stability control button located on the instrument panel.

| AdvanceTrac® with RSC® Features (Single rear wheels only) | | | | |
|---|---|----------|----------------------|----------|
| Button functions | Stability control light | RSC® | ESC | TCS |
| Default at start-up | Illuminated during bulb check | Enabled | Enabled | Enabled |
| Button pressed momentarily | Illuminated solid | Enabled | Enabled ¹ | Disabled |
| Button pressed and held for more than 5 seconds at vehicle speed under 35 mph (56 km/h) | Flashes then illuminated solid ² | Disabled | Disabled | Disabled |
| Vehicle speed exceeds 35 mph (56 km/h) after button is pressed and held for more than 5 seconds | Illuminated solid | Enabled | Enabled ¹ | Disabled |
| Button pressed again after deactivation | Not illuminated | Enabled | Enabled | Enabled |
| Transfer case switched to 4WD Low ³ | Illuminated | Disabled | Disabled | Disabled |

¹Electronic stability control has reduced sensitivity compared to fully active system.

²Lamp light starts blinking for four seconds after entering the press and hold state.

³Engaging 4WD Low locked automatically disables roll stability control, electronic stability control and the traction control system.

Hill descent control (if equipped)

Hill descent control allows the driver to set and maintain vehicle speed while descending steep grades in various surface conditions.



WARNING: Hill descent control cannot control descent in all surface conditions and circumstances, such as ice or extremely steep grades. Hill descent control is a driver assist system and cannot substitute for good judgment by the driver. Failure to do so may result in loss of vehicle control, crash or serious injury.

Hill descent control can maintain vehicle speeds on downhill grades between 2 mph (3 km/h) and 12 mph (20 km/h). Above 20 mph (32 km/h), the system remains armed, but descent speed cannot be set or maintained.



WARNING: Hill descent control does not provide hill hold at zero mph (0 km/h). When stopped, the parking brake must be applied and/or the vehicle must be placed in P (Park) or it may roll away.

Hill descent control requires a cooling down interval after a period of sustained use. The amount of time that the feature can remain active before cooling varies with conditions. The system will provide a warning in the message center and a chime will sound when the system is about to disengage for cooling. At this time, manually apply the brakes as needed to maintain descent speed.

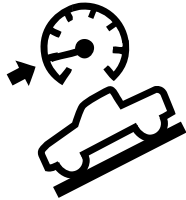
Enabling hill descent control and setting the descent speed

1. Press and release the hill descent button located on the instrument panel. A light in the cluster will illuminate and chime will sound when this feature is activated.

2. To increase descent speed, press the accelerator pedal until the desired speed is reached. To decrease descent speed, press the brake pedal until the desired speed is reached.

Whether accelerating or decelerating, once the desired descent speed is reached, remove your feet from the pedals and the chosen vehicle speed will be maintained.

Note: Noise from the ABS pump motor may be observed during hill descent control operation. This is a normal characteristic of the ABS and should be no reason for concern.

Hill descent modes

- At speeds below 20 mph (32 km/h): When the HDC switch is pressed and HDC is active, the HDC telltale will flash.
- At speeds below 20 mph (32 km/h): When the HDC switch is pressed and conditions are not correct for hill descent activation, the HDC system will be enabled, the light in the cluster will be on solid and HILL DESCENT CONTROL READY will be displayed in the message center.
- At speeds above 20 mph (32 km/h): When the HDC switch is pressed, the HDC system will be enabled, the light in the cluster will not be illuminated and FOR HILL CNTRL, 20 MPH OR LESS will be displayed in the message center.

Refer to *Message center* in the *Instrument Cluster* chapter for hill descent control messages.

SENSING SYSTEM (IF EQUIPPED)

WARNING: To help avoid personal injury, please read and understand the limitations of the system as contained in this section. Sensing is only an aid for some (generally large and fixed) objects when moving in reverse on a flat surface at parking speeds. Traffic control systems, inclement weather, air brakes, and external motors and fans may also affect the function of the sensing system; this may include reduced performance or a false activation.



WARNING: To help avoid personal injury, always use caution when in R (Reverse) and when using the sensing system.



WARNING: This system is not designed to prevent contact with small or moving objects. The system is designed to provide a warning to assist the driver in detecting large stationary objects to avoid damaging the vehicle. The system may not detect smaller objects, particularly those close to the ground.



WARNING: Certain add-on devices such as large trailer hitches, bike or surfboard racks and any device that may block the normal detection zone of the system, may create false beeps.

Note: Keep the sensors (located on the bumper/fascia) free from snow, ice and large accumulations of dirt. If the sensors are covered, the system's accuracy can be affected. Do not clean the sensors with sharp objects.

Note: If your vehicle sustains damage to the bumper/fascia, leaving it misaligned or bent, the sensing zone may be altered causing inaccurate measurement of obstacles or false alarms.

Note: If your vehicle is equipped with MyKey®, it is possible to prevent turning the sensing system off. Refer to the *MyKey®* chapter.

Note: If your vehicle is equipped with a fully integrated electronic trailer brake controller (TBC) and a trailer with electric trailer brakes is connected to your vehicle, the RSS will be disabled. When the vehicle is shifted into reverse, the message center display will remain in the Rear Park Aid Off selection. For more information on the TBC, refer to the *Towing* chapter.

The sensing system warns the driver of obstacles within a certain range of the bumper area. The system turns on automatically whenever the ignition is switched on.

When receiving a detection warning, the radio volume is reduced to a predetermined level. After the warning goes away, the radio volume returns to the previous level.

Using the Rear Sensing System

The rear sensors are only active when the transmission is in **R**. As the vehicle moves closer to the obstacle, the rate of the audible warning increases. When the obstacle is fewer than 12 inches (30 centimeters) away, the warning sounds continuously. If a stationary or receding object is detected farther than 12 inches (30 centimeters) from the side of the vehicle, the tone sounds for only three seconds. Once the system detects an object approaching, the warning sounds again.

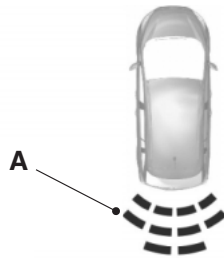



A. Coverage area of up to 6 feet (2 meters) from the rear bumper (with a decreased coverage area at the outer corners of the bumper).

The system detects certain objects while the transmission is in **R**:

- and moving toward a stationary object at a speed of 3 mph (5 km/h) or less.
- but not moving, and a moving object is approaching the rear of the vehicle at a speed of 3 mph (5 km/h) or less.
- and moving at a speed of less than 3 mph (5 km/h) and a moving object is approaching the rear of the vehicle at a speed of less than 3 mph (5 km/h).

REAR VIEW CAMERA SYSTEM (IF EQUIPPED)

 **WARNING:** The rear view camera system is a reverse aid supplement device that still requires the driver to use it in conjunction with the interior and exterior mirrors for maximum coverage.

 **WARNING:** Objects that are close to either corner of the bumper or under the bumper, might not be seen on the screen due to the limited coverage of the camera system.

 **WARNING:** Back up as slow as possible since higher speeds might limit your reaction time to stop the vehicle.

 **WARNING:** Use caution when turning camera features on or off while in R (Reverse). Make sure the vehicle is not moving.

The rear view camera system provides a video image of the area behind the vehicle.

During operation, lines appear in the display which represent your vehicle's path and proximity to objects behind the vehicle.



The camera is located on the tailgate.

Using the Rear View Camera System

The rear view camera system displays what is behind your vehicle when you place the transmission in R (Reverse). The system uses two types of guides to help you see what is behind your vehicle:

1. Fixed guidelines: Show the actual path the vehicle is moving in while reversing in a straight line, which can be helpful when backing into a parking space or aligning the vehicle with another object behind the vehicle.
2. Centerline: Helps align the center of the vehicle with an object (i.e. a trailer).

Note: If the image comes on while the transmission is not in R (Reverse), have the system inspected by your authorized dealer.

Note: When towing, the camera only sees what is being towed behind the vehicle. This might not provide adequate coverage as it usually provides in normal operation and some objects might not be seen. In some vehicles, the guidelines may disappear once the trailer tow connector is engaged.

Note: The default setting for the camera delay is off. Press the Settings button found on the navigation screen (if equipped) to set the camera delay feature to on or off.

Note: The camera may not operate correctly under the following conditions:

- Nighttime or dark areas if one or both reverse lamps are not operating.
- The camera's view is obstructed by mud, water or debris. Clean the lens with a soft, lint-free cloth and non-abrasive cleaner.
- The rear of the vehicle is hit or damaged, causing the camera to become misaligned.

Guidelines and the Centerline

Note: Fixed guidelines are only available when the transmission is in R (Reverse).

Note: The centerline is only available if fixed guidelines are on.

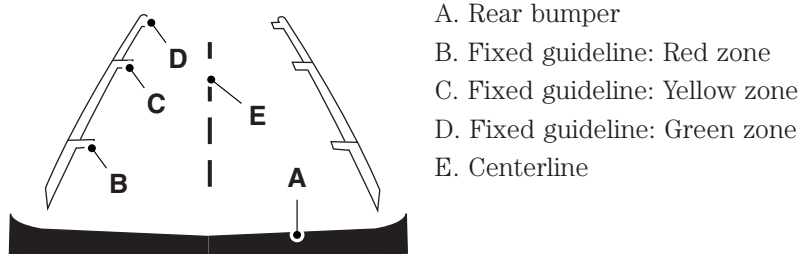

- A. Rear bumper
- B. Fixed guideline: Red zone
- C. Fixed guideline: Yellow zone
- D. Fixed guideline: Green zone
- E. Centerline

The fixed guidelines fade in and out depending on the steering wheel position.

Always use caution while reversing. Objects in the red zone are closest to your vehicle and objects in the green zone are further away. Objects are getting closer to your vehicle as they move from the green zone to the yellow or red zones. Use the side view mirrors and rear view mirror to get better coverage on both sides and rear of the vehicle.

Selectable settings for this feature are FIXED and OFF.

Visual Park Aid Alert

Note: Visual park alert is only available when the transmission is in R (Reverse).

Note: The reverse sensing system is not effective at speeds above 3 mph (5 km/h) and may not detect certain angular or moving objects.

The visual park aid alert allows the driver to view the area that is being detected by the reverse sensing system. The system uses red, yellow and green highlights which appear on top of the video image when an object is detected by the reverse sensing system. The alert highlights the closest object detected. The reverse sensing alert can be disabled and if visual park aid alert is enabled, highlighted areas are still displayed.

Selectable settings for this feature are ON and OFF.

Rear Camera Delay

Navigation display

When shifting the transmission out of R (Reverse) and into any gear other than P (Park), the camera image remains in the display until the vehicle speed reaches 5 mph (8 km/h). This occurs when the rear camera delay feature is on, or until a radio button is selected.

Selectable settings for this feature are ON and OFF. The default setting for the rear camera delay is OFF.

Rearview mirror display

When shifting out of R (Reverse) and into any other gear, the image in the rearview mirror will remain on for a few seconds before it shuts off to assist in parking or trailer hookup.

PRINCIPLES OF OPERATION

Cruise control lets you maintain a set speed without keeping your foot on the accelerator pedal.

USING CRUISE CONTROL (IF EQUIPPED)

WARNING: Do not use cruise control in heavy traffic or on roads that are winding, slippery or unpaved.

Note: Vehicle speed may vary momentarily when driving up or down a steep hill. Apply the brakes if your vehicle speed increases above the set speed while driving downhill.

Note: Cruise control will disengage if your vehicle speed decreases more than 10 mph (16 km/h) below your set speed while driving uphill.



The speed controls are located on the steering wheel.

Switching Cruise Control On

Press and release **ON**.



The indicator will turn on in the instrument cluster.

Setting a Speed

1. Accelerate to the desired speed.
2. Press and release **SET +**.
3. Take your foot off the accelerator pedal.

The indicator will change colors in the instrument cluster.

Changing the Set Speed

Note: If you accelerate by pressing the accelerator pedal, the set speed will not change. When you release the accelerator pedal, you will return to the speed that you previously set.

- Press and hold **SET +** or **SET -**. Release the control when you reach the desired speed.
- Press and release **SET +** or **SET -**. The set speed will change in approximately 1 mph (2 km/h) increments.
- Press the accelerator or brake pedal until you reach the desired speed. Press and release **SET +**.

Canceling the Set Speed

Press **CNCL** or tap the brake pedal. You will not erase the set speed.

Resuming the Set Speed

Press and release **RSM**.

Switching Cruise Control Off

Note: You will erase the set speed if you switch the system off.

Press and release **OFF** or switch the ignition off.

Steering

To help prevent damage to the power steering system:

- Never hold the steering wheel at its furthest turning points (until it stops) for more than three to five seconds when the engine is running.
- Do not operate the vehicle with a low power steering pump fluid level (below the MIN mark on the reservoir).
- Some noise is normal during operation. If excessive, check for low power steering pump fluid level before seeking service by your dealer.
- Heavy or uneven efforts may be caused by low power steering fluid. Check for low power steering pump fluid level before seeking service by your dealer.
- Do not fill the power steering pump reservoir above the MAX mark on the reservoir, as this may result in leaks from the reservoir.

If the power steering system breaks down (or if the engine is turned off), you can steer the vehicle manually, but it takes more effort.

If the steering wanders or pulls, check for:

- an improperly inflated tire
- uneven tire wear
- loose or worn suspension components
- loose or worn steering components
- improper steering alignment

If any steering components are serviced or replaced, install new fasteners (many are coated with thread adhesive or have prevailing torque features which may not be re-used). Never re-use a bolt or nut. Torque fasteners to specifications in *Workshop Manual*.

A high crown in the road or high crosswinds may also make the steering seem to wander/pull.

LOAD LIMIT**Vehicle Loading – With and Without a Trailer**

This section will guide you in the proper loading of your vehicle and/or trailer, to keep your loaded vehicle weight within its design rating capability, with or without a trailer. Properly loading your vehicle will provide maximum return of vehicle design performance. Before loading your vehicle, familiarize yourself with the following terms for determining your vehicle's weight ratings, with or without a trailer, from the vehicle's Tire Label or Safety Compliance Certification Label:

Base Curb Weight – is the weight of the vehicle including a full tank of fuel and all standard equipment. It does not include passengers, cargo, or optional equipment.

Vehicle Curb Weight – is the weight of your new vehicle when you picked it up from your authorized dealer plus any aftermarket equipment.

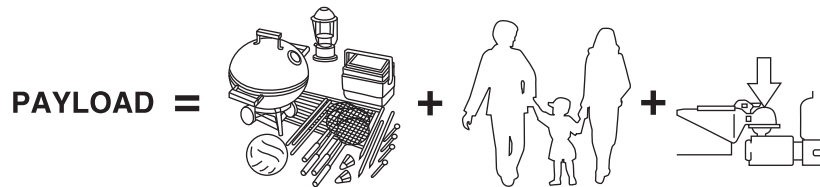

Payload – is the combined weight of cargo and passengers that the vehicle is carrying. The maximum payload for your vehicle can be found on the Tire Label on the B-Pillar or the edge of the driver's door (vehicles exported outside the US and Canada may not have a Tire Label). Look for **“THE COMBINED WEIGHT OF OCCUPANTS AND CARGO SHOULD NEVER EXCEED XXX kg OR XXX lb.”** for maximum payload. The payload listed on the Tire Label is the maximum payload for the vehicle as built by the assembly plant. If any aftermarket or authorized-dealer installed equipment has been installed on the vehicle, the weight of the equipment must be subtracted from the payload listed on the Tire Label in order to determine the new payload.

WARNING: The appropriate loading capacity of your vehicle can be limited either by volume capacity (how much space is available) or by payload capacity (how much weight the vehicle should carry). Once you have reached the maximum payload of your vehicle, do not add more cargo, even if there is space available. Overloading or improperly loading your vehicle can contribute to loss of vehicle control and vehicle rollover.

Example only:

TIRE AND LOADING INFORMATION

SEATING CAPACITY | TOTAL 5 | FRONT 2 | REAR 3

The combined weight of occupants and cargo should never exceed : **XXX kg or XXX lbs.**

| TIRE | SIZE | COLD TIRE PRESSURE | SEE OWNERS MANUAL FOR ADDITIONAL INFORMATION |
|-------|--------------------------|------------------------------------|---|
| FRONT | LT225/75R 16,5E | 200 KPA, 29 PSI | |
| REAR | LT225/75R 16,5E | 200 KPA, 29 PSI | |
| SPARE | T145/80D16 P225/60R17 | 420 KPA, 60 PSI 200 KPA, 29 PSI | |

TIRE AND LOADING INFORMATION
RENSEIGNEMENTS SUR LES PNEUS ET LE CHARGEMENT

SEATING CAPACITY | TOTAL 5 | FRONT 2 | REAR 3
NOMBRE DE PLACES | TOTAL 5 | AVANT 2 | ARRIERE 3

The combined weight of occupants and cargo should never exceed 492 kg or 1085 lbs.
Le poids total des occupants et du chargement ne doit jamais dépasser 492 kg ou 1085 lb.

| TIRE PNEU | SIZE DIMENSIONS | COLD TIRE PRESSURE PRESSION DES PNEUS A FROID | SEE OWNER'S MANUAL FOR ADDITIONAL INFORMATION VOIR LE MANUEL DE L'USAGER POUR PLUS DE RENSEIGNEMENTS |
|------------------|-----------------|---|---|
| FRONT AVANT | P235/70R16 | 240 KPA, 35 PSI | |
| REAR ARRIERE | P235/70R16 | 240 KPA, 35 PSI | |
| SPARE DE SECOURS | T145/90R17 | 415 KPA, 60 PSI | |



Cargo Weight – includes all weight added to the Base Curb Weight, including cargo and optional equipment. When towing, trailer tongue load or king pin weight is also part of cargo weight.

GAW (Gross Axle Weight) – is the total weight placed on each axle (front and rear) – including vehicle curb weight and all payload.

GAWR (Gross Axle Weight Rating) – is the maximum allowable weight that can be carried by a single axle (front or rear). **These numbers are shown on the Safety Compliance Certification Label. The label shall be affixed to either the door hinge pillar, door-latch post, or the door edge that meets the door-latch post, next to the driver's seating position. The total load on each axle must never exceed its GAWR.**

Note: For trailer towing information refer to the *RV and Trailer Towing Guide* provided by your authorized dealer.

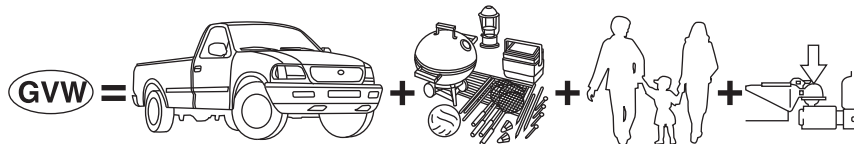

GVW (Gross Vehicle Weight) – is the Vehicle Curb Weight + cargo + passengers.

GVWR (Gross Vehicle Weight Rating) – is the maximum allowable weight of the fully loaded vehicle (including all options, equipment, passengers and cargo). **The GVWR is shown on the Safety Compliance Certification Label. The label shall be affixed to either the door hinge pillar, door-latch post, or the door edge that meets the door-latch post, next to the driver's seating position. The GVW must never exceed the GVWR.**

- Example only:

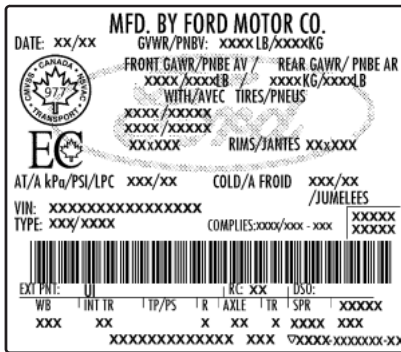
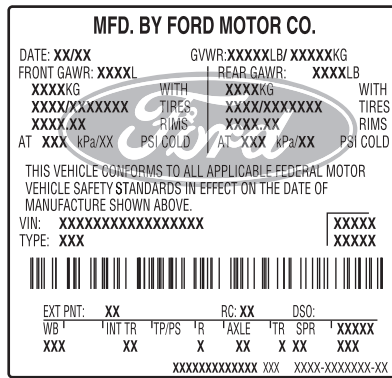

⚠ WARNING: Exceeding the Safety Compliance Certification Label vehicle weight rating limits could result in substandard vehicle handling or performance, engine, transmission and/or structural damage, serious damage to the vehicle, loss of control and personal injury.



GCW (Gross Combined Weight) – is the weight of the loaded vehicle (GVW) plus the weight of the fully loaded trailer.

GCWR (Gross Combined Weight Rating) – is the maximum allowable weight of the vehicle and the loaded trailer – including all cargo and passengers – that the vehicle can handle without risking damage. (Important: The towing vehicle's braking system is rated for operation at GVWR, not at GCWR.) Separate functional brakes should be used for safe control of towed vehicles and for trailers where the GCW of the towing vehicle plus the trailer exceed the GVWR of the towing vehicle.

The GCW must never exceed the GCWR.

Maximum Loaded Trailer Weight – is the highest possible weight of a fully loaded trailer the vehicle can tow. It assumes a vehicle with only mandatory options, no cargo (internal or external), a tongue load of 10–15% (conventional trailer) or king pin weight of 15–25% (fifth wheel trailer), and driver only (150 lb. [68 kg]). **Consult your authorized dealer (or the *RV and Trailer Towing Guide* provided by your authorized dealer) for more detailed information.**

Tongue Load or Fifth Wheel King Pin Weight – refers to the amount of the weight that a trailer pushes down on a trailer hitch.

Examples: For a 5,000 lb. (2,268 kg) conventional trailer, multiply 5,000 by 0.10 and 0.15 to obtain a proper tongue load range of 500 to 750 lb. (227 to 340 kg). For an 11,500 lb. (5,216 kg) fifth wheel trailer, multiply by 0.15 and 0.25 to obtain a proper king pin load range of 1,725 to 2,875 lb. (782 to 1,304 kg)



WARNING: Do not exceed the GVWR or the GAWR specified on the Safety Compliance Certification Label.



WARNING: Do not use replacement tires with lower load carrying capacities than the original tires because they may lower the vehicle's GVWR and GAWR limitations. Replacement tires with a higher limit than the original tires do not increase the GVWR and GAWR limitations.



WARNING: Exceeding any vehicle weight rating limitation could result in serious damage to the vehicle and/or personal injury.

Steps for determining the correct load limit:

1. Locate the statement "The combined weight of occupants and cargo should never exceed XXX kg or XXX lb." on your vehicle's placard.
2. Determine the combined weight of the driver and passengers that will be riding in your vehicle.
3. Subtract the combined weight of the driver and passengers from XXX kg or XXX lb.
4. The resulting figure equals the available amount of cargo and luggage load capacity. For example, if the "XXX" amount equals 1,400 lb. and there will be five 150 lb. passengers in your vehicle, the amount of available cargo and luggage load capacity is 650 lb. (1400-750 (5 x 150) = 650 lb.).
5. Determine the combined weight of luggage and cargo being loaded on the vehicle. That weight may not safely exceed the available cargo and luggage load capacity calculated in Step 4.
6. If your vehicle will be towing a trailer, load from your trailer will be transferred to your vehicle. Consult this manual to determine how this reduces the available cargo and luggage load capacity of your vehicle.

The following gives you a few examples on how to calculate the available amount of cargo and luggage load capacity:

- Suppose your vehicle has a 1400 lb. (635 kg) cargo and luggage capacity. You decide to go golfing. Is there enough load capacity to carry you, 4 of your friends and all the golf bags? You and four friends average 220 lb. (99 kg) each and the golf bags weigh approximately 30 lb. (13.5 kg) each. The calculation would be: $1400 - (5 \times 220) - (5 \times 30) = 1400 - 1100 - 150 = 150$ lb. Yes, you have enough load capacity in your vehicle to transport four friends and your golf bags. In metric units, the calculation would be: $635 \text{ kg} - (5 \times 99 \text{ kg}) - (5 \times 13.5 \text{ kg}) = 635 - 495 - 67.5 = 72.5$ kg.

- Suppose your vehicle has a 1400 lb. (635 kg) cargo and luggage capacity. You and one of your friends decide to pick up cement from the local home improvement store to finish that patio you have been planning for the past 2 years. Measuring the inside of the vehicle with the rear seat folded down, you have room for 12-100 lb. (45 kg) bags of cement. Do you have enough load capacity to transport the cement to your home? If you and your friend each weigh 220 lb. (99 kg), the calculation would be: $1400 - (2 \times 220) - (12 \times 100) = 1400 - 440 - 1200 = -240$ lb. No, you do not have enough cargo capacity to carry that much weight. In metric units, the calculation would be: $635 \text{ kg} - (2 \times 99 \text{ kg}) - (12 \times 45 \text{ kg}) = 635 - 198 - 540 = -103$ kg. You will need to reduce the load weight by at least 240 lb. (104 kg). If you remove 3-100 lb. (45 kg) cement bags, then the load calculation would be:
 $1400 - (2 \times 220) - (9 \times 100) = 1400 - 440 - 900 = 60$ lb. Now you have the load capacity to transport the cement and your friend home. In metric units, the calculation would be: $635 \text{ kg} - (2 \times 99 \text{ kg}) - (9 \times 45 \text{ kg}) = 635 - 198 - 405 = 32$ kg.

The above calculations also assume that the loads are positioned in your vehicle in a manner that does not overload the Front or the Rear Gross Axle Weight Rating specified for your vehicle on the Safety Compliance Certification Label. The label shall be affixed to either the door hinge pillar, door-latch post, or the door edge that meets the door-latch post, next to the driver's seating position.

Special Loading Instructions for Owners of Pick-up Trucks and Utility-type Vehicles



WARNING: Loaded vehicles may handle differently than unloaded vehicles. Extra precautions, such as slower speeds and increased stopping distance, should be taken when driving a heavily loaded vehicle.

Your vehicle can haul more cargo and people than most passenger cars. Depending upon the type and placement of the load, hauling cargo and people may raise the center of gravity of the vehicle.

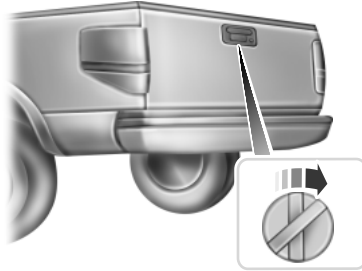
TAILGATE**Tailgate Lock**

The tailgate lock is designed to help prevent theft of the tailgate.

Insert the ignition key into the tailgate lock. Turn it to the right to lock or to the left to unlock the tailgate.

Tailgate Removal

WARNING: Always properly secure cargo to prevent shifting cargo or cargo falling from vehicle, which could result in compromised vehicle stability and serious personal injury to vehicle occupants or others.

Your tailgate is removable to allow more room for loading.

Note: If equipped with a rearview camera system, do Steps 1 through 3 before removing the tailgate.

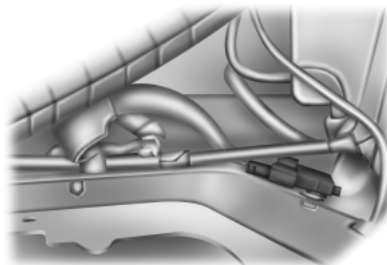

1. Before removal of the tailgate, locate and disconnect the tailgate in-line connector under the pickup box on the passenger side of the vehicle near the spare tire.
2. Install a protective cap (tethered to the wire assembly) onto the in-line rearview camera system connector that remains under the pickup box.

3. Partially lower tailgate and carefully feed tailgate harness up through the gap between the pickup box and the bumper. Place the tailgate harness out of the way under the pickup box.

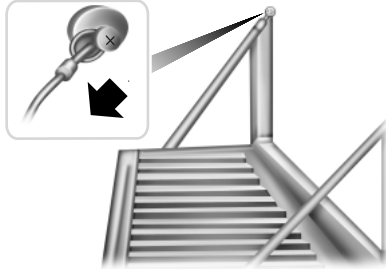

4. Lower the tailgate.
 5. Using a screwdriver, gently pry the spring clip (on each connector) past the head of the support screw. Disconnect cable.
 6. Disconnect the other cable.
 7. Lift tailgate to a 45-degree angle from horizontal.
 8. Lift right side off of its hinge.
 9. Lift tailgate to a 80-degree angle from horizontal.
 10. Remove tailgate from left side hinge by sliding tailgate to the right.
- To install, follow the removal procedures in reverse order.

Tailgate Step (If Equipped)

This feature allows easier entry into the truck bed.

Note: To reduce risk of falling:

- Operate the step only when the vehicle is on a level surface.
- Operate the step only in areas with sufficient lighting.
- Always open the flip panel to widen step.
- Always use the grab handle when stepping up and down.
- Do not use the step with bare feet.
- Keep the step clean from contamination before use (e.g. snow, mud).
- Keep the step load (you plus the load) below 350 pounds (159 kilograms).
- Never drive with the step deployed.

Opening the Tailgate Step

1. Flip down the tailgate.



2. Pull the yellow latch lever to the unlock position to release the grab handle from its stowed position.



3. Raise the handle upright until you feel it latch and see the latch lever in the lock position. The yellow lever only needs to be used when releasing the grab handle.

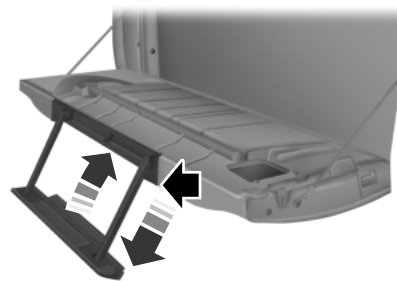

4. Rotate the center molding to unlatch the tailgate step and pull it toward you to extend it.

5. Flip open the step panel to widen the step.

Close the Tailgate Step

1. Close the step panel, then lift and fully close the tailgate step into the tailgate.

2. Slide the latch at the bottom of the handle, then lower the handle.

Note:

- Fully close and latch the tailgate step before moving the vehicle.
- Never drive with the step or grab handle deployed.
- Replace the slip resistance tape (serviceable item) if worn out.
- Replace the handle molding (serviceable item) if damaged.
- Do not tow with the grab handle or step frame.

BED EXTENDER (IF EQUIPPED)

Note: This feature is not intended for off-road usage.

Note: Make sure the locking pins and knobs are fully engaged when the vehicle is in motion.

Note: Make sure all cargo is secured.

Note: The tailgate load must not exceed 150 pounds (68 kilograms) when the vehicle is in motion.

Note: The bed extender should always be kept in the grocery mode or stowed position with the tailgate closed when not being used for the purpose of restraining cargo in the tailgate mode.

To open the bed extender into tailgate mode:

1. Pull the locking pin toward the center of the vehicle.

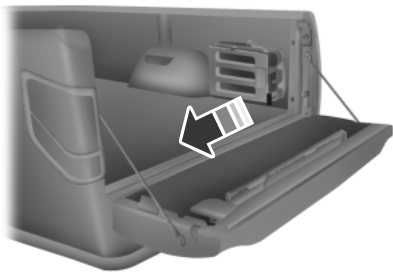

2. Open the latches to release the panels.

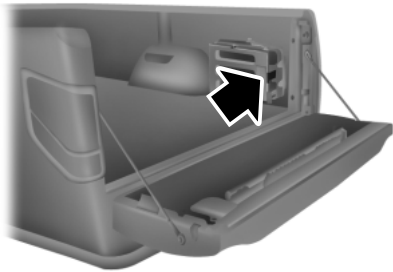

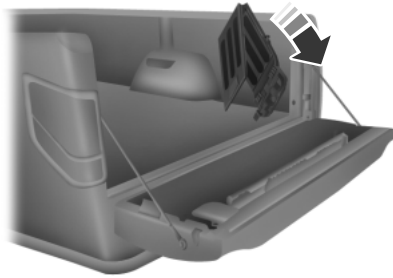

3. Rotate the panels toward the tailgate.

Repeat Steps 1–3 for the other side of the bed extender.

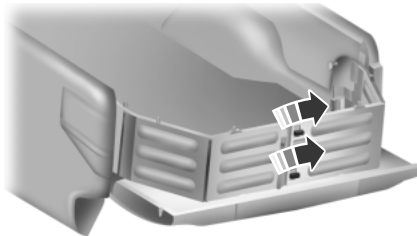

4. Connect the two panels, then rotate both knobs a quarter-turn clockwise to secure the panels.

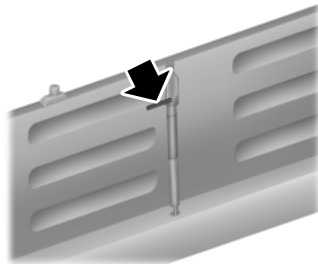

5. Make sure the latch rod is inserted into the tailgate hole and the locking pins on both sides are engaged into their holes in the pick-up box.

6. Reverse steps for storage of the bed extender.

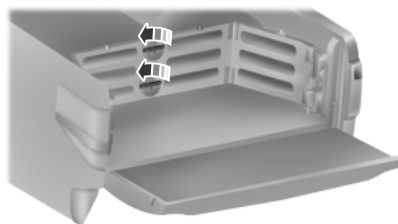

To open the bed extender into grocery mode, follow Steps 1–4 by rotating the panels away from the tailgate. Close the tailgate.

TOWING A TRAILER

WARNING: Do not exceed the GVWR or the GAWR specified on the certification label.



WARNING: Towing trailers beyond the maximum recommended gross trailer weight exceeds the limit of your vehicle and could result in engine damage, transmission damage, structural damage, loss of vehicle control, vehicle rollover and personal injury.

Note: For information on electrical items such as fuses or relays, see the *Fuses* chapter.

Your vehicle's load capacity designation is by weight, not by volume, so you cannot necessarily use all available space when loading a vehicle.

Towing a trailer places an extra load on your vehicle's engine, transmission, axle, brakes, tires and suspension. Inspect these components periodically during, and after, any towing operation.

Load Placement

To help minimize how trailer movement affects your vehicle when driving:

- Load the heaviest items closest to the trailer floor.
- Load the heaviest items centered between the left and right side trailer tires.
- Load the heaviest items above the trailer axles or just slightly forward toward the trailer tongue. Do not allow the final trailer tongue weight to go above or below 10–15% of the loaded trailer weight.
- Select a tow bar with the correct rise or drop. When both the loaded vehicle and trailer are connected, the trailer frame should be level, or slightly angled down toward your vehicle, when viewed from the side.

When driving with a trailer or payload, a slight takeoff vibration or shudder may be present due to the increased payload weight. You can find more information about proper trailer loading and setting your vehicle up for towing under *Load limit* in the *Load Carrying* chapter and in the *RV & Trailer Towing Guide*, available at an authorized dealer.

TRAILER SWAY CONTROL (IF EQUIPPED)

WARNING: Turning off trailer sway control increases the risk of loss of vehicle control, serious injury or death. Ford does not recommend disabling this feature except in situations where speed reduction may be detrimental (such as hill climbing), the driver has significant trailer towing experience, and can control trailer sway and maintain safe operation.

Note: This feature does not prevent trailer sway, but reduces it once it begins.

Note: This feature cannot stop all trailers from swaying.

Note: In some cases, if vehicle speed is too high, the system may turn on multiple times, gradually reducing vehicle speed.

This feature applies your vehicle brakes at individual wheels and, if necessary, reduces engine power. If the trailer begins to sway, the stability control light flashes. The first thing to do is slow your vehicle down, then pull safely to the side of the road and check for proper tongue load and trailer load distribution. See the *Load Carrying* chapter for specific loading information.

RECOMMENDED TOWING WEIGHTS

Note: Do not exceed a trailer weight of 5000 pounds (2268 kilograms) when towing with, or by, bumper only.

Note: The total area in square feet (meters) exposed to air resistance of a moving vehicle and its trailer is the trailer frontal area. Do not exceed 60 feet² (5.57 meters²) trailer frontal area.

Note: Exceeding this limitation may significantly reduce the performance of your towing vehicle. Selecting a trailer with a low aerodynamic drag and rounded front design helps optimize performance and fuel economy.

Note: For high altitude operation, reduce the gross combined weight by 2% per 1000 feet (300 meters) starting at the 1000 foot (300 meter) elevation point.

Note: Certain states require electric trailer brakes for trailers over a specified weight. Be sure to check state regulations for this specified weight. The maximum trailer weights listed may be limited to this specified weight, as your vehicle's electrical system may not include the wiring connector needed to use electric trailer brakes.

Your vehicle may tow a class I, II, III and IV trailer or fifth-wheel trailer provided the maximum trailer weight is less than or equal to the maximum trailer weight listed for your engine and rear axle ratio on the following chart.

To calculate the maximum loaded trailer weight for your vehicle:

1. Start with the gross combined weight rating for your vehicle model and axle ratio. See the following chart.
2. Subtract all of the following that apply to your vehicle:
 - Vehicle curb weight
 - Hitch hardware weight, such as a draw bar, ball, locks or weight distributing
 - Driver weight
 - Passenger(s) weight
 - Payload, cargo and luggage weight
 - Aftermarket equipment weight.
3. This equals the maximum loaded trailer weight for this combination.

Note: The trailer tongue load figures into the payload for your vehicle. Reduce the total payload by the final trailer tongue weight.

Consult an authorized dealer to determine the maximum trailer weight allowed for your vehicle if you are not sure.

Further trailer and hitch restrictions exist depending on the type of trailer and hitch listed. This information follows the table listing the maximum gross combined weight ratings.

| Vehicle type | Rear axle ratio | Maximum GCWR - lb. (kg) |
|-----------------------------------|-----------------|----------------------------|
| F-250, F-350 single rear wheel | 3.73 | 19000 (8617) |
| | 4.30 | 22000 (9977) |
| F-350 dual rear wheel | 3.73 | 19500 (8844) |
| | 4.30 | 22500 (10204) |
| F-450 and F-550 | 4.88 | 26000 (11791) |

ESSENTIAL TOWING CHECKS

Follow these guidelines for safe towing:

- Do not tow a trailer until you drive your vehicle at least 1000 miles (1600 kilometers).
- Consult your local motor vehicle laws for towing a trailer.
- See the instructions included with towing accessories for the proper installation and adjustment specifications.
- Service your vehicle more frequently if you tow a trailer. See your scheduled maintenance information.
- If you use a rental trailer, follow the instructions the rental agency gives you.

For load specification terms found on the tire label and Safety Compliance label and for instructions on calculating your vehicle's load, refer to *Load limit* in the *Load Carrying* chapter.

Remember to account for the trailer tongue weight as part of your vehicle load when calculating the total vehicle weight.

Hitches

WARNING: On pick-up trucks, the trailer hitch provided on this vehicle enhances crash protection for the fuel system. Do not remove!

Do not use a hitch that either clamps onto the bumper or attaches to the axle. You must distribute the load in your trailer so that 10–15% for conventional towing or 15–25% for fifth wheel towing of the total weight of the trailer is on the tongue.

Weight-Distributing Hitches

WARNING: Do not adjust a weight-distributing hitch to any position where the rear bumper of the vehicle is higher than it was before attaching the trailer. Doing so will defeat the function of the weight-distributing hitch, which may cause unpredictable handling, and could result in serious personal injury.

When hooking-up a trailer using a weight-distributing hitch, always use the following procedure:

1. Park the loaded vehicle, without the trailer, on a level surface.
2. Measure the height to the top of your vehicle's front wheel opening on the fender. This is H1.

3. Securely attach the loaded trailer to your vehicle without the weight-distributing bars connected.
4. Measure the height to the top of your vehicle's front wheel opening on the fender a second time. This is H2.
5. Install and adjust the tension in the weight-distributing bars so that the height of your vehicle's front wheel opening on the fender is approximately halfway between H1 and H2.
6. Check that the trailer is level or slightly nose down toward your vehicle. If not, adjust the ball height accordingly and repeat Steps 2–6.

Once the trailer is level or slightly nose down toward the vehicle:

- Lock the bar tension adjuster in place.
- Check that the trailer tongue securely attaches and locks onto the hitch.
- Install safety chains, lighting, and trailer brake controls as required by law or the trailer manufacturer.

Fifth-Wheel Trailer Hitch (If Equipped)



WARNING: The mounting pads in the bed are specifically designed for certain fifth-wheel trailer hitches and gooseneck ball hitches. Do not use these mounting pads for other purposes. Doing so could result in vehicle structural damage, loss of vehicle control, and personal injury. Contact an authorized dealer to purchase gooseneck and fifth-wheel hitches that are compatible with your vehicle.



WARNING: Towing trailers beyond the maximum limit of the towing system could result in vehicle structural damage, loss of vehicle control and personal injury.



WARNING: The hitch rating listed on the trailer hitch label is the maximum possible trailer rating. To find the maximum trailer weight allowed for your specific vehicle, consult an authorized dealer or the *RV & Trailer Towing Guide* provided by an authorized dealer.

Your vehicle may be equipped with a fifth-wheel prep package. This package enables your vehicle to accept certain fifth-wheel trailer hitches and gooseneck ball hitches. The fifth-wheel trailer hitch attaches to the four mounting pads in the pick-up bed. An optional 7-pin trailer wiring connector may be in the bed as well. The gooseneck ball hitch is a separate mounting pad from the fifth-wheel hitch, located in the center of the bed.

Shorter pick-up boxes, such as a 6½-foot box on the F-250 and F-350, provide less clearance between the cab and the fifth-wheel and gooseneck trailer compared to longer box pick-ups, such as an 8-foot box on the F-250 and F-350. When selecting a trailer and tow vehicle, it is critical to check that this combination provides clearance between the front of the trailer and tow vehicle for turns up to 90 degrees. Failure to follow this recommendation could result in the trailer contacting the cab of the tow vehicle during tight turns that are typical during low-speed parking and turning maneuvers. This contact could result in damage to the trailer and tow vehicle.

To find the maximum trailer weight allowed for your vehicle, consult an authorized dealer or see the *RV & Trailer Towing Guide* provided by an authorized dealer.

Safety Chains

Note: Do not attach safety chains to the bumper.

Always connect the trailer's safety chains to the frame or hook retainers of your vehicle hitch.

To connect the trailer's safety chains, cross the chains under the trailer tongue and allow enough slack for turning tight corners. Do not allow the chains to drag on the ground.

Trailer Brakes



WARNING: Do not connect a trailer's hydraulic brake system directly to your vehicle's brake system. Your vehicle may not have enough braking power and your chances of having a collision greatly increase.

Electric brakes and manual, automatic or surge-type trailer brakes are safe if you install them properly and adjust them to the manufacturer's specifications. The trailer brakes must meet local and federal regulations.

The rating for the tow vehicle's braking system operation is at the gross vehicle weight rating, not the gross combined weight rating.

Separate functioning brake systems are required for safe control of towed vehicles and trailers weighing more than 1500 pounds (680 kilograms) when loaded.

Integrated Trailer Brake Controller (If Equipped)

 **WARNING:** The Ford TBC has been verified to be compatible with trailers having electric-actuated drum brakes (one to four axles) and some electric-over-hydraulic (EOH) brakes. It will not activate hydraulic surge-style trailer brakes. It is the responsibility of the customer to ensure that the trailer brakes are adjusted appropriately, functioning normally and all electric connections are properly made. Failure to do so may result in loss of vehicle control, crash or serious injury.

When used properly, the trailer brake controller assists in smooth and effective trailer braking by powering the trailer's electric or electric-over-hydraulic brakes with a proportional output based on the towing vehicle's brake pressure.

Ford has tested the trailer brake controller to be compatible with several major brands of electric-over-hydraulic trailer brakes. Contact an authorized dealer for information on which brands you can use.

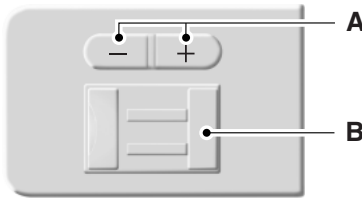

The controller user interface consists of the following:

A. + and - (Gain adjustment buttons): Pressing these buttons adjusts the controller's power output to the trailer brakes in 0.5 increments. You can increase the gain setting to 10.0 (maximum trailer braking) or decrease it to 0 (no trailer braking). Pressing and holding a button raises or lowers the setting continuously. The gain setting displays in the message center as follows: TBC GAIN = XX.X.

The controller shows gain setting, output bar graph, and trailer connectivity status in the information display. They appear in the information display as follows:

- **TBC GAIN = XX.X NO TRAILER:** Shows the current gain setting during a given ignition cycle and when adjusting the gain. This also displays if you use the manual control lever or make gain adjustments with no trailer connected.

- **TBC GAIN = XX.X OUTPUT = // // // // /:** Displays when you push your vehicle's brake pedal, or when you use the manual control. Bar indicators illuminate in the information display to indicate the amount of power going to the trailer brakes relative to the brake pedal or manual control input. One bar indicates the least amount of output; six bars indicate maximum output.
- **TRAILER CONNECTED:** Displays when the system senses a correct trailer wiring connection (a trailer with electric trailer brakes) during a given ignition cycle.
- **TRAILER DISCONNECTED:** Displays, accompanied by a single audible chime, when the system senses a trailer connection and then a disconnection, either intentional or unintentional, during a given ignition cycle. It also displays if a truck or trailer-wiring fault occurs causing the trailer to appear disconnected. This message can also display if you use the manual control lever without a trailer connected.

B. **Manual control lever:** Slide the control lever to the left to turn on the trailer's electric brakes independent of the tow vehicle's brakes. See the following *Procedure for adjusting gain* section for instructions on proper use of this feature. If you use the manual control while the brake is also applied, the greater of the two inputs determines the power sent to the trailer brakes.

- **Stop lamps:** Using the manual control lever illuminates both the trailer brake lamps and your vehicle brake lamps except the center high-mount stop lamp, if you make the proper electrical connection to the trailer. Pressing your vehicle brake pedal also illuminates both trailer and vehicle brake lamps.

Procedure for Adjusting Gain

Note: Only perform this procedure in a traffic-free environment at speeds of approximately 20–25 mph (30–40 km/h).

The gain setting sets the trailer brake controller for the specific towing condition. You should change the setting as towing conditions change. Changes to towing conditions include trailer load, vehicle load, road conditions and weather.

The gain should be set to provide the maximum trailer braking assistance while making sure the trailer wheels do not lock when using the brakes. Locked trailer wheels may lead to trailer instability.

1. Make sure the trailer brakes are in good working condition, functioning normally and properly adjusted. See your trailer dealer if necessary.
2. Hook up the trailer and make the electrical connections according to the trailer manufacturer's instructions.
3. When you plug in a trailer with electric or electric-over-hydraulic brakes, **TRAILER CONNECTED** appears in the information display.
4. Use the gain adjustment (+ and -) buttons to increase or decrease the gain setting to the desired starting point. A gain setting of 6.0 is a good starting point for heavier loads.
5. In a traffic-free environment, tow the trailer on a dry, level surface at a speed of 20–25 mph (30–40 km/h) and squeeze the manual control lever completely.
6. If the trailer wheels lock up, indicated by squealing tires, reduce the gain setting. If the trailer wheels turn freely, increase the gain setting. Repeat Steps 5 and 6 until the gain setting is at a point just below trailer wheel lock-up. If towing a heavier trailer, trailer wheel lock-up may not be attainable even with the maximum gain setting of 10.

Explanation of Information Display Warning Messages

Note: An authorized dealer can diagnose the trailer brake controller to determine exactly which trailer fault has occurred. However, your Ford warranty does **not** cover this diagnosis if the fault is with the trailer.

TRAILER BRAKE MODULE FAULT: Displays in response to faults sensed by the trailer brake controller, accompanied by a single chime. If this message appears, contact an authorized dealer as soon as possible for diagnosis and repair. The controller may still function, but performance may be degraded.

WIRING FAULT ON TRAILER: Displays when there is a short circuit on the electric brake output wire. If the **WIRING FAULT ON TRAILER** message displays, accompanied by a single chime, with no trailer connected, the problem is with your vehicle wiring between the trailer brake controller and the 7-pin connector at the bumper. If the message only displays with a trailer connected, the problem is with the trailer wiring. Consult your trailer dealer for assistance. This can be a short to ground (such as a chaffed wire), short to voltage (such as a pulled pin on trailer emergency breakaway battery) or the trailer brakes may be drawing too much current.

Points to Remember

Note: Do not attempt removal of the trailer brake controller without consulting the *Workshop Manual*. Damage to the unit may result.

- Adjust gain setting before using the trailer brake controller for the first time.
- Adjust gain setting, using the procedure above, whenever road, weather and trailer or vehicle loading conditions change from when the gain was initially set.
- Only use the manual control lever for proper adjustment of the gain during trailer setup. Misuse, such as application during trailer sway, could cause instability of trailer or tow vehicle.
- Avoid towing in adverse weather conditions. The trailer brake controller does not provide anti-lock control of the trailer wheels. Trailer wheels can lock up on slippery surfaces, resulting in reduced stability of trailer and tow vehicle.
- The trailer brake controller is equipped with a feature that reduces output at vehicle speeds below 11 mph (18 km/h) so trailer and vehicle braking is not jerky or harsh. This feature is only available when applying the brakes using your vehicle's brake pedal, not the controller.
- The controller interacts with the brake control system and powertrain control system of your vehicle to provide the best performance on different road conditions.
- Your vehicle's brake system and the trailer brake system work independently of each other. Changing the gain setting on the controller does not affect the operation of your vehicle's brakes whether you attach a trailer or not.
- When you turn the engine off, the controller output is disabled and the display and module shut down. The controller module and display turn on when you turn the ignition on.
- The trailer brake controller is only a factory-installed or dealer-installed item. Ford is not responsible for warranty or performance of the controller due to misuse or customer installation.

Trailer Lamps



WARNING: Never connect any trailer lamp wiring to the vehicle's tail lamp wiring; this may damage the electrical system resulting in a fire. Contact an authorized dealer as soon as possible for assistance in proper trailer tow wiring installation. Additional electrical equipment may be required.

Trailer lamps are required on most towed vehicles. Make sure all running lights, brake lights, turn signals and hazard lights are working.

Using a Step Bumper (If Equipped)

The rear bumper is equipped with an integral hitch and only requires a ball with a one-inch (25.4 millimeter) shank diameter. The bumper has a 5000-pound (2268 kilogram) trailer weight and a 500-pound (227 kilogram) tongue weight capacity.

If it is necessary to relocate the hitch ball position, you must install a frame-mounted trailer hitch.

Before Towing a Trailer

Practice turning, stopping and backing up to get the feel of your vehicle-trailer combination before starting on a trip. When turning, make wider turns so the trailer wheels clear curbs and other obstacles.

When Towing a Trailer

- Do not drive faster than 70 mph (113 km/h) during the first 500 miles (800 kilometers).
- Do not make full-throttle starts.
- Check your hitch, electrical connections and trailer wheel lug nuts thoroughly after you have traveled 50 miles (80 kilometers).
- When stopped in congested or heavy traffic during hot weather, place the gearshift in position **P** to aid engine and transmission cooling and to help A/C performance.
- Turn off the speed control with heavy loads or in hilly terrain. The speed control may turn off automatically when you are towing on long, steep grades.
- Shift to a lower gear when driving down a long or steep hill. Do not apply the brakes continuously, as they may overheat and become less effective.

- If your transmission is equipped with the Tow/Haul feature, use this when towing. This provides engine braking and helps eliminate excessive transmission shifting for optimum fuel economy and transmission cooling.
- If your vehicle is equipped with AdvanceTrac™ with RSC, this system may turn on during typical cornering maneuvers with a heavily loaded trailer. This is normal. Turning the corner at a slower speed while towing may reduce this tendency.
- If you are towing a trailer frequently in hot weather, hilly conditions, at the gross combined weight rating (or any combination of these factors), consider refilling your rear axle with synthetic gear lubricant (if the axle is not already filled with it). See the *Capacities and Specifications* chapter for the lubricant specification.
- Allow more distance for stopping with a trailer attached. Anticipate stops and brake gradually.
- Avoid parking on a grade. However, if you must park on a grade:
 1. Turn the steering wheel to point your vehicle tires away from traffic flow.
 2. Set your vehicle parking brake.
 3. Place the automatic transmission in position **P**.
 4. Place wheel chocks in front and back of the trailer wheels. (Chocks not included with vehicle.)

Your vehicle may be equipped with a temporary or conventional spare tire. A “temporary” spare tire is different in size (diameter or width), tread-type (All-Season or All-Terrain) or is from a different manufacturer than the road tires on your vehicle. Consult information on the tire label or Safety Compliance label for limitations when using.

Launching or Retrieving a Boat or Personal Watercraft (PWC)

Note: Disconnect the wiring to the trailer **before** backing the trailer into the water.

Note: Reconnect the wiring to the trailer **after** removing the trailer from the water.

When backing down a ramp during boat launching or retrieval:

- Do not allow the static water level to rise above the bottom edge of the rear bumper.
- Do not allow waves to break higher than 6 inches (15 centimeters) above the bottom edge of the rear bumper.

Exceeding these limits may allow water to enter vehicle components:

- Causing internal damage to the components.
- Affecting driveability, emissions, and reliability.

Replace the rear axle lubricant anytime the rear axle submerges in water. Water may have contaminated the rear axle lubricant, which does not normally require checking or changing unless it is leaking or other axle repair is required.

Recovery Hooks



WARNING: Using recovery hooks is dangerous and should only be done by a person familiar with proper vehicle recovery safety practices. Improper use of recovery hooks may cause hook failure and/or separation from the vehicle and could result in serious injury or death.



WARNING: Always slowly remove the slack from the recovery strap prior to pulling. Failure to do so can introduce significantly higher loads which can cause the recovery hooks to break off, or the recovery strap to fail which can cause serious injury or death.



WARNING: Never link two straps together with a clevis pin. These heavy metal objects could become projectiles if the strap breaks and can cause serious injury or death.

Your vehicle comes equipped with frame-mounted front recovery hooks. These hooks should never have a load applied to them greater than the gross vehicle weight rating of your vehicle.

Before using recovery hooks:

- Make sure all attaching points are secure and capable of withstanding the applied load.
- Never use chains, cables or tow straps with metal hook ends.
- Only use recovery straps that have a minimum breaking strength two to three times the gross vehicle weight of the stuck vehicle.
- Make sure the recovery strap is in good condition and free of visible cuts, tears or damage.
- Use a damper device such as a tarp, heavy blanket or piece of carpet draped over the recovery strap to help absorb the energy in the event the strap breaks.

- Make sure the stuck vehicle is not loaded heavier than its gross vehicle weight rating specified on the certification label.
- Always align the tow vehicle and stuck vehicle in a straight line (within 10 degrees).
- Keep bystanders to the **sides** of the vehicle, at a distance of at least twice the length of the recovery strap. This helps avoid injury from the hazard of a recovery hook or strap breaking, or a vehicle lurching into their path.

TRANSPORTING THE VEHICLE

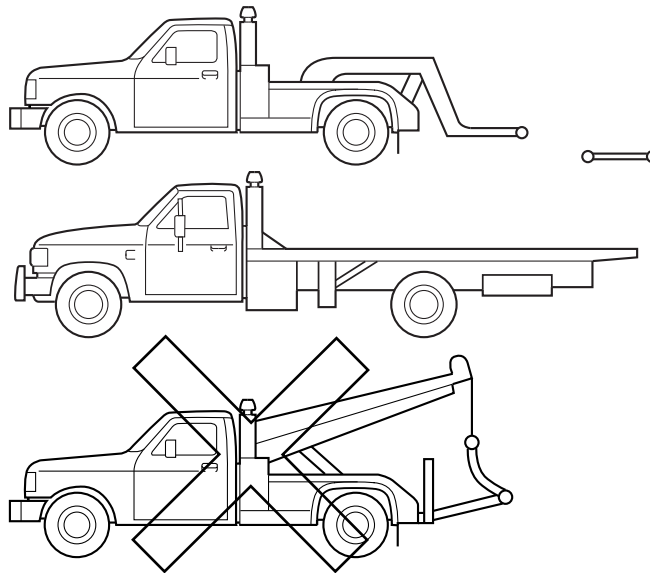

If you need to have your vehicle towed, contact a professional towing service or, if you are a member of a roadside assistance program, your roadside assistance service provider.

We recommend the use of a wheel lift and dollies or flatbed equipment to tow your vehicle. Do not tow with a slingbelt. Ford Motor Company has not approved a slingbelt towing procedure. Vehicle damage may occur if towed incorrectly, or by any other means.

Ford Motor Company produces a towing manual for all authorized tow truck operators. Have your tow truck operator refer to this manual for proper hook-up and towing procedures for your vehicle.

It is acceptable to have your two-wheel drive vehicle towed with the front wheels on the ground (without dollies) and the rear wheels off the ground.

We recommend towing a four-wheel drive vehicle with all wheels off the ground, such as using a wheel lift and dollies or flatbed equipment. However, it is acceptable to use a wheel lift to raise the rear of your vehicle so long as, depending on vehicle configuration, you perform the following before towing:

- If your vehicle is equipped with a manual-shift transfer case, make sure the front wheel hub locks are in the **FREE** position before towing.
- If your vehicle is equipped with an electronic shift-on-the-fly transfer case, make sure you turn the four-wheel drive control to the **2L** position before towing.

Note: Towing an electronic shift-on-the-fly four-wheel drive vehicle with the front wheels on the ground without disengaging the front hubs may cause damage to the automatic transmission.

Note: Towing a two-wheel drive vehicle or an electronic shift-on-the-fly four-wheel drive vehicle with the rear wheels on the ground for more than 50 miles (80 km) or faster than 35 mph (56 km/h) may cause damage to the automatic transmission.

Note: Using wheel lift equipment to tow a dual rear wheel vehicle requires removing an outer rear wheel before towing.

TOWING THE VEHICLE ON FOUR WHEELS**Emergency Towing**

If your vehicle becomes inoperable (without access to wheel dollies, car-hauling trailer, or flatbed transport vehicle), it can be flat-towed (all wheels on the ground, regardless of the powertrain and transmission configuration) under the following conditions:

- Your vehicle is facing forward for towing in a forward direction.
- Place the transmission in position **N**. See *Automatic transmission* in the *Transmission* chapter if you cannot move the transmission into **N**.
- Maximum speed is 35 mph (56 km/h).
- Maximum distance is 50 miles (80 kilometers).

Recreational Towing

Note: Put your climate control system in recirculated air mode to prevent exhaust fumes from entering your vehicle. See the *Climate Control* chapter.

Follow these guidelines if you have a need for recreational towing, such as towing your vehicle behind a motorhome. We designed these guidelines to prevent damage to your transmission.

Four-wheel Drive Vehicles Equipped with a Manual-shift Transfer Case

1. Put the transmission in position **N**.
2. Put the transfer case in position **N**.
3. Put the hub locks in the **FREE** position. Always make sure that both hub locks are set to the same position.

Two-wheel Drive Vehicles and Four-wheel Drive Vehicles Equipped with an Electronic-shift Transfer Case

Do not tow your vehicle with any wheels on the ground, as vehicle or transmission damage may occur. It is recommended to tow your vehicle with all four (4) wheels off the ground, such as when using a car-hauling trailer. Otherwise, you cannot tow your vehicle.

BREAKING-IN

You need to break in new tires for approximately 300 miles (480 kilometers). During this time, your vehicle may exhibit some unique driving characteristics. Avoid driving too fast during the first 1000 miles (1600 kilometers). Vary your speed frequently and change up through the gears early. Do not labor the engine. Do not tow during the first 1000 miles (1600 kilometers).

ECONOMICAL DRIVING

Fuel economy is affected by several things, such as how you drive, the conditions you drive under and how you maintain your vehicle.

There are some things to keep in mind that may improve your fuel economy:

- Accelerate and slow down in a smooth, moderate fashion.
- Drive at steady speeds without stopping.
- Anticipate stops; slowing down may eliminate the need to stop.
- Combine errands and minimize stop-and-go driving.
- Close the windows for high-speed driving.
- Drive at reasonable speeds (traveling at 55 mph [88 km/h] uses 15% less fuel than traveling at 65 mph [105 km/h]).
- Keep the tires properly inflated and use only the recommended size.
- Use the recommended engine oil.
- Perform all regularly scheduled maintenance.

There are also some things you may not want to do because they may reduce your fuel economy:

- Sudden or hard accelerations.
- Rev the engine before turning it off.
- Idle for periods longer than one minute.
- Warm up your vehicle on cold mornings.
- Use the air conditioner or front defroster.
- Use the speed control in hilly terrain.
- Rest your foot on the brake pedal while driving.
- Drive a heavily loaded vehicle or tow a trailer.

- Carry unnecessary weight (approximately 1 mpg [0.4 km/L] is lost for every 400 pounds [180 kilograms] of weight carried).
- Add particular accessories to your vehicle (e.g.; bug deflectors, rollbars or light bars, running boards, ski racks).
- Drive with the wheels out of alignment.

Conditions

- Heavily loading a vehicle or towing a trailer may reduce fuel economy at any speed.
- Carrying unnecessary weight may reduce fuel economy (approximately 1 mpg [0.4 km/L] is lost for every 400 lb [180 kg] of weight carried).
- Adding certain accessories to your vehicle (for example bug deflectors, rollbars/light bars, running boards, ski/luggage racks) may reduce fuel economy.
- To maximize the fuel economy, drive with the tonneau cover installed (if equipped).
- Using fuel blended with alcohol may lower fuel economy.
- Fuel economy may decrease with lower temperatures during the first 8–10 miles (12–16 km) of driving.
- Driving on flat terrain offers improved fuel economy as compared to driving on hilly terrain.
- Transmissions give their best fuel economy when operated in the top cruise gear and with steady pressure on the gas pedal.
- Four-wheel-drive operation (if equipped) is less fuel efficient than two-wheel-drive operation.
- Close windows for high speed driving.

DRIVING THROUGH WATER

Note: If you drove through deep water, check the transmission and engine fluid. If water is found, replace the fluid.

Do not drive quickly through standing water, especially if the depth is unknown. Traction or brake capability may be limited and if the ignition system gets wet, your engine may stall. Water may also enter your engine's air intake and severely damage your engine.

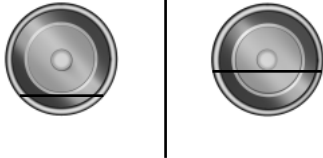

If driving through deep or standing water is unavoidable, proceed very slowly. Never drive through water that is higher than the bottom of the hubs (for trucks) or the bottom of the wheel rims (for cars).

Once through the water, always try the brakes. Wet brakes do not stop the vehicle as effectively as dry brakes. Drying can be improved by moving your vehicle slowly while applying light pressure on the brake pedal.

FLOOR MATS

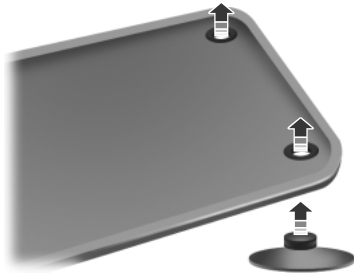

! **WARNING:** Always use floor mats that are designed to fit the footwell of your vehicle. Only use floor mats that leave the pedal area unobstructed. Only use floor mats that are firmly secured to retention posts so that they cannot slip out of position and interfere with the pedals or impair safe operation of your vehicle in other ways.

- Pedals that cannot move freely can cause loss of vehicle control and increase the risk of serious personal injury.
- Always make sure that the floor mats are properly attached to the retention posts in the carpet that are supplied with your vehicle. Floor mats must be properly secured to both retention posts to ensure mats do not shift out of position.

**WARNING** (Continued)

- Never place floor mats or any other covering in the vehicle footwell that cannot be properly secured to prevent them from moving and interfering with the pedals or the ability to control the vehicle.
- Never place floor mats or any other covering on top of already installed floor mats. Floor mats should always rest on top of the vehicle carpeting surface and not another floor mat or other covering. Additional floor mats or any other covering will reduce the pedal clearance and potentially interfere with pedal operation.
- Check attachment of floor mats on a regular basis. Always properly reinstall and secure floor mats that have been removed for cleaning or replacement.
- Always make sure that objects cannot fall into the driver footwell while the vehicle is moving. Objects that are loose can become trapped under the pedals causing a loss of vehicle control.
- Failure to properly follow floor mat installation or attachment instructions can potentially cause interference with pedal operation causing loss of control of vehicle.
- To install floor mats, position the floor mat so that the eyelet is over the retention post and press down to lock in.
- To remove the floor mat, reverse the installation procedure.

SNOWPLOWING

Ford recommends that the Super Duty F-Series used for snow removal includes the snow plow package option.

Installing the Snowplow

Weight limits and guidelines for selecting and installing the snowplow can be found in the *Ford Truck Body Builders Layout Book*, snowplow section, found at www.fleet.ford.com/truckbbas. A typical installation affects the following:

- Certification to government safety laws such as occupant protection and airbag deployment, braking, and lighting. Look for an *Alterer's Label* on the vehicle from the snowplow installer certifying that the installation meets all applicable Federal Motor Vehicle Safety Standards (FMVSS).

- The Total Accessory Reserve Capacity (TARC) is shown on the lower right side of the vehicle's Safety Compliance Certification Label. This applies to Ford-completed vehicles of 10,000 pounds (4,536 kilograms) GVWR or less. This is the weight of permanently-attached auxiliary equipment, such as snowplow frame-mounting hardware, that can be added to the vehicle and satisfy Ford compliance certification to FMVSS. Exceeding this weight may require the auxiliary equipment installer additional safety certification responsibility. The Front Accessory Reserve Capacity (FARC) is added for customer convenience.
- Rear ballast weight behind the rear axle may be required to prevent exceeding the FGAWR, and provide front-to-rear weight balance for proper braking and steering.
- Front wheel toe may require re-adjustment to prevent premature uneven tire wear. Specifications are found in the Ford *Workshop Manual*.
- Headlight aim may require re-adjustment.
- The tire air pressures recommended for general driving are found on the vehicle's Safety Certification Label. The maximum cold inflation pressure for the tire and associated load rating is imprinted on the tire sidewall. Tire air pressure may require re-adjustment within these pressure limits to accommodate the additional weight of the snowplow installation.
- Federal and some local regulations require additional exterior lamps for snowplow-equipped vehicles. Consult your authorized dealer for additional information.

Operating the Vehicle with the Snowplow Attached

Note: Do not use your vehicle for snow removal until it has been driven at least 500 miles (800 kilometers).

Ford recommends vehicle speed does not exceed 45 mph (72 km/h) when snowplowing.

The attached snowplow blade restricts airflow to the radiator, and may cause the engine to run at a higher temperature: Attention to engine temperature is especially important when outside temperatures are above freezing. Angle the blade to maximize airflow to the radiator and monitor engine temperature to determine whether a left or right angle provides the best performance.

Follow the severe duty schedule in your *scheduled maintenance information* for engine oil and transmission fluid change intervals.

Snowplowing with your Air Bag Equipped Vehicle

WARNING: Do not attempt to service, repair, or modify the air bag supplemental restraint system (SRS) or its fuses. See your Ford or Lincoln Mercury dealer.



WARNING: Additional equipment such as snowplow equipment may effect the performance of the air bag sensors increasing the risk of injury. Please refer to the *Body Builders Layout Book* for instructions about the appropriate installation of additional equipment.



WARNING: All occupants of the vehicle, including the driver, should always properly wear their safety belts, even when an air bag supplemental restraint system (SRS) is provided.

Your vehicle is equipped with a driver and passenger air bag supplemental restraint system. The supplemental restraint system is designed to activate in certain frontal and offset frontal collisions when the vehicle sustains sufficient longitudinal deceleration.

Careless or high speed driving while plowing snow which results in sufficient vehicle decelerations can deploy the air bag. Such driving also increases the risk of accidents.

Never remove or defeat the tripping mechanisms designed into the snow removal equipment by its manufacturer. Doing so may cause damage to the vehicle and the snow removal equipment as well as possible air bag deployment.

Transmission operation while plowing

WARNING: Do not spin the wheels at over 35 mph (55 km/h). The tires may fail and injure a passenger or bystander.

Operate the vehicle with the transmission in **D** (Drive with Overdrive) and tow/haul off.

- Shift transfer case to **4L** (4WD Low) when plowing in small areas at speeds below 5 mph (8 km/h).
- Shift transfer case to **4H** (4WD High) when plowing larger areas or light snow at higher speeds. Do not exceed 15 mph (24 km/h).
- Do not shift the transmission from a forward gear to **R** (Reverse) until the engine is at idle and the wheels are stopped.
- If the vehicle is stuck, shift the transmission in a steady motion between forward and reverse gears. Do not rock the vehicle for more than a minute. The transmission and tires may be damaged or the engine can overheat.

VEHICLE USED AS A STATIONARY POWER SOURCE

Auxiliary equipment called power take-off, or PTO, is often added to the engine or transmission to operate utility equipment. Examples include a wheel-lift for tow trucks, cranes, tools for construction or tire service, and pumping fluids. PTO applications draw auxiliary horsepower from the powertrain, often while the vehicle is stationary. In this condition, there is limited cooling air flow through the radiator and around the vehicle that normally occurs when a vehicle is moving. The aftermarket PTO system installer, having the most knowledge of the final application, is responsible for determining whether additional chassis heat protection or powertrain cooling is required, and alerting the user to the safe and proper operation.

Ford Super Duty Vehicles are approved for use as a stationary (including split shaft capability) or mobile power source, within limits and operating guidelines detailed in the *Ford Truck Body Builders Layout Book*, found at www.fleet.ford.com/truckbbas, and through the Ford Truck Body Builders Advisory Service.

ROADSIDE ASSISTANCE**Vehicles Sold in the U.S.: Getting Roadside Assistance**

To fully assist you should you have a vehicle concern, Ford Motor Company offers a complimentary roadside assistance program. This program is separate from the New Vehicle Limited Warranty. The service is available:

- 24 hours a day, seven days a week
- for the coverage period listed on the Roadside Assistance Card included in your owner's manual portfolio.

Roadside assistance will cover:

- a flat tire change with a good spare (except vehicles that have been supplied with a tire inflation kit).
- battery jump start.
- lock-out assistance (key replacement cost is the customer's responsibility).
- fuel delivery – Independent Service Contractors, if not prohibited by state, local or municipal law, shall deliver up to 2.0 gallons (7.5 liters) of gasoline or 5.0 gallons (18.9 liters) of diesel fuel to a disabled vehicle. Fuel delivery service is limited to two no-charge occurrences within a 12-month period.
- winch out – available within 100 feet (30.5 meters) of a paved or county maintained road, no recoveries.
- towing – Ford and Lincoln eligible vehicles towed to an authorized dealer within 35 miles (56 kilometers) of the disablement location or to the nearest authorized dealer. If a member requests to be towed to an authorized dealer more than 35 miles (56 kilometers) from the disablement location, the member shall be responsible for any mileage costs in excess of 35 miles (56 kilometers).

Trailers shall be covered up to \$200 if the disabled eligible vehicle requires service at the nearest authorized dealer. If the trailer is disabled, but the towing vehicle is operational, the trailer does not qualify for any roadside services.

Vehicles Sold in the U.S.: Using Roadside Assistance

Complete the roadside assistance identification card and place it in your wallet for quick reference. This card is found in the owner's manual portfolio in the glove compartment.

U.S. Ford vehicle customers who require Roadside Assistance, call 1-800-241-3673.

If you need to arrange roadside assistance for yourself, Ford Motor Company will reimburse a reasonable amount for towing to the nearest dealership within 35 miles (56 kilometers). To obtain reimbursement information, U.S. Ford vehicle customers call 1-800-241-3673. Customers will be asked to submit their original receipts.

Vehicles Sold in Canada: Getting Roadside Assistance

Canadian customers who require roadside assistance, call 1-800-665-2006.

Vehicles Sold in Canada: Using Roadside Assistance

Complete the roadside assistance identification card and place it in your wallet for quick reference. In Canada, the card is found in the warranty information in the glove box.

Canadian roadside coverage and benefits may differ from the U.S. coverage. Please see your warranty information or visit our website at www.ford.ca for information on Canadian services and benefits.

Canadian customers who need to obtain roadside information, call 1-800-665-2006 or visit our website at www.ford.ca.

HAZARD FLASHER CONTROL

Note: The hazard warning flashers will operate when the ignition is in any position or if the key is not in the ignition. If used when the engine is not running, the battery will lose charge. As a result, there may be insufficient power to restart your engine.



In some models, the hazard flasher control is located on the instrument panel.

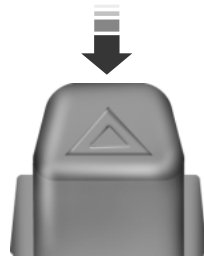

In other models, this feature is located on the steering column, just behind the steering wheel.

Use your hazard warning flashers when your vehicle is creating a safety hazard for other motorists.

- Press the flasher control and all front and rear direction indicators flash.
- Press the flasher control again to turn them off.

FUEL CUT-OFF SWITCH

WARNING: Failure to inspect and if necessary repair fuel leaks after a collision may increase the risk of fire and serious injury. Ford Motor Company recommends that the fuel system be inspected by an authorized dealer after any collision.

In the event of a moderate to severe collision, this vehicle is equipped with a fuel pump shut-off feature that stops the flow of fuel to the engine. Not every impact will cause a shut-off.

Should your vehicle shut off after a collision, you may restart your vehicle by doing the following:

1. Turn the ignition off.
2. Turn the ignition on.
3. Repeat steps 1 and 2 to re-enable fuel pump.

Note: If your vehicle has the push button start system, press the stop/start button twice to reactivate the fuel system.

JUMP-STARTING THE VEHICLE

WARNING: The gases around the battery can explode if exposed to flames, sparks, or lit cigarettes. An explosion could result in injury or vehicle damage.



WARNING: Batteries contain sulfuric acid which can burn skin, eyes and clothing, if contacted.

Do not attempt to push-start your automatic transmission vehicle. Automatic transmissions do not have push-start capability. Attempting to push-start a vehicle with an automatic transmission may cause transmission damage.

When the battery is disconnected or a new battery is installed, the automatic transmission must relearn its shift strategy. As a result, the transmission may exhibit a combination of firm and soft shifts. This operation is considered normal and will not affect function or durability of the transmission. Over time, the adaptive learning process will fully update transmission operation.

Preparing Your Vehicle

Note: Use only a 12-volt supply to start your vehicle.

Note: Do not disconnect the battery of the disabled vehicle as this could damage the vehicle's electrical system.

1. Park the booster vehicle close to the hood of the disabled vehicle making sure the two vehicles do not touch. Set the parking brake on both vehicles and stay clear of the engine cooling fan and other moving parts.
2. Check all battery terminals. Remove the positive terminal cover (if equipped) and any excessive corrosion before you attach the battery cables. Ensure that vent caps are tight and level.
3. Turn the heater fan on in both vehicles to protect from any electrical surges. Turn all other accessories off.

Connecting the Jumper Cables



WARNING: Do not connect the end of the second cable to the negative (-) terminal of the battery to be jumped. A spark may cause an explosion of the gases that surround the battery.

Note: Do not attach the negative (-) cable to fuel lines, engine rocker covers, the intake manifold or electrical components as grounding points.

Note: In the illustration, the vehicle on the bottom is used to designate the assisting (boosting) battery.

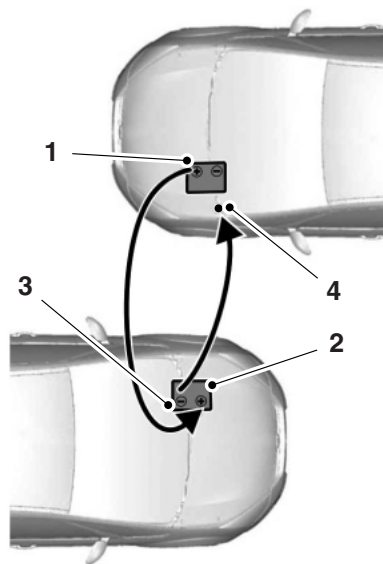

1. Connect the positive (+) jumper cable to the positive (+) terminal of the discharged battery.

2. Connect the other end of the positive (+) cable to the positive (+) terminal of the assisting battery.

3. Connect the negative (-) cable to the negative (-) terminal of the assisting battery.

4. Make the final connection of the negative (-) cable to an exposed metal part of the stalled vehicle's engine, away from the battery and the carburetor or fuel injection system.

Ensure that the cables are clear of fan blades, belts, moving parts of both engines, or any fuel delivery system parts.

Jump Starting

1. Start the engine of the booster vehicle and run the engine at a moderately increased speed.
2. Start the engine of the disabled vehicle.
3. Once the disabled vehicle has been started, run both engines for an additional three minutes before disconnecting the jumper cables.

Removing the Jumper Cables

Note: In the illustration, the vehicle on the bottom is used to designate the assisting (boosting) battery.

Remove the jumper cables in the reverse order that they were connected.

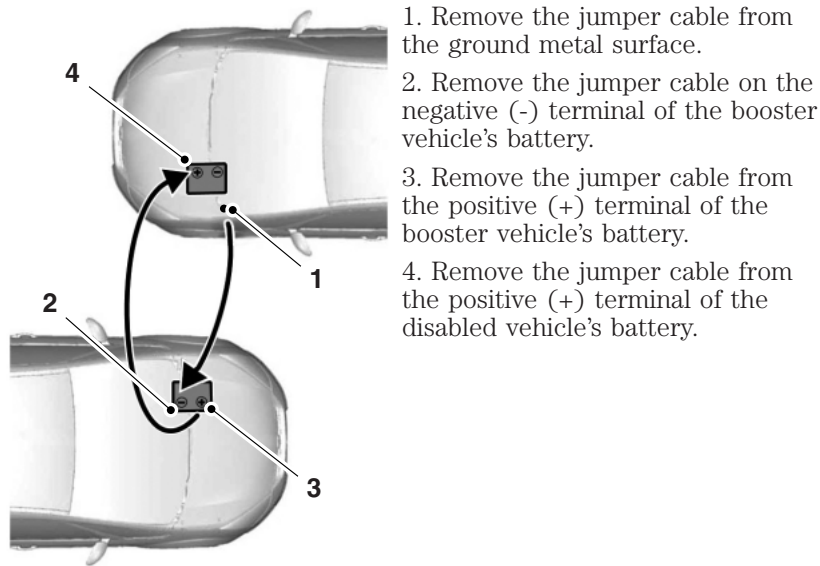

After the disabled vehicle has been started and the jumper cables removed, allow it to idle for several minutes so the engine computer can relearn its idle conditions.

GETTING THE SERVICES YOU NEED

Warranty repairs to your vehicle must be performed by an authorized dealer. While any authorized dealer handling your vehicle line will provide warranty service, we recommend you return to your selling authorized dealer who wants to ensure your continued satisfaction.

Please note that certain warranty repairs require special training, equipment or both, so not all authorized dealers are authorized to perform all warranty repairs. This means that, depending on the warranty repair needed, you may have to take your vehicle to another authorized dealer.

A reasonable time must be allowed to perform a repair after taking your vehicle to the authorized dealer. Repairs will be made using Ford or Motorcraft parts, or remanufactured or other parts that are authorized by Ford.

Away from Home

If you are away from home when your vehicle needs service, contact the Ford Customer Relationship Center or use the online resources listed below to find the nearest authorized dealer.

In the United States:

Mailing Address

Ford Motor Company
Customer Relationship Center
P.O. Box 6248
Dearborn, MI 48121

Telephone

1-800-392-3673 (FORD)
(TDD for the hearing impaired: 1-800-232-5952)

Online

Additional information and resources are available online at www.fordowner.com.

These are some of the items that can be found online:

- U.S. Dealer Locator by Dealer Name, City/State, or Zip Code
- Owner Manuals
- Maintenance Schedules
- Recalls
- Ford Extended Service Plans

- Ford Genuine Accessories
- Service specials and promotions.

In Canada:

Mailing address

Customer Relationship Centre
Ford Motor Company of Canada, Limited
P.O. Box 2000
Oakville, Ontario L6K 0C8

Telephone

1-800-565-3673 (FORD)

Online

www.ford.ca

Additional Assistance

If you have questions or concerns, or are unsatisfied with the service you are receiving, follow these steps:

1. Contact your Sales Representative or Service Advisor at your selling or servicing authorized dealer.
2. If your inquiry or concern remains unresolved, contact the Sales Manager, Service Manager or Customer Relations Manager.
3. If you require assistance or clarification on Ford Motor Company policies, please contact the Ford Customer Relationship Center.

In order to help serve you better, please have the following information available when contacting a Customer Relationship Center:

- Vehicle Identification Number (VIN)
- Your telephone number (home and business)
- The name of the authorized dealer and city where located
- The vehicle's current odometer reading.

In some states, you must directly notify Ford in writing before pursuing remedies under your state's warranty laws. Ford is also allowed a final repair attempt in some states.

In the United States, a warranty dispute must be submitted to the BBB AUTO LINE before taking action under the Magnuson-Moss Warranty Act, or to the extent allowed by state law, before pursuing replacement or repurchase remedies provided by certain state laws. This dispute handling procedure is not required prior to enforcing state created rights or other rights which are independent of the Magnuson-Moss Warranty Act or state replacement or repurchase laws.

IN CALIFORNIA (U.S. ONLY)

California Civil Code Section 1793.2(d) requires that, if a manufacturer or its representative is unable to repair a motor vehicle to conform to the vehicle's applicable express warranty after a reasonable number of attempts, the manufacturer shall be required to either replace the vehicle with one substantially identical or repurchase the vehicle and reimburse the buyer in an amount equal to the actual price paid or payable by the consumer (less a reasonable allowance for consumer use). The consumer has the right to choose whether to receive a refund or replacement vehicle.

California Civil Code Section 1793.22(b) presumes that the manufacturer has had a reasonable number of attempts to conform the vehicle to its applicable express warranties if, within the first 18 months of ownership of a new vehicle or the first 18000 mi (29 000 km), whichever occurs first:

1. Two or more repair attempts are made on the same nonconformity likely to cause death or serious bodily injury OR
2. Four or more repair attempts are made on the same nonconformity (a defect or condition that substantially impairs the use, value or safety of the vehicle) OR
3. The vehicle is out of service for repair of nonconformities for a total of more than 30 calendar days (not necessarily all at one time).

In the case of 1 or 2 above, the consumer must also notify the manufacturer of the need for the repair of the nonconformity at the following address:

Ford Motor Company
16800 Executive Plaza Drive
Mail Drop 3NE-B
Dearborn, MI 48126

You are required to submit your warranty dispute to BBB AUTO LINE before asserting in court any rights or remedies conferred by California Civil Code Section 1793.22(b). You are also required to use BBB AUTO LINE before exercising rights or seeking remedies created by the Federal Magnuson-Moss Warranty Act, 15 U.S.C. sec. 2301 et seq. If you choose to seek redress by pursuing rights and remedies not created by California Civil Code Section 1793.22(b) or the Magnuson-Moss Warranty Act, resorting to BBB AUTO LINE is not required by those statutes.

**THE BETTER BUSINESS BUREAU (BBB) AUTO LINE PROGRAM
(U.S. ONLY)**

Your satisfaction is important to Ford Motor Company and to your dealer. If a warranty concern has not been resolved using the three-step procedure outlined earlier in this chapter in the *Getting the Services You Need* section, you may be eligible to participate in the BBB AUTO LINE program.

The BBB AUTO LINE program consists of two parts – mediation and arbitration. During mediation, a representative of the BBB will contact both you and Ford Motor Company to explore options for settlement of the claim. If an agreement is not reached during mediation or you do not want to participate in mediation, and if your claim is eligible, you may participate in the arbitration process. An arbitration hearing will be scheduled so that you can present your case in an informal setting before an impartial person. The arbitrator will consider the testimony provided and make a decision after the hearing.

Disputes submitted to the BBB AUTO LINE program are usually decided within 40 days after you file your claim with the BBB. You are not bound by the decision, and may reject the decision and proceed to court where all findings of the BBB Auto Line dispute, and decision, are admissible in the court action. Should you choose to accept the BBB AUTO LINE decision, Ford is then bound by the decision, and must comply with the decision within 30 days of receipt of your acceptance letter.

BBB AUTO LINE Application: Using the information provided below, please call or write to request a program application. You will be asked for your name and address, general information about your new vehicle, information about your warranty concerns, and any steps you have already taken to try to resolve them. A Customer Claim Form will be mailed that will need to be completed, signed and returned to the BBB along with proof of ownership. Upon receipt, the BBB will review the claim for eligibility under the Program Summary Guidelines.

You can get more information by calling BBB AUTO LINE at 1-800-955-5100, or writing to:

**BBB AUTO LINE
3033 Wilson Boulevard, Suite 600
Arlington, Virginia 22201**

BBB AUTO LINE applications can also be requested by calling the Ford Motor Company Customer Relationship Center at 1-800-392-3673.

Note: Ford Motor Company reserves the right to change eligibility limitations, modify procedures, or to discontinue this process at any time without notice and without obligation.

**UTILIZING THE MEDIATION or ARBITRATION PROGRAM
(CANADA ONLY)**

This pertains to vehicles delivered to authorized Canadian dealers. In those cases, where you continue to feel that the efforts by Ford of Canada and the authorized dealer to resolve a factory-related vehicle service concern have been unsatisfactory, Ford of Canada participates in an impartial third party mediation or arbitration program administered by the Canadian Motor Vehicle Arbitration Plan (CAMVAP).

The CAMVAP program is a straightforward and relatively speedy alternative to resolve a disagreement when all other efforts to produce a settlement have failed. This procedure is without cost to you and is designed to eliminate the need for lengthy and expensive legal proceedings.

In the CAMVAP program, impartial third-party arbitrators conduct hearings at mutually convenient times and places in an informal environment. These impartial arbitrators review the positions of the parties, make decisions and, when appropriate, render awards to resolve disputes. CAMVAP decisions are fast, fair, and final as the arbitrator's award is binding on both you and Ford of Canada.

CAMVAP services are available in all Canadian territories and provinces. For more information, without charge or obligation, call your CAMVAP Provincial Administrator directly at 1-800-207-0685 or visit www.camvap.ca.

GETTING ASSISTANCE OUTSIDE THE U.S. AND CANADA

Before exporting your vehicle to a foreign country, contact the appropriate foreign embassy or consulate. These officials can inform you of local vehicle registration regulations and where to find unleaded fuel.

If you cannot find unleaded fuel or can only get fuel with an anti-knock index lower than is recommended for your vehicle, contact our Customer Relationship Center.

The use of leaded fuel in your vehicle without proper conversion may damage the effectiveness of your emission control system and may cause engine knocking or serious engine damage. Ford Motor Company or Ford of Canada is not responsible for any damage caused by use of improper fuel. Using leaded fuel may also result in difficulty importing your vehicle back into the United States.

If your vehicle must be serviced while you are traveling or living in Asia-Pacific Region, Sub-Saharan Africa, U.S. Virgin Islands, Central America, the Caribbean, and Israel, contact the nearest authorized dealer. If the authorized dealer cannot help you, contact:

**FORD MOTOR COMPANY
FORD EXPORT OPERATIONS & GLOBAL INITIATIVES**

Customer Relationship Center
1555 Fairlane Drive Fairlane Business Park #3
Allen Park, Michigan 48101
U.S.A.
Telephone: (313) 594-4857
FAX: (313) 390-0804 Email: expcac@ford.com

For customers in Guam, the Commonwealth of the Northern Mariana Islands (CNMI), America Samoa, and the U.S. Virgin Islands, please feel free to call our Toll-Free Number: (800) 841-FORD (3673)

If your vehicle must be serviced while you are traveling or living in Puerto Rico, contact the nearest authorized dealer. If the authorized dealer cannot help you, contact:

**FORD MOTOR COMPANY
FORD EXPORT OPERATIONS & GLOBAL INITIATIVES**

Customer Relationship Center
1555 Fairlane Drive Fairlane Business Park #3
Allen Park, Michigan 48101
U.S.A.
Telephone: (313) 594-4857
FAX: (313) 390-0804 Email: www.ford.com.pr

If your vehicle must be serviced while you are traveling or living in the Middle East, contact the nearest authorized dealer. If the authorized dealer cannot help you, contact:

**Ford Middle East
Customer Relationship Center**

P.O. Box 21470 Dubai, United Arab Emirates
Telephone: +971 4 3326084
Toll-Free Number of the Kingdom of Saudi Arabia: 800 8971409
Local Telephone Number of Kuwait: 24810575
FAX: +971 4 3327299
Email: menacac@ford.com
www.me.ford.com

If you buy your vehicle in North America and then relocate to any of the above locations, register your vehicle identification number (VIN) and new address with Ford Motor Company Export Operations & Global Growth Initiatives by emailing expcac@ford.com.

If you are in another foreign country, contact the nearest authorized dealer. In the event your inquiry is unresolved, communicate your concern with the dealership's Sales Manager, Service Manager or Customer Relations Manager. If you require additional assistance or clarification, please contact the respective Customer Relationship Center as previously listed.

Customers in the U.S. should call 1-800-392-3673.

ORDERING ADDITIONAL OWNER'S LITERATURE

To order the publications in this portfolio, contact Helm, Incorporated at:

HELM, INCORPORATED
47911 Halyard Drive
Plymouth, Michigan 48170
Attention: Customer Service

Or to order a free publication catalog, call toll free: 1-800-782-4356

Monday-Friday 8:00 a.m. - 6:00 p.m. EST

Helm, Incorporated can also be reached by their website:
www.helminc.com.

(Items in this catalog may be purchased by credit card, check or money order.)

Obtaining a French Owner's Manual

A French owner's manual can be obtained from your authorized dealer or by contacting Helm, Incorporated using the contact information listed previously in this section.

REPORTING SAFETY DEFECTS (U.S. ONLY)

If you believe that your vehicle has a defect which could cause a crash or could cause injury or death, you should immediately inform the National Highway Traffic Safety

Administration (NHTSA) in addition to notifying Ford Motor Company.

If NHTSA receives similar complaints, it may open an investigation, and if it finds that a safety defect exists in a group of vehicles, it may order a recall and remedy campaign. However, NHTSA cannot become involved in individual problems between you, your dealer, or Ford Motor Company.

To contact NHTSA, you may call the Vehicle Safety Hotline toll-free at 1-888-327-4236 (TTY: 1-800-424-9153); go to <http://www.safercar.gov>; or write to:

Administrator
1200 New Jersey Avenue, Southeast
Washington, D.C. 20590

You can also obtain other information about motor vehicle safety from <http://www.safercar.gov>.

REPORTING SAFETY DEFECTS (CANADA ONLY)

If you believe that your vehicle has a defect which could cause a crash or could cause injury or death, you should immediately inform Transport Canada, using their toll-free number: 1-800-333-0510, or online at: <https://wwwapps.tc.gc.ca/Saf-Sec-Sur/7/PCDB-BDPP/Index.aspx>.

CHANGING A FUSE**Fuses**

WARNING: Always replace a fuse with one that has the specified amperage rating. Using a fuse with a higher amperage rating can cause severe wire damage and could start a fire.

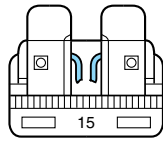

If electrical components in the vehicle are not working, a fuse may have blown. Blown fuses are identified by a broken wire within the fuse. Check the appropriate fuses before replacing any electrical components.

Standard Fuse Amperage Rating and Color

| COLOR | | | | | |
|-------------|------------|----------------|------------|----------------------|---------------------|
| Fuse rating | Mini fuses | Standard fuses | Maxi fuses | Cartridge maxi fuses | Fuse link cartridge |
| 2A | Grey | Grey | — | — | — |
| 3A | Violet | Violet | — | — | — |
| 4A | Pink | Pink | — | — | — |
| 5A | Tan | Tan | — | — | — |
| 7.5A | Brown | Brown | — | — | — |
| 10A | Red | Red | — | — | — |
| 15A | Blue | Blue | — | — | — |
| 20A | Yellow | Yellow | Yellow | Blue | Blue |
| 25A | Natural | Natural | — | Natural | Natural |
| 30A | Green | Green | Green | Pink | Pink |
| 40A | — | — | Orange | Green | Green |
| 50A | — | — | Red | Red | Red |
| 60A | — | — | Blue | Yellow | Yellow |
| 70A | — | — | Tan | — | Brown |
| 80A | — | — | Natural | Black | Black |

FUSE SPECIFICATION CHART

Power Distribution Box



WARNING: Always disconnect the battery before servicing high current fuses.



WARNING: To reduce risk of electrical shock, always replace the cover to the power distribution box before reconnecting the battery or refilling fluid reservoirs.

The power distribution box is located in the engine compartment. It has high-current fuses that protect your vehicle's main electrical systems from overloads.

If the battery has been disconnected and reconnected, see *Changing the Vehicle Battery* in the *Maintenance* chapter.

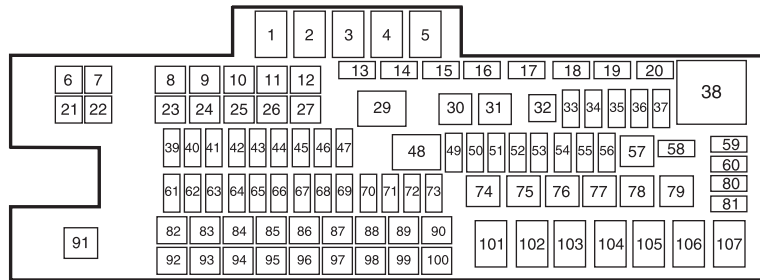

The high-current fuses are coded as follows:

| Fuse or relay location | Fuse amp rating | Protected circuits |
|------------------------|-----------------|---------------------------------------|
| 1 | Relay | Blower motor |
| 2 | — | Not used |
| 3 | Relay | Urea heaters (diesel engine) |
| 4 | — | Not used |
| 5 | Relay | Rear window defroster, Heated mirrors |
| 6 | — | Not used |

| Fuse or relay location | Fuse amp rating | Protected circuits |
|------------------------|-----------------|---------------------------------------|
| 7 | 50A* | Rear window defroster, Heated mirrors |
| 8 | 30A* | Passenger seat |
| 9 | 30A* | Driver seat |
| 10 | — | Not used |
| 11 | — | Not used |
| 12 | 30A* | Smart window motor |
| 13 | — | Not used |
| 14 | — | Not used |
| 15 | Diode | Fuel pump (diesel engine) |
| 16 | — | Not used |
| 17 | 15A** | Heated mirror |
| 18 | — | Not used |
| 19 | — | Not used |
| 20 | — | Not used |
| 21 | — | Not used |
| 22 | 30A* | Trailer tow electric brake |
| 23 | 40A* | Blower motor |
| 24 | — | Not used |
| 25 | 30A* | Wipers |
| 26 | 30A* | Trailer tow park lamps |
| 27 | 25A* | Urea heaters (diesel engine) |
| 28 | — | Buss bar |
| 29 | Relay | Trailer tow park lamps |
| 30 | Relay | A/C clutch |
| 31 | Relay | Wipers |
| 32 | — | Not used |
| 33 | 15A** | Vehicle power 1 |
| 34 | 15A** | Vehicle power 2 (diesel engine) |
| | 20A** | Vehicle power 2 (gas engine) |
| 35 | 10A** | Vehicle power 3 |

| Fuse or relay location | Fuse amp rating | Protected circuits |
|------------------------|-----------------|---|
| 36 | 15A** | Vehicle power 4 (diesel engine) |
| | 20A** | Vehicle power 4 (gas engine) |
| 37 | 10A** | Vehicle power 5 (diesel engine) |
| 38 | Relay | Powertrain control module (diesel engine), Electronic control module (gas engine) |
| 39 | 10A** | 4x4 hub lock |
| 40 | 15A** | 4x4 electronic lock |
| 41 | — | Not used |
| 42 | 20A** | Rear heated seats |
| 43 | — | Not used |
| 44 | — | Not used |
| 45 | 10A** | Run/start relay coil |
| 46 | 10A** | Transmission control module keep-alive power (diesel engine) |
| 47 | 10A** | A/C clutch feed |
| 48 | Relay | Run/start |
| 49 | 10A** | Rearview camera system |
| 50 | 10A** | Blower motor relay coil |
| 51 | — | Not used |
| 52 | 10A** | Powertrain control module / Electronic control module / Transmission control module run/start |
| 53 | 10A** | 4x4 module |
| 54 | 10A** | Anti-lock brake system run/start |
| 55 | 10A** | Rear window defroster coil, Battery charge coil |
| 56 | 20A** | Passenger compartment fuse panel run/start feed |
| 57 | Relay | Fuel pump |
| 58 | — | Not used |

| Fuse or relay location | Fuse amp rating | Protected circuits |
|------------------------|-----------------|--|
| 59 | — | Not used |
| 60 | — | Not used |
| 61 | — | Not used |
| 62 | — | Not used |
| 63 | — | Not used |
| 64 | — | Not used |
| 65 | — | Not used |
| 66 | 20A** | Fuel pump |
| 67 | — | Not used |
| 68 | 10A** | Fuel pump relay coil |
| 69 | — | Not used |
| 70 | 10A** | Trailer tow backup lamp |
| 71 | 10A** | Canister vent (gas engine) |
| 72 | 10A** | Powertrain control module / Electronic control module relay coil feed keep-alive power |
| 73 | — | Not used |
| 74 | Relay | Trailer tow left-hand stop/turn |
| 75 | Relay | Trailer tow right-hand stop/turn |
| 76 | Relay | Backup lamp |
| 77 | — | Not used |
| 78 | — | Not used |
| 79 | — | Not used |
| 80 | — | Not used |
| 81 | — | Not used |
| 82 | 20A* | Auxiliary power point #2 |
| 83 | 20A* | Auxiliary power point #1 |
| 84 | 30A* | 4x4 shift motor |
| 85 | 30A* | Heated/cooled seats |
| 86 | 25A* | Anti-lock brake system coil feed |
| 87 | 20A* | Auxiliary power point #5 |

| Fuse or relay location | Fuse amp rating | Protected circuits |
|---------------------------------|-----------------|---------------------------------|
| 88 | 20A* | Auxiliary power point #6 |
| 89 | 40A* | Starter motor |
| 90 | 25A* | Trailer tow battery charge |
| 91 | — | Not used |
| 92 | 20A* | Auxiliary power point #4 |
| 93 | 20A* | Auxiliary power point #3 |
| 94 | 25A* | Upfitter #1 |
| 95 | 25A* | Upfitter #2 |
| 96 | 50A* | Anti-lock brake system pump |
| 97 | 40A* | Inverter |
| 98 | — | Not used |
| 99 | 40A* | Instrument panel power inverter |
| 100 | 25A* | Trailer tow turn signals |
| 101 | Relay | Starter |
| 102 | Relay | Trailer tow battery charge |
| 103 | — | Not used |
| 104 | — | Not used |
| 105 | — | Not used |
| 106 | — | Not used |
| 107 | — | Not used |
| * Cartridge fuses ** Mini fuses | | |

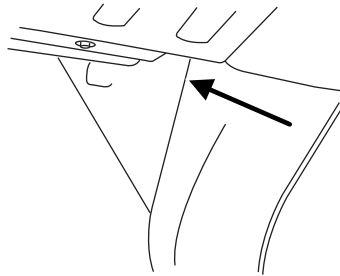
Passenger Compartment Fuse Panel

The fuse panel is located in the passenger's footwell. Remove the panel cover to access the fuses.

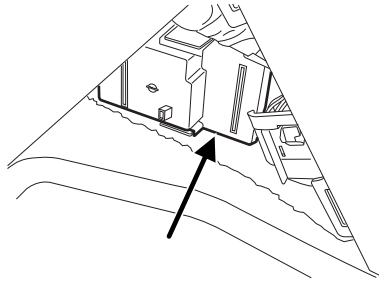

To remove the fuse panel cover, pull the panel toward you. When the clips of the panel disengage, let the panel fall easily.

To remove a fuse, use the fuse puller tool provided on the fuse panel cover.

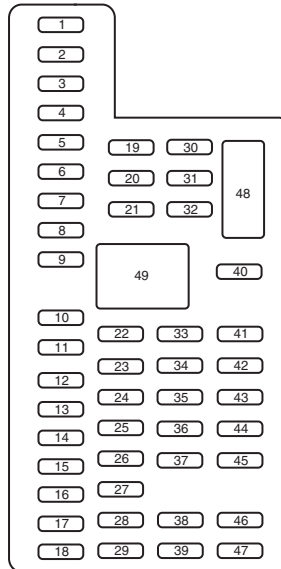

The fuses are coded as follows.

| Fuse or relay location | Fuse amp rating | Protected circuits |
|------------------------|-----------------|---|
| 1 | 30A | Not used (spare) |
| 2 | 15A | Upfitter relay #4 |
| 3 | 30A | Smart window motor |
| 4 | 10A | Interior lights, Hood lamp |
| 5 | 20A | Moonroof |
| 6 | 5A | Driver seat module |
| 7 | 7.5A | Driver seat switch, Driver lumbar motor |
| 8 | 10A | Power mirror switch |
| 9 | 10A | Upfitter relay #3 |
| 10 | 10A | Run/accessory relay, Customer access feed |
| 11 | 10A | Instrument cluster |

| Fuse or relay location | Fuse amp rating | Protected circuits |
|------------------------|-----------------|---|
| 12 | 15A | Interior lighting, Lighted running board lamps |
| 13 | 15A | Right turn signals and brake lamps, Right trailer tow stop turn relay |
| 14 | 15A | Left turn signals and brake lamps, Left trailer tow stop turn relay |
| 15 | 15A | High-mounted stop lamps, Backup lamps, Trailer tow backup relay, Reverse signal interior mirror |
| 16 | 10A | Right low beam headlamp |
| 17 | 10A | Left low beam headlamp |
| 18 | 10A | Keypad illumination, Passive anti-theft indicator, Powertrain control module, Brake shift interlock |
| 19 | 20A | Subwoofer, Amplifier |
| 20 | 20A | Power door locks |
| 21 | 10A | Brake on/off switch |
| 22 | 20A | Horn |
| 23 | 15A | Not used (spare) |
| 24 | 15A | Steering wheel control module, Diagnostic connector, Power fold mirror relay, Remote keyless entry, Electronic finish panel |
| 25 | 15A | Not used (spare) |
| 26 | 5A | Steering wheel control module |
| 27 | 20A | Not used (spare) |
| 28 | 15A | Ignition switch |
| 29 | 20A | SYNC, GPS module, Radio faceplate |

Fuses

299

| Fuse or relay location | Fuse amp rating | Protected circuits |
|------------------------|-----------------|---|
| 30 | 15A | Parking lamp relay, Trailer tow parking lamp relay |
| 31 | 5A | Trailer brake controller (brake signal), Customer access |
| 32 | 15A | Moonroof motor, Telescoping mirror switch, Auto dimming mirrors, Power inverter, Driver and passenger door lock switch illumination, Rear heated seat switch illumination |
| 33 | 10A | Restraint control module |
| 34 | 10A | Heated steering wheel module, Rear heated seats module |
| 35 | 5A | Select shift switch, Reverse park aid module, Trailer brake control module |
| 36 | 10A | Fuel tank select switch |
| 37 | 10A | PTC heater |
| 38 | 10A | AM/FM radio faceplate |
| 39 | 15A | High beam headlamps |
| 40 | 10A | Parking lamps (in mirrors), Roof marker lamps |
| 41 | 7.5A | Passenger airbag deactivation indicator |
| 42 | 5A | Not used (spare) |
| 43 | 10A | Wiper relay |
| 44 | 10A | Upfitter switches |
| 45 | 5A | Not used (spare) |
| 46 | 10A | Climate control |
| 47 | 15A | Fog lamps, Fog lamp indicator (in switch) |

| Fuse or relay location | Fuse amp rating | Protected circuits |
|------------------------|---------------------|--|
| 48 | 30A Circuit Breaker | Power windows switch, Power rear sliding window switch |
| 49 | Relay | Delayed accessory |

UPFITTER CONTROLS (IF EQUIPPED)



The upfitter option package provides four switches, mounted in the center of the instrument panel. These switches will only operate while the ignition is in the on position, whether the engine is running or not. However, it is recommended that the engine

remain running to maintain battery charge when using the upfitter switches for extended duration or higher current draws. (This is even more important for vehicles with diesel engines since the glow plugs are also draining battery power when the ignition key is in the on position.)

When switched on, they provide 8 amps, 12 amps or 20 amps of electrical battery power for a variety of personal or commercial uses.

There will also be a relay box located on the driver side end of the instrument panel. See your authorized dealer for service.

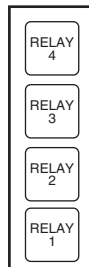

The relays are coded as shown.

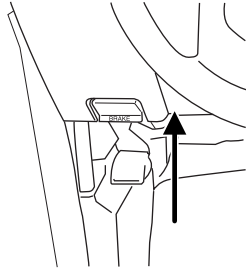

There will also be one power lead for each switch found as a blunt-cut and sealed wire located below the instrument panel and to the left of the steering column.

They are coded as follows:

| Switch | Circuit Number | Wire Color | Fuse Amp Rating |
|--------|----------------|-------------------------|-----------------|
| AUX 1 | CAC05 | Yellow | 25A |
| AUX 2 | CAC06 | Green with Brown Trace | 25A |
| AUX 3 | CAC07 | Violet with Green Trace | 10A |
| AUX 4 | CAC08 | Brown | 15A |

More detailed information about upfitter switches can be found at <https://www.fleet.ford.com/truckbbas/>.

GENERAL INFORMATION

WARNING: Turn off the power running boards, if equipped, before working under the vehicle, jacking or placing any object under the vehicle. Never place your hand between the extended running board and the vehicle. A moving running board may cause injury.

Have your vehicle serviced regularly to help maintain its roadworthiness and resale value. There is a large network of Ford authorized dealers that are there to help you with their professional servicing expertise. We believe that their specially trained technicians are best qualified to service your vehicle properly and expertly. They are supported by a wide range of highly specialized tools developed specifically for servicing your vehicle.

To help you service your vehicle, we provide *scheduled maintenance information* which makes tracking routine service easy.

If your vehicle requires professional service, your authorized dealer can provide the necessary parts and service. Check your warranty information to find out which parts and services are covered.

Use only recommended fuels, lubricants, fluids and service parts conforming to specifications. Motorcraft® parts are designed and built to provide the best performance in your vehicle.

Precautions

- Do not work on a hot engine.
- Make sure that nothing gets caught in moving parts.
- Do not work on a vehicle with the engine running in an enclosed space, unless you are sure you have enough ventilation.
- Keep all open flames and other burning material (such as cigarettes) away from the battery and all fuel related parts.

Working with the Engine Off

1. Set the parking brake and shift to **P** (Park).
2. Turn off the engine and remove the key (if equipped).
3. Block the wheels.

Working with the Engine On

WARNING: To reduce the risk of vehicle damage or personal burn injuries, do not start your engine with the air cleaner removed and do not remove it while the engine is running.

1. Set the parking brake and shift to position **P**.
2. Block the wheels.

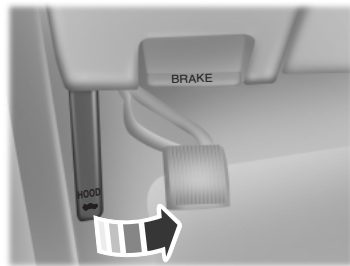
OPENING AND CLOSING THE HOOD

1. Inside the vehicle, pull the hood release handle located under the bottom left corner of the instrument panel.
2. Go to the front of the vehicle to release the auxiliary latch located at the top center of the grille. Slide the handle left to release the auxiliary latch.
3. Lift the hood until the lift cylinders hold it open.

UNDER HOOD OVERVIEW

Refer to the diesel supplement for diesel engine component locations.

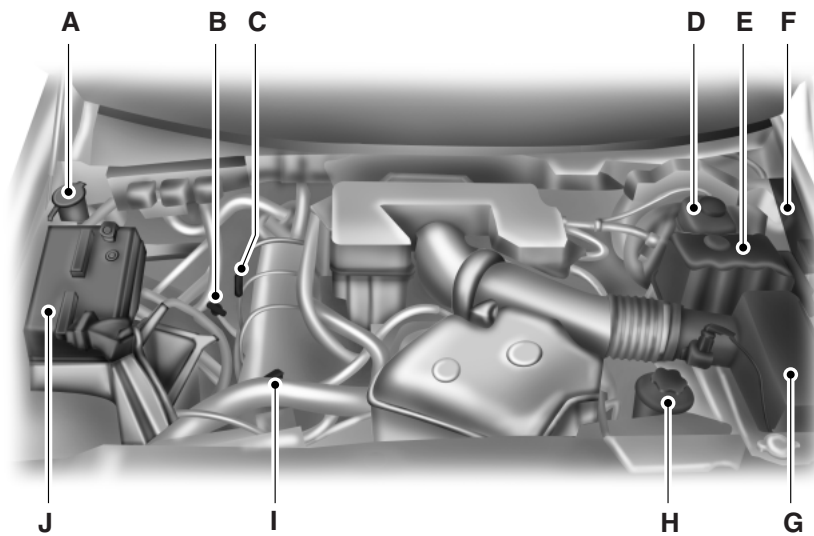
6.2L V8 Gasoline Engine

- A. Windshield washer fluid reservoir
- B. Engine oil dipstick
- C. Automatic transmission fluid dipstick
- D. Brake fluid reservoir
- E. Engine coolant reservoir
- F. Power distribution box
- G. Air filter assembly
- H. Power steering fluid reservoir
- I. Engine oil filler cap
- J. Battery

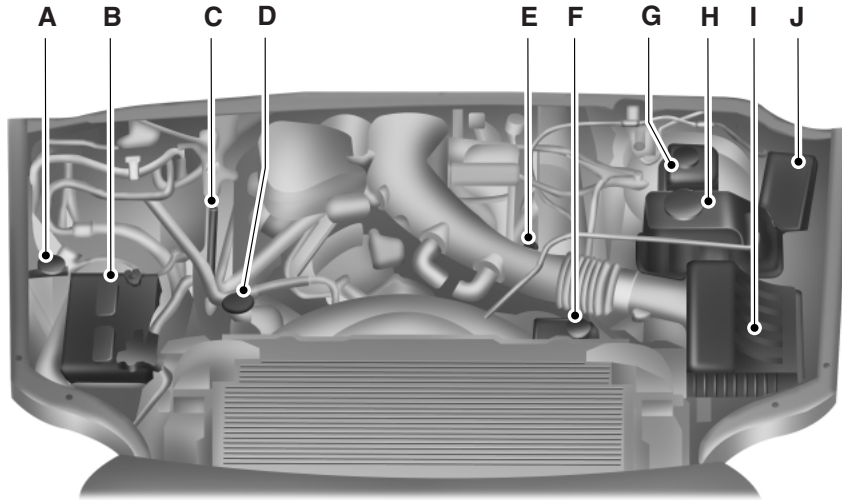
6.8L V10 Gasoline Engine

- A. Windshield washer fluid reservoir
- B. Battery
- C. Automatic transmission fluid dipstick
- D. Engine oil filler cap
- E. Engine oil dipstick
- F. Power steering fluid reservoir
- G. Brake fluid reservoir
- H. Engine coolant reservoir
- I. Air filter assembly
- J. Power distribution box

ENGINE OIL DIPSTICK

A. – MIN

B. – MAX

**ENGINE OIL CHECK**

Note: For diesel engine information, refer to the diesel supplement.

Refer to the *scheduled maintenance information* for the appropriate intervals for checking the engine oil.

1. Make sure the vehicle is on level ground.
2. Turn the engine off and wait 15 minutes for the oil to drain into the oil pan.
3. Set the parking brake and ensure the gearshift is securely latched in P (Park).
4. Open the hood. Protect yourself from engine heat.
5. Locate and carefully remove the engine oil level dipstick. See the *Under Hood Overview* in this chapter for location of dipstick.
6. Wipe the dipstick clean. Insert the dipstick fully, then remove it again.

If the oil level is between the lower and upper holes, the oil level is acceptable. **DO NOT ADD OIL.**

If the oil level is below the lower hole, add enough oil to raise the level within the lower and upper holes.

Oil levels above the upper hole may cause engine damage. Some oil must be removed from the engine by an authorized dealer.

7. Put the dipstick back in and ensure it is fully seated.

Adding Engine Oil

Note: Do not remove the engine oil level dipstick or the filler cap when the engine is running.

Note: Do not add engine oil further than the MAX mark. Oil levels above the MAX mark may cause engine damage.



Only use oils certified for gasoline engines by the American Petroleum Institute (API). An oil with this trademark symbol conforms to the current engine and emission system protection standards and fuel economy requirements of the International Lubricants Specification Advisory Council (ILSAC), comprised of U.S. and Japanese automobile manufacturers.

1. Check the engine oil level.
2. If the engine oil level is not within the normal range, add engine oil that meets Ford specifications. See *Capacities and Specifications* for more information. Remove the engine oil filler cap and use a funnel to pour the engine oil into the opening.
3. Recheck the engine oil level. Make sure the oil level is not above the normal operating range on the engine oil level dipstick.
4. Install the dipstick and ensure it is fully seated.
5. Fully install the engine oil filler cap by turning the filler cap clockwise until three clicks are heard or until the cap is fully seated.

ENGINE COOLANT CHECK

Checking the Engine Coolant

The concentration and level of engine coolant should be checked at the intervals listed in *scheduled maintenance information*.

The coolant concentration should be maintained within 48% to 50%, which equates to a freeze point between -30°F (-34°C) and -34°F (-37°C).

Note: For best results, coolant concentration should be tested with a refractometer such as Rotunda tool 300-ROB75240 available from your dealer. Ford does not recommend the use of hydrometers or coolant test strips for measuring coolant concentrations.

Note: Make sure that the level is between the MIN and MAX marks on the coolant reservoir.

Note: Coolant expands when it is hot. The level may extend beyond the MAX mark.

If the level is at the MIN mark, add coolant immediately. See *Adding Engine Coolant* in this chapter.

Note: Automotive fluids are not interchangeable; do not use engine coolant/antifreeze or windshield washer fluid outside of its specified function and vehicle location.

Adding Engine Coolant



WARNING: Do not add engine coolant when the engine is hot. Steam and scalding liquids released from a hot cooling system can burn you badly. Also, you can be burned if you spill coolant on hot engine parts.



WARNING: Do not put engine coolant in the windshield washer fluid container. If sprayed on the windshield, engine coolant could make it difficult to see through the windshield.



WARNING: To reduce the risk of personal injury, make sure the engine is cool before unscrewing the coolant pressure relief cap. The cooling system is under pressure; steam and hot liquid can come out forcefully when the cap is loosened slightly.



WARNING: Do not add coolant further than the MAX mark.

Note: Do not use stop leak pellets, cooling system sealants or additives, as they can cause damage to the engine cooling and/or heating systems. This damage would not be covered under your vehicle's warranty.

Note: During normal vehicle operation, the engine coolant may change color from orange to pink or light red. As long as the engine coolant is clear and uncontaminated, this color change does not indicate the engine coolant has degraded nor does it require the engine coolant to be drained, the system to be flushed, or the engine coolant to be replaced.

- DO NOT MIX different colors or types of coolant in your vehicle. Make sure the correct coolant is used. Mixing of engine coolants may harm your engine's cooling system. The use of an improper coolant may harm engine and cooling system components and may void the warranty.

- In case of emergency, a large amount of water without engine coolant may be added in order to reach a vehicle service location. In this instance, the cooling system must be drained, chemically cleaned with Motorcraft Premium Cooling System Flush, and refilled with engine coolant as soon as possible. Water alone (without engine coolant) can cause engine damage from corrosion, overheating or freezing.
- Do not use alcohol, methanol, brine or any engine coolants mixed with alcohol or methanol antifreeze (coolant). Alcohol and other liquids can cause engine damage from overheating or freezing.
- Do not add extra inhibitors or additives to the coolant. These can be harmful and compromise the corrosion protection of the engine coolant.

Unscrew the cap slowly. Any pressure will escape as you unscrew the cap.

Add prediluted engine coolant meeting the Ford specification.

See *Capacities and Specifications* for more information.

Whenever coolant has been added, the coolant level in the coolant reservoir should be checked the next few times you drive the vehicle. If necessary, add enough prediluted engine coolant to bring the coolant level to the proper level.

Recycled Engine Coolant

Ford Motor Company does not recommend the use of recycled engine coolant since a Ford-approved recycling process is not yet available.



Used engine coolant should be disposed of in an appropriate manner. Follow your community's regulations and standards for recycling and disposing of automotive fluids.

Severe Climates

If you drive in extremely cold climates:

- It may be necessary to have a Ford authorized dealer increase the coolant concentration above 50%.
- A coolant concentration of 60% will provide improved freeze point protection. Engine coolant concentrations above 60% will decrease the overheat protection characteristics of the engine coolant and may cause engine damage.

If you drive in extremely hot climates:

- It may be necessary to have a Ford authorized dealer decrease the coolant concentration to 40%.
- A coolant concentration of 40% will provide improved overheat protection. Engine coolant concentrations below 40% will decrease the corrosion and freeze protection characteristics of the engine coolant and may cause engine damage.

Vehicles driven year-round in non-extreme climates should use prediluted engine coolant for optimum cooling system and engine protection.

What You Should Know About Fail-Safe Cooling (If Equipped)



WARNING: If fail-safe cooling activates, pull off the road as soon as safely possible and turn the engine off. The engine may automatically shut off while driving without further indication.

If the engine coolant supply is depleted, this feature allows the vehicle to be driven temporarily before incremental component damage is incurred. The “fail-safe” distance depends on ambient temperatures, vehicle load and terrain.

How Fail-Safe Cooling Works

If the engine begins to overheat:

- The engine coolant temperature gauge will move to the red (hot) area.
- The information display will indicate the engine is overheating.
- The service engine soon indicator will illuminate.

If the engine reaches a preset over-temperature condition, the engine will automatically switch to alternating cylinder operation. Each disabled cylinder acts as an air pump and cools the engine.

When this occurs the vehicle will still operate. However:

- The engine power will be limited.
- The air conditioning system will be disabled.

Continued operation will increase the engine temperature and the engine will completely shut down, causing steering and braking effort to increase.

Once the engine temperature cools, the engine can be restarted. Take your vehicle to an authorized dealer as soon as possible to minimize engine damage.

When Fail-Safe Mode is Activated

WARNING: Never remove the coolant reservoir cap while the engine is running or hot.

Note: Driving the vehicle without repairing the engine problem increases the chance of engine damage. Take your vehicle to an authorized dealer as soon as possible.

You have limited engine power when in the fail-safe mode, so drive the vehicle with caution. The vehicle will not be able to maintain high-speed operation and the engine will run rough. Remember that the engine is capable of completely shutting down automatically to prevent engine damage; therefore:

1. Pull off the road as soon as safely possible and turn off the engine.
2. Arrange for the vehicle to be taken to an authorized dealer.
3. If this is not possible, wait a short period for the engine to cool.
4. Check the coolant level and replenish if low.
5. Restart the engine and take your vehicle to an authorized dealer.

Engine Fluid Temperature Management (If Equipped)

WARNING: To reduce the risk of collision and injury, be prepared that the vehicle speed may reduce and the vehicle may not be able to accelerate with full power until the fluid temperatures reduce.

Your vehicle has been designed to pull a trailer, but because of the added load, the vehicle's engine may temporarily reach higher temperatures during severe operating conditions such as ascending a long or steep grade while pulling a trailer in hot ambient temperatures.

At this time, you may notice your engine coolant temperature gauge needle move toward the H and the POWER REDUCED TO LOWER TEMP message may appear in the information display.

You may notice a reduction in the vehicle's speed caused by reduced engine power. Your vehicle has been designed to enter this mode if certain high temperature/high load conditions take place in order to manage the engine's fluid temperatures. The amount of speed reduction will depend on the vehicle loading, towing, grade, ambient temperature, and other factors. If this occurs, there is no need to pull off the road. The vehicle can continue to be driven while this message is active.

The air conditioning may also cycle on and off during severe operating conditions to protect overheating of the engine. When the engine coolant temperature decreases to a more normal operating temperature, the air conditioning will turn on once again.

If you notice any of the following:

- the engine coolant temperature gauge moves fully into the red (hot) area
 - the coolant temperature warning light illuminates
 - the service engine soon indicator illuminates
1. Pull off the road as soon as safely possible and place the vehicle in **P** (Park).
 2. Leave the engine running until the coolant temperature gauge needle moves away from the H range. After several minutes, if this does not happen, follow the remaining steps.
 3. Turn the engine off and wait for it to cool before checking the coolant level.



WARNING: Never remove the coolant reservoir cap while the engine is running or hot.

4. If the coolant level is normal, you may restart your engine and continue on.
 5. If the coolant is low, add coolant, restart the engine and take your vehicle to an authorized dealer. See *Adding engine coolant* in this chapter for more information.
- Refer to fail-safe cooling for additional information.

TRANSMISSION FLUID CHECK**Checking Automatic Transmission Fluid (If Equipped)**

Refer to your *Scheduled Maintenance Information* for scheduled intervals for fluid checks and changes. Your transmission does not consume fluid. However, the fluid level should be checked if the transmission is not working properly, i.e., if the transmission slips or shifts slowly or if you notice some sign of fluid leakage.

Automatic transmission fluid expands when warmed. To obtain an accurate fluid check, drive the vehicle until it is at normal operating temperature (approximately 20 miles [30 km]). Verify that the transmission fluid temperature gauge, located on the instrument cluster, is within normal range.

1. Drive the vehicle 20 miles (30 km) or until it reaches normal operating temperature.
2. Park the vehicle on a level surface and engage the parking brake.
3. With the engine running, parking brake engaged and your foot on the brake pedal, move the gearshift lever through all of the gear ranges. Allow sufficient time for each gear to engage.
4. Latch the gearshift lever in P (Park) and leave the engine running.
5. Remove the dipstick, wiping it clean with a clean, dry lint free rag. If necessary, refer to *Under Hood Overview* in this chapter for the location of the dipstick.
6. Install the dipstick making sure it is fully seated in the filler tube.
7. Remove the dipstick and inspect the fluid level. The fluid should be in the designated area for normal operating temperature or ambient temperature.

Your vehicle is equipped with one of the following dipsticks.

Low Fluid Level

Type A



Type B

Do not drive the vehicle if there is no indication of fluid on the dipstick and the ambient temperature is above 50°F (10°C).

Correct Fluid Level

For vehicles equipped with 5-speed transmissions, the fluid should be checked at normal operating temperature 150°F-170°F (66°C-77°C) on a level surface. For vehicles equipped with 6-speed transmissions, the fluid should be checked at normal operating temperature 196°F-216°F (91°C-102°C) on a level surface. The normal operating temperature can be reached after approximately 20 miles (30 km) of driving.

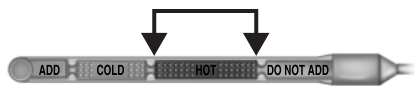

Type A

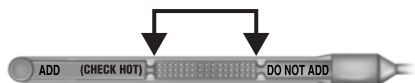

Type B

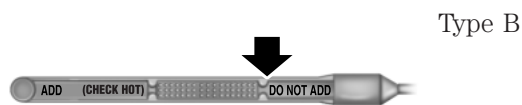
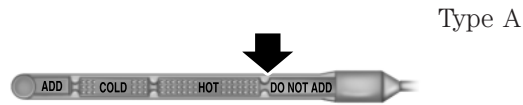
High Fluid Level

Fluid levels above the safe range may result in transmission failure. An overfill condition of transmission fluid may cause shift and/or engagement concerns and/or possible damage.

High fluid levels can be caused by an overheating condition.

Adjusting Automatic Transmission Fluid Levels

Note: Use of a non-approved automatic transmission fluid may cause internal transmission component damage.

Before adding any fluid, make sure the correct type is used. The type of fluid used is normally indicated on the dipstick handle and also in the *Capacities and Specifications* chapter.

If necessary, add fluid in 1/2 pint (250 ml) increments through the filler tube until the level is correct.

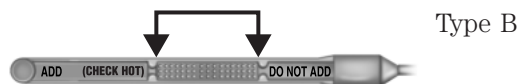
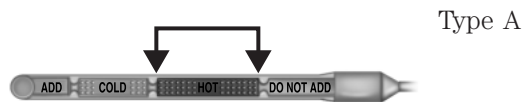

If an overfill occurs, excess fluid should be removed by a qualified technician.

Note: An overfill condition of transmission fluid may cause shift and/or engagement concerns and/or possible damage.

Do not use supplemental transmission fluid additives, treatments or cleaning agents. The use of these materials may affect transmission operation and result in damage to internal transmission components.

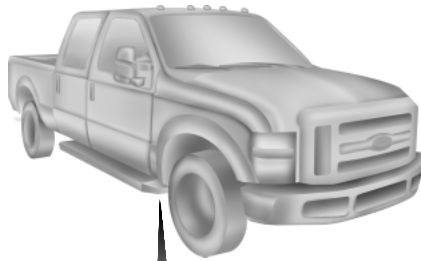
TRANSFER CASE FLUID CHECK (IF EQUIPPED)

1. Clean the filler plug.
2. Remove the filler plug and inspect the fluid level.

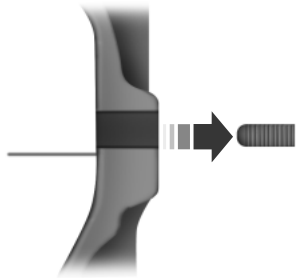
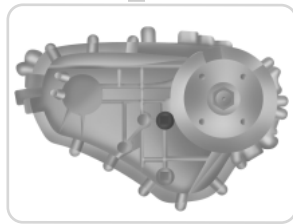

3. Add only enough fluid through the filler opening so that the fluid level is at the bottom of the opening.

Use only fluid that meets Ford specifications. Refer to the *Capacities and Specifications* section .

BRAKE FLUID CHECK

Fluid levels between the MIN and MAX lines are within the normal operating range; there is no need to add fluid. If the fluid levels are outside of the normal operating range, the performance of the system could be compromised; seek service from your authorized dealer immediately.

POWER STEERING FLUID CHECK

Check the power steering fluid. Refer to your *Scheduled Maintenance Information*. If adding fluid is necessary, use only MERCON® V ATF.

Note: This procedure is for vehicles with gasoline engines. Vehicles with diesel engines are similar. Refer to *Under Hood Overview* in your diesel supplement.

Check the fluid level when it is at ambient temperature, 20°F–80°F (-7°C–25°C):

1. Check the fluid level in the reservoir. It should be between the MIN and MAX range. Do not add fluid if the level is within this range.
2. If the fluid level is low. Add fluid to bring fluid level up to be between the MIN and MAX range.
3. Start the engine.
4. While the engine idles, turn the steering wheel left and right several times.
5. Turn the engine off.
6. Recheck the fluid level in the reservoir. Do not add fluid if the level is between the MIN and MAX range.
7. If the fluid is low, add fluid in small amounts, continuously checking the level until it is between the MIN and MAX range. Refer to *Capacities and Specifications* for the proper fluid type. Be sure to put the cap back on the reservoir.

FUEL FILTER

If equipped with a gasoline engine, your vehicle is equipped with a lifetime fuel filter that is integrated with the fuel tank. Regular maintenance or replacement is not needed.

If equipped with a diesel engine, refer to the diesel supplement.

WASHER FLUID CHECK

WARNING: If you operate your vehicle in temperatures below 40°F (5°C), use washer fluid with antifreeze protection. Failure to use washer fluid with antifreeze protection in cold weather could result in impaired windshield vision and increase the risk of injury or accident.

Add fluid to fill the reservoir if the level is low. Only use a washer fluid that meets Ford specifications. See the technical specifications chart in the *Capacities and Specifications* chapter.

State or local regulations on volatile organic compounds may restrict the use of methanol, a common windshield washer antifreeze additive. Washer fluids containing non-methanol antifreeze agents should be used only if they provide cold weather protection without damaging the vehicle's paint finish, wiper blades or washer system.

CHANGING THE VEHICLE BATTERY

WARNING: This vehicle may be equipped with more than one battery, removal of cable from only one battery does not disconnect the vehicle electrical system. Be sure to disconnect cables from all batteries when disconnecting power. Failure to do so may cause serious personal injury or property damage.



WARNING: Batteries normally produce explosive gases which can cause personal injury. Therefore, do not allow flames, sparks or lighted substances to come near the battery. When working near the battery, always shield your face and protect your eyes. Always provide proper ventilation.



WARNING: When lifting a plastic-cased battery, excessive pressure on the end walls could cause acid to flow through the vent caps, resulting in personal injury and/or damage to the vehicle or battery. Lift the battery with a battery carrier or with your hands on opposite corners.



WARNING: Keep batteries out of reach of children. Batteries contain sulfuric acid. Avoid contact with skin, eyes or clothing. Shield your eyes when working near the battery to protect against possible splashing of acid solution. In case of acid contact with skin or eyes, flush immediately with water for a minimum of 15 minutes and get prompt medical attention. If acid is swallowed, call a physician immediately.



WARNING: Battery posts, terminals and related accessories contain lead and lead compounds. Wash hands after handling.

Note: If your battery has a cover/shield, make sure it is reinstalled after the battery has been cleaned or replaced.

Note: Electrical or electronic accessories or components added to the vehicle by the dealer or the owner may adversely affect battery performance and durability.

Your vehicle is equipped with a Motorcraft® maintenance-free battery which normally does not require additional water during its life of service.

For longer, trouble-free operation, keep the top of the battery clean and dry. Also, make certain the battery cables are always tightly fastened to the battery terminals.

If you see any corrosion on the battery or terminals, remove the cables from the terminals and clean with a wire brush. You can neutralize the acid with a solution of baking soda and water.

It is recommended that the negative battery cable terminal be disconnected from the battery if you plan to store your vehicle for an extended period of time. This will minimize the discharge of your battery during storage.

Because your vehicle's engine is electronically controlled by a computer, some control conditions are maintained by power from the battery. When the battery is disconnected or a new battery is installed, the engine must relearn its idle and fuel trim strategy for optimum driveability and performance. Flexible fuel vehicles (FFV) must also relearn the ethanol content of the fuel for optimum driveability and performance. To begin this process:

1. With the vehicle at a complete stop, set the parking brake.
2. Put the gearshift in P (Park), turn off all accessories and start the engine.

3. Run the engine until it reaches normal operating temperature.
4. Allow the engine to idle for at least one minute.
5. Turn the A/C on and allow the engine to idle for at least one minute.
6. Release the parking brake. With your foot on the brake pedal and with the A/C on, put the vehicle in D (Drive) and allow the engine to idle for at least one minute.

Note: If you do not allow the engine to relearn its idle trim, the idle quality of your vehicle may be adversely affected until the idle trim is eventually relearned.

7. Drive the vehicle to complete the relearning process.

- The vehicle may need to be driven 10 miles (16 kilometers) or more to relearn the idle and fuel trim strategy along with the ethanol content for flexible fuel vehicles.
- For flexible fuel vehicles, if you are operating on E85, you may experience poor starts or an inability to start the engine and driveability problems until the fuel trim and ethanol content have been relearned.

If the battery has been disconnected or a new battery has been installed, the clock and radio settings must be reset once the battery is reconnected.

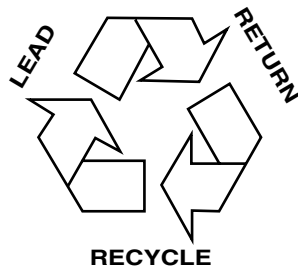

- Always dispose of automotive batteries in a responsible manner. Follow your local authorized standards for disposal. Call your local authorized recycling center to find out more about recycling automotive batteries.

Battery Management System (If Equipped)

The battery management system (BMS) monitors battery conditions and takes actions to extend battery life. If excessive battery drain is detected, the system may temporarily disable certain electrical features to protect the battery. Those electrical accessories affected include the rear defrost, heated/cooled seats, climate control fan, heated steering wheel, audio and navigation system. A message may be shown in the information displays to alert the driver that battery protection actions are active. These messages are only for notification that an action is taking place, and not intended to indicate an electrical problem or that the battery requires replacement.

Electrical accessory installation

To ensure proper operation of the BMS, any electrical devices that are added to the vehicle should not have their ground connection made directly at the negative battery post. A connection at the negative battery post can cause inaccurate measurements of the battery condition and potential incorrect system operation.

Note: Electrical or electronic accessories added to the vehicle by the dealer or the owner may adversely affect battery performance and durability, and may also affect the performance of other electrical systems in the vehicle.

When a battery replacement is required, the battery should only be replaced with a Ford recommended replacement battery which matches the electrical requirements of the vehicle. After battery replacement, or in some cases after charging the battery with the external charger, the BMS requires eight hours of vehicle sleep time (key off with doors closed) to relearn the new battery state of charge. Prior to relearning the state of charge, the BMS may disable electrical features (to protect the battery) earlier than normal.

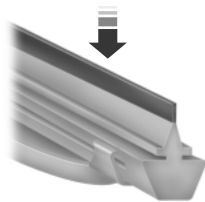
CHECKING THE WIPER BLADES

Run the tip of your fingers over the edge of the blade to check for roughness.

Clean the wiper blades with washer fluid or water applied with a soft sponge or cloth.

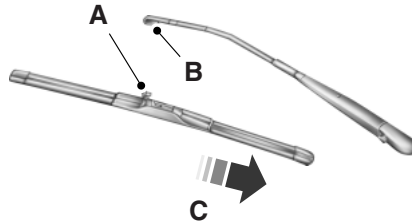
CHANGING THE WIPER BLADES

1. To remove the wiper blade, pull the wiper arm away from the vehicle. Pry open the lock cover (A) with your thumb to release the blade.

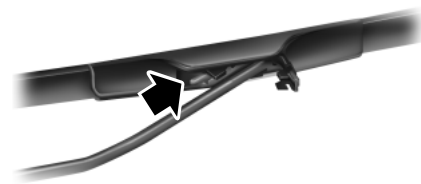

2. Press the retaining clip to disengage the wiper blade, then pull the wiper blade down (C) toward the windshield to remove it from the arm.

3. To install the new wiper blade, insert the wiper blade into the wiper arm hook (B).

4. While holding the wiper arm, push the wiper blade up and away from the windshield.

5. Close the lock cover.

Replace wiper blades at least once per year for optimum performance.

Poor wiper quality can be improved by cleaning the wiper blades and the windshield. Refer to *Cleaning the windows and wiper blades* in the *Vehicle Care* chapter.

To prolong the life of the wiper blades, it is highly recommended to scrape off the ice on the windshield before turning on the wipers. The layer of ice has many sharp edges and can damage the micro edge of the wiper rubber element.

AIR FILTER CHECK

Refer to *Scheduled Maintenance Information* for the appropriate intervals for changing the air filter element.

When changing the air filter element, use only the Motorcraft® air filter element listed. Refer to the *Motorcraft® Part Numbers*.

The following procedure is for vehicles equipped with a gasoline engine. If your vehicle is equipped with a diesel engine, refer to the diesel supplement.

Note: Do not start your engine with the air cleaner removed and do not remove it while the engine is running.

Note: Failure to use the correct air filter element may result in severe engine damage. The customer warranty may be void for any damage to the engine if the correct air filter element is not used.

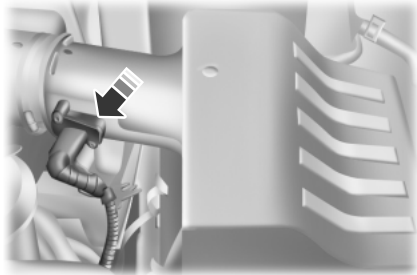
Changing the Air Filter Element

1. Locate the mass air flow sensor electrical connector on the air outlet tube. This connector will need to be unplugged.

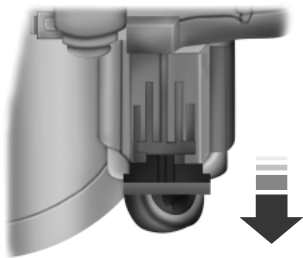

2. Reposition the locking clip on the connector (connector shown from below for clarity), squeeze the connector and pull it off of the air outlet tube.

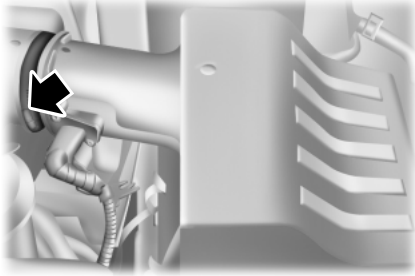

3. Clean the area around the air tube to air cover connection to prevent debris from entering the system and then loosen the bolt on the air tube clamp so the clamp is no longer snug to the air tube. It is not necessary to completely remove the clamp.

4. Pull the air tube off from the air cleaner housing.

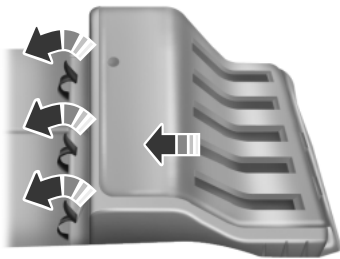

5. Release the three clamps that secure the cover to the air filter housing. Push the air filter cover toward the center of the vehicle and up slightly to release it.

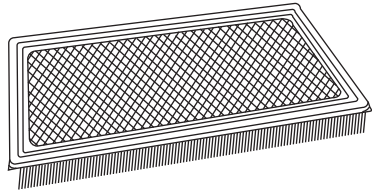

6. Remove the air filter element from the air filter housing.

7. Install a new air filter element.



8. Replace the air filter housing cover and secure the clamps. Be careful not to crimp the filter element edges between the air filter housing and cover and ensure that the tabs on the edge are properly aligned into the slots.

9. Slip the air tube onto the air filter housing and tighten the air-tube clamp bolt snugly, but do not overtighten it.

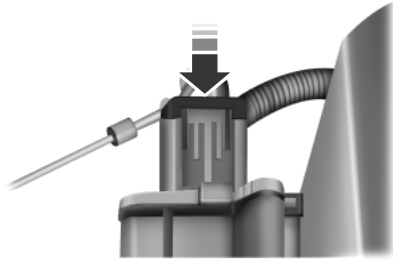

10. Reconnect the mass air flow sensor electrical connector to the outlet tube. Make sure the locking tab on the connector is in the "locked" position (connector shown from below for clarity).

ADJUSTING THE HEADLAMPS

The headlamps on your vehicle are properly aimed at the assembly plant. If your vehicle has been in an accident, the alignment of your headlamps should be checked by your authorized dealer.

Vertical Aim Adjustment

1. Park the vehicle directly in front of a wall or screen on a level surface, approximately 25 feet (7.6 meters) away.

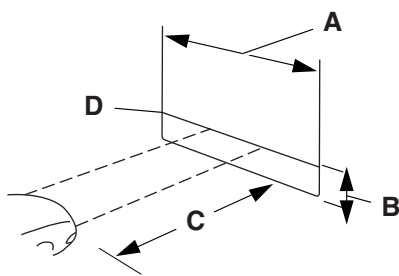

- (A) 8 feet (2.4 meters)
- (B) Center height of lamp to ground
- (C) 25 feet (7.6 meters)
- (D) Horizontal reference line

2. Measure the height from the center of your headlamp (indicated by a 3.0 millimeter circle on the lens) to the ground and mark an 8 foot (2.4 meter) horizontal reference line on the vertical wall or screen at this height (a piece of masking tape works well).

3. Turn on the low beam headlamps to illuminate the wall or screen and open the hood. Cover one of the headlamps so no light from that lamp hits the wall.



4. On the wall or screen you will observe a light pattern with a distinct horizontal edge towards the right. If this edge is not at the horizontal reference line, the beam will need to be adjusted so the edge is at the same height as the horizontal reference line.

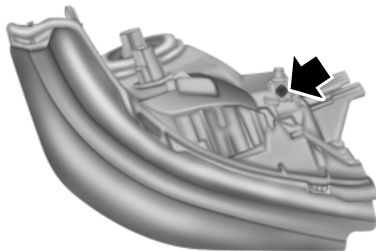

5. Locate the vertical adjuster on each headlamp. Use a number 2 Phillips screwdriver to turn the adjuster either counterclockwise or clockwise in order to adjust the vertical aim of the headlamp. The upper edge of the light pattern should touch the horizontal reference line.

6. Repeat Steps 3–5 for the other headlamp.

7. Close the hood and turn off the lamps.

HORIZONTAL AIM IS NOT REQUIRED FOR THIS VEHICLE AND IS NOT ADJUSTABLE.

CHANGING A BULB

Lamp Assembly Condensation

Exterior lamps are vented to accommodate normal changes in pressure. Condensation can be a natural by-product of this design. When moist air enters the lamp assembly through the vents, there is a possibility that condensation can occur when the temperature is cold. When normal condensation occurs, a thin film of mist can form on the interior of the lens. The thin mist eventually clears and exits through the vents during normal operation. Clearing time may take as long as 48 hours under dry weather conditions.

These are examples of acceptable condensation:

- Presence of thin mist (no streaks, drip marks or droplets).
- Fine mist covers less than 50% of the lens.

These are examples of unacceptable moisture (usually caused by a lamp water leak):

- Water puddle inside the lamp.
- Large water droplets, drip marks or streaks present on the interior of the lens.

Take your vehicle to a dealer for service if any of the above conditions of unacceptable moisture are present.

Replacing Headlamps, Park Lamps, Turn Lamps

1. Make sure that the exterior lamps are off, then open the hood.

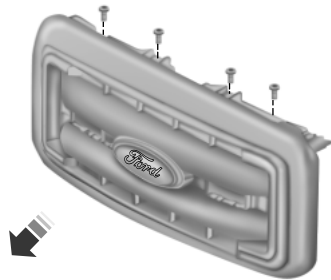

2. Using masking tape or a marker, make an alignment mark between one of the grille brackets and the vehicle radiator support to ensure correct grille alignment during the installation procedure. Do not scratch the black coating from the radiator support.

3. Remove the two grille to headlamp assembly push pins and the four bolts attaching the top of the grille to the radiator support.

4. Pull the top of the grille forward to gain access to the lower grille spring clips.

5. Depress the spring clips through the lower inner grille access openings using a flat head screwdriver.

6. Pull the grill straight out to remove.



7. Remove the four bolts from the headlamp assembly.

8. Pull the assembly straight out disengaging one snap clip from the fender.

9. Disconnect the electrical connector by squeezing the release tab and pushing the connector forward, then pulling it rearward.

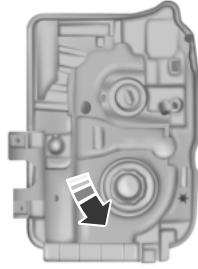

10. For the headlamp bulb, remove the bulb by turning it counterclockwise and pulling it straight out.

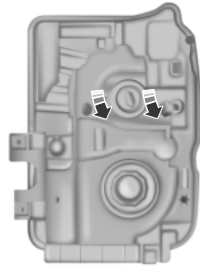

11. For the park or turn lamp bulb, remove the bulb by turning it counterclockwise and pulling it straight out.



WARNING: Handle a halogen headlamp bulb carefully and keep out of children's reach. Grasp the bulb only by its plastic base and do not touch the glass. The oil from your hand could cause the bulb to break the next time the headlamps are operated.

Install the new bulb(s) in reverse order.

Replacing Front Clearance and Identification Lamp Bulbs (If Equipped)

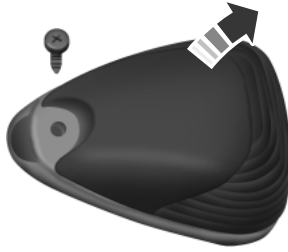

1. Make sure the headlamps are off.
2. Remove the screw and lens from the lamp assembly.
3. Pull the bulb straight out of the socket.

Install the bulb(s) in reverse order.

Replacing Fog Lamp Bulbs (If Equipped)

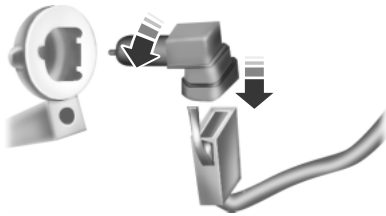

1. Make sure the headlamps are off.
2. Remove the bulb socket from the fog lamp by turning it counterclockwise.
3. Disconnect the electrical connector from the fog lamp bulb.

Install the new bulb(s) in reverse order.

Replacing Brake/Tail/Turn/Reverse Lamp Bulbs (Pickups Only)

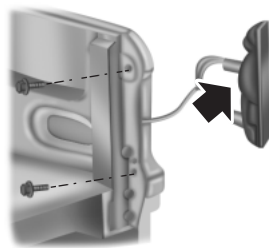

1. Make sure the headlamps are off, then open the tailgate to expose the lamp assemblies.
 2. Remove the two bolts from the tail lamp assembly and carefully pull the lamp assembly from the tailgate pillar by releasing the two retaining tabs.
 3. Rotate the bulb socket counterclockwise and remove from lamp assembly.
 4. Pull the bulb straight out of the socket.
- Install the new bulb(s) in reverse order.

Replacing Brake/Tail/Turn/Reverse Lamp Bulbs (Chassis Cabs only) (If Equipped)



1. Make sure the headlamps are off.
2. Remove the four screws and the lamp lens from lamp assembly.
3. Carefully pull the bulb straight out of the socket and push in the new bulb.

Replacing Cargo Lamp and High-mount Brake Lamp Bulbs

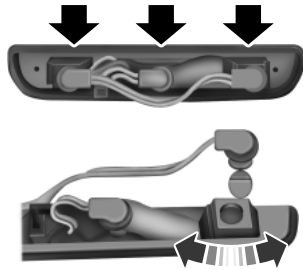

1. Make sure the headlamps are off.
2. Remove the screws and lamp assembly from the vehicle as wiring permits.
3. Remove the bulb socket by rotating it counterclockwise.
4. Pull the bulb straight out of the socket.

Replacing License Plate Lamp Bulbs

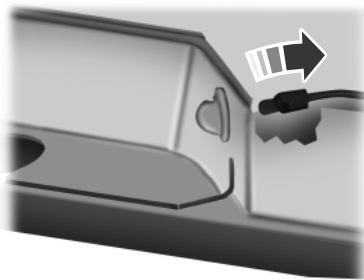

The license plate bulbs are located behind the rear bumper. To change the license plate lamp bulbs:

1. Reach behind the rear bumper to locate the bulb.
2. Twist the bulb socket counterclockwise and carefully pull to remove it from the lamp assembly.
3. Pull out the old bulb from the socket and push in the new bulb.
4. Install the bulb socket in lamp assembly by turning it clockwise.

BULB SPECIFICATION CHART

Replacement bulbs are specified in the chart below. Headlamp bulbs must be marked with an authorized "D.O.T." for North America and an "E" for Europe to ensure lamp performance, light brightness and pattern and safe visibility. The correct bulbs will not damage the lamp assembly or void the lamp assembly warranty and will provide quality bulb illumination time.

| Function | Number of bulbs | Trade number |
|---|------------------------|---------------------|
| Headlamps | 2 | H13/9008 |
| Park/Turn lamp | 2 | 3157NA |
| Side marker | 2 | W5W |
| Tail/stop/turn/side marker (pickups only) | 2 | 3157 |
| Tail/stop/turn/side marker (chassis cabs only; if equipped) | 2 | 3157 |
| Reverse (pickups only) | 2 | 921 |
| Reverse (chassis cabs only) | 2 | 3157 |
| High-mount brake lamp | 1 | 912 |
| Fog lamp | 2 | 9145 |
| License plate lamp | 2 | 194 |
| Cargo lamp | 2 | 912 |
| Map lamp | 2 | 12V6W |
| Dome/reading lamps | 3 | 578 |
| Interior visor lamp (if equipped) | 4 | 194 |
| Mirror turn signal | 2 | 2825 |
| Mirror clearance lamp | 2 | 2825 |
| * Front clearance lamps (2) and front identification lamps (3) | 5 | 194 |
| * Rear fender clearance | 4 | LED** |
| * Rear identification | 3 | 193** |
| Underhood Lamp | 1 | LED** |
| To replace all instrument panel lights - see your authorized dealer | | |
| * Dual rear wheels, or if equipped. | | |
| ** See your authorized dealer to replace the lamp assembly. | | |

GENERAL INFORMATION

Your Ford or Lincoln authorized dealer has many quality products available to clean your vehicle and protect its finishes.

CLEANING PRODUCTS

For best results, use the following products or products of equivalent quality:

- Motorcraft® Bug and Tar Remover (ZC-42)
- Motorcraft® Custom Bright Metal Cleaner (ZC-15)
- Motorcraft® Detail Wash (ZC-3-A)
- Motorcraft® Dusting Cloth (ZC-24)
- Motorcraft® Engine Shampoo and Degreaser (U.S. only) (ZC-20)
- Motorcraft® Engine Shampoo (Canada only) (CXC-66-A)
- Motorcraft® Multi-Purpose Cleaner (Canada only) (CXC-101)
- Motorcraft® Premium Glass Cleaner (Canada only) (CXC-100)
- Motorcraft® Premium Quality Windshield Washer Fluid (Canada only) [CXC-37-(A, B, D or F)]
- Motorcraft® Premium Windshield Washer Concentrate (U.S. only) (ZC-32-A)
- Motorcraft® Professional Strength Carpet & Upholstery Cleaner (ZC-54)
- Motorcraft® Spot and Stain Remover (U.S. only) (ZC-14)
- Motorcraft® Ultra-Clear Spray Glass Cleaner (ZC-23)
- Motorcraft® Vinyl Cleaner (Canada only) (CXC-93)
- Motorcraft® Wheel and Tire Cleaner (ZC-37-A)

CLEANING THE EXTERIOR

Wash your vehicle regularly with cool or lukewarm water and a neutral pH shampoo, such as Motorcraft® Detail Wash (ZC-3-A), which is available from your authorized dealer.

- Never use strong household detergents or soap, such as dish washing or laundry liquid. These products can discolor and spot painted surfaces.
- Never wash a vehicle that is hot to the touch or during exposure to strong, direct sunlight.
- Always use a clean sponge or car wash mitt with plenty of water for best results.

- Dry the vehicle with a chamois or soft, terry cloth towel in order to eliminate water spotting.
- It is especially important to wash the vehicle regularly during the winter months, as dirt and road salt are difficult to remove and cause damage to the vehicle.
- Immediately remove items such as gasoline, diesel fuel, bird droppings and insect deposits because they can cause damage to the vehicle's paintwork and trim over time. Use Motorcraft® Bug and Tar Remover (ZC-42), which is available from your authorized dealer.
- Remove any exterior accessories, such as antennas, before entering a car wash.
- Suntan lotions and insect repellents can damage any painted surface; if these substances come in contact with your vehicle, wash off as soon as possible.
- If your vehicle is equipped with running boards, use Motorcraft Detail Wash (ZC-3-A), and, as required, Motorcraft Bug and Tar Remover (ZC-42), both as per the directions on the products' labels. To manually dry, use a clean, dry, lint-free towel. Do not use rubber, plastic and vinyl protectant products on the running board surface, as the area may become slippery.

Exterior Chrome

- Wash the vehicle first, using cool or lukewarm water and a neutral pH shampoo, such as Motorcraft® Detail Wash (ZC-3-A).
- Use Motorcraft® Custom Bright Metal Cleaner (ZC-15), available from your authorized dealer. Apply the product as you would a wax to clean bumpers and other chrome parts; allow the cleaner to dry for a few minutes, then wipe off the haze with a clean, dry rag.
- Never use abrasive materials, such as steel wool or plastic pads, as they can scratch the chrome surface.

Underbody

Flush the complete underside of your vehicle frequently. Keep body and door drain holes free from packed dirt.

Rear suspension components may require regular cleaning with a power washer or a thorough rinse with a strong stream of water if the vehicle is operated in dusty or muddy environments. Rear leaf springs or other suspension components may emit squeak or popping noises while operating the vehicle if particles, such as dirt, rocks, or other debris, are present in the components.

Cleaning Plastic Exterior Parts

Use only approved products to clean plastic parts.

- For routine cleaning, use Motorcraft® Detail Wash.
- If tar or grease spots are present, use Motorcraft® Bug and Tar Remover.

WAXING

- Wash the vehicle first.
- Use a quality wax that does not contain abrasives.
- Do not allow paint sealant to come in contact with any non-body (low-gloss black) colored trim, such as grained door handles, roof racks, bumpers, side moldings, mirror housings or the windshield cowl area. The paint sealant will grey or stain the parts over time.

REPAIRING MINOR PAINT DAMAGE

Your authorized dealer has touch-up paint to match your vehicle's color. Take your color code (printed on a sticker in the driver's door jamb) to your authorized dealer to make sure you get the correct color.

- Remove particles, such as bird droppings, tree sap, insect deposits, tar spots, road salt and industrial fallout, before repairing paint chips.
- Always read the instructions before using the products.

CLEANING THE ENGINE

Engines are more efficient when they are clean because grease and dirt buildup keep the engine warmer than normal.

When washing:

- Take care when using a power washer to clean the engine. The high-pressure fluid could penetrate the sealed parts and cause damage.
- Do not spray a hot engine with cold water to avoid cracking the engine block or other engine components.
- Spray Motorcraft® Engine Shampoo and Degreaser on all parts that require cleaning and pressure rinse clean. In Canada, use Motorcraft® Engine Shampoo.
- Never wash or rinse the engine while it is hot or running; water in the running engine may cause internal damage.
- Never wash or rinse any ignition coil, spark plug wire or spark plug well, or the area in and around these locations.
- Cover the battery, power distribution box, and air filter assembly to prevent water damage when cleaning the engine.

CLEANING THE WINDOWS AND WIPER BLADES

The windows and wiper blades should be cleaned regularly. If the wipers do not wipe properly, substances on the vehicle's glass or the wiper blades may cause squeaking or chatter noise from the blades, and streaking and smearing of the windshield. To clean these items, follow these tips:

- The windows may be cleaned with a non-abrasive cleaner such as Motorcraft® Ultra-Clear Spray Glass Cleaner.
- The wiper blades can be cleaned with isopropyl (rubbing) alcohol or Motorcraft® Premium Windshield Washer Concentrate in the U.S., or Premium Quality Windshield Washer Fluid in Canada. Be sure to replace wiper blades when they appear worn or do not function properly.
- Do not use abrasives, as they may cause scratches.
- Do not use fuel, kerosene, or paint thinner to clean any parts.

If you cannot remove those streaks after cleaning with the glass cleaner or if the wipers chatter and move in a jerky motion, clean the outer surface of the windshield and the wiper blades using a sponge or soft cloth with a neutral detergent or mild-abrasive cleaning solution. After cleaning, rinse the windshield and wiper blades with clean water. The windshield is clean if beads do not form when you rinse the windshield with water.

Note: Do not use sharp objects, such as a razor blade, to clean the inside of the rear window or to remove decals, as it may cause damage to the rear window defroster's heated grid lines.

CLEANING THE INTERIOR

WARNING: Do not use cleaning solvents, bleach or dye on the vehicle's safety belts, as these actions may weaken the belt webbing.



WARNING: On vehicles equipped with seat-mounted airbags, do not use chemical solvents or strong detergents. Such products could contaminate the side airbag system and affect performance of the side airbag in a crash.

For fabric, carpets, cloth seats, safety belts and seats equipped with side airbags:

- Remove dust and loose dirt with a vacuum cleaner.
- Remove light stains and soil with Motorcraft® Professional Strength Carpet & Upholstery Cleaner.
- If grease or tar is present on the material, spot-clean the area first with Motorcraft® Spot and Stain Remover. In Canada, use Motorcraft® Multi-Purpose Cleaner.
- If a ring forms on the fabric after spot cleaning, clean the entire area immediately (but do not oversaturate) or the ring will set.
- Do not use household cleaning products or glass cleaners, which can stain and discolor the fabric and affect the flame retardant abilities of the seat materials.

CLEANING THE INSTRUMENT PANEL AND INSTRUMENT CLUSTER LENS



WARNING: Do not use chemical solvents or strong detergents when cleaning the steering wheel or instrument panel to avoid contamination of the airbag system.

Clean the instrument panel and cluster lens with a clean, damp, white, cotton cloth, then use a clean and dry, white, cotton cloth to dry these areas.

- Avoid cleaners or polishes that increase the gloss of the upper portion of the instrument panel. The dull finish in this area helps protect the driver from undesirable windshield reflection.
- Be certain to wash or wipe your hands clean if you have been in contact with certain products, such as insect repellent and suntan lotion, in order to avoid possible damage to the interior painted surfaces.
- Do not use household or glass cleaners as these may damage the finish of the instrument panel, interior trim and cluster lens.
- Do not allow air fresheners and hand sanitizers to spill on interior surfaces. If a spill occurs, wipe off immediately. Damage may not be covered by your warranty.

If a staining liquid like coffee or juice has been spilled on the instrument panel or on interior trim surfaces, clean as follows:

1. Wipe up spilled liquid using a clean, white, cotton cloth.
2. Wipe the surface with a damp, clean, white, cotton cloth. For more thorough cleaning, use a mild soap and water solution. If the spot cannot be completely cleaned by this method, the area may be cleaned using a commercially available cleaning product designed for automotive interiors.
3. If necessary, apply more soap and water solution or cleaning product to a clean, white, cotton cloth and press the cloth onto the soiled area; allow this to set at room temperature for 30 minutes.
4. Remove the soaked cloth, and if it is not soiled badly, use this cloth to clean the area by using a rubbing motion for 60 seconds.
5. Following this, wipe area dry with a clean, white, cotton cloth.

Instrument Panel, Door Panels and Console (FX appearance package)

Your vehicle's instrument panel, door panels and console are uniquely painted with both high and low gloss paints that require special care. The high gloss area is similar to that of the vehicle's exterior; the low gloss area is designed to help protect the driver from undesirable windshield reflection.

High gloss paint area

In order to maintain the finish, the high gloss areas should be treated similar to the that of exterior paint or glossy plastic surfaces. When cleaning the high gloss areas:

- **Do not use** paper towels or newspaper.
- **Do not use** silicone or Teflon® (PTFE)-based products.

Dust the high gloss areas with a clean, dry cloth, or use Motorcraft Dusting Cloth (ZC-24).

For general cleaning, use mild, soapy water and a soft, damp cloth, then dry with a clean, dry cloth.

For removal of fine scuffs and scratches, use Scotch-Brite® Microfiber Cloth or cheese cloth along with Motorcraft Premium Liquid Wax (ZC-53-A), Motorcraft Paint Sealant (ZC-45), or Motorcraft Custom Clear Coat Polish (ZC-8-A). **Note:** Removal of deep scuffs and scratches should be performed by an authorized dealer or an experienced repair facility.

Low gloss paint area

The low gloss area of the instrument panel's upper dash should be cleaned with mild, soapy water and a soft, damp cloth, then dried with a clean, dry cloth. When cleaning the low gloss areas:

- **Do not use** paper towels or newspaper.
- **Do not use** silicone or Teflon® (PTFE)-based products.
- **Do not use** exterior paint waxes or sealants.

Dust the low gloss areas with a clean, dry cloth, or use Motorcraft Dusting Cloth (ZC-24).

**CLEANING LEATHER SEATS
(IF EQUIPPED, EXCEPT FOR THE KING RANCH® EDITION)**

Note: For the King Ranch® Edition leather seats, refer to a separate section in this chapter.

- Clean spills and stains as quickly as possible.
- For routine cleaning, wipe the surface with a soft, damp cloth. For more thorough cleaning, wipe the surface with a mild soap and water solution. In Canada, use Motorcraft® Vinyl Cleaner (CXC-93). Dry the area with a soft cloth.
- If the leather cannot be completely cleaned using a mild soap and water solution, the leather may be cleaned using a commercially available leather cleaning product designed for automotive interiors.
- To check for compatibility, first test any cleaner or stain remover on an inconspicuous part of the leather.
- Do not use household cleaning products, alcohol solutions, solvents or cleaners intended for rubber, vinyl and plastics, or oil/petroleum-based leather conditioners. These products may cause premature wearing or damage to the leather.

**CLEANING LEATHER SEATS
(IF EQUIPPED WITH THE KING RANCH® EDITION)**

Your vehicle is equipped with seating covered in premium, top-grain leather which is extremely durable, but still requires special care and maintenance in order to ensure longevity and comfort.

Regular cleaning and conditioning will maintain the appearance of the leather.

Cleaning

For dirt, use a vacuum cleaner then use a clean, damp cloth or soft brush.

For routine cleaning, wipe the surface with a soft, damp cloth. For more thorough cleaning, wipe the surface with a mild soap and water solution.

- Clean spills as quickly as possible.
- Test any cleaner or stain remover on an inconspicuous part of the leather as cleaners may darken the leather.
- Do not spill coffee, ketchup, mustard, orange juice or oil-based products on the leather as they may permanently stain the leather.
- Do not use household cleaning products, alcohol solutions, solvents or cleaners intended for rubber, vinyl or plastics.

Scratches

Natural Markings - Because the leather in the seat comes from genuine steer hides, there will be evidence of naturally occurring markings, such as small scars. These markings give character to the seating covers and should be considered as proof of a genuine leather product.

In order to lessen the appearance of certain scratches and other wear marks, apply conditioner on the affected area following the same instructions as in the *Conditioning* section.

Conditioning

Bottles of King Ranch® Leather Conditioner are available at the King Ranch® Saddle Shop. Visit the website at www.krsaddleshop.com, or telephone (in the United States) 1-800-282-KING (5464). If you are unable to obtain King Ranch® Leather Conditioner, use another premium leather conditioner.

- Clean the surfaces using the steps outlined in the *Cleaning* section.
- Ensure the leather is dry then apply a nickel-sized amount of conditioner to a clean, dry cloth.
- Rub the conditioner into leather until it disappears. Allow the conditioner to dry and repeat the process for the entire interior. If a film appears, wipe off film with a dry, clean cloth.

CLEANING THE ALLOY WHEELS

Note: Do not use chrome cleaner, metal cleaner or polish on wheels and wheel covers.

Aluminum wheels and wheel covers are coated with a clearcoat paint finish. In order to maintain their shine:

- Clean weekly with Motorcraft® Wheel and Tire Cleaner. Heavy dirt and brake dust accumulation may require agitation with a sponge. Rinse thoroughly with a strong stream of water.
- Never apply any cleaning chemical to hot or warm wheel rims or covers.
- Some automatic car washes may cause damage to the finish on your wheel rims or covers. Industrial-strength (heavy-duty) cleaners, or cleaning chemicals, in combination with brush agitation to remove brake dust and dirt, could wear away the clearcoat finish over time.
- Do not use hydrofluoric acid-based or high caustic-based wheel cleaners, steel wool, fuels or strong household detergent.
- To remove tar and grease, use Motorcraft® Bug and Tar Remover.

VEHICLE STORAGE

If you plan on storing your vehicle for an extended period of time (30 days or more), read the following maintenance recommendations to make sure your vehicle stays in good operating condition.

All motor vehicles and their components were engineered and tested for reliable, regular driving. Long-term storage under various conditions may lead to component degradation or failure unless specific precautions are taken to preserve the components.

General

- Store all vehicles in a dry, ventilated place.
- Protect from sunlight, if possible.
- If vehicles are stored outside, they require regular maintenance to protect against rust and damage.

Body

- Wash vehicle thoroughly to remove dirt, grease, oil, tar or mud from exterior surfaces, rear-wheel housing and underside of front fenders.
- Periodically wash vehicles stored in exposed locations.
- Touch up raw or primed metal to prevent rust.
- Cover chrome and stainless steel parts with a thick coat of auto wax to prevent discoloration. Re-wax as necessary when the vehicle is washed.
- Lubricate hood latch, all door latches and trunk lid hinges with a light grade oil.
- Cover interior trim to prevent fading.
- Keep all rubber parts free from oil and solvents.

Engine

- The engine oil and filter should be changed prior to storage, as used engine oil contains contaminants that may cause engine damage.
- Start the engine every 15 days. Run at fast idle until it reaches normal operating temperature.
- With your foot on the brake, shift through all the gears while the engine is running.

Fuel system

- Fill the fuel tank with high-quality fuel until the first automatic shutoff of the fuel pump nozzle.

Note: During extended periods of vehicle storage (30 days or more), fuel may deteriorate due to oxidation. Add a quality gas stabilizer product to the vehicle fuel system whenever actual or expected storage periods exceed 30 days. Follow the instructions on the additive label. The vehicle should then be operated at idle speed to circulate the additive throughout the fuel system.

Cooling system

- Protect against freezing temperatures.
- When removing vehicle from storage, check coolant fluid level. Confirm there are no cooling system leaks, and fluid is at the recommended level.

Battery

- Check and recharge as necessary. Keep connections clean.
- If storing your vehicle for more than 30 days without recharging the battery, it may be advisable to disconnect the battery cables to ensure battery charge is maintained for quick starting.

Note: If battery cables are disconnected, it will be necessary to reset memory features.

Brakes

- Make sure brakes and parking brake are fully released.

Tires

- Maintain recommended air pressure.

Miscellaneous

- Make sure all linkages, cables, levers and pins under vehicle are covered with grease to prevent rust.
- Move vehicles at least 25 feet (8 meters) every 15 days to lubricate working parts and prevent corrosion.

Removing Vehicle from Storage

When your vehicle is ready to come out of storage, do the following:

- Wash your vehicle to remove any dirt or grease film build-up on window surfaces.
- Check windshield wipers for any deterioration.
- Check under the hood for any foreign material that may have collected during storage (mice/squirrel nests).
- Check the exhaust for any foreign material that may have collected during storage.
- Check tire pressures and set tire inflation per the Tire Label.
- Check brake pedal operation. Drive the vehicle 15 feet (4.5 meters) back and forth to remove rust build-up.
- Check fluid levels (including coolant, oil and gas) to make sure there are no leaks and fluids are at recommended levels.
- If the battery was removed, clean the battery cable ends and inspect.

Contact your authorized dealer if you have any concerns or issues.

GENERAL INFORMATION**Notice to Utility Vehicle, Van and Truck Owners**

WARNING: Utility vehicles have a significantly higher rollover rate than other types of vehicles. To reduce the risk of serious injury or death from a rollover or other crash you must:

- Avoid sharp turns and abrupt maneuvers;
- Drive at safe speeds for the conditions;
- Keep tires properly inflated;
- Never overload or improperly load your vehicle; and
- Make sure every passenger is properly restrained.



WARNING: In a rollover crash, an unbelted person is significantly more likely to die than a person wearing a seat belt. All occupants must wear seat belts. Children and infants must use appropriate restraints to minimize the risk of injury or ejection.



Utility vehicles, vans and trucks handle differently than passenger cars in the various driving conditions that are encountered on streets, highways and off-road. Utility vehicles, vans and trucks are not designed for cornering at speeds as high as passenger cars any more than low-slung sports cars are designed to perform satisfactorily under off-road conditions.

Four-Wheel Drive System (If Equipped)

WARNING: Do not become overconfident in the ability of four-wheel drive vehicles. Although a four-wheel drive vehicle may accelerate better than a two-wheel drive vehicle in low-traction situations, it will not stop any faster than two-wheel drive vehicles. Always drive at a safe speed.

A vehicle equipped with four-wheel drive (when selected) has the ability to use all four wheels to power itself. This increases traction which may enable you to safely drive over terrain and road conditions that a conventional two-wheel drive vehicle cannot.

Power is supplied to all four wheels through a transfer case or power transfer unit. Four-wheel drive vehicles allow you to select different drive modes as necessary. You can find information on transfer case operation and shifting procedures in the *Transmission* chapter. You can find information on transfer case maintenance in the *Maintenance* chapter. You should become thoroughly familiar with this information before you operate your vehicle.

On some four-wheel drive models, the initial shift from two-wheel drive to four-wheel drive while the vehicle is moving can cause a momentary clunk and ratcheting sound. These sounds are normal as the front drivetrain comes up to speed and are not cause for concern.

How Your Vehicle Differs from Other Vehicles

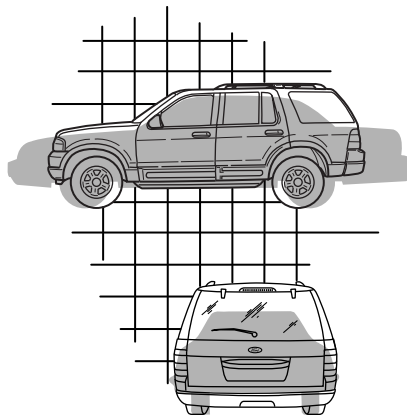

Sport-utility vehicles, vans and trucks can differ from some other vehicles in a few noticeable ways. Your vehicle may be:

- Higher – to allow higher load carrying capacity and to allow it to travel over rough terrain without getting hung up or damaging underbody components.
- Shorter – to give it the capability to approach inclines and drive over the crest of a hill without getting hung up or damaging underbody components. All other things held equal, a shorter

wheelbase may make your vehicle quicker to respond to steering inputs than a vehicle with a longer wheelbase.

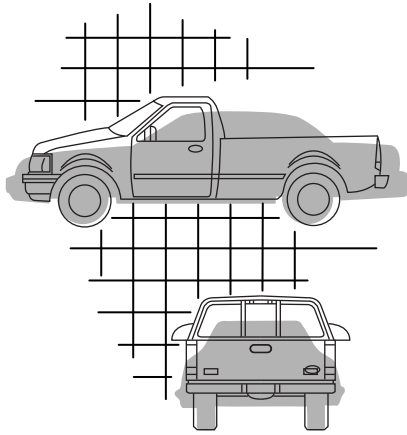

- Narrower – to provide greater maneuverability in tight spaces, particularly in off-road use.

As a result of the above dimensional differences, sport-utility vehicles, vans and trucks often will have a higher center of gravity and a greater difference in center of gravity between the loaded and unloaded condition.

These differences that make your vehicle so versatile also make it handle differently than an ordinary passenger car.

TIRE CARE

Information About Uniform Tire Quality Grading



Tire Quality Grades apply to new pneumatic passenger car tires. The Tire Quality Grades can be found where applicable on the tire sidewall between tread shoulder and maximum section width. For example:

- **Treadwear 200 Traction AA Temperature A**

These Tire Quality Grades are determined by standards that the United States Department of Transportation has set.

Tire Quality Grades apply to new pneumatic passenger car tires. They do not apply to deep tread, winter-type snow tires, space-saver or temporary use spare tires, light truck or LT type tires, tires with nominal rim diameters of 10 to 12 inches or limited production tires as defined in Title 49 Code of Federal Regulations Part 575.104(c)(2).

U.S. Department of Transportation-Tire quality grades: The U.S. Department of Transportation requires Ford Motor Company to give you the following information about tire grades exactly as the government has written it.

Treadwear

The treadwear grade is a comparative rating based on the wear rate of the tire when tested under controlled conditions on a specified government test course. For example, a tire graded 150 would wear 1½ times as well on the government course as a tire graded 100. The relative performance of tires depends upon the actual conditions of their use, however, and may depart significantly from the norm due to variations in driving habits, service practices, and differences in road characteristics and climate.

Traction AA A B C

WARNING: The traction grade assigned to this tire is based on straight-ahead braking traction tests, and does not include acceleration, cornering, hydroplaning or peak traction characteristics.

The traction grades, from highest to lowest are AA, A, B, and C. The grades represent the tire's ability to stop on wet pavement as measured under controlled conditions on specified government test surfaces of asphalt and concrete. A tire marked C may have poor traction performance.

Temperature A B C

WARNING: The temperature grade for this tire is established for a tire that is properly inflated and not overloaded. Excessive speed, underinflation, or excessive loading, either separately or in combination, can cause heat buildup and possible tire failure.

The temperature grades are A (the highest), B and C, representing the tire's resistance to the generation of heat and its ability to dissipate heat when tested under controlled conditions on a specified indoor laboratory test wheel. Sustained high temperature can cause the material of the tire to degenerate and reduce tire life, and excessive temperature can lead to sudden tire failure. The grade C corresponds to a level of performance which all passenger car tires must meet under the Federal Motor Vehicle Safety Standard No. 139. Grades B and A represent higher levels of performance on the laboratory test wheel than the minimum required by law.

Glossary of Tire Terminology

- **Tire label:** A label showing the OE (Original Equipment) tire sizes, recommended inflation pressure and the maximum weight the vehicle can carry.
- **Tire Identification Number (TIN):** A number on the sidewall of each tire providing information about the tire brand and manufacturing plant, tire size and date of manufacture. Also referred to as DOT code.
- **Inflation pressure:** A measure of the amount of air in a tire.
- **Standard load:** A class of P-metric or Metric tires designed to carry a maximum load at 35 psi [37 psi (2.5 bar) for Metric tires]. Increasing the inflation pressure beyond this pressure will not increase the tire's load-carrying capability.
- **Extra load:** A class of P-metric or Metric tires designed to carry a heavier maximum load at 41 psi [43 psi (2.9 bar) for Metric tires]. Increasing the inflation pressure beyond this pressure will not increase the tire's load-carrying capability.
- **kPa:** Kilopascal, a metric unit of air pressure.
- **PSI:** Pounds per square inch, a standard unit of air pressure.
- **Cold tire pressure:** The tire pressure when the vehicle has been stationary and out of direct sunlight for an hour or more and prior to the vehicle being driven for 1 mile (1.6 kilometers).
- **Recommended inflation pressure:** The cold inflation pressure found on the Safety Compliance Certification Label (affixed to either the door hinge pillar, door-latch post, or the door edge that meets the door-latch post, next to the driver's seating position) or Tire Label located on the B-Pillar or the edge of the driver's door.
- **B-pillar:** The structural member at the side of the vehicle behind the front door.
- **Bead area of the tire:** Area of the tire next to the rim.
- **Sidewall of the tire:** Area between the bead area and the tread.
- **Tread area of the tire:** Area of the perimeter of the tire that contacts the road when mounted on the vehicle.
- **Rim:** The metal support (wheel) for a tire or a tire and tube assembly upon which the tire beads are seated.

INFORMATION CONTAINED ON THE TIRE SIDEWALL

Both U.S. and Canada Federal regulations require tire manufacturers to place standardized information on the sidewall of all tires. This information identifies and describes the fundamental characteristics of the tire and also provides a U.S. DOT Tire Identification Number for safety standard certification and in case of a recall.

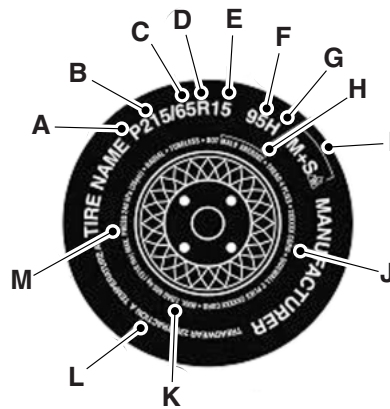
Information on P Type Tires

P215/65R15 95H is an example of a tire size, load index and speed rating. The definitions of these items are listed below. (Note that the tire size, load index and speed rating for your vehicle may be different from this example.)

A. **P:** Indicates a tire, designated by the Tire and Rim Association, that may be used for service on cars, sport utility vehicles, minivans and light trucks.

Note: If your tire size does not begin with a letter, this may mean it is designated by either the European Tire and Rim Technical Organization or the Japan Tire Manufacturing Association.

B. **215:** Indicates the nominal width of the tire in millimeters from sidewall edge to sidewall edge. In general, the larger the number, the wider the tire.

C. **65:** Indicates the aspect ratio which gives the tire's ratio of height to width.

D. **R:** Indicates a radial type tire.

E. **15:** Indicates the wheel or rim diameter in inches. If you change your wheel size, you will have to purchase new tires to match the new wheel diameter.

F. 95: Indicates the tire's load index. It is an index that relates to how much weight a tire can carry. You may find this information in your owner's manual. If not, contact a local tire dealer.

Note: You may not find this information on all tires because it is not required by federal law.

G. H: Indicates the tire's speed rating. The speed rating denotes the speed at which a tire is designed to be driven for extended periods of time under a standard condition of load and inflation pressure. The tires on your vehicle may operate at different conditions for load and inflation pressure. These speed ratings may need to be adjusted for the difference in conditions. The ratings range from 81 mph (130 km/h) to 186 mph (299 km/h). These ratings are listed in the following chart.

Note: You may not find this information on all tires because it is not required by federal law.

| Letter rating | Speed rating - mph (km/h) |
|---------------|---------------------------|
| M | 81 (130) |
| N | 87 (140) |
| Q | 99 (159) |
| R | 106 (171) |
| S | 112 (180) |
| T | 118 (190) |
| U | 124 (200) |
| H | 130 (210) |
| V | 149 (240) |
| W | 168 (270) |
| Y | 186 (299) |

Note: For tires with a maximum speed capability over 149 mph (240 km/h), tire manufacturers sometimes use the letters ZR. For those with a maximum speed capability over 186 mph (299 km/h), tire manufacturers always use the letters ZR.

H. U.S. DOT Tire Identification Number (TIN): This begins with the letters DOT and indicates that the tire meets all federal standards. The next two numbers or letters are the plant code designating where it was manufactured, the next two are the tire size code and the last four numbers represent the week and year the tire was built. For example, the numbers 317 mean the 31st week of 1997. After 2000 the numbers go to four digits. For example, 2501 means the 25th week of 2001. The numbers in between are identification codes used for traceability. This information is used to contact customers if a tire defect requires a recall.

I. **M+S or M/S:** Mud and Snow, or
AT: All Terrain, or
AS: All Season.

J. **Tire Ply Composition and Material Used:** Indicates the number of plies or the number of layers of rubber-coated fabric in the tire tread and sidewall. Tire manufacturers also must indicate the ply materials in the tire and the sidewall, which include steel, nylon, polyester, and others.

K. **Maximum Load:** Indicates the maximum load in kilograms and pounds that can be carried by the tire. See the Safety Compliance Certification Label (affixed to either the door hinge pillar, door-latch post, or the door edge that meets the door-latch post, next to the driver's seating position), for the correct tire pressure for your vehicle.

L. **Treadwear, Traction and Temperature Grades**

- **Treadwear:** The treadwear grade is a comparative rating based on the wear rate of the tire when tested under controlled conditions on a specified government test course. For example, a tire graded 150 would wear one and one-half (1½) times as well on the government course as a tire graded 100.
- **Traction:** The traction grades, from highest to lowest, are AA, A, B, and C. The grades represent the tire's ability to stop on wet pavement as measured under controlled conditions on specified government test surfaces of asphalt and concrete. A tire marked C may have poor traction performance.
- **Temperature:** The temperature grades are A (the highest), B and C, representing the tire's resistance to the generation of heat and its ability to dissipate heat when tested under controlled conditions on a specified indoor laboratory test wheel.

M. **Maximum Inflation Pressure:** Indicates the tire manufacturer's maximum permissible pressure or the pressure at which the maximum load can be carried by the tire. This pressure is normally higher than the vehicle manufacturer's recommended cold inflation pressure, which can be found on the Safety Compliance Certification Label (affixed to either the door hinge pillar, door-latch post, or the door edge that meets the door-latch post, next to the driver's seating position), or Tire Label which is located on the B-Pillar or the edge of the driver's door. The cold inflation pressure should never be set lower than the recommended pressure on the vehicle label.

The tire suppliers may have additional markings, notes or warnings, such as standard load or radial tubeless.

Additional Information Contained on the Tire Sidewall for LT Type Tires

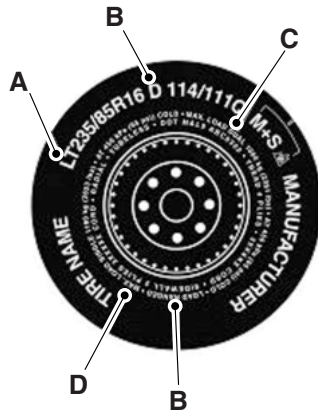

LT type tires have some additional information beyond those of P type tires. These differences are described below.

Note: Tire Quality Grades do not apply to this type of tire.

A. LT: Indicates a tire, designated by the Tire and Rim Association, that is intended for service on light trucks.

B. Load Range/Load Inflation Limits: Indicates the tire's load-carrying capabilities and its inflation limits.

C. Maximum Load Dual lb (kg) at psi (kPa) cold: Indicates the maximum load and tire pressure when the tire is used as a dual, defined as four tires on the rear axle (a total of six or more tires on the vehicle).

D. Maximum Load Single lb (kg) at psi (kPa) cold: Indicates the maximum load and tire pressure when the tire is used as a single, defined as two tires (total) on the rear axle.

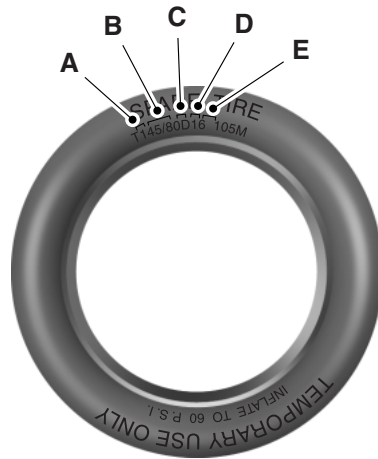
Information on T Type Tires

T type tires have some additional information beyond those of P type tires. These differences are described below.

T145/80D16 is an example of a tire size.

Note: The temporary tire size for your vehicle may be different from this example. Tire Quality Grades do not apply to this type of tire.

A. **T:** Indicates a type of tire, designated by the Tire and Rim Association, that is intended for temporary service on cars, sport-utility vehicles, minivans and light trucks.

B. **145:** Indicates the nominal width of the tire in millimeters from sidewall edge to sidewall edge. In general, the larger the number, the wider the tire.

C. **80:** Indicates the aspect ratio, which gives the tire's ratio of height to width. Numbers of 70 or lower indicate a short sidewall.

D. **D:** Indicates a diagonal type tire. **R:** Indicates a radial type tire.

E. **16:** Indicates the wheel or rim diameter in inches. If you change your wheel size, you will have to purchase new tires to match the new wheel diameter.

Location of the Tire Label

You will find a Tire Label containing tire inflation pressure by tire size and other important information located on the B-Pillar or the edge of the driver's door. See the payload description and graphic in the *Load Carrying* chapter .

INFLATING YOUR TIRES

Safe operation of your vehicle requires that your tires are properly inflated. Remember that a tire can lose up to half of its air pressure without appearing flat.

Every day before you drive, check your tires. If one looks lower than the others, use a tire gauge to check pressure of all tires and adjust if required.

At least once a month and before long trips, inspect each tire and check the tire pressure with a tire gauge (including spare, if equipped). Inflate all tires to the inflation pressure recommended by Ford Motor Company.



WARNING: Under-inflation is the most common cause of tire failures and may result in severe tire cracking, tread separation or blowout, with unexpected loss of vehicle control and increased risk of injury. Under-inflation increases sidewall flexing and rolling resistance, resulting in heat buildup and internal damage to the tire. It also may result in unnecessary tire stress, irregular wear, loss of vehicle control and accidents. A tire can lose up to half of its air pressure and not appear to be flat!

You are strongly urged to buy a reliable tire pressure gauge, as automatic service station gauges may be inaccurate. Ford recommends the use of a digital or dial-type tire pressure gauge rather than a stick-type tire pressure gauge.

Use the recommended cold inflation pressure for optimum tire performance and wear. Under-inflation or over-inflation may cause uneven treadwear patterns.

Always inflate your tires to the Ford recommended inflation pressure even if it is less than the maximum inflation pressure information found on the tire. The Ford recommended tire inflation pressure is found on the Safety Compliance Certification Label (affixed to either the door hinge pillar, door-latch post, or the door edge that meets the door-latch post, next to the driver's seating position), or Tire Label which is located on the B-Pillar or the edge of the driver's door. Failure to follow the tire pressure recommendations can cause uneven treadwear patterns and adversely affect the way your vehicle handles.

Note: Do not reduce tire pressure to change the ride characteristics of the vehicle. If you do not maintain the inflation pressure at the levels specified by Ford, your vehicle may experience a condition known as shimmy. Shimmy is a severe vibration and oscillation in the steering wheel after the vehicle travels over a bump or dip in the road that does not dampen out by itself. Shimmy may result from significant under-inflation of the tires, improper tires (load range, size, or type), or vehicle modifications such as lift-kits. In the event that your vehicle experiences shimmy, you should slowly reduce speed by either lifting off the accelerator pedal or lightly applying the brakes. The shimmy will cease as the vehicle speed decreases.

Maximum Inflation Pressure is the tire manufacturer's maximum permissible pressure or the pressure at which the maximum load can be carried by the tire. This pressure is normally higher than the manufacturer's recommended cold inflation pressure which can be found on the Safety Compliance Certification Label (affixed to either the door hinge pillar, door-latch post, or the door edge that meets the door-latch post, next to the driver's seating position), or Tire Label which is located on the B-Pillar or the edge of the driver's door. The cold inflation pressure should never be set lower than the recommended pressure on the Safety Compliance Certification Label or Tire Label.

When weather temperature changes occur, tire inflation pressures also change. A 10°F (6°C) temperature drop can cause a corresponding drop of 1 psi (7 kPa) in inflation pressure. Check your tire pressures frequently and adjust them to the proper pressure which can be found on the Safety Compliance Certification Label or Tire Label.

To check the pressure in your tire(s):

1. Make sure the tires are cool, meaning they are not hot from driving even a mile.

If you are checking tire pressure when the tire is hot (for example, driven more than 1 mile [1.6 kilometers]), never bleed or reduce air pressure. The tires are hot from driving and it is normal for pressures to increase above recommended cold pressures. A hot tire at or below recommended cold inflation pressure could be significantly under-inflated.

Note: If you have to drive a distance to get air for your tire(s), check and record the tire pressure first and add the appropriate air pressure when you get to the pump. It is normal for tires to heat up and the air pressure inside to go up as you drive.

2. Remove the cap from the valve on one tire, then firmly press the tire gauge onto the valve and measure the pressure.

3. Add enough air to reach the recommended air pressure.

Note: If you overfill the tire, release air by pushing on the metal stem in the center of the valve. Then recheck the pressure with your tire gauge.

4. Replace the valve cap.

5. Repeat this procedure for each tire, including the spare.

Note: Some spare tires operate at a higher inflation pressure than the other tires. For T-type or mini-spare tires, see the *Dissimilar spare tire and wheel assembly information* section. Store and maintain at 60 psi (4.15 bar). For full-size and dissimilar spare tires, see *Dissimilar spare tire and wheel assembly information* under *Changing a Road Wheel* in this section. Store and maintain at the higher of the front and rear inflation pressure as shown on the Tire Label.

6. Visually inspect the tires to make sure there are no nails or other objects embedded that could poke a hole in the tire and cause an air leak.

7. Check the sidewalls to make sure there are no gouges, cuts or bulges.

Tire Inflation Information



WARNING: An inflated tire and rim can be very dangerous if improperly used, serviced or maintained. To reduce the risk of serious injury, never attempt to re-inflate a tire which has been run flat or seriously under-inflated without first removing the tire from the wheel assembly for inspection. Do not attempt to add air to tires or replace tires or wheels without first taking precautions to protect persons and property.

All tires with Steel Carcass Plies (if equipped):

This type of tire utilizes steel cords in the sidewalls. As such, they cannot be treated like normal light truck tires. Tire service, including adjusting tire pressure, must be performed by personnel trained, supervised and equipped according to Federal Occupational Safety and Health Administration regulations. For example, during any procedure involving tire inflation, the technician or individual must utilize a remote inflation device, and make sure that all persons are clear of the trajectory area.

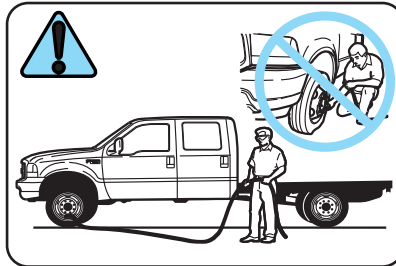

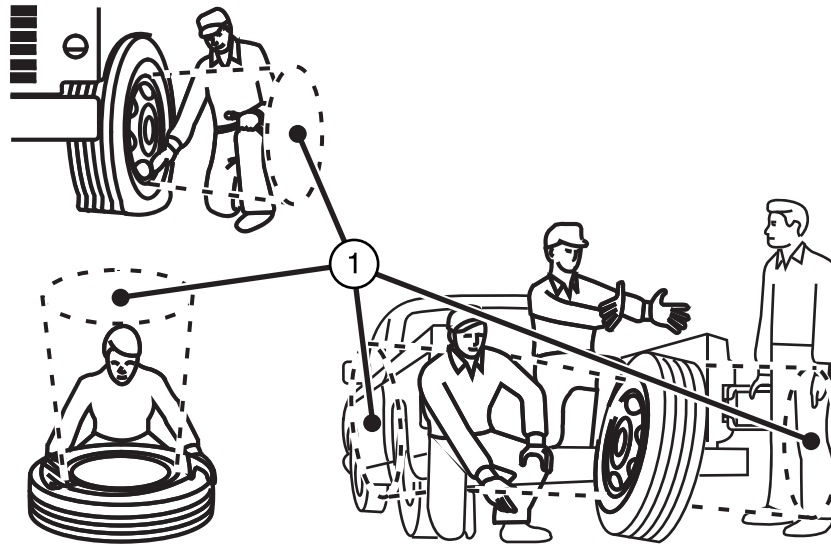

WARNING: Stay out of the trajectory (1) as indicated in the illustration.

Inspecting Your Tires and Wheel Valve Stems

Periodically inspect the tire treads for uneven or excessive wear and remove objects such as stones, nails or glass that may be wedged in the tread grooves. Check the tire and valve stems for holes, cracks, or cuts that may permit air leakage and repair or replace the tire and replace the valve stem. Inspect the tire sidewalls for cracking, cuts, bruises and other signs of damage or excessive wear. If internal damage to the tire is suspected, have the tire demounted and inspected in case it needs to be repaired or replaced. For your safety, tires that are damaged or show signs of excessive wear should not be used because they are more likely to blow out or fail.

Improper or inadequate vehicle maintenance can cause tires to wear abnormally. Inspect all your tires, including the spare, frequently, and replace them if one or more of the following conditions exist:

Tire Wear

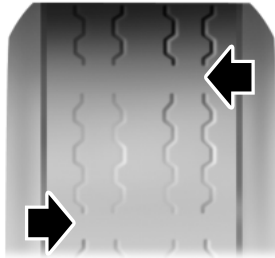

When the tread is worn down to 1/16th of an inch (2 millimeters), tires must be replaced to help prevent your vehicle from skidding and hydroplaning. Built-in treadwear indicators, or wear bars, which look like narrow strips of smooth rubber across the tread will appear on the tire when the tread is worn down to 1/16th of an inch (2 millimeters).

When the tire tread wears down to the same height as these wear bars, the tire is worn out and must be replaced.

Damage

Periodically inspect the tire treads and sidewalls for damage (such as bulges in the tread or sidewalls, cracks in the tread groove and separation in the tread or sidewall). If damage is observed or suspected, have the tire inspected by a tire professional. Tires can be damaged during off-road use, so inspection after off-road use is also recommended.



WARNING: Age

Tires degrade over time depending on many factors such as weather, storage conditions, and conditions of use (such as load, speed, inflation pressure) the tires experience throughout their lives. In general, tires should be replaced after six years regardless of tread wear. However, heat caused by hot climates or frequent high loading conditions can accelerate the aging process and may require tires to be replaced more frequently.

You should replace your spare tire when you replace the road tires or after six years due to aging even if it has not been used.

U.S. DOT Tire Identification Number

Both U.S. and Canada Federal regulations require tire manufacturers to place standardized information on the sidewall of all tires. This information identifies and describes the fundamental characteristics of the tire and also provides a U.S. DOT Tire Identification Number for safety standard certification and in case of a recall.

This begins with the letters DOT and indicates that the tire meets all federal standards. The next two numbers or letters are the plant code designating where it was manufactured, the next two are the tire size code and the last four numbers represent the week and year the tire was built. For example, the numbers 317 mean the 31st week of 1997. After 2000 the numbers go to four digits. For example, 2501 means the 25th week of 2001. The numbers in between are identification codes used for traceability. This information is used to contact customers if a tire defect requires a recall.

Tire Replacement Requirements

WARNING: Only use replacement tires and wheels that are the same size, load index, speed rating and type (such as P-metric versus LT-metric or all-season versus all-terrain) as those originally provided by Ford. The recommended tire and wheel size may be found on either the Safety Compliance Certification Label (affixed to either the door hinge pillar, door-latch post, or the door edge that meets the door-latch post, next to the driver's seating position), or the Tire Label which is located on the B-Pillar or edge of the driver's door. If this information is not found on these labels then you should contact your authorized dealer as soon as possible. Use of any tire or wheel not recommended by Ford can affect the safety and performance of your vehicle, which could result in an increased risk of loss of vehicle control, vehicle rollover, personal injury and death. Additionally, the use of non-recommended tires and wheels could cause steering, suspension, axle, transfer case, or power transfer unit failure. If you have questions regarding tire replacement, contact your authorized dealer as soon as possible.



WARNING: To reduce the risk of serious injury, when mounting replacement tires and wheels, you should not exceed the maximum pressure indicated on the sidewall of the tire to set the beads without additional precautions listed below. If the beads do not seat at the maximum pressure indicated, re-lubricate and try again.

When inflating the tire for mounting pressures up to 20 psi (138 kPa) greater than the maximum pressure on the tire sidewall, take the following precautions to protect the person mounting the tire:

1. Make sure that you have the correct tire and wheel size.
2. Lubricate the tire bead and wheel bead seat area again.
3. Stand at a minimum of 12 feet (3.66 meters) away from the tire wheel assembly.
4. Use both eye and ear protection.

For a mounting pressure more than 20 psi (138 kPa) greater than the maximum pressure, an authorized dealer or other tire service professional should do the mounting.

Always inflate steel carcass tires with a remote air fill with the person inflating standing at a minimum of 12 feet (3.66 meters) away from the tire wheel assembly.

Your vehicle is equipped with tires designed to provide a safe ride and handling capability.

Important: Remember to replace the wheel valve stems when the road tires are replaced on your vehicle.

The two front tires or two rear tires should generally be replaced as a pair.

The tire pressure sensors mounted in the wheels are not designed to be used in aftermarket wheels.

The use of wheels or tires not recommended by Ford Motor Company may affect the operation of your tire pressure monitoring system (if equipped).

If the tire pressure monitoring system indicator is flashing, the system is malfunctioning. Your replacement tire might be incompatible with your tire pressure monitoring system, or some component of the system may be damaged (if equipped).

Safety Practices



WARNING: If your vehicle is stuck in snow, mud, or sand, do not rapidly spin the tires. Spinning the tires can tear the tire and cause an explosion. A tire can explode in as little as three to five seconds.



WARNING: Do not spin the wheels at over 35 mph (56 km/h).
The tires may fail and injure a passenger or bystander.

Driving habits have a great deal to do with your tire mileage and safety.

- Observe posted speed limits.
- Avoid fast starts, stops and turns.
- Avoid potholes and objects on the road.
- Do not run over curbs or hit the tire against a curb when parking.

Highway Hazards

No matter how carefully you drive, there is always the possibility that you may eventually have a flat tire on the highway. Drive slowly to the closest safe area out of traffic. This may further damage the flat tire, but your safety is more important.

If you feel a sudden vibration or ride disturbance while driving, or you suspect your tire or vehicle has been damaged, immediately reduce your speed. Drive with caution until you can safely pull off the road. Stop and inspect the tires for damage. If a tire is under-inflated or damaged, deflate it, remove the wheel and replace it with your spare tire and wheel. If you cannot detect a cause, have the vehicle towed to the nearest repair facility or tire dealer to have the vehicle inspected.

Tire and Wheel Alignment

A bad jolt from hitting a curb or pothole can cause the front end of your vehicle to become misaligned or cause damage to your tires. If your vehicle seems to pull to one side when you are driving, the wheels may be out of alignment. Have an authorized dealer check the wheel alignment periodically.

Wheel misalignment in the front or the rear can cause uneven and rapid treadwear of your tires and should be corrected by an authorized dealer. Front-wheel drive vehicles and those with an independent rear suspension may require alignment of all four wheels.

The tires should also be balanced periodically. An unbalanced tire and wheel assembly may result in irregular tire wear.

Tire Rotation



WARNING: If the tire label shows different tire pressures for the front and rear tires and the vehicle is equipped with a tire pressure monitoring system, then the settings for the system sensors need to be updated. Always perform the system reset procedure after tire rotation. If the system is not reset, it may not provide a low tire pressure warning when necessary. See the TPMS reset procedure in this chapter.

Note: If your tires show uneven wear ask an authorized dealer to check for and correct any wheel misalignment, tire imbalance or mechanical problem involved before tire rotation.

Note: Your vehicle may be equipped with a dissimilar spare tire and wheel assembly. A dissimilar spare tire and wheel assembly is defined as a spare tire or wheel that is different in brand, size or appearance from the road tires and wheels. If you have a dissimilar spare tire and wheel assembly, it is intended for temporary use only and should not be used in a tire rotation.

Note: After having your tires rotated, inflation pressure must be checked and adjusted to the vehicle requirements.

Rotating your tires at the recommended interval (as indicated in the scheduled maintenance information) will help your tires wear more evenly, providing better tire performance and longer tire life.

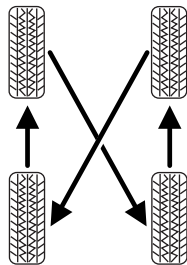

- Rear-wheel drive vehicles/
Four-wheel drive vehicles
(front tires at top of diagram)

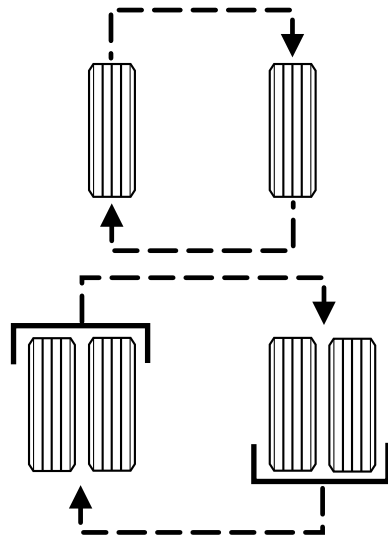

- Dual rear wheel vehicles – six tire rotation

If your vehicle is equipped with dual rear wheels, it is recommended that the front and rear tires (in pairs) be rotated only side to side. We do not recommend splitting up the dual rear wheels. Rotate them side to side as a pair. After tire rotation, inflation pressures must be adjusted for the tires new positions in accordance with vehicle requirements.

Sometimes irregular tire wear can be corrected by rotating the tires.

USING SNOW CHAINS



WARNING: Snow tires must be the same size, load index, speed rating as those originally provided by Ford. Use of any tire or wheel not recommended by Ford can affect the safety and performance of your vehicle, which could result in an increased risk of loss of vehicle control, vehicle rollover, personal injury and death. Additionally, the use of non-recommended tires and wheels could cause steering, suspension, axle, transfer case or power transfer unit failure.

Note: Do not use snow chains on vehicles with 20 inch wheels and tires.

The tires on your vehicle have all-weather treads to provide traction in rain and snow. However, in some climates, you may need to use snow tires and chains. If you need to use chains, it is recommended that steel wheels (of the same size and specifications) be used, as chains may chip aluminum wheels.

Note: The suspension insulation and bumpers will help prevent vehicle damage. Do not remove these components from your vehicle when using snow tires and chains.

Follow these guidelines when using snow tires and chains:

- If possible, avoid fully loading your vehicle.
- Use only SAE Class S chains.
- Install chains securely, verifying that the chains do not touch any wiring, brake lines or fuel lines.
- Drive cautiously. If you hear the chains rub or bang against your vehicle, stop and retighten the chains. If this does not work, remove the chains to prevent damage to your vehicle.
- Remove the tire chains when they are no longer needed. Do not use tire chains on dry roads.

TIRE PRESSURE MONITORING SYSTEM



WARNING: The tire pressure monitoring system is NOT a substitute for manually checking tire pressure. The tire pressure should be checked periodically (at least monthly) using a tire gauge. See *Inflating Your Tires* in this chapter. Failure to properly maintain your tire pressure could increase the risk of tire failure, loss of control, vehicle rollover and personal injury.



Each tire, including the spare (if provided), should be checked monthly when cold and inflated to the inflation pressure recommended by the vehicle manufacturer on the vehicle placard or tire inflation pressure label. (If your vehicle has tires of a different size than the size indicated on the vehicle placard or tire inflation pressure label, you should determine the proper tire inflation pressure for those tires.)

As an added safety feature, your vehicle has been equipped with a tire pressure monitoring system (TPMS) that illuminates a low tire pressure telltale when one or more of your tires is significantly under-inflated. Accordingly, when the low tire pressure telltale illuminates, you should stop and check your tires as soon as possible, and inflate them to the proper pressure. Driving on a significantly under-inflated tire causes the tire to overheat and can lead to tire failure. Under-inflation also reduces fuel efficiency and tire tread life, and may affect the vehicle's handling and stopping ability.

Please note that the TPMS is not a substitute for proper tire maintenance, and it is the driver's responsibility to maintain correct tire pressure, even if under-inflation has not reached the level to trigger illumination of the TPMS low tire pressure telltale.

Your vehicle has also been equipped with a TPMS malfunction indicator to indicate when the system is not operating properly. The TPMS malfunction indicator is combined with the low tire pressure telltale. When the system detects a malfunction, the telltale will flash for approximately one minute and then remain continuously illuminated. This sequence will continue upon subsequent vehicle start-ups as long as the malfunction exists.

When the malfunction indicator is illuminated, the system may not be able to detect or signal low tire pressure as intended. TPMS malfunctions may occur for a variety of reasons, including the installation of replacement or alternate tires or wheels on the vehicle that prevent the TPMS from functioning properly. Always check the TPMS malfunction telltale after replacing one or more tires or wheels on your vehicle to ensure that the replacement or alternate tires and wheels allow the TPMS to continue to function properly.

The tire pressure monitoring system complies with part 15 of the FCC rules and with RSS-210 of Industry Canada. Operation is subject to the following two conditions: (1) This device may not cause harmful interference, and (2) This device must accept any interference received, including interference that may cause undesired operation.

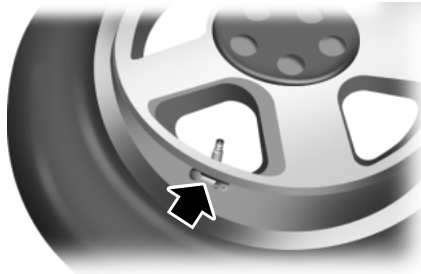
Changing Tires with a Tire Pressure Monitoring System

Note: Each road tire is equipped with a tire pressure sensor located inside the tire and wheel assembly cavity. The pressure sensor is attached to the valve stem. The pressure sensor is covered by the tire and is not visible unless the tire is removed. Take care when changing the tire to avoid damaging the sensor.

You should always have your tires serviced by an authorized dealer.

Check the tire pressure periodically (at least monthly) using an accurate tire gauge. See *Inflating Your Tires* in this chapter.

Understanding Your Tire Pressure Monitoring System

The tire pressure monitoring system measures pressure in your four road tires and sends the tire pressure readings to your vehicle. The low tire pressure warning light will turn on if the tire pressure is significantly low. Once the light is illuminated, your tires are under-inflated and need to be inflated to the manufacturer's recommended tire pressure. Even if the light turns on and a short time later turns off, your tire pressure still needs to be checked.

When your temporary spare tire is installed

When one of your road tires needs to be replaced with the temporary spare, the tire pressure monitoring system will continue to identify an issue to remind you that the damaged road wheel or tire needs to be repaired and put back on your vehicle.

To restore the full function of the tire pressure monitoring system, have the damaged road wheel or tire repaired and remounted on your vehicle. For additional information, see *Changing Tires with a Tire Pressure Monitoring System* in this section.

When you believe your system is not operating properly

The main function of the tire pressure monitoring system is to warn you when your tires need air. It can also warn you in the event the system is no longer capable of functioning as intended. See the following chart for information concerning your tire pressure monitoring system:

| Low tire pressure warning light | Possible cause | Customer action required |
|---------------------------------|---|--|
| Solid warning light | Tire(s) under-inflated | 1. Make sure tires are at the proper pressure. See <i>Inflating your tires</i> in this chapter. 2. After inflating your tires to the manufacturer's recommended pressure as shown on the Tire Label (located on the edge of driver's door or the B-Pillar), the vehicle must be driven for at least two minutes over 20 mph (32 km/h) before the light turns off. |
| | Spare tire in use | Repair the damaged road wheel and tire and reinstall it on the vehicle to restore system function. For a description on how the system functions, see <i>When your temporary spare tire is installed</i> in this section. |
| | Tire pressure monitoring system malfunction | If the tires are properly inflated and the spare tire is not in use but the light remains on, contact your authorized dealer as soon as possible. |
| | Tire rotation without sensor training | On vehicles with different front and rear tire pressures, the system must be retrained following every tire rotation. See <i>Tire rotation</i> in this chapter. |

| Low tire pressure warning light | Possible cause | Customer action required |
|---------------------------------|---|---|
| Flashing warning light | Spare tire in use | Repair the damaged road wheel and tire and reinstall it on the vehicle to restore system function. For a description on how the system functions, see <i>When your temporary spare tire is installed</i> in this section. |
| | Tire pressure monitoring system malfunction | If the tires are properly inflated and the spare tire is not in use but the light remains on, contact your authorized dealer as soon as possible. |

When inflating your tires

When putting air into your tires (such as at a gas station or in your garage), the tire pressure monitoring system may not respond immediately to the air added to your tires.

It may take up to two minutes of driving over 20 mph (32 km/h) for the light to turn off after you have filled your tires to the recommended inflation pressure.

How temperature affects your tire pressure

The tire pressure monitoring system monitors tire pressure in each pneumatic tire. While driving in a normal manner, a typical passenger tire inflation pressure may increase approximately 2 to 4 psi (14 to 28 kPa) from a cold start situation. If the vehicle is stationary overnight with the outside temperature significantly lower than the daytime temperature, the tire pressure may decrease approximately 3 psi (21 kPa) for a drop of 30°F (17°C) in ambient temperature. This lower pressure value may be detected by the system as being significantly lower than the recommended inflation pressure and activate the system warning light for low tire pressure. If the low tire pressure warning light is on, visually check each tire to verify that no tire is flat. If one or more tires are flat, repair as necessary. Check air pressure in the road tires. If any tire is under-inflated, carefully drive the vehicle to the nearest location where air can be added to the tires. Inflate all the tires to the recommended inflation pressure.

Tire Pressure Monitoring System Reset Procedure

WARNING: To determine the required pressure(s) for your vehicle, see the Safety Compliance Certification Label (affixed to either the door hinge pillar, door-latch post, or the door edge that meets the door-latch post, next to the driver's seating position), or Tire Label located on the B-Pillar or the edge of the driver's door. See *Load Carrying* for more information.

Note: The tire pressure monitoring system reset procedure needs to be performed after each tire rotation on vehicles that require different recommended tire pressures in the front tires as compared to the rear tires.

Overview

To provide the vehicle's load carrying capability, some vehicles require different recommended tire pressures in the front tires as compared to the rear tires. The tire pressure monitoring system equipped on these vehicles is designed to illuminate the low tire pressure warning light at two different pressures; one for the front tires and one for the rear tires.

Since tires need to be rotated to provide consistent performance and maximum tire life, the tire pressure monitoring system needs to know when the tires are rotated to determine which set of tires are on the front and which are on the rear. With this information, the system can detect and properly warn of low tire pressures.

System reset tips:

- To reduce the chances of interference from another vehicle, the system reset procedure should be performed at least three feet (one meter) away from another Ford Motor Company vehicle undergoing the system reset procedure at the same time.
- Do not wait more than two minutes between resetting each tire sensor or the system will time-out and the entire procedure will have to be repeated on all four wheels.
- A double horn chirp indicates the need to repeat the procedure.

Performing the System Reset Procedure

Read the entire procedure before attempting.

1. Drive the vehicle above 20 mph (32 km/h) for at least two minutes and then park in a safe location where you can easily get to all four tires and have access to an air pump.
2. Place the ignition in the off position and keep the key in the ignition.
3. Cycle the ignition to the on position with the engine off.
4. Turn the hazard flashers on then off three times. This must be accomplished within 10 seconds.

If the reset mode has been entered successfully, the horn will sound once, the system indicator will flash and a message is shown in the information display (if equipped). If this does not occur, please try again starting at Step 2.

If after repeated attempts to enter the reset mode, the horn does not sound, the system indicator does not flash and no message is shown in the information display (if equipped), seek service from your authorized dealer.

5. **Note:** Train the tire pressure monitoring system sensors in the tires using the following system reset sequence starting with the left front tire in the following clockwise order:

- Left front (Driver's side front tire)
- Right front (Passenger's side front tire)
- Right rear (Passenger's side rear tire)
- Left rear (Driver's side rear tire)

6. Remove the valve cap from the valve stem on the left front tire; decrease the air pressure until the horn sounds.

Note: The single horn chirp confirms that the sensor identification code has been learned by the module for this position. If a double horn is heard, the reset procedure was unsuccessful, and must be repeated.

7. Remove the valve cap from the valve stem on the right front tire; decrease the air pressure until the horn sounds.

8. Remove the valve cap from the valve stem on the right rear tire; decrease the air pressure until the horn sounds.

9. Remove the valve cap from the valve stem on the left rear tire; decrease the air pressure until the horn sounds.

Training is complete after the horn sounds for the last tire trained (driver's side rear tire), the system indicator stops flashing, and a message is shown in the information display (if equipped).

10. Turn the ignition off. If two short horn beeps are heard, the reset procedure was unsuccessful and must be repeated.

If after repeating the procedure and two short beeps are heard when the ignition is turned to off, seek assistance from your authorized dealer.

11. Set all four tires to the recommended air pressure as indicated on the Safety Compliance Certification Label (affixed to either the door hinge pillar, door-latch post, or the door edge that meets the door-latch post, next to the driver's seating position) or Tire Label located on the B-Pillar or the edge of the driver's door. See *Load Carrying* for more information.

CHANGING A ROAD WHEEL



WARNING: The use of tire sealants may damage your tire pressure monitoring system and should not be used. However, if you must use a sealant, the tire pressure monitoring system sensor and valve stem on the wheel must be replaced by an authorized Ford dealer.



WARNING: See *Tire Pressure Monitoring System* in this chapter for important information. If the tire pressure monitor sensor becomes damaged, it will no longer function.

Note: If your vehicle is equipped with the tire pressure monitoring system, the indicator light will illuminate when the spare tire is in use. To restore the full function of the monitoring system, all road wheels equipped with tire pressure monitoring sensors must be mounted on the vehicle.

If you get a flat tire while driving, do not apply the brake heavily. Instead, gradually decrease your speed. Hold the steering wheel firmly and slowly move to a safe place on the side of the road.

If your vehicle is equipped with the tire pressure monitoring system, have a flat serviced by an authorized dealer in order to prevent damage to the system sensors. See *Tire Pressure Monitoring System* in this chapter. Replace the spare tire with a road tire as soon as possible. During repairing or replacing of the flat tire, have the authorized dealer inspect the system sensor for damage.

Dissimilar Spare Tire and Wheel Assembly Information

WARNING: Failure to follow these guidelines could result in an increased risk of loss of vehicle control, injury or death.

If you have a dissimilar spare tire and wheel assembly, then it is intended for temporary use only. This means that if you need to use it, you should replace it as soon as possible with a road tire and wheel assembly that is the same size and type as the road tires and wheels that were originally provided by Ford. If the dissimilar spare tire or wheel is damaged, it should be replaced rather than repaired.

A dissimilar spare tire and wheel assembly is defined as a spare tire or wheel that is different in brand, size or appearance from the road tires and wheels and can be one of three types:

1. **T-type mini-spare:** This spare tire begins with the letter T for tire size and may have Temporary Use Only molded in the sidewall.
2. **Full-size dissimilar spare with label on wheel:** This spare tire has a label on the wheel that states: THIS TIRE AND WHEEL FOR TEMPORARY USE ONLY

When driving with one of the dissimilar spare tires listed above, do not:

- exceed 50 mph (80 km/h).
- load the vehicle beyond maximum vehicle load rating listed on the Safety Compliance Label.
- tow a trailer.
- use snow chains on the end of the vehicle with the dissimilar spare tire.
- use more than one dissimilar spare tire at a time.
- use commercial car washing equipment.
- try to repair the dissimilar spare tire.

Use of one of the dissimilar spare tires listed above at any one wheel location can lead to impairment of the following:

- Handling, stability and braking performance
- Comfort and noise
- Ground clearance and parking at curbs
- Winter weather driving capability
- Wet weather driving capability
- All-wheel driving capability

3. Full-size dissimilar spare without label on wheel

When driving with the full-size dissimilar spare tire and wheel assembly, do not:

- exceed 70 mph (113 km/h).
- use more than one dissimilar spare tire and wheel at a time.
- use commercial car washing equipment.
- use snow chains on the end of the vehicle with the dissimilar spare tire and wheel.

The usage of a full-size dissimilar spare tire and wheel assembly can lead to impairment of the following:

- Handling, stability and braking performance
- Comfort and noise
- Ground clearance and parking at curbs
- Winter weather driving capability
- Wet weather driving capability
- All-wheel driving capability (if applicable)
- Load leveling adjustment (if applicable)

When driving with the full-size dissimilar spare tire and wheel assembly, additional caution should be given to:

- towing a trailer.
- driving vehicles equipped with a camper body.
- driving vehicles with a load on the cargo rack.

Drive cautiously when using a full-size dissimilar spare tire and wheel, and seek service as soon as possible.

Location of the Spare Tire and Tools

If your vehicle is equipped with a spare tire, jack and associated tools, refer to the following table for their locations:

| Tool | Location |
|----------------------------------|--|
| Spare tire (pick-up trucks only) | Under the vehicle, just forward of the rear bumper |
| Jack | Regular cab and Crew Cab: Fastened to floor pan behind rearmost seat on passenger side SuperCab: Under rear bench seat on passenger side |

| Tool | Location |
|---|---|
| Jack handle, lug wrench, lug wrench extension (only available on Dual Rear Wheel [DRW] vehicles) and wheel chock (only available on Single Rear Wheel [SRW] vehicles equipped with a diesel engine) | Regular cab: Fastened to floor behind driver seat SuperCab: Fastened to floor under rear seat Crew Cab: Fastened to floor behind rear seat at driver side |
| Key and spare tire lock | In the glove box |

Removing the Spare Tire (With Spare Tire Carrier Only)

1. The following tools are required to remove the spare tire:

- one handle extension and two typical extensions. To assemble, align the button with the hole and slide the parts together.

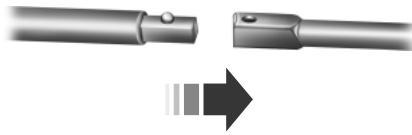

To disconnect, press the button and pull apart.

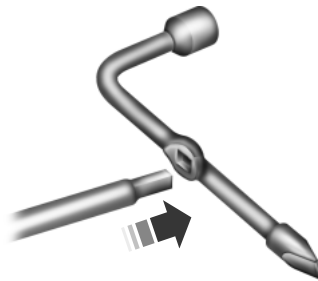

- one wheel nut wrench. Slide over the square end of the jack handle.

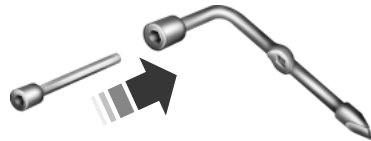

- **Note:** For vehicles equipped with dual rear wheels, insert the lug wrench extension into the lug wrench to reach the lug nuts.

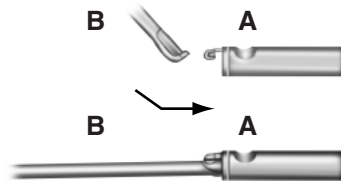

2. Attach the spare tire lock key (A) to the jack handle (B).



3. Fully insert the jack handle (with one extension) through the bumper hole and into the guide tube. The key and lock will engage with a slight push and counterclockwise turn. Some resistance will be felt when turning the jack handle assembly.

4. Turn the handle counterclockwise and lower the spare tire until you can slide the tire rearward and the cable is slack.

5. Remove the retainer through the center of the wheel.

Note: If equipped with a tether, perform the following steps:

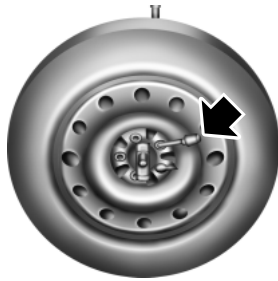

6. Lift the spare tire on end to access the tether attachment.

7. Use the lug wrench to remove the lug nut from the spare tire tether.

8. If not replacing the spare or flat tire to the underbody storage area, raise the wheel retainer up into the installed position.

9. Use the attached fastener strap (on the spare tire tether) to attach the tether end to the winch retainer prior to raising to the installed position.

Tire Change Procedure



WARNING: When one of the front wheels is off the ground, the transmission alone will not prevent the vehicle from moving or slipping off the jack, even if the transmission selector lever is in position **P**.



WARNING: To help prevent the vehicle from moving when you change a tire, be sure to place the transmission selector lever in position **P**, set the parking brake and block (in both directions) the wheel that is diagonally opposite (other side and end of the vehicle) to the tire being changed.



WARNING: Never get underneath a vehicle that is supported only by a jack. If the vehicle slips off the jack, you or someone else could be seriously injured.



WARNING: Do not attempt to change a tire on the side of the vehicle close to moving traffic. Pull far enough off the road to avoid the danger of being hit when operating the jack or changing the wheel.

 **WARNING:** Always use the jack provided as original equipment with your vehicle. If using a jack other than the one provided as original equipment with your vehicle, make sure the jack capacity is adequate for the vehicle weight, including any vehicle cargo or modifications.

Note: Passengers should not remain in the vehicle when the vehicle is being jacked.

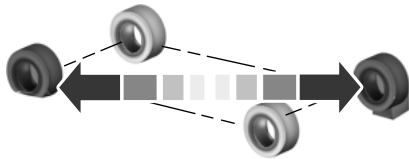

1. Turn the engine off and block the wheel that is diagonally opposite of the flat tire using the wheel chock, if equipped. **Note:** If the vehicle is a 4x4, lock the manual hub on the wheel.

2. Remove the jack, jack handle, lug wrench and spare tire from the stowage locations.

3. Use the tip of the lug wrench to remove any wheel trim.

4. Loosen each wheel lug nut one-half turn counterclockwise, but do not remove them until the wheel is raised off the ground.

The following steps apply to F-250 and F-350 single rear wheel vehicles only:

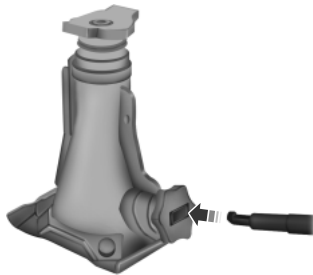

5. Insert the hooked end of the jack handle into the jack and use the handle to slide the jack under the vehicle.

6. Position the jack according to the following guides:

- Front (4x2)

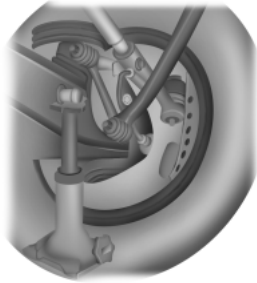

- Front driver side (4x4)

Note: Make sure the jack fits onto the flat area on the outboard side of the differential.

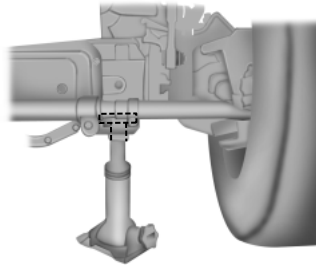

- Front passenger side (4x4)

Note: View shown from the rear of the vehicle to clearly identify the jack point. Place the jack directly under the axle.

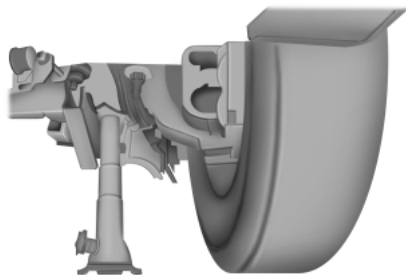

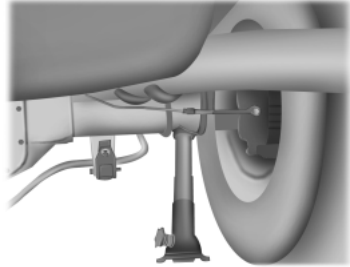

- Rear

Note: Jack at the specified locations to avoid damage to the vehicle.



7. Turn the jack handle clockwise until the wheel is completely off the ground and high enough to install the spare tire.

8. Remove the lug nuts with the lug wrench.

9. Replace the flat tire with the spare tire, making sure the valve stem is facing outward for all front wheels and single rear wheel

vehicles. If replacing an inboard rear tire on dual rear wheel vehicles, the valve stem must be facing outward. If replacing the outboard wheel, the valve stem must be facing inward. Reinstall the lug nuts until the wheel is snug against the hub. Do not fully tighten the lug nuts until the wheel has been lowered.

10. Lower the wheel by turning the jack handle counterclockwise.

Go to Step 19.

The following steps apply to F-350 Dual Rear Wheel, F-450 and F-550 vehicles only:

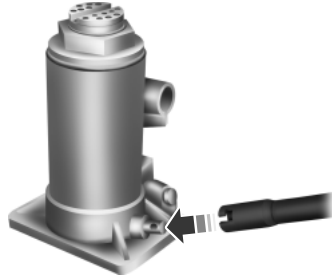

11. Slide the notched end of the jack handle over the release valve and use the handle to slide the jack under the vehicle. Make sure the valve is closed by turning it clockwise.

12. Position the jack according to the following guides:

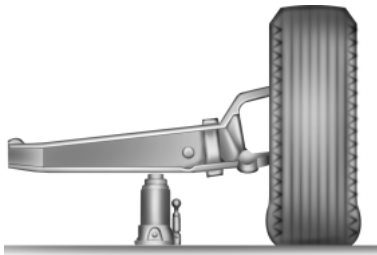

- Front (4x2): F-350 dual rear wheel

Note: Place the jack directly under the I-beam.

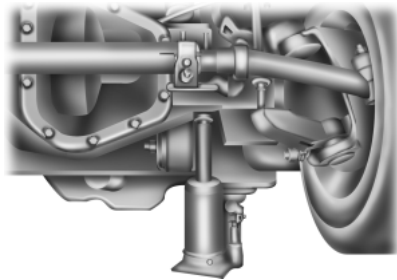

- Front driver side (4x4): F-350 dual rear wheel

Note: Make sure the jack fits onto the flat area on the outboard side of the differential housing.

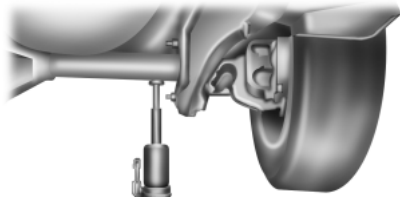

- Front passenger side (4x4):
F-350 dual rear wheel

Note: View shown from the rear of the vehicle to clearly identify the jack point.

Note: Place the jack directly under the axle and inboard of the radius arm so that the jack clears the radius arm.

- Front: F-450 and F-550

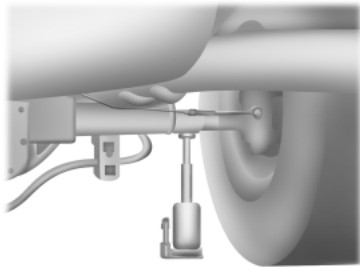
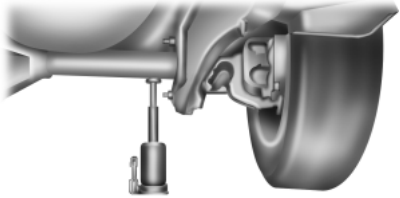

- Rear: F-350 dual rear wheel

- Rear: F-450 and F-550

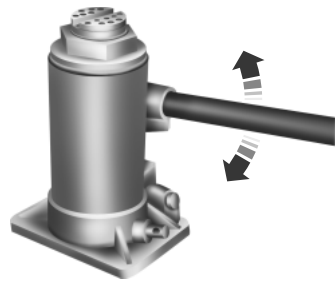
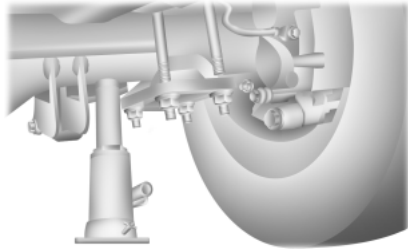

13. Insert the jack handle into the pump linkage.

14. Use an up-and-down motion with the jack handle to raise the wheel completely off the ground.

Note: Hydraulic jacks are equipped with a pressure release valve that prevents lifting loads which exceed the jack's rated capacity.

15. Remove the lug nuts with the lug wrench.

16. Replace the flat tire with the spare tire, making sure the valve stem is facing outward on all front and inboard rear wheels. If replacing the outboard wheel, the valve stem must be facing inward. Reinstall the lug nuts until the wheel is snug against the hub. Do not fully tighten the lug nuts until the wheel has been lowered.

17. Lower the wheel by slowly turning the release valve counterclockwise. Opening the release valve slowly will provide a more controlled rate of descent.

Note: The following steps apply to all vehicles:

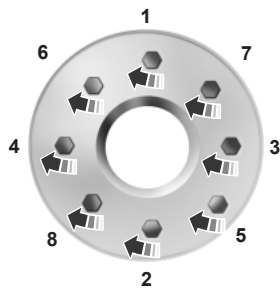

18. Remove the jack and fully tighten the lug nuts in the order shown. See *Wheel Lug Nut Torque Specifications* in this chapter for the proper lug nut torque specification.

8-lug nut torque sequence



10-lug nut torque sequence

19. Stow the flat tire. See *Stowing the flat or spare tire* if the vehicle is equipped with a spare tire carrier.

20. Stow the jack, jack handle and lug wrench. Make sure the jack is securely fastened so it does not rattle when driving.

21. Unblock the wheels.

The following step applies to F-250 and F-350 Single Rear Wheel vehicles only:

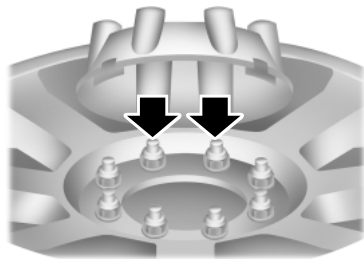

22. When installing the wheel center ornaments, ensure that the ornament retention towers on the back side of the ornament are aligned with the studs or lug nuts. The retention towers are designed to be installed over the studs or nuts and retain to the flange on the lug nut.

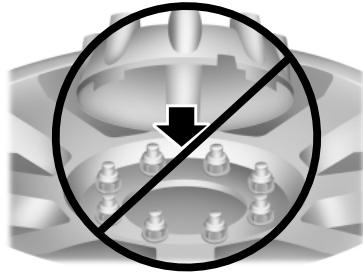

If the ornament retention towers are aligned between the studs or lug nuts, the ornament is improperly installed. This improper installation may appear and sound correct, but will not keep the ornament on the vehicle. Ornaments improperly installed in this manner will fall off or become loose with minimal force or impact.

Installing Dual Rear Wheel Ornaments

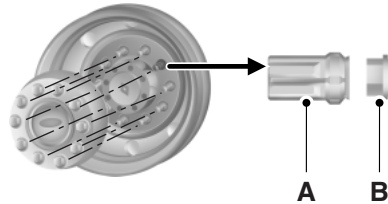

1. Align the ornament with the lug nuts.

- (A) is the clip and (B) is the flange.

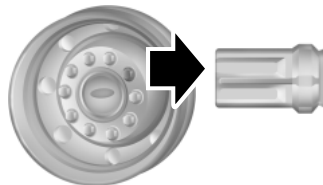

2. Hold the ornament so that all of the retention clips are sitting on the flange of the lug nuts.

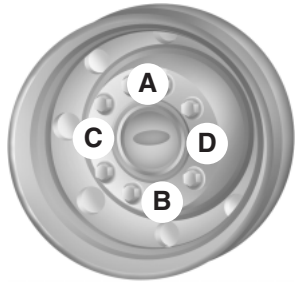

3. Use your hand or rubber mallet to tap the ornament in a star pattern. There should be an even gap between the ornament and the wheel.

4. Be sure to install all the clips on the nuts over the flanges so that there is an even gap all around and the retention clips are fully seated.

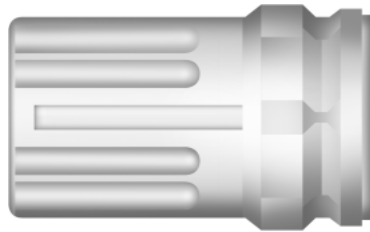

Stowing the flat/spare tire

Note: Failure to follow spare tire stowage instructions may result in failure of cable or loss of spare tire.

Note: If you are stowing a tire that requires reattaching it to the vehicle with a tether, perform these steps first, then proceed with the steps following.

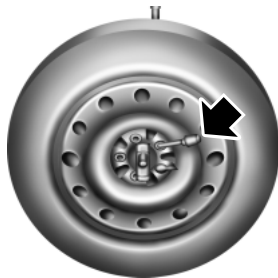

1. Place the tire on end with the valve stem facing toward the front of the vehicle.

2. Place the tether into the bolt holes in the wheel and attach the lug nut using the lug winch.

3. Lay the tire on the ground with the valve stem facing up.

4. Slide the wheel partially under the vehicle and install the retainer through the wheel center. Pull on the cable to align the components at the end of the cable.

5. Turn the jack handle clockwise until the tire is raised to its stowed position underneath the vehicle. The effort to turn the jack handle increases significantly and the spare tire carrier ratchets or slips when the tire is raised to the maximum tightness. Tighten to the best of your ability, to the point where the ratchet/slip occurs, if possible. The spare tire carrier will not allow you to overtighten. If the spare tire carrier ratchets or slips with little effort, take the vehicle to your authorized dealer for assistance at your earliest convenience.

6. Check that the tire lies flat against the frame and is properly tightened. Try to push or pull, then turn the tire to be sure it will not move. Loosen and retighten, if necessary. Failure to properly stow the spare tire may result in failure of the winch cable and loss of the tire.

7. Repeat this tightness check procedure when servicing the spare tire pressure (every six months, per *scheduled maintenance information*), or at any time that the spare tire is disturbed through service of other components.

8. If removed, install the spare tire lock (if equipped) into the bumper drive tube with the spare tire lock key (if equipped) and jack handle.

TECHNICAL SPECIFICATIONS**Wheel Lug Nut Torque Specifications**

WARNING: When a wheel is installed, always remove any corrosion, dirt or foreign materials present on the mounting surfaces of the wheel or the surface of the wheel hub, brake drum or brake disc that contacts the wheel. Make sure that any fasteners that attach the rotor to the hub are secured so they do not interfere with the mounting surfaces of the wheel. Installing wheels without correct metal-to-metal contact at the wheel mounting surfaces can cause the wheel nuts to loosen and the wheel to come off while the vehicle is in motion, resulting in loss of control.

On vehicles equipped with single rear wheels, retighten the lug nuts to the specified torque at 100 miles (160 kilometers) after any wheel disturbance (such as tire rotation, changing a flat tire, wheel removal).

On vehicles equipped with dual rear wheels, retighten the wheel lug nuts to the specified torque at 100 miles (160 kilometers), and again at 500 miles (800 kilometers) of new vehicle operation and after any wheel disturbance (such as tire rotation, changing a flat tire, wheel removal).

| Bolt size | Wheel lug nut torque* | |
|-----------|-----------------------|-----|
| | ft-lb | N•m |
| M14 x 1.5 | 165 | 224 |

* Torque specifications are for nut and bolt threads free of dirt and rust. Use only Ford recommended replacement fasteners.

It is important to follow the proper wheel mounting and lug nut torque procedures.



On all two-piece flat wheel nuts, apply one drop of motor oil between the flat washer and the nut.



Inspect the wheel pilot hole and mounting surface prior to installation. Remove any visible corrosion or loose particles.

ENGINE SPECIFICATIONS

| Engine | 6.2L V8 engine | 6.8L V10 engine |
|-------------------|------------------------------------|----------------------------------|
| Cubic inches | 378 | 413 |
| Required fuel | Minimum 87 octane or Ethanol (E85) | Minimum 87 octane |
| Firing order | 1-5-4-8-6-3-7-2 | 1-6-5-10-2-7-3-8-4-9 |
| Spark plug gap | 0.041-0.047 inch (1.04-1.20 mm) | 0.039-0.043 inch (1.0-1.1 mm) |
| Ignition system | Coil on plug | Coil on plug |
| Compression ratio | 9.8:1 | 9.2:1 |

Engine Drivebelt Routing

6.2L V8 engine

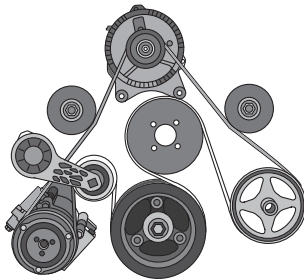

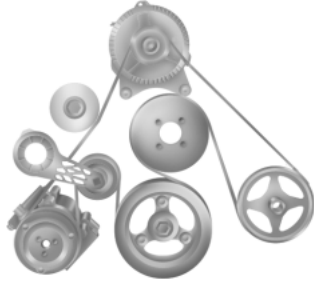

6.8L V10 engine with A/C

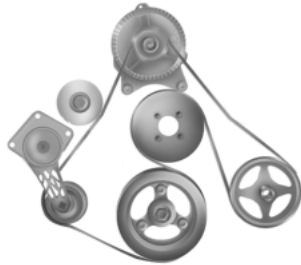

6.8L V10 engine - without A/C

TECHNICAL SPECIFICATIONS

| Item | Capacity | Ford part name | Ford part number / Ford specification |
|--|--|--|--|
| Front axle | 5.8 pints (2.8L) | Motorcraft® SAE 80W-90 Premium Rear Axle Lubricant | XY-80W-90-QL / WSP-M2C197-A |
| Spindle bearing | — | High Temperature 4X4 Front Axle and Wheel Bearing Grease | XG-11 / WSS-M1C267-A1 |
| Rear axle - F-250/350 (10.50 inch axle) ¹ | 6.9 pints (3.3L) | Motorcraft® SAE 75W-140 Synthetic Rear Axle Lubricant | XY-75W140-QL / WSL-M2C192-A |
| Rear axle - F-350 (Dana M80) | 8.5 pints (4.0L) | Motorcraft® SAE 75W-90 Synthetic Rear Axle Lubricant | XY-75W90-QLS / WSS-M2C918-A |
| Rear axle - F-450/550 (Dana S110/S130) | 14.0 pints (6.6L) | Motorcraft® SAE 75W-140 Synthetic Rear Axle Lubricant | XY-75W140-QL / WSL-M2C192-A |
| Brake fluid | Between MIN/MAX on brake fluid reservoir | Motorcraft® High Performance DOT 3 Motor Vehicle Brake Fluid | PM-1-C / WSS-M6C62-A or WSS-M6C65-A1 |
| Engine coolant (6.2L V8 engine) ² | 21.3 quarts (20.2L) | Motorcraft® Orange Antifreeze/Coolant Prediluted | VC-3DIL-B (US) / CVC-3DIL-B (Canada) / WSS-M97B44-D2 |
| Engine coolant (6.8L V10 engine) ² | 26.7 quarts (25.3L) | | |

| Item | Capacity | Ford part name | Ford part number / Ford specification |
|---|-------------------|---|---------------------------------------|
| Engine and fuel coolant (diesel engine) | | Refer to the diesel supplement. | |
| Engine oil (6.2L V8 and 6.8L V10 gasoline engines) ^{5,6} | 7.0 quarts (6.6L) | Motorcraft® or equivalent SAE 5W-20 motor oil | WSS-M2C945-A |
| Engine oil (diesel engine) | | Refer to the diesel supplement. | |
| Fuel tank (incomplete vehicle, steel tank, middle location) | 28 gallons (106L) | — | — |
| Fuel tank (pickup with gasoline engine) | 35 gallons (132L) | — | — |
| Fuel tank (incomplete vehicle, steel tank, aft axle location) | 40 gallons (151L) | — | — |
| Fuel tank (diesel engine) | | Refer to the diesel supplement. | |
| Hinges, latches, striker plates, fuel filler door hinge and seat tracks | — | Multi-Purpose Grease | XG-4 or XL-5 / ESB-M1C93-B |
| Lock cylinders | — | Motorcraft® Penetrating and Lock Lubricant | XL-1 / None |
| Transmission / parking brake linkages and pivots, brake pedal shift | — | Motorcraft® Premium Long-Life Grease | XG-1-C or XG-1-K / WSD-M1C227-A |

| Item | Capacity | Ford part name | Ford part number / Ford specification |
|---|---|---|--|
| Power steering fluid | Keep fluid level between MIN and MAX on reservoir | Motorcraft® MERCON® V ATF | XT-5-QM / MERCON® V |
| Transfer case fluid | 2.0 quarts (1.9L) | Motorcraft® Transfer Case Fluid | XL-12 / — |
| Automatic transmission fluid (5-speed) ^{3,4,7} | 17.5 quarts (16.6L) | Motorcraft® MERCON® LV ATF | XT-10-QLV / MERCON® LV |
| | 18.5 quarts (17.5L) | | |
| Automatic transmission fluid (6-speed) ^{3,4,8} | 16.7 quarts (15.8L) | | |
| Windshield washer fluid | Fill as required | Motorcraft® Premium Windshield Washer Concentrate (US) Premium Quality Windshield Washer Fluid (Canada) | ZC-32-A (US) CXC-37-(A, B, D, and F) (Canada) / WSB-M8B16-A2 / - - |

¹Add 8 oz. (236 ml) of Additive Friction Modifier XL-3 or equivalent meeting Ford Specification EST-M2C118-A for complete refill of limited slip Ford axles. Ford design rear axles contain a synthetic lubricant that does not require changing unless the axle has been submerged in water.

²Add the coolant type originally equipped in your vehicle.

³Ensure the correct automatic transmission fluid is used. Transmission fluid requirements are indicated on the dipstick blade or the dipstick handle. Check the container to verify the fluid being added is of the correct type. Refer to your *scheduled maintenance information* to determine the correct service interval.

Note: Automatic transmissions that require MERCON® LV should only use MERCON® LV fluid. Use of any fluid other than the recommended fluid may cause transmission damage.

⁴Indicates only approximate dry-fill capacity. Some applications may vary based on cooler size and if equipped with an in-tank cooler. The amount of transmission fluid and fluid level should be set by the indication on the dipstick's normal operating range.

⁵Use of synthetic or synthetic blend motor oil is not mandatory. Engine oil must meet or exceed the requirements of Ford specification WSS-M2C945-A, SAE 5W-20, and display the API Starburst Certification Mark.

⁶If the Ford specification is not shown on the oil container, the oil container must display the API Starburst Certification Mark and the correct viscosity.

⁷Refer to *Checking automatic transmission fluid* in this chapter for the correct dipstick type. Fill to the proper capacity according to dipstick Type A.

⁸Refer to *Checking automatic transmission fluid* in this chapter for the correct dipstick type. Fill to the proper capacity according to dipstick Type B.

MOTORCRAFT® PART NUMBERS

| Component | 6.2L V8 engine | 6.8L V10 engine |
|------------------------|----------------|-----------------|
| Air filter element | FA-1883 | FA-1883 |
| Oil filter | FL-820-S | FL-820-S |
| Battery (standard) | BXT-65-650 | BXT-65-650 |
| Battery (optional) | BXT-65-750 | BXT-65-750 |
| Spark plugs-platinum | 1 | |
| Seat filter | FS-107 | |
| Windshield wiper blade | WW-2201-PF | |

¹For spark plug replacement, see your authorized dealer. Refer to the *scheduled maintenance information* for the appropriate intervals for changing the spark plugs.

Note: Replace the spark plugs with ones that meet Ford material and design specifications for your vehicle, such as Motorcraft® or equivalent replacement parts. The customer warranty may be void for any damage to the engine if such spark plugs are not used.

VEHICLE IDENTIFICATION NUMBER

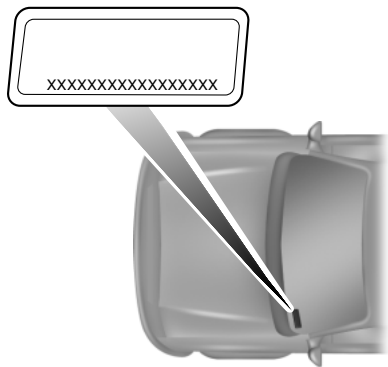

The vehicle identification number is located on the driver's side instrument panel.

Please note that in the graphic, XXXX is representative of your vehicle identification number.

The Vehicle Identification Number (VIN) contains the following information:

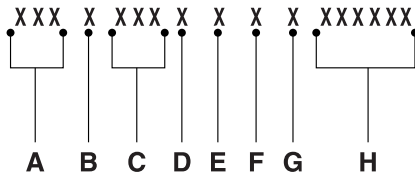

- A. World manufacturer identifier
- B. Brake system / Gross Vehicle Weight Rating (GVWR) / Restraint Devices and their location
- C. Make, vehicle line, series, body type
- D. Engine type
- E. Check digit
- F. Model year
- G. Assembly plant
- H. Production sequence number.

VEHICLE CERTIFICATION LABEL

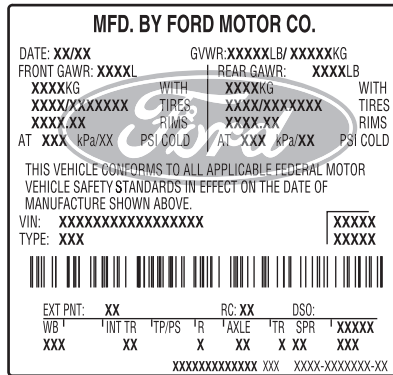

The National Highway Traffic Safety Administration Regulations require that a Safety Compliance Certification Label be affixed to a vehicle and prescribe where the Safety Compliance Certification Label may be located. The Safety Compliance Certification Label shall be affixed to either the door hinge pillar, the door latch post, or the edge of the door near the door latch, next to the driver's seating position.

TRANSMISSION CODE DESIGNATION

MFD. BY FORD MOTOR CO.

DATE: XX/XX GVWR: XXXXXLB/ XXXXXKG
 FRONT GAWR: XXXXL REAR GAWR: XXXXLB
 XXXXKG WITH XXXXKG WITH
 XXXX/XXXXXXXXX TIRES XXXX/XXXXXXXXX TIRES
 XXXX.XX RIMS XXXX.XX RIMS
 AT XXX kPa/XX PSI COLD AT XXX kPa/XX PSI COLD

THIS VEHICLE CONFORMS TO ALL APPLICABLE FEDERAL MOTOR VEHICLE SAFETY STANDARDS IN EFFECT ON THE DATE OF MANUFACTURE SHOWN ABOVE.

VIN: XXXXXXXXXXXXXXXX XXXXX
 TYPE: XXX XXXXX



EXT PNT: XX RC: XX DSO: XXXXX
 WB¹ INT TR TP/PS R AXLE TR SPR XXXXX
 XXX XX X XX X XX XXX

XXXXXXXXXXXXX XX XXXX-XXXXXX-XX

You can find a transmission code on the Safety Compliance Certification Label. The following table tells you which transmission each code represents.

| Description | Code |
|--|------|
| Five-speed manual (TR4050) | 2 |
| Five-speed automatic (5R110W) | T |
| Six-speed automatic (6R140) (gasoline engines) | P |
| Six-speed automatic (6R140W) (diesel engines) | W |

ACCESSORIES

For a complete listing of the accessories that are available for your vehicle, please contact your dealer or visit our online store at:

Accessories.Ford.com (U.S. only).

Ford Custom Accessories are available for your vehicle through your local Ford or Ford of Canada dealer. Ford Motor Company will repair or replace any properly dealer-installed Ford Custom Accessories found to be defective in factory-supplied materials or workmanship during the warranty period, as well as any component damaged by the defective accessories. The accessories will be warranted for whichever provides you the greatest benefit:

- 12 months or 12000 miles (20000 kilometers) (whichever occurs first), or
- the remainder of your new vehicle limited warranty.

Contact your dealer for details and a copy of the warranty.

Exterior style

- Bug shields
- Bright metallic exhaust tips
- Deflectors
- Running boards
- Splash guards
- Step bars
- Fog lamps
- Custom graphics*
- Stainless steel wheel covers*
- Wheel well liners

Interior style

- Floor mats
- Cargo organizers
- Custom seat covers*

Lifestyle

- Ash cup / smoker's package
- Bedliners and bedmats
- Rear seat entertainment*
- Tonneau covers*
- Trailer hitches, wiring harnesses and accessories
- Racks and carriers*
- Truck bed camping tent*
- Sportliner cargo liner*
- Bed extender

Peace of mind

- Keyless entry keypad
- Remote start
- Vehicle security systems
- Wheel locks
- Protective seat covers*
- Bumper and hitch mounted parking sensors*
- Back up alarm*
- Cable lock*
- Bed hooks*
- Tool/Cargo boxes*
- Speed/cruise control

*Ford Licensed Accessories (FLA) are warranted by the accessory manufacturer's warranty. Ford Licensed Accessories are fully designed and developed by the accessory manufacturer and have not been designed or tested to Ford Motor Company engineering requirements. Contact your Ford dealer for details regarding the manufacturer's limited warranty and/or a copy of the FLA product limited warranty offered by the accessory manufacturer.

For maximum vehicle performance, keep the following information in mind when adding accessories or equipment to your vehicle:

- When adding accessories, equipment, passengers and luggage to your vehicle, do not exceed the total weight capacity of the vehicle or of the front or rear axle (GVWR or GAWR as indicated on the Safety Compliance Certification label). Consult your authorized dealer for specific weight information.
- The Federal Communications Commission (FCC) and Canadian Radio Telecommunications Commission (CRTC) regulate the use of mobile communications systems — such as two-way radios, telephones and theft alarms — that are equipped with radio transmitters. Any such equipment installed in your vehicle should comply with FCC or CRTC regulations and should be installed only by a qualified service technician.
- Mobile communications systems may harm the operation of your vehicle, particularly if they are not properly designed for automotive use.
- To avoid interference with other vehicle functions, such as anti-lock braking systems, amateur radio users who install radios and antennas onto their vehicle should not locate the amateur radio antennas in the area of the driver's side hood.
- Any non-Ford custom electrical or electronic accessories or components that are added to the vehicle by the authorized dealer or the owner may adversely affect battery performance and durability, and may also adversely affect the performance of other electrical systems in the vehicle.

FORD ESP EXTENDED SERVICE PLANS

PROTECT YOURSELF FROM THE RISING COST OF VEHICLE REPAIRS WITH A FORD EXTENDED SERVICE PLAN.

SERVICE PLANS (U.S. only)

More than 32 Million Ford and Lincoln owners have discovered the powerful protection Ford ESP. It is the only extended service plan backed by Ford Motor Company, and provides peace of mind protection beyond the expiration of the New Vehicle Warranty coverage.

Ford ESP can quickly pay for itself

One service bill – the cost of parts and labor – can easily exceed the price of your Ford Extended Service Plan. With Ford ESP, you minimize your risk for unexpected repair bills and rising repair costs.

Coverage for up to 500+ covered components

There are four, Extended Service Plans with different levels of coverage. Ask your dealer for details.

1. PremiumCARE – Our most comprehensive coverage. With over 500 covered components, this plan is so complete that we generally only discuss what's not covered.
2. ExtraCARE – Covers 113 components, and includes many high tech items
3. BaseCARE – Covers 84 components
4. PowertrainCARE – Covers 29 critical components

Ford ESP is honored by all Ford and Lincoln Dealers in the United States and Canada. It is the only Extended Service Plan authorized and backed by Ford Motor Company. That means you get:

- Reliable, quality service anywhere you go
- Repairs performed by factory trained technicians, using Genuine Ford and Lincoln parts

Rental Car Reimbursement

1st day Rental Benefit – You take advantage of replacement transportation if your vehicle is at the dealership for same day covered repairs.

Extended Rental Benefits – If your vehicle is kept overnight for covered repairs, you are eligible for rental car coverage, including Bumper to Bumper warranty repairs, or Field Service Actions.

Roadside Assistance

Exclusive 24/7 roadside assistance, including:

- Towing, flat-tire change and battery jump starts
- Out of fuel and lock-out assistance
- Travel Expense reimbursement for lodging, meals and rental car
- Destination assistance for taxi, shuttle, rental car coverage and emergency transportation

Transferable Coverage

If you sell your vehicle before your Ford Extended Service Plan coverage expires, you can transfer any remaining coverage to the new owner. Whenever you sell your vehicle, prospective buyers may have a higher degree of confidence that vehicle was properly maintained with Ford ESP, thereby improving resale value!

Avoid the Rising cost of vehicle maintenance

Ford ESP also offers a Premium Maintenance Plan that covers all scheduled maintenance, and select items that routinely wear out.

The coverage is prepaid, so you never have to worry about affording vehicle maintenance. It covers regular checkups, routine inspections, preventative care and replacement items that require periodic attention for normal wear:

- Windshield Wiper Blades
- Spark Plugs (except in California)
- The clutch Disc
- Brake pads and linings
- Shock Absorbers
- Belts and Hoses
- Diesel Exhaust Fluid Replenishment

Contact your selling dealership today so they can customize a Genuine Ford Extended Service Plan that fits your driving lifestyle and budget.

Interest Free Financing Options Available

Take advantage of our interest free installment payment plan. Just a 10% down payment will provide you with an affordable, no interest, no fee payment program.

Complete the information below and mail to:

Ford ESP
PO Box 8072
Royal Oak Michigan 48068-0039

To learn more, call our Ford ESP specialists at 800-367-3377. Don't forget to ask about our interest free payment program, allowing you all the security and benefits Ford ESP has to offer while paying over time. You are pre-approved with no credit checks, no hassles!

SERVICE PLANS (CANADA ONLY)

You can get more protection for your vehicle by purchasing a Ford Extended Service Plan. Ford Extended Service Plan is the only service contract backed by Ford Motor Company of Canada, Limited. Depending on the plan you purchase, Ford Extended Service Plan provides benefits such as:

- Rental reimbursement
- Coverage for certain maintenance and wear items
- Protection against repair costs after your New Vehicle Limited Warranty Coverage expires
- Roadside Assistance benefits

There are several Ford Extended Service Plans available in various time, distance and deductible combinations. Each plan is tailored to fit your own driving needs, including reimbursement for towing and rental.

When you purchase Ford Extended Service Plan, you receive added peace-of-mind protection throughout Canada and the United States, provided by a network of participating Ford Motor Company dealers. The Lincoln Maintenance Protection Plan is honored at authorized Lincoln dealers.

Note: Repairs performed outside of Canada and the United States are not eligible for Ford Extended Service Plan coverage.

This information is subject to change.

For more information, visit your local Ford of Canada dealer or www.ford.ca to find the Ford Extended Service Plan that is right for you.

GENERAL MAINTENANCE INFORMATION**Why Maintain Your Vehicle?**

Carefully following the maintenance schedule helps protect against major repair expenses resulting from neglect or inadequate maintenance and may also help to increase the value of your vehicle when you sell or trade it. Keep all receipts for completed maintenance with the vehicle.

Regular maintenance intervals for your vehicle have been established based upon rigorous testing. It is important that you have your vehicle serviced at the proper times. These intervals serve two purposes; one is to maintain the reliability of your vehicle and the second is to keep your cost of owning the vehicle down.

It is your responsibility to see that all scheduled maintenance is performed and that the materials used meet the specifications identified in the *Capacities and Specifications* chapter. Failure to perform scheduled maintenance invalidates warranty coverage on parts affected by the lack of maintenance.

Why Maintain Your Vehicle at Your Dealership?***Factory-Trained Technicians***

Service technicians participate in extensive factory-sponsored certification training to help them become experts on the operation of your vehicle. Ask your dealership about the training and certification their technicians have received.

Genuine Ford and Motorcraft® Replacement Parts

Dealerships stock Ford, Motorcraft® and Ford-authorized branded remanufactured replacement parts. These parts meet or exceed Ford Motor Company's specifications. Parts installed at your dealership carry a nationwide, 12 month/12000 mile (20000 kilometer) parts and labor limited warranty. If you do not use Ford authorized parts, they may not meet Ford specifications and, depending on the part, it could affect emissions compliance.

Convenience

Many dealerships have extended evening and Saturday hours to make your service visit more convenient and they offer one stop shopping. They can perform any services that are required on your vehicle, from general maintenance to collision repairs.

Note: Not all dealers have extended hours or bodyshops. Please contact your dealer for details.

Protecting Your Investment

Maintenance is an investment that will pay dividends in the form of improved reliability, durability and resale value. To maintain the proper performance of your vehicle and its emission control systems, it is imperative that scheduled maintenance be completed at the designated intervals.

Your vehicle is very sophisticated and built with multiple, complex, performance systems. Every manufacturer develops these systems using different specifications and performance features. That is why it is important to rely upon your dealership to properly diagnose and repair your vehicle.

Ford Motor Company has recommended maintenance intervals for various parts and component systems based upon engineering testing. Ford Motor Company relies upon this testing to determine the most appropriate mileage for replacement of oils and fluids to protect your vehicle at the lowest overall cost to you and recommends against maintenance schedules that deviate from the scheduled maintenance information.

Ford strongly recommends the use of only genuine Ford, Motorcraft® or Ford-authorized remanufactured replacement parts because they are engineered for your vehicle.

Additives and Chemicals

Ford Motor Company recommended additives and chemicals are listed in the owner manual and in the Ford Workshop Manual. Additional chemicals or additives, not approved by Ford Motor Company, are not recommended as part of normal maintenance. Please consult your warranty information.

Oils, Fluids and Flushing

In many cases, fluid discoloration is a normal operating characteristic and, by itself, does not necessarily indicate a concern or that the fluid needs to be changed. However, discolored fluids that also show signs of overheating and foreign material contamination should be inspected immediately by a qualified expert, such as the factory-trained technicians at your dealership. Your vehicle's oils and fluids should be changed at the specified intervals or in conjunction with a repair. Flushing is a viable way to change fluid for many vehicle sub-systems during scheduled maintenance. It is critical that systems are flushed only with new fluid that is the same as that required to fill and operate the system, or using a Ford-approved flushing chemical.

Owner Checks and Services

Certain basic maintenance checks and inspections should be performed every month or at six month intervals.

| Check every month |
|---|
| Engine oil level. |
| Function of all interior and exterior lights. |
| Tires (including spare) for wear and proper pressure. |
| Windshield washer fluid level. |
| Check every six months |
| Battery connections. Clean if necessary. |
| Body and door drain holes for obstructions. Clean if necessary. |
| Cooling system fluid level and coolant strength. |
| Door weatherstrips for wear. Lubricate if necessary. |
| Hinges, latches and outside locks for proper operation. Lubricate if necessary. |
| Parking brake for proper operation. |
| Safety belts and seat latches for wear and function. |
| Safety warning lamps (brake, ABS, airbag, safety belt) for operation. |
| Washer spray and wiper operation. Clean or replace blades as necessary. |

Multi-point Inspection

In order to keep your vehicle running right, it is important to have the systems on your vehicle checked regularly. This can help identify potential issues and prevent major problems. Ford Motor Company recommends the following multi-point inspection be performed at every scheduled maintenance interval to help make sure your vehicle keeps running great.

| Multi-point inspection | |
|--|--|
| Accessory drive belt(s) | Horn operation |
| Battery performance | Radiator, cooler, heater and A/C hoses |
| Engine air filter | Suspension component for leaks or damage |
| Exhaust system | Steering and linkage |
| Exterior lamps and hazard warning system operation | Tires (including spare) for wear and proper pressure** |
| Fluid levels*; fill if necessary | Windshield for cracks, chips or pits |
| For oil and fluid leaks | Washer spray and wiper operation |

*Brake, coolant recovery reservoir, automatic transmission, power steering and window washer.

**If your vehicle is equipped with a temporary mobility kit, check the tire sealant expiration Use By date on the canister. Replace as needed.

Be sure to ask your dealership service advisor or technician about the multi-point vehicle inspection. It is a comprehensive way to perform a thorough inspection of your vehicle. It is your checklist that gives you immediate feedback on the overall condition of your vehicle. You will know what has been checked, what is okay, as well as those things that may require future or immediate attention. The multi-point vehicle inspection is one more way to keep your vehicle running great!

GENUINE
PARTS & SERVICE

Personal Member of:
 Personal Service Business

Multi-Point Inspection Report Card as Recommended by Ford Motor Company

Name: _____

E-Mail Address: _____

Today's Date: _____

State Inspection Month: _____

SCHEDULED MAINTENANCE / INSPECTION CHECKS FOR SERVICE ON THIS MODEL

| | |
|--|---|
| <input type="checkbox"/> Engine Air Filter | <input type="checkbox"/> Oil Filter |
| <input type="checkbox"/> Engine Air Filter | <input type="checkbox"/> Spark Plugs |
| <input type="checkbox"/> Engine Coolant | <input type="checkbox"/> Tire Rotation |
| <input type="checkbox"/> Fuel Filter | <input type="checkbox"/> Transmission Fluid |
| <input type="checkbox"/> Oil Change | |

*This is only a partial list of vehicle maintenance items and is NOT all-inclusive. Please consult your Owner Manual or visit www.ford.com/ownersvc for vehicle specific maintenance requirements.

SYNC VEHICLE HEALTH REPORT

VMS Activation: Yes No

Checked and OK (this area contributes to vehicle with a green status)

CHECK FLUID LEVELS AND FILL

Oil and/or Oil Additives

Coolant

Windshield Washer

Power Steering

Brake Fluid

Transmission

Battery

Air Conditioning

Fuel System

Exhaust System

Suspension (bushes, bearings, loose parts)

Steering and Drive Axle

Brakes (if equipped)

Tire Tread, Inspect for uneven wear and damage (if equipped)

Lights (head, tail, brake, turn, fog, hazard, and backup)

Wipers (washer spray, upper and lower blades)

Wheel and Tire Condition

Wheel and Tire Alignment

Wheel and Tire Balance

Wheel and Tire Rotation

Wheel and Tire Inflation

Wheel and Tire Pressure

Wheel and Tire Condition

Wheel and Tire Alignment

Wheel and Tire Balance

Wheel and Tire Rotation

Wheel and Tire Inflation

Wheel and Tire Pressure

EXTERIOR BODY

Factory spot and scratch repair

Any existing exterior body damage or defects

TIRES/BRAKE WEAR

| LEFT FRONT | | RIGHT FRONT | |
|---|---|---|---|
| <input type="checkbox"/> Tire Tread | <input type="checkbox"/> Tire Tread Depth | <input type="checkbox"/> Tire Tread | <input type="checkbox"/> Tire Tread Depth |
| <input type="checkbox"/> Tire Wear Pattern Damage | <input type="checkbox"/> Tire Pressure - set to factory recommended PSI | <input type="checkbox"/> Tire Wear Pattern Damage | <input type="checkbox"/> Tire Pressure - set to factory recommended PSI |
| <input type="checkbox"/> Brake Lining | <input type="checkbox"/> Brake Lining | <input type="checkbox"/> Brake Lining | <input type="checkbox"/> Brake Lining |
| <input type="checkbox"/> Tire Alignment | <input type="checkbox"/> Tire Alignment | <input type="checkbox"/> Tire Alignment | <input type="checkbox"/> Tire Alignment |
| <input type="checkbox"/> Tire Rotation | <input type="checkbox"/> Tire Rotation | <input type="checkbox"/> Tire Rotation | <input type="checkbox"/> Tire Rotation |
| <input type="checkbox"/> Tire Inflation | <input type="checkbox"/> Tire Inflation | <input type="checkbox"/> Tire Inflation | <input type="checkbox"/> Tire Inflation |
| <input type="checkbox"/> Tire Pressure | <input type="checkbox"/> Tire Pressure | <input type="checkbox"/> Tire Pressure | <input type="checkbox"/> Tire Pressure |

Comments: _____

Service Advisor: _____ Customer Signature: _____

Technician: _____

12-XXXXXXXX

NORMAL SCHEDULED MAINTENANCE AND LOG

| Normal scheduled maintenance – 6.2L and 6.8L engines only* | |
|---|---|
| Every 7500 miles (12000 km) or six months (whichever comes first) | Change engine oil and filter. |
| | Rotate tires**, inspect tire wear and measure tread depth. |
| | Inspect wheels and related components for abnormal noise, wear, looseness or drag. |
| | Perform multi-point inspection (recommended). |
| Every 15000 miles (24000 km) or 12 months (whichever comes first) | Inspect automatic transmission fluid level. Consult dealer for requirements. |
| | Inspect brake pads, shoes, rotors, drums, brake linings, hoses and parking brake. |
| | Inspect engine cooling system strength and hoses. |
| | Inspect exhaust system and heat shields. |
| | Inspect front axle and U-joints. Lubricate if equipped with grease fittings (Four-wheel drive vehicles). |
| | Inspect steering linkage, ball joints, suspension, tie-rod ends, driveshaft and U-joints. Lubricate if equipped with grease fittings. |

*Scheduled maintenance for the 6.7L diesel engine can be found in the diesel supplement.

**Vehicles equipped with dual rear wheels should rotate the front wheels when specified; rear wheels only if unusual wear is noted.

| Other maintenance items | |
|-----------------------------------|--|
| Every 30000 miles (48000 km) | Replace climate-controlled (heated and cooled) seat filter (if equipped). |
| | Replace engine air filter. |
| Every 60000 miles (96000 km) | Change automatic transmission fluid and filter on 5-speed transmission. Consult dealer for requirements. |
| | Replace front wheel bearing grease and grease seal if non-sealed bearings are used. |
| Every 97500 miles (156000 km) | Replace spark plugs. |
| Every 105000 miles (168000 km) | Change engine coolant.* |
| | Change rear axle fluid (Dana axles). |
| | Inspect accessory drive belt(s).** |
| Every 150000 miles (240000 km) | Change automatic transmission fluid and filter on 6-speed transmission. Consult dealer for requirements. |
| | Change front axle fluid (Four-wheel drive vehicles). |
| | Change rear axle fluid (non-Dana axles). |
| | Change transfer case fluid (Four-wheel drive vehicles). |
| | Replace accessory drive belt(s) if not replaced within the last 100000 miles (160000 km). |
| | Replace front wheel bearings and seals if non-sealed bearings are used. |

*Initial replacement at six years or 105000 miles (168000 kilometers), then every three years or 45000 miles (72000 kilometers).

**If not replaced, inspect every 15000 miles (24000 kilometers).

Maintenance Schedule Log

| | |
|--|--|
| <p style="text-align: center;">DEALER VALIDATION:</p> <p>RO#: P&A CODE: HOURS: DATE: MILEAGE:</p> | <p style="text-align: center;">DEALER VALIDATION:</p> <p>RO#: P&A CODE: HOURS: DATE: MILEAGE:</p> |
| <p style="text-align: center;">DEALER VALIDATION:</p> <p>RO#: P&A CODE: HOURS: DATE: MILEAGE:</p> | <p style="text-align: center;">DEALER VALIDATION:</p> <p>RO#: P&A CODE: HOURS: DATE: MILEAGE:</p> |
| <p style="text-align: center;">DEALER VALIDATION:</p> <p>RO#: P&A CODE: HOURS: DATE: MILEAGE:</p> | <p style="text-align: center;">DEALER VALIDATION:</p> <p>RO#: P&A CODE: HOURS: DATE: MILEAGE:</p> |
| <p style="text-align: center;">DEALER VALIDATION:</p> <p>RO#: P&A CODE: HOURS: DATE: MILEAGE:</p> | <p style="text-align: center;">DEALER VALIDATION:</p> <p>RO#: P&A CODE: HOURS: DATE: MILEAGE:</p> |
| <p style="text-align: center;">DEALER VALIDATION:</p> <p>RO#: P&A CODE: HOURS: DATE: MILEAGE:</p> | <p style="text-align: center;">DEALER VALIDATION:</p> <p>RO#: P&A CODE: HOURS: DATE: MILEAGE:</p> |

Scheduled Maintenance

411

| | |
|---|---|
| <p style="text-align: center;">DEALER VALIDATION:</p> <p style="text-align: center;">P&A CODE:</p> <p>RO#: HOURS:</p> <p>DATE: MILEAGE:</p> | <p style="text-align: center;">DEALER VALIDATION:</p> <p style="text-align: center;">P&A CODE:</p> <p>RO#: HOURS:</p> <p>DATE: MILEAGE:</p> |
| <p style="text-align: center;">DEALER VALIDATION:</p> <p style="text-align: center;">P&A CODE:</p> <p>RO#: HOURS:</p> <p>DATE: MILEAGE:</p> | <p style="text-align: center;">DEALER VALIDATION:</p> <p style="text-align: center;">P&A CODE:</p> <p>RO#: HOURS:</p> <p>DATE: MILEAGE:</p> |
| <p style="text-align: center;">DEALER VALIDATION:</p> <p style="text-align: center;">P&A CODE:</p> <p>RO#: HOURS:</p> <p>DATE: MILEAGE:</p> | <p style="text-align: center;">DEALER VALIDATION:</p> <p style="text-align: center;">P&A CODE:</p> <p>RO#: HOURS:</p> <p>DATE: MILEAGE:</p> |
| <p style="text-align: center;">DEALER VALIDATION:</p> <p style="text-align: center;">P&A CODE:</p> <p>RO#: HOURS:</p> <p>DATE: MILEAGE:</p> | <p style="text-align: center;">DEALER VALIDATION:</p> <p style="text-align: center;">P&A CODE:</p> <p>RO#: HOURS:</p> <p>DATE: MILEAGE:</p> |
| <p style="text-align: center;">DEALER VALIDATION:</p> <p style="text-align: center;">P&A CODE:</p> <p>RO#: HOURS:</p> <p>DATE: MILEAGE:</p> | <p style="text-align: center;">DEALER VALIDATION:</p> <p style="text-align: center;">P&A CODE:</p> <p>RO#: HOURS:</p> <p>DATE: MILEAGE:</p> |

Scheduled Maintenance

| | |
|---|---|
| <p style="text-align: center;">DEALER VALIDATION:</p> <p style="text-align: center;">P&A CODE:</p> <p>RO#: HOURS:</p> <p>DATE: MILEAGE:</p> | <p style="text-align: center;">DEALER VALIDATION:</p> <p style="text-align: center;">P&A CODE:</p> <p>RO#: HOURS:</p> <p>DATE: MILEAGE:</p> |
| <p style="text-align: center;">DEALER VALIDATION:</p> <p style="text-align: center;">P&A CODE:</p> <p>RO#: HOURS:</p> <p>DATE: MILEAGE:</p> | <p style="text-align: center;">DEALER VALIDATION:</p> <p style="text-align: center;">P&A CODE:</p> <p>RO#: HOURS:</p> <p>DATE: MILEAGE:</p> |
| <p style="text-align: center;">DEALER VALIDATION:</p> <p style="text-align: center;">P&A CODE:</p> <p>RO#: HOURS:</p> <p>DATE: MILEAGE:</p> | <p style="text-align: center;">DEALER VALIDATION:</p> <p style="text-align: center;">P&A CODE:</p> <p>RO#: HOURS:</p> <p>DATE: MILEAGE:</p> |
| <p style="text-align: center;">DEALER VALIDATION:</p> <p style="text-align: center;">P&A CODE:</p> <p>RO#: HOURS:</p> <p>DATE: MILEAGE:</p> | <p style="text-align: center;">DEALER VALIDATION:</p> <p style="text-align: center;">P&A CODE:</p> <p>RO#: HOURS:</p> <p>DATE: MILEAGE:</p> |
| <p style="text-align: center;">DEALER VALIDATION:</p> <p style="text-align: center;">P&A CODE:</p> <p>RO#: HOURS:</p> <p>DATE: MILEAGE:</p> | <p style="text-align: center;">DEALER VALIDATION:</p> <p style="text-align: center;">P&A CODE:</p> <p>RO#: HOURS:</p> <p>DATE: MILEAGE:</p> |

SPECIAL OPERATING CONDITIONS – 6.2L AND 6.8L ENGINES ONLY

Note: If your vehicle is equipped with the 6.7L diesel engine, see the diesel supplement for special operating condition maintenance.

If you operate your vehicle **primarily** in one of the more demanding conditions listed below, you need to have some items maintained more frequently. If you only **occasionally** operate your vehicle under these conditions, it is not necessary to perform the additional maintenance. For specific recommendations, see your dealership service advisor or technician.

| Towing a trailer or using a camper or car-top carrier | |
|--|--|
| Inspect frequently, service as required | Inspect and lubricate U-joints. |
| | See axle maintenance items under <i>Exceptions</i> . |
| Every 5000 miles (8000 km) | Inspect the wheels and related components for abnormal noise, wear, looseness or drag. |
| | Rotate tires*, inspect tires for wear and measure tread depth. |
| Every 5000 miles (8000 km) or six months | Change engine oil and filter. |
| | Inspect and lubricate U-joints. |
| Every 30000 miles (48000 km) | Replace front wheel bearing grease and grease seals if non-sealed bearings are used. |

*Vehicles equipped with dual rear wheels should rotate the front wheels when specified; rear wheels only if unusual wear is noted.

Scheduled Maintenance

| Extensive idling or low-speed driving for long distances as in heavy commercial use (such as delivery, taxi, patrol car or livery) | |
|---|--|
| Inspect frequently, service as required | Replace engine air filter. |
| Every 5000 miles (8000 km) | Inspect brake system. |
| | Inspect wheels and related components for abnormal noise, wear, looseness or drag. |
| | Lubricate control arm and steering ball joints if equipped with grease fittings. |
| Every 5000 miles (8000 km) or six months | Rotate tires*, inspect tires for wear and measure tread depth. |
| | Change engine oil and filter. |
| Every 30000 miles (48000 km) | Inspect and lubricate U-joints. |
| | Replace front wheel bearing grease and grease seals if non-sealed bearings are used. |
| Every 60000 miles (96000 km) | Change transfer case fluid (4WD vehicles). |
| | Replace spark plugs. |

*Vehicles equipped with dual rear wheels should rotate the front wheels when specified; rear wheels only if unusual wear is noted.

| Operating in dusty or sandy conditions such as unpaved or dusty roads | |
|--|--|
| Inspect frequently, service as required | Replace engine air filter. |
| Every 5000 miles (8000 km) | Inspect the wheels and related components for abnormal noise, wear, looseness or drag. |
| | Rotate tires*, inspect tires for wear and measure tread depth. |
| Every 5000 miles (8000 km) or six months | Change engine oil and filter. |
| | Inspect and lubricate U-joints. |
| Every 30000 miles (48000 km) | Replace front wheel bearing grease and grease seals if non-sealed bearings are used. |

| Operating in dusty or sandy conditions such as unpaved or dusty roads | |
|--|--|
| Every 50000 miles (80000 km) | Change rear axle fluid (F-450/550 only). |
| Every 60000 miles (96000 km) | Change transfer case fluid (4WD vehicles). |

*Vehicles equipped with dual rear wheels should rotate the front wheels when specified; rear wheels only if unusual wear is noted.

| Off-road operation | |
|--|---|
| Inspect frequently, service as required | Inspect steering linkage, ball joints and U-joints, Lubricate if equipped with grease fittings. |
| | Replace engine air filter. |
| Every 5000 miles (8000 km) or six months | Change engine oil and filter. |
| | Inspect the wheels and related components for abnormal noise, wear, looseness or drag. |
| | Rotate tires*, inspect tires for wear and measure tread depth. |
| Every 30000 miles (48000 km) | Replace front wheel bearing grease and grease seals if non-sealed bearings are used. |
| Every 50000 miles (80000 km) | Change rear axle fluid (F-450/550 only). |
| Every 60000 miles (96000 km) | Change transfer case fluid (4WD vehicles). |

*Vehicles equipped with dual rear wheels should rotate the front wheels when specified; rear wheels only if unusual wear is noted.

| Exclusive use of E85 (flex fuel vehicles only) | |
|---|--|
| Every oil change interval | If ran exclusively on E85, fill the fuel tank full with regular unleaded fuel. |

Special Operating Condition Log

| | |
|--|--|
| <p>DEALER VALIDATION:</p> <p>RO#: P&A CODE: HOURS: DATE: MILEAGE:</p> | <p>DEALER VALIDATION:</p> <p>RO#: P&A CODE: HOURS: DATE: MILEAGE:</p> |
| <p>DEALER VALIDATION:</p> <p>RO#: P&A CODE: HOURS: DATE: MILEAGE:</p> | <p>DEALER VALIDATION:</p> <p>RO#: P&A CODE: HOURS: DATE: MILEAGE:</p> |
| <p>DEALER VALIDATION:</p> <p>RO#: P&A CODE: HOURS: DATE: MILEAGE:</p> | <p>DEALER VALIDATION:</p> <p>RO#: P&A CODE: HOURS: DATE: MILEAGE:</p> |
| <p>DEALER VALIDATION:</p> <p>RO#: P&A CODE: HOURS: DATE: MILEAGE:</p> | <p>DEALER VALIDATION:</p> <p>RO#: P&A CODE: HOURS: DATE: MILEAGE:</p> |
| <p>DEALER VALIDATION:</p> <p>RO#: P&A CODE: HOURS: DATE: MILEAGE:</p> | <p>DEALER VALIDATION:</p> <p>RO#: P&A CODE: HOURS: DATE: MILEAGE:</p> |

Scheduled Maintenance

417

| | |
|--|--|
| <p style="text-align: center;">DEALER VALIDATION:</p> <p style="text-align: center;">P&A CODE:</p> <p>RO#: HOURS:</p> <p>DATE: MILEAGE:</p> | <p style="text-align: center;">DEALER VALIDATION:</p> <p style="text-align: center;">P&A CODE:</p> <p>RO#: HOURS:</p> <p>DATE: MILEAGE:</p> |
| <p style="text-align: center;">DEALER VALIDATION:</p> <p style="text-align: center;">P&A CODE:</p> <p>RO#: HOURS:</p> <p>DATE: MILEAGE:</p> | <p style="text-align: center;">DEALER VALIDATION:</p> <p style="text-align: center;">P&A CODE:</p> <p>RO#: HOURS:</p> <p>DATE: MILEAGE:</p> |
| <p style="text-align: center;">DEALER VALIDATION:</p> <p style="text-align: center;">P&A CODE:</p> <p>RO#: HOURS:</p> <p>DATE: MILEAGE:</p> | <p style="text-align: center;">DEALER VALIDATION:</p> <p style="text-align: center;">P&A CODE:</p> <p>RO#: HOURS:</p> <p>DATE: MILEAGE:</p> |
| <p style="text-align: center;">DEALER VALIDATION:</p> <p style="text-align: center;">P&A CODE:</p> <p>RO#: HOURS:</p> <p>DATE: MILEAGE:</p> | <p style="text-align: center;">DEALER VALIDATION:</p> <p style="text-align: center;">P&A CODE:</p> <p>RO#: HOURS:</p> <p>DATE: MILEAGE:</p> |
| <p style="text-align: center;">DEALER VALIDATION:</p> <p style="text-align: center;">P&A CODE:</p> <p>RO#: HOURS:</p> <p>DATE: MILEAGE:</p> | <p style="text-align: center;">DEALER VALIDATION:</p> <p style="text-align: center;">P&A CODE:</p> <p>RO#: HOURS:</p> <p>DATE: MILEAGE:</p> |

EXCEPTIONS

Normal vehicle axle maintenance: Rear axles and power take-off units with synthetic fluid and light-duty trucks equipped with Ford-design axles are lubricated for life; do not check or change fluid unless a leak is suspected, service is required or the assembly has been submerged in water. During long periods of trailer towing with outside temperatures above 70°F (21°C) and at wide-open throttle for long periods above 45 mph (72 km/h), non-synthetic rear axle fluids should be changed every 3000 miles (4800 kilometers) or three months, whichever comes first. This interval can be waived if the axle is filled with 75W140 synthetic gear fluid meeting Ford specification WSL-M2C192-A, part number F1TZ-19580-B or equivalent. Add friction modifier XL-3 (EST-M2C118-A) or equivalent for complete refill of Traction-Lok rear axles (see *Technical specifications* in the *Capacities and Specifications* chapter for details).

Police/Taxi/Livery vehicle axle maintenance: Change rear axle fluid every 100000 miles (160000 km). Rear axle fluid change may be waived if the axle was filled with 75W140 synthetic gear fluid meeting Ford specification WSL-M2C192-A, part number FITZ-19580-B or equivalent. Add four ounces (118 mL) of additive friction modifier XL-3 (EST-M2C118-A) or equivalent for complete refill of Traction-Lok rear axles. The axle fluid should be changed anytime the axle has been submerged in water.

California fuel filter replacement: If the vehicle is registered in California, the California Air Resources Board has determined that the failure to perform this maintenance item will not nullify the emission warranty or limit recall liability prior to the completion of the vehicle's useful life. Ford Motor Company, however, urges you to have all recommended maintenance services performed at the specified intervals and to record all vehicle service.

Hot climate oil change intervals: Vehicles operating in the Middle East, North Africa, Sub-Saharan Africa or locations with similar climates using an American Petroleum Institute (API) Certified for Gasoline Engines (Certification mark) oil of SM or SN quality, the normal oil change interval is 5000 miles (8000 kilometers). If the available API SM or SN oils are not available, then the oil change service interval is 3000 miles (4800 kilometers).

Engine air filter replacement: Engine air filter life is dependent on exposure to dusty and dirty conditions. Vehicles operated in these conditions require frequent inspection and replacement of the engine air filter.

Scheduled Maintenance

419

ENGINE COOLANT CHANGE RECORD

| | |
|----------------------|--|
| Initial change | Six years or 105000 miles (168000 km) (whichever comes first) |
| After initial change | Every three years or 45000 miles (72000 km) |

Engine Coolant Change Log

| | |
|---|---|
| <p style="text-align: center;">DEALER VALIDATION:</p> <p style="text-align: center;">P&A CODE:</p> <p>RO#: HOURS:</p> <p>DATE: MILEAGE:</p> | <p style="text-align: center;">DEALER VALIDATION:</p> <p style="text-align: center;">P&A CODE:</p> <p>RO#: HOURS:</p> <p>DATE: MILEAGE:</p> |
| <p style="text-align: center;">DEALER VALIDATION:</p> <p style="text-align: center;">P&A CODE:</p> <p>RO#: HOURS:</p> <p>DATE: MILEAGE:</p> | <p style="text-align: center;">DEALER VALIDATION:</p> <p style="text-align: center;">P&A CODE:</p> <p>RO#: HOURS:</p> <p>DATE: MILEAGE:</p> |
| <p style="text-align: center;">DEALER VALIDATION:</p> <p style="text-align: center;">P&A CODE:</p> <p>RO#: HOURS:</p> <p>DATE: MILEAGE:</p> | <p style="text-align: center;">DEALER VALIDATION:</p> <p style="text-align: center;">P&A CODE:</p> <p>RO#: HOURS:</p> <p>DATE: MILEAGE:</p> |

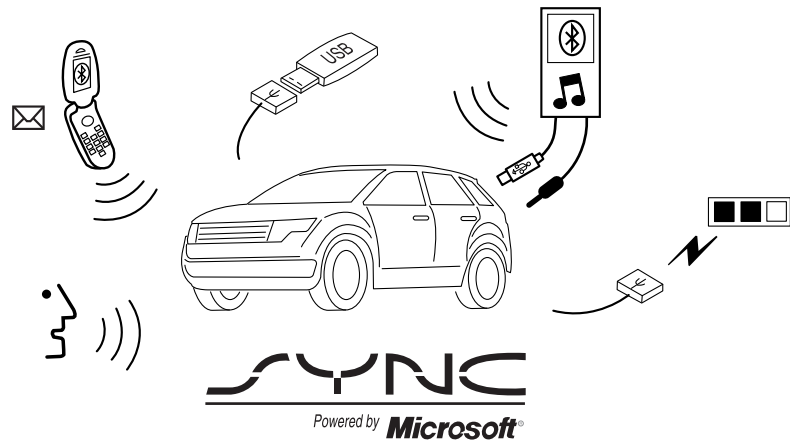

SYNC is an in-vehicle communications system that works with your Bluetooth-enabled cellular phone and portable media player. This allows you to:

- Make and receive calls.
- Access and play music from your portable music player.
- Use 911 Assist, Vehicle Health Report and SYNC Services (Traffic, Directions & Information) (if equipped).
- Use applications, such as Pandora and Stitcher, via SYNC AppLink™ (if applicable).
- Access phonebook contacts and music via voice commands.
- Stream music from your connected phone.
- Text message.
- Use the advanced voice recognition system.
- USB device charging (if your device supports this).

GENERAL INFORMATION

Make sure you review your device's manual before using it with SYNC.

Support

The SYNC support team is available to help you with any questions you cannot answer on your own.

Monday-Saturday, 8:30am-8:00pm EST.

In the United States, call: 1-888-270-1055.

In Canada, call: 1-800-565-3673.

Times are subject to change due to holidays.

SYNC Owner Account

Why do I need a SYNC owner account?

- Required to activate Vehicle Health Report and to view the reports online.
- Required to activate the subscription-based SYNC Services and to personalize your Saved Points and Favorites.
- Essential for keeping up with the latest software downloads available for SYNC.
- Access to customer support for any questions you may have.

Driving Restrictions

For your safety, certain features are speed-dependent and restricted when your vehicle is traveling over 3 mph (5 km/h).

Safety Information

WARNING: Driving while distracted can result in loss of vehicle control, accident and injury. Ford strongly recommends that drivers use extreme caution when using any device that may take their focus off the road. Your primary responsibility is the safe operation of the vehicle. We recommend against the use of any handheld device while driving, encourage the use of voice-operated systems when possible and that you become aware of applicable state and local laws that may affect use of electronic devices while driving.

When using SYNC:

- Do not operate playing devices if the power cords or cables are broken, split or damaged. Place cords and cables out of the way, so they do not interfere with the operation of pedals, seats, compartments or safe driving abilities.
- Do not leave playing devices in your vehicle during extreme conditions as it could cause them damage. See your device's manual for further information.
- Do not attempt to service or repair the system. See your authorized dealer.

For your safety, some SYNC functions are speed-dependent. Their use is limited to when your vehicle is traveling at speeds under 3 mph (5 km/h).

Make sure that you review your device's manual before using it with SYNC.

Privacy Information

When a cellular phone is connected to SYNC, the system creates a profile within your vehicle that is linked to that cellular phone. This profile is created in order to offer you more cellular features and to operate more efficiently. Among other things, this profile may contain data about your cellular phone book, text messages (read and unread), and call history, including history of calls when your cell phone was not connected to the system. In addition, if you connect a media device, the system creates and retains an index of supported media content. The system also records a short development log of approximately 10 minutes of all recent system activity. The log profile and other system data may be used to improve the system and help diagnose any problems that may occur.

The cellular profile, media device index, and development log remain in the vehicle unless you delete them and are generally accessible only in the vehicle when the cellular phone or media player is connected. If you no longer plan to use the system or the vehicle, we recommend you perform a Master Reset to erase all stored information.

System data cannot be accessed without special equipment and access to the vehicle's SYNC module. Ford Motor Company and Ford of Canada do not access the system data for any purpose other than as described absent consent, a court order, or where required by law enforcement, other government authorities, or other third parties acting with lawful authority. Other parties may seek to access the information independently of Ford Motor Company and Ford of Canada. For further privacy information, see the sections on 911 Assist, Vehicle Health Report, and Traffic, Directions and Information.

USING VOICE RECOGNITION

This system helps you control many features using voice commands. This allows you to keep your hands on the wheel and focus on what is in front of you.

Initiating a Voice Session



Push the voice icon; a tone sounds and Listening appears in the display. Say any of the following:

| Say: | If you want to: |
|-------------------------|--|
| “Phone” | Make calls. |
| “USB” | Access the device connected to your USB port. |
| “Bluetooth Audio” | Stream audio from your phone. |
| “Line in” | Access the device connected to the auxiliary input jack. |
| “Cancel” | Cancel the requested action. |
| “SYNC” | Return to the main menu. |
| “Voice settings” | Adjust the level of voice interaction and feedback. |
| “Vehicle Health Report” | Run a vehicle health report.* |
| “Services” | Access the SYNC Services portal.* |
| “Mobile apps” | Access mobile applications.* |
| “Help” | Hear a list of voice commands available in the current mode. |

*If equipped, U.S. only.

System Interaction and Feedback

The system provides feedback through audible tones, prompts, questions and spoken confirmations depending on the situation and the chosen level of interaction (voice settings). You can customize the voice recognition system to provide more or less instruction and feedback.

The default setting is to a higher level of interaction in order to help you learn to use the system. You can change these settings at any time.

Adjusting the Interaction Level



Push the voice icon; when prompted, say “Voice settings”, then any of the following:

| When you say: | The system: |
|-----------------------------|--|
| “Interaction mode standard” | Provides more detailed interaction and guidance. |
| “Interaction mode advanced” | Provides less audible interaction and more tone prompts. |

The system defaults to the standard interaction mode.

Confirmation prompts are short questions the system asks when it is not sure of your request or when there are multiple possible responses to your request. (For example, the system may ask “Phone, is that correct?”) If turned off, the system simply makes a best guess as to what you requested and you may still occasionally be asked to confirm settings.

| |
|----------------------------|
| “Confirmation prompts on” |
| “Confirmation prompts off” |

The system creates candidate lists when it has the same confidence level of several options based on your voice command. When turned on, you may be prompted with as many as four possibilities for clarification.

For example, “Say 1 after the tone to call John Doe at home. Say 2 after the tone to call Johnny Doe on mobile. Say 3 after the tone to call Jane Doe at home.” Or, “Say 1 after the tone to play John Doe, Say 2 after the tone to play Johnny Doe.”

| |
|-----------------------------|
| “Phone candidate lists on” |
| “Phone candidate lists off” |
| “Media candidate lists on” |
| “Media candidate lists off” |

Helpful Hints

- Make sure the interior of the vehicle is as quiet as possible. Wind noise from open windows and road vibrations may prevent the system from correctly recognizing spoken commands.
- After pressing the voice icon, wait until after the tone sounds and Listening appears before saying a command. Any command spoken prior to this does not register with the system.
- Speak naturally, without long pauses between words.
- At any time you can interrupt the system while it is speaking by pressing the voice icon.

USING SYNC WITH YOUR PHONE

Hands-free calling is one of the main features of SYNC. While the system supports a variety of features, many are dependent on your cellular phone's functionality. At a minimum, most cellular phones with Bluetooth wireless technology support the following functions:

- Answering an incoming call
- Ending a call
- Using privacy mode
- Dialing a number
- Redialing
- Call waiting notification
- Caller ID.

Other features, such as text messaging using Bluetooth and automatic phonebook download, are phone-dependent features. To check your phone's compatibility, see your phone's user manual and visit www.SYNCMYride.com, www.SYNCMYride.ca or www.syncmaroute.ca.

Pairing a Phone for the First Time

Note: SYNC can support downloading up to approximately 2000 entries per Bluetooth-enabled cellular phone.

Note: Make sure the vehicle ignition and radio are turned on and the transmission is in position **P**.

Note: To scroll through the menus, press the up and down arrows on your audio system.

Wirelessly pairing your phone with SYNC allows you to make and receive hands-free calls.

1. Press the phone button; when the display indicates no phone is paired, press **OK**.
2. When **Find SYNC** appears in the display, press **OK**.
3. Put your phone into Bluetooth discovery mode. See your phone's user guide if necessary.
4. When prompted on your phone's display, enter the six-digit PIN provided by SYNC in the radio display.
5. The display indicates when the pairing is successful.

Depending on your phone's capability and your market, the system may prompt you with questions such as setting the current phone as the primary phone (the phone SYNC automatically tries to connect with first upon vehicle start-up), downloading your phone book, etc.

Pairing Subsequent Phones

Note: To scroll through the menus, press the up and down arrows on your audio system.

Note: Make sure the vehicle ignition and radio are turned on and that the transmission is in position **P**.

1. Press the phone button and scroll until System Settings is selected.
2. Press OK and scroll until Bluetooth Devices is selected and press OK.
3. Scroll until Add Bluetooth Device is selected and press OK.
4. When Find SYNC appears in the display, press OK.
5. Put your phone into Bluetooth discovery mode. See your phone's user guide if necessary.
6. When prompted on your phone's display, enter the six-digit PIN provided by SYNC in the radio display. The display indicates when the pairing is successful.
7. The system then prompts with questions such as if you would like to set the current phone as the primary phone (the phone SYNC automatically tries to connect with first upon vehicle start-up), download your phone book, etc.

Phone Voice Commands



Press the voice icon and say “Phone”. Say any of the following:

| “PHONE” |
|---|
| “Call <name>” ^{1,2} |
| “Call <name> on mobile OR cell” ^{1,2} |
| “Call <name> on other” ^{1,2} |
| “Phone book <name> at home” ² |
| “Phone book <name> on mobile OR cell” ² |
| “Call history outgoing” ² |
| “Phone book <name> on Other” ² |
| “Call history missed” ² |
| “Menu” ^{2,3} |
| “Join” |
| “Call <name> at home” ^{1,2} |
| “Call <name> at work” OR “Call <name> in office” ^{1,2} |
| “Dial” ^{1,4} |
| “Phone book <name>” ² |
| “Phone book <name> at work” OR “Phone book <name> at office” ² |
| “Call history incoming” ² |
| “Connections” ² |
| “Go to privacy” |
| “Hold” |

¹These commands do not require you to say “Phone” first.

²These commands are not available until phone information is completely downloaded using Bluetooth.

³See “MENU” table below.

⁴See “DIAL” table below.

| “MENU” |
|--|
| “(Phone) connections”* |
| “(Phone) settings (message) notification off”* |
| “(Phone) settings (message) notification on”* |
| “(Phone) settings (set) phone ringer”* |
| “(Phone) settings (set) ringer 1”* |
| “(Phone) settings (set) ringer 2”* |
| “(Phone) settings (set) ringer 3”* |
| “(Phone) settings (set) ringer off”* |
| “Battery” |
| “Phone name” |
| “Signal” |
| “Text message inbox” |

*Words in () are optional and do not have to be spoken for the system to understand the command.

Phone book commands: When you ask SYNC® to access a phone book name, number, etc., the requested information appears in the display to view. Press the phone button and say “Call” to call the contact.

| “DIAL” |
|--|
| “411” (four-one-one), “911” (nine-one-one) |
| “700 (seven hundred)” (seven hundred) |
| “800 (eight hundred)” (eight hundred) |
| “900 (nine hundred)” (nine hundred) |
| “#” (pound) |
| “<number> 0-9” |
| “Asterisk” (*) |
| “Clear” (deletes all entered digits) |
| “Delete” (deletes one digit) |
| “Plus” |
| “Star” |

Note: To exit dial mode, press and hold the phone button or press MENU to go to the PHONE menu.

Making Calls

Press the voice icon and when prompted say:

1. Say “Call <name>” or “Dial”, then the desired number.
2. When the system confirms the number, say “Dial” again to initiate the call.

To erase the last spoken digit, say “Delete” or press the left arrow button. To erase all spoken digits, say “Clear” or press and hold the left arrow button.

To end the call, press and hold the phone button.

Receiving Calls

When receiving a call, you can:

- Answer the call by pressing the phone button.
- Reject the call by pressing and holding the phone button.
- Ignore the call by doing nothing.

Phone Options during an Active Call

During an active call, you have additional menu features which become available such as putting a call on hold, joining calls, etc. Use the arrow buttons to scroll through the menu options.

To access:

1. Press MENU during an active call.
2. When Active Call Menu is selected, press OK.
3. Scroll to cycle through the following options:

| When you select: | You can: |
|-------------------|--|
| Mute Call? | Mute the call. |
| Privacy | Switch a call from an active hands-free environment to your cellular phone for a more private conversation. Press OK when Privacy on/off appears. (The display indicates In Privacy and the system transfers your call.) |
| Call Hold | Put an active call on hold. Press OK when Place Call on Hold? appears. To answer another call at this time, press the phone button. |

| When you select: | You can: |
|-------------------------|---|
| Join Calls | Join two separate calls. 1. Press the phone button. 2. Access the desired contact through SYNC or use voice commands to place the second call. Once actively in the second call, press MENU. 3. Scroll until Join Calls appears and press OK. Press OK again when Join Calls? appears. Note: SYNC supports a maximum of three callers on a multiparty/conference call. |
| Enter Tones | Enter “tones” such as numbers for passwords. Scroll until the desired number appears in the display, then press OK; a tone sounds as confirmation. Repeat as necessary. |
| Phonebook | Access your phonebook contacts. 1. Press OK to select, then scroll through your phonebook contacts. 2. Press OK again when the desired selection appears in the display. 3. Press the phone button. |
| Call History | Access your call history log. 1. Press OK to select, then scroll through your call history options (incoming, outgoing or missed). 2. Press OK when the desired selection appears in the display. 3. Press the phone button to call the selection. |
| Return | Exit the current menu. |

Accessing Features through the Phone Menu

SYNC's phone menu allows you to redial a number, access your call history and phone book and send text messages as well as access phone and system settings. You can also access advanced features, such as 911 Assist, Vehicle Health Report and SYNC Services.

1. Press the phone button to enter the Phone Menu.
2. Scroll to cycle through:

| When you select: | You can: |
|---------------------------------|--|
| Phone Redial | Redial the last number called (if available). Press OK to select, then press OK again to confirm. |
| Call History¹ | Allows you to access any previously dialed, received or missed calls while your phone has been connected to the system. 1. Press OK to select. 2. Scroll to select from Call History Incoming, Call History Outgoing or Call History Missed. Press OK make your selection. 3. Press OK or the phone button to call the desired selection. Note: The system attempts to automatically re-download your phone book and call history each time your phone connects to SYNC (if the auto download feature is on and your Bluetooth-enabled cellular phone supports this feature). |
| Phonebook^{1,2} | Allows you to access your downloaded phonebook. 1. Press OK to confirm and enter. If your phonebook has fewer than 255 listings, they appear alphabetically in flat file mode. If there are more, they are organized into alphabetical categories. 2. Scroll until the desired contact appears, then press OK. 3. Press OK or the phone button. |

| When you select: | You can: |
|---|---|
| Text Message ¹ | Enables you to send, download and delete text messages. |
| Phone Settings ¹ | Allows you to view your phone's status, set ring tones, select your message notification, change phone book entries and automatically download your cellular phone among other features. |
| SYNC Services ³ | Access the SYNC services portal where you can request various types of information, traffic reports and directions. |
| 911 Assist ⁴ | Place an emergency call to a 911 operator for you after an accident (if the feature is used properly). |
| Vehicle Health Report ³ | Create and receive a diagnostic report card on your vehicle. |
| Mobile Apps ³ | Interact with SYNC-capable mobile applications on your smartphone. |
| System Settings | Access Bluetooth Devices menu listings (add, connect, set as primary, on/off, delete) as well as Advanced menu listings (prompts, languages, defaults, master reset, install application and system information). |
| Exit Phone Menu | Exit the phone menu by pressing OK. |

¹This is a phone-dependent feature.

²This is a phone-dependent and speed-dependent feature.

³If equipped, United States only.

⁴If equipped, United States and Canada only.

Text Messaging

Note: This is a phone-dependent feature.

SYNC allows you to receive, send, download and delete text messages. The system can also read incoming text messages to you so that you do not have to take your eyes off the road.

Receiving a Text Message

Note: This is a phone-dependent feature. Your phone must support downloading text messages using Bluetooth to receive incoming text messages.

Note: Forwarding a text message is a speed-dependent feature and can only be done when the vehicle is traveling at 3 mph (5 km/h) or less.

Note: Only one recipient is allowed per text message.

When a new message arrives, an audible tone sounds and the display indicates you have a new message. You have these options:

1. Press the voice button, wait for the prompt and say "Read Message" to have SYNC read the message to you.
2. Press OK to receive and open the text message or do nothing and the message goes into your text message inbox. Press OK again and SYNC reads your message aloud as you are not able to view the message. You can then also choose whether you'd like to reply or forward the message.
3. Press OK and scroll to choose between:
 - Reply to Text Message: Press OK to access and then scroll through the list of pre-defined messages to send.
 - Forward Text Message: Press OK to forward the message to anyone in your Phonebook or Call History. You can also choose Enter Number.

Sending, Downloading and Deleting Your Text Messages

Text messaging is a phone-dependent feature. If your phone is compatible, SYNC allows you to receive, send, download and delete text messages.

1. Press the phone button.
2. Scroll until Text Message appears and press OK.
3. Scroll to select from the following options:

Send Text Message? enables you to send a new text message based on a pre-defined set of 15 messages.

Download Unread Msgs allows you to download your unread messages (only) to SYNC. To download the messages, press OK to select. The display indicates your messages are being downloaded. When complete, SYNC takes you to your inbox.

Delete All Messages? allows you to delete current text messages from SYNC (not your phone). To delete the messages, press OK to select. The display indicates when all your text messages have been deleted and SYNC returns you to the text message menu.

Note: SYNC does not automatically download all of your unread text messages at every ignition cycle (as it does with call history and phonebook if automatic download is set to on).

Return exits the current menu when you press OK.

If you select **Send Text Message?**:

1. Press OK to select. If the system detects your phone does not support this feature, Unsupported appears in the display and SYNC returns to the main menu.
2. Scroll to cycle through the message options in the following chart.
3. Press OK when the desired selection is in the display. The system now needs to know who to send the message to.
4. Scroll to cycle through Phonebook or Call History entries. You can also select Enter Number to audibly enter a desired number.
5. Press OK to enter the desired menu and scroll to select the specific contact.
6. Press OK when the contact appears and press OK again to confirm when the system asks if you would like to send the message. Each text message is sent with the following signature: "This message was sent from my <Ford or Lincoln>".

| Pre-defined text message options |
|---|
| Can't talk right now |
| Call me |
| Call you later |
| Be there in 10 minutes |
| Be there in 20 minutes |
| Yes |
| No |
| Why? |
| Thanks |
| Where R you? |
| I need more directions |
| I love you |
| Too funny |
| Can't wait to see you |
| I'm stuck in traffic |

Accessing Your Phone Settings

These are phone-dependent features. Your phone settings allow you to access and adjust features such as your ring tone, text message notification, modify your phone book and also set up automatic download.

1. Press the phone button.
2. Scroll until Phone Settings appears, then press OK.
3. Scroll to select from the following options:

| When you select: | You can: |
|-----------------------------|---|
| Phone Status | See the provider, name, signal power, battery power and roaming status of your connected phone. Press OK to select and scroll to view the information. When done, press OK again to return to the phone status menu. |
| Set Ringer | Select which ring tone sounds during an incoming call (one of the system's or your phone's). 1. Press OK to select and scroll to hear Ringer 1, Ringer 2, Ringer 3 and Phone Ringer. 2. Press OK to select. Note: If your phone supports in-band ringing, your phone's ringer sounds when Phone Ringer is chosen. |
| Message Notification | Have the option of hearing an audible tone to notify you when a text message arrives. 1. Press OK to select and scroll between Message Notification On or Message Notification Off. 2. Press OK to select. |

| When you select: | You can: |
|-------------------------|---|
| Modify Phonebook | <p>Modify the contents of your phone book (i.e., add, delete, download). Press OK to select and scroll between:</p> <p>Add Contacts: Press OK to add more contacts from your phone book. Push the desired contact(s) on your phone. See your phone's user guide on how to push contacts.</p> <p>Delete Phonebook: Press OK to delete the current phone book and call history. When Delete Phonebook appears, press OK to confirm. SYNC takes you back to the Phone Settings menu.</p> <p>Download Phonebook: Press OK to select and press OK again when Confirm Download? appears.</p> |
| Auto Download | <p>Automatically download your phone book each time your phone connects to SYNC. Press OK to select. When Auto Download On? appears, press OK to have your phonebook automatically downloaded each time.</p> <p>Select Off to NOT download your phonebook every time your phone connects to SYNC. Your phonebook, call history and text messages can only be accessed when your specific phone is connected to SYNC.</p> <p>Note: Downloading times are phone- and quantity-dependent.</p> <p>Note: When auto download is on, any changes, additions or deletions saved since your last download are deleted.</p> |
| Return | Exit the current menu. |

System Settings

System Settings provide access to your Bluetooth Devices and Advanced menu features. Use the arrow buttons to scroll through the menu options.

The Bluetooth Devices menu allows you to add, connect, delete and set a phone as primary as well as turn your Bluetooth feature on and off.

The Advanced menu allows you to access and set prompts, languages, defaults, perform a master reset, install an application and view system information.

Bluetooth Devices Menu Options

This menu allows you to add, connect, delete, set a phone as primary, and turn Bluetooth on or off.

1. Press the phone button to enter the Phone Menu.
2. Scroll until System Settings appears and press OK.
3. Scroll until Bluetooth Devices appears and select OK.
4. Scroll to select from the following options:

| If you select: | You can: |
|---------------------------------|--|
| Add Bluetooth Device* | See <i>Using SYNC with your phone</i> earlier in this chapter for pairing instructions. |
| Connect Bluetooth Device | <p>Connect a previously paired Bluetooth-enabled phone.</p> <ol style="list-style-type: none"> 1. Press OK to select and view a list of previously paired phones. 2. Scroll until the desired device is chosen, then press OK to connect the phone. <p>Note: Only one device can be connected at a time. When another phone is connected, the previous one is disconnected.</p> |

| If you select: | You can: |
|-----------------------------|--|
| Set Primary Phone | Set a previously paired phone as your primary phone. Press OK to select and scroll to select the desired phone. Press OK to confirm. Note: SYNC attempts to connect with the primary phone at every ignition cycle. When a phone is selected as primary, it appears first in the list and is marked with an asterisk (*). |
| Set Bluetooth On/Off | Turn the Bluetooth feature on and off. Press OK and scroll to toggle between On and Off. When the desired selection is chosen, press OK. Note: Turning Bluetooth off disconnects all Bluetooth devices and deactivates all Bluetooth features. |
| Delete Device | Delete a paired phone. Press OK and scroll to select the device. Press OK to confirm. |
| Delete All Devices | Delete all previously paired phones (and all information originally saved with those phones). Press OK to select. |
| Return | Exit the current menu. |

*This is a speed-dependent feature.

Advanced Menu Options

This menu allows you to access settings such as prompts, languages, defaults, perform a master reset, install an application and view system information.

1. Press the phone button to enter the Phone Menu.
2. Scroll until System Settings appears and press OK.
3. Scroll until Advanced appears and select OK.
4. Scroll to select from the following options:

| If you select: | You can: |
|-------------------------|--|
| Prompts | Get help from SYNC by using questions, helpful hints or asking you for a specific action. To turn these prompts on or off: <ol style="list-style-type: none"> 1. Press OK to select and scroll to select between on or off. 2. Press OK when the desired selection appears in the display. SYNC takes you back to the Advanced menu. |
| Languages | Choose between English, Espanol and Francais. Once selected, all of SYNC's radio displays and prompts are in the selected language. <ol style="list-style-type: none"> 1. Press OK to select and then scroll through the languages. 2. Press OK when the desired selection appears in the display. If you change the language setting, the display indicates that the system is updating. When complete, SYNC takes you back to the Advanced menu. |
| Factory Defaults | Return to the factory default settings. This selection does not erase your indexed information (phonebook, call history, text messages and paired devices). <ol style="list-style-type: none"> 1. Press OK to select and then press OK again when Restore Defaults? appears in the display. 2. Press OK to confirm. |

| If you select: | You can: |
|----------------------------|--|
| Master Reset | Completely erase all information stored on SYNC (phonebook, call history, text messages and paired devices) and return to the factory default settings. Press OK to select. The display indicates when complete and SYNC takes you back to the Advanced menu. |
| Install Application | Install applications you have downloaded. Press OK and scroll to select. Press OK to confirm. |
| System Info | Access the Auto Version number as well as the FPN number. Press OK to select. |
| MAP Profile | This is a Bluetooth component which can further help your phone with the exchange of text messages. |
| Return | Exit the current menu. |

SYNC APPLICATIONS AND SERVICES (IF EQUIPPED)

Note: In order for the following features to work, your cellular phone must be compatible with SYNC. To check your phone's compatibility, visit www.SYNCMYride.com, www.SYNCMYride.ca or www.syncmaroute.ca.

- SYNC Services (if equipped, United States only): Provides access to traffic, directions and information such as travel, horoscopes, stock prices and more.
- 911 Assist: Can alert 911 in the event of an emergency.
- Vehicle Health Report (if equipped, United States only): Provides a diagnostic and maintenance report card of your vehicle.
- SYNC AppLink: Allows you to connect to and use certain applications such as Pandora and Stitcher (if your phone is compatible).

911 Assist®

WARNING: Unless the 911 Assist setting is set on prior to a crash, the system will not dial for help which could delay response time, potentially increasing the risk of serious injury or death after a crash.



WARNING: Do not wait for 911 Assist to make an emergency call if you can do it yourself. Dial emergency services immediately to avoid delayed response time which could increase the risk of serious injury or death after a crash. If you do not hear 911 Assist within five seconds of the crash, the system or phone may be damaged or non-functional.



WARNING: Always place your phone in a secure location in the vehicle so it does not become a projectile or get damaged in a crash. Failure to do so may cause serious injury to someone or damage the phone which could prevent 911 Assist from working properly.

Note: SYNC 911 Assist feature must be set on prior to the incident.

Note: Before setting this feature on, ensure that you read the 911 Assist privacy notice later in this section for important information.

Note: If 911 Assist is turned on or off by any user, that setting applies for all paired phones. If 911 Assist is turned off, a voice message plays and/or a display message/icon comes on when the vehicle is started after a previously paired phone connects.

Note: Every phone operates differently. While SYNC 911 Assist works with most cellular phones, some may have trouble using this feature.

If a crash deploys an airbag (excludes knee airbags and rear inflatable safety belts [if equipped]) or activates the fuel pump shut-off, your SYNC equipped vehicle may be able to contact emergency services by dialing 911 through a paired and connected Bluetooth-enabled phone. For more information about 911 Assist, visit www.SYNCMYRide.com, www.SYNCMYRide.ca or www.syncmaroute.ca.

- For information on airbag deployment, see the *Supplementary Restraints System* chapter.
- For information on the fuel pump shut-off, see the *Roadside Emergencies* chapter.

Setting 911 Assist On

Perform the following:

1. Press the phone button to enter the Phone Menu.
2. Scroll until 911 Assist is selected.
3. Press OK to confirm and enter the 911 Assist menu.
4. Scroll to select between On and Off selections.
5. Press OK when the desired option appears in the radio display. Set On or Set Off appears in the display as confirmation.

Off selections include: Off with reminder and Off without reminder. Off with reminder provides a display and voice reminder at phone connection at vehicle start. Off without reminder provides a display reminder only without a voice reminder at phone connection.

To make sure that 911 Assist works properly:

- SYNC must be powered and working properly at the time of the incident and throughout feature activation and use.
- SYNC 911 Assist feature must be set on prior to the incident.
- A Bluetooth-enabled and compatible phone has to be paired and connected to SYNC.
- A connected Bluetooth-enabled phone must have the ability to make and maintain an outgoing call at the time of the incident.
- A connected Bluetooth-enabled phone must have adequate network coverage, battery power and signal strength.
- The vehicle must have battery power and be located in the United States, Canada or in a territory in which 911 is the emergency number.

In the Event of a Crash

Not all crashes deploy an airbag or activate the fuel pump shut-off (which would activate 911 Assist); however, if 911 Assist is triggered, SYNC tries to contact emergency services. If a connected phone is damaged or loses connection to SYNC, SYNC searches for, and tries to connect to, any available previously paired phone and tries to make the call to 911.

Before making the call:

- SYNC provides a short window of time (about 10 seconds) to cancel the call. Failure to cancel the call results in SYNC attempting to dial 911.
- SYNC says the following, or a similar message: "SYNC will attempt to call 911, to cancel the call, press Cancel on your screen or press and hold the phone button on your steering wheel."

If the call is not cancelled and a successful call is made, a pre-recorded message is played for the 911 operator, then the occupant(s) in the vehicle is able to talk with the operator. Be prepared to provide your name, phone number and location immediately, because not all 911 systems are capable of receiving this information electronically.

911 Assist May Not Work If

- Your cellular phone or 911 Assist hardware was damaged in a crash.
- The vehicle's battery or SYNC system has no power.
- The phone(s) paired and connected to the system was thrown from the vehicle.

911 Assist Privacy Notice

Once 911 Assist is set on, it may disclose to emergency services that the vehicle has been in a crash involving the deployment of an airbag or activation of the fuel pump shut-off. Certain versions or updates to 911 Assist may also be capable of electronically or verbally disclosing to 911 operators the vehicle location, and/or other details about the vehicle or crash to assist 911 operators to provide the most appropriate emergency services. If you do not want to disclose this information, do not turn the feature on.

Vehicle Health Report

WARNING: Always follow scheduled maintenance instructions, regularly inspect your vehicle, and seek repair for any damage or problem you suspect. Vehicle Health Report supplements, but cannot replace normal maintenance and vehicle inspection. Vehicle Health Report only monitors certain systems that are electronically monitored by the vehicle and will not monitor or report the status of any other system, (i.e., brake lining wear). Failure to perform scheduled maintenance and regularly inspect your vehicle may result in vehicle damage and serious injury.

Note: Your Vehicle Health Report feature requires activation prior to use. Visit www.SYNCMYride.com to register. There is no fee or subscription associated with Vehicle Health Report, but you must register to use this feature.

Note: This feature may not function properly if you have enabled caller ID blocking on your mobile phone. Before running a report, review the *Vehicle Health Report privacy notice*.

Note: In order to allow a break-in period for your vehicle, you may not be able to create a Vehicle Health Report until your vehicle odometer has reached 200 miles.

Register for Vehicle Health Report and set your report preferences at www.SYNCMYRide.com. After registering, you can request a Vehicle Health Report (inside your vehicle). Return to your account at www.SYNCMYRide.com to view your report. You can also choose for SYNC to automatically remind you to run reports at specific mileage intervals. Cellular phone airtime usage may apply when reporting.

The system allows you to check your vehicle's overall health in the form of a diagnostic report card. The vehicle health report contains valuable information such as:

- Vehicle Diagnostic Information
- Scheduled maintenance
- Open Recalls and Field Service Actions
- Unserved items from vehicle inspections by your authorized dealer.

You can run a report (after the vehicle has been running a minimum of 60 seconds) by pressing the voice button and saying "Vehicle health report", or pressing the phone button.

To run a report using the phone button:

1. Press the phone button to enter Phone Menu.
2. Scroll until Vehicle Health is selected and press OK.
3. Scroll to select from the following options:

| Vehicle Health Report options | |
|--|--|
| User Preferences: Press OK to select and enter the menu. Scroll to select from: | Automatic Reports: Press OK and select on or off. Select On to have SYNC automatically prompt you to run a health report at certain mileage intervals. Note: You must first turn this feature on before you can select the mileage intervals at which you would like to be prompted. |
| | Mileage Intervals: Press OK. Scroll to select between 5000, 7500 or 10000 mile intervals and press OK to make your selection. |
| | Return: Press OK to exit the menu. |

| Vehicle Health Report options | |
|-------------------------------|---|
| Run Report? | Press OK for SYNC to run a health report of your vehicle's diagnostic systems and send the results to Ford where it is combined with scheduled maintenance information, open recalls and other field service actions and unserviced vehicle inspection items from your authorized dealer. |

Vehicle Health Report Privacy Notice

When you run a Vehicle Health Report, Ford Motor Company may collect your cellular phone number (to process your report request) and diagnostic information about your vehicle. Certain versions or updates to Vehicle Health Report may also collect additional vehicle information. Ford may use the vehicle information it collects for any purpose. If you do not want to disclose your cellular phone number or vehicle information, do not run the feature or set up your Vehicle Health Report profile at www.SYNCMYride.com. See www.SYNCMYride.com - Vehicle Health Report Terms and Conditions, and Privacy Statement - for more information.

SYNC Services: Traffic, Directions & Information (TDI)

Note: SYNC Services requires activation prior to use. Visit www.SYNCMYride.com to register and check your eligibility for complimentary services. Standard phone and message rates may apply. Subscription may be required. You must also have the active SYNC Services Bluetooth-enabled cellular phone paired and connected to the system in order to connect to, and use, SYNC Services. See *Using SYNC with your phone* for pairing instructions.

Note: This feature does not function properly if you have enabled caller ID blocking on your mobile phone. Make sure your mobile phone is not blocking caller ID before using SYNC Services.

Note: The driver is ultimately responsible for the safe operation of the vehicle, and therefore, must evaluate whether it is safe to follow the suggested directions. Any navigation features are provided only as an aid. Make your driving decisions based on your observations of local conditions and existing traffic regulations. Do not follow the route suggestions if doing so would result in an unsafe or illegal maneuver, if you would be placed in an unsafe situation, or if you would be directed into an area that you consider unsafe. Maps used by this system may be inaccurate because of errors, changes in roads, traffic conditions or driving conditions.

Note: When you connect, the service uses GPS technology and advanced vehicle sensors to collect the vehicle's current location, travel direction and speed to help provide you with the directions, traffic reports, or business searches you request. Further, to provide the services you request and for continuous improvement, the service may collect and record call details and voice communications. For more information, see SYNC Services Terms and Conditions at www.SYNCMYRIDE.com. If you do not want Ford or its service providers to collect the vehicle travel information or other information identified in the Terms and Conditions, do not activate or use the service.

SYNC Services uses advanced vehicle sensors, integrated GPS technology and comprehensive map and traffic data, to give you personalized traffic reports, precise turn-by-turn directions, business search, news, sports, weather and more. For a complete list of services, or to learn more, please visit www.SYNCMYRIDE.com.

Connecting to SYNC Services Using Voice Commands

1. Press the voice button.
2. When prompted, say "Services". This initiates an outgoing call to SYNC Services using your paired and connected Bluetooth-enabled cellular phone.
3. Once you are connected to the service, follow the voice prompts to request the desired service, such as "Traffic" or "Directions". You can also say "What are my choices?" to receive a complete list of available services from which to choose.
4. Say "Services" to return to the services main menu or for help, say "Help".

Connecting to SYNC Services Using the Phone Menu

1. Press the phone button to enter the Phone Menu.
2. Scroll until *Services* appears in the display.
3. Press OK to confirm and enter the Services menu. The display indicates the system is connecting.
4. Press OK. SYNC initiates the call to the Services portal.
5. Once connected, follow the voice prompts to request your desired Service, such as Traffic or Directions. You can also say "What are my choices?" to receive a complete list of available services from which to choose.
6. To return to the Services menu, say "Services" or for help, say "Help".

Receiving Turn-by-Turn Directions

1. When connected to SYNC Services, say “Directions” or “Business search”. To find the closest business or type of business to your current location, just say “Business search” and then “Search near me”. If you need further assistance in finding a location you can say “Operator” at any time within a Directions or Business search to speak with a live operator. You may also be prompted to speak with an operator when the automatic system has difficulty matching your voice request. The live operator can assist you by searching for businesses by name or by category, residential addresses by street address or by name or specific street intersections. Operator Assist is a feature of your SYNC Services subscription. For more information on Operator Assist visit www.SYNCMYride.com/support.
2. Follow the voice prompts to select your destination. Once your destination is selected, your current vehicle location is uploaded and a route based on current traffic conditions is calculated and sent back to your vehicle. After the route download is complete, the phone call is automatically ended. You then receive audible and visual driving instructions as you travel toward your destination.
3. While on an active route, you can select or say “Route summary” or “Route status” to view the Route Summary turn list or the Route Status ETA. You can also turn voice guidance on or off, cancel the route or update the route.

If you miss a turn, SYNC automatically asks if you want the route updated. Just say, “Yes” when prompted and a new route will be delivered to your vehicle.

Disconnecting from SYNC Services

1. Press and hold the phone button on the steering wheel.
2. Say “Good-bye” from the SYNC Services main menu.

| SYNC Services quick tips | |
|---------------------------------|---|
| Personalizing | You can personalize your Services feature to provide quicker access to your most used or favorite information. You can save address points such as work or home. You can also save favorite information like sports teams or a news category. To learn more, log onto www.SYNCMYride.com . |
| Push to interrupt | Press the voice button at any time (while you are connected to SYNC TDI Services) to interrupt a voice prompt or an audio clip (such as a sports report), wait for the listening tone, and say your voice command. |
| Portable | Your subscription is associated with your Bluetooth-enabled cellular phone number, not your VIN (Vehicle Identification Number). You can pair and connect your phone to any vehicle equipped with Traffic, Directions and Information and continue enjoying your personalized services. You can even access your account outside the vehicle. Just use the number on your phone's call history. Traffic and Directions features do not function properly but information services and the 411 connect and text message features are available. |

SYNC AppLink™

Note: This feature is only available in the United States.

Note: Your smartphone must be paired and connected to SYNC to access AppLink.

Note: iPhone users need to connect the phone to the USB port in order to start the application. It is recommended to lock your iPhone after starting an application.

Note: The AppLink feature is not available if your vehicle is equipped with the MyFord Touch or MyLincoln Touch system.

Depending on your display type, you can access AppLink from the media menu, the phone menu, or by using voice commands. Once an app is running through AppLink, you can control main features of the app through voice commands and steering wheel controls.

To Access Using the Phone Menu

1. Press the phone button to access the SYNC phone menu on-screen.
2. Scroll to Mobile Apps and press **OK** to access a list of available applications.
3. Scroll through the list of available applications and press **OK** to select a particular app.
4. Once an app is running through SYNC, you can access an app's menu by pressing the **MENU** button to first access the SYNC menu.
5. Select "SYNC-Media" by pressing **OK**.
6. Scroll until "<App name> Menu" is displayed (such as Pandora Menu), then press **OK**. From here, you can access an application's features, such as Thumbs up, Thumbs down, etc. For more information, please visit www.SYNCMyRide.com.

To Access Using the Media Menu

1. **Press AUX** button on the center console.
2. Press **MENU** to access the SYNC menu.
3. Select "SYNC-Media" by pressing **OK**.
4. Then scroll to Mobile Apps and press **OK** to access a list of available applications.
5. Scroll through the list of available applications and press **OK** to select a particular app.
6. Once an app is running through SYNC, you can access an app's menu by pressing the **MENU** button to first access the SYNC menu.
7. Select "SYNC-Media" by pressing **OK**.
8. Scroll until "<App name> Menu" is displayed (such as Pandora Menu), then press **OK**. From here, you can access an application's features, such as Thumbs up, Thumbs down, etc. For more information, please visit www.SYNCMyRide.com.

To Access Using Voice Commands

1. Press the voice icon.
2. When prompted, say “Mobile Apps”.
3. Say the name of the application after the tone.
4. The app should start. While an app is running through SYNC, you can press the voice button and speak commands specific to the app, such as “Play Station Quickmix”. Say “Help” to discover available voice commands.

USING SYNC WITH YOUR MEDIA PLAYER

You can access and play music from your digital music player over the vehicle's speaker system using the system's media menu or voice commands. You can also sort and play your music by specific categories, such as artists, albums, etc.

SYNC is capable of hosting nearly any digital media player including: iPod, Zune™, Plays from device players, and most USB drives. SYNC also supports audio formats such as MP3, WMA, WAV and ACC.

Connecting Your Digital Media Player via the USB Port

Note: If your digital media player has a power switch, ensure that the device is turned on.

To connect using voice commands:

1. Plug the device into the vehicle's USB port.
2. Press the voice icon and when prompted, say “USB”.
3. You can now play music by saying any of the appropriate voice commands. See the media voice commands.

To connect using the system menu:

1. Plug the device into the vehicle's USB port.
2. Press AUX and then MENU to enter the Media Menu.
3. Scroll until Select Source appears and press OK.
4. Scroll to select USB and press OK.
5. Depending on how many digital media files are on your connected device, Indexing may appear in the radio display. When indexing is complete, the screen returns to the Play Menu.

6. Press OK and scroll through selections of:

- Play All
- Artists
- Albums
- Genres
- Playlists
- Tracks
- Explore USB
- Similar Music
- Return

When the desired selection appears in the display, press OK to build your desired music selection.

What's Playing?



At any time when a track is playing, you can press the voice icon and ask the system, "What's playing?". The system reads the metadata tags (if populated) of the playing track to you.

Media Voice Commands



Press the voice icon and, when prompted, say "USB" then any of the following:

| "USB" |
|---|
| "Autoplay off" |
| "Autoplay on" |
| "(Phone) (Media) (Bluetooth) Connections" |
| "Pause" |
| "Play" |
| "Play album <name>" ^{1,3} |
| "Play all" |
| "Play artist <name>" ^{1,3} |
| "Play genre <name>" ^{1,3} |
| "Play next folder" ² |

| “USB” |
|---------------------------------------|
| “Play next track” |
| “Play playlist <name>” ^{1,3} |
| “Play previous folder” ² |
| “Play previous track” |
| “Play song <name>” ^{1,3} |
| “Play track <name>” ^{1,3} |
| “Refine album <name>” ^{1,3} |
| “Refine artist <name>” ^{1,3} |
| “Refine song <name>” ^{1,3} |
| “Refine track <name>” ^{1,3} |
| “Repeat off” |
| “Repeat on” |
| “Search album <name>” ^{1,3} |
| “Search artist <name>” ^{1,3} |
| “Search genre <name>” ^{1,3} |
| “Search song <name>” ^{1,3} |
| “Search track <name>” ^{1,3} |
| “Shuffle off” |
| “Shuffle on” |
| “Similar music” |
| “What’s playing?” |

¹“<name>” is a dynamic listing, meaning that it could be the name of any desired group, artist, etc.

²Voice commands which are only available in folder mode.

³Voice commands which are not available until indexing is complete.

| Voice command guide | |
|---|--|
| “Autoplay” | Turn on to listen to music which has already been randomly indexed during the indexing process. Turn off and the system does not begin to play any of your music until all media has all been indexed. Indexing times can vary from device to device and also with regard to the number of songs being indexed. |
| “Search/Play Genre” | The system searches all the data from your indexed music and, if available, begins to play the chosen type of music. You can only play genres of music which are present in the GENRE metadata tags that you have on your digital media player. |
| “Similar Music” | The system compiles a playlist and then plays similar music to what is currently playing from the USB port using indexed metadata information. |
| “Search/Play Artist/Track/Album” | The system searches for a specific artist/track/album from the music indexed through the USB port. |
| “Refine” | This allows you to make your previous command more specific. For example, if you asked to search and play all music by a certain artist, you could then say “refine album” and choose a specific album from the list to view. If you then select Play, the system only plays music from that specific album. |

Press the voice icon and when prompted say “Bluetooth Audio” and then any of the following:

| “BLUETOOTH AUDIO” |
|---|
| “(Phone) (Media) (Bluetooth) Connections” |
| “Pause” |
| “Play” |
| “Play next track ” |
| “Play previous track ” |

Media Menu Features

The media menu allows you to select your media source, how to play your music (by artist, genre, shuffle, repeat, etc.), and also to add, connect or delete devices.

1. Press AUX and then MENU to enter the Media Menu.
2. Scroll to cycle through:

| When you select: | You can: |
|----------------------|---|
| Play Menu | Play your music by artist, album, genre, playlists, tracks, similar music or to simply play all. You can also choose to Explore USB to view the supported digital music files on your playing device. See Play Menu later in this section for more information. |
| Select Source | <p>SYNC USB: Press OK to access music plugged into your USB port. You can also plug in devices to charge them (if supported by your device). Once connected, the system indexes any readable media files. (The time required to complete this depends on the size of the media content being indexed.) If Autoplay is on, you can access media files randomly as they are indexed. If turned off, indexed media is not available until the indexing process is complete. SYNC is capable of indexing thousands of average size media and notifies you if the maximum indexing file size is reached.</p> <p>Bluetooth Audio: This is a phone-dependent feature which allows you to stream music playing on your Bluetooth-enabled phone. If supported by your device, you can press SEEK to play the previous or next track.</p> <p>SYNC Line In: Press OK to select and play music from your portable music player over the vehicle's speakers. Note: If you have already connected a device to the USB port, you cannot access the line in feature. Some digital media players require both USB and line in ports to stream data and music separately.</p> |

| When you select: | You can: |
|------------------------|--|
| Media Settings | <p>Choose to shuffle or repeat your music and select your Autoplay settings. Once these selections are turned on, they remain on until turned off. Press SEEK to play the previous or next track.</p> <p>Note: Some digital media players require both USB and line in ports to stream data and music separately. Press OK to select and then scroll to choose from:</p> <p>Shuffle: Press OK to shuffle available media files in the current playlist. Note: To shuffle all media tracks, you must select Play All in the Play Menu and then select Shuffle.</p> <p>Repeat: Press OK to repeat any song.</p> <p>Autoplay: Press OK to listen to music which has already been randomly indexed during the indexing process.</p> |
| Mobile Apps | <p>Interact with SYNC-capable mobile applications on your smart phone. See <i>SYNC AppLink</i> earlier in this chapter for more information.</p> |
| System Settings | <p>Access Bluetooth Device menu listings (add, connect, set as primary, on/off, delete) as well as Advanced menu listings (prompts, languages, defaults, master reset, install application and system information).</p> <p>Note: See System Settings for more information.</p> |
| Exit Media Menu | <p>Press OK to exit the media menu.</p> |

Accessing Your Play Menu

This menu allows you to select and play your media by artist, album, genre, playlist, track, similar music or even to explore what is on your USB device.

1. Make sure that your device is plugged into the USB port and is turned on.
2. Press AUX and then MENU to enter the Media Menu.
3. Scroll to select the Play Menu and press OK.

If there are no media files to access, the display indicates there is no media. If there are media files, you have the following options to scroll through and select from:

| When you select: | You can: |
|-------------------------|---|
| Play All | Play all indexed media (tracks) from your playing device in flat file mode, one at a time in numerical order. Press OK to select. The first track title appears in the display. |
| Artists | Sort all indexed media by artist. Once selected, the system lists and then play all artists and tracks alphabetically. If there are less than 255 indexed artist, they are listed alphabetically in flat file mode. If there are more, they are categorized in alphabetical categories. 1. Press OK to select. You can select to play All Artists or any indexed artist. 2. Scroll until the desired artist is chosen and press OK. |
| Albums | Sort all indexed media by albums. If there are less than 255 indexed albums, they are listed alphabetically in flat file mode. If there are more, they are organized into alphabetical categories. 1. Press OK to enter the album menu and select from playing all albums or from any individual indexed album. 2. Scroll until the desired album is chosen and press OK. |
| Genres | Sort indexed music by genre (category) type. SYNC lists the genres alphabetically in flat file mode. If there are more than 255, SYNC automatically organizes them into alphabetical categories. Press OK to select and then scroll to select the desired genre and press OK. |
| Playlists | Access your playlists (from formats such as ASX, .M3U, .WPL, .MTP.). The system lists your playlists alphabetically in flat file mode. If there are more than 255, they are organized into alphabetical categories. Press OK to select. Then scroll to select the desired playlist and press OK. |

| When you select: | You can: |
|----------------------|--|
| Tracks | Search for and play a specific track which has been indexed. SYNC lists your tracks alphabetically in flat file mode. If there are more than 255, SYNC automatically organizes them into alphabetical categories. Press OK to select. Then scroll to select the desired track and press OK. |
| Explore USB | Explore all supported digital media on your media device connected to the USB port. You can only view media content which is compatible with SYNC; other files saved are not visible. Press OK to select. Then scroll to explore indexed media on your flash drive. |
| Similar Music | Play music similar to what is currently playing from the USB port. The system uses the metadata information of each song to compile a playlist for you. Press OK to select. The system creates a new list of similar songs and begins playing. The metadata tags must be populated for this feature to include each track. Note: With certain playing devices, if your metadata tags are not populated, the tracks won't be available in voice recognition, play menu or similar music. However, if you place these tracks onto your playing device in "Mass Storage Device Mode", they are available in voice recognition, play menu browsing and similar music. Unknowns are placed into any unpopulated metadata tag. |
| Return | Exit the current menu. |

System Settings

System settings provide access to your Bluetooth Devices and Advanced menu features.

The Bluetooth Devices menu allows you to add, connect and delete a device as turn the Bluetooth feature on and off.

Your Advanced menu allows you to access and set prompts, languages, defaults and perform a master reset.

Bluetooth Devices Menu Options

This menu allows you to add, connect and delete devices as well as turn Bluetooth on and off.

1. Press AUX and then MENU to enter the Media Menu.
2. Scroll until System Settings appears and select OK.
3. Scroll until Bluetooth Devices appears.
4. Press OK and then scroll to select from:

| When you select: | You can: |
|---------------------------------|---|
| Add Bluetooth Device* | Allows you to pair additional devices to the system. 1. Press OK to select and press OK again when Find SYNC appears in the display. 2. Follow the directions in your phone's user guide to put your phone into discovery mode. A six-digit PIN appears in the display. 3. When prompted on your phone's six-digit display, enter the PIN. |
| Connect Bluetooth Device | Connect a previously paired Bluetooth-enabled phone. 1. Press OK to select and view a list of devices. 2. Scroll until the desired device is chosen and press OK to connect the device. |
| Set Bluetooth On/Off | Turn the Bluetooth feature on and off. Press OK and scroll to toggle between On and Off. When the desired selection is chosen, press OK. Turning Bluetooth off disconnects all Bluetooth devices and deactivates Bluetooth features. |
| Delete Device | Delete a paired media device. Press OK and scroll to select the device. Press OK to confirm. |
| Delete All Devices | Delete all previously paired devices. Press OK to select. |
| Return | Exit the current menu. |

*This is a speed-dependent feature

Advanced Menu Options

This menu allows you to access settings such as prompts, language, performing a master reset as well as returning to factory defaults.

1. Press AUX and then MENU to access the Media Menu.
2. Scroll until System Settings appears and select OK.
3. Scroll until Advanced appears.
4. Press OK and then scroll to select from the following:

| When you select: | You can: |
|-------------------------|---|
| Prompts | Have SYNC guide you via questions, helpful hints or ask you for a specific action. 1. Press OK to select and scroll to select between on or off. 2. Press OK when the desired selection appears in the display. SYNC takes you back to the Advanced menu. |
| Languages | Choose from English, Francais and Espanol. The displays and prompts are in the selected language. 1. Press OK to select and then scroll through the languages. 2. Press OK when the desired selection appears in the display. 3. If you change the language setting, the display indicates that the system is updating. When complete, SYNC takes you back to the Advanced menu. |
| Factory Defaults | Return to the factory default settings. This selection does not erase your indexed information (phonebook, call history, text messages and paired devices). 1. Press OK to select and then press OK again when Restore Defaults? appears in the display. 2. Press OK to confirm. |
| Master Reset | Completely erase all information stored on SYNC (all phonebook, call history, text messages and all paired devices) and return to the factory default settings. |
| Application | Download new software applications (if available) and then load the desired applications through your USB port. See the web site for more information. |
| Return | Exit the current menu. |

TROUBLESHOOTING

Your SYNC system is easy to use. However, should questions arise, see the tables below.

Use the website at any time to check your phone's compatibility, register your account and set preferences as well as access a customer representative via an online chat (during certain hours). Visit www.SYNCMYride.com, www.SYNCMYride.ca or www.syncmaroute.ca for more information.

| Phone issues | | |
|---|--|---|
| Issue | Possible cause(s) | Possible solution(s) |
| Excessive background noise during a phone call. | The audio control settings on your phone may be affecting SYNC performance. | Review your phone's user guide regarding audio adjustments. |
| During a call, I can hear the other person but they cannot hear me. | Possible phone malfunction. | Try turning off the device, resetting the device, removing the device's battery, then trying again. |
| SYNC is not able to download my phonebook. | <ul style="list-style-type: none"> • This is a phone-dependent feature, OR • Possible phone malfunction. | <ul style="list-style-type: none"> • Go to the website to review your phone's compatibility. • Try turning off the device, resetting the device or removing the device's battery, then trying again. • Try pushing your phonebook contacts to SYNC by using the Add Contacts feature. • Use the SYNCmyphone feature available on the website. |

| Phone issues | | |
|--|--|--|
| Issue | Possible cause(s) | Possible solution(s) |
| The system says Phonebook Downloaded but my phonebook in SYNC is empty or is missing contacts. | Limitations on your phone's capability. | <ul style="list-style-type: none"> • Try pushing your phonebook contacts to SYNC by using the Add Contacts feature. • If the missing contacts are stored on your SIM card, try moving them to the device memory. • Remove any pictures or special ring tones associated with the missing contact. |
| I am having trouble connecting my phone to SYNC. | <ul style="list-style-type: none"> • This is a phone-dependent feature, OR • Possible phone malfunction. | <ul style="list-style-type: none"> • Go to the website to review your phone's compatibility. • Try turning off the device, resetting the device or removing the device's battery, then trying again. • Try deleting your device from SYNC, deleting SYNC from your device and trying again. • Check the security and auto accept/prompt always settings relative to the SYNC Bluetooth connection on your phone. • Update your device's software firmware. • Turn off the Auto phonebook download setting. |
| Text messaging is not working on SYNC. | <ul style="list-style-type: none"> • This is a phone-dependent feature, OR • Possible phone malfunction. | <ul style="list-style-type: none"> • Go to the website to review your phone's compatibility. • Try turning off the device, resetting the device or removing the device's battery, then trying again. |

| USB and media issues | | |
|---|--|--|
| Issue | Possible cause(s) | Possible solution(s) |
| I am having trouble connecting my device. | Possible device malfunction. | <ul style="list-style-type: none"> • Try turning off the device, resetting the device or removing the device's battery, then trying again. • Make sure you are using the manufacturer's cable. • Make sure the USB cable is properly inserted into the device and the vehicle's USB port. • Make sure that the device does not have an auto-install program or active security settings. |
| SYNC does not recognize my device when I turn on the car. | This is a device limitation. | Make sure you are not leaving the device in your vehicle during very hot or cold temperatures. |
| Bluetooth audio does not stream. | <ul style="list-style-type: none"> • This is a phone-dependent feature, OR • The device is not connected. | Make sure the device is connected to SYNC and that you have pressed play on your device. |
| SYNC does not recognize music that is on my device. | <ul style="list-style-type: none"> • Your music files may not contain the proper artist, song title, album or genre information, OR • The file may be corrupted, OR • The song may have copyright protection which does not allow it to play. | <ul style="list-style-type: none"> • Make sure that all song details are populated. • Some devices require you to change the USB settings from mass storage to MTP class. |

| Vehicle Health Report and SYNC Services (Traffic, Directions and Information) issues | | |
|---|---|---|
| Issue | Possible cause(s) | Possible solution(s) |
| I received a text that the Vehicle Health Report is not activated. | <ul style="list-style-type: none"> Your account may not be activated on the website, OR You may have the wrong VIN (vehicle identification number) listed. | <ul style="list-style-type: none"> This is a free feature, but you must first register online to use it. Make sure that your VIN is correctly listed in your account. |
| I am unable to retrieve the report on the website, or I receive a system error. | The preferred dealer information did not load correctly. | When you register your account, you must list a preferred dealer. If one is already listed, try selecting another dealer and logging out. Log back in and change it back to your preferred dealer and retrieve the report. |
| I am unable to submit a report. | <ul style="list-style-type: none"> This could be due to your phone's compatibility, OR Bad signal strength, OR Your phone may not be activated on the website. | <ul style="list-style-type: none"> Update your mobile number in your account on the website. Make sure you have full signal strength and that your <i>Bluetooth</i> volume level has been turned up. Try deleting your phone and performing a clean pairing. |
| I heard a commercial when I tried to use Traffic, Directions and Information. | <ul style="list-style-type: none"> The phone in use is not activated, OR Your phone has ID blocker active. | <ul style="list-style-type: none"> This is a free feature, but you must first register online to use it. Turn off ID blocker on your phone as the system recognizes you by your phone number. Make sure the currently connected phone is the same one that is registered on your SyncMyRide account. |

| Voice command issues | | |
|--|--|--|
| Issue | Possible cause(s) | Possible solution(s) |
| SYNC does not understand what I am saying. | <ul style="list-style-type: none"> • You may be using the wrong voice commands, OR • You may be speaking too soon or at the wrong time. | <ul style="list-style-type: none"> • Review the Phone voice commands and the Media voice commands at the beginning of their respective sections. • Be aware that SYNC's microphone is either in your rear view mirror or in the headliner just above the windshield. |
| SYNC does not understand the name of a song or artist. | <ul style="list-style-type: none"> • You may be using the wrong voice commands, OR • You may not be saying the name exactly as it is saved, OR • The system may not be reading the name the same way you are saying it. | <ul style="list-style-type: none"> • Review the media voice commands at the beginning of the media section. • Say the song or artist exactly as listed. If you say, "Play Artist Prince", the system does not play music by Prince and the Revolution or Prince and the New Power Generation. • Make sure you are saying the complete title, such as "California remix featuring Jennifer Nettles". • If the songs are saved in all CAPS, you have to spell them. LOLA requires you to say, "Play L-O-L-A". • Do not use special characters in the title as the system does not recognize them. |

| Voice command issues | | |
|---|---|--|
| Issue | Possible cause(s) | Possible solution(s) |
| <p>SYNC does not understand or is calling the wrong contact when I want to make a call.</p> | <ul style="list-style-type: none"> • You may be using the wrong voice commands, OR • You may not be saying the name exactly as it is saved, OR • Contacts in your phonebook may be very short and similar, or they may contain special characters, OR • Your phonebook contacts may be saved in CAPS. | <ul style="list-style-type: none"> • Review the phone voice commands at the beginning of the phone section. • Make sure you are saying the contacts exactly as listed. For example, if a contact is saved as Joe Wilson, say "Call Joe Wilson". • The system works better if you list full names, such as "Joe Wilson" rather than "Joe". • Do not use special characters such as 123 or ICE, as the system does not recognize them. • If contacts are saved in CAPS, you have to spell them. JAKE requires you to say, "Call J-A-K-E". |

INTRODUCTION

WARNING: Driving while distracted can result in loss of vehicle control, crash and injury. We strongly recommend that you use extreme caution when using any device that may take your focus off the road. Your primary responsibility is the safe operation of your vehicle. We recommend against the use of any hand-held device while driving and encourage the use of voice-operated systems when possible. Make sure you are aware of all applicable local laws that may affect the use of electronic devices while driving.

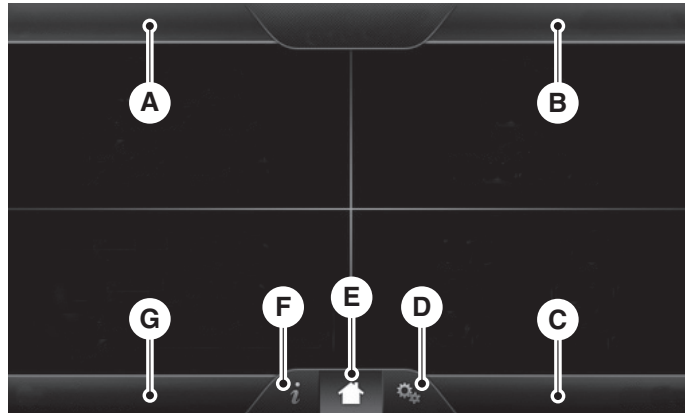

- A. Phone
- B. Navigation (or Information if your vehicle is not equipped with Navigation)
- C. Climate
- D. Settings
- E. Home
- F. Information
- G. Entertainment

This system uses a four-corner strategy to provide quick access several vehicle features and settings. The touchscreen provides easy interaction with your cellular phone, multimedia, climate control and navigation system. The corners display any active modes within those menus, such as phone status or the climate temperature.

Note: Some features are not available while your vehicle is moving.

Note: Your system is equipped with a feature that allows you to access and control audio features for 30 minutes after you switch the ignition off (and no doors open).

PHONE

Press to select any of the following:

- Making and Receiving Calls
- Quick Dial
- Phonebook
- Call History
- Text Messaging
- Settings

NAVIGATION

Press to select any of the following:

- My Home
- Favorites
- Previous Destinations
- Point of Interest
- Emergency
- Street Address
- Intersection
- City Center
- Map
- Edit Route Cancel Route

CLIMATE

Press to select any of the following:

- Driver Settings
- Recirculated Air
- Auto
- Dual
- Passenger Settings
- A/C
- Defrost

**SETTINGS**

Press to select any of the following:

- Clock
- Display
- Sound
- Vehicle
- Settings
- Help

**HOME**

Press to access your home screen. Depending on your vehicle's option package and software, your screens may vary in appearance from the descriptions in this section. Your features may also be limited depending on your market. Check with your authorized dealer for availability.

**INFORMATION**

Press to select any of the following:

- SYNC Services
- SIRIUS Travel Link
- Alerts
- Calendar
- SYNC Apps

If the icon is yellow, see *Alerts* in the *Information* section of this chapter.

ENTERTAINMENT

Press to select any of the following:

- AM
- FM
- SIRIUS
- CD
- USB
- BT Stereo
- SD Card
- A/V In

Using the Touch-sensitive Controls on Your System

To turn a feature on and off, just touch the graphic with your finger.

To get the best performance from the touch-sensitive controls:

- Do not press hard on the controls. They are sensitive to light touch.
- Use your bare finger to touch the center of a touch-control graphic. Touching off-center of the graphic may affect operation of a nearby control.
- Make sure your hands are clean and dry.
- Keep metal and other conductive material away from the surface of the touchscreen as this may cause electronic interference (for example, inadvertently turning on a feature other than the one you meant to turn on).

Depending on your vehicle and option package, you may also have these controls on your bezel:

- **Power:** Switch the media or climate features off and on.
- **VOL:** Control the volume of playing media.
- **Fan:** Control the speed of the climate system fan.
- **Seek and Tune buttons:** Use as you normally would in media modes.
- **Eject:** Eject a CD from the entertainment system.
- **Radio preset buttons:** Located below the touchscreen, you can use these buttons to enter a radio preset in addition to using the touchscreen.
- **MEDIA:** Touch the word repeatedly to see all available media modes. The screen does not change, but you see the media change in the lower left status bar.
- **Hazard flasher:** Switch the hazard flashers off and on.

Cleaning the Touchscreen Display

Use a clean, soft cloth such as one used for cleaning glasses. If dirt or fingerprints are still visible, apply a small amount of alcohol to the cloth. Do not pour or spray alcohol onto the display. Do not use detergent or any type of solvent to clean the display.

Support

The SYNC support team is available to help you with any questions you aren't able to answer on your own.

Monday-Saturday, 8:30 am-8pm EST

In the United States, call: 1-888-270-1055

In Canada, call: 1-800-565-3673

Times are subject to change due to holidays.

Safety information

WARNING: Driving while distracted can result in loss of vehicle control, accident and injury. Ford strongly recommends that drivers use extreme caution when using any device that may take their focus off the road. Your primary responsibility is the safe operation of the vehicle. We recommend against the use of any handheld device while driving, encourage the use of voice-operated systems when possible and that you become aware of applicable state and local laws that may affect use of electronic devices while driving.

- Do not attempt to service or repair SYNC®. See your authorized dealer.
- Do not operate playing devices if the power cords and/or cables are broken, split or damaged. Carefully place cords and/or cables where they will not be stepped on or interfere with the operation of pedals, seats and/or compartments, or safe driving abilities.
- Do not leave playing devices in the vehicle in extreme conditions as it could cause damage to your device. Refer to your device's user guide for further information.
- For your safety, some SYNC® functions are speed dependent and cannot be performed when the vehicle is traveling at speeds greater than 3 mph (5 km/h).
- Ensure that you review your device's user guide before using with SYNC®.

Speed-restricted Features

Some features of this system may be too difficult to use while your vehicle is moving so they are restricted from use unless your vehicle is stationary.

- Screens that are too crowded with information, such as Point of Interest reviews and ratings, SIRIUS Travel Link sports scores, movie times and ski conditions.
- Any action that requires you to use a keyboard is restricted, such as entering a navigation destination or editing information.
- All lists are limited so the user can view fewer entries (such as phone contacts or recent phone call entries).

See the following chart for more specific examples:

| Restricted Features | |
|-----------------------------|--|
| Cellular Phone | Pairing a Bluetooth phone |
| | Adding phonebook contacts or uploading phonebook contacts (from a USB) |
| | List entries are limited for phone contacts and recent phone call entries |
| System Functionality | Editing the keypad code |
| | Enabling Valet Mode |
| | Editing settings while the rear view camera or Active Park Assist are active |
| Wi-Fi and Wireless | Editing wireless settings |
| | Editing the list of wireless networks |
| Videos, Photos and Graphics | Playing video |
| | Editing the screen's wallpaper or adding new wallpaper |
| Text Messages | Composing text messages |
| | Viewing received text messages |
| | Editing preset text messages |
| Navigation | Using the keyboard to enter a destination |
| | Demo navigation route |
| | Adding or Editing Address Book entries or Avoid Areas |

Privacy information

When a cellular phone is connected to SYNC®, SYNC® creates a profile within your vehicle that is linked to that cellular phone. This profile is created in order to offer you more cellular features and to operate more efficiently. Among other things, this profile may contain data about your cellular phone book, text messages (read and unread), and call history, including history of calls when your cell phone was not connected to SYNC®. In addition, if you connect a media device, SYNC® creates and retains an index of media content supported by SYNC®. SYNC® also records a short development log of approximately 10 minutes of all recent SYNC® activity. The log profile and other SYNC® data may be used to improve SYNC® and help diagnose any problems that may occur.

The cellular profile, media device index, and development log will remain in the vehicle unless you delete it and are generally accessible only in the vehicle when the cellular phone or media player is connected. If you no longer plan to use SYNC® or the vehicle, we recommend you perform a Master Reset to erase all information stored in SYNC®.

SYNC® data cannot be accessed without special equipment and access to the vehicle's SYNC® module. Ford Motor Company and Ford of Canada will not access SYNC® data for any purpose other than as described absent consent, a court order, or where required by law enforcement, other government authorities, or other third parties acting with lawful authority. Other parties may seek to access the information independently of Ford Motor Company and Ford of Canada. For further privacy information, see the sections on 911 Assist™ (if equipped), Vehicle Health Report (if equipped), and Traffic, Directions and Information (if equipped).

USING VOICE RECOGNITION

This system helps you control many features using voice commands. This allows you to keep your hands on the wheel and focus on what is in front of you. The system provides feedback through audible tones, prompts, questions and spoken confirmations depending on the situation and the chosen level of interaction (voice settings).

The system also asks short questions (confirmation prompts) when it is not sure of your request or when there are multiple possible responses to your request.

When using voice commands, words and icons may appear in the lower left status bar indicating the status of the voice session (such as Listening, Success, Failed, Paused or Try Again).

How to Use Voice Commands with Your System

Press the voice icon. After the tone, speak your command clearly.

| These commands can be said at any time. |
|--|
| “Cancel” |
| “Exit” |
| “Go back” |
| “List of commands” |
| “Main menu” |
| “Next page” |
| “Previous page” |
| “What can I say?” |
| “Help” |

What Can I Say?

To access the available voice commands for the current session, do one of the following:

- During a voice session, press the Help icon (?) in the lower left status bar of the screen.
- Say, “What can I say?” for an on-screen listing of the possible voice commands associated with your current voice session.
- Press the voice icon. After the tone, say, “Help” to hear a list of possible voice commands.

Helpful Hints

- Make sure the interior of your vehicle is as quiet as possible. Wind noise from open windows and road vibrations may prevent the system from correctly recognizing spoken commands.
- After pressing the voice icon, wait until after the tone sounds and Listening appears before saying a command. Any command spoken prior to this does not register with the system.
- Speak naturally, without long pauses between words.
- At any time, you can interrupt the system while it is speaking by pressing the voice icon.

Accessing a List of Available Commands

- If you use the touchscreen, press the Settings icon > **Help** > **Voice Command List**.
- If you use the steering wheel control, press the voice icon. After the tone, speak your command clearly.

| Voice command list |
|---------------------------------------|
| “Audio list of commands” |
| “Bluetooth audio list of commands” |
| “Browse list of commands” |
| “CD list of commands” |
| “Climate control list of commands” |
| “List of commands” |
| “Navigation list of commands”* |
| “Phone list of commands” |
| “Radio list of commands” |
| “SD card list of commands” |
| “Sirius satellite list of commands”** |
| “Travel link list of commands”* |
| “USB list of commands” |
| “Voice instructions list of commands” |
| “Voice settings list of commands” |
| “Help” |

*This command is only available when your vehicle is equipped with the navigation system, and the navigation system SD card is in the card slot.

**This command is only available when you have an active SIRIUS satellite radio subscription.

Voice Settings

Voice settings allow you to customize the level of system interaction, help and feedback. The system defaults to standard interaction that uses candidate lists and confirmation prompts as these provide the highest level of guidance and feedback.

Interaction Mode: Novice mode provides detailed interaction and guidance while the advanced mode has less audible interaction and more tone prompts.

Confirmation Prompts: The system uses these short questions to confirm your voice request. If turned off, the system simply makes a best guess as to what you requested. The system may still occasionally ask you to confirm settings.

Phone/Media Candidate Lists: Candidate lists are lists of possible results from your voice commands. The system creates these lists when it has the same confidence level of several options based on your voice command.

To access these settings using the touchscreen:

1. Press the Settings icon > **Settings** > **Voice Control**.
2. Select from:
 - Interaction Mode
 - Confirmation Prompts
 - Media Candidate Lists
 - Phone Candidate Lists
 - Voice Control Volume.

To access these settings using voice commands:



Press the voice icon. Wait for the prompt “Please say a command”. Another tone sounds to let you know the system is listening.

| Voice settings using voice commands |
|-------------------------------------|
| “Interaction Mode Novice” |
| “Interaction Mode Advanced” |
| “Confirmation Prompts On” |
| “Confirmation Prompts Off” |
| “Phone Candidate Lists On” |
| “Phone Candidate Lists Off” |
| “Media Candidate Lists On” |
| “Media Candidate Lists Off” |
| “Help” |

Using Voice Commands with the Touchscreen Options

Your voice system has a dual mode feature which allows you to switch between using voice commands and making on-screen selections. This is most often available when using navigation.

Buttons outlined in blue indicate selections that are part of the dual mode feature. For example, if while you are in a voice session rather than saying the command “Enter Street Name” to change the field, you can press Street and the voice session does not end. Instead, the voice system changes to the Street field and asks you to say the street name. You cannot use the buttons not outlined in blue as voice commands. If they are touched during a voice session, the voice session ends.

For example, you can choose from the following on the Navigation home screen:

- My Home
- Favorites
- Previous Destinations
- Point of Interest (POI)
- Emergency
- Street Address
- Intersection
- Cancel Route.

Some of the voice commands that are available while viewing this screen are:

| “DESTINATION” |
|-------------------------------------|
| “Destination my home” |
| “Destination street address” |
| “Destination favorites” |
| “Destination previous destinations” |
| “Destination POI” |
| “Destination intersection” |
| “Destination emergency” |

If you choose Street Address from the navigation screen, you can choose from the following:

- Number
- City
- Street Name
- State/Prov.

Some of the voice commands that are available while viewing this screen are:

| “STREET ADDRESS” |
|-------------------------|
| “Enter house number” |
| “Change house number” |
| “Enter street name” |
| “Change street name” |
| “Enter city” |
| “Change city” |
| “Enter state” |
| “Change state” |

If you choose Points of Interest from the navigation screen, you can choose from the following:

- Search Area
- Search By Name
- Fuel Station
- ATM
- All Restaurants
- Accommodations
- Parking.

Some of the voice commands that are available while viewing this screen are:

| “POINTS OF INTEREST” or “POI” |
|--------------------------------------|
| “Destination <POI category name>” |
| “Search by name” |
| “Search by category” |
| “Change search area” |

Note: These are just a sample of the voice commands available within the Points of Interest section; the categories themselves are also technically voice commands.

If you choose Intersection from the navigation screen, you can choose from the following:

- 1st Street
- 2nd Street
- City
- State/Prov.

478 MyFord Touch® (If Equipped)

Some of the voice commands that are available while viewing this screen are:

| “INTERSECTION” |
|-----------------------------|
| “Enter first street name” |
| “Change first street name” |
| “Enter second street name” |
| “Change second street name” |
| “Enter city” |
| “Change city” |
| “Enter state” |
| “Change state” |

The dual mode feature is also available when the voice system displays a list of items to pick from during a voice session, where you would be able to touch the line item or say “Line 2”. If the system does not understand a voice command, or there are multiple options, the system displays a voice command list for you.

ENTERTAINMENT



- A. AM 1 and AM AST
- B. FM 1, FM 2 and FM AST
- C. SIRIUS
- D. CD
- E. USB

F. Touch this button to scroll down for more options, such as:

- SD Card
- BT Stereo
- A/V In

G. These buttons change with the media mode you are in.

H. Radio memory presets and CD controls.

Note: Some features may not be available in your area. Contact an authorized dealer for more information.

You can access these options using the touchscreen or voice commands.

Browsing Device Content

When listening to audio on a device, you can browse through other devices without having to change sources. For example, if you are currently listening to audio on an SD card, you can browse all the artists that are stored on your USB device.



Press the voice icon on the steering wheel. When prompted, you can say:

| “BROWSE” within Devices |
|-------------------------------------|
| “Browse”* |
| “Browse <league> games” |
| “Browse <Sirius category> channels” |
| “Browse CD track list” |
| “Browse Sirius channel guide” |
| “Browse SD card” |
| “Browse USB” |
| “Help” |

*If you have said “Browse”, you can then say any commands in the following chart.

**This command is only usable if you have an active subscription to SIRIUS satellite radio.

| “BROWSE” |
|------------------------------|
| “<League> games” |
| ”<Sirius category> channels” |
| “CD track list” |
| “SD card” |
| “Sirius channel guide” |
| “USB” |
| “Help” |

*This command is only usable if you have an active subscription to SIRIUS satellite radio.

**For more commands in SD card or USB mode, see the “SD card and USB Port” section of this chapter.

For a complete list of “Browse” voice commands, see *USB and SD card voice commands* and *Bluetooth audio voice commands* in the following sections.

Your voice system allows you to change audio sources with a simple voice command. For example, if you are listening to music on a USB device, then want to switch to a satellite radio channel, simply press the voice button on the steering wheel controls and say the name of the SIRIUS station (such as, “the Highway”). The following voice commands are available at the top level of the voice session no matter which current audio source you are listening to (such as a USB device or SIRIUS satellite radio). **Note:** This is only available when your MyFord Touch system language is set to North American English.

| | |
|--------------------------|---|
| “AM <530 - 1710>” | “FM <87.7 – 107.9>” |
| “<530 - 1710>” | “<87.7 – 107.9>” |
| “Sirius <0-223>”* | “<Channel name>”* |
| “Play [genre] <name>”** | “Play [playlist] <name>”** |
| “Play [artist] <name>”** | “Play [song] <name>”** |
| “Play [album] <name>”** | “Play <name (song or album)> by <artist name>” |
| “Play <name>” | “Sports games”* |

*This command is only usable if you have an active subscription to SIRIUS satellite radio.

**The commands that have [] around the word means that the word is optional. For example, if you say, “Play Metallica”, this is the same as the voice command, “Play [artist] <name>”.

AM and FM

Touch the **AM** or **FM** tab to listen to the radio.

To change between AM and FM presets, just touch the **AM** or **FM** tab.

Memory Presets

Save a station by pressing and holding one of the memory preset areas. There is a brief mute while the radio saves the station. Sound returns when finished.

HD Radio

Touch this button to turn HD Radio on. The light on the button illuminates when the feature is on. HD Radio allows you to receive radio broadcasts digitally, where available, providing free, crystal-clear sound. See *HD Radio information* later in this chapter.

Scan

Touch this button to go to the next strong AM or FM radio station. The light on the button illuminates when the feature is on.

Options

Sound Settings allows you to adjust settings for:

- Bass
- Midrange
- Treble
- Balance and Fade
- DSP (Digital Signal Processing)
- Occupancy Mode
- Speed Compensated Volume.

Note: Your vehicle may not have all these sound settings.

Set PTY for Seek/Scan allows you to select a category of music you would like to search for. You can then choose to either seek or scan for the stations playing that category.

RDS Text Display allows you to view the information broadcast by FM stations.

AST allows you to have the system automatically store the six strongest stations in your current location.

TAG Button is available when HD Radio is on, and allows you to tag a song to download later. When you select **On**, TAG appears on-screen when HD Radio is active. You can touch **TAG** to save the information of the song that is playing. When you plug in your portable music player, the information transfers, if supported by your device. When you are connected to iTunes, the tags appear to remind you of the songs you would like to download. See *HD Radio information* later in this chapter.

Direct Tune

Touch this button to manually enter the desired station number. Touch **Enter** when you are done.

HD Radio™ Information (If Available)

Note: HD Radio broadcasts are not available in all markets.

HD Radio technology is the digital evolution of analog AM/FM radio. Your system has a special receiver that allows it to receive digital broadcasts (where available) in addition to the analog broadcasts, it already receives. Digital broadcasts provide a better sound quality than analog broadcasts with free, crystal-clear audio and no static or distortion. For more information, and a guide to available stations and programming, please visit www.hdradio.com.

When HD Radio is on and you tune to a station broadcasting HD Radio technology, you may notice the following indicators on your screen:



HD) logo blinks when acquiring a digital station and stays solid when digital audio is playing. When this logo is available, you may also see Title and Artist fields on-screen.

Multicast indicator appears in FM mode (only) if the current station is broadcasting multiple digital broadcasts. The highlighted numbers signify available digital channels where new or different content is available. HD1 signifies the main programming status and is available in analog and digital broadcasts. Other multicast stations (HD2 through HD7) are only available digitally.

TAG allows you to save a song to download later when you are on an acquired HD Radio station and the feature is on. To turn the feature on and use it:

1. Press **AM** or **FM** > **Options** > **TAG** button > **On**.
2. When you hear a song you like, touch **TAG**.
3. The system automatically saves the song's information and transfers it to your portable music player (if supported) when you connect it to the system. The system automatically transfers the tag to your player (if already connected) and a pop-up confirms the transfer.
4. When you access iTunes with your portable music player, the tags appear to you as a reminder. The system allows you to tag up to approximately 100 songs. For a list of devices that support tagging, see www.SYNCMYRide.com, www.SYNCMYRide.ca or www.syncmaroute.ca.

When HD Radio broadcasts are active, you can access the following functions:

- **Scan** allows you to hear a brief sampling of all available stations. This feature still works when HD Radio reception is on, although it does not scan for HD2-HD7 channels. You may see the HD logo appear if the station has a digital broadcast.
- **Memory presets** allow you to save an active channel as a memory preset. Touch and hold a memory preset slot until the sound returns. There is a brief mute while the radio saves the station. Sound returns when finished. When switching to an HD2 or HD3 memory preset, the sound mutes before the digital audio plays, because the system has to reacquire the digital signal.
 - **Note:** As with any saved radio station, you cannot access the saved station if your vehicle is outside the station's reception area.

HD Radio Reception and Station Troubleshooting

| Potential Reception Issues | |
|-----------------------------------|--|
| Reception area | If you are listening to a multicast station and you are on the fringe of the reception area, the station may mute due to weak signal strength. |
| | If you are listening to HD1, the system switches back to the analog broadcast until the digital broadcast is available again. However, if you are listening to any of the possible HD2 through HD7 multicast channels, the station mutes and stays muted unless it is able to connect to the digital signal again. |
| Station blending | When the system first receives a station (aside from HD2-HD7 multicast stations), it first plays the station in the analog version. Once the receiver verifies the station is an HD Radio station, it shifts to the digital version. Depending on the station quality, you may hear a slight sound change when the station changes from analog to digital. Blending is the shift from analog to digital sound or digital back to analog sound. |

In order to provide the best possible experience, use the contact form to report any station issues found while listening to a station broadcasting with HD Radio technology. Independent entities own and operate each station. These stations are responsible for making sure all audio streams and data fields are accurate.

| Potential station issues | | |
|--|---|---|
| Issue | Cause | Action |
| Echo, stutter, skip or repeat in audio. Increase or decrease in audio volume. | This is poor time alignment by the radio broadcaster. | No action required. This is a broadcast issue. |
| Sound fading or blending in and out. | The radio is shifting between analog and digital audio. | No action required. The reception issue may clear up as you continue to drive. |
| There is an audio mute delay when selecting HD2 or HD3, multicast preset or Direct Tune . | The digital multicast is not available until the HD Radio broadcast is decoded. Once decoded, the audio is available. | No action required. This is normal behavior. Wait until the audio is available. |
| Cannot access HD2 or HD3 multicast channel when recalling a preset or from a direct tune. | The previously stored multicast preset or direct tune is not available in your current reception area. | No action required. The station is not available in your current location. |
| Text information does not match currently playing audio. | Data service issue by the radio broadcaster. | Fill out the station issue form at website listed below.* |
| There is no text information shown for currently selected frequency. | Data service issue by the radio broadcaster. | Fill out the station issue form at website listed below.* |
| HD2-HD7 stations not found when Scan is pressed. | Pressing Scan disables HD2-HD7 channel search. | No action required. This is normal behavior. |

*http://www.ibiquity.com/automotive/report_radio_station_experiences

HD Radio Technology manufactured under license from iBiquity Digital Corp. U.S. and foreign patents. HD Radio and the HD and HD Radio logos are proprietary trademarks of iBiquity Digital Corp. Ford Motor Company and iBiquity Digital Corp. are not responsible for the content sent using HD Radio technology. Content may be changed, added or deleted at any time at the station owner's discretion.

Radio Voice Commands

If you are listening to the radio, press the voice button on the steering wheel control. When prompted, say any of the commands in the following chart.

If you are not listening to the radio, press the voice button and, after the tone, say “Radio”, then any of the commands in the following chart.

| “RADIO” | |
|---------------------------------------|--------------------------|
| “<87.9–107.9>” | “FM autotset preset <#>” |
| “<87.9–107.9> HD” ¹ | “FM preset <#>” |
| “<530–1710>” | “FM1” |
| “AM” | “FM 1 preset <#>” |
| “AM <530–1710>” | “FM2” |
| “AM autotset” | “FM 2 preset <#>” |
| “AM autotset preset <#>” | “HD <#>” ¹ |
| “AM preset <#>” | “Preset <#>” |
| “Browse” ² | “Radio off” |
| “FM” | “Radio on” |
| “FM <87.9–107.9>” | “Set PTY” |
| “FM <87.9–107.9> HD <#>” ¹ | “Tune” ³ |
| “FM autotset” | “Help” |

¹If available.

²If you have said, “Browse”, see *Browsing device content* earlier in this section.

³If you have said, “Tune”, see the following “Tune” chart.

| “TUNE” | |
|---------------------------|--------------------------|
| “<87.9-107.9>” | “FM autosest” |
| “<87.9-107.9> HD <#>”* | “FM autosest preset <#>” |
| “<530-1710>” | “FM preset <#>” |
| “AM” | “FM1” |
| “AM <530-1710>” | “FM 1 preset <#>” |
| “AM autosest” | “FM2” |
| “AM autosest preset <#>” | “FM 2 preset <#>” |
| “AM preset <#>” | “HD <#>”* |
| “FM” | “Preset <#>” |
| “FM <87.9-107.9>” | “Help” |
| “FM <87.9-107.9> HD <#>”* | |

*If available.

SIRIUS® Satellite Radio (If Activated)



Press the lower left corner of the touchscreen, then select the **SIRIUS** tab.

Presets

Save a channel by pressing and holding one of the memory preset areas. There is a brief mute while the radio saves the channel. Sound returns when finished.

ALERT

Save the current song, artist, or team as a favorite. The system alerts you when it plays again on any channel.

Replay

Replay audio on the current channel. You can replay approximately 45 minutes of audio as long as you have remained tuned to the current station. Changing stations erases the previous audio.

While in replay mode:

- Press and release the seek buttons to hear the previous or next song.
- Press and hold the seek buttons to reverse or fast forward in the current track.
- Press play or pause to play or pause the audio.
- Press **Replay** to return to live audio if you have been using the feature to replay audio.

Scan

Touch this button to hear a brief sampling of channels.

Options

Sound Settings allows you to adjust settings for:

- Bass
- Midrange
- Treble
- Balance and Fade
- DSP (Digital Signal Processing)
- Occupancy Mode
- Speed Compensated Volume.

Note: Your vehicle may not have all these sound settings.

Set Category for Seek/Scan allows you to select a category of music you would like to search for. You can then choose to either seek or scan for the stations playing that category.

Parental Lockout allows you to lock and unlock channels, change or reset your PIN or unlock all channels. To use this feature, you need your initial PIN, which is 1234.

Artist/Title/Team Alerts allows you to select Artists, Titles and Teams that you would like the system to alert you to when they are playing on other channels. Press **Edit Alerts** to delete or turn off alerts. You can also set all alerts to on or off. When an alert appears on the screen, you can choose to Tune to the channel, to Cancel the alert or to Disable Alerts. If you are listening to a sporting event, you can save your favorite teams so that the system can alert you when they are playing on a satellite radio channel.

Note: SIRIUS does not support the Alert feature on all channels. Ford Motor Company shall not be responsible for Alert feature variation.

Electronic Serial Number (ESN) is required when communicating with SIRIUS about your account.

Direct Tune

Touch this button to manually enter the desired satellite channel number. Touch **Enter** when you are done.

Browse

Touch this button to view a list of all available stations. Scroll to see more categories. Touch the station you want to listen to.

Touch **Skip** if you want to skip this channel.

Touch **Lock** if you do not want anyone to listen to this channel.

Touch **Title** or **Artist** to see song and artists on other stations.

Satellite Radio Voice Commands

If you are listening to SIRIUS satellite radio, press the voice button on the steering wheel control. When prompted, say any of the commands in the following chart.

If you are not listening to SIRIUS satellite radio, press the voice button and, after the tone, say “Sirius”, then any of the commands in the following chart.

| “SIRIUS” | |
|--------------------|--------------------|
| “Sirius <0–223>” | “SAT 3” |
| “<Channel name>” | “SAT 3 preset <#>” |
| “Preset <#>” | “SAT preset <#>” |
| “SAT” | “Sirius off” |
| “SAT 1” | “Sirius on” |
| “SAT 1 preset <#>” | “Sports game”* |
| “SAT 2” | “Tune”** |
| “SAT 2 preset <#>” | “Help” |

*If you have said, “Sports game”, see the following “Sports game” chart.

**If you have said, “Tune”, see the following “Tune” chart.

| “SPORTS GAME” |
|--|
| “Tune to the <college name> game” |
| “Tune to the <team city> game” |
| “Tune to the <team city> <team name> game” |
| “Tune to the <team name> game” |
| “Help” |

| |
|--------------------|
| “TUNE” |
| “Sirius <0–223>” |
| “<Channel name>” |
| “Preset <#>” |
| “SAT” |
| “SAT 1” |
| “SAT 1 preset <#>” |
| “SAT 2” |
| “SAT 2 preset <#>” |
| “SAT 3” |
| “SAT 3 preset <#>” |
| “Help” |

SIRIUS Satellite Radio Information

Note: SIRIUS reserves the unrestricted right to change, rearrange, add or delete programming including canceling, moving or adding particular channels, and its prices, at any time, with or without notice to you. Ford Motor Company shall not be responsible for any such programming changes.

Note: This receiver includes the eCos real-time operating system. eCos is published under the eCos License.



SIRIUS satellite radio is a subscription-based satellite radio service that broadcasts a variety of music, sports, news, weather, traffic and entertainment programming.

Your factory-installed SIRIUS satellite radio system includes

hardware and a limited subscription term that begins on the date of sale or lease of your vehicle. See your authorized dealer for availability.

For more information on extended subscription terms (a service fee is required), the online media player and a list of SIRIUS satellite radio channels, and other features, please visit www.siriusxm.com in the United States, www.sirius.ca in Canada, or call SIRIUS at 1-888-539-7474.

Satellite radio electronic serial number (ESN): You need your ESN to activate, modify or track your satellite radio account. The ESN is on the System Information Screen (SR ESN: XXXXXXXXXXXX). To access your ESN, press the bottom left corner of the touchscreen, then **SIRIUS** > **Options**.

| Potential satellite radio reception issues | |
|---|---|
| Antenna obstructions | For optimal reception performance, keep the antenna clear of snow and ice build-up and keep luggage and other materials as far away from the antenna as possible. |
| Terrain | Hills, mountains, tall buildings, bridges, tunnels, freeway overpasses, parking garages, dense tree foliage and thunderstorms can interfere with your reception. |
| Station overload | When you pass a ground-based broadcast-repeating tower, a stronger signal may overtake a weaker one and the audio system may mute. |
| Satellite radio signal interference | Your display may show ACQUIRING . . . to indicate the interference and the audio system may mute. |

| SIRIUS troubleshooting tips | | |
|------------------------------------|---|--|
| Radio display | Condition | Possible action |
| Acquiring... | Radio requires more than two seconds to produce audio for the selected channel. | No action required. This message should disappear shortly. |
| Sat Fault/SIRIUS system failure. | There is an internal module or system failure present. | If this message does not clear shortly, or with an ignition key cycle, your receiver may have a fault. See your authorized dealer for service. |
| Invalid Channel. | The channel is no longer available. | Tune to another channel or choose another preset. |

| SIRIUS troubleshooting tips | | |
|----------------------------------|---|--|
| Radio display | Condition | Possible action |
| Unsubscribed Channel. | Your subscription does not include this channel. | Contact SIRIUS at 1-888-539-7474 to subscribe to the channel, or tune to another channel. |
| No Signal. | The signal is lost from the SIRIUS satellite or SIRIUS tower to your vehicle antenna. | The signal is blocked. When you move into an open area, the signal should return. |
| Updating. | Update of channel programming in progress. | No action required. The process may take up to three minutes. |
| Call SIRIUS 1-888-539-7474. | Your satellite service is no longer available. | Contact SIRIUS at 1-888-539-7474 to resolve subscription issues. |
| None Found. Check Channel Guide. | All the channels in the selected channels are either skipped or locked. | Use the channel guide to turn off the Lock or Skip function on that station. |
| Subscription Updated. | SIRIUS has updated the channels available for your vehicle. | No action required. |

CD

Press the lower left corner of the touchscreen, and then select the **CD** tab.

You can also advance and reverse the current track or current folder, if applicable.

Repeat

Touch this button to repeat the currently playing track, all tracks on the disc or turn the feature off if already on.

Shuffle

Touch this button to play the tracks or entire albums in random order, or turn the feature off if already on.

Scan

Touch this button to hear a brief sampling of all available tracks.

More Info

Touch this button to see disc information.

Options

Sound Settings allows you to adjust settings for:

- Bass
- Midrange
- Treble
- Balance and Fade
- DSP (Digital Signal Processing)
- Occupancy Mode
- Speed Compensated Volume.

Note: Your vehicle may not have all these sound settings.

Compression allows you to turn the compression feature on and off.

Browse

Touch this button to look through all available CD tracks.

CD Voice Commands

If you are listening to a CD, press the voice button on the steering wheel control. When prompted, say any of the commands in the following chart.

If you are not listening to a CD, press the voice button and, after the tone, say "CD", then any of the commands in the following chart.

| "CD" | |
|-----------------------|-------------------|
| "Pause" | "Repeat off" |
| "Play" | "Repeat track" |
| "Play next track" | "Shuffle" |
| "Play previous track" | "Shuffle CD"* |
| "Play track <1-512>" | "Shuffle folder"* |
| "Repeat" | "Shuffle off" |
| "Repeat folder"* | "Help" |

*This applies to WMA or MP3 files only.

SD Card Slot and USB Port**SD Card Slot**

Note: Your SD card slot is spring-loaded. To remove the SD card, press the card in and the system ejects it. Do not attempt to pull the card to remove it as this could cause damage.

Note: The navigation system also uses this card slot. See *Navigation system* later in this chapter for more information.

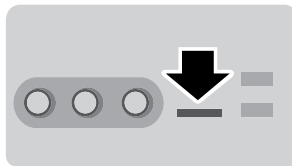

The slot is located in a compartment on top of the instrument panel. Push down on the top of the compartment to access it. To access and play music from your card, press the lower left corner of the touchscreen, and then select the **SD Card** tab.

SD logo is a trademark of SD-3C, LLC.

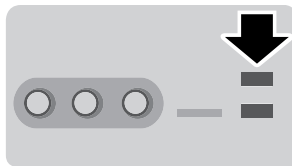
**USB Port**

The ports are located in a compartment on top of the instrument panel. Push down on the top of the compartment to access them. To access and play music from your device, press the lower left corner of the touchscreen, and then select the **USB** tab.

This feature allows you to plug in media playing devices, memory sticks, flash drives or thumb drives, and charge devices if they support this feature.

In order to playback video from your iPod or iPhone, if compatible, you must have a special combination USB/RCA composite video cable, which you can buy from Apple. When you connect the cable to your iPod or iPhone, plug the other end into both the RCA jacks and the USB port.

Playing Music from Your Device

Insert your device and select the **SD Card** or **USB** tab once the system recognizes it. You can then select from the following options:

Repeat replays the currently playing song or album.

Shuffle plays music on the selected album or folder in random order.

Similar Music allows you to choose music similar to what is currently playing.

More Info displays information such as current track, artist name, album and genre.

Options allows you to view and adjust various media settings.

- **Sound Settings** allows you to adjust settings for:
 - Bass
 - Midrange
 - Treble
 - Balance and Fade
 - DSP (Digital Signal Processing)
 - Occupancy Mode
 - Speed Compensated Volume.

Note: Your vehicle may not have all these sound settings.

- **Media Player Settings** allows you to select more settings, which is under **Media Player**. See *Settings*.
- **Device Information** displays software and firmware information about the currently connected media device.
- **Update Media Index** indexes your device each time you connect it to make sure you have the latest voice commands available for all media on the device.

Browse allows you to view the contents of the device. It also allows you to search by categories, such as genre, artist or album.

If you want to view song information such as Title, Artist, File, Folder, Album, and Genre, touch the on-screen album art.

You can also touch **What's Playing** to hear how the system pronounces the current band and song. This can be helpful when using voice commands to make sure the system correctly plays your request.

SD Card and USB Voice Commands

If you are listening to a USB device or an SD card, press the voice button on the steering wheel control. When prompted, say any of the commands in the following chart.

If you are not listening to a USB device or an SD card, press the voice button and, after the tone, say “USB” or “SD card”, then any of the commands in the following chart.

| “USB” or “SD CARD” | |
|-------------------------------|---------------------------------------|
| “Browse”* | “Play previous song” |
| “Next” | “Play similar music” |
| “Pause” | “Play song <name>” |
| “Play” | “Play TV show <name>”** |
| “Play album <name>” | “Play TV show episode <name>”** |
| “Play all” | “Play video <name>”** |
| “Play artist <name>” | “Play video podcast <name>”** |
| “Play audiobook <name>” | “Play video podcast episode <name>”** |
| “Play author <name>” | “Play video playlist <name>”** |
| “Play composer <name>” | “Previous” |
| “Play folder <name>” | “Repeat all” |
| “Play genre <name>” | “Repeat off” |
| “Play movie <name>”** | “Repeat one” |
| “Play music video <name>”** | “Shuffle” |
| “Play next song” | “Shuffle off” |
| “Play playlist <name>” | “What’s this?” |
| “Play podcast <name>” | “Help” |
| “Play podcast episode <name>” | |

*If you have said you would like to browse your USB or SD card, the system prompts you to specify what you would like to browse. When prompted, see the following “Browse” chart.

**This command is only available in USB mode and are device-dependent.

| “BROWSE” | |
|------------------------|--------------------------|
| “Album <name>” | “All video podcasts”* |
| “All albums” | “All videos”* |
| “All artists” | “Artist <name>” |
| “All audiobooks” | “Audiobook <name>” |
| “All authors” | “Author <name>” |
| “All composers” | “Composer <name>” |
| “All folders” | “Folder <name>” |
| “All genres” | “Genre <name>” |
| “All movies” * | “Playlist <name>” |
| “All music videos”* | “Podcast <name>” |
| “All playlists” | “TV show <name>”* |
| “All podcasts” | “Video <name>”* |
| “All songs” | “Video playlist <name>”* |
| “All TV shows”* | “Video podcast <name>”* |
| “All video playlists”* | “Help” |

*This command is only available in USB mode and are device-dependent.

Supported Media Players, Formats and Metadata Information

SYNC is capable of hosting nearly any digital media player, including iPod®, Zune™, plays from device players, and most USB drives. Supported audio formats include MP3, WMA, WAV and AAC.

It is also able to organize your indexed media from your playing device by metadata tags. Metadata tags, which are descriptive software identifiers embedded in the media files, provide information about the file.

If your indexed media files contain no information embedded in these metadata tags, SYNC may classify the empty metadata tags as

Unknown.

In order to playback video from your iPod® or iPhone®, (if compatible), you MUST have a special combination USB/RCA composite video cable (which you can buy from Apple®). When the cable is connected to your iPod® or iPhone®, plug the other end into both the RCA jacks and the USB port.

Bluetooth Audio

Your system allows you to stream audio over your vehicle's speakers from your connected, Bluetooth-enabled cellular phone.



To access, press the lower left corner on the touchscreen, then select the **BT Stereo** tab.

Bluetooth Audio Voice Commands

If you are listening to a Bluetooth audio device, press the voice button on the steering wheel control. When prompted, say "Next song", "Pause", "Play" or "Previous song".

If you are not listening to a Bluetooth audio device, press the voice button and, after the tone, say "Bluetooth Audio", then "Next song", "Pause", "Play" or "Previous song".

A/V Inputs

WARNING: Driving while distracted can result in loss of vehicle control, crash and injury. We strongly recommend that you use extreme caution when using any device that may take your focus off the road. Your primary responsibility is the safe operation of your vehicle. We recommend against the use of any hand-held device while driving and encourage the use of voice-operated systems when possible. Make sure you are aware of all applicable local laws that may affect the use of electronic devices while driving.



WARNING: For safety reasons, do not connect or adjust the settings on your portable music player while your vehicle is moving.



WARNING: Store the portable music player in a secure location, such as the center console or the glove box, when your vehicle is in motion. Hard objects may become projectiles in a crash or sudden stop, which may increase the risk of serious injury. The audio extension cable must be long enough to allow the portable music player to be safely stored while your vehicle is moving.

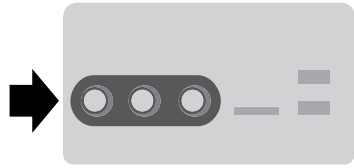

Your A/V inputs allow you to connect an auxiliary audio/video source (such as a gaming systems or a personal camcorder) by connecting RCA cords (not included) to these input jacks. The jacks are yellow, red and white and are located either behind a small access door on the

instrument panel or in your center console.

You can also use the A/V inputs as an auxiliary input jack to play music from your portable music player over your vehicle's speakers. Plug in your 1/8 inch (3.5 millimeter) RCA adapter into the two left A/V input jacks (red and white).

Press the lower left corner of the touchscreen, and then select **A/V In**.

To use the auxiliary input jack feature, make sure that your portable music player is designed for use with headphones and that it is fully charged. You also need an audio extension cable with stereo male 1/8th-inch (3.5 millimeter) connectors at one end and a RCA jack at the other.

1. Switch off the engine, radio and portable music player. Set the parking brake and put the transmission in position **P**.
2. Attach one end of the audio extension cable to the headphone output of your player and the other end into the adapter in one of the two left A/V input jacks (white or red) inside the center console.
3. Press the lower left corner on the touchscreen. Select either a tuned FM station or a CD (if there is a CD already loaded into the system).
4. Adjust the volume as desired.
5. Turn the portable music player on and adjust the volume to ½ the maximum.
6. Press the lower left corner on the touchscreen. Select the A/V In tab. (You should hear audio from your portable music player although it may be low.)
7. Adjust the sound on your portable music player until it reaches the level of the FM station or CD by switching back and forth between the controls.

In order to playback video from your iPod® or iPhone® (if compatible), you must have a special combination USB/RCA composite video cable (which you can buy from Apple®). When the cable is connected to your iPod® or iPhone®, plug the other end into both the RCA jacks and the USB port.

Troubleshooting

- Do not connect the audio input jack to a line level output. The jack only works correctly with devices that have a headphone output with a volume control.
- Do not set the portable music player's volume level higher than is necessary to match the volume of the CD or FM radio as this causes distortion and reduces sound quality.
- If the music sounds distorted at lower listening levels, turn the portable music player volume down. If the problem persists, replace or recharge the batteries in the portable media player.
- Control the portable media player in the same manner when used with headphones, as the auxiliary input jack does not provide control (such as Play or Pause) over the attached portable media player.

PHONE

- A. Phone
- B. Quick Dial
- C. Phonebook
- D. History
- E. Messaging
- F. Settings

Hands-free calling is one of the main features of SYNC®. Once you pair your phone, you can access many options using the touchscreen or voice commands. While the system supports a variety of features, many are dependent on your cellular phone's functionality. At a minimum, most cellular phones with Bluetooth wireless technology support the following functions:

- Answering an incoming call
- Ending a call
- Using privacy mode
- Dialing a number
- Redialing
- Call waiting notification
- Caller ID.

Other features, such as text messaging using Bluetooth and automatic phonebook download, are phone-dependent features. To check your phone's compatibility, see your phone's user manual and visit www.SYNCMyRide.com, www.SYNCMyRide.ca or www.syncmaroute.ca.

Pairing Your Phone for the First Time



WARNING: Driving while distracted can result in loss of vehicle control, crash and injury. We strongly recommend that you use extreme caution when using any device that may take your focus off the road. Your primary responsibility is the safe operation of your vehicle. We recommend against the use of any hand-held device while driving and encourage the use of voice-operated systems when possible. Make sure you are aware of all applicable local laws that may affect the use of electronic devices while driving.

The first thing you must do to use the phone features of SYNC is to pair your Bluetooth-enabled cellular phone with SYNC. This allows you to use your phone in a hands-free manner.

Note: Put the transmission in position **P**. Turn on your vehicle ignition and the radio.

1. Touch **Add Phone** in the upper left corner of the touchscreen. **Find SYNC** appears on the screen and instructs you to begin the pairing process from your device.
2. Make sure that Bluetooth is set to **On** and that your cellular phone is in the proper mode. See your phone's manual if necessary.
 - Select **SYNC**, and a six-digit PIN appears on your device.

3. If you are prompted to enter a PIN on your device, it does not support Secure Simple Pairing. To pair, enter the PIN displayed on the touchscreen. Skip the next step.
4. When prompted on your phone's display, confirm that the PIN provided by SYNC matches the PIN displayed on your cellular phone.
5. The display indicates when the pairing is successful.

SYNC may prompt you with more phone options. For more information on your phone's capability, see your phone's manual and visit the website.

Pairing Subsequent Phones

Note: Put the transmission in position **P**. Turn on your vehicle ignition and the radio.

1. Press the **Phone** corner of the touchscreen > **Settings** > **BT Devices** > **Add Device**.
2. Make sure that Bluetooth is set to **On** and that your cellular phone is in the proper mode. See your phone's user guide if necessary.
3. When prompted on your phone's display, enter the six-digit PIN provided by SYNC on the screen. The display indicates when the pairing is successful. The system asks you if you want to download your phonebook.

SYNC may prompt you with more phone options. For more information on your phone's capability, see your phone's user guide and visit the website.

Making Calls



Press the voice button on your steering wheel controls. When prompted, say, "Call <name>" or say "Dial", then the desired number.



To end the call or exit phone mode, press and hold the phone button.

Receiving Calls

During an incoming call, an audible tone sounds. Call information appears in the display if it is available.



Accept the call by pressing **Accept** on the touchscreen or by pressing the phone button on your steering wheel controls.

Reject the call by pressing **Reject** on the touchscreen or by pressing and holding the phone button on your steering wheel controls.

Ignore the call by doing nothing. SYNC logs it as a missed call.

Phone Menu Options

Press the top left corner on your touchscreen to select from the following options:

Phone

Touch this button to access the on-screen numerical pad to enter a number and place a call. During an active call, you can also choose to:

- Mute the call
- Put it on hold
- Turn on privacy (returns the call to your cellular phone)
- Join two calls
- End the call.

Quick Dial

Set up favorite contacts from your phonebook or history folder.

Phonebook

Touch this button to access and call any contacts in your previously downloaded phone book. The system places the entries in alphabetical categories summarized at the top of the screen.

To turn on contact picture settings, if your device supports this feature, press **Phone > Settings > Manage Phonebook > Download photos from Phonebook > On.**

Certain smart phones may support transferring street addresses when listed with phone book contact information. If your phone supports this feature, you can select and use these addresses as destinations and save them as favorites.

History

After you connect your Bluetooth-enabled phone to SYNC, you can access any previously dialed, received or missed calls. You can also choose to save these to your **Favorites** or to **Quick Dial**.

Note: This is a phone-dependent feature. If your phone does not support downloading call history using Bluetooth, SYNC keeps track of calls made with the SYNC system.

Messaging

Send text messages using your touchscreen. See *Text messaging* later in this section.

Settings

Touch this button to access various phone settings, such turning Bluetooth on and off, managing your phonebook and more. See *Phone settings* later in this section.

Text Messaging

Note: Downloading and sending text messages using Bluetooth are phone-dependent features.

Note: Certain features in text messaging are speed-dependent and not available when your vehicle is traveling at speeds over 3 mph (5 km/h).

Note: SYNC does not download read text messages from your phone.

You can send and receive text messages using Bluetooth, read them aloud and translate text messaging acronyms, such as LOL.

1. Touch the top left corner of the display to access the **Phone** menu.
2. Select **Messaging**.
3. Choose from the following:
 - **Listen** (speaker icon)
 - **Dial**
 - **Send Text**
 - **View**
 - **Delete**.

Composing a Text Message

Note: This is a speed-dependent feature. It is unavailable when your vehicle is traveling at speeds over 3 mph (5 km/h).

Note: Downloading and sending text messages using Bluetooth are phone-dependent features.

1. Touch the top left corner of the display to access the **Phone** menu.
2. Touch **Messaging > Send Text**.
3. Enter a phone number or choose from your phone book.
4. You can select from the following options:
 - **Send** which sends the message as it is.
 - **Edit Text** allows you to customize the pre-defined message or create a message on your own.

You can then preview the message, verify the recipient as well as update the message list, and send it to a connected device (such as a USB drive).

| Pre-defined Text Message Options |
|--|
| I'll call you back in a few minutes. |
| I just left, I'll be there soon. |
| Can you give me a call? |
| I'm on my way. |
| I'm running a few minutes late. |
| I'm ahead of schedule, so I'll be there early. |
| I'm outside. |
| I'll call you when I get there. |
| OK |
| Yes |
| No |
| Thanks |
| Stuck in traffic. |
| Call me later. |
| LOL |

Receiving a Text Message

When a new message arrives, an audible tone sounds and the screen displays a pop-up with the caller name and ID, if supported by your phone. You can press:

- **View** to view the text message.
- **Listen** for SYNC to read the message to you.
- **Dial** to call the contact.
- **Ignore** to exit the screen.

Note: If you select **View** and your vehicle is traveling over 5 mph (8 km/h), the system offers to read the message to you instead of allowing you to view it while driving.

Phone Settings

Press **Phone** > **Settings**.

Bluetooth Devices

Touch this tab to connect, disconnect, add or delete a device, as well as save it as a favorite.

Bluetooth

Touch this tab to turn Bluetooth off or on.

Do Not Disturb

Touch this tab if you want all calls to go directly to your voice mail and not ring in the vehicle. When this feature is on, text message notifications do not ring inside the cabin either.

911 Assist

Turn on or turn off the 911 Assist feature. See *911 Assist* in the *SYNC Services and Applications* section.

Phone Ringer

Select the ring tone you want to hear when you receive a call. Choose from possible system ring tones, your currently paired phone's ring tone, a beep, text-to-speech or a silent notification.

Text Message Notification

Select a text message notification, if supported by your phone. Choose from possible system alert tones, text-to-speech or silent.

Internet Data Connection

If your phone is compatible, use this screen to adjust your internet data connection. Select to make your connection profile with the personal area network or to turn off your connection. You can also choose to adjust your settings or have the system always connect, never connect when roaming or query on connect. Press **?** for more information.

Manage Phonebook

Touch this button to access features such as automatic phonebook download, re-download your phonebook, add contacts from your phone as well as delete or upload your phonebook.

Roaming Warning

Touch this button to have the system alert you when your phone is in roaming mode.

Phone Voice Commands



Press the voice button on the steering wheel control. After the tone, say any of the following commands:

| “PHONE” | |
|-------------------------|------------------------------|
| “Bluetooth off” | “Hold call off”* |
| “Bluetooth on” | “Hold on”* |
| “Call” | “Join calls”* |
| “Call <name>” | “Listen to text message <#>” |
| “Call <name> at home” | “Listen to text messages” |
| “Call <name> at work” | “Messages”** |
| “Call <name> on cell” | “Mute call”* |
| “Call <name> on other” | “Pair phone” |
| “Call voicemail” | “Privacy on”* |
| “Dial” | “Reply to text messages” |
| “Do not disturb off” | “Turn ringer off” |
| “Do not disturb on” | “Turn ringer on” |
| “Forward text messages” | “Unmute call”* |
| “Go to hands free”* | “Help” |

*This command is only available during an active call.

**If you have said “Messages”, see the following “Messages” chart.

| “MESSAGES” |
|------------------------------|
| “Call” |
| “Forward text messages” |
| “Listen to text message <#>” |
| “Listen to text messages” |
| “Reply to text messages” |
| “Help” |

INFORMATION

 If your vehicle is equipped with Navigation, touch the i (Information) button to access these features. If your vehicle is not equipped with Navigation, touch the corner of the touchscreen with the green tab.



Under the Information menu, you can access features, such as:

- A. SYNC Services
- B. SIRIUS Travel Link
- C. Alerts
- D. Calendar
- E. SYNC Applications.

SYNC Services (If Equipped, United States Only)

Note: SYNC Services requires activation before use. Visit www.SYNCMYride.com to register and check your eligibility for complimentary services. Standard phone and message rates may apply. Subscription may be required. You must also have the active SYNC Services Bluetooth-enabled cellular phone paired and connected to the system in order to connect to, and use, SYNC Services. See *Phone* earlier in this chapter for pairing instructions.

Note: This feature does not function properly if you have enabled caller ID blocking on your mobile phone. Make sure your mobile phone is not blocking caller ID before using SYNC Services.

Note: The driver is ultimately responsible for the safe operation of the vehicle, and therefore, must evaluate whether it is safe to follow the suggested directions. Any navigation features are provided only as an aid. Make your driving decisions based on your observations of local conditions and existing traffic regulations. Do not follow the route suggestions if doing so would result in an unsafe or illegal maneuver, if you would be placed in an unsafe situation, or if you would be directed into an area that you consider unsafe. Maps used by this system may be inaccurate because of errors, changes in roads, traffic conditions or driving conditions.

Note: When you connect, the service uses GPS technology and advanced vehicle sensors to collect your vehicle's current location, travel direction and speed to help provide you with the directions, traffic reports, or business searches you request. Further, to provide the services you request, for continuous improvement, the service may collect and record call details and voice communications. For more information, see SYNC Services Terms and Conditions at www.SYNCMYride.com. If you do not want Ford or its service providers to collect your vehicle travel information or other information identified in the Terms and Conditions, do not subscribe or use the service.

SYNC Services uses advanced vehicle sensors, integrated GPS technology and comprehensive map and traffic data, to give you personalized traffic reports, precise turn-by-turn directions, business search, news, sports, weather and more. For a complete list of services, or to learn more, please visit www.SYNCMYride.com.

Connecting to SYNC Services Using Voice Commands



Press the voice button on the steering wheel controls.

1. When prompted, say "Services". This initiates an outgoing call to SYNC Services using your paired and connected Bluetooth-enabled cellular phone.
2. Once you connect to the service, follow the voice prompts to request the desired service, such as "Traffic" or "Directions". You can also say, "What are my choices?" to receive a list of available services from which to choose.
3. Say, "Services" to return to the Services main menu or for help, say, "Help".

Connecting to SYNC Services Using the Touchscreen

 If your vehicle is equipped with Navigation, touch the **i** (Information) button to access these features. If your vehicle is not equipped with Navigation, touch the corner of the touchscreen with the green tab.

Press **Services**.

1. Select **Connect to Services** to initiate an outgoing call to SYNC Services using your paired and connected Bluetooth-enabled cellular phone.
2. Once you connect to the service, follow the voice prompts to request the desired service, such as “Traffic” or “Directions”. You can also say, “What are my choices?” to receive a list of available services from which to choose.
3. Say, “Services” to return to the Services main menu or for help, say, “Help”.

Receiving Turn-by-Turn Directions

1. When connected to SYNC Services, say “Directions” or “Business Search”. To find the closest business or type of business to your current location, just say “Business Search” and then “Search Near Me”. If you need further assistance in finding a location, you can say “Operator” at any time within a Directions or Business search to speak with a live operator. The system may prompt you to speak with an operator when it has difficulty matching your voice request. The live operator can assist you by searching for businesses by name or by category, residential addresses by street address or by name or specific street intersections. Operator Assist is a feature of your SYNC Services subscription. For more information on Operator Assist, visit www.SYNCMYRide.com/support.
2. Follow the voice prompts to select your Destination. After the route download is finished, the phone call automatically ends.

If your vehicle is not equipped with Navigation:

- Turn-by-turn directions appear in the information display, in the status bar of your touchscreen system and on the SYNC Services screen. You also receive driving instructions from audible prompts.
- When on an active route, you can select **Route Summary** or **Route Status** using the touchscreen controls or voice commands to view the **Route Summary Turn List** or the **Route Status ETA**. You can also turn voice guidance on or off, cancel the route or update the route.

If you miss a turn, SYNC automatically asks if you want the route updated. Just say, “Yes” when prompted and the system delivers a new route to your vehicle.

If your vehicle is equipped with Navigation, SYNC Services downloads your requested destination to the navigation system. The navigation system then calculates the route and provides driving instructions. See the *Navigation system* section for more information.

Disconnecting from SYNC Services

1. Press and hold the phone button on the steering wheel.
2. Say “Good-bye” from the SYNC Services main menu.

| SYNC Services quick tips | |
|---------------------------------|--|
| Personalizing | You can personalize your Services feature to provide quicker access to your most used or favorite information. You can save address points, such as work or home. You can also save favorite information like sports teams, such as Detroit Lions, or a news category. You can learn more about personalization by logging onto www.SYNCMYride.com . |
| Push to interrupt | Press the voice button at any time (while connected to SYNC TDI Services) to interrupt a voice prompt or an audio clip (such as a sports report) and say your voice command. |
| Portable | Your subscription is associated with your Bluetooth-enabled cellular phone number, not your VIN (Vehicle Identification Number). You can pair and connect your phone to any vehicle equipped with Traffic, Directions and Information and continue enjoying your personalized services. |

SYNC Services Voice Commands

When a route has been downloaded (non-navigation systems), press the voice button on the steering wheel control. When prompted, say any of the following commands:

| |
|------------------------|
| “SERVICES” |
| “Cancel route” |
| “Navigation voice off” |
| “Navigation voice on” |
| “Next turn” |
| “Route status” |
| “Route summary” |
| “Services” |
| “Update route” |
| “Help” |

SIRIUS Travel Link (If Equipped and If Activated)

WARNING: Driving while distracted can result in loss of vehicle control, crash and injury. We strongly recommend that you use extreme caution when using any device that may take your focus off the road. Your primary responsibility is the safe operation of your vehicle. We recommend against the use of any hand-held device while driving and encourage the use of voice-operated systems when possible. Make sure you are aware of all applicable local laws that may affect the use of electronic devices while driving.

Note: In order to use SIRIUS Travel Link, your vehicle must be equipped with navigation and your navigation SD card must be in the SD card slot.

Note: A paid subscription is required to access and use these features. Go to www.siriusxm.com/travellink for more information.

Note: Visit www.siriusxm.com/traffic# and click on Coverage map and details for a complete listing of all traffic areas covered by SIRIUS Travel Link.

Note: Neither SIRIUS nor Ford is responsible for any errors or inaccuracies in the SIRIUS Travel Link services or its use in vehicles.

When you subscribe to SIRIUS Travel Link, it can help you locate the best gas prices, find movie listings, get current traffic alerts, view the current weather map, get accurate ski conditions and see scores to current sports games.



If your vehicle is equipped with Navigation, touch the **i** (Information) button to access these features. If your vehicle is not equipped with Navigation, touch the corner of the touchscreen with the green tab.

Traffic On Route and Traffic Nearby

Touch these buttons to identify traffic incidents on your route, nearby your vehicle's current location or near any of your favorite places, if programmed.

Fuel Prices

Touch this button to view fuel prices at stations close to your vehicle's location or on an active navigation route.

Movie Listings

Touch this button to view nearby movie theaters and their show times, if available.

Weather

Touch this button to view the nearby weather, current weather, or the five day forecast for the chosen area. Select **Map** to see the weather map, which can show storms, radar information, charts and winds. Select **Area** to select from a listing of weather locations.

Sports Info

Touch this button to view scores and schedules from a variety of sports. You can also save up to 10 favorite teams for easier access. The score automatically refreshes when a game is in progress.

Ski Conditions

Touch this button to view ski conditions for a specific area.

SIRIUS Travel Link Voice Commands

Note: In order to use SIRIUS Travel Link, your vehicle must be equipped with navigation and your navigation SD card must be in the SD card slot.



Press the voice button on the steering wheel controls and, when prompted, say any of the following:

| Travel Link voice commands | |
|----------------------------|------------------|
| "5-day weather forecast" | "Sports scores"* |
| "Fuel prices" | "Traffic" |
| "Movie listings" | "Travel Link"** |
| "Sports headlines"* | "Weather" |
| "Sports schedule"* | "Weather map" |

*If you have said, "Sports headlines", "Sports schedule" or "Sports scores", you may say any of the commands in the "Sports headlines, Sports schedules and Sports scores" commands chart:

**If you have said, "Travel Link", you may say any of the commands in the "Travel Link" chart:

| Sports headlines, sports schedules and sports scores voice commands | |
|---|------------|
| "Baseball" | "My teams" |
| "College basketball" | "NBA" |
| "College football" | "NFL" |
| "Golf" | "NHL" |
| "MLS" | "WNBA" |
| "Motor sports" | |

| "TRAVEL LINK" | | |
|--------------------------------|-----------------|-----------------|
| "5-day weather forecast" | "Golf schedule" | "NBA scores" |
| "Baseball headlines" | "MLS headlines" | "NFL headlines" |
| "Baseball schedule" | "MLS schedule" | "NFL schedule" |
| "Baseball scores" | "MLS scores" | "NFL scores" |
| "College basketball headlines" | "Motor sports" | "NHL headlines" |

| “TRAVEL LINK” | | |
|-------------------------------|-------------------------|------------------|
| “College basketball schedule” | “Motor sports order” | “NHL schedule” |
| “College basketball scores” | “Motor sports schedule” | “NHL scores” |
| “College football headlines” | “Movie listings” | “Traffic” |
| “College football schedule” | “My team headlines” | “Weather” |
| “College football scores” | “My teams schedule” | “Weather map” |
| “Fuel prices” | “My teams scores” | “WNBA headlines” |
| “Golf headlines” | “NBA headlines” | “WNBA schedule” |
| “Golf leaderboard” | “NBA schedule” | “WNBA scores” |

Alerts



If your vehicle is equipped with Navigation, touch the i (Information) button to access these features. If your vehicle is not equipped with Navigation, touch the corner of the touchscreen with the green tab.

Press **Alerts**, and then choose from any of the following services:

- **View** the message.
- **Delete** the message.
- **Delete All** messages.

This screen displays any system messages (such as an SD card fault).

Note: The system alerts you to any messages by turning the information icon yellow. After you read or delete the messages, the icon returns to white.

Calendar



If your vehicle is equipped with Navigation, touch the i (Information) button to access these features. If your vehicle is not equipped with Navigation, touch the corner of the touchscreen with the green tab.

Press **Calendar**. You can view the current calendar by day, week or month.

911 Assist® (If Equipped)

WARNING: Unless the 911 Assist setting is set on before a crash, the system will not dial for help, which could delay response time, potentially increasing the risk of serious injury or death after a crash.



WARNING: Do not wait for 911 Assist to make an emergency call if you can do it yourself. Dial emergency services immediately to avoid delayed response time, which could increase the risk of serious injury or death after a crash. If you do not hear 911 Assist within five seconds of the crash, the system or phone may be damaged or non-functional.



WARNING: Always place your phone in a secure location in your vehicle so it does not become a projectile or damaged in a crash. Failure to do so may cause serious injury to someone or damage the phone, which could prevent 911 Assist from working properly.

Note: The SYNC 911 Assist feature must be set on prior to the incident.

Note: Before setting this feature on, make sure that you read the 911 Assist privacy notice later in this section for important information.

Note: If any user turns 911 Assist on or off, that setting applies for all paired phones. If 911 Assist is turned off, either a voice message plays or a display message (or icon) comes on (or both) when your vehicle is started after a previously paired phone connects.

Note: Every phone operates differently. While SYNC 911 Assist works with most cellular phones, some may have trouble using this feature.

If a crash deploys an airbag (excludes knee airbags and rear inflatable safety belts [if equipped]) or activates the fuel pump shut-off, your SYNC-equipped vehicle may be able to contact emergency services by dialing 911 through a paired and connected Bluetooth-enabled phone. You can learn more about the 911 Assist feature, visit

www.SYNCMYRide.com, www.SYNCMYRide.ca or www.syncmaroute.ca.

- For information on airbag deployment, see the *Supplementary Restraints System* chapter.
- For information on the fuel pump shut-off, see the *Roadside Emergencies* chapter.

Setting 911 Assist On

If your vehicle is equipped with Navigation, touch the i (Information) button to access these features. If your vehicle is not equipped with Navigation, touch the corner of the touchscreen with the green tab.

Press **Apps > 911 Assist, > On.**

You can also access 911 Assist by:



- Pressing the Settings icon > **Settings > Phone > 911 Assist**, or
- Pressing the Settings icon > **Help > 911 Assist.**

To Make Sure that 911 Assist Works Properly

- SYNC must be powered and working properly at the time of the incident and throughout feature activation and use.
- The 911 Assist feature must be set on before the incident.
- You must pair and connect a Bluetooth-enabled and compatible phone to SYNC.
- A connected Bluetooth-enabled phone must have the ability to make and maintain an outgoing call at the time of the incident.
- A connected Bluetooth-enabled phone must have adequate network coverage, battery power and signal strength.
- The vehicle must have battery power and be located in the United States, Canada or in a territory in which 911 is the emergency number.

In the Event of a Crash

Not all crashes deploy an airbag or activate the fuel pump shut-off (which would trigger 911 Assist); however, SYNC tries to contact emergency services if 911 Assist triggers. If a connected phone sustains damage or loses connection to SYNC, SYNC searches for, and tries to connect to, any available previously paired phone and tries to make the call to 911.

Before making the call:

- SYNC provides a short window of time (about 10 seconds) to cancel the call. If you fail to cancel the call, SYNC attempts to dial 911.
- SYNC says the following, or a similar message: “SYNC will attempt to call 911, to cancel the call, press Cancel on your screen or press and hold the phone button on your steering wheel.”

518 MyFord Touch® (If Equipped)

If you do not cancel the call, and SYNC makes a successful call, a pre-recorded message plays for the 911 operator, and then the occupant(s) in your vehicle is able to talk with the operator. Be prepared to provide your name, phone number and location immediately, because not all 911 systems are capable of receiving this information electronically.

911 Assist May Not Work If

- Your cellular phone or 911 Assist hardware sustains damage in a crash.
- The vehicle's battery or SYNC system has no power.
- The phone(s) thrown from your vehicle are the ones paired and connected to the system.

911 Assist Privacy Notice

When you turn on 911 Assist, it may disclose to emergency services that your vehicle has been in a crash involving the deployment of an airbag or activation of the fuel pump shut-off. Certain versions or updates to 911 Assist may also be capable of electronically or verbally disclosing to 911 operators your vehicle location or other details about your vehicle or crash to assist 911 operators to provide the most appropriate emergency services. If you do not want to disclose this information, do not turn the feature on.

Vehicle Health Report (If Equipped, United States Only)



WARNING: Always follow scheduled maintenance instructions, regularly inspect your vehicle, and seek repair for any damage or problem you suspect. Vehicle Health Report supplements, but cannot replace, normal maintenance and vehicle inspection. Vehicle Health Report only monitors certain systems electronically monitored by your vehicle and will not monitor or report the status of any other system, (such as brake lining wear). Failure to perform scheduled maintenance and regularly inspect your vehicle may result in vehicle damage and serious injury.

Note: Your Vehicle Health Report feature requires activation prior to use. Visit www.SYNCMYride.com to register. There is no fee or subscription associated with Vehicle Health Report, but you must register to use this feature.

Note: This feature may not function properly if you have enabled caller ID blocking on your mobile phone. Before running a report, review the *Vehicle Health Report Privacy Notice*.

Note: In order to allow a break-in period for your vehicle, you may not be able to create a Vehicle Health Report until your vehicle odometer has reached 200 miles.

Note: Cellular phone and SMS charges may apply when making a report.

Register for Vehicle Health Report and set your report preferences at www.SYNCMYride.com. After registering, you can request a Vehicle Health Report (inside your vehicle). Return to your account at www.SYNCMYride.com to view your report. You can also choose for SYNC to remind you automatically to run reports at specific mileage intervals. Cellular phone airtime usage may apply when reporting.

The system allows you to check your vehicle's overall health in the form of a diagnostic report card. The Vehicle Health Report contains valuable information, such as:

- Vehicle Diagnostic Information
- Scheduled maintenance
- Open Recalls and Field Service Actions
- Items noted during vehicle inspections by your authorized dealer that still need servicing.

Making a Report



If your vehicle is equipped with Navigation, touch the **i** (Information) button to access these features. If your vehicle is not equipped with Navigation, touch the corner of the touchscreen with the green tab.

If you want to run a report by using the touchscreen, touch **Apps > Vehicle Health Report**.



To run a report by voice command, press the voice button on the steering wheel and, when prompted, say "Vehicle health report".

Vehicle Health Report Privacy Notice

When you create a Vehicle Health Report, Ford Motor Company may collect your cellular phone number (to process your report request) and diagnostic information about your vehicle. Certain versions or updates to Vehicle Health Report may also collect more vehicle information. Ford may use your vehicle information it collects for any purpose. If you do not want to disclose your cellular phone number or vehicle information, do not run the feature or set up your Vehicle Health Report profile at www.SYNCMYride.com. See www.SYNCMYride.com (Vehicle Health Report Terms and Conditions, and Privacy Statement) for more information.

SETTINGS



- A. Clock
- B. Display
- C. Sound
- D. Vehicle
- E. Settings
- F. Help



Under this menu, you can set your clock, access and adjust the display, sound and vehicle settings as well as access settings for specific modes or the help feature.

Clock

Note: You cannot manually set the date. Your vehicle's GPS does this for you.

Note: If the battery has been disconnected, your vehicle needs to acquire a GPS signal to update the clock. Once your vehicle acquires the signal, it may take a few minutes for the update to display the correct time.

1. Press the Settings icon > **Clock**.
2. Press + and - to adjust the time.

From this screen, you can also make other adjustments, such as 12- or 24-hour mode, activate GPS time synchronization and have the system automatically update for daylight savings time and new time zones.

You can also turn the outside air temperature display on and off. It appears at the top center of the touchscreen, next to the time and date.

The system automatically saves any updates you make to the settings.

Display

You can adjust the touchscreen display through the touchscreen or by pressing the voice button on your steering wheel controls and when prompted, say, "Display settings".



Press the Settings icon > **Display**, then select from the following:

Brightness allows you to make the screen display brighter or dimmer.

Mode allows you to set the screen to a certain brightness or have the system automatically change based on the outside light level.

- If you select **AUTO** or **NIGHT**, you have the options of turning the display's Auto Dim feature on or off and changing the Auto Dim Manual Offset feature.

Edit Wallpaper

- You can have your touchscreen display the default photo or upload your own.

Uploading Photos for Your Home Screen Wallpaper

Note: You cannot load photos directly from your camera. You must access the photos either from your USB mass storage device or from an SD card.

Note: Photographs with extremely large dimensions (such as 2048 x 1536) may not be compatible and appear as a blank (black) image on the display.

Your system allows you to upload and view up to 32 photos.

To access, press the Settings icon > **Display** > **Edit Wallpaper**, and then follow the system prompts to upload your photographs.

Only the photograph(s), which meets the following conditions, display:

- Compatible file formats are as follows: .jpg, .gif, .png, .bmp.
- Each file must be 1.5 MB or less.
- Recommended dimensions: 800 x 384.

Sound

Press the Settings icon > **Sound**, then select from the following:

| Sound Settings | |
|----------------------|--------------------------|
| Bass | DSP* |
| Midrange | Occupancy Mode* |
| Treble | Speed Compensated Volume |
| Set Balance and Fade | |

*If equipped.

Vehicle

Press the **Settings** icon > **Vehicle**, then select from the following:

- Active Park Assist
- Ambient Lighting
- Vehicle Health Report
- Door Keypad Code
- Rear View Camera
- Enable Valet Mode.

Active Park Assist

When activated, your system displays directions for you regarding the active park assist process.

For complete information on this system, see *Active park assist* in the *Driving Aids* chapter.

Ambient Lighting (If Equipped)

When activated, ambient lighting illuminates footwells and cupholders with a choice of colors. To access and make adjustments:

1. Press the Settings icon > **Vehicle** > **Ambient Lighting**.
2. Touch the desired color.
3. Use the scroll bar to increase or decrease the intensity.

To turn the feature on or off, press the power button.

Vehicle Health Report

Turn Automatic Reminders on and off and set the mileage interval at which you would like to receive the reports. Press ? for more information on these selections.

When done making your selections, press **Run Vehicle Health Report Now** if you want your report.

Door Keypad Code

To change the keypad code for your keyless entry keypad system:

1. Press the Settings icon > **Vehicle** > **Door Keypad Code**.
2. Enter your current factory code, then, when prompted, enter your new code.

Rear View Camera

This menu allows you to access settings for your rear view camera.

Press the Settings icon > **Vehicle** > **Rear View Camera**, then select from the following settings:

- Rear Camera Delay
- Visual Park Aid Alert
- Guidelines.

Enable Valet Mode

Note: If the system locks, and you need to reset the PIN, enter 3681 and the system unlocks.

Valet mode allows you to lock the system. No information is accessible until the system is unlocked with the correct PIN.

1. Press the Settings icon > **Vehicle** > **Enable Valet Mode**.
2. When prompted, enter a four-digit PIN.

After you press Continue, the system locks until you enter the PIN again.

Settings

Access and adjust system settings, voice features, as well as phone, navigation and wireless settings.

System

Press the Settings icon > **Settings** > **System**, then select from the following:

| System | |
|---------------------------------|--|
| Language | Select to have the touchscreen display in English, Spanish or French. |
| Distance | Select to display units in kilometers or miles. |
| Temperature | Select to display units in Celsius or Fahrenheit. |
| System Prompt Volume | Adjust the volume of voice prompts from the system. |
| Touch Screen Button Beep | Select to have the system beep to confirm choices made through the touchscreen. |
| Touch Panel Button Beep | Select to have the system beep to confirm button choices made through the climate or audio system. |
| Keyboard Layout | Have the touchscreen keyboard display in QWERTY or ABC format. |
| Install Applications | Install any downloaded applications or view the current software licenses. |
| Master Reset | Select to restore factory defaults. This erases all personal settings and personal data. |

Voice Control

Press the Settings icon > **Settings** > **Voice Control**, then select from the following:

| Voice control | |
|------------------------------|---|
| Interaction Mode | Standard interaction mode provides more detailed interaction and guidance. Advanced mode has less audible interaction and more tone prompts. |
| Confirmation Prompts | Have the system ask you short questions if it has not clearly heard or understood your request. Note: Even with confirmation prompts turned off, the system may occasionally ask you to confirm settings. |
| Media Candidate Lists | Candidate lists are possible results from your voice commands. The system simply makes a best guess at your request with these turned off. |
| Phone Candidate Lists | Candidate lists are possible results from your voice commands. The system simply makes a best guess at your request with these turned off. |
| Voice Control Volume | This allows you to adjust the system's voice volume level. |

Media Player

Press the Settings icon > **Settings** > **Media Player**, then select from the following:

| Media player | |
|--------------------------------|--|
| Autoplay | When this feature is on, the system automatically switches to the media source upon initial connection. This allows you to listen to music during the indexing process. When this feature is off, the system does not automatically switch to the inserted media source. |
| Bluetooth Devices | Select to connect, disconnect, add or delete a device. You can also set a device as your favorite so that the system automatically attempts to connect to that device at every ignition cycle. |
| Gracenote Database Info | This allows you to view the version level of the Gracenote Database. |
| Gracenote Mgmt | With this feature on, the Gracenote Database supplies metadata information for your music files. This overrides information from your device. This feature defaults to off. |
| Cover Art Priority | With this feature on, the Gracenote Database supplied cover art for your music files. This overrides any art from your device. This feature defaults to Media Player. |

Navigation

Press the Settings icon > **Settings** > **Navigation**, then select from the following:

| Navigation | |
|-------------------------------|---|
| Map Preferences | Turn breadcrumbs on and off. |
| | Have the system display your turn list top to bottom or bottom to top. |
| | Turn the Parking POI notification on and off. |
| Route Preferences | Have the system display the shortest route, fastest route or ecological route. |
| | Have the system avoid freeways. |
| | Have the system avoid tollroads. |
| | Have the system avoid ferries or car trains. |
| | Have the system use high-occupancy vehicle lanes. |
| Navigation Preferences | Have the system use guidance prompts. |
| | Have the system automatically fill-in State/Province information. |
| Traffic Preferences | Have the system display areas where roadwork occurs. |
| | Have the system display incident icons. |
| | Have the system display areas where difficult driving conditions may occur. |
| | Have the system display areas where snow and ice on the road may occur. |
| | Have the system display any smog alerts. |
| | Have the system display weather warnings. |
| | Have the system display where there may be reduced visibility. |
| | Have the system turn on your radio for traffic announcements. |
| Avoid Areas | Enter specific areas that you would like to avoid on planned navigation routes. |

Phone Settings

Press the Settings icon > **Settings** > **Phone**, then select from the following:

| Phone | |
|----------------------------------|---|
| Bluetooth Devices | Connect, disconnect, add or delete a device, as well as save it as a favorite. |
| Bluetooth | Turn Bluetooth on and off. |
| Do Not Disturb | Have all calls go directly to your voice mail and not ring inside your vehicle. With this feature turned on, text message notifications are also suppressed and do not ring inside your vehicle. |
| 911 Assist | Turn on or turn off the 911 Assist feature. See <i>911 Assist</i> in the <i>SYNC applications and services</i> section. |
| Phone Ringer | Select the type of notification for phone calls - ring tone, beep, text to speech, or have it be silent. |
| Text Message Notification | Select the type of notification for text messages - alert tone, beep, text to speech, or have it be silent. |
| Internet Data Connection | If compatible with your phone, you can adjust your internet data connection. Select to make your connection profile with the personal area network or to turn off your connection. You can also choose to adjust your settings or have the system always connect, never connect when roaming or query on connect. Press ? for more information. |
| Manage Phonebook | Access features, such as automatic phonebook download, re-download your phonebook, add contacts from your phone as well as delete or upload your phonebook. |
| Roaming Warning | Have the system alert you when in Roaming mode. |

Wireless & Internet

Your system has a Wi-Fi feature that creates a wireless network within your vehicle, thereby allowing other devices (such as personal computers or phones) in your vehicle to speak to each other, share files or play games. Using this Wi-Fi feature, everyone in your vehicle can also gain access the internet if you have a USB mobile broadband connection inside your vehicle, your phone supports personal area networking and if you park outside a wireless hotspot.



Press the Settings icon > **Settings** > **Wireless & Internet**, then select from the following:

| Wireless & Internet | |
|--------------------------------|--|
| Wi-Fi Settings | Wi-Fi Network (Client) Mode turns the Wi-Fi feature on and off in your vehicle. Make sure you turn it on for connectivity purposes. |
| | Choose a Wireless Network allows you to use a previously stored wireless network. You can categorize by alphabetical listing, priority and signal strength. You can also choose to search for a network, connect to a network, disconnect from a network, receive more information, prioritize a network or delete a network. |
| | Gateway (Access Point) Mode makes SYNC an access point for a phone or a computer when turned on. This forms the local area network within your vehicle for things, such as game playing, file transfer and internet browsing. Press ? for more information. |
| | Gateway (Access Point) Settings allows you to view and change settings for using SYNC as the internet gateway. |
| | Gateway (Access Point) Device List allows you to view recent connections to your Wi-Fi system. |

| Wireless & Internet | |
|--------------------------------------|--|
| USB Mobile Broadband | Instead of using Wi-Fi, your system can also use a USB mobile broadband connection to access the internet. (You must turn on your mobile broadband device on your personal computer before connecting it to the system.) This screen allows you to set up what is your typical area for your USB mobile broadband connection. (USB mobile broadband settings may not display if the device is already on.) You can select the following: Country, Carrier, Phone Number, User Name and Password. |
| Bluetooth Settings | Shows you the currently paired devices as well as giving you your typical Bluetooth options to connect, disconnect, set as favorite, delete and add device. Bluetooth is a registered trademark of the Bluetooth SIG. |
| Prioritize Connection Methods | Choose your connection methods and change them as needed. You can select to Change Order and have the system either always attempt to connect using a USB mobile broadband or using Wi-Fi. |

The Wi-Fi CERTIFIED Logo is a certification mark of the Wi-Fi Alliance.



Wi-Fi

Your system has a Wi-Fi feature which creates a wireless network within your vehicle, thereby allowing other devices (i.e. personal computers or phones) in your vehicle to speak to each other, share files, play games, etc. Using this Wi-Fi feature, everyone in your vehicle can also gain access the internet if:

- You have a USB mobile broadband connection inside the vehicle
- Your phone supports PAN (personal area networking)
- You are parked outside of a wireless hotspot

To access, press the Menu icon > Settings > Wireless and Internet > Wi-Fi settings, then select from the following options:

- **Wi-Fi Network (Client) Mode:** Turn the wi-fi feature on and off in your vehicle. Make sure it is turned on for connectivity purposes.
- **Choose a Wireless Network:** Use a previously stored wireless network. You can categorize by alphabetical listing, priority and signal strength. You can also choose to search for a network, connect to a network, disconnect from a network, receive more information, prioritize a network or delete a network.
- **Gateway Access Point Mode:** Make SYNC an access point for a phone or a computer by turning this feature on. This forms the local area network within the vehicle for things such as game playing, file transfer, internet browsing, etc. Press ? for more information.
- **Gateway (Access Point) Settings:** View and change settings for using SYNC as the internet gateway.
- **Gateway Access Point Device List:** View who has connected to your Wi-Fi connection recently.

Press the ? button (if available) for additional information.



The Wi-Fi CERTIFIED Logo is a certification mark of the Wi-Fi Alliance.

USB Mobile Broadband

Instead of using Wi-Fi, your system can also use a USB mobile broadband connection to access the internet. (You must activate your mobile broadband device on your PC prior to connecting it to the system.)

This screen allows you to set up what is your typical area for your USB mobile broadband connection. (USB mobile broadband settings may not be displayed if the device is already activated.) You can select the following:

- Country
- Carrier
- Phone Number
- User Name
- Password

Prioritize Connection Methods

This screen allows you to choose your connection methods and change them as needed. You can select to Change Order and have the system either always attempt to connecting using a USB mobile broadband or using Wi-Fi.

Bluetooth Settings

Shows you what device is currently paired with the system as well as giving you your typical Bluetooth options to connect, disconnect, set as favorite, delete and add device.

Bluetooth is a registered trademark of the Bluetooth SIG.

Help

Press the Settings icon > **Help**, then select from the following:

| Help | |
|-----------------------------|---|
| Where Am I? | View your vehicle's current location, if your vehicle is equipped with navigation. If your vehicle is not equipped with navigation, nothing displays. |
| System Information | Touchscreen system serial number. |
| | Your vehicle identification number (VIN). |
| | Touchscreen system software version. |
| | Navigation system version. |
| | Map database version. |
| | Sirius satellite radio electronic serial number (ESN). |
| | Gracenote Database Information and Library version. |
| Software Licenses | View the licenses for any software and applications installed on your system. |
| Driving Restrictions | Certain features are not accessible when your vehicle is moving. |
| 911 Assist | Turn on and turn off the 911 Assist feature. See <i>911 Assist</i> in the <i>SYNC applications and services</i> section. In Case of Emergency (ICE) Speed Dial allows you to save up to two numbers as ICE contacts for quick access if there is an emergency. Select Edit to access your phonebook and then select the desired contacts. The numbers then appear as options on this screen for the ICE 1 and ICE 2 buttons. The ICE contacts you select appear at the end of the 911 Assist call process. |
| Voice Command List | View categorized lists of voice commands. |

To access Help using the voice commands, press the voice button, then, after the tone, say "Help". The system provides allowable voice commands for the current mode.

CLIMATE

Press the lower right corner on the touchscreen to access your climate control features. Depending on your vehicle line and option package, your climate screen may look different from the screen shown here.

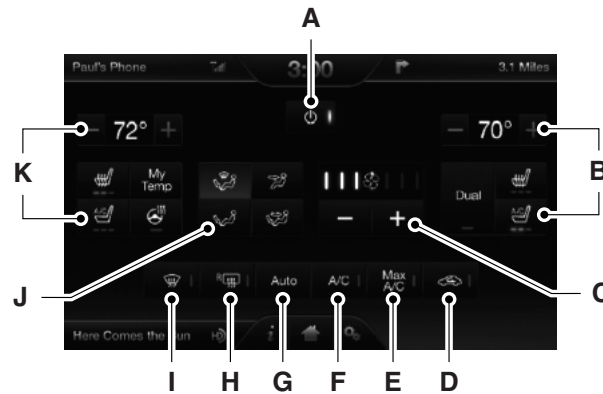

A. **Power:** Touch to switch the system off and on. Outside air cannot enter your vehicle when you switch off the system.

B. **Passenger settings:**

- Touch **DUAL** to switch on the passenger temperature control.
- Touch **+** or **-** to adjust the temperature.
- Touch the heated seat icon to control the heated seat.
- Touch the cooled seat icon to control the cooled seat.

C. **Fan speed:** Touch **+** or **-** to adjust fan speed.

D. **Recirculated air:** Touch to turn the recirculated air on or off which:

- May reduce the amount of time needed to cool down the interior.
- May help reduce odors from reaching the interior.
- Engages automatically when MAX A/C is selected.
- May be engaged manually in any airflow mode except defrost.
- May turn off in all airflow modes except MAX A/C to reduce fog potential.

E. **MAX A/C:** Touch to cool your vehicle with recirculated air. Touch again for normal A/C operation. MAX A/C:

- Distributes air through instrument panel vents.
- Is more economical and efficient than normal A/C mode.
- May help reduce odors from entering your vehicle.

- F. **A/C:** Touch to turn the air conditioning on or off.
- Use with recirculated air to improve cooling performance and efficiency.
 - Engages automatically in MAX A/C, defrost and floor/defrost.
- G. **AUTO:** Touch to engage automatic operation, then set the temperature using the temperature control. The system automatically controls:
- Fan speed
 - Airflow distribution
 - A/C on or off
 - Outside or recirculated air.
- H. **Rear defroster:** Touch to turn the rear window defroster and heated mirrors.
- I. **Defrost:** Touch to clear the windshield of fog and thin ice. Touch again to return to the previous airflow selection. When on, defrost:
- Provides outside air to reduce window fogging.
 - Distributes air through the windshield defroster vents and demister vents.
- J. **Manual controls:** Select any of the following airflow distribution modes:
- **Floor and Defrost:** Distributes air through the windshield defroster vents, demister vents, floor vents and rear seat floor vents, and provides outside air to reduce window fogging.
 - **Panel:** Distributes air through the instrument panel vents.
 - **Panel and Floor:** Distributes air through the instrument panel vents, demister vents, floor vents and rear seat floor vents.
 - **Floor:** Distributes air through the demister vents, floor vents and rear seat floor vents.
- K. **Driver settings:** Depending on your vehicle and option package, you may have the following features:
- Touch **+** or **-** to adjust the temperature.
 - If your vehicle is equipped with heated seats, touch the heated seat icon to control the heated seat. See the *Seats* chapter.
 - If your vehicle is equipped with cooled seats, touch the cooled seat icon to control the cooled seat. See the *Seats* chapter.
 - Touch and hold **MyTemp** to select a temperature you would like your vehicle to remember and maintain for you.
 - If your vehicle is equipped with a heated steering wheel, touch the heated steering wheel icon to warm the steering wheel.
- Note:** If your vehicle is equipped with a wood-trimmed steering wheel, it does not heat between the 10 o'clock and 2 o'clock positions.

Climate Control Voice Commands

The following voice commands are available at the main menu level of a voice session. For example, press the voice button and after the prompt, “Say a command”; say any of the following commands:

| Climate control voice commands |
|---|
| “Climate automatic” |
| “Climate my temperature” |
| “Climate off” |
| “Climate on” |
| “Climate temperature <15.5–29.5> degrees” |
| “Climate temperature <60–85> degrees” |
| “Help” |

There are additional climate control commands but in order to access them, you have to say “Climate” first, then when the system is ready to listen, you may say any of the following commands:

| Additional climate control voice commands | |
|--|-----------------------------------|
| “Automatic” | “Panel off” |
| “A/C off” | “Panel on” |
| “A/C on” | “Rear defrost off” |
| “Defrost off” | “Rear defrost on” |
| “Defrost on” | “Recirc off” |
| “Dual off” | “Recirc on” |
| “Fan decrease” | “Temperature” [*] |
| “Fan increase” | “Temperature <15.5–29.5> degrees” |
| “Floor on” | “Temperature <60–85> degrees” |
| “Max A/C off” | “Temperature decrease” |
| “Max A/C on” | “Temperature high” |
| “My temp” | “Temperature increase” |
| “Off” | “Temperature low” |
| “On” | “Windshield floor on” |
| “Panel floor on” | “Help” |

^{*}If you have said “Temperature”, you can say any of the commands in the following “Temperature” chart.

| “TEMPERATURE” |
|-----------------------|
| “High” |
| “Low” |
| “<15.5–29.5> degrees” |
| “<60–85> degrees” |
| “Help” |

NAVIGATION SYSTEM (IF EQUIPPED)

Note: The navigation SD card must be in the SD card slot to operate the navigation system. If you need a replacement SD card, see your authorized dealer.

Note: The SD card slot is spring-loaded. To remove the SD card, just push the card in and release it. Do not attempt to pull the card out to remove it; this could cause damage.

Your navigation system is comprised of two main features, destination mode and map mode.

To set a destination, press the green corner of your touchscreen, then **Dest** when it appears. See *Setting a destination* later in this chapter.

To view the navigation map and your vehicle’s current location, touch the green bar in the upper right hand corner of the touchscreen, or, press **Dest > Map**. See *Map mode* later in this chapter.

Setting a Destination

Press the green corner of your touchscreen, then **Dest** when it appears. Choose any of the following:

| Destination Selections | |
|-------------------------|-------------------------|
| My Home | Street Address |
| Favorites | Intersection |
| Previous Destinations | City Center |
| Point of Interest | Map |
| Emergency | Edit Route Cancel Route |
| Previous Starting Point | Freeway Entrance/Exit |
| Latitude/Longitude | |

1. Enter the necessary information into the highlighted text fields (in any order). For address destination entry, **Go!** appears once you enter all the necessary information. Pressing **Go!** makes the address location appear on the map. If you choose **Previous Destination**, the last 20 destinations you have selected appear.
2. Select **Set as Dest** to make this your destination. You can also choose to set this as a waypoint (have the system route to this point on the way to your current destination) or save it as a favorite. The system considers any **Avoid Areas** selections in its route calculation.
3. Choose from up to three different types of routes, and then select **Start Route**.
 - **Fastest Route:** Uses the fastest moving roads possible.
 - **Shortest Route:** Uses the shortest distance possible.
 - **Eco Route:** Uses the most fuel-efficient route.

You can cancel the route or have the system demo the route for you. Select **Route Prefs** to set route preferences like avoiding freeways, tollroads, ferries and car trains as well as to use or not use high-occupancy vehicle lanes. (High-occupancy vehicle lanes are also known as carpool or diamond lanes. People who ride in buses, vanpools or carpools use these lanes.)

Note: If your vehicle is on a recognized road and you do not press the **Start Route** button, the system defaults to the **Fastest Route** option and begins guidance.

During route guidance, you can press the talking bubble icon that appears in the upper right navigation corner (green bar) if you want the system to repeat route guidance information. When the system repeats the last guidance instruction, it updates the distance to the next guidance instruction, since it detects when the vehicle is moving.

Point of Interest (POI) Categories

Your system offers a variety of points of interest categories.

| Main categories | |
|-------------------------|----------------------|
| Food/Drink & Dining | Automotive |
| Travel & Transportation | Shopping |
| Financial | Entertainment & Arts |
| Emergency | Recreation & Sports |
| Community | Government |
| Health & Medicine | Domestic Services |

Within these main categories, there are subcategories which contain more listings:

| Subcategories |
|------------------------|
| Restaurant |
| Golf |
| Parking |
| Home & Garden |
| Personal Care Services |
| Automobile Dealership |
| Government Office |
| Public Transit |
| Education |

To expand these listings, press the **+** in front of the point of interest listing.

When programming a point of interest destination, the system allows you to sort the resulting lists alphabetically, by distance or by cityseekr listings (if available).

cityseekr (If Available)

Note: cityseekr point of interest information is limited to approximately 154 cities (132 in the United States, 13 in Canada and 9 in Mexico).



cityseekr, when available, is a service that provides more information about certain points of interest such as restaurants, hotels and attractions.

When you have selected a point of interest, the location and information appear, such as address and phone number. If cityseekr lists the point of

interest, more information is available, such as a brief description, hotel check-in and checkout times or restaurant hours.

Press **More Information** for a longer review, a list of services and facilities, the average room or meal price as well as the website link.

This screen displays point of interest icons, such as:



Hotel



Coffeehouse



Food & Drink



Nightlife













Attraction



This icon appears when your selection exists in multiple categories within the system.

When you are viewing more information for hotels, cityseekr also tells you if the hotel has certain services and facilities using icons.

| Hotel services and facilities | |
|--|---|
|  Restaurant |  24 Hr Room Service |
|  Business Center |  Fitness Center |
|  Handicap Facilities |  Internet Access |
|  Laundry |  Pool |
|  Refrigerator |  Wi-Fi |

For restaurants, cityseekr can provide information, such as star rating, average cost, review, handicap access, hours of operation, and website address.

For hotels, cityseekr can provide information, such as star rating, price category, review, check-in and check-out times, hotel service icons and website address.

Setting Your Navigation Preferences

Select settings for the system to take into account when planning your route.



Press the Settings icon > **Settings** > **Navigation**.

| When you select: | You can: |
|-------------------------------|---|
| Map Preferences | Turn breadcrumbs on and off. Have the system display your turn list top to bottom or bottom to top. Set the automatic parking points of interest notification. When parking points of interest notification is on, the icons display on the map when you get close to your destination. (This may not be very useful in dense areas, and may clutter the map when other points of interest display.) |
| Route Preferences | Choose to have the system display the shortest route, fastest route or most ecological route. Avoid freeways, toll roads, ferries and car trains when planning your route. Use high-occupancy vehicle lanes (if available). |
| Navigation Preferences | Choose prompts to be either voice or tone only. Have the system automatically fill in the state and province based on the information already entered into the system. |

| When you select: | You can: |
|----------------------------|--|
| Traffic Preferences | <p>Choose how you want the system to handle traffic problems along your route.</p> <p>Automatic: Have the system reroute you to avoid traffic incidents that develop and impact the current route (no notification is provided).</p> <p>Manual: Have the system always provide a traffic alert notification for traffic incidents along the planned route. You have a choice to accept or ignore the notification before making the route deviation.</p> <hr/> <p>Turn on certain, or all, traffic icons on the map (such as road work, incident, accidents and closed roads).</p> |
| Avoid Areas | <p>Choose areas which you want the system to avoid when calculating a route for you. Press Add to select a category.</p> <p>Once you select, the system tries to avoid the area(s) if possible for all routes. To delete a selection, choose the listing on the screen. When the screen changes to Avoid Areas Edit, you can press Delete at the bottom right of the screen.</p> |

Map Mode

Press the green bar in the upper right area of the touchscreen to view map mode. Map mode shows advanced viewing comprised of both 2D city maps as well as 3D landmarks (when available).

2D city maps show detailed outlines of buildings, visible land use and land elements and detailed railway infrastructure for the most essential cities around the globe. These maps also contain features, such as town blocks, building footprints, and railways.

3D landmarks appear as clear, visible objects that are typically recognizable and have a certain tourist value. The 3D landmarks appear in 3D map mode only. Coverage varies, and improves with updated map releases.



Change the appearance of the map display by repeatedly pressing the arrow button in the upper left corner of the screen. It toggles between three different map modes: Heading up, North up, and 3D.



Heading up (2D map) always shows the direction of forward travel to be upward on the screen. This view is available for map scales up to 2.5 miles (4 kilometers). The system remembers this setting for larger map scales, but shows the map in North up only. If the scale returns below this level, the system restores Heading up.



North up (2D map) always shows the northern direction to be upward on the screen.



3D map mode provides an elevated perspective of the map. This viewing angle can be adjusted and the map can be rotated 180 degrees by dragging your finger along the shaded bar with arrows at the bottom of the map.



Re-center the map by pressing this icon whenever you scroll the map away from your vehicle's current location.

Auto Zoom

Press the green bar to access map mode, then select the + or - zoom button to bring up the zoom level and Auto buttons on the touchscreen. When you press **Auto**, Auto Zoom turns on and **Auto** displays in the bottom left corner of the screen in the map scale. The map zoom level then synchronizes with vehicle speed. The slower your vehicle is traveling, the farther in the map zooms in; the faster your vehicle is traveling, the farther the map zooms out. To turn the feature off, just press the + or - button again.

In 3D mode, rotate the map view by swiping your finger across the shaded bar with the arrows.

Map Icons

Vehicle mark shows the current location of your vehicle. It stays in the center of the map display, except when in scroll mode.



Scroll cursor allows you to scroll the map; the fixed icon is in the center of the screen. The map position closest to the cursor is in a window on the top center part of the screen.



Address book entry default icon(s) indicates the location on the map of an address book entry. This is the default symbol shown after the entry has been stored to the Address Book by any method other than the map. You can select from any of the 22 icons available. You can use each icon more than once.



Home indicates the location on the map currently stored as the home position. You can only save one address from the Address Book as your Home entry. You cannot change this icon.



POI (Point Of Interest) icons indicate locations of any point of interest categories you choose to display on the map. You can choose to display about 56 point of interest subcategories on the map at one time.



Starting point indicates the starting point of a planned route.



Waypoints indicates the location of a waypoint on the map. The number inside the circle is different for each waypoint and represents the position of the waypoint in the route list.



Destination symbol indicates the ending point of a planned route.



Next maneuver point indicates the location of the next turn on the planned route.



No GPS symbol indicates that insufficient GPS satellite signals are available for accurate map positioning. This icon may display under normal operation in an area with poor GPS access.

Quick-touch Buttons

When in map mode, touch anywhere on the map display to access the following options:

| When you select: | You can: |
|--------------------------|---|
| Set as Dest | Select a scrolled location on the map as your destination. (You may scroll the map by pressing your index finger on the map display. When you reach the desired location, simply let go and then touch Set as Dest.) |
| Set as Waypoint | Set the current location as a waypoint. |
| Save to Favorites | Save the current location to your favorites. |
| POI Icons On/Off | Select icons to display on the map. You can select up to three icons to display on the map at the same time. |
| Cancel Route | Cancel the active route. |
| View/Edit Route | Access these features when a route is active: <ul style="list-style-type: none"> • View route • Edit destination/waypoints • Edit turn list • Detour • Edit route preferences • Edit traffic preferences • Cancel route. |

Navteq is the digital map provider for the navigation application. If you find map data errors, you may report them directly to Navteq by going to <http://mapreporter.navteq.com>. Navteq evaluates all reported map errors and responds with the result of their investigation by e-mail.

Navigation Map Updates

Annual navigation map updates are available for purchase through your dealership, by calling 1-800-NAVMAPS (in Mexico, call 01-800-557-5539) or going to www.navigation.com/ford. You need to specify the make and model of your vehicle to determine if there is an update available.

Navigation Voice Commands

When in navigation mode, press the voice button on the steering wheel control. After the tone, say any of the following commands:

| Navigation system voice commands | |
|--------------------------------------|---|
| “Cancel next waypoint” ¹ | “Navigation” ³ |
| “Cancel route” ¹ | “Navigation voice volume decrease” ¹ |
| “Destination” ² | “Navigation voice volume increase” |
| “Destination <nametag>” | “Repeat instruction” |
| “Destination <POI category>” | “Show 3D” |
| “Destination favorites” | “Show heading up” |
| “Destination home” | “Show map” |
| “Destination intersection” | “Show north up” |
| “Destination nearest <POI category>” | “Show route” ¹ |
| “Destination nearest POI” | “Show turn list” ¹ |
| “Destination play nametags” | “Voice guidance off” |
| “Destination POI” | “Voice guidance on” |
| “Destination POI category” | “Where am I?” |
| “Destination previous destination” | “Zoom in” |
| “Destination street address” | “Zoom out” |
| “Detour” ¹ | “Help” |

¹This command is only available when a navigation route is active.

²If you have said the command, “Destination”, you may say any of the above commands or commands in the following Destination chart.

³If you have said the command, “Navigation”, you may say any of the above commands or commands in the following Navigation chart.

| |
|--------------------------|
| “DESTINATION” |
| “<nametag>” |
| “<POI category>” |
| “Favorites” |
| “Home” |
| “Intersection” |
| “Nearest <POI category>” |
| “Nearest POI” |
| “Play nametags” |
| “POI category” |
| “Previous destination” |
| “Street address” |
| “Help” |
| “NAVIGATION” |
| “Destination”* |
| “Zoom city” |
| “Zoom country” |
| “Zoom in minimum” |
| “Zoom out maximum” |
| “Zoom province” |
| “Zoom state” |
| “Zoom street” |
| “Zoom to <distance>” |
| “Help” |

*If you have said, “Destination”, you may say any of the commands in the Destination chart.

One-shot Destination Street Address

When you say either “Navigation destination street address” or “Destination street address”, the system asks you to say the full address. The system displays an example on-screen. You can then speak the address naturally, such as “One two three four Main Street, Anytown”.

GENERAL INFORMATION**SYNC® End User License Agreement (EULA)**

- You have acquired a device (“DEVICE”) that includes software licensed by Ford Motor Company and its affiliates (“FORD MOTOR COMPANY”) from an affiliate of Microsoft Corporation (“MS”). Those installed software products of MS origin, as well as associated media, printed materials, and “online” or electronic documentation (“MS SOFTWARE”) are protected by international intellectual property laws and treaties. The MS SOFTWARE is licensed, not sold. All rights reserved.
- The MS SOFTWARE may interface with and/or communicate with, or may be later upgraded to interface with and/or communicate with additional software and/or systems provided by FORD MOTOR COMPANY. The additional software and systems of FORD MOTOR COMPANY origin, as well as associated media, printed materials, and “online” or electronic documentation (“FORD SOFTWARE”) are protected by international intellectual property laws and treaties. The FORD SOFTWARE is licensed, not sold. All rights reserved.
- The MS SOFTWARE and/or FORD SOFTWARE may interface with and/or communicate with, or may be later upgraded to interface with and/or communicate with additional software and/or systems provided by third party software and service suppliers. The additional software and services of third party origin, as well as associated media, printed materials, and “online” or electronic documentation (“THIRD PARTY SOFTWARE”) are protected by international intellectual property laws and treaties. The THIRD PARTY SOFTWARE is licensed, not sold. All rights reserved.
- The MS SOFTWARE, FORD SOFTWARE and THIRD PARTY SOFTWARE hereinafter collectively and individually will be referred to as “SOFTWARE.”

IF YOU DO NOT AGREE TO THIS END USER LICENSE AGREEMENT (“EULA”), DO NOT USE THE DEVICE OR COPY THE SOFTWARE. ANY USE OF THE SOFTWARE, INCLUDING BUT NOT LIMITED TO USE ON THE DEVICE, WILL CONSTITUTE YOUR AGREEMENT TO THIS EULA (OR RATIFICATION OF ANY PREVIOUS CONSENT).

GRANT OF SOFTWARE LICENSE: This EULA grants you the following license:

- You may use the SOFTWARE as installed on the DEVICE and as otherwise interfacing with systems and/or services provide by or through FORD MOTOR COMPANY or its third party software and service providers.

DESCRIPTION OF OTHER RIGHTS AND LIMITATIONS:

- **Speech Recognition:** If the SOFTWARE includes speech recognition component(s), you should understand that speech recognition is an inherently statistical process and that recognition errors are inherent in the process. Neither FORD MOTOR COMPANY nor its suppliers shall be liable for any damages arising out of errors in the speech recognition process.
- **Limitations on Reverse Engineering, Decompilation and Disassembly:** You may not reverse engineer, decompile, or disassemble nor permit others to reverse engineer, decompile or disassemble the SOFTWARE, except and only to the extent that such activity is expressly permitted by applicable law notwithstanding this limitation.
- **Limitations on Distributing, Copying, Modifying and Creating Derivative Works:** You may not distribute, copy, make modifications to or create derivative works based on the SOFTWARE, except and only to the extent that such activity is expressly permitted by applicable law notwithstanding this limitation.
- **Single EULA:** The end user documentation for the DEVICE and related systems and services may contain multiple EULAs, such as multiple translations and/or multiple media versions (e.g., in the user documentation and in the software). Even if you receive multiple EULAs, you are licensed to use only one (1) copy of the SOFTWARE.
- **SOFTWARE Transfer:** You may permanently transfer your rights under this EULA only as part of a sale or transfer of the DEVICE, provided you retain no copies, you transfer all of the SOFTWARE (including all component parts, the media and printed materials, any upgrades, and, if applicable, the Certificate(s) of Authenticity), and the recipient agrees to the terms of this EULA. If the SOFTWARE is an upgrade, any transfer must include all prior versions of the SOFTWARE.
- **Termination:** Without prejudice to any other rights, FORD MOTOR COMPANY or MS may terminate this EULA if you fail to comply with the terms and conditions of this EULA.

- **Security Updates/Digital Rights Management:** Content owners use the WMDRM technology included in your DEVICE to protect their intellectual property, included copyrighted content. Portions of the SOFTWARE on your DEVICE use WMDRM software to access WMDRM-protected content. If the WMDRM software fails to protect the content, content owners may ask Microsoft to revoke the SOFTWARE's ability to use WMDRM to play or copy protected content. This action does not affect unprotected content. When your DEVICE downloads licenses for protected content, you agree that Microsoft may include a revocation list with the licenses. Content owners may require you to upgrade the SOFTWARE on your DEVICE to access their content. If you decline an upgrade, you will not be able to access content that requires the upgrade.
- **Consent to Use of Data:** You agree that MS, Microsoft Corporation, FORD MOTOR COMPANY, third party software and systems suppliers, their affiliates and/or their designated agent may collect and use technical information gathered in any manner as part of product support services related to the SOFTWARE or related services. MS, Microsoft Corporation, FORD MOTOR COMPANY, third party software and services suppliers, their affiliates and/or their designated agent may use this information solely to improve their products or to provide customized services or technologies to you. MS, Microsoft Corporation, FORD MOTOR COMPANY, third party software and systems suppliers, their affiliates and/or their designated agent may disclose this information to others, but not in a form that personally identifies you.
- **Internet-Based Services Components:** The SOFTWARE may contain components that enable and facilitate the use of certain Internet-based services. You acknowledge and agree that MS, Microsoft Corporation, FORD MOTOR COMPANY, third party software and service suppliers, their affiliates and/or their designated agent may automatically check the version of the SOFTWARE and/or its components that you are utilizing and may provide upgrades or supplements to the SOFTWARE that may be automatically downloaded to your DEVICE.
- **Additional Software/Services:** The SOFTWARE may permit FORD MOTOR COMPANY, third party software and service suppliers, MS, Microsoft Corporation, their affiliates and/or their designated agent to provide or make available to you SOFTWARE updates, supplements, add-on components, or Internet-based services components of the SOFTWARE after the date you obtain your initial copy of the SOFTWARE ("Supplemental Components").

If FORD MOTOR COMPANY or third party software and services suppliers provide or make available to you Supplemental Components and no other EULA terms are provided along with the Supplemental Components, then the terms of this EULA shall apply.

If MS, Microsoft Corporation, their affiliates and/or their designated agent make available Supplemental Components, and no other EULA terms are provided, then the terms of this EULA shall apply, except that the MS, Microsoft Corporation or affiliate entity providing the Supplemental Component(s) shall be the licensor of the Supplemental Component(s).

FORD MOTOR COMPANY, MS, Microsoft Corporation, their affiliates and/or their designated agent reserve the right to discontinue without liability any Internet-based services provided to you or made available to you through the use of the SOFTWARE.

- **Links to Third Party Sites:** The MS SOFTWARE may provide you with the ability to link to third party sites through the use of the SOFTWARE. The third party sites are not under the control of MS, Microsoft Corporation, their affiliates and/or their designated agent. Neither MS nor Microsoft Corporation nor their affiliates nor their designated agent are responsible for (i) the contents of any third party sites, any links contained in third party sites, or any changes or updates to third party sites, or (ii) webcasting or any other form of transmission received from any third party sites. If the SOFTWARE provides links to third party sites, those links are provided to you only as a convenience, and the inclusion of any link does not imply an endorsement of the third party site by MS, Microsoft Corporation, their affiliates and/or their designated agent.
- **Obligation to Drive Responsibly:** You recognize your obligation to drive responsibly and keep attention on the road. You will read and abide with the DEVICE operating instructions particularly as they pertain to safety and assumes any risk associated with the use of the DEVICE.

UPGRADES AND RECOVERY MEDIA: If the SOFTWARE is provided by FORD MOTOR COMPANY separate from the DEVICE on media such as a ROM chip, CD ROM disk(s) or via web download or other means, and is labeled "For Upgrade Purposes Only" or "For Recovery Purposes Only" you may install one (1) copy of such SOFTWARE onto the DEVICE as a replacement copy for the existing SOFTWARE, and use it in accordance with this EULA, including any additional EULA terms accompanying the upgrade SOFTWARE.

INTELLECTUAL PROPERTY RIGHTS: All title and intellectual property rights in and to the SOFTWARE (including but not limited to any images, photographs, animations, video, audio, music, text and “applets,” incorporated into the SOFTWARE), the accompanying printed materials, and any copies of the SOFTWARE, are owned by MS, Microsoft Corporation, FORD MOTOR COMPANY, or their affiliates or suppliers. The SOFTWARE is licensed, not sold. You may not copy the printed materials accompanying the SOFTWARE. All title and intellectual property rights in and to the content which may be accessed through use of the SOFTWARE is the property of the respective content owner and may be protected by applicable copyright or other intellectual property laws and treaties. This EULA grants you no rights to use such content. All rights not specifically granted under this EULA are reserved by MS, Microsoft Corporation, FORD MOTOR COMPANY, third party software and service providers, their affiliates and suppliers. Use of any on-line services which may be accessed through the SOFTWARE may be governed by the respective terms of use relating to such services. If this SOFTWARE contains documentation that is provided only in electronic form, you may print one copy of such electronic documentation.

EXPORT RESTRICTIONS: You acknowledge that the SOFTWARE is subject to U.S. and European Union export jurisdiction. You agree to comply with all applicable international and national laws that apply to the SOFTWARE, including the U.S. Export Administration Regulations, as well as end-user, end-use and destination restrictions issued by U.S. and other governments. For additional information, see <http://www.microsoft.com/exporting/>.

TRADEMARKS: This EULA does not grant you any rights in connection with any trademarks or service marks of FORD MOTOR COMPANY, MS, Microsoft Corporation, third party software or service providers, their affiliates or suppliers.

PRODUCT SUPPORT: Product support for the SOFTWARE is not provided by MS, its parent corporation Microsoft Corporation, or their affiliates or subsidiaries. For product support, please refer to FORD MOTOR COMPANY instructions provided in the documentation for the DEVICE. Should you have any questions concerning this EULA, or if you desire to contact FORD MOTOR COMPANY for any other reason, please refer to the address provided in the documentation for the DEVICE.

No Liability for Certain Damages: EXCEPT AS PROHIBITED BY LAW, FORD MOTOR COMPANY, ANY THIRD PARTY SOFTWARE OR SERVICES SUPPLIERS, MS, MICROSOFT CORPORATION AND THEIR AFFILIATES SHALL HAVE NO LIABILITY FOR ANY INDIRECT, SPECIAL, CONSEQUENTIAL OR INCIDENTAL DAMAGES ARISING FROM OR IN CONNECTION WITH THE USE OR PERFORMANCE OF THE SOFTWARE. THIS LIMITATION SHALL APPLY EVEN IF ANY REMEDY FAILS OF ITS ESSENTIAL PURPOSE. IN NO EVENT SHALL MS, MICROSOFT CORPORATION AND/OR THEIR AFFILIATES BE LIABLE FOR ANY AMOUNT IN EXCESS OF U.S. TWO HUNDRED FIFTY DOLLARS (U.S.\$250.00).

- THERE ARE NO WARRANTIES OTHER THAN THOSE THAT MAY EXPRESSLY BE PROVIDED FOR YOUR NEW VEHICLE.

Adobe

Contains Adobe® [Flash® Player] or [AIR®] technology by Adobe Systems Incorporated. This [Licensee Product] contains [Adobe® Flash® Player] [Adobe® AIR®] software under license from Adobe Systems Incorporated, Copyright © 1995-2009 Adobe Macromedia Software LLC. All rights reserved. Adobe, Flash and AIR are trademarks of Adobe Systems Incorporated.

End user notice

Microsoft® Windows® Mobile for Automotive Important Safety Information

This system Ford SYNC™ contains software that is licensed to Manufacturer FORD MOTOR COMPANY by an affiliate of Microsoft Corporation pursuant to a license agreement. Any removal, reproduction, reverse engineering or other unauthorized use of the software from this system in violation of the license agreement is strictly prohibited and may subject you to legal action.

Read and follow instructions

Before using your Windows Automotive-based system, read and follow all instructions and safety information provided in this end user manual (“User’s Guide”). Not following precautions found in this User’s Guide can lead to an accident or other serious consequences.

Keep User's Guide in Vehicle

When kept in the vehicle, the User's Guide will be a ready reference for you and other users unfamiliar with the Windows Automotive-based system. Please make certain that before using the system for the first time, all persons have access to the User's Guide and read its instructions and safety information carefully.



WARNING: Operating certain parts of this system while driving can distract your attention away from the road, and possibly cause an accident or other serious consequences. Do not change system settings or enter data non-verbally (using your hands) while driving. Stop the vehicle in a safe and legal manner before attempting these operations. This is important since while setting up or changing some functions you might be required to distract your attention away from the road and remove your hands from the wheel.

General operation**Voice Command Control**

Functions within the Windows Automotive-based system may be accomplished using only voice commands. Using voice commands while driving allows you to operate the system without removing your hands from the wheel.

Prolonged Views of Screen

Do not access any function requiring a prolonged view of the screen while you are driving. Pull over in a safe and legal manner before attempting to access a function of the system requiring prolonged attention. Even occasional short scans to the screen may be hazardous if your attention has been diverted away from your driving task at a critical time.

Volume Setting

Do not raise the volume excessively. Keep the volume at a level where you can still hear outside traffic and emergency signals while driving. Driving while unable to hear these sounds could cause an accident.

Use of Speech Recognition Functions

Speech recognition software is inherently a statistical process which is subject to errors. It is your responsibility to monitor any speech recognition functions included in the system and address any errors.

Navigation Features

Any navigation features included in the system are intended to provide turn by turn instructions to get you to a desired destination. Please make certain all persons using this system carefully read and follow instructions and safety information fully.

Distraction Hazard

Any navigation features may require manual (non-verbal) setup. Attempting to perform such set-up or insert data while driving can seriously distract your attention and could cause an accident or other serious consequences. Stop the vehicle in a safe and legal manner before attempting these operations.

Let Your Judgment Prevail

Any navigation features are provided only as an aid. Make your driving decisions based on your observations of local conditions and existing traffic regulations. Any such feature is not a substitute for your personal judgment. Any route suggestions made by this system should never replace any local traffic regulations or your personal judgment or knowledge of safe driving practices.

Route Safety

Do not follow the route suggestions if doing so would result in an unsafe or illegal maneuver, if you would be placed in an unsafe situation, or if you would be directed into an area that you consider unsafe. The driver is ultimately responsible for the safe operation of the vehicle and therefore, must evaluate whether it is safe to follow the suggested directions.

Potential Map Inaccuracy

Maps used by this system may be inaccurate because of changes in roads, traffic controls or driving conditions. Always use good judgment and common sense when following the suggested routes.

Emergency Services

Do not rely on any navigation features included in the system to route you to emergency services. Ask local authorities or an emergency services operator for these locations. Not all emergency services such as police, fire stations, hospitals and clinics are likely to be contained in the map database for such navigation features.

TeleNav Software End User License Agreement

Please read these terms and conditions carefully before you use the TeleNav Software. Your use of the TeleNav Software indicates that you accept these terms and conditions. If you do not accept these terms and conditions, do not break the seal of the package, launch, or otherwise use the TeleNav Software.

TeleNav may revise this Agreement and the privacy policy at any time, with or without notice to you. You agree to visit <http://www.telenav.com> from time to time to review the then current version of this Agreement and of the privacy policy.

1. Safe and Lawful Use

You acknowledge that devoting attention to the TeleNav Software may pose a risk of injury or death to you and others in situations that otherwise require your undivided attention, and you therefore agree to comply with the following when using the TeleNav Software: (a) observe all traffic laws and otherwise drive safely; (b) use your own personal judgment while driving. If you feel that a route suggested by the TeleNav Software instructs you to perform an unsafe or illegal maneuver, places you in an unsafe situation, or directs you into an area that you consider to be unsafe, do not follow such instructions; (c) do not input destinations, or otherwise manipulate the TeleNav Software, unless your vehicle is stationary and parked; (d) do not use the TeleNav Software for any illegal, unauthorized, unintended, unsafe, hazardous, or unlawful purposes, or in any manner inconsistent with this Agreement; (e) arrange all GPS and wireless devices and cables necessary for use of the TeleNav Software in a secure manner in your vehicle so that they will not interfere with your driving and will not prevent the operation of any safety device (such as an airbag).

You agree to indemnify and hold TeleNav harmless against all claims resulting from any dangerous or otherwise inappropriate use of the TeleNav Software in any moving vehicle, including as a result of your failure to comply with the directions above.

2. Account Information

You agree: (a) when registering the TeleNav Software, to provide TeleNav with true, accurate, current, and complete information about yourself, and (b) to inform TeleNav promptly of any changes to such information, and to keep it true, accurate, current and complete.

3. Software License

Subject to your compliance with the terms of this Agreement, TeleNav hereby grants to you a personal, non-exclusive, non-transferable license (except as expressly permitted below in connection with your permanent transfer of the TeleNav Software license), without the right to sublicense, to use the TeleNav Software (in object code form only) in order to access and use the TeleNav Software. This license shall terminate upon any termination or expiration of this Agreement. You agree that you will use the TeleNav Software only for your personal business or leisure purposes, and not to provide commercial navigation services to other parties.

3.1 License limitations

You agree not to do any of the following: (a) reverse engineer, decompile, disassemble, translate, modify, alter or otherwise change the TeleNav Software or any part thereof; (b) attempt to derive the source code, audio library or structure of the TeleNav Software without the prior express written consent of TeleNav; (c) remove from the TeleNav Software, or alter, any of TeleNav's or its suppliers' trademarks, trade names, logos, patent or copyright notices, or other notices or markings; (d) distribute, sublicense or otherwise transfer the TeleNav Software to others, except as part of your permanent transfer of the TeleNav Software; or (e) use the TeleNav Software in any manner that (i) infringes the intellectual property or proprietary rights, rights of publicity or privacy or other rights of any party, (ii) violates any law, statute, ordinance or regulation, including but not limited to laws and regulations related to spamming, privacy, consumer and child protection, obscenity or defamation, or (iii) is harmful, threatening, abusive, harassing, tortuous, defamatory, vulgar, obscene, libelous, or otherwise objectionable; and (f) lease, rent out, or otherwise permit unauthorized access by third parties to the TeleNav Software without advanced written permission of TeleNav.

4. Disclaimers

To the fullest extent permissible pursuant to applicable law, in no event will TeleNav, its licensors and suppliers, or agents or employees of any of the foregoing, be liable for any decision made or action taken by you or anyone else in reliance on the information provided by the TeleNav Software. TeleNav also does not warrant the accuracy of the map or other data used for the TeleNav Software. Such data may not always reflect reality due to, among other things, road closures, construction, weather, new roads and other changing conditions. You are responsible for the entire risk arising out of your use of the TeleNav Software. For example but without limitation, you agree not to rely on the TeleNav Software for critical navigation in areas where the well-being or survival

of you or others is dependent on the accuracy of navigation, as the maps or functionality of the TeleNav Software are not intended to support such high risk applications, especially in more remote geographical areas. TELENAV EXPRESSLY DISCLAIMS AND EXCLUDES ALL WARRANTIES IN CONNECTION WITH THE TELENAV SOFTWARE, WHETHER STATUTORY, EXPRESS OR IMPLIED, INCLUDING ALL WARRANTIES WHICH MAY ARISE FROM COURSE OF DEALING, CUSTOM OR TRADE AND INCLUDING, BUT NOT LIMITED TO, THE IMPLIED WARRANTIES OF MERCHANTABILITY, FITNESS FOR A PARTICULAR PURPOSE AND NON-INFRINGEMENT OF THIRD PARTY RIGHTS WITH RESPECT TO THE TELENAV SOFTWARE. Certain jurisdictions do not permit the disclaimer of certain warranties, so this limitation may not apply to you.

5. Limitation of Liability

TO THE EXTENT PERMITTED UNDER APPLICABLE LAW, UNDER NO CIRCUMSTANCES SHALL TELENAV OR ITS LICENSORS AND SUPPLIERS BE LIABLE TO YOU OR TO ANY THIRD PARTY FOR ANY INDIRECT, INCIDENTAL, CONSEQUENTIAL, SPECIAL OR EXEMPLARY DAMAGES (INCLUDING IN EACH CASE, BUT NOT LIMITED TO, DAMAGES FOR THE INABILITY TO USE THE EQUIPMENT OR ACCESS DATA, LOSS OF DATA, LOSS OF BUSINESS, LOSS OF PROFITS, BUSINESS INTERRUPTION OR THE LIKE) ARISING OUT OF THE USE OF OR INABILITY TO USE THE TELENAV SOFTWARE, EVEN IF TELENAV HAS BEEN ADVISED OF THE POSSIBILITY OF SUCH DAMAGES.

NOTWITHSTANDING ANY DAMAGES THAT YOU MIGHT INCUR FOR ANY REASON WHATSOEVER (INCLUDING, WITHOUT LIMITATION, ALL DAMAGES REFERENCED HEREIN AND ALL DIRECT OR GENERAL DAMAGES IN CONTRACT, TORT (INCLUDING NEGLIGENCE) OR OTHERWISE), THE ENTIRE LIABILITY OF TELENAV AND OF ALL OF TELENAV'S SUPPLIERS SHALL BE LIMITED TO THE AMOUNT ACTUALLY PAID BY YOU FOR THE TELENAV SOFTWARE. SOME STATES AND/OR JURISDICTIONS DO NOT ALLOW THE EXCLUSION OR LIMITATION OF INCIDENTAL OR CONSEQUENTIAL DAMAGES, SO THE ABOVE LIMITATIONS OR EXCLUSIONS MAY NOT APPLY TO YOU.

6. Arbitration and Governing Law

You agree that any dispute, claim or controversy arising out of or relating to this Agreement or the TeleNav Software shall be settled by independent arbitration involving a neutral arbitrator and administered by the American Arbitration Association in the County of Santa Clara, California. The arbitrator shall apply the Commercial Arbitration Rules of the American Arbitration Association, and the judgment upon the award rendered by the arbitrator may be entered by any court having jurisdiction. Note that there is no judge or jury in an arbitration proceeding and the decision of the arbitrator shall be binding upon both parties. You expressly agree to waive your right to a jury trial.

This Agreement and performance hereunder will be governed by and construed in accordance with the laws of the State of California, without giving effect to its conflict of laws provisions. To the extent judicial action is necessary in connection with the binding arbitration, both TeleNav and you agree to submit to the exclusive jurisdiction of the courts of the County of Santa Clara, California. The United Nations Convention on Contracts for the International Sale of Goods shall not apply.

7. Assignment

You may not resell, assign, or transfer this Agreement or any of your rights or obligations, except in totality, in connection with your permanent transfer of the TeleNav Software, and expressly conditioned upon the new user of the TeleNav Software agreeing to be bound by the terms and conditions of this Agreement. Any such sale, assignment or transfer that is not expressly permitted under this paragraph will result in immediate termination of this Agreement, without liability to TeleNav, in which case you and all other parties shall immediately cease all use of the TeleNav Software. Notwithstanding the foregoing, TeleNav may assign this Agreement to any other party at any time without notice, provided the assignee remains bound by this Agreement.

8. Miscellaneous

8.1 This Agreement constitutes the entire agreement between TeleNav and you with respect to the subject matter hereof.

8.2 Except for the limited licenses expressly granted in this Agreement, TeleNav retains all right, title and interest in and to the TeleNav Software, including without limitation all related intellectual property rights. No licenses or other rights which are not expressly granted in this Agreement are intended to, or shall be, granted or conferred by implication, statute, inducement, estoppel or otherwise, and TeleNav and its suppliers and licensors hereby reserve all of their respective rights other than the licenses explicitly granted in this Agreement.

8.3 By using the TeleNav Software, you consent to receive from TeleNav all communications, including notices, agreements, legally required disclosures or other information in connection with the TeleNav Software (collectively, “Notices”) electronically. TeleNav may provide such Notices by posting them on TeleNav’s Website or by downloading such Notices to your wireless device. If you desire to withdraw your consent to receive Notices electronically, you must discontinue your use of the TeleNav Software.

8.4 TeleNav’s or your failure to require performance of any provision shall not affect that party’s right to require performance at any time thereafter, nor shall a waiver of any breach or default of this Agreement constitute a waiver of any subsequent breach or default or a waiver of the provision itself.

8.5 If any provision herein is held unenforceable, then such provision will be modified to reflect the intention of the parties, and the remaining provisions of this Agreement will remain in full force and effect.

8.6 The headings in this Agreement are for convenience of reference only, will not be deemed to be a part of this Agreement, and will not be referred to in connection with the construction or interpretation of this Agreement. As used in this Agreement, the words “include” and “including,” and variations thereof, will not be deemed to be terms of limitation, but rather will be deemed to be followed by the words “without limitation.”

9. Other Vendors Terms and Conditions

The TeleNav Software utilizes map and other data licensed to TeleNav by third party vendors for the benefit of you and other end users. This Agreement includes end-user terms applicable to these companies (included at the end of this Agreement), and thus your use of the TeleNav Software is also subject to such terms. You agree to comply with the following additional terms and conditions, which are applicable to TeleNav’s third party vendor licensors:

NavTeq End User License Agreement

END USER TERMS

The content provided (“Data”) is licensed, not sold. By opening this package, or installing, copying, or otherwise using the Data, you agree to be bound by the terms of this agreement. If you do not agree to the terms of this agreement, you are not permitted to install, copy, use, resell or transfer the Data. If you wish to reject the terms of this agreement, and have not installed, copied, or used the Data, you must contact your retailer or NAVTEQ North America, LLC (“NT”) within thirty (30) days of purchase for a refund of your purchase price. To contact NT, please visit www.navteq.com.

The Data is provided for your personal, internal use only and may not be resold. It is protected by copyright, and is subject to the following terms (this “End User License Agreement”) and conditions which are agreed to by you, on the one hand, and NAVTEQ North America, LLC (“NT”) and its licensors (including their licensors and suppliers) on the other hand.

The Data for areas of Canada includes information taken with permission from Canadian authorities, including: © Her Majesty the Queen in Right of Canada, © Queen’s Printer for Ontario, © Canada Post Corporation, GeoBase ®.

NT holds a nonexclusive license from the United States Postal Service ® to publish and sell ZIP+4 ® information.

© United States Postal Service ® 2009. Prices are not established, controlled or approved by the United States Postal Service ®. The following trademarks and registrations are owned by the USPS: United States Postal Service, USPS, and ZIP+4.

The Data for Mexico includes certain Data from Instituto Nacional de Estadística y Geografía.

TERMS AND CONDITIONS

License Limitations on Use: You agree that your license to use this Data is limited to and conditioned on use for solely personal, noncommercial purposes, and not for service bureau, timesharing or other similar purposes. Except as otherwise set forth herein, you agree not to otherwise reproduce, copy, modify, decompile, disassemble or reverse engineer any portion of this Data, and may not transfer or distribute it in any form, for any purpose, except to the extent permitted by mandatory laws.

License Limitations on Transfer: Your limited license does not allow transfer or resale of the Data, except on the condition that you may transfer the Data and all accompanying materials on a permanent basis if: (a) you retain no copies of the Data; (b) the recipient agrees to the terms of this End User License Agreement; and (c) you transfer the Data in the exact same form as you purchased it by physically transferring the original media (e.g., the CD-ROM or DVD you purchased), all original packaging, all Manuals and other documentation. Specifically, Multi-disc sets may only be transferred or sold as a complete set as provided to you and not as a subset thereof.

Additional License Limitations: Except where you have been specifically licensed to do so by NT in a separate written agreement, and without limiting the preceding paragraph, your license is conditioned on use of the Data as prescribed in this agreement, and you may not (a) use this Data with any products, systems, or applications installed or otherwise connected to or in communication with vehicles capable of vehicle navigation, positioning, dispatch, real time route guidance, fleet management or similar applications; or (b) with, or in communication with, including without limitation, cellular phones, palmtop and handheld computers, pagers, and personal digital assistants or PDAs.



WARNING: This Data may contain inaccurate or incomplete information due to the passage of time, changing circumstances, sources used and the nature of collecting comprehensive geographic Data, any of which may lead to incorrect results.

No Warranty: This Data is provided to you “as is”, and you agree to use it at your own risk. NT and its licensors (and their licensors and suppliers) make no guarantees, representations or warranties of any kind, express or implied, arising by law or otherwise, including but not limited to, content, quality, accuracy, completeness, effectiveness, reliability, fitness for a particular purpose, usefulness, use or results to be obtained from this Data, or that the Data or server will be uninterrupted or error free.

Disclaimer of Warranty: NT AND ITS LICENSORS (INCLUDING THEIR LICENSORS AND SUPPLIERS) DISCLAIM ANY WARRANTIES, EXPRESS OR IMPLIED, OF QUALITY, PERFORMANCE, MERCHANTABILITY, FITNESS FOR A PARTICULAR PURPOSE OR NON-INFRINGEMENT. Some States, Territories and Countries do not allow certain warranty exclusions, so to that extent the above exclusion may not apply to you.

Disclaimer of Liability: NT AND ITS LICENSORS (INCLUDING THEIR LICENSORS AND SUPPLIERS) SHALL NOT BE LIABLE TO YOU IN RESPECT OF ANY CLAIM, DEMAND OR ACTION, IRRESPECTIVE OF THE NATURE OF THE CAUSE OF THE CLAIM, DEMAND OR ACTION ALLEGING ANY LOSS, INJURY OR DAMAGES, DIRECT OR INDIRECT, WHICH MAY RESULT FROM THE USE OR POSSESSION OF THIS DATA; OR FOR ANY LOSS OF PROFIT, REVENUE, CONTRACTS OR SAVINGS, OR ANY OTHER DIRECT, INDIRECT, INCIDENTAL, SPECIAL OR CONSEQUENTIAL DAMAGES ARISING OUT OF YOUR USE OF OR INABILITY TO USE THIS DATA, ANY DEFECT IN THIS DATA, OR THE BREACH OF THESE TERMS OR CONDITIONS, WHETHER IN AN ACTION IN CONTRACT OR TORT OR BASED ON A WARRANTY, EVEN IF NT OR ITS LICENSORS HAVE BEEN ADVISED OF THE POSSIBILITY OF SUCH DAMAGES. Some States, Territories and Countries do not allow certain liability exclusions or damages limitations, so to that extent the above may not apply to you.

Export Control: You agree not to export from anywhere any part of the Data or any direct product thereof except in compliance with, and with all licenses and approvals required under, applicable export laws, rules and regulations, including but not limited to the laws, rules and regulations administered by the Office of Foreign Assets Control of the U.S. Department of Commerce and the Bureau of Industry and Security of the U.S. Department of Commerce. To the extent that any such export laws, rules or regulations prohibit NT from complying with any of its obligations hereunder to deliver or distribute Data, such failure shall be excused and shall not constitute a breach of this Agreement.

Entire Agreement: These terms and conditions constitute the entire agreement between NT (and its licensors, including their licensors and suppliers) and you pertaining to the subject matter hereof, and supersedes in their entirety any and all written or oral agreements previously existing between us with respect to such subject matter.

Severability: You and NT agree that if any portion of this agreement is found illegal or unenforceable, that portion shall be severed and the remainder of the Agreement shall be given full force and effect.

Governing Law: The above terms and conditions shall be governed by the laws of the State of Illinois, without giving effect to (i) its conflict of laws provisions, or (ii) the United Nations Convention for Contracts for the International Sale of Goods, which is explicitly excluded. You agree to submit to the personal jurisdiction of the State of Illinois for any and all disputes, claims and actions arising from or in connection with the Data provided to you hereunder.

Government End Users: If the Data is being acquired by or on behalf of the United States government or any other entity seeking or applying rights similar to those customarily claimed by the United States government, this Data is a “commercial item” as that term is defined at 48 C.F.R. (“FAR”) 2.101, is licensed in accordance with this End User License Agreement, and each copy of Data delivered or otherwise furnished shall be marked and embedded as appropriate with the following “Notice of Use”, and be treated in accordance with such Notice:

NOTICE OF USE

CONTRACTOR (MANUFACTURER/ SUPPLIER)

NAME:

NAVTEQ

CONTRACTOR (MANUFACTURER/SUPPLIER)

ADDRESS:

425 West Randolph Street, Chicago, IL 60606.

This Data is a commercial item as defined in FAR 2.101 and is subject to the EndUser License Agreement under which this Data was provided.

© 2011 NAVTEQ. All rights reserved.

If the Contracting Officer, federal government agency, or any federal official refuses to use the legend provided herein, the Contracting Officer, federal government agency, or any federal official must notify NAVTEQ prior to seeking additional or alternative rights in the Data.

Wi-Fi hotspot data provided by JiWire ©2013 JiWire.

Gracenote® Copyright

CD and music — related data from Gracenote, Inc., copyright © 2000–2007 Gracenote. Gracenote Software, copyright © 2000–2007 Gracenote. This product and service may practice one or more of the following U.S. Patents #5,987,525; #6,061,680; #6,154,773, #6,161,132, #6,230,192, #6,230,207, #6,240,459, #6,330,593, and other patents issued or pending. Some services supplied under license from Open Globe, Inc. for U.S. Patent: #6,304,523.

Gracenote and CDDB are registered trademarks of Gracenote. The Gracenote logo and logotype, and the “Powered by Gracenote™” logo are trademarks of Gracenote.

Gracenote® End User License Agreement (EULA)

This device contains software from Gracenote, Inc. of 2000 Powell Street Emeryville, California 94608 (“Gracenote”).

The software from Gracenote (the “Gracenote Software”) enables this device to do disc and music file identification and obtain music-related information, including name, artist, track, and title information (“Gracenote Data”) from online servers (“Gracenote Servers”), and to perform other functions. You may use Gracenote Data only by means of the intended End User functions of this device

This device may contain content belonging to Gracenote’s providers. If so, all of the restrictions set forth herein with respect to Gracenote Data shall also apply to such content and such content providers shall be entitled to all of the benefits and protections set forth herein that are available to Gracenote.

You agree that you will use the content from Gracenote (“Gracenote Content”), Gracenote Data, the Gracenote Software, and Gracenote Servers for your own personal, non-commercial use only. You agree not to assign, copy, transfer or transmit the Gracenote Content, Gracenote Software or any Gracenote Data (except in a Tag associated with a music file) to any third party. **YOU AGREE NOT TO USE OR EXPLOIT GRACENOTE CONTENT, GRACENOTE DATA, THE GRACENOTE SOFTWARE, OR GRACENOTE SERVERS, EXCEPT AS EXPRESSLY PERMITTED HEREIN.**

You agree that your non-exclusive licenses to use the Gracenote Content, Gracenote Data, the Gracenote Software, and Gracenote Servers will terminate if you violate these restrictions. If your licenses terminate, you agree to cease any and all use of the Gracenote Content, Gracenote Data, the Gracenote Software, and Gracenote Servers. Gracenote, respectively, reserve all rights in Gracenote Data, the Gracenote Software, and the Gracenote Servers and Gracenote Content, including all ownership rights. Under no circumstances will either Gracenote become liable for any payment to you for any information that you provide, including any copyrighted material or music file information. You agree that Gracenote may enforce its respective rights, collectively or separately, under this agreement against you, directly in each company’s own name.

Gracenote uses a unique identifier to track queries for statistical purposes. The purpose of a randomly assigned numeric identifier is to allow Gracenote to count queries without knowing anything about who you are. For more information, see the web page at www.gracenote.com for the Gracenote Privacy Policy

THE GRACENOTE SOFTWARE, EACH ITEM OF GRACENOTE DATA AND THE GRACENOTE CONTENT ARE LICENSED TO YOU "AS IS." NEITHER GRACENOTE MAKES ANY REPRESENTATIONS OR WARRANTIES, EXPRESS OR IMPLIED, REGARDING THE ACCURACY OF ANY GRACENOTE DATA FROM THE GRACENOTE SERVERS OR GRACENOTE CONTENT. GRACENOTE COLLECTIVELY AND SEPARATELY RESERVE THE RIGHT TO DELETE DATA AND/OR CONTENT FROM THE COMPANIES' RESPECTIVE SERVERS OR, IN THE CASE OF GRACENOTE, CHANGE DATA CATEGORIES FOR ANY CAUSE THAT GRACENOTE DEEMS SUFFICIENT. NO WARRANTY IS MADE THAT EITHER GRACENOTE CONTENT OR THE GRACENOTE SOFTWARE OR GRACENOTE SERVERS ARE ERROR-FREE OR THAT THE FUNCTIONING OF THE GRACENOTE SOFTWARE OR GRACENOTE SERVERS WILL BE UNINTERRUPTED. GRACENOTE IS NOT OBLIGATED TO PROVIDE YOU WITH ANY ENHANCED OR ADDITIONAL DATA TYPES THAT GRACENOTE MAY CHOOSE TO PROVIDE IN THE FUTURE AND IS FREE TO DISCONTINUE ITS ONLINE SERVICES AT ANY TIME. GRACENOTE DISCLAIM ALL WARRANTIES EXPRESS OR IMPLIED, INCLUDING, BUT NOT LIMITED TO, IMPLIED WARRANTIES OF MERCHANTABILITY, FITNESS FOR A PARTICULAR PURPOSE, TITLE, AND NON-INFRINGEMENT. NEITHER GRACENOTE WARRANTS THE RESULTS THAT WILL BE OBTAINED BY YOUR USE OF THE GRACENOTE SOFTWARE OR ANY GRACENOTE SERVER. IN NO CASE WILL GRACENOTE BE LIABLE FOR ANY CONSEQUENTIAL OR INCIDENTAL DAMAGES OR FOR ANY LOST PROFITS OR LOST REVENUES FOR ANY REASON WHATSOEVER.

© Gracenote 2007

Vehicle with SYNC only

FCC ID: KMHSG1G1 IC: 1422A-SG1G1

FCC ID: WDGSG1G1 IC: 5248B-SG1G1

Vehicle with SYNC and MyFord Touch or MyLincoln Touch

FCC ID: KMHSYNG2 IC: 1422A-SYNG2

This device complies with Part 15 of the FCC Rules and with RSS-210 of Industry Canada. Operation is subject to the following two conditions:

(1) This device may not cause harmful interference, and (2) this device must accept any interference received, including interference that may cause undesired operation.



WARNING: Changes or modifications not expressly approved by the party responsible for compliance could void the user's authority to operate the equipment. The term "IC:" before the radio certification number only signifies that Industry Canada technical specifications were met.

The antenna used for this transmitter must not be co-located or operating in conjunction with any other antenna or transmitter.

-
- 911 Assist™441, 516
- A**
- ABS (see Brakes)223
- Accessing and using your
USB port494
- Accessing call history/phone
book during active call429
- Accessing your calendar515
- Accessing your media menu
features454
- Accessing your phone menu
features431
- Accessory delay92
- Active call menu options429
- Adding (pairing) a phone502
- Advanced menu options ...439, 459
- Advanced menu options
(prompts, languages, defaults,
master reset, installing
applications)439
- Airbag supplemental restraint
system48
and child safety seats49
description48
disposal60
driver airbag48
passenger airbag48
passenger deactivation
switch51
side airbag48, 56
- Air cleaner filter323, 395
- Air conditioning146
manual heating and air
conditioning system146
- Air filter323, 395
- All Wheel Drive (AWD),
driving off road209
- Ambient mood/lighting522–523
- Ambulance packages16
- AM/FM481
- Antifreeze
(see Engine coolant)307
- Anti-lock brake system
(see Brakes)223
- Anti-theft system77, 79
arming the system77, 79
disarming a triggered system ..79
- AppLink™449
- Audio system
Single CD136–137, 140
- Audio system
(see Radio)136–137, 140
- Automatic transmission201
driving an automatic
overdrive199
fluid, adding313
fluid, checking313
fluid, refill capacities391
fluid, specification391
Selectshift (SST)204
- Auxiliary Input Jack490
- Auxiliary input jack (Line in) ..141
- Auxiliary powerpoint178
- A/V inputs143, 498
- Axle
refill capacities391
- B**
- Battery318
acid, treating emergencies318
jumping a disabled battery279

-
- maintenance-free318
 - replacement, specifications ...395
 - servicing318
 - Bed extender251
 - Booster seats23
 - Brakelamp
 - bulb replacement329–330
 - Brakes223
 - anti-lock223
 - anti-lock brake system (ABS)
 - warning light223
 - brake warning light223
 - fluid, checking and adding ...317
 - fluid, refill capacities391
 - fluid, specifications391
 - parking224
 - shift interlock206
 - trailer258–259
 - Bulbs331
 - C**
 - Capacities for refilling fluids ...391
 - Car2U® Home Automation System168
 - CD136–137, 140
 - CD player134, 492
 - CD voice commands493
 - Cell phone use17
 - Changing a tire371
 - Changing the air filter323
 - Child safety seats
 - attaching with tether straps ...31
 - automatic locking mode (retractor)40
 - in front seat28
 - in rear seat28
 - LATCH31
 - Child safety seats - booster seats23
 - Cleaning the touchscreen469
 - Cleaning your vehicle332
 - engine compartment334
 - exterior332
 - instrument panel336–337
 - interior335
 - plastic parts334
 - washing332
 - waxing334
 - wheels340
 - wiper blades335
 - Climate control (see Air conditioning or Heating)146
 - Climate voice commands536
 - Clock136–137, 520
 - Console181
 - overhead181
 - Controls
 - power seat159
 - Coolant307
 - checking and adding307
 - recovery reservoir304
 - refill capacities391
 - Customer Assistance276
 - Ford Extended Service
 - lan400
 - Getting roadside assistance ...276
 - Getting the service you need282
 - Ordering additional owner's literature288
 - Utilizing the Mediation/Arbitration Program286

-
- D**
- Daytime running lamps
(see Lamps)87
 - Defrost146, 148
 - rear window152
 - Dipstick
 - automatic transmission
 - fluid313
 - engine oil304, 306
 - Display settings521
 - Drivebelt389
 - Driving under special
 - conditions207, 218, 220
 - sand218
 - snow and ice221
 - through water219, 270
 - Dual automatic temperature
 - control (DATC)148
- E**
- Electronic message center104
 - Electronic stability control228
 - Emergencies, roadside
 - jump-starting279
 - running out of fuel192
 - Emergency Flashers278
 - Emission control system195
 - End user license agreement549
 - Engine304, 389
 - cleaning334
 - coolant307
 - fail-safe cooling310
 - refill capacities391
 - service points304–305
 - Engine block heater186
 - Engine oil
 - checking and adding306
 - dipstick306
 - filter, specifications395
 - refill capacities391
 - Event data recording12
 - Exhaust fumes185
- F**
- Fail safe cooling310
 - Filter
 - fuel317
 - Fleet MyKey programming67
 - Flexible Fuel Vehicle (FFV)188
 - Floor mats271
 - Fluid capacities391
 - Fog lamps88
 - Four-Wheel Drive vehicles209
 - driving off road216
 - electronic shift209, 213
 - indicator light210
 - lever operated shift211
 - manual locking hubs209
 - Fuel
 - cap193
 - capacity391
 - choosing the right fuel ...190–191
 - filler funnel192
 - filling your vehicle with
 - fuel193
 - fuel pump shut-off278
 - octane rating191, 389
 - quality190
 - running out of fuel192
 - safety information relating to
 - automotive fuels188

-
- Fuel - flex fuel vehicle (FFV)188, 191
 - Fuses290–291, 296
 - G**
 - Garage door opener168, 172
 - Gas cap (see Fuel cap)193
 - Gauges97
 - H**
 - Hazard flashers278
 - HD Radio™482
 - Headlamps85
 - aiming325
 - autolamp system86
 - bulb specifications331
 - checking alignment325
 - daytime running lights87
 - flash to pass85
 - high beam85
 - replacing bulbs327
 - turning on and off85
 - Head restraints155
 - Heated steering wheel534
 - Heating146, 148
 - Help533
 - Hill descent mode230
 - Hill start assist208
 - Homelink wireless control system172
 - Hood303
 - How to use voice commands ...473
 - I**
 - Ignition183, 389
 - Illuminated visor mirror95
 - Information displays104
 - Inspection/maintenance (I/M) testing198
 - Instrument panel
 - cleaning336–337
 - cluster99
 - lighting up panel and interior87
 - J**
 - Jack371
 - positioning371
 - storage371
 - Joining two calls (multiparty/conference call)429
 - Jump-starting your vehicle279
 - K**
 - Keyless entry system
 - autolock73
 - keypad75
 - locking and unlocking doors76
 - programming entry code75
 - Keys62, 77
 - positions of the ignition183
 - L**
 - Lamps85
 - autolamp system86
 - bulb replacement specifications chart331
 - daytime running light87
 - fog lamps88
 - headlamps85
 - headlamps, flash to pass85
 - instrument panel, dimming87

-
- interior lamps89
 - replacing bulbs327, 329–330
 - Lane change indicator
(see Turn signal)88
 - LATCH anchors31
 - Lights, warning and indicator99
 - Listening to music478
 - Loading instructions247
 - Load limits241
 - Locks
 - autolock73
 - childproof35
 - doors72
 - Lug nuts387
 - Lumbar support, seats158
 - M**
 - Making and receiving calls502
 - Manual transmission
 - fluid capacities391
 - MAP DVD - Loading and
Unloading502
 - Map icons545
 - Map mode543
 - Map preferences542
 - Map updates546
 - Media Bluetooth menu options
(adding, connecting, deleting,
turning on/off)458
 - Message center104–105
 - warning messages119
 - Mirrors92, 94
 - fold away93–94
 - programmable memory63
 - side view mirrors (power)92
 - Moon roof96
 - Motorcraft® parts332, 395
 - MyFord Touch™ system466
 - MyKey67
 - N**
 - Navigation features537
 - Navigation voice commands547
 - Notifications515
 - O**
 - Octane rating191
 - P**
 - Pairing other phones426, 502
 - Pairing your phone501
 - Pairing your phone for
the first time426, 501
 - Parental MyKey programming ...67
 - Parking brake224
 - Parts
(see Motorcraft® parts)395
 - Phone Bluetooth menu options
(adding, connecting, deleting,
turning on/off)437
 - Phone redial431
 - Phone settings505, 528
 - Phone voice commands507
 - Playing music (by artist,
album, genre, playlist,
tracks, similar)455
 - POI categories539
 - Point of Interest (POI)539

-
- Power distribution box
(see Fuses)291
- Power door locks72
- Power mirrors92
- Powerpoint178
- Power steering240
 fluid, checking and adding317
 fluid, refill capacity391
- Power Windows90
- Privacy information422, 472
- Putting a call on/off hold429
- Q**
- Quick touch buttons546
- R**
- Radio136–137, 140
 AM/FM481
 Single CD136–137, 140
- Radio reception134
- Radio voice commands486
- Rear heated seats163
- Rear view camera
display234, 523
- Rear window defroster146, 148
- Receiving a text
message433, 505
- Recommendations for
attaching safety restraints
for children25
- Relays290–291
- Remote entry system
 illuminated entry74
 locking/unlocking doors72
 replacing the batteries62
- Reverse sensing system233
- Roadside assistance276
- Roll stability control228
- Route preferences542
- S**
- Safety Belt Maintenance45
- Safety belts
(see Safety restraints)38, 42
- Safety defects, reporting289
- Safety information422, 470
- Safety restraints38, 40, 42
 Belt-Minder®43
 extension assembly42
 for adults38, 40
 for children20, 25
 safety belt maintenance45
 seat belt maintenance45
 warning light and chime43
- Safety restraints -
LATCH anchors31
- Safety seats for children20, 25
- Safety Compliance
Certification Label396
- Satellite Radio487
- Scheduled Maintenance Guide
 Normal Scheduled
 Maintenance and Log408
- SD card143, 494, 537
- Seat belts
(see Safety restraints)38
- Seats
 child safety seats20, 25
 cleaning338
 climate control166
 filter166

-
- heated163
 - memory seat63, 160
 - SecuriCode keyless entry system75
 - SecuriLock passive anti-theft system77
 - Selecting your media source (USB, Line in, BT audio)454
 - Sending new text messages504
 - Setting a destination537
 - Setting a destination by voice537
 - Settings520
 - Setting the clock136–137, 520
 - Side air curtain57
 - Side-curtain airbags system57
 - SIRIUS® satellite radio487
 - SIRIUS satellite radio voice commands489
 - SIRIUS Travel Link512
 - SIRIUS Travel Link voice commands514
 - Snowplowing16, 272–274
 - SOS Post Crash Alert47
 - Spark plugs, specifications389, 395
 - Special notice17
 - ambulance conversions16
 - four-wheel drive vehicles275
 - Stability system228
 - Starting a flex fuel vehicle185
 - Starting your vehicle183, 185
 - jump starting279
 - Steering wheel80
 - controls80
 - tilting80
 - Supplemental Restraint System (SRS) (see airbags)48
 - Supported media file types497
 - Supported player, media formats and metadata information497
 - SYNC® AppLink™449
 - SYNC® customer support421
 - SYNC® Services445, 508
 - System settings524
- T**
- Tailgate248
 - Tail lamps
 - bulb replacement329–330
 - Temperature control (see Climate control)146, 148, 534
 - Text messaging432, 504
 - Text messaging (sending, downloading, deleting)433, 435
 - Tilt steering wheel80
 - Tires345–346, 371
 - alignment361
 - care345
 - changing371, 376
 - checking the pressure355
 - inflating353
 - label352
 - replacing359
 - rotating362
 - safety practices360
 - sidewall information348
 - snow tires and chains363
 - spare tire372

-
- terminology347
 - tire grades346
 - treadwear346, 358
 - Touchscreen features
 - (climate)534
 - Towing253, 266, 268
 - recreational towing268
 - Trailer Brake
 - Controller-Integrated259
 - trailer towing253
 - wrecker266
 - Traction control225
 - Traffic, Directions and Information445
 - Traffic preferences542
 - Trailer Brake
 - Controller-Integrated259
 - Trailer sway control254
 - Transfer case
 - fluid checking316
 - Transmission199
 - brake-shift interlock (BSI)206
 - fluid, checking and adding
 - (automatic)313
 - fluid, refill capacities391
 - Turn signal88
 - U**
 - Universal garage door opener ..168
 - Upfitter controls300
 - USB port142–143, 494
 - Using privacy mode429
 - V**
 - Vehicle health report443, 518
 - Vehicle Identification Number (VIN)395
 - Vehicle loading241
 - Ventilating your vehicle186
 - Voice commands in media mode451
 - Voice commands in phone mode427
 - Voice recognition472
 - W**
 - Warning lights (see Lights)99
 - Washer fluid318
 - reservoir304
 - Water, Driving through270
 - Wi-Fi531
 - Windows
 - power90
 - Windshield washer fluid and wipers84
 - checking and adding fluid318
 - replacing wiper blades322
 - reservoir304
 - Wrecker towing266