



fordowner.com



ford.ca



<b>Table of Contents</b>	<b>1</b>
<hr/>	
<b>Introduction</b>	<b>10</b>
<b>Child Safety</b>	<b>19</b>
Child seat positioning . . . . .	.21
Booster seats . . . . .	.23
Installing child seats . . . . .	.26
Child safety locks . . . . .	.38
<b>Safety Belts</b>	<b>39</b>
Fastening the safety belts . . . . .	.41
Safety belt height adjustment . . . . .	.44
Safety belt warning light and indicator chime . . . . .	.45
Safety belt-minder . . . . .	.45
Rear inflatable safety belt . . . . .	.47
Child restraint and safety belt maintenance . . . . .	.49
<b>Personal Safety System</b>	<b>50</b>
<b>Supplementary Restraints System</b>	<b>51</b>
Driver and passenger airbags . . . . .	.53
Front passenger sensing system . . . . .	.55
Side airbags . . . . .	.58
Safety canopy curtain airbags . . . . .	.59
Crash sensors and airbag indicator . . . . .	.61
Airbag disposal . . . . .	.62
<b>Keys and Remote Control</b>	<b>63</b>
General information on radio frequencies . . . . .	.63
Remote control . . . . .	.64
Keys . . . . .	.64
Replacing a lost key or remote control . . . . .	.70

---

<b>MyKey</b>	<b>71</b>
Settings, MyKey . . . . .	.71
Creating . . . . .	.72
Clearing . . . . .	.73
System status . . . . .	.73
Remote start, MyKey . . . . .	.74
Troubleshooting, MyKey . . . . .	.74
<b>Locks</b>	<b>76</b>
Locking and unlocking . . . . .	.76
SecuriCode™ keyless entry keypad . . . . .	.85
<b>Security</b>	<b>88</b>
SecuriLock® passive anti-theft system . . . . .	.88
Anti-theft alarm . . . . .	.91
<b>Steering Wheel</b>	<b>93</b>
Adjusting the steering wheel . . . . .	.93
Steering wheel controls . . . . .	.95
<b>Pedals</b>	<b>98</b>
Adjustable pedals . . . . .	.98
<b>Wipers and Washers</b>	<b>99</b>
Windshield wipers . . . . .	.99
Rain-sensing wipers . . . . .	.99
Windshield washers . . . . .	.100
Rear-window wiper and washer . . . . .	.100

## Table of Contents

3

---

<b>Lighting</b>	<b>101</b>
Lighting control . . . . .	101
Autolamps . . . . .	102
Instrument lighting dimmer . . . . .	102
Headlamp exit delay . . . . .	103
Daytime running lamps . . . . .	103
Automatic high beam control . . . . .	104
Front fog lamps . . . . .	105
Direction indicators . . . . .	106
Interior lamps . . . . .	106
<b>Windows and Mirrors</b>	<b>109</b>
Power windows . . . . .	109
Exterior mirrors . . . . .	111
Interior mirrors . . . . .	114
Sun visors . . . . .	114
Moonroof . . . . .	115
<b>Instrument Cluster</b>	<b>117</b>
Gauges . . . . .	117
Warning lamps and indicators . . . . .	118
Audible warnings and indicators . . . . .	123
<b>Information Displays</b>	<b>124</b>
Controls . . . . .	124
Trip computer . . . . .	128
Information messages . . . . .	133
<b>Climate Control</b>	<b>145</b>
Manual heating and air conditioning . . . . .	145
Dual automatic temperature control . . . . .	147
Rear window defroster . . . . .	154
Cabin air filter . . . . .	154

<b>Seats</b>	<b>156</b>
Sitting in the correct position . . . . .	156
Head restraints . . . . .	157
Manual seats . . . . .	160
Power seats . . . . .	161
Memory function . . . . .	163
Heated seats . . . . .	164
Heated and ventilated seats . . . . .	165
Rear seats . . . . .	167
<b>Universal Garage Door Opener (If Equipped)</b>	<b>179</b>
HomeLink® wireless control system . . . . .	180
<b>Auxiliary Power Points</b>	<b>184</b>
<b>Storage Compartments</b>	<b>187</b>
Center console . . . . .	187
Overhead console . . . . .	188
<b>Starting and Stopping the Engine</b>	<b>189</b>
Ignition switch . . . . .	190
Engine block heater . . . . .	194
<b>Fuel and Refueling</b>	<b>196</b>
Fuel quality . . . . .	197
Running out of fuel . . . . .	199
Refueling . . . . .	200
Fuel consumption . . . . .	203
<b>Transmission</b>	<b>207</b>
Automatic transmission . . . . .	207
Hill start assist . . . . .	213
<b>Four-Wheel Drive (If Equipped)</b>	<b>215</b>
Four wheel drive . . . . .	215

## Table of Contents

5

---

<b>Brakes</b>	<b>223</b>
Brakes . . . . .	.223
Hints on driving with anti-lock brakes . . . . .	.224
Parking brake . . . . .	.224
<b>Traction Control</b>	<b>225</b>
Traction Control™ . . . . .	.225
<b>Stability Control</b>	<b>226</b>
AdvanceTrac® . . . . .	.227
<b>Terrain Response</b>	<b>228</b>
Hill descent control . . . . .	.229
<b>Parking Aids</b>	<b>231</b>
Sensing system . . . . .	.231
Active park assist . . . . .	.233
Rear-view camera system . . . . .	.237
<b>Cruise Control</b>	<b>242</b>
Using cruise control . . . . .	.242
Using Adaptive Cruise Control . . . . .	.243
<b>Driving Aids</b>	<b>252</b>
Driver alert . . . . .	.252
Lane keeping system . . . . .	.254
Blind Spot Information System (BLIS) with Cross Traffic Alert (CTA) . . . . .	.258
Collision warning system . . . . .	.264
Steering . . . . .	.267

<b>Load Carrying</b>	<b>269</b>
Cargo net . . . . .	.269
Roof racks and load carriers . . . . .	.269
Vehicle loading . . . . .	.270
<b>Towing</b>	<b>278</b>
Trailer towing . . . . .	.278
Wrecker towing . . . . .	.285
Recreational towing . . . . .	.286
<b>Driving Hints</b>	<b>288</b>
Economical driving . . . . .	.288
Floor mats . . . . .	.290
<b>Roadside Emergencies</b>	<b>291</b>
Getting roadside assistance . . . . .	.291
Hazard warning flashers . . . . .	.292
Fuel cut-off switch . . . . .	.293
Jump-starting the vehicle . . . . .	.294
<b>Customer Assistance</b>	<b>297</b>
Reporting safety defects (U.S. only) . . . . .	.304
Reporting safety defects (Canada only) . . . . .	.304
<b>Fuses</b>	<b>305</b>
Changing a fuse . . . . .	.305
Fuse specification chart . . . . .	.306

## Table of Contents

7

---

<b>Maintenance</b>	<b>315</b>
General information . . . . .	.315
Opening and closing the hood . . . . .	.316
Under hood overview . . . . .	.317
Engine oil dipstick . . . . .	.320
Engine oil check . . . . .	.320
Engine coolant check . . . . .	.321
Automatic transmission fluid check . . . . .	.326
Brake fluid check . . . . .	.331
Fuel filter . . . . .	.331
Washer fluid check . . . . .	.332
Battery . . . . .	.332
Checking the wiper blades . . . . .	.335
Air filter(s) . . . . .	.336
Adjusting the headlamps . . . . .	.338
Changing a bulb . . . . .	.340
Bulb specification chart . . . . .	.344
<b>Vehicle Care</b>	<b>346</b>
Cleaning products . . . . .	.346
Cleaning the exterior . . . . .	.346
Waxing . . . . .	.348
Repairing minor paint damage . . . . .	.348
Cleaning the engine . . . . .	.348
Cleaning the windows and wiper blades . . . . .	.349
Cleaning the interior . . . . .	.350
Cleaning the instrument panel and instrument cluster lens . . . . .	.350
Cleaning leather seats . . . . .	.351
Cleaning the alloy wheels . . . . .	.352
Vehicle storage . . . . .	.352



---

<b>Wheels and Tires</b>	<b>355</b>
Tire care . . . . .	.357
Using snow chains . . . . .	.374
Tire Pressure Monitoring System (TPMS) . . . . .	.375
Changing a road wheel . . . . .	.379
Technical specifications . . . . .	.387
Wheel lug nut torque . . . . .	.387
<b>Capacities and Specifications</b>	<b>388</b>
Engine specifications . . . . .	.388
Part numbers . . . . .	.394
Vehicle identification number . . . . .	.395
Vehicle certification label . . . . .	.396
Transmission code designation . . . . .	.396
<b>Accessories</b>	<b>397</b>
Accessories . . . . .	.397
<b>Extended Service Plan</b>	<b>399</b>
<b>Audio System</b>	<b>402</b>
MyFord™ system . . . . .	.404
Satellite radio information . . . . .	.415
Auxiliary input jack . . . . .	.418
USB port . . . . .	.419
<b>SYNC®</b>	<b>420</b>
Pairing your phone for the first time . . . . .	.425
911 Assist™ . . . . .	.441
Vehicle Health Report . . . . .	.443

## Table of Contents 9

---

<b>MyFord Touch® (If Equipped)</b>	<b>469</b>
Infotainment display . . . . .	.476
Voice recognition . . . . .	.477
Listening to music . . . . .	.481
Phone features . . . . .	.501
Information Menu . . . . .	.509
Settings . . . . .	.521
Climate features . . . . .	.533
Navigation system. . . . .	.536
<b>Appendices</b>	<b>548</b>
<b>Scheduled Maintenance</b>	<b>568</b>
Normal scheduled maintenance and log . . . . .	.573
<b>Index</b>	<b>585</b>

The information contained in this publication was correct at the time of going to print. In the interest of continuous development, we reserve the right to change specifications, design or equipment at any time without notice or obligation. No part of this publication may be reproduced, transmitted, stored in a retrieval system or translated into any language in any form by any means without our written permission. Errors and omissions excepted.

© Ford Motor Company 2014

**ABOUT THIS MANUAL**

Thank you for choosing Ford. We recommend that you take some time to get to know your vehicle by reading this manual. The more that you know about it, the greater the safety and pleasure you will get from driving it.



**WARNING:** Always drive with due care and attention when using and operating the controls and features on your vehicle.

**Note:** This manual describes product features and options available throughout the range of available models, sometimes even before they are generally available. It may describe options not fitted to your vehicle.

**Note:** Some of the illustrations in this manual may be used for different models, so may appear different to you on your vehicle. However, the essential information in the illustrations is always correct.

**Note:** Always use and operate your vehicle in line with all applicable laws and regulations.

**Note:** Pass on this manual when selling your vehicle. It is an integral part of the vehicle.

This manual may qualify the location of a component as left-hand side or right-hand side. The side is determined when facing forward in the seat.

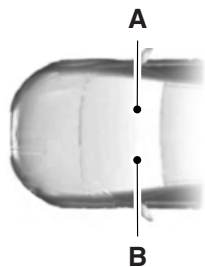

A. Right-hand side

B. Left-hand side

**Protecting the Environment**





















You must play your part in protecting the environment. Correct vehicle usage and the authorized disposal of waste, cleaning and lubrication materials are significant steps toward this aim.

## SYMBOL GLOSSARY

 **WARNING:** You risk death or serious injury to yourself and others if you do not follow the instruction highlighted by the warning symbol.

These are some of the symbols you may see on your vehicle.

Symbol	Description	Symbol	Description	Symbol	Description
	Safety alert		See Owner's Manual		Anti-lock braking system
	Avoid smoking, flames, or sparks		Battery		Battery acid
	Brake fluid – non petroleum base		Brake system		Cabin air filter
	Check fuel cap		Child Safety Door Lock and Unlock		Child seat lower anchor
	Child seat tether anchor		Cruise control		Do not open when hot
	Engine air filter		Engine coolant		Engine coolant temperature
	Engine oil		Explosive gas		Fan warning
	Fasten safety belt		Front airbag		Front fog lamps

Symbol	Description	Symbol	Description	Symbol	Description
	Fuel pump reset		Fuse compartment		Hazard warning flasher
	Heated rear window		Interior luggage compartment release		Jack
	Lighting control		Low tire pressure warning		Maintain correct fluid level
	Panic alarm		Parking aid system		Parking brake system
	Power steering fluid		Power windows front and rear		Power window lockout
	Service engine soon		Side airbag		Stability control
	Windshield defrost and demist		Windshield washer and wiper		

---

**DATA RECORDING****Service Data Recording**

Service data recorders in your vehicle are capable of collecting and storing diagnostic information about your vehicle. This potentially includes information about the performance or status of various systems and modules in the vehicle, such as engine, throttle, steering or brake systems. In order to properly diagnose and service your vehicle, Ford Motor Company, Ford of Canada, and service and repair facilities may access or share among them vehicle diagnostic information received through a direct connection to your vehicle when diagnosing or servicing your vehicle. Additionally, when your vehicle is in for service or repair, Ford Motor Company, Ford of Canada, and service and repair facilities may access or share among them data for vehicle improvement purposes. For U.S. only (if equipped), if you choose to use the SYNC® Vehicle Health Report, you consent that certain diagnostic information may also be accessed electronically by Ford Motor Company and Ford authorized service facilities, and that the diagnostic information may be used for any purpose. See the SYNC® chapter for more information.

**Event Data Recording**

**This vehicle is equipped with an event data recorder (EDR). The main purpose of an EDR is to record, in certain crash or near crash-like situations, such as an airbag deployment or hitting a road obstacle; this data will assist in understanding how a vehicle's systems performed. The EDR is designed to record data related to vehicle dynamics and safety systems for a short period of time, typically 30 seconds or less. The EDR in this vehicle is designed to record such data as:**

- **How various systems in your vehicle were operating;**
- **Whether or not the driver and passenger safety belts were buckled/fastened;**
- **How far (if at all) the driver was depressing the accelerator and/or the brake pedal;**
- **How fast the vehicle was travelling;**
- **Where the driver was positioning the steering wheel.**

**This data can help provide a better understanding of the circumstances in which crashes and injuries occur.**

**Note:** EDR data is recorded by your vehicle only if a non-trivial crash situation occurs; no data is recorded by the EDR under normal driving conditions and no personal data or information (e.g., name, gender, age, and crash location) is recorded (see limitations regarding 911 Assist and Traffic, Directions and Information privacy below). However, parties, such as law enforcement, could combine the EDR data with the type of personally identifying data routinely acquired during a crash investigation.

To read data recorded by an EDR, special equipment is required, and access to the vehicle or the EDR is needed. In addition to the vehicle manufacturer, other parties, such as law enforcement, that have such special equipment, can read the information if they have access to the vehicle or the EDR. Ford Motor Company and Ford of Canada do not access event data recorder information without obtaining consent, unless pursuant to court order or where required by law enforcement, other government authorities or other third parties acting with lawful authority. Other parties may seek to access the information independently of Ford Motor Company and Ford of Canada.

**Note:** Including to the extent that any law pertaining to Event Data Recorders applies to SYNC® or its features, please note the following: Once 911 Assist (if equipped) is enabled (set ON), 911 Assist may, through any paired and connected cell phone, disclose to emergency services that the vehicle has been in a crash involving the deployment of an airbag or, in certain vehicles, the activation of the fuel pump shut-off. Certain versions or updates to 911 Assist may also be capable of being used to electronically or verbally provide to 911 operators the vehicle location (such as latitude and longitude), and/or other details about the vehicle or crash or personal information about the occupants to assist 911 operators to provide the most appropriate emergency services. If you do not want to disclose this information, do not activate the 911 Assist feature. See your SYNC® chapter for more information.

Additionally, when you connect to Traffic, Directions and Information (if equipped, U.S. only), the service uses GPS technology and advanced vehicle sensors to collect the vehicle's current location, travel direction, and speed ("vehicle travel information"), only to help provide you with the directions, traffic reports, or business searches that you request. If you do not want Ford or its vendors to receive this information, do not activate the service. For more information, see Traffic, Directions and Information, Terms and Conditions. See your SYNC® chapter for more information.

**CALIFORNIA PROPOSITION 65**

**WARNING:** Some constituents of engine exhaust, certain vehicle components, certain fluids contained in vehicles and certain products of component wear contain or emit chemicals known to the State of California to cause cancer and birth defects or other reproductive harm.

**PERCHLORATE MATERIAL**

**Note:** Certain components in your vehicle, such as airbag modules, safety belt pretensioners, and remote control batteries, may contain perchlorate material. Special handling may apply for service or vehicle end of life disposal. See [www.dtsc.ca.gov/hazardouswaste/perchlorate](http://www.dtsc.ca.gov/hazardouswaste/perchlorate) for more information.

**FORD CREDIT (U.S. ONLY)**

Ford Credit offers a full range of financing and lease plans to help you acquire your vehicle. If you have financed or leased your vehicle through Ford Credit, thank you for your business.

For your convenience, we offer a number of ways to contact us, as well as help manage your account.

Phone: 1-800-727-7000

For more information regarding Ford Credit, as well as access to Account Manager, please go to [www.fordcredit.com](http://www.fordcredit.com).

**REPLACEMENT PARTS RECOMMENDATION**

Your vehicle has been built to the highest standards using quality parts. We recommend that you demand the use of genuine Ford and Motorcraft parts whenever your vehicle requires scheduled maintenance or repair. You can clearly identify genuine Ford and Motorcraft parts by looking for the Ford, FoMoCo or Motorcraft branding on the parts or their packaging.

**Scheduled Maintenance and Mechanical Repairs**

One of the best ways for you to make sure that your vehicle provides years of service is to have it maintained in line with our recommendations using parts that conform to the specifications detailed in this owner's manual. Genuine Ford and Motorcraft parts meet or exceed these specifications.



**Collision Repairs**

We hope that you never experience a collision, but accidents do happen. Genuine Ford replacement collision parts meet our stringent requirements for fit, finish, structural integrity, corrosion protection and dent resistance. During vehicle development, we validate that these parts deliver the intended level of protection as a whole system. A great way to know for sure you are getting this level of protection is to use genuine Ford replacement collision parts.

**Warranty on Replacement Parts**

Genuine Ford and Motorcraft replacement parts are the only replacement parts that benefit from a Ford Warranty. Damage caused to your vehicle as a result of the failure of non-Ford parts may not be covered by the Ford Warranty. For additional information, see the terms and conditions of the Ford Warranty.

**SPECIAL NOTICES****New Vehicle Limited Warranty**

For a detailed description of what is covered and what is not covered by your vehicle's New Vehicle Limited Warranty, see the warranty information that is provided to you along with your owner's manual.

**Special Instructions**

For your added safety, your vehicle is fitted with sophisticated electronic controls.



**WARNING:** Please read the *Supplementary Restraints System* chapter. Failure to follow the specific warnings and instructions could result in personal injury.



**WARNING:** Front seat mounted rear-facing child or infant seats should **NEVER** be placed in front of an active passenger airbag.

**Notice to owners of pickup trucks and utility type vehicles**

**WARNING:** Utility vehicles have a significantly higher rollover rate than other types of vehicles.

Before you drive your vehicle, please read this Owner's Manual carefully. Your vehicle is not a passenger car. As with other vehicles of this type, failure to operate your vehicle correctly may result in loss of vehicle control, vehicle rollover, personal injury or death.

**Using your vehicle with a snowplow****Do not use this vehicle for snowplowing.**

Your vehicle is not equipped with a snowplowing package.

**Using your vehicle as an ambulance****Do not use this vehicle as an ambulance.**

Your vehicle is not equipped with the Ford Ambulance Preparation Package.

**MOBILE COMMUNICATIONS EQUIPMENT**

Using mobile communications equipment is becoming increasingly important in the conduct of business and personal affairs. However, you must not compromise your own or others' safety when using such equipment. Mobile communications can enhance personal safety and security when appropriately used, particularly in emergency situations. Safety must be paramount when using mobile communications equipment to avoid negating these benefits.

Mobile communication equipment includes, but is not limited to, cellular phones, pagers, portable email devices, text messaging devices and portable two-way radios.



**WARNING:** Driving while distracted can result in loss of vehicle control, crash and injury. We strongly recommend that you use extreme caution when using any device that may take your focus off the road. Your primary responsibility is the safe operation of your vehicle. We recommend against the use of any handheld device while driving and encourage the use of voice-operated systems when possible. Make sure you are aware of all applicable local laws that may affect the use of electronic devices while driving.

**EXPORT UNIQUE (NON-UNITED STATES/CANADA) VEHICLE  
SPECIFIC INFORMATION**

For your particular global region, your vehicle may be equipped with features and options that are different from the features and options that are described in this owner's manual. A market unique supplement may be supplied that complements this book. By referring to the market unique supplement, if provided, you can properly identify those features, recommendations and specifications that are unique to your vehicle. This owner's manual is written primarily for the U.S. and Canadian Markets. Features or equipment listed as standard may be different on units built for Export. **See this owner's manual for all other required information and warnings.**

**GENERAL INFORMATION**

See the following sections for directions on how to properly use safety restraints for children.



**WARNING:** Always make sure your child is secured properly in a device that is appropriate for their height, age and weight. Child safety restraints must be bought separately from your vehicle. Failure to follow these instructions and guidelines may result in an increased risk of serious injury or death to your child.



**WARNING:** All children are shaped differently. The recommendations for safety restraints are based on probable child height, age and weight thresholds from NHTSA and other safety organizations, or are the minimum requirements of law. Ford recommends checking with a NHTSA Certified Child Passenger Safety Technician (CPST) and consulting your pediatrician to make sure your child seat is appropriate for your child, and is compatible with and properly installed in your vehicle. To locate a child seat fitting station and CPST, contact the NHTSA toll free at 1-888-327-4236 or on the internet at <http://www.nhtsa.dot.gov>. In Canada, check with your local St. John Ambulance office for referral to a CPST or for further information, contact your provincial ministry of transportation, or locate your local St. John Ambulance office by searching for St. John Ambulance on the internet, or Transport Canada at 1-800-333-0371 (<http://www.tc.gc.ca>). Failure to properly restrain children in safety seats made especially for their height, age, and weight may result in an increased risk of serious injury or death to your child.

<b>Recommendations for Safety Restraints for Children</b>		
	<b>Child size, height, weight, or age</b>	<b>Recommended restraint type</b>
Infants or toddlers	Children weighing 40 lb (18 kg) or less (generally age four or younger).	Use a child safety seat (sometimes called an infant carrier, convertible seat, or toddler seat).
Small children	Children who have outgrown or no longer properly fit in a child safety seat (generally children who are less than 4 ft. 9 in. (1.45 m) tall, are greater than age four (4) and less than age twelve (12), and between 40 lb (18 kg) and 80 lb (36 kg) and upward to 100 lb (45 kg) if recommended by your child restraint manufacturer).	Use a belt-positioning booster seat.
Larger children	Children who have outgrown or no longer properly fit in a belt-positioning booster seat (generally children who are at least 4 ft. 9 in. (1.45 m) tall or greater than 80 lb (36 kg) or 100 lb (45 kg) if recommended by child restraint manufacturer).	Use a vehicle safety belt having the lap belt snug and low across the hips, shoulder belt centered across the shoulder and chest, and seat back upright.

- You are required by law to properly use safety seats for infants and toddlers in the United States and Canada.
- Many states and provinces require that small children use approved booster seats until they reach age eight, a height of 4 feet 9 inches (1.45 meters) tall, or 80 pounds (36 kilograms). Check your local and state or provincial laws for specific requirements about the safety of children in your vehicle.

- When possible, always properly restrain children twelve (12) years of age and under in a rear seating position of your vehicle. Accident statistics suggest that children are safer when properly restrained in the rear seating positions than in a front seating position. See *Front Passenger Sensing System* in the *Supplementary Restraints System* chapter for more information.

### CHILD SEAT POSITIONING



**WARNING:** Airbags can kill or injure a child in a child seat.

Never place a rear-facing child seat in front of an active airbag. If you must use a forward-facing child seat in the front seat, move the vehicle seat upon which the child seat is installed all the way back. When possible, all children age 12 and under should be properly restrained in a rear seating position. If all children cannot be seated and restrained properly in a rear seating position, properly restrain the largest child in the front seat.



**WARNING:** Always carefully follow the instructions and warnings provided by the manufacturer of any child restraint to determine if the restraint device is appropriate for your child's size, height, weight, or age. Follow the child restraint manufacturer's instructions and warnings provided for installation and use in conjunction with the instructions and warnings provided by your vehicle manufacturer. A safety seat that is improperly installed or utilized, is inappropriate for your child's height, age or weight, or does not properly fit the child, may increase the risk of serious injury or death.





**WARNING:** Never let a passenger hold a child on his or her lap while your vehicle is moving. The passenger cannot protect the child from injury in a crash, which may result in serious injury or death.



**WARNING:** Never use pillows, books, or towels to boost a child. They can slide around and increase the likelihood of injury or death in a crash.

 **WARNING:** Always restrain an unoccupied child seat or booster seat. These objects may become projectiles in a crash or sudden stop, which may increase the risk of serious injury.

 **WARNING:** Never place, or allow a child to place, the shoulder belt under a child's arm or behind the back because it reduces the protection for the upper part of the body and may increase the risk of injury or death in a crash.

 **WARNING:** To avoid risk of injury, do not leave children or pets unattended in your vehicle.

#### Recommendations for attaching child safety restraints for children

Restraint Type	Combined weight of child and child restraint seat	Use any attachment method as indicated below by X.				
		LATCH (lower anchors and top tether anchor)	LATCH (lower anchors only)	Safety belt and top tether anchor	Safety belt and LATCH (lower anchors and top tether anchor)	Safety belt only
Rear-facing child seat	Up to 65 lb (29.5 kg)		X			X
Rear-facing child seat	Over 65 lb (29.5 kg)					X
Forward-facing child seat	Up to 65 lb (29.5 kg)	X		X	X	
Forward-facing child seat	Over 65 lb (29.5 kg)			X	X	

**Note:** The child seat must rest tightly against the vehicle seat upon which it is installed. It may be necessary to lift or remove the head restraint. See the *Seats* chapter for information on head restraints.

**BOOSTER SEATS**



**WARNING:** Never place, or allow a child to place, the shoulder belt under a child’s arm or behind the back because it reduces the protection for the upper part of the body and may increase the risk of injury or death in a crash.

**Note:** Some booster seat safety belt guides may not accommodate the shoulder portion of the inflatable safety belt.

Use a belt-positioning booster seat for children who have outgrown or no longer properly fit in a child safety seat (generally children who are less than 4 feet 9 inches (1.45 meters) tall, are greater than age four (4) and less than age twelve (12), and between 40 pounds (18 kilograms) and 80 pounds (36 kilograms) and upward to 100 pounds (45 kilograms) if recommended by your child restraint manufacturer). Many state and provincial laws require that children use approved booster seats until they reach age eight, a height of 4 feet 9 inches (1.45 meters) tall, or 80 pounds (36 kilograms).

Booster seats should be used until you can answer YES to ALL of these questions when seated without a booster seat.

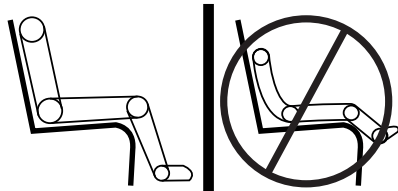

- Can the child sit all the way back against their vehicle seat with knees bent comfortably at the edge of the seat cushion?
- Can the child sit without slouching?

- Does the lap belt rest low across the hips?
- Is the shoulder belt centered on the shoulder and chest?
- Can the child stay seated like this for the whole trip?

Always use booster seats in conjunction with your vehicle lap and shoulder belt.



**Types of Booster Seats**

- Backless booster seats

If your backless booster seat has a removable shield, remove the shield. If a vehicle seating position has a low seat back or no head restraint, a backless booster seat may place your child's head (as measured at the tops of the ears) above the top of the seat. In this case, move the backless booster to another seating position with a higher seat back or head restraint and lap and shoulder belts, or consider using a high back booster seat.



- High back booster seats

If, with a backless booster seat, you cannot find a seating position that adequately supports your child's head, a high back booster seat would be a better choice.

Children and booster seats vary in size and shape. Choose a booster that keeps the lap belt low and snug across the hips, never up across the stomach, and lets you adjust the shoulder belt to cross the chest and rest snugly near the center of the shoulder. The following drawings compare the ideal fit (center) to a shoulder belt uncomfortably close to the neck and a shoulder belt that could slip off the shoulder. The drawings also show how the lap belt should be low and snug across the child's hips.

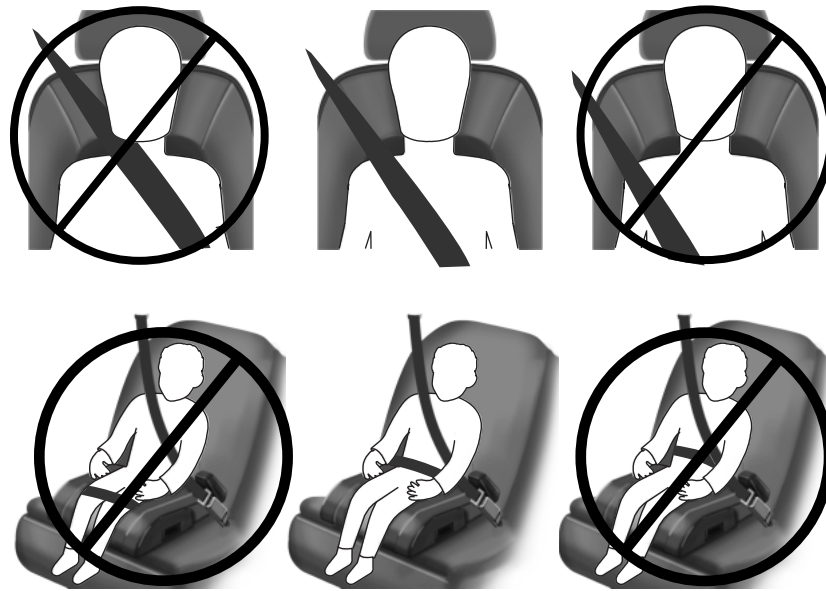

If the booster seat slides on the vehicle seat upon which it is being used, placing a rubberized mesh sold as shelf or carpet liner under the booster seat may improve this condition. Do not introduce any item thicker than this under the booster seat. Check with the booster seat manufacturer's instructions.

---

**INSTALLING CHILD SEATS****Child Seats**

Use a child safety seat (sometimes called an infant carrier, convertible seat, or toddler seat) for infants, toddlers or children weighing 40 pounds (18 kilograms) or less (generally age four or younger).

**Using Lap and Shoulder Belts**

**WARNING:** Airbags can kill or injure a child in a child seat.

Never place a rear-facing child seat in front of an active airbag.

If you must use a forward-facing child seat in the front seat, move the seat upon which the child seat is installed all the way back.



**WARNING:** Airbags can kill or injure a child in a child seat.

Children 12 and under should be properly restrained in the rear seat whenever possible.



**WARNING:** Depending on where you secure a child restraint, and depending on the child restraint design, you may block access to certain safety belt buckle assemblies or LATCH lower anchors, rendering those features potentially unusable. To avoid risk of injury, occupants should only use seating positions where they are able to be properly restrained.

When installing a child safety seat with combination lap and shoulder belts:

- Use the correct safety belt buckle for that seating position.
- Insert the belt tongue into the proper buckle until you hear a snap and feel it latch. Make sure the tongue is securely fastened in the buckle.

- Keep the buckle release button pointing up and away from the safety seat, with the tongue between the child seat and the release button, to prevent accidental unbuckling.
- Place the vehicle seat upon which the child seat will be installed in the upright position.
- For second-row seating positions, the recliner may be adjusted slightly to improve child seat fit. If needed, the head restraints may be removed.
- For third-row seating positions, the head restraints may be stowed to improve child seat fit. See the *Seats* chapter for information on folding the head restraints.
- Put the safety belt in the automatic locking mode. See Step 5 below. This vehicle does not require the use of a locking clip.

Perform the following steps when installing the child seat with combination lap and shoulder belts:

**Note:** Although the child seat illustrated is a forward-facing child seat, the steps are the same for installing a rear-facing child seat.

**Note:** The lock-off device on some child restraints may not accommodate the shoulder portion of the inflatable safety belt. Follow all instructions provided by the manufacturer of the child restraint regarding the necessary and proper use of the lock-off device. In some instances these devices have been provided only for use in vehicles with safety belt systems that would otherwise require a locking clip.



1. Position the child safety seat in a seat with a combination lap and shoulder belt.

2. After positioning the child safety seat in the proper seating position, do the following:

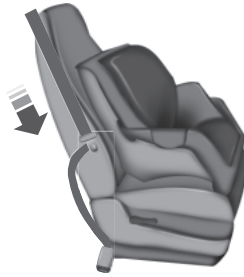

- Standard safety belt: pull down on the shoulder belt and then grasp the shoulder belt and lap belt together behind the belt tongue.



- Inflatable safety belt: grasp the shoulder belt and lap belt together behind the belt tongue.

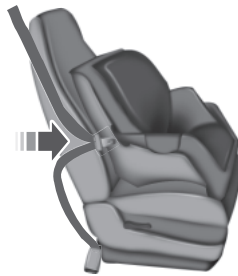

3. While holding the shoulder and lap belt portions together, route the tongue through the child seat according to the child seat manufacturer's instructions. Be sure the belt webbing is not twisted.

4. Insert the belt tongue into the proper buckle (the buckle closest to the direction the tongue is coming from) for that seating position until you hear a snap and feel the latch engage. Make sure the tongue is latched securely by pulling on it.

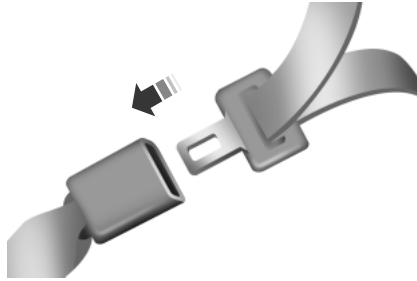

- Standard safety belt buckle

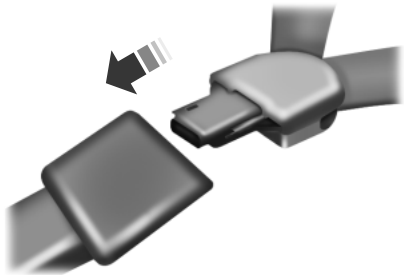

- Inflatable safety belt buckle

5. To put the retractor in the automatic locking mode, do the following;



- Standard safety belt: grasp the shoulder portion of the belt and pull downward until all of the belt is pulled out.

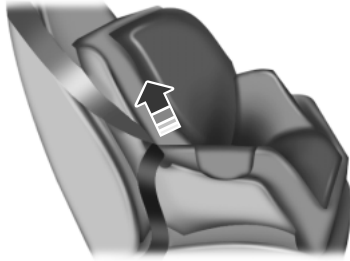

- Inflatable safety belt: grasp the lap portion of the inflatable safety belt and pull upward until all of the belt is pulled out.

**Note:** Unlike the standard safety belt, the inflatable safety belt's unique lap portion locks the child seat for installation. The ability for the shoulder portion of the belt to move freely is normal, even after the lap belt has been put into the automatic locking mode.

6. Allow the belt to retract to remove slack. The belt will click as it retracts to indicate it is in the automatic locking mode.

7. Try to pull the belt out of the retractor to make sure the retractor is in the automatic locking mode (you should not be able to pull more belt out). If the retractor is not locked, repeat Steps 5 and 6.

8. Remove remaining slack from the belt. Force the seat down with extra weight, for example, by pressing down or kneeling on the child restraint while pulling up on the shoulder belt (for standard safety belt) or pulling down on the lap belt (for inflatable safety belt) in order to force slack from the belt. This is necessary to remove the remaining slack that will exist once the extra weight of the child is added to the child restraint. It also helps to achieve the proper snugness of the child seat to your vehicle. Sometimes, a slight lean toward the buckle will provide extra help to remove remaining slack from the belt.

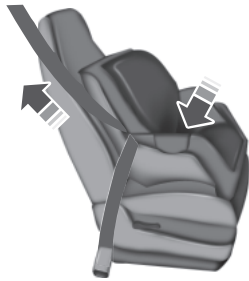

- Standard safety belt

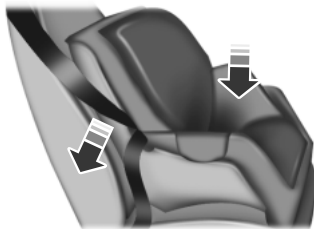

- Inflatable safety belt

9. Attach the tether strap (if the child seat is equipped). See *Using Tether Straps* later in this chapter.

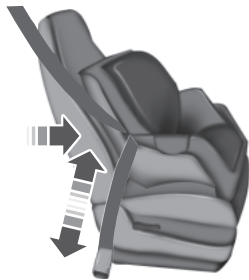

10. Before placing the child in the seat, forcibly move the seat forward and back to make sure the seat is securely held in place. To check this, grab the seat at the belt path and attempt to move it side to side and forward and back. There should be no more than 1 inch (2.5 centimeters) of movement for proper installation.

Ford recommends checking with a NHTSA Certified Child Passenger Safety Technician to make certain the child restraint is properly installed. In Canada, check with your local St. John Ambulance office for referral to a Child Passenger Safety Technician.



### Using Lower Anchors and Tethers for Children (LATCH)



**WARNING:** Never attach two child safety seats to the same anchor. In a crash, one anchor may not be strong enough to hold two child safety seat attachments and may break, causing serious injury or death.



**WARNING:** Depending on where you secure a child restraint, and depending on the child restraint design, you may block access to certain safety belt buckle assemblies or LATCH lower anchors, rendering those features potentially unusable. To avoid risk of injury, occupants should only use seating positions where they are able to be properly restrained.

The LATCH system is composed of three vehicle anchor points: two lower anchors located where seat back and seat cushion meet (called the seat bight) and one top tether anchor located behind that seating position.

LATCH compatible child safety seats have two rigid or webbing mounted attachments that connect to the two lower anchors at the LATCH equipped seating positions in your vehicle. This type of attachment method eliminates the need to use safety belts to attach the child seat, however the safety belt can still be used to attach the child seat. For forward-facing child seats, the top tether strap must also be attached to the proper top tether anchor, if a top tether strap has been provided with your child seat.

Your vehicle has LATCH lower anchors for child seat installation at the seating positions marked with the child seat symbol.

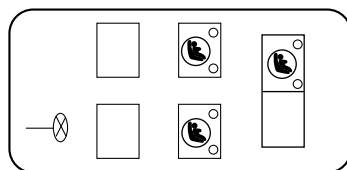

- Second-row bucket seats and third-row passenger side

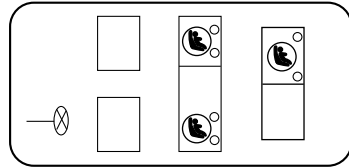

- Second-row bench seats and third-row passenger side



The LATCH anchors are located at the rear section of the rear seat between the cushion and seat back below the symbols as shown. Follow the child seat manufacturer's instructions to properly install a child seat with LATCH attachments.

Follow the instructions on attaching child safety seats with tether straps. See *Using Tether Straps* later in this chapter.

Attach LATCH lower attachments of the child seat only to the anchors shown.

**Use of inboard lower anchors from the outboard seating positions (center seating use)**

**!** **WARNING:** The standardized spacing for LATCH lower anchors is 11 inches (28 centimeters) center to center. Do not use LATCH lower anchors for the center seating position unless the child seat manufacturer's instructions permit and specify using anchors spaced at least as far apart as those in this vehicle.

The lower anchors at the center of the second row bench seat are spaced 20.5 inches (52 centimeters) apart. The standardized spacing for LATCH lower anchors is 11 inches (28 centimeters) center to center. A child seat with rigid LATCH attachments cannot be installed at the center seating position. LATCH compatible child seats (with attachments on belt webbing) can only be used at this seating position provided that the child seat manufacturer's instructions permit use with the anchor spacing stated. Do not attach a child seat to any lower anchor if an adjacent child seat is attached to that anchor.

Each time you use the safety seat, check that the seat is properly attached to the lower anchors and tether anchor, if applicable. Tug the child seat from side to side and forward and back where it is secured to your vehicle. The seat should move less than one inch when you do this for a proper installation.

If the safety seat is not anchored properly, the risk of a child being injured in a crash greatly increases.

### Combining Safety Belt and LATCH Lower Anchors for Attaching Child Safety Seats

When used in combination, either the safety belt or the LATCH lower anchors may be attached first, provided a proper installation is achieved. Attach the tether strap afterward, if included with the child seat.

### USING TETHER STRAPS



Many forward-facing child safety seats include a tether strap which extends from the back of the child safety seat and hooks to an anchoring point called the top tether anchor. Tether straps are available as an accessory for many older safety seats.

Contact the manufacturer of your child seat for information about ordering a tether strap, or to obtain a longer tether strap if the tether strap on your safety seat does not reach the appropriate top tether anchor in your vehicle.

Once the child safety seat has been installed using either the safety belt, the lower anchors of the LATCH system, or both, you can attach the top tether strap.

The tether strap anchors in your vehicle are in the following positions (shown from top view):

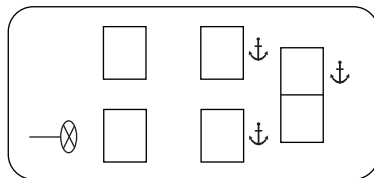

- Second-row bucket seats and third-row passenger side

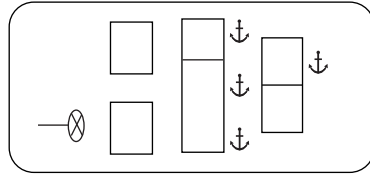

- Second-row bench seats and third-row passenger side

Perform the following steps to install a child safety seat with tether anchors:

**Note:** If you install a child seat with rigid LATCH attachments, do not tighten the tether strap enough to lift the child seat off your vehicle seat cushion when the child is seated in it. Keep the tether strap just snug without lifting the front of the child seat. Keeping the child seat just touching your vehicle seat gives the best protection in a severe crash.



1. Route the tether strap.

- Second-row outboard seat positions: Route the child safety seat tether strap over the seat back, under the head restraint and between the head restraint posts. If needed, remove the head restraint to improve the fit of the child safety seat or tether strap.
- Second-row center seat positions: Route the child safety seat tether strap over the top of the head restraint. If needed, remove the head restraint to improve the fit of the child safety seat or tether strap. See *Rear Seats* in this chapter for head restraint information.
- Third-row seat position: Route the child safety seat tether strap over the seat back, under the head restraint and between the head restraint posts. If needed, fold the head restraint down to improve the fit of the child safety seat or tether strap. See *Rear seats* in the *Seats* chapter for head restraint information.

2. Locate the correct anchor for the selected rear seating position.

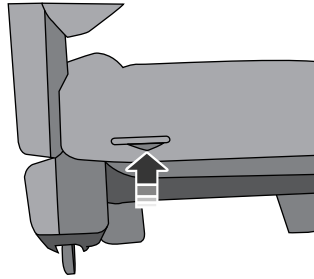

- Second-row bucket (40/40)

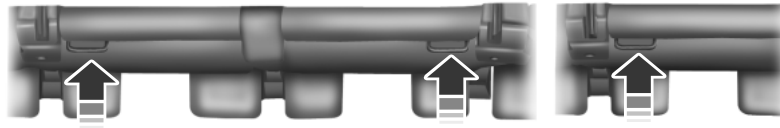

- Second-row bench (60/40)

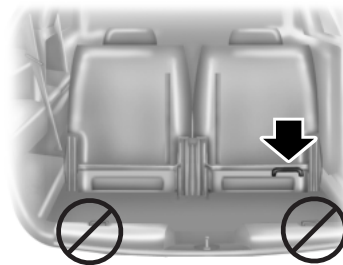

- Third-row seat

**Note:** The cargo tie-downs at the rear edge of the floor are not tether anchors.

3. Clip the tether hook to the anchor as shown. The tether hook may be twisted 1/2 turn to improve installation.

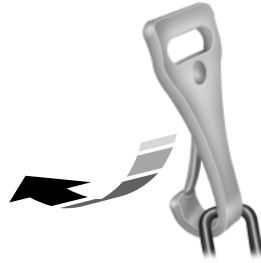

If the tether strap is clipped incorrectly, the child safety seat may not be retained properly in the event of a crash.

4. Tighten the child safety seat tether strap according to the manufacturer's instructions.

If the safety seat is not anchored properly, the risk of a child being injured in a crash greatly increases.

If your child restraint system is equipped with a tether strap, and the child restraint manufacturer recommends its use, Ford also recommends its use.

**CHILD SAFETY LOCKS**

When these locks are set, the rear doors cannot be opened from the inside.



The childproof locks are located on the rear edge of each rear door and must be set separately for each door.

- Insert the key and turn to the lock position (key horizontal) to engage the childproof locks.
- Insert the key and turn to the unlock position (key vertical) to disengage the childproof locks.

### PRINCIPLES OF OPERATION



**WARNING:** Always drive and ride with your seat back upright and the lap belt snug and low across the hips.



**WARNING:** To reduce the risk of injury, make sure children sit where they can be properly restrained.



**WARNING:** Never let a passenger hold a child on his or her lap while the vehicle is moving. The passenger cannot protect the child from injury in a collision.



**WARNING:** All occupants of the vehicle, including the driver, should always properly wear their safety belts, even when an airbag supplemental restraint system is provided. Failure to properly wear your safety belt could seriously increase the risk of injury or death.



**WARNING:** It is extremely dangerous to ride in a cargo area, inside or outside of a vehicle. In a collision, people riding in these areas are more likely to be seriously injured or killed. Do not allow people to ride in any area of your vehicle that is not equipped with seats and safety belts. Be sure everyone in your vehicle is in a seat and using a safety belt properly.



**WARNING:** In a rollover crash, an unbelted person is significantly more likely to die than a person wearing a safety belt.



**WARNING:** Each seating position in your vehicle has a specific safety belt assembly which is made up of one buckle and one tongue that are designed to be used as a pair. 1) Use the shoulder belt on the outside shoulder only. Never wear the shoulder belt under the arm. 2) Never swing the safety belt around your neck over the inside shoulder. 3) Never use a single belt for more than one person.





**WARNING:** When possible, all children 12 years old and under should be properly restrained in a rear seating position. Failure to follow this could seriously increase the risk of injury or death.



**WARNING:** Safety belts and seats can become hot in a vehicle that has been closed up in sunny weather; they could burn a small child. Check seat covers and buckles before you place a child anywhere near them.



**WARNING:** Front and rear seat occupants, including pregnant women, should wear safety belts for optimum protection in an accident.

All seating positions in this vehicle have lap and shoulder safety belts. All occupants of the vehicle should always properly wear their safety belts, even when an airbag supplemental restraint system is provided.

The safety belt system consists of:

- Lap and shoulder safety belts.
- Shoulder safety belt with automatic locking mode (except driver and rear inflatable safety belt).
- Height adjuster at the front outboard seating positions.
- Safety belt pretensioner at the front outboard seating positions.
- Belt tension sensor at the front outboard passenger seating position.



- Safety belt warning light and chime. See *Safety Belt Warning Light and Indicator Chime* later in this chapter.



- Crash sensors and monitoring system with readiness indicator. See *Crash Sensors and Airbag Indicator* in the *Supplemental Restraint System* chapter.

The safety belt pretensioners and rear inflatable safety belts are designed to activate in frontal, near-frontal and side crashes, and in rollovers. The safety belt pretensioners at the front seating positions are designed to tighten the safety belts firmly against the occupant's body when activated. This helps increase the effectiveness of the safety belts. In frontal crashes, the safety belt pretensioners can be activated alone or, if the crash is of sufficient severity, together with the front airbags.

### FASTENING THE SAFETY BELTS

The front outboard and rear safety restraints in your vehicle are combination lap and shoulder belts.

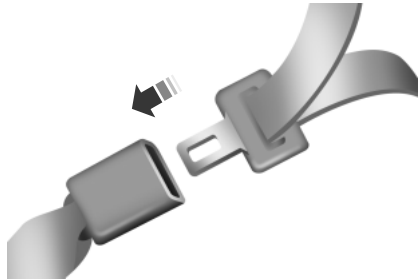

1. Insert the belt tongue into the proper buckle (the buckle closest to the direction the tongue is coming from) until you hear a snap and feel it latch. Make sure the tongue is securely fastened in the buckle.

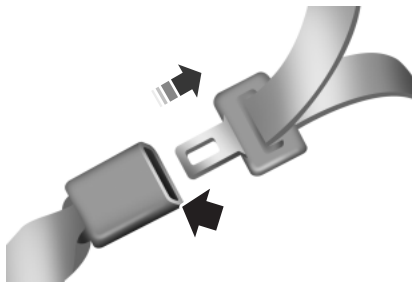

2. To unfasten, press the release button and remove the tongue from the buckle.

### Using Safety Belts During Pregnancy



**WARNING:** Always ride and drive with your seatback upright and the safety belt properly fastened. The lap portion of the safety belt should fit snug and be positioned low across the hips. The shoulder portion of the safety belt should be positioned across the chest. Pregnant women should also follow this practice. See the following figure.

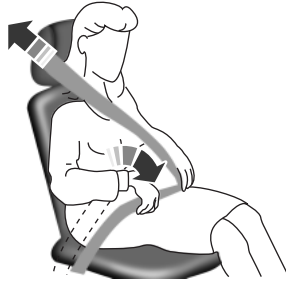

Pregnant women should always wear their safety belts. The lap belt portion of a combination lap and shoulder belt should be positioned low across the hips below the belly and worn as tight as comfort will allow. The shoulder belt should be positioned to cross the middle of the shoulder and the center of the chest.

### Safety Belt Locking Modes



**WARNING:** After any vehicle crash, the safety belt system at all passenger seating positions must be checked by an authorized dealer to verify that the automatic locking retractor feature for child seats is still functioning properly. In addition, all safety belts should be checked for proper function.



**WARNING:** The belt and retractor assembly must be replaced if the safety belt assembly automatic locking retractor feature or any other safety belt function is not operating properly when checked by an authorized dealer. Failure to replace the belt and retractor assembly could increase the risk of injury in crashes.

All safety restraints in the vehicle are combination lap and shoulder belts. The driver safety belt has the first locking mode. The front outboard passenger and rear seat safety belts have both types of locking modes described as follows:

#### **Vehicle Sensitive Mode**

This is the normal retractor mode, which allows free shoulder or lap belt length adjustment to your movements and locking in response to vehicle movement. For example, if the driver brakes suddenly or turns a corner sharply, or the vehicle receives an impact of about 5 mph (8 km/h) or more, the combination safety belts will lock to help reduce forward movement of the driver and passengers.

In addition, the retractor(s) is designed to lock if the webbing is pulled out too quickly. If this occurs, let the belt retract slightly and pull webbing out again in a slow and controlled manner.

**Automatic Locking Mode**

In this mode, the shoulder belt or lap belt is automatically pre-locked. The belt will still retract to remove any slack in the shoulder or lap belt. The automatic locking mode is not available on the driver safety belt.

**When to Use the Automatic Locking Mode**

This mode should be used any time a child safety seat, except a booster, is installed in passenger front or rear seating positions. Children 12 years old and under should be properly restrained in a rear seating position whenever possible.

**How to use the automatic locking mode**

**Non-inflatable safety belts**

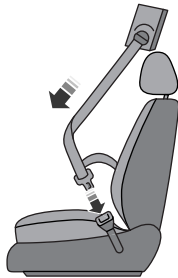

1. Buckle the combination lap and shoulder belt.
2. Grasp the shoulder portion of the belt and pull downward until the entire belt is pulled out.
3. Allow the belt to retract. As the belt retracts, you will hear a clicking sound. This indicates the safety belt is now in the automatic locking mode.

**Rear outboard inflatable safety belts (second row only—if equipped)**



1. Buckle the combination lap and shoulder belt.
2. Grasp the lap portion of the belt and pull upward until the entire belt is pulled out.
3. Allow the belt to retract. As the belt retracts, you will hear a clicking sound. This indicates the safety belt is now in the automatic locking mode.

**How to Disengage the Automatic Locking Mode**

Unbuckle the combination lap and shoulder belt and allow it to retract completely to disengage the automatic locking mode and activate the vehicle sensitive (emergency) locking mode.

**Safety Belt Extension Assembly**

**WARNING:** Do not use extensions to change the fit of the shoulder belt across the torso.



**WARNING:** Do not use extensions with an inflatable safety belt.

Safety belt extensions are vehicle-specific. See an authorized dealer to make sure you obtain the proper safety belt extension for your vehicle. Use only extensions manufactured by the same supplier as the safety belt. A safety belt extension is not available for the inflatable safety belt. Also, use the safety belt extension only if the safety belt is too short for you when fully extended.

**SAFETY BELT HEIGHT ADJUSTMENT**

**WARNING:** Position the safety belt height adjusters so that the belt rests across the middle of your shoulder. Failure to adjust the safety belt properly could reduce the effectiveness of the seat belt and increase the risk of injury in a collision.

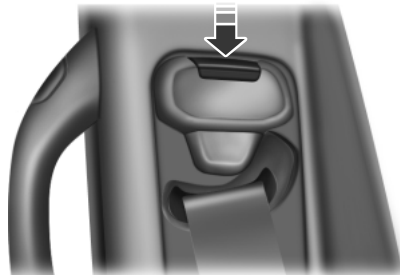

1. Adjust the height of the shoulder belt so the belt rests across the middle of your shoulder.
2. Slide the adjuster up to raise the belt and push the button and slide it down to lower the belt.

**SAFETY BELT WARNING LIGHT AND INDICATOR CHIME**



This lamp illuminates and an audible warning will sound if the driver's safety belt has not been fastened when the vehicle's ignition is turned on.

**Conditions of Operation**

If...	Then...
The driver safety belt is not buckled before the ignition switch is turned to the on position...	The safety belt warning light illuminates 1-2 minutes and the warning chime sounds 4-8 seconds.
The driver safety belt is buckled while the indicator light is illuminated and the warning chime is sounding...	The safety belt warning light and warning chime turn off.
The driver safety belt is buckled before the ignition switch is turned to the on position...	The safety belt warning light and indicator chime remain off.

**SAFETY BELT-MINDER™**

This feature supplements the safety belt warning function by providing additional reminders by intermittently sounding a chime and illuminating the safety belt warning light when the driver or front passenger seat is occupied and the safety belt is unbuckled.

The system uses information from the front passenger sensing system to determine if a front seat passenger is present and therefore potentially in need of a warning. To avoid activating the Belt-Minder feature for objects placed in the front passenger seat, warnings will only be given to front seat occupants as determined by the front passenger sensing system.

If the Belt-Minder warnings have expired (warnings for about five minutes) for one occupant (driver or front passenger), the other occupant can still activate the Belt-Minder feature.

If...	Then...
The driver and front passenger safety belts are buckled before the ignition switch is turned to the on position or less than 1-2 minutes have elapsed since the ignition switch has been turned to on...	The Belt-Minder feature will not activate.
The driver or front passenger safety belt is not buckled when the vehicle has reached at least 6 mph (9.7 km/h) and 1-2 minutes have elapsed since the ignition switch has been turned to on...	The Belt-Minder feature is activated - the safety belt warning light illuminates and the warning chime sounds for six seconds every 25 seconds, repeating for about five minutes or until the safety belts are buckled.
The driver or front passenger safety belt becomes unbuckled for about one minute while the vehicle is traveling at least 6 mph (9.7 km/h) and more than 1-2 minutes have elapsed since the ignition switch has been turned to on...	The Belt-Minder feature is activated - the safety belt warning light illuminates and the warning chime sounds for six seconds every 25 seconds, repeating for about five minutes or until the safety belts are buckled.

### ***Deactivating and Activating the Belt-Minder Feature***



**WARNING:** While the system allows you to deactivate it, this system is designed to improve your chances of being safely belted and surviving an accident. We recommend you leave the system activated for yourself and others who may use the vehicle. To reduce the risk of injury, do not deactivate or activate the system while driving the vehicle.

**Note:** The driver and front passenger warning are deactivated and activated independently. When deactivating or activating one seating position, do not buckle the other position as this will terminate the process.

*Read Steps 1 - 4 thoroughly before proceeding with the programming procedure.*

Before following the procedure, make sure that:

- The parking brake is set.
  - The transmission is in park **(P)**.
  - The ignition is off.
  - The driver and front passenger safety belts are unbuckled.
1. Turn the ignition on. Do not start the engine.
  2. Wait until the safety belt warning light turns off (about one minute).
  3. Wait 10 seconds after the safety belt warning light turns off.
    - Step 4 must be completed within 20 seconds after the completion of Step 3.
  4. For the seating position being disabled, buckle then unbuckle the safety belt three times at a moderate speed, ending in the unbuckled state.
    - After Step 4, the safety belt warning light will be turned on for three seconds.
  5. Within about seven seconds of the light turning off, buckle then unbuckle the safety belt.
    - This will disable the feature for that seating position if it is currently enabled.
    - This will enable the feature for that seating position if it is currently disabled.

### **REAR INFLATABLE SAFETY BELT (IF EQUIPPED)**



**WARNING:** Do not attempt to service, repair, or modify the rear inflatable safety belt as you could be seriously injured or killed.

**Note:** The rear inflatable safety belts are compatible with most infant and child safety car seats and belt positioning booster seats when properly installed. This is because they are designed to fill with a cool gas at a lower pressure and at a slower rate than traditional airbags. After inflation, the shoulder portion of the safety belt remains cool to the touch.

The rear inflatable safety belts are located in the shoulder portion of the safety belts of the second-row outboard seating positions.



The rear inflatable safety belt consists of the following:

- An inflatable bag located in the shoulder safety belt webbing.
- Lap safety belt webbing with automatic locking mode.
-  Crash sensors and monitoring system with readiness indicator.

See *Crash Sensors and Airbag Indicator* in the *Supplemental Restraint System* chapter.

### How Does the Rear Inflatable Safety Belt System Work?



**WARNING:** If the rear inflatable safety belt has deployed, it will not function again. The rear inflatable safety belt system must be replaced by an authorized dealer.

- The rear inflatable safety belts will function like standard restraints in everyday usage.

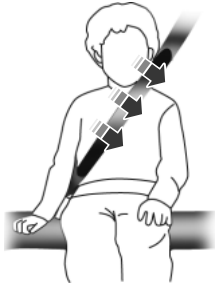

- During a crash of sufficient force, the inflatable belt will inflate from inside the webbing.



- The fully inflated belt's increased diameter more effectively holds the occupant in the appropriate seating position, and spreads crash forces over more area of the body than regular safety belts. This helps reduce pressure on the chest and helps control head and neck motion for passengers.

---

### **CHILD RESTRAINT AND SAFETY BELT MAINTENANCE**

Inspect the vehicle safety belts and child safety seat systems periodically to make sure they work properly and are not damaged. Inspect the vehicle and child seat safety belts to make sure there are no nicks, tears or cuts. Replace if necessary. All vehicle safety belt assemblies, including retractors, buckles, front safety belt buckle assemblies, buckle support assemblies (slide bar-if equipped), shoulder belt height adjusters (if equipped), shoulder belt guide on seatback (if equipped), rear inflatable safety belts (if equipped), child safety seat LATCH and tether anchors, and attaching hardware, should be inspected after a crash. See the child restraint manufacturer's instructions for additional inspection and maintenance information specific to the child restraint.

Ford Motor Company recommends that all safety belt assemblies in use in vehicles involved in a crash be replaced. However, if the crash was minor and an authorized dealer finds that the belts do not show damage and continue to operate properly, they do not need to be replaced. Safety belt assemblies not in use during a crash should also be inspected and replaced if either damage or improper operation is noted.

For proper care of soiled safety belts, see *Interior* in the *Cleaning* chapter.

**PERSONAL SAFETY SYSTEM™**

The Personal Safety System provides an improved overall level of frontal crash protection to front seat occupants and is designed to help further reduce the risk of airbag-related injuries. The system is able to analyze different occupant conditions and crash severity before activating the appropriate safety devices to help better protect a range of occupants in a variety of frontal crash situations.

Your vehicle's Personal Safety System consists of:

- Driver and passenger dual-stage airbag supplemental restraints.
- Front outboard safety belts with pretensioners, energy management retractors (first row only), and safety belt usage sensors.
- Driver's seat position sensor.
- Front passenger sensing system.
- Passenger airbag off and on indicator lamp.
- Front crash severity sensors.
- Restraints control module with impact and safing sensors.
- Restraint system warning light and backup tone.
- The electrical wiring for the airbags, crash sensor(s), safety belt pretensioners, front safety belt usage sensors, driver seat position sensor, front passenger sensing system, and indicator lights.

**How Does the Personal Safety System Work?**

The Personal Safety System can adapt the deployment strategy of your vehicle's safety devices according to crash severity and occupant conditions. A collection of crash and occupant sensors provides information to the restraints control module. During a crash, the restraints control module may activate the safety belt pretensioners and/or either one or both stages of the dual-stage airbag supplemental restraints based on crash severity and occupant conditions.

**PRINCIPLES OF OPERATION**

**WARNING:** Airbags do not inflate slowly or gently, and the risk of injury from a deploying airbag is the greatest close to the trim covering the airbag module.



**WARNING:** All occupants of your vehicle, including the driver, should always properly wear their safety belts, even when an airbag supplemental restraint system is provided. Failure to properly wear your safety belt could seriously increase the risk of injury or death.



**WARNING:** Airbags can kill or injure a child in a child seat. Always transport children 12 years old and under in the back seat and always properly use appropriate child restraints.



**WARNING:** Never place your arm over the airbag module, as a deploying airbag can result in serious arm fractures or other injuries.



**WARNING:** Airbags can kill or injure a child in a child seat. Never place a rear-facing child seat in front of an active airbag. If you must use a forward-facing child seat in the front seat, move the seat upon which the child seat is installed all the way back.



**WARNING:** Do not attempt to service, repair, or modify the airbag supplemental restraint systems or its fuses as you could be seriously injured or killed. Contact your authorized dealer as soon as possible.



**WARNING:** Several airbag system components get hot after inflation. Do not touch them after inflation as this may result in serious injury.



**WARNING:** If the airbag has deployed, the airbag will not function again and must be replaced immediately. If the airbag is not replaced, the unrepaired area will increase the risk of injury in a crash.

The airbags are a supplemental restraint system and are designed to work with the safety belts to help protect the driver and right front passenger from certain upper body injuries. Airbags do not inflate slowly; there is a risk of injury from a deploying airbag.

**Note:** You will hear a loud bang and see a cloud of harmless powdery residue if an airbag deploys. This is normal.

The airbags inflate and deflate rapidly upon activation. After airbag deployment, it is normal to notice a smoke-like, powdery residue or smell the burnt propellant. This may consist of cornstarch, talcum powder (to lubricate the bag) or sodium compounds (for example, baking soda) that result from the combustion process that inflates the airbag. Small amounts of sodium hydroxide may be present which may irritate the skin and eyes, but none of the residue is toxic.

While the system is designed to help reduce serious injuries, contact with a deploying airbag may also cause abrasions or swelling. Temporary hearing loss is also a possibility as a result of the noise associated with a deploying airbag. Because airbags must inflate rapidly and with considerable force, there is the risk of death or serious injuries, such as fractures, facial and eye injuries or internal injuries, particularly to occupants who are not properly restrained or are otherwise out of position at the time of airbag deployment. Thus, it is extremely important that occupants be properly restrained as far away from the airbag module as possible while maintaining vehicle control.

Routine maintenance of the airbags is not required.

### **SOS POST-CRASH ALERT SYSTEM™**

The system flashes the turn signal lamps and sounds the horn (intermittently) in the event of a serious impact that deploys an airbag equipped on your vehicle, such as front, side, side curtain or Safety Canopy.

The horn and lamps will turn off when:

- You press the hazard control button.
- You press the panic button (if equipped) on the remote entry transmitter.
- Your vehicle runs out of power.

**DRIVER AND PASSENGER AIRBAGS**

 **WARNING:** Never place your arm or any objects over an airbag module. Placing your arm over a deploying airbag can result in serious arm fractures or other injuries. Objects placed on or over the airbag inflation area may cause those objects to be propelled by the airbag into your face and torso causing serious injury.

 **WARNING:** Airbags can kill or injure a child in a child seat. Never place a rear-facing child seat in front of an active airbag. If you must use a forward-facing child seat in the front seat, move the seat upon which the child seat is installed all the way back.

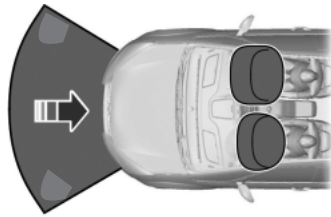

The driver and front passenger airbags will deploy during significant frontal and near-frontal crashes.

The driver and passenger front airbag system consists of:

- Driver and passenger airbag modules.
-  Crash sensors and monitoring system with readiness indicator. See *Crash Sensors and Airbag Indicator* later in this chapter.
- Front passenger sensing system.

## 54 Supplementary Restraints System

### Proper Driver and Front Passenger Seating Adjustment

 **WARNING:** The National Highway Traffic Safety Administration recommends a minimum distance of at least 10 inches (25 centimeters) between an occupant's chest and the driver airbag module. Failure to follow this could seriously increase the risk of injury or death.

To properly position yourself away from the airbag:

- Move your seat to the rear as far as you can while still reaching the pedals comfortably.
- Recline the seat slightly (one or two degrees) from the upright position.

After all occupants have adjusted their seats and put on safety belts, it is very important that they continue to sit properly. Properly seated occupants sit upright, lean against the seat back, and center themselves on the seat cushion, with their feet comfortably extended on the floor. Sitting improperly can increase the chance of injury in a crash event. For example, if an occupant slouches, lies down, turns sideways, sits forward, leans forward or sideways, or puts one or both feet up, the chance of injury during a crash is greatly increased.

### Children and Airbags

 **WARNING:** Airbags can kill or injure a child in a child seat. Never place a rear-facing child seat in front of an active airbag. If you must use a forward-facing child seat in the front seat, move the seat upon which the child seat is installed all the way back.



Children must always be properly restrained. Accident statistics suggest that children are safer when properly restrained in the rear seating positions than in the front seating position. Failure to follow these instructions may increase the risk of injury in a crash.

**Knee Airbag System (Passenger’s Side Only)**

The knee airbag is located under the instrument panel. When the passenger’s front airbag activates in a crash, the passenger’s knee airbag will deploy.

As with front and side airbags, it is important to be properly seated and restrained to reduce the risk of death or serious injury.

**FRONT PASSENGER SENSING SYSTEM**

 **WARNING:** Even with Advanced Restraints Systems, children 12 and under should be properly restrained in a rear seating position. Failure to follow this could seriously increase the risk of injury or death.

 **WARNING:** Sitting improperly out of position or with the seat back reclined too far can take off weight from the seat cushion and affect the decision of the front passenger sensing system, resulting in serious injury or death in a crash. Always sit upright against your seat back, with your feet on the floor.

 **WARNING:** Any alteration or modification to the front passenger seat may affect the performance of the front passenger sensing system which could seriously increase the risk of injury or death.

This system works with sensors that are part of the front passenger’s seat and safety belt to detect the presence of a properly seated occupant and determine if the front passenger’s frontal airbag should be enabled (may inflate) or not.

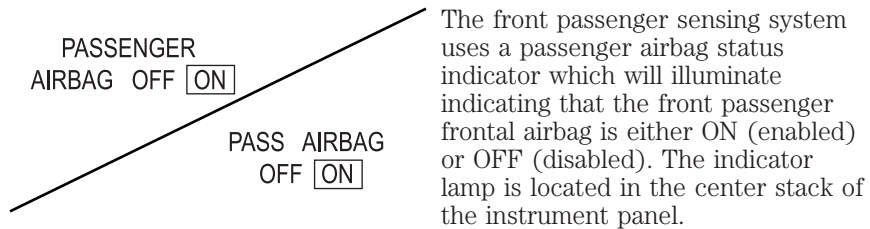

**Note:** When the ignition is first turned on, the passenger airbag status indicator OFF and ON lamps will illuminate for a short period of time to confirm they are functional.



## 56            **Supplementary Restraints System**

---

The front passenger sensing system is designed to disable (will not inflate) the front passenger's frontal airbag when the front passenger seat is unoccupied, or when a rear-facing infant seat, a forward-facing child restraint, or a booster seat is detected. Even with this technology, parents are **strongly** encouraged to always properly restrain children in the rear seat. The sensor also turns off the passenger front airbag and seat-mounted side airbag when the passenger seat is empty.

- When the front passenger sensing system disables (will not inflate) the front passenger frontal airbag, the passenger airbag status indicator will illuminate the OFF lamp and stay lit to remind you that the front passenger frontal airbag is disabled.
- If the child restraint has been installed and the passenger airbag status indicator illuminates the ON lamp, then turn the vehicle off, remove the child restraint from the vehicle and reinstall the restraint following the child restraint manufacturer's instructions.

The front passenger sensing system is designed to enable (may inflate) the front passenger's frontal airbag anytime the system senses that a person of adult size is sitting properly in the front passenger seat.

- When the front passenger sensing system enables the front passenger frontal airbag (may inflate), the passenger airbag status indicator will illuminate the ON lamp and remain illuminated.

If a person of adult size is sitting in the front passenger's seat, but the passenger airbag status indicator OFF lamp is lit, it is possible that the person isn't sitting properly in the seat. If this happens:

- Turn the vehicle off and ask the person to place the seatback in the full upright position.
- Have the person sit upright in the seat, centered on the seat cushion, with the person's legs comfortably extended.
- Restart the vehicle and have the person remain in this position for about two minutes. This will allow the system to detect that person and enable the passenger's frontal airbag.
- If the passenger airbag status indicator OFF lamp remains lit even after this, the person should be advised to ride in the rear seat.

Occupant	Passenger airbag status indicator	Passenger airbag
Empty	OFF: Lit	Disabled
	ON: Unlit	
Child	OFF: Lit	Disabled
	ON: Unlit	
Adult	OFF: Unlit	Enabled
	ON: Lit	

**Note:** When the passenger airbag status indicator OFF lamp is illuminated, the passenger side airbag (seat-mounted) may be disabled to avoid the risk of airbag deployment injuries.

After all occupants have adjusted their seats and put on safety belts, it is very important that they continue to sit properly. Properly seated occupants sit upright, lean against the seat back, and center themselves on the seat cushion, with their feet comfortably extended on the floor. Sitting improperly can increase the chance of injury in a crash event. For example, if an occupant slouches, lies down, turns sideways, sits forward, leans forward or sideways, or puts one or both feet up, the chance of injury during a crash is greatly increased.



Make sure the front passenger sensing system is operating properly. See *Crash Sensors and Airbag Indicator* later in this chapter.

Do not attempt to repair or service the system; take your vehicle immediately to an authorized dealer.

If it is necessary to modify an advanced front airbag system to accommodate a person with disabilities, contact the Ford Customer Relationship Center at the phone number shown in the *Getting the services you need* section of the *Customer Assistance* chapter, or see your authorized dealer.

## 58      **Supplementary Restraints System**

---

### **SIDE AIRBAGS**

 **WARNING:** Do not place objects or mount equipment on or near the airbag cover, on the side of the seatbacks (of the front seats), or in front seat areas that may come into contact with a deploying airbag. Failure to follow these instructions may increase the risk of personal injury in the event of a crash.

 **WARNING:** Do not use accessory seat covers. The use of accessory seat covers may prevent the deployment of the side airbags and increase the risk of injury in an accident.

 **WARNING:** Do not lean your head on the door. The side airbag could injure you as it deploys from the side of the seatback.

 **WARNING:** Do not attempt to service, repair, or modify the airbag, its fuses or the seat cover on a seat containing an airbag, as you could be seriously injured or killed. Contact your authorized dealer as soon as possible.

 **WARNING:** If the side airbag has deployed, the airbag will not function again. The side airbag system (including the seat) must be inspected and serviced by an authorized dealer. If the airbag is not replaced, the unrepaired area will increase the risk of injury in a crash.

The side airbags are located on the outboard side of the seat backs of the front seats. In certain sideways crashes, the airbag on the side affected by the crash will be inflated. The airbag was designed to inflate between the door panel and occupant to further enhance the protection provided occupants in side impact crashes.



The system consists of the following:

- A tag on the seatback indicating that side airbags are found on your vehicle.
- Side airbags located inside the seatback of the driver and front passenger seats.



- Crash sensors and monitoring system with readiness indicator. See *Crash Sensors and Airbag Indicator* later in this chapter.

- Front passenger sensing system.

**Note:** The passenger sensing system will deactivate the passenger seat-mounted side airbag if it detects an empty passenger seat.

The design and development of the side airbag system included recommended testing procedures that were developed by a group of automotive safety experts known as the Side Airbag Technical Working Group. These recommended testing procedures help reduce the risk of injuries related to the deployment of side airbags.

### SAFETY CANOPY® CURTAIN AIRBAGS



**WARNING:** Do not place objects or mount equipment on or near the headliner at the siderail that may come into contact with a deploying curtain airbag. Failure to follow these instructions may increase the risk of personal injury in the event of a crash.



**WARNING:** Do not lean your head on the door. The curtain airbag could injure you as it deploys from the headliner.



**WARNING:** Do not attempt to service, repair, or modify the curtain airbags, its fuses, the A, B, C or D pillar trim, or the headliner on a vehicle containing curtain airbags, as you could be seriously injured or killed. Contact your authorized dealer as soon as possible.

**!** **WARNING:** All occupants of your vehicle including the driver should always wear their safety belts even when an airbag supplemental restraint system and curtain airbag is provided. Failure to properly wear your safety belt could seriously increase the risk of injury or death.

**!** **WARNING:** To reduce risk of injury, do not obstruct or place objects in the deployment path of the curtain airbag.

**!** **WARNING:** If the curtain airbags have deployed, the curtain airbags will not function again. The curtain airbags (including the A, B, C or D pillar trim and headliner) must be inspected and serviced by an authorized dealer. If the curtain airbag is not replaced, the unrepaired area will increase the risk of injury in a crash.

The Safety Canopy will deploy during significant side crashes or when a certain likelihood of a rollover event is detected by the rollover sensor. The Safety Canopy is mounted to the roof side-rail sheet metal, behind the headliner, above each row of seats. In certain sideways crashes or rollover events, the Safety Canopy will be activated, regardless of which seats are occupied. The Safety Canopy is designed to inflate between the side window area and occupants to further enhance protection provided in side impact crashes and rollover events.

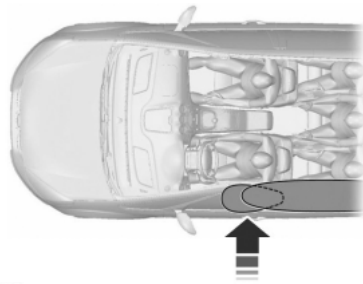

The system consists of:

- Safety canopy curtain airbags fitted above the trim panels over the front and rear side windows identified by a label or wording on the headliner or roof-pillar trim.
- A flexible headliner which opens above the side doors to allow air curtain deployment.



- Crash sensors and monitoring system with readiness indicator. See *Crash Sensors and Airbag Indicator* in this chapter.

Children 12 years old and under should always be properly restrained in the rear seats. The Safety Canopy will not interfere with children restrained using a properly installed child or booster seat because it is designed to inflate downward from the headliner above the doors along the side window opening.

The design and development of the Safety Canopy included recommended testing procedures that were developed by a group of automotive safety experts known as the Side Airbag Technical Working Group. These recommended testing procedures help reduce the risk of injuries related to the deployment of side airbags (including the Safety Canopy).

#### CRASH SENSORS AND AIRBAG INDICATOR



**WARNING:** Modifying or adding equipment to the front end of your vehicle (including frame, bumper, front end body structure and tow hooks) may affect the performance of the airbag system, increasing the risk of injury. Do not modify the front end of your vehicle.

Your vehicle has a collection of crash and occupant sensors which provide information to the restraints control module. The restraints control module deploys (activates) the front safety belt pretensioners, rear inflatable safety belts, driver airbag, passenger airbag, passenger knee airbag, seat mounted side airbags, and the Safety Canopy. Based on the type of accident (frontal impact, side impact or rollover) the restraints control module will deploy the appropriate safety devices.

The restraints control module also monitors the readiness of the above safety devices plus the crash and occupant sensors. The readiness of the safety system is indicated by a warning indicator light in the instrument cluster or by a backup tone if the warning light is not working. See the *Instrument Cluster* chapter. Routine maintenance of the airbag is not required.

## 62      **Supplementary Restraints System**

---

A difficulty with the system is indicated by one or more of the following:



- The readiness light will either flash or stay lit.
- The readiness light will not illuminate immediately after the ignition is turned on.
- A series of five beeps will be heard. The tone pattern will repeat periodically until the problem or light is repaired.

If any of these things happen, even intermittently, have the supplemental restraint system serviced at an authorized dealer immediately. Unless serviced, the system may not function properly in the event of a crash.

The safety belt pretensioners, rear inflatable safety belts and the airbag supplemental restraint system are designed to activate when the vehicle sustains frontal or sideways deceleration sufficient to cause the restraints control module to deploy a safety device or when a certain likelihood of a rollover event is detected by the rollover sensor.

The fact that the safety belt pretensioners or airbags did not activate for both front seat occupants in a crash does not mean that something is wrong with the system. Rather, it means the restraints control module determined the accident conditions (such as crash severity, belt usage) were not appropriate to activate these safety devices.

- The design of the front airbags is to activate only in frontal and near-frontal crashes (not rollovers, side impacts or rear impacts) unless the crash causes sufficient frontal deceleration.
- The design of the safety belt pretensioners and rear inflatable safety belts is to activate in frontal, near-frontal and side crashes, and in rollovers.
- The design of the side airbags is to inflate in certain side impact crashes. Side airbags may activate in other types of crashes if the vehicle experiences sufficient sideways motion or deformation.
- The design of the Safety Canopy is to inflate in certain side impact crashes or rollover events. The Safety Canopy may activate in other types of crashes if the vehicle experiences sufficient sideways motion or deformation, or a certain likelihood of rollover.

### **AIRBAG DISPOSAL**

Contact your authorized dealer as soon as possible. Airbags must be disposed of by qualified personnel.

**GENERAL INFORMATION ON RADIO FREQUENCIES**

This device complies with part 15 of the FCC Rules and with Industry Canada license-exempt RSS standard(s). Operation is subject to the following two conditions: (1) This device may not cause harmful interference, and (2) This device must accept any interference received, including interference that may cause undesired operation.

**Note:** Changes or modifications not expressly approved by the party responsible for compliance could void the user's authority to operate the equipment. The term **IC** before the radio certification number only signifies that Industry Canada technical specifications were met.

The typical operating range for your transmitter is approximately 33 feet (10 meters). Vehicles with the remote start feature will have a greater range. A decrease in operating range could be caused by:

- weather conditions
- nearby radio towers
- structures around your vehicle
- other vehicles parked next to your vehicle.

The radio frequency used by your remote control can also be used by other short-distance radio transmissions, for example amateur radios, medical equipment, wireless headphones, remote controls and alarm systems. If the frequencies are jammed, you will not be able to use your remote control. You can lock and unlock the doors with the key.

**Note:** Make sure your vehicle is locked before leaving it unattended.

**Note:** If you are in range, the remote control will operate if you press any button unintentionally.

**Intelligent Access (If Equipped)**

The system uses a radio frequency signal to communicate with your vehicle and authorize your vehicle to unlock when one of the following conditions is met:

- You touch the inside of the front exterior door handle.
- You press the luggage compartment button.
- You press a button on the transmitter.

If excessive radio frequency interference is present in the area or if the transmitter battery is low, it may be necessary to mechanically unlock your door. You can use the mechanical key blade in your intelligent access key to open the driver door in this situation. Refer to *Remote Control* in this chapter for more information on the location and use of the mechanical key blade.

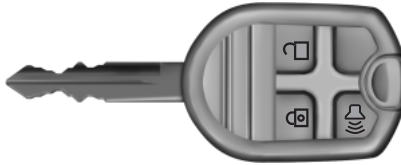

**REMOTE CONTROL****Integrated Keyhead Transmitters (IKTs) (If Equipped)**

Use the key blade to start your vehicle and unlock or lock the driver door from outside your vehicle. The transmitter portion functions as the remote control.



**Note:** Your vehicle's keys came with a security label that provides important key cut information. Keep the label in a safe place for future reference.

**Intelligent Access Key (If Equipped)**

Your intelligent access keys operate the power locks and the remote start system. The key must be in your vehicle to activate the push-button start system.

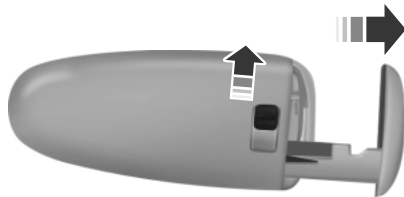

The intelligent access key also contains a removable mechanical key blade that you can use to unlock the driver door. Slide the release on the back of the transmitter to release the key blade, and then pull the blade out.



**Note:** Your vehicle's back-up keys came with a security tag that provides important key cut information. Keep the tag in a safe place for future reference.

### Replacing the Battery

**Note:** Refer to local regulations when disposing of transmitter batteries.

**Note:** Do not wipe off any grease on the battery terminals or on the back surface of the circuit board.

**Note:** Replacing the battery will not delete the transmitter from your vehicle. The transmitter should operate normally.

The remote control uses one coin-type three-volt lithium battery CR2032 or equivalent.

### Integrated Keyhead Transmitter

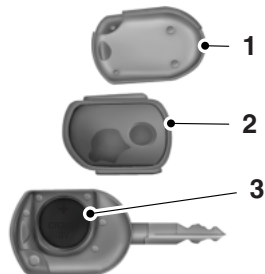

1. Twist a thin coin in the slot near the key ring to remove the battery cover (1).
2. Carefully peel up the rubber gasket (2) from the transmitter if it does not come off with the battery cover.
3. Remove the old battery (3).

4. Insert the new battery. Refer to the instructions inside the integrated keyhead transmitter for the correct orientation of the battery. Press the battery down to ensure that the battery is fully seated in the battery housing cavity.

5. Reinstall the rubber gasket.

6. Snap the battery cover back onto the key.

**Intelligent Access Transmitter**

1. Remove the backup key from the transmitter.

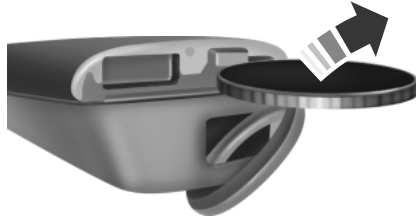

2. Twist a thin coin under the tab hidden behind the backup key head to remove the battery cover. Do not use the backup key to remove the cover or you could damage the intelligent access key.

3. Remove the old battery.



4. Insert a new battery with the **+** facing downward. Press the battery down to make sure it is fully in the housing.

5. Snap the battery cover back onto the transmitter and install the backup key.

**Memory Feature (If Equipped)**

The memory feature allows you to recall these available features: driver seat, power mirrors, steering column, power adjustable pedal and power steering column memory positions.

Press the unlock button on the remote control or activate intelligent access to recall memory. The mirrors will move to the programmed position and the seat will move to the easy entry position. The seat will move to the final position when you switch the ignition on if you have enabled the feature.

### ***Programming Memory to the Remote Control***

1. Turn the ignition on.



2. Move the memory features to the desired positions using the associated controls.

3. Press and hold button **1** for five seconds. A tone will sound in about two seconds. Continue to hold until you hear a second tone.

4. Press the lock button on the remote control within three seconds.

5. Repeat this procedure for another memory button and transmitter if desired.

### ***Deactivating Memory from the Remote Control***

1. Press and hold the desired memory button for five seconds. You will hear a tone in about two seconds. Continue to hold until you hear a second tone.

2. Press the unlock button on the remote control.

3. Repeat this procedure for each additional transmitter if desired.

### **Car Finder**



Press the button twice within three seconds. The horn will sound and the turn signals will flash. We recommend you use this method to locate your vehicle, rather than using the panic alarm.

### **Sounding a Panic Alarm**



Press the button to activate the alarm. Press the button again or switch the ignition on to deactivate.

**Note:** The panic alarm will only operate when the ignition is off.

**Remote Start (If Equipped)**

**WARNING:** To avoid exhaust fumes, do not use remote start if your vehicle is parked indoors or areas that are not well ventilated.

**Note:** Do not use remote start if your vehicle is low on fuel.



The remote start button is on the transmitter.

This feature allows you to start your vehicle from outside your vehicle. The transmitter has an extended operating range.

Vehicles with automatic climate control can be configured to operate when the vehicle is remote started. See the *Climate Control* chapter for more information. A manual climate control system will run at the setting it was set to when your vehicle was last turned off.

Many states and provinces have restrictions for the use of remote start. Check your local and state or provincial laws for specific requirements regarding remote start systems.

The remote start system will not work if:

- the ignition is on
- the alarm system is triggered
- you disable the feature
- the hood is open
- the transmission is not in **P**
- the vehicle battery voltage is too low
- the fuel is too low
- the service engine soon light is on.

**Remote Starting the Vehicle**

**Note:** You must press each button within three seconds of each other. Your vehicle will not remote start and the horn will not sound if you do not follow this sequence.

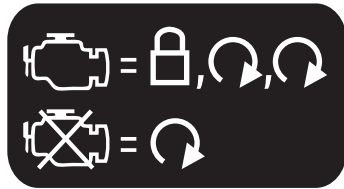

The label on your transmitter details the starting procedure.

To remote start your vehicle:

1. Press the lock button to lock all the doors.
2. Press the remote start button twice. The exterior lamps will flash twice.

The horn will sound if the system fails to start.

**Note:** If you remote start your vehicle with an integrated keyhead transmitter, you must switch the ignition on before driving your vehicle. If you remote start your vehicle with an intelligent access transmitter, you must have a programmed intelligent access key inside your vehicle and press the **START/STOP** button on the instrument panel once while applying the brake pedal before driving your vehicle.

The power windows will not work during the remote start and the radio will not turn on automatically.

The parking lamps will remain on and your vehicle will run for 5, 10, or 15 minutes, depending on the setting. See the *Information Displays* chapter to select the duration of the remote start system.

**Extending the Vehicle Run Time**

Repeat Steps 1 and 2 with your vehicle still running to extend the run time for another remote start duration. If the duration is set to last 10 minutes, the duration will extend by another 10 minutes beginning after what is left of the first activation time. For example, if your vehicle had been running from the first remote start for five minutes, your vehicle will continue to run now for 15 additional minutes.

Wait at least five seconds before remote starting after a vehicle shutdown.

***Turning the Vehicle Off After Remote Starting***

Press the button once. The parking lamps will turn off.

You may have to be closer to your vehicle than when starting due to ground reflection and the added noise of the running vehicle.

You can disable or enable the remote start system through the information display. See the *Information Display* chapter.

**REPLACING A LOST KEY OR REMOTE CONTROL**

You can purchase replacement or additional keys or remote controls from an authorized dealer. A dealer can program the transmitters to your vehicle or you may be able to program them yourself. See the *Security* chapter for information on programming your transmitters.

---

**PRINCIPLES OF OPERATION**

MyKey allows you to program keys with restricted driving modes to promote good driving habits. All but one of the keys programmed to the vehicle can be activated with these restricted modes.

Any keys that have not been programmed are referred to as administrator keys or admin keys. These can be used to:

- Create a MyKey.
- Program configurable MyKey settings.
- Clear all MyKey features.

When you have programmed a MyKey, you can access the following information using the information display:

- How many admin keys and MyKeys are programmed to your vehicle.
- The total distance your vehicle has traveled using a MyKey.

**Note:** All MyKeys are programmed to the same settings. You cannot program them individually.

**Note:** For vehicles with intelligent access (push-button start), when both a MyKey and an admin transmitter are present, the admin transmitter will be recognized to start the vehicle.

**Non-configurable Settings**

The following settings cannot be changed by an admin key user:

- Belt-Minder. You cannot disable this feature. The audio system will mute when the front seat occupants' safety belts are not fastened.
- Early low fuel warning. The low fuel warning is activated earlier, giving the MyKey user more time to refuel.
- Driver assist features, if equipped on your vehicle, are forced on: parking aid, blind spot information system (BLIS) with cross traffic alert, lane departure warning and forward collision warning system.
- Satellite radio adult content restrictions.



**Configurable Settings**

With an admin key, you can configure certain MyKey settings when you first create a MyKey and before you recycle the key or restart the engine. You can also change the settings afterward with an admin key.

- A vehicle speed limit can be set. Warnings will be shown in the display followed by an audible tone when your vehicle reaches the set speed. You cannot override the set speed by fully depressing the accelerator pedal or by setting cruise control.
- Vehicle speed minders of 45, 55 or 65 mph (75, 90 or 105 km/h). Once you select a speed, it will be shown in the display, followed by an audible tone when the preselected vehicle speed is exceeded.
- Audio system maximum volume of 45%. A message will be shown in the display when you attempt to exceed the limited volume. Also, the speed-sensitive or compensated automatic volume control will be disabled.
- Always on setting. When this is selected, you will not be able to turn off AdvanceTrac or the do not disturb feature (if your vehicle is equipped with this feature).

**CREATING A MYKEY**

Use the information display to create a MyKey:

1. Insert the key you want to program into the ignition. If your vehicle is equipped with a push-button start, place the intelligent access key in the backup slot. The location of your backup slot is in another chapter. See *Starting and Stopping the Engine*.
2. Switch the ignition on.
3. Access the main menu on the information display controls, and select **Settings**, then **MyKey** by pressing **OK** or the **>** button.
4. Press **OK** or the **>** button to select **Create MyKey**.
5. When prompted, hold the **OK** button until you see a message informing you to label this key as a MyKey. The key will be restricted at the next start.

MyKey is successfully created. Make sure you label it so you can distinguish it from the admin keys.

You can also program configurable settings for the key(s). Refer to *Programming/Changing Configurable Settings*.

---

### Programming/Changing Configurable Settings

Use the information display to access your configurable MyKey settings:

1. Switch the ignition on using an admin key. If your vehicle has push-button start, put the intelligent access key fob into the backup slot. The location of your backup slot is in another chapter. See *Starting and Stopping the Engine*.
2. Access the main menu and select **Settings**, then **MyKey** by pressing **OK** or the **>** button.
3. Use the arrow buttons to get to a configurable feature.
4. Press **OK** or **>** to scroll through settings.
5. Press **OK** or **>** to make a selection.

**Note:** You can clear or change your MyKey settings at any time during the same key cycle as you created the MyKey. Once you have switched the engine off, however, you will need an admin key to change or clear your MyKey settings.

### CLEARING ALL MYKEYS

You can clear all MyKeys within the same key cycle as you created the MyKey. If you switch your ignition off, however, you will need to use an admin key to clear your MyKeys.

**Note:** When you clear your MyKeys, you remove all restrictions and return all MyKeys to their original admin key status at once.

To clear all MyKeys of all MyKey settings, use the information display to do the following:

1. Access the main menu and select **Settings**, then **MyKey**.
2. Scroll to **Clear All** and press the **OK** button.
3. Hold the **OK** button until **ALL MYKEYS CLEARED** displays .

### CHECKING MYKEY SYSTEM STATUS

You can find information about your programmed MyKeys by using the information display.

### MYKEY DISTANCE

Tracks the distance when drivers use a MyKey. The only way to delete the accumulated distance is by using an admin key to clear your MyKey. If the distance does not accumulate as expected, then the intended user is not using the MyKey, or an admin key user recently cleared and then recreated a MyKey.

**NUMBER OF MYKEY(S)**

Indicates the number of MyKeys programmed to your vehicle. Use this feature to detect how many MyKeys you have for your vehicle and determine when a MyKey has been deleted.

**NUMBER OF ADMIN KEY(S)**

Indicates how many admin keys are programmed to your vehicle. Use this feature to determine how many unrestricted keys you have for your vehicle, and detect if an additional MyKey has been programmed.

**USING MYKEY WITH REMOTE START SYSTEMS**

MyKey is not compatible with non-Ford-approved aftermarket remote start systems. If you choose to install a remote start system, please see your Ford authorized dealer for a Ford-approved remote start system.

**MYKEY TROUBLESHOOTING**

Condition	Potential causes
I cannot create a MyKey.	<ul style="list-style-type: none"> <li>• The key or fob used to start the vehicle does not have admin privileges.</li> <li>• The key or fob used to start the vehicle is the only admin key (there always has to be at least one admin key).</li> <li>• Vehicles with push-button start: The intelligent access key is not in the backup slot. The backup slot location information is in another chapter. See <i>Starting and Stopping the Vehicle</i>.</li> <li>• SecuriLock passive anti-theft system is disabled or in unlimited mode.</li> </ul>
I cannot program the configurable settings.	<ul style="list-style-type: none"> <li>• The key or fob used to start the vehicle does not have admin privileges.</li> <li>• No MyKeys are created. See <i>Creating a MyKey</i>.</li> </ul>
I cannot clear the MyKeys.	<ul style="list-style-type: none"> <li>• The key or fob used to start the vehicle does not have admin privileges.</li> <li>• No MyKeys are created. Refer to <i>Creating a MyKey</i>.</li> </ul>

Condition	Potential causes
I lost the only admin key.	<ul style="list-style-type: none"> <li>• Purchase a new key from your authorized dealer.</li> </ul>
I lost a key.	<ul style="list-style-type: none"> <li>• Program a spare key. See <i>SecuriLock</i> in the <i>Security</i>.</li> </ul>
No MyKey functions with intelligent access key (push- button start).	<ul style="list-style-type: none"> <li>• An admin fob is present at engine start.</li> <li>• No MyKey has been created. See <i>Creating a MyKey</i>.</li> </ul>
MyKey distances do not accumulate.	<ul style="list-style-type: none"> <li>• The MyKey user is not using the MyKey.</li> <li>• An admin key holder cleared the MyKeys and created new MyKeys.</li> <li>• The key system has been reset.</li> </ul>

**LOCKING AND UNLOCKING**

You can use the power door lock control or the remote control to lock and unlock your vehicle.

**Power Door Locks**

The power door lock control is located on the driver and front passenger door panels.



A. Unlock

B. Lock

**Remote Control**

You can use the remote control anytime your vehicle is not running.

**Unlocking the Doors (Two-Stage Unlock)**

Press the button to unlock the driver door.

Press the button again within three seconds to unlock all doors. The turn signals will flash.

Press and hold both the lock and unlock buttons on the remote control for four seconds to disable or enable two-stage unlocking. Disabling two-stage unlocking allows all vehicle doors to unlock with one press of the button. The turn signals will flash twice to indicate a change to the unlocking mode. The unlocking mode applies to the remote control, keyless entry keypad and intelligent access.

Intelligent access at the driver door unlocks all doors when you have disabled two-stage unlocking.

**Locking the Doors**

Press the button to lock all the doors. The turn signals will illuminate.

Press the button again within three seconds to confirm that all the doors are closed. The doors will lock again, the horn will sound and the turn signals will illuminate if all the doors and the luggage compartment are closed.

**Note:** If any door or the luggage compartment is open, or if the hood is open on vehicles with an anti-theft alarm or remote start, the horn sounds twice and the lamps will not flash.

**Power Liftgate (If Equipped)**

**WARNING:** Make sure all persons are clear of the liftgate area before using power liftgate control.



**WARNING:** Make sure to close and latch the liftgate to prevent drawing exhaust fumes into your vehicle. This will also prevent passengers and cargo from falling out. If you must drive with the liftgate open, keep the vents or windows open so outside air comes into your vehicle. Failure to follow this warning could result in serious personal injury.

**Note:** Be careful when opening or closing the liftgate in a garage or other enclosed area to avoid damaging the liftgate.



Press twice within three seconds to open or close the liftgate, or to reverse the movement.

**Activating Intelligent Access (If Equipped)**

You must have the intelligent access key within 3 feet (1 meter) of your vehicle.

**At the Front Doors**

Pull a front exterior door handle to unlock and open the door. The unlock sensor is on the back of the handle. Make sure not to touch the lock sensor area on the front of the handle.

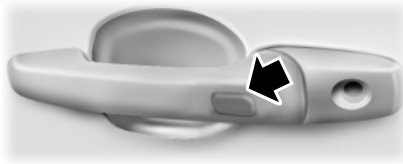

Press and hold the lock sensor area for about a second to lock your vehicle. To avoid unlocking the door inadvertently, make sure to only touch the lock sensor and not other areas of the door handle.

After locking the doors with the lock sensor, there is a brief delay before you can unlock your vehicle. This delay lets you pull the door handle to make sure it locked.

**Note:** Keep the door handle surface clean to avoid issues with operation.

**At the Liftgate**

Press the exterior liftgate release button on the top of the liftgate pull-cup handle.

**Smart Unlocks for Integrated Keyhead Transmitter**

This feature helps to prevent you from locking yourself out of your vehicle if your key is still in the ignition.

When you open one of the front doors and lock your vehicle with the power door lock control, all the doors will lock then unlock if your key is still in the ignition.

You can still lock your vehicle with the key in the ignition. To do this, use the keyless entry keypad with the driver door closed, or press the lock button on the transmitter even if the doors are not closed.

If both front doors are closed, you can lock your vehicle by any method, regardless of whether the key is in the ignition or not.

**Smart Unlocks for Intelligent Access Keys (If Equipped)**

This feature helps to prevent you from unintentionally locking your intelligent access key inside your vehicle's passenger compartment or rear cargo area.

When you lock your vehicle using the driver or passenger power door lock control (with the door open, transmission in **P** and ignition off), after you close the door your vehicle will search for an intelligent access key in the passenger compartment. If your vehicle finds a key, all of the doors will immediately unlock and the horn will sound, indicating that a key is inside.

You can override the smart unlock feature and intentionally lock the intelligent access key inside your vehicle. To do this, lock your vehicle after you have closed all the doors by:

- using the keyless entry keypad
- pressing the lock button on another intelligent access key
- touching the locking area on the handle with another intelligent access key in your hand.

When you open one of the front doors and lock your vehicle using the power door lock control, all doors will lock then unlock if:

- the ignition is on, or
- the ignition is off and the transmission is not in **P**.

**Autolock Feature (If Enabled)**

The autolock feature will lock all the doors when:

- all the doors are closed,
- the ignition is on,
- you shift into any gear putting your vehicle in motion, and
- your vehicle reaches a speed greater than 12 mph (20 km/h).

The autolock feature repeats when:

- you open then close any door while the ignition is on and the vehicle speed is 9 mph (15 km/h) or lower, and
- your vehicle then reaches a speed greater than 12 mph (20 km/h).



**Autounlock Feature (If Enabled)**

The autounlock feature unlocks all the doors when:

- the ignition is on, all the doors are closed, and your vehicle has been in motion at a speed greater than 12 mph (20 km/h);
- your vehicle has then come to a stop and you switch the off ignition or to accessory; and
- you open the driver door within 10 minutes of switching the ignition off or to accessory.

**Note:** The doors will not autounlock if you electronically lock your vehicle after you switch the ignition off and before you open the driver door.

**Enabling or Disabling**

**Note:** You can enable or disable the autolock and autounlock features independently of each other.

You can enable or disable these features:

- through an authorized dealer
- using the information display.

**Illuminated Entry**

The interior lamps and select exterior lamps illuminate when you use the integrated keyhead transmitter, intelligent access key or the keyless entry keypad to unlock the vehicle.

The system will turn off the lights if:

- you switch the ignition on
- you press the lock button on the remote control
- you lock your vehicle using the keyless entry keypad
- after 25 seconds of illumination.

The lights will not turn off if:

- you turn them on with the dimmer control
- any door is open.

**Illuminated Exit**

The interior lamps and select exterior lamps illuminate when all doors are closed and you switch the ignition off and remove the key from the ignition (integrated keyhead transmitter only).

The lamps turn off if all the doors remain closed and:

- 25 seconds elapse
- you insert the key in the ignition (integrated keyhead transmitter only)
- you press the **START/STOP** button (intelligent access key only).

**Battery Saver**

If you leave the courtesy lamps, dome lamps or headlamps on, the battery saver shuts them off 10 minutes after you switch the ignition off.

**Accessory Mode Battery Saver for Intelligent Access Keys (If Equipped)**

If you leave your vehicle in the run ignition state, it will shut off once it detects a certain amount of battery drain or after 45 minutes.

**LIFTGATE**

**WARNING:** It is extremely dangerous to ride in a cargo area, inside or outside of a vehicle. In a crash, people riding in these areas are more likely to be seriously injured or killed. Do not allow people to ride in any area of your vehicle that is not equipped with seats and safety belts. Be sure everyone in your vehicle is in a seat and using a safety belt properly.

**Manual Liftgate**

**WARNING:** Make sure to close and latch the liftgate to prevent drawing exhaust fumes into your vehicle. This will also prevent passengers and cargo from falling out. If you must drive with the liftgate open, keep the vents or windows open so outside air comes into your vehicle. Failure to follow this warning could result in serious personal injury.

**Note:** Be careful when opening or closing the liftgate in a garage or other enclosed area to avoid damaging the liftgate.

**Note:** Do not hang anything, for example a bike rack, from the spoiler, glass or liftgate. This could damage the liftgate and its components.

**Note:** Do not leave the liftgate open while driving. This could damage the liftgate and its components.

The liftgate area is only intended for cargo, not passengers.

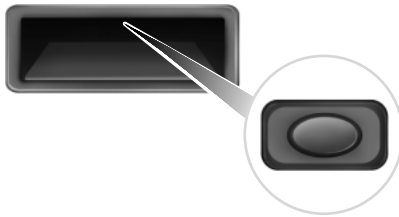

**To open the liftgate:** Press the button located in the top of the liftgate pull-cup handle to unlatch the liftgate, and then pull on the outside handle.

If your vehicle has lost power, you can release the latch from inside your vehicle. Use the access panel on the liftgate trim.

### Power Liftgate (If Equipped)



**WARNING:** Make sure all persons are clear of the power liftgate area before using the power liftgate control.



**WARNING:** Keep keys out of reach of children. Do not allow children to play near an open or moving power liftgate.

**Note:** Cycling the ignition while the liftgate is power closing and is near the latch may cause the liftgate to reverse to full open position. Make sure that you close the liftgate before operating or moving the vehicle, especially in an enclosure like a garage or a parking structure. You could damage the liftgate or its components.

**Note:** Do not drive with the liftgate open without first disabling the power function and securing the liftgate to the vehicle.

**Note:** In case of operation in extreme cold  $-40^{\circ}\text{F}$  ( $-40^{\circ}\text{C}$ ), or on extreme inclines, manual operation of the liftgate is suggested.

You can enable or disable the power liftgate using the information display. The remote control and instrument panel button will still operate the liftgate regardless of the setting.

### Opening and Closing the Power Liftgate

**Note:** You can reverse the liftgate movement direction with a second press of the instrument panel button, or the control button on the liftgate, or a second double press of the transmitter button.

The liftgate will only operate with the transmission in **P**.

A chime will sound three times as the liftgate begins to power close. A single chime indicates a problem with the close request, caused by:

- the ignition is on and the transmission is not in **P**; or
- the battery voltage is below the minimum operating voltage; or
- the vehicle speed is at or above 3 mph (5 km/h).

If the liftgate reverses and starts to close after an open request, a fast continuous chime indicates excessive load on the gate or a possible strut failure. Have your vehicle checked by an authorized dealer if you still have a fast chime after you remove the load.



**To open or close from the instrument panel:** Press the instrument panel button.



**To open or close with the remote control:** Press the remote control button twice within three seconds.

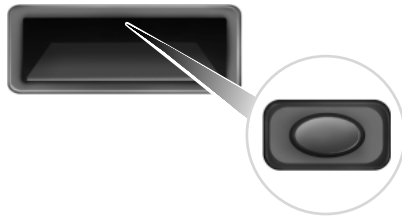

#### To open with the outside liftgate control button:

1. Unlock the liftgate with the remote control or power door unlock control. If the intelligent access transmitter is within 3 feet (1 meter) of the liftgate, the liftgate will unlock when you press the liftgate release button.

2. Press the control button located in the top of the liftgate pull-cup handle.

**Note:** Allow the power system to open the liftgate after pressing the control. Manually pushing or pulling the liftgate may activate the system's obstacle detection feature and stop the power operation.



**To close with the rear cargo area control:** Press and release the button.



**WARNING:** Keep clear of the liftgate when activating the rear switch.

### **Setting Liftgate Open Height**

1. Open the liftgate.
2. Manually move the liftgate to the desired height.
3. Press and hold the control button on the liftgate until a tone sounds, indicating the new height is set. **Note:** You cannot set an open height if the liftgate position is too low.

The new open liftgate height will now be recalled when the power liftgate is opened. To change the programmed height, repeat the above procedure. Once you open the power liftgate you can manually move it to a different height.

When operating the power liftgate after a set height lower than full-open is set, you can fully open the liftgate by manually pushing it upward to the maximum open position.

### **Obstacle Detection**

**When closing:** The system will reverse to full open when it detects an obstacle. A tone will sound three times as the liftgate begins to reopen. Remove the obstacle to close the liftgate.

**Note:** Entering the vehicle while the liftgate is closing can cause the vehicle to bounce and activate obstacle detection. To prevent this, allow the power liftgate to fully close before entering the vehicle. Before driving off, check the instrument cluster for a liftgate or door ajar message or warning indicator. Driving off without first checking for the liftgate or door ajar message or warning indicator could result in unintentionally leaving the liftgate open while you are driving.

**When opening:** The system will stop and a tone will sound three times when it detects an obstacle. Remove the obstacle to operate the liftgate.

### **Resetting the Power Liftgate**

The liftgate may not operate properly and you may need to reset it if any of these conditions occur:

- A low voltage or dead battery
- A disconnected battery
- You manually close the liftgate and leave it ajar (unlatched)

To reset the power liftgate:

1. Disconnect the battery for 20 seconds then, reconnect the battery.
2. Manually close and fully latch the liftgate.
3. Power open the liftgate by using the transmitter or the instrument panel control button.

### **SECURICODE™ KEYLESS ENTRY KEYPAD (IF EQUIPPED)**

The keypad, located near the driver window, is invisible until touched and then it lights up so you can see and touch the appropriate buttons.

**Note:** If you enter your entry code too fast on the keypad, the unlock function may not work. Enter your entry code again more slowly.

You can use the keypad to:

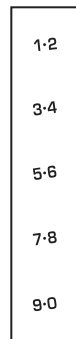

- lock or unlock the doors
- recall memory features
- enable or disable the autolock and autounlock
- arm and disarm the anti-theft alarm

You can operate the keypad with the factory-set 5-digit entry code. This code is located on the owner's wallet card in the glove box and is available from an authorized dealer. You can also create up to three of your own 5-digit personal entry codes.

**Programming a Personal Entry Code**

To create your own personal entry code:

1. Enter the factory-set code.
2. Press the **1•2** on the keypad within five seconds.
3. Enter your personal 5-digit code. You must enter each number within five seconds of each other.
4. For memory recall feature, enter the sixth digit **1•2** to store driver 1 settings or **3•4** to store driver 2 settings.

**Note:** Pressing **5•6**, **7•8**, or **9•0** keypad numbers as a sixth digit will not recall a driver memory setting.

**Note:** The factory-set code cannot be associated with a memory setting.

5. The doors will lock and then unlock to confirm that programming is complete.

You may also program a personal entry code through the MyFord Touch or MyLincoln Touch system. Refer to the *MyFord Touch* or *MyLincoln Touch* chapter.

**Tips:**

- Do not set a code that uses five of the same number.
- Do not use five numbers in sequential order.
- The factory-set code will work even if you have set your own personal code.

**Erasing a Personal Code**

1. Enter the factory-set 5-digit code.
2. Press and release **1•2** on the keypad within five seconds.
3. Press and hold **1•2** for two seconds. This must be done within five seconds of completing Step 2.

All personal codes are now erased and only the factory-set 5-digit code will work.

### Anti-Scan Feature

The keypad will go into an anti-scan mode if you enter the wrong code seven times (35 consecutive button presses). This mode disables the keypad for one minute and the keypad lamp will flash.

The anti-scan feature will turn off after:

- one minute of keypad inactivity
- pressing the unlock button on the remote control
- switching the ignition on
- unlocking the vehicle using intelligent access.

### Unlocking and Locking the Doors

**To unlock the driver door:** Enter the factory-set 5-digit code or your personal code. You must press each number within five seconds of each other. The interior lamps will illuminate. **Note:** All doors will unlock if the two-stage unlocking feature is disabled. Refer to *Locking and Unlocking* earlier in this chapter.

**To unlock all doors:** Enter the factory-set code or your personal code, then press **3•4** within five seconds.

**To lock all doors:** Press and hold **7•8** and **9•0** at the same time with the driver door closed. You do not need to enter the keypad code first.

### Displaying the Factory-Set Code

#### *With Integrated Keyhead Transmitters*

**Note:** You will need to have two programmed passive anti-theft keys for this procedure.

To display the factory-set code in the information display:

1. Place the first programmed key into the ignition and switch on the ignition.
2. Switch the ignition off and remove the first programmed key.
3. Place the second programmed key into the ignition.

The factory-set code will briefly appear in the message center.



**SECURILOCK® PASSIVE ANTI-THEFT SYSTEM**

**Note:** The system is not compatible with non-Ford aftermarket remote start systems. Use of these systems may result in vehicle starting problems and a loss of security protection.

**Note:** Metallic objects, electronic devices or a second coded key on the same key chain may cause vehicle starting issues if they are too close to the key when starting your vehicle. Prevent these objects from touching the coded key while starting the engine. Switch the ignition off, move all objects on the key chain away from the coded key and restart your vehicle if a problem occurs.

**Note:** Do not leave a duplicate coded key in your vehicle. Always take your keys and lock all doors when leaving your vehicle.

The system helps prevent the engine from starting unless you use a coded key programmed to your vehicle. Using the wrong key may prevent your vehicle from starting. A message may appear in the information display.

If you are unable to start your vehicle with a correctly coded key, a malfunction has occurred. A message may appear in the information display.

**Automatic Arming**

Your vehicle arms immediately after you switch the ignition off.

**Automatic Disarming**

Your vehicle disarms when you switch the ignition on with a coded key.

**Replacement Keys**

**Note:** Your vehicle comes with two integrated keyhead transmitters or two intelligent access keys.

The integrated keyhead transmitter functions as a programmed ignition key that operates all the locks and starts the vehicle, as well as a remote control.

The intelligent access key functions as a programmed key that operates the driver door lock and activates the intelligent access with push button start systems, as well as a remote control.

If your programmed transmitters or standard SecuriLock coded keys (integrated keyhead transmitters only) are lost or stolen and you do not have an extra coded key, you will need to have your vehicle towed to an authorized dealer. The key codes need to be erased from your vehicle and new coded keys will need to be programmed.

Store an extra programmed key away from the vehicle in a safe place to help prevent any inconveniences. See an authorized dealer to purchase additional spare or replacement keys.

### ***Programming a Spare Integrated Keyhead Transmitter***

**Note:** You can program a maximum of eight coded keys to your vehicle. Only four of these eight can be integrated keyhead transmitters.

You can program your own integrated keyhead transmitters or standard SecuriLock coded keys to your vehicle. This procedure will program both the engine immobilizer key code and the remote entry portion of the remote control to your vehicle.

Only use integrated keyhead transmitters or standard SecuriLock keys.

You must have two previously programmed coded keys and the new unprogrammed key readily accessible. See an authorized dealer to have the spare key programmed if two previously programmed coded keys are not available.

Read and understand the entire procedure before you begin.

1. Insert the first previously programmed coded key into the ignition.
2. Switch the ignition from off to on. Keep the ignition on for at least three seconds, but no more than 10 seconds.
3. Switch the ignition off and remove the first coded key from the ignition.
4. After three seconds but within 10 seconds of switching the ignition off, insert the second previously coded key into the ignition.
5. Switch the ignition from off to on. Keep the ignition on for at least three seconds, but no more than 10 seconds.
6. Switch the ignition off and remove the second previously programmed coded key from the ignition.
7. After three seconds but within 20 seconds of switching the ignition off and removing the previously programmed coded key, insert the new unprogrammed key into the ignition.
8. Switch the ignition from off to on. Keep the ignition on for at least six seconds until you hear the door locks cycle .
9. Remove the newly programmed coded key from the ignition.

The key will start the engine and will operate the remote entry system (if the new key is an integrated keyhead transmitter) if it has been successfully programmed.

Wait 20 seconds and repeat Steps 1 through 8 if programming the key was not successful. Take your vehicle to an authorized dealer to have the new key programmed if you are still unsuccessful.

Wait 20 seconds and then repeat this procedure from Step 1 to program an additional key.

### ***Programming a Spare Intelligent Access Key (if equipped)***

**Note:** You can program a maximum of four intelligent access keys to your vehicle. You must take your vehicle and all access keys to an authorized dealer to have them erased and reprogrammed if you would like to replace a previously programmed access key with a new access key, or if you already have four access keys programmed to your vehicle.

You must have two previously programmed intelligent access keys inside the vehicle and the new unprogrammed intelligent access keys readily accessible. See an authorized dealer to have the spare key programmed if two previously programmed keys are not available.

Make sure that the vehicle is off before beginning this procedure. Make sure to close all the doors before beginning and that they remain closed throughout the procedure. Perform all steps within 30 seconds of starting the sequence. Stop and wait for at least one minute before starting again if you perform any steps out of sequence.

Read and understand the entire procedure before you begin.



1. Place the new unprogrammed intelligent access key, with the buttons facing out, in the pocket inside of the center console.
2. Press the driver or passenger power door unlock control three times.
3. Press and release the brake pedal one time.
4. Press the driver or passenger power door lock control three times.

5. Press and release the brake pedal one time. The indicator on the **START/STOP** button should begin to flash rapidly. This indicates the vehicle is in programming mode and that it has detected two programmed intelligent access keys in the vehicle.
6. Press the **START/STOP** button within one minute. A message will appear in the information display indicating that the new intelligent access key was programmed.
7. Remove the intelligent access key from the center console pocket and press the unlock button on the newly programmed intelligent access key to exit programming mode.
8. Verify that the remote entry functions operate (press lock then unlock, making sure you end in unlock) and that the vehicle starts with new intelligent access key.

#### **ANTI-THEFT ALARM (IF EQUIPPED)**

The system will warn you of unauthorized entry to your vehicle.

The turn signal lamps will flash and sound the horn up to a total of 10 times when:

- any door, the hood or the luggage compartment is opened without using the keypad, the remote control or the intelligent access transmitter (if equipped)
- the ignition is turned on with an invalid key.

Take all keys and remote controls to an authorized dealer if there is any potential alarm problem with your vehicle.

#### **Arming the Alarm**

The system is ready to arm whenever the ignition is off. Lock the vehicle to arm the alarm.

The turn signal lamps will flash once after locking the vehicle to indicate the alarm is in the pre-armed mode. It will become fully armed in 20 seconds.

**Disarming the Alarm**

To disarm the alarm, do any of the following:

- Press the power door unlock button within the 20-second pre-armed mode.
- Press the unlock button on the remote control.
- Unlock the doors with the keyless entry pad.
- Enter the vehicle using intelligent access (if equipped).
- Turn the ignition on with a valid key (if equipped with an integrated keyhead transmitter only).
- Press the panic button on the remote control. The alarm system will still be armed, but this shuts off the horn and turn lamps when the alarm is sounding.

**Note:** If the driver door is unlocked with a key, a tone will sound when you open the door and a message will appear in the information display. You will have 12 seconds to disarm the alarm using any of the actions above, otherwise the alarm will trigger.

### ADJUSTING THE STEERING WHEEL



**WARNING:** Do not adjust the steering wheel when your vehicle is moving.

**Note:** Make sure that you are sitting in the correct position. See *Sitting in the Correct Position* in the *Seats* chapter.

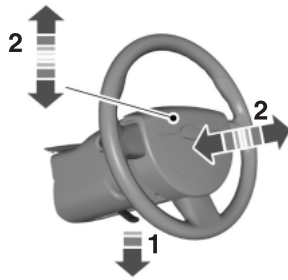

1. Unlock the steering column.
2. Adjust the steering wheel to the desired position.



3. Lock the steering column.

**Power Tilt and Telescope Steering Column (If Equipped)**

**WARNING:** Do not adjust the steering wheel when your vehicle is moving.

**Note:** Make sure that you are sitting in the correct position. Refer to *Sitting in the Correct Position* in the *Seats* chapter.



Use the control on the side of the steering column to adjust the position.

To adjust:

- tilt: press the top or bottom of the control
- telescope: press the front or rear of the control.

**Easy Entry and Exit Feature**

When you switch the ignition off, the steering column will move to the full up and forward position to allow extra room to exit your vehicle. The column will return to the previous setting when you switch the ignition on. You can enable or disable this feature in the information display. See *General Information* in the *Information Displays* chapter.

**Memory Feature**

You can save and recall the steering column position with the memory function. Refer to the *Seats* chapter.

Pressing the adjustment control during memory recall cancels the operation. The column responds to the adjustment control.

The steering column sets a stopping position just short of the end of the column position to prevent damage to the steering column. A new stopping position sets if the steering column encounters an object when tilting or telescoping.

To reset the steering column to its normal stopping position:

1. Press the steering column control again after encountering the new stopping position.
2. Continue pressing the control until it reaches the end of the column position.

A new stopping position is set. The next time you tilt or telescope the steering column, it will stop just short of the end of the column position.

### AUDIO CONTROL

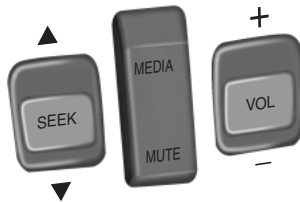

**SEEK:** Press to select the next or previous stored preset or track. Press and hold to select the next or previous frequency or seek through a track.

**MEDIA:** Press repeatedly to scroll through available audio modes.

**MUTE:** Press to silence the radio.

**VOL (Volume):** Press to increase or decrease the volume.

### VOICE CONTROL (IF EQUIPPED)

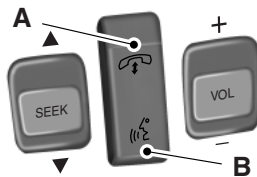

A. Phone mode

B. Voice recognition

See the *SYNC* or *MyFord Touch* chapter.

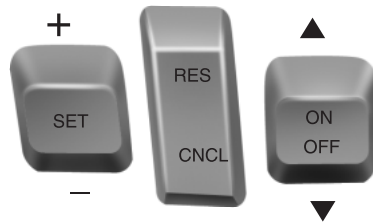
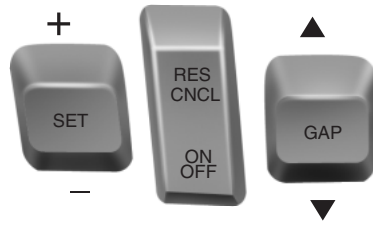

**CRUISE CONTROL****Type 1****Type 2**

See the *Cruise Control* chapter for information on this feature.

**INFORMATION DISPLAY CONTROL**

See the *Information Displays* chapter for more information.

### Cluster Display Control Features



If equipped with:

**MyFord system:** This control functions the same as the center control on the faceplate. See *MyFord system* in the *Audio Systems* chapter.

**MyFord Touch:** Use this control to adjust the right side of the cluster display. Navigate through the screen and press **OK** to select. See the *MyFord Touch* chapter.

### HEATED STEERING WHEEL (IF EQUIPPED)

See the *MyFord Touch* chapter.

**ADJUSTABLE PEDALS (IF EQUIPPED)**

**WARNING:** Never adjust the accelerator and brake pedal with feet on the pedals while the vehicle is moving.

The control is located on the left side of the steering column. Press and hold the appropriate control to move the pedals.

A. Farther

B. Closer

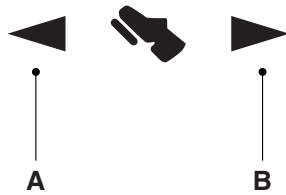

The pedal positions are saved and recalled with the memory feature (if equipped). Refer to the *Seats* chapter.

The pedals should only be adjusted when the vehicle is parked.

**WINDSHIELD WIPERS**

**Note:** Fully defrost the windshield in icy conditions before turning on the windshield wipers.

**Note:** Make sure the windshield wipers are switched off before entering a car wash.

**Note:** Clean the windshield and wiper blades if they begin to leave streaks or smears. If that does not resolve the issue, install new wiper blades.

**Note:** Do not operate the wipers on a dry windshield. This may scratch the glass, damage the wiper blades or cause the wiper motor to burn out. Always use the windshield washers before wiping a dry windshield.

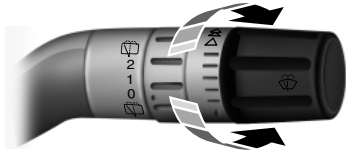

Rotate the end of the control away from you to increase the speed of the wipers. Rotate toward you to decrease the speed of the wipers.

Press the stalk down and release for a single swipe of the wipers.

**Speed-dependent Wipers (If Equipped)**

When your vehicle speed increases, the interval between wipes will decrease when intermittent wipe is selected.

**RAIN-SENSING WIPERS (IF EQUIPPED)**

**Note:** Wet road conditions may result in inconsistent or unexpected wiping or smearing. Lower the sensitivity, switch to normal or high-speed wiping or turn the wipers off to reduce smearing.

**Note:** Turn off the wipers before entering a car wash.

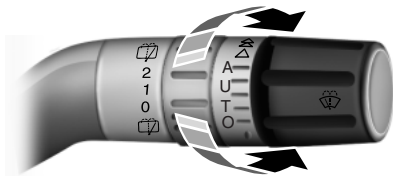

Use the rotary control to adjust the sensitivity to one of the interval moisture settings. The wipers will not cycle until moisture is detected on the windshield. The wiper speed will vary based on the amount of moisture detected on the windshield and the sensitivity setting.

The wipers will continue to wipe as long as moisture is detected.

This feature can be turned on or off using the information display.

Keep the outside of the windshield clean, especially the area around the interior mirror where the sensor is located, or sensor performance may be affected.

### WINDSHIELD WASHERS

**Note:** Do not operate the wipers on a dry windshield. This may scratch the glass, damage the wiper blades or cause the wiper motor to burn out. Always use the windshield washer before wiping a dry windshield.

**Note:** Do not operate the washer when the washer reservoir is empty. This may cause the washer pump to overheat.



Press the end of the stalk to activate the washer.

- A brief press causes the wipers to swipe three times with washer fluid.
- A long press and hold will activate the wipers and washer fluid for up to 10 seconds.

A wipe will occur a few seconds after washing to clear any remaining washer fluid. This feature can be turned on and off in the information display.

### REAR-WINDOW WIPER AND WASHERS



Rotate the control to select:

**2** — Intermittent operation (shortest pause between wipes).

**1** — Intermittent operation (longest pause between wipes).

**0** — Off.

Rotate and hold the control to either the top or bottom position to activate the rear washer. The control will return to the **2** or **0** position when you release it.

When you select reverse gear, the rear wiper will switch on to intermittent if the front wipers are on.

**LIGHTING CONTROL**

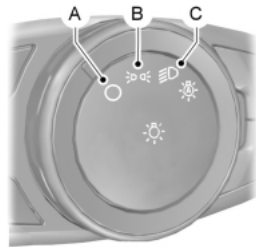

- A. Off
- B. Parking lamps, instrument panel lamps, license plate lamps and tail lamps
- C. Headlamps

**High Beams**



Push the lever forward to switch the high beams on.  
Push the lever forward again or pull the lever toward you to switch the high beams off.

**Headlamp Flasher**



Pull toward you slightly to activate and release to deactivate.

**AUTOLAMPS**

**WARNING:** In severe weather conditions, it may be necessary to switch your headlamps on manually.

**Note:** If the vehicle is equipped with autolamps, it will have the *windshield wiper rainlamp feature*. When the windshield wipers are turned to low- or high-speed wiping during daylight, and the headlamp control is in the autolamp position, the exterior lamps will turn on after a brief delay and will remain on until the wipers are turned off.



The autolamp system provides light sensitive automatic on-off control of the exterior lights normally controlled by the headlamp control.

The headlamps will remain on for a period of time after you switch the ignition off. You can adjust the time delay using the message center in the instrument cluster.

See *Information displays*.

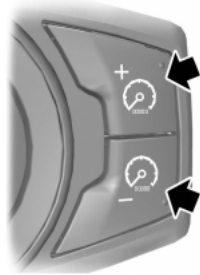
**INSTRUMENT LIGHTING DIMMER**

Press repeatedly or press and hold until the desired level is reached.

**Note:** In the uplevel message center only, a message will pop up that will show incrementally where the dimmer is in relation to the dimming steps. These steps will also vary for daytime and night time dimming.

**Note:** If the battery is disconnected, discharged, or a new battery is installed, the dimmer will set the illuminated components to the maximum setting automatically.

**HEADLAMP EXIT DELAY**

You can set the delay time to keep the headlamps on for up to three minutes after the ignition is turned off.

Follow the steps below to change the delay time (Steps 1 through 6 must be done within 10 seconds):

1. Turn the ignition off.
2. Turn the lighting control to the autolamp position.
3. Turn the lighting control to the off position.
4. Turn the ignition on.
5. Turn the ignition off.
6. Turn the lighting control to the autolamp position. The headlamps and parking lamps will turn on.
7. Turn the lighting control to the off position when the desired delay time has been reached. The headlamps and parking lamps will turn off.

You can set the headlamp exit delay to one of the following settings:

- Off
- 10 seconds
- 20 seconds
- 120 seconds

**Note:** You can also adjust the time delay using the display controls in the instrument cluster. See the *Information Displays* chapter.

**DAYTIME RUNNING LAMPS (IF EQUIPPED)**

**WARNING:** Always remember to turn on your headlamps at dusk or during inclement weather. The Daytime Running Lamp (DRL) system does not activate the tail lamps and generally may not provide adequate lighting during these conditions. Failure to activate your headlamps under these conditions may result in a collision.

The system turns the headlamps on with a reduced output.

To activate:

- the ignition must be in the on position and
- the lighting control is in the off, autolamp, or parking lamp position and
- the transmission is not in PARK.



**AUTOMATIC HIGH BEAM CONTROL (IF EQUIPPED)**

The system will automatically turn on your high beams if it is dark enough and no other traffic is present. When it detects an approaching vehicle's headlights, a preceding vehicle's tail lamps or street lighting, the system will turn off the high beams (low beams remain on) before they distract other drivers.

**Note:** If it appears that automatic control of the high beams is not functioning properly, check the windshield in front of the camera for blockage. A clear view of the road is required for proper system operation. Any windshield damage in the area of the camera field-of-view should be repaired.

**Note:** If a blockage is detected (e.g. bird dropping, bug splatter, snow, or ice) and no changes are observed, the system will go into low beam mode until the blockage is cleared. A message may also appear in the instrument cluster display noting the front camera is blocked.

**Note:** Typical road dust, dirt and water spots will not affect the automatic high beam system's performance. However, in cold or inclement weather conditions, the automatic high beam system's availability may be decreased. If the driver wants to change the beam state independently of the system, the driver may turn the high beams on or off using the multifunction switch stalk. Automatic control will resume when conditions are correct.

**Note:** Modification of the vehicle ride height (e.g. using much larger tires) may degrade feature performance.

A camera sensor is centrally mounted behind the windshield of the vehicle, and monitors the conditions to decide when to switch the high beams off and on.

Once the system is active the high beams will switch on if:

- The ambient light level is low enough that high beams are needed.
- There is no traffic in front of the vehicle.
- Vehicle speed is greater than 25 mph (40 km/h).
- Severe weather is not detected.

The high beams will switch off if:

- An approaching vehicle's headlights or a preceding vehicle's tail lamps are detected.
- The vehicle speed falls below 19 mph (30 km/h).
- The ambient light level is high enough that high beams are not needed.

- Severe rain, snow or fog is detected.
- The camera is blocked.

### Activating the system

Switch the system on within the information display. See *Information displays*.



Turn the lighting control to the autolamps position.

### Manually overriding the system



When the automatic control has activated high beams, pushing or pulling the stalk will provide a temporary override to low beam.

To permanently deactivate the system use the information display menu or turn the lighting control switch from autolamps to headlamps.

### FRONT FOG LAMPS



The fog lamps can be turned on when the lighting control is in the headlamps, parking lamps or autolamps positions and the high beams are not turned on.

**DIRECTION INDICATORS**

The turn signal lever does not mechanically lock in the upward or downward position when activated. The turn signal control activation and cancellation is electronic.



- Push down to activate the left turn signal.
- Push up to activate the right turn signal.
- Push the lever again in either direction to manually cancel turn signal operation.

**Note:** Tap the lever up or down to make the direction indicators flash only three times to indicate a lane change.

**INTERIOR LAMPS****Dome Lamp Control****Without fog lamps**

**With fog lamps**

Use to manually turn the dome lamp on.

- Press the control. This will turn on the interior courtesy lights. The lights will remain on until the control is pressed again.

**Front Row Map Lamps (If Equipped)**

To turn on the map lamps, press the outer edge of the clear lens. The front row map lamp lights when:

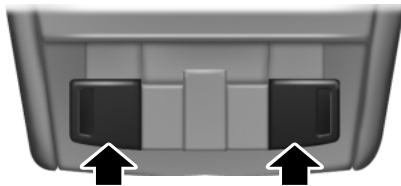

- any door is opened.
- the dome lamp button on the instrument panel is activated.
- the remote entry controls are pressed and the ignition is off.

**Second row dome/map lamps (if equipped)**

The dome lamp lights when:

- any door is opened.
- the instrument panel dimmer button is pressed until the courtesy lamps come on.
- any of the remote entry controls are pressed and the ignition is off.

The reading function can be turned on and off at the lamp with the left and right switches.

**Second row dome/courtesy lamps (if equipped)**

The dome lamp lights when:

- any door is opened.
- the instrument panel dimmer button is pressed until the courtesy lamps come on.

- any of the remote entry controls are pressed and the ignition is off.

The courtesy lamp can also be turned on and off manually by pressing the lens depression.

**Third row cargo lamp**

The dome lamp lights when:

- any door is opened.
- the instrument panel dimmer button is pressed until the courtesy lamp comes on.
- any of the remote entry controls are pressed and the ignition is off.

The courtesy lamp can also be turned on and off manually by pressing the control switch.

**Battery saver**

The battery saver will shut off the exterior lamps and interior lamps, except the hazard warning lamps if activated, 10 minutes after the ignition control has been turned off. The system will not turn off the parking lamps if the lighting control is in the parking lamps on position.

**POWER WINDOWS**

 **WARNING:** Do not leave children unattended in your vehicle and do not let children play with the power windows. They may seriously injure themselves.

 **WARNING:** When closing the power windows, you should verify they are free of obstructions and make sure that children and pets are not in the proximity of the window openings.

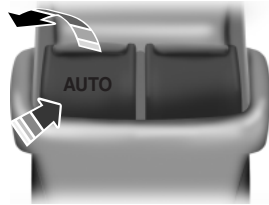

Press or lift the switches to operate the windows.

- Press the switch to the first detent and hold to open the window.
- Lift the switch to the first detent and hold to close the window.

**Rear Window Buffeting**

You may hear a pulsing noise when one or both of the rear windows are open. This noise can be reduced by lowering a front window approximately 2–3 inches (5–8 centimeters).

**One-Touch Down**

This feature automatically opens the window.

Press the switch completely down and release. The window will open fully. Press or lift it again to stop the window.

**One-Touch Up or Down (Front Windows) (If Equipped)**

This feature automatically opens or closes the window.

Press or lift the switch completely and release. The window will fully open or close. Press or lift it again to stop the window.

**Window Lock**

Press the control to lock or unlock the rear window controls.

**Bounce-Back**

The window will stop automatically while closing and reverse some distance if there is an obstacle in the way.

***Overriding the Bounce-Back Feature***

**WARNING:** When you override the bounce-back feature the window will not reverse if it detects an obstacle. Take care when closing the windows to avoid personal injury or damage to your vehicle.

Pull up the window switch and hold within two seconds of the window reaching the bounce-back position. The window will travel up with no bounce-back protection. The window will stop if you release the switch before the window is fully closed.

**Accessory Delay**

You can use the window switches for several minutes after you switch the ignition off, or until you open either front door.

**EXTERIOR MIRRORS****Power Exterior Mirrors**

**WARNING:** Do not adjust the mirror while your vehicle is in motion.



- A. Left mirror
- B. Adjustment control
- C. Right mirror

To adjust your mirrors:

1. Press the button to select the mirror you want to adjust. An indicator light on the button will illuminate.
2. Use the adjustment control to adjust the position of the mirror.
3. Press the mirror button again to deselect the mirror. The indicator light will turn off.

**Foldaway Exterior Mirrors**

Push the mirror toward the door window glass. Make sure that you fully engage the mirror in its support when returning it to its original position.



**Power-Folding Mirrors (If Equipped)**

**Note:** Activating the button 10 or more times within one minute, or repeated folding and unfolding of the mirrors while holding the button down during full travel, may disable the system to protect motors from overheating. Wait approximately three minutes with the vehicle running, and up to 10 minutes with the vehicle off, for the system to reset and for function to return to normal.



Press the button to fold the mirrors in or out.

A mirror may also be manually folded by pulling it toward the door window glass. This may cause the mirror to appear loose and it will need to be re-synchronized. Press the button to fold the mirrors in. A click will be heard indicating re-synchronization. If the click is not heard, use the button to fold the mirrors out, then in again. Once the click is heard the mirrors will operate normally until they are again manually folded.

**Heated Exterior Mirror (If Equipped)**

The heated exterior mirrors switch on with the heated rear window. See *Heated Windows and Mirrors* in the *Climate Control* chapter.

**Memory Mirrors (If Equipped)**

You can save and recall the mirror positions through the memory function. See *Memory function* in the *Seats* chapter.

**Signal Indicator Mirrors (If Equipped)**

The outer portion of the appropriate mirror housing blinks when you activate the turn signal.

**Integrated Blind Spot Mirrors (If Equipped)**

**WARNING:** Objects in the blind spot mirror are closer than they appear.

Blind spot mirrors have an integrated convex mirror built into the upper outboard corner of the exterior mirrors. They are designed to assist you by increasing visibility along the side of your vehicle.

Check the main mirror first before a lane change, then check the blind spot mirror. If no vehicles are present in the blind spot mirror and the traffic in the adjacent lane is at a safe distance, signal that you are going to change lanes. Glance over your shoulder to verify traffic is clear, and carefully change lanes.

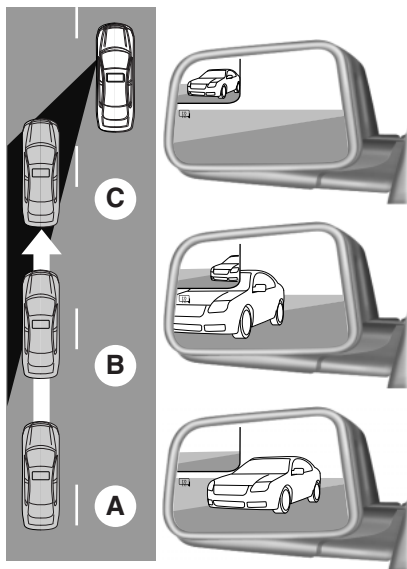

The image of the approaching vehicle is small and near the inboard edge of the main mirror when it is at a distance. The image becomes larger and begins to move outboard across the main mirror as the vehicle approaches (A). The image will transition from the main mirror and begin to appear in the blind spot mirror as the vehicle approaches (B). The vehicle will transition to your peripheral field of view as it leaves the blind spot mirror (C).

**Blind Spot Information System (BLIS®) with Cross Traffic Alert (CTA) (If Equipped)**

Refer to *Blind Spot Information System (BLIS®) with Cross Traffic Alert (CTA)* in the *Driving Aids* chapter.

**INTERIOR MIRROR**

**WARNING:** Do not adjust the mirror when your vehicle is moving.

**Note:** Do not clean the housing or glass of any mirror with harsh abrasives, fuel or other petroleum or ammonia based cleaning products.

You can adjust the interior mirror to your preference. Some mirrors also have a second pivot point. This lets you move the mirror head up or down and from side to side.

Pull the tab below the mirror toward you to reduce glare at night.

**Auto-Dimming Mirror (If Equipped)**

**Note:** Do not block the sensors on the front and back of the mirror. Mirror performance may be affected. A rear center passenger or raised rear center head restraint may also block light from reaching the sensor.

The mirror will dim automatically to reduce glare when bright lights are detected from behind your vehicle. It will automatically return to normal reflection when you select reverse gear to make sure you have a clear view when backing up.

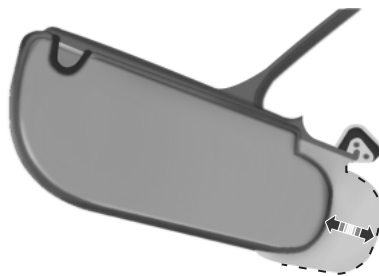
**SUN VISORS****Slide-On-Rod**

Rotate the visor toward the side window and extend it rearward for extra sunlight coverage.

Retract the visor before moving it back toward the windshield and storing it.

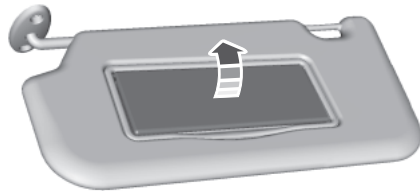
**Illuminated Visor Vanity Mirror (If Equipped)**

Lift the cover to switch on the lamp.

**DUAL PANEL MOONROOF AND POWER SUNSCREEN (IF EQUIPPED)**

**!** **WARNING:** Do not let children play with the moon roof or leave children unattended in the vehicle. They may seriously hurt themselves.

**!** **WARNING:** When closing the dual panel moon roof, you should verify that it is free of obstructions and ensure that children and/or pets are not in the proximity of the roof opening.

The moonroof and sunscreen controls are located on the overhead console.

The moonroof and sunscreen have a one-touch open and close feature. To stop their motion during one-touch operation, press the control a second time.

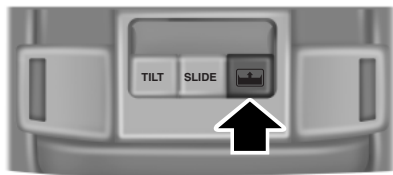
**Opening and Closing the Sunscreen**

Press and release the control to open the sunscreen.

**Note:** The sunscreen stops at the first panel for the dual panel moon roof. Press and release again to continue to open the sunscreen past the second panel.

Pull and release the control to close the sunscreen. The moonroof, if open, will automatically close prior to closing the sunscreen.

**Opening and Closing the Moonroof**

Press and release the **SLIDE** control to open the moonroof. The sunscreen, if closed, will automatically open prior to opening the moonroof. The moonroof will stop short of the fully opened position.

**Note:** This position helps to reduce rumbling wind noise which may happen with the roof fully open. Press and release the **SLIDE** control again to fully open the moonroof.

Pull and release the **SLIDE** control to close the moonroof.

**Bounce-Back**

The moonroof automatically stops closing and reverses if an obstacle is detected while closing.

Pull and hold the **SLIDE** control within two seconds of a bounce-back event to override the function. The closing force begins to increase each of the next three times the moonroof is closed, with bounce-back active.

**Venting the Moonroof**

Press and release the **TILT** control to vent the moonroof. Pull and release the **TILT** control to close the moonroof.

**GAUGES****Type 1**

Cluster shown in standard measure – metric clusters similar.

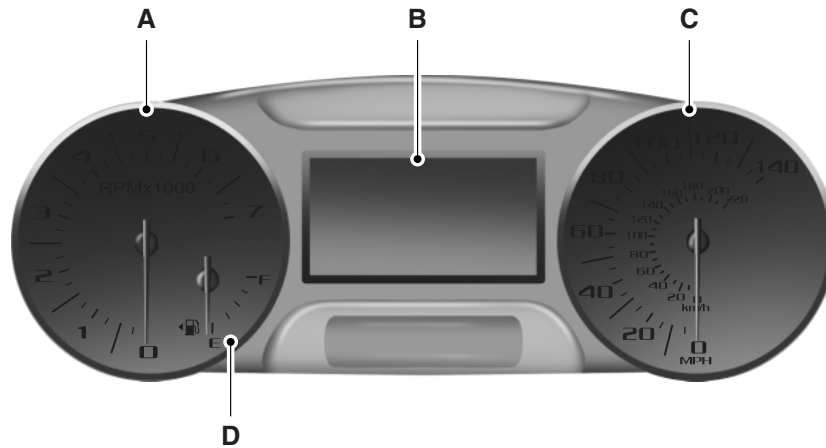

- A. Tachometer
- B. Information display. See *Information displays* for more information.
- C. Speedometer
- D. Fuel gauge

**Fuel Gauge**

Indicates approximately how much fuel is left in the fuel tank (when the ignition is on). The fuel gauge may vary slightly when the vehicle is in motion or on a grade. The fuel icon and arrow indicates which side of the vehicle the fuel filler door is located.

**Type 2**

Cluster shown in standard measure – metric clusters similar.

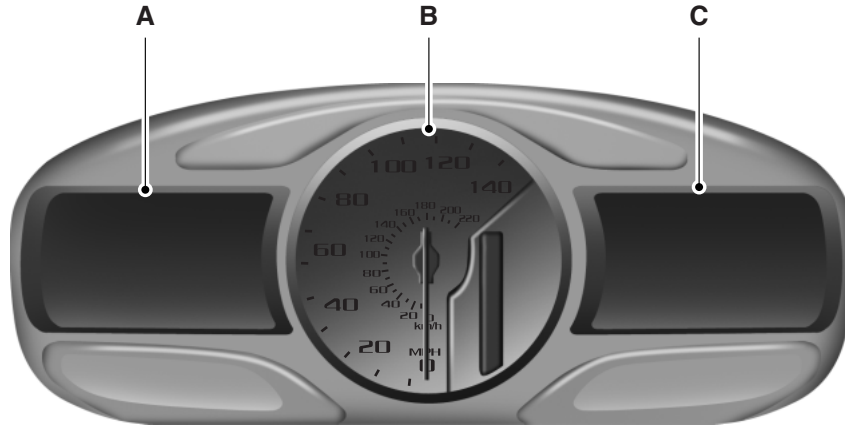

A. Left information display. See *Information displays* for more information.

B. Speedometer

C. Right information display. See *MyFord Touch®* for more information.

**WARNING LAMPS AND INDICATORS**

There are indicators that can alert you to a vehicle condition that may become serious enough to cause expensive repairs. Many lights will illuminate when you start your vehicle to make sure they work. If any light remains on after starting the vehicle, refer to the respective system warning light for additional information.

**Note:** Some warning indicators are reconfigurable telltales (RTT). These indicators appear in the information display and function the same as a warning light, but do not display on startup.

**Adaptive cruise control (RTT) (if equipped)**

The speed control system indicator light changes color to indicate what mode the system is in:



- On (gray light): Illuminates when the adaptive cruise control system is turned on. Turns off when the speed control system is turned off.
- Engaged (green light): Illuminates when the adaptive cruise control system is engaged. Turns off when the speed control system is disengaged.

**Airbag readiness**

If this light fails to illuminate when the ignition is turned on, continues to flash or remains on, contact your authorized dealer as soon as possible. A chime will sound when there is a malfunction in the indicator light.

**Anti-lock brake system**

If the ABS light stays illuminated or continues to flash, a malfunction has been detected. Contact your authorized dealer as soon as possible. Normal braking is still functional unless the brake warning light also is illuminated.

**Brake system warning light**

To confirm the brake system warning light is functional, it will momentarily illuminate when the ignition is turned to the on position when the engine is not running, or in a position between on and start, or by applying the parking brake when the ignition is turned to the on position.

If it illuminates when you are driving, check that the parking brake is not engaged. If the parking brake is not engaged, this indicates low brake fluid level or a brake system malfunction. Have the system checked immediately by your authorized dealer.



**WARNING:** Driving a vehicle with the brake system warning light on is dangerous. A significant decrease in braking performance may occur. It will take you longer to stop the vehicle. Have the vehicle checked by your authorized dealer as soon as possible. Driving extended distances with the parking brake engaged can cause brake failure and the risk of personal injury.



**Charging system (RTT)**

Illuminates when the battery is not charging properly. If it stays on while the engine is running, there may be a malfunction with the charging system. Contact your authorized dealer as soon as possible. This indicates a problem with the electrical system or a related component.

**Door ajar (RTT)**

Displays when the ignition is on and any door is not completely closed.

**Engine oil pressure (RTT)**

Illuminates when the oil pressure falls below the normal range.

**Engine coolant temperature (RTT)**

Illuminates when the engine coolant temperature is high. Stop the vehicle as soon as possible, switch off the engine and let cool.

**Fog lamps**

Illuminates when the fog lamps are turned on.

**Grade assist (RTT) (if equipped)**

Illuminates when grade assist is turned on.

**Heads up display (if equipped)**

A red beam of lights will illuminate on the windshield in certain instances when using adaptive cruise control and/or the collision warning system. It will also illuminate momentarily when you start your vehicle to make sure the display works.

**Hill descent (RTT) (if equipped)**

Illuminates when hill descent is turned on.

**High beams**

Illuminates when the high-beam headlamps are on.

**Low fuel (RTT)**

Illuminates when the fuel level in the fuel tank is at or near empty.

**Liftgate ajar (RTT)**

Illuminates when the ignition is on and liftgate is not completely closed.

**Low tire pressure warning**

Illuminates when your tire pressure is low. If the light remains on at start up or while driving, the tire pressure should be checked. When the ignition is first turned to on, the light will illuminate for 3 seconds to ensure the bulb is working. If the light does not turn on or begins to flash, contact your authorized dealer as soon as possible.

**Low washer fluid (RTT)**

Illuminates when the windshield washer fluid is low.

**Parking Lamps (RTT)**

It will illuminate when you switch the parking lamps on.

**Powertrain malfunction/reduced power**

Illuminates when a powertrain or an 4WD fault has been detected. Contact your authorized dealer as soon as possible.

**Safety belt**

Reminds you to fasten your safety belt. A Belt-Minder® chime will also sound to remind you to fasten your safety belt.

**Service engine soon**

The *service engine soon* indicator light illuminates when the ignition is first turned to the on position to check the bulb and to indicate whether the vehicle is ready for Inspection/Maintenance (I/M) testing. Normally, the “service engine soon” light will stay on until the engine is cranked, then turn itself off if no malfunctions are present. However, if after 15 seconds the “service engine soon” light blinks eight times, it means that the vehicle is not ready for I/M testing. See the *Readiness for inspection/maintenance (I/M) testing* in the *Fuel and Refueling* chapter.

Solid illumination after the engine is started indicates the on-board diagnostics system (OBD-II) has detected a malfunction. Refer to *On-board diagnostics (OBD-II)* in the *Fuel and Refueling* chapter. If the light is blinking, engine misfire is occurring which could damage your catalytic converter. Drive in a moderate fashion (avoid heavy acceleration and deceleration) and have your vehicle serviced immediately by your authorized dealer.



**WARNING:** Under engine misfire conditions, excessive exhaust temperatures could damage the catalytic converter, the fuel system, interior floor coverings or other vehicle components, possibly causing a fire.

**Speed control (RTT) (if equipped)**

The speed control system indicator light changes color to indicate what mode the system is in:

- On (gray light–type 1 and type 2): Illuminates when the speed control system is turned on. Turns off when the speed control system is turned off.
- Engaged (white light–type 1, green light–type 2): Illuminates when the speed control system is engaged. Turns off when the speed control system is disengaged.

**Stability Control System**

Displays when the AdvanceTrac®/Traction control is active. If the light remains on, have the system serviced immediately.

**Stability Control System Off**

Illuminates when AdvanceTrac®/Traction control has been disabled by the driver.

**Transmission Tow/Haul Feature (RTT) (if equipped)**

Displays when the Tow/Haul feature has been activated. If the light flashes steadily, have the system serviced immediately, damage to the transmission could occur.

**Turn signal**

Illuminates when the left or right turn signal or the hazard warning flasher is turned on. If the indicators stay on or flash faster, check for a burned out bulb.

**AUDIBLE WARNINGS AND INDICATORS****Key In Ignition Warning Chime**

Sounds when the key is left in the ignition in the off or accessory position and the driver's door is opened.

**Keyless Warning Alert (If Equipped)**

Sounds the horn twice when you exit your vehicle with the intelligent access key, after the last door is closed and your keyless vehicle is in RUN, indicating your vehicle is still on.

**Headlamps On Warning Chime**

Sounds when the headlamps or parking lamps are on, the ignition is off (the key is not in the ignition) and the driver's door is opened.

**Parking Brake On Warning Chime**

Sounds when you have left the parking brake on and drive your vehicle. If the warning chime remains on after you have released the parking brake, have the system checked by your authorized dealer immediately.

**GENERAL INFORMATION**

 **WARNING:** Driving while distracted can result in loss of vehicle control, crash and injury. We strongly recommend that you use extreme caution when using any device that may take your focus off the road. Your primary responsibility is the safe operation of your vehicle. We recommend against the use of any handheld device while driving and encourage the use of voice-operated systems when possible. Make sure you are aware of all applicable local laws that may affect the use of electronic devices while driving..

Various systems on your vehicle can be controlled using the information display controls on the steering wheel. Corresponding information is displayed in the information display.

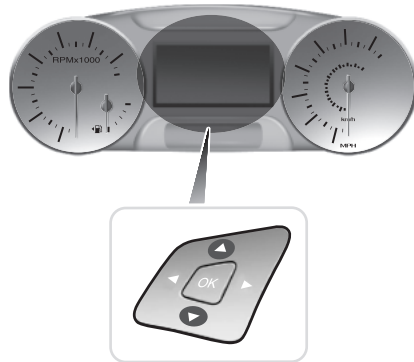
**Information Display Controls (Type 1)**

- Press the up and down arrow buttons to scroll through and highlight the options within a menu.
- Press the right arrow button to enter a sub-menu.
- Press the left arrow button to exit a menu.
- Press the OK button to choose and confirm a setting/messages.

**Menu**

You can access the menus using the information display control.

**Note:** Some options may appear slightly different or not at all if the items are optional.

†Trip 1 & 2
Distance to E
Trip Odometer
Trip Timer
Inst Fuel Econ
Average Fuel
Fuel Used
Total Odometer (located in lower right of display). <b>Note:</b> this will also display in other menus.
†See <i>Trip computer</i> later in this section for more information.
Information
Driver Alert — Displays the alertness level status.
Intelligent 4WD — Displays power distribution between the front and rear wheels. More power to either front or rear wheels will be displayed by more area filled in. Also indicates currently selected terrain management mode.
MyKey® Distance (if key is programmed) — Distance traveled when a programmed key is in use.
MyKey® Information — Number of MyKeys and admin keys programmed)
Coolant Temp. — The engine coolant indicator will change colors indicating: blue for cool, gray for normal and red for hot. If the engine coolant temperature exceeds the normal range, stop the vehicle as soon as safely possible, switch off the engine and let the engine cool.

Settings				
Driver Assist	Traction Ctrl — check enabled (default) / uncheck disabled			
	Blind Spot — check enabled (default) / uncheck disabled			
	Collision Warning	Sensitivity (if MyKey is programmed)	High, Normal or Low	
	Cross Traffic — check enabled (default) / uncheck disabled			
	Cruise Control	Adaptive or Normal		
	Driver Alert — check enabled (default) / uncheck disabled			
	Front Park Aid — check enabled (default) / uncheck disabled			
	Lane Keeping Sys	Mode	Alert, Aid or Alert +Aid	
		Intensity	High, Normal or Low	
	Rear Park Aid — check enabled (default) / uncheck disabled			
	Trailer Sway — check enabled (default) / uncheck disabled			
	Display	Language	English, Español or Français	
Units		Distance	Miles & Gal.	
			L/100km	
			km/L	
	Temperature	Fahrenheit (°F) or Celsius (°C)		

Settings			
Convenience	Auto Highbeam — check enabled (default) / uncheck disabled		
	Autolamp Delay	Off or number of seconds	
	Compass Display	Display — check enabled (default) / uncheck disabled	
		Calibrate	Hold OK to calibrate Circle slowly to calibrate Calibration complete
		Zone	Zone 1 — 15
	DTE Calculation	Normal or Towing	
	Easy Entry/Exit — check enabled (default) / uncheck disabled		
	Locks	Autolock — check enabled (default) / uncheck disabled	
		Autounlock — check enabled (default) / uncheck disabled	
		Remote Unlock	All Doors or Driver First
	Oil life Reset	Percent Oil Life XXX% — Hold OK to Reset	
	Power Liftgate	Enable or Disable switch	
	Remote Start	Climate Control	Auto or Last Setting
		Seats and Wheel	Auto or Off
		Wheel	Auto or Off
		Duration	5, 10 or 15 minutes
		System — check enabled (default) / uncheck disabled	
Windows	Remote Open or Close		
Wipers	Courtesy Wipe — check enabled (default) / uncheck disabled		
	Rain Sensing — check enabled (default) / uncheck disabled		
MyKey	Create MyKey	Hold OK to Create MyKey	
	911 Assist	Always On / User Selectable	
	Traction Control	Always On or User Selectable	
	Max Speed	80 MPH (130 km/h) or Off	
	Speed Warning	45 mph (75 km/h), 55 mph (90 km/h), 65 mph (105 km/h) or Off	
	Volume Limiter		
	Do Not Disturb	Always On / User Selectable	
	Clear MyKeys	Hold OK to Clear MyKeys	



**Trip Computer*****Resetting the Trip Computer***

Press and hold OK on the current screen to reset the respective trip, distance, time and fuel information.

***Trip Odometer***

Registers the mileage of individual journeys.

***Distance to E***

Indicates the approximate distance the vehicle will travel on the fuel remaining in the tank. Changes in driving pattern may cause the value to vary.

***Average fuel***

Indicates the average fuel consumption since the function was last reset.

***Fuel Used***

Shows the amount of fuel used for a given trip.

***Total Odometer***

Registers the total mileage of the vehicle.

**Information Messages**

See *Information Messages* later in this chapter for more information.

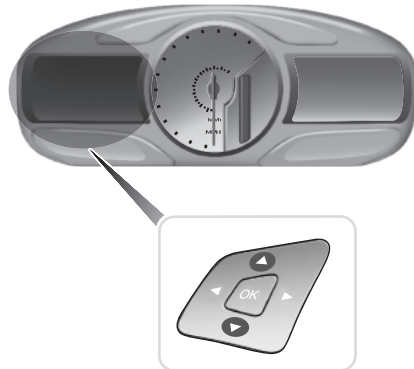
**Information Display Controls (Type 2)**

- Press the up and down arrow buttons to scroll through and highlight the options within a menu.
- Press the right arrow button to enter a sub-menu.
- Press the left arrow button to exit a menu.
- Press the OK button to choose and confirm a setting/messages.

The menu travel icon in the upper left corner displays the available button options.

**Main menu**

From the main menu bar on the left side of the information display, you can choose from the following categories:

- Display Mode
- Trip 1 & 2
- Fuel Economy
- Driver Assist
- Settings

Scroll up/down to highlight one of the categories, then press the right arrow key to enter into that category. Press the left arrow key as needed to exit back to the main menu.

**Display Mode**

Use the left/right arrow buttons to choose the following display options.

Display mode	†Option 1	Option 2	Option 3	†Option 4
XXX mi (km) to empty	X			
Bar tachometer	X			X
Round tachometer		X	X	
Engine coolant temp gauge			X	
Intelligent 4WD				X
Fuel gauge	Always Present	Always Present	Always Present	Always Present
Total odometer (lower left corner)	Always Present	Always Present	Always Present	Always Present

†Vehicles with Intelligent 4WD only. You can choose to have only the fuel gauge show in this mode. Refer to *Display > Gauge Display* found in the table under the *Settings* section later in this chapter.

Regardless of display mode chosen, when SelectShift Automatic™ transmission (SST) is activated, the cluster will change to the round tachometer if not already selected. After the round tachometer displays, other display modes with the bar tachometer can also be chosen.

- XXX mi (km) to empty: Shows approximate fuel level before the fuel tank reaches empty. The value is dynamic and can change (raise or lower) depending on driving style.

- Fuel gauge: Indicates approximately how much fuel is left in the fuel tank. The fuel gauge may vary slightly when the vehicle is in motion or on a grade. When the fuel level becomes low, the level indicator will change to amber. When the fuel level becomes critically low (0 miles [0 km] to empty), the level indicator will change to red.  
**Note:** When a MyKey® is in use, low fuel warnings will display earlier. The fuel icon and arrow indicates which side of the vehicle the fuel filler door is located.
- Bar/Round tachometer: Indicates the engine speed in revolutions per minute. Driving with your tachometer pointer continuously at the top of the scale may damage the engine. During SelectShift Automatic™ transmission (SST) use, the currently selected gear will appear in the display. Refer to *Transmission* chapter.
- Engine coolant temperature gauge: Indicates engine coolant temperature. At normal operating temperature, the level indicator will be in the normal range. If the engine coolant temperature exceeds the normal range, stop the vehicle as soon as safely possible, switch off the engine and let the engine cool.
- Intelligent 4WD (if equipped): displays power distribution between the front and rear wheels. More power to either front or rear wheels will be displayed by more area filled in. Also displays the currently selected terrain management mode.

**Trip 1 & 2**

Choose between the standard or enhanced trip display.

Trip 1 & 2	
Trip 1 & 2	Trip distance
	Average fuel economy
	Elapsed trip time
	Hold OK to Reset
Estimated amount of fuel consumed	
Total odometer (lower left corner)	
Press and hold OK to reset the currently displayed trip information.	

- Trip distance — shows the accumulated trip distance.
- Elapsed trip time— timer stops when the vehicle is turned off and restarts when the vehicle is restarted.
- Average fuel economy — shows the average fuel economy for a given trip.

**Fuel Economy**

Use the left/right arrow buttons to choose the desired fuel economy display.

Fuel Economy		
Fuel Economy	Inst Fuel Economy	XX. Min Fuel History
Instantaneous fuel usage	X	
Fuel usage over a 30 minute time span		X
Average fuel economy	Always Present	
XXX mi (km) to empty	Always Present	
Total odometer (lower left corner)		
Press and hold OK to reset the currently displayed fuel usage information.		

- Inst. Fuel Economy: This display shows a visual graph of your instantaneous fuel economy.
- XX. Min Fuel History: This display shows a bar chart of your fuel history.

**Driver Assist**

In this mode, you can configure different driver assist setting choices.

**Note:** Some items are optional and may not appear.

Driver Assist		
Traction Control — check enabled (default) / uncheck disabled		
Blindspot — check enabled (default) / uncheck disabled		
Collision Warning	Sensitivity	High / Normal / Low
Cross Traffic — check enabled (default) / uncheck disabled		
Cruise Control	Adaptive or Normal	
Driver Alert — check enabled / uncheck disabled		
Front Park Aid — check enabled (default) / uncheck disabled		
Lane Keeping	Mode	Alert / Aid / Both
	Intensity	High / Normal / Low
Rear Park Aid — check enabled (default) / uncheck disabled		
Trailer Sway — check enabled (default) / uncheck disabled		

**Settings**

In this mode, you can configure different driver setting choices.

**Note:** Some items are optional and may not appear.

Settings			
Vehicle	DTE Calculation	Normal / Towing	
	Easy Entry/Exit	— check enabled / uncheck disabled	
	Lighting	Auto highbeam	On / Off
		Autolamp Delay	Off or number of seconds
	Locks	Autolock	On / Off
		Autounlock	On / Off
		Remote Unlocking	All doors / Driver's door
	Oil Life Reset	Percent Oil Life XXX % Hold OK to Reset	
	Power Liftgate	Enabled or Disabled	
	Remote Start	Climate Control (using this feature allows you to select different climate control modes when the vehicle is started using the remote start feature)	Auto / Last Settings
		Seats and Wheel or Seats	Auto / Off
		Duration	5 / 10 /15 minutes
		System	Enable / Disable
	Windows	Remote Open or Close	
	Wipers	Courtesy Wipe	On / Off
Rain Sensing		On / Off	

Settings (cont'd)		
*MyKey	MyKey Status	MyKeys / Admin Keys
	Create MyKey	Hold OK to Create MyKey
	911 Assist	Always On / User Selectable
	Traction Control	Always On / User Selectable
	Max Speed	Choose desired speed or off
	Speed Warning	Choose desired speed or off
	Volume Limiter	On / Off
	Do Not Disturb	Always On / User Selectable
	Clear MyKeys	Hold OK to Clear All MyKeys

\*Some MyKey items will only appear if a MyKey is set.

Settings (cont'd)		
Display	Distance	Miles & GAL, l/100km or km/l
	Gauge Display	Fuel Gauge / Fuel + Tach
	Language	Select your applicable language
	Temperature	Fahrenheit (°F) / Celsius (°C)

**INFORMATION MESSAGES**

**Note:** Depending on the vehicle options equipped with your vehicle, not all of the messages will display or be available. Certain messages may be abbreviated or shortened depending upon which cluster type you have.



Press the OK button to acknowledge and remove some messages from the information display. Other messages will be removed automatically after a short time. Certain messages need to be confirmed before you can access the menus.

**Message indicators:** Some messages will be supplemented by a system specific symbol.

<b>Adaptive Cruise Control Messages</b>	<b>Action / Description</b>
Adaptive Cruise Malfunction	Displayed when a radar malfunction is preventing the ACC from engaging.
Adaptive Cruise Not Available	Displayed when conditions exist such that the adaptive cruise cannot function properly.
Adaptive Cruise Not Available Sensor Blocked	Displayed when the radar is blocked because of poor radar visibility due to bad weather or ice/mud/water in front of radar. Driver can typically clean the sensor to resolve.
<b>AdvanceTrac® / Traction Control Messages</b>	<b>Action / Description</b>
Service AdvanceTrac	Displayed when the AdvanceTrac® system has detected a condition that requires service. Contact your authorized dealer as soon as possible.
Trailer Sway Reduce Speed	Displayed when the trailer sway control has detected trailer sway.
<b>Alarm/Security Messages</b>	<b>Action / Description</b>
To Stop Alarm, Start Vehicle	Displayed when the perimeter alarm system is armed and the vehicle is entered using the key on the driver's side door. In order to prevent the perimeter alarm system from triggering, the ignition must be turned to start or on before the 12 second chime expires.

AWD/4WD Messages	Action / Description
AWD Off	Displayed when the system has been automatically disabled to protect itself. This is caused by operating the vehicle with the compact spare tire installed or if the system is overheating. The system will resume normal function and clear this message after driving a short distance with the road tire re-installed or after the system is allowed to cool.
Check AWD	Displayed in conjunction with the powertrain malfunction/reduced power light when the system is not operating properly. If the warning stays on or continues to come on, contact your authorized dealer as soon as possible.
Battery and Charging System Messages	Action / Description
Check Charging System	Displayed when the charging system needs servicing. If the warning stays on or continues to come on, contact your authorized dealer as soon as possible.
Turn Power Off to Save Battery	<p>Displayed when the battery management system determines that:</p> <ul style="list-style-type: none"> <li>• the battery is at a low state of charge or,</li> <li>• the ignition has been in accessory position or on position with the engine off for approximately 45 minutes.</li> </ul> <p>Turn the ignition off as soon as possible to protect the battery. This message will clear once the vehicle has been started and the battery state of charge has recovered. Turning off unnecessary electrical loads will allow faster battery state-of-charge recovery.</p>



<b>Battery and Charging System Messages</b>	<b>Action / Description</b>
Transport Mode Contact Dealer	Contact your authorized dealer as soon as possible.
Factory Mode Contact Dealer	Contact your authorized dealer as soon as possible.
Low Battery Features Tempor. Turned Off	Displayed when the battery management system detects an extended low-voltage condition. Various vehicle features will be disabled to help preserve the battery. Turn off as many of the electrical loads as soon as possible to improve system voltage. If the system voltage has recovered, the disabled features will operate again as normal.
<b>BLIS® Messages</b>	<b>Action / Description</b>
Blind Spot Not Available Sensor Blocked	Displayed when the blind spot information system/cross traffic alert system sensors are blocked. Driver can typically clean the sensor to resolve.
Blind Spot System Fault	Displayed when a fault with the blind spot information system has occurred. Contact your authorized dealer as soon as possible.
Cross Traffic Not Available Sensor Blocked	Displayed when the blind spot information system/cross traffic alert system sensors are blocked. Driver can typically clean the sensor to resolve.
Cross Traffic System Fault	Displayed when a fault with the cross traffic alert system has occurred. Contact your authorized dealer as soon as possible.
Vehicle Coming From X	Displayed when the blind spot information system with cross traffic alert (CTA) system is operating and senses a vehicle.

<b>Brake System Messages</b>	<b>Action / Description</b>
Brake Fluid Level Low	Indicates the brake fluid level is low and the brake system should be inspected immediately.
Check Brake System	Displayed when the brake system needs servicing. If the warning stays on or continues to come on, contact your authorized dealer as soon as possible.
Park Brake Engaged	Displayed when the parking brake is set, the engine is running and the vehicle is driven more than 3 mph (5 km/h). If the warning stays on after the parking brake is released, contact your authorized dealer as soon as possible.
<b>Collision Warning System Messages</b>	<b>Action / Description</b>
Collision Warn Not Available	Displayed when there is a system malfunction with the collision warning system. The system will be disabled. Contact your authorized dealer as soon as possible.
Collision Warn Not Available Sensor Blocked	Displayed when the collision warning system radar is blocked because of poor radar visibility due to bad weather or ice/mud/water in front of the radar. Driver can typically clean the sensor to resolve. Contact your authorized dealer as soon as possible.
Collision Warning Malfunction	Displayed when there is a system malfunction with the collision warning system. The system will be disabled. Contact your authorized dealer as soon as possible.

<b>Door Messages</b>	<b>Action / Description</b>
X Door Ajar	Displayed when a door is not completely closed.
Liftgate Ajar	Displayed when the liftgate is not completely closed.
<b>Driver Alert Messages</b>	<b>Action / Description</b>
Driver Alert Warning Rest Now	Stop and rest as soon as it is safe to do so.
Driver Alert Warning Rest suggested	Take a rest break soon.
<b>Fuel Messages</b>	<b>Action / Description</b>
Check Fuel Fill Inlet	Displayed when the fuel fill inlet may not be properly closed.
Fuel Level Low	Displayed as an early reminder of a low fuel condition.
<b>Keys and Intelligent Access Messages</b>	<b>Action / Description</b>
No Key Detected	Displayed if the intelligent access key is not detected by the system in the following three scenarios: <ul style="list-style-type: none"> <li>•When the start/stop button is pressed in an attempt to either start the engine or cycle through the ignition states.</li> <li>•When the engine is running and a door is opened then closed.</li> <li>•When the vehicle's speed exceeds 10 mph (16 km/h) for the first time after starting.</li> </ul>
Key Programmed x Keys Total	Displayed during spare key programming, when an intelligent access key is programmed to the system.
Max Number of Keys Programmed	Displayed during spare key programming when the maximum number of keys have been programmed.

<b>Keys and Intelligent Access Messages</b>	<b>Action / Description</b>
Press Brake to Start	Displayed when the start/stop button is pressed without the brake pedal being applied. This is a reminder that the brake pedal must be applied when the start/stop button is pressed in order to start the engine.
Restart Now or Key is Needed	Displayed when the start/stop button is pressed to shut off the engine and a Intelligent Access Key is not detected inside the vehicle.
Accessory Power Active	Displayed when the vehicle is in the accessory ignition state.
Starting System Fault	This message is displayed when there is a problem with your vehicle's starting system. See your authorized dealer for service.
<b>Lane Keeping System Messages</b>	<b>Action / Description</b>
Lane keeping Sys. Malfunction Service required	The system has malfunctioned. Contact your authorized dealer as soon as possible.
Front Camera Temporarily Not Available	The system has detected a condition that has caused the system to be temporarily unavailable.
Front Camera Low Visibility Clean Screen	The system has detected a condition the requires the windshield to be cleaned to operate properly.
Front Camera Malfunction Service Required	The system has malfunctioned. Contact your authorized dealer as soon as possible.
Keep Hands on Steering Wheel	Displayed when the system requests the driver to keep their hands on the steering wheel.

## Information Displays

<b>Maintenance Messages</b>	<b>Action / Description</b>
LOW Engine Oil Pressure	Stop the vehicle as soon as safely possible, turn off the engine. Check the oil level. If the warning stays on or continues to come on with your engine running, contact your authorized dealer as soon as possible.
Change Engine Oil Soon	Displayed when the engine oil life remaining is 10% or less.
Oil Change Required	Displayed when the oil life left reaches 0%.
Engine Coolant Over Temp	Displayed when the engine coolant temperature is excessively high.
Washer Fluid Level Low	Indicates the washer fluid reservoir is less than one quarter full. Check the washer fluid level.
Steering Malfunction Service Now	Displays when the steering system needs service. See your authorized dealer.
Service Power Steering	The power steering system has detected a condition that requires service. See your authorized dealer.
Service Power Steering Now	The power steering system has detected a condition within the power steering system that requires service immediately. See your authorized dealer.
Power Steering Assist Fault	The power steering system has disabled power steering assist due to a system error. See your authorized dealer.
<b>MyKey® Messages</b>	<b>Action / Description</b>
MyKey active Drive Safely	Displayed when MyKey® is active.
MyKey not Created	Displayed during key programming when MyKey® cannot be programmed.
Speed Limited to xx MPH/km/h	Displayed when starting the vehicle and MyKey® is in use and the MyKey speed limit is on.

<b>MyKey® Messages</b>	<b>Action / Description</b>
Vehicle Near MyKey Top Speed	Displayed when a MyKey® is in use and the MyKey speed limit is on and the vehicle speed is 80 mph (130 km/h).
Vehicle Near MyKey Top Speed	Displayed when a MyKey® is in use and the MyKey speed limit is on and the vehicle speed is approaching 80 mph (130 km/h).
Check Speed Drive Safely	Displayed when a MyKey® is in use and the optional setting is on and the vehicle exceeds a preselected speed.
Buckle Up to Unmute Audio	Displayed when a MyKey® is in use and Belt-Minder® is activated.
Could Not Program Key	Displayed when an attempt is made to program a spare key using two existing MyKeys.
<b>Park Aid / Active Park Messages</b>	<b>Action / Description</b>
Check Park Aid	Displayed when the transmission is in R (Reverse) and the park aid is disabled.
Check Rear Park Aid	Displayed when the transmission is in R (Reverse) and the park aid is disabled.
Rear Park Aid On Off	Displays the rear park aid status.
Active Park Fault	Displayed when a fault has occurred with the active park assist system.
<b>Passenger Sensing System Messages</b>	<b>Action / Description</b>
Remove Objects Near Passenger Seat	Displayed when objects are by the passenger seat. After the objects are moved away from the seat, if the warning stays on or continues to come on contact your authorized dealer as soon as possible.

<b>Reminder Messages</b>	<b>Action / Description</b>
Steering Lock Turn Wheel to Unlock	Displays when you need to turn the steering wheel in order to disengage the steering lock.
Shift to Park	Displays as a reminder to shift into park if gear shift lever is not in park and a door is opened.
Engine On	Displays when the driver's door is opened, the vehicle is in park and the engine is on.
<b>Remote Start</b>	<b>Action / Description</b>
To Drive: Turn Key to On	Displays as a reminder to turn the key on to drive the vehicle after a remote start.
To Drive: Press Brake and START Button	Displays as a reminder to apply the brake and the start button to drive the vehicle after a remote start.
<b>Terrain Management / Off Road / Hill Descent Messages</b>	<b>Action / Description</b>
For Hill Descent Reduce Speed XX MPH/km/h or Less	Displayed when hill descent speed exceeds 20 MPH (32 KM/H).
For Hill Descent Shift into Gear	Displayed when hill descent control mode requires driver shift transmission into gear.
Driver Resume Control	Displayed when the hill control mode requires the driver to resume control.
Hill Descent Control Active	Displayed when hill descent control mode is activated.
Hill Descent Control FAULT	Displayed when a hill descent system fault is present.
Hill Descent Control Off	Displayed when hill descent control mode is deactivated.
Hill Descent Control OFF System Cooling	Displayed when hill descent control mode is disabled to cool the brake system.

<b>Terrain Management / Off Road / Hill Descent Messages</b>	<b>Action / Description</b>
Hill Descent Control Ready	Displayed when hill descent control mode is activated.
Terrain Management Normal Mode	Displays driver selected terrain management normal mode.
Normal Mode Active	Displays terrain management normal mode is currently active.
Terrain Management Snow Mode	Displays driver selected terrain management snow, grass, gravel mode.
Snow, Gravel, Grass Mode Active	Displays terrain management snow, gravel, grass mode is currently active.
Terrain Management Mud, Ruts Mode	Displays driver selected terrain management mud, ruts mode.
Mud, Rut Mode Active	Displays terrain management mud, ruts mode is currently active.
Terrain Management Sand Mode	Displays driver selected terrain management sand mode.
Sand Mode Active	Displays terrain management sand mode is currently active.
Mode Change Not Accepted, Retry	Displayed when terrain management mode cannot be changed at time of driver request.
Terrain Management System Fault	Displays when the terrain management system detects an error.



Tire Messages	Action / Description
Low Tire Pressure	Displays when one or more tires on your vehicle have low tire pressure.
Tire Pressure Monitor Fault	Displays when the tire pressure monitoring system is malfunctioning. If the warning stays on or continues to come on, contact your authorized dealer.
Tire Pressure Sensor Fault	Displayed when a tire pressure sensor is malfunctioning, or your spare tire is in use. For more information on how the system operates under these conditions, refer to <i>Tire Pressure Monitoring System (TPMS)</i> in the <i>Wheels and tires</i> chapter. If the warning stays on or continues to come on, contact your authorized dealer as soon as possible.

## MANUAL CLIMATE CONTROL

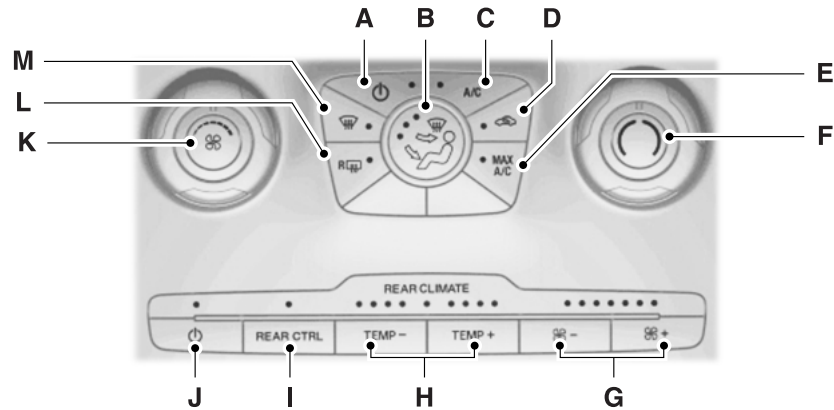

A. **Power:** Press the button to turn the system on and off. Switching off the climate control system prevents outside air from entering the vehicle.

B. **Air distribution control:** Press these buttons to turn airflow from the windshield, instrument panel, or footwell vents on or off. The system can distribute air through any combination of these vents.

C. **A/C:** Press the button to turn air conditioning compressor on or off. Use air conditioning with recirculated air to improve cooling performance and efficiency.

D. **Recirculated air:** Press the button to switch between outside air and recirculated air. When recirculated air is selected, the air currently in the passenger compartment recirculates. This may reduce the time needed to cool the interior (when used with **A/C**) and may also reduce unwanted odors from entering your vehicle.

**Note:** Recirculated air may turn off automatically (or be prevented from turning on) in all airflow modes except **MAX A/C** to reduce risk of fogging.

E. **MAX A/C:** Turn the temperature control dial all the way past the full cool position to maximize cooling. Recirculated air flows through the instrument panel vents, air conditioning automatically turns on, and the fan automatically adjusts to the highest speed.

F. **Front temperature control:** Controls the temperature of the airflow in the front of your vehicle. Adjust to select the desired temperature.

G. **Rear fan speed control:** Controls the volume of air circulated in the rear of your vehicle. Press **+** or **-** to select the desired fan speed.

H. **Rear temperature control:** Controls the temperature of the airflow in the rear of your vehicle. Press **TEMP +** and **TEMP -** to select the desired temperature.

I. **REAR CTRL:** Press to change control of the rear climate controls system from the front controls to the rear controls.

J. **Rear climate control system power:** Press the button to turn the rear climate system on and off.

K. **Front fan speed control:** Controls the volume of air circulated in your vehicle. Adjust to select the desired fan speed.

L. **Heated rear window:** Turns the heated rear window on and off. See *Heated windows and mirrors* later in this chapter for more information.

M. **Defrost:** Press the button to distribute air to the windshield vents and de-mister. Air distribution to instrument panel and footwell vents turn off. You can use this setting to defog and clear the windshield of a thin covering of ice.

## AUTOMATIC CLIMATE SYSTEM (WITH SONY® AUDIO SYSTEM)

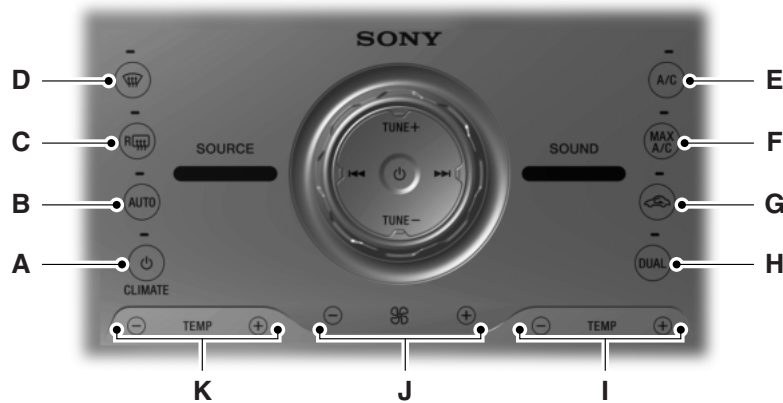

**Note:** You can switch temperature units between Fahrenheit and Celsius. See *Menu features* in the *MyFord Touch* or *MyLincoln Touch* chapter.

A. **CLIMATE:** Press the button to turn the system on and off. Switching off the climate control system prevents outside air from entering the vehicle.

B. **AUTO:** Press the button to turn on automatic operation. Select the desired temperature using the temperature control. The system adjusts fan speed, air distribution, air conditioning operation, and selects outside air or recirculated air to heat or cool the vehicle in order to maintain the desired temperature. You can also use the **AUTO** button to turn off dual zone operation by pressing and holding the button for more than two seconds.

C. **Heated rear window:** Turns the heated rear window on and off. See *Heated windows and mirrors* later in this chapter for more information. If your vehicle is equipped with heated mirrors, this button turns them on also.

D. **Defrost:** Press the button to distribute air to the windshield vents and de-mister. Air distribution to instrument panel and footwell vents turn off. You can use this setting to defog and clear the windshield of a thin covering of ice.

E. **A/C**: Press the button to turn air conditioning compressor on or off. Use air conditioning with recirculated air to improve cooling performance and efficiency.

F. **MAX A/C**: Press the button to maximize cooling. Recirculated air flows through the instrument panel vents, air conditioning automatically turns on, and the fan automatically adjusts to the highest speed.

G. **Recirculated air**: Press the button to switch between outside air and recirculated air. When you select recirculated air, the air currently in the passenger compartment recirculates. This may reduce the time needed to cool the interior (when used with **A/C**) and may reduce unwanted odors from entering your vehicle.

**Note:** Recirculated air may turn off automatically (or be prevented from turning on) in all airflow modes except **MAX A/C** to reduce risk of fogging.

H. **DUAL**: Press the button to allow the passenger to set their temperature independent of the driver temperature.

I. **Passenger temperature control**: Press **+** or **-** to increase or decrease the air temperature on the passenger side of the vehicle. This turns on dual zone mode.

J. **Fan speed control**: Press **+** or **-** to increase or decrease the volume of air circulated in the vehicle.

K. **Driver temperature control**: Press **+** or **-** to increase or decrease the air temperature for the driver side of the vehicle. This control also adjusts the passenger side temperature when not in dual zone mode.

## AUTOMATIC CLIMATE CONTROL (WITH MyTemp)

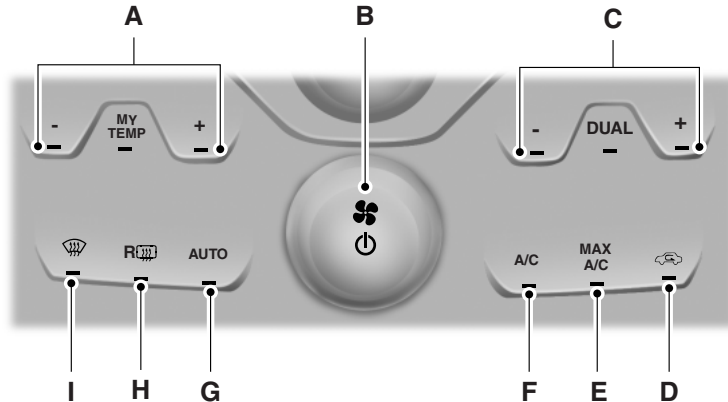

**Note:** You can switch temperature units between Fahrenheit and Celsius. See *Settings* in the *MyFord Touch* or *MyLincoln Touch* chapter.

A. **MyTemp:** Allows you to quickly adjust to a frequently used setting with a single touch.

Press **+** or **-** to increase and decrease the temperature.

Touch and hold **MyTemp** to save the current temperature. To access the setting again, touch the **MyTemp** indicator again.

B. **Power/Fan speed control:** Press the button to turn the system on and off. Switching off the climate control system prevents outside air from entering the vehicle.

Turn to increase or decrease the volume of air circulated in the vehicle.

C. **DUAL:** Press the button to allow the passenger to set their temperature independent of the driver temperature.

D. **Recirculated air:** Press the button to switch between outside air and recirculated air. When you select recirculated air, the air currently in the passenger compartment recirculates. This may reduce the time needed to cool the interior (when used with **A/C**) and may reduce unwanted odors from entering your vehicle.

**Note:** Recirculated air may turn off automatically (or be prevented from turning on) in all airflow modes except **MAX A/C** to reduce risk of fogging.

E. **MAX A/C:** Press the button to maximize cooling. Recirculated air flows through the instrument panel vents, air conditioning automatically turns on, and the fan automatically adjusts to the highest speed.

F. **A/C:** Press the button to turn air conditioning compressor on or off. Use air conditioning with recirculated air to improve cooling performance and efficiency.

G. **AUTO:** Press the button to turn on automatic operation. Select the desired temperature using the temperature control. The system adjusts fan speed, air distribution, air conditioning operation, and selects outside air or recirculated air to heat or cool the vehicle in order to maintain the desired temperature. You can also use the **AUTO** button to turn off dual zone operation by pressing and holding the button for more than two seconds.

H. **Heated rear window:** Turns the heated rear window on and off. See *Heated windows and mirrors* later in this chapter for more information. If your vehicle is equipped with heated mirrors, this button turns them on also.

I. **Defrost:** Press the button to distribute air to the windshield vents and de-mister. Air distribution to instrument panel and footwell vents turn off. You can use this setting to defog and clear the windshield of a thin covering of ice.

#### REAR PASSENGER CLIMATE CONTROLS

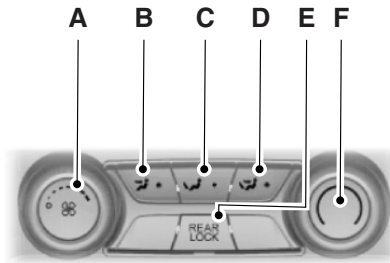

A. **Fan control:** Controls the volume of air circulated in the rear of your vehicle. Adjust to select the desired fan speed.

B. **Panel:** Press to select air flow direction to the panel.

C. **Floor:** Press to direct air flow to the floor vents.

D. **Panel and floor:** Press to direct air flow to the panel and floor vents.

E. **REAR LOCK:** Illuminates when the rear (auxiliary) climate system is being controlled by the front controls. The rear (auxiliary) climate controls do not work when this graphic is illuminated

F. **Temperature control:** Controls the temperature of the airflow in the rear of your vehicle.

### GENERAL OPERATING TIPS

#### General Hints

**Note:** Prolonged use of recirculated air may cause the windows to fog up.

**Note:** You may feel a small amount of air from the footwell air vents regardless of the air distribution setting.

**Note:** To reduce humidity build-up inside your vehicle, do not drive with the system switched off or with recirculated air always switched on.

**Note:** Do not place objects under the front seats as this may interfere with the airflow to the rear seats.

**Note:** Remove any snow, ice or leaves from the air intake area at the base of the windshield.

**Note:** To improve the time to reach comfort in hot weather, drive with the windows slightly open for 2-3 minutes after start-up or until your vehicle airs out.

#### Manual Climate Control

**Note:** To reduce fogging of the windshield during humid weather, adjust the air distribution control to the windshield air vents position.

#### Automatic Climate Control

**Note:** Adjusting the settings when your vehicle interior is extremely hot or cold is not necessary. The system automatically adjusts to heat or cool the cabin to your selected temperature as quickly as possible. For the system to function efficiently, the instrument panel and side air vents should be fully open.

**Note:** If you select **AUTO** during cold outside temperatures, the system directs airflow to the windshield and side window vents. In addition, the fan may run at a slower speed until the engine warms up.

**Note:** If you select **AUTO** during hot outside temperatures, or when the inside of the vehicle is hot, the system automatically uses recirculated air to maximize interior cooling. When the interior reaches the selected temperature, the system automatically switches to using outside air.



**Heating the Interior Quickly**

	<b>Vehicles with manual climate control</b>	<b>Vehicles with automatic climate control</b>
1	Adjust the fan speed to the highest speed setting.	Press the <b>AUTO</b> button.
2	Adjust the temperature control to the highest setting.	Adjust the temperature control to the desired setting.
3	Select the footwell air vents using the air distribution buttons.	

**Recommended Settings for Heating**

	<b>Vehicles with manual climate control</b>	<b>Vehicles with automatic climate control</b>
1	Adjust the fan speed to the center setting.	Press the <b>AUTO</b> button.
2	Adjust the temperature control to the midway point of the hot settings.	Adjust the temperature control to the desired setting. Use 72°F (22°C) as a starting point, then adjust the setting as necessary.
3	Select the footwell air vents using the air distribution buttons.	

**Cooling the Interior Quickly**

	<b>Vehicles with manual climate control</b>	<b>Vehicles with automatic climate control</b>
1	Adjust the temperature control to the <b>MAX A/C</b> position.	Press the <b>MAX A/C</b> button.
2	Drive with the windows open for 2-3 minutes.	

**Recommended Settings for Cooling**

	<b>Vehicles with manual climate control</b>	<b>Vehicles with automatic climate control</b>
1	Adjust the fan speed to the center setting.	Press the <b>AUTO</b> button.
2	Adjust the temperature control to the midway point of the cold settings.	Adjust the temperature control to the desired setting. Use 72°F (22°C) as a starting point, then adjust the setting as necessary.
3	Select the instrument panel air vents using the air distribution buttons.	

**Side Window Defogging in Cold Weather**

	<b>Vehicles with manual climate control</b>	<b>Vehicles with automatic climate control</b>
1	Select the instrument panel and footwell air vents positions through the air distribution control.	Press the defrost button.
2	Press the <b>A/C</b> button.	Adjust the temperature control to the desired setting. Use 72°F (22°C) as a starting point, then adjust the setting as necessary.
3	Adjust the temperature control to the desired setting.	
4	Adjust the fan speed to the highest setting.	
5	Direct the instrument panel side air vents toward the side windows.	
6	Close the instrument panel vents.	

**HEATED WINDOWS AND MIRRORS (IF EQUIPPED)****Heated Rear Window**

**Note:** The ignition must be switched on to use this feature.

Press the button to clear the rear window of thin ice and fog. Press the button again within 10 minutes to switch it off. It switches off automatically after 10 minutes, or when you switch the ignition off.

**Do not use razor blades or other sharp objects to clean the inside of the rear window or to remove decals from the inside of the rear window. This may cause damage to the heated grid lines. Your warranty does not cover this damage.**

**Heated Exterior Mirrors (If Equipped)**

**Note:** Do not remove ice from the mirrors with a scraper or attempt to readjust the mirror glass that has frozen in place. These actions could cause damage to the glass and mirrors.

**Note:** Do not clean the housing or glass of any mirror with harsh abrasives, fuel or other petroleum-based cleaning products.

Both mirrors heat to remove ice, mist and fog when you switch on the heated rear window.

**CABIN AIR FILTER**

**Note:** Make sure you have a cabin air filter installed at all times. This prevents foreign objects from entering the system. Running the system without a filter in place could result in degradation or damage to the system.

Your vehicle is equipped with a cabin air filter, which is located just in front of the windshield under the cowl grille on the passenger side of your vehicle.

The particulate air filtration system reduces the concentration of airborne particles, such as dust, spores and pollen, in the air supplied to the interior of your vehicle. The particulate filtration system gives the following benefits to customers:

- Improves the customer's driving comfort by reducing particle concentration.
- Improves the interior compartment cleanliness.
- Protects the climate control components from particle deposits.

For more information regarding the interval at which you should replace the cabin air filter, see the *Scheduled Maintenance* chapter.

For additional cabin air filter information, or to replace the filter, see an authorized dealer.

### REMOTE START (IF EQUIPPED)

The remote start feature allows you to pre-condition the interior of your vehicle. The climate control system works to achieve comfort according to your previous settings.

**Note:** You cannot adjust the system during remote start operation.

Turn the ignition on to return the system to its previous settings. You can now make adjustments normally, but you need to turn certain vehicle-dependent features back on, such as:

- Heated seats.
- Cooled seats.
- Heated steering wheel.
- Heated mirrors.
- Heated rear window.

You can adjust the default remote start settings using the information display controls. See the *Information Displays* chapter.

### Automatic Settings

In hot weather, the system is set to 72°F (22°C). The cooled seats are set to high (if available, and selected to AUTO in the information display).

In moderate weather, the system either heats or cools (based on previous settings). The rear defroster, heated mirrors and heated seats do not automatically turn on.

In cold weather, the system is set to 72°F (22°C). The heated seats are set to high (if available, and selected to AUTO in the information display). The rear defroster and heated mirrors automatically turn on.

**SITTING IN THE CORRECT POSITION**

 **WARNING:** Sitting improperly out of position or with the seat back reclined too far can take off weight from the seat cushion and affect the decision of the passenger sensing system, resulting in serious injury or death in a crash. Always sit upright against your seat back, with your feet on the floor.

 **WARNING:** Do not recline the seat back as this can cause the occupant to slide under the seat's safety belt, resulting in severe personal injury in the event of a crash.

 **WARNING:** Do not place objects higher than the seat backs to reduce the risk of injury in a crash or during heavy braking or when stopping suddenly.

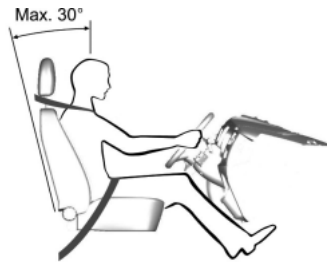

When you use them properly, the seat, head restraint, safety belt and airbags will provide optimum protection in the event of a crash.

We recommend that you follow these guidelines:

- Do not recline the seat back more than 30 degrees from vertical.
- Sit in an upright position with the base of your spine as far back as possible.
- Adjust the head restraint so that the top of it is level with the top of your head and as far forward as possible, remaining comfortable.
- Keep sufficient distance between yourself and the steering wheel. We recommend a minimum of 10 inches (25 centimeters) between your breastbone and the airbag cover.
- Hold the steering wheel with your arms slightly bent.

- Bend your legs slightly so that you can press the pedals fully.
- Position the shoulder strap of the safety belt over the center of your shoulder and position the lap strap tightly across your hips.

Make sure that your driving position is comfortable and that you can maintain full control of your vehicle.

### HEAD RESTRAINTS

 **WARNING:** To minimize the risk of neck injury in the event of a crash, the driver and passenger occupants should not sit in or operate the vehicle until the head restraint is placed in its proper position. The driver should never adjust the head restraint while the vehicle is in motion.

 **WARNING:** The adjustable head restraint is a safety device. Whenever possible it should be installed and properly adjusted when the seat is occupied.

 **WARNING:** Install the head restraint properly to minimize the risk of neck injury in the event of a crash.

**Note:** Before adjusting any head restraint, adjust the seat back to an upright driving or riding position. Properly adjust the head restraint so that the top of the head restraint is even with the top of your head and positioned as close as possible to the back of your head. For occupants of extremely tall stature, adjust the head restraint to its full up position.

To adjust the head restraint, do the following:

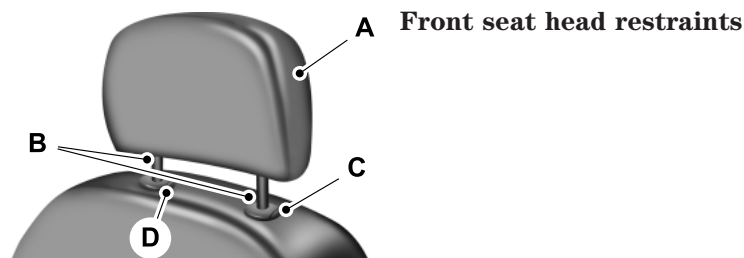

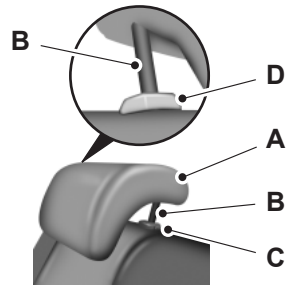

**Second-row center seat head restraint (if equipped)**

The head restraints consist of:

- A. Energy absorbing head restraint
- B. Steel stems
- C. Guide sleeve adjust and release button
- D. Guide sleeve unlock and remove button

- Raise: Pull up on the head restraint (A).
- Lower: Press and hold the guide sleeve adjust and release button (C) and push down on the head restraint (A).
- Remove: Pull up the head restraint until it reaches the highest adjustment position and then press and hold both the adjust and release button (C) and the unlock and remove button (D), then pull up on the head restraint.
- Reinstall: Align the steel stems into the guide sleeves and push the head restraint down until it locks.

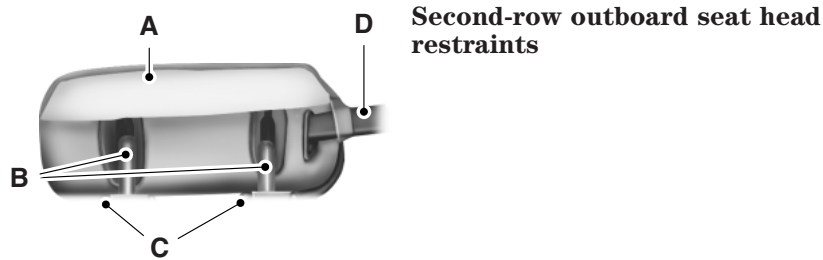

**Second-row outboard seat head restraints**

The head restraints consist of:

- A. Energy absorbing head restraint
- B. Steel stems
- C. Guide sleeve unlock and remove buttons
- D. Fold strap

- Fold: Pull the fold strap (D). Pull it back up to reset.
- Remove: Fold the head restraint. Press and hold both of the unlock and remove buttons (C), then pull up on the head restraint.
- Reinstall: Align the steel stems into the guide sleeves and push the head restraint down until it locks.

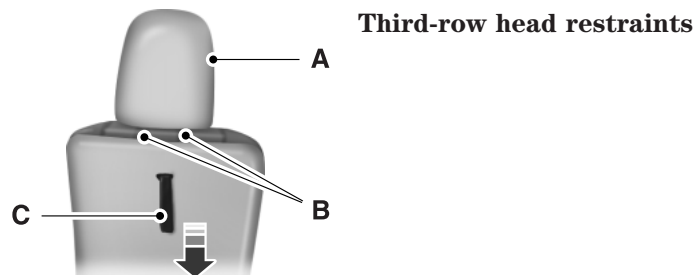

**Third-row head restraints**

The head restraints consist of:

- A. Energy absorbing head restraint
- B. Steel stems
- C. Fold strap

Fold: Pull the fold strap (C). Pull it back up to reset.

**Note:** Press the stow or fold button on the power folding seats to automatically fold the head restraint.



**Tilting Head Restraints (If Equipped)**

The front head restraints may tilt for extra comfort. To tilt the head restraint, do the following:



1. Adjust the seatback to an upright driving or riding position.
2. Tilt the head restraint forward by gently pulling the top of the head restraint.

Once it is in its forward-most position, tilt it forward once more to release it to the upright position.

**Note:** Do not attempt to force the head restraint backward after it is tilted. Instead, continue tilting it forward until the head restraint releases to the upright position.

**MANUAL SEATS**

**WARNING:** Always drive and ride with your seatback upright and the lap belt snug and low across the hips.

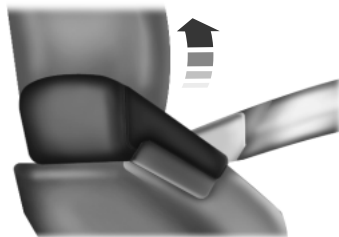
**Recline adjustment**

**WARNING:** Do not adjust the driver seat or seatback while the vehicle is moving.

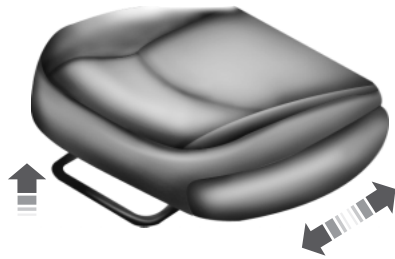

**Moving the seats backward and forward**



**WARNING:** Rock the seat backward and forward after releasing the lever to make sure that it is fully engaged.



**Lumbar adjustment (if equipped)**

#### **POWER SEATS (IF EQUIPPED)**



**WARNING:** Never adjust the driver seat or seatback when the vehicle is moving.



**WARNING:** Before returning the seatback to its original position, make sure that cargo or any objects are not trapped behind the seatback.

**Power Seat Adjustments**

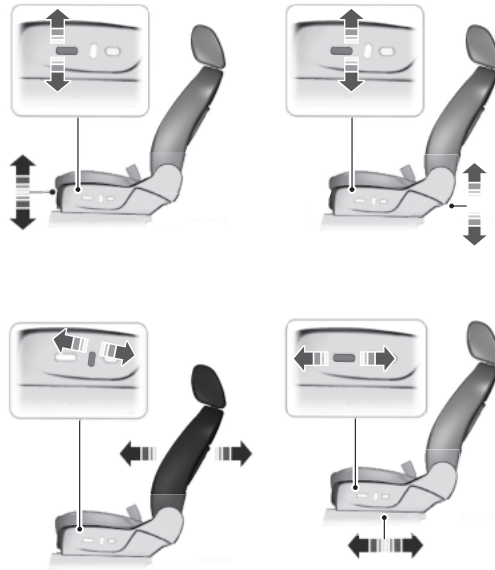

**Power Lumbar**

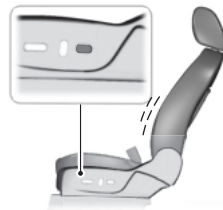

**MEMORY FUNCTION (IF EQUIPPED)**

This memory control, located on the driver door, allows automatic positioning of the driver seat and power mirrors to three programmable positions. You may also have this feature for the steering column and power adjustable foot pedals.

**Programming a memory position**

**Note:** You can program a memory position at any time.

- To program position 1, move the memory features to the desired positions using the associated controls. Press and hold button 1 for at least two seconds. A chime will sound confirming that a memory position has been set.
- To program position 2 and 3, repeat the previous procedure using the respective buttons.

**Recalling a memory position**

You can recall a programmed memory position:

- In any gearshift position if the ignition is not on.
- Only in park (P) or neutral (N) if the ignition is on.

Press the desired memory control to recall a memory position.

**Recalling memory positions with the remote control**

You can recall memory positions when you press unlock on your remote control (if the transmitter is programmed to a memory position) or, when you enter a valid personal entry code that is programmed to a memory position. If the easy entry feature is enabled, the seat will first move to the easy entry position. The seat will move to the final position when the key is in the ignition or when the push button start system (if equipped) is put in accessory mode or started.

To program the memory feature to a remote control, see the *Keys and Remote Control* chapter.

**Easy Entry and Exit Feature (If Equipped)**

This feature can move the seat rearward and the optional steering column up and forward to allow extra room to exit the vehicle.

This occurs when:

- You place the transmission in neutral (N) or park (P), and
- You switch the ignition off.

The seat and steering wheel will move to their original positions when:

- You place the transmission in neutral (N) or park (P), and
- You switch the ignition on.

Turn the Easy Entry/Exit feature on or off through the information display settings menu. See the *Information Displays* chapter.

**HEATED SEATS (IF EQUIPPED)**

**WARNING:** Persons who are unable to feel pain to the skin because of advanced age, chronic illness, diabetes, spinal cord injury, medication, alcohol use, exhaustion, or other physical conditions, must exercise care when using the seat heater. The seat heater may cause burns even at low temperatures, especially if used for long periods of time. Do not place anything on the seat that insulates against heat, such as a blanket or cushion, because this may cause the seat heater to overheat. Do not puncture the seat with pins, needles, or other pointed objects because this may damage the heating element which may cause the seat heater to overheat. An overheated seat may cause serious personal injury.

The heated seats will only function when the ignition is in the on position.

**Note:** Do not do the following:

- Place heavy objects on the seat
- Operate the seat heater if water or any other liquid is spilled on the seat. Allow the seat to dry thoroughly.

To operate the heated seats:



Press the heated seat symbol to cycle through the various heat settings and off. Warmer settings are indicated by more indicator lights.

## HEATED AND COOLED SEATS (IF EQUIPPED)

### Heated Seats



**WARNING:** Persons who are unable to feel pain to the skin because of advanced age, chronic illness, diabetes, spinal cord injury, medication, alcohol use, exhaustion, or other physical conditions, must exercise care when using the seat heater. The seat heater may cause burns even at low temperatures, especially if used for long periods of time. Do not place anything on the seat that insulates against heat, such as a blanket or cushion, because this may cause the seat heater to overheat. Do not puncture the seat with pins, needles, or other pointed objects because this may damage the heating element which may cause the seat heater to overheat. An overheated seat may cause serious personal injury.

The heated seats will only function when the engine is running.

**Note:** Do not do the following:

- Place heavy objects on the seat
- Operate the seat heater if water or any other liquid is spilled on the seat. Allow the seat to dry thoroughly.

To operate the heated seats:



Press the heated seat symbol to cycle through the various heat settings and off. Warmer settings are indicated by more indicator lights.

If the engine falls below 350 RPM while the heated seats are on, the feature will turn itself off. You will need to reactivate it.

**Cooled Seats**

The cooled seats will only function when the engine is running.

To operate the cooled seats:



Press the cooled seat symbol to cycle through the various cooling settings and off. Cooler settings are indicated by more indicator lights.

If the engine falls below 350 RPM while the cooled seats are on, the feature will turn itself off. You will need to reactivate it.

**Note:** When the heated or cooled front seat is active, you will be able to hear the fan operating inside the seat. This is normal.

**Heated and Cooled Seat Air Filter Replacement (If Equipped)**

The climate controlled seat system includes air filters. You must replace them periodically. See the *scheduled maintenance information*.

Locate the filters under each front seat and access them from the second-row foot-well area. Move the front seats all the way forward and to the full up positions to ease access.

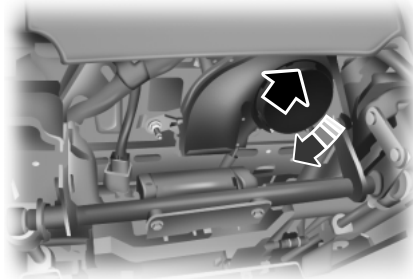

To remove an air filter:

1. Turn the vehicle off.
2. Push up on the outside rigid edge of the filter and rotate counterclockwise once the tabs are released, then remove the filter.

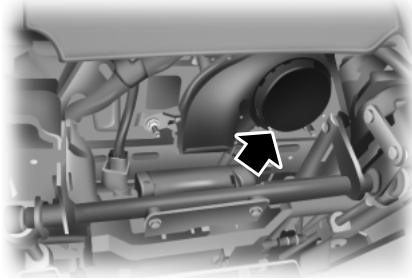

To install a filter:

1. First, position the filter in its housing making sure that the far forward end is all the way up in the housing.
2. Push in on the center of the outside edge of the filter and rotate up into the housing until it clips into position.

## REAR SEATS

### Second Row Seats

#### *Recline Adjustment*



**WARNING:** Always drive and ride with your seatback upright and the lap belt snug and low across the hips.



**WARNING:** Reclining the seatback can cause an occupant to slide under the seat's safety belt, resulting in severe personal injuries in the event of a crash.



Lift the handle to adjust seatback rearward or forward. The seat back can also fold forward until it is flat.

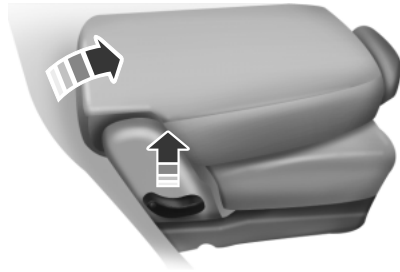

**Fold-flat seatback**

Lift the handle and fold the seatback forward until it is flat.

**Note:** For the bench seats, make sure the center safety belt is unbuckled before folding the seatback.

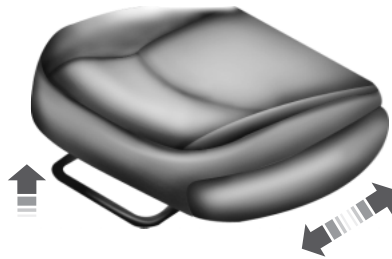
**Moving the seats backward and forward (if equipped)****Second-Row Heated Seats (If Equipped)**

**WARNING:** Persons who are unable to feel pain to the skin because of advanced age, chronic illness, diabetes, spinal cord injury, medication, alcohol use, exhaustion, or other physical conditions, must exercise care when using the seat heater. The seat heater may cause burns even at low temperatures, especially if used for long periods of time. Do not place anything on the seat that insulates against heat, such as a blanket or cushion, because this may cause the seat heater to overheat. Do not puncture the seat with pins, needles, or other pointed objects because this may damage the heating element which may cause the seat heater to overheat. An overheated seat may cause serious personal injury.

**Note:** Do not do the following:

- Place heavy objects on the seat
- Operate the seat heater if water or any other liquid is spilled on the seat. Allow the seat to dry thoroughly.

The heated seats only operate when the ignition is on.

To operate the heated seats:



Press the button located on the rear of the floor console to cycle through the various heat settings and off. Warmer settings are indicated by more indicator lights.

When activated, the heated seats will turn off automatically when the engine is turned off.

### Third Row Seats

#### **Third-Row Seat Access (Manual Seats)**



**WARNING:** Before returning the seatback to its original position, make sure that cargo or any objects are not trapped behind the seatback. After returning the seatback to its original position, pull on the seatback to make sure that it has fully latched. An unlatched seat may become dangerous in the event of a sudden stop or crash.



**WARNING:** Do not adjust or release the seat floor latch while vehicle is in motion. Do not operate the vehicle with seats in tumbled position. Always latch the vehicle seat to the floor, whether the seat is occupied or empty. If not latched or if the seat is tumbled, the seat may cause injury during a sudden stop.

**Note:** Remove items from the second-row seat and make sure that no bulky objects such as purses or briefcases are on the floor in front of the second-row seats before tumbling them.

**Note:** For second-row bench seats, make sure the center safety belt is unbuckled before folding the seatback.

**Note:** You may have to move the front-row seat forward to allow the second-row seat to be fully tumbled.

**Note:** You may have to lower the center head restraint. See *Head Restraints* earlier.

Fold and tumble the second-row seat to access the third row:

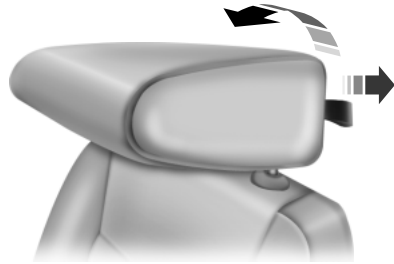

1. Fold the outboard head restraint by pulling the head restraint release strap.

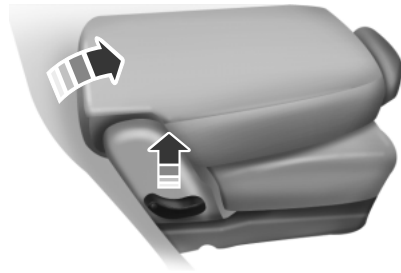

2. Lift the handle located on the side of the seat to fold the seatback flat.

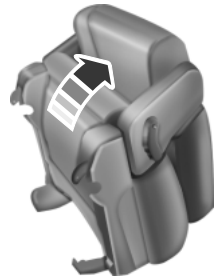

3. Lift the handle all the way up until the seat releases from the floor. Rotate the seat forward to allow access to the third row.



4. To return the seat back to the floor from the tumbled position, rotate the seat down until you hear it latching to the floor.



5. Lift the seatback toward the rear of the vehicle, and rotate the seatback until you hear a click, locking it in the upright position.

**Note:** The seatback will not raise if the rear latch hooks are not properly engaged to the floor striker. If the seatback does not raise, then repeat Step 4.

6. Pull the head restraint back up to its normal adjusted position.

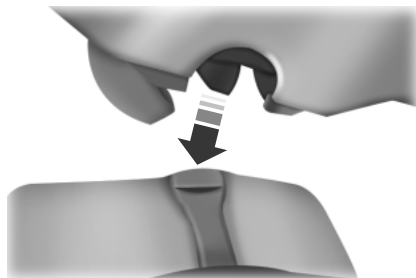

Make sure that the rear latch hooks are properly engaged with the floor striker.

**Note:** Make sure that the seat and seatback are latched securely in position. Keep floor area free of objects that would prevent proper seat engagement.

**Third-row seat access (power fold and tumble seat – if equipped)**

 **WARNING:** Make sure that the seat is unoccupied when folding it down. Folding the seat while occupied could result in occupant injury or damage to the seat.



Press and hold the control located at the back of the rear door opening to fold the seatback down and tumble the seat forward for access to the third row.

**Third-row seat exit (manual and power fold and tumble seat)**

 **WARNING:** Before returning the seat back to its original position, make sure that cargo or any objects are not trapped behind the seatback. After returning the seat back to its original position, pull on the seatback to make sure that it has fully latched. An unlatched seat may become dangerous in the event of a sudden stop or crash.

 **WARNING:** Do not adjust or release the seat floor latch while vehicle is in motion. Do not operate the vehicle with seats in tumbled position. Always latch the vehicle seat to the floor, whether the seat is occupied or empty. If not latched or if the seat is tumbled, the seat may cause injury during a sudden stop.

**Note:** You may have to lower the center head restraint. See *Head Restraints* earlier.



1. Fold the outboard head restraint by pulling the head restraint release strap.



2. Pull on the strap located on the back of the second row seat. This will fold the seat back forward. Pull the strap a second time to tumble the seat forward, allowing easy exit from the third row seat.



3. To return the seatback to the floor from the tumbled position, rotate the seat down until you hear it latching to the floor.



4. Lift the seatback toward the rear of the vehicle, and rotate the seatback until you hear a click, locking it in the upright position.

**Note:** The seatback will not raise if the rear latch hooks are not properly engaged to the floor striker. If the seatback does not raise, then repeat Step 3.

5. Pull the head restraint back up to its normal adjusted position.

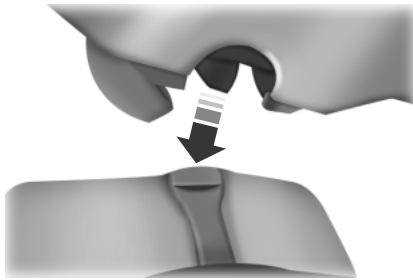

Make sure that the rear latch hooks are properly engaged with the floor striker.

**Note:** Make sure that the seat and seatback are latched securely in position. Keep floor area free of objects that would prevent proper seat engagement.

### **Folding the Third-Row Manual Seat**

1. Remove all objects from the seat and stowage tub.

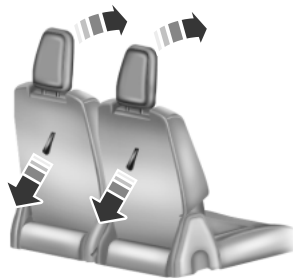

2. Fold the outboard head restraint by pulling the head restraint release strap.

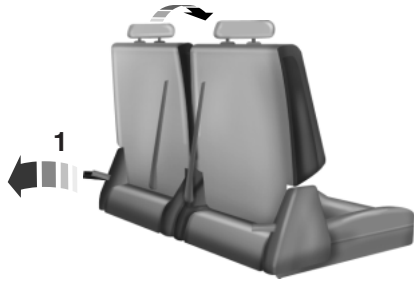

3. From the rear of the vehicle, fold the seat back by pulling and holding the number 1 strap while pushing the seat back forward. Release the strap once the seat back starts rotating forward.

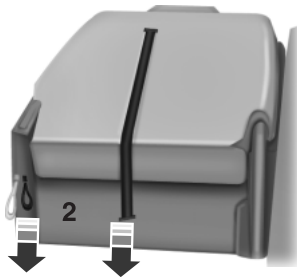

4. Release the cushion latches by pulling the number 2 strap while pulling on the strap located at the top of the seat back to tumble the seat all the way into the tub in the floor.

**Note:** Do not use the seat anchors as cargo tie downs.



**Note:** Do not use the third-row seat back as a load floor when the seat back is folded.

**Note:** Make sure that the area under the seat is free of objects before stowing it.



**Unfolding the third row manual seat**

**Note:** Make sure that there are no objects such as books, purses or briefcases on the load floor before unstowing the seat. Failure to remove all objects from the top of the load floor prior to unstowing it may cause damage to the seat.

**Note:** Make sure the area under the load floor is free of objects before unstowing it.



1. Unlatch and lift the seat out of the tub in the floor by squeezing and pulling up on the handle. Once the seat is at a vertical position, push the seat over, letting it fall onto the latches.



2. To return the seat back to upright position, pull the number 1 strap, then while holding the number 1 strap, pull the long strap located on the seat back to raise the seat back.

3. Pull the head restraints up to their normal positions.



**WARNING:** Make sure seat is latched to vehicle floor by pushing and pulling on the seat. If not latched, the seat may cause injury during a sudden stop.



**WARNING:** Before returning the seat back to its original position, make sure that cargo or any objects are not trapped behind the seat back. After returning the seat back to its original position, pull on the seat back to make sure that it has fully latched. An unlatched seat may become dangerous in the event of a sudden stop or crash.



**!** **WARNING:** Do not drive the vehicle when the third-row seat is rotated backwards. During a sudden stop, the safety belts are not functional in this position and the third-row seat can rapidly tip back to the forward position, all of which may result in serious injury.

**Note:** Do not use seat in this position or damage to seat may occur.

***PowerFold® Third-Row Seats (If Equipped)***

**Note:** The third-row seat includes obstacle detection that allows the seat to stop and reverse direction if it hits an obstacle so that the obstacle can be removed.

**Note:** Pressing a different button while the power seat feature is already being performed may cause the first selected seat movement to be cancelled. Allow the first seat movement to be completed before pressing a button for another function.

**Note:** Make sure that there are no objects such as books, purses or briefcases on the load floor before unstowing the seat. Failure to remove all objects from the top of the load floor prior to unstowing it may cause damage to the seat.

**Note:** In order to allow the seat to complete the stowed position, do not place objects under the seat before stowing. Remove all objects from the seat and stowage tub.

**Note:** In the unlikely event that the third-row power seat stops prematurely or travels to an unexpected position, press the FOLD button (C) to reset the seat and return it to a normal position.

These seats feature a power one-touch operation that allows you fold and stow the seats.

- The power fold seats work only when the transmission is in park **(P)** and the liftgate is open.
- If the ignition is off and the feature is still running, the battery saver will turn it off after 10 minutes. Press unlock on the remote entry key transmitter to reactivate the power seats or unlock it with the keyless entry keypad. See the *Keys and Remote Control* chapter.

The third-row power seat buttons are located behind the third-row seats on the left-hand quarter trim panel.

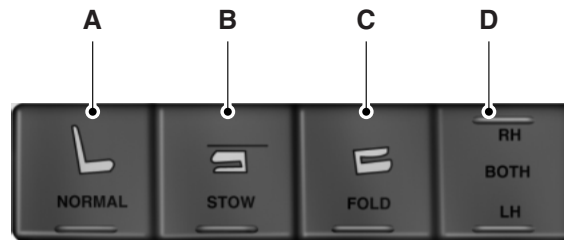

A. NORMAL: Press to return the seat to the normal seating position.

B. STOW: Press to stow the seat into the tub floor.

C. FOLD: Press to fold down the seat back.

D. RH / BOTH / LH: Press to select the normal, stow and fold modes to activate the right-hand seat, the left-hand seat or both.

## Universal Garage Door Opener (If Equipped) 179

### HOMELINK® WIRELESS CONTROL SYSTEM (IF EQUIPPED)

 **WARNING:** Make sure that the garage door and security device are free from obstruction when you are programming. Do not program the system with the vehicle in the garage.

 **WARNING:** Do not use the system with any garage door opener that does not have the safety stop and reverse feature as required by U.S. Federal Safety Standards (this includes any garage door opener manufactured before April 1, 1982).

**Note:** Make sure you keep the original remote control transmitter for use in other vehicles as well as for future system programming.

**Note:** We recommend that upon the sale or lease termination of your vehicle, you erase the programmed function buttons for security reasons. See *Erasing the function button codes* later in this section.

**Note:** You can program a maximum of three devices. To change or replace any of the three devices after it has been initially programmed, you must first erase the current settings. See *Erasing the function button codes* later in this section.

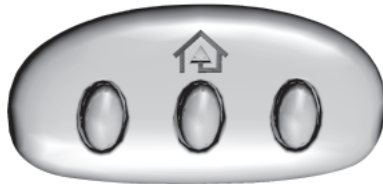

The universal garage door opener replaces the common hand-held garage door opener with a three-button transmitter that is integrated into the driver's sun visor.

The system includes two primary features, a garage door opener and a platform for remote activation of devices with the home. As well as being programmed for garage doors, the system transmitter can be programmed to operate entry gate operators, security systems, entry door locks, and home or office lighting.

Additional system information can be found online at [www.homelink.com](http://www.homelink.com) or by calling the toll-free help line on 1-800-355-3515.

## 180 Universal Garage Door Opener (If Equipped)

---

### **Programming**

**Note:** Put a new battery in the hand-held transmitter. This will ensure quicker training and accurate transmission of the radio-frequency signal.

1. With your vehicle parked outside of the garage and your key in the ignition, turn the key so that the ignition is in the on position.

2. Hold your hand-held, garage door transmitter 1–3 inches (2–8 centimeters) away from the HomeLink button you want to program.

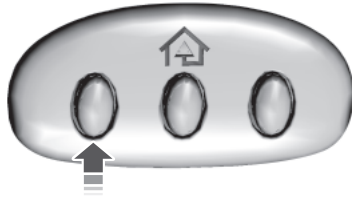

3. Using both hands, simultaneously press and hold the desired HomeLink button and the hand-held transmitter button. DO NOT release either one until the HomeLink indicator light flashes slowly and then rapidly. When the indicator light flashes rapidly, both buttons may be released. The rapid flashing indicates successful training.

4. Press and hold the HomeLink button you programmed for five seconds, then release. You may need to do this twice to activate the door. If your garage door does not operate, watch the HomeLink indicator light.

If the indicator light stays on, the programming is complete. Press and release the programmed HomeLink button, and then begin programming your garage door opener. See below for Steps 5 – 7.

If the indicator light flashes rapidly for two seconds and then turns to a constant light, the HomeLink button is not programmed yet. Do the following:

Press and hold the HomeLink button while you press and release the hand-held transmitter button every two seconds. The HomeLink indicator light will flash slowly and then rapidly once the HomeLink function button recognizes and accepts the hand-held transmitter's radio frequency signal.

## Universal Garage Door Opener (If Equipped) 181

After programming the HomeLink button, follow Steps 5 – 7 as listed below to program your garage door opener.



**Note:** You may need a ladder to reach the unit and you may need to remove the cover or lamp lens on your garage door opener.

5. Press the learn button on the garage door opener motor, and then you have 30 seconds to complete the next step.

6. Return to your car.

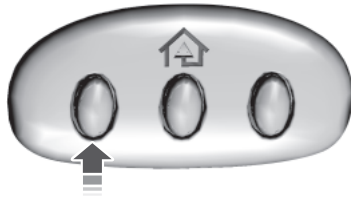

7. Press and hold the function button you want to program for two seconds, then release. Repeat this step. Depending on your brand of garage door opener, you may need to repeat this sequence a third time.

To program additional buttons, repeat Steps 1 – 4 .

For questions or comments, please contact HomeLink® at [www.homelink.com](http://www.homelink.com) or 1-800-355-3515.

### **Erasing the Function Button Codes**

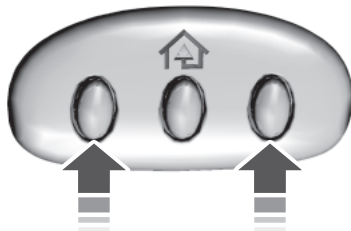

**Note:** You cannot erase individual buttons.

1. Press and hold the outer two function buttons simultaneously for approximately 20 seconds until the indicator lights above the buttons flash rapidly.

2. When the indicator lights flash, release the buttons. The codes for all buttons are erased.

### **Reprogramming a single button**

To program a device to a previously trained button, follow these steps:

1. Press and hold the desired button. **Do NOT** release the button.

2. The indicator light will begin to flash after 20 seconds. Without releasing the button, follow Step 1 in the *Programming* section.

For questions or comments, contact HomeLink® at [www.homelink.com](http://www.homelink.com) or 1-800-355-3515.

## 182 Universal Garage Door Opener (If Equipped)

---

### **Programming HomeLink to a Genie Intellicode 2 garage door opener**

**Note:** The Genie Intellicode 2 transmitter must already be programmed to operate with the garage door opener.

#### **Programing the transmitters**

To program HomeLink to the transmitter you must first put the transmitter into programming mode. To do this:

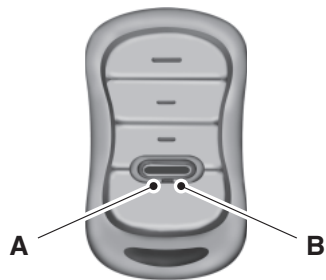

- A. Red LED
- B. Green LED

1. Press and hold one of the buttons on the hand-held transmitter for 10 seconds. The LED light will change from green to green and red.
2. Press the same button twice to confirm the change to Programming mode. If done properly the LED light will appear red.
3. Hold the transmitter within 1–3 inches (2–8 centimeters) of the button on the sun visor you want to program.
4. Press and hold both the programmed Genie button on the hand-held transmitter and the button on the sun visor you want to program. The indicator light on the sun visor will flash rapidly when the programming is successful.

**Note:** the Genie transmitter will transmit for up to 30 seconds. If HomeLink does not program within 30 seconds the Genie transmitter will need to be pressed again. If the Genie transmitter LED displays green and red, release the button until the LED turns off before pressing the button again.

Once HomeLink has been programmed successfully, the Genie transmitter must be changed out of program mode. To do this:

1. Press and hold the previously programmed Genie button on the hand-held transmitter for 10 seconds. The indicator light will change from red to red and green.
2. Press the same button twice to confirm the change. If done correctly the LED will turn green.

## Universal Garage Door Opener (If Equipped) 183

### **Programming HomeLink to the Genie Intellicode garage door opener motor**

**Note:** You may need a ladder to access the garage door opener motor.

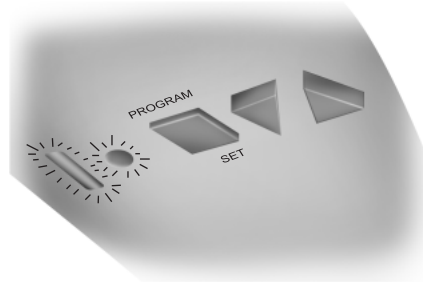

To program HomeLink to the garage door opener motor:

1. Press and hold the PROGRAM button on the garage door opener motor until both blue LED's turn on.
2. Release the PROGRAM button. Only the smaller round LED should be on.
3. Press and release the program button. The larger purple LED will flash.  
**Note:** The next two steps must be completed in 30 seconds.
4. Press and release the Genie Intellicode 2 hand-held transmitter's previously programmed button. Both indicator lights on the garage door opener motor unit should now flash purple.
5. Press and hold the previously programmed button on the sun visor for two seconds. Repeat this step up to 3 times until the garage door moves. Programming is now complete.

### **Clearing a HomeLink device**

To erase programming from the three HomeLink buttons, press and hold the two outer HomeLink buttons until the indicator light begins to flash. The LED will begin flashing in 10 to 20 seconds, at which time both buttons should be released. Programming has now been erased, and the LED should blink slowly to indicate the device is in train mode when any one of the three HomeLink buttons is pressed.

### **FCC and RSS-210 Industry Canada Compliance**

This device complies with Part 15 of the FCC Rules and with RSS-210 of Industry Canada. Operation is subject to the following two conditions: (1) this device may not cause harmful interference, and (2) this device must accept any interference received, including interference that may cause undesired operation.

Changes or modifications to your device not expressly approved by the party responsible for compliance can void the user's authority to operate the equipment.



**AUXILIARY POWER POINTS**

**WARNING:** Do not plug optional electrical accessories into the cigarette lighter socket (if equipped). Improper use of the lighter can cause damage not covered by your warranty, and can result in fire or serious injury.

**Note:** If used when the engine is not running, the battery will discharge. There may be insufficient power to restart your engine.

**Note:** Do not insert objects other than an accessory plug into the power point. This will damage the outlet and blow the fuse.

**Note:** Do not hang any type of accessory or accessory bracket from the plug.

**Note:** Do not use the power point over the vehicle capacity of 12 volts DC180 watts or a fuse may blow.

**Note:** Do not use the power point for operating a cigarette lighter element.

**Note:** Improper use of the power outlet can cause damage not covered by your warranty.

**Note:** Always keep the power point caps closed when not being used.

Run the engine for full capacity use of the power point . To prevent the battery from being discharged:

- Do not use the power point longer than necessary when the engine is not running.
- Do not leave devices plugged in overnight or when the vehicle is parked for extended periods.

**Locations**

Power points may be found:

- on the front of the center console
- inside the utility compartment
- on the rear of the console, accessible from the rear seats
- in the cargo area.

### 110 Volt AC Power Point (If Equipped)



**WARNING:** Do not keep electrical devices plugged in the power point whenever the device is not in use. Do not use any extension cord with the 110 volt AC power point, since it will defeat the safety protection design. Doing so may cause the power point to overload due to powering multiple devices that can reach beyond the 150-watt load limit and could result in fire or serious injury.

**Note:** The cap should always be closed whenever the power point outlet is not in use.

**Note:** The power point will turn off after 13 minutes if the ignition is on without the engine running. Keep the engine running to use the power point.

The 110-volt AC power point outlet is used for powering electrical devices that require up to 150 watts. Exceeding the 150-watt limit will cause the power point to cut off the power temporarily to provide overload protection.



The power point is located on the back of the center console.

The power point is not designed for the following electric appliances; they may not work properly:

- Cathode-ray, tube-type televisions
- Motor loads, such as vacuum cleaners, electric saws and other electric power tools, compressor-driven refrigerators, etc.
- Measuring devices that process precise data, such as medical equipment, measuring equipment, etc.
- Other appliances requiring an extremely stable power supply: microcomputer-controlled electric blankets, touch sensor lamps, etc.

The power point can switch to a fault mode when it is overloaded, overheated or shorted. Unplug your device and turn the ignition off then on for overloading and shorting conditions. Let the system cool off, then turn the ignition off then on for an overheating condition.

The power point can provide power whenever the ignition is on and the indicator light is on. The indicator light is located in the top left corner of the power point.

When the indicator light is:

- on — power point is ready to supply power
- off — power point power supply is off; ignition is not on
- blinking — power point is in fault mode

**CENTER CONSOLE**



**WARNING:** Use only soft cups in the cupholder. Hard objects can injure you in a collision.

Available console features include:

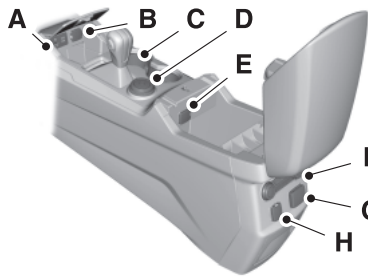

- A. USB and audio jack
- B. Power point (if equipped)
- C. Large cupholders with handle relief and individual grips
- D. Hill descent control (if equipped)
- E. 110-volt AC power point (if equipped)
- F. Rear climate controls (if equipped)
- G. 110-volt AC power point
- H. Power point (if equipped)

**Rear Center Console (If Equipped)**

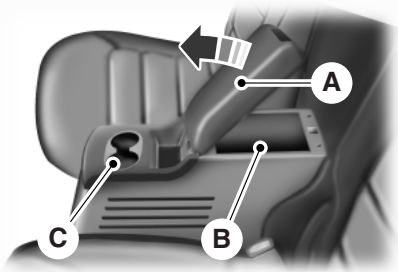

- A. Flip forward armrest to provide a flat load floor
- B. Utility compartment
- C. Cupholders

**OVERHEAD CONSOLE**

The appearance of the overhead console will vary according to your option package.

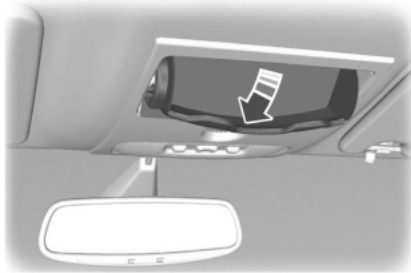



Press near the rear edge of the door to open it.

**GENERAL INFORMATION**

 **WARNING:** Extended idling at high engine speeds can produce very high temperatures in the engine and exhaust system, creating the risk of fire or other damage.

 **WARNING:** Do not park, idle, or drive your vehicle on dry grass or other dry ground cover. The emission system heats up the engine compartment and exhaust system, which can start a fire.

 **WARNING:** Do not start your vehicle in a closed garage or in other enclosed areas. Exhaust fumes can be toxic. Always open the garage door before you start the engine.

 **WARNING:** If you smell exhaust fumes inside your vehicle, have your vehicle checked by an authorized dealer immediately. Do not drive if you smell exhaust fumes.

If you disconnect the battery, your vehicle may exhibit some unusual driving characteristics for approximately 5 miles (8 kilometers) after you connect it. This is because the engine management system must realign itself with the engine. You may disregard any unusual driving characteristics during this period.

The powertrain control system meets all Canadian interference-causing equipment standard requirements regulating the impulse electrical field or radio noise.

Do not press the accelerator pedal while starting the engine. If you have difficulty starting the engine, see *Failure to start* later in this section.

**IGNITION SWITCH (IF EQUIPPED)**

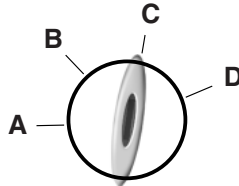

A. **Off:** The ignition is off.

**Note:** When you switch the ignition off and leave your vehicle, do not leave your key in the ignition. This could cause your vehicle battery to lose charge.

B. **Accessory:** Allows the electrical accessories, such as the radio, to operate while the engine is not running.

**Note:** Do not leave the ignition key in this position for too long. This could cause your vehicle battery to lose charge.

C. **On:** All electrical circuits are operational and the warning lamps and indicators illuminate.

D. **Start:** Cranks the engine.

**KEYLESS STARTING (IF EQUIPPED)**

**Note:** The keyless starting system may not function if the key is close to metal objects or electronic devices such as cellular phones.

**Note:** A valid key must be located inside your vehicle to switch the ignition on and start the engine.

**Note:** When locking your vehicle, any remote controls left inside the vehicle may become disabled. A message may appear in the information display indicating that there is no key detected if you try to start the engine. Press the unlock button on the remote control to enable it, and then start the engine.

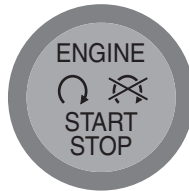
**Ignition Modes**

**Off:** Turns the ignition off.

- Without applying the brake pedal, press and release the button once when the ignition is in the on mode, or when the engine is running but the vehicle is not in motion.

**Accessory:** Allows some electrical accessories to operate while the engine is not running.

- Without applying the brake pedal, press and release the button once.

**On:** All electrical circuits are operational. Warning lamps and indicators are illuminated.

- Without applying the brake pedal, press and release the button once from accessory mode.
- Without applying the brake pedal, press and release the button twice from off mode.

**Start:** Starts the engine.

- Press the brake pedal, and then press the button for any length of time. An indicator light on the button illuminates when the ignition is on and when the engine starts.

Your vehicle may have remote start capability. Refer to *Remote start* in the *Keys and Remote Control* chapter.

**STARTING A GASOLINE ENGINE**

When you start the engine, the idle speed increases, this helps to warm up the engine. If the engine idle speed does not slow down automatically, have your vehicle checked by an authorized dealer.

Before starting the engine check the following:

- Make sure all occupants have fastened their safety belts.
- Make sure the headlamps and electrical accessories are off.
- Make sure the parking brake is on.
- Make sure the gearshift is in position **P**.
- Turn the ignition key to the on position. If your vehicle is equipped with a keyless ignition, see the following instructions.



## 192 Starting and Stopping the Engine

---

### Vehicles with an Ignition Key

**Note:** Do not touch the accelerator pedal.

1. Fully press the brake pedal.
2. Turn the key to the start position. Release the key when the engine starts.

**Note:** The engine may continue cranking for up to 15 seconds or until it starts.

**Note:** If you cannot start the engine on the first try, wait for a short period and try again.

### Vehicles with Keyless Start

**Note:** Do not touch the accelerator pedal.

1. Fully press the brake pedal.
2. Press the button.

The system does not function if:

- The key frequencies are jammed.
- The key battery has no charge.

If you are unable to start your vehicle, do the following:



1. Locate the key backup slot in the center console utility compartment.
2. With the buttons facing the rear of the vehicle and the key ring up, place the key into backup slot.
3. With the key in this position, press the brake pedal, then the button to switch the ignition on and start your vehicle.

**Fast Restart (Vehicles with Keyless Start)**

The fast restart feature allows you to restart the engine within 20 seconds of switching it off, even if a valid key is not present.

Within 20 seconds of switching the engine off, press the brake pedal and press the button. After 20 seconds have expired, you can no longer start the engine without the key present inside your vehicle.

Once the engine has started, it remains running until you press the button, even if the system does not detect a valid key. If you open and close a door while the engine is running, the system searches for a valid key. You cannot start the engine if the system does not detect a valid key within 20 seconds.

**Failure to Start**

If you cannot start the engine after three attempts, wait 10 seconds and follow this procedure:

1. Fully press the brake pedal.
2. Fully press the accelerator pedal and hold it there.
3. Start the engine.

**Stopping the Engine When Your Vehicle is Stationary**

1. Move the transmission selector lever to position **P**.
2. If your vehicle has an ignition key, turn the key to the off position.  
If your vehicle has a keyless start system, press the button once.
3. Apply the parking brake.

**Note:** This switches off the ignition, all electrical circuits, warning lamps and indicators.

**Stopping the Engine When Your Vehicle is Moving**

**WARNING:** Switching off the engine when the vehicle is still moving will result in a loss of brake and steering assistance.

The steering will not lock, but higher effort will be required. When the ignition is switched off, some electrical circuits, warning lamps and indicators may also be off.

1. **If your vehicle has an ignition key**, move the transmission selector lever to position **N** and use the brakes to bring your vehicle to a safe stop. When your vehicle has stopped, move the transmission selector lever to position **P** and turn the key to the off position.

## 194 Starting and Stopping the Engine

---

2. **If your vehicle has a keyless start system**, move the transmission selector lever to position **N** and use the brakes to bring your vehicle to a safe stop. When your vehicle has stopped, move the transmission selector lever to position **P** and switch the ignition off by pressing and holding the button for one second, or pressing it three times within two seconds.
3. Apply the parking brake.

### Guarding Against Exhaust Fumes



**WARNING:** If you smell exhaust fumes inside your vehicle, have this checked immediately. Do not drive your vehicle if you smell exhaust fumes. Carbon monoxide is present in exhaust fumes. Take precautions to avoid its dangerous effects.

### Important Ventilating Information

If you stop your vehicle and leave the engine idling for long periods, we recommend that you do one of the following:

- Open the windows at least 1 inch (2.5 centimeters).
- Set your climate control to outside air.

### ENGINE BLOCK HEATER (IF EQUIPPED)



**WARNING:** Failure to follow engine block heater instructions could result in property damage or personal injury.



**WARNING:** Do not use your heater with ungrounded electrical systems or two-pronged (cheater) adapters. There is a risk of electrical shock.

**Note:** The heater is most effective when outdoor temperatures are below 0°F (-18°C).

The heater acts as a starting aid by warming the engine coolant. This allows the climate control system to respond quickly. The equipment includes a heater element (installed in the engine block) and a wire harness. You can connect the system to a grounded 120-volt A/C electrical source.

We recommend that you do the following for safe and correct operation:

- Use a 16-gauge outdoor extension cord that is product certified by Underwriter's Laboratory or Canadian Standards Association. This extension cord must be suitable for use outdoors, in cold temperatures, and be clearly marked *Suitable for Use with Outdoor Appliances*. Never use an indoor extension cord outdoors; it could result in an electric shock or become a fire hazard.
- Use as short an extension cord as possible.
- Do not use multiple extension cords.
- Make sure that when in operation, the extension cord plug and the heater cord plug connections are free and clear of water. This could cause an electric shock or fire.
- Make sure your vehicle is parked in a clean area, clear of combustibles.
- Make sure the heater, heater cord and extension cord are firmly connected.
- Check for heat anywhere in the electrical hookup once the system has been operating for approximately 30 minutes.
- Make sure the system is unplugged and properly stowed before driving your vehicle. Make sure the protective cover seals the prongs of the block heater cord plug when not in use.
- Keep plug terminals clean and free of dirt and corrosion.
- Make sure the heater system is checked for proper operation before winter.

### Using the Engine Block Heater

Make sure the receptacle terminals are clean and dry before use. To clean them, use a dry cloth.

The heater uses 0.4 to 1.0 kilowatt-hours of energy per hour of use. The system does not have a thermostat. It achieves maximum temperature after approximately three hours of operation. Using the heater longer than three hours does not improve system performance and unnecessarily uses electricity.

**SAFETY PRECAUTIONS**

**WARNING:** Do not overfill the fuel tank. The pressure in an overfilled tank may cause leakage and lead to fuel spray and fire.



**WARNING:** The fuel system may be under pressure. If you hear a hissing sound near the fuel filler inlet, do not refuel until the sound stops. Otherwise, fuel may spray out, which could cause serious personal injury.



**WARNING:** Automotive fuels can cause serious injury or death if misused or mishandled.



**WARNING:** The flow of fuel through a fuel pump nozzle can produce static electricity, which can cause a fire if fuel is pumped into an ungrounded fuel container.



**WARNING:** Fuel ethanol and gasoline may contain benzene, which is a cancer-causing agent.



**WARNING:** When refueling always shut the engine off and never allow sparks or open flames near the filler neck. Never smoke while refueling. Fuel vapor is extremely hazardous under certain conditions. Care should be taken to avoid inhaling excess fumes.

Observe the following guidelines when handling automotive fuel:

- Extinguish all smoking materials and any open flames before refueling your vehicle.
- Always turn off the vehicle before refueling.
- Automotive fuels can be harmful or fatal if swallowed. Fuel, such as gasoline, is highly toxic and if swallowed can cause death or permanent injury. If fuel is swallowed, call a physician immediately, even if no symptoms are immediately apparent. The toxic effects of fuel may not be visible for hours.
- Avoid inhaling fuel vapors. Inhaling too much fuel vapor of any kind can lead to eye and respiratory tract irritation. In severe cases, excessive or prolonged breathing of fuel vapor can cause serious illness and permanent injury.

- Avoid getting fuel liquid in your eyes. If fuel is splashed in the eyes, remove contact lenses (if worn), flush with water for 15 minutes and seek medical attention. Failure to seek proper medical attention could lead to permanent injury.
- Fuels can also be harmful if absorbed through the skin. If fuel is splashed on the skin or clothing, promptly remove contaminated clothing and wash skin thoroughly with soap and water. Repeated or prolonged skin contact with fuel liquid or vapor causes skin irritation.
- Be particularly careful if you are taking Antabuse or other forms of disulfiram for the treatment of alcoholism. Breathing gasoline vapors, or skin contact could cause an adverse reaction. In sensitive individuals, serious personal injury or sickness may result. If fuel is splashed on the skin, promptly wash skin thoroughly with soap and water. Consult a physician immediately if you experience an adverse reaction.

#### FUEL QUALITY

**Note:** Use of any fuel other than those recommended may cause powertrain damage and a loss of vehicle performance; repairs may not be covered under warranty.

#### Choosing the Right Fuel (Gasoline Engines)

Use only UNLEADED gasoline or UNLEADED gasoline blended with a maximum of 15% ethanol in your gasoline vehicle. If your vehicle is a Flex Fuel Vehicle (FFV), it will have a yellow bezel placed over the fuel fill inlet.

Do not use:

- Fuels containing more than 15% ethanol or E-85 fuel.
- Fuels containing methanol.
- Fuels containing metallic based additives, including manganese-based compounds.
- Fuels containing the octane booster additive, methylcyclopentadienyl manganese tricarbonyl (MMT).
- Leaded-fuel (The use of leaded fuel is prohibited by law).

**Note:** Use of any fuel other than recommended fuel can cause powertrain damage, impair the emission control system or cause loss of vehicle performance. Any damage to vehicle that is caused by use of fuel not recommended will not be covered under warranty.

**Choosing the Right Fuel With a Flex Fuel Vehicle (If Equipped)**

Use only UNLEADED gasoline or UNLEADED gasoline blended with a maximum of 85% ethanol (E-85) in your Flex Fuel Vehicle (FFV). If your vehicle is flex fuel capable, it will have a yellow bezel placed over the fuel fill inlet

Do not use:

- fuels containing more than 85% ethanol or E-100 fuel
- fuels containing methanol
- fuels containing metallic based additives, including manganese-based compounds
- fuels containing the octane booster additive, methylcyclopentadienyl manganese tricarbonyl (MMT)
- leaded-fuel (The use of leaded fuel is prohibited by law)

**Note:** Use of any fuel other than recommended fuel can cause powertrain damage, impair the emission control system or cause loss of vehicle performance. Any damage to a vehicle that is caused by the use of fuel not recommended will not be covered under warranty.

**Octane recommendations**

3.5L V6 engine:

Regular unleaded gasoline with a pump (R+M)/2 octane rating of 87 is recommended. Some stations offer fuels posted as Regular with an octane rating below 87, particularly in high altitude areas. Fuels with octane levels below 87 are not recommended.

2.0L/3.5L EcoBoost® engines:

Regular unleaded gasoline with a pump (R+M)/2 octane rating of 87 is recommended. Some stations offer fuels posted as “Regular” with an octane rating below 87, particularly in high altitude areas. Fuels with octane levels below 87 are not recommended. Premium fuel will provide improved performance and is recommended for severe duty usage such as trailer tow.



Do not be concerned if your engine sometimes knocks lightly. However, if it knocks heavily while you are using fuel with the recommended octane rating, see your authorized dealer to prevent any engine damage.

**RUNNING OUT OF FUEL**

Avoid running out of fuel because this situation may have an adverse effect on powertrain components.

If you have run out of fuel:

- You may need to cycle the ignition from off to on several times after refueling to allow the fuel system to pump the fuel from the tank to the engine. On restarting, crank time will be a few seconds longer than normal. With keyless ignition, just start the engine. Crank time will be longer than usual.
- Normally, adding 1 gallon (3.8 liters) of fuel is enough to restart the engine. If the vehicle is out of fuel and on a steep grade, more than 1 gallon (3.8 liters) may be required.
- The service engine soon indicator may come on. For more information on the service engine soon indicator, see *Warning Lamps and Indicators* in the *Instrument Cluster* chapter.

**Refilling with a Portable Fuel Container**

**WARNING:** Do not insert the nozzle of a portable fuel container or aftermarket funnel into the capless fuel system. This could damage the fuel system and its seal, and may cause fuel to run onto the ground instead of filling the tank, which could result in serious personal injury.



**WARNING:** Do not try to pry open or push open the capless fuel system with foreign objects. This could damage the fuel system and its seal and cause injury to you or others.

**Note:** Do not use aftermarket funnels; they will not work with the capless fuel system and can damage it. The included funnel has been specially designed to work safely with your vehicle.



When filling the vehicle's fuel tank from a portable fuel container, use the funnel included with the vehicle.

1. Locate the white plastic funnel in the spare tire compartment.

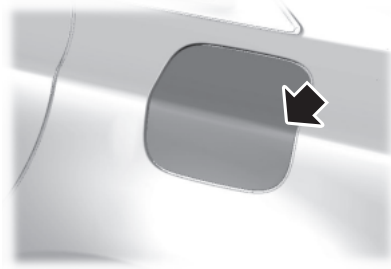

2. To open the fuel filler door, press the center of the rear edge and then release.

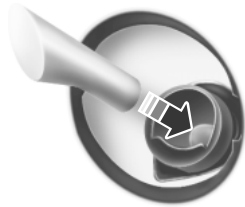

3. Slowly insert the funnel into the capless fuel system.

4. Fill the vehicle with fuel from the portable fuel container.
5. When done, clean the funnel or properly dispose of it. Extra funnels can be purchased from your authorized dealer if you choose to dispose of the funnel.

### **REFUELING**



**WARNING:** Fuel vapor burns violently and a fuel fire can cause severe injuries. To help avoid injuries to you and others:

- Read and follow all the instructions on the pump island.
- Turn off your engine when you are refueling.
- Do not smoke if you are near fuel or refueling your vehicle.
- Keep sparks, flames and smoking materials away from fuel.
- Stay outside your vehicle and do not leave the fuel pump unattended when refueling your vehicle - this is against the law in some places.
- Keep children away from the fuel pump; never let children pump fuel.
- Do not use personal electronic devices while refueling.

Use the following guidelines to avoid electrostatic charge build-up when filling an ungrounded fuel container:

- Place approved fuel container on the ground.
- DO NOT fill a fuel container while it is in the vehicle (including the cargo area).
- Keep the fuel pump nozzle in contact with the fuel container while filling.
- DO NOT use a device that would hold the fuel pump handle in the fill position.

### Easy Fuel® No Cap Fuel System

 **WARNING:** The fuel system may be under pressure. If you hear a hissing sound near the fuel filler door, do not refuel until the sound stops. Otherwise, fuel may spray out, which could cause serious personal injury.

When fueling your vehicle:

1. Turn the engine off.

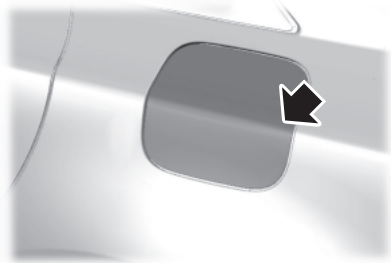

2. To open the fuel filler door, press the center of the rear edge and then release.

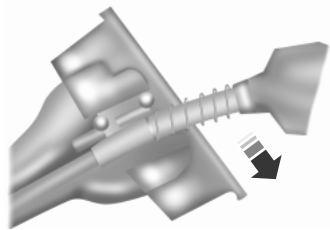

3. Slowly insert the fuel filler nozzle fully into the fuel system, and leave the nozzle fully inserted to open both doors until you are done pumping. Hold handle higher during insertion for easier access.

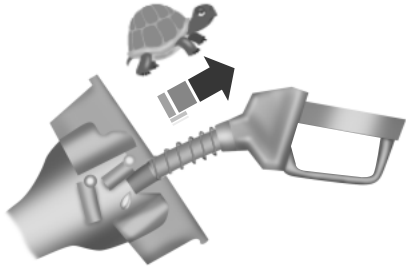

4. After you are done pumping fuel, slowly remove the fuel filler nozzle—allow about five to ten seconds after pumping fuel before removing the fuel filler nozzle. This allows residual fuel to drain back into the fuel tank and not spill onto the vehicle.

**Note:** A fuel spillage concern may occur if overfilling the fuel tank. Do not overfill the tank to the point that the fuel is able to bypass the fuel filler nozzle. The overfilled fuel may run down the drain located within the fuel filler housing and to the ground.

5. To close the fuel filler door, press the center of the rear edge and then release. The fuel door with latch closed.

If the fuel fill inlet was not properly closed, a Check Fuel Fill Inlet message may appear on the information display.

At the next opportunity, do the following:

1. Safely pull off the road.
2. Turn off the engine.
3. Open the fuel filler door and remove any visible debris from the fuel fill opening.
4. Insert either the fuel fill nozzle or the fuel fill funnel provided with the vehicle several times to dislodge any debris and allow the inlet to close properly.

If this action corrects the problem, the message may not reset immediately. It may take several driving cycles for the message to turn off. A driving cycle consists of an engine start-up (after four or more hours with the engine off) followed by city or highway driving. Continuing to drive with the message on may cause the service engine soon lamp to turn on as well.

---

**FUEL CONSUMPTION****Filling the Tank**

The advertised capacity is the indicated capacity and the empty reserve combined. Indicated capacity is the difference in the amount of fuel in a full tank and a tank when the fuel gauge indicates empty. Empty reserve is the amount of fuel in the tank after the fuel gauge indicates empty.

**Note:** The amount of usable fuel in the empty reserve varies and should not be relied upon to increase driving range. When refueling your vehicle after the fuel gauge indicates empty, you might not be able to refuel the full amount of the advertised capacity of the fuel tank due to the empty reserve still present in the tank.

For consistent results when filling the fuel tank:

- Turn the ignition off before fueling; an inaccurate reading results if the engine is left running.
- Use the same fill rate (low–medium–high) each time the tank is filled.
- Allow no more than two automatic click–offs when filling.

Results are most accurate when the filling method is consistent.

**Calculating Fuel Economy**

Do not measure fuel economy during the first 1000 miles (1600 kilometers) of driving (this is your engine's break-in period); a more accurate measurement is obtained after 2000 miles–3000 miles (3200 kilometers–4800 kilometers). Also, fuel expense, frequency of fill-ups or fuel gauge readings are not accurate ways to measure fuel economy.

1. Fill the fuel tank completely and record the initial odometer reading.
2. Each time you fill the tank, record the amount of fuel added.
3. After at least three to five tank fill-ups, fill the fuel tank and record the current odometer reading.
4. Subtract your initial odometer reading from the current odometer reading.
5. Calculate fuel economy as follows:
  - Standard: Divide miles traveled by gallons used.
  - Metric: Multiply liters used by 100, then divide by kilometers traveled.

Keep a record for at least one month and record the type of driving (city or highway). This provides an accurate estimate of the vehicle's fuel economy under current driving conditions. Additionally, keeping records during summer and winter show how temperature impacts fuel economy. In general, lower temperatures mean lower fuel economy.

**EMISSION CONTROL SYSTEM**

**WARNING:** Do not park, idle, or drive your vehicle in dry grass or other dry ground cover. The emission system heats up the engine compartment and exhaust system, which can start a fire.



**WARNING:** Exhaust leaks may result in entry of harmful and potentially lethal fumes into the passenger compartment. If you smell exhaust fumes inside your vehicle, have your dealer inspect your vehicle immediately. Do not drive if you smell exhaust fumes.

Your vehicle is equipped with various emission control components and a catalytic converter which will enable your vehicle to comply with applicable exhaust emission standards. To make sure that the catalytic converter and other emission control components continue to work properly:

- Use only the specified fuel listed.
- Avoid running out of fuel.
- Do not turn off the ignition while your vehicle is moving, especially at high speeds.
- Have the items listed in *Scheduled Maintenance Information* performed according to the specified schedule.

The scheduled maintenance items listed in *Scheduled Maintenance Information* are essential to the life and performance of your vehicle and to its emissions system.

If other than Ford, Motorcraft® or Ford-authorized parts are used for maintenance replacements or for service of components affecting emission control, such non-Ford parts should be equivalent to genuine Ford Motor Company parts in performance and durability.

Illumination of the service engine soon indicator, charging system warning light or the temperature warning light, fluid leaks, strange odors, smoke or loss of engine power could indicate that the emission control system is not working properly.

An improperly operating or damaged exhaust system may allow exhaust to enter the vehicle. Have a damaged or improperly operating exhaust system inspected and repaired immediately.

Do not make any unauthorized changes to your vehicle or engine. By law, vehicle owners and anyone who manufactures, repairs, services, sells, leases, trades vehicles, or supervises a fleet of vehicles are not permitted to intentionally remove an emission control device or prevent it from working. Information about your vehicle's emission system is on the Vehicle Emission Control Information Decal located on or near the engine. This decal also lists engine displacement.

Please consult your warranty information for complete emission warranty information.

### On-board Diagnostics (OBD-II)

Your vehicle is equipped with a computer that monitors the engine's emission control system. This system is commonly known as the on-board diagnostics system (OBD-II). The OBD-II system protects the environment by ensuring that your vehicle continues to meet government emission standards. The OBD-II system also assists your authorized dealer in properly servicing your vehicle.



When the service engine soon indicator illuminates, the OBD-II system has detected a malfunction. Temporary malfunctions may cause the service engine soon indicator to illuminate.

Examples are:

1. The vehicle has run out of fuel—the engine may misfire or run poorly.
2. Poor fuel quality or water in the fuel—the engine may misfire or run poorly.
3. The fuel fill inlet may not have been properly closed. See *Easy Fuel® No Cap Fuel System* in this chapter.
4. Driving through deep water—the electrical system may be wet.

These temporary malfunctions can be corrected by filling the fuel tank with good quality fuel, properly closing the fuel fill inlet or letting the electrical system dry out. After three driving cycles without these or any other temporary malfunctions present, the service engine soon indicator should stay off the next time the engine is started. A driving cycle consists of a cold engine start-up followed by mixed city or highway driving. No additional vehicle service is required.

If the service engine soon indicator remains on, have your vehicle serviced at the first available opportunity. Although some malfunctions detected by the OBD-II may not have symptoms that are apparent, continued driving with the service engine soon indicator on can result in increased emissions, lower fuel economy, reduced engine and transmission smoothness, and can lead to more costly repairs.

### Readiness for Inspection/Maintenance (I/M) Testing

Some state, provincial and local governments may have Inspection/Maintenance (I/M) programs to inspect the emission control equipment on your vehicle. Failure to pass this inspection could prevent you from getting a vehicle registration.



If the service engine soon indicator is on or the bulb does not work, the vehicle may need to be serviced. See *On-board Diagnostics (OBD-II)* in this chapter.

Your vehicle may not pass the I/M test if the service engine soon indicator is on or not working properly (bulb is burned out), or if the OBD-II system has determined that some of the emission control systems have not been properly checked. In this case, the vehicle is considered not ready for I/M testing.

If the vehicle's engine or transmission has just been serviced, or the battery has recently run down or been replaced, the OBD-II system may indicate that the vehicle is not ready for I/M testing. To determine if the vehicle is ready for I/M testing, turn the ignition key to the on position for 15 seconds without cranking the engine. If the service engine soon indicator blinks eight times, it means that the vehicle is not ready for I/M testing; if the service engine soon indicator stays on solid, it means that the vehicle is ready for I/M testing.

The OBD-II system is designed to check the emission control system during normal driving. A complete check may take several days. If the vehicle is not ready for I/M testing, the following driving cycle consisting of mixed city and highway driving may be performed:

15 minutes of steady driving on an expressway or highway followed by 20 minutes of stop-and-go driving with at least four 30-second idle periods.

Allow the vehicle to sit for at least eight hours without starting the engine. Then, start the engine and complete the above driving cycle. The engine must warm up to its normal operating temperature. Once the engine is started, do not turn off the engine until the above driving cycle is complete. If the vehicle is still not ready for I/M testing, the above driving cycle will have to be repeated.

**AUTOMATIC TRANSMISSION**

 **WARNING:** Always set the parking brake fully and make sure the gearshift is latched in **P** (Park). Turn the ignition to the off position and remove the key whenever you leave your vehicle.

 **WARNING:** Do not use the tow feature when driving in icy or slippery conditions as the increased engine braking can cause the rear wheels to slide and the vehicle to swing around with the possible loss of vehicle control.

Your vehicle has been designed to improve fuel economy by reducing fuel usage while coasting or decelerating. When you take your foot off the accelerator pedal and the vehicle begins to slow down, the torque converter clutch locks up and aggressively shuts off fuel flow to the engine while decelerating. This fuel economy benefit may be perceived as a light to medium braking sensation when removing your foot from the accelerator pedal.

**P (Park)**

This position locks the transmission and prevents the front wheels from turning.

To shift your vehicle from P into gear:

- Press the brake pedal
- Move the gearshift lever into the desired gear

To put your vehicle in **P** (Park):

- Come to a complete stop
- Move the gearshift lever and securely latch it in **P** (Park)

**R**

With the gearshift lever in **R** (Reverse), the vehicle will move backward. Always come to a complete stop before shifting into and out of **R** (Reverse).

**N** (Neutral)

With the gearshift lever in **N** (Neutral), the vehicle can be started and is free to roll. Hold the brake pedal down while in this position.



**D (Drive) with Overdrive**

The normal driving position for the best fuel economy. Transmission operates in gears one through six.

The automatic transmission shift strategy has the ability to detect hilly terrain or mountainous areas and will provide a limited amount of grade assist features automatically. Refer to **D (Drive) with Grade assist** or **SelectShift** for more information.

**D (Drive) with Tow on**

Press the **TOW** switch located on the instrument panel by the headlamp control to activate tow. The **TOW/HAUL** message will illuminate in the instrument cluster.

The tow feature improves transmission operation when towing a trailer or a heavy load. All transmission gear ranges are available when using tow.

The tow feature delays upshifts to reduce frequency of transmission shifting. Tow also provides engine braking in all forward gears when the transmission is in the **D (Overdrive)** position. This engine braking will slow the vehicle and assist the driver in controlling the vehicle when descending a grade. Depending on driving conditions and load conditions, the transmission may downshift, slow the vehicle and control the vehicle speed when descending a hill, without the accelerator pedal being pressed. The amount of downshift braking provided will vary based upon the amount the brake pedal is depressed.

Press the **TOW** button to deactivate the tow feature and return to normal driving mode. The tow light will no longer be illuminated.

When you shut-off and restart the engine, the transmission will automatically return to normal **D (Overdrive)** mode (tow off).

**D (Drive) with Grade Assist**

Press the transmission control switch on the side of the gearshift lever to activate grade assist and cancel overdrive.



Grade assist:

- Provides additional grade (engine) braking and extends lower gear operation on uphill climbs for hilly terrain or mountainous areas.
- Provides additional engine braking through the automatic transmission shift strategy which reacts to vehicle inputs (vehicle acceleration, accelerator pedal, brake pedal and vehicle speed).
- Allows the transmission to select gears that will provide the desired engine braking based on the vehicle inputs mentioned above. This will increase engine RPM during engine braking.
- The grade assist lamp in the instrument cluster is illuminated.

Grade assist is designed to aid the driver with optimal gear selection in hilly terrain or mountainous areas but is not intended for normal operation. It is recommended that you return to O/D (overdrive mode) on flat terrain to provide the best fuel economy and transmission function.

Press the transmission control switch again to return to normal D (Drive) position (with O/D).

- The grade assist lamp in the instrument cluster will not be illuminated.
- The transmission will operate in gears one through six.

#### **L (Low)**

- Provides maximum engine braking.
- Will downshift to the lowest available gear for the current vehicle speed; allows for first gear when vehicle reaches slower speeds.
- Is not intended for use under extended or normal driving conditions and results in lower fuel economy.

#### **M (Manual) (if equipped)**

Moving the gearshift lever to M (Manual):

- Provides additional grade (engine) braking and extends lower gear operation to enhance performance for uphill climbs, hilly terrain or mountainous areas. This will increase engine RPM during engine braking.
- Provides additional lower gear operation through the automatic transmission shift strategy which reacts to vehicle inputs (vehicle acceleration, accelerator pedal, brake pedal and vehicle speed).
- Gears are selected more quickly and at higher engine speeds.

**Note:** The system will stay in M (Manual) until the gear shift lever is moved into another gear for example P (park) or D (Drive).

**SelectShift Automatic® Transmission**

Your SelectShift automatic transmission gives you the ability to manually change gears if you'd like. To use SelectShift, move the gearshift lever into **M** (Manual). Now you can use select shift to manually change gears.

If your vehicle is equipped with (+)/(-) buttons on the side of your gearshift lever:



- Press (-) on the gearshift lever button to manually downshift the transmission.
- Press (+) on the gearshift lever button to manually upshift the transmission.

**Paddle Shifters (If Equipped)**

The paddle shifters allow you to shift gears quickly, without taking your hands off the steering wheel. Temporary manual control is provided when pulling the paddles with the gearshift in the **D** (Drive) position. The system will determine when temporary manual control is no longer desired and reverts back to automatic control. Extensive manual control can be achieved by moving the shifter to the **M** (Manual) position. The system will stay in manual control until the shifter is moved out of the manual position.

If your vehicle is equipped with paddles on the steering wheel:



- Pull the left paddle (-) to downshift the transmission.
- Pull the right paddle (+) to upshift the transmission.

Upshift to the recommended shift speeds according to the following chart.

<b>Upshifts when accelerating (recommended for best fuel economy)</b>	
Shift from:	
1 - 2	15 mph (24 km/h)
2 - 3	25 mph (40 km/h)
3 - 4	40 mph (64 km/h)
4 - 5	45 mph (72 km/h)
5 - 6	50 mph (80 km/h)

The information display in the instrument cluster will show the current selected gear you are in.

In order to prevent the engine from running at too low an RPM, which may cause it to stall, SelectShift will automatically make some downshifts even if it has determined that you have not downshifted in time. Although the SelectShift will make some downshifts for you, it will still allow you to downshift at any time as long as the SelectShift determines that the engine will not be damaged from over-revving.

**Note:** Engine damage may occur if excessive engine revving is held without shifting.

### Brake-shift interlock



**WARNING:** Do not drive your vehicle until you verify that the brakelamps are working.



**WARNING:** When doing this procedure, you will be taking the vehicle out of park which means the vehicle can roll freely.

To avoid unwanted vehicle movement, always fully set the parking brake prior to doing this procedure. Use wheel chocks if appropriate.



**WARNING:** If the parking brake is fully released, but the brake warning lamp remains illuminated, the brakes may not be working properly. See your authorized dealer.

Use the BSI lever to move the gearshift lever from the park position in the event of an electrical malfunction or if your vehicle has a dead battery.

Apply the parking brake, turn the ignition key to the off position, and remove the key.



1. Using a screwdriver (or similar tool), carefully pry off and remove the Brake shift interlock access panel.

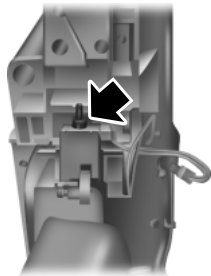

2. Locate the brake shift interlock lever in front of the shifter assembly.

3. Apply the brake pedal. Gently push and hold the brake shift interlock lever while pulling the gearshift lever out of the P (Park) position and into the N (Neutral) position.

4. Install the trim panel.

5. Apply the brake pedal, start the vehicle, and release the parking brake.

**Note:** See your authorized dealer as soon as possible if this procedure is used.

#### **Automatic Transmission Adaptive Learning**

This feature is designed to increase durability and provide consistent shift feel over the life of the vehicle. A new vehicle or transmission may have firm shifts, soft shifts or both. This operation is considered normal and will not affect function or durability of the transmission. Over time, the adaptive learning process will fully update transmission operation. Additionally, whenever the battery is disconnected or a new battery installed, the strategy must be relearned.

**If Your Vehicle Gets Stuck in Mud or Snow**

**Note:** Do not rock the vehicle if the engine is not at normal operating temperature or damage to the transmission may occur.

**Note:** Do not rock the vehicle for more than a minute or damage to the transmission and tires may occur, or the engine may overheat.

If your vehicle gets stuck in mud or snow, it may be rocked out by shifting between forward and reverse gears, stopping between shifts in a steady pattern. Press lightly on the accelerator in each gear.

**HILL START ASSIST**

**WARNING:** The hill start assist feature does not replace the parking brake. When you leave the vehicle, always apply the parking brake and shift the transmission into park (P).



**WARNING:** You must remain in the vehicle once you have activated the hill start assist feature.



**WARNING:** During all times, you are responsible for controlling the vehicle, supervising the hill start assist system and intervening, if required.



**WARNING:** If the engine is revved excessively, or if a malfunction is detected when the hill start assist feature is active, the hill start assist feature will be deactivated.

Hill start assist keeps your vehicle stationary long enough to move your foot from the brake pedal to the accelerator pedal when your vehicle is on a slope.

The brakes are released automatically once the engine has developed sufficient drive to prevent the vehicle from rolling down the slope. This is an advantage when pulling away on a slope, (for example from a car park ramp, traffic lights or when reversing uphill into a parking space).

**Using Hill Start Assist**

1. Press the brake pedal to bring the vehicle to a complete standstill. Keep the brake pedal pressed.
2. If the sensors detect that the vehicle is on a slope, the hill start assist feature will be activated automatically.
3. When you remove your foot from the brake pedal, the vehicle will remain on the slope without rolling away for approximately two or three seconds. This hold time will automatically be extended if you are in the process of driving off.
4. Drive off in the normal manner. The brakes will be released automatically.

**USING YOUR FOUR WHEEL DRIVE (4WD) SYSTEM**

The intelligent 4WD system continuously monitors vehicle conditions and automatically adjusts the power distribution between the front and rear wheels. It combines transparent all-surface operation with highly capable four-wheel drive.

The 4WD system is always active and requires no driver input. It is capable of handling all road conditions, including street and highway driving as well as off-road and winter driving. The driver can optimize more 4WD control by moving the terrain management switch for the correct terrain. See the *Terrain Management* chapter for more information.

**Note:** When an 4WD system fault is present, the warning Check AWD will display in the information display. The 4WD system is not functioning correctly and will default to front-wheel drive. When this warning is displayed, have your vehicle serviced at an authorized dealer.

**Note:** The AWD Off message may also be displayed in the information display if the 4WD system has overheated and defaulted to front-wheel drive. This condition may occur if the vehicle was operated in extreme conditions with excessive wheel slip, such as deep sand. To resume normal 4WD function as soon as possible, stop the vehicle in a safe location and stop the engine for at least 10 minutes. After the engine has been restarted and the 4WD system has adequately cooled, the AWD Off message will turn off and normal 4WD function will return. The AWD Off message will turn off when the system cools and normal 4WD function returns.

If your vehicle is equipped with 4WD, a spare tire of a different size other than the tire provided should never be used. If the mini-spare tire is installed, the 4WD system may disable automatically and enter front-wheel drive only mode to protect driveline components. This condition may be indicated by an AWD Off message in the information display. If there is an AWD Off message in the information display from using the spare tire, this indicator should turn off after reinstalling the repaired or replaced normal road tire and cycling the ignition off and on. It is recommended to reinstall the repaired or replaced road tire as soon as possible. Major dissimilar tire sizes between the front and rear axles could cause the 4WD system to stop functioning and default to front-wheel drive or damage the 4WD system.



## 216 **Four-Wheel Drive (If Equipped)**

---

### **How Utility Vehicles Differ from Other Vehicles**

Truck and utility vehicles can differ from some other vehicles. Your vehicle may be higher to allow it to travel over rough terrain without getting hung up or damaging underbody components.

The differences that make your vehicle so versatile also make it handle differently than an ordinary passenger car.

Maintain steering wheel control at all times, especially in rough terrain. Since sudden changes in terrain can result in abrupt steering wheel motion, make sure you grip the steering wheel from the outside. Do not grip the spokes.

Drive cautiously to avoid vehicle damage from concealed objects such as rocks and stumps.

You should either know the terrain or examine maps of the area before driving. Map out your route before driving in the area. To maintain steering and braking control of your vehicle, you must have all four wheels on the ground and they must be rolling, not sliding or spinning.

### **Driving In Special Conditions With Four-Wheel Drive (4WD)**

**Note:** 4WD vehicles are specially equipped for driving on sand, snow, mud and rough terrain and have operating characteristics that are somewhat different from conventional vehicles, both on and off the road.

Truck and utility vehicles can differ from some other vehicles. Your vehicle may be higher to allow it to travel over rough terrain without getting hung up or damaging underbody components. The differences that make your vehicle so versatile also make it handle differently than an ordinary passenger car. Maintain steering wheel control at all times, especially in rough terrain. Since sudden changes in terrain can result in abrupt steering wheel motion, make sure you grip the steering wheel from the outside. Drive cautiously to avoid vehicle damage from concealed objects such as rocks and stumps. You should either know the terrain or examine maps of the area before driving. Map out your route before driving in the area. To maintain steering and braking control of your vehicle, you must have all four wheels on the ground and they must be rolling, not sliding or spinning.

### ***Basic Operating Principles in Special Conditions***

- Drive slower in strong crosswinds which can affect the normal steering characteristics of your vehicle.
- Be extremely careful when driving on pavement made slippery by loose sand, water, gravel, snow or ice.

***If your vehicle goes off the edge of the pavement***

**WARNING:** Vehicles with a higher center of gravity such as utility and four-wheel drive vehicles handle differently than vehicles with a lower center of gravity. Utility and four-wheel drive vehicles are not designed for cornering at speeds as high as passenger cars any more than low-slung sports cars are designed to perform satisfactorily under off-road conditions. Avoid sharp turns, excessive speed and abrupt maneuvers in these vehicles. Failure to drive cautiously could result in an increased risk of loss of vehicle control, vehicle rollover, personal injury and death.

- If your vehicle goes off the edge of the pavement, slow down, but avoid severe brake application, ease the vehicle back onto the pavement only after reducing your speed. Do not turn the steering wheel too sharply while returning to the road surface.
- It may be safer to stay on the apron or shoulder of the road and slow down gradually before returning to the pavement. You may lose control if you do not slow down or if you turn the steering wheel too sharply or abruptly.
- It often may be less risky to strike small objects, such as highway reflectors, with minor damage to your vehicle rather than attempt a sudden return to the pavement which could cause the vehicle to slide sideways out of control or roll over. Remember, your safety and the safety of others should be your primary concern.

***If your vehicle gets stuck***

**WARNING:** Always set the parking brake fully and make sure the gearshift is latched in P (Park). Turn the ignition to the off position and remove the key whenever you leave your vehicle.



**WARNING:** If the parking brake is fully released, but the brake warning lamp remains illuminated, the brakes may not be working properly. See your authorized dealer.



**WARNING:** Do not spin the wheels at over 35 mph (56 km/h). The tires may fail and injure a passenger or bystander.

## 218 Four-Wheel Drive (If Equipped)

---

If your vehicle gets stuck in mud or snow it may be rocked out by shifting between forward and reverse gears, stopping between shifts, in a steady pattern. Press lightly on the accelerator in each gear.

**Note:** Do not rock the vehicle if the engine is not at normal operating temperature or damage to the transmission may occur.

**Note:** Do not rock the vehicle for more than a few minutes or damage to the transmission and tires may occur or the engine may overheat.

### ***Emergency maneuvers***



**WARNING:** Vehicles with a higher center of gravity such as utility and four-wheel drive vehicles handle differently than vehicles with a lower center of gravity. Utility and four-wheel drive vehicles are not designed for cornering at speeds as high as passenger cars any more than low-slung sports cars are designed to perform satisfactorily under off-road conditions. Avoid sharp turns, excessive speed and abrupt maneuvers in these vehicles. Failure to drive cautiously could result in an increased risk of loss of vehicle control, vehicle rollover, personal injury and death.

- In an unavoidable emergency situation where a sudden sharp turn must be made, remember to avoid “over-driving” your vehicle, i.e., turn the steering wheel only as rapidly and as far as required to avoid the emergency. Excessive steering will result in less vehicle control, not more. Additionally, smooth variations of the accelerator and/or brake pedal pressure should be utilized if changes in vehicle speed are called for. Avoid abrupt steering, acceleration or braking which could result in an increased risk of loss of vehicle control, vehicle rollover and/or personal injury. Use all available road surface to return the vehicle to a safe direction of travel.
- In the event of an emergency stop, avoid skidding the tires and do not attempt any sharp steering wheel movements.
- If the vehicle goes from one type of surface to another (i.e., from concrete to gravel) there will be a change in the way the vehicle responds to a maneuver (steering, acceleration or braking). Again, avoid these abrupt inputs.

***Sand***

When driving over sand, try to keep all four wheels on the most solid area of the trail. Avoid reducing the tire pressures but shift to a lower gear and drive steadily through the terrain. Apply the accelerator slowly and avoid spinning the wheels.

Avoid excessive speed because vehicle momentum can work against you and cause the vehicle to become stuck to the point that assistance may be required from another vehicle. Remember, you may be able to back out the way you came if you proceed with caution.

***Mud and water***

**Note:** Driving through deep water may damage your vehicle.

If you must drive through high water, drive slowly. Traction or brake capability may be limited.

When driving through water, determine the depth; avoid water higher than the bottom of the hubs (if possible) and proceed slowly. If the ignition system gets wet, the vehicle may stall.

Once through water, always try the brakes. Wet brakes do not stop the vehicle as effectively as dry brakes. Drying can be improved by moving your vehicle slowly while applying light pressure on the brake pedal.

Be cautious of sudden changes in vehicle speed or direction when you are driving in mud. Even 4WD vehicles can lose traction in slick mud. As when you are driving over sand, apply the accelerator slowly and avoid spinning your wheels. If the vehicle does slide, steer in the direction of the slide until you regain control of the vehicle.

If the transmission, transfer case or front axle are submerged in water, their fluids should be checked and changed, if necessary.

If the front or rear axle is submerged in water, the axle lubricant should be replaced.

After driving through mud, clean off residue stuck to rotating driveshafts and tires. Excess mud stuck on tires and rotating driveshafts causes an imbalance that could damage drive components.



Service and the Bureau of Land Management in encouraging you to help preserve our national forest and other public and private lands by “treading lightly.”

“Tread Lightly” is an educational program designed to increase public awareness of land-use regulations and responsibilities in our nation’s wilderness areas. Ford Motor Company joins the U.S. Forest

### ***Driving on hilly or sloping terrain***

**Note:** Avoid driving crosswise or turning on steep slopes or hills. A danger lies in losing traction, slipping sideways and possibly rolling over.

Although natural obstacles may make it necessary to travel diagonally up or down a hill or steep incline, you should always try to drive straight up or straight down. Whenever driving on a hill, determine beforehand the route you will use. Do not drive over the crest of a hill without seeing what conditions are on the other side. Do not drive in reverse over a hill without the aid of an observer.

When climbing a steep slope or hill, start in a lower gear rather than downshifting to a lower gear from a higher gear once the ascent has started. This reduces strain on the engine and the possibility of stalling.

If you do stall out, Do not try to turn around because you might roll over. It is better to back down to a safe location.

Apply just enough power to the wheels to climb the hill. Too much power will cause the tires to slip, spin or lose traction, resulting in loss of vehicle control.



Descend a hill in the same gear you would use to climb up the hill to avoid excessive brake application and brake overheating. Do not descend in neutral; instead, disengage overdrive or manually shift to a lower gear. When descending a steep hill, avoid sudden hard braking as you could lose control. When you brake hard, the front wheels cannot turn and if

they are not turning, you will not be able to steer. The front wheels have to be turning in order to steer the vehicle.

Since your vehicle has anti-lock brakes, apply the brakes steadily. Do not “pump” the brakes.

***Driving on snow and ice***

**WARNING:** If you are driving in slippery conditions that require tire chains or cables, then it is critical that you drive cautiously. Keep speeds down, allow for longer stopping distances and avoid aggressive steering to reduce the chances of a loss of vehicle control which can lead to serious injury or death. If the rear end of the vehicle slides while cornering, steer in the direction of the slide until you regain control of the vehicle.

4WD vehicles have advantages over 2WD vehicles in snow and ice but can skid like any other vehicle.

Should you start to slide while driving on snowy or icy roads, turn the steering wheel in the direction of the slide until you regain control.

Avoid sudden applications of power and quick changes of direction on snow and ice. Apply the accelerator slowly and steadily when starting from a full stop.

Avoid sudden braking as well. Although a 4WD vehicle may accelerate better than a two-wheel drive vehicle in snow and ice, it won't stop any faster, because as in other vehicles, braking occurs at all four wheels. Do not become overconfident as to road conditions.

Make sure you allow sufficient distance between you and other vehicles for stopping. Drive slower than usual and consider using one of the lower gears. In emergency stopping situations, avoid locking of the wheels. Use a "squeeze" technique, push on the brake pedal with a steadily increasing force which allows the wheels to brake yet continue to roll so that you may steer in the direction you want to travel. If you lock the wheels, release the brake pedal and repeat the squeeze technique. Since your vehicle is equipped with a Four Wheel Anti-Lock Brake System (ABS), apply the brake steadily. Do not "pump" the brakes. Refer to *Brakes* chapter for additional information on the operation of the anti-lock brake system.

***Maintenance and modifications***

The suspension and steering systems on your vehicle have been designed and tested to provide predictable performance whether loaded or empty and durable load carrying capability. For this reason, Ford Motor Company strongly recommends that you do not make modifications such as adding or removing parts (such as lift kits or stabilizer bars) or by using replacement parts not equivalent to the original factory equipment.

Any modifications to a vehicle that raise the center of gravity can make it more likely the vehicle will roll over as a result of a loss of control.

Ford Motor Company recommends that caution be used with any vehicle equipped with a high load or device (such as ladder racks or pickup box cover).

Failure to maintain your vehicle properly may void the warranty, increase your repair cost, reduce vehicle performance and operational capabilities and adversely affect driver and passenger safety. Frequent inspection of vehicle chassis components is recommended if the vehicle is subjected to heavy off-road usage.

**GENERAL INFORMATION**

**Note:** Occasional brake noise is normal. If a metal-to-metal, continuous grinding or continuous squeal sound is present, the brake linings may be worn out. Have them inspected by an authorized dealer. If your vehicle has continuous vibration or shudder in the steering wheel while braking, have your vehicle inspected by an authorized dealer.

**Note:** Brake dust may accumulate on the wheels, even under normal driving conditions. Some dust is inevitable as the brakes wear and does not contribute to brake noise. See the *Vehicle Care* chapter for wheel cleaning instructions.



See the *Instrument Cluster* chapter for information on the brake system warning light.

Wet brakes result in reduced braking efficiency. Gently press the brake pedal a few times when driving from a car wash or standing water to dry the brakes.

**Brake Over Accelerator**

In the event the accelerator pedal becomes stuck or entrapped, apply steady and firm pressure to the brake pedal to slow your vehicle and reduce engine power. If you experience this condition, apply the brakes and bring your vehicle to a safe stop. Turn the engine off, shift to park (P) and apply the parking brake. Inspect the accelerator pedal and the area around it for any items or debris that may be obstructing its movement. If none are found and the condition persists, have your vehicle towed to the nearest authorized dealer.

**Brake Assist**

Brake assist detects when you brake heavily by measuring the rate at which you press the brake pedal. It provides maximum braking efficiency as long as you press the pedal. Brake assist can reduce stopping distances in critical situations.



### Anti-Lock Brake System

This system helps you maintain steering control during emergency stops by keeping the brakes from locking.



This lamp momentarily illuminates when you turn the ignition on. If the light does not illuminate during start-up, remains on or flashes, the anti-lock brake system may be disabled and may need to be serviced.



If the anti-lock brake system is disabled, normal braking is still effective. If the brake warning lamp illuminates with the parking brake released, have your brake system serviced immediately.

### HINTS ON DRIVING WITH ANTI-LOCK BRAKES

When the system is operating, the brake pedal will pulse and may travel further. Maintain pressure on the brake pedal. You may also hear a noise from the system. This is normal.

The anti-lock braking system will not eliminate the dangers inherent when:

- You drive too closely to the vehicle in front of you.
- Your vehicle is hydroplaning.
- You take corners too fast.
- The road surface is poor.

### PARKING BRAKE



**WARNING:** If the parking brake is fully released, but the brake warning lamp remains illuminated, then driving your vehicle could result in reduced braking ability, increased stopping distances and potential loss of brakes. See your authorized dealer as soon as possible.



**WARNING:** Always set the parking brake fully and make sure that the transmission is securely latched in park (P). Failure to set the parking brake and engage park could result in vehicle roll-away, property damage or bodily injury.

To set the parking brake, press the parking brake pedal down to its fullest extent.

To release the parking brake, press the parking brake pedal down again.

**PRINCIPLES OF OPERATION**

The traction control system helps avoid drive wheel spin and loss of traction.

If your vehicle begins to slide, the system applies the brakes to individual wheels and, when needed, reduces engine power at the same time. If the wheels spin when accelerating on slippery or loose surfaces, the system reduces engine power in order to increase traction.

**USING TRACTION CONTROL**

In certain situations (for example, stuck in snow or mud), turning the traction control off may be beneficial as this allows the wheels to spin with full engine power. Turn the traction control system off through the information display. See the *Information Displays* chapter.

**System Indicator Lights and Messages**

**WARNING:** If a failure has been detected within the Traction Control System, the stability control light will illuminate steadily. Verify that the Traction Control System was not manually disabled using the information display control. If the stability control light still illuminates steadily, have the system serviced by an authorized dealer immediately. Operating your vehicle with Traction Control disabled could lead to an increased risk of loss of vehicle control, vehicle rollover, personal injury and death.



The stability control light temporarily illuminates on engine start-up and flashes when a driving condition activates the stability system.



The stability control off light temporarily illuminates on engine start-up and stays on when the traction control system is turned off or if a problem occurs in the stability system.

When the traction control system is turned off or on, a message appears in the information display showing system status.

---

**PRINCIPLES OF OPERATION**

**WARNING:** Vehicle modifications involving braking system, aftermarket roof racks, suspension, steering system, tire construction and wheel or tire size may change the handling characteristics of the vehicle and may adversely affect the performance of the AdvanceTrac® system. In addition, installing any stereo loudspeakers may interfere with and adversely affect the AdvanceTrac® system. Install any aftermarket stereo loudspeaker as far as possible from the front center console, the tunnel, and the front seats in order to minimize the risk of interfering with the AdvanceTrac® sensors. Reducing the effectiveness of the AdvanceTrac® system could lead to an increased risk of loss of vehicle control, vehicle rollover, personal injury and death.



**WARNING:** Remember that even advanced technology cannot defy the laws of physics. It's always possible to lose control of a vehicle due to inappropriate driver input for the conditions. Aggressive driving on any road condition can cause you to lose control of your vehicle increasing the risk of personal injury or property damage. Activation of the AdvanceTrac® system is an indication that at least some of the tires have exceeded their ability to grip the road; this could reduce the operator's ability to control the vehicle potentially resulting in a loss of vehicle control, vehicle rollover, personal injury and death. If your AdvanceTrac® system activates, SLOW DOWN.

The AdvanceTrac® with Roll Stability Control™ system helps you keep control of your vehicle when on a slippery surface. The electronic stability control portion of the system helps avoid skids and lateral slides, curve control assists in vehicle handling in following the road during adverse maneuvering and roll stability control helps avoid a vehicle rollover. The traction control system helps avoid drive wheel spin and loss of traction. See the *Traction Control* chapter for details on traction control system operation.

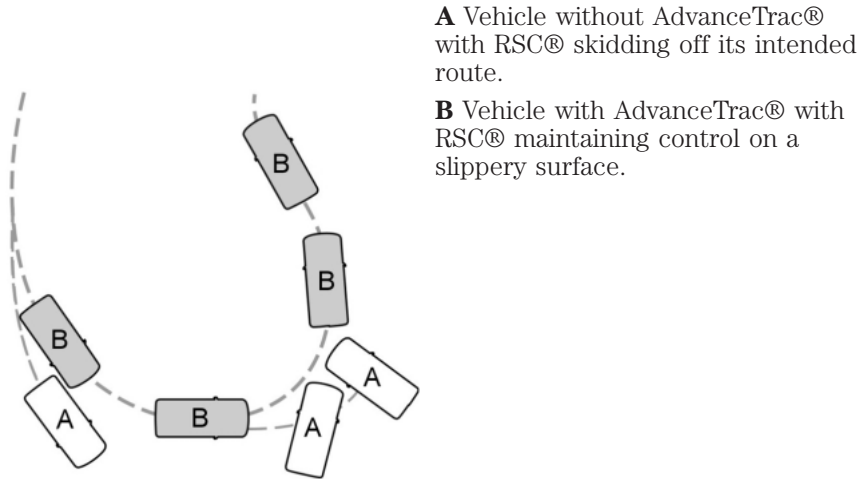

### USING ADVANCETRAC® WITH RSC®

The system automatically activates when you start your engine. The AdvanceTrac® with RSC® system cannot be completely turned off, but the electronic stability control and roll stability control portions of the system are disabled when the transmission is in reverse (R). You can turn curve control off by using the terrain management system. See the *Terrain Management* chapter. You can also turn off the traction control portion of the system independently. See the *Traction Control* chapter.

**TERRAIN MANAGEMENT (IF EQUIPPED)**

This system optimizes drivability and comfort as well as maximizing traction while operating on different types of terrain.

Turn the control located on the center console to choose between the following modes:

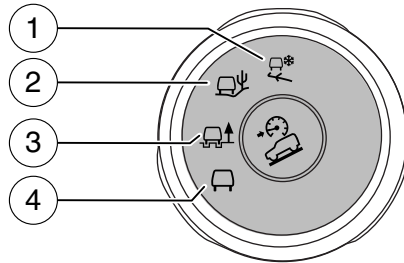

1. **Grass/Gravel/Snow** mode should be selected where a firm surface is covered with loose or slippery material such as packed snow, ice, water, grass, or a thin layer of gravel or sand. For deep gravel or sand, select Sand mode. If the vehicle cannot gain traction in deep snow, turning off the traction control system may help (turn traction control back on when traction is regained). See the *Traction Control* chapter.

2. **Sand** mode should be selected in soft dry sand or deep gravel. If crossing wet sand that may be sufficiently deep enough for the wheels to sink into the surface, select Mud/Ruts mode.

3. **Mud/Ruts** mode should be selected for muddy, rutted, soft, or uneven terrain.

4. **Normal** mode is for on-road conditions and should be selected before driving on surfaces which are similar to a hard road surface or once the need for a special mode has passed. Select Normal mode when towing a trailer.

**Note:** Cruise control is available only in Normal and Snow modes.

**Note:** The Sand and Mud/Ruts modes are for off-road use only.

**Note:** The curve control portion of the AdvanceTrac® system is unavailable when Sand or Mud/Ruts is selected.

If the system becomes inoperable, selecting some modes may not be possible and a message is displayed. If it becomes inoperable due to a system malfunction, all of the mode indicators on the control turn off and one of the following messages appears in the information display:

**TERRAIN MANAGEMENT SYSTEM FAULT:** Cycling the key may clear the fault. If key cycling does not work, have the system serviced by an authorized dealer.

**MODE CHANGE NOT ACCEPTED, RETRY:** A mode change cannot be made at the time of driver request. Try the mode change again.

#### **HILL DESCENT CONTROL™ (IF EQUIPPED)**



**WARNING:** Hill descent control cannot control descent in all surface conditions and circumstances, such as ice or extremely steep grades. Hill descent control is a driver assist system and cannot substitute for good judgment by the driver. Failure to do so may result in loss of vehicle control, crash or serious injury.



**WARNING:** Hill descent control does not provide hill hold at zero mph (0 km/h). When stopped, the parking brake must be applied and/or the vehicle must be placed in P (Park) or it may roll away.

Hill descent control allows the driver to set and maintain vehicle speed while descending steep grades in various surface conditions.

Hill descent control can maintain vehicle speeds on downhill grades between 3 mph (5 km/h) and 20 mph (32 km/h). Above 20 mph (32 km/h), the system remains armed, but descent speed cannot be set or maintained.

Hill descent control requires a cooling down interval after a period of sustained use. The amount of time that the feature can remain active before cooling varies with conditions. The system will provide a warning in the message center and a chime will sound when the system is about to disengage for cooling. At this time, manually apply the brakes as needed to maintain descent speed.

To enable hill descent control and set the descent speed, do the following:



1. Press and release the hill descent button located in the center of the terrain management control. A light in the control will illuminate and chime will sound when this feature is activated.

2. To increase descent speed, press the accelerator pedal until the desired speed is reached. To decrease descent speed, press the brake pedal until the desired speed is reached.

Whether accelerating or decelerating, once the desired descent speed is reached, remove your feet from the pedals and the chosen vehicle speed will be maintained.

**Note:** Noise from the ABS pump motor may be observed during hill descent control operation. This is a normal characteristic of the ABS and should be no reason for concern.

Hill descent modes

- At speeds below 20 mph (32 km/h): When the HDC button is pressed and HDC is active, HILL DESCENT CONTROL ACTIVE will appear in the message center for several seconds.
- At speeds below 20 mph (32 km/h): When the HDC button is pressed and conditions are not correct for hill descent activation, the HDC system will be enabled, the light on the button will be on solid and HILL DESCENT CONTROL READY will be displayed in the message center for several seconds.
- At speeds above 20 mph (32 km/h): When the HDC button is pressed, the HDC system will be enabled, the light on the button will be illuminated, and FOR HILL CNTRL, 20 MPH OR LESS will be displayed in the message center for several seconds.
- For HDC to enable, the vehicle must be in a drive gear or (R) Reverse. If the vehicle is in P (Park) or N (Neutral) and the HDC button is pressed, FOR HILL CNTRL, SELECT GEAR will be displayed in the message center for several seconds.

Refer to *Warning lamps and indicators* in the *Instrument Cluster* chapter for hill descent control messages.

**SENSING SYSTEM (IF EQUIPPED)**

 **WARNING:** To help avoid personal injury, please read and understand the limitations of the system as contained in this section. Sensing is only an aid for some (generally large and fixed) objects when moving in reverse on a flat surface at parking speeds. Traffic control systems, inclement weather, air brakes, and external motors and fans may also affect the function of the sensing system; this may include reduced performance or a false activation.

 **WARNING:** To help avoid personal injury, always use caution when in R (Reverse) and when using the sensing system.

 **WARNING:** This system is not designed to prevent contact with small or moving objects. The system is designed to provide a warning to assist the driver in detecting large stationary objects to avoid damaging the vehicle. The system may not detect smaller objects, particularly those close to the ground.

 **WARNING:** Certain add-on devices such as large trailer hitches, bike or surfboard racks and any device that may block the normal detection zone of the system, may create false beeps.

**Note:** Keep the sensors (located on the bumper/fascia) free from snow, ice and large accumulations of dirt. If the sensors are covered, the system's accuracy can be affected. Do not clean the sensors with sharp objects.

**Note:** If your vehicle sustains damage to the bumper/fascia, leaving it misaligned or bent, the sensing zone may be altered causing inaccurate measurement of obstacles or false alarms.

The sensing system warns the driver of obstacles within a certain range of the bumper area. The system turns on automatically whenever the ignition is switched on.

When receiving a detection warning, the radio volume is reduced to a predetermined level. After the warning goes away, the radio volume returns to the previous level.

The system can be turned off using the information display control. Refer to the *Information Display* chapter.



If a fault is present in the system, a warning message appears in the information display and does not allow the driver to switch the faulted system on.

**Note:** If your vehicle is equipped with MyKey®, it is possible to prevent turning the sensing system off. Refer to the *MyKey®* chapter.

### Using the Rear Sensing System

The rear sensors are only active when the transmission is in **R**. As the vehicle moves closer to the obstacle, the rate of the audible warning increases. When the obstacle is fewer than 12 inches (30 centimeters) away, the warning sounds continuously. If a stationary or receding object is detected farther than 12 inches (30 centimeters) from the side of the vehicle, the tone sounds for only three seconds. Once the system detects an object approaching, the warning sounds again.

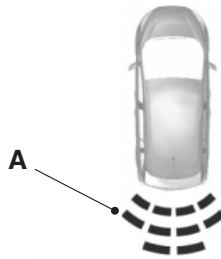

A. Coverage area of up to 6 feet (2 meters) from the rear bumper (with a decreased coverage area at the outer corners of the bumper).

The system detects certain objects while the transmission is in **R**:

- and moving toward a stationary object at a speed of 3 mph (5 km/h) or less.
- but not moving, and a moving object is approaching the rear of the vehicle at a speed of 3 mph (5 km/h) or less.

**ACTIVE PARK ASSIST (IF EQUIPPED)**

**WARNING:** This system is designed to be a supplementary park aid. It may not work in all conditions and is not intended to replace the driver's attention and judgment. The driver is responsible for avoiding hazards and maintaining a safe distance and speed, even when the system is in use.

**Note:** The driver is always responsible for controlling the vehicle, supervising the system and intervening if required.

The system detects an available parallel parking space and automatically steers the vehicle into the space (hands-free) while you control the accelerator, gearshift and brakes. The system visually and/or audibly instructs the driver to park the vehicle.

The system may not function correctly if something passes between the front bumper and the parking space (i.e. a pedestrian or cyclist) or if the edge of the neighboring parked vehicle is high from the ground (i.e. a bus, tow truck or flatbed truck).

**Note:** The sensors may not detect objects in heavy rain or other conditions that cause disruptive reflections.

**Note:** The sensors may not detect objects with surfaces that absorb ultrasonic waves.

**Note:** After a tire change the system will go through a relearning procedure. During this time the system performance may deteriorate.

The system should not be used if:

- a foreign object (i.e. bike rack or trailer) is attached to the front or rear of the vehicle or at another location close to the sensors.
- an overhanging object (i.e. surfboard) is attached to the roof.
- the front bumper or side sensors are damaged (i.e. in a collision) or obstructed by a foreign object (i.e. front bumper cover).
- a mini-spare tire is in use.

**Using Active Park Assist**

Press the button; the touch screen displays a message and a corresponding graphic to indicate it's searching for a parking space. Use the turn signal to indicate which side of the vehicle you want the system to search on.

**Note:** If the turn signal is not on, the system automatically searches on the vehicle's passenger side.

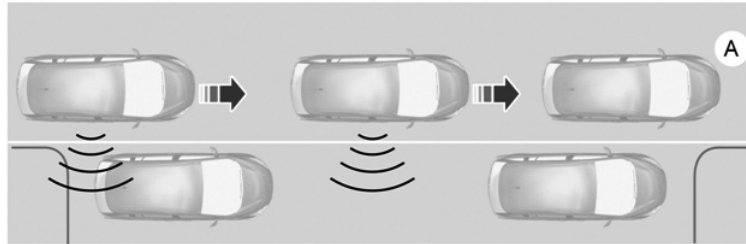

When a suitable space is found, the touch screen displays a message and a chime sounds. Slow down and stop at approximately position (A), then follow the instructions on the touch screen.

**Note:** You must observe that the selected space remains clear of obstructions at all times in the maneuver.

**Note:** Vehicles with overhanging loads (e.g. a bus or a truck), street furniture and other items may not be detected by active park assist. You must ensure the selected space is suitable for parking.

**Note:** The vehicle should be driven as parallel to other vehicles as possible while passing a parking space.

**Note:** The system always offers the last detected parking space (i.e. if the vehicle detects multiple spaces while you are driving, it offers the last one).

**Note:** If driven above approximately 20 mph (35 km/h), the touch screen shows a message to alert the driver to reduce vehicle speed.

**Automatic Steering into Parking Space**

**Note:** If vehicle speed exceeds 6 mph (10 km/h), the system turns off and you need to take full control of the vehicle.

**Note:** If a maneuver is interrupted before completion, the system turns off and you need to full take control of the vehicle. In some instances after an interruption a message may appear that would allow you to resume the maneuver.

With hands off the wheel (and nothing obstructing its movement) and the transmission in **R** (Reverse), the vehicle steers itself as instructions to safely move the vehicle back and forward in the space are displayed in the touch screen. While reversing, the touch screen displays a message instructing the driver to check their surroundings (for safety reasons) and to back-up slowly, accompanied by a corresponding graphic.



When you think your vehicle has enough space in front and behind it, or you hear a solid tone from the parking aid (accompanied by a touchscreen display message and a chime), bring your vehicle to a complete stop.

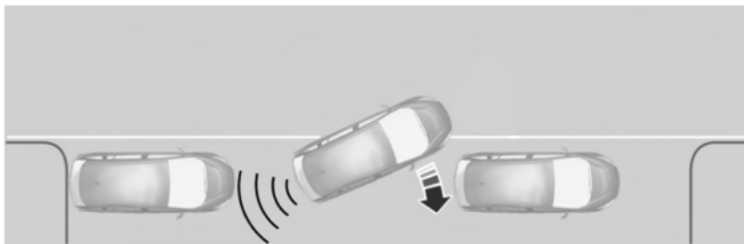

When automatic steering is finished, the touch screen displays a message indicating that the active park assist process is done. The driver is responsible for checking the parking job and making any necessary corrections before putting the transmission in **P** (Park).

**Deactivating the Park Assist Feature**

The system can be deactivated manually by:

- pressing the active park assist button
- grabbing the steering wheel
- driving above approximately 20 mph (35 km/h) for 30 seconds during an active park search
- driving above 6 mph (10 km/h) during automatic steering
- turning off the traction control system.

Certain vehicle conditions can also deactivate the system:

- Traction control has activated on a slippery or loose surface.
- Anti-lock brake system activation or failure.
- Any door (except the driver's) opens.
- Something touches the steering wheel.

If a problem occurs with the system, a warning message is displayed, followed by a chime. Occasional active park assist messages may occur in normal operation. For recurring or frequent active park assist faults, contact an authorized dealer to have your vehicle serviced.

**Troubleshooting the System**

<b>The system does not look for a space</b>
The traction control system may be off
Any door (except the driver's) may not be completely closed
<b>The system does not offer a particular space</b>
Something may be contacting the front bumper or side sensors
There is not enough room on both sides of the vehicle in order to park
There is not enough space for the parking maneuver on the opposite side of the parking space
The vehicle is farther than 5 ft (1.5 m) from the parking space
The vehicle is closer than 16 in. (40 cm) from neighboring parked vehicles
The transmission is in R (Reverse); the vehicle must be moving forward to detect a parking space
The vehicle is going faster than 20 mph (35 km/h)

<b>The system does not position the vehicle where I want in the space</b>
The vehicle is rolling in the opposite direction of the transmission (i.e. rolling forward when R [Reverse] is selected)
The transmission is in R (Reverse); the vehicle must be moving forward to detect a parking space
An irregular curb along the parking space prevents the system from aligning the vehicle properly
Vehicles or objects bordering the space may not be positioned correctly
The vehicle was pulled too far past the parking space. The system performs best when you drive the same distance past the parking space
The tires may not be installed or maintained correctly (i.e. not inflated correctly, improper size, or of different sizes)
A repair or alteration has changed detection capabilities
A parked vehicle has a high attachment (i.e. salt sprayer, snowplow, moving truck bed, etc.)
The parking space length or position of parked objects changed after your vehicle passed
The temperature around your vehicle changes quickly (i.e. driving from a heated garage into the cold, or after leaving a car wash)

**REAR VIEW CAMERA SYSTEM (IF EQUIPPED)**

 **WARNING:** The rear view camera system is a reverse aid supplement device that still requires the driver to use it in conjunction with the interior and exterior mirrors for maximum coverage.

 **WARNING:** Objects that are close to either corner of the bumper or under the bumper, might not be seen on the screen due to the limited coverage of the camera system.

 **WARNING:** Back up as slow as possible since higher speeds might limit your reaction time to stop the vehicle.

 **WARNING:** Use caution when using the rear video camera and the liftgate is ajar. If the liftgate is ajar, the camera will be out of position and the video image may be incorrect. All guidelines have been removed when the liftgate is ajar.

 **WARNING:** Use caution when turning camera features on or off while in R (Reverse). Make sure the vehicle is not moving.

The rear view camera system provides a video image of the area behind the vehicle.

During operation, lines appear in the display which represent your vehicle's path and proximity to objects behind the vehicle.



The camera is located on the liftgate.

### Using the Rear View Camera System

The rear view camera system displays what is behind your vehicle when you place the transmission in R (Reverse). The system uses three types of guides to help you see what is behind your vehicle:

1. Active guidelines: Show the intended path of the vehicle when reversing.
2. Fixed guidelines: Show the actual path the vehicle is moving in while reversing in a straight line, which can be helpful when backing into a parking space or aligning the vehicle with another object behind the vehicle.
3. Centerline: Helps align the center of the vehicle with an object (i.e. a trailer).

**Note:** If the transmission is in R (Reverse) and the trunk/liftgate is ajar, no rear view camera features are displayed.

**Note:** If the image comes on while the transmission is not in R (Reverse), have the system inspected by your authorized dealer.

**Note:** When towing, the camera only sees what is being towed behind the vehicle. This might not provide adequate coverage as it usually provides in normal operation and some objects might not be seen. In some vehicles, the guidelines may disappear once the trailer tow connector is engaged.

**Note:** The camera may not operate correctly under the following conditions:

- Nighttime or dark areas if one or both reverse lamps are not operating. Do not use the rear view camera display when lighting is low until both reverse lamps are functional.
- The camera's view is obstructed by mud, water or debris. Clean the lens with a soft, lint-free cloth and non-abrasive cleaner.
- The rear of the vehicle is hit or damaged, causing the camera to become misaligned. Check with your authorized dealer to have the rear view camera system checked for proper coverage and operation.

#### ***Adjusting the Rear View Camera Settings (If Equipped)***

To access any of the rear view camera system settings, make the following selections in the touch screen when the transmission is not in R (Reverse):

1. Menu
2. Vehicle
3. Rear View Camera

After changing a system setting, the touch screen shows a preview of the feature(s) selected.



**Guidelines and the Centerline**

**Note:** Fixed guidelines and active guidelines (if equipped) are only available when the transmission is in R (Reverse).

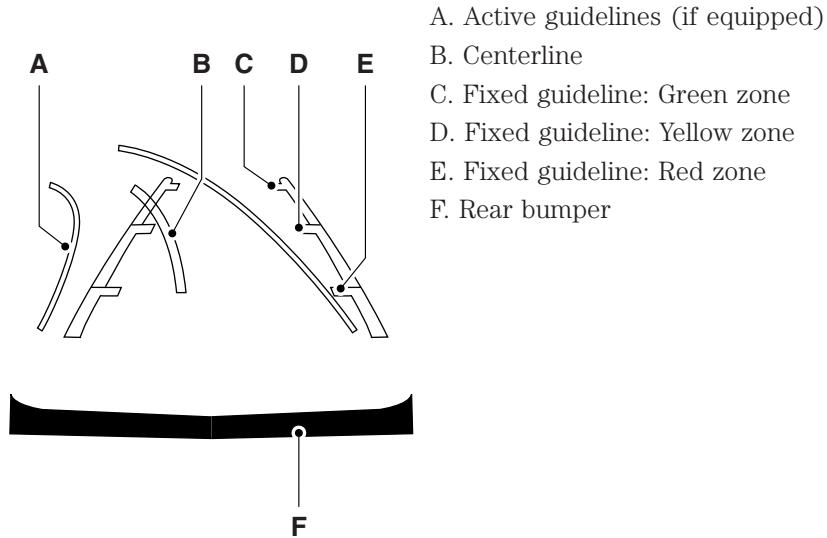

If your vehicle is equipped with active guidelines they are only shown with fixed guidelines. To use active guidelines, turn the steering wheel to point the guidelines toward an intended path. If the steering wheel position is changed while reversing, the vehicle might deviate from the original intended path.

The fixed and active guidelines fade in and out depending on the steering wheel position. When the steering wheel position is straight, the active guidelines are not shown.

Always use caution while reversing. Objects in the red zone are closest to your vehicle and objects in the green zone are further away. Objects are getting closer to your vehicle as they move from the green zone to the yellow or red zones. Use the side view mirrors and rear view mirror to get better coverage on both sides and rear of the vehicle.

**Enhanced Park Aids**

**Note:** Enhanced park aids is only available when the transmission is in R (Reverse).

**Note:** The reverse sensing system is not effective at speeds above 3 mph (5 km/h) and may not detect certain angular or moving objects.

The enhanced park aids allows the driver to view the area that is being detected by the reverse sensing system. The system uses red, yellow and green highlights which appear on top of the video image when an object is detected by the reverse sensing system. The alert highlights the closest object detected. The reverse sensing alert can be disabled and if enhanced park aids is enabled, highlighted areas are still displayed.

Selectable settings for this feature are ON and OFF.

**Manual Zoom**

**WARNING:** When manual zoom is on, the full area behind the vehicle is not shown. Be aware of your surroundings when using the manual zoom feature.

**Note:** Manual zoom is only available when the transmission is in R (Reverse).

**Note:** When manual zoom is enabled, only the centerline is shown.

Allows the driver to get a closer view of an object behind the vehicle. The zoomed image keeps the bumper in the image to provide a reference. The zoom is only active while the transmission is in R (Reverse), When the transmission is shifted out of R (Reverse), the feature automatically turns off and must be reset when it is used again.

Selectable settings for this feature are OFF and ON. Press the zoom button to change the view. The default setting for the manual zoom is OFF.

**Rear Camera Delay**

When shifting the transmission out of R (Reverse) and into any gear other than P (Park), the camera image remains in the display until the vehicle speed reaches 6 mph (10 km/h). This occurs when the rear camera delay feature is on, or until a radio button is selected.

Selectable settings for this feature are ON and OFF. The default setting for the rear camera delay is OFF.

**PRINCIPLES OF OPERATION**

Cruise control lets you maintain a set speed without keeping your foot on the accelerator pedal.

**USING CRUISE CONTROL**

 **WARNING:** Do not use cruise control in heavy traffic, on winding roads or when the road surface is slippery. This could result in loss of vehicle control, serious injury or death.

 **WARNING:** When you are going downhill, your vehicle speed may increase above the set speed. The system will not apply the brakes. Change down a gear to assist the system in maintaining the set speed. Failure to do so could result in loss of vehicle control, serious injury or death.

**Note:** Cruise control will disengage if your vehicle speed decreases more than 10 mph (16 km/h) below your set speed while driving uphill.

The cruise controls are located on the steering wheel.

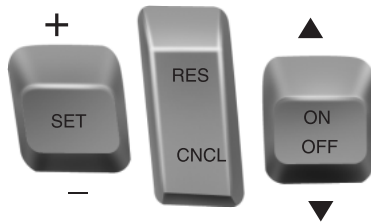
**Switching Cruise Control On**

Press the **ON** control up and release.



The indicator will appear in the instrument cluster.

**Setting a Speed**

1. Accelerate to the desired speed.
2. Press the **SET** control upward and release.
3. Take your foot off the accelerator pedal.

The indicator will change colors in the instrument cluster.

**Changing the Set Speed**

**Note:** If you accelerate by pressing the accelerator pedal, the set speed will not change. When you release the accelerator pedal, you will return to the speed that you previously set.

- Press **SET** up or down and hold to increase or decrease the set speed. Release the control when you reach the desired speed.
- Press **SET** up or down and release. The set speed will change in approximately 1 mph (2 km/h) increments.
- Press the accelerator pedal or brake pedal until you reach the desired speed. Press **SET** up and release.

**Canceling the Set Speed**

Press **CNCL** or tap the brake pedal. The set speed will not be erased.

**Resuming the Set Speed**

Press and release **RES**.

**Switching Cruise Control Off**

**Note:** The set speed is erased when you switch off cruise control.

Press the **OFF** control down and release or turn off the ignition.

**USING ADAPTIVE CRUISE CONTROL (IF EQUIPPED)**

**WARNING:** Always pay close attention to changing road conditions, especially when using adaptive cruise control. Adaptive cruise control cannot replace attentive driving. Failing to follow any of the warnings below or failing to pay attention to the road may result in a collision, serious injury or death.

 **WARNING:** Adaptive cruise control is not a collision warning or avoidance system. Additionally, adaptive cruise control will not detect:

- stationary or slow moving vehicles below 6 mph (10 km/h)
- pedestrians or objects in the roadway
- oncoming vehicles in the same lane.

 **WARNING:** Do not use the adaptive cruise control when entering or leaving a highway, in heavy traffic or on roads that are winding, slippery or unpaved.

 **WARNING:** Do not use in poor visibility, specifically fog, rain, spray or snow.

**Note:** It is your responsibility to stay alert, drive safely and be in control of your vehicle at all times.

The system adjusts your speed to maintain a proper distance between you and the vehicle in front of you in the same lane. You can select from one of four GAP settings. The controls are located on the steering wheel.

At startup, the system sets the gap to the last selected setting. Once activated, you can deactivate the system at any time by pressing the brake pedal, pressing the steering wheel **OFF** control or pressing the **CNCL** control. In addition, you can temporarily increase the vehicle speed above the current speed by manually pressing on the accelerator pedal.

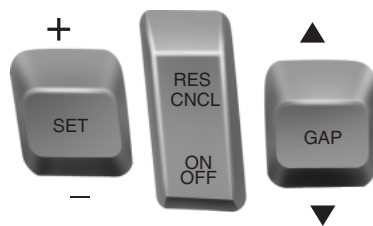

The controls for using your cruise control are located on the steering wheel.

### Setting Adaptive Cruise Control



1. Press and release **ON**.

The information display will show the gray indicator light, current gap setting and **SET**. The system is set to standby mode.

2. Accelerate to the desired speed.
3. Press **SET** upward and release. The vehicle speed is stored in the memory.



The information display will show a green indicator light, current gap setting and desired set speed.

4. Take your foot off the accelerator pedal.



5. A lead vehicle graphic will illuminate if there is a vehicle detected in front of you.

**Note:** When adaptive cruise control is active, the set speed displayed in the information display may vary slightly from the speedometer.

### Following a Vehicle



**WARNING:** When following a vehicle in front of you, your vehicle will not decelerate automatically to a stop, nor will your vehicle always decelerate quickly enough to avoid a collision without driver intervention. Always apply the brakes when necessary. Failing to do so may result in a collision, serious injury or death.



**WARNING:** Adaptive cruise control only warns of vehicles detected by the radar sensor. In some cases there may be no warning or the warning may be delayed. The driver should always apply the brakes when necessary. Failing to do so may result in a collision, serious injury or death.

**Note:** The brakes may emit a sound when they are being modulated by the adaptive cruise control system.

When a vehicle ahead of you enters the same lane or a slower vehicle is ahead in the same lane, the vehicle speed adjusts to maintain a preset gap distance. The distance setting is adjustable.

The lead vehicle graphic will be illuminated.

Your vehicle will maintain a constant distance between the vehicle ahead until:

- the vehicle in front of you accelerates to a speed above the set speed
- the vehicle in front of you moves out of your lane or out of view
- the vehicle speed falls below 16 mph (26 km/h)
- a new gap distance is set.

The vehicle brakes will be automatically applied to slow your vehicle to maintain a safe distance from the vehicle in front. The maximum braking which is applied by the system is limited and can be overridden by the driver applying the brakes.

If the system predicts that its maximum braking level will not be sufficient, an audible warning will sound while the system continues to brake. This is accompanied by a heads-up display; a red warning bar illuminating on the windshield. You should take immediate action.

### Setting the Gap Distance

**Note:** It is your responsibility to select a gap appropriate to the driving conditions.



You can decrease or increase the distance between your vehicle and the vehicle in front of you by pressing the **GAP** control up or down. The selected gap will display

in the information display as shown by the bars in the graphic. Four gap distance settings are available.

Graphic display (bars between vehicles)	Following distance	Following distance at 60 mph (100 km/h)	Dynamic behavior
1 bar	1 second	31 yards (28 m)	Sporty
2 bars	1.4 seconds	43 yards (39 m)	Normal
3 bars	1.8 seconds	55 yards (50 m)	Normal
4 bars	2.2 seconds	67 yards (61 m)	Comfort

Each time you restart your vehicle, the system will select the last chosen gap for the current driver.

### Disengaging Adaptive Cruise Control

Press the brake pedal or press **CNCL** to disengage the system. The last set speed will display with a strikethrough.

Disengaging the system will not erase your previous set speed.

### Overriding Adaptive Cruise Control



**WARNING:** Whenever the driver is overriding the ACC by pressing the accelerator pedal, the ACC will not automatically apply the brakes to maintain separation from any vehicle ahead.

You can override the set speed and gap distance by pressing the accelerator pedal.



When you are overriding the system, the green indicator light illuminates and the follow vehicle does not show in the information display. The system will resume operation when you release the accelerator pedal. The vehicle speed will decrease to the set speed, or a lower speed if following a slower vehicle.

### Changing the Set Speed

There are three ways to change the set speed:

- Accelerate or brake to the desired speed and press **SET** upward and release.
- Increase or decrease the speed by holding **SET** upward or downward until the desired set speed is shown on the information display. The vehicle speed will gradually change to the selected speed.
- Increase or decrease the speed in increments of 1 mph (2 km/h) by briefly pressing **SET** upward or downward.



The system may apply the brakes to slow your vehicle down to the new set speed. The set speed will display continuously in the information display while the system is active.

**Resuming the Set Speed**

**Note:** Resume should only be used if you are aware of the set speed and intend to return to it.

Press and release **RES**. Your vehicle will return to the previously set speed. The set speed will display continuously in the information display while the system is active.

**Low Speed Automatic Cancellation**

The system is not functional at vehicle speeds below 16 mph (26 km/h). An audible alarm sounds and the automatic braking released if your vehicle drops below this speed.

**Hilly Condition Usage**

**Note:** An audible alarm sounds and the system shuts down if it is applying brakes for an extended period of time. This allows the brakes to cool down. The system will function normally again when the brakes have cooled down.

You should select a lower gear position when the system is active in situations such as prolonged downhill driving on steep grades, for example driving in mountainous areas. Your vehicle needs additional engine braking in these situations to reduce the load on the vehicle's regular brake system to prevent them from overheating.

**Switching Off Adaptive Cruise Control**

**Note:** The set speed memory will erase when you switch the system off. Press and release **OFF** or turn off the ignition.

### Detection Issues

The radar sensor has a limited field of vision. It may not detect vehicles at all or detect a vehicle later than expected in some situations. The lead vehicle graphic will not illuminate if the system does not detect a vehicle in front of you.

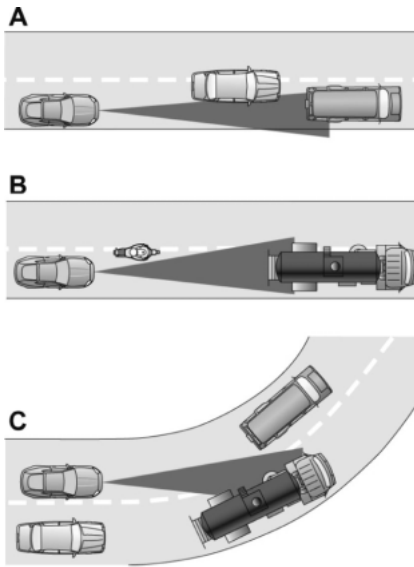

Detection issues can occur:

- A. When driving on a different line than the vehicle in front.
- B. With vehicles that edge into your lane. The system can only detect these vehicles once they move fully into your lane.
- C. There may be issues with the detection of vehicles in front when driving into and coming out of a bend or curve in the road.

In these cases the system may brake late or unexpectedly. You should stay alert and intervene when necessary.

If the front end of your vehicle is hit or damaged, the radar sensing zone may be altered causing missed or false vehicle detections. See your authorized dealer to have the radar checked for proper coverage and operation.

### Adaptive Cruise Control Not Available

Several conditions exist which can cause the system to deactivate or prevent the system from activating when requested. These conditions include:

- a blocked sensor
- high brake temperature
- a failure in the system or a related system.

**Blocked Sensor**

 **WARNING:** Do not use ACC when towing a trailer with brake controls. Aftermarket trailer brakes will not function properly when ACC is activated because the brakes are electronically controlled. Failing to do so may result in loss of vehicle control, which could result in serious injury.

 **WARNING:** Do not use tires sizes other than those recommended because this can affect the normal operation of ACC. Failing to do so may result in a loss of vehicle control, which could result in serious injury.

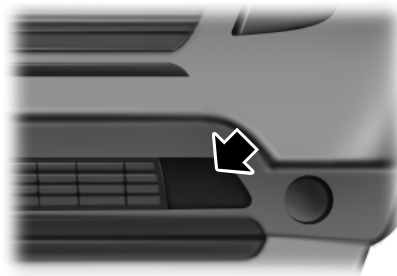

A message regarding a blocked sensor is displayed if the radar signals from the sensor have been obstructed. The sensor is located behind a fascia cover near the driver side of the lower grille. A vehicle ahead cannot be detected and the system will not function when the radar signals are obstructed. The following table lists possible causes and actions for this message being displayed.

Cause	Action
The surface of the radar in the grille is dirty or obstructed in some way.	Clean the grille surface in front of the radar or remove the object causing the obstruction.
The surface of the radar in the grille is clean but the message remains in the display.	Wait a short time. It may take several minutes for the radar to detect that it is no longer obstructed.
Heavy rain or snow is interfering with the radar signals.	Do not use the system in these conditions because it may not detect any vehicle ahead.

Cause	Action
Swirling water, or snow or ice on the surface of the road may interfere with the radar signals.	Do not use system in these conditions because it may not detect any vehicle ahead.
You are in a desert or remote area with no other vehicles and no roadside objects.	Wait a short time or switch to normal cruise control.

Due to the nature of radar technology, it is possible to get a blockage warning and not be blocked. This can happen, for example, when driving in sparse rural or desert environments. A false blocked condition will either self-clear or clear after a key cycle.

### Switching to Normal Cruise Control



**WARNING:** Normal cruise control will not brake due to slower vehicles. Always be aware of which mode is selected and apply the brakes when necessary.

You can manually change from adaptive cruise control to normal cruise control through the information display.



The cruise control indicator light will replace the adaptive cruise control indicator light if normal cruise system control is selected. The gap setting will not be displayed, the system will not automatically respond to lead vehicles and automatic braking will not be activated. The system will default to adaptive cruise control when the engine is started.

**DRIVER ALERT (IF EQUIPPED)**

**WARNING:** The driver alert system is designed to aid you. It is not intended to replace your attention and judgment. You are still responsible to drive with due care and attention.

**Note:** The system will store the on/off setting in the information display menu through ignition cycles.

**Note:** If enabled in the menu, the system will be active above 40 mph (64 km/h). When below the activation speed the driver alert system display will inform you that the system is unavailable.

**Note:** The system works as long as one lane marking can be detected by the camera.

**Note:** If the camera is blocked or if the windshield is damaged, the system may not function.

**Note:** The system may not be available in poor weather or other low visibility conditions.

The system automatically monitors your driving behavior using various inputs including the front camera sensor.

If the system detects that your driving alertness is reduced below a certain threshold, the system will alert you using a chime and a message in the cluster display

**Switching the System On and Off**

You may switch the system on or off through the Information Display. Refer to the *Information Displays* chapter. The system on or off setting is stored and will use your last setting the next time the vehicle is started.

**System Warnings**

**Note:** The system will not issue warnings below approximately 40 mph (64 km/h).

The warning system is in two stages. At first the system issues a temporary warning that you need to take a rest. This message will only appear for a short time. If the system detects further reduction in driving alertness, another warning may be issued which will remain in the information display for a longer time. Press OK on the steering wheel control to clear the warning.

### System Display

When active the system will run automatically in the background and only issue a warning if required. You can view the status at any time using the information display. Refer to the *Information Displays* chapter.

The alertness level is shown by six steps in a colored bar.



The current assessment of your alertness is within a typical range.



The current assessment of your alertness indicates that you should rest as soon as safely possible.

The status bar will travel from left to right as the calculated alertness level decreases. As the rest icon is approached the color turns from green to yellow to red. The yellow position represents the first warning is active and the red position represents the second warning is active.

**Note:** If you have recently received a warning; you should consider resting, even if the current assessment is with the typical range.

**Note:** If the camera sensor cannot track the road lane markings or if your vehicle speed drops below approximately 40 mph (64 km/h), the alertness level will change to grey for a short time and the information display will inform you that the system is unavailable.

### Resetting the System

You can reset the system by either:

- Switching the ignition off and on.
- Stopping the vehicle and then opening and closing the driver's door.

**LANE KEEPING SYSTEM (IF EQUIPPED)**

**WARNING:** The system is designed to aid the driver. It is not intended to replace the driver's attention and judgment. The driver is still responsible to drive with due care and attention.

The system detects unintentional drifting toward the outside of the lane and alerts and/or aids the driver to stay in the lane through the steering system and instrument cluster display. The system automatically detects and tracks the road lane markings using a camera that is mounted behind the interior rear view mirror.

**Note:** The system works above 40 mph (64 km/h).

**Note:** The system works as long as one lane marking can be detected by the camera.

**Note:** If the camera is blocked or if the windshield is damaged, the system may not function.

**Note:** When Aid mode is on and the system detects no driver steering activity for a short period after system activation, the system alerts the driver to keep their hands on the steering wheel. The system may detect a light touch or grip on the steering wheel as hands-off driving.

**Switching the System On and Off**

Press the button located on the turn signal lever to switch the system on or off.

**Note:** The system on/off setting is stored until it is manual changed, unless a MyKey® is detected. If a MyKey® is detected, the system is defaulted to on and the mode is set to Alert.

**Note:** If a MyKey® is detected, pressing the button will not affect the on/off status of the system. Only the Mode and Intensity settings can be changed when a MyKey® is present.

**System Settings**

The system has one standard feature setting and one optional setting menu available. To view or adjust the settings, refer to the *Information Displays* chapter. The last-known selection for each of these settings is stored by the system. You do not need to readjust your settings each time you turn on the system.

**Mode:** This setting allows you to enable one of the system features.

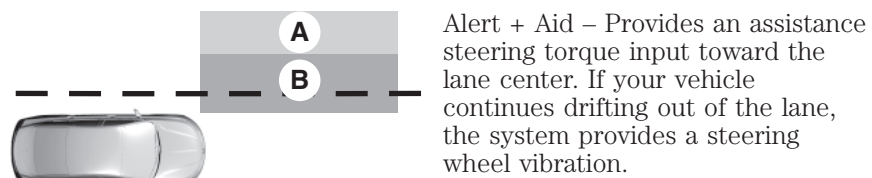
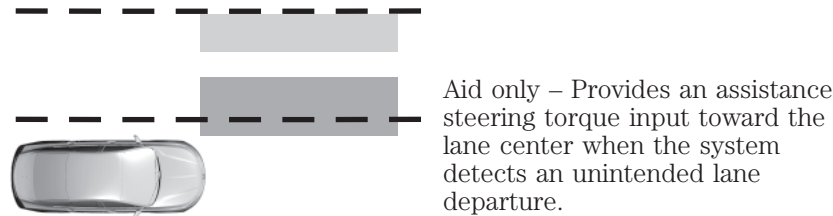

A. Alert  
B. Aid

**Note:** The alert and aid diagrams are meant to illustrate general zone coverage. They are not intended to provide the exact zone parameters.



**Intensity:** This setting affects the intensity of the steering wheel vibration used for the alert mode. This setting does not impact the aid mode.

- Low
- Medium
- High

### System Display



When you switch the system on, an overhead graphic of a vehicle with lane markings will be displayed in the left instrument cluster display.



If the aid mode is selected after you switch the system on, arrows will be displayed with the lane markings.

When you switch the system off, the lane marking graphics will no longer be displayed.

**Note:** The overhead vehicle graphic may still be displayed if adaptive cruise control is enabled.

While the system is on, the color of the lane markings will change to indicate the system status.

Gray: Indicates that the system is temporarily unable to provide a warning or intervention on the indicated side(s). This may be because:

- the vehicle is under the activation speed
- the turn indicator is active
- the vehicle is in a dynamic maneuver
- the road has no or poor lane markings in the camera field-of-view
- the camera is obscured or unable to detect the lane markings due to environmental conditions (e.g. significant sun angles or shadows, snow, heavy rain, fog), traffic conditions (e.g. following a large vehicle that is blocking or shadowing the lane), or vehicle conditions (e.g. poor headlamp illumination).

See *Troubleshooting* for additional information.

Green: Indicates that the system is available or ready to provide a warning or intervention, on the indicated side(s).

Yellow: Indicates that the system is providing or has just provided a lane keeping aid intervention.

Red: Indicates that the system is providing or has just provided a lane keeping alert warning.

The system can be temporarily disabled at any time by the following:

- Quick braking
- Fast acceleration
- Using the turn signal indicator
- Evasive steering maneuver

**Troubleshooting**

Why is the feature not available (line markings are gray) when I can see the lane markings on the road?
Vehicle speed is outside the operational range of the feature
Sun is shining directly into the camera lens
Quick intentional lane change
Staying too close to the lane marking
Driving at high speeds in curves
Previous feature activation happened within the last one second
Ambiguous lane markings (mainly in construction zones)
Rapid transition from light to dark or vice versa
Sudden offset in lane markings
ABS or AdvanceTrac activation
Camera blockage due to dirt, grime, fog, frost or water on the windshield
Driving too close to the vehicle in front of you
Transitioning between no lane markings to lane markings or vice versa
Standing water on the road
Faint lane markings (partial yellow lane markings on concrete roads)
Lane width too narrow or too wide
Camera not calibrated after a windshield replacement
When driving on tight roads or on uneven roads

<b>Why does the vehicle not come back into the middle of the lane always, as expected, in the Aid or Aid + Alert mode?</b>
--

High cross winds
------------------

Large road crown
------------------

Rough roads, grooves, shoulder drop-offs
--

Heavy uneven loading of the vehicle or improper tire inflation pressure
---

If the tires have been exchanged (including snow tires), or the suspension has been modified
--

**BLIND SPOT INFORMATION SYSTEM (BLIS®) WITH CROSS TRAFFIC ALERT (CTA) (IF EQUIPPED)**



**WARNING:** To help avoid injuries, NEVER use the BLIS® as a replacement for using the interior and exterior mirrors and looking over your shoulder before changing lanes. BLIS® is not a replacement for careful driving and only an assist.

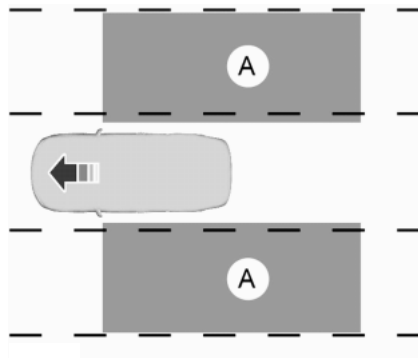

BLIS® aids the driver in detecting vehicles that may have entered the blind spot zone (A). The detection area is on both sides of the vehicle, extending rearward from the exterior mirrors to approximately 10 feet (3 meters) beyond the bumper. The system alerts you if certain vehicles enter the blind spot zone while driving.

CTA warns the driver of vehicles approaching from the sides when the transmission is in R (Reverse).

**Note:** BLIS® is not designed to prevent contact with other vehicles or objects; or to detect parked vehicles, people, animals or infrastructure (fences, guardrails, trees, etc.). It is designed to alert the driver to vehicles in the blind zones.

**Note:** When a vehicle passes quickly through the blind zone (typically fewer than two seconds), the system does not trigger.

### Using the Systems

BLIS® turns on when the engine is started and the vehicle is driven forward above 3 mph (5 km/h); it remains on while the transmission is in D (Drive) or N (Neutral). If shifted out of D (Drive) or N (Neutral), the system enters CTA mode. Once shifted back into D (Drive), BLIS® turns back on when the vehicle is driven above 3 mph (5 km/h).

**Note:** BLIS® does not function in R (Reverse) or P (Park) or provide any additional warning when a turn signal is on.

CTA detects approaching vehicles from up to 45 feet (14 meters) away though coverage decreases when the sensors are blocked. Reversing slowly helps increase the coverage area and effectiveness.



**WARNING:** To help avoid personal injury, NEVER use the CTA system as a replacement for using the interior and exterior mirrors and looking over your shoulder before backing out of a parking space. CTA is not a replacement for careful driving and only an assist.

In this first example, the left sensor is only partially obstructed; zone coverage is nearly maximized.

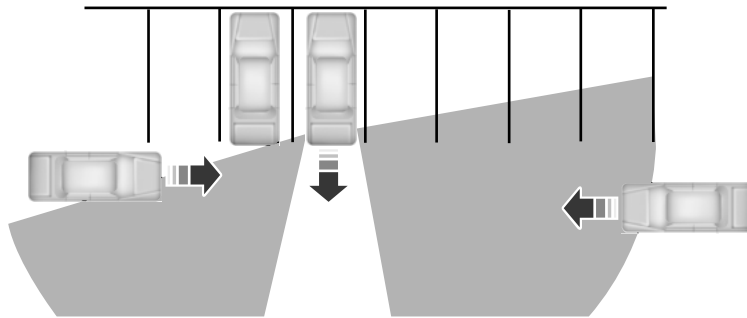

Zone coverage also decreases when parking at shallow angles. Here, the left sensor is mostly obstructed; zone coverage on that side is severely limited.

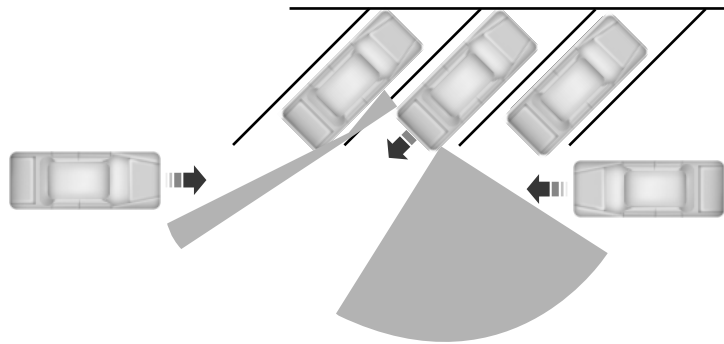

### System Lights and Messages



The BLIS® and CTA systems illuminate a yellow alert indicator in the outside mirror on the side of the vehicle the approaching vehicle is coming from.

**Note:** The alert indicator dims when nighttime darkness is detected.

CTA also sounds an audible alarm and a message appears in the information display indicating a vehicle is coming from the right or left. CTA works with the reverse sensing system which sounds its own audible alarm; see the *Parking Aids* chapter.

### System Sensors



**WARNING:** Just prior to the system recognizing a blocked condition and alerting the driver, the number of missed objects will increase. To help avoid injuries, NEVER use the BLIS® as a replacement for using the side and rear view mirrors and looking over your shoulder before changing lanes. BLIS® is not a replacement for careful driving and only an assist.

**Note:** It is possible to get a blockage warning with no blockage present; this is rare and known as a false blockage warning. A false blocked condition either self-corrects or clears after a key cycle.

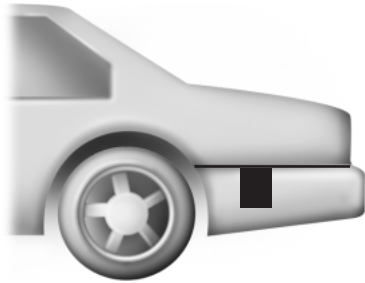

The system uses radar sensors which are located behind the bumper fascia on each side of the vehicle. Do not allow these areas to become obstructed by mud, snow or bumper stickers, as this can cause degraded system performance.

If the system detects a degraded performance condition, a blocked sensor warning or low visibility warning will appear in the information display and the alert indicator illuminates in the appropriate mirror(s). The information display warning can be cleared but the alert indicator remains illuminated.

When the blockage is removed, the system can be reset in two ways: 1) when at least two objects are detected while driving, or 2) turn the ignition key from on to off, then back on. If the blockage is still present after the key cycle, the system senses again that it is blocked after driving in traffic.

Reasons for messages being displayed	
The radar surface is dirty or obstructed	Clean the fascia area in front of the radar or remove the obstruction.
The radar surface is not dirty or obstructed	Drive normally in traffic for a few minutes to allow the radar to detect passing vehicles so it can clear the blocked state.
Heavy rainfall/snowfall interferes with the radar signals	No action required. The system automatically resets to an unblocked state once the rainfall/snowfall rate decreases or stops. Do not use BLIS® and/or CTA in these conditions.

### System Limitations

The BLIS® and CTA systems do have their limitations; situations such as severe weather conditions or debris build-up on the sensor area may limit vehicle detection.

The following are other situations that may limit the BLIS®:

- Certain maneuvering of vehicles entering and exiting the blind zone.
- Vehicles passing through the blind zone at very fast rates.
- When several vehicles forming a convoy pass through the blind zone.

The following are other situations that may limit the CTA system:

- Adjacently parked vehicles or objects obstructing the sensors.
- Approaching vehicles passing at speeds greater than 15 mph (24 km/h).
- Driving in reverse faster than 3 mph (5 km/h).
- Backing out of an angled parking spot.

**False Alerts**

**Note:** If you connected a trailer to your vehicle the BLIS® system may detect the trailer causing a false alert. To avoid false alerts you may want to turn the BLIS off manually.

There may be certain instances when either the BLIS® or CTA systems illuminate the alert indicator with no vehicle in the coverage zone; this is known as a false alert. Some amount of false alerts are normal; they are temporary and self-correct.

**System Errors**

If either system senses a problem with the left or right sensor, the BLIS® indicator in the information display will illuminate and remain on. Also, **BLIND SPOT SYSTEM FAULT** or **CROSS TRAFFIC SYSTEM FAULT** message will appear. When problems that may cause the left or right indicator not to illuminate, only the information display message faults appear.

**Switching the Systems Off and On**

One or both systems can be switched off temporarily by using the information display control; refer to the *Information Display* chapter. When the BLIS® is switched off, the driver does not receive alerts and the information display shows BLIND SPOT SYS OFF and/or CTA SYSTEM OFF. The system switches back on whenever the ignition is switched on.

One or both systems can also be switched off permanently at your authorized dealer. Once switched off, switching it back on must also be done at the dealership.



**COLLISION WARNING SYSTEM (IF EQUIPPED)**

 **WARNING:** This system is designed to be a supplementary driving aid. It is not intended to replace the driver's attention, and judgment, or the need to apply the brakes. This system does NOT activate the brakes automatically. Failure to press the brake pedal to activate the brakes may result in a collision.

 **WARNING:** The collision warning system with brake support cannot help prevent all collisions. Do not rely on this system to replace driver judgment and the need to maintain distance and speed.

**Note:** The system does not detect, warn or respond to potential collisions with vehicles to the rear or sides of the vehicle.

**Note:** The collision warning system is active at speeds above approximately 5 mph (8 km/h).



This system is designed to alert the driver of certain collision risks. A radar detects if your vehicle is rapidly approaching another vehicle traveling in the same direction as yours.

If it is, a red warning light illuminates and an audible warning chime sounds.

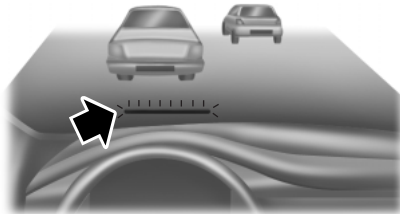

The brake support system assists the driver in reducing the collision speed by charging the brakes. If the risk of collision further increases after the warning light illuminates, the brake support prepares the brake system for rapid braking. This may be apparent to the driver. The system does not automatically activate the brakes but, if the brake pedal is pressed, full force braking is applied even if the brake pedal is lightly pressed.

**Using the Collision Warning System**

**!** **WARNING:** The collision warning system's brake support can only help reduce the speed at which a collision occurs if the driver applies the vehicle's brakes. The brake pedal must be pressed just like any typical braking situation.

The warning system sensitivity can be adjusted to one of three possible settings by using the information display control. Refer to the *Information Displays* chapter.

**Note:** If collision warnings are perceived as being too frequent or disturbing then the warning sensitivity can be reduced, though the manufacturer recommends using the highest sensitivity setting where possible. Setting lower sensitivity would lead to fewer and later system warnings. Refer to the *Information Displays* chapter for instructions on reducing the sensitivity.

**Blocked Sensors**

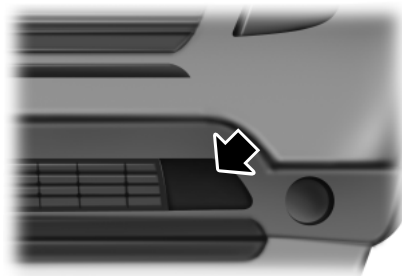

If a message regarding a blocked sensor appears in the information display, the radar signals from the sensor have been obstructed. The sensors are located behind a fascia cover near the driver side of the lower grille. When the sensors are obstructed, a vehicle ahead cannot be detected and the collision warning system does not function. The following table lists possible

causes and actions for this message being displayed.

Cause	Action
The surface of the radar in the grille is dirty or obstructed in some way	Clean the grille surface in front of the radar or remove the object causing the obstruction
The surface of the radar in the grille is clean but the message remains in the display	Wait a short time. It may take several minutes for the radar to detect that it is no longer obstructed

Cause	Action
Heavy rain, spray, snow, or fog is interfering with the radar signals	The collision warning system is temporarily disabled. Collision warning should automatically reactivate a short time after the weather conditions improve.
Swirling water, or snow or ice on the surface of the road may interfere with the radar signals	The collision warning system is temporarily disabled. Collision warning should automatically reactivate a short time after the weather conditions improve.

### System Limitations



**WARNING:** The collision warning system's brake support can only help reduce the speed at which a collision occurs if the driver applies the vehicle's brakes. The brake pedal must be pressed just like any typical braking situation.

Due to the nature of radar technology, there may be certain instances where vehicles do not provide a collision warning. These include:

- Stationary vehicles or vehicles moving below 6 mph (10 km/h).
- Pedestrians or objects in the roadway.
- Oncoming vehicles in the same lane.
- Severe weather conditions (see blocked sensor section).
- Debris build-up on the grille near the headlamps (see blocked sensor section).
- Small distance to vehicle ahead.
- Steering wheel and pedal movements are large (very active driving style).
- High interior temperatures, which may deactivate the illumination or the warning lamps until the interior temperature reduces (audible warning still sounds).

Certain conditions may reduce the visibility of the warning lamp; therefore, it is recommended to keep the audible warning on.

If the front end of the vehicle is hit or damaged, the radar sensing zone may be altered causing missed or false collision warnings. See your authorized dealer to have your collision warning radar checked for proper coverage and operation.

## STEERING

### Electric Power Steering



**WARNING:** The electric power steering system has diagnostic checks that continuously monitor the system to ensure proper operation. When a system error is detected a steering message will appear in the information display.



**WARNING:** The electric power steering system has diagnostic checks that continuously monitor the system to ensure proper operation of the electronic system. When an electronic error is detected, a message will be displayed in the information display. If this happens, stop the vehicle in a safe place, and turn off the engine. After at least 10 seconds, reset the system by restarting the engine, and watch the information display for a steering message. If a steering message returns, or returns while driving, take the vehicle to your dealer to have it checked.



**WARNING:** Obtain immediate service if a system error is detected. You may not notice any difference in the feel of your steering, but a serious condition may exist. Failure to do so may result in loss of steering control.

Your vehicle is equipped with an electric power-assisted steering system. There is no fluid reservoir to check or fill.

If your vehicle loses electrical power while you are driving (or if the ignition is turned off), you can steer the vehicle manually, but it takes more effort. Extreme continuous steering may increase the effort it takes for you to steer. This occurs to prevent internal overheating and permanent damage to your steering system. If this should occur, you will neither lose the ability to steer the vehicle manually nor will it cause permanent damage. Typical steering and driving maneuvers will allow the system to cool and steering assist will return to normal.

When a steering system error is detected, steering messages may appear in the information display.

***Steering Tips***

If the steering wanders or pulls, check for:

- an improperly inflated tire
- uneven tire wear
- loose or worn suspension components
- loose or worn steering components
- improper vehicle alignment

A high crown in the road or high crosswinds may also make the steering seem to wander/pull.

**CARGO NETS (IF EQUIPPED)**

**WARNING:** This net is not designed to restrain objects during a collision or heavy braking.

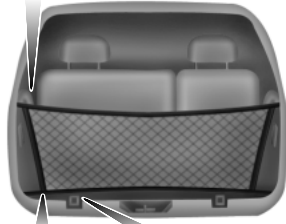

The cargo net secures lightweight objects in the cargo area. Attach the net to the loops and anchors provided.

**ROOF RACKS AND LOAD CARRIERS (IF EQUIPPED)**

**WARNING:** When loading the roof racks, we recommend you evenly distribute the load, as well as maintain a low center of gravity. Loaded vehicles, with higher centers of gravity, may handle differently than unloaded vehicles. Take extra precautions, such as slower speeds and increased stopping distance, when driving a heavily loaded vehicle.

**Note:** The maximum recommended load, evenly distributed on the crossbars, is 100 pounds (45 kilograms).

**Note:** Never place loads directly on the roof panel. The roof panel is not designed to directly carry a load.

For correct roof rack system function, you must place loads directly on crossbars affixed to the roof rack side rails. We recommend you use Ford Genuine Accessory crossbars designed specifically for your vehicle.

Make sure that you securely fasten the load. Check the tightness of the load before driving and at each fuel stop.

### Adjusting the Crossbars (If Equipped)

**Note:** Wind noise can be minimized by either removing or repositioning the crossbars when they are not in use. Position the rear crossbar fully rearward and the front crossbar 10 inches (25 centimeters) from the front end-cap.

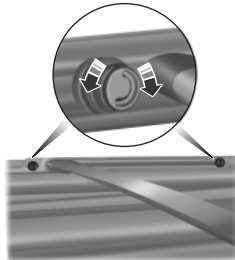

1. Loosen the tie-down hooks at both sides of the crossbar by turning them counterclockwise. A small screwdriver or similar tool can be used to break the torque by inserting the shaft into the tie-down hook and twisting.
2. Slide the crossbar to the desired position. This may require someone on each side of the crossbar.

3. Tighten the tie-down hooks at both sides of the crossbar by turning them clockwise until tight. A small screwdriver or similar tool can be used to tighten the hook an additional half turn.

Make sure to check that the tie-down hooks are tight each time a load is added or removed from the roof rack, and periodically while traveling. Make sure that the load is secure before traveling.

### LOAD LIMIT

#### Vehicle Loading – With and Without a Trailer

This section will guide you in the proper loading of your vehicle and/or trailer, to keep your loaded vehicle weight within its design rating capability, with or without a trailer. Properly loading your vehicle will provide maximum return of vehicle design performance. Before loading your vehicle, familiarize yourself with the following terms for determining your vehicle's weight ratings, with or without a trailer, from the vehicle's Tire Label or Safety Compliance Certification Label:

**Base Curb Weight** – is the weight of the vehicle including a full tank of fuel and all standard equipment. It does not include passengers, cargo, or optional equipment.

**Vehicle Curb Weight** – is the weight of your new vehicle when you picked it up from your authorized dealer plus any aftermarket equipment.

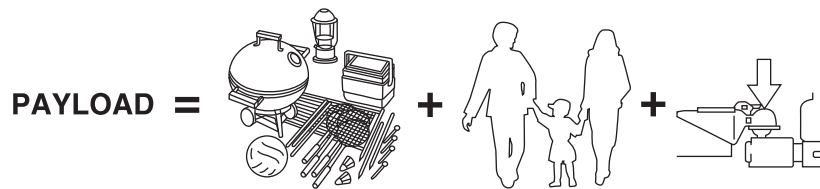

**Payload** – is the combined weight of cargo and passengers that the vehicle is carrying. The maximum payload for your vehicle can be found on the Tire Label on the B-Pillar or the edge of the driver's door (vehicles exported outside the US and Canada may not have a Tire Label). Look for **“THE COMBINED WEIGHT OF OCCUPANTS AND CARGO SHOULD NEVER EXCEED XXX kg OR XXX lb.”** for maximum payload. The payload listed on the Tire Label is the maximum payload for the vehicle as built by the assembly plant. If any aftermarket or authorized-dealer installed equipment has been installed on the vehicle, the weight of the equipment must be subtracted from the payload listed on the Tire Label in order to determine the new payload.

**!** **WARNING:** The appropriate loading capacity of your vehicle can be limited either by volume capacity (how much space is available) or by payload capacity (how much weight the vehicle should carry). Once you have reached the maximum payload of your vehicle, do not add more cargo, even if there is space available. Overloading or improperly loading your vehicle can contribute to loss of vehicle control and vehicle rollover.



Example only:

**TIRE AND LOADING INFORMATION**

SEATING CAPACITY TOTAL 5 FRONT 2 REAR 3

The combined weight of occupants and cargo should never exceed : **XXX kg or XXX lbs.**

TIRE	SIZE	COLD TIRE PRESSURE	SEE OWNERS MANUAL FOR ADDITIONAL INFORMATION
FRONT	LT225/75R 16.5E	200 KPA, 29 PSI	
REAR	LT225/75R 16.5E	200 KPA, 29 PSI	
SPARE	T145/80D16 P225/60R17	420 KPA, 60 PSI 200 KPA, 29 PSI	

**TIRE AND LOADING INFORMATION**  
**RENSEIGNEMENTS SUR LES PNEUS ET LE CHARGEMENT**

SEATING CAPACITY TOTAL 5 FRONT 2 REAR 3  
NOMBRE DE PLACES TOTAL 5 AVANT 2 ARRIERE 3

The combined weight of occupants and cargo should never exceed 492 kg or 1085 lbs.  
Le poids total des occupants et du chargement ne doit jamais dépasser 492 kg ou 1085 lbs.

TIRE PNEU	SIZE DIMENSIONS	COLD TIRE PRESSURE PRESSION DES PNEUS A FROID	SEE OWNER'S MANUAL FOR ADDITIONAL INFORMATION  VOIR LE MANUEL DE L'USAGER POUR PLUS DE RENSEIGNEMENTS
FRONT AVANT	P235/70R16	240 KPA, 35 PSI	
REAR ARRIERE	P235/70R16	240 KPA, 35 PSI	
SPARE DE SECOURS	T145/90R17	415 KPA, 60 PSI	



**Cargo Weight** – includes all weight added to the Base Curb Weight, including cargo and optional equipment. When towing, trailer tongue load or king pin weight is also part of cargo weight.

**GAW (Gross Axle Weight)** – is the total weight placed on each axle (front and rear) – including vehicle curb weight and all payload.

**GAWR (Gross Axle Weight Rating)** – is the maximum allowable weight that can be carried by a single axle (front or rear). **These numbers are shown on the Safety Compliance Certification Label. The label shall be affixed to either the door hinge pillar, door-latch post, or the door edge that meets the door-latch post, next to the driver's seating position. The total load on each axle must never exceed its GAWR.**

**Note:** For trailer towing information refer to the *RV and Trailer Towing Guide* provided by your authorized dealer.

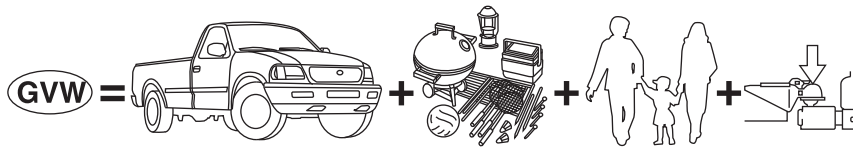

**GVW (Gross Vehicle Weight)** – is the Vehicle Curb Weight + cargo + passengers.

**GVWR (Gross Vehicle Weight Rating)** – is the maximum allowable weight of the fully loaded vehicle (including all options, equipment, passengers and cargo). **The GVWR is shown on the Safety Compliance Certification Label. The label shall be affixed to either the door hinge pillar, door-latch post, or the door edge that meets the door-latch post, next to the driver's seating position. The GVW must never exceed the GVWR.**

- Example only:

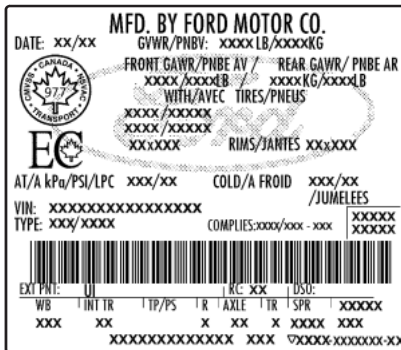
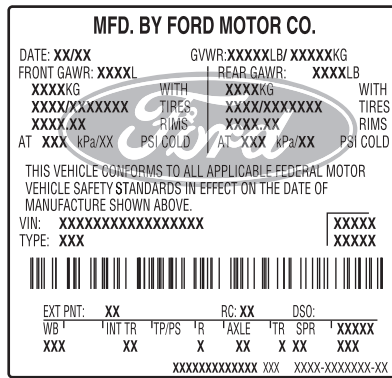

 **WARNING:** Exceeding the Safety Compliance Certification Label vehicle weight rating limits could result in substandard vehicle handling or performance, engine, transmission and/or structural damage, serious damage to the vehicle, loss of control and personal injury.



**GCW (Gross Combined Weight)** – is the weight of the loaded vehicle (GVW) plus the weight of the fully loaded trailer.

**GCWR (Gross Combined Weight Rating)** – is the maximum allowable weight of the vehicle and the loaded trailer – including all cargo and passengers – that the vehicle can handle without risking damage. (Important: The towing vehicle's braking system is rated for operation at GVWR, not at GCWR.) Separate functional brakes should be used for safe control of towed vehicles and for trailers where the GCW of the towing vehicle plus the trailer exceed the GVWR of the towing vehicle. **The GCW must never exceed the GCWR.**

**Maximum Loaded Trailer Weight** – is the highest possible weight of a fully loaded trailer the vehicle can tow. It assumes a vehicle with only mandatory options, no cargo (internal or external), a tongue load of 10–15% (conventional trailer) or king pin weight of 15–25% (fifth wheel trailer), and driver only (150 lb. [68 kg]). **Consult your authorized dealer (or the *RV and Trailer Towing Guide* provided by your authorized dealer) for more detailed information.**

**Tongue Load or Fifth Wheel King Pin Weight** – refers to the amount of the weight that a trailer pushes down on a trailer hitch.

**Examples:** For a 5,000 lb. (2,268 kg) conventional trailer, multiply 5,000 by 0.10 and 0.15 to obtain a proper tongue load range of 500 to 750 lb. (227 to 340 kg). For an 11,500 lb. (5,216 kg) fifth wheel trailer, multiply by 0.15 and 0.25 to obtain a proper king pin load range of 1,725 to 2,875 lb. (782 to 1,304 kg)



**WARNING:** Do not exceed the GVWR or the GAWR specified on the Safety Compliance Certification Label.



**WARNING:** Do not use replacement tires with lower load carrying capacities than the original tires because they may lower the vehicle's GVWR and GAWR limitations. Replacement tires with a higher limit than the original tires do not increase the GVWR and GAWR limitations.



**WARNING:** Exceeding any vehicle weight rating limitation could result in serious damage to the vehicle and/or personal injury.

**Steps for determining the correct load limit:**

1. Locate the statement “The combined weight of occupants and cargo should never exceed XXX kg or XXX lb.” on your vehicle’s placard.
2. Determine the combined weight of the driver and passengers that will be riding in your vehicle.
3. Subtract the combined weight of the driver and passengers from XXX kg or XXX lb.
4. The resulting figure equals the available amount of cargo and luggage load capacity. For example, if the “XXX” amount equals 1,400 lb. and there will be five 150 lb. passengers in your vehicle, the amount of available cargo and luggage load capacity is 650 lb. (1400-750 (5 x 150) = 650 lb.).
5. Determine the combined weight of luggage and cargo being loaded on the vehicle. That weight may not safely exceed the available cargo and luggage load capacity calculated in Step 4.
6. If your vehicle will be towing a trailer, load from your trailer will be transferred to your vehicle. Consult this manual to determine how this reduces the available cargo and luggage load capacity of your vehicle.

The following gives you a few examples on how to calculate the available amount of cargo and luggage load capacity:

- Suppose your vehicle has a 1400 lb. (635 kg) cargo and luggage capacity. You decide to go golfing. Is there enough load capacity to carry you, 4 of your friends and all the golf bags? You and four friends average 220 lb. (99 kg) each and the golf bags weigh approximately 30 lb. (13.5 kg) each. The calculation would be:  $1400 - (5 \times 220) - (5 \times 30) = 1400 - 1100 - 150 = 150$  lb. Yes, you have enough load capacity in your vehicle to transport four friends and your golf bags. In metric units, the calculation would be:  $635 \text{ kg} - (5 \times 99 \text{ kg}) - (5 \times 13.5 \text{ kg}) = 635 - 495 - 67.5 = 72.5$  kg.

- Suppose your vehicle has a 1400 lb. (635 kg) cargo and luggage capacity. You and one of your friends decide to pick up cement from the local home improvement store to finish that patio you have been planning for the past 2 years. Measuring the inside of the vehicle with the rear seat folded down, you have room for 12-100 lb. (45 kg) bags of cement. Do you have enough load capacity to transport the cement to your home? If you and your friend each weigh 220 lb. (99 kg), the calculation would be:  $1400 - (2 \times 220) - (12 \times 100) = 1400 - 440 - 1200 = -240$  lb. No, you do not have enough cargo capacity to carry that much weight. In metric units, the calculation would be:  $635 \text{ kg} - (2 \times 99 \text{ kg}) - (12 \times 45 \text{ kg}) = 635 - 198 - 540 = -103$  kg. You will need to reduce the load weight by at least 240 lb. (104 kg). If you remove 3-100 lb. (45 kg) cement bags, then the load calculation would be:  
 $1400 - (2 \times 220) - (9 \times 100) = 1400 - 440 - 900 = 60$  lb. Now you have the load capacity to transport the cement and your friend home. In metric units, the calculation would be:  $635 \text{ kg} - (2 \times 99 \text{ kg}) - (9 \times 45 \text{ kg}) = 635 - 198 - 405 = 32$  kg.

The above calculations also assume that the loads are positioned in your vehicle in a manner that does not overload the Front or the Rear Gross Axle Weight Rating specified for your vehicle on the Safety Compliance Certification Label. The label shall be affixed to either the door hinge pillar, door-latch post, or the door edge that meets the door-latch post, next to the driver's seating position.

### Special Loading Instructions for Owners of Pick-up Trucks and Utility-type Vehicles



**WARNING:** Loaded vehicles may handle differently than unloaded vehicles. Extra precautions, such as slower speeds and increased stopping distance, should be taken when driving a heavily loaded vehicle.

Your vehicle can haul more cargo and people than most passenger cars. Depending upon the type and placement of the load, hauling cargo and people may raise the center of gravity of the vehicle.

**TOWING A TRAILER**

**WARNING:** Do not exceed the GVWR or the GAWR specified on the certification label.



**WARNING:** Towing trailers beyond the maximum recommended gross trailer weight exceeds the limit of your vehicle and could result in engine damage, transmission damage, structural damage, loss of vehicle control, vehicle rollover and personal injury.

**Note:** For information on electrical items such as fuses or relays, see the *Fuses* chapter.

Your vehicle's load capacity designation is by weight, not by volume, so you cannot necessarily use all available space when loading a vehicle.

Towing a trailer places an extra load on your vehicle's engine, transmission, axle, brakes, tires and suspension. Inspect these components periodically during, and after, any towing operation.

**Load Placement**

To help minimize how trailer movement affects your vehicle when driving:

- Load the heaviest items closest to the trailer floor.
- Load the heaviest items centered between the left and right side trailer tires.
- Load the heaviest items above the trailer axles or just slightly forward toward the trailer tongue. Do not allow the final trailer tongue weight to go above or below 10–15% of the loaded trailer weight.
- Select a tow bar with the correct rise or drop. When both the loaded vehicle and trailer are connected, the trailer frame should be level, or slightly angled down toward your vehicle, when viewed from the side.

When driving with a trailer or payload, a slight takeoff vibration or shudder may be present due to the increased payload weight. You can find more information about proper trailer loading and setting your vehicle up for towing under *Load limit* in the *Load Carrying* chapter.

You can also find information in the *RV and Trailer Towing Guide* available at your authorized dealer.

**TRAILER SWAY CONTROL (IF EQUIPPED)**

**WARNING:** Turning off trailer sway control increases the risk of loss of vehicle control, serious injury or death. Ford does not recommend disabling this feature except in situations where speed reduction may be detrimental (such as hill climbing), the driver has significant trailer towing experience, and can control trailer sway and maintain safe operation.

**Note:** This feature does not prevent trailer sway, but reduces it once it begins.

**Note:** This feature cannot stop all trailers from swaying.

**Note:** In some cases, if vehicle speed is too high, the system may turn on multiple times, gradually reducing vehicle speed.

This feature applies your vehicle brakes at individual wheels and, if necessary, reduces engine power. If the trailer begins to sway, the stability control light flashes. The first thing to do is slow your vehicle down, then pull safely to the side of the road and check for proper tongue load and trailer load distribution. See the *Load Carrying* chapter for specific loading information.

**RECOMMENDED TOWING WEIGHTS**

**Note:** Do not exceed the trailer weight for your vehicle configuration listed in the chart below.

**Note:** Make sure to take into consideration trailer frontal area. Do not exceed:

- 20 feet<sup>2</sup> (1.86 meters<sup>2</sup>) trailer frontal area if your vehicle can tow a Class I trailer.
- 40 feet<sup>2</sup> (3.72 meters<sup>2</sup>) trailer frontal area if your vehicle can tow a Class III trailer.

**Note:** For high altitude operation, reduce the gross combined weight by 2% per 1000 feet (300 meters) starting at the 1000 foot (300 meter) elevation point.

**Note:** Certain states require electric trailer brakes for trailers over a specified weight. Be sure to check state regulations for this specified weight. The maximum trailer weights listed may be limited to this specified weight, as your vehicle's electrical system may not include the wiring connector needed to activate electric trailer brakes.



Your vehicle may tow a Class I or III trailer provided the maximum trailer weight is less than or equal to the maximum trailer weight listed for your vehicle configuration on the following chart.

Engine and trailer class	Maximum GCWR	Maximum trailer weight
<b>Front-wheel drive vehicles</b>		
2.0L GTDI, Class I	6880 lb (3120 kg)	2000 lb (907 kg)
3.5L TiVCT, Class I	6940 lb (3147 kg)	2000 lb (907 kg)
3.5L TiVCT, Class III	9980 lb (4526 kg)	5000 lb (2268 kg)*
<b>Four-wheel drive vehicles</b>		
3.5L TiVCT, Class I	7110 lb (3224 kg)	2000 lb (907 kg)
3.5L GTDI, Class I	7400 lb (3356 kg)	2000 lb (907 kg)
3.5L TiVCT, Class III	10160 lb (4608 kg)	5000 lb (2268 kg)
3.5L GTDI, Class III	10400 lb (4717 kg)	5000 lb (2268 kg)

\*For towing trailers up to 3500 pounds (1588 kilograms), use a weight-carrying hitch and ball, which uniformly spreads the trailer tongue loads through your vehicle's underbody structure. For towing trailers over 3500 pounds (1588 kilograms), up to the maximum trailer weight, we recommend you use a weight-distributing hitch to increase front axle load while towing.

### ESSENTIAL TOWING CHECKS

Follow these guidelines for safe towing:

- Do not tow a trailer until you drive your vehicle at least 1000 miles (1600 kilometers).
- Consult your local motor vehicle laws for towing a trailer.
- See the instructions included with towing accessories for the proper installation and adjustment specifications.
- Service your vehicle more frequently if you tow a trailer. See your scheduled maintenance information.
- If you use a rental trailer, follow the instructions the rental agency gives you.

For load specification terms found on the tire label and Safety Compliance label and for instructions on calculating your vehicle's load, refer to *Load limit* in the *Load Carrying* chapter.

Remember to account for the trailer tongue weight as part of your vehicle load when calculating the total vehicle weight.

### Trailer Towing Connector (Vehicles with a Trailer Towing Package and 7-Pin Connector)

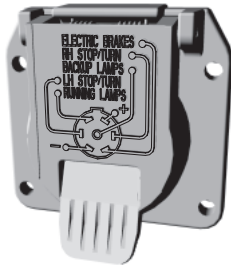

When attaching the trailer wiring connector to your vehicle, only use a proper fitting connector that works with the vehicle and trailer functions. If your vehicle has a trailer towing package, it may have a 7-pin connector. Some connectors may have the SAE J2863 logo, which confirms that it is the proper wiring connector and works correctly with your vehicle.

Color	Function
1. Yellow	Left turn signal and stop lamp
2. White	Ground (-)
3. Blue	Electric brakes
4. Green	Right turn signal and stop lamp
5. Orange	Battery (+)
6. Brown	Running lights
7. Grey	Reverse lights

### Trailer Hitch Cover

Your vehicle is equipped with a removable trailer hitch trim cover. To remove the trim cover:

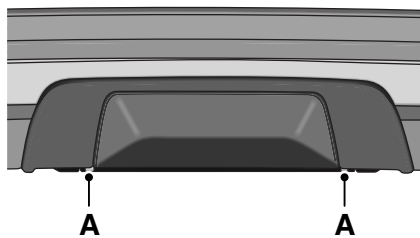

1. Loosen the two  $\frac{1}{4}$ -turn fasteners (A) in the bottom of the cover by turning them counterclockwise. Pull the cover rearward to remove it. The fasteners remain attached to the cover.

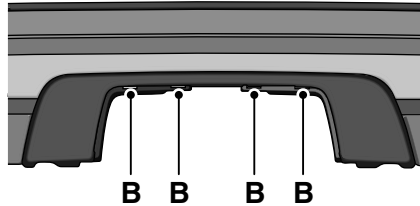

2. To reinstall the cover, insert the four plastic tabs on top of the cover into the corresponding slots (B), and push the cover into the bumper trim.

3. Hold the cover against the bumper trim and reinstall the two ¼-turn fasteners by turning them clockwise.

### Hitches

Do not use a hitch that clamps onto your vehicle's bumper. Use a load-carrying hitch.

You must distribute the load in your trailer so that 10–15% of the total weight of the trailer is on the tongue. Do not to exceed the maximum tongue load of 500 pounds (227 kilograms) on a Class III receiver.

### **Weight-Distributing Hitch**



**WARNING:** Do not adjust a weight-distributing hitch to any position where the rear bumper of the vehicle is higher than it was before attaching the trailer. Doing so will defeat the function of the weight-distributing hitch, which may cause unpredictable handling, and could result in serious personal injury.

When hooking-up a trailer using a weight-distributing hitch, always use the following procedure:

1. Park your vehicle, without the trailer, on a level surface.
2. Measure the height of the top of your vehicle's front wheel opening on the fender. This is H1.
3. Attach the trailer to your vehicle without the weight-distributing bars connected.
4. Measure the height of the top of your vehicle's front wheel opening on the fender a second time. This is H2.
5. Install and adjust the tension in the weight distributing bars so that the height of the front fender is approximately halfway between H1 and H2.
6. Check that the trailer is level. If not level, adjust the ball height accordingly and repeat Steps 3–6.

### Safety Chains

**Note:** Never attach safety chains to the bumper.

Always connect the safety chains to the hook retainers of your vehicle hitch.

To connect the safety chains, cross them under the trailer tongue and allow enough slack for turning tight corners. Do not allow the chains to drag on the ground.

### Trailer Brakes



**WARNING:** Do not connect a trailer's hydraulic brake system directly to your vehicle's brake system. Your vehicle may not have enough braking power and your chances of having a collision greatly increase.

Electric brakes and manual, automatic or surge-type trailer brakes are safe if you install them properly and adjust them to the manufacturer's specifications. The trailer brakes must meet local and federal regulations.

**The rating for the tow vehicle's braking system operation is at the gross vehicle weight rating, not the gross combined weight rating.**

**Separate functioning brake systems are required for safe control of towed vehicles and trailers weighing more than 1500 pounds (680 kilograms) when loaded.**

### Trailer Lamps



**WARNING:** Never connect any trailer lamp wiring to the vehicle's tail lamp wiring; this may damage the electrical system resulting in a fire. Contact an authorized dealer as soon as possible for assistance in proper trailer tow wiring installation. Additional electrical equipment may be required.

Trailer lamps are required on most towed vehicles. Make sure all running lights, brake lights, turn signals and hazard lights are working.

### Before Towing a Trailer

Practice turning, stopping and backing up to get the feel of your vehicle-trailer combination before starting on a trip. When turning, make wider turns so the trailer wheels clear curbs and other obstacles.

**When Towing a Trailer**

- Do not drive faster than 70 mph (113 km/h) during the first 500 miles (800 kilometers).
- Do not make full-throttle starts.
- Check your hitch, electrical connections and trailer wheel lug nuts thoroughly after you have traveled 50 miles (80 kilometers).
- When stopped in congested or heavy traffic during hot weather, place the gearshift in position **P** to aid engine and transmission cooling and to help air conditioning performance.
- Turn off the speed control with heavy loads or in hilly terrain. The speed control may turn off automatically when you are towing on long, steep grades.
- Shift to a lower gear when driving down a long or steep hill. Do not apply the brakes continuously, as they may overheat and become less effective.
- Use the Grade Assist or Tow/Haul feature when towing. These provide engine braking and help eliminate excessive transmission shifting for optimum fuel economy and transmission cooling.
- Allow more distance for stopping with a trailer attached. Anticipate stops and brake gradually.
- Avoid parking on a grade. However, if you must park on a grade:
  1. Turn the steering wheel to point your vehicle tires away from traffic flow.
  2. Set your vehicle parking brake.
  3. Place the automatic transmission in position **P**.
  4. Place wheel chocks in front and back of the trailer wheels.  
(Chocks not included with vehicle.)

**Launching or Retrieving a Boat or Personal Watercraft (PWC)**

**Note:** Disconnect the wiring to the trailer **before** backing the trailer into the water.

**Note:** Reconnect the wiring to the trailer **after** removing the trailer from the water.

When backing down a ramp during boat launching or retrieval:

- Do not allow the static water level to rise above the bottom edge of the rear bumper.
- Do not allow waves to break higher than 6 inches (15 centimeters) above the bottom edge of the rear bumper.

Exceeding these limits may allow water to enter vehicle components:

- Causing internal damage to the components.
- Affecting driveability, emissions, and reliability.

Replace the rear axle lubricant anytime the rear axle submerges in water. Water may have contaminated the rear axle lubricant, which does not normally require checking or changing unless it is leaking or other axle repair is required.

### TRANSPORTING THE VEHICLE

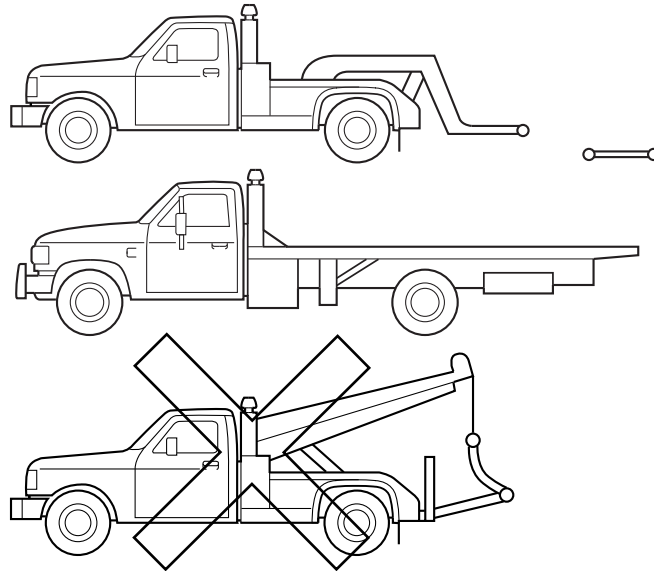

If you need to have your vehicle towed, contact a professional towing service or, if you are a member of a roadside assistance program, your roadside assistance service provider.

We recommend the use of a wheel lift and dollies or flatbed equipment to tow your vehicle. Do not tow with a slingbelt. Ford Motor Company has not approved a slingbelt towing procedure. Vehicle damage may occur if towed incorrectly, or by any other means.

Ford Motor Company produces a towing manual for all authorized tow truck operators. Have your tow truck operator refer to this manual for proper hook-up and towing procedures for your vehicle.

It is acceptable to have your front-wheel drive vehicle towed from the front if using proper wheel lift equipment to raise the front wheels off the ground. When towing in this manner, the rear wheels can remain on the ground.

Front-wheel drive vehicles must have the front wheels placed on a tow dolly when towing your vehicle from the rear using wheel lift equipment. This prevents damage to the transmission.

Towing an all-wheel drive vehicle requires that all wheels be off the ground, such as using a wheel lift and dollies or flatbed equipment. This prevents damage to the transmission, all-wheel drive system and vehicle.

### **TOWING THE VEHICLE ON FOUR WHEELS**

#### **Emergency Towing**

If your vehicle becomes inoperable (without access to wheel dollies, car-hauling trailer, or flatbed transport vehicle), it can be flat-towed (all wheels on the ground, regardless of the powertrain and transmission configuration) under the following conditions:

- Your vehicle is facing forward for towing in a forward direction.
- Place the transmission in position **N**. See *Automatic transmission* in the *Transmission* chapter if you cannot move the transmission into **N**.
- Maximum speed is 35 mph (56 km/h).
- Maximum distance is 50 miles (80 kilometers).

#### **Recreational Towing**

##### ***Vehicles Equipped with a 2.0L Engine***

**Note:** Put your climate control system in recirculated air mode to prevent exhaust fumes from entering your vehicle. See the *Climate Control* chapter.

Follow these guidelines if you have a need for recreational towing, such as towing your vehicle behind a motorhome. We designed these guidelines to prevent damage to your transmission.

Front-wheel drive vehicles **CANNOT** be flat-towed (all wheels on the ground) as vehicle or transmission damage may occur. You must place the front wheels on a two-wheel tow dolly. If you are using a tow dolly, follow the instructions specified by the equipment provider.

**Vehicles Equipped with a 3.5L or 3.7L Engine**

**Note:** Put your climate control system in recirculated air mode to prevent exhaust fumes from entering your vehicle. See the *Climate Control* chapter.

Follow these guidelines if you have a need for recreational towing, such as towing your vehicle behind a motorhome or truck. We designed these guidelines to prevent damage to your vehicle after it is hooked-up to the recreational vehicle or tow dolly.

You can tow your front-wheel drive vehicle with all four wheels on the ground or with the front wheels off the ground by using a tow dolly. If you are using a tow dolly, follow the instructions specified by the equipment provider. If you are towing with all four wheels on the ground, see the following instructions.

You can tow your all-wheel drive vehicle with all four wheels on the ground or with all four wheels off the ground using a vehicle transport trailer. Do not tow your all-wheel drive vehicle with the front wheels off the ground (by using a tow dolly) and the rear wheels on the ground. This causes damage to your all-wheel drive system. If you are using a vehicle transport trailer, follow the instruction specified by the equipment provider. If you are towing with all four wheels on the ground, see the following instructions.

If you tow your vehicle with all four wheels on the ground:

- Tow only in the forward direction.
- Release the parking brake.
- Place the transmission in position **N**.
- Place the ignition in the accessory position. See the *Starting and Stopping the Engine* chapter.
- Do not exceed 65 mph (105 km/h).
- Start the engine and allow it to run for five minutes at the beginning of each day and every six hours thereafter. With the engine running and your foot on the brake, shift into position **D** and then into position **R** before shifting back into position **N**.



**BREAKING-IN**

You need to break in new tires for approximately 300 miles (480 kilometers). During this time, your vehicle may exhibit some unique driving characteristics. Avoid driving too fast during the first 1000 miles (1600 kilometers). Vary your speed frequently and change up through the gears early. Do not labor the engine. Do not tow during the first 1000 miles (1600 kilometers).

**ECONOMICAL DRIVING**

Fuel economy is affected by several things, such as how you drive, the conditions you drive under and how you maintain your vehicle.

There are some things to keep in mind that may improve your fuel economy:

- Accelerate and slow down in a smooth, moderate fashion.
- Drive at steady speeds without stopping.
- Anticipate stops; slowing down may eliminate the need to stop.
- Combine errands and minimize stop-and-go driving.
- Close the windows for high-speed driving.
- Drive at reasonable speeds (traveling at 55 mph [88 km/h] uses 15% less fuel than traveling at 65 mph [105 km/h]).
- Keep the tires properly inflated and use only the recommended size.
- Use the recommended engine oil.
- Perform all regularly scheduled maintenance.

There are also some things you may not want to do because they may reduce your fuel economy:

- Sudden or hard accelerations.
- Rev the engine before turning it off.
- Idle for periods longer than one minute.
- Warm up your vehicle on cold mornings.
- Use the air conditioner or front defroster.
- Use the speed control in hilly terrain.
- Rest your foot on the brake pedal while driving.
- Drive a heavily loaded vehicle or tow a trailer.

- Carry unnecessary weight (approximately 1 mpg [0.4 km/L] is lost for every 400 pounds [180 kilograms] of weight carried).
- Add particular accessories to your vehicle (e.g.; bug deflectors, rollbars or light bars, running boards, ski racks).
- Drive with the wheels out of alignment.

#### DRIVING THROUGH WATER

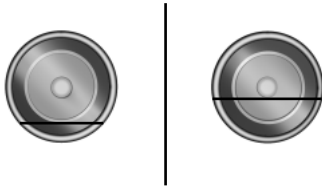

If driving through deep or standing water is unavoidable, proceed very slowly. Never drive through water that is higher than the bottom of the wheel rims (for cars) or the bottom of the hubs (for trucks).

When driving through water, traction or brake capability may be limited. Also, water may enter your engine's air intake and severely damage your engine or your vehicle may stall.

**Note:** Driving through deep water where the transmission vent tube is submerged may allow water into the transmission and cause internal transmission damage.

**Note:** Once through the water, always dry the brakes by moving your vehicle slowly while applying light pressure on the brake pedal. Wet brakes do not stop the vehicle as quickly as dry brakes.

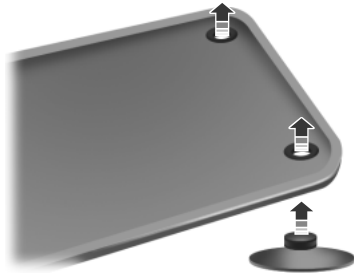
**FLOOR MATS**

**!** **WARNING:** Always use floor mats that are designed to fit the foot well of your vehicle, leaving the pedal area unobstructed, and which can be firmly secured to retention posts so that they cannot slip out of position and interfere with the pedals or impair safe operation of your vehicle in other ways.

- Incorrectly fitted floor mats can cause the accelerator pedal to become stuck in the open position. This can cause loss of vehicle control.
- Always correctly install the floor mats to the retention posts so that they cannot slip out of position or obstruct pedal operation.
- Do not place unsecured floor mats or any other covering in the foot well.
- Do not place additional floor mats or any other covering on top of the original floor mats. This will reduce the pedal clearance and interfere with the pedal operation.
- Do not allow objects to fall or become trapped under the pedals of your vehicle. This can cause loss of vehicle control.
- Carry out regular inspections to make sure the floor mats are secure.

To install the floor mats, position the floor mat eyelet over the retention post and press down to lock in position.

Remove in reverse order.

**ROADSIDE ASSISTANCE****Vehicles Sold in the United States: Getting Roadside Assistance**

To fully assist you should you have a vehicle concern, Ford Motor Company offers a complimentary Roadside Assistance program. This program is separate from the New Vehicle Limited Warranty.

- 24 hours a day, seven days a week
- For the coverage period listed on the Roadside Assistance Card included in your Owner's Manual portfolio.

Roadside assistance will cover:

- A flat tire change with a good spare (except vehicles that have been supplied with a tire inflation kit).
- Battery jump start.
- Lock-out assistance (key replacement cost is the customer's responsibility).
- Fuel delivery – Independent Service Contractors, if not prohibited by state, local or municipal law, shall deliver up to 2.0 gallons (7.5 liters) of gasoline or 5.0 gallons (18.9 liters) of diesel fuel to a disabled vehicle. Fuel delivery service is limited to two no-charge occurrences within a 12-month period.
- Winch out – available within 100 feet (30.5 meters) of a paved or county maintained road, no recoveries.
- Towing – Ford eligible vehicles will be towed to an authorized dealer within 35 miles (56.3 kilometers) of the disablement location or to the nearest authorized dealer. If a member requests to be towed to an authorized dealer more than 35 miles (56.3 kilometers) from the disablement location, the member shall be responsible for any mileage costs in excess of 35 miles (56.3 kilometers).

Roadside Assistance will include up to \$200 coverage for a towed trailer if the disabled eligible vehicle requires service at the nearest authorized dealer. If the towing vehicle is operational but the trailer is not, then the trailer does not qualify for any roadside services.

**Vehicles Sold in the United States: Using Roadside Assistance**

Complete the roadside assistance identification card and place it in your wallet for quick reference. This card is found in the owner's manual portfolio in the glove compartment.

United States Ford vehicle customers who require Roadside Assistance, call 1-800-241-3673. If you need to arrange roadside assistance for yourself, Ford Motor Company will reimburse a reasonable amount for towing to the nearest Ford dealership within 35 miles (56.3 kilometers). To obtain reimbursement information, United States Ford vehicle customers call 1-800-241-3673. Customers will be asked to submit their original receipts.

**Vehicles Sold in Canada: Getting Roadside Assistance**

Canadian clients who require roadside assistance, call 1-800-665-2006.

**Vehicles Sold in Canada: Using Roadside Assistance**

For your convenience, you may complete the roadside assistance identification card found in the centerfold of this warranty guide and retain for future reference.

Canadian roadside coverage and benefits may differ from the U.S. coverage. If you require more information, please refer to the coverage section of your warranty guide, call us in Canada at 1-800-665-2006 or visit our website at [www.ford.ca](http://www.ford.ca).

**HAZARD WARNING FLASHERS**

The hazard flasher control is located on the instrument panel by the radio. Use it when your vehicle is disabled and is creating a safety hazard for other motorists.

- Press the flasher control and all front and rear direction signals will flash.
- Press the flasher control again to turn them off.

**Note:** With extended use, the flashers may run down your 12-volt battery.

**FUEL SHUTOFF**

**WARNING:** Failure to inspect and if necessary repair fuel leaks after a collision may increase the risk of fire and serious injury. Ford Motor Company recommends that the fuel system be inspected by an authorized dealer after any collision.

In the event of a moderate to severe collision, this vehicle includes a fuel pump shutoff feature that stops the flow of fuel to the engine. Not every impact will cause a shutoff.

Should your vehicle shut off after a collision, you may restart your vehicle. For vehicles equipped with a key system:

1. Switch off the ignition.
2. Switch on the ignition.
3. Repeat Steps 1 and 2 to re-enable fuel pump.

For vehicles equipped with a push button start system:

1. Press the **START/STOP** button to switch off the ignition.
2. Press the brake pedal and press the **START/STOP** button to start the vehicle.
3. Remove your foot from the brake pedal and press the **START/STOP** button to switch off the ignition.
4. You can either attempt to start the engine by pressing the brake pedal and the **START/STOP** button, or switch on the ignition only by pressing the **START/STOP** button without pressing the brake pedal. Both ways re-enable the fuel system.

**Note:** When you try to restart your vehicle after a fuel shutoff, the vehicle makes sure that various systems are safe to restart. Once your vehicle determines that the systems are safe, then the vehicle will allow you to restart.

**Note:** In the event that your vehicle does not restart after your third attempt, contact an authorized dealer.

**JUMP-STARTING THE VEHICLE**

**WARNING:** The gases around the battery can explode if exposed to flames, sparks, or lit cigarettes. An explosion could result in injury or vehicle damage.



**WARNING:** Batteries contain sulfuric acid which can burn skin, eyes and clothing, if contacted.

Do not attempt to push-start your automatic transmission vehicle. Automatic transmissions do not have push-start capability. Attempting to push-start a vehicle with an automatic transmission may cause transmission damage.

When the battery is disconnected or a new battery is installed, the automatic transmission must relearn its shift strategy. As a result, the transmission may exhibit a combination of firm and soft shifts. This operation is considered normal and will not affect function or durability of the transmission. Over time, the adaptive learning process will fully update transmission operation.

**Preparing Your Vehicle**

**Note:** Use only a 12-volt supply to start your vehicle.

**Note:** Do not disconnect the battery of the disabled vehicle as this could damage the vehicle's electrical system.

1. Park the booster vehicle close to the hood of the disabled vehicle making sure the two vehicles do not touch. Set the parking brake on both vehicles and stay clear of the engine cooling fan and other moving parts.
2. Check all battery terminals. Remove the positive terminal cover (if equipped) and any excessive corrosion before you attach the battery cables. Ensure that vent caps are tight and level.
3. Turn the heater fan on in both vehicles to protect from any electrical surges. Turn all other accessories off.

### Connecting the Jumper Cables

**WARNING:** Do not connect the end of the second cable to the negative (-) terminal of the battery to be jumped. A spark may cause an explosion of the gases that surround the battery.

**Note:** Do not attach the negative (-) cable to fuel lines, engine rocker covers, the intake manifold or electrical components as grounding points.

**Note:** In the illustration, the vehicle on the bottom is used to designate the assisting (boosting) battery.

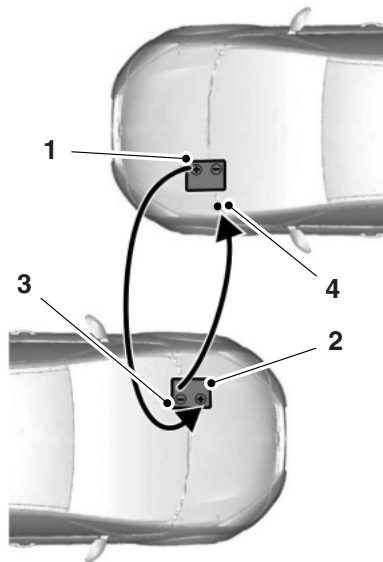

1. Connect the positive (+) jumper cable to the positive (+) terminal of the discharged battery.

2. Connect the other end of the positive (+) cable to the positive (+) terminal of the assisting battery.

3. Connect the negative (-) cable to the negative (-) terminal of the assisting battery.

4. Make the final connection of the negative (-) cable to an exposed metal part of the stalled vehicle's engine, away from the battery and the carburetor or fuel injection system.

Ensure that the cables are clear of fan blades, belts, moving parts of both engines, or any fuel delivery system parts.

### Jump Starting

1. Start the engine of the booster vehicle and run the engine at a moderately increased speed.
2. Start the engine of the disabled vehicle.
3. Once the disabled vehicle has been started, run both engines for an additional three minutes before disconnecting the jumper cables.



**Removing the Jumper Cables**

**Note:** In the illustration, the vehicle on the bottom is used to designate the assisting (boosting) battery.

Remove the jumper cables in the reverse order that they were connected.

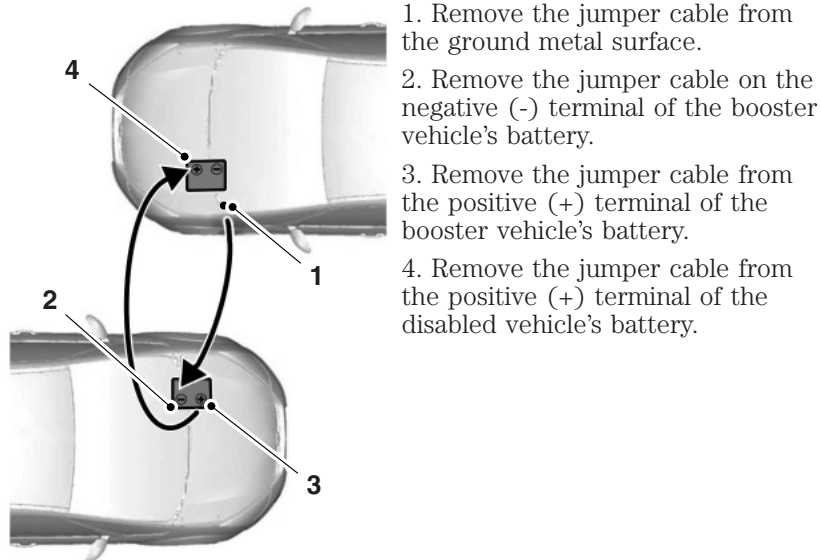

After the disabled vehicle has been started and the jumper cables removed, allow it to idle for several minutes so the engine computer can relearn its idle conditions.

**GETTING THE SERVICES YOU NEED**

Warranty repairs to your vehicle must be performed by an authorized dealer. While any authorized dealer handling your vehicle line will provide warranty service, we recommend you return to your selling authorized dealer who wants to ensure your continued satisfaction.

Please note that certain warranty repairs require special training, equipment or both, so not all authorized dealers are authorized to perform all warranty repairs. This means that, depending on the warranty repair needed, you may have to take your vehicle to another authorized dealer.

A reasonable time must be allowed to perform a repair after taking your vehicle to the authorized dealer. Repairs will be made using Ford or Motorcraft parts, or remanufactured or other parts that are authorized by Ford.

**Away from Home**

If you are away from home when your vehicle needs service, contact the Ford Customer Relationship Center or use the online resources listed below to find the nearest authorized dealer.

In the United States:

**Mailing Address**

Ford Motor Company  
Customer Relationship Center  
P.O. Box 6248  
Dearborn, MI 48121

**Telephone**

1-800-392-3673 (FORD)  
(TDD for the hearing impaired: 1-800-232-5952)

**Online**

Additional information and resources are available online at [www.fordowner.com](http://www.fordowner.com).

These are some of the items that can be found online:

- U.S. Dealer Locator by Dealer Name, City/State, or Zip Code
- Owner Manuals
- Maintenance Schedules
- Recalls
- Ford Extended Service Plans

- Ford Genuine Accessories
- Service specials and promotions.

In Canada:

**Mailing address**

Customer Relationship Centre  
Ford Motor Company of Canada, Limited  
P.O. Box 2000  
Oakville, Ontario L6K 1C8

**Telephone**

1-800-565-3673 (FORD)

**Online**

[www.ford.ca](http://www.ford.ca)

**Additional Assistance**

If you have questions or concerns, or are unsatisfied with the service you are receiving, follow these steps:

1. Contact your Sales Representative or Service Advisor at your selling or servicing authorized dealer.
2. If your inquiry or concern remains unresolved, contact the Sales Manager, Service Manager or Customer Relations Manager.
3. If you require assistance or clarification on Ford Motor Company policies, please contact the Ford Customer Relationship Center.

In order to help serve you better, please have the following information available when contacting a Customer Relationship Center:

- Vehicle Identification Number (VIN)
- Your telephone number (home and business)
- The name of the authorized dealer and city where located
- The vehicle's current odometer reading.

In some states, you must directly notify Ford in writing before pursuing remedies under your state's warranty laws. Ford is also allowed a final repair attempt in some states.

In the United States, a warranty dispute must be submitted to the BBB AUTO LINE before taking action under the Magnuson-Moss Warranty Act, or to the extent allowed by state law, before pursuing replacement or repurchase remedies provided by certain state laws. This dispute handling procedure is not required prior to enforcing state created rights or other rights which are independent of the Magnuson-Moss Warranty Act or state replacement or repurchase laws.

**IN CALIFORNIA (U.S. ONLY)**

California Civil Code Section 1793.2(d) requires that, if a manufacturer or its representative is unable to repair a motor vehicle to conform to the vehicle's applicable express warranty after a reasonable number of attempts, the manufacturer shall be required to either replace the vehicle with one substantially identical or repurchase the vehicle and reimburse the buyer in an amount equal to the actual price paid or payable by the consumer (less a reasonable allowance for consumer use). The consumer has the right to choose whether to receive a refund or replacement vehicle.

California Civil Code Section 1793.22(b) presumes that the manufacturer has had a reasonable number of attempts to conform the vehicle to its applicable express warranties if, within the first 18 months of ownership of a new vehicle or the first 18000 mi (29 000 km), whichever occurs first:

1. Two or more repair attempts are made on the same nonconformity likely to cause death or serious bodily injury OR
2. Four or more repair attempts are made on the same nonconformity (a defect or condition that substantially impairs the use, value or safety of the vehicle) OR
3. The vehicle is out of service for repair of nonconformities for a total of more than 30 calendar days (not necessarily all at one time).

In the case of 1 or 2 above, the consumer must also notify the manufacturer of the need for the repair of the nonconformity at the following address:

Ford Motor Company  
16800 Executive Plaza Drive  
Mail Drop 3NE-B  
Dearborn, MI 48126

You are required to submit your warranty dispute to BBB AUTO LINE before asserting in court any rights or remedies conferred by California Civil Code Section 1793.22(b). You are also required to use BBB AUTO LINE before exercising rights or seeking remedies created by the Federal Magnuson-Moss Warranty Act, 15 U.S.C. sec. 2301 et seq. If you choose to seek redress by pursuing rights and remedies not created by California Civil Code Section 1793.22(b) or the Magnuson-Moss Warranty Act, resorting to BBB AUTO LINE is not required by those statutes.

**THE BETTER BUSINESS BUREAU (BBB) AUTO LINE PROGRAM (U.S. ONLY)**

Your satisfaction is important to Ford Motor Company and to your dealer. If a warranty concern has not been resolved using the three-step procedure outlined earlier in this chapter in the *Getting the Services You Need* section, you may be eligible to participate in the BBB AUTO LINE program.

The BBB AUTO LINE program consists of two parts – mediation and arbitration. During mediation, a representative of the BBB will contact both you and Ford Motor Company to explore options for settlement of the claim. If an agreement is not reached during mediation or you do not want to participate in mediation, and if your claim is eligible, you may participate in the arbitration process. An arbitration hearing will be scheduled so that you can present your case in an informal setting before an impartial person. The arbitrator will consider the testimony provided and make a decision after the hearing.

Disputes submitted to the BBB AUTO LINE program are usually decided within 40 days after you file your claim with the BBB. You are not bound by the decision, and may reject the decision and proceed to court where all findings of the BBB Auto Line dispute, and decision, are admissible in the court action. Should you choose to accept the BBB AUTO LINE decision, Ford is then bound by the decision, and must comply with the decision within 30 days of receipt of your acceptance letter.

BBB AUTO LINE Application: Using the information provided below, please call or write to request a program application. You will be asked for your name and address, general information about your new vehicle, information about your warranty concerns, and any steps you have already taken to try to resolve them. A Customer Claim Form will be mailed that will need to be completed, signed and returned to the BBB along with proof of ownership. Upon receipt, the BBB will review the claim for eligibility under the Program Summary Guidelines.

**You can get more information by calling BBB AUTO LINE at 1-800-955-5100, or writing to:**

**BBB AUTO LINE  
3033 Wilson Boulevard, Suite 600  
Arlington, Virginia 22201**

BBB AUTO LINE applications can also be requested by calling the Ford Motor Company Customer Relationship Center at 1-800-392-3673.

**Note:** Ford Motor Company reserves the right to change eligibility limitations, modify procedures, or to discontinue this process at any time without notice and without obligation.

---

**UTILIZING THE MEDIATION or ARBITRATION PROGRAM  
(CANADA ONLY)**

This pertains to vehicles delivered to authorized Canadian dealers. In those cases, where you continue to feel that the efforts by Ford of Canada and the authorized dealer to resolve a factory-related vehicle service concern have been unsatisfactory, Ford of Canada participates in an impartial third party mediation or arbitration program administered by the Canadian Motor Vehicle Arbitration Plan (CAMVAP).

The CAMVAP program is a straightforward and relatively speedy alternative to resolve a disagreement when all other efforts to produce a settlement have failed. This procedure is without cost to you and is designed to eliminate the need for lengthy and expensive legal proceedings.

In the CAMVAP program, impartial third-party arbitrators conduct hearings at mutually convenient times and places in an informal environment. These impartial arbitrators review the positions of the parties, make decisions and, when appropriate, render awards to resolve disputes. CAMVAP decisions are fast, fair, and final as the arbitrator's award is binding on both you and Ford of Canada.

CAMVAP services are available in all Canadian territories and provinces. For more information, without charge or obligation, call your CAMVAP Provincial Administrator directly at 1-800-207-0685 or visit [www.camvap.ca](http://www.camvap.ca).

**GETTING ASSISTANCE OUTSIDE THE U.S. AND CANADA**

Before exporting your vehicle to a foreign country, contact the appropriate foreign embassy or consulate. These officials can inform you of local vehicle registration regulations and where to find unleaded fuel.

If you cannot find unleaded fuel or can only get fuel with an anti-knock index lower than is recommended for your vehicle, contact our Customer Relationship Center.

The use of leaded fuel in your vehicle without proper conversion may damage the effectiveness of your emission control system and may cause engine knocking or serious engine damage. Ford Motor Company or Ford of Canada is not responsible for any damage caused by use of improper fuel. Using leaded fuel may also result in difficulty importing your vehicle back into the United States.

**If your vehicle must be serviced while you are traveling or living in Asia-Pacific Region, Sub-Saharan Africa, U.S. Virgin Islands, Central America, the Caribbean, and Israel, contact the nearest authorized dealer. If the authorized dealer cannot help you, contact:**

**FORD MOTOR COMPANY  
FORD EXPORT OPERATIONS & GLOBAL INITIATIVES**

Customer Relationship Center  
1555 Fairlane Drive  
Fairlane Business Park #3  
Allen Park, Michigan 48101  
U.S.A.  
Telephone: (313) 594-4857  
FAX: (313) 390-0804  
Email: [expcac@ford.com](mailto:expcac@ford.com)

**For customers in Guam, the Commonwealth of the Northern Mariana Islands (CNMI), America Samoa, and the U.S. Virgin Islands, please feel free to call our Toll-Free Number:  
(800) 841-FORD (3673)**

**If your vehicle must be serviced while you are traveling or living in Puerto Rico, contact the nearest authorized dealer. If the authorized dealer cannot help you, contact:**

**FORD MOTOR COMPANY  
FORD EXPORT OPERATIONS & GLOBAL INITIATIVES**

Customer Relationship Center  
1555 Fairlane Drive  
Fairlane Business Park #3  
Allen Park, Michigan 48101  
Telephone: (800) 841-FORD (3673)  
FAX: (313) 390-0804  
Email: [prcac@ford.com](mailto:prcac@ford.com)  
[www.ford.com.pr](http://www.ford.com.pr)

**If your vehicle must be serviced while you are traveling or living in the Middle East, contact the nearest authorized dealer. If the authorized dealer cannot help you, contact:**

**Ford Middle East  
Customer Relationship Center**

P.O. Box 21470  
Dubai, United Arab Emirates  
Telephone: +971 4 3326084  
Toll-Free Number of the Kingdom of Saudi Arabia: 800 8971409  
Local Telephone Number of Kuwait: 24810575  
FAX: +971 4 3327299  
Email: [menacac@ford.com](mailto:menacac@ford.com)  
[www.me.ford.com](http://www.me.ford.com)

If you buy your vehicle in North America and then relocate to any of the above locations, register your vehicle identification number (VIN) and new address with Ford Motor Company Export Operations & Global Growth Initiatives by emailing [expcac@ford.com](mailto:expcac@ford.com).

**If you are in another foreign country, contact the nearest authorized dealer. In the event your inquiry is unresolved, communicate your concern with the dealership's Sales Manager, Service Manager or Customer Relations Manager. If you require additional assistance or clarification, please contact the respective Customer Relationship Center as previously listed.**

**Customers in the U.S. should call 1-800-392-3673.**

**ORDERING ADDITIONAL OWNER'S LITERATURE**

To order the publications in this portfolio, contact Helm, Incorporated at:

HELM, INCORPORATED  
47911 Halyard Drive  
Plymouth, Michigan 48170  
Attention: Customer Service

Or to order a free publication catalog, call toll free: 1-800-782-4356

Monday-Friday 8:00 a.m. - 6:00 p.m. EST

Helm, Incorporated can also be reached by their website:  
[www.helminc.com](http://www.helminc.com).

*(Items in this catalog may be purchased by credit card, check or money order.)*



**Obtaining a French Owner's Manual**

A French owner's manual can be obtained from your authorized dealer or by contacting Helm, Incorporated using the contact information listed previously in this section.

**REPORTING SAFETY DEFECTS (U.S. ONLY)**

If you believe that your vehicle has a defect which could cause a crash or could cause injury or death, you should immediately inform the National Highway Traffic Safety

Administration (NHTSA) in addition to notifying Ford Motor Company.

If NHTSA receives similar complaints, it may open an investigation, and if it finds that a safety defect exists in a group of vehicles, it may order a recall and remedy campaign. However, NHTSA cannot become involved in individual problems between you, your dealer, or Ford Motor Company.

To contact NHTSA, you may call the Vehicle Safety Hotline toll-free at 1-888-327-4236 (TTY: 1-800-424-9153); go to <http://www.safercar.gov>; or write to:

Administrator  
1200 New Jersey Avenue, Southeast  
Washington, D.C. 20590

You can also obtain other information about motor vehicle safety from <http://www.safercar.gov>.

**REPORTING SAFETY DEFECTS (CANADA ONLY)**

If you believe that your vehicle has a defect which could cause a crash or could cause injury or death, you should immediately inform Transport Canada, using their toll-free number: 1-800-333-0510, or online at: <http://www.tc.gc.ca/eng/roadsafety/menu.htm>

**CHANGING A FUSE**

**Fuses**

 **WARNING:** Always replace a fuse with one that has the specified amperage rating. Using a fuse with a higher amperage rating can cause severe wire damage and could start a fire.

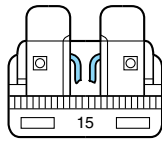

If electrical components in your vehicle are not working, a fuse may have blown. Blown fuses are identified by a broken wire within the fuse. Check the appropriate fuses before replacing any electrical components.

**Standard Fuse Amperage Rating and Color**

COLOR					
Fuse rating	Mini fuses	Standard fuses	Maxi fuses	Cartridge maxi fuses	Fuse link cartridge
2A	Grey	Grey	—	—	—
3A	Violet	Violet	—	—	—
4A	Pink	Pink	—	—	—
5A	Tan	Tan	—	—	—
7.5A	Brown	Brown	—	—	—
10A	Red	Red	—	—	—
15A	Blue	Blue	—	—	—
20A	Yellow	Yellow	Yellow	Blue	Blue
25A	Natural	Natural	—	Natural	Natural
30A	Green	Green	Green	Pink	Pink
40A	—	—	Orange	Green	Green
50A	—	—	Red	Red	Red
60A	—	—	Blue	Yellow	Yellow
70A	—	—	Tan	—	Brown
80A	—	—	Natural	Black	Black

---

**FUSE SPECIFICATION CHART**
**Power Distribution Box**

**WARNING:** Always disconnect the battery before servicing high current fuses.



**WARNING:** To reduce risk of electrical shock, always replace the cover to the power distribution box before reconnecting the battery or refilling fluid reservoirs.

The power distribution box is located in the engine compartment. It has high-current fuses that protect your vehicle's main electrical systems from overloads.

If the battery has been disconnected and reconnected, see *Changing the Vehicle Battery* in the *Maintenance* chapter.

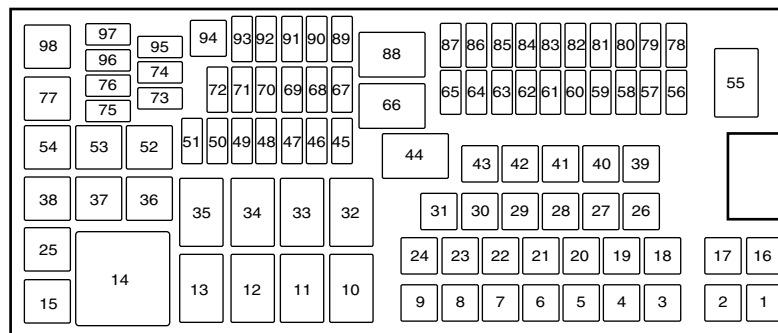

The high-current fuses are coded as follows:

Fuse or relay number	Fuse amp rating	Protected components
1	—	Not used
2	—	Not used
3	30A**	Trailer brake control module

Fuse or relay number	Fuse amp rating	Protected components
4	30A**	Wipers, Front washer
5	50A**	Anti-lock brake system pump
6	—	Not used
7	30A**	Power liftgate
8	20A**	Moonroof
9	20A**	Power point #2 (console rear)
10	—	3rd row rear seat release relay
11	—	Rear window defroster relay
12	—	Trailer tow battery charge relay
13	—	Starter motor relay
14	—	Engine cooling fan #2 high speed relay
15	—	Fuel pump relay
16	—	Not used
17	40A**	110-volt AC power point
18	40A**	Front blower motor
19	30A**	Starter motor
20	20A**	Power point #1, cigar lighter
21	20A**	Power point #3 (cargo area)
22	30A**	Third row seat module
23	30A**	Driver power seat, Memory module
24	30A**	Trailer tow battery charge
25	—	Not used
26	40A**	Rear window defroster, Heated mirrors
27	20A**	Power point (console)
28	30A**	Climate controlled seats
29	40A**	Engine cooling fan #1 high speed power, Engine cooling fan #1 and #2 low speed primary fuse

Fuse or relay number	Fuse amp rating	Protected components
30	40A**	Engine cooling fan #2 high speed fuse
31	25A**	Engine cooling fan #1 and #2 low speed secondary fuse
32	—	Auxiliary blower motor relay
33	—	Engine cooling fan #1 and #2 low speed relay #2
34	—	Blower motor relay
35	—	Engine cooling fan #1 high speed relay, Engine cooling fan #1 and #2 low speed relay #1
36	—	Not used
37	—	Trailer tow right stop/turn lamps relay
38	—	Trailer tow backup relay
39	40A**	Auxiliary blower motor
40	—	Not used
41	30A**	Second row heated seats
42	30A**	Passenger seat
43	40A**	Anti-lock brake system valves
44	—	Rear washer relay
45	5A*	Rain sensor
46	—	Not used
47	—	Not used
48	—	Not used
49	—	Not used
50	15A*	Heated mirrors
51	—	Not used
52	—	Not used
53	—	Trailer tow left stop/turn lamps relay
54	—	Not used

Fuse or relay number	Fuse amp rating	Protected components
55	—	Wiper relay
56	15A*	Transmission control module
57	20A*	Left high-intensity discharge headlamps
58	10A*	Alternator sensor
59	10A*	Brake on/off switch
60	10A*	Trailer tow back-up lamps
61	20A*	Second row seat release
62	10A*	Air conditioning clutch
63	15A*	Trailer tow stop/turn lamps
64	15A*	Rear wipers
65	30A*	Fuel pump
66	—	Powertrain control module relay
67	20A*	Vehicle power #2 (emission related powertrain components)
68	20A*	Vehicle power #4 (ignition coils)
69	20A*	Vehicle power #1 (powertrain control module)
70	10A*	Vehicle power #3 (coil), All-wheel drive module, Air conditioning variable compressor control
71	—	Not used
72	—	Not used
73	—	Not used
74	—	Not used
75	—	Not used
76	—	Not used
77	—	Trailer tow park lamps relay
78	20A*	Right high-intensity discharge headlamps
79	5A*	Adaptive cruise control

Fuse or relay number	Fuse amp rating	Protected components
80	—	Not used
81	—	Not used
82	15A*	Rear washer
83	—	Not used
84	20A*	Trailer tow park lamps
85	—	Not used
86	7.5A*	Powertrain control module keep-alive power, Powertrain control module relay, Canister vent solenoid
87	5A*	Run/start relay coil
88	—	Run/start relay
89	5A*	Front blower relay coil, Electronic power assist steering module
90	10A*	Powertrain control module, Transmission control module, Engine control module (2.0L engine)
91	10A*	Adaptive cruise control
92	10A*	Anti-lock brake system module, Plant EVAC and fill
93	5A*	Rear blower motor, Rear defroster, Trailer tow battery charge relays
94	30A**	Passenger compartment fuse panel run/start
95	—	Not used
96	—	Not used
97	—	Not used
98	—	Air conditioning clutch relay
*Mini Fuses **Cartridge Fuses		

**Passenger Compartment Fuse Panel**

The fuse panel is located below and to the left of the steering wheel by the brake pedal. Remove the panel cover to access the fuses.

To remove a fuse use the fuse puller tool provided on the fuse panel cover.

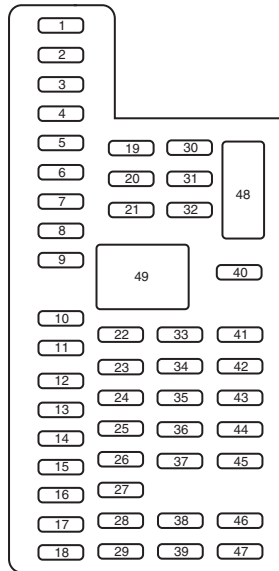

The fuses are coded as follows:

Fuse or relay number	Fuse amp rating	Protected components
1	30A	One-touch up and down driver front window
2	15A	Not used (spare)
3	30A	One-touch up and down passenger front window
4	10A	Interior demand lamps (overhead console, second row, cargo), Glove box lamp, Second and third row seat release, Visor lamps



Fuse or relay number	Fuse amp rating	Protected components
5	20A	Amplifier
6	5A	Not used (spare)
7	7.5A	Memory seat module logic feed
8	10A	Not used (spare)
9	10A	4-inch radio display, Power liftgate logic, Electronic finish panel, SYNC
10	10A	Run/accessory relay (wipers, rear washer), Rain sensor
11	10A	Instrument cluster, Heads-up display
12	15A	Interior courtesy lamps (overhead console, Second row, cargo), Puddle lamps, Console bin LED, Backlighting
13	15A	Right turn lamps, Right trailer tow turn/stop lamps
14	15A	Left turn lamps, Left trailer tow turn/stop lamps
15	15A	Reverse lamps, Stop lamps, High-mounted stop lamp
16	10A	Low beam headlamps (right)
17	10A	Low beam headlamps (left)
18	10A	Keypad illumination, Brake shift interlock, Start button run indicator, Passive anti-theft system, Powertrain control module wake-up, Rear seat power enable
19	20A	Memory seat power
20	20A	Locks
21	10A	Intelligent access, Keypad

Fuse or relay number	Fuse amp rating	Protected components
22	20A	Horn relay
23	15A	Steering wheel control module, Intelligent access, Headlamp switch
24	15A	Datalink connector, Steering wheel control module
25	15A	Liftgate release
26	5A	Radio frequency module
27	20A	Intelligent access module
28	15A	Ignition switch, Push-button start switch
29	20A	Radio, Global positioning system module
30	15A	Front park lamps
31	5A	Trailer tow brake controller
32	15A	110-volt AC power point, Power folding mirror, Power mirrors, One-touch up and down front windows, Door lock illumination, Memory switch illumination
33	10A	Occupant classification sensor
34	10A	Blind spot monitor, Rearview camera, Reverse sensing system, Lane departure warning module, Second row heated seats module
35	5A	Heads-up display, Climate control humidity sensor, Terrain management system, Hill descent switch, Headlamp switch ignition sensor
36	10A	Heated steering wheel
37	10A	Restraints control module

Fuse or relay number	Fuse amp rating	Protected components
38	10A	Auto-dimming rearview mirror, Moonroof
39	15A	High beam headlamp shutters
40	10A	Rear park lamps, License plate lamps, Trailer tow park lamps
41	7.5A	Overdrive cancel, Tow/haul
42	5A	Not used (spare)
43	10A	Not used (spare)
44	10A	Not used (spare)
45	5A	Not used (spare)
46	10A	Climate control module
47	15A	Fog lamps, left and right turn signal mirror feed
48	30A Circuit Breaker	Rear power windows, Passenger power window, One-touch down (driver side only), Driver window switch
49	Delayed accessory relay	Body control module

**GENERAL INFORMATION**

Have your vehicle serviced regularly to help maintain its roadworthiness and resale value. There is a large network of Ford authorized dealers who are there to help you with their professional servicing expertise. We believe that their specially trained technicians are best qualified to service your vehicle properly and expertly. They are supported by a wide range of highly specialized tools developed specifically for servicing your vehicle.

To help you service your vehicle, we provide *Scheduled Maintenance Information* which makes tracking routine service easy.

If your vehicle requires professional service, your authorized dealer can provide the necessary parts and service. Check your warranty information to find out which parts and services are covered.

Use only recommended fuels, lubricants, fluids and service parts conforming to specifications. Motorcraft® parts are designed and built to provide the best performance in your vehicle.

**Precautions**

- Do not work on a hot engine.
- Make sure that nothing gets caught in moving parts.
- Do not work on a vehicle with the engine running in an enclosed space, unless you are sure you have enough ventilation.
- Keep all open flames and other burning material (such as cigarettes) away from the battery and all fuel related parts.

**Working with the Engine Off**

1. Set the parking brake and shift to **P** (Park).
2. Turn off the engine and remove the key (if equipped).
3. Block the wheels.

**Working with the Engine On**

**WARNING:** To reduce the risk of vehicle damage or personal burn injuries, do not start your engine with the air cleaner removed and do not remove it while the engine is running.

1. Set the parking brake and shift to position **P** (Park) .
2. Block the wheels.

**OPENING AND CLOSING THE HOOD**

1. Inside the vehicle, pull the hood release handle located under the bottom left corner of the instrument panel.

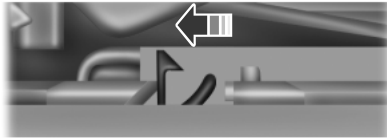

2. Go to the front of the vehicle and release the auxiliary latch that is located under the front center of the hood.

3. Lift the hood.

**Note:** Make sure the hood is properly closed.

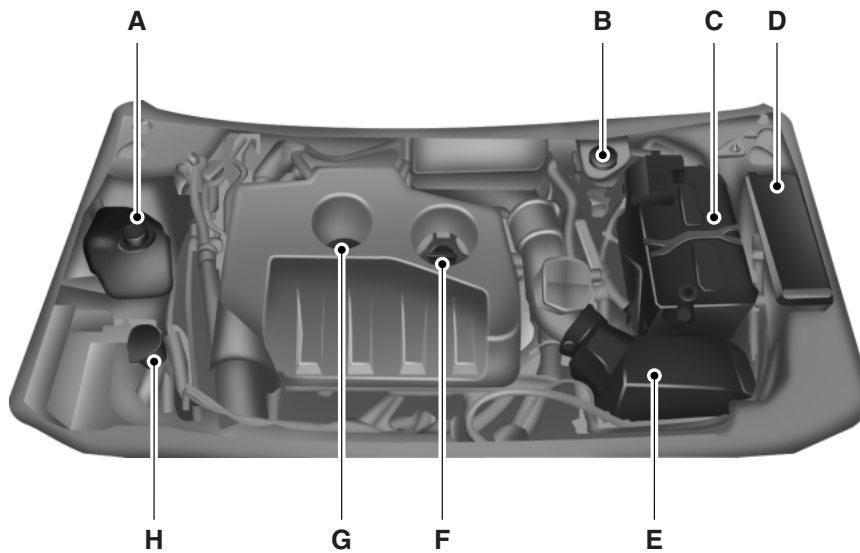
**UNDER HOOD OVERVIEW****2.0L EcoBoost® Engine**

- A. Engine coolant reservoir
- B. Brake fluid reservoir
- C. Battery
- D. Power distribution box
- E. Air filter assembly
- F. Engine oil filler cap
- G. Engine oil dipstick
- H. Windshield washer fluid reservoir

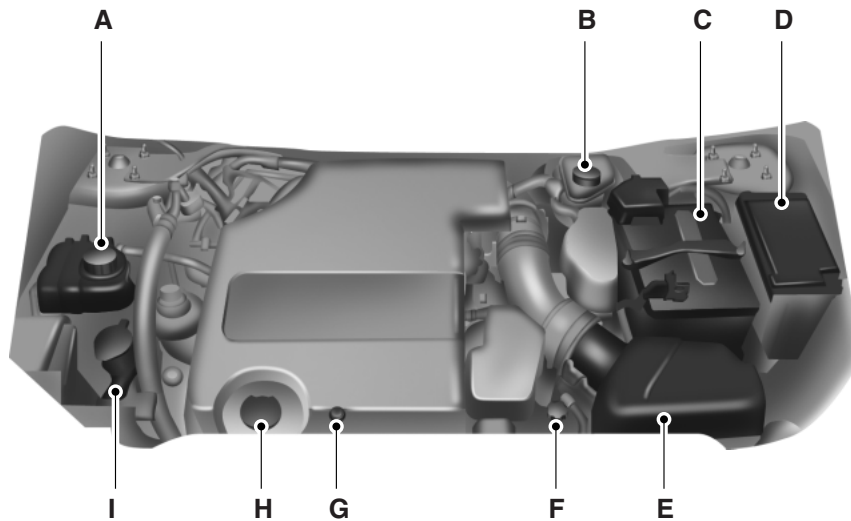
**3.5L V6 Engine**

- A. Engine coolant reservoir
- B. Brake fluid reservoir
- C. Battery
- D. Power distribution box
- E. Air filter assembly
- F. Transmission fluid dipstick (out of view)
- G. Engine oil dipstick
- H. Engine oil filler cap
- I. Windshield washer fluid reservoir

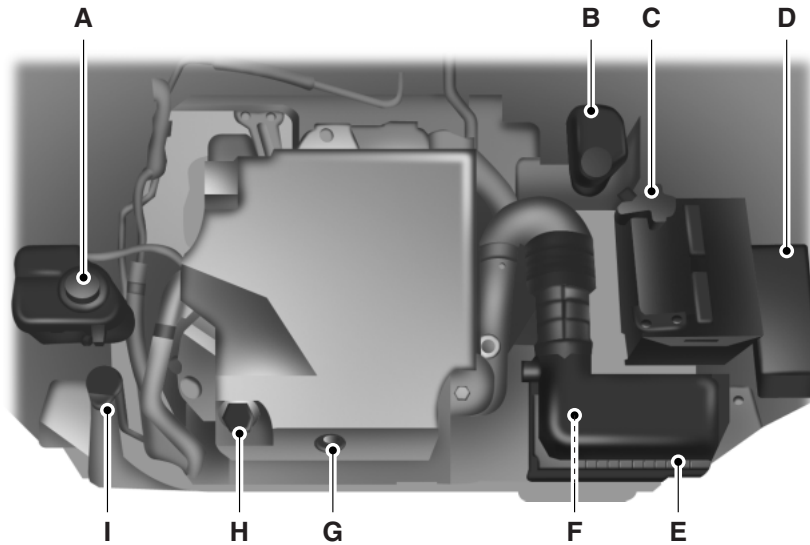
**3.5L V6 EcoBoost® Engine**

- A. Engine coolant reservoir
- B. Brake fluid reservoir
- C. Battery
- D. Power distribution box
- E. Air filter assembly
- F. Automatic transmission fluid dipstick (out of view)
- G. Engine oil dipstick
- H. Engine oil filler cap
- I. Windshield washer fluid reservoir



**Engine shield**

Some vehicles may be equipped with an aero-shield under the engine. This shield needs to be removed for service, including oil and filter changes. It is secured with four quick release fasteners.

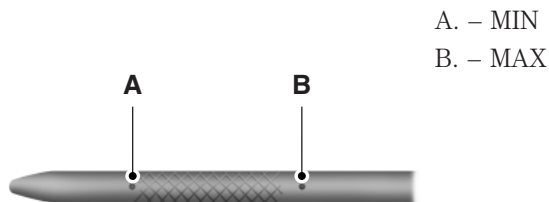
**ENGINE OIL DIPSTICK**

A. - MIN

B. - MAX

**ENGINE OIL CHECK**

**Note:** Check the level before starting the engine.

**Note:** Make sure that the level is between the MIN and MAX marks.

1. Make sure that your vehicle is on level ground.
2. Turn the engine off and wait 10 minutes for the oil to drain into the oil pan.
3. Remove the dipstick and wipe it with a clean, lint-free cloth. Replace the dipstick and remove it again to check the oil level.

If the level is at the MIN mark, add oil immediately.

### Adding Engine Oil

**Note:** Do not remove the filler cap when the engine is running.

**Note:** Do not add engine oil further than the MAX mark. Oil levels above the MAX mark may cause engine damage.



Only use oils certified for gasoline engines by the American Petroleum Institute (API). An oil with this trademark symbol conforms to the current engine and emission system protection standards and fuel economy requirements of the International Lubricants Specification Advisory Council (ILSAC), comprised of U.S. and Japanese automobile manufacturers.

1. Remove the filler cap.
2. Add engine oil that meets Ford specifications. See *Capacities and Specifications* for more information.
3. Replace the filler cap. Turn it until you feel a strong resistance.

### ENGINE COOLANT CHECK

#### Checking the Engine Coolant

The concentration and level of engine coolant should be checked at the intervals listed in *scheduled maintenance information*.

Make sure that the level is at the FULL COLD level or within the COLD FILL RANGE in the coolant reservoir.

Coolant expands when it is hot. The level may extend beyond the COLD FILL RANGE.

If the level is below the COLD FILL RANGE, add coolant immediately.

The coolant concentration should be maintained within 48% to 50%, which equates to a freeze point between -30 °F (-34 °C) and -34 °F (-37 °C).

**Note:** For best results, coolant concentration should be tested with a refractometer such as Rotunda tool 300-ROB75240 available from your dealer. Ford does not recommend the use of hydrometers or coolant test strips for measuring coolant concentration.

**Note:** Automotive fluids are not interchangeable; do not use engine coolant/antifreeze or windshield washer fluid outside of its specified function and vehicle location.

**Adding Engine Coolant**

**WARNING:** Do not add engine coolant when the engine is hot. Steam and scalding liquids released from a hot cooling system can burn you badly. Also, you can be burned if you spill coolant on hot engine parts.



**WARNING:** Do not put engine coolant in the windshield washer fluid container. If sprayed on the windshield, engine coolant could make it difficult to see through the windshield.



**WARNING:** To reduce the risk of personal injury, make sure the engine is cool before unscrewing the coolant pressure relief cap. The cooling system is under pressure; steam and hot liquid can come out forcefully when the cap is loosened slightly.



**WARNING:** Do not add coolant further than the MAX mark.

**Note:** Do not use stop leak pellets, cooling system sealants or additives as they can cause damage to the engine cooling and/or heating systems. This damage would not be covered under your vehicle's warranty.

**Note:** During normal vehicle operation, the engine coolant may change color from orange to pink or light red. As long as the engine coolant is clear and uncontaminated, this color change does not indicate the engine coolant has degraded nor does it require the engine coolant to be drained, the system to be flushed, or the engine coolant to be replaced.

- DO NOT MIX different colors or types of coolant in your vehicle. Make sure the correct coolant is used. Mixing of engine coolants may harm your engine's cooling system. The use of an improper coolant may harm engine and cooling system components and may void the warranty.
- In case of emergency, a large amount of water without engine coolant may be added in order to reach a vehicle service location. In this instance, the cooling system must be drained, chemically cleaned with Motorcraft Premium Cooling System Flush, and refilled with engine coolant as soon as possible. Water alone (without engine coolant) can cause engine damage from corrosion, overheating or freezing.

- Do not use alcohol, methanol, brine or any engine coolants mixed with alcohol or methanol antifreeze (coolant). Alcohol and other liquids can cause engine damage from overheating or freezing.
- Do not add extra inhibitors or additives to the coolant. These can be harmful and compromise the corrosion protection of the engine coolant.

Unscrew the cap slowly. Any pressure will escape as you unscrew the cap.

Add prediluted engine coolant meeting the Ford specification. See *Capacities and Specifications* for more information.

Whenever coolant has been added, the coolant level in the coolant reservoir should be checked the next few times you drive the vehicle. If necessary, add enough prediluted engine coolant to bring the coolant level to the proper level.

### Recycled Engine Coolant

Ford Motor Company does not recommend the use of recycled engine coolant since a Ford-approved recycling process is not yet available.



Used engine coolant should be disposed of in an appropriate manner. Follow your community's regulations and standards for recycling and disposing of automotive fluids.

### Severe Climates

If you drive in extremely cold climates:

- It may be necessary to have a Ford authorized dealer increase the coolant concentration above 50%.
- A coolant concentration of 60% will provide improved freeze point protection. Engine coolant concentrations above 60% will decrease the overheat protection characteristics of the engine coolant and may cause engine damage.

If you drive in extremely hot climates:

- It may be necessary to have a Ford authorized dealer decrease the coolant concentration to 40%.
- A coolant concentration of 40% will provide improved overheat protection. Engine coolant concentrations below 40% will decrease the corrosion and freeze protection characteristics of the engine coolant and may cause engine damage.

Vehicles driven year-round in non-extreme climates should use prediluted engine coolant for optimum cooling system and engine protection.

### Engine Fluid Temperature Management (If Equipped)



**WARNING:** To reduce the risk of collision and injury, be prepared that the vehicle speed may reduce and the vehicle may not be able to accelerate with full power until the fluid temperatures reduce.

Your vehicle has been designed to pull a trailer, but because of the added load, the vehicle's engine may temporarily reach higher temperatures during severe operating conditions such as ascending a long or steep grade while pulling a trailer in hot ambient temperatures.

At this time, you may notice your engine coolant temperature gauge needle move toward the H and the POWER REDUCED TO LOWER TEMP message may appear in the information display.

You may notice a reduction in the vehicle's speed caused by reduced engine power. Your vehicle has been designed to enter this mode if certain high temperature/high load conditions take place in order to manage the engine's fluid temperatures. The amount of speed reduction will depend on the vehicle loading, towing, grade, ambient temperature, and other factors. If this occurs, there is no need to pull off the road. The vehicle can continue to be driven while this message is active.

The air conditioning may also cycle on and off during severe operating conditions to protect overheating of the engine. When the engine coolant temperature decreases to a more normal operating temperature, the air conditioning will turn on once again.

If you notice any of the following:

- the engine coolant temperature gauge moves fully into the red (hot) area
- the coolant temperature warning light illuminates
- the service engine soon indicator illuminates

1. Pull off the road as soon as safely possible and place the vehicle in **P** (Park).

2. Leave the engine running until the coolant temperature gauge needle moves away from the H range. After several minutes, if this does not happen, follow the remaining steps.

3. Turn the engine off and wait for it to cool before checking the coolant level.



**WARNING:** Never remove the coolant reservoir cap while the engine is running or hot.

4. If the coolant level is normal, you may restart your engine and continue on.

5. If the coolant is low, add coolant, restart the engine and take your vehicle to an authorized dealer. See *Adding engine coolant* in this chapter for more information.

Refer to fail-safe cooling for additional information.

### What You Should Know About Fail-Safe Cooling

If the engine coolant supply is depleted, this feature allows the vehicle to be driven temporarily before incremental component damage is incurred. The fail-safe distance depends on ambient temperatures, vehicle load and terrain.

#### How Fail-Safe Cooling Works

If the engine begins to overheat, the engine coolant temperature gauge will move to the red (hot) area and:



The coolant temperature warning light will illuminate.



The service engine soon indicator will illuminate.

If the engine reaches a preset over-temperature condition, the engine will automatically switch to alternating cylinder operation. Each disabled cylinder acts as an air pump and cools the engine.

When this occurs the vehicle will still operate. However:

- The engine power will be limited.
- The air conditioning system will be disabled.

Continued operation will increase the engine temperature and the engine will completely shut down, causing steering and braking effort to increase.

Once the engine temperature cools, the engine can be restarted. Take your vehicle to an authorized dealer as soon as possible to minimize engine damage.

**When Fail-Safe Mode is Activated**

**WARNING:** Fail-safe mode is for use during emergencies only.

Operate the vehicle in fail-safe mode only as long as necessary to bring the vehicle to rest in a safe location and seek immediate repairs. When in fail-safe mode, the vehicle will have limited power, will not be able to maintain high-speed operation, and may completely shut down without warning, potentially losing engine power, power steering assist, and power brake assist, which may increase the possibility of a crash resulting in serious injury.



**WARNING:** Never remove the coolant reservoir cap while the engine is running or hot.

You have limited engine power when in the fail-safe mode, so drive the vehicle with caution. The vehicle will not be able to maintain high-speed operation and the engine will run rough. Remember that the engine is capable of completely shutting down automatically to prevent engine damage, therefore:

1. Pull off the road as soon as safely possible and turn off the engine.
2. Arrange for the vehicle to be taken to an authorized dealer.
3. If this is not possible, wait a short period for the engine to cool.
4. Check the coolant level and replenish if low.
5. Restart the engine and take your vehicle to an authorized dealer.

**Note:** Driving the vehicle without repairing the engine problem increases the chance of engine damage. Take your vehicle to an authorized dealer as soon as possible.

**TRANSMISSION FLUID CHECK****6F35 TRANSMISSION (if equipped)**

**Note:** Transmission fluid should be checked by an authorized dealer. If required, fluid should be added by an authorized dealer.

The automatic transmission does not have a transmission fluid dipstick.

Refer to your *scheduled maintenance information* for scheduled intervals for fluid checks and changes. Your transmission does not consume fluid. However, the fluid level should be checked if the transmission is not working properly, (i.e., if the transmission slips or shifts slowly) or if you notice some sign of fluid leakage.

Do not use supplemental transmission fluid additives, treatments or cleaning agents. The use of these materials may affect transmission operation and result in damage to internal transmission components.

### 6F50/6F55 Transmission



**WARNING:** The dipstick cap and surrounding components may be hot; gloves are recommended.



**WARNING:** Use gloves when moving the air filter assembly; components will be hot.

**Note:** Automatic transmission fluid expands when warmed. To obtain an accurate fluid check, drive the vehicle until it is warmed up (approximately 20 miles [30 km]). If your vehicle has been operated for an extended period at high speeds, in city traffic during hot weather or pulling a trailer, the vehicle should be turned off until normal operating temperatures are reached to allow the fluid to cool before checking. Depending on vehicle use, cooling times could take up to 30 minutes or longer.

Refer to your *scheduled maintenance information* for scheduled intervals for fluid checks and changes. Your transmission does not consume fluid. However, the fluid level should be checked if the transmission is not working properly, i.e., if the transmission slips or shifts slowly or if you notice some sign of fluid leakage.

1. Drive the vehicle 20 miles (30 km) or until it reaches normal operating temperature.
2. Park the vehicle on a level surface and engage the parking brake.
3. With the parking brake engaged and your foot on the brake pedal, start the engine and move the gearshift lever through all of the gear ranges. Allow a minimum of 10 seconds for each gear to engage.
4. Latch the gearshift lever in **P** (Park) and leave the engine running.
5. Remove the dipstick, wiping it clean with a clean, dry lintfree rag. If necessary, refer to *Under hood overview* in this chapter for the location of the dipstick. (For vehicles with the EcoBoost engine, move the air filter assembly aside to access the transmission dipstick. See *Moving the Air Filter Assembly (EcoBoost engine)* for more information.
6. Install the dipstick making sure it is fully seated in the filler tube by turning it to the locked position.
7. Remove the dipstick and inspect the fluid level. The fluid should be in the designated areas for normal operating temperature.



**Moving the Air Filter Assembly (EcoBoost engine)**

**WARNING:** Do not run engine with the air filter disconnected.

1. Shut the engine off.

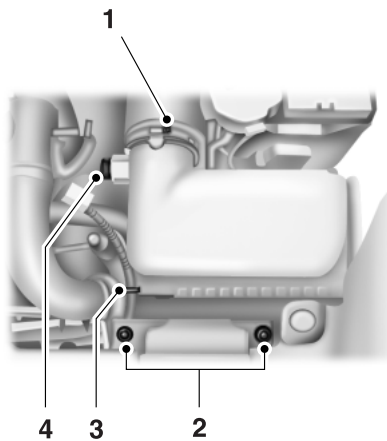

2. Clean the area around the clamp that connects the air filter assembly to the rubber hose (1).

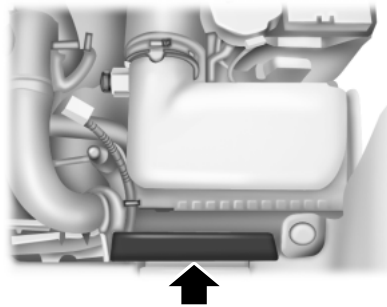

3. Remove the bolt cover (if equipped).

4. Remove two bolts that attach the air filter assembly to the front of the vehicle (2).

5. Loosen the clamp holding the air filter assembly to the rubber hose (1).

6. Remove the harness retaining clip by pulling up (3). Do not disconnect the sensor (4).

7. Without disconnecting the sensor (4), pull the air filter assembly up to disconnect the air filter assembly from the seated grommets located underneath the air filter assembly.

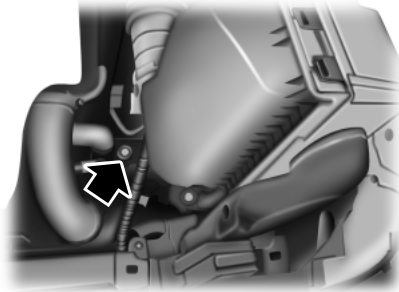

8. Rotate the air filter assembly 90 degrees counterclockwise and reinstall into the rubber hose.

9. Tighten the clamp (1).

10. The transmission fluid level indicator can now be accessed.

**Low fluid level**

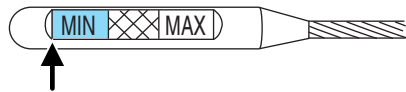

If the fluid level is below the MIN range of the dipstick, add fluid to reach the hash mark level. **Note:** If the fluid level is below the MIN level,

do not drive the vehicle. An underfill condition may cause shift and/or engagement concerns and/or possible damage.

**Correct fluid level**

The transmission fluid should be checked at normal operating temperature 180°F-200°F (82°C-93°C) on a level surface. The normal operating temperature can be reached after approximately 20 miles (30 km) of driving.

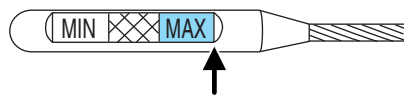

The transmission fluid level should be targeted within the cross-hatch area if at normal operating temperature 180°F-200°F (82°C-93°C).

**High fluid level**

If the fluid level is above the MAX range of the dipstick, remove fluid to reach the hashmark level. **Note:** Fluid level above the MAX level may

cause shift and/or engagement concerns and/or possible damage.

High fluid levels can be caused by an overheating condition. If your vehicle has been operated for an extended period at high speeds, in city traffic during hot weather or pulling a trailer, the vehicle should be turned off until normal operating temperatures are reached. Depending on vehicle use, cooling times could take up to 30 minutes or longer.

**Adjusting Automatic Transmission Fluid Levels**

Before adding any fluid, make sure the correct type is used. The type of fluid used is normally indicated on the dipstick and also in the *Technical specifications* section in this chapter.

**Note:** Use of a non-approved automatic transmission fluid may cause internal transmission component damage.

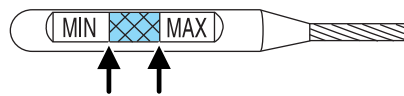

If necessary, add fluid in 1/2 pint (250 ml) increments through the filler tube until the level is correct.

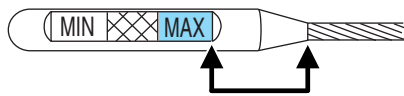

If an overfill occurs, excess fluid should be removed by an authorized dealer.

**Note:** An overfill condition of transmission fluid may cause shift and/or engagement concerns and/or possible damage.

Do not use supplemental transmission fluid additives, treatments or cleaning agents. The use of these materials may affect transmission operation and result in damage to internal transmission components.

For vehicles equipped with the EcoBoost engine, reinstall the air filter assembly.

After the fluid level has been checked and adjusted as necessary, do the following:

1. Shut the engine off.
2. Loosen the clamp holding the air filter assembly to the rubber hose.
3. Rotate the air filter assembly 90 degrees clockwise without disconnecting the sensor.

4. Seat the air filter assembly back into the grommets by pushing down on the air filter assembly.
5. Tighten the clamp.
6. Install and tighten two bolts that attach air filter assembly to the front of the vehicle.
7. Install the bolt cover (if equipped).
8. Reinstall the harness retaining clip into the front of the air filter assembly.

#### **BRAKE FLUID CHECK**

Fluid levels between the MIN and MAX lines are within the normal operating range; there is no need to add fluid. If the fluid levels are outside of the normal operating range, the performance of the system could be compromised; seek service from your authorized dealer immediately.

#### **POWER STEERING FLUID CHECK**

Your vehicle is equipped with an electric power steering (EPS) system. There is no fluid reservoir to check or fill. For additional information on the electric power steering (EPS) system, Refer to *Driving Aids*.

#### **FUEL FILTER**

Your vehicle is equipped with a lifetime fuel filter that is integrated with the fuel tank. Regular maintenance or replacement is not needed.

#### **WASHER FLUID CHECK**



**WARNING:** If you operate your vehicle in temperatures below 40°F (5°C), use washer fluid with antifreeze protection. Failure to use washer fluid with antifreeze protection in cold weather could result in impaired windshield vision and increase the risk of injury or accident.

Add fluid to fill the reservoir if the level is low. Only use a washer fluid that meets Ford specifications. See the technical specifications chart in the *Capacities and Specifications* chapter.

**Note:** The front and rear washer systems are supplied from the same reservoir.

State or local regulations on volatile organic compounds may restrict the use of methanol, a common windshield washer antifreeze additive.

Washer fluids containing non-methanol antifreeze agents should be used only if they provide cold weather protection without damaging the vehicle's paint finish, wiper blades or washer system.

### CHANGING THE VEHICLE BATTERY



**WARNING:** Batteries normally produce explosive gases which can cause personal injury. Therefore, do not allow flames, sparks or lighted substances to come near the battery. When working near the battery, always shield your face and protect your eyes. Always provide proper ventilation.



**WARNING:** When lifting a plastic-cased battery, excessive pressure on the end walls could cause acid to flow through the vent caps, resulting in personal injury and damage to the vehicle or battery. Lift the battery with a battery carrier or with your hands on opposite corners.



**WARNING:** Keep batteries out of reach of children. Batteries contain sulfuric acid. Avoid contact with skin, eyes or clothing. Shield your eyes when working near the battery to protect against possible splashing of acid solution. In case of acid contact with skin or eyes, flush immediately with water for a minimum of 15 minutes and get prompt medical attention. If acid is swallowed, call a physician immediately.



**WARNING:** Battery posts, terminals and related accessories contain lead and lead compounds. Wash hands after handling.

Your vehicle is equipped with a Motorcraft® maintenance-free battery which normally does not require additional water during its life of service.

**Note:** If your battery has a cover or a shield, make sure it is reinstalled after the battery has been cleaned or replaced.

For longer, trouble-free operation, keep the top of the battery clean and dry. Also, make certain the battery cables are always tightly fastened to the battery terminals.

If you see any corrosion on the battery or terminals, remove the cables from the terminals and clean with a wire brush. You can neutralize the acid with a solution of baking soda and water.

It is recommended that the negative battery cable terminal be disconnected from the battery if you plan to store your vehicle for an extended period of time.

### Battery relearn

Because your vehicle's engine is electronically controlled by a computer, some control conditions are maintained by power from the battery. When the battery is disconnected or a new battery is installed, the engine must relearn its idle and fuel trim strategy for optimum driveability and performance. To begin this process:

1. With the vehicle at a complete stop, set the parking brake.
  2. Put the gearshift lever in **P** (Park), turn off all accessories and start the engine.
  3. Run the engine until it reaches normal operating temperature.
  4. Allow the engine to idle for at least one minute.
  5. Turn the A/C on and allow the engine to idle for at least one minute.
  6. Drive the vehicle to complete the relearning process.
- The vehicle may need to be driven to relearn the idle and fuel trim strategy.
  - **Note:** If you do not allow the engine to relearn its idle trim, the idle quality of your vehicle may be adversely affected until the idle trim is eventually relearned.

When the battery is disconnected or a new battery installed, the transmission must relearn its adaptive strategy. As a result of this, the transmission may shift firmly. This operation is considered normal and will not affect function or durability of the transmission. Over time the adaptive learning process will fully update transmission operation to its optimum shift feel.

If the battery has been disconnected or a new battery has been installed, the clock and the preset radio stations must be reset once the battery is reconnected.

Always dispose of automotive batteries in a responsible manner. Follow your local authorized standards for disposal. Call your local authorized recycling center to find out more about recycling automotive batteries.

**Battery management system**

The battery management system (BMS) monitors battery conditions and takes actions to extend battery life. If excessive battery drain is detected, the system may temporarily disable certain electrical features to protect the battery. Those electrical accessories affected include rear defrost, heated/cooled seats, climate control fan, heated steering wheel, audio and navigation system. A message may be displayed on the instrument cluster or center stack display to alert the driver that battery protection actions are active. See the *Information displays* in the *Instrument Cluster* and *Entertainment Systems* chapters for more information. These messages are only for notification that an action is taking place, and do not necessarily indicate that an electrical problem exists or that the battery requires replacement.

**Electrical accessory installation**

To ensure proper operation of the BMS, any electrical devices that are added to the vehicle should not have their ground connection made directly at the negative battery post. A connection at the negative battery post can cause inaccurate measurements of the battery condition and potential incorrect system operation.

**Note:** Electrical or electronic accessories added to the vehicle by the dealer or the owner may adversely affect battery performance and durability and may also affect the performance of other electrical systems in the vehicle.

When a battery replacement is required, the battery should be replaced with a Ford recommended replacement battery that matches the electrical requirements of the vehicle. After battery replacement, or in some cases after charging the battery with an external charger, the BMS requires eight hours of vehicle sleep time (key off with doors closed) to relearn the new battery state of charge. Prior to relearning state of charge, the BMS may disable electrical features (to protect the battery) earlier than normal.

**CHECKING THE WIPER BLADES**

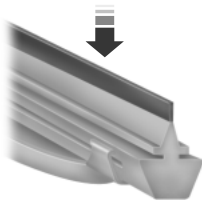

Run the tip of your fingers over the edge of the blade to check for roughness.

Clean the wiper blades with washer fluid or water applied with a soft sponge or cloth.

**CHANGING THE WIPER BLADES**

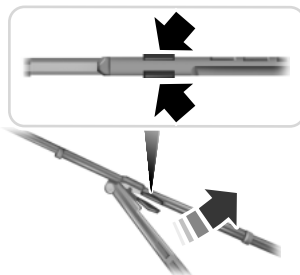

1. Pull the wiper blade and arm away from the glass.
2. Squeeze the locking tabs to release the blade from the arm and pull the blade away from the arm to remove it.
3. Attach the new blade to the arm and snap it into place.

Replace wiper blades at least once per year for optimum performance.

Poor wiper quality can be improved by cleaning the wiper blades and the windshield.

To prolong the life of the wiper blades, it is highly recommended to scrape off the ice on the windshield before turning on the wipers. The layer of ice has many sharp edges and can damage the micro edge of the wiper rubber element.

**Changing the rear window wiper blade**

To replace the rear wiper blade:

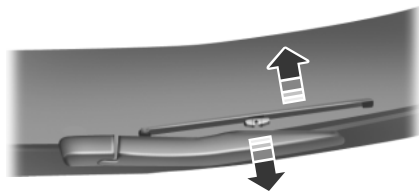

1. Press the wiper blade against the glass with one hand and hold it.
2. Pull the wiper arm away from the wiper blade to separate.



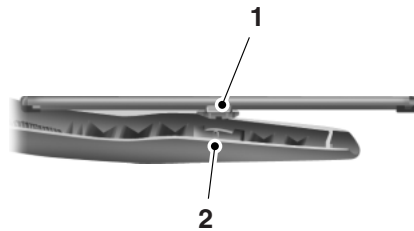

3. To attach the new wiper to the wiper arm, align the slot (1) and cross pin (2) and firmly press the wiper arm into the wiper blade until a click is heard.

If you find this procedure too difficult, please see your dealer.

#### AIR FILTER CHECK



**WARNING:** To reduce the risk of vehicle damage and/or personal burn injuries, do not start your engine with the air cleaner removed and do not remove it while the engine is running.

When changing the air filter element, use only the air filter element listed. Refer to *Motorcraft® Part Numbers* in the *Capacities and Specifications* chapter.

For EcoBoost equipped vehicles: When servicing the air cleaner, it is important that no foreign material enter the air induction system. The engine and turbocharger are susceptible to damage from even small particles.

Refer to *Scheduled Maintenance* for the appropriate intervals for changing the air filter element.

**Note:** Failure to use the correct air filter element may result in severe engine damage. The customer warranty may be void for any damage to the engine if the correct air filter element is not used.

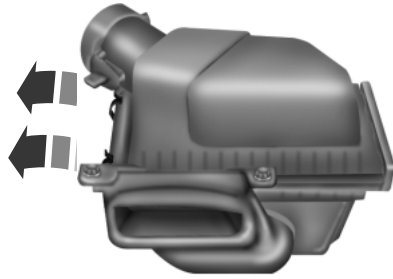
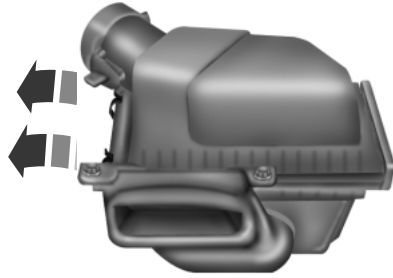
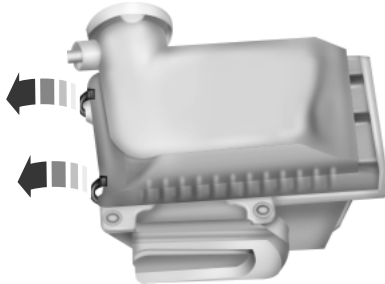
**Changing the Air Filter Element****3.5L V6 engine****2.0L EcoBoost® engine****3.5L V6 EcoBoost® engine**

1. On the passenger's side of the air filter housing, release the two clamps from the air filter housing cover.
2. Lift the passenger's side of the cover and push the cover toward the passenger's side. Release the three tabs on the cover from the three slots in the driver's side of the housing.

3. Carefully separate the cover from the housing.
4. Remove the air filter element from the housing.
5. Wipe the cover and the housing clean to remove any dirt or debris and to make sure the cover seals to the housing.
6. Install a new air filter element. Be careful not to crimp the filter element edges between the housing and the cover. This could cause filter damage and allow unfiltered air to enter the engine if not properly seated.

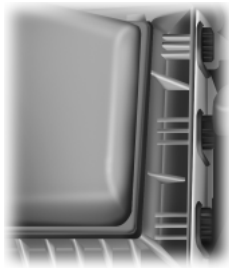

7. Lower the driver's side of the cover and slide the three tabs on the cover into the three slots in the housing.

8. Lower the passenger's side of the cover. Engage the two clamps to secure the cover to the housing.

### **ADJUSTING THE HEADLAMPS**

The headlamps on your vehicle are properly aimed at the assembly plant. If your vehicle has been in an accident, an authorized dealer should check the alignment of your headlamps.

#### **Vertical Aim Adjustment**

The headlamps on your vehicle can only be vertically adjusted. Your vehicle does not require horizontal aim adjustments.

To adjust the headlamps:

1. Park your vehicle on a level surface about 25 feet (7.6 meters) away from a vertical plain surface (3). Check your headlamp alignment at night or in a dark area so that you can see the headlamp beam pattern.

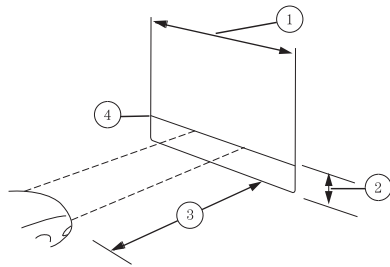

- (1) 8 feet (2.4 meters)
- (2) Center height of lamp to ground
- (3) 25 feet (7.6 meters)
- (4) Horizontal reference line

2. The center of the headlamp has a 3.0 millimeter circle on the lens. Measure the height from the center of your headlamp to the ground (2) and mark an 8 foot (2.4 meter) long horizontal line on the plain surface (1) at this height (masking tape works well).

3. Turn on the low beam headlamps to illuminate the wall or screen and open the hood. To see a clearer light pattern for adjusting, block the light from one headlamp while adjusting the other.

**For vehicles with halogen headlamps:**



On the wall or screen you will observe a flat zone of high intensity light located at the top of the right hand portion of the beam pattern. If the top edge of the high intensity light zone is not at the horizontal reference line, the headlamp will need to be adjusted.

**For vehicles with HID headlamps:**

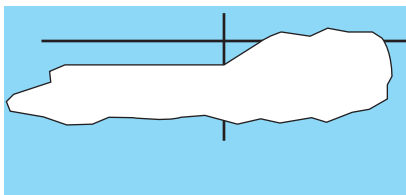

There is a distinct cut-off (change from light to dark) in the left portion of the beam pattern. The top edge of this cut-off should be positioned two inches (50.8 millimeters) below the horizontal reference line.

4. Open the hood.

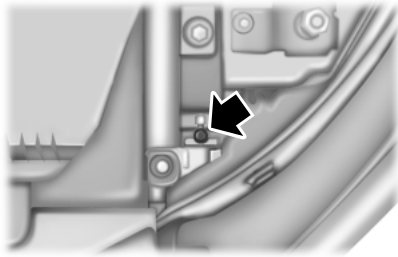

5. Locate the vertical adjuster for each headlamp. Using a Phillips #2 screwdriver, turn the adjuster control either clockwise or counterclockwise in order to adjust the vertical aim of the headlamp.

**Note:** HORIZONTAL AIMING IS NOT REQUIRED FOR THIS VEHICLE AND IS NON-ADJUSTABLE.

## CHANGING A BULB

### Lamp Assembly Condensation

Exterior lamps are vented to accommodate normal changes in pressure. Condensation can be a natural by-product of this design. When moist air enters the lamp assembly through the vents, there is a possibility that condensation can occur when the temperature is cold. When normal condensation occurs, a thin film of mist can form on the interior of the lens. The thin mist eventually clears and exits through the vents during normal operation. Clearing time may take as long as 48 hours under dry weather conditions.

These are examples of acceptable condensation:

- Presence of thin mist (no streaks, drip marks or droplets).
- Fine mist covers less than 50% of the lens.

These are examples of unacceptable moisture (usually caused by a lamp water leak):

- Water puddle inside the lamp.
- Large water droplets, drip marks or streaks present on the interior of the lens.

Take your vehicle to a dealer for service if any of the above conditions of unacceptable moisture are present.

**Replacing headlamp bulbs**

 **WARNING:** Handle a halogen headlamp bulb carefully and keep out of children's reach. Grasp the bulb only by its plastic base and do not touch the glass. The oil from your hand could cause the bulb to break the next time the headlamps are operated.

**Note:** If the bulb is accidentally touched, it should be cleaned with rubbing alcohol before being used.

1. Make sure that the headlamp control is in the off position.
2. Open the hood.

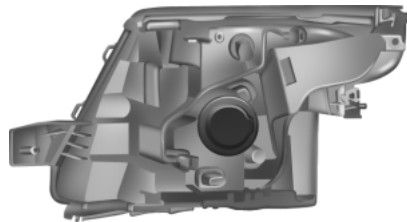

3. Remove the bulb cover.



4. Turn the bulb base counterclockwise and remove it.

5. Disconnect the electrical connector.

Reverse steps to reinstall bulb(s).

**Replacing HID headlamp bulbs (if equipped)**

The headlamps on your vehicle use a “high intensity discharge” source. These lamps operate at a high voltage. When the bulb is burned out, the bulb and starter capsule assembly must be replaced by your authorized dealer.

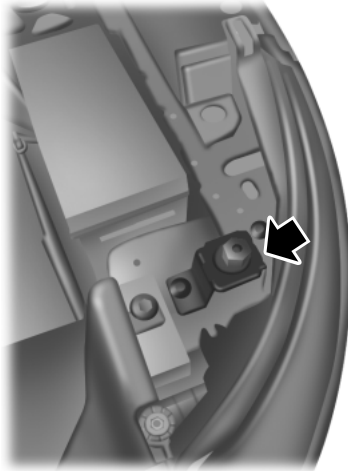
**Front parking lamp/turn signal and sidemarker bulbs**

1. Make sure that the headlamp control is in the off position.
2. Open the hood.
3. Remove the hood overslam bumper tower to service park/turn or sidemarker bulbs (if needed).

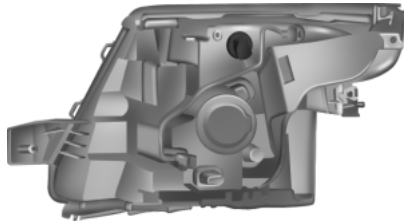
**Replacing front parking lamp/turn signal bulbs**

1. Rotate the bulb socket counterclockwise and remove it from the lamp assembly.
2. Pull the bulb straight out of the socket.

Reverse steps to reinstall bulb(s).

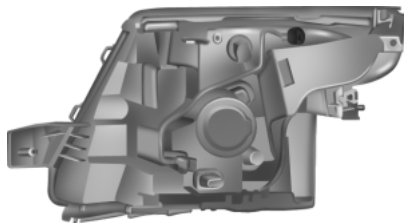
**Replacing sidemarker bulbs**

1. Rotate the bulb socket counterclockwise and remove it from the lamp assembly.
2. Pull the bulb straight out of the socket.

Reverse steps to reinstall bulb(s).

**Replacing front fog lamp bulbs**

1. Make sure the headlamp switch is off.

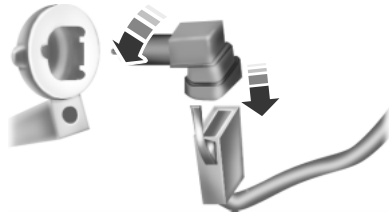

1. Make sure that the fog lamp switch is in the off position.

2. Remove the bulb socket from the fog lamp by turning it counterclockwise.

3. Disconnect the electrical connector.

Reverse steps to reinstall bulb(s).

**Replacing turn/backup lamp bulbs**

The turn/backup lamp bulbs are located in the same area of the tail lamp assembly, one below the other. Follow the same steps to replace these bulbs:



1. Make sure the headlamp switch is in the off position, then open the liftgate to expose the lamp assembly bolts.

2. Remove the two bolt covers using a standard flattip screwdriver.

3. Remove the two bolts from the lamp assembly.

4. Carefully remove the lamp assembly away from the vehicle by pulling the assembly straight out to expose the bulb socket.



5. Remove the bulb socket from the lamp assembly by turning it counterclockwise.

6. Pull bulb straight out of socket.

7. Install the new bulb in reverse order.



Carefully install the tail lamp assembly on the vehicle by securing the lamp assembly with two bolts. Reinstall bolt covers.

### Replacing tail/brake lamp bulbs

For bulb replacement, see your authorized dealer.

### Replacing the License Plate Lamp Bulb

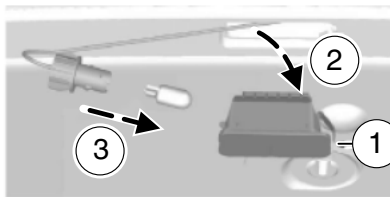

1. Carefully release the spring clip.
2. Remove the lamp.
3. Remove the bulb.

Install the new bulb in reverse order.

### Replacing high-mount brake lamp bulb

Your vehicle is equipped with an LED center high-mount stop lamp located in the spoiler. It is designed to last the life of the vehicle. If replacement is required, see your authorized dealer.

### BULB SPECIFICATION CHART

Replacement bulbs are specified in the chart below. Headlamp bulbs must be marked with an authorized "D.O.T." for North America and an "E" for Europe to ensure lamp performance, light brightness and pattern and safe visibility. Using incorrect bulbs may damage the lamp assembly or void the lamp assembly warranty or may not provide quality bulb burn time.

Function	Number of bulbs	Trade number
Low/high beam headlamp	2	HB3
* HID headlamp	2	D3S
Front park/turn lamp	2	3457K
Sidemarker	2	W5W
* Tail lamp	n/a	LED
Backup lamp	2	W21W
Rear turn lamp	2	WY21W (amber)

Function	Number of bulbs	Trade number
* Stop lamp	n/a	LED
* High-mount stop lamps	n/a	LED
Rear license plate lamp	1	W5W
Front fog lamp	2	H11
Interior front map lamps	2	168 (T10)
Second row dome/courtesy lamp	2	168 (T10)
* Second row dome/map lamp	n/a	LED
* Third row cargo lamp	n/a	LED
Visor vanity lamp - Slideon rail system (SOR)	2	A6224PF
All replacement bulbs are clear in color, except where noted.		
To replace all instrument panel lights - see your authorized dealer.		
* To replace these lamps - see your authorized dealer.		

**GENERAL INFORMATION**

Your Ford or Lincoln authorized dealer has many quality products available to clean your vehicle and protect its finishes.

**CLEANING PRODUCTS**

For best results, use the following products or products of equivalent quality:

- Motorcraft Bug and Tar Remover (ZC-42)
- Motorcraft Custom Bright Metal Cleaner (ZC-15)
- Motorcraft Detail Wash (ZC-3-A)
- Motorcraft Dusting Cloth (ZC-24)
- Motorcraft Engine Shampoo and Degreaser (United States only) (ZC-20)
- Motorcraft Engine Shampoo (Canada only) (CXC-66-A)
- Motorcraft Multi-Purpose Cleaner (Canada only) (CXC-101)
- Motorcraft Premium Glass Cleaner (Canada only) (CXC-100)
- Motorcraft Premium Quality Windshield Washer Fluid (Canada only) [CXC-37-(A, B, D or F)]
- Motorcraft Premium Windshield Wash Concentrate with Bitterant (United States only) ZC-32-B1)
- Motorcraft Professional Strength Carpet & Upholstery Cleaner (ZC-54)
- Motorcraft Spot and Stain Remover (United States only) (ZC-14)
- Motorcraft Ultra-Clear Spray Glass Cleaner (ZC-23)
- Motorcraft Wheel and Tire Cleaner (ZC-37-A)

**CLEANING THE EXTERIOR**

Wash your vehicle regularly with cool or lukewarm water and a neutral pH shampoo, such as Motorcraft® Detail Wash.

- Never use strong household detergents or soap, such as dish washing or laundry liquid. These products can discolor and spot painted surfaces.
- Never wash a vehicle that is hot to the touch or during exposure to strong, direct sunlight.
- Dry the vehicle with a chamois or soft terry cloth towel in order to eliminate water spotting.
- Immediately remove items such as gasoline, diesel fuel, bird droppings and insect deposits because they can cause damage to the vehicle's paintwork and trim over time. Use Motorcraft Bug and Tar Remover.

- **Note:** Suntan lotions and insect repellents can damage any painted surface; if these substances come in contact with your vehicle, wash it off as soon as possible.
- Remove any exterior accessories before entering a car wash.

**Stripes or Graphics (if equipped)**

Do not use a commercial or high-pressure wand on the surface or edge of stripes and graphics. This can cause damage to the film and cause the edge of the film to peel away from the vehicle surface.

**Exterior Chrome**

**Note:** Never use abrasive materials such as steel wool or plastic pads as they can scratch the chrome surface.

**Note:** Do not use chrome cleaner, metal cleaner or polish on wheels and wheel covers.

- Wash the vehicle first, using cool or lukewarm water and a neutral pH shampoo, such as Motorcraft Detail Wash.
- Use Motorcraft Custom Bright Metal Cleaner. Apply the product as you would a wax to clean bumpers and other chrome parts; allow the cleaner to dry for a few minutes, then wipe off the haze with a clean, dry rag.
- Do not apply cleaning product to hot surfaces and do not leave cleaning product on chrome surfaces for a period of time exceeding that which is recommended.
- **Note:** Using other non-recommended cleaners can result in severe and permanent cosmetic damage.

**Underbody**

Flush the complete underside of your vehicle frequently. Keep body and door drain holes free from packed dirt.

**Cleaning Plastic Exterior Parts**

Use only approved products to clean plastic parts.

- For routine cleaning, use Motorcraft Detail Wash.
- If tar or grease spots are present, use Motorcraft Bug and Tar Remover.

**WAXING**

Regular waxing is necessary to protect the paint on your car from the elements. We recommend that you wash and wax the painted surface once or twice a year.

When washing and waxing, park your vehicle in a shaded area out of direct sunlight. Always wash your vehicle before applying wax.

- Use a quality wax that does not contain abrasives.
- Follow the manufacturer's instructions to apply and remove the wax.
- Apply a small amount of wax in a back-and-forth motion, not in circles.
- Do not allow wax to come in contact with any non-body (low-gloss black) colored trim. The wax discolors or stains the parts over time, such as:
  - Bumpers
  - Grained door handles
  - Side mouldings
  - Mirror housings
  - Windshield cowl area.
- Do not apply wax to glass areas.
- After waxing, your car's paint should feel smooth, and be free of streaks and smudges.

**REPAIRING MINOR PAINT DAMAGE**

Your authorized dealer has touch-up paint to match your vehicle's color. Take your color code (printed on a sticker in the driver's door jamb) to an authorized dealer to make sure you get the correct color.

- Remove particles, such as bird droppings, tree sap, insect deposits, tar spots, road salt and industrial fallout, before repairing paint chips.
- Always read the instructions before using the products.

**CLEANING THE ENGINE**

Engines are more efficient when they are clean because grease and dirt buildup keep the engine warmer than normal.

When washing:

- Take care when using a power washer to clean the engine. The high-pressure fluid could penetrate the sealed parts and cause damage.
- Do not spray a hot engine with cold water to avoid cracking the engine block or other engine components.

- Spray Motorcraft Engine Shampoo and Degreaser on all parts that require cleaning and pressure rinse clean. In Canada, use Motorcraft Engine Shampoo.
- Never wash or rinse the engine while it is hot or running; water in the running engine may cause internal damage.
- Never wash or rinse any ignition coil, spark plug wire or spark plug well, or the area in and around these locations.
- Cover the battery, power distribution box, and air filter assembly to prevent water damage when cleaning the engine.

### CLEANING THE WINDOWS AND WIPER BLADES

The windows and wiper blades should be cleaned regularly. If the wipers do not wipe properly, substances on the vehicle's glass or the wiper blades may cause squeaking or chatter noise from the blades, and streaking and smearing of the windshield. To clean these items, follow these tips:

- The windows may be cleaned with a non-abrasive cleaner such as Motorcraft® Ultra-Clear Spray Glass Cleaner.
- The wiper blades can be cleaned with isopropyl (rubbing) alcohol or Motorcraft Premium Windshield Washer Concentrates in the U.S., or Motorcraft Premium Quality Windshield Washer Fluid in Canada. Replace your wiper blades when they appear worn or do not function properly.
- Do not use abrasive materials, as they may cause scratches.
- Do not use fuel, kerosene, or paint thinner to clean any parts.

If you cannot remove those streaks after cleaning with the glass cleaner or if the wipers chatter and move in a jerky motion, clean the outer surface of the windshield and the wiper blades using a sponge or soft cloth with a neutral detergent or mild-abrasive cleaning solution. After cleaning, rinse the windshield and wiper blades with clean water. The windshield is clean if beads do not form when you rinse the windshield with water.

**Note:** Do not use sharp objects, such as a razor blade, to clean the inside of the rear window or to remove decals, as it may cause damage to the rear window defroster's heated grid lines.

**CLEANING THE INTERIOR**

**WARNING:** Do not use cleaning solvents, bleach or dye on the vehicle's safety belts, as these actions may weaken the belt webbing.



**WARNING:** On vehicles equipped with seat-mounted airbags, do not use chemical solvents or strong detergents. Such products could contaminate the side airbag system and affect performance of the side airbag in a collision.

For fabric, carpets, cloth seats, safety belts and seats equipped with side airbags:

- Remove dust and loose dirt with a vacuum cleaner.
- Apply a layer of high quality foam cleaner, designed for automotive interiors, to the dry stained area (s) of the item you are cleaning and allow soaking for one minute.
- If grease or tar is present on the material, spot-clean the area first with Motorcraft Spot and Stain Remover. In Canada, use Motorcraft Multi-Purpose Cleaner.
- If a ring forms on the fabric after spot cleaning, clean the entire area immediately (but do not oversaturate) or the ring can set.
- Do not use household cleaning products or glass cleaners, which can stain and discolor the fabric and affect the flame retardant abilities of the seat materials.

**CLEANING THE INSTRUMENT PANEL AND INSTRUMENT CLUSTER LENS**

**WARNING:** Do not use chemical solvents or strong detergents when cleaning the steering wheel or instrument panel to avoid contamination of the airbag system.

Clean the instrument panel and cluster lens with a clean, damp, white, cotton cloth, then use a clean and dry, white, cotton cloth to dry these areas.

- Avoid cleaners or polishes that increase the gloss of the upper portion of the instrument panel. The dull finish in this area helps protect the driver from undesirable windshield reflection.

- Be certain to wash or wipe your hands clean if you have been in contact with certain products, such as insect repellent and suntan lotion, in order to avoid possible damage to the interior painted surfaces.
- Do not use household or glass cleaners as these may damage the finish of the instrument panel, interior trim and cluster lens.
- Do not allow air fresheners and hand sanitizers to spill on interior surfaces. If a spill occurs, wipe off immediately. Damage may not be covered by your warranty.

If a staining liquid like coffee or juice has been spilled on the instrument panel or on interior trim surfaces, clean as follows:

1. Wipe up spilled liquid using a clean, white, cotton cloth.
2. Wipe the surface with a damp, clean, white, cotton cloth. For more thorough cleaning, use a mild soap and water solution. If the spot cannot be completely cleaned by this method, the area may be cleaned using a commercially available cleaning product designed for automotive interiors.
3. If necessary, apply more soap and water solution or cleaning product to a clean, white, cotton cloth and press the cloth onto the soiled area; allow this to set at room temperature for 30 minutes.
4. Remove the soaked cloth, and if it is not soiled badly, use this cloth to clean the area by using a rubbing motion for 60 seconds.
5. Following this, wipe area dry with a clean, white, cotton cloth.

#### **CLEANING LEATHER SEATS (IF EQUIPPED)**

- Remove dust and loose dirt with a vacuum cleaner.
- Clean spills and stains as quickly as possible.
- For routine cleaning, wipe the surface with a soft, damp cloth. For more thorough cleaning, wipe the surface with a mild soap and water solution. Dry the area with a soft cloth.
- If the leather cannot be completely cleaned using a mild soap and water solution, the leather may be cleaned using a commercially available leather cleaning product designed for automotive interiors.



- To check for compatibility, first test any cleaner or stain remover on an inconspicuous part of the leather.
- Do not use household cleaning products, alcohol solutions, oil/petroleum-based leather conditioners, or solvents or cleaners intended specifically for rubber, vinyl and plastics. These products may cause premature wearing or damage to the leather.

### **CLEANING THE ALLOY WHEELS**

**Note:** Do not use chrome cleaner, metal cleaner or polish on wheels and wheel covers.

A clearcoat paint finish coats aluminum wheels and wheel covers. In order to maintain their condition:

- Clean weekly with Motorcraft Wheel and Tire Cleaner. Use a sponge to remove heavy deposits of dirt and brake dust accumulation. Rinse thoroughly with a strong stream of water when you have completed the cleaning process.
- To remove tar and grease, use Motorcraft Bug and Tar Remover.
- Never apply any cleaning chemical to hot or warm wheel rims or covers.
- Some automatic car washes may cause damage to the finish on your wheel rims or covers.
- Industrial-strength (heavy-duty) cleaners, or cleaning chemicals, in combination with brush agitation to remove brake dust and dirt, could wear away the clearcoat finish over time.
- Do not use hydrofluoric acid-based or high caustic-based wheel cleaners, steel wool, fuels or strong household detergent.
- If you intend on parking your vehicle for an extended period after cleaning the wheels with a wheel cleaner, drive your vehicle for a few minutes before doing so. This reduces the risk of increased corrosion of the brake discs.

### **VEHICLE STORAGE**

If you plan on storing your vehicle for an extended period of time (30 days or more), read the following maintenance recommendations to make sure your vehicle stays in good operating condition.

All motor vehicles and their components were engineered and tested for reliable, regular driving. Long-term storage under various conditions may lead to component degradation or failure unless specific precautions are taken to preserve the components.

*General*

- Store all vehicles in a dry, ventilated place.
- Protect from sunlight, if possible.
- If vehicles are stored outside, they require regular maintenance to protect against rust and damage.

*Body*

- Wash vehicle thoroughly to remove dirt, grease, oil, tar or mud from exterior surfaces, rear-wheel housing and underside of front fenders.
- Periodically wash vehicles stored in exposed locations.
- Touch up raw or primed metal to prevent rust.
- Cover chrome and stainless steel parts with a thick coat of auto wax to prevent discoloration. Re-wax as necessary when the vehicle is washed.
- Lubricate hood latch, all door latches and trunk lid hinges with a light grade oil.
- Cover interior trim to prevent fading.
- Keep all rubber parts free from oil and solvents.

*Engine*

- The engine oil and filter should be changed prior to storage, as used engine oil contains contaminants that may cause engine damage.
- Start the engine every 15 days. Run at fast idle until it reaches normal operating temperature.
- With your foot on the brake, shift through all the gears while the engine is running.

*Fuel system*

- Fill the fuel tank with high-quality fuel until the first automatic shutoff of the fuel pump nozzle.

*Cooling system*

- Protect against freezing temperatures.
- When removing vehicle from storage, check coolant fluid level. Confirm there are no cooling system leaks, and fluid is at the recommended level.

*Battery*

- Check and recharge as necessary. Keep connections clean.
- If storing your vehicle for more than 30 days without recharging the battery, it may be advisable to disconnect the battery cables to ensure battery charge is maintained for quick starting.

**Note:** If battery cables are disconnected, it will be necessary to reset memory features.

*Brakes*

- Make sure brakes and parking brake are fully released.

*Tires*

- Maintain recommended air pressure.

*Miscellaneous*

- Make sure all linkages, cables, levers and pins under vehicle are covered with grease to prevent rust.
- Move vehicles at least 25 feet (8 meters) every 15 days to lubricate working parts and prevent corrosion.

**Removing Vehicle from Storage**

When your vehicle is ready to come out of storage, do the following:

- Wash your vehicle to remove any dirt or grease film build-up on window surfaces.
- Check windshield wipers for any deterioration.
- Check under the hood for any foreign material that may have collected during storage (mice/squirrel nests).
- Check the exhaust for any foreign material that may have collected during storage.
- Check tire pressures and set tire inflation per the Tire Label.
- Check brake pedal operation. Drive the vehicle 15 feet (4.5 meters) back and forth to remove rust build-up.
- Check fluid levels (including coolant, oil and gas) to make sure there are no leaks and fluids are at recommended levels.
- If the battery was removed, clean the battery cable ends and inspect.

Contact your authorized dealer if you have any concerns or issues.

**GENERAL INFORMATION****Notice to Utility Vehicle, Van and Truck Owners**

 **WARNING:** Utility vehicles have a significantly higher rollover rate than other types of vehicles. To reduce the risk of serious injury or death from a rollover or other crash you must:

- Avoid sharp turns and abrupt maneuvers;
- Drive at safe speeds for the conditions;
- Keep tires properly inflated;
- Never overload or improperly load your vehicle; and
- Make sure every passenger is properly restrained.

 **WARNING:** In a rollover crash, an unbelted person is significantly more likely to die than a person wearing a seat belt. All occupants must wear seat belts. Children and infants must use appropriate restraints to minimize the risk of injury or ejection.



Utility vehicles, vans and trucks handle differently than passenger cars in the various driving conditions that are encountered on streets, highways and off-road. Utility vehicles, vans and trucks are not designed for cornering at speeds as high as passenger cars any more than low-slung sports cars are designed to perform satisfactorily under off-road conditions.

**Four-Wheel Drive System (If Equipped)**

 **WARNING:** Do not become overconfident in the ability of four-wheel drive vehicles. Although a four-wheel drive vehicle may accelerate better than a two-wheel drive vehicle in low-traction situations, it will not stop any faster than two-wheel drive vehicles. Always drive at a safe speed.

A vehicle equipped with four-wheel drive (when selected) has the ability to use all four wheels to power itself. This increases traction which may enable you to safely drive over terrain and road conditions that a conventional two-wheel drive vehicle cannot.

Power is supplied to all four wheels through a transfer case or power transfer unit. Four-wheel drive vehicles allow you to select different drive modes as necessary. You can find information on transfer case operation and shifting procedures in the *Transmission* chapter. You can find information on transfer case maintenance in the *Maintenance* chapter. You should become thoroughly familiar with this information before you operate your vehicle.

On some four-wheel drive models, the initial shift from two-wheel drive to four-wheel drive while the vehicle is moving can cause a momentary clunk and ratcheting sound. These sounds are normal as the front drivetrain comes up to speed and are not cause for concern.

### How Your Vehicle Differs from Other Vehicles

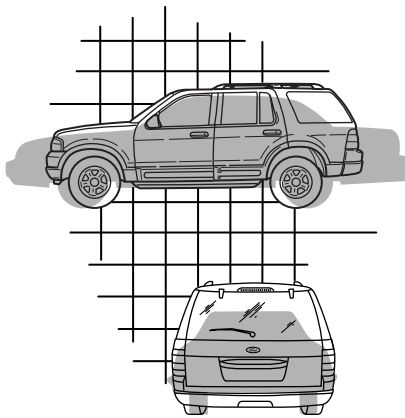

Sport-utility vehicles, vans and trucks can differ from some other vehicles in a few noticeable ways. Your vehicle may be:

- Higher – to allow higher load carrying capacity and to allow it to travel over rough terrain without getting hung up or damaging underbody components.
- Shorter – to give it the capability to approach inclines and drive over the crest of a hill without getting hung up or damaging underbody components. All other things held equal, a shorter wheelbase may make your vehicle quicker to respond to steering inputs than a vehicle with a longer wheelbase.

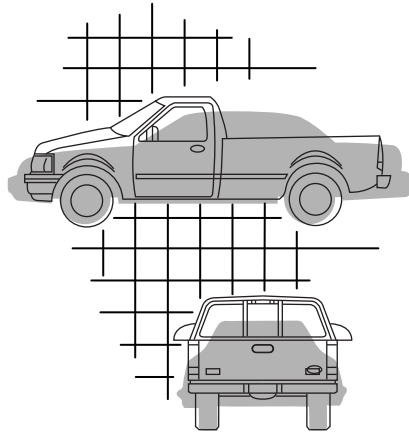

- Narrower – to provide greater maneuverability in tight spaces, particularly in off-road use.

As a result of the above dimensional differences, sport-utility vehicles, vans and trucks often will have a higher center of gravity and a greater difference in center of gravity between the loaded and unloaded condition.

These differences that make your vehicle so versatile also make it handle differently than an ordinary passenger car.

**TIRE CARE**

**Important Tire Information for 265/45ZR20 Sport Tires and Wheels**

Sport vehicles equipped with the optional 265/45ZR20 tires are designed to enhance performance. To continue providing this performance, extra care must be taken when operating and maintaining your vehicle.

<b>Tires</b>	265/45ZR20
<b>Wheels</b>	20 inch x 9.0 inch aluminum wheels

These low-profile, high-performance tires are designed to optimize the driving dynamics you expect in a Sport vehicle. These tires are not optimized for off-road or winter (snow or cold weather) performance and their ride, noise and wear characteristics are different than non-performance tires. With low-profile tires, you may notice an increase in road noise and faster tire wear, depending on road conditions and driving habits. Also, because of their lower profile, the tires are more susceptible to damage due to potholes, rough roads, unpaved roads, car wash rails and curb contact than standard tires and wheels. To make sure that your tires perform as intended, it is important that you maintain your tires properly:

- The Sport, optional 265/45ZR20 tires are optimized for performance in both wet and dry conditions. Ford does not recommend using the original equipment tires when temperatures drop to about 40°F (5°C) or below (depending on tire wear and environmental conditions) or in snow/ice conditions.

- The Sport, optional 265/45ZR20 tires were designed for track use and may exhibit significantly reduced tread life and increased tire noise compared to the standard equipment tires under normal driving conditions. Increasing the front camber settings beyond the factory settings may further accelerate tread wear and induce tire noise.
- Do not use tire chains on the optional 265/45ZR20 Sport tires and wheels of your vehicle. The use of any type of tire chain on these tires may damage your vehicle.
- For tire pressures, see the placard located on the B-pillar inside the driver's door.
- Always maintain your tire pressures according to the tire information placard on the driver's door jamb, using an accurate gauge.

If your vehicle is equipped with P265/45ZR20 tires, they are low-profile tires. These tires and wheels are designed to give your vehicle a sport appearance. With low-profile tires, you may notice an increase in road noise and faster tire wear, depending on road conditions and driving styles. Due to their design, low-profile tires and wheels are more prone to road damage from potholes, rough or unpaved roads, car wash rails and curb contact than standard tires and wheels.

**Note:** Your vehicle's warranty does not cover these types of damage. Tires should always be kept at the correct inflation pressures and extra caution should be taken when operating on rough roads to avoid impacts that could cause wheel and tire damage.

#### Information About Uniform Tire Quality Grading



Tire Quality Grades apply to new pneumatic passenger car tires. The Tire Quality Grades can be found where applicable on the tire sidewall between tread shoulder and maximum section width. For example:

- **Treadwear 200 Traction AA Temperature A**

These Tire Quality Grades are determined by standards that the United States Department of Transportation has set.

Tire Quality Grades apply to new pneumatic passenger car tires. They do not apply to deep tread, winter-type snow tires, space-saver or temporary use spare tires, light truck or LT type tires, tires with nominal rim diameters of 10 to 12 inches or limited production tires as defined in Title 49 Code of Federal Regulations Part 575.104(c)(2).

**U.S. Department of Transportation-Tire quality grades:** The U.S. Department of Transportation requires Ford Motor Company to give you the following information about tire grades exactly as the government has written it.

### Treadwear

The treadwear grade is a comparative rating based on the wear rate of the tire when tested under controlled conditions on a specified government test course. For example, a tire graded 150 would wear 1½ times as well on the government course as a tire graded 100. The relative performance of tires depends upon the actual conditions of their use, however, and may depart significantly from the norm due to variations in driving habits, service practices, and differences in road characteristics and climate.

### Traction AA A B C



**WARNING:** The traction grade assigned to this tire is based on straight-ahead braking traction tests, and does not include acceleration, cornering, hydroplaning or peak traction characteristics.

The traction grades, from highest to lowest are AA, A, B, and C. The grades represent the tire's ability to stop on wet pavement as measured under controlled conditions on specified government test surfaces of asphalt and concrete. A tire marked C may have poor traction performance.

### Temperature A B C



**WARNING:** The temperature grade for this tire is established for a tire that is properly inflated and not overloaded. Excessive speed, underinflation, or excessive loading, either separately or in combination, can cause heat buildup and possible tire failure.

The temperature grades are A (the highest), B and C, representing the tire's resistance to the generation of heat and its ability to dissipate heat when tested under controlled conditions on a specified indoor laboratory test wheel. Sustained high temperature can cause the material of the tire to degenerate and reduce tire life, and excessive temperature can lead to sudden tire failure. The grade C corresponds to a level of performance which all passenger car tires must meet under the Federal Motor Vehicle Safety Standard No. 139. Grades B and A represent higher levels of performance on the laboratory test wheel than the minimum required by law.



**Glossary of Tire Terminology**

- **Tire label:** A label showing the OE (Original Equipment) tire sizes, recommended inflation pressure and the maximum weight the vehicle can carry.
- **Tire Identification Number (TIN):** A number on the sidewall of each tire providing information about the tire brand and manufacturing plant, tire size and date of manufacture. Also referred to as DOT code.
- **Inflation pressure:** A measure of the amount of air in a tire.
- **Standard load:** A class of P-metric or Metric tires designed to carry a maximum load at set pressure. For example: For P-metric tires 35 psi (2.4 bar) or 36 (2.5 bar) depending on tire size and for Metric tires 36 psi (2.5 bar). Increasing the inflation pressure beyond this pressure will not increase the tire capability.
- **Extra load:** A class of P-metric or Metric tires designed to carry a heavier maximum load at 42 psi (2.9 bar). Increasing the inflation pressure beyond this pressure will not increase the tire's load-carrying capability.
- **kPa:** Kilopascal, a metric unit of air pressure.
- **PSI:** Pounds per square inch, a standard unit of air pressure.
- **Cold tire pressure:** The tire pressure when the vehicle has been stationary and out of direct sunlight for an hour or more and prior to the vehicle being driven for 1 mile (1.6 kilometers).
- **Recommended inflation pressure:** The cold inflation pressure found on the Safety Compliance Certification Label (affixed to either the door hinge pillar, door-latch post, or the door edge that meets the door-latch post, next to the driver's seating position) or Tire Label located on the B-Pillar or the edge of the driver's door.
- **B-pillar:** The structural member at the side of the vehicle behind the front door.
- **Bead area of the tire:** Area of the tire next to the rim.
- **Sidewall of the tire:** Area between the bead area and the tread.
- **Tread area of the tire:** Area of the perimeter of the tire that contacts the road when mounted on the vehicle.
- **Rim:** The metal support (wheel) for a tire or a tire and tube assembly upon which the tire beads are seated.

**INFORMATION CONTAINED ON THE TIRE SIDEWALL**

Both U.S. and Canada Federal regulations require tire manufacturers to place standardized information on the sidewall of all tires. This information identifies and describes the fundamental characteristics of the tire and also provides a U.S. DOT Tire Identification Number for safety standard certification and in case of a recall.

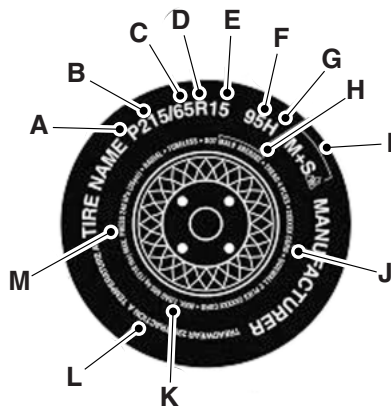
**Information on P Type Tires**

P215/65R15 95H is an example of a tire size, load index and speed rating. The definitions of these items are listed below. (Note that the tire size, load index and speed rating for your vehicle may be different from this example.)

A. **P:** Indicates a tire, designated by the Tire and Rim Association, that may be used for service on cars, sport utility vehicles, minivans and light trucks.

**Note:** If your tire size does not begin with a letter, this may mean it is designated by either the European Tire and Rim Technical Organization or the Japan Tire Manufacturing Association.

B. **215:** Indicates the nominal width of the tire in millimeters from sidewall edge to sidewall edge. In general, the larger the number, the wider the tire.

C. **65:** Indicates the aspect ratio which gives the tire's ratio of height to width.

D. **R:** Indicates a radial type tire.

E. **15:** Indicates the wheel or rim diameter in inches. If you change your wheel size, you will have to purchase new tires to match the new wheel diameter.

**F. 95:** Indicates the tire's load index. It is an index that relates to how much weight a tire can carry. You may find this information in your owner's manual. If not, contact a local tire dealer.

**Note:** You may not find this information on all tires because it is not required by federal law.

**G. H:** Indicates the tire's speed rating. The speed rating denotes the speed at which a tire is designed to be driven for extended periods of time under a standard condition of load and inflation pressure. The tires on your vehicle may operate at different conditions for load and inflation pressure. These speed ratings may need to be adjusted for the difference in conditions. The ratings range from 81 mph (130 km/h) to 186 mph (299 km/h). These ratings are listed in the following chart.

**Note:** You may not find this information on all tires because it is not required by federal law.

Letter rating	Speed rating - mph (km/h)
M	81 (130)
N	87 (140)
Q	99 (159)
R	106 (171)
S	112 (180)
T	118 (190)
U	124 (200)
H	130 (210)
V	149 (240)
W	168 (270)
Y	186 (299 )

**Note:** For tires with a maximum speed capability over 149 mph (240 km/h), tire manufacturers sometimes use the letters ZR. For those with a maximum speed capability over 186 mph (299 km/h), tire manufacturers always use the letters ZR.

**H. U.S. DOT Tire Identification Number (TIN):** This begins with the letters DOT and indicates that the tire meets all federal standards. The next two numbers or letters are the plant code designating where it was manufactured, the next two are the tire size code and the last four numbers represent the week and year the tire was built. For example, the numbers 317 mean the 31st week of 1997. After 2000 the numbers go to four digits. For example, 2501 means the 25th week of 2001.

The numbers in between are identification codes used for traceability. This information is used to contact customers if a tire defect requires a recall.

**I. M+S or M/S:** Mud and Snow, or

**AT:** All Terrain, or

**AS:** All Season.

**J. Tire Ply Composition and Material Used:** Indicates the number of plies or the number of layers of rubber-coated fabric in the tire tread and sidewall. Tire manufacturers also must indicate the ply materials in the tire and the sidewall, which include steel, nylon, polyester, and others.

**K. Maximum Load:** Indicates the maximum load in kilograms and pounds that can be carried by the tire. See the Safety Compliance Certification Label (affixed to either the door hinge pillar, door-latch post, or the door edge that meets the door-latch post, next to the driver's seating position), for the correct tire pressure for your vehicle.

**L. Treadwear, Traction and Temperature Grades**

- **Treadwear:** The treadwear grade is a comparative rating based on the wear rate of the tire when tested under controlled conditions on a specified government test course. For example, a tire graded 150 would wear one and one-half (1½) times as well on the government course as a tire graded 100.
- **Traction:** The traction grades, from highest to lowest, are AA, A, B, and C. The grades represent the tire's ability to stop on wet pavement as measured under controlled conditions on specified government test surfaces of asphalt and concrete. A tire marked C may have poor traction performance.
- **Temperature:** The temperature grades are A (the highest), B and C, representing the tire's resistance to the generation of heat and its ability to dissipate heat when tested under controlled conditions on a specified indoor laboratory test wheel.

**M. Maximum Inflation Pressure:** Indicates the tire manufacturer's maximum permissible pressure or the pressure at which the maximum load can be carried by the tire. This pressure is normally higher than the vehicle manufacturer's recommended cold inflation pressure, which can be found on the Safety Compliance Certification Label (affixed to either the door hinge pillar, door-latch post, or the door edge that meets the door-latch post, next to the driver's seating position), or Tire Label which is located on the B-Pillar or the edge of the driver's door. The cold inflation pressure should never be set lower than the recommended pressure on the vehicle label.

The tire suppliers may have additional markings, notes or warnings, such as standard load or radial tubeless.

### **Additional Information Contained on the Tire Sidewall for LT Type Tires**

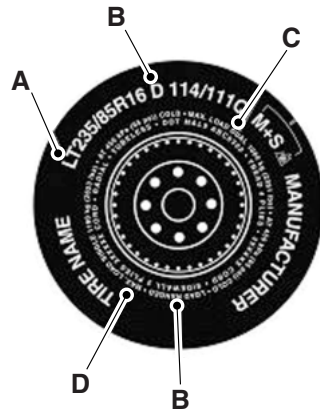

LT type tires have some additional information beyond those of P type tires. These differences are described below.

**Note:** Tire Quality Grades do not apply to this type of tire.

A. **LT:** Indicates a tire, designated by the Tire and Rim Association, that is intended for service on light trucks.

B. **Load Range/Load Inflation Limits:** Indicates the tire's load-carrying capabilities and its inflation limits.

C. **Maximum Load Dual lb (kg) at psi (kPa) cold:** Indicates the maximum load and tire pressure when the tire is used as a dual, defined as four tires on the rear axle (a total of six or more tires on the vehicle).

D. **Maximum Load Single lb (kg) at psi (kPa) cold:** Indicates the maximum load and tire pressure when the tire is used as a single, defined as two tires (total) on the rear axle.

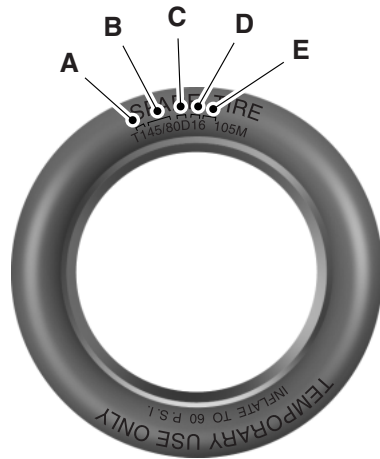
**Information on T Type Tires**

T type tires have some additional information beyond those of P type tires. These differences are described below.

T145/80D16 is an example of a tire size.

**Note:** The temporary tire size for your vehicle may be different from this example. Tire Quality Grades do not apply to this type of tire.

A. **T:** Indicates a type of tire, designated by the Tire and Rim Association, that is intended for temporary service on cars, sport-utility vehicles, minivans and light trucks.

B. **145:** Indicates the nominal width of the tire in millimeters from sidewall edge to sidewall edge. In general, the larger the number, the wider the tire.

C. **80:** Indicates the aspect ratio, which gives the tire's ratio of height to width. Numbers of 70 or lower indicate a short sidewall.

D. **D:** Indicates a diagonal type tire. **R:** Indicates a radial type tire.

E. **16:** Indicates the wheel or rim diameter in inches. If you change your wheel size, you will have to purchase new tires to match the new wheel diameter.

**Location of the Tire Label**

You will find a Tire Label containing tire inflation pressure by tire size and other important information located on the B-Pillar or the edge of the driver's door. See the payload description and graphic in the *Load Carrying* chapter.

**INFLATING YOUR TIRES**

Safe operation of your vehicle requires that your tires are properly inflated. Remember that a tire can lose up to half of its air pressure without appearing flat.

Every day before you drive, check your tires. If one looks lower than the others, use a tire gauge to check pressure of all tires and adjust if required.

At least once a month and before long trips, inspect each tire and check the tire pressure with a tire gauge (including spare, if equipped). Inflate all tires to the inflation pressure recommended by Ford Motor Company.



**WARNING:** Under-inflation is the most common cause of tire failures and may result in severe tire cracking, tread separation or blowout, with unexpected loss of vehicle control and increased risk of injury. Under-inflation increases sidewall flexing and rolling resistance, resulting in heat build-up and internal damage to the tire. It also may result in unnecessary tire stress, irregular wear, loss of vehicle control and accidents. A tire can lose up to half of its air pressure and not appear to be flat!

You are strongly urged to buy a reliable tire pressure gauge, as automatic service station gauges may be inaccurate. Ford recommends the use of a digital or dial-type tire pressure gauge rather than a stick-type tire pressure gauge.

Use the recommended cold inflation pressure for optimum tire performance and wear. Under-inflation or over-inflation may cause uneven treadwear patterns.

Always inflate your tires to the Ford recommended inflation pressure even if it is less than the maximum inflation pressure information found on the tire. The Ford recommended tire inflation pressure is found on the Safety Compliance Certification Label (affixed to either the door hinge pillar, door-latch post, or the door edge that meets the door-latch post, next to the driver's seating position), or Tire Label which is located on the B-Pillar or the edge of the driver's door. Failure to follow the tire pressure recommendations can cause uneven treadwear patterns and adversely affect the way your vehicle handles.

**Maximum Inflation Pressure** is the tire manufacturer's maximum permissible pressure or the pressure at which the maximum load can be carried by the tire. This pressure is normally higher than the manufacturer's recommended cold inflation pressure, which can be found on the Safety Compliance Certification Label (affixed to either the door hinge pillar, door-latch post, or the door edge that meets the door-latch post, next to the driver's seating position), or Tire Label which is located on the B-Pillar or the edge of the driver's door. The cold inflation pressure should never be set lower than the recommended pressure on the Safety Compliance Certification Label or Tire Label.

When weather temperature changes occur, tire inflation pressures also change. A 10°F (6°C) temperature drop can cause a corresponding drop of 1 psi (7 kPa) in inflation pressure. Check your tire pressures frequently and adjust them to the proper pressure which can be found on the Safety Compliance Certification Label or Tire Label.

To check the pressure in your tire(s):

1. Make sure the tires are cool, meaning they are not hot from driving even a mile.

**Note:** If you are checking tire pressure when the tire is hot (for example, driven more than 1 mile [1.6 kilometers]), never bleed or reduce air pressure. The tires are hot from driving and it is normal for pressures to increase above recommended cold pressures. A hot tire at or below recommended cold inflation pressure could be significantly under-inflated.

**Note:** If you have to drive a distance to get air for your tire(s), check and record the tire pressure first and add the appropriate air pressure when you get to the pump. It is normal for tires to heat up and the air pressure inside to go up as you drive.

2. Remove the cap from the valve on one tire, then firmly press the tire gauge onto the valve and measure the pressure.
3. Add enough air to reach the recommended air pressure.

**Note:** If you overfill the tire, release air by pressing on the metal stem in the center of the valve. Then recheck the pressure with your tire gauge.

4. Replace the valve cap.
5. Repeat this procedure for each tire, including the spare.



**Note:** Some spare tires operate at a higher inflation pressure than the other tires. For T-type mini-spare tires, see the *Dissimilar Spare Tire and Wheel Assembly Information* section. Store and maintain at 60 psi (4.15 bar). For full-size and dissimilar spare tires, see *Dissimilar Spare Tire and Wheel Assembly Information* under *Changing a Road Wheel* in this chapter. Store and maintain at the higher of the front and rear inflation pressure as shown on the Tire Label.

6. Visually inspect the tires to make sure there are no nails or other objects embedded that could poke a hole in the tire and cause an air leak.
7. Check the sidewalls to make sure there are no gouges, cuts or bulges.

### Inspecting Your Tires and Wheel Valve Stems

Periodically inspect the tire treads for uneven or excessive wear and remove objects such as stones, nails or glass that may be wedged in the tread grooves. Check the tire and valve stems for holes, cracks, or cuts that may permit air leakage and repair or replace the tire and replace the valve stem. Inspect the tire sidewalls for cracking, cuts, bruises and other signs of damage or excessive wear. If internal damage to the tire is suspected, have the tire demounted and inspected in case it needs to be repaired or replaced. For your safety, tires that are damaged or show signs of excessive wear should not be used because they are more likely to blow out or fail.

Improper or inadequate vehicle maintenance can cause tires to wear abnormally. Inspect all your tires, including the spare, frequently, and replace them if one or more of the following conditions exist:

#### Tire Wear

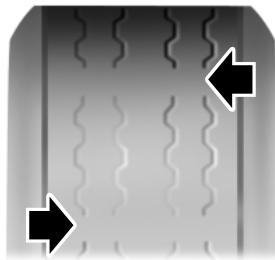

When the tread is worn down to 1/16th of an inch (2 millimeters), tires must be replaced to help prevent your vehicle from skidding and hydroplaning. Built-in treadwear indicators, or wear bars, which look like narrow strips of smooth rubber across the tread will appear on the tire when the tread is worn down to 1/16th of an inch (2 millimeters).

When the tire tread wears down to the same height as these wear bars, the tire is worn out and must be replaced.

**Damage**

Periodically inspect the tire treads and sidewalls for damage (such as bulges in the tread or sidewalls, cracks in the tread groove and separation in the tread or sidewall). If damage is observed or suspected, have the tire inspected by a tire professional. Tires can be damaged during off-road use, so inspection after off-road use is also recommended.

**WARNING: Age**

Tires degrade over time depending on many factors such as weather, storage conditions, and conditions of use (such as load, speed, inflation pressure) the tires experience throughout their lives. In general, tires should be replaced after six years regardless of tread wear. However, heat caused by hot climates or frequent high loading conditions can accelerate the aging process and may require tires to be replaced more frequently.

You should replace your spare tire when you replace the road tires or after six years due to aging even if it has not been used.

**U.S. DOT Tire Identification Number**

Both U.S. and Canada Federal regulations require tire manufacturers to place standardized information on the sidewall of all tires. This information identifies and describes the fundamental characteristics of the tire and also provides a U.S. DOT Tire Identification Number for safety standard certification and in case of a recall.

This begins with the letters DOT and indicates that the tire meets all federal standards. The next two numbers or letters are the plant code designating where it was manufactured, the next two are the tire size code and the last four numbers represent the week and year the tire was built. For example, the numbers 317 mean the 31st week of 1997. After 2000 the numbers go to four digits. For example, 2501 means the 25th week of 2001. The numbers in between are identification codes used for traceability. This information is used to contact customers if a tire defect requires a recall.

**Tire Replacement Requirements**

**WARNING:** Only use replacement tires and wheels that are the same size, load index, speed rating and type (such as P-metric versus LT-metric or all-season versus all-terrain) as those originally provided by Ford. The recommended tire and wheel size may be found on either the Safety Compliance Certification Label (affixed to either the door hinge pillar, door-latch post, or the door edge that meets the door-latch post, next to the driver's seating position), or the Tire Label which is located on the B-Pillar or edge of the driver's door. If this information is not found on these labels, then you should contact your authorized dealer as soon as possible. Use of any tire or wheel not recommended by Ford can affect the safety and performance of your vehicle, which could result in an increased risk of loss of vehicle control, vehicle rollover, personal injury and death. Additionally the use of non-recommended tires and wheels could cause steering, suspension, axle, transfer case or power transfer unit failure. If you have questions regarding tire replacement, contact your authorized dealer as soon as possible.



**WARNING:** To reduce the risk of serious injury, when mounting replacement tires and wheels, you should not exceed the maximum pressure indicated on the sidewall of the tire to set the beads without additional precautions listed below. If the beads do not seat at the maximum pressure indicated, re-lubricate and try again.

When inflating the tire for mounting pressures up to 20 psi (1.38 bar) greater than the maximum pressure on the tire sidewall, the following precautions must be taken to protect the person mounting the tire:

1. Make sure that you have the correct tire and wheel size.
2. Lubricate the tire bead and wheel bead seat area again.
3. Stand at a minimum of 12 feet (3.66 meters) away from the tire wheel assembly.
4. Use both eye and ear protection.

For a mounting pressure more than 20 psi (1.38 bar) greater than the maximum pressure, a Ford dealer or other tire service professional should do the mounting.

Always inflate steel carcass tires with a remote air fill with the person inflating standing at a minimum of 12 feet (3.66 meters) away from the tire wheel assembly.

Your vehicle is equipped with tires designed to provide a safe ride and handling capability.

**Important:** Remember to replace the wheel valve stems when the road tires are replaced on your vehicle.

The two front tires or two rear tires should generally be replaced as a pair.

The tire pressure sensors mounted in the wheels (originally installed on your vehicle) are not designed to be used in aftermarket wheels.

The use of wheels or tires not recommended by Ford Motor Company may affect the operation of your tire pressure monitoring system.

If the tire pressure monitoring system indicator is flashing, the system is malfunctioning. Your replacement tire might be incompatible with your tire pressure monitoring system, or some component of the system may be damaged.

**Safety Practices**

**WARNING:** If your vehicle is stuck in snow, mud, or sand, do not rapidly spin the tires. Spinning the tires can tear the tire and cause an explosion. A tire can explode in as little as three to five seconds.



**WARNING:** Do not spin the wheels at over 35 mph (56 km/h). The tires may fail and injure a passenger or bystander.

Driving habits have a great deal to do with your tire mileage and safety.

- Observe posted speed limits.
- Avoid fast starts, stops and turns.
- Avoid potholes and objects on the road.
- Do not run over curbs or hit the tire against a curb when parking.

**Highway Hazards**

No matter how carefully you drive, there is always the possibility that you may eventually have a flat tire on the highway. Drive slowly to the closest safe area out of traffic. This may further damage the flat tire, but your safety is more important.

If you feel a sudden vibration or ride disturbance while driving, or you suspect your tire or vehicle has been damaged, immediately reduce your speed. Drive with caution until you can safely pull off the road. Stop and inspect the tires for damage. If a tire is under-inflated or damaged, deflate it, remove the wheel and replace it with your spare tire and wheel. If you cannot detect a cause, have the vehicle towed to the nearest repair facility or tire dealer to have the vehicle inspected.

**Tire and Wheel Alignment**

A bad jolt from hitting a curb or pothole can cause the front end of your vehicle to become misaligned or cause damage to your tires. If your vehicle seems to pull to one side when you are driving, the wheels may be out of alignment. Have an authorized dealer check the wheel alignment periodically.

Wheel misalignment in the front or the rear can cause uneven and rapid treadwear of your tires and should be corrected by an authorized dealer. Front-wheel drive vehicles and those with an independent rear suspension may require alignment of all four wheels.

The tires should also be balanced periodically. An unbalanced tire and wheel assembly may result in irregular tire wear.

### Tire Rotation

**Note:** If your tires show uneven wear ask an authorized dealer to check for and correct any wheel misalignment, tire imbalance or mechanical problem involved before tire rotation.

**Note:** Your vehicle may be equipped with a dissimilar spare tire and wheel assembly. A dissimilar spare tire and wheel assembly is defined as a spare tire or wheel that is different in brand, size or appearance from the road tires and wheels. If you have a dissimilar spare tire and wheel assembly, it is intended for temporary use only and should not be used in a tire rotation.

**Note:** After having your tires rotated, inflation pressure must be checked and adjusted to the vehicle requirements.

Rotating your tires at the recommended interval (as indicated in the scheduled maintenance information) will help your tires wear more evenly, providing better tire performance and longer tire life.

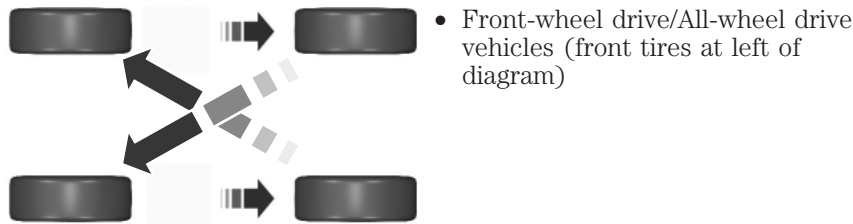

Sometimes irregular tire wear can be corrected by rotating the tires.

### SUMMER TIRES (IF EQUIPPED)

Summer tires provide superior performance on wet and dry roads. Summer tires do not have the Mud and Snow (M+S or M/S) tire traction rating on the tire side wall. Since summer tires do not have the same traction performance as All-season or Snow tires, Ford does not recommend using summer tires when temperatures drop to approximately 40°F (5°C) or below (depending on tire wear and environmental conditions) or in snow and ice conditions. Like any tire, summer tire performance is affected by tire wear and environmental conditions. If you must drive in those conditions, Ford recommends using Mud and Snow (M+S, M/S), All-season or Snow tires.

**USING SNOW CHAINS**

**WARNING:** Snow tires must be the same size, load index and speed rating as those originally provided by Ford. Use of any tire or wheel not recommended by Ford can affect the safety and performance of your vehicle, which could result in an increased risk of loss of vehicle control, vehicle rollover, personal injury and death. Additionally, the use of non-recommended tires and wheels could cause steering, suspension, axle, transfer case or power transfer unit failure.

**Note:** The suspension insulation and bumpers will help prevent vehicle damage. Do not remove these components from your vehicle when using snow tires and chains.

The tires on your vehicle have all-weather treads to provide traction in rain and snow. However, in some climates, you may need to use snow tires and chains. If you need to use chains, it is recommended that cable chains are used only with steel wheels (of the same size and specifications) as chains may chip aluminum wheels.

Follow these guidelines when using snow tires and cable chains:

- If possible, avoid fully loading your vehicle.
- Install cable chains only on the front wheels.
- Use cable chains only on vehicles equipped with either P245/65R17 tires or P245/60R18 tires.
- Do not use tire chains, cables or optional traction devices on vehicles equipped with P255/50R20 or 265/45ZR20 tires.
- Drive cautiously. If you hear the cable chains rub or bang against your vehicle, stop and retighten the cable chains. If this does not work, remove the cable chains to prevent damage to your vehicle.
- Remove the tire cable chains when they are no longer needed. Do not use tire cable chains on dry roads.

**TIRE PRESSURE MONITORING SYSTEM**

**WARNING:** The tire pressure monitoring system is NOT a substitute for manually checking tire pressure. The tire pressure should be checked periodically (at least monthly) using a tire gauge. See *Inflating Your Tires* in this chapter. Failure to properly maintain your tire pressure could increase the risk of tire failure, loss of control, vehicle rollover and personal injury.



Each tire, including the spare (if provided), should be checked monthly when cold and inflated to the inflation pressure recommended by the vehicle manufacturer on the vehicle placard or tire inflation pressure label. (If your vehicle has tires of a different size than the size indicated on the vehicle placard or tire inflation pressure label, you should determine the proper tire inflation pressure for those tires.)

As an added safety feature, your vehicle has been equipped with a tire pressure monitoring system (TPMS) that illuminates a low tire pressure telltale when one or more of your tires is significantly under-inflated. Accordingly, when the low tire pressure telltale illuminates, you should stop and check your tires as soon as possible, and inflate them to the proper pressure. Driving on a significantly under-inflated tire causes the tire to overheat and can lead to tire failure. Under-inflation also reduces fuel efficiency and tire tread life, and may affect the vehicle's handling and stopping ability.

Please note that the TPMS is not a substitute for proper tire maintenance, and it is the driver's responsibility to maintain correct tire pressure, even if under-inflation has not reached the level to trigger illumination of the TPMS low tire pressure telltale.

Your vehicle has also been equipped with a TPMS malfunction indicator to indicate when the system is not operating properly. The TPMS malfunction indicator is combined with the low tire pressure telltale. When the system detects a malfunction, the telltale will flash for approximately one minute and then remain continuously illuminated. This sequence will continue upon subsequent vehicle start-ups as long as the malfunction exists.

When the malfunction indicator is illuminated, the system may not be able to detect or signal low tire pressure as intended. TPMS malfunctions may occur for a variety of reasons, including the installation of replacement or alternate tires or wheels on the vehicle that prevent the TPMS from functioning properly. Always check the TPMS malfunction



telltale after replacing one or more tires or wheels on your vehicle to ensure that the replacement or alternate tires and wheels allow the TPMS to continue to function properly.

The tire pressure monitoring system complies with part 15 of the FCC rules and with RSS-210 of Industry Canada. Operation is subject to the following two conditions: (1) This device may not cause harmful interference, and (2) This device must accept any interference received, including interference that may cause undesired operation.

### Changing Tires with a Tire Pressure Monitoring System

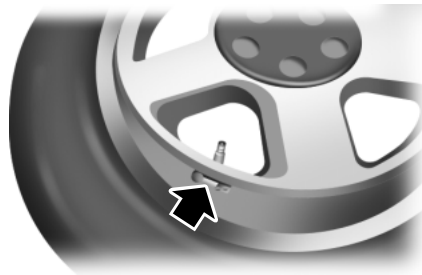

**Note:** Each road tire is equipped with a tire pressure sensor located inside the tire and wheel assembly cavity. The pressure sensor is attached to the valve stem. The pressure sensor is covered by the tire and is not visible unless the tire is removed. Take care when changing the tire to avoid damaging the sensor.

You should always have your tires serviced by an authorized dealer.

Check the tire pressure periodically (at least monthly) using an accurate tire gauge. See *Inflating Your Tires* in this chapter.

### Understanding Your Tire Pressure Monitoring System

The tire pressure monitoring system measures pressure in your four road tires and sends the tire pressure readings to your vehicle. The low tire pressure warning light will turn on if the tire pressure is significantly low. Once the light is illuminated, your tires are under-inflated and need to be inflated to the manufacturer's recommended tire pressure. Even if the light turns on and a short time later turns off, your tire pressure still needs to be checked.

### When Your Temporary Spare Tire Is Installed

When one of your road tires needs to be replaced with the temporary spare, the system will continue to identify an issue to remind you that the damaged road wheel and tire assembly needs to be repaired and put back on your vehicle.

To restore the full function of the tire pressure monitoring system, have the damaged road wheel and tire assembly repaired and remounted on your vehicle.

**When You Believe Your System Is Not Operating Properly**

The main function of the tire pressure monitoring system is to warn you when your tires need air. It can also warn you in the event the system is no longer capable of functioning as intended. See the following chart for information concerning your tire pressure monitoring system:

<b>Low tire pressure warning light</b>	<b>Possible cause</b>	<b>Customer action required</b>
Solid warning light	Tire(s) under-inflated	1. Make sure tires are at the proper pressure. See <i>Inflating Your Tires</i> in this chapter. 2. After inflating your tires to the manufacturer's recommended pressure as shown on the Tire Label (located on the edge of driver's door or the B-Pillar), the vehicle must be driven for at least two minutes over 20 mph (32 km/h) before the light turns off.
	Spare tire in use	Repair the damaged road wheel and tire and reinstall it on the vehicle to restore system function. For a description on how the system functions, see <i>When Your Temporary Spare Tire is Installed</i> in this section.
	TPMS malfunction	If the tires are properly inflated and the spare tire is not in use but the light remains on, contact your authorized dealer as soon as possible.

Low tire pressure warning light	Possible cause	Customer action required
Flashing warning light	Spare tire in use	Repair the damaged road wheel and tire assembly and reinstall it on the vehicle to restore system function. For a description on how the system functions, see <i>When Your Temporary Spare Tire is Installed</i> in this section.
	TPMS malfunction	If the tires are properly inflated and the spare tire is not in use but the light remains on, contact your authorized dealer as soon as possible.

#### ***When Inflating Your Tires***

When putting air into your tires (such as at a gas station or in your garage), the tire pressure monitoring system may not respond immediately to the air added to your tires.

It may take up to two minutes of driving over 20 mph (32 km/h) for the light to turn off after you have filled your tires to the recommended inflation pressure.

#### ***How Temperature Affects Your Tire Pressure***

The tire pressure monitoring system monitors tire pressure in each pneumatic tire. While driving in a normal manner, a typical passenger tire inflation pressure may increase about 2 to 4 psi (14 to 28 kPa) from a cold start situation. If the vehicle is stationary overnight with the outside temperature significantly lower than the daytime temperature, the tire pressure may decrease approximately 3 psi (21 kPa) for a drop of 30°F (17°C) in ambient temperature. This lower pressure value may be detected by the tire pressure monitoring system as being significantly lower than the recommended inflation pressure and activate the system warning light for low tire pressure. If the low tire pressure warning light is on, visually check each tire to verify that no tire is flat. If one or more tires are flat, repair as necessary. Check the air pressure in the road tires. If any tire is under-inflated, carefully drive the vehicle to the nearest location where air can be added to the tires. Inflate all the tires to the recommended inflation pressure.

**CHANGING A ROAD WHEEL**

**WARNING:** The use of tire sealants may damage your tire pressure monitoring system and should not be used. However, if you must use a sealant, have an authorized dealer install a new tire pressure monitoring system sensor and valve stem.



**WARNING:** See *Tire Pressure Monitoring System* in this chapter for important information. If the tire pressure monitoring sensor becomes damaged, it will no longer function.

**Note:** The tire pressure monitoring system indicator light will illuminate when the spare tire is in use. To restore the full function of the monitoring system, all road wheels equipped with tire pressure monitoring sensors must be mounted on this vehicle.

If you get a flat tire while driving, do not apply the brake heavily. Instead, gradually decrease your speed. Hold the steering wheel firmly and slowly move to a safe place on the side of the road.

Have a flat serviced by an authorized dealer in order to prevent damage to the system sensors. See *Tire Pressure Monitoring System* earlier in this chapter. Replace the spare tire with a road tire as soon as possible. During repairing or replacing of the flat tire, have the authorized dealer inspect the tire pressure monitoring system sensor for damage.

**Dissimilar Spare Tire and Wheel Assembly Information**

**WARNING:** Failure to follow these guidelines could result in an increased risk of loss of vehicle control, injury or death.

If you have a dissimilar spare tire and wheel assembly, then it is intended for temporary use only. This means that if you need to use it, you should replace it as soon as possible with a road tire and wheel assembly that is the same size and type as the road tires and wheels that were originally provided by Ford. If the dissimilar spare tire or wheel is damaged, it should be replaced rather than repaired.

A dissimilar spare tire and wheel assembly is defined as a spare tire or wheel that is different in brand, size or appearance from the road tires and wheels and can be one of three types:

1. **T-type mini-spare:** This spare tire begins with the letter T for tire size and may have Temporary Use Only molded in the sidewall.

2. **Full-size dissimilar spare with label on wheel:** This spare tire has a label on the wheel that states: THIS TIRE AND WHEEL FOR TEMPORARY USE ONLY

When driving with one of the dissimilar spare tires listed above, do not:

- exceed 50 mph (80 km/h).
- load the vehicle beyond maximum vehicle load rating listed on the Safety Compliance Label.
- tow a trailer.
- use snow chains on the end of the vehicle with the dissimilar spare tire.
- use more than one dissimilar spare tire at a time.
- use commercial car washing equipment.
- try to repair the dissimilar spare tire.

Use of one of the dissimilar spare tires listed above at any one wheel location can lead to impairment of the following:

- Handling, stability and braking performance
- Comfort and noise
- Ground clearance and parking at curbs
- Winter weather driving capability
- Wet weather driving capability
- All-wheel driving capability

3. **Full-size dissimilar spare without label on wheel**

When driving with the full-size dissimilar spare tire and wheel assembly, do not:

- exceed 70 mph (113 km/h).
- use more than one dissimilar spare tire and wheel at a time.
- use commercial car washing equipment.
- use snow chains on the end of the vehicle with the dissimilar spare tire and wheel.

The usage of a full-size dissimilar spare tire and wheel assembly can lead to impairment of the following:

- Handling, stability and braking performance
- Comfort and noise
- Ground clearance and parking at curbs
- Winter weather driving capability
- Wet weather driving capability
- All-wheel driving capability (if applicable)
- Load leveling adjustment (if applicable)

When driving with the full-size dissimilar spare tire and wheel assembly, additional caution should be given to:

- towing a trailer.
- driving vehicles equipped with a camper body.
- driving vehicles with a load on the cargo rack.

Drive cautiously when using a full-size dissimilar spare tire and wheel, and seek service as soon as possible.

#### Tire Change Procedure



**WARNING:** When one of the front wheels is off the ground, the transmission alone will not prevent the vehicle from moving or slipping off the jack, even if the transmission is in park **(P)**.



**WARNING:** To help prevent the vehicle from moving when you change a tire, be sure to place the transmission in park **(P)**, set the parking brake and block (in both directions) the wheel that is diagonally opposite (other side and end of the vehicle) to the tire being changed.



**WARNING:** Never get underneath a vehicle that is supported only by a jack. If the vehicle slips off the jack, you or someone else could be seriously injured.



**WARNING:** Do not attempt to change a tire on the side of the vehicle close to moving traffic. Pull far enough off the road to avoid the danger of being hit when operating the jack or changing the wheel.



**WARNING:** Always use the jack provided as original equipment with your vehicle. If using a jack other than the one provided as original equipment with your vehicle, make sure the jack capacity is adequate for the vehicle weight, including any vehicle cargo or modifications.

**Note:** Passengers should not remain in the vehicle when the vehicle is being jacked.

**Note:** If the third-row seat is stowed in the floor, you will need to unstow it (raised position) to access the spare tire and jack. See *Rear Seats* in the *Seats* chapter for this procedure.

1. Park on a level surface, set the parking brake and activate the hazard flashers.
2. Place the transmission in park (**P**) and turn the engine off.



3. Turn the two knobs on the floor filler counterclockwise, then remove the floor filler and carpeted floor panel located in the rear of the vehicle.

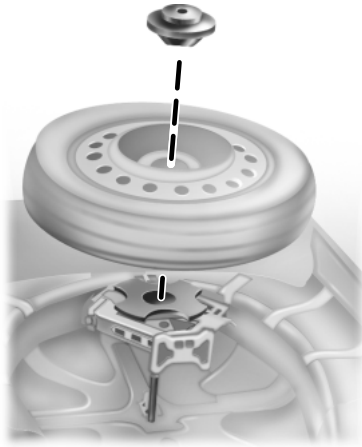

4. Remove the wing nut securing the spare tire by turning it counterclockwise.

5. Lift and remove the spare tire from the spare tire well.

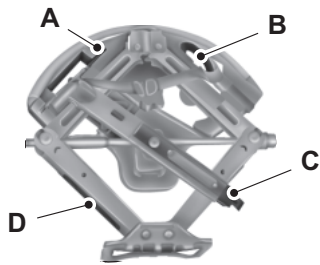

6. Remove the wing bolt that secures the jack kit by turning it counterclockwise.

7. Remove the jack kit which includes the jack (D), wheel wrench (lug wrench) (C), L-shaped bolt (A) and the tow recovery hook (B).

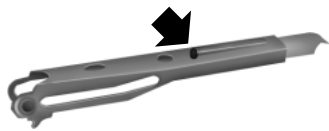

8. Turn the lead screw (where the lug wrench attaches) of the jack by hand to release the wheel wrench from the jack. Press the button on the wrench to extend the handle. Fold down the wrench socket.

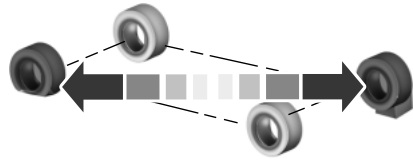

**Vehicle Jacking**

1. Block the diagonally opposite wheel.
2. Loosen each wheel lug nut one-half turn counterclockwise but do not remove them until the wheel is raised off the ground.

3. The vehicle jacking points are shown here, and are depicted on the warning label on the jack.



**Note:** Jack at the specified locations to avoid damage to the vehicle.

4. Small arrow-shaped marks on the sills show the location of the jacking points.



5. Remove the lug nuts with the lug wrench.
6. Replace the flat tire with the spare tire, making sure the valve stem is facing outward. Reinstall the lug nuts until the wheel is snug against the hub. Do not fully tighten the lug nuts until the wheel has been lowered.
7. Lower the wheel by turning the jack handle counterclockwise.

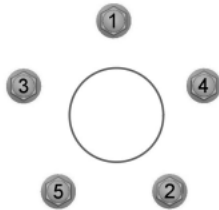

8. Remove the jack and fully tighten the lug nuts in the order shown. See *Wheel Lug Nut Torque Specifications* later in this chapter for the proper lug nut torque specification.

### Stowing the mini-spare and jack

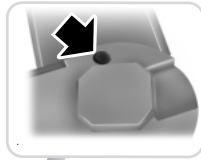

1. Adjust the jack to the proper height to install the wrench. Turn the jack lead screw until the arrow on the upper link is slightly below the circle indicator shown on the lower link.

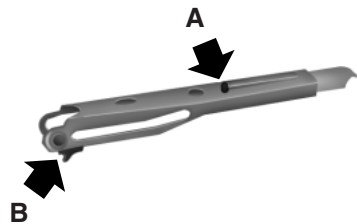

Push the button (A) to retract the wrench handle and place the wrench over the raised tab on the lower link and drop the tang (B) through the hole in the diagonally opposite upper link. Turn the lead screw of the jack clockwise until the arrow aligns with the circle indicator to secure the wrench onto the jack.

2. Place the jack in the foam tray and secure it with the attached strap.
3. Place the foam tray over the mounting bracket on the floor of the spare tire well.
4. Replace the mini-spare over the jack and secure with the wing nut.

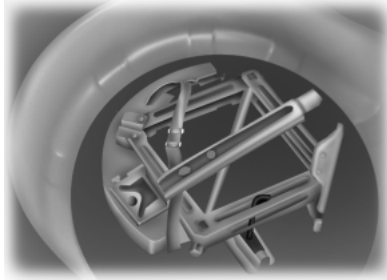
**Stowing the flat tire**

1. Place the third-row seat in the raised position.
2. Secure the jack kit in the alternate position by inserting the L-shaped bolt through the hole in the side of the jack channel as shown.

**Note:** The L-shaped bolt is located in the foam tray.

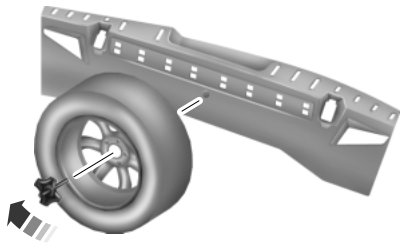

3. Stand the flat tire vertically in the mini-spare tub with the tire's valve stem facing rearward toward the rear lift gate back panel.
4. Fasten the flat tire to the rear lift gate back panel by inserting the wing bolt through one of the lug bolt holes in the wheel.
5. Turn the wing bolt clockwise into the threaded hole in the rear lift gate back panel until the tire is secured.

**TECHNICAL SPECIFICATIONS**

**Wheel Lug Nut Torque Specifications**

**!** **WARNING:** When a wheel is installed, always remove any corrosion, dirt or foreign materials present on the mounting surfaces of the wheel or the surface of the wheel hub, brake drum or brake disc that contacts the wheel. Make sure that any fasteners that attach the rotor to the hub are secured so they do not interfere with the mounting surfaces of the wheel. Installing wheels without correct metal-to-metal contact at the wheel mounting surfaces can cause the wheel nuts to loosen and the wheel to come off while your vehicle is in motion, resulting in loss of control.

Retighten the lug nuts to the specified torque within 100 miles (160 kilometers) after any wheel disturbance (such as rotation, flat tire, wheel removal).

Lug nut socket size/Bolt size	Wheel lug nut torque*	
	ft-lb	N•m
1/2 x 20	100	135

\* Torque specifications are for nut and bolt threads free of dirt and rust. Use only Ford recommended replacement fasteners.



**Note:** Inspect the wheel pilot hole and mounting surface prior to installation. Remove any visible corrosion or loose particles.

## ENGINE SPECIFICATIONS

Engine	3.5L V6 engine	3.5L V6 EcoBoost engine	2.0L EcoBoost engine
Cubic inches	214	214	122
Required fuel	Minimum 87 octane	Minimum 87 octane	Minimum 87 octane
Firing order	1-4-2-5-3-6	1-4-2-5-3-6	1-3-4-2
Ignition system	Coil on plug	Coil on plug	Coil on plug
Spark plug gap	0.049-0.053 in. (1.25-1.35 mm)	0.033-0.037 in. (0.84-0.94 mm)	0.027-0.031 in. (0.70-0.80 mm)
Compression ratio	10.8:1	10.0:1	9.3:1

**Engine Drivebelt Routing**

3.5L / 3.5L V6 EcoBoost engines



2.0L EcoBoost engine

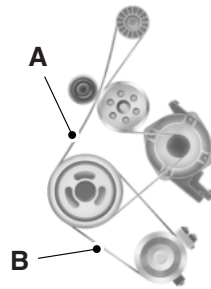

- A. Long drivebelt on the first pulley groove closer to the engine
- B. Short drivebelt on the second pulley groove farther from the engine

## TECHNICAL SPECIFICATIONS

Item	Capacity	Ford part name or equivalent	Ford part number / Ford specification
Brake fluid <sup>1</sup>	Between MIN and MAX on reservoir	Motorcraft DOT 4 LV High Performance Motor Vehicle Brake Fluid	PM-20 / WSS-M6C65-A2
Hinges, latches, striker plates and rotors, seat tracks, fuel filler door hinge and spring	—	Multi-Purpose Grease (Lithium grease)	Motorcraft XL-5 (aerosol) and/or CRC SL315IESB / ESB-M1C93-B
Door weatherstrips	—	Silicone Spray Lubricant	XL-6 / ESR-M13P4-A
Lock cylinders	—	Motorcraft Penetrating and Lock Lubricant	XL-1 / None
Engine oil <sup>2,3,4</sup>	(3.5L) V6 engine 6.0 qt (5.7L)	Motorcraft SAE 5W-20 Motor Oil	WSS-M2C945-A
	(3.5L EcoBoost) 6.0 qt (5.7L)	Motorcraft SAE 5W-30 Motor Oil	WSS-M2C946 -A
	(2.0L EcoBoost) 5.7 qt (5.4L)	Motorcraft SAE 5W-30 Motor Oil	WSS-M2C946 -A
Power Transfer Unit (PTU) fluid (All Wheel Drive)	18 oz (0.53L)	Motorcraft SAE 75W-140 Synthetic Rear Axle Lubricant	XY-75W140-QL / WSL-M2C192-A

Item	Capacity	Ford part name or equivalent	Ford part number / Ford specification
Engine coolant <sup>5</sup>	3.5L V6 engine 12.2 qt (11.5L)	Motorcraft Orange Antifreeze/Coolant Prediluted	VC-3DIL-B (US); CVC-3DIL-B (Canada) / WSS-M97B44-D2
	3.5L V6 EcoBoost 11.4 qt (10.8L)		
	2.0L EcoBoost 11.6 qt (11.0L)		
	10.8 qt (10.3L)		
6F50 Automatic transmission fluid <sup>6,7</sup>	10.8 qt (10.3L)	Motorcraft MERCON LV ATF	XT-10-QLV / MERCON LV
6F55 Automatic transmission fluid <sup>6,7</sup>	1 1.6 qt (11.0L)		
6F35 Automatic transmission fluid <sup>6,7</sup>	9.0 qt (8.5L)		
Rear axle fluid	2.4 pt (1.15L)	Motorcraft SAE 80W-90 Premium Rear Axle Lubricant	XY-80W90-QL / WSP-M2C197-A
Windshield washer fluid	Fill as required	Motorcraft Premium Windshield Washer Concentrate with Bitterant (US); Premium Quality Windshield Washer Fluid (Canada)	ZC-32-B2 (US); CXC-37-(A, B, D, and F) (Canada) / WSB-M8B16-A2
Fuel tank	18.6 gal (70.4L)	—	—



Item	Capacity	Ford part name or equivalent	Ford part number / Ford specification
A/C Refrigerant <sup>8</sup>	2.0L Ecoboost & 3.5L Ecoboost engines 47 oz (1.33kg). 3.5LV6 engine 41 oz (1.16 kg)	Motorcraft R134a Refrigerant	YN-19 (US); CYN-16-R (Canada) / WSH-M17B19-A
A/C Refrigerant Compressor Oil <sup>8</sup>	2.0L Ecoboost & 3.5L Ecoboost engines 7.2 fl oz (215mL) 3.5LV6 engine 9.2 fl oz (275 mL)	Motorcraft PAG Refrigerant Compressor Oil	YN-12-D / WSH-M1C231-B.
<sup>1</sup> Ford recommends using Motorcraft (Ford) DOT 4 LV High Performance Motor Vehicle Brake Fluid or equivalent meeting WSS-M6C65-A2. Use of any fluid other than the recommended fluid may cause degraded brake performance and not meet the Ford performance standards. Keep brake fluid clean and dry. Contamination with dirt, water, petroleum products or other materials may result in brake system damage and possible failure.			
<sup>2</sup> Your engine has been designed to use Motorcraft engine oils or equivalent oils that meet Ford Specification. It is also acceptable to use an engine oil of recommended viscosity grade that meets API SN requirements and displays the API certifications mark for gasoline engines.			
<sup>3</sup> Do not use oils labeled as API SN unless the label also displays the API certification mark. These oils do not meet the requirements of your vehicle's engine and emissions system.			
<sup>4</sup> Do not use supplemental engine oil additives. They are unnecessary and could lead to engine damage that is not covered by your Ford warranty.			

Item	Capacity	Ford part name or equivalent	Ford part number / Ford specification
<sup>5</sup> Add the coolant type originally equipped in your vehicle.			
<sup>6</sup> Indicates only approximate dry-fill capacity. Some applications may vary based on cooler size and if equipped with an in-tank cooler. The amount of transmission fluid and fluid level should be checked by a qualified technician.			
<sup>7</sup> Use of a dual usage fluid in an automatic transmission requiring MERCON LV may cause transmission damage. Use of any fluid other than the recommended fluid may cause transmission damage. Refer to <i>scheduled maintenance information</i> to determine the correct service interval.			
<sup>8</sup> See warning below:			

 **WARNING:** The air conditioning refrigerant system contains refrigerant R134a under high pressure. Opening the air conditioning refrigerant system can cause personal injury. Only qualified personnel should service the air conditioning refrigerant system.

**MOTORCRAFT® PART NUMBERS**

<b>Component</b>	<b>3.5L V6 engine</b>	<b>3.5L V6 EcoBoost engine</b>	<b>2.0L EcoBoost engine</b>
Air filter element	FA-1884	FA-1884	FA-1884
Oil filter	FL-500-S	FL-500-S	FL-910-S
Battery	BXT-59 BXT-65-650 <sup>1</sup>	BXT-59 BXT-65-650 <sup>1</sup>	BXT-59 BXT-65-650 <sup>1</sup>
Spark plugs	SP-520 <sup>2</sup>	SP-534 <sup>2</sup>	SP-537 <sup>2</sup>
Cabin air filter	FP68	FP68	FP68
Seat air filter	FS-104	FS-104	FS-104
Windshield wiper blade	WW-2601-PF (driver's side) WW-2201-PF (passenger side) WW-1106-PF (rear wiper)		

<sup>1</sup>This Motorcraft part is designed for vehicles with Passive Entry or Passive Start.

<sup>2</sup>For spark plug replacement, see your authorized dealer. Refer to *scheduled maintenance information* for the appropriate intervals for changing the spark plugs.

**Note:** Replace the spark plugs with ones that meet Ford material and design specifications for your vehicle, such as Motorcraft® or equivalent replacement parts. The customer warranty may be void for any damage to the engine if such spark plugs are not used.

**VEHICLE IDENTIFICATION NUMBER**

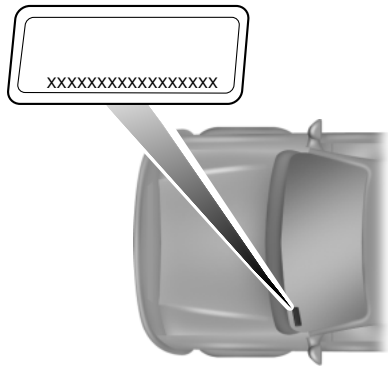

The vehicle identification number is located on the driver's side instrument panel.

Please note that in the graphic, XXXX is representative of your vehicle identification number.

The Vehicle Identification Number (VIN) contains the following information:

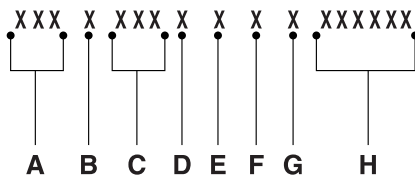

- A. World manufacturer identifier
- B. Brake system / Gross Vehicle Weight Rating (GVWR) / Restraint Devices and their location
- C. Make, vehicle line, series, body type
- D. Engine type
- E. Check digit
- F. Model year

- G. Assembly plant
- H. Production sequence number.

**VEHICLE CERTIFICATION LABEL**

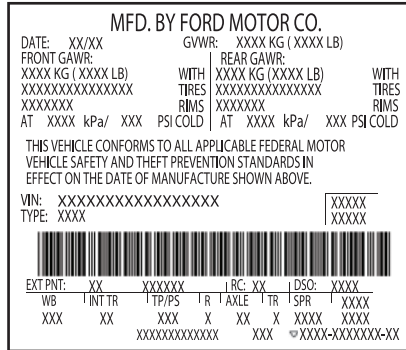

The National Highway Traffic Safety Administration Regulations require that a Safety Compliance Certification Label be affixed to a vehicle and prescribe where the Safety Compliance Certification Label may be located. The Safety Compliance Certification Label shall be affixed to either the door hinge pillar, the door latch post, or the edge of the door near the door latch, next to the driver's seating position.

**TRANSMISSION CODE DESIGNATION**

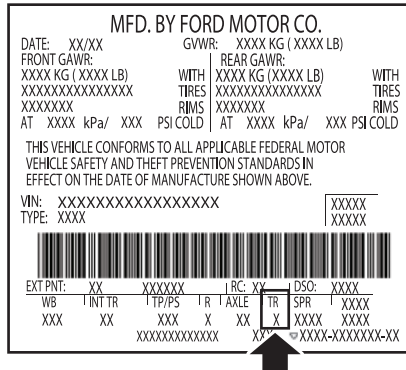

You can find a transmission code on the Safety Compliance Certification Label. The following table tells you which transmission each code represents.

Description	Code
Six-speed automatic (6F50)	J
Six-speed automatic (6F55)	C
Six-speed automatic (6F35)	6

**ACCESSORIES**

For a complete listing of the accessories that are available for your vehicle, please contact an authorized dealer or visit our online store at **www.Accessories.Ford.com** (United States only).

Ford Motor Company will repair or replace any properly authorized dealer-installed Ford Genuine Accessories found to be defective in factory-supplied materials or workmanship during the warranty period, as well as any component damaged by the defective accessories.

Ford Motor Company will warrant your vehicle through the warranty that provides the greatest benefit:

- 24 months, unlimited mileage.
- The remainder of your new vehicle limited warranty.

Contact an authorized dealer for details and a copy of the warranty.

**Exterior style**

- Hood deflectors
- Bumper protector
- Side window deflectors
- Splash guards

**Interior style**

- Ambient lighting
- Floor mats
- Cargo area protector
- Rear console

**Lifestyle**

- Ash cup (smoker's package)
- Trailer hitch balls
- Car covers\*
- Rear seat entertainment\*
- Cargo organization and management
- Trailer hitch drawbars, and towing accessories
- Camping tent\*
- Racks and carriers\*
- Roof crossbars

**Peace of mind**

- Keyless entry keypad
- Cargo shade
- Vehicle security systems
- Locking gas plug for capless fuel system
- Wheel locks
- Remote start
- Parking sensors\*

\*The accessory manufacturer designs, develops and therefore warrants Ford Licensed Accessories, and does not design or test these accessories to Ford Motor Company engineering requirements. Contact an authorized Ford dealer for the manufacturer's limited warranty details, and request a copy of the Ford Licensed Accessories product limited warranty from the accessory manufacturer.

For maximum vehicle performance, keep the following information in mind when adding accessories or equipment to your vehicle:

- When adding accessories, equipment, passengers and luggage to your vehicle, do not exceed the total weight capacity of the vehicle or of the front or rear axle (GVWR or GAWR as indicated on the Safety Compliance Certification label). Ask an authorized dealer for specific weight information.
- The Federal Communications Commission (FCC) and Canadian Radio Telecommunications Commission (CRTC) regulate the use of mobile communications systems that are equipped with radio transmitters, for example, two-way radios, telephones and theft alarms. Any such equipment installed in your vehicle should comply with Federal Communications Commission (FCC) and Canadian Radio Telecommunications Commission (CRTC) regulations and should be installed only by an authorized dealer.
- An authorized dealer needs to install mobile communications systems. Improper installation may harm the operation of your vehicle, particularly if the manufacturer did not design the mobile communication system specifically for automotive use.
- If you or an authorized Ford dealer add any non-Ford electrical or electronic accessories or components to your vehicle, you may adversely affect battery performance and durability. In addition, you may also adversely affect the performance of other electrical systems in the vehicle.

**Extended Service Plan**

PROTECT YOURSELF FROM THE RISING COST OF VEHICLE REPAIRS WITH A FORD EXTENDED SERVICE PLAN.

**SERVICE PLANS (U.S. Only)**

More than 32 million Ford owners have discovered the powerful protection of Ford Extended Service Plan. It is the only extended service plan backed by Ford Motor Company, and provides peace of mind protection beyond the New Vehicle Limited Warranty coverage.

**Ford ESP Can Quickly Pay for Itself**

One service bill – the cost of parts and labor – can easily exceed the price of your Ford Extended Service Plan. With Ford ESP, you minimize your risk for unexpected repair bills and rising repair costs.

**Up to 1,000+ Covered Vehicle Components**

There are four Extended Service Plans with different levels of coverage. Ask your authorized dealer for details.

1. PremiumCARE - Our most comprehensive coverage. With over 1,000 covered components, this plan is so complete that we generally only discuss what's not covered.
2. ExtraCARE - Covers 113 components, and includes many high-tech items.
3. BaseCARE - Covers 84 components.
4. PowertrainCARE - Covers 29 critical components.

Ford Extended Service Plan is honored by all authorized Ford dealers in the U.S. and Canada. It is the only extended service plan authorized and backed by Ford Motor Company.

That means you get:

- Reliable, quality service at any Ford or Lincoln dealership
- Repairs performed by factory trained technicians, using genuine parts

**Rental Car Reimbursement***1st day Rental Benefit*

You take advantage of replacement transportation if your vehicle is at your authorized dealer for same day covered repairs.

*Extended Rental Benefits*

If your vehicle is kept overnight for covered repairs, you are eligible for rental car coverage, including bumper to bumper warranty repairs, and Field Service Actions.



**Roadside Assistance**

Exclusive 24/7 roadside assistance, including:

- Towing, flat-tire change and battery jump starts
- Out of fuel and lock-out assistance
- Travel expense reimbursement for lodging, meals and rental car
- Destination assistance for taxi, shuttle, rental car coverage and emergency transportation

**Transferable Coverage**

If you sell your vehicle before your Ford Extended Service Plan coverage expires, you can transfer any remaining coverage to the new owner. Whenever you sell your vehicle, prospective buyers may have a higher degree of confidence that vehicle was properly maintained with Ford ESP, thereby improving resale value.

**Avoid the Rising Cost of Properly Maintaining Your Vehicle!**

Ford Extended Service Plan also offers a Premium Maintenance Plan that covers all scheduled maintenance, and selected wear items. The coverage is prepaid, so you never have to worry about affording your vehicle's maintenance. It covers regular checkups, routine inspections, preventive care and replacement of select items that require periodic attention for normal wear:

- Windshield wiper blades
- Spark plugs (except in California)
- The clutch disc
- Brake pads and linings
- Shock absorbers
- Belts and hoses
- Diesel exhaust fluid replenishment

Contact your selling authorized Ford or Lincoln dealership today so they can customize a Ford Extended Service Plan that fits your driving lifestyle and budget.

**Interest Free Finance Options Available**

Take advantage of our interest free installment payment plan. Just a 10% down payment will provide you with an affordable, no interest, no fee payment program allowing you all the security and benefits Ford ESP has to offer while paying over time. You are pre-approved with no credit checks, no hassles! To learn more, call our Ford ESP specialists at 800-367-3377.

Ford ESP  
P.O. Box 8072  
Royal Oak, MI 48068-0039

**SERVICE PLANS (CANADA ONLY)**

You can get more protection for your vehicle by purchasing a Ford Extended Service Plan. Ford Extended Service Plan is the only service contract backed by Ford Motor Company of Canada, Limited. Depending on the plan you purchase, Ford Extended Service Plan provides benefits such as:

- Rental reimbursement
- Coverage for certain maintenance and wear items
- Protection against repair costs after your New Vehicle Limited Warranty Coverage expires
- Roadside Assistance benefits

There are several Ford Extended Service Plans available in various time, distance and deductible combinations. Each plan is tailored to fit your own driving needs, including reimbursement for towing and rental. When you purchase Ford Extended Service Plan, you receive added peace-of-mind protection throughout Canada and the United States, provided by a network of participating authorized Ford Motor Company dealers.

**Note:** Repairs performed outside of Canada and the United States are not eligible for Ford Extended Service Plan coverage.

This information is subject to change. For more information, visit your local Ford of Canada dealer or [www.ford.ca](http://www.ford.ca) to find the Ford Extended Service Plan that is right for you.

**GENERAL INFORMATION****Radio Frequencies and Reception Factors**

AM and FM frequencies are established by the Federal Communications Commission (FCC) and the Canadian Radio and Telecommunications Commission (CRTC). Those frequencies are:

AM: 530, 540–1700, 1710 kHz

FM: 87.9–107.7, 107.9 MHz

<b>Radio reception factors</b>	
<b>Distance and strength</b>	The further you travel from an FM station, the weaker the signal and the weaker the reception.
<b>Terrain</b>	Hills, mountains, tall buildings, bridges, tunnels, freeway overpasses, parking garages, dense tree foliage and thunderstorms can interfere with the reception.
<b>Station overload</b>	When you pass a ground-based broadcast repeating tower, a stronger signal may overtake a weaker one and result in the audio system muting.

**CD and CD Player Information**

**Note:** CD units play commercially pressed 4.75-inch (12 centimeter) audio compact discs only. Due to technical incompatibility, certain recordable and re-recordable compact discs may not function correctly when used in Ford CD players.

**Note:** Do not insert CDs with homemade paper (adhesive) labels into the CD player as the label may peel and cause the CD to become jammed. You should use a permanent felt tip marker rather than adhesive labels on your homemade CDs. Ballpoint pens may damage CDs. Please contact your authorized dealer for further information.

**Note:** Do not use any irregularly shaped discs or discs with a scratch protection film attached.

Always handle discs by their edges only. Clean the disc with an approved CD cleaner only. Wipe it from the center of the disc toward the edge. Do not clean in a circular motion.

Do not expose discs to direct sunlight or heat sources for extended periods.

---

**MP3 Track and Folder Structure**

Audio systems capable of recognizing and playing MP3 individual tracks and folder structures work as follows:

- There are two different modes for MP3 disc playback: MP3 track mode (system default) and MP3 folder mode.
- MP3 track mode ignores any folder structure on the MP3 disc. The player numbers each MP3 track on the disc (noted by the .mp3 file extension) from T001 to a maximum of T255. **Note:** The maximum number of playable MP3 files may be less depending on the structure of the CD and exact model of radio present.
- MP3 folder mode represents a folder structure consisting of one level of folders. The CD player numbers all MP3 tracks on the disc (noted by the .mp3 file extension) and all folders containing MP3 files, from F001 (folder) T001 (track) to F253 T255.
- Creating discs with only one level of folders helps with navigation through the disc files.

If you are burning your own MP3 discs, it is important to understand how the system reads the structures you create. While various files may be present, (files with extensions other than mp3), only files with the .mp3 extension are played; other files are ignored by the system. This enables you to use the same MP3 disc for a variety of tasks on your work computer, home computer and your in-vehicle system.

In track mode, the system displays and plays the structure as if it were only one level deep (all .mp3 files play, regardless of being in a specific folder). In folder mode, the system only plays the .mp3 files in the current folder.

## MyFord® SYSTEM

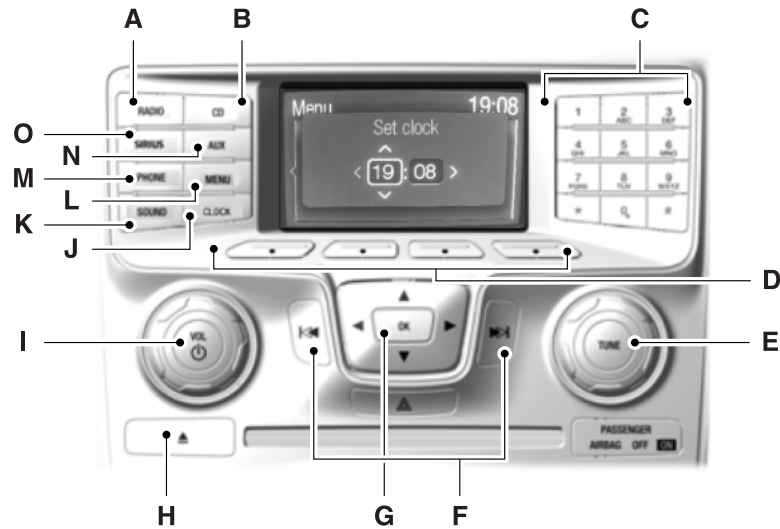

**WARNING:** Driving while distracted can result in loss of vehicle control, crash and injury. We strongly recommend that you use extreme caution when using any device that may take your focus off the road. Your primary responsibility is the safe operation of your vehicle. We recommend against the use of any hand-held device while driving and encourage the use of voice-operated systems when possible. Make sure you are aware of all applicable local laws that may affect the use of electronic devices while driving.

**Note:** Some features, such as Sirius satellite radio, may not be available in your location. Check with an authorized dealer.

A. **RADIO:** Press this button to listen to the radio or change radio frequency bands. Press the function buttons below the radio screen to select different radio functions.

B. **CD:** Press this button to listen to a CD. Press the function buttons below the radio screen to select on-screen options of Repeat or Shuffle.

**C. Memory presets:**

- In radio mode, store your favorite radio stations. To store a radio station, tune to the station, then press and hold a preset button until sound returns.
- In CD mode, press one of these buttons to select a track.

D. **Function buttons:** Select different functions of the audio system depending on which mode you are in (such as Radio mode or CD mode).

**E. TUNE:**

- In radio mode, turn the control to manually search the frequency band.
- In satellite radio mode, turn the control to tune to the next or previous channel.

**F. Reverse and Fast Forward; AM/FM/CD Seek:**

- In radio mode, select a frequency band and press one of these buttons. The system stops at the first station it finds in that direction. Press and hold one of these buttons to move quickly in that direction to the next strong radio station or memory preset.
- In Sirius mode, press one of these buttons to select the previous or next channel. If you select a specific category (such as Jazz, Rock or News), use these buttons to find the previous or next channel in the selected category. Press and hold one of these buttons to move quickly in that direction to the next channel or category.
- In CD mode, press one of these buttons to select the previous or next track. Press and hold one of these buttons to move quickly in that direction within the current track.

**G. OK and arrow buttons:**

- Press the up and down or left and right arrow buttons to browse menu selections.
- Press **OK** to confirm menu selections.

H. **Eject:** Press this button to eject a CD.

**I. Power and Volume:**

- Press this button to switch the system off and on.
- Turn it to adjust the volume.

J. **CLOCK:** Press this button to access the clock setting. Use the center arrow controls to change the hours and minutes.

K. **SOUND:** Press this button to adjust settings for Treble, Midrange, Bass, Balance and Fade.

L. **MENU:** Press this button to access different audio system features. See *Menu structure* later in this section.

M. **PHONE:** Press this button to access the phone features of the SYNC system. See the *SYNC* chapter for more information.

N. **AUX:** Press this button to access your auxiliary input jack or switch between devices you plug into the input jack or USB port. See *Auxiliary input jack* later in this chapter.

O. **SIRIUS:** Press this button to listen to Sirius satellite radio.

### Menu Structure

**Note:** Depending on your system, some options may appear slightly different.

Press **MENU**.

Press the up and down arrow buttons to scroll through the options.

Press the right arrow to enter a menu. Press the left arrow to exit a menu.

Press **OK** to confirm a selection.

<b>Radio Settings</b>	
<b>Scan</b>	Select for a brief sampling of all available channels.
<b>RBDS/RDS Text</b>	Select to view additional broadcast data, if available. This feature defaults to off. RBDS must be on for you to set a category.
<b>SIRIUS</b>	
<b>Scan</b>	Select for a brief sampling of all available channels.
<b>Show ESN</b>	Select to view your satellite radio electronic serial number (ESN). You need this number when communicating with Sirius to activate, modify or track your account.

<b>SIRIUS</b>	
<b>Channel Guide</b>	Select to view available satellite radio channels. Press <b>OK</b> to open a list of the following options for this channel: Tune Channel, Skip Channel or Lock Channel. Once you skip or lock a channel, you can only access it by pressing Direct and entering the channel number. Locking or unlocking a channel requires your PIN.
<b>Set Category</b>	Select to view channel categories (such as Pop, Rock or News). If you select a category, seek and scan functions only stop on channels in that category.
<b>Alerts</b>	Select to turn off or turn on alerts for songs, artists or teams. The system alerts you when the selection is playing on another channel. Save up to 20 alerts.
<b>Unlock All Stations</b>	Use your PIN to unlock previously locked stations.
<b>Skip No Stations</b>	Remove the skip feature from all the channels you previously skipped.
<b>Parental Lock (PIN)</b>	Select to create a PIN, which allows you to lock or unlock channels. Your initial PIN is 1234.
<b>Audio Settings</b>	
<b>Speed Compensated Volume</b>	Automatically adjusts the volume to compensate for speed and wind noise. You can set the system between 0 and +7.
<b>Sound</b>	Select to adjust settings for Treble, Midrange, Bass, Fade and Balance.



<b>CD Settings</b>	
<b>Scan All</b>	Select to scan all disc selections.
<b>Scan Folder</b>	Select to scan all music in the current MP3 folder.
<b>CD Compression</b>	Select to bring soft and loud passages together for a more consistent listening level.
<b>Clock Settings</b>	
<b>Set Time</b>	Select to set the time.
<b>Set Date</b>	Select to set the calendar date.
<b>24h Mode</b>	Select to view clock time in a 12-hour mode or 24-hour mode.
<b>Display Settings</b>	
<b>Dimming</b>	Select to change display brightness.
<b>Language</b>	Select to display the language in English, French or Spanish.
<b>Temp. Setting</b>	Select to display the outside temperature in Fahrenheit or Celsius.

## AM/FM/CD PREMIUM AUDIO SYSTEM

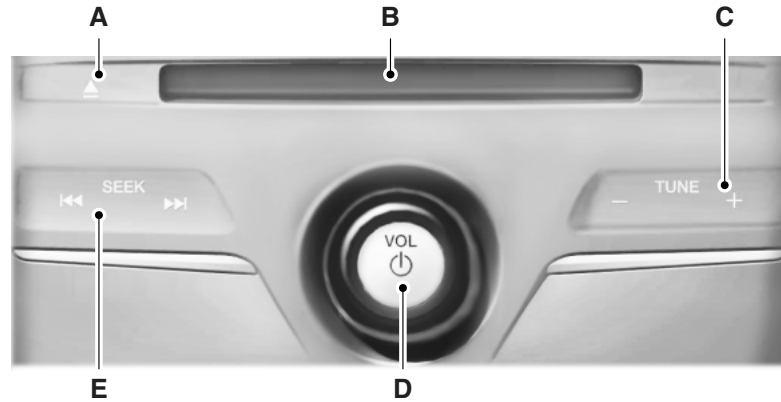

**WARNING:** Driving while distracted can result in loss of vehicle control, crash and injury. We strongly recommend that you use extreme caution when using any device that may take your focus off the road. Your primary responsibility is the safe operation of your vehicle. We recommend against the use of any hand-held device while driving and encourage the use of voice-operated systems when possible. Make sure you are aware of all applicable local laws that may affect the use of electronic devices while driving.

**Note:** The MyFord Touch system controls most of the audio features. See the *MyFord Touch* chapter for more information.

A. **Eject:** Press this button to eject a CD.

B. **CD Slot:** Insert a CD.

C. **TUNE + and TUNE - :**

- In radio mode, press these buttons to manually search through the radio frequency band.
- In Sirius mode, press these buttons to find the next or previous available satellite radio station.

D. **Volume and Power:**

- Press this button to switch the system off and on.
- Turn it to adjust the volume.

**E. SEEK, Reverse and Fast Forward:**

- In radio mode, select a frequency band and press one of these buttons. The system stops at the first station it finds in that direction.
- In Sirius mode, press these buttons to select the previous or next channel. If a specific category is selected (such as Jazz, Rock or News), use these buttons to find the previous or next channel in the selected category.
- In CD mode, press these buttons to select the previous or next track.

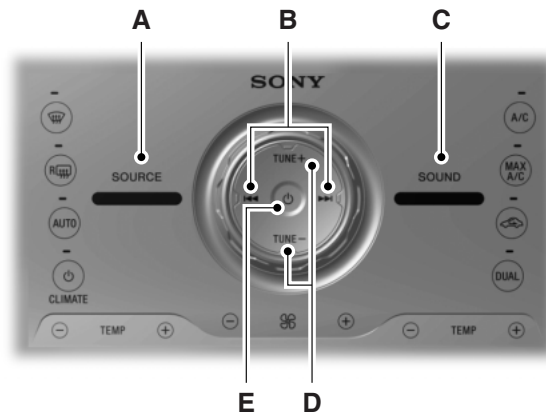
**AM/FM/CD SONY® AUDIO SYSTEM (IF EQUIPPED)**

**WARNING:** Driving while distracted can result in loss of vehicle control, crash and injury. We strongly recommend that you use extreme caution when using any device that may take your focus off the road. Your primary responsibility is the safe operation of your vehicle. We recommend against the use of any hand-held device while driving and encourage the use of voice-operated systems when possible. Make sure you are aware of all applicable local laws that may affect the use of electronic devices while driving.

**Note:** The MyFord Touch system controls most of the audio features. See the *MyFord Touch* chapter for more information.

A. **SOURCE:** Press this button to access different audio modes, such as AM, FM and A/V Input.

**B. Seek, Reverse and Fast Forward:**

- In radio mode, select a frequency band and press one of these buttons. The system stops at the first station it finds in that direction.
- In Sirius mode, press these buttons to select the previous or next channel. If a specific category is selected (such as Jazz, Rock or News), use these buttons to find the previous or next channel in the selected category.
- In CD mode, press these buttons to select the previous or next track.

C. **SOUND:** Press this button to access settings for Treble, Midrange, Bass, Balance and Fade.

**D. TUNE + and TUNE - :**

- In radio mode, press these buttons to manually search through the radio frequency band.
- In Sirius mode, press these buttons to find the next or previous available satellite radio station.

**E. Power and Volume:**

- Press this button to switch the system off and on.
- Turn it to adjust the volume.

**HD RADIO™ INFORMATION (IF AVAILABLE)**

**Note:** HD Radio broadcasts are not available in all markets.

HD Radio technology is the digital evolution of analog AM/FM radio. Your system has a special receiver that allows it to receive digital broadcasts (where available) in addition to the analog broadcasts, it already receives. Digital broadcasts provide a better sound quality than analog broadcasts with free, crystal-clear audio and no static or distortion. For more information, and a guide to available stations and programming, please visit [www.hdradio.com](http://www.hdradio.com).

When HD Radio is on and you tune to a station broadcasting HD Radio technology, you may notice the HD Radio logo on your screen. When this logo is available, you may also see Title and Artist fields on-screen.

The multicast indicator appears in FM mode (only) if the current station is broadcasting multiple digital broadcasts. The highlighted numbers signify available digital channels where new or different content is available. HD1 signifies the main programming status and is available in analog and digital broadcasts. Other multicast stations (HD2 through HD7) are only available digitally.

When HD Radio broadcasts are active, you can access the following functions:

<b>When you select:</b>	<b>You can:</b>
<b>Scan</b>	Hear a brief sampling of all available stations. This feature still works when HD Radio reception is on, although it does not scan for HD2-HD7 channels. You may see the HD logo appear if the station has a digital broadcast.
<b>To save a multicast station as a preset</b>	When the channel is active on-screen, press and hold a memory preset slot until the sound returns. There is a brief mute while the radio saves the station. Sound returns when finished. When recalling a HD2 or HD3 memory preset, there is a mute before the digital audio plays, as the system must once again acquire the digital signal. As with any saved radio station, you cannot access the saved station if your vehicle is outside the station's reception area.

**HD Radio Reception and Station Troubleshooting**

<b>Potential reception issues</b>	
<b>Reception area</b>	<p>If you are listening to a multicast station and you are on the fringe of the reception area, the station may mute due to weak signal strength.</p> <p>If you are listening to HD1, the system switches back to the analog broadcast until the digital broadcast is available again. However, if you are listening to any of the possible HD2 through HD7 multicast channels, the station mutes and stays muted unless it is able to connect to the digital signal again.</p>
<b>Station blending</b>	<p>When the system first receives a station (aside from HD2-HD7 multicast stations), it first plays the station in the analog version. Once the receiver verifies the station is an HD Radio station, it shifts to the digital version. Depending on the station quality, you may hear a slight sound change when the station changes from analog to digital. Blending is the shift from analog to digital sound or digital back to analog sound.</p>

In order to provide the best possible experience, use the contact form to report any station issues found while listening to a station broadcasting with HD Radio technology. Independent entities own and operate each station. These stations are responsible for making sure all audio streams and data fields are accurate.

<b>Potential station issues</b>		
<b>Issue</b>	<b>Cause</b>	<b>Action</b>
Echo, stutter, skip or repeat in audio. Increase or decrease in audio volume.	This is poor time alignment by the radio broadcaster.	No action required. This is a broadcast issue.

Potential station issues		
Issue	Cause	Action
Sound fading or blending in and out.	The radio is shifting between analog and digital audio.	No action required. The reception issue may clear up as you continue to drive.
There is an audio mute delay when selecting HD2 or HD3, multicast preset or <b>Direct Tune</b> .	The digital multicast is not available until the HD Radio broadcast is decoded. Once decoded, the audio is available.	No action required. This is normal behavior. Wait until the audio is available.
Cannot access HD2 or HD3 multicast channel when recalling a preset or from a direct tune.	The previously stored multicast preset or direct tune is not available in your current reception area.	No action required. The station is not available in your current location.
Text information does not match currently playing audio.	Data service issue by the radio broadcaster.	Fill out the station issue form at website listed below.*
There is no text information shown for currently selected frequency.	Data service issue by the radio broadcaster.	Fill out the station issue form at website listed below.*
HD2-HD7 stations not found when <b>Scan</b> is pressed.	Pressing <b>Scan</b> disables HD2-HD7 channel search.	No action required. This is normal behavior.

\*[http://www.ibequity.com/automotive/report\\_radio\\_station\\_experiences](http://www.ibequity.com/automotive/report_radio_station_experiences)

HD Radio™ Technology manufactured under license from iBiquity Digital Corp. U.S. and foreign patents. HD Radio™ and the HD and HD Radio logos are proprietary trademarks of iBiquity Digital Corp. Ford Motor Company and iBiquity Digital Corp. are not responsible for the content sent using HD Radio technology. Content may be changed, added or deleted at any time at the station owner's discretion.

**SATELLITE RADIO INFORMATION (IF EQUIPPED)**

**Satellite Radio Channels**

Sirius broadcasts a variety of music, news, sports, weather, traffic and entertainment satellite radio channels. For more information and a complete list of Sirius satellite radio channels, visit [www.siriusxm.com](http://www.siriusxm.com) in the United States, [www.sirius.ca](http://www.sirius.ca) in Canada, or call Sirius at 1-888-539-7474.

**Note:** This receiver includes the eCos real-time operating system. eCos is published under the eCos License.

**Satellite Radio Reception Factors**

<b>Potential satellite radio reception issues</b>	
<b>Antenna obstructions</b>	For optimal reception performance, keep the antenna clear of snow and ice build-up and keep luggage and other material as far away from the antenna as possible.
<b>Terrain</b>	Hills, mountains, tall buildings, bridges, tunnels, freeway overpasses, parking garages, dense tree foliage and thunderstorms can interfere with your reception.
<b>Station overload</b>	When you pass a ground-based broadcast-repeating tower, a stronger signal may overtake a weaker one and the audio system may mute.
<b>Satellite radio signal interference</b>	Your display may show ACQUIRING . . . to indicate the interference and the audio system may mute.



**Sirius Satellite Radio Service**

**Note:** Sirius reserves the unrestricted right to change, rearrange, add or delete programming including canceling, moving or adding particular channels, and its prices, at any time, with or without notice to you. Ford Motor Company shall not be responsible for any such programming changes.



Sirius satellite radio is a subscription-based satellite radio service that broadcasts a variety of music, sports, news, weather, traffic and entertainment programming.

Your factory-installed Sirius satellite radio system includes hardware and a limited subscription term which begins on the date of sale or lease of your vehicle. See an authorized dealer for availability.

For more information on extended subscription terms (a service fee is required), the online media player and a complete list of Sirius satellite radio channels, and other features, please visit [www.siriusxm.com](http://www.siriusxm.com) in the United States, [www.sirius.ca](http://www.sirius.ca) in Canada, or call Sirius at 1-888-539-7474.

**Satellite Radio Electronic Serial Number (ESN)**

You need your ESN to activate, modify or track your satellite radio account. When in satellite radio mode, you can view this number by pressing **SIRIUS** and memory preset 1 at the same time, or tuning to channel 0. To access your ESN, press the bottom left corner of the touchscreen, then **SIRIUS > Options**.

**Troubleshooting**

Radio display	Condition	Possible action
Acquiring	Radio requires more than two seconds to produce audio for the selected channel.	No action required. This message should disappear shortly.
Sat Fault/SIRIUS system failure	There is an internal module or system failure present.	If this message does not clear shortly, or with an ignition key cycle, your receiver may have a fault. See an authorized dealer for service.

<b>Radio display</b>	<b>Condition</b>	<b>Possible action</b>
Invalid Channel	The channel is no longer available.	Tune to another channel or choose another preset.
Unsubscribed Channel	Your subscription does not include this channel.	Contact Sirius at 1-888-539-7474 to subscribe to the channel, or tune to another channel.
No Signal	The signal is lost from the Sirius satellite or Sirius tower to your vehicle antenna.	The signal is blocked. When you move into an open area, the signal should return.
Updating	Update of channel programming in progress.	No action required. The process may take up to three minutes.
Call SIRIUS 1-888-539-7474	Your satellite service is no longer available.	Call Sirius at 1-888-539-7474 to resolve subscription issues.
None Found. Check Channel Guide.	All the channels in the selected category are either skipped or locked.	Use the channel guide to turn off the Lock or Skip function on that station.
Subscription Updated	Sirius has updated the channels available for your vehicle.	No action required.

**AUXILIARY INPUT JACK**

 **WARNING:** Driving while distracted can result in loss of vehicle control, crash and injury. We strongly recommend that you use extreme caution when using any device that may take your focus off the road. Your primary responsibility is the safe operation of your vehicle. We recommend against the use of any hand-held device while driving and encourage the use of voice-operated systems when possible. Make sure you are aware of all applicable local laws that may affect the use of electronic devices while driving.

 **WARNING:** For safety reasons, do not connect or adjust the settings on your portable music player while your vehicle is moving.

 **WARNING:** Store the portable music player in a secure location, such as the center console or the glove box, when your vehicle is moving. Hard objects may become projectiles in a crash or sudden stop, which may increase the risk of serious injury. The audio extension cable must be long enough to allow the portable music player to be safely stored while your vehicle is moving.

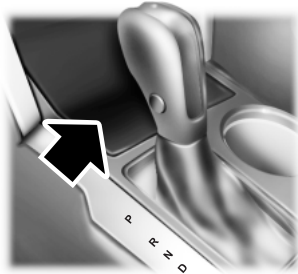

The auxiliary input jack allows you to connect and play music from your portable music player through your vehicle speakers. You can use any portable music player designed for use with headphones. Your audio extension cable must have male 1/8-inch (3.5 millimeter) connectors at each end.

1. Switch off the engine, radio and portable music player. Set the parking brake and put the transmission in position **P**.
2. Plug the extension cable from the portable music player into the auxiliary input jack.
3. Switch the radio on. Select either a tuned FM station or a CD.
4. Adjust the volume as desired.

5. Switch your portable music player on and adjust its volume to half its maximum level.
6. Press **AUX** until **LINE** or **LINE IN** appears in the display. You should hear music from your device even if it is low.
7. Adjust the volume on your portable music player until it reaches the volume level of the FM station or CD. Do this by switching back and forth between the AUX and FM or CD controls.

**USB PORT (IF EQUIPPED)**

**!** **WARNING:** Driving while distracted can result in loss of vehicle control, crash and injury. We strongly recommend that you use extreme caution when using any device that may take your focus off the road. Your primary responsibility is the safe operation of your vehicle. We recommend against the use of any hand-held device while driving and encourage the use of voice-operated systems when possible. Make sure you are aware of all applicable local laws that may affect the use of electronic devices while driving.

The USB port is located in the center console. It allows you to plug in media playing devices, memory sticks and charge devices (if supported). See the *SYNC* chapter for more information.

**MEDIA HUB**

The media hub is located in the center console and has the following features:

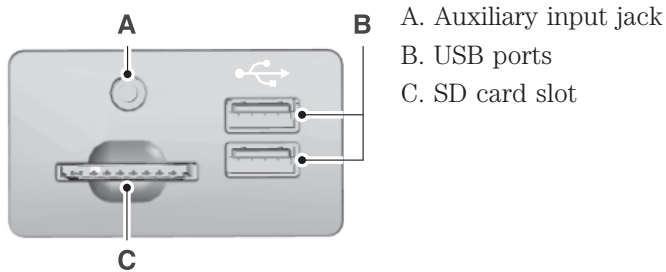

For more information, see the *MyFord Touch* chapter.

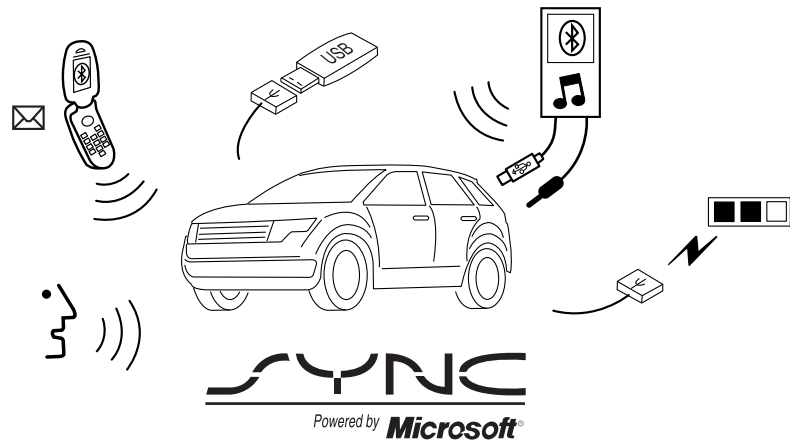

SYNC is an in-vehicle communications system that works with your Bluetooth-enabled cellular phone and portable media player. This allows you to:

- Make and receive calls.
- Access and play music from your portable music player.
- Use 911 Assist, Vehicle Health Report and SYNC Services (Traffic, Directions & Information) (if equipped).
- Use applications, such as Pandora and Stitcher, via SYNC AppLink™ (if applicable).
- Access phonebook contacts and music via voice commands.
- Stream music from your connected phone.
- Text message.
- Use the advanced voice recognition system.
- USB device charging (if your device supports this).

**GENERAL INFORMATION**

Make sure you review your device's manual before using it with SYNC.

**Support**

The SYNC support team is available to help you with any questions you cannot answer on your own.

Monday-Saturday, 8:30am-9:00pm EST.

Sunday, 10:30am-7:30pm EST.

In the United States, call: 1-800-392-3673.

In Canada, call: 1-800-565-3673.

Times are subject to change due to holidays.

**SYNC Owner Account**

Why do I need a SYNC owner account?

- Required to activate Vehicle Health Report and to view the reports online.
- Required to activate the subscription-based SYNC Services and to personalize your Saved Points and Favorites.
- Essential for keeping up with the latest software downloads available for SYNC.
- Access to customer support for any questions you may have.

**Driving Restrictions**

For your safety, certain features are speed-dependent and restricted when your vehicle is traveling over 3 mph (5 km/h).

**Safety Information**

**WARNING:** Driving while distracted can result in loss of vehicle control, crash and injury. We strongly recommend that you use extreme caution when using any device that may take your focus off the road. Your primary responsibility is the safe operation of your vehicle. We recommend against the use of any handheld device while driving and encourage the use of voice-operated systems when possible. Make sure you are aware of all applicable local laws that may affect the use of electronic devices while driving.

When using SYNC:

- Do not operate playing devices if the power cords or cables are broken, split or damaged. Place cords and cables out of the way, so they do not interfere with the operation of pedals, seats, compartments or safe driving abilities.
- Do not leave playing devices in your vehicle during extreme conditions as it could cause them damage. See your device's manual for further information.
- Do not attempt to service or repair the system. See your authorized dealer.

For your safety, some SYNC functions are speed-dependent. Their use is limited to when your vehicle is traveling at speeds under 3 mph (5 km/h).

Make sure that you review your device's manual before using it with SYNC.

### **Privacy Information**

When a cellular phone is connected to SYNC, the system creates a profile within your vehicle that is linked to that cellular phone. This profile is created in order to offer you more cellular features and to operate more efficiently. Among other things, this profile may contain data about your cellular phone book, text messages (read and unread), and call history, including history of calls when your cell phone was not connected to the system. In addition, if you connect a media device, the system creates and retains an index of supported media content. The system also records a short development log of approximately 10 minutes of all recent system activity. The log profile and other system data may be used to improve the system and help diagnose any problems that may occur.

The cellular profile, media device index, and development log remain in the vehicle unless you delete them and are generally accessible only in the vehicle when the cellular phone or media player is connected. If you no longer plan to use the system or the vehicle, we recommend you perform a Master Reset to erase all stored information.

System data cannot be accessed without special equipment and access to the vehicle's SYNC module. Ford Motor Company and Ford of Canada do not access the system data for any purpose other than as described absent consent, a court order, or where required by law enforcement, other government authorities, or other third parties acting with lawful authority. Other parties may seek to access the information independently of Ford Motor Company and Ford of Canada. For further privacy information, see the sections on 911 Assist, Vehicle Health Report, and Traffic, Directions and Information.

**USING VOICE RECOGNITION**

This system helps you control many features using voice commands. This allows you to keep your hands on the wheel and focus on what is in front of you.

**Initiating a Voice Session**



Push the voice icon; a tone sounds and Listening appears in the display. Say any of the following:

Say:	If you want to:
“Phone”	Make calls.
“USB”	Access the device connected to your USB port.
“Bluetooth Audio”	Stream audio from your phone.
“Line in”	Access the device connected to the auxiliary input jack.
“Cancel”	Cancel the requested action.
“SYNC”	Return to the main menu.
“Voice settings”	Adjust the level of voice interaction and feedback.
“Vehicle Health Report”	Run a vehicle health report.*
“Services”	Access the SYNC Services portal.*
“Mobile apps”	Access mobile applications.*
“Help”	Hear a list of voice commands available in the current mode.

\*If equipped, U.S. only.

**System Interaction and Feedback**

The system provides feedback through audible tones, prompts, questions and spoken confirmations depending on the situation and the chosen level of interaction (voice settings). You can customize the voice recognition system to provide more or less instruction and feedback.

The default setting is to a higher level of interaction in order to help you learn to use the system. You can change these settings at any time.



**Adjusting the Interaction Level**

Push the voice icon; when prompted, say “Voice settings”, then any of the following:

<b>When you say:</b>	<b>The system:</b>
“Interaction mode standard”	Provides more detailed interaction and guidance.
“Interaction mode advanced”	Provides less audible interaction and more tone prompts.

The system defaults to the standard interaction mode.

Confirmation prompts are short questions the system asks when it is not sure of your request or when there are multiple possible responses to your request. (For example, the system may ask “Phone, is that correct?”) If turned off, the system simply makes a best guess as to what you requested and you may still occasionally be asked to confirm settings.

“Confirmation prompts on”
“Confirmation prompts off”

The system creates candidate lists when it has the same confidence level of several options based on your voice command. When turned on, you may be prompted with as many as four possibilities for clarification.

For example, “Say 1 after the tone to call John Doe at home. Say 2 after the tone to call Johnny Doe on mobile. Say 3 after the tone to call Jane Doe at home.” Or, “Say 1 after the tone to play John Doe, Say 2 after the tone to play Johnny Doe.”

“Phone candidate lists on”
“Phone candidate lists off”
“Media candidate lists on”
“Media candidate lists off”

**Helpful Hints**

- Make sure the interior of the vehicle is as quiet as possible. Wind noise from open windows and road vibrations may prevent the system from correctly recognizing spoken commands.
- After pressing the voice icon, wait until after the tone sounds and Listening appears before saying a command. Any command spoken prior to this does not register with the system.

- Speak naturally, without long pauses between words.
- At any time you can interrupt the system while it is speaking by pressing the voice icon.

### USING SYNC WITH YOUR PHONE

Hands-free calling is one of the main features of SYNC. While the system supports a variety of features, many are dependent on your cellular phone's functionality. At a minimum, most cellular phones with Bluetooth wireless technology support the following functions:

- Answering an incoming call
- Ending a call
- Using privacy mode
- Dialing a number
- Redialing
- Call waiting notification
- Caller ID.

Other features, such as text messaging using Bluetooth and automatic phonebook download, are phone-dependent features. To check your phone's compatibility, see your phone's user manual and visit [www.SYNCMYRide.com](http://www.SYNCMYRide.com), [www.SYNCMYRide.ca](http://www.SYNCMYRide.ca) or [www.syncmaroute.ca](http://www.syncmaroute.ca).

### Pairing a Phone for the First Time

**Note:** SYNC can support downloading up to approximately 1000 entries per Bluetooth-enabled cellular phone.

**Note:** Make sure the vehicle ignition and radio are turned on and the transmission is in position **P**.

**Note:** To scroll through the menus, press the up and down arrows on your audio system.

Wirelessly pairing your phone with SYNC allows you to make and receive hands-free calls.

1. Press the phone button; when the display indicates no phone is paired, press **OK**.
2. When **Find SYNC** appears in the display, press **OK**.
3. Put your phone into Bluetooth discovery mode. See your phone's user guide if necessary.
4. When prompted on your phone's display, enter the six-digit PIN provided by SYNC in the radio display.
5. The display indicates when the pairing is successful.

Depending on your phone's capability and your market, the system may prompt you with questions such as setting the current phone as the primary phone (the phone SYNC automatically tries to connect with first upon vehicle start-up), downloading your phone book, etc.

### Pairing Subsequent Phones

**Note:** To scroll through the menus, press the up and down arrows on your audio system.

**Note:** Make sure the vehicle ignition and radio are turned on and that the transmission is in position **P**.

1. Press the phone button and scroll until System Settings is selected.
2. Press OK and scroll until Bluetooth Devices is selected and press OK.
3. Scroll until Add Bluetooth Device is selected and press OK.
4. When Find SYNC appears in the display, press OK.
5. Put your phone into Bluetooth discovery mode. See your phone's user guide if necessary.
6. When prompted on your phone's display, enter the six-digit PIN provided by SYNC in the radio display. The display indicates when the pairing is successful.
7. The system then prompts with questions such as if you would like to set the current phone as the primary phone (the phone SYNC automatically tries to connect with first upon vehicle start-up), download your phone book, etc.

### Phone Voice Commands



Press the voice icon and say "Phone". Say any of the following:

<b>"PHONE"</b>
"Call <name>" <sup>1,2</sup>
"Call <name> on mobile OR cell" <sup>1,2</sup>
"Call <name> on other" <sup>1,2</sup>
"Phone book <name> at home" <sup>2</sup>
"Phone book <name> on mobile OR cell" <sup>2</sup>
"Call history outgoing" <sup>2</sup>
"Phone book <name> on Other" <sup>2</sup>
"Call history missed" <sup>2</sup>
"Menu" <sup>2,3</sup>
"Join"

<b>“PHONE”</b>
“Call <name> at home” <sup>1,2</sup>
“Call <name> at work” OR “Call <name> in office” <sup>1,2</sup>
“Dial” <sup>1,4</sup>
“Phone book <name>” <sup>2</sup>
“Phone book <name> at work” OR “Phone book <name> at office” <sup>2</sup>
“Call history incoming” <sup>2</sup>
“Connections” <sup>2</sup>
“Go to privacy”
“Hold”

<sup>1</sup>These commands do not require you to say “Phone” first.

<sup>2</sup>These commands are not available until phone information is completely downloaded using Bluetooth.

<sup>3</sup>See “MENU” table below.

<sup>4</sup>See “DIAL” table below.

<b>“MENU”</b>
“(Phone) connections” <sup>*</sup>
“(Phone) settings (message) notification off” <sup>*</sup>
“(Phone) settings (message) notification on” <sup>*</sup>
“(Phone) settings (set) phone ringer” <sup>*</sup>
“(Phone) settings (set) ringer 1” <sup>*</sup>
“(Phone) settings (set) ringer 2” <sup>*</sup>
“(Phone) settings (set) ringer 3” <sup>*</sup>
“(Phone) settings (set) ringer off” <sup>*</sup>
“Battery”
“Phone name”
“Signal”
“Text message inbox”

<sup>\*</sup>Words in ( ) are optional and do not have to be spoken for the system to understand the command.

**Phone book commands:** When you ask SYNC® to access a phone book name, number, etc., the requested information appears in the display to view. Press the phone button and say “Call” to call the contact.

<b>“DIAL”</b>
“411” (four-one-one), “911” (nine-one-one)
“700 (seven hundred)” (seven hundred)
“800 (eight hundred)” (eight hundred)
“900 (nine hundred)” (nine hundred)
“#” (pound)
“<number> 0–9”
“Asterisk” (*)
“Clear” (deletes all entered digits)
“Delete” (deletes one digit)
“Plus”
“Star”

**Note:** To exit dial mode, press and hold the phone button or press MENU to go to the PHONE menu.

### **Making Calls**

Press the voice icon and when prompted say:

1. Say “Call <name>” or “Dial”, then the desired number.
2. When the system confirms the number, say “Dial” again to initiate the call.

To erase the last spoken digit, say “Delete” or press the left arrow button. To erase all spoken digits, say “Clear” or press and hold the left arrow button.

To end the call, press and hold the phone button.

### **Receiving Calls**

When receiving a call, you can:

- Answer the call by pressing the phone button.
- Reject the call by pressing and holding the phone button.
- Ignore the call by doing nothing.

**Phone Options during an Active Call**

During an active call, you have additional menu features which become available such as putting a call on hold, joining calls, etc. Use the arrow buttons to scroll through the menu options.

To access:

1. Press MENU during an active call.
2. When Active Call Menu is selected, press OK.
3. Scroll to cycle through the following options:

When you select:	You can:
<b>Mute Call?</b>	Mute the call.
<b>Privacy</b>	Switch a call from an active hands-free environment to your cellular phone for a more private conversation. Press OK when Privacy on/off appears. (The display indicates In Privacy and the system transfers your call.)
<b>Call Hold</b>	Put an active call on hold. Press OK when Place Call on Hold? appears. To answer another call at this time, press the phone button.
<b>Join Calls</b>	Join two separate calls. 1. Press the phone button. 2. Access the desired contact through SYNC or use voice commands to place the second call. Once actively in the second call, press MENU. 3. Scroll until Join Calls appears and press OK. Press OK again when Join Calls? appears. <b>Note:</b> SYNC supports a maximum of three callers on a multiparty/conference call.
<b>Enter Tones</b>	Enter “tones” such as numbers for passwords. Scroll until the desired number appears in the display, then press OK; a tone sounds as confirmation. Repeat as necessary.

<b>When you select:</b>	<b>You can:</b>
<b>Phonebook</b>	Access your phonebook contacts. 1. Press OK to select, then scroll through your phonebook contacts. 2. Press OK again when the desired selection appears in the display. 3. Press the phone button.
<b>Call History</b>	Access your call history log. 1. Press OK to select, then scroll through your call history options (incoming, outgoing or missed). 2. Press OK when the desired selection appears in the display. 3. Press the phone button to call the selection.
<b>Return</b>	Exit the current menu.

**Accessing Features through the Phone Menu**

SYNC's phone menu allows you to redial a number, access your call history and phone book and send text messages as well as access phone and system settings. You can also access advanced features, such as 911 Assist, Vehicle Health Report and SYNC Services.

1. Press the phone button to enter the Phone Menu.
2. Scroll to cycle through:

When you select:	You can:
<b>Phone Redial</b>	Redial the last number called (if available). Press OK to select, then press OK again to confirm.
<b>Call History<sup>1</sup></b>	Allows you to access any previously dialed, received or missed calls while your phone has been connected to the system. 1. Press OK to select. 2. Scroll to select from Call History Incoming, Call History Outgoing or Call History Missed. Press OK make your selection. 3. Press OK or the phone button to call the desired selection. <b>Note:</b> The system attempts to automatically re-download your phone book and call history each time your phone connects to SYNC (if the auto download feature is on and your Bluetooth-enabled cellular phone supports this feature).
<b>Phonebook<sup>1,2</sup></b>	Allows you to access your downloaded phonebook. 1. Press OK to confirm and enter. If your phonebook has fewer than 255 listings, they appear alphabetically in flat file mode. If there are more, they are organized into alphabetical categories. 2. Scroll until the desired contact appears, then press OK. 3. Press OK or the phone button.



When you select:	You can:
<b>Text Message</b> <sup>1</sup>	Enables you to send, download and delete text messages.
<b>Phone Settings</b> <sup>1</sup>	Allows you to view your phone's status, set ring tones, select your message notification, change phone book entries and automatically download your cellular phone among other features.
<b>SYNC Services</b> <sup>3</sup>	Access the SYNC services portal where you can request various types of information, traffic reports and directions.
<b>911 Assist</b> <sup>4</sup>	Place an emergency call to a 911 operator for you after an accident (if the feature is used properly).
<b>Vehicle Health Report</b> <sup>3</sup>	Create and receive a diagnostic report card on your vehicle.
<b>Mobile Apps</b> <sup>3</sup>	Interact with SYNC-capable mobile applications on your smartphone.
<b>System Settings</b>	Access Bluetooth Devices menu listings (add, connect, set as primary, on/off, delete) as well as Advanced menu listings (prompts, languages, defaults, master reset, install application and system information).
<b>Exit Phone Menu</b>	Exit the phone menu by pressing OK.

<sup>1</sup>This is a phone-dependent feature.

<sup>2</sup>This is a phone-dependent and speed-dependent feature.

<sup>3</sup>If equipped, United States only.

<sup>4</sup>If equipped, United States and Canada only.

### Text Messaging

**Note:** This is a phone-dependent feature.

SYNC allows you to receive, send, download and delete text messages. The system can also read incoming text messages to you so that you do not have to take your eyes off the road.

**Receiving a Text Message**

**Note:** This is a phone-dependent feature. Your phone must support downloading text messages using Bluetooth to receive incoming text messages.

**Note:** Forwarding a text message is a speed-dependent feature and can only be done when the vehicle is traveling at 3 mph (5 km/h) or less.

**Note:** Only one recipient is allowed per text message.

When a new message arrives, an audible tone sounds and the display indicates you have a new message. You have these options:

1. Press the voice button, wait for the prompt and say "Read Message" to have SYNC read the message to you.
2. Press OK to receive and open the text message or do nothing and the message goes into your text message inbox. Press OK again and SYNC reads your message aloud as you are not able to view the message. You can then also choose whether you'd like to reply or forward the message.
3. Press OK and scroll to choose between:
  - Reply to Text Message: Press OK to access and then scroll through the list of pre-defined messages to send.
  - Forward Text Message: Press OK to forward the message to anyone in your Phonebook or Call History. You can also choose Enter Number.

**Sending, Downloading and Deleting Your Text Messages**

Text messaging is a phone-dependent feature. If your phone is compatible, SYNC allows you to receive, send, download and delete text messages.

1. Press the phone button.
2. Scroll until Text Message appears and press OK.
3. Scroll to select from the following options:

**Send Text Message?** enables you to send a new text message based on a pre-defined set of 15 messages.

**Download Unread Msgs** allows you to download your unread messages (only) to SYNC. To download the messages, press OK to select. The display indicates your messages are being downloaded. When complete, SYNC takes you to your inbox.

**Delete All Messages?** allows you to delete current text messages from SYNC (not your phone). To delete the messages, press OK to select. The display indicates when all your text messages have been deleted and SYNC returns you to the text message menu.

**Note:** SYNC does not automatically download all of your unread text messages at every ignition cycle (as it does with call history and phonebook if automatic download is set to on).

**Return** exits the current menu when you press OK.

If you select **Send Text Message?**:

1. Press OK to select. If the system detects your phone does not support this feature, Unsupported appears in the display and SYNC returns to the main menu.
2. Scroll to cycle through the message options in the following chart.
3. Press OK when the desired selection is in the display. The system now needs to know who to send the message to.
4. Scroll to cycle through Phonebook or Call History entries. You can also select Enter Number to audibly enter a desired number.
5. Press OK to enter the desired menu and scroll to select the specific contact.
6. Press OK when the contact appears and press OK again to confirm when the system asks if you would like to send the message. Each text message is sent with the following signature: "This message was sent from my <Ford or Lincoln>".

<b>Pre-defined text message options</b>
Can't talk right now
Call me
Call you later
Be there in 10 minutes
Be there in 20 minutes
Yes
No
Why?
Thanks
Where R you?
I need more directions
I love you
Too funny
Can't wait to see you
I'm stuck in traffic

**Accessing Your Phone Settings**

These are phone-dependent features. Your phone settings allow you to access and adjust features such as your ring tone, text message notification, modify your phone book and also set up automatic download.

1. Press the phone button.
2. Scroll until Phone Settings appears, then press OK.
3. Scroll to select from the following options:

When you select:	You can:
<b>Phone Status</b>	See the provider, name, signal power, battery power and roaming status of your connected phone. Press OK to select and scroll to view the information. When done, press OK again to return to the phone status menu.
<b>Set Ringer</b>	Select which ring tone sounds during an incoming call (one of the system's or your phone's). 1. Press OK to select and scroll to hear Ringer 1, Ringer 2, Ringer 3 and Phone Ringer. 2. Press OK to select. <b>Note:</b> If your phone supports in-band ringing, your phone's ringer sounds when Phone Ringer is chosen.
<b>Message Notification</b>	Have the option of hearing an audible tone to notify you when a text message arrives. 1. Press OK to select and scroll between Message Notification On or Message Notification Off. 2. Press OK to select.

When you select:	You can:
<b>Modify Phonebook</b>	<p>Modify the contents of your phone book (such as add, delete, download). Press OK to select and scroll between:</p> <p>Add Contacts: Press OK to add more contacts from your phone book. Push the desired contact(s) on your phone. See your phone's user guide on how to push contacts.</p> <p>Delete Phonebook: Press OK to delete the current phone book and call history. When Delete Phonebook appears, press OK to confirm. SYNC takes you back to the Phone Settings menu.</p> <p>Download Phonebook: Press OK to select and press OK again when Confirm Download? appears.</p>
<b>Auto Download</b>	<p>Automatically download your phone book each time your phone connects to SYNC. Press OK to select. When Auto Download On? appears, press OK to have your phonebook automatically downloaded each time.</p> <p>Select Off to NOT download your phonebook every time your phone connects to SYNC. Your phonebook, call history and text messages can only be accessed when your specific phone is connected to SYNC.</p> <p><b>Note:</b> Downloading times are phone- and quantity-dependent.</p> <p><b>Note:</b> When auto download is on, any changes, additions or deletions saved since your last download are deleted.</p>
<b>Return</b>	Exit the current menu.

**System Settings**

System Settings provide access to your Bluetooth Devices and Advanced menu features. Use the arrow buttons to scroll through the menu options.

The Bluetooth Devices menu allows you to add, connect, delete and set a phone as primary as well as turn your Bluetooth feature on and off.

The Advanced menu allows you to access and set prompts, languages, defaults, perform a master reset, install an application and view system information.

**Bluetooth Devices Menu Options**

This menu allows you to add, connect, delete, set a phone as primary, and turn Bluetooth on or off.

1. Press the phone button to enter the Phone Menu.
2. Scroll until System Settings appears and press OK.
3. Scroll until Bluetooth Devices appears and select OK.
4. Scroll to select from the following options:

If you select:	You can:
<b>Add Bluetooth Device*</b>	See <i>Using SYNC with your phone</i> earlier in this chapter for pairing instructions.
<b>Connect Bluetooth Device</b>	Connect a previously paired Bluetooth-enabled phone. 1. Press OK to select and view a list of previously paired phones. 2. Scroll until the desired device is chosen, then press OK to connect the phone. <b>Note:</b> Only one device can be connected at a time. When another phone is connected, the previous one is disconnected.
<b>Set Primary Phone</b>	Set a previously paired phone as your primary phone. Press OK to select and scroll to select the desired phone. Press OK to confirm. <b>Note:</b> SYNC attempts to connect with the primary phone at every ignition cycle. When a phone is selected as primary, it appears first in the list and is marked with an asterisk (*).

If you select:	You can:
<b>Set Bluetooth On/Off</b>	Turn the Bluetooth feature on and off. Press OK and scroll to toggle between On and Off. When the desired selection is chosen, press OK. <b>Note:</b> Turning Bluetooth off disconnects all Bluetooth devices and deactivates all Bluetooth features.
<b>Delete Device</b>	Delete a paired phone. Press OK and scroll to select the device. Press OK to confirm.
<b>Delete All Devices</b>	Delete all previously paired phones (and all information originally saved with those phones). Press OK to select.
<b>Return</b>	Exit the current menu.

\*This is a speed-dependent feature.

**Advanced Menu Options**

This menu allows you to access settings such as prompts, languages, defaults, perform a master reset, install an application and view system information.

1. Press the phone button to enter the Phone Menu.
2. Scroll until System Settings appears and press OK.
3. Scroll until Advanced appears and select OK.
4. Scroll to select from the following options:

<b>If you select:</b>	<b>You can:</b>
<b>Prompts</b>	Get help from SYNC by using questions, helpful hints or asking you for a specific action. To turn these prompts on or off: 1. Press OK to select and scroll to select between on or off. 2. Press OK when the desired selection appears in the display. SYNC takes you back to the Advanced menu.
<b>Languages</b>	Choose between English, Espanol and Francais. Once selected, all of SYNC's radio displays and prompts are in the selected language. 1. Press OK to select and then scroll through the languages. 2. Press OK when the desired selection appears in the display. If you change the language setting, the display indicates that the system is updating. When complete, SYNC takes you back to the Advanced menu.
<b>Factory Defaults</b>	Return to the factory default settings. This selection does not erase your indexed information (phonebook, call history, text messages and paired devices). 1. Press OK to select and then press OK again when Restore Defaults? appears in the display. 2. Press OK to confirm.



If you select:	You can:
<b>Master Reset</b>	Completely erase all information stored on SYNC (phonebook, call history, text messages and paired devices) and return to the factory default settings. Press OK to select. The display indicates when complete and SYNC takes you back to the Advanced menu.
<b>Install Application</b>	Install applications you have downloaded. Press OK and scroll to select. Press OK to confirm.
<b>System Info</b>	Access the Auto Version number as well as the FPN number. Press OK to select.
<b>MAP Profile</b>	This is a Bluetooth component which can further help your phone with the exchange of text messages.
<b>Return</b>	Exit the current menu.

#### SYNC APPLICATIONS AND SERVICES (IF EQUIPPED)

**Note:** In order for the following features to work, your cellular phone must be compatible with SYNC. To check your phone's compatibility, visit [www.SYNCMYride.com](http://www.SYNCMYride.com), [www.SYNCMYride.ca](http://www.SYNCMYride.ca) or [www.syncmaroute.ca](http://www.syncmaroute.ca).

- SYNC Services (if equipped, United States only): Provides access to traffic, directions and information such as travel, horoscopes, stock prices and more.
- 911 Assist: Can alert 911 in the event of an emergency.
- Vehicle Health Report (if equipped, United States only): Provides a diagnostic and maintenance report card of your vehicle.

**911 Assist®**

**WARNING:** Unless the 911 Assist setting is set on prior to a crash, the system will not dial for help which could delay response time, potentially increasing the risk of serious injury or death after a crash.



**WARNING:** Do not wait for 911 Assist to make an emergency call if you can do it yourself. Dial emergency services immediately to avoid delayed response time which could increase the risk of serious injury or death after a crash. If you do not hear 911 Assist within five seconds of the crash, the system or phone may be damaged or non-functional.



**WARNING:** Always place your phone in a secure location in the vehicle so it does not become a projectile or get damaged in a crash. Failure to do so may cause serious injury to someone or damage the phone which could prevent 911 Assist from working properly.

**Note:** SYNC 911 Assist feature must be set on prior to the incident.

**Note:** Before setting this feature on, ensure that you read the 911 Assist privacy notice later in this section for important information.

**Note:** If 911 Assist is turned on or off by any user, that setting applies for all paired phones. If 911 Assist is turned off, a voice message plays and/or a display message/icon comes on when the vehicle is started after a previously paired phone connects.

**Note:** Every phone operates differently. While SYNC 911 Assist works with most cellular phones, some may have trouble using this feature.

If a crash deploys an airbag (excludes knee airbags and rear inflatable safety belts [if equipped]) or activates the fuel pump shut-off, your SYNC equipped vehicle may be able to contact emergency services by dialing 911 through a paired and connected Bluetooth-enabled phone. For more information about 911 Assist, visit [www.SYNCMYRide.com](http://www.SYNCMYRide.com), [www.SYNCMYRide.ca](http://www.SYNCMYRide.ca) or [www.syncmaroute.ca](http://www.syncmaroute.ca).

- For information on airbag deployment, see the *Supplementary Restraints System* chapter.
- For information on the fuel pump shut-off, see the *Roadside Emergencies* chapter.

**Setting 911 Assist On**

Perform the following:

1. Press the phone button to enter the Phone Menu.
2. Scroll until 911 Assist is selected.
3. Press OK to confirm and enter the 911 Assist menu.
4. Scroll to select between On and Off selections.
5. Press OK when the desired option appears in the radio display. Set On or Set Off appears in the display as confirmation.

Off selections include: Off with reminder and Off without reminder. Off with reminder provides a display and voice reminder at phone connection at vehicle start. Off without reminder provides a display reminder only without a voice reminder at phone connection.

To make sure that 911 Assist works properly:

- SYNC must be powered and working properly at the time of the incident and throughout feature activation and use.
- SYNC 911 Assist feature must be set on prior to the incident.
- A Bluetooth-enabled and compatible phone has to be paired and connected to SYNC.
- A connected Bluetooth-enabled phone must have the ability to make and maintain an outgoing call at the time of the incident.
- A connected Bluetooth-enabled phone must have adequate network coverage, battery power and signal strength.
- The vehicle must have battery power and be located in the United States, Canada or in a territory in which 911 is the emergency number.

**In the Event of a Crash**

Not all crashes deploy an airbag or activate the fuel pump shut-off (which would activate 911 Assist); however, if 911 Assist is triggered, SYNC tries to contact emergency services. If a connected phone is damaged or loses connection to SYNC, SYNC searches for, and tries to connect to, any available previously paired phone and tries to make the call to 911.

Before making the call:

- SYNC provides a short window of time (about 10 seconds) to cancel the call. Failure to cancel the call results in SYNC attempting to dial 911.
- SYNC says the following, or a similar message: “SYNC will attempt to call 911, to cancel the call, press Cancel on your screen or press and hold the phone button on your steering wheel.”

If the call is not cancelled and a successful call is made, a pre-recorded message is played for the 911 operator, then the occupant(s) in the vehicle is able to talk with the operator. Be prepared to provide your name, phone number and location immediately, because not all 911 systems are capable of receiving this information electronically.

**911 Assist May Not Work If**

- Your cellular phone or 911 Assist hardware was damaged in a crash.
- The vehicle's battery or SYNC system has no power.
- The phone(s) paired and connected to the system was thrown from the vehicle.

**911 Assist Privacy Notice**

Once 911 Assist is set on, it may disclose to emergency services that the vehicle has been in a crash involving the deployment of an airbag or activation of the fuel pump shut-off. Certain versions or updates to 911 Assist may also be capable of electronically or verbally disclosing to 911 operators the vehicle location, and/or other details about the vehicle or crash to assist 911 operators to provide the most appropriate emergency services. If you do not want to disclose this information, do not turn the feature on.

**Vehicle Health Report**

**WARNING:** Always follow scheduled maintenance instructions, regularly inspect your vehicle, and seek repair for any damage or problem you suspect. Vehicle Health Report supplements, but cannot replace normal maintenance and vehicle inspection. Vehicle Health Report only monitors certain systems that are electronically monitored by the vehicle and will not monitor or report the status of any other system, (i.e., brake lining wear). Failure to perform scheduled maintenance and regularly inspect your vehicle may result in vehicle damage and serious injury.

**Note:** Your Vehicle Health Report feature requires activation prior to use. Visit [www.SYNCMYride.com](http://www.SYNCMYride.com) to register. There is no fee or subscription associated with Vehicle Health Report, but you must register to use this feature.

**Note:** This feature may not function properly if you have enabled caller ID blocking on your mobile phone. Before running a report, review the *Vehicle Health Report privacy notice*.

**Note:** In order to allow a break-in period for your vehicle, you may not be able to create a Vehicle Health Report until your vehicle odometer has reached 200 miles.

Register for Vehicle Health Report and set your report preferences at [www.SYNCMYRide.com](http://www.SYNCMYRide.com). After registering, you can request a Vehicle Health Report (inside your vehicle). Return to your account at [www.SYNCMYRide.com](http://www.SYNCMYRide.com) to view your report. You can also choose for SYNC to automatically remind you to run reports at specific mileage intervals. Cellular phone airtime usage may apply when reporting.

The system allows you to check your vehicle's overall health in the form of a diagnostic report card. The vehicle health report contains valuable information such as:

- Vehicle Diagnostic Information
- Scheduled maintenance
- Open Recalls and Field Service Actions
- Unserved items from vehicle inspections by your authorized dealer.

You can run a report (after the vehicle has been running a minimum of 60 seconds) by pressing the voice button and saying "Vehicle health report", or pressing the phone button.

To run a report using the phone button:

1. Press the phone button to enter Phone Menu.
2. Scroll until Vehicle Health is selected and press OK.
3. Scroll to select from the following options:

<b>Vehicle Health Report options</b>	
<b>User Preferences:</b> <b>Press OK to select and enter the menu.</b> <b>Scroll to select from:</b>	<b>Automatic Reports:</b> Press OK and select on or off. Select On to have SYNC automatically prompt you to run a health report at certain mileage intervals. <b>Note:</b> You must first turn this feature on before you can select the mileage intervals at which you would like to be prompted.
	<b>Mileage Intervals:</b> Press OK. Scroll to select between 5000, 7500 or 10000 mile intervals and press OK to make your selection.
	<b>Return:</b> Press OK to exit the menu.

Vehicle Health Report options	
<b>Run Report?</b>	Press OK for SYNC to run a health report of your vehicle's diagnostic systems and send the results to Ford where it is combined with scheduled maintenance information, open recalls and other field service actions and unserviced vehicle inspection items from your authorized dealer.

**Vehicle Health Report Privacy Notice**

When you run a Vehicle Health Report, Ford Motor Company may collect your cellular phone number (to process your report request) and diagnostic information about your vehicle. Certain versions or updates to Vehicle Health Report may also collect additional vehicle information. Ford may use the vehicle information it collects for any purpose. If you do not want to disclose your cellular phone number or vehicle information, do not run the feature or set up your Vehicle Health Report profile at [www.SYNCMYRide.com](http://www.SYNCMYRide.com). See [www.SYNCMYRide.com](http://www.SYNCMYRide.com) - Vehicle Health Report Terms and Conditions, and Privacy Statement - for more information.

**SYNC Services: Traffic, Directions & Information (TDI)  
(If Equipped, United States Only)**

**Note:** SYNC Services varies by trim level and model year and may require a subscription. Traffic alerts and turn-by-turn directions available in select markets. Message and data rates may apply. Ford Motor Company reserves the right to change or discontinue this product service at any time without prior notification or incurring any future obligation.

**Note:** SYNC Services requires activation prior to use. Visit [www.SYNCMYRide.com](http://www.SYNCMYRide.com) to register and check your eligibility for complimentary services. Standard phone and message rates may apply. Subscription may be required. You must also have the active SYNC Services Bluetooth-enabled cellular phone paired and connected to the system in order to connect to, and use, SYNC Services. See *Using SYNC with your phone* for pairing instructions.

**Note:** This feature does not function properly if you have enabled caller ID blocking on your mobile phone. Make sure your mobile phone is not blocking caller ID before using SYNC Services.

**Note:** The driver is ultimately responsible for the safe operation of the vehicle, and therefore, must evaluate whether it is safe to follow the suggested directions. Any navigation features are provided only as an aid. Make your driving decisions based on your observations of local conditions and existing traffic regulations. Do not follow the route suggestions if doing so would result in an unsafe or illegal maneuver, if you would be placed in an unsafe situation, or if you would be directed into an area that you consider unsafe. Maps used by this system may be inaccurate because of errors, changes in roads, traffic conditions or driving conditions.

**Note:** When you connect, the service uses GPS technology and advanced vehicle sensors to collect the vehicle's current location, travel direction and speed to help provide you with the directions, traffic reports, or business searches you request. Further, to provide the services you request and for continuous improvement, the service may collect and record call details and voice communications. For more information, see SYNC Services Terms and Conditions at [www.SYNCMYride.com](http://www.SYNCMYride.com). If you do not want Ford or its service providers to collect the vehicle travel information or other information identified in the Terms and Conditions, do not activate or use the service.

SYNC Services uses advanced vehicle sensors, integrated GPS technology and comprehensive map and traffic data, to give you personalized traffic reports, precise turn-by-turn directions, business search, news, sports, weather and more. For a complete list of services, or to learn more, please visit [www.SYNCMYride.com](http://www.SYNCMYride.com).

### ***Connecting to SYNC Services Using Voice Commands***

1. Press the voice button.
2. When prompted, say "Services". This initiates an outgoing call to SYNC Services using your paired and connected Bluetooth-enabled cellular phone.
3. Once you are connected to the service, follow the voice prompts to request the desired service, such as "Traffic" or "Directions". You can also say "What are my choices?" to receive a complete list of available services from which to choose.
4. Say "Services" to return to the services main menu or for help, say "Help".

---

**Connecting to SYNC Services Using the Phone Menu**

1. Press the phone button to enter the Phone Menu.
2. Scroll until *Services* appears in the display.
3. Press OK to confirm and enter the Services menu. The display indicates the system is connecting.
4. Press OK. SYNC initiates the call to the Services portal.
5. Once connected, follow the voice prompts to request your desired Service, such as Traffic or Directions. You can also say “What are my choices?” to receive a complete list of available services from which to choose.
6. To return to the Services menu, say “Services” or for help, say “Help”.

**Receiving Turn-by-Turn Directions**

1. When connected to SYNC Services, say “Directions” or “Business search”. To find the closest business or type of business to your current location, just say “Business search” and then “Search near me”. If you need further assistance in finding a location you can say “Operator” at any time within a Directions or Business search to speak with a live operator. You may also be prompted to speak with an operator when the automatic system has difficulty matching your voice request. The live operator can assist you by searching for businesses by name or by category, residential addresses by street address or by name or specific street intersections. Operator Assist is a feature of your SYNC Services subscription. For more information on Operator Assist visit [www.SYNCMYride.com/support](http://www.SYNCMYride.com/support).
2. Follow the voice prompts to select your destination. Once your destination is selected, your current vehicle location is uploaded and a route based on current traffic conditions is calculated and sent back to your vehicle. After the route download is complete, the phone call is automatically ended. You then receive audible and visual driving instructions as you travel toward your destination.
3. While on an active route, you can select or say “Route summary” or “Route status” to view the Route Summary turn list or the Route Status ETA. You can also turn voice guidance on or off, cancel the route or update the route.

If you miss a turn, SYNC automatically asks if you want the route updated. Just say, “Yes” when prompted and a new route will be delivered to your vehicle.



**Disconnecting from SYNC Services**

1. Press and hold the phone button on the steering wheel.
2. Say “Good-bye” from the SYNC Services main menu.

<b>SYNC Services quick tips</b>	
<b>Personalizing</b>	You can personalize your Services feature to provide quicker access to your most used or favorite information. You can save address points such as work or home. You can also save favorite information like sports teams or a news category. To learn more, log onto <a href="http://www.SYNCMYride.com">www.SYNCMYride.com</a> .
<b>Push to interrupt</b>	Press the voice button at any time (while you are connected to SYNC Services) to interrupt a voice prompt or an audio clip (such as a sports report), wait for the listening tone, and say your voice command.
<b>Portable</b>	Your subscription is associated with your Bluetooth-enabled cellular phone number, not your VIN (Vehicle Identification Number). You can pair and connect your phone to any vehicle equipped with SYNC Services and continue enjoying your personalized services. You can even access your account outside the vehicle. Just use the number on your phone’s call history. Traffic and Directions features do not function properly but information services and the 411 connect and text message features are available.

**USING SYNC WITH YOUR MEDIA PLAYER**

You can access and play music from your digital music player over the vehicle’s speaker system using the system’s media menu or voice commands. You can also sort and play your music by specific categories, such as artists or albums.

**Note:** The system is capable of indexing up to 30,000 songs.

SYNC is capable of hosting nearly any digital media player including: iPod, Zune™, Plays from device players, and most USB drives. SYNC also supports audio formats such as MP3, WMA, WAV and ACC.

### Connecting Your Digital Media Player via the USB Port

**Note:** If your digital media player has a power switch, ensure that the device is turned on.

To connect using voice commands:

1. Plug the device into the vehicle's USB port.
2. Press the voice icon and when prompted, say "USB".
3. You can now play music by saying any of the appropriate voice commands. See the media voice commands.

To connect using the system menu:

1. Plug the device into the vehicle's USB port.
2. Press AUX and then MENU to enter the Media Menu.
3. Scroll until Select Source appears and press OK.
4. Scroll to select USB and press OK.
5. Depending on how many digital media files are on your connected device, Indexing may appear in the radio display. When indexing is complete, the screen returns to the Play Menu.
6. Press OK and scroll through selections of:
  - Play All
  - Artists
  - Albums
  - Genres
  - Playlists
  - Tracks
  - Explore USB
  - Similar Music
  - Return

When the desired selection appears in the display, press OK to build your desired music selection.

### What's Playing?



At any time when a track is playing, you can press the voice icon and ask the system, "What's playing?". The system reads the metadata tags (if populated) of the playing track to you.

**Media Voice Commands**

Press the voice icon and, when prompted, say “USB” then any of the following:

<b>“USB”</b>
“Autoplay off”
“Autoplay on”
“(Phone) (Media) (Bluetooth) Connections”
“Pause”
“Play”
“Play album <name>” <sup>1,3</sup>
“Play all”
“Play artist <name>” <sup>1,3</sup>
“Play genre <name>” <sup>1,3</sup>
“Play next folder” <sup>2</sup>
“Play next track”
“Play playlist <name>” <sup>1,3</sup>
“Play previous folder” <sup>2</sup>
“Play previous track”
“Play song <name>” <sup>1,3</sup>
“Play track <name>” <sup>1,3</sup>
“Refine album <name>” <sup>1,3</sup>
“Refine artist <name>” <sup>1,3</sup>
“Refine song <name>” <sup>1,3</sup>
“Refine track <name>” <sup>1,3</sup>
“Repeat off”
“Repeat on”
“Search album <name>” <sup>1,3</sup>
“Search artist <name>” <sup>1,3</sup>
“Search genre <name>” <sup>1,3</sup>
“Search song <name>” <sup>1,3</sup>
“Search track <name>” <sup>1,3</sup>
“Shuffle off”
“Shuffle on”

<b>“USB”</b>
“Similar music”
“What’s playing?”

<sup>1</sup>“<name>” is a dynamic listing, meaning that it could be the name of any desired group, artist, etc.

<sup>2</sup>Voice commands which are only available in folder mode.

<sup>3</sup>Voice commands which are not available until indexing is complete.

<b>Voice command guide</b>	
<b>“Autoplay”</b>	Turn on to listen to music which has already been randomly indexed during the indexing process. Turn off and the system does not begin to play any of your music until all media has all been indexed. Indexing times can vary from device to device and also with regard to the number of songs being indexed.
<b>“Search/Play Genre”</b>	The system searches all the data from your indexed music and, if available, begins to play the chosen type of music. You can only play genres of music which are present in the GENRE metadata tags that you have on your digital media player.
<b>“Similar Music”</b>	The system compiles a playlist and then plays similar music to what is currently playing from the USB port using indexed metadata information.

<b>Voice command guide</b>	
<b>“Search/Play Artist/Track/Album”</b>	The system searches for a specific artist/track/album from the music indexed through the USB port.
<b>“Refine”</b>	This allows you to make your previous command more specific. For example, if you asked to search and play all music by a certain artist, you could then say “refine album” and choose a specific album from the list to view. If you then select Play, the system only plays music from that specific album.

Press the voice icon and when prompted say “Bluetooth Audio” and then any of the following:

<b>“BLUETOOTH AUDIO”</b>
“(Phone) (Media) (Bluetooth) Connections”
“Pause”
“Play”
“Play next track ”
“Play previous track ”

**Media Menu Features**

The media menu allows you to select your media source, how to play your music (by artist, genre, shuffle, repeat, etc.), and also to add, connect or delete devices.

1. Press AUX and then MENU to enter the Media Menu.
2. Scroll to cycle through:

When you select:	You can:
<b>Play Menu</b>	Play your music by artist, album, genre, playlists, tracks, similar music or to simply, play all. You can also choose to Explore USB to view the supported digital music files on your playing device. See Play Menu later in this section for more information.
<b>Select Source</b>	<p><b>SYNC USB:</b> Press OK to access music plugged into your USB port. You can also plug in devices to charge them (if supported by your device). Once connected, the system indexes any readable media files. (The time required to complete this depends on the size of the media content being indexed.) If Autoplay is on, you can access media files randomly as they are indexed. If turned off, indexed media is not available until the indexing process is complete. SYNC is capable of indexing thousands of average size media and notifies you if the maximum indexing file size is reached.</p> <p><b>Bluetooth Audio:</b> This is a phone-dependent feature which allows you to stream music playing on your Bluetooth-enabled phone. If supported by your device, you can press SEEK to play the previous or next track.</p> <p><b>SYNC Line In:</b> Press OK to select and play music from your portable music player over the vehicle's speakers.  <b>Note:</b> If you have already connected a device to the USB port, you cannot access the line in feature. Some digital media players require both USB and line in ports to stream data and music separately.</p>

When you select:	You can:
<b>Media Settings</b>	<p>Choose to shuffle or repeat your music and select your Autoplay settings. Once these selections are turned on, they remain on until turned off. Press SEEK to play the previous or next track.</p> <p><b>Note:</b> Some digital media players require both USB and line in ports to stream data and music separately. Press OK to select and then scroll to choose from:</p> <p><b>Shuffle:</b> Press OK to shuffle available media files in the current playlist. <b>Note:</b> To shuffle all media tracks, you must select Play All in the Play Menu and then select Shuffle.</p> <p><b>Repeat:</b> Press OK to repeat any song.</p> <p><b>Autoplay:</b> Press OK to listen to music which has already been randomly indexed during the indexing process.</p>
<b>Mobile Apps</b>	Interact with SYNC-capable mobile applications on your smart phone. See <i>SYNC AppLink</i> earlier in this chapter for more information.
<b>System Settings</b>	<p>Access Bluetooth Device menu listings (add, connect, set as primary, on/off, delete) as well as Advanced menu listings (prompts, languages, defaults, master reset, install application and system information).</p> <p><b>Note:</b> See System Settings for more information.</p>
<b>Exit Media Menu</b>	Press OK to exit the media menu.

### Accessing Your Play Menu

This menu allows you to select and play your media by artist, album, genre, playlist, track, similar music or even to explore what is on your USB device.

1. Make sure that your device is plugged into the USB port and is turned on.
2. Press AUX and then MENU to enter the Media Menu.
3. Scroll to select the Play Menu and press OK.

If there are no media files to access, the display indicates there is no media. If there are media files, you have the following options to scroll through and select from:

<b>When you select:</b>	<b>You can:</b>
<b>Play All</b>	Play all indexed media (tracks) from your playing device in flat file mode, one at a time in numerical order. Press OK to select. The first track title appears in the display.
<b>Artists</b>	Sort all indexed media by artist. Once selected, the system lists and then play all artists and tracks alphabetically. If there are less than 255 indexed artist, they are listed alphabetically in flat file mode. If there are more, they are categorized in alphabetical categories. 1. Press OK to select. You can select to play All Artists or any indexed artist. 2. Scroll until the desired artist is chosen and press OK.
<b>Albums</b>	Sort all indexed media by albums. If there are less than 255 indexed albums, they are listed alphabetically in flat file mode. If there are more, they are organized into alphabetical categories. 1. Press OK to enter the album menu and select from playing all albums or from any individual indexed album. 2. Scroll until the desired album is chosen and press OK.



<b>When you select:</b>	<b>You can:</b>
<b>Genres</b>	Sort indexed music by genre (category) type. SYNC lists the genres alphabetically in flat file mode. If there are more than 255, SYNC automatically organizes them into alphabetical categories. Press OK to select and then scroll to select the desired genre and press OK.
<b>Playlists</b>	Access your playlists (from formats such as ASX, .M3U, .WPL, .MTP). The system lists your playlists alphabetically in flat file mode. If there are more than 255, they are organized into alphabetical categories. Press OK to select. Then scroll to select the desired playlist and press OK.
<b>Tracks</b>	Search for and play a specific track which has been indexed. SYNC lists your tracks alphabetically in flat file mode. If there are more than 255, SYNC automatically organizes them into alphabetical categories. Press OK to select. Then scroll to select the desired track and press OK.
<b>Explore USB</b>	Explore all supported digital media on your media device connected to the USB port. You can only view media content which is compatible with SYNC; other files saved are not visible. Press OK to select. Then scroll to explore indexed media on your flash drive.

When you select:	You can:
<b>Similar Music</b>	Play music similar to what is currently playing from the USB port. The system uses the metadata information of each song to compile a playlist for you. Press OK to select. The system creates a new list of similar songs and begins playing. The metadata tags must be populated for this feature to include each track. <b>Note:</b> With certain playing devices, if your metadata tags are not populated, the tracks won't be available in voice recognition, play menu or similar music. However, if you place these tracks onto your playing device in "Mass Storage Device Mode", they are available in voice recognition, play menu browsing and similar music. Unknowns are placed into any unpopulated metadata tag.
<b>Return</b>	Exit the current menu.

**System Settings**

System settings provide access to your Bluetooth Devices and Advanced menu features.

The Bluetooth Devices menu allows you to add, connect and delete a device as turn the Bluetooth feature on and off.

Your Advanced menu allows you to access and set prompts, languages, defaults and perform a master reset.

**Bluetooth Devices Menu Options**

This menu allows you to add, connect and delete devices as well as turn Bluetooth on and off.

1. Press AUX and then MENU to enter the Media Menu.
2. Scroll until System Settings appears and select OK.
3. Scroll until Bluetooth Devices appears.
4. Press OK and then scroll to select from:

<b>When you select:</b>	<b>You can:</b>
<b>Add Bluetooth Device*</b>	Allows you to pair additional devices to the system. 1. Press OK to select and press OK again when Find SYNC appears in the display. 2. Follow the directions in your phone's user guide to put your phone into discovery mode. A six-digit PIN appears in the display. 3. When prompted on your phone's six-digit display, enter the PIN.
<b>Connect Bluetooth Device</b>	Connect a previously paired Bluetooth-enabled phone. 1. Press OK to select and view a list of devices. 2. Scroll until the desired device is chosen and press OK to connect the device.
<b>Set Bluetooth On/Off</b>	Turn the Bluetooth feature on and off. Press OK and scroll to toggle between On and Off. When the desired selection is chosen, press OK. Turning Bluetooth off disconnects all Bluetooth devices and deactivates Bluetooth features.
<b>Delete Device</b>	Delete a paired media device. Press OK and scroll to select the device. Press OK to confirm.
<b>Delete All Devices</b>	Delete all previously paired devices. Press OK to select.
<b>Return</b>	Exit the current menu.

\*This is a speed-dependent feature

**Advanced Menu Options**

This menu allows you to access settings such as prompts, language, performing a master reset as well as returning to factory defaults.

1. Press AUX and then MENU to access the Media Menu.
2. Scroll until System Settings appears and select OK.
3. Scroll until Advanced appears.
4. Press OK and then scroll to select from the following:

<b>When you select:</b>	<b>You can:</b>
<b>Prompts</b>	Have SYNC guide you via questions, helpful hints or ask you for a specific action. <ol style="list-style-type: none"> <li>1. Press OK to select and scroll to select between on or off.</li> <li>2. Press OK when the desired selection appears in the display. SYNC takes you back to the Advanced menu.</li> </ol>
<b>Languages</b>	Choose from English, Francais and Espanol. The displays and prompts are in the selected language. <ol style="list-style-type: none"> <li>1. Press OK to select and then scroll through the languages.</li> <li>2. Press OK when the desired selection appears in the display.</li> <li>3. If you change the language setting, the display indicates that the system is updating. When complete, SYNC takes you back to the Advanced menu.</li> </ol>
<b>Factory Defaults</b>	Return to the factory default settings. This selection does not erase your indexed information (phonebook, call history, text messages and paired devices). <ol style="list-style-type: none"> <li>1. Press OK to select and then press OK again when Restore Defaults? appears in the display.</li> <li>2. Press OK to confirm.</li> </ol>

<b>When you select:</b>	<b>You can:</b>
<b>Master Reset</b>	Completely erase all information stored on SYNC (all phonebook, call history, text messages and all paired devices) and return to the factory default settings.
<b>Application</b>	Download new software applications (if available) and then load the desired applications through your USB port. See the web site for more information.
<b>Return</b>	Exit the current menu.

### TROUBLESHOOTING

Your SYNC system is easy to use. However, should questions arise, see the tables below.

Use the website at any time to check your phone's compatibility, register your account and set preferences as well as access a customer representative via an online chat (during certain hours). Visit [www.SYNCMYRide.com](http://www.SYNCMYRide.com), [www.SYNCMYRide.ca](http://www.SYNCMYRide.ca) or [www.syncmaroute.ca](http://www.syncmaroute.ca) for more information.

<b>Phone issues</b>		
<b>Issue</b>	<b>Possible cause(s)</b>	<b>Possible solution(s)</b>
Excessive background noise during a phone call.	The audio control settings on your phone may be affecting SYNC performance.	Review your phone's user guide regarding audio adjustments.
During a call, I can hear the other person but they cannot hear me.	Possible phone malfunction.	Try turning off the device, resetting the device, removing the device's battery, then trying again.

Phone issues		
Issue	Possible cause(s)	Possible solution(s)
SYNC is not able to download my phonebook.	<ul style="list-style-type: none"> <li>• This is a phone-dependent feature, OR</li> <li>• Possible phone malfunction.</li> </ul>	<ul style="list-style-type: none"> <li>• Go to the website to review your phone's compatibility.</li> <li>• Try turning off the device, resetting the device or removing the device's battery, then trying again.</li> <li>• Try pushing your phonebook contacts to SYNC by using the Add Contacts feature.</li> <li>• Use the SYNCmyphone feature available on the website.</li> </ul>
The system says Phonebook Downloaded but my phonebook in SYNC is empty or is missing contacts.	Limitations on your phone's capability.	<ul style="list-style-type: none"> <li>• Try pushing your phonebook contacts to SYNC by using the Add Contacts feature.</li> <li>• If the missing contacts are stored on your SIM card, try moving them to the device memory.</li> <li>• Remove any pictures or special ring tones associated with the missing contact.</li> </ul>

Phone issues		
Issue	Possible cause(s)	Possible solution(s)
I am having trouble connecting my phone to SYNC.	<ul style="list-style-type: none"> <li>• This is a phone-dependent feature, OR</li> <li>• Possible phone malfunction.</li> </ul>	<ul style="list-style-type: none"> <li>• Go to the website to review your phone's compatibility.</li> <li>• Try turning off the device, resetting the device or removing the device's battery, then trying again.</li> <li>• Try deleting your device from SYNC, deleting SYNC from your device and trying again.</li> <li>• Check the security and auto accept/prompt always settings relative to the SYNC Bluetooth connection on your phone.</li> <li>• Update your device's software firmware.</li> <li>• Turn off the Auto phonebook download setting.</li> </ul>
Text messaging is not working on SYNC.	<ul style="list-style-type: none"> <li>• This is a phone-dependent feature, OR</li> <li>• Possible phone malfunction.</li> </ul>	<ul style="list-style-type: none"> <li>• Go to the website to review your phone's compatibility.</li> <li>• Try turning off the device, resetting the device or removing the device's battery, then trying again.</li> </ul>

USB and media issues		
Issue	Possible cause(s)	Possible solution(s)
I am having trouble connecting my device.	Possible device malfunction.	<ul style="list-style-type: none"> <li>• Try turning off the device, resetting the device or removing the device's battery, then trying again.</li> <li>• Make sure you are using the manufacturer's cable.</li> <li>• Make sure the USB cable is properly inserted into the device and the vehicle's USB port.</li> <li>• Make sure that the device does not have an auto-install program or active security settings.</li> </ul>
SYNC does not recognize my device when I turn on the car.	This is a device limitation.	Make sure you are not leaving the device in your vehicle during very hot or cold temperatures.
Bluetooth audio does not stream.	<ul style="list-style-type: none"> <li>• This is a phone-dependent feature, OR</li> <li>• The device is not connected.</li> </ul>	Make sure the device is connected to SYNC and that you have pressed play on your device.



<b>USB and media issues</b>		
<b>Issue</b>	<b>Possible cause(s)</b>	<b>Possible solution(s)</b>
SYNC does not recognize music that is on my device.	<ul style="list-style-type: none"> <li>• Your music files may not contain the proper artist, song title, album or genre information, OR</li> <li>• The file may be corrupted, OR</li> <li>• The song may have copyright protection which does not allow it to play.</li> </ul>	<ul style="list-style-type: none"> <li>• Make sure that all song details are populated.</li> <li>• Some devices require you to change the USB settings from mass storage to MTP class.</li> </ul>

<b>Vehicle Health Report and SYNC Services (Traffic, Directions and Information) issues</b>		
<b>Issue</b>	<b>Possible cause(s)</b>	<b>Possible solution(s)</b>
I received a text that the Vehicle Health Report is not activated.	<ul style="list-style-type: none"> <li>• Your account may not be activated on the website, OR</li> <li>• You may have the wrong VIN (vehicle identification number) listed.</li> </ul>	<ul style="list-style-type: none"> <li>• This is a free feature, but you must first register online to use it.</li> <li>• Make sure that your VIN is correctly listed in your account.</li> </ul>

<b>Vehicle Health Report and SYNC Services (Traffic, Directions and Information) issues</b>		
<b>Issue</b>	<b>Possible cause(s)</b>	<b>Possible solution(s)</b>
I am unable to retrieve the report on the website, or I receive a system error.	The preferred dealer information did not load correctly.	When you register your account, you must list a preferred dealer. If one is already listed, try selecting another dealer and logging out. Log back in and change it back to your preferred dealer and retrieve the report.
I am unable to submit a report.	<ul style="list-style-type: none"> <li>• This could be due to your phone's compatibility, OR</li> <li>• Bad signal strength, OR</li> <li>• Your phone may not be activated on the website.</li> </ul>	<ul style="list-style-type: none"> <li>• Update your mobile number in your account on the website.</li> <li>• Make sure you have full signal strength and that your <i>Bluetooth</i> volume level has been turned up.</li> <li>• Try deleting your phone and performing a clean pairing.</li> </ul>
I heard a commercial when I tried to use Traffic, Directions and Information.	<ul style="list-style-type: none"> <li>• The phone in use is not activated, OR</li> <li>• Your phone has ID blocker active.</li> </ul>	<ul style="list-style-type: none"> <li>• This is a free feature, but you must first register online to use it.</li> <li>• Turn off ID blocker on your phone as the system recognizes you by your phone number.</li> <li>• Make sure the currently connected phone is the same one that is registered on your SyncMyRide account.</li> </ul>

<b>Voice command issues</b>		
<b>Issue</b>	<b>Possible cause(s)</b>	<b>Possible solution(s)</b>
SYNC does not understand what I am saying.	<ul style="list-style-type: none"> <li>• You may be using the wrong voice commands, OR</li> <li>• You may be speaking too soon or at the wrong time.</li> </ul>	<ul style="list-style-type: none"> <li>• Review the Phone voice commands and the Media voice commands at the beginning of their respective sections.</li> <li>• Be aware that SYNC's microphone is either in your rear view mirror or in the headliner just above the windshield.</li> </ul>
SYNC does not understand the name of a song or artist.	<ul style="list-style-type: none"> <li>• You may be using the wrong voice commands, OR</li> <li>• You may not be saying the name exactly as it is saved, OR</li> <li>• The system may not be reading the name the same way you are saying it.</li> </ul>	<ul style="list-style-type: none"> <li>• Review the media voice commands at the beginning of the media section.</li> <li>• Say the song or artist exactly as listed. If you say, "Play Artist Prince", the system does not play music by Prince and the Revolution or Prince and the New Power Generation.</li> <li>• Make sure you are saying the complete title, such as "California remix featuring Jennifer Nettles".</li> <li>• If the songs are saved in all CAPS, you have to spell them. LOLA requires you to say, "Play L-O-L-A".</li> <li>• Do not use special characters in the title as the system does not recognize them.</li> </ul>

Voice command issues		
Issue	Possible cause(s)	Possible solution(s)
<p>SYNC does not understand or is calling the wrong contact when I want to make a call.</p>	<ul style="list-style-type: none"> <li>• You may be using the wrong voice commands, OR</li> <li>• You may not be saying the name exactly as it is saved, OR</li> <li>• Contacts in your phonebook may be very short and similar, or they may contain special characters, OR</li> <li>• Your phonebook contacts may be saved in CAPS.</li> </ul>	<ul style="list-style-type: none"> <li>• Review the phone voice commands at the beginning of the phone section.</li> <li>• Make sure you are saying the contacts exactly as listed. For example, if a contact is saved as Joe Wilson, say “Call Joe Wilson”.</li> <li>• The system works better if you list full names, such as “Joe Wilson” rather than “Joe”.</li> <li>• Do not use special characters such as 123 or ICE, as the system does not recognize them.</li> <li>• If contacts are saved in CAPS, you have to spell them. JAKE requires you to say, “Call J-A-K-E”.</li> </ul>

<b>AppLink issues</b>		
<b>Issue</b>	<b>Possible cause(s)</b>	<b>Possible solution(s)</b>
SYNC does not find any mobile apps that are on my phone.	<ul style="list-style-type: none"> <li>• Your device may not support the AppLink feature, OR</li> <li>• The application does not support AppLink., OR</li> <li>• If you have an iPhone, it may not be plugged in, OR</li> <li>• Your phone may not be paired or connected.</li> </ul>	<ul style="list-style-type: none"> <li>• Check the website for compatible devices and applications.</li> <li>• Make sure your device is paired and connected. If you have an iPhone, make sure it is plugged in using the USB and that the application is running in the foreground.</li> </ul>

**INTRODUCTION**

 **WARNING:** Driving while distracted can result in loss of vehicle control, crash and injury. We strongly recommend that you use extreme caution when using any device that may take your focus off the road. Your primary responsibility is the safe operation of your vehicle. We recommend against the use of any hand-held device while driving and encourage the use of voice-operated systems when possible. Make sure you are aware of all applicable local laws that may affect the use of electronic devices while driving.

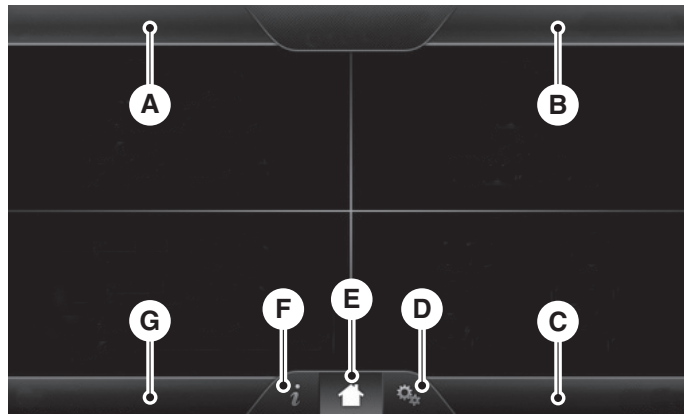

- A. Phone
- B. Navigation (or Information if your vehicle is not equipped with Navigation)
- C. Climate
- D. Settings
- E. Home
- F. Information
- G. Entertainment

This system uses a four-corner strategy to provide quick access several vehicle features and settings. The touchscreen provides easy interaction with your cellular phone, multimedia, climate control and navigation system. The corners display any active modes within those menus, such as phone status or the climate temperature.

**Note:** Some features are not available while your vehicle is moving.

**Note:** Your system is equipped with a feature that allows you to access and control audio features for 30 minutes after you switch the ignition off (and no doors open).

**PHONE**

Press to select any of the following:

- Making and Receiving Calls
- Quick Dial
- Phonebook
- Call History
- Text Messaging
- Settings

**NAVIGATION**

Press to select any of the following:

- My Home
- Favorites
- Previous Destinations
- Point of Interest
- Emergency
- Street Address
- Intersection
- City Center
- Map
- Edit Route Cancel Route

**CLIMATE**

Press to select any of the following:

- Driver Settings
- Recirculated Air
- Auto
- Dual
- Passenger Settings
- A/C
- Defrost

**SETTINGS**

Press to select any of the following:

- Clock
- Display
- Sound
- Vehicle
- Settings
- Help

**HOME**

Press to access your home screen. Depending on your vehicle's option package and software, your screens may vary in appearance from the descriptions in this section. Your features may also be limited depending on your market. Check with your authorized dealer for availability.

**INFORMATION**

Press to select any of the following:

- SYNC Services
- Sirius Travel Link
- Alerts
- Calendar
- SYNC Apps

If the icon is yellow, see *Alerts* in the *Information* section of this chapter.

**ENTERTAINMENT**

Press to select any of the following:

- AM
- FM
- SIRIUS
- CD
- USB
- BT Stereo
- SD Card
- A/V In



**Using the Touch-sensitive Controls on Your System**

To turn a feature on and off, just touch the graphic with your finger.

To get the best performance from the touch-sensitive controls:

- Do not press hard on the controls. They are sensitive to light touch.
- Use your bare finger to touch the center of a touch-control graphic. Touching off-center of the graphic may affect operation of a nearby control.
- Make sure your hands are clean and dry.
- Keep metal and other conductive material away from the surface of the touchscreen as this may cause electronic interference (for example, inadvertently turning on a feature other than the one you meant to turn on).

Depending on your vehicle and option package, you may also have these controls on your bezel:

- Power: Switch the media or climate features off and on.
- **VOL:** Control the volume of playing media.
- Fan: Control the speed of the climate system fan.
- Seek and Tune buttons: Use as you normally would in media modes.
- Eject: Eject a CD from the entertainment system.
- **SOURCE:** Touch the word repeatedly to see all available media modes. The screen does not change, but you see the media change in the lower left status bar.
- **SOUND:** Touch the word to access the Sound menu where you can adjust settings such as: Bass, Treble, Midrange, Balance and Fade, THX Deep Note Demo, DSP (Digital Signal Processing), Occupancy Mode and Speed Compensated Volume. (Your vehicle may not have all of these sound options.)
- Hazard flasher: Switch the hazard flashers off and on.

**Cleaning the Touchscreen Display**

Use a clean, soft cloth such as one used for cleaning glasses. If dirt or fingerprints are still visible, apply a small amount of alcohol to the cloth. Do not pour or spray alcohol onto the display. Do not use detergent or any type of solvent to clean the display.

**Support**

The SYNC support team is available to help you with any questions you cannot answer on your own.

Monday-Saturday, 8:30am-9:00pm EST.

Sunday, 10:30am-7:30pm EST.

In the United States, call: 1-800-392-3673.

In Canada, call: 1-800-565-3673.

Times are subject to change due to holidays.

**Safety Information**

**WARNING:** Driving while distracted can result in loss of vehicle control, crash and injury. We strongly recommend that you use extreme caution when using any device that may take your focus off the road. Your primary responsibility is the safe operation of your vehicle. We recommend against the use of any handheld device while driving and encourage the use of voice-operated systems when possible. Make sure you are aware of all applicable local laws that may affect the use of electronic devices while driving.

When using SYNC:

- Do not operate playing devices if the power cords or cables are broken, split or damaged. Place cords and cables out of the way, so they do not interfere with the operation of pedals, seats, compartments or safe driving abilities.
- Do not leave playing devices in your vehicle during extreme conditions as it could cause them damage. See your device's manual for further information.
- Do not attempt to service or repair the system. See your authorized dealer.

For your safety, some SYNC functions are speed-dependent. Their use is limited to when your vehicle is traveling at speeds under 3 mph (5 km/h).

Make sure that you review your device's manual before using it with SYNC.

**Speed-restricted Features**

Some features of this system may be too difficult to use while your vehicle is moving so they are restricted from use unless your vehicle is stationary.

- Screens that are too crowded with information, such as Point of Interest reviews and ratings, Sirius Travel Link sports scores, movie times and ski conditions.
- Any action that requires you to use a keyboard is restricted, such as entering a navigation destination or editing information.
- All lists are limited so the user can view fewer entries (such as phone contacts or recent phone call entries).

See the following chart for more specific examples:

<b>Restricted Features</b>	
Cellular Phone	Pairing a Bluetooth phone
	Adding phonebook contacts or uploading phonebook contacts (from a USB)
	List entries are limited for phone contacts and recent phone call entries
System Functionality	Editing the keypad code
	Enabling Valet Mode
	Editing settings while the rear view camera or Active Park Assist are active
Wi-Fi and Wireless	Editing wireless settings
	Editing the list of wireless networks
Videos, Photos and Graphics	Playing video
	Editing the screen's wallpaper or adding new wallpaper
Text Messages	Composing text messages
	Viewing received text messages
	Editing preset text messages
Navigation	Using the keyboard to enter a destination
	Demo navigation route
	Adding or Editing Address Book entries or Avoid Areas

**Privacy Information**

When a cellular phone is connected to SYNC, the system creates a profile within your vehicle that is linked to that cellular phone. This profile is created in order to offer you more cellular features and to operate more efficiently. Among other things, this profile may contain data about your cellular phone book, text messages (read and unread), and call history, including history of calls when your cell phone was not connected to the system. In addition, if you connect a media device, the system creates and retains an index of supported media content. The system also records a short development log of approximately 10 minutes of all recent system activity. The log profile and other system data may be used to improve the system and help diagnose any problems that may occur.

The cellular profile, media device index, and development log remain in the vehicle unless you delete them and are generally accessible only in the vehicle when the cellular phone or media player is connected. If you no longer plan to use the system or the vehicle, we recommend you perform a Master Reset to erase all stored information.

System data cannot be accessed without special equipment and access to the vehicle's SYNC module. Ford Motor Company and Ford of Canada do not access the system data for any purpose other than as described absent consent, a court order, or where required by law enforcement, other government authorities, or other third parties acting with lawful authority. Other parties may seek to access the information independently of Ford Motor Company and Ford of Canada. For further privacy information, see the sections on 911 Assist, Vehicle Health Report, and Traffic, Directions and Information.

**ACCESSING AND ADJUSTING MODES THROUGH YOUR RIGHT VEHICLE INFORMATION DISPLAY (IF EQUIPPED)**

The display is located on the right side of your instrument cluster. You can use your steering wheel controls to view and make minor adjustments to active modes without taking your hands off the wheel. For example:

- In Entertainment mode, you can view what is now playing, change the audio source (such as AM, FM and CD) and scroll through memory presets.
- In Phone mode, you can accept or reject an incoming call, or make a call by choosing from select menus within the Phone menu.
- If your vehicle is equipped with Navigation, you can view the current route or cancel a route.

**Note:** If your vehicle is not equipped with Navigation, Compass appears in the display instead of Navigation. If you press the right arrow to go into the Compass menu, you can see the compass graphic. The compass displays the direction in which the vehicle is traveling, not true direction. (For example, if the vehicle is traveling west, the middle of the compass graphic displays west; north displays to the left of west though its true direction is to the right of west).

**Audio Sources and Memory Presets**

Use the **OK** and arrow buttons on the right side of your steering wheel to scroll through the available modes.

You can make selections from the menu by using the **OK** button. The selection menu expands and different options appear.

- Press **OK** to enter the mode.
- Press the left or right arrows to make adjustments within the chosen mode. Small white arrows appear in the menu you are in which indicate that you can scroll in those directions to enter more menus.
- Press **OK** to confirm your selection.

You can also use the arrow buttons to scroll through memory presets of the currently playing audio source.

**USING VOICE RECOGNITION**

This system helps you control many features using voice commands. This allows you to keep your hands on the wheel and focus on what is in front of you. The system provides feedback through audible tones, prompts, questions and spoken confirmations depending on the situation and the chosen level of interaction (voice settings).

The system also asks short questions (confirmation prompts) when it is not sure of your request or when there are multiple possible responses to your request.

When using voice commands, words and icons may appear in the lower left status bar indicating the status of the voice session (such as Listening, Success, Failed, Paused or Try Again).

**How to Use Voice Commands with Your System**

Press the voice icon. After the tone, speak your command clearly.

<b>These commands can be said at any time.</b>
“Cancel”
“Exit”
“Go back”
“List of commands”
“Main menu”
“Next page”
“Previous page”
“What can I say?”
“Help”

**What Can I Say?**

To access the available voice commands for the current session, do one of the following:

- During a voice session, press the Help icon (?) in the lower left status bar of the screen.
- Say, “What can I say?” for an on-screen listing of the possible voice commands associated with your current voice session.
- Press the voice icon. After the tone, say, “Help” to hear a list of possible voice commands.

**Helpful Hints**

- Make sure the interior of your vehicle is as quiet as possible. Wind noise from open windows and road vibrations may prevent the system from correctly recognizing spoken commands.
- After pressing the voice icon, wait until after the tone sounds and Listening appears before saying a command. Any command spoken prior to this does not register with the system.
- Speak naturally, without long pauses between words.
- At any time, you can interrupt the system while it is speaking by pressing the voice icon.

**Accessing a List of Available Commands**

- If you use the touchscreen, press the Settings icon > **Help** > **Voice Command List**.
- If you use the steering wheel control, press the voice icon. After the tone, speak your command clearly.

<b>Voice command list</b>
“Audio list of commands”
“Bluetooth audio list of commands”
“Browse list of commands”
“CD list of commands”
“Climate control list of commands”
“List of commands”
“Navigation list of commands”*
“Phone list of commands”
“Radio list of commands”
“SD card list of commands”
“Sirius satellite list of commands”**
“Travel link list of commands”*
“USB list of commands”
“Voice instructions list of commands”
“Voice settings list of commands”
“Help”

\*This command is only available when your vehicle is equipped with the navigation system, and the navigation system SD card is in the card slot.

\*\*This command is only available when you have an active Sirius satellite radio subscription.

**Voice Settings**

Voice settings allow you to customize the level of system interaction, help and feedback. The system defaults to standard interaction that uses candidate lists and confirmation prompts as these provide the highest level of guidance and feedback.

**Interaction Mode:** Novice mode provides detailed interaction and guidance while the advanced mode has less audible interaction and more tone prompts.



**Confirmation Prompts:** The system uses these short questions to confirm your voice request. If turned off, the system simply makes a best guess as to what you requested. The system may still occasionally ask you to confirm settings.

**Phone/Media Candidate Lists:** Candidate lists are lists of possible results from your voice commands. The system creates these lists when it has the same confidence level of several options based on your voice command.

To access these settings using the touchscreen:

1. Press the Settings icon > **Settings** > **Voice Control**.
2. Select from:
  - Interaction Mode
  - Confirmation Prompts
  - Media Candidate Lists
  - Phone Candidate Lists
  - Voice Control Volume.

To access these settings using voice commands:



Press the voice icon. Wait for the prompt “Please say a command”. Another tone sounds to let you know the system is listening.

<b>Voice settings using voice commands</b>
“Interaction Mode Novice”
“Interaction Mode Advanced”
“Confirmation Prompts On”
“Confirmation Prompts Off”
“Phone Candidate Lists On”
“Phone Candidate Lists Off”
“Media Candidate Lists On”
“Media Candidate Lists Off”
“Help”

### **Using Voice Commands with the Touchscreen Options**

Your voice system has a dual mode feature which allows you to switch between using voice commands and making on-screen selections. This is available only when the system displays a list of candidates generated during a voice session. For example, when entering in a street address or trying to call a contact from the phone you paired to the system.

## ENTERTAINMENT



A. AM 1 and AM AST

B. FM 1, FM 2 and FM AST

C. SIRIUS

D. CD

E. USB

F. Touch this button to scroll down for more options, such as:

- SD Card
- BT Stereo
- A/V In

G. These buttons change with the media mode you are in.

H. Radio memory presets and CD controls.

**Note:** Some features may not be available in your area. Contact an authorized dealer for more information.

You can access these options using the touchscreen or voice commands.

**Browsing Device Content**

When listening to audio on a device, you can browse through other devices without having to change sources. For example, if you are currently listening to audio on an SD card, you can browse all the artists that are stored on your USB device.



Press the voice icon on the steering wheel. When prompted, you can say:

<b>“BROWSE” within devices</b>
“Browse” <sup>*</sup>
“Browse <league> games” <sup>**,*</sup>
“Browse <Sirius category> channels” <sup>**,*</sup>
“Browse Sirius channel guide” <sup>**,*</sup>
“Browse SD card”
“Browse USB”
“Help”

<sup>\*</sup>If you have said “Browse”, you can then say any commands in the following chart.

<sup>\*\*</sup>This command is only usable if you have an active subscription to Sirius satellite radio.

<b>“BROWSE”</b>
“<League> games” <sup>*</sup>
”<Sirius category> channels” <sup>*</sup>
“SD card” <sup>**,*</sup>
“Sirius channel guide” <sup>*</sup>
“USB” <sup>**,*</sup>
“Help”

<sup>\*</sup>This command is only usable if you have an active subscription to Sirius satellite radio.

<sup>\*\*</sup>For more commands in SD card or USB mode, see the “SD card and USB Port” section of this chapter.

For a complete list of “Browse” voice commands, see *USB and SD card voice commands* and *Bluetooth audio voice commands* in the following sections.

Your voice system allows you to change audio sources with a simple voice command. For example, if you are listening to music on a USB device, then want to switch to a satellite radio channel, simply press the voice button on the steering wheel controls and say the name of the Sirius station (such as, “the Highway”). The following voice commands are available at the top level of the voice session no matter which current audio source you are listening to (such as a USB device or Sirius satellite radio). **Note:** This is only available when your MyFord Touch system language is set to North American English.

“AM <530 - 1710>”	“FM <87.9 - 107.9>”
“<530 - 1710>”	“<87.9 - 107.9>”
“Sirius <0-223>”*	“<Channel name>”*
“Play [genre] <name>”**	“Play [playlist] <name>”**
“Play [artist] <name>”**	“Play [song] <name>”**
“Play [album] <name>”**	“Play <name (song or album)> by <artist name>”
“Play <name>”	“Sports games”*

\*This command is only usable if you have an active subscription to Sirius satellite radio.

\*\*The commands that have [ ] around the word means that the word is optional. For example, if you say, “Play Metallica”, this is the same as the voice command, “Play [artist] <name>”.

### AM and FM



Touch the **AM** or **FM** tab to listen to the radio.

To change between AM and FM presets, just touch the **AM** or **FM** tab.

### Memory Presets

Save a station by pressing and holding one of the memory preset areas. There is a brief mute while the radio saves the station. Sound returns when finished.

### HD Radio

Touch this button to turn HD Radio on. The light on the button illuminates when the feature is on. HD Radio allows you to receive radio broadcasts digitally, where available, providing free, crystal-clear sound. See *HD Radio information* later in this chapter.

**Scan**

Touch this button to go to the next strong AM or FM radio station. The light on the button illuminates when the feature is on.

**Options**

**Sound Settings** allows you to adjust settings for:

- Bass
- Midrange
- Treble
- Balance and Fade
- DSP (Digital Signal Processing)
- Occupancy Mode
- Speed Compensated Volume.

**Note:** Your vehicle may not have all these sound settings.

**Set PTY for Seek/Scan** allows you to select a category of music you would like to search for. You can then choose to either seek or scan for the stations playing that category.

**RDS Text Display** allows you to view the information broadcast by FM stations.

**AST** allows you to have the system automatically store the six strongest stations in your current location.

**TAG Button** is available when HD Radio is on, and allows you to tag a song to download later. When you select **On**, TAG appears on-screen when HD Radio is active. You can touch **TAG** to save the information of the song that is playing. When you plug in your portable music player, the information transfers, if supported by your device. When you are connected to iTunes, the tags appear to remind you of the songs you would like to download. See *HD Radio information* later in this chapter.

**Direct Tune**

Touch this button to manually enter the desired station number. Touch **Enter** when you are done.

**HD Radio™ Information (If Available)**

**Note:** HD Radio broadcasts are not available in all markets.

HD Radio technology is the digital evolution of analog AM/FM radio. Your system has a special receiver that allows it to receive digital broadcasts (where available) in addition to the analog broadcasts, it already receives. Digital broadcasts provide a better sound quality than analog broadcasts with free, crystal-clear audio and no static or distortion. For more information, and a guide to available stations and programming, please visit [www.hdradio.com](http://www.hdradio.com).

When HD Radio is on and you tune to a station broadcasting HD Radio technology, you may notice the following indicators on your screen:



**HD) logo** either blinks when acquiring a digital station, and then stays solid when digital audio is playing, or is grey when acquiring a digital station, and then changes to orange when digital audio is playing. When this logo is available, you may also see Title and Artist fields on-screen.

**Multicast indicator** appears in FM mode (only) if the current station is broadcasting multiple digital broadcasts. The highlighted numbers signify available digital channels where new or different content is available. HD1 signifies the main programming status and is available in analog and digital broadcasts. Other multicast stations (HD2 through HD7) are only available digitally.

**TAG** allows you to save a song to download later when you are on an acquired HD Radio station and the feature is on. To turn the feature on and use it:

1. Press **AM** or **FM** > **Options** > **TAG** button > **On**.
2. When you hear a song you like, touch **TAG**.
3. The system automatically saves the song's information and transfers it to your portable music player (if supported) when you connect it to the system. The system automatically transfers the tag to your player (if already connected) and a pop-up confirms the transfer.
4. When you access iTunes with your portable music player, the tags appear to you as a reminder. The system allows you to tag up to approximately 100 songs. For a list of devices that support tagging, see [www.SYNCMYRide.com](http://www.SYNCMYRide.com), [www.SYNCMYRide.ca](http://www.SYNCMYRide.ca) or [www.syncmaroute.ca](http://www.syncmaroute.ca).

When HD Radio broadcasts are active, you can access the following functions:

- **Scan** allows you to hear a brief sampling of all available stations. This feature still works when HD Radio reception is on, although it does not scan for HD2-HD7 channels. You may see the HD logo appear if the station has a digital broadcast.
- **Memory presets** allow you to save an active channel as a memory preset. Touch and hold a memory preset slot until the sound returns. There is a brief mute while the radio saves the station. Sound returns when finished. When switching to an HD2 or HD3 memory preset, the sound mutes before the digital audio plays, because the system has to reacquire the digital signal.
  - **Note:** As with any saved radio station, you cannot access the saved station if your vehicle is outside the station's reception area.

#### **HD Radio Reception and Station Troubleshooting**

<b>Potential Reception Issues</b>	
<b>Reception area</b>	If you are listening to a multicast station and you are on the fringe of the reception area, the station may mute due to weak signal strength.
	If you are listening to HD1, the system switches back to the analog broadcast until the digital broadcast is available again. However, if you are listening to any of the possible HD2 through HD7 multicast channels, the station mutes and stays muted unless it is able to connect to the digital signal again.
<b>Station blending</b>	When the system first receives a station (aside from HD2-HD7 multicast stations), it first plays the station in the analog version. Once the receiver verifies the station is an HD Radio station, it shifts to the digital version. Depending on the station quality, you may hear a slight sound change when the station changes from analog to digital. Blending is the shift from analog to digital sound or digital back to analog sound.

In order to provide the best possible experience, use the contact form to report any station issues found while listening to a station broadcasting with HD Radio technology. Independent entities own and operate each station. These stations are responsible for making sure all audio streams and data fields are accurate.

Potential station issues		
Issue	Cause	Action
Echo, stutter, skip or repeat in audio. Increase or decrease in audio volume.	This is poor time alignment by the radio broadcaster.	No action required. This is a broadcast issue.
Sound fading or blending in and out.	The radio is shifting between analog and digital audio.	No action required. The reception issue may clear up as you continue to drive.
There is an audio mute delay when selecting HD2 or HD3, multicast preset or <b>Direct Tune</b> .	The digital multicast is not available until the HD Radio broadcast is decoded. Once decoded, the audio is available.	No action required. This is normal behavior. Wait until the audio is available.
Cannot access HD2 or HD3 multicast channel when recalling a preset or from a direct tune.	The previously stored multicast preset or direct tune is not available in your current reception area.	No action required. The station is not available in your current location.
Text information does not match currently playing audio.	Data service issue by the radio broadcaster.	Fill out the station issue form at website listed below.*
There is no text information shown for currently selected frequency.	Data service issue by the radio broadcaster.	Fill out the station issue form at website listed below.*
HD2-HD7 stations not found when <b>Scan</b> is pressed.	Pressing <b>Scan</b> disables HD2-HD7 channel search.	No action required. This is normal behavior.

\*[http://www.ibiquity.com/automotive/report\\_radio\\_station\\_experiences](http://www.ibiquity.com/automotive/report_radio_station_experiences)

HD Radio Technology manufactured under license from iBiquity Digital Corp. U.S. and foreign patents. HD Radio and the HD and HD Radio logos are proprietary trademarks of iBiquity Digital Corp. Ford Motor Company and iBiquity Digital Corp. are not responsible for the content sent using HD Radio technology. Content may be changed, added or deleted at any time at the station owner's discretion.



**Radio Voice Commands**

If you are listening to the radio, press the voice button on the steering wheel control. When prompted, say any of the commands in the following chart.

If you are not listening to the radio, press the voice button and, after the tone, say “Radio”, then any of the commands in the following chart.

“RADIO”	
“<87.9–107.9>”	“FM preset <#>”
“<87.9–107.9> HD”*	“FM1”
“<530–1710>”	“FM 1 preset <#>”
“AM”	“FM2”
“AM <530–1710>”	“FM 2 preset <#>”
“AM autosest”	“HD <#>”*
“AM autosest preset <#>”	“Preset <#>”
“AM preset <#>”	“Radio off”
“FM”	“Radio on”
“FM <87.9–107.9>”	“Set PTY”
“FM <87.9–107.9> HD <#>”*	“Tune”**
“FM autosest”	“Help”
“FM autosest preset <#>”	

\*If available.

\*\*If you have said, “Tune”, see the following “Tune” chart.

“TUNE”	
“<87.9–107.9>”	“FM autosest”
“<87.9–107.9> HD <#>”*	“FM autosest preset <#>”
“<530–1710>”	“FM preset <#>”
“AM”	“FM1”
“AM <530–1710>”	“FM 1 preset <#>”
“AM autosest”	“FM2”
“AM autosest preset <#>”	“FM 2 preset <#>”
“AM preset <#>”	“HD <#>”*
“FM”	“Preset <#>”
“FM <87.9–107.9>”	“Help”
“FM <87.9–107.9> HD <#>”*	

\*If available.

**Sirius Satellite Radio (If Activated)**

Press the lower left corner of the touchscreen, then select the **SIRIUS** tab.

**Presets**

Save a channel by pressing and holding one of the memory preset areas. There is a brief mute while the radio saves the channel. Sound returns when finished.

**ALERT**

Save the current song, artist, or team as a favorite. The system alerts you when it plays again on any channel.

**Replay**

Replay audio on the current channel. You can replay approximately 45 minutes of audio as long as you have remained tuned to the current station. Changing stations erases the previous audio.

While in replay mode:

- Press and release the seek buttons to hear the previous or next song.
- Press and hold the seek buttons to reverse or fast forward in the current track.
- Press play or pause to play or pause the audio.
- Press **Replay** to return to live audio if you have been using the feature to replay audio.

**Scan**

Touch this button to hear a brief sampling of channels.

**Options**

**Sound Settings** allows you to adjust settings for:

- Bass
- Midrange
- Treble
- Balance and Fade
- DSP (Digital Signal Processing)
- Occupancy Mode
- Speed Compensated Volume.

**Note:** Your vehicle may not have all these sound settings.

**Set Category for Seek/Scan** allows you to select a category of music you would like to search for. You can then choose to either seek or scan for the stations playing that category.

**Parental Lockout** allows you to lock and unlock channels, change or reset your PIN or unlock all channels. To use this feature, you need your initial PIN, which is 1234.

**Artist/Title/Team Alerts** allows you to select Artists, Titles and Teams that you would like the system to alert you to when they are playing on other channels. Press **Edit Alerts** to delete or turn off alerts. You can also set all alerts to on or off. When an alert appears on the screen, you can choose to Tune to the channel, to Cancel the alert or to Disable Alerts. If you are listening to a sporting event, you can save your favorite teams so that the system can alert you when they are playing on a satellite radio channel.

**Note:** Sirius does not support the Alert feature on all channels. Ford Motor Company shall not be responsible for Alert feature variation.

**Electronic Serial Number (ESN)** is required when you need to activate, modify or track your satellite radio account. The ESN is on the System Information Screen (SR ESN: XXXXXXXXXXXX). To access your ESN, press the bottom left corner of the touchscreen, then **SIRIUS > Options.**

#### **Direct Tune**

Touch this button to manually enter the desired satellite channel number. Touch **Enter** when you are done.

#### **Browse**

Touch this button to view a list of all available stations. Scroll to see more categories. Touch the station you want to listen to.

Touch **Skip** if you want to skip this channel.

Touch **Lock** if you do not want anyone to listen to this channel.

Touch **Title** or **Artist** to see song and artists on other stations.

#### **Satellite Radio Voice Commands**



If you are listening to Sirius satellite radio, press the voice button on the steering wheel control. When prompted, say any of the commands in the following chart.

If you are not listening to Sirius satellite radio, press the voice button and, after the tone, say “Sirius”, then any of the commands in the following chart.

<b>“SIRIUS”</b>	
“Sirius <0-223>”	“SAT 3”
“<Channel name>”	“SAT 3 preset <#>”
“Preset <#>”	“SAT preset <#>”
“SAT”	“Sirius off”
“SAT 1”	“Sirius on”
“SAT 1 preset <#>”	“Sports game”*
“SAT 2”	“Tune”**
“SAT 2 preset <#>”	“Help”

\*If you have said, “Sports game”, see the following “Sports game” chart.

\*\*If you have said, “Tune”, see the following “Tune” chart.

<b>“SPORTS GAME”</b>
“Tune to the <college name> game”
“Tune to the <team city> game”
“Tune to the <team city> <team name> game”
“Tune to the <team name> game”
“Help”

<b>“TUNE”</b>
“Sirius <0-223>”
“<Channel name>”
“Preset <#>”
“SAT”
“SAT 1”
“SAT 1 preset <#>”
“SAT 2”
“SAT 2 preset <#>”
“SAT 3”
“SAT 3 preset <#>”
“Help”

**Sirius Satellite Radio Information**

**Note:** Sirius reserves the unrestricted right to change, rearrange, add or delete programming including canceling, moving or adding particular channels, and its prices, at any time, with or without notice to you. Ford Motor Company shall not be responsible for any such programming changes.

**Note:** This receiver includes the eCos real-time operating system. eCos is published under the eCos License.



Sirius satellite radio is a subscription-based satellite radio service that broadcasts a variety of music, sports, news, weather, traffic and entertainment programming. Your factory-installed Sirius satellite radio system includes hardware and

a limited subscription term that begins on the date of sale or lease of your vehicle. See your authorized dealer for availability.

For more information on extended subscription terms (a service fee is required), the online media player and a list of Sirius satellite radio channels, and other features, please visit [www.siriusxm.com](http://www.siriusxm.com) in the United States, [www.sirius.ca](http://www.sirius.ca) in Canada, or call Sirius at 1-888-539-7474.

<b>Potential satellite radio reception issues</b>	
<b>Antenna obstructions</b>	For optimal reception performance, keep the antenna clear of snow and ice build-up and keep luggage and other materials as far away from the antenna as possible.
<b>Terrain</b>	Hills, mountains, tall buildings, bridges, tunnels, freeway overpasses, parking garages, dense tree foliage and thunderstorms can interfere with your reception.
<b>Station overload</b>	When you pass a ground-based broadcast-repeating tower, a stronger signal may overtake a weaker one and the audio system may mute.
<b>Satellite radio signal interference</b>	Your display may show ACQUIRING . . . to indicate the interference and the audio system may mute.

<b>Sirius troubleshooting tips</b>		
<b>Radio display</b>	<b>Condition</b>	<b>Possible action</b>
Acquiring...	Radio requires more than two seconds to produce audio for the selected channel.	No action required. This message should disappear shortly.
Sat Fault/SIRIUS system failure.	There is an internal module or system failure present.	If this message does not clear shortly, or with an ignition key cycle, your receiver may have a fault. See your authorized dealer for service.
Invalid Channel.	The channel is no longer available.	Tune to another channel or choose another preset.
Unsubscribed Channel.	Your subscription does not include this channel.	Contact Sirius at 1-888-539-7474 to subscribe to the channel, or tune to another channel.
No Signal.	The signal is lost from the Sirius satellite or Sirius tower to your vehicle antenna.	The signal is blocked. When you move into an open area, the signal should return.
Updating.	Update of channel programming in progress.	No action required. The process may take up to three minutes.
Call SIRIUS 1-888-539-7474.	Your satellite service is no longer available.	Contact Sirius at 1-888-539-7474 to resolve subscription issues.

Sirius troubleshooting tips		
Radio display	Condition	Possible action
None Found. Check Channel Guide.	All the channels in the selected channels are either skipped or locked.	Use the channel guide to turn off the <b>Lock</b> or <b>Skip</b> function on that station.
Subscription Updated.	Sirius has updated the channels available for your vehicle.	No action required.

**CD**

Press the lower left corner of the touchscreen, and then select the **CD** tab.

You can also advance and reverse the current track or current folder, if applicable.

**Repeat**

Touch this button to repeat the currently playing track, all tracks on the disc or turn the feature off if already on.

**Shuffle**

Touch this button to play the tracks or entire albums in random order, or turn the feature off if already on.

**Scan**

Touch this button to hear a brief sampling of all available tracks.

**More Info**

Touch this button to see disc information.

**Options**

**Sound Settings** allows you to adjust settings for:

- Bass
- Midrange
- Treble
- Balance and Fade
- DSP (Digital Signal Processing)
- Occupancy Mode
- Speed Compensated Volume.

**Note:** Your vehicle may not have all these sound settings.

**Compression** allows you to turn the compression feature on and off.

### **Browse**

Touch this button to look through all available CD tracks.

### **CD Voice Commands**



If you are listening to a CD, press the voice button on the steering wheel control. When prompted, say any of the commands in the following chart.

If you are not listening to a CD, press the voice button and, after the tone, say “CD”, then any of the commands in the following chart.

“CD”	
“Pause”	“Repeat off”
“Play”	“Repeat track”
“Play next track”	“Shuffle”
“Play previous track”	“Shuffle CD”*
“Play track <1-512>”	“Shuffle folder”*
“Repeat”	“Shuffle off”
“Repeat folder”*	“Help”

\*This applies to WMA or MP3 files only.

### **SD Card Slot and USB Port**

#### **SD Card Slot**

**Note:** Your SD card slot is spring-loaded. To remove the SD card, press the card in and the system ejects it. Do not attempt to pull the card to remove it as this could cause damage.

**Note:** The navigation system also uses this card slot. See *Navigation system* later in this chapter for more information.



The slot is located either in the center console or behind a small access door in the instrument panel. To access and play music from your card, press the lower left corner of the touchscreen, and then select **SD Card** from the list on the left side of the screen.





SD logo is a trademark of SD-3C, LLC.

### USB Port



The ports are located either in the center console or behind a small access door in the instrument panel. To access and play music from your device, press the lower left corner of the touchscreen, and then select the **USB** tab.

This feature allows you to plug in media playing devices, memory sticks, flash drives or thumb drives, and charge devices if they support this feature.

### Playing Music from Your Device

**Note:** The system is capable of indexing up to 30,000 songs.

Insert your device and select the **SD Card** or **USB** tab once the system recognizes it. You can then select from the following options:

**Repeat** replays the currently playing song or album.

**Shuffle** plays music on the selected album or folder in random order.

**Similar Music** allows you to choose music similar to what is currently playing.

**More Info** displays information such as current track, artist name, album and genre.

**Options** allows you to view and adjust various media settings.

- **Sound Settings** allows you to adjust settings for:
  - Bass
  - Midrange
  - Treble
  - Balance and Fade
  - DSP (Digital Signal Processing)
  - Occupancy Mode
  - Speed Compensated Volume.

**Note:** Your vehicle may not have all these sound settings.

- **Media Player Settings** allows you to select more settings, which is under **Media Player**. See *Settings*.
- **Device Information** displays software and firmware information about the currently connected media device.
- **Update Media Index** indexes your device each time you connect it to make sure you have the latest voice commands available for all media on the device.

**Browse** allows you to view the contents of the device. It also allows you to search by categories, such as genre, artist or album.

If you want to view song information such as Title, Artist, File, Folder, Album, and Genre, touch the on-screen album art.

You can also touch **What's Playing** to hear how the system pronounces the current band and song. This can be helpful when using voice commands to make sure the system correctly plays your request.

#### **SD Card and USB Voice Commands**



If you are listening to a USB device or an SD card, press the voice button on the steering wheel control. When prompted, say any of the commands in the following chart.

If you are not listening to a USB device or an SD card, press the voice button and, after the tone, say “USB” or “SD card”, then any of the commands in the following chart.

<b>“USB” or “SD CARD”</b>	
“Browse”*	“Play previous song”
“Next”	“Play similar music”
“Pause”	“Play song <name>”
“Play”	“Play TV show <name>”**
“Play album <name>”	“Play TV show episode <name>”**
“Play all”	“Play video <name>”**
“Play artist <name>”	“Play video podcast <name>”**
“Play audiobook <name>”	“Play video podcast episode <name>”**
“Play author <name>”	“Play video playlist <name>”**
“Play composer <name>”	“Previous”
“Play folder <name>”	“Repeat all”
“Play genre <name>”	“Repeat off”

<b>“USB” or “SD CARD”</b>	
“Play movie <name>”**	“Repeat one”
“Play music video <name>”**	“Shuffle”
“Play next song”	“Shuffle off”
“Play playlist <name>”	“What’s this?”
“Play podcast <name>”	“Help”
“Play podcast episode <name>”	

\*If you have said you would like to browse your USB or SD card, the system prompts you to specify what you would like to browse. When prompted, see the following “Browse” chart.

\*\*This command is only available in USB mode and are device-dependent.

<b>“BROWSE”</b>	
“Album <name>”	“All video podcasts”*
“All albums”	“All videos”*
“All artists”	“Artist <name>”
“All audiobooks”	“Audiobook <name>”
“All authors”	“Author <name>”
“All composers”	“Composer <name>”
“All folders”	“Folder <name>”
“All genres”	“Genre <name>”
“All movies” *	“Playlist <name>”
“All music videos”*	“Podcast <name>”
“All playlists”	“TV show <name>”*
“All podcasts”	“Video <name>”*
“All songs”	“Video playlist <name>”*
“All TV shows”*	“Video podcast <name>”*
“All video playlists”*	“Help”

\*This command is only available in USB mode and are device-dependent.

**Supported Media Players, Formats and Metadata Information**

SYNC is capable of hosting nearly any digital media player, including iPod®, Zune™, plays from device players, and most USB drives. Supported audio formats include MP3, WMA, WAV and AAC.

It is also able to organize your indexed media from your playing device by metadata tags. Metadata tags, which are descriptive software identifiers embedded in the media files, provide information about the file.

If your indexed media files contain no information embedded in these metadata tags, SYNC may classify the empty metadata tags as

**Unknown.**

In order to playback video from your iPod® or iPhone®, (if compatible), you **MUST** have a special combination USB/RCA composite video cable (which you can buy from Apple®). When the cable is connected to your iPod® or iPhone®, plug the other end into both the RCA jacks and the USB port.

**Bluetooth Audio**

Your system allows you to stream audio over your vehicle's speakers from your connected, Bluetooth-enabled cellular phone.



To access, press the lower left corner on the touchscreen, then select the **BT Stereo** tab.

**Bluetooth Audio Voice Commands**

If you are listening to a Bluetooth audio device, press the voice button on the steering wheel control. When prompted, say "Next song", "Pause", "Play" or "Previous song".

If you are not listening to a Bluetooth audio device, press the voice button and, after the tone, say "Bluetooth Audio", then "Next song", "Pause", "Play" or "Previous song".

**Line In (Auxiliary Input Jack)**

 **WARNING:** Driving while distracted can result in loss of vehicle control, crash and injury. We strongly recommend that you use extreme caution when using any device that may take your focus off the road. Your primary responsibility is the safe operation of your vehicle. We recommend against the use of any hand-held device while driving and encourage the use of voice-operated systems when possible. Make sure you are aware of all applicable local laws that may affect the use of electronic devices while driving.

 **WARNING:** For safety reasons, do not connect or adjust the settings on your portable music player while your vehicle is moving.

 **WARNING:** Store the portable music player in a secure location, such as the center console or the glove box, when your vehicle is in motion. Hard objects may become projectiles in a crash or sudden stop, which may increase the risk of serious injury. The audio extension cable must be long enough to allow the portable music player to be safely stored while your vehicle is moving.

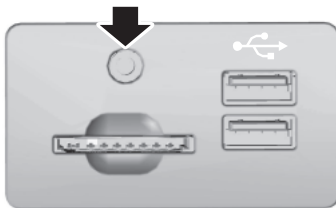

The auxiliary input jack allows you to connect and play music from your portable music player through your vehicle speakers. You can use any portable music player designed for use with headphones. Your audio extension cable must have male 1/8-inch (3.5 millimeter) connectors at each end.

1. Switch off the engine, radio and portable music player. Set the parking brake and put the transmission in position **P**.
2. Plug the extension cable from the portable music player into the auxiliary input jack.
3. Switch the radio on. Select either a tuned FM station or a CD.
4. Adjust the volume as desired.
5. Switch your portable music player on and adjust its volume to half its maximum level.
6. Press **AUX** until **LINE** or **LINE IN** appears in the display. You should hear music from your device even if it is low.

- Adjust the volume on your portable music player until it reaches the volume level of the FM station or CD. Do this by switching back and forth between the AUX and FM or CD controls.

### **Troubleshooting**

- Do not connect the audio input jack to a line level output. The jack only works correctly with devices that have a headphone output with a volume control.
- Do not set the portable music player's volume level higher than is necessary to match the volume of the CD or FM radio as this causes distortion and reduces sound quality.
- If the music sounds distorted at lower listening levels, turn the portable music player volume down. If the problem persists, replace or recharge the batteries in the portable media player.
- Control the portable media player in the same manner when used with headphones, as the auxiliary input jack does not provide control (such as Play or Pause) over the attached portable media player.

### **PHONE**



- A. Phone
- B. Quick Dial
- C. Phonebook
- D. History
- E. Messaging
- F. Settings

Hands-free calling is one of the main features of SYNC. Once you pair your phone, you can access many options using the touchscreen or voice commands. While the system supports a variety of features, many are dependent on your cellular phone's functionality. At a minimum, most cellular phones with Bluetooth wireless technology support the following functions:

- Answering an incoming call
- Ending a call
- Using privacy mode
- Dialing a number
- Redialing
- Call waiting notification
- Caller ID.

Other features, such as text messaging using Bluetooth and automatic phonebook download, are phone-dependent features. To check your phone's compatibility, see your phone's user manual and visit [www.SYNCMyRide.com](http://www.SYNCMyRide.com), [www.SYNCMyRide.ca](http://www.SYNCMyRide.ca) or [www.syncmaroute.ca](http://www.syncmaroute.ca).

### Pairing Your Phone for the First Time



**WARNING:** Driving while distracted can result in loss of vehicle control, crash and injury. We strongly recommend that you use extreme caution when using any device that may take your focus off the road. Your primary responsibility is the safe operation of your vehicle. We recommend against the use of any hand-held device while driving and encourage the use of voice-operated systems when possible. Make sure you are aware of all applicable local laws that may affect the use of electronic devices while driving.

The first thing you must do to use the phone features of SYNC is to pair your Bluetooth-enabled cellular phone with SYNC. This allows you to use your phone in a hands-free manner.

**Note:** Put the transmission in position **P**. Turn on your vehicle ignition and the radio.

1. Touch **Add Phone** in the upper left corner of the touchscreen. **Find SYNC** appears on the screen and instructs you to begin the pairing process from your device.
2. Make sure that Bluetooth is set to **On** and that your cellular phone is in the proper mode. See your phone's manual if necessary.
  - Select **SYNC**, and a six-digit PIN appears on your device.

3. If you are prompted to enter a PIN on your device, it does not support Secure Simple Pairing. To pair, enter the PIN displayed on the touchscreen. Skip the next step.
4. When prompted on your phone's display, confirm that the PIN provided by SYNC matches the PIN displayed on your cellular phone.
5. The display indicates when the pairing is successful.

SYNC may prompt you with more phone options. For more information on your phone's capability, see your phone's manual and visit the website.

### Pairing Subsequent Phones

**Note:** Put the transmission in position **P**. Turn on your vehicle ignition and the radio.

1. Press the **Phone** corner of the touchscreen > **Settings** > **BT Devices** > **Add Device**.
2. Make sure that Bluetooth is set to **On** and that your cellular phone is in the proper mode. See your phone's manual if necessary.
  - Select **SYNC**, and a six-digit PIN appears on your device.
3. If you are prompted to enter a PIN on your device, it does not support Secure Simple Pairing. To pair, enter the PIN displayed on the touchscreen. Skip the next step.
4. When prompted on your phone's display, confirm that the PIN provided by SYNC matches the PIN displayed on your cellular phone.
5. The display indicates when the pairing is successful.

SYNC may prompt you with more phone options. For more information on your phone's capability, see your phone's user guide and visit the website.

### Making Calls



Press the voice button on your steering wheel controls. When prompted, say, "Call <name>" or say "Dial", then the desired number.



To end the call or exit phone mode, press this phone button.



**Receiving Calls**

During an incoming call, an audible tone sounds. Call information appears in the display if it is available.



Accept the call by pressing **Accept** on the touchscreen or by pressing this phone button on your steering wheel controls

Reject the call by pressing **Reject** on the touchscreen or by pressing this phone button on your steering wheel controls.

Ignore the call by doing nothing. SYNC logs it as a missed call.

**Phone Menu Options**

Press the top left corner on your touchscreen to select from the following options:

**Phone**

Touch this button to access the on-screen numerical pad to enter a number and place a call. During an active call, you can also choose to:

- Mute the call
- Put it on hold
- Turn on privacy (returns the call to your cellular phone)
- Join two calls
- End the call.

**Quick Dial**

Set up favorite contacts from you phonebook or history folder.

**Phonebook**

Touch this button to access and call any contacts in your previously downloaded phone book. The system places the entries in alphabetical categories summarized at the top of the screen.

To turn on contact picture settings, if your device supports this feature, press **Phone > Settings > Manage Phonebook > Download photos from Phonebook > On.**

**History**

After you connect your Bluetooth-enabled phone to SYNC, you can access any previously dialed, received or missed calls. You can also choose to save these to your **Favorites** or to **Quick Dial**.

**Note:** This is a phone-dependent feature. If your phone does not support downloading call history using Bluetooth, SYNC keeps track of calls made with the SYNC system.

### **Messaging**

Send text messages using your touchscreen. See *Text messaging* later in this section.

### **Settings**

Touch this button to access various phone settings, such as turning Bluetooth on and off, managing your phonebook and more. See *Phone settings* later in this section.

### **Text Messaging**

**Note:** Downloading and sending text messages using Bluetooth are phone-dependent features.

**Note:** Certain features in text messaging are speed-dependent and not available when your vehicle is traveling at speeds over 3 mph (5 km/h).

**Note:** SYNC does not download read text messages from your phone.

You can send and receive text messages using Bluetooth, read them aloud and translate text messaging acronyms, such as LOL.

1. Touch the top left corner of the display to access the **Phone** menu.
2. Select **Messaging**.
3. Choose from the following:
  - **Listen** (speaker icon)
  - **Dial**
  - **Send Text**
  - **View**
  - **Delete**.

### **Composing a Text Message**

**Note:** This is a speed-dependent feature. It is unavailable when your vehicle is traveling at speeds over 3 mph (5 km/h).

**Note:** Downloading and sending text messages using Bluetooth are phone-dependent features.

1. Touch the top left corner of the display to access the **Phone** menu.
2. Touch **Messaging > Send Text**.
3. Enter a phone number or choose from your phone book.
4. You can select from the following options:
  - **Send** which sends the message as it is.
  - **Edit Text** allows you to customize the pre-defined message or create a message on your own.

You can then preview the message, verify the recipient as well as update the message list.

Pre-defined text message options
I'll call you back in a few minutes.
I just left, I'll be there soon.
Can you give me a call?
I'm on my way.
I'm running a few minutes late.
I'm ahead of schedule, so I'll be there early.
I'm outside.
I'll call you when I get there.
OK
Yes
No
Thanks
Stuck in traffic.
Call me later.
LOL

### ***Receiving a Text Message***

When a new message arrives, an audible tone sounds and the screen displays a pop-up with the caller name and ID, if supported by your phone. You can press:

- **View** to view the text message.
- **Listen** for SYNC to read the message to you.
- **Dial** to call the contact.
- **Ignore** to exit the screen.

**Note:** If you select **View** and your vehicle is traveling over 3 mph (5 km/h), the system offers to read the message to you instead of allowing you to view it while driving.

### **Phone Settings**

Press **Phone** > **Settings**.

### ***Bluetooth Devices***

Touch this tab to connect, disconnect, add or delete a device, as well as save it as a favorite.

**Bluetooth**

Touch this tab to turn Bluetooth off or on.

**Do Not Disturb**

Touch this tab if you want all calls to go directly to your voice mail and not ring in the vehicle. When this feature is on, text message notifications do not ring inside the cabin either.

**911 Assist**

Turn on or turn off the 911 Assist feature. See *911 Assist* in the *SYNC Services and Applications* section.

**Phone Ringer**

Select the ring tone you want to hear when you receive a call. Choose from possible system ring tones, your currently paired phone's ring tone, a beep, text-to-speech or a silent notification.

**Text Message Notification**

Select a text message notification, if supported by your phone. Choose from possible system alert tones, text-to-speech or silent.

**Internet Data Connection**

If your phone is compatible, use this screen to adjust your internet data connection. Select to make your connection profile with the personal area network or to turn off your connection. You can also choose to adjust your settings or have the system always connect, never connect when roaming or query on connect. Press ? for more information.

**Manage Phonebook**

Touch this button to access features such as automatic phonebook download, re-download your phonebook, add contacts from your phone as well as delete or upload your phonebook.

**Roaming Warning**

Touch this button to have the system alert you when your phone is in roaming mode.

**Phone Voice Commands**

Press the voice button on the steering wheel control. After the tone, say any of the following commands:

<b>“PHONE”</b>	
“Call”	“Join calls”*
“Call <name>”	“Listen to text message <#>”
“Call <name> at home”	“Listen to text messages”
“Call <name> at work”	“Messages”**
“Call <name> on cell”	“Mute call”*
“Call <name> on other”	“Pair phone”
“Call voicemail”	“Privacy on”*
“Dial”	“Read text message”
“Do not disturb off”	“Reply to text messages”
“Do not disturb on”	“Turn ringer off”
“Forward text messages”	“Turn ringer on”
“Go to hands free”*	“Unmute call”*
“Hold call off”*	“Help”
“Hold on”*	

\*This command is only available during an active call.

\*\*If you have said “Messages”, see the following “Messages” chart.

<b>“MESSAGES”</b>
“Call”
“Forward text messages”
“Listen to text message <#>”
“Listen to text messages”
“Reply to text messages”
“Help”

**INFORMATION**

 If your vehicle is equipped with Navigation, touch the i (Information) button to access these features. If your vehicle is not equipped with Navigation, touch the corner of the touchscreen with the green tab.



Under the Information menu, you can access features, such as:

- A. SYNC Services
- B. Sirius Travel Link
- C. Alerts
- D. Calendar
- E. SYNC Applications.

**SYNC Services (If Equipped, United States Only)**

**Note:** SYNC Services varies by trim level and model year and may require a subscription. Traffic alerts and turn-by-turn directions available in select markets. Message and data rates may apply. Ford Motor Company reserves the right to change or discontinue this product service at any time without prior notification or incurring any future obligation.

**Note:** SYNC Services requires activation before use. Visit [www.SYNCMYride.com](http://www.SYNCMYride.com) to register and check your eligibility for complimentary services. Standard phone and message rates may apply. Subscription may be required. You must also have the active SYNC Services Bluetooth-enabled cellular phone paired and connected to the system in order to connect to, and use, SYNC Services. See *Phone* earlier in this chapter for pairing instructions.

**Note:** This feature does not function properly if you have enabled caller ID blocking on your mobile phone. Make sure your mobile phone is not blocking caller ID before using SYNC Services.

**Note:** The driver is ultimately responsible for the safe operation of the vehicle, and therefore, must evaluate whether it is safe to follow the suggested directions. Any navigation features are provided only as an aid. Make your driving decisions based on your observations of local conditions and existing traffic regulations. Do not follow the route suggestions if doing so would result in an unsafe or illegal maneuver, if you would be placed in an unsafe situation, or if you would be directed into an area that you consider unsafe. Maps used by this system may be inaccurate because of errors, changes in roads, traffic conditions or driving conditions.

**Note:** When you connect, the service uses GPS technology and advanced vehicle sensors to collect your vehicle's current location, travel direction and speed to help provide you with the directions, traffic reports, or business searches you request. Further, to provide the services you request, for continuous improvement, the service may collect and record call details and voice communications. For more information, see SYNC Services Terms and Conditions at [www.SYNCMYride.com](http://www.SYNCMYride.com). If you do not want Ford or its service providers to collect your vehicle travel information or other information identified in the Terms and Conditions, do not subscribe or use the service.

SYNC Services uses advanced vehicle sensors, integrated GPS technology and comprehensive map and traffic data, to give you personalized traffic reports, precise turn-by-turn directions, business search, news, sports, weather and more. For a complete list of services, or to learn more, please visit [www.SYNCMYride.com](http://www.SYNCMYride.com).

### **Connecting to SYNC Services Using Voice Commands**



Press the voice button on the steering wheel controls.

1. When prompted, say "Services". This initiates an outgoing call to SYNC Services using your paired and connected Bluetooth-enabled cellular phone.
2. Once you connect to the service, follow the voice prompts to request the desired service, such as "Traffic" or "Directions". You can also say, "What are my choices?" to receive a list of available services from which to choose.
3. Say, "Services" to return to the Services main menu or for help, say, "Help".

**Connecting to SYNC Services Using the Touchscreen**

 If your vehicle is equipped with Navigation, touch the **i** (Information) button to access these features. If your vehicle is not equipped with Navigation, touch the corner of the touchscreen with the green tab.

Press **Services**.

1. Select **Connect to Services** to initiate an outgoing call to SYNC Services using your paired and connected Bluetooth-enabled cellular phone.
2. Once you connect to the service, follow the voice prompts to request the desired service, such as “Traffic” or “Directions”. You can also say, “What are my choices?” to receive a list of available services from which to choose.
3. Say, “Services” to return to the Services main menu or for help, say, “Help”.

**Receiving Turn-by-Turn Directions**

1. When connected to SYNC Services, say “Directions” or “Business Search”. To find the closest business or type of business to your current location, just say “Business Search” and then “Search Near Me”. If you need further assistance in finding a location, you can say “Operator” at any time within a Directions or Business search to speak with a live operator. The system may prompt you to speak with an operator when it has difficulty matching your voice request. The live operator can assist you by searching for businesses by name or by category, residential addresses by street address or by name or specific street intersections. Operator Assist is a feature of your SYNC Services subscription. For more information on Operator Assist, visit [www.SYNCMYride.com/support](http://www.SYNCMYride.com/support).
2. Follow the voice prompts to select your Destination. After the route download is finished, the phone call automatically ends.

If your vehicle is not equipped with Navigation:

- Turn-by-turn directions appear in the information display, in the status bar of your touchscreen system and on the SYNC Services screen. You also receive driving instructions from audible prompts.
- When on an active route, you can select **Route Summary** or **Route Status** using the touchscreen controls or voice commands to view the **Route Summary Turn List** or the **Route Status ETA**. You can also turn voice guidance on or off, cancel the route or update the route.



If you miss a turn, SYNC automatically asks if you want the route updated. Just say, “Yes” when prompted and the system delivers a new route to your vehicle.

If your vehicle is equipped with Navigation, SYNC Services downloads your requested destination to the navigation system. The navigation system then calculates the route and provides driving instructions. See the *Navigation system* section for more information.

**Disconnecting from SYNC Services**

1. Press and hold the phone button on the steering wheel.
2. Say “Good-bye” from the SYNC Services main menu.

<b>SYNC Services quick tips</b>	
<b>Personalizing</b>	You can personalize your Services feature to provide quicker access to your most used or favorite information. You can save address points, such as work or home. You can also save favorite information like sports teams, such as Detroit Lions, or a news category. You can learn more about personalization by logging onto <a href="http://www.SYNCMyRide.com">www.SYNCMyRide.com</a> .
<b>Push to interrupt</b>	Press the voice button at any time (while connected to SYNC Services) to interrupt a voice prompt or an audio clip (such as a sports report) and say your voice command.
<b>Portable</b>	Your subscription is associated with your Bluetooth-enabled cellular phone number, not your VIN (Vehicle Identification Number). You can pair and connect your phone to any vehicle equipped with SYNC Services and continue enjoying your personalized services.

**SYNC Services Voice Commands**

When a route has been downloaded (non-navigation systems), press the voice button on the steering wheel control. When prompted, say any of the following commands:

<b>“SERVICES”</b>
“Cancel route”
“Navigation voice off”
“Navigation voice on”
“Next turn”
“Route status”
“Route summary”
“Services”
“Update route”
“Help”

**Sirius Travel Link (If Equipped and If Activated)**

**WARNING:** Driving while distracted can result in loss of vehicle control, crash and injury. We strongly recommend that you use extreme caution when using any device that may take your focus off the road. Your primary responsibility is the safe operation of your vehicle. We recommend against the use of any hand-held device while driving and encourage the use of voice-operated systems when possible. Make sure you are aware of all applicable local laws that may affect the use of electronic devices while driving.

**Note:** In order to use Sirius Travel Link, your vehicle must be equipped with navigation and your navigation SD card must be in the SD card slot.

**Note:** A paid subscription is required to access and use these features. Go to [www.siriusxm.com/travellink](http://www.siriusxm.com/travellink) for more information.

**Note:** Visit [www.siriusxm.com/traffic#](http://www.siriusxm.com/traffic#) and click on Coverage map and details for a complete listing of all traffic areas covered by Sirius Travel Link.

**Note:** Neither Sirius nor Ford is responsible for any errors or inaccuracies in the Sirius Travel Link services or its use in vehicles.

When you subscribe to Sirius Travel Link, it can help you locate the best gas prices, find movie listings, get current traffic alerts, view the current weather map, get accurate ski conditions and see scores to current sports games.



If your vehicle is equipped with Navigation, touch the **i** (Information) button to access these features. If your vehicle is not equipped with Navigation, touch the corner of the touchscreen with the green tab.

#### ***Traffic On Route and Traffic Nearby***

Touch these buttons to identify traffic incidents on your route, nearby your vehicle's current location or near any of your favorite places, if programmed.

#### ***Fuel Prices***

Touch this button to view fuel prices at stations close to your vehicle's location or on an active navigation route.

#### ***Movie Listings***

Touch this button to view nearby movie theaters and their show times, if available.

#### ***Weather***

Touch this button to view the nearby weather, current weather, or the five day forecast for the chosen area. Select **Map** to see the weather map, which can show storms, radar information, charts and winds. Select **Area** to select from a listing of weather locations.

#### ***Sports Info***

Touch this button to view scores and schedules from a variety of sports. You can also save up to 10 favorite teams for easier access. The score automatically refreshes when a game is in progress.

#### ***Ski Conditions***

Touch this button to view ski conditions for a specific area.

**Sirius Travel Link Voice Commands**

**Note:** In order to use Sirius Travel Link, your vehicle must be equipped with navigation and your navigation SD card must be in the SD card slot.



Press the voice button on the steering wheel controls and, when prompted, say any of the following:

Travel Link voice commands	
“5-day weather forecast”	“Sports scores”*
“Fuel prices”	“Traffic”
“Movie listings”	“Travel Link”**
“Sports headlines”*	“Weather”
“Sports schedule”*	“Weather map”

\*If you have said, “Sports headlines”, “Sports schedule” or “Sports scores”, you may say any of the commands in the “Sports headlines, Sports schedules and Sports scores” commands chart:

\*\*If you have said, “Travel Link”, you may say any of the commands in the “Travel Link” chart:

Sports headlines, sports schedules and sports scores voice commands	
“Baseball”	“My teams”
“College basketball”	“NBA”
“College football”	“NFL”
“Golf”	“NHL”
“MLS”	“WNBA”
“Motor sports”	

“TRAVEL LINK”		
“5-day weather forecast”	“Golf schedule”	“NBA scores”
“Baseball headlines”	“MLS headlines”	“NFL headlines”
“Baseball schedule”	“MLS schedule”	“NFL schedule”
“Baseball scores”	“MLS scores”	“NFL scores”
“College basketball headlines”	“Motor sports”	“NHL headlines”

“TRAVEL LINK”		
“College basketball schedule”	“Motor sports order”	“NHL schedule”
“College basketball scores”	“Motor sports schedule”	“NHL scores”
“College football headlines”	“Movie listings”	“Traffic”
“College football schedule”	“My team headlines”	“Weather”
“College football scores”	“My teams schedule”	“Weather map”
“Fuel prices”	“My teams scores”	“WNBA headlines”
“Golf headlines”	“NBA headlines”	“WNBA schedule”
“Golf leaderboard”	“NBA schedule”	“WNBA scores”

### Alerts



If your vehicle is equipped with Navigation, touch the **i** (Information) button to access these features. If your vehicle is not equipped with Navigation, touch the corner of the touchscreen with the green tab.

Press **Alerts**, and then choose from any of the following services:

- **View** the message.
- **Delete** the message.
- **Delete All** messages.

This screen displays any system messages (such as an SD card fault).

**Note:** The system alerts you to any messages by turning the information icon yellow. After you read or delete the messages, the icon returns to white.

### Calendar



If your vehicle is equipped with Navigation, touch the **i** (Information) button to access these features. If your vehicle is not equipped with Navigation, touch the corner of the touchscreen with the green tab.

Press **Calendar**. You can view the current calendar by day, week or month.

**911 Assist® (If Equipped)**

**WARNING:** Unless the 911 Assist setting is set on before a crash, the system will not dial for help, which could delay response time, potentially increasing the risk of serious injury or death after a crash.



**WARNING:** Do not wait for 911 Assist to make an emergency call if you can do it yourself. Dial emergency services immediately to avoid delayed response time, which could increase the risk of serious injury or death after a crash. If you do not hear 911 Assist within five seconds of the crash, the system or phone may be damaged or non-functional.



**WARNING:** Always place your phone in a secure location in your vehicle so it does not become a projectile or damaged in a crash. Failure to do so may cause serious injury to someone or damage the phone, which could prevent 911 Assist from working properly.

**Note:** The SYNC 911 Assist feature must be set on prior to the incident.

**Note:** Before setting this feature on, make sure that you read the 911 Assist privacy notice later in this section for important information.

**Note:** If any user turns 911 Assist on or off, that setting applies for all paired phones. If 911 Assist is turned off, either a voice message plays or a display message (or icon) comes on (or both) when your vehicle is started after a previously paired phone connects.

**Note:** Every phone operates differently. While SYNC 911 Assist works with most cellular phones, some may have trouble using this feature.

If a crash deploys an airbag (excludes knee airbags and rear inflatable safety belts [if equipped]) or activates the fuel pump shut-off, your SYNC-equipped vehicle may be able to contact emergency services by dialing 911 through a paired and connected Bluetooth-enabled phone.

You can learn more about the 911 Assist feature, visit

[www.SYNCMYride.com](http://www.SYNCMYride.com), [www.SYNCMYride.ca](http://www.SYNCMYride.ca) or [www.syncmaroute.ca](http://www.syncmaroute.ca).

- For information on airbag deployment, see the *Supplementary Restraints System* chapter.
- For information on the fuel pump shut-off, see the *Roadside Emergencies* chapter.

**Setting 911 Assist On**

If your vehicle is equipped with Navigation, touch the i (Information) button to access these features. If your vehicle is not equipped with Navigation, touch the corner of the touchscreen with the green tab.

Press **Apps > 911 Assist, > On.**

You can also access 911 Assist by:



- Pressing the Settings icon > **Settings > Phone > 911 Assist**, or
- Pressing the Settings icon > **Help > 911 Assist.**

**To Make Sure that 911 Assist Works Properly**

- SYNC must be powered and working properly at the time of the incident and throughout feature activation and use.
- The 911 Assist feature must be set on before the incident.
- You must pair and connect a Bluetooth-enabled and compatible phone to SYNC.
- A connected Bluetooth-enabled phone must have the ability to make and maintain an outgoing call at the time of the incident.
- A connected Bluetooth-enabled phone must have adequate network coverage, battery power and signal strength.
- The vehicle must have battery power and be located in the United States, Canada or in a territory in which 911 is the emergency number.

**In the Event of a Crash**

Not all crashes deploy an airbag or activate the fuel pump shut-off (which would trigger 911 Assist); however, SYNC tries to contact emergency services if 911 Assist triggers. If a connected phone sustains damage or loses connection to SYNC, SYNC searches for, and tries to connect to, any available previously paired phone and tries to make the call to 911.

Before making the call:

- SYNC provides a short window of time (about 10 seconds) to cancel the call. If you fail to cancel the call, SYNC attempts to dial 911.
- SYNC says the following, or a similar message: “SYNC will attempt to call 911, to cancel the call, press Cancel on your screen or press and hold the phone button on your steering wheel.”

If you do not cancel the call, and SYNC makes a successful call, a pre-recorded message plays for the 911 operator, and then the occupant(s) in your vehicle is able to talk with the operator. Be prepared to provide your name, phone number and location immediately, because not all 911 systems are capable of receiving this information electronically.

**911 Assist May Not Work If**

- Your cellular phone or 911 Assist hardware sustains damage in a crash.
- The vehicle's battery or SYNC system has no power.
- The phone(s) thrown from your vehicle are the ones paired and connected to the system.

**911 Assist Privacy Notice**

When you turn on 911 Assist, it may disclose to emergency services that your vehicle has been in a crash involving the deployment of an airbag or activation of the fuel pump shut-off. Certain versions or updates to 911 Assist may also be capable of electronically or verbally disclosing to 911 operators your vehicle location or other details about your vehicle or crash to assist 911 operators to provide the most appropriate emergency services. If you do not want to disclose this information, do not turn the feature on.

**Vehicle Health Report (If Equipped, United States Only)**

**WARNING:** Always follow scheduled maintenance instructions, regularly inspect your vehicle, and seek repair for any damage or problem you suspect. Vehicle Health Report supplements, but cannot replace, normal maintenance and vehicle inspection. Vehicle Health Report only monitors certain systems electronically monitored by your vehicle and will not monitor or report the status of any other system, (such as brake lining wear). Failure to perform scheduled maintenance and regularly inspect your vehicle may result in vehicle damage and serious injury.

**Note:** Your Vehicle Health Report feature requires activation prior to use. Visit [www.SYNCMYride.com](http://www.SYNCMYride.com) to register. There is no fee or subscription associated with Vehicle Health Report, but you must register to use this feature.

**Note:** This feature may not function properly if you have enabled caller ID blocking on your mobile phone. Before running a report, review the *Vehicle Health Report Privacy Notice*.



**Note:** In order to allow a break-in period for your vehicle, you may not be able to create a Vehicle Health Report until your vehicle odometer has reached 200 miles.

**Note:** Cellular phone and SMS charges may apply when making a report.

Register for Vehicle Health Report and set your report preferences at [www.SYNCMYRide.com](http://www.SYNCMYRide.com). After registering, you can request a Vehicle Health Report (inside your vehicle). Return to your account at [www.SYNCMYRide.com](http://www.SYNCMYRide.com) to view your report. You can also choose for SYNC to remind you automatically to run reports at specific mileage intervals. Cellular phone airtime usage may apply when reporting.

The system allows you to check your vehicle's overall health in the form of a diagnostic report card. The Vehicle Health Report contains valuable information, such as:

- Vehicle Diagnostic Information
- Scheduled maintenance
- Open Recalls and Field Service Actions
- Items noted during vehicle inspections by your authorized dealer that still need servicing.

### ***Making a Report***



If your vehicle is equipped with Navigation, touch the **i** (Information) button to access these features. If your vehicle is not equipped with Navigation, touch the corner of the touchscreen with the green tab.

If you want to run a report by using the touchscreen, touch **Apps > Vehicle Health Report**.



To run a report by voice command, press the voice button on the steering wheel and, when prompted, say "Vehicle health report".

### ***Vehicle Health Report Privacy Notice***

When you create a Vehicle Health Report, Ford Motor Company may collect your cellular phone number (to process your report request) and diagnostic information about your vehicle. Certain versions or updates to Vehicle Health Report may also collect more vehicle information. Ford may use your vehicle information it collects for any purpose. If you do not want to disclose your cellular phone number or vehicle information, do not run the feature or set up your Vehicle Health Report profile at [www.SYNCMYRide.com](http://www.SYNCMYRide.com). See [www.SYNCMYRide.com](http://www.SYNCMYRide.com) (Vehicle Health Report Terms and Conditions, and Privacy Statement) for more information.

## SETTINGS



- A. Clock
- B. Display
- C. Sound
- D. Vehicle
- E. Settings
- F. Help



Under this menu, you can set your clock, access and adjust the display, sound and vehicle settings as well as access settings for specific modes or the help feature.

**Clock**

**Note:** You cannot manually set the date. Your vehicle's GPS does this for you.

**Note:** If the battery has been disconnected, your vehicle needs to acquire a GPS signal to update the clock. Once your vehicle acquires the signal, it may take a few minutes for the update to display the correct time.

1. Press the Settings icon > **Clock**.
2. Press **+** and **-** to adjust the time.

From this screen, you can also make other adjustments, such as 12- or 24-hour mode, activate GPS time synchronization and have the system automatically update for new time zones.

You can also turn the outside air temperature display on and off. It appears at the top center of the touchscreen, next to the time and date. The system automatically saves any updates you make to the settings.

### Display

You can adjust the touchscreen display through the touchscreen or by pressing the voice button on your steering wheel controls and when prompted, say, "Display settings".



Press the Settings icon > **Display**, to access and make adjustments using the touchscreen.

- **Brightness** allows you to make the screen display brighter or dimmer.
- **Auto DIM**, when set to **On**, lets you use the Auto Dim Manual Offset feature. When set to **Off**, screen brightness does not change.
- **Mode** allows you to set the screen to a certain brightness or have the system automatically change based on the outside light level, or turn the display off.
  - If you select **AUTO** or **NIGHT**, you have the options of turning the display's Auto Dim feature on or off and changing the Auto Dim Manual Offset feature.
- **Auto Dim Manual Offset** allows you to adjust screen dimming as the outside lighting conditions change from day to night. This feature also allows you to adjust screen brightness using the instrument panel dimming control.

### Edit Wallpaper

- You can have your touchscreen display the default photo or upload your own.

### Uploading Photos for Your Home Screen Wallpaper

**Note:** You cannot load photos directly from your camera. You must access the photos either from your USB mass storage device or from an SD card.

**Note:** Photographs with extremely large dimensions (such as 2048 x 1536) may not be compatible and appear as a blank (black) image on the display.

Your system allows you to upload and view up to 32 photos.

To access, press the Settings icon > **Display** > **Edit Wallpaper**, and then follow the system prompts to upload your photographs.

Only the photograph(s), which meets the following conditions, display:

- Compatible file formats are as follows: .jpg, .gif, .png, .bmp.
- Each file must be 1.5 MB or less.
- Recommended dimensions: 800 x 384.

### Sound



Press the Settings icon > **Sound**, then select from the following:

Sound Settings	
Bass	DSP*
Midrange	Occupancy Mode*
Treble	Speed Compensated Volume
Set Balance and Fade	

\*If equipped.

### Vehicle



Press the Settings icon > **Vehicle**, then select from the following:

- Ambient Lighting
- Vehicle Health Report
- Door Keypad Code
- Rear View Camera
- Enable Valet Mode.

#### **Ambient Lighting (If Equipped)**

When activated, ambient lighting illuminates footwells and cupholders with a choice of colors. To access and make adjustments:

1. Press the Settings icon > **Vehicle** > **Ambient Lighting**.
2. Touch the desired color.
3. Use the scroll bar to increase or decrease the intensity.

To turn the feature on or off, press the power button.

#### **Vehicle Health Report**

Turn Automatic Reminders on and off and set the mileage interval at which you would like to receive the reports. Press ? for more information on these selections.

When done making your selections, press **Run Vehicle Health Report Now** if you want your report.

**Door Keypad Code**

To change the keypad code for your keyless entry keypad system:

1. Press the Settings icon > **Vehicle** > **Door Keypad Code**.
2. Enter your current factory code, then, when prompted, enter your new code.

**Rear View Camera**

This menu allows you to access settings for your rear view camera.

Press the Settings icon > **Vehicle** > **Rear View Camera**, then select from the following settings:

- Rear Camera Delay
- Visual Park Aid Alert
- Guidelines.

**Enable Valet Mode**

Valet mode allows you to lock the system. No information is accessible until the system is unlocked with the correct PIN.

1. Press the Settings icon > **Vehicle** > **Enable Valet Mode**.
2. When prompted, enter a four-digit PIN.

After you press Continue, the system locks until you enter the PIN again.

**Note:** If the system locks, and you need to reset the PIN, enter 3681 and the system unlocks.

**Settings**

Access and adjust system settings, voice features, as well as phone, navigation and wireless settings.

**System**

Press the Settings icon > **Settings** > **System**, then select from the following:

<b>System</b>	
<b>Language</b>	Select to have the touchscreen display in English, Spanish or French.
<b>Distance</b>	Select to display units in kilometers or miles.
<b>Temperature</b>	Select to display units in Celsius or Fahrenheit.
<b>System Prompt Volume</b>	Adjust the volume of voice prompts from the system.

System	
<b>Touch Screen Button Beep</b>	Select to have the system beep to confirm choices made through the touchscreen.
<b>Touch Panel Button Beep</b>	Select to have the system beep to confirm button choices made through the climate or audio system.
<b>Keyboard Layout</b>	Have the touchscreen keyboard display in QWERTY or ABC format.
<b>Install Applications</b>	Install any downloaded applications or view the current software licenses.
<b>Master Reset</b>	Select to restore factory defaults. This erases all personal settings and personal data.

**Voice Control**

Press the Settings icon > **Settings** > **Voice Control**, then select from the following:

Voice control	
<b>Interaction Mode</b>	Standard interaction mode provides more detailed interaction and guidance. Advanced mode has less audible interaction and more tone prompts.
<b>Confirmation Prompts</b>	Have the system ask you short questions if it has not clearly heard or understood your request. <b>Note:</b> Even with confirmation prompts turned off, the system may occasionally ask you to confirm settings.
<b>Media Candidate Lists</b>	Candidate lists are possible results from your voice commands. The system simply makes a best guess at your request with these turned off.

Voice control	
<b>Phone Candidate Lists</b>	Candidate lists are possible results from your voice commands. The system simply makes a best guess at your request with these turned off.
<b>Voice Control Volume</b>	This allows you to adjust the system's voice volume level.

**Media Player**

Press the Settings icon > **Settings** > **Media Player**, then select from the following:

Media player	
<b>Autoplay</b>	When this feature is on, the system automatically switches to the media source upon initial connection. This allows you to listen to music during the indexing process. When this feature is off, the system does not automatically switch to the inserted media source.
<b>Bluetooth Devices</b>	Select to connect, disconnect, add or delete a device. You can also set a device as your favorite so that the system automatically attempts to connect to that device at every ignition cycle.
<b>Gracenote Database Info</b>	This allows you to view the version level of the Gracenote Database.
<b>Gracenote Mgmt</b>	With this feature on, the Gracenote Database supplies metadata information for your music files. This overrides information from your device. This feature defaults to off.
<b>Cover Art Priority</b>	With this feature on, the Gracenote Database supplied cover art for your music files. This overrides any art from your device. This feature defaults to Media Player.

**Navigation**

Press the Settings icon > **Settings** > **Navigation**, then select from the following:

<b>Navigation</b>	
<b>Map Preferences</b>	Turn breadcrumbs on and off.
	Have the system display your turn list top to bottom or bottom to top.
	Turn the Parking POI notification on and off.
<b>Route Preferences</b>	<b>Preferred Route</b> allows you to choose to have the system display the <b>Shortest</b> , <b>Fastest</b> or most <b>Ecological</b> route first. If you set <b>Always Use Preferred Route</b> to <b>Yes</b> , the system uses the selected route type to calculate only one route to the desired destination. <b>Always Use Preferred Route</b> bypasses route selection in destination programming. The system only calculates one route based on the preferred route setting.
	<b>Eco Time Penalty</b> allows you to select a low, medium or high cost for the calculated Eco Route. The higher the setting, the longer the time allotment is for the route.
	Have the system avoid freeways.
	Have the system avoid tollroads.
	Have the system avoid ferries or car trains.
	Have the system use high-occupancy vehicle lanes.
<b>Navigation Preferences</b>	Have the system use guidance prompts.
	Have the system automatically fill-in State/Province information.



Navigation	
<b>Traffic Preferences</b>	Have the system display areas where roadwork occurs.
	Have the system display incident icons.
	Have the system display areas where difficult driving conditions may occur.
	Have the system display areas where snow and ice on the road may occur.
	Have the system display any smog alerts.
	Have the system display weather warnings.
	Have the system display where there may be reduced visibility.
	Have the system turn on your radio for traffic announcements.
<b>Avoid Areas</b>	Enter specific areas that you would like to avoid on planned navigation routes.

### Phone Settings



Press the Settings icon > **Settings** > **Phone**, then select from the following:

Phone	
<b>Bluetooth Devices</b>	Connect, disconnect, add or delete a device, as well as save it as a favorite.
<b>Bluetooth</b>	Turn Bluetooth on and off.
<b>Do Not Disturb</b>	Have all calls go directly to your voice mail and not ring inside your vehicle. With this feature turned on, text message notifications are also suppressed and do not ring inside your vehicle.
<b>911 Assist</b>	Turn on or turn off the 911 Assist feature. See <i>911 Assist</i> in the <i>SYNC applications and services</i> section.

<b>Phone</b>	
<b>Phone Ringer</b>	Select the type of notification for phone calls - ring tone, beep, text to speech, or have it be silent.
<b>Text Message Notification</b>	Select the type of notification for text messages - alert tone, beep, text to speech, or have it be silent.
<b>Internet Data Connection</b>	If compatible with your phone, you can adjust your internet data connection. Select to make your connection profile with the personal area network or to turn off your connection. You can also choose to adjust your settings or have the system always connect, never connect when roaming or query on connect. Press ? for more information.
<b>Manage Phonebook</b>	Access features, such as automatic phonebook download, re-download your phonebook, add contacts from your phone as well as delete or upload your phonebook.
<b>Roaming Warning</b>	Have the system alert you when in Roaming mode.

**Wireless & Internet**

Your system has a Wi-Fi feature that creates a wireless network within your vehicle, thereby allowing other devices (such as personal computers or phones) in your vehicle to speak to each other, share files or play games. Using this Wi-Fi feature, everyone in your vehicle can also gain access the internet if you have a USB mobile broadband connection inside your vehicle, your phone supports personal area networking and if you park outside a wireless hotspot.



Press the Settings icon > **Settings** > **Wireless & Internet**, then select from the following:

<b>Wireless &amp; Internet</b>	
<b>Wi-Fi Settings</b>	<b>Wi-Fi Network (Client) Mode</b> turns the Wi-Fi feature on and off in your vehicle. Make sure you turn it on for connectivity purposes.
	<b>Choose a Wireless Network</b> allows you to use a previously stored wireless network. You can categorize by alphabetical listing, priority and signal strength. You can also choose to search for a network, connect to a network, disconnect from a network, receive more information, prioritize a network or delete a network.
	<b>Gateway (Access Point) Mode</b> makes SYNC an access point for a phone or a computer when turned on. This forms the local area network within your vehicle for things, such as game playing, file transfer and internet browsing. Press ? for more information.
	<b>Gateway (Access Point) Settings</b> allows you to view and change settings for using SYNC as the internet gateway.
	<b>Gateway (Access Point) Device List</b> allows you to view recent connections to your Wi-Fi system.

<b>Wireless &amp; Internet</b>	
<b>USB Mobile Broadband</b>	Instead of using Wi-Fi, your system can also use a USB mobile broadband connection to access the internet. (You must turn on your mobile broadband device on your personal computer before connecting it to the system.) This screen allows you to set up what is your typical area for your USB mobile broadband connection. (USB mobile broadband settings may not display if the device is already on.) You can select the following: Country, Carrier, Phone Number, User Name and Password.
<b>Bluetooth Settings</b>	Shows you the currently paired devices as well as giving you your typical Bluetooth options to connect, disconnect, set as favorite, delete and add device. Bluetooth is a registered trademark of the Bluetooth SIG.
<b>Prioritize Connection Methods</b>	Choose your connection methods and change them as needed. You can select to Change Order and have the system either always attempt to connect using a USB mobile broadband or using Wi-Fi.

The Wi-Fi CERTIFIED Logo is a certification mark of the Wi-Fi Alliance.



**Help**

Press the Settings icon > **Help**, then select from the following:

<b>Help</b>	
<b>Where Am I?</b>	View your vehicle's current location, if your vehicle is equipped with navigation. If your vehicle is not equipped with navigation, nothing displays.
<b>System Information</b>	Touchscreen system serial number.
	Your vehicle identification number (VIN).
	Touchscreen system software version.
	Navigation system version.
	Map database version.
	Sirius satellite radio electronic serial number (ESN).
	Gracenote Database Information and Library version.
<b>Software Licenses</b>	View the licenses for any software and applications installed on your system.
<b>Driving Restrictions</b>	Certain features are not accessible when your vehicle is moving.
<b>911 Assist</b>	Turn on and turn off the 911 Assist feature. See <i>911 Assist</i> in the <i>SYNC applications and services</i> section. <b>In Case of Emergency (ICE) Speed Dial</b> allows you to save up to two numbers as ICE contacts for quick access if there is an emergency. Select <b>Edit</b> to access your phonebook and then select the desired contacts. The numbers then appear as options on this screen for the ICE 1 and ICE 2 buttons. The ICE contacts you select appear at the end of the 911 Assist call process.
<b>Voice Command List</b>	View categorized lists of voice commands.

To access Help using the voice commands, press the voice button, then, after the tone, say “Help”. The system provides allowable voice commands for the current mode.

## CLIMATE

Press the lower right corner on the touchscreen to access your climate control features. Depending on your vehicle line and option package, your climate screen may look different from the screen shown here.

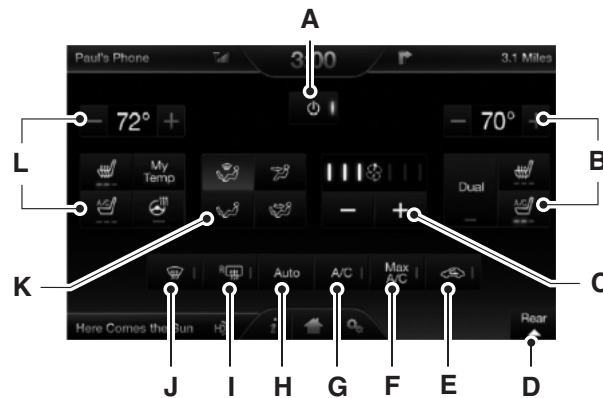

A. **Power:** Touch to switch the system off and on. Switching off the climate control system prevents outside air from entering the vehicle.

### B. Passenger settings:

- Touch **DUAL** to switch on the passenger temperature control.
- Touch **+** or **-** to adjust the temperature.
- Touch the heated seat icon to control the heated seat.
- Touch the cooled seat icon to control the cooled seat.

C. **Fan speed:** Touch **+** or **-** to adjust fan speed.

D. **Rear:** Touch to access the rear climate control. Rear climate control settings appear at the bottom of the screen.

- Touch the power icon to turn the rear climate control functions off and on.
- Touch **Rear Control** to allow the rear seat passengers to adjust the rear climate settings. Touch it again to prevent the rear seat passengers from adjusting the settings. **Rear Control** automatically turns off when you use the touchscreen to adjust the rear climate settings.
- Touch **+** or **-** to adjust the temperature.

- To adjust fan speed, touch + or – next to the fan icon.
  - Touch **Rear** again to close the rear controls. Closing the rear climate control functions does not affect their current settings.
- E. **Recirculated air:** Touch to turn the recirculated air on or off which:
- May reduce the amount of time needed to cool down the interior.
  - May help reduce odors from reaching the interior.
  - Engages automatically when MAX A/C is selected.
  - May be engaged manually in any airflow mode except defrost.
  - May turn off in all airflow modes except MAX A/C to reduce fog potential.
- F. **MAX A/C:** Touch to cool your vehicle with recirculated air. Touch again for normal A/C operation. MAX A/C:
- Distributes air through instrument panel vents.
  - Is more economical and efficient than normal A/C mode.
  - May help reduce odors from entering your vehicle.
- G. **A/C:** Touch to turn the air conditioning on or off.
- Use with recirculated air to improve cooling performance and efficiency.
  - Engages automatically in MAX A/C, defrost and floor/defrost.
- H. **AUTO:** Touch to engage automatic operation, then set the temperature using the temperature control. The system automatically controls:
- Fan speed
  - Airflow distribution
  - A/C on or off
  - Outside or recirculated air.
- I. **Rear defroster:** Touch to turn the rear window defroster and heated mirrors.
- J. **Defrost:** Touch to clear the windshield of fog and thin ice. Touch again to return to the previous airflow selection. When on, defrost:
- Provides outside air to reduce window fogging.
  - Distributes air through the windshield defroster vents and demister vents.
- K. **Manual controls:** Select any of the following airflow distribution modes:
- **Floor and Defrost:** Distributes air through the windshield defroster vents, demister vents, floor vents and rear seat floor vents, and provides outside air to reduce window fogging.
  - **Panel:** Distributes air through the instrument panel vents.

- **Panel and Floor:** Distributes air through the instrument panel vents, demister vents, floor vents and rear seat floor vents.
- **Floor:** Distributes air through the demister vents, floor vents and rear seat floor vents.

L. **Driver settings:** Depending on your vehicle and option package, you may have the following features:

- Touch **+** or **-** to adjust the temperature.
- If your vehicle is equipped with heated seats, touch the heated seat icon to control the heated seat. See the *Seats* chapter.
- If your vehicle is equipped with cooled seats, touch the cooled seat icon to control the cooled seat. See the *Seats* chapter.
- Touch and hold **MyTemp** to select a temperature you would like your vehicle to remember and maintain for you.
- If your vehicle is equipped with a heated steering wheel, touch the heated steering wheel icon to warm the steering wheel.

**Note:** If your vehicle is equipped with a wood-trimmed steering wheel, it does not heat between the 10 o'clock and 2 o'clock positions.

#### Climate Control Voice Commands



The following voice commands are available at the main menu level of a voice session. For example, press the voice button and after the prompt, "Say a command"; say any of the following commands:

Climate control voice commands
"Climate automatic"
"Climate my temperature"
"Climate off"
"Climate on"
"Climate temperature <15.5-29.5> degrees"
"Climate temperature <60-85> degrees"
"Help"



There are additional climate control commands but in order to access them, you have to say “Climate” first, then when the system is ready to listen, you may say any of the following commands:

<b>Additional climate control voice commands</b>	
“Automatic”	“Panel on”
“A/C off”	“Rear defrost off”
“A/C on”	“Rear defrost on”
“Defrost off”	“Recirc off”
“Defrost on”	“Recirc on”
“Dual off”	“Temperature”*
“Fan decrease”	“Temperature <15.5–29.5> degrees”
“Fan increase”	“Temperature <60–85> degrees”
“Floor on”	“Temperature decrease”
“Max A/C off”	“Temperature high”
“Max A/C on”	“Temperature increase”
“My temp”	“Temperature low”
“Off”	“Windshield floor on”
“On”	“Help”
“Panel floor on”	

\*If you have said “Temperature”, you can say any of the commands in the following “Temperature” chart.

<b>“TEMPERATURE”</b>
“High”
“Low”
“<15.5–29.5> degrees”
“<60–85> degrees”
“Help”

#### **NAVIGATION SYSTEM (IF EQUIPPED)**

**Note:** The navigation SD card must be in the SD card slot to operate the navigation system. If you need a replacement SD card, see your authorized dealer.

**Note:** The SD card slot is spring-loaded. To remove the SD card, just push the card in and release it. Do not attempt to pull the card out to remove it; this could cause damage.

Your navigation system is comprised of two main features, destination mode and map mode.

To set a destination, press the green corner of your touchscreen, then **Dest** when it appears. See *Setting a destination* later in this chapter.

To view the navigation map and your vehicle's current location, touch the green bar in the upper right hand corner of the touchscreen, or, press **Dest > Map**. See *Map mode* later in this chapter.

### Setting a Destination

Press the green corner of your touchscreen, then **Dest** when it appears. Choose any of the following:

Destination selections	
My Home	Street Address
Favorites	Intersection
Previous Destinations	City Center
Point of Interest	Map
Emergency	Edit Route Cancel Route

1. Enter the necessary information into the highlighted text fields (in any order). For address destination entry, **Go!** appears once you enter all the necessary information. Pressing **Go!** makes the address location appear on the map. If you choose **Previous Destination**, the last 20 destinations you have selected appear.
2. Select **Set as Dest** to make this your destination. You can also choose to set this as a waypoint (have the system route to this point on the way to your current destination) or save it as a favorite. The system considers any **Avoid Areas** selections in its route calculation.
3. Choose from up to three different types of routes, and then select **Start Route**.
  - **Fastest Route:** Uses the fastest moving roads possible.
  - **Shortest Route:** Uses the shortest distance possible.
  - **Eco Route:** Uses the most fuel-efficient route.

You can cancel the route or have the system demo the route for you. Select **Route Prefs** to set route preferences like avoiding freeways, tollroads, ferries and car trains as well as to use or not use high-occupancy vehicle lanes. (High-occupancy vehicle lanes are also known as carpool or diamond lanes. People who ride in buses, vanpools or carpools use these lanes.)

**Note:** If your vehicle is on a recognized road and you do not press the **Start Route** button, the system defaults to the **Fastest Route** option and begins guidance.

During route guidance, you can press the talking bubble icon that appears in the upper right navigation corner (green bar) if you want the system to repeat route guidance information. When the system repeats the last guidance instruction, it updates the distance to the next guidance instruction, since it detects when the vehicle is moving.

### Point of Interest (POI) Categories

Your system offers a variety of points of interest categories.

Main categories	
Food/Drink & Dining	Automotive
Travel & Transportation	Shopping
Financial	Entertainment & Arts
Emergency	Recreation & Sports
Community	Government
Health & Medicine	Domestic Services

Within these main categories, there are subcategories which contain more listings:

Subcategories
Restaurant
Golf
Parking
Home & Garden
Personal Care Services
Automobile Dealership
Government Office
Public Transit
Education

To expand these listings, press the **+** in front of the point of interest listing.

When programming a point of interest destination, the system allows you to sort the resulting lists alphabetically, by distance or by cityseekr listings (if available).

Pressing the **Search Areas** button allows you to search for points of interest nearby, near a city or state or near a destination, if a route is active.

Pressing the **Search By Name** button allows you to directly enter the point of interest name into the system by using the keyboard.

#### cityseekr (If Available)

**Note:** cityseekr point of interest information is limited to approximately 912 cities (881 in the United States, 20 in Canada and 11 in Mexico).



cityseekr, when available, is a service that provides more information about certain points of interest such as restaurants, hotels and attractions.

When you have selected a point of interest, the location and information appear, such as address and phone number. If cityseekr lists the point of interest, more information is available, such as a brief description, hotel check-in and checkout times or restaurant hours.

Press **More Information** for a longer review, a list of services and facilities, the average room or meal price as well as the website link.

This screen displays either a facility photo (if available) or point of interest icons, such as:



Hotel



Coffeehouse



Food & Drink



Nightlife



Attraction



This icon appears when your selection exists in multiple categories within the system.

When you are viewing more information for hotels, cityseekr also tells you if the hotel has certain services and facilities using icons.

Hotel services and facilities	
Restaurant	24 Hr Room Service
Business Center	Fitness Center
Handicap Facilities	Internet Access
Laundry	Pool
Refrigerator	Wi-Fi

For restaurants, cityseekr can provide information, such as star rating, average cost, review, handicap access, hours of operation, and website address.

For hotels, cityseekr can provide information, such as star rating, price category, review, check-in and check-out times, hotel service icons and website address.

### Setting Your Navigation Preferences

Select settings for the system to take into account when planning your route.



Press the Settings icon > **Settings** > **Navigation**.

**Map Preferences**

**Breadcrumbs** displays your vehicle's previously traveled route with white dots. Turn this feature **ON** or **OFF**.

**Turn List Format** allows you to choose to have the system display your turn list **Top to Bottom** or **Bottom to Top**.

**Parking POI Notification** sets the automatic parking points of interest notification. Turn this feature **ON** or **OFF**. When parking points of interest notification is on, the icons display on the map when you get close to your destination. This may not be very useful in dense areas, and may clutter the map when other points of interest display.

**Route Preferences**

**Preferred Route** allows you to choose to have the system display the **Shortest**, **Fastest** or most **Ecological** route first. If you set **Always Use Preferred Route** to **Yes**, the system uses the selected route type to calculate only one route to the desired destination.

**Always Use Preferred Route** bypasses route selection in destination programming. The system only calculates one route based on the preferred route setting.

**Eco Time Penalty** allows you to select a low, medium or high cost for the calculated Eco Route. The higher the setting, the longer the time allotment is for the route.

**Avoid** features allows you to choose to have the system avoid freeways, toll roads, ferries and car trains when planning your route. Turn these features **ON** or **OFF**.

**Use HOV Lanes** allows you to choose to have the system use high-occupancy vehicle lanes, if available, when planning your route.

**Navigation Preferences**

**Guidance Prompts** allows you to choose to have the system use **Voice & Tones** or **Tone Only** on your programmed route.

**Auto - Fill State/Province** allows you have the system automatically fill in the state and province based on the information already entered into the system. Turn this feature **ON** or **OFF**.

**Traffic Preferences**

**Avoid Traffic Problems** allows you to choose how you want the system to handle traffic problems along your route.

- **Automatic:** Have the system reroute you to avoid traffic incidents that develop and impact the current route. The system does not provide a traffic alert notification.
- **Manual:** Have the system always provide a traffic alert notification for traffic incidents along the planned route. You have a choice to accept or ignore the notification before making the route deviation.

**Traffic Alert Notification** allows you to choose have the system display traffic alert notifications.

Other traffic alert features allows you to turn on certain, or all, traffic icons on the map such as road work, incident, accidents and closed roads. Scroll down to view all the different types of alerts. Turn these features **ON** or **OFF**.

**Avoid Areas**

**Avoid Areas** allows you to choose areas which you want the system to avoid when calculating a route for you.

Press **Add** to program an entry. Once you make a selection, the system tries to avoid the area(s) if possible for all routes. To delete a selection, choose the listing on the screen. When the screen changes to **Avoid Areas Edit**, you can press **Delete** at the bottom right of the screen.

**Map Mode**

Press the green bar in the upper right area of the touchscreen to view map mode. Map mode shows advanced viewing comprised of both 2D city maps as well as 3D landmarks (when available).

**2D city maps** show detailed outlines of buildings, visible land use and land elements and detailed railway infrastructure for the most essential cities around the globe. These maps also contain features, such as town blocks, building footprints, and railways.

**3D landmarks** appear as clear, visible objects that are typically recognizable and have a certain tourist value. The 3D landmarks appear in 3D map mode only. Coverage varies, and improves with updated map releases.

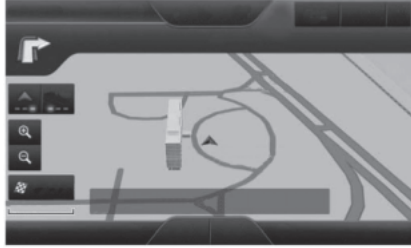

Change the appearance of the map display by repeatedly pressing the arrow button in the upper left corner of the screen. It toggles between three different map modes: Heading up, North up, and 3D.



**Heading up (2D map)** always shows the direction of forward travel to be upward on the screen. This view is available for map scales up to 2.5 miles (4 kilometers). The system remembers this setting for larger map scales, but shows the map in North up only.

If the scale returns below this level, the system restores Heading up.



**North up (2D map)** always shows the northern direction to be upward on the screen.



**3D map mode** provides an elevated perspective of the map. This viewing angle can be adjusted and the map can be rotated 180 degrees by touching the map twice, and then dragging your finger along the shaded bar with arrows at the bottom of the map.

**View** switches between full map, street list and exit view in route guidance.

**Menu** displays a pop-up box that allows direct access to navigation settings, View/Edit Route, Sirius Travel Link, Guidance Mute and Cancel Route.



Re-center the map by pressing this icon whenever you scroll the map away from your vehicle's current location.

### **Auto Zoom**

Press the green bar to access map mode, then select the + or - zoom button to bring up the zoom level and Auto buttons on the touchscreen. When you press **Auto**, Auto Zoom turns on and **Auto** displays in the bottom left corner of the screen in the map scale. The map zoom level then synchronizes with vehicle speed. The slower your vehicle is traveling, the farther in the map zooms in; the faster your vehicle is traveling, the farther the map zooms out. To turn the feature off, just press the + or - button again.



In 3D mode, rotate the map view by swiping your finger across the shaded bar with the arrows.

### Map Icons



**Vehicle mark** shows the current location of your vehicle. It stays in the center of the map display, except when in scroll mode.



**Scroll cursor** allows you to scroll the map; the fixed icon is in the center of the screen. The map position closest to the cursor is in a window on the top center part of the screen.



**Address book entry default icon(s)** indicates the location on the map of an address book entry. This is the default symbol shown after the entry has been stored to the Address Book by any method other than the map. You can select from any of the 22 icons available. You can use each icon more than once.



**Home** indicates the location on the map currently stored as the home position. You can only save one address from the Address Book as your Home entry. You cannot change this icon.



**POI (Point Of Interest) icons** indicate locations of any point of interest categories you choose to display on the map. You can choose to display three point of interest categories on the map at one time.



**Starting point** indicates the starting point of a planned route.



**Waypoints** indicates the location of a waypoint on the map. The number inside the circle is different for each waypoint and represents the position of the waypoint in the route list.



**Destination symbol** indicates the ending point of a planned route.



**Next maneuver point** indicates the location of the next turn on the planned route.



**No GPS symbol** indicates that insufficient GPS satellite signals are available for accurate map positioning. This icon may display under normal operation in an area with poor GPS access.

### **Quick-touch Buttons**

When in map mode, touch anywhere on the map display to access more features.

#### ***Set as Dest***

Touch this button to select a scrolled location on the map as your destination. You may scroll the map by pressing your index finger on the map display. When you reach the desired location, simply let go and then touch **Set as Dest**.

#### ***Set as Waypoint***

Touch this button to set the current location as a waypoint.

#### ***Save to Favorites***

Touch this button to save the current location to your favorites.

#### ***POI Icons***

Touch this button to select icons to display on the map. You can select up to three icons to display on the map at the same time. Turn these **ON** or **OFF**.

#### ***Cancel Route***

Touch this button to cancel the active route.

#### ***View/Edit Route***

Access these features when a route is active:

- View Route
- Edit Destination/Waypoints
- Edit Turn List
- Detour
- Edit Route Preferences
- Edit Traffic Preferences
- Cancel Route.

Nokia is the digital map provider for the navigation application. If you find map data errors, you may report them directly to Nokia by going to <http://mapreporter.navteq.com>. Nokia evaluates all reported map errors and responds with the result of their investigation by e-mail.

### Navigation Map Updates

Annual navigation map updates are available for purchase through your dealership, by calling 1-800-NAVMAPS (in Mexico, call 01-800-557-5539) or going to [www.navigation.com/ford](http://www.navigation.com/ford). You need to specify the make and model of your vehicle to determine if there is an update available.

### Navigation Voice Commands



When in navigation mode, press the voice button on the steering wheel control. After the tone, say any of the following commands:

Navigation system voice commands	
“Cancel next waypoint” <sup>1</sup>	“Navigation” <sup>3</sup>
“Cancel route” <sup>1</sup>	“Navigation voice volume decrease” <sup>1</sup>
“Destination” <sup>2</sup>	“Navigation voice volume increase” <sup>1</sup>
“Destination <nametag>”	“Repeat instruction”
“Destination <POI category>”	“Show 3D”
“Destination favorites”	“Show heading up”
“Destination home”	“Show map”
“Destination intersection”	“Show north up”
“Destination nearest <POI category>”	“Show route” <sup>1</sup>
“Destination nearest POI”	“Show turn list” <sup>1</sup>
“Destination play nametags”	“Voice guidance off”
“Destination POI”	“Voice guidance on”
“Destination POI category”	“Where am I?”
“Destination previous destination”	“Zoom in”
“Destination street address”	“Zoom out”
“Detour” <sup>1</sup>	“Help”

<sup>1</sup>This command is only available when a navigation route is active.

<sup>2</sup>If you have said the command, “Destination”, you may say any of the above commands or commands in the following Destination chart.

<sup>3</sup>If you have said the command, “Navigation”, you may say any of the above commands or commands in the following Navigation chart.

<b>“DESTINATION”</b>
“<nametag>”
“<POI category>”
“Favorites”
“Home”
“Intersection”
“Nearest <POI category>”
“Nearest POI”
“Play nametags”
“POI category”
“Previous destination”
“Street address”
“Help”
<b>“NAVIGATION”</b>
“Destination”*
“Zoom city”
“Zoom country”
“Zoom in minimum”
“Zoom out maximum”
“Zoom province”
“Zoom state”
“Zoom street”
“Zoom to <distance>”
“Help”

\*If you have said, “Destination”, you may say any of the commands in the Destination chart.

#### **One-shot Destination Street Address**

When you say either “Navigation destination street address” or “Destination street address”, the system asks you to say the full address. The system displays an example on-screen. You can then speak the address naturally, such as “One two three four Main Street, Anytown”.

**GENERAL INFORMATION****SYNC® End User License Agreement (EULA)**

- You have acquired a device (“DEVICE”) that includes software licensed by Ford Motor Company and its affiliates (“FORD MOTOR COMPANY”) from an affiliate of Microsoft Corporation (“MS”). Those installed software products of MS origin, as well as associated media, printed materials, and “online” or electronic documentation (“MS SOFTWARE”) are protected by international intellectual property laws and treaties. The MS SOFTWARE is licensed, not sold. All rights reserved.
- The MS SOFTWARE may interface with and/or communicate with, or may be later upgraded to interface with and/or communicate with additional software and/or systems provided by FORD MOTOR COMPANY. The additional software and systems of FORD MOTOR COMPANY origin, as well as associated media, printed materials, and “online” or electronic documentation (“FORD SOFTWARE”) are protected by international intellectual property laws and treaties. The FORD SOFTWARE is licensed, not sold. All rights reserved.
- The MS SOFTWARE and/or FORD SOFTWARE may interface with and/or communicate with, or may be later upgraded to interface with and/or communicate with additional software and/or systems provided by third party software and service suppliers. The additional software and services of third party origin, as well as associated media, printed materials, and “online” or electronic documentation (“THIRD PARTY SOFTWARE”) are protected by international intellectual property laws and treaties. The THIRD PARTY SOFTWARE is licensed, not sold. All rights reserved.
- The MS SOFTWARE, FORD SOFTWARE and THIRD PARTY SOFTWARE hereinafter collectively and individually will be referred to as “SOFTWARE.”

**IF YOU DO NOT AGREE TO THIS END USER LICENSE AGREEMENT (“EULA”), DO NOT USE THE DEVICE OR COPY THE SOFTWARE. ANY USE OF THE SOFTWARE, INCLUDING BUT NOT LIMITED TO USE ON THE DEVICE, WILL CONSTITUTE YOUR AGREEMENT TO THIS EULA (OR RATIFICATION OF ANY PREVIOUS CONSENT).**

**GRANT OF SOFTWARE LICENSE:** This EULA grants you the following license:

- You may use the SOFTWARE as installed on the DEVICE and as otherwise interfacing with systems and/or services provide by or through FORD MOTOR COMPANY or its third party software and service providers.

**DESCRIPTION OF OTHER RIGHTS AND LIMITATIONS:**

- **Speech Recognition:** If the SOFTWARE includes speech recognition component(s), you should understand that speech recognition is an inherently statistical process and that recognition errors are inherent in the process. Neither FORD MOTOR COMPANY nor its suppliers shall be liable for any damages arising out of errors in the speech recognition process.
- **Limitations on Reverse Engineering, Decompilation and Disassembly:** You may not reverse engineer, decompile, or disassemble nor permit others to reverse engineer, decompile or disassemble the SOFTWARE, except and only to the extent that such activity is expressly permitted by applicable law notwithstanding this limitation.
- **Limitations on Distributing, Copying, Modifying and Creating Derivative Works:** You may not distribute, copy, make modifications to or create derivative works based on the SOFTWARE, except and only to the extent that such activity is expressly permitted by applicable law notwithstanding this limitation.
- **Single EULA:** The end user documentation for the DEVICE and related systems and services may contain multiple EULAs, such as multiple translations and/or multiple media versions (e.g., in the user documentation and in the software). Even if you receive multiple EULAs, you are licensed to use only one (1) copy of the SOFTWARE.
- **SOFTWARE Transfer:** You may permanently transfer your rights under this EULA only as part of a sale or transfer of the DEVICE, provided you retain no copies, you transfer all of the SOFTWARE (including all component parts, the media and printed materials, any upgrades, and, if applicable, the Certificate(s) of Authenticity), and the recipient agrees to the terms of this EULA. If the SOFTWARE is an upgrade, any transfer must include all prior versions of the SOFTWARE.
- **Termination:** Without prejudice to any other rights, FORD MOTOR COMPANY or MS may terminate this EULA if you fail to comply with the terms and conditions of this EULA.

- **Security Updates/Digital Rights Management:** Content owners use the WMDRM technology included in your DEVICE to protect their intellectual property, included copyrighted content. Portions of the SOFTWARE on your DEVICE use WMDRM software to access WMDRM-protected content. If the WMDRM software fails to protect the content, content owners may ask Microsoft to revoke the SOFTWARE's ability to use WMDRM to play or copy protected content. This action does not affect unprotected content. When your DEVICE downloads licenses for protected content, you agree that Microsoft may include a revocation list with the licenses. Content owners may require you to upgrade the SOFTWARE on your DEVICE to access their content. If you decline an upgrade, you will not be able to access content that requires the upgrade.
- **Consent to Use of Data:** You agree that MS, Microsoft Corporation, FORD MOTOR COMPANY, third party software and systems suppliers, their affiliates and/or their designated agent may collect and use technical information gathered in any manner as part of product support services related to the SOFTWARE or related services. MS, Microsoft Corporation, FORD MOTOR COMPANY, third party software and services suppliers, their affiliates and/or their designated agent may use this information solely to improve their products or to provide customized services or technologies to you. MS, Microsoft Corporation, FORD MOTOR COMPANY, third party software and systems suppliers, their affiliates and/or their designated agent may disclose this information to others, but not in a form that personally identifies you.
- **Internet-Based Services Components:** The SOFTWARE may contain components that enable and facilitate the use of certain Internet-based services. You acknowledge and agree that MS, Microsoft Corporation, FORD MOTOR COMPANY, third party software and service suppliers, their affiliates and/or their designated agent may automatically check the version of the SOFTWARE and/or its components that you are utilizing and may provide upgrades or supplements to the SOFTWARE that may be automatically downloaded to your DEVICE.
- **Additional Software/Services:** The SOFTWARE may permit FORD MOTOR COMPANY, third party software and service suppliers, MS, Microsoft Corporation, their affiliates and/or their designated agent to provide or make available to you SOFTWARE updates, supplements, add-on components, or Internet-based services components of the SOFTWARE after the date you obtain your initial copy of the SOFTWARE ("Supplemental Components").

If FORD MOTOR COMPANY or third party software and services suppliers provide or make available to you Supplemental Components and no other EULA terms are provided along with the Supplemental Components, then the terms of this EULA shall apply.

If MS, Microsoft Corporation, their affiliates and/or their designated agent make available Supplemental Components, and no other EULA terms are provided, then the terms of this EULA shall apply, except that the MS, Microsoft Corporation or affiliate entity providing the Supplemental Component(s) shall be the licensor of the Supplemental Component(s).

FORD MOTOR COMPANY, MS, Microsoft Corporation, their affiliates and/or their designated agent reserve the right to discontinue without liability any Internet-based services provided to you or made available to you through the use of the SOFTWARE.

- **Links to Third Party Sites:** The MS SOFTWARE may provide you with the ability to link to third party sites through the use of the SOFTWARE. The third party sites are not under the control of MS, Microsoft Corporation, their affiliates and/or their designated agent. Neither MS nor Microsoft Corporation nor their affiliates nor their designated agent are responsible for (i) the contents of any third party sites, any links contained in third party sites, or any changes or updates to third party sites, or (ii) webcasting or any other form of transmission received from any third party sites. If the SOFTWARE provides links to third party sites, those links are provided to you only as a convenience, and the inclusion of any link does not imply an endorsement of the third party site by MS, Microsoft Corporation, their affiliates and/or their designated agent.
- **Obligation to Drive Responsibly:** You recognize your obligation to drive responsibly and keep attention on the road. You will read and abide with the DEVICE operating instructions particularly as they pertain to safety and assumes any risk associated with the use of the DEVICE.

**UPGRADES AND RECOVERY MEDIA:** If the SOFTWARE is provided by FORD MOTOR COMPANY separate from the DEVICE on media such as a ROM chip, CD ROM disk(s) or via web download or other means, and is labeled "For Upgrade Purposes Only" or "For Recovery Purposes Only" you may install one (1) copy of such SOFTWARE onto the DEVICE as a replacement copy for the existing SOFTWARE, and use it in accordance with this EULA, including any additional EULA terms accompanying the upgrade SOFTWARE.



**INTELLECTUAL PROPERTY RIGHTS:** All title and intellectual property rights in and to the SOFTWARE (including but not limited to any images, photographs, animations, video, audio, music, text and “applets,” incorporated into the SOFTWARE), the accompanying printed materials, and any copies of the SOFTWARE, are owned by MS, Microsoft Corporation, FORD MOTOR COMPANY, or their affiliates or suppliers. The SOFTWARE is licensed, not sold. You may not copy the printed materials accompanying the SOFTWARE. All title and intellectual property rights in and to the content which may be accessed through use of the SOFTWARE is the property of the respective content owner and may be protected by applicable copyright or other intellectual property laws and treaties. This EULA grants you no rights to use such content. All rights not specifically granted under this EULA are reserved by MS, Microsoft Corporation, FORD MOTOR COMPANY, third party software and service providers, their affiliates and suppliers. Use of any on-line services which may be accessed through the SOFTWARE may be governed by the respective terms of use relating to such services. If this SOFTWARE contains documentation that is provided only in electronic form, you may print one copy of such electronic documentation.

**EXPORT RESTRICTIONS:** You acknowledge that the SOFTWARE is subject to U.S. and European Union export jurisdiction. You agree to comply with all applicable international and national laws that apply to the SOFTWARE, including the U.S. Export Administration Regulations, as well as end-user, end-use and destination restrictions issued by U.S. and other governments. For additional information, see <http://www.microsoft.com/exporting/>.

**TRADEMARKS:** This EULA does not grant you any rights in connection with any trademarks or service marks of FORD MOTOR COMPANY, MS, Microsoft Corporation, third party software or service providers, their affiliates or suppliers.

**PRODUCT SUPPORT:** Product support for the SOFTWARE is not provided by MS, its parent corporation Microsoft Corporation, or their affiliates or subsidiaries. For product support, please refer to FORD MOTOR COMPANY instructions provided in the documentation for the DEVICE. Should you have any questions concerning this EULA, or if you desire to contact FORD MOTOR COMPANY for any other reason, please refer to the address provided in the documentation for the DEVICE.

**No Liability for Certain Damages:** EXCEPT AS PROHIBITED BY LAW, FORD MOTOR COMPANY, ANY THIRD PARTY SOFTWARE OR SERVICES SUPPLIERS, MS, MICROSOFT CORPORATION AND THEIR AFFILIATES SHALL HAVE NO LIABILITY FOR ANY INDIRECT, SPECIAL, CONSEQUENTIAL OR INCIDENTAL DAMAGES ARISING FROM OR IN CONNECTION WITH THE USE OR PERFORMANCE OF THE SOFTWARE. THIS LIMITATION SHALL APPLY EVEN IF ANY REMEDY FAILS OF ITS ESSENTIAL PURPOSE. IN NO EVENT SHALL MS, MICROSOFT CORPORATION AND/OR THEIR AFFILIATES BE LIABLE FOR ANY AMOUNT IN EXCESS OF U.S. TWO HUNDRED FIFTY DOLLARS (U.S.\$250.00).

- THERE ARE NO WARRANTIES OTHER THAN THOSE THAT MAY EXPRESSLY BE PROVIDED FOR YOUR NEW VEHICLE.

**Adobe**

Contains Adobe® [Flash® Player] or [AIR®] technology by Adobe Systems Incorporated. This [Licensee Product] contains [Adobe® Flash® Player] [Adobe® AIR®] software under license from Adobe Systems Incorporated, Copyright © 1995-2009 Adobe Macromedia Software LLC. All rights reserved. Adobe, Flash and AIR are trademarks of Adobe Systems Incorporated.

**End user notice****Microsoft® Windows® Mobile for Automotive Important Safety Information**

This system Ford SYNC™ contains software that is licensed to Manufacturer FORD MOTOR COMPANY by an affiliate of Microsoft Corporation pursuant to a license agreement. Any removal, reproduction, reverse engineering or other unauthorized use of the software from this system in violation of the license agreement is strictly prohibited and may subject you to legal action.

**Read and follow instructions**

Before using your Windows Automotive-based system, read and follow all instructions and safety information provided in this end user manual (“User’s Guide”). Not following precautions found in this User’s Guide can lead to an accident or other serious consequences.

**Keep User's Guide in Vehicle**

When kept in the vehicle, the User's Guide will be a ready reference for you and other users unfamiliar with the Windows Automotive-based system. Please make certain that before using the system for the first time, all persons have access to the User's Guide and read its instructions and safety information carefully.



**WARNING:** Operating certain parts of this system while driving can distract your attention away from the road, and possibly cause an accident or other serious consequences. Do not change system settings or enter data non-verbally (using your hands) while driving. Stop the vehicle in a safe and legal manner before attempting these operations. This is important since while setting up or changing some functions you might be required to distract your attention away from the road and remove your hands from the wheel.

**General operation****Voice Command Control**

Functions within the Windows Automotive-based system may be accomplished using only voice commands. Using voice commands while driving allows you to operate the system without removing your hands from the wheel.

**Prolonged Views of Screen**

Do not access any function requiring a prolonged view of the screen while you are driving. Pull over in a safe and legal manner before attempting to access a function of the system requiring prolonged attention. Even occasional short scans to the screen may be hazardous if your attention has been diverted away from your driving task at a critical time.

**Volume Setting**

Do not raise the volume excessively. Keep the volume at a level where you can still hear outside traffic and emergency signals while driving. Driving while unable to hear these sounds could cause an accident.

**Use of Speech Recognition Functions**

Speech recognition software is inherently a statistical process which is subject to errors. It is your responsibility to monitor any speech recognition functions included in the system and address any errors.

**Navigation Features**

Any navigation features included in the system are intended to provide turn by turn instructions to get you to a desired destination. Please make certain all persons using this system carefully read and follow instructions and safety information fully.

**Distraction Hazard**

Any navigation features may require manual (non-verbal) setup. Attempting to perform such set-up or insert data while driving can seriously distract your attention and could cause an accident or other serious consequences. Stop the vehicle in a safe and legal manner before attempting these operations.

**Let Your Judgment Prevail**

Any navigation features are provided only as an aid. Make your driving decisions based on your observations of local conditions and existing traffic regulations. Any such feature is not a substitute for your personal judgment. Any route suggestions made by this system should never replace any local traffic regulations or your personal judgment or knowledge of safe driving practices.

**Route Safety**

Do not follow the route suggestions if doing so would result in an unsafe or illegal maneuver, if you would be placed in an unsafe situation, or if you would be directed into an area that you consider unsafe. The driver is ultimately responsible for the safe operation of the vehicle and therefore, must evaluate whether it is safe to follow the suggested directions.

**Potential Map Inaccuracy**

Maps used by this system may be inaccurate because of changes in roads, traffic controls or driving conditions. Always use good judgment and common sense when following the suggested routes.

**Emergency Services**

Do not rely on any navigation features included in the system to route you to emergency services. Ask local authorities or an emergency services operator for these locations. Not all emergency services such as police, fire stations, hospitals and clinics are likely to be contained in the map database for such navigation features.

**TeleNav Software End User License Agreement**

*Please read these terms and conditions carefully before you use the Telenav Software. Your use of the Telenav Software indicates that you accept these terms and conditions. If you do not accept these terms and conditions, do not break the seal of the package, launch, or otherwise use the Telenav Software.*

These terms and conditions represent the agreement (“Agreement”) between you and Telenav, Inc. (“Telenav”) with respect to the Telenav Software (including upgrades, modifications, or additions thereto) (collectively “Telenav Software”). All references herein to “you” and “your” means you, your employees, agents, and contractors, and any other entity on whose behalf you accept these terms and conditions, all of whom shall also be bound by this Agreement. Additionally, all of your account information, as well as other payment and personal information provided by you to Telenav (directly or through the use of the Telenav Software, is subject to Telenav’s privacy policy located at <http://www.telenav.com>.

Telenav may revise this Agreement and the privacy policy at any time, with or without notice to you. You agree to visit <http://www.telenav.com> from time to time to review the then current version of this Agreement and of the privacy policy.

**1. Safe and Lawful Use**

You acknowledge that devoting attention to the Telenav Software may pose a risk of injury or death to you and others in situations that otherwise require your undivided attention, and you therefore agree to comply with the following when using the Telenav Software: (a) observe all traffic laws and otherwise drive safely; (b) use your own personal judgment while driving. If you feel that a route suggested by the Telenav Software instructs you to perform an unsafe or illegal maneuver, places you in an unsafe situation, or directs you into an area that you consider to be unsafe, do not follow such instructions; (c) do not input destinations, or otherwise manipulate the Telenav Software, unless your vehicle is stationary and parked; (d) do not use the Telenav Software for any illegal, unauthorized, unintended, unsafe, hazardous, or unlawful purposes, or in any manner inconsistent with this Agreement; (e) arrange all GPS and wireless devices and cables necessary for use of the Telenav Software in a secure manner in your vehicle so that they will not interfere with your driving and will not prevent the operation of any safety device (such as an airbag).

You agree to indemnify and hold Telenav harmless against all claims resulting from any dangerous or otherwise inappropriate use of the Telenav Software in any moving vehicle, including as a result of your failure to comply with the directions above.

**2. Account Information**

You agree: (a) when registering the Telenav Software, to provide Telenav with true, accurate, current, and complete information about yourself, and (b) to inform Telenav promptly of any changes to such information, and to keep it true, accurate, current and complete.

**3. Software License**

Subject to your compliance with the terms of this Agreement, Telenav hereby grants to you a personal, non-exclusive, non-transferable license (except as expressly permitted below in connection with your permanent transfer of the Telenav Software license), without the right to sublicense, to use the Telenav Software (in object code form only) in order to access and use the Telenav Software. This license shall terminate upon any termination or expiration of this Agreement. You agree that you will use the Telenav Software only for your personal business or leisure purposes, and not to provide commercial navigation services to other parties.

**3.1 License limitations**

You agree not to do any of the following: (a) reverse engineer, decompile, disassemble, translate, modify, alter or otherwise change the Telenav Software or any part thereof; (b) attempt to derive the source code, audio library or structure of the Telenav Software without the prior express written consent of Telenav; (c) remove from the Telenav Software, or alter, any of Telenav's or its suppliers' trademarks, trade names, logos, patent or copyright notices, or other notices or markings; (d) distribute, sublicense or otherwise transfer the Telenav Software to others, except as part of your permanent transfer of the Telenav Software; or (e) use the Telenav Software in any manner that (i) infringes the intellectual property or proprietary rights, rights of publicity or privacy or other rights of any party, (ii) violates any law, statute, ordinance or regulation, including but not limited to laws and regulations related to spamming, privacy, consumer and child protection, obscenity or defamation, or (iii) is harmful, threatening, abusive, harassing, tortuous, defamatory, vulgar, obscene, libelous, or otherwise objectionable; and (f) lease, rent out, or otherwise permit unauthorized access by third parties to the Telenav Software without advanced written permission of Telenav.

**4. Disclaimers**

To the fullest extent permissible pursuant to applicable law, in no event will Telenav, its licensors and suppliers, or agents or employees of any of the foregoing, be liable for any decision made or action taken by you or anyone else in reliance on the information provided by the Telenav Software. Telenav also does not warrant the accuracy of the map or other data used for the Telenav Software. Such data may not always

reflect reality due to, among other things, road closures, construction, weather, new roads and other changing conditions. You are responsible for the entire risk arising out of your use of the Telenav Software. For example but without limitation, you agree not to rely on the Telenav Software for critical navigation in areas where the well-being or survival of you or others is dependent on the accuracy of navigation, as the maps or functionality of the Telenav Software are not intended to support such high risk applications, especially in more remote geographical areas. TELENAV EXPRESSLY DISCLAIMS AND EXCLUDES ALL WARRANTIES IN CONNECTION WITH THE TELENAV SOFTWARE, WHETHER STATUTORY, EXPRESS OR IMPLIED, INCLUDING ALL WARRANTIES WHICH MAY ARISE FROM COURSE OF DEALING, CUSTOM OR TRADE AND INCLUDING, BUT NOT LIMITED TO, THE IMPLIED WARRANTIES OF MERCHANTABILITY, FITNESS FOR A PARTICULAR PURPOSE AND NON-INFRINGEMENT OF THIRD PARTY RIGHTS WITH RESPECT TO THE TELENAV SOFTWARE. Certain jurisdictions do not permit the disclaimer of certain warranties, so this limitation may not apply to you.

#### **5. Limitation of Liability**

TO THE EXTENT PERMITTED UNDER APPLICABLE LAW, UNDER NO CIRCUMSTANCES SHALL TELENAV OR ITS LICENSORS AND SUPPLIERS BE LIABLE TO YOU OR TO ANY THIRD PARTY FOR ANY INDIRECT, INCIDENTAL, CONSEQUENTIAL, SPECIAL OR EXEMPLARY DAMAGES (INCLUDING IN EACH CASE, BUT NOT LIMITED TO, DAMAGES FOR THE INABILITY TO USE THE EQUIPMENT OR ACCESS DATA, LOSS OF DATA, LOSS OF BUSINESS, LOSS OF PROFITS, BUSINESS INTERRUPTION OR THE LIKE) ARISING OUT OF THE USE OF OR INABILITY TO USE THE TELENAV SOFTWARE, EVEN IF TELENAV HAS BEEN ADVISED OF THE POSSIBILITY OF SUCH DAMAGES.

NOTWITHSTANDING ANY DAMAGES THAT YOU MIGHT INCUR FOR ANY REASON WHATSOEVER (INCLUDING, WITHOUT LIMITATION, ALL DAMAGES REFERENCED HEREIN AND ALL DIRECT OR GENERAL DAMAGES IN CONTRACT, TORT (INCLUDING NEGLIGENCE) OR OTHERWISE), THE ENTIRE LIABILITY OF TELENAV AND OF ALL OF TELENAV'S SUPPLIERS SHALL BE LIMITED TO THE AMOUNT ACTUALLY PAID BY YOU FOR THE TELENAV SOFTWARE. SOME STATES AND/OR JURISDICTIONS DO NOT ALLOW THE EXCLUSION OR LIMITATION OF INCIDENTAL OR CONSEQUENTIAL DAMAGES, SO THE ABOVE LIMITATIONS OR EXCLUSIONS MAY NOT APPLY TO YOU.

**6. Arbitration and Governing Law**

You agree that any dispute, claim or controversy arising out of or relating to this Agreement or the Telenav Software shall be settled by independent arbitration involving a neutral arbitrator and administered by the American Arbitration Association in the County of Santa Clara, California. The arbitrator shall apply the Commercial Arbitration Rules of the American Arbitration Association, and the judgment upon the award rendered by the arbitrator may be entered by any court having jurisdiction. Note that there is no judge or jury in an arbitration proceeding and the decision of the arbitrator shall be binding upon both parties. You expressly agree to waive your right to a jury trial. This Agreement and performance hereunder will be governed by and construed in accordance with the laws of the State of California, without giving effect to its conflict of laws provisions. To the extent judicial action is necessary in connection with the binding arbitration, both Telenav and you agree to submit to the exclusive jurisdiction of the courts of the County of Santa Clara, California. The United Nations Convention on Contracts for the International Sale of Goods shall not apply.

**7. Assignment**

You may not resell, assign, or transfer this Agreement or any of your rights or obligations, except in totality, in connection with your permanent transfer of the Telenav Software, and expressly conditioned upon the new user of the Telenav Software agreeing to be bound by the terms and conditions of this Agreement. Any such sale, assignment or transfer that is not expressly permitted under this paragraph will result in immediate termination of this Agreement, without liability to Telenav, in which case you and all other parties shall immediately cease all use of the Telenav Software. Notwithstanding the foregoing, Telenav may assign this Agreement to any other party at any time without notice, provided the assignee remains bound by this Agreement.



**8. Miscellaneous**

8.1 This Agreement constitutes the entire agreement between Telenav and you with respect to the subject matter hereof.

8.2 Except for the limited licenses expressly granted in this Agreement, Telenav retains all right, title and interest in and to the Telenav Software, including without limitation all related intellectual property rights. No licenses or other rights which are not expressly granted in this Agreement are intended to, or shall be, granted or conferred by implication, statute, inducement, estoppel or otherwise, and Telenav and its suppliers and licensors hereby reserve all of their respective rights other than the licenses explicitly granted in this Agreement.

8.3 By using the Telenav Software, you consent to receive from Telenav all communications, including notices, agreements, legally required disclosures or other information in connection with the Telenav Software (collectively, "Notices") electronically. Telenav may provide such Notices by posting them on Telenav's Website or by downloading such Notices to your wireless device. If you desire to withdraw your consent to receive Notices electronically, you must discontinue your use of the Telenav Software.

8.4 Telenav's or your failure to require performance of any provision shall not affect that party's right to require performance at any time thereafter, nor shall a waiver of any breach or default of this Agreement constitute a waiver of any subsequent breach or default or a waiver of the provision itself.

8.5 If any provision herein is held unenforceable, then such provision will be modified to reflect the intention of the parties, and the remaining provisions of this Agreement will remain in full force and effect.

8.6 The headings in this Agreement are for convenience of reference only, will not be deemed to be a part of this Agreement, and will not be referred to in connection with the construction or interpretation of this Agreement. As used in this Agreement, the words "include" and "including," and variations thereof, will not be deemed to be terms of limitation, but rather will be deemed to be followed by the words "without limitation".

**9. Other Vendors Terms and Conditions**

*The Telenav Software utilizes map and other data licensed to Telenav by third party vendors for the benefit of you and other end users. This Agreement includes end-user terms applicable to these companies (included at the end of this Agreement), and thus your use of the Telenav Software is also subject to such terms. You agree to comply with the following additional terms and conditions, which are applicable to Telenav's third party vendor licensors:*

**End User License Agreement For Distribution By HERE For North America/APAC****END USER TERMS**

The content provided ("Data") is licensed, not sold. By opening this package, or installing, copying, or otherwise using the Data, you agree to be bound by the terms of this agreement. If you do not agree to the terms of this agreement, you are not permitted to install, copy, use, resell or transfer the Data. If you wish to reject the terms of this agreement, and have not installed, copied, or used the Data, you must contact your retailer or HERE North America, LLC (as defined below) within thirty (30) days of purchase for a refund of your purchase price. To contact HERE, please visit [www.here.com](http://www.here.com).

The Data is provided for your personal, internal use only and may not be resold. It is protected by copyright, and is subject to the following terms (this "End User License Agreement") and conditions which are agreed to by you, on the one hand, and HERE and its licensors (including their licensors and suppliers) on the other hand. For purposes of these terms, "HERE" shall mean (a) HERE North America, LLC with respect to Data for the Americas and/or the Asia Pacific region and (b) HERE Europe B.V. for Data for Europe, the Middle East and/or Africa.

The Data includes certain information and related content provided under license to HERE from third parties and is subject to the applicable supplier terms and copyright notices set forth at the following URL: [http://corporate.navteq.com/supplier\\_terms.html](http://corporate.navteq.com/supplier_terms.html).

**TERMS AND CONDITIONS**

**License Limitations on Use:** You agree that your license to use this Data is limited to and conditioned on use for solely personal, noncommercial purposes, and not for service bureau, timesharing or other similar purposes. Except as otherwise set forth herein, you agree not to otherwise reproduce, copy, modify, decompile, disassemble or reverse engineer any portion of this Data, and may not transfer or distribute it in any form, for any purpose, except to the extent permitted by mandatory laws.

**License Limitations on Transfer:** Your limited license does not allow transfer or resale of the Data, except on the condition that you may transfer the Data and all accompanying materials on a permanent basis if: (a) you retain no copies of the Data; (b) the recipient agrees to the terms of this End-User License Agreement; and (c) you transfer the Data in the exact same form as you purchased it by physically transferring the original media (e.g., the CD-ROM or DVD you purchased), all original packaging, all Manuals and other documentation. Specifically, Multi-disc sets may only be transferred or sold as a complete set as provided to you and not as a subset thereof.

**Additional License Limitations:** Except where you have been specifically licensed to do so by HERE in a separate written agreement, and without limiting the preceding paragraph, your license is conditioned on use of the Data as prescribed in this agreement, and you may not (a) use this Data with any products, systems, or applications installed or otherwise connected to or in communication with vehicles capable of vehicle navigation, positioning, dispatch, real time route guidance, fleet management or similar applications; or (b) with, or in communication with, including without limitation, cellular phones, palmtop and handheld computers, pagers, and personal digital -assistants or PDAs. This Data may contain inaccurate or incomplete information due to the passage of time, changing circum-stances, sources used and the nature of collecting comprehensive geographic Data, any of which may lead to incorrect results.

**No Warranty:** This Data is provided to you “as is”, and you agree to use it at your own risk. HERE and its licensors (and their licensors and suppliers) make no guarantees, representations or warranties of any kind, express or implied, arising by law or otherwise, including but not limited to, content, quality, accuracy, completeness, effectiveness, reliability, fitness for a particular purpose, usefulness, use or results to be obtained from this Data, or that the Data or server will be uninterrupted or error free.

**Disclaimer of Warranty:** HERE AND ITS LICENSORS (INCLUDING THEIR LICENSORS AND SUPPLIERS) DISCLAIM ANY WARRANTIES, EXPRESS OR IMPLIED, OF QUALITY, PERFORMANCE, MERCHANTABILITY, FITNESS FOR A PARTICULAR PURPOSE OR NON-INFRINGEMENT. Some States, Territories and Countries do not allow certain warranty exclusions, so to that extent the above exclusion may not apply to you.

**Disclaimer of Liability:** HERE AND ITS LICENSORS (INCLUDING THEIR LICENSORS AND SUPPLIERS) SHALL NOT BE LIABLE TO YOU IN RESPECT OF ANY CLAIM, DEMAND OR ACTION, IRRESPECTIVE OF THE NATURE OF THE CAUSE OF THE CLAIM, DEMAND OR ACTION ALLEGING ANY LOSS, INJURY OR DAMAGES, DIRECT OR INDIRECT, WHICH MAY RESULT FROM THE USE OR POSSESSION OF THIS DATA; OR FOR ANY LOSS OF PROFIT, REVENUE, CONTRACTS OR SAVINGS, OR ANY OTHER DIRECT, INDIRECT, INCIDENTAL, SPECIAL OR CONSEQUENTIAL DAMAGES ARISING OUT OF YOUR USE OF OR INABILITY TO USE THIS DATA, ANY DEFECT IN THIS DATA, OR THE BREACH OF THESE TERMS OR CONDITIONS, WHETHER IN AN ACTION IN CONTRACT OR TORT OR BASED ON A WARRANTY, EVEN IF HERE OR ITS LICENSORS HAVE BEEN ADVISED OF THE POSSIBILITY OF SUCH DAMAGES. Some States, Territories and Countries do not allow certain liability exclusions or damages limitations, so to that extent the above may not apply to you.

**Export Control:** You agree not to export from anywhere any part of the Data or any direct product thereof except in compliance with, and with all licenses and approvals required under, applicable export laws, rules and regulations, including but not limited to the laws, rules and regulations administered by the Office of Foreign Assets Control of the U.S. Department of Commerce and the Bureau of Industry and Security of the U.S. Department of Commerce. To the extent that any such export laws, rules or regulations prohibit HERE from complying with any of its obligations hereunder to deliver or distribute Data, such failure shall be excused and shall not constitute a breach of this Agreement.

**Entire Agreement:** These terms and conditions constitute the entire agreement between HERE (and its licensors, including their licensors and suppliers) and you pertaining to the subject matter hereof, and supersedes in their entirety any and all written or oral agreements previously existing between us with respect to such subject matter.

**Severability:** You and HERE agree that if any portion of this agreement is found illegal or unenforceable, that portion shall be severed and the remainder of the Agreement shall be given full force and effect.

**Governing Law:** The above terms and conditions shall be governed by the laws of the State of Illinois (for Data for the Americas and/or the Asia Pacific region) or The Netherlands (for Data for Europe, the Middle East and Africa), without giving effect to (i) its conflict of laws provisions, or (ii) the United Nations Convention for Contracts for the International Sale of Goods, which is explicitly excluded. For any and all disputes, claims and actions arising from or in connection with the Data

(“Claims”), you agree to submit to the personal jurisdiction of (a) the State of Illinois for Claims related to Data for the Americas and/or the Asia Pacific region provided to you hereunder, and (b) The Netherlands for Data for Europe, the Middle East and/or Africa provided to you hereunder.

**Government End Users:** If the Data is being acquired by or on behalf of the United States government or any other entity seeking or applying rights similar to those customarily claimed by the United States government, this Data is a “commercial item” as that term is defined at 48 C.F.R. (“FAR”) 2.101, is licensed in accordance with this End[not ] User License Agreement, and each copy of Data delivered or otherwise furnished shall be marked and embedded as appropriate with the following “Notice of Use”, and be treated in accordance with such Notice:

**NOTICE OF USE**

CONTRACTOR (MANUFACTURER/ SUPPLIER)

NAME:

**HERE**

CONTRACTOR (MANUFACTURER/SUPPLIER)

ADDRESS:

**425 West Randolph Street, Chicago, IL 60606.**

This Data is a commercial item as defined in FAR 2.101 and is subject to the End User License Agreement under which this Data was provided.

© 1987-2013 HERE. All rights reserved.

If the Contracting Officer, federal government agency, or any federal official refuses to use the legend provided herein, the Contracting Officer, federal government agency, or any federal official must notify HERE prior to seeking additional or alternative rights in the Data.

Wi-Fi hotspot data provided by JiWire ©2013 JiWire.

**Gracenote® Copyright**

CD and music — related data from Gracenote, Inc., copyright © 2000–2007 Gracenote. Gracenote Software, copyright © 2000–2007 Gracenote. This product and service may practice one or more of the following U.S. Patents #5,987,525; #6,061,680; #6,154,773, #6,161,132, #6,230,192, #6,230,207, #6,240,459, #6,330,593, and other patents issued or pending. Some services supplied under license from Open Globe, Inc. for U.S. Patent: #6,304,523.

Gracenote and CDDB are registered trademarks of Gracenote. The Gracenote logo and logotype, and the "Powered by Gracenote™" logo are trademarks of Gracenote.

**Gracenote® End User License Agreement (EULA)**

This device contains software from Gracenote, Inc. of 2000 Powell Street Emeryville, California 94608 ("Gracenote").

The software from Gracenote (the "Gracenote Software") enables this device to do disc and music file identification and obtain music-related information, including name, artist, track, and title information ("Gracenote Data") from online servers ("Gracenote Servers"), and to perform other functions. You may use Gracenote Data only by means of the intended End User functions of this device

This device may contain content belonging to Gracenote's providers. If so, all of the restrictions set forth herein with respect to Gracenote Data shall also apply to such content and such content providers shall be entitled to all of the benefits and protections set forth herein that are available to Gracenote.

You agree that you will use the content from Gracenote ("Gracenote Content"), Gracenote Data, the Gracenote Software, and Gracenote Servers for your own personal, non-commercial use only. You agree not to assign, copy, transfer or transmit the Gracenote Content, Gracenote Software or any Gracenote Data (except in a Tag associated with a music file) to any third party. YOU AGREE NOT TO USE OR EXPLOIT GRACENOTE CONTENT, GRACENOTE DATA, THE GRACENOTE SOFTWARE, OR GRACENOTE SERVERS, EXCEPT AS EXPRESSLY PERMITTED HEREIN.

You agree that your non-exclusive licenses to use the Gracenote Content, Gracenote Data, the Gracenote Software, and Gracenote Servers will terminate if you violate these restrictions. If your licenses terminate, you agree to cease any and all use of the Gracenote Content, Gracenote Data, the Gracenote Software, and Gracenote Servers. Gracenote, respectively, reserve all rights in Gracenote Data, the Gracenote Software, and the Gracenote Servers and Gracenote Content, including all ownership rights. Under no circumstances will either Gracenote become liable for any payment to you for any information that you provide, including any copyrighted material or music file information. You agree that Gracenote may enforce its respective rights, collectively or separately, under this agreement against you, directly in each company's own name.

Gracenote uses a unique identifier to track queries for statistical purposes. The purpose of a randomly assigned numeric identifier is to allow Gracenote to count queries without knowing anything about who you are. For more information, see the web page at [www.gracenote.com](http://www.gracenote.com) for the Gracenote Privacy Policy

THE GRACENOTE SOFTWARE, EACH ITEM OF GRACENOTE DATA AND THE GRACENOTE CONTENT ARE LICENSED TO YOU "AS IS." NEITHER GRACENOTE MAKES ANY REPRESENTATIONS OR WARRANTIES, EXPRESS OR IMPLIED, REGARDING THE ACCURACY OF ANY GRACENOTE DATA FROM THE GRACENOTE SERVERS OR GRACENOTE CONTENT. GRACENOTE COLLECTIVELY AND SEPARATELY RESERVE THE RIGHT TO DELETE DATA AND/OR CONTENT FROM THE COMPANIES' RESPECTIVE SERVERS OR, IN THE CASE OF GRACENOTE, CHANGE DATA CATEGORIES FOR ANY CAUSE THAT GRACENOTE DEEMS SUFFICIENT. NO WARRANTY IS MADE THAT EITHER GRACENOTE CONTENT OR THE GRACENOTE SOFTWARE OR GRACENOTE SERVERS ARE ERROR-FREE OR THAT THE FUNCTIONING OF THE GRACENOTE SOFTWARE OR GRACENOTE SERVERS WILL BE UNINTERRUPTED. GRACENOTE IS NOT OBLIGATED TO PROVIDE YOU WITH ANY ENHANCED OR ADDITIONAL DATA TYPES THAT GRACENOTE MAY CHOOSE TO PROVIDE IN THE FUTURE AND IS FREE TO DISCONTINUE ITS ONLINE SERVICES AT ANY TIME. GRACENOTE DISCLAIM ALL WARRANTIES EXPRESS OR IMPLIED, INCLUDING, BUT NOT LIMITED TO, IMPLIED WARRANTIES OF MERCHANTABILITY, FITNESS FOR A PARTICULAR PURPOSE, TITLE, AND NON-INFRINGEMENT. NEITHER GRACENOTE WARRANTS THE RESULTS THAT WILL BE OBTAINED BY YOUR USE OF THE GRACENOTE SOFTWARE OR ANY GRACENOTE SERVER. IN NO CASE WILL GRACENOTE BE LIABLE FOR ANY CONSEQUENTIAL OR INCIDENTAL DAMAGES OR FOR ANY LOST PROFITS OR LOST REVENUES FOR ANY REASON WHATSOEVER.

© Gracenote 2007

**Vehicle with SYNC only**

FCC ID: KMHSG1G1 IC: 1422A-SG1G1

**Vehicle with SYNC and MyFord Touch or MyLincoln Touch**

FCC ID: KMHSYNG2-L IC: 1422A-SYNG2-L

---

This device complies with Part 15 of the FCC Rules and with RSS-210 of Industry Canada. Operation is subject to the following two conditions: (1) This device may not cause harmful interference, and (2) this device must accept any interference received, including interference that may cause undesired operation.



**WARNING:** Changes or modifications not expressly approved by the party responsible for compliance could void the user's authority to operate the equipment. The term "IC:" before the radio certification number only signifies that Industry Canada technical specifications were met.

The antenna used for this transmitter must not be co-located or operating in conjunction with any other antenna or transmitter.



**GENERAL MAINTENANCE INFORMATION****Why Maintain Your Vehicle?**

Carefully following the maintenance schedule helps protect against major repair expenses resulting from neglect or inadequate maintenance and may help to increase the value of your vehicle when you sell or trade it. Keep all receipts for completed maintenance with your vehicle.

We have established regular maintenance intervals for your vehicle based upon rigorous testing. It is important that you have your vehicle serviced at the proper times. These intervals serve two purposes; one is to maintain the reliability of your vehicle and the second is to keep your cost of owning your vehicle down.

It is your responsibility to have all scheduled maintenance performed and to make sure that the materials used meet the specifications identified in the *Capacities and Specifications* chapter of this owner's manual.

Failure to perform scheduled maintenance invalidates warranty coverage on parts affected by the lack of maintenance.

**Why Maintain Your Vehicle at Your Dealership?*****Factory-Trained Technicians***

Service technicians participate in extensive factory-sponsored certification training to help them become experts on the operation of your vehicle. Ask your dealership about the training and certification their technicians have received.

***Genuine Ford and Motorcraft® Replacement Parts***

Dealerships stock Ford, Motorcraft and Ford-authorized branded re-manufactured replacement parts. These parts meet or exceed our specifications. Parts installed at your dealership carry a nationwide 24-month or unlimited miles (kilometers) parts and labor limited warranty.

If you do not use Ford authorized parts they may not meet our specifications and depending on the part, it could affect emissions compliance.

**Convenience**

Many dealerships have extended evening and Saturday hours to make your service visit more convenient and they offer one stop shopping. They can perform any services that are required on your vehicle, from general maintenance to collision repairs.

**Note:** Not all dealers have extended hours or body shops. Please contact your dealer for details.

**Protecting Your Investment**

Maintenance is an investment that will pay dividends in the form of improved reliability, durability and resale value. To maintain the proper performance of your vehicle and its emission control systems, it is imperative that scheduled maintenance be completed at the designated intervals.

Your vehicle is equipped with the Intelligent Oil-Life Monitor (IOLM) system which displays a message in the information display at the proper oil change service interval; this interval may be up to one year or 10000 miles (16000 kilometers). When ENGINE OIL CHANGE DUE or OIL CHANGE REQUIRED appears in the information display, it is time for an oil change; the oil change must be done within two weeks or 500 miles (800 kilometers) of the ENGINE OIL CHANGE DUE or OIL CHANGE REQUIRED message appearing. The Intelligent Oil-Life Monitor must be reset after each oil change; see the *Information Displays* chapter.

If your information display is prematurely reset or becomes inoperative, you should perform the oil change interval at six months or 5000 miles (8000 kilometers) from your last oil change. Never exceed one year or 10000 miles (16000 kilometers) between oil change intervals.

Your vehicle is very sophisticated and built with multiple, complex, performance systems. Every manufacturer develops these systems using different specifications and performance features. That is why it is important to rely upon your dealership to properly diagnose and repair your vehicle.

Ford Motor Company has recommended maintenance intervals for various parts and component systems based upon engineering testing. Ford Motor Company relies upon this testing to determine the most appropriate mileage for replacement of oils and fluids to protect your vehicle at the lowest overall cost to you and recommends against maintenance schedules that deviate from the scheduled maintenance information.

Ford strongly recommends the use of only genuine Ford, Motorcraft or Ford-authorized remanufactured replacement parts because they are engineered for your vehicle.

#### **Additives and Chemicals**

Ford Motor Company recommended additives and chemicals are listed in the owner manual and in the Ford Workshop Manual. Additional chemicals or additives not approved by Ford Motor Company are not recommended as part of normal maintenance. Please consult your warranty information.

#### **Oils, Fluids and Flushing**

In many cases, fluid discoloration is a normal operating characteristic and, by itself, does not necessarily indicate a concern or that the fluid needs to be changed. However, discolored fluids that also show signs of overheating and foreign material contamination should be inspected immediately by a qualified expert, such as the factory-trained technicians at your dealership. Your vehicle's oils and fluids should be changed at the specified intervals or in conjunction with a repair. Flushing is a viable way to change fluid for many vehicle sub-systems during scheduled maintenance. It is critical that systems are flushed only with new fluid that is the same as that required to fill and operate the system, or using a Ford-approved flushing chemical.

#### **Owner Checks and Services**

Certain basic maintenance checks and inspections should be performed every month or at six month intervals.

<b>Check every month</b>
Engine oil level.
Function of all interior and exterior lights.
Tires (including spare) for wear and proper pressure.
Windshield washer fluid level.
<b>Check every six months</b>
Battery connections. Clean if necessary.
Body and door drain holes for obstructions. Clean if necessary.
Cooling system fluid level and coolant strength.
Door weatherstrips for wear. Lubricate if necessary.

<b>Check every six months</b>	
Hinges, latches and outside locks for proper operation. Lubricate if necessary.	
Parking brake for proper operation.	
Safety belts and seat latches for wear and function.	
Safety warning lamps (brake, ABS, airbag, safety belt) for operation.	
Washer spray and wiper operation. Clean or replace blades as necessary.	

**Multi-point Inspection**

In order to keep your vehicle running right, it is important to have the systems on your vehicle checked regularly. This can help identify potential issues and prevent major problems. Ford Motor Company recommends the following multi-point inspection be performed at every scheduled maintenance interval to help make sure your vehicle keeps running great.

<b>Multi-point inspection</b>	
Accessory drive belt(s)	Hazard warning system operation
Battery performance	Horn operation
Engine air filter	Radiator, cooler, heater and A/C hoses
Exhaust system	Suspension components for leaks or damage
Exterior lamps operation	Steering and linkage
Fluid levels* ; fill if necessary	Tires (including spare) for wear and proper pressure**
For oil and fluid leaks	Windshield for cracks, chips or pits
Half-shaft dust boots	Washer spray and wiper operation

\*Brake, coolant recovery reservoir, automatic transmission (with an underhood dipstick) and window washer.

\*\*If your vehicle is equipped with a temporary mobility kit, check the tire sealant expiration Use By date on the canister. Replace as needed.

Be sure to ask your dealership service advisor or technician about the multi-point vehicle inspection. It is a comprehensive way to perform a thorough inspection of your vehicle. It is your checklist that gives you immediate feedback on the overall condition of your vehicle. You will know what has been checked, what is okay, as well as those things that may require future or immediate attention. The multi-point vehicle inspection is one more way to keep your vehicle running great!

GENUINE  
PARTS & SERVICE

Personal Member of:  
Personal Service Business

Multi-Point Inspection Report Card as Recommended by Ford Motor Company

Name: \_\_\_\_\_

Today's Date: \_\_\_\_\_

State Inspection Month: \_\_\_\_\_

Home Address: \_\_\_\_\_

Home/Work/Year: \_\_\_\_\_

mileage: \_\_\_\_\_

SYNC VEHICLE HEALTH REPORT (VHR) CHECKED

VHR Available:  Yes  No  File  Review

Checked and OK (if this box is checked, it contributes to vehicle with a good VHR score)

**SCHEDULED MAINTENANCE** (NAME OUR FOR SERVICES ON THIS MAINT PLAN)

<input type="checkbox"/> Engine Air Filter	<input type="checkbox"/> Oil	<input type="checkbox"/> Oil Filter	<input type="checkbox"/> Spark Plugs
<input type="checkbox"/> Engine Coolant	<input type="checkbox"/> Tire Rotation	<input type="checkbox"/> Transmission Fluid	<input type="checkbox"/> Transmission Filter
<input type="checkbox"/> Fuel Filter	<input type="checkbox"/> Wash/Wax	<input type="checkbox"/> Wash/Wax	<input type="checkbox"/> Wash/Wax
<input type="checkbox"/> Oil Change	<input type="checkbox"/> Wash/Wax	<input type="checkbox"/> Wash/Wax	<input type="checkbox"/> Wash/Wax

\*This is only a partial list of vehicle maintenance items and is NOT all-inclusive. Please consult your Owner's Manual or visit [www.fordmotor.com](http://www.fordmotor.com) for vehicle specific maintenance requirements.

**CHECK FLUID LEVELS AND FILL**

All and/or fluid leaks

<input type="checkbox"/> Oil	<input type="checkbox"/> Coolant	<input type="checkbox"/> Power Steering	<input type="checkbox"/> Windshield Washer
<input type="checkbox"/> Brake	<input type="checkbox"/> Windshield Washer	<input type="checkbox"/> Windshield Washer	<input type="checkbox"/> Windshield Washer

**BATTERY**

State of Health: \_\_\_\_\_

Condition of \_\_\_\_\_

Factory spec cold cranking amps: \_\_\_\_\_

Arctic Crank:  Yes  No

**EXTERIOR BODY**

None or existing exterior body damage or defects:

<input type="checkbox"/> Headlights	<input type="checkbox"/> Bumper	<input type="checkbox"/> Fenders	<input type="checkbox"/> Doors
<input type="checkbox"/> Trunk	<input type="checkbox"/> Tailgate	<input type="checkbox"/> Rear Bumper	<input type="checkbox"/> Wheel Wells

**THE BRAKE WEAR**

Brake Lining: \_\_\_\_\_

Disc Thickness: \_\_\_\_\_

Hub/Bushing: \_\_\_\_\_

Caliper: \_\_\_\_\_

Brake Pedal: \_\_\_\_\_

Brake Fluid: \_\_\_\_\_

**WHEELS AND TIRES**

LEFT FRONT		RIGHT FRONT	
<input type="checkbox"/> Tire Tread Depth	<input type="checkbox"/> Tire Tread Depth	<input type="checkbox"/> Tire Tread Depth	<input type="checkbox"/> Tire Tread Depth
<input type="checkbox"/> Tire Wear Pattern/Damage	<input type="checkbox"/> Tire Wear Pattern/Damage	<input type="checkbox"/> Tire Wear Pattern/Damage	<input type="checkbox"/> Tire Wear Pattern/Damage
<input type="checkbox"/> Tire Pressure - set to factory recommended PSI	<input type="checkbox"/> Tire Pressure - set to factory recommended PSI	<input type="checkbox"/> Tire Pressure - set to factory recommended PSI	<input type="checkbox"/> Tire Pressure - set to factory recommended PSI
<input type="checkbox"/> Brake Lining	<input type="checkbox"/> Brake Lining	<input type="checkbox"/> Brake Lining	<input type="checkbox"/> Brake Lining

**WHEELS AND TIRES**

LEFT REAR		RIGHT REAR	
<input type="checkbox"/> Tire Tread Depth	<input type="checkbox"/> Tire Tread Depth	<input type="checkbox"/> Tire Tread Depth	<input type="checkbox"/> Tire Tread Depth
<input type="checkbox"/> Tire Wear Pattern/Damage	<input type="checkbox"/> Tire Wear Pattern/Damage	<input type="checkbox"/> Tire Wear Pattern/Damage	<input type="checkbox"/> Tire Wear Pattern/Damage
<input type="checkbox"/> Tire Pressure - set to factory recommended PSI	<input type="checkbox"/> Tire Pressure - set to factory recommended PSI	<input type="checkbox"/> Tire Pressure - set to factory recommended PSI	<input type="checkbox"/> Tire Pressure - set to factory recommended PSI
<input type="checkbox"/> Brake Lining	<input type="checkbox"/> Brake Lining	<input type="checkbox"/> Brake Lining	<input type="checkbox"/> Brake Lining

**LIGHTS/UNDERCARRIAGE**

Operation of Horn, Indicator Lights, Exterior Lights, Turn Signals, Hazard and Brake Lamps

Wash/Wax:  Yes  No

Wash/Wax:  Yes  No

Wash/Wax:  Yes  No

**WASHERS/WAX**

Wash/Wax:  Yes  No

Wash/Wax:  Yes  No

Wash/Wax:  Yes  No

**WASHERS/WAX**

Wash/Wax:  Yes  No

Wash/Wax:  Yes  No

Wash/Wax:  Yes  No

Comments: \_\_\_\_\_

Service Advisor: \_\_\_\_\_ Customer Signature: \_\_\_\_\_

Technician: \_\_\_\_\_

12-XXXXXXXX

© 2013 Ford Motor Company. Ford Motor Company, an Equal Opportunity Employer.

**NORMAL SCHEDULED MAINTENANCE AND LOG****Intelligent Oil-Life Monitor®**

Your vehicle is equipped with an Intelligent Oil-Life Monitor that determines when the engine oil needs to be changed based on how your vehicle is used. By using several important factors in its calculations, the monitor helps reduce the cost of owning your vehicle and reduce environmental waste at the same time. This means you won't have to remember to change the oil on a mileage-based schedule; the vehicle lets you know when an oil change is due by displaying ENGINE OIL CHANGE DUE or OIL CHANGE REQUIRED in the information display. The following table is intended to provide examples of vehicle use and its impact on engine oil change intervals; it is provided as a guideline only. Actual engine oil change intervals depend on several factors and generally decrease with severity of use.

<b>When to expect the OIL CHANGE REQUIRED message</b>	
<b>Interval</b>	<b>Vehicle use and examples</b>
7500-10000 miles (12000-16000 km)	<b>Normal</b>
	<ul style="list-style-type: none"> <li>- Normal commuting with highway driving</li> <li>- No, or moderate, load or towing</li> <li>- Flat to moderately hilly roads</li> <li>- No extended idling</li> </ul>
5000-7499 miles (8000-11999 km)	<b>Severe</b>
	<ul style="list-style-type: none"> <li>- Moderate to heavy load or towing</li> <li>- Mountainous or off-road conditions</li> <li>- Extended idling</li> <li>- Extended hot or cold operation</li> </ul>
3000-4999 miles (4800-7999 km)	<b>Extreme</b>
	<ul style="list-style-type: none"> <li>- Maximum load or towing</li> <li>- Extreme hot or cold operation</li> </ul>

Normal scheduled maintenance*	
At every oil change interval as indicated by the information display	Change engine oil and filter.**
	Rotate tires, inspect tire wear and measure tread depth.
	Perform multi-point inspection (recommended).
	Inspect automatic transmission fluid level (if equipped with dipstick). Consult dealer for requirements.
	Inspect brake pads, shoes, rotors, drums, brake linings, hoses and parking brake.
	Inspect engine cooling system strength and hoses.
	Inspect exhaust system and heat shields.
	Inspect rear axle and U-joints. Lubricate if equipped with grease fittings (All-wheel drive vehicles).
	Inspect half-shaft boots.
	Inspect steering linkage, ball joints, suspension, tie-rod ends, driveshaft and U-joints. Lubricate if equipped with grease fittings.
	Inspect wheels and related components for abnormal noise, wear, looseness or drag.

\*Do not exceed one year or 10000 miles (16000 kilometers) between service intervals.

\*\*Reset your Intelligent Oil-Life Monitor after each engine oil and filter change. See the *Instrument Cluster* chapter.

<b>Other maintenance items<sup>1</sup></b>	
Every 20000 miles (32000 km)	Replace cabin air filter (if equipped).
Every 30000 miles (48000 km)	Replace climate-controlled (heated and cooled) seat filter. <sup>2</sup>
	Replace engine air filter.
At 100000 miles (160000 km)	Change engine coolant. <sup>3</sup>
Every 100000 miles (160000 km)	Replace spark plugs.
	Inspect accessory drive belt(s). <sup>4</sup>
Every 150000 miles (240000 km)	Change automatic transmission fluid
	Replace accessory drive belt(s) if not replaced within the last 100000 miles (160000 km).

<sup>1</sup>These maintenance items can be performed within 3000 miles (4800 kilometers) of the last oil change. Do not exceed the designated distance for the interval.

<sup>2</sup>If your vehicle has climate-controlled (heated and cooled) seats.

<sup>3</sup>Initial replacement at six years or 100000 miles (160000 kilometers), then every three years or 50000 miles (80000 kilometers).

<sup>4</sup>After initial inspection, inspect every other oil change until replaced.



## Maintenance Schedule Log

<p>DEALER VALIDATION:</p> <p>RO#: P&amp;A CODE: DATE: HOURS: MILEAGE:</p>	<p>DEALER VALIDATION:</p> <p>RO#: P&amp;A CODE: DATE: HOURS: MILEAGE:</p>
<p>DEALER VALIDATION:</p> <p>RO#: P&amp;A CODE: DATE: HOURS: MILEAGE:</p>	<p>DEALER VALIDATION:</p> <p>RO#: P&amp;A CODE: DATE: HOURS: MILEAGE:</p>
<p>DEALER VALIDATION:</p> <p>RO#: P&amp;A CODE: DATE: HOURS: MILEAGE:</p>	<p>DEALER VALIDATION:</p> <p>RO#: P&amp;A CODE: DATE: HOURS: MILEAGE:</p>
<p>DEALER VALIDATION:</p> <p>RO#: P&amp;A CODE: DATE: HOURS: MILEAGE:</p>	<p>DEALER VALIDATION:</p> <p>RO#: P&amp;A CODE: DATE: HOURS: MILEAGE:</p>
<p>DEALER VALIDATION:</p> <p>RO#: P&amp;A CODE: DATE: HOURS: MILEAGE:</p>	<p>DEALER VALIDATION:</p> <p>RO#: P&amp;A CODE: DATE: HOURS: MILEAGE:</p>

## Scheduled Maintenance

577

<p style="text-align: center;">DEALER VALIDATION:</p>  <p style="text-align: center;">P&amp;A CODE:</p> <p>RO#:                    HOURS:</p> <p>DATE:                   MILEAGE:</p>	<p style="text-align: center;">DEALER VALIDATION:</p>  <p style="text-align: center;">P&amp;A CODE:</p> <p>RO#:                    HOURS:</p> <p>DATE:                   MILEAGE:</p>
<p style="text-align: center;">DEALER VALIDATION:</p>  <p style="text-align: center;">P&amp;A CODE:</p> <p>RO#:                    HOURS:</p> <p>DATE:                   MILEAGE:</p>	<p style="text-align: center;">DEALER VALIDATION:</p>  <p style="text-align: center;">P&amp;A CODE:</p> <p>RO#:                    HOURS:</p> <p>DATE:                   MILEAGE:</p>
<p style="text-align: center;">DEALER VALIDATION:</p>  <p style="text-align: center;">P&amp;A CODE:</p> <p>RO#:                    HOURS:</p> <p>DATE:                   MILEAGE:</p>	<p style="text-align: center;">DEALER VALIDATION:</p>  <p style="text-align: center;">P&amp;A CODE:</p> <p>RO#:                    HOURS:</p> <p>DATE:                   MILEAGE:</p>
<p style="text-align: center;">DEALER VALIDATION:</p>  <p style="text-align: center;">P&amp;A CODE:</p> <p>RO#:                    HOURS:</p> <p>DATE:                   MILEAGE:</p>	<p style="text-align: center;">DEALER VALIDATION:</p>  <p style="text-align: center;">P&amp;A CODE:</p> <p>RO#:                    HOURS:</p> <p>DATE:                   MILEAGE:</p>
<p style="text-align: center;">DEALER VALIDATION:</p>  <p style="text-align: center;">P&amp;A CODE:</p> <p>RO#:                    HOURS:</p> <p>DATE:                   MILEAGE:</p>	<p style="text-align: center;">DEALER VALIDATION:</p>  <p style="text-align: center;">P&amp;A CODE:</p> <p>RO#:                    HOURS:</p> <p>DATE:                   MILEAGE:</p>

**Scheduled Maintenance**

<p style="text-align: center;">DEALER VALIDATION:</p>  <p style="text-align: center;">P&amp;A CODE:</p> <p>RO#:            HOURS:</p> <p>DATE:           MILEAGE:</p>	<p style="text-align: center;">DEALER VALIDATION:</p>  <p style="text-align: center;">P&amp;A CODE:</p> <p>RO#:            HOURS:</p> <p>DATE:           MILEAGE:</p>
<p style="text-align: center;">DEALER VALIDATION:</p>  <p style="text-align: center;">P&amp;A CODE:</p> <p>RO#:            HOURS:</p> <p>DATE:           MILEAGE:</p>	<p style="text-align: center;">DEALER VALIDATION:</p>  <p style="text-align: center;">P&amp;A CODE:</p> <p>RO#:            HOURS:</p> <p>DATE:           MILEAGE:</p>
<p style="text-align: center;">DEALER VALIDATION:</p>  <p style="text-align: center;">P&amp;A CODE:</p> <p>RO#:            HOURS:</p> <p>DATE:           MILEAGE:</p>	<p style="text-align: center;">DEALER VALIDATION:</p>  <p style="text-align: center;">P&amp;A CODE:</p> <p>RO#:            HOURS:</p> <p>DATE:           MILEAGE:</p>
<p style="text-align: center;">DEALER VALIDATION:</p>  <p style="text-align: center;">P&amp;A CODE:</p> <p>RO#:            HOURS:</p> <p>DATE:           MILEAGE:</p>	<p style="text-align: center;">DEALER VALIDATION:</p>  <p style="text-align: center;">P&amp;A CODE:</p> <p>RO#:            HOURS:</p> <p>DATE:           MILEAGE:</p>
<p style="text-align: center;">DEALER VALIDATION:</p>  <p style="text-align: center;">P&amp;A CODE:</p> <p>RO#:            HOURS:</p> <p>DATE:           MILEAGE:</p>	<p style="text-align: center;">DEALER VALIDATION:</p>  <p style="text-align: center;">P&amp;A CODE:</p> <p>RO#:            HOURS:</p> <p>DATE:           MILEAGE:</p>

**SPECIAL OPERATING CONDITIONS**

If you operate your vehicle **primarily** in any of the following conditions, you need to perform additional maintenance as indicated. If you **occasionally** operate your vehicle under any of these conditions, it is not necessary to perform the additional maintenance. For specific recommendations, see your dealership service advisor or technician.

Perform the services shown in the following tables when specified or within 3000 miles (4800 kilometers) of the OIL CHANGE REQUIRED message appearing in the information display.

**Example #1:** The OIL CHANGE REQUIRED message comes on at 28751 miles (46270 kilometers); perform the 30000 mile (48000 kilometer) automatic transmission fluid replacement.

**Example #2:** The OIL CHANGE REQUIRED message has **not** come on, but the odometer reads 30000 miles (48000 kilometers); perform the engine air filter replacement. (For example, the Intelligent Oil-Life Monitor was reset at 25000 miles [40000 kilometers].)

<b>Towing a trailer or using a camper or car-top carrier</b>	
As required	Change engine oil and filter as indicated by the information display and perform services listed in the Normal Scheduled Maintenance chart.
Inspect frequently, service as required	Inspect and lubricate U-joints.
	See axle maintenance items under <i>Exceptions</i> .
Every 30000 miles (48000 km)	Change automatic transmission fluid.

<b>Extensive idling or low-speed driving for long distances as in heavy commercial use (such as delivery, taxi, patrol car or livery)</b>	
As required	Change engine oil and filter as indicated by the information display and perform services listed in the Normal Scheduled Maintenance chart.
Inspect frequently, service as required	Replace cabin air filter (if equipped).
	Replace engine air filter.
Every 30000 miles (48000 km)	Change automatic transmission fluid.
Every 60000 miles (96000 km)	Replace spark plugs.
<b>Operating in dusty or sandy conditions such as unpaved or dusty roads</b>	
Inspect frequently, service as required	Replace cabin air filter (if equipped).
	Replace engine air filter.
Every 5000 miles (8000 km)	Inspect the wheels and related components for abnormal noise, wear, looseness or drag.
	Rotate tires, inspect tires for wear and measure tread depth.
Every 5000 miles (8000 km) or six months	Change engine oil and filter.*
	Perform multi-point inspection.
Every 30000 miles (48000 km)	Change automatic transmission fluid.

\*Reset your Intelligent Oil-Life Monitor after each engine oil and filter change. See the *Instrument Cluster* chapter.

Special Operating Condition Log

<p>DEALER VALIDATION:</p> <p>RO#: P&amp;A CODE:                  HOURS:                  DATE: MILEAGE:</p>	<p>DEALER VALIDATION:</p> <p>RO#: P&amp;A CODE:                  HOURS:                  DATE: MILEAGE:</p>
<p>DEALER VALIDATION:</p> <p>RO#: P&amp;A CODE:                  HOURS:                  DATE: MILEAGE:</p>	<p>DEALER VALIDATION:</p> <p>RO#: P&amp;A CODE:                  HOURS:                  DATE: MILEAGE:</p>
<p>DEALER VALIDATION:</p> <p>RO#: P&amp;A CODE:                  HOURS:                  DATE: MILEAGE:</p>	<p>DEALER VALIDATION:</p> <p>RO#: P&amp;A CODE:                  HOURS:                  DATE: MILEAGE:</p>
<p>DEALER VALIDATION:</p> <p>RO#: P&amp;A CODE:                  HOURS:                  DATE: MILEAGE:</p>	<p>DEALER VALIDATION:</p> <p>RO#: P&amp;A CODE:                  HOURS:                  DATE: MILEAGE:</p>
<p>DEALER VALIDATION:</p> <p>RO#: P&amp;A CODE:                  HOURS:                  DATE: MILEAGE:</p>	<p>DEALER VALIDATION:</p> <p>RO#: P&amp;A CODE:                  HOURS:                  DATE: MILEAGE:</p>

**Scheduled Maintenance**

<p style="text-align: center;">DEALER VALIDATION:</p>  <p style="text-align: center;">P&amp;A CODE:</p> <p>RO#:            HOURS:</p> <p>DATE:           MILEAGE:</p>	<p style="text-align: center;">DEALER VALIDATION:</p>  <p style="text-align: center;">P&amp;A CODE:</p> <p>RO#:            HOURS:</p> <p>DATE:           MILEAGE:</p>
<p style="text-align: center;">DEALER VALIDATION:</p>  <p style="text-align: center;">P&amp;A CODE:</p> <p>RO#:            HOURS:</p> <p>DATE:           MILEAGE:</p>	<p style="text-align: center;">DEALER VALIDATION:</p>  <p style="text-align: center;">P&amp;A CODE:</p> <p>RO#:            HOURS:</p> <p>DATE:           MILEAGE:</p>
<p style="text-align: center;">DEALER VALIDATION:</p>  <p style="text-align: center;">P&amp;A CODE:</p> <p>RO#:            HOURS:</p> <p>DATE:           MILEAGE:</p>	<p style="text-align: center;">DEALER VALIDATION:</p>  <p style="text-align: center;">P&amp;A CODE:</p> <p>RO#:            HOURS:</p> <p>DATE:           MILEAGE:</p>
<p style="text-align: center;">DEALER VALIDATION:</p>  <p style="text-align: center;">P&amp;A CODE:</p> <p>RO#:            HOURS:</p> <p>DATE:           MILEAGE:</p>	<p style="text-align: center;">DEALER VALIDATION:</p>  <p style="text-align: center;">P&amp;A CODE:</p> <p>RO#:            HOURS:</p> <p>DATE:           MILEAGE:</p>
<p style="text-align: center;">DEALER VALIDATION:</p>  <p style="text-align: center;">P&amp;A CODE:</p> <p>RO#:            HOURS:</p> <p>DATE:           MILEAGE:</p>	<p style="text-align: center;">DEALER VALIDATION:</p>  <p style="text-align: center;">P&amp;A CODE:</p> <p>RO#:            HOURS:</p> <p>DATE:           MILEAGE:</p>

**EXCEPTIONS**

There are several exceptions to the Normal Schedule. They are listed below:

**Normal vehicle axle maintenance:** Rear axles and power take-off units with synthetic fluid and light-duty trucks equipped with Ford-design axles are lubricated for life; do not check or change fluid unless a leak is suspected, service is required or the assembly has been submerged in water. During long periods of trailer towing with outside temperatures above 70°F (21°C) and at wide-open throttle for long periods above 45 mph (72 km/h), non-synthetic rear axle fluids should be changed every 3000 miles (4800 kilometers) or three months, whichever comes first. This interval can be waived if the axle is filled with 75W140 synthetic gear fluid meeting Ford specification WSL-M2C192-A, part number FITZ-19580-B or equivalent. Add friction modifier XL-3 (EST-M2C118-A) or equivalent for complete refill of Traction-Lok rear axles (see *Technical specifications* in the *Capacities and Specifications* chapter for details).

**Police, Taxi and Livery vehicle axle maintenance:** Change rear axle fluid every 100000 miles (160000 kilometers). Rear axle fluid change may be waived if the axle was filled with 75W140 synthetic gear fluid meeting Ford specification WSL-M2C192-A, part number FITZ-19580-B or equivalent. Add four ounces (118 mL) of additive friction modifier XL-3 (EST-M2C118-A) or equivalent for complete refill of Traction-Lok rear axles. The axle fluid should be changed anytime the axle has been submerged in water.

**California fuel filter replacement:** If the vehicle is registered in California, the California Air Resources Board has determined that the failure to perform this maintenance item will not nullify the emission warranty or limit recall liability prior to the completion of the vehicle's useful life. Ford Motor Company, however, urges you to have all recommended maintenance services performed at the specified intervals and to record all vehicle service.

**Hot climate oil change intervals:** Vehicles operating in the Middle East, North Africa, Sub-Saharan Africa or locations with similar climates using an American Petroleum Institute (API) Certified for Gasoline Engines (Certification mark) oil of SM or SN quality, the normal oil change interval is 5000 miles (8000 kilometers). If the available API SM or SN oils are not available, then the oil change service interval is 3000 miles (4800 kilometers).



**Engine air filter & cabin air filter replacement:** Engine air filter and cabin air filter life is dependent on exposure to dusty and dirty conditions. Vehicles operated in these conditions require frequent inspection and replacement of the engine air filter and cabin air filter.

#### ENGINE COOLANT CHANGE RECORD

Initial change	Six years or 100000 miles (160000 km) (whichever comes first)
After initial change	Every three years or 50000 miles (80000 km)

#### Engine Coolant Change Log

<p>DEALER VALIDATION:</p>  <p>P&amp;A CODE:</p> <p>RO#: HOURS:</p> <p>DATE: MILEAGE:</p>	<p>DEALER VALIDATION:</p>  <p>P&amp;A CODE:</p> <p>RO#: HOURS:</p> <p>DATE: MILEAGE:</p>
<p>DEALER VALIDATION:</p>  <p>P&amp;A CODE:</p> <p>RO#: HOURS:</p> <p>DATE: MILEAGE:</p>	<p>DEALER VALIDATION:</p>  <p>P&amp;A CODE:</p> <p>RO#: HOURS:</p> <p>DATE: MILEAGE:</p>
<p>DEALER VALIDATION:</p>  <p>P&amp;A CODE:</p> <p>RO#: HOURS:</p> <p>DATE: MILEAGE:</p>	<p>DEALER VALIDATION:</p>  <p>P&amp;A CODE:</p> <p>RO#: HOURS:</p> <p>DATE: MILEAGE:</p>

- 
- 911 Assist™ .....441, 517
- A**
- ABS (see Brakes) .....224
- Accessing and using your  
USB port .....495
- Accessing call history/phone  
book during active call .....429
- Accessing your calendar .....516
- Accessing your media menu  
features .....453
- Accessing your phone menu  
features .....431
- Accessory delay .....110
- Active call menu options .....429
- Active Park Assist .....233
- Adaptive Cruise Control .....243
- Adding (pairing) a phone .....503
- Advanced menu options ...439, 459
- Advanced menu options  
(prompts, languages, defaults,  
master reset, installing  
applications) .....439
- Airbag supplemental restraint  
system .....53  
and child safety seats .....54  
description .....53  
disposal .....62  
driver airbag .....53  
passenger airbag .....53  
side airbag .....53, 58
- Air cleaner filter .....336–337, 394
- Air conditioning .....145  
manual heating and air  
conditioning system .....145
- Air filter .....337
- Air filter, cabin .....154
- All Wheel Drive (AWD),  
driving off road .....215
- Ambient mood/lighting .....523
- Ambulance packages .....17
- AM/FM .....483
- Antifreeze (see Engine  
coolant) .....321
- Anti-lock brake system  
(see Brakes) .....224
- Anti-theft system .....88, 91  
arming the system .....88, 91  
disarming a triggered system ..91
- Audio system  
Single CD .....404, 409–410
- Audio system  
(see Radio) .....404, 409–410
- Automatic transmission .....207  
fluid, adding .....326–327  
fluid, checking .....326–327  
fluid, refill capacities .....390  
fluid, specification .....390  
Selectshift (SST) .....210
- Auxiliary Input Jack .....492
- Auxiliary input jack (Line in) ..418
- Auxiliary powerpoint .....184
- A/V inputs .....419, 500
- Axle  
lubricant specifications .....390  
refill capacities .....390
- B**
- Battery .....332  
acid, treating emergencies ....332  
jumping a disabled battery ....294  
maintenance-free .....332

- 
- replacement, specifications ...394
  - servicing .....332
  - Blind Spot Information System .....258
  - Booster seats .....24
  - Brakes .....223
    - anti-lock .....224
    - anti-lock brake system (ABS) warning light .....224
    - brake warning light .....224
    - fluid, checking and adding ...331
    - fluid, refill capacities .....390
    - fluid, specifications .....390
    - lubricant specifications .....390
    - parking .....224
    - shift interlock .....211
    - trailer .....283
  - C**
  - Capacities for refilling fluids ....390
  - Cargo net .....269
  - CD .....404, 409–410
  - CD player .....402, 494
  - CD voice commands .....495
  - Cell phone use .....17
  - Changing a tire .....379
  - Changing the air filter .....337
  - Child safety restraints .....32, 34
  - Child safety seats
    - attaching with tether straps ....34
    - automatic locking mode (retractor) .....42
    - LATCH .....32
  - Child safety seats - booster seats .....24
  - Cleaning the touchscreen .....472
  - Cleaning your vehicle .....346
    - engine compartment .....348
    - instrument panel .....350
    - interior .....350
    - plastic parts .....347
    - washing .....346
    - waxing .....348
    - wheels .....352
    - wiper blades .....349
  - Climate control (see Air conditioning or Heating) .....145
  - Climate voice commands .....535
  - Clock .....404, 521
  - Collision Warning System .....264
  - Console .....187
    - overhead .....188
    - rear .....187
  - Coolant .....321
    - checking and adding .....321
    - refill capacities .....390
    - specifications .....390
  - Cross Traffic Alert .....258
  - Cruise control .....242
  - Customer Assistance .....291
    - Ford Extended Service Plan .....399
    - Getting roadside assistance ...291
    - Getting the service you need .....297
    - Ordering additional owner's literature .....303
    - Utilizing the Mediation/Arbitration Program .....301

- 
- D**
- Defrost .....145, 147, 149
    - rear window .....154
  - Dipstick
    - automatic transmission
      - fluid .....326–327
      - engine oil .....320
  - Display settings .....522
  - Driver alert .....252
  - Driving under special conditions .....213, 217, 220
    - sand .....219
    - snow and ice .....221
    - through water .....219, 289
  - Dual automatic temperature control (DATC) .....147, 149
- E**
- Electronic message center .....124
  - Electronic stability control .....227
  - Emergencies, roadside
    - jump-starting .....294
    - running out of fuel .....199
  - Emergency brake (see Parking brake) .....224
  - Emission control system .....204
  - End user license agreement ....548
  - Engine .....388
    - cleaning .....348
    - coolant .....321
    - fail-safe cooling .....325
    - idle speed control .....332
    - lubrication specifications .....390
    - refill capacities .....390
    - service points .....317–319
  - Engine block heater .....194
  - Engine oil
    - checking and adding .....320
    - dipstick .....320
    - filter, specifications .....394
    - refill capacities .....390
    - specifications .....390
  - Event data recording .....13
  - Exhaust fumes .....194
- F**
- Fail safe cooling .....325
  - Fleet MyKey programming .....71
  - Floor mats .....290
  - Fluid capacities .....390
  - Fuel
    - cap .....201
    - capacity .....390
    - choosing the right fuel ...197–198
    - filler funnel .....199
    - filling your vehicle with fuel ..201
    - filter, specifications .....331, 394
    - fuel pump shut-off .....293
    - octane rating .....388
    - quality .....197
    - running out of fuel .....199
    - safety information relating to automotive fuels .....196
  - Fuel and distance computer ....128
    - outside temperature indicator .....128
    - to empty indicator .....128
    - trip distance .....128
    - trip/reset button .....128
  - Fuel - flex fuel vehicle (FFV) .....198
  - Fuses .....305–306, 311

- 
- G**
- Garage door opener .....179
  - Gas cap (see Fuel cap) .....201
  - Gauges .....117–118
    - odometer .....128
    - trip odometer .....128
- H**
- Hazard flashers .....292
  - HD Radio™ .....485
  - Headlamps
    - aiming .....338
    - bulb specifications .....344
    - flash to pass .....101
    - high beam .....101, 104
  - Head restraints .....157
  - Heated steering wheel .....533
  - Heating .....145, 147, 149
  - Help .....532
  - Hill descent mode .....229
  - Hill start assist .....213
  - Homelink wireless control system .....179
  - Hood .....316
  - How to use voice commands ...478
- I**
- Ignition .....190, 388
  - Illuminated visor mirror ...114–115
  - Information displays .....124
  - Inspection/maintenance (I/M) testing .....206
  - Instrument panel
    - cleaning .....350
    - cluster .....118
  - Intelligent Access Key .....64
- J**
- Jack .....379
    - positioning .....379
    - storage .....379
  - Joining two calls (multiparty/conference call) ....429
  - Jump-starting your vehicle .....294
- K**
- Keyless entry system
    - autolock .....79
    - keypad .....86
    - locking and unlocking doors ....87
    - programming entry code .....86
  - Keys .....64, 88
    - positions of the ignition .....190
- L**
- Lamps
    - bulb replacement specifications chart .....344
    - headlamps, flash to pass .....101
    - interior lamps .....106–108
  - Lane keeping system .....254
  - LATCH anchors .....32
  - Liftgate .....77, 81–82
  - Lights, warning and indicator ..118
  - Listening to music .....481
  - Loading instructions .....277
  - Load limits .....270

Locks	
autolock .....	79
childproof .....	38
doors .....	76
Lubricant specifications .....	390
Lug nuts .....	387
<b>M</b>	
Making and receiving calls .....	503
MAP DVD - Loading and Unloading .....	503
Map icons .....	544
Map mode .....	542
Map preferences .....	540
Map updates .....	546
Media Bluetooth menu options (adding, connecting, deleting, turning on/off) .....	458
Message center .....	124
warning messages .....	128, 133
Mirrors .....	111, 114
fold away .....	111
programmable memory .....	66
side view mirrors (power) .....	111
Moon roof .....	115
Motorcraft® parts .....	346, 394
MyFord Touch™ system .....	469
MyKey .....	71
<b>N</b>	
Navigation features .....	536
Navigation voice commands .....	546
Notifications .....	516
<b>P</b>	
Pairing other phones .....	426, 503
Pairing your phone .....	502
Pairing your phone for the first time .....	425, 502
Parental MyKey programming ...	71
Park Assist .....	233
Parking brake .....	224
Parts (see Motorcraft® parts) .....	394
Passenger Occupant Classification Sensor .....	55
Phone Bluetooth menu options (adding, connecting, deleting, turning on/off) .....	437
Phone redial .....	431
Phone settings .....	506, 528
Phone voice commands .....	508
Playing music (by artist, album, genre, playlist, tracks, similar) .....	454
POI categories .....	538
Point of Interest (POI) .....	538
Power distribution box (see Fuses) .....	306
Power door locks .....	76
Power liftgate .....	82
Power mirrors .....	111
Powerpoint .....	184
Power steering .....	267
fluid, checking and adding ...	331
Power Windows .....	109
Privacy information .....	422, 475

- 
- Push button start system .....190
- Putting a call on/off hold .....429
- Q**
- Quick touch buttons .....545
- R**
- Radio .....404, 409–410  
 AM/FM .....483  
 Single CD .....404, 409–410
- Radio reception .....402
- Radio voice commands .....488
- Rear heated seats .....168
- Rear view camera  
 display .....237, 524
- Rear window  
 defroster .....145, 147, 149
- Receiving a text  
 message .....433, 506
- Recommendations for  
 attaching safety restraints for  
 children .....26
- Relays .....305–306
- Remote entry system  
 illuminated entry .....80–81  
 locking/unlocking doors .....76–77  
 opening the trunk .....77  
 replacing the batteries .....65
- Reverse sensing system .....232
- Roadside assistance .....291
- Roll stability control .....227
- Roof rack .....269
- Route preferences .....540
- S**
- Safety Belt Maintenance .....49
- Safety belts (see Safety  
 restraints) .....41, 44
- Safety defects, reporting .....304
- Safety information .....421, 473
- Safety restraints .....41–42, 44  
 Belt-Minder® .....45  
 Belt-Minder®,  
 deactivating/activating .....46  
 extension assembly .....44  
 for adults .....41–42  
 for children .....26  
 inflatable safety belt .....47  
 Occupant Classification  
 Sensor .....55  
 safety belt maintenance .....49  
 seat belt maintenance .....49  
 warning light and chime .....45
- Safety restraints - LATCH  
 anchors .....32
- Safety seats for children .....26
- Safety Compliance  
 Certification Label .....396
- Satellite Radio .....404, 489
- Scheduled Maintenance Guide  
 Normal Scheduled  
 Maintenance and Log .....573
- SD card .....419, 495, 536
- Seat belts (see Safety  
 restraints) .....41
- Seats .....167  
 child safety seats .....26  
 climate control .....166  
 easy access/easyout feature ..164  
 front seats .....160–161, 165  
 heated .....164, 168

- 
- memory seat .....66, 163
  - second row seats .....167
  - third row seats .....169, 174, 176
  - Second-row power fold seat ....172
  - SecuriCode keyless entry system .....85
  - SecuriLock passive anti-theft system .....88
  - Selecting your media source (USB, Line in, BT audio) .....453
  - Sending new text messages .....505
  - Setting a destination .....536
  - Setting a destination by voice .....537
  - Settings .....521
  - Setting the clock .....404, 521
  - Side air curtain .....59
  - Side-curtain airbags system .....59
  - SIRIUS® satellite radio ....404, 489
  - SIRIUS satellite radio voice commands .....490
  - SIRIUS Travel Link .....513
  - SIRIUS Travel Link voice commands .....515
  - Snowplowing .....17
  - SOS Post Crash Alert .....52
  - Spark plugs, specifications .....388, 394
  - Special notice
    - ambulance conversions .....17
    - utility-type vehicles .....17
  - Specification chart, lubricants .....390
  - Stability system .....227
  - Starting your vehicle .....191
    - jump starting .....294
    - push button start system .....190
  - Steering wheel .....93
    - controls .....95
    - tilting .....93–94
  - Supplemental Restraint System (SRS) (see airbags) .....53
  - Supported media file types .....499
  - Supported player, media formats and metadata information .....499
  - SYNC® customer support .....421, 473
  - SYNC® Services .....445, 509
  - System settings .....524
- T**
- Temperature control (see Climate control) .....145, 147, 149, 533
  - Text messaging .....432, 505
  - Text messaging (sending, downloading, deleting) ....433, 435
  - Third-row power fold seat .....177
  - Tilt steering wheel .....93–94
  - Tires .....358–359, 379
    - alignment .....372
    - care .....357
    - changing .....379, 381
    - checking the pressure .....368
    - inflating .....366
    - label .....365
    - replacing .....370
    - rotating .....373
    - safety practices .....372
    - sidewall information .....361



- 
- snow tires and chains .....374
  - spare tire .....379
  - terminology .....360
  - tire grades .....359
  - treadwear .....359, 368
  - Touchscreen features
    - (climate) .....533
  - Towing .....278, 285–286
    - recreational towing .....286
    - trailer towing .....278
    - wrecker .....285
  - Traction control .....225
  - Traffic, Directions and Information .....445
  - Traffic preferences .....540
  - Trailer sway control .....279
  - Transmission
    - brake-shift interlock (BSI) ....211
    - fluid, checking and adding (automatic) .....326–327
    - fluid, refill capacities .....390
    - lubricant specifications .....390
  - Turn signal .....106
  - U**
  - USB port .....419, 495
  - Using privacy mode .....429
  - V**
  - Vehicle health report .....443, 519
  - Vehicle Identification Number (VIN) .....395
  - Vehicle loading .....270
  - Ventilating your vehicle .....194
  - Voice commands in media mode .....450
  - Voice commands in phone mode .....426
  - Voice recognition .....477
  - W**
  - Warning lights (see Lights) ....118
  - Washer fluid .....331–332
  - Water, Driving through .....289
  - Windows
    - power .....109
    - rear wiper/washer .....100
  - Windshield washer fluid and wipers .....99
    - checking and adding fluid .....331–332
    - replacing wiper blades .....335
  - Wrecker towing .....285