

The logo consists of the letters "GMC" in a bold, sans-serif font above the word "TRUCK" in a smaller, all-caps sans-serif font. Both are white and set against a red square background.

GMC
TRUCK

1996
1996
1996
1996
1996
1996
1996

Savana

D W N E R ' S M A N U A L

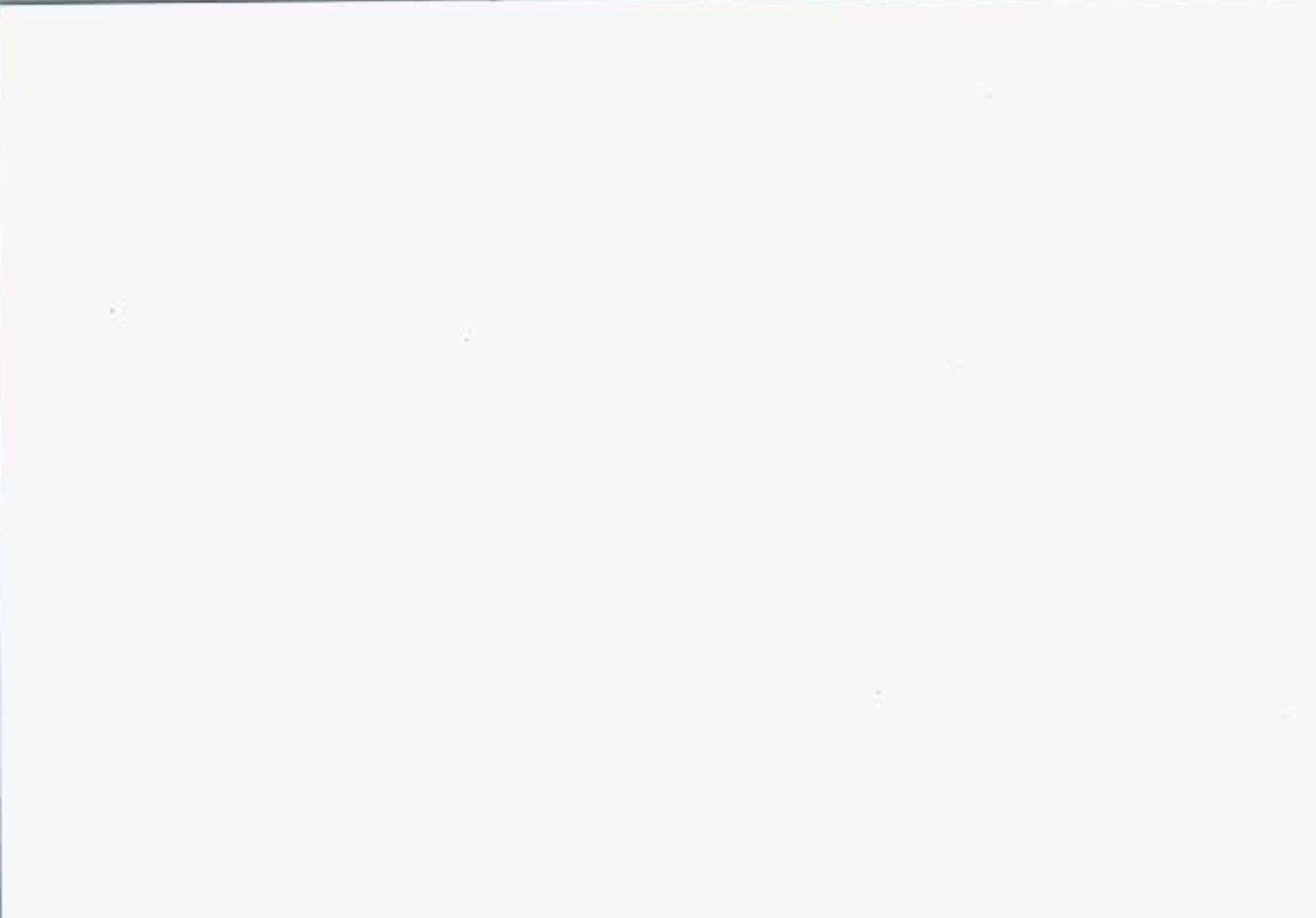

The 1996 GMC Savana Owner's Manual

Seats and Restraint Systems	1-1
This section tells you how to use your seats and safety belts properly. It also explains the "SIR" system.	
Features and Controls	2-1
This section explains how to start and operate your vehicle.	
Comfort Controls and Audio Systems	3-1
This section tells you how to adjust the ventilation and comfort controls and how to operate your audio system.	
Your Driving and the Road	4-1
Here you'll find helpful information and tips about the road and how to drive under different conditions.	
Problems on the Road	5-1
This section tells you what to do if you have a problem while driving, such as a flat tire or overheated engine, etc.	
Service and Appearance Care	6-1
Here the manual tells you how to keep your vehicle running properly and looking good.	
Maintenance Schedule	7-1
This section tells you when to perform vehicle maintenance and what fluids and lubricants to use.	
Customer Assistance Information	8-1
This section tells you how to contact GMC Truck for assistance and how to get service and owner publications. It also gives you information on "Reporting Safety Defects" on page 8-8.	
Index	9-1
Here's an alphabetical listing of almost every subject in this manual. You can use it to quickly find something you want to read.	



GENERAL MOTORS, GM, the GM Emblem, GMC TRUCK, the GMC TRUCK Emblem and the name SAVANA are registered trademarks of General Motors Corporation.

This manual includes the latest information at the time it was printed. We reserve the right to make changes in the product after that time without further notice. For vehicles first sold in Canada, substitute the name "General Motors of Canada Limited" for GMC Truck Division whenever it appears in this manual.

Please keep this manual in your vehicle, so it will be there if you ever need it when you're on the road. If you sell the vehicle, please leave this manual in it so the new owner can use it.

Litho in U.S.A.
X9614 B First Edition



We support voluntary technician certification.

For Canadian Owners Who Prefer a French Language Manual:

Aux propriétaires canadiens: Vous pouvez vous procurer un exemplaire de ce guide en français chez votre concessionnaire ou au:

DGN Marketing Services Ltd.
1500 Bonhill Rd.
Mississauga, Ontario L5T 1C7

© Copyright General Motors Corporation 1996
All Rights Reserved

How to Use this Manual

Many people read their owner's manual from beginning to end when they first receive their new vehicle. If you do this, it will help you learn about the features and controls for your vehicle. In this manual, you'll find that pictures and words work together to explain things quickly.

Index

A good place to look for what you need is the Index in the back of the manual. It's an alphabetical list of all that's in the manual, and the page number where you'll find it.

Safety Warnings and Symbols

You will find a number of safety cautions in this book. We use a box and the word CAUTION to tell you about things that could hurt you if you were to ignore the warning.



CAUTION:

These mean there is something that could hurt you or other people.

In the caution area, we tell you what the hazard is. Then we tell you what to do to help avoid or reduce the hazard. Please read these cautions. If you don't, you or others could be hurt.



You will also find a circle with a slash through it in this book. This safety symbol means “Don’t,” “Don’t do this,” or “Don’t let this happen.”

In the notice area, we tell you about something that can damage your vehicle. Many times, this damage would not be covered by your warranty, and it could be costly. But the notice will tell you what to do to help avoid the damage.

When you read other manuals, you might see CAUTION and NOTICE warnings in different colors or in different words.

You’ll also see warning labels on your vehicle. They use the same words, CAUTION or NOTICE.

Vehicle Damage Warnings

Also, in this book you will find these notices:

NOTICE:

These mean there is something that could damage your vehicle.

Vehicle Symbols

These are some of the symbols you may find on your vehicle.

For example, these symbols are used on an original battery:

CAUTION
POSSIBLE
INJURY



PROTECT
EYES BY
SHIELDING



CAUSTIC
BATTERY
ACID COULD
CAUSE
BURNS



AVOID
SPARKS OR
FLAMES



SPARK OR
FLAME
COULD
EXPLODE
BATTERY



These symbols are important for you and your passengers whenever your vehicle is driven:

DOOR LOCK
UNLOCK



FASTEN
SEAT
BELTS



POWER
WINDOW



AIR BAG



These symbols have to do with your lights:

MASTER
LIGHTING
SWITCH



TURN
SIGNALS

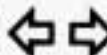

PARKING
LAMPS



HAZARD
WARNING
FLASHER



DAYTIME
RUNNING
LAMPS



FOG LAMPS

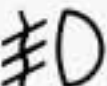

These symbols are on some of your controls:

WINDSHIELD
WIPER



WINDSHIELD
WASHER



WINDSHIELD
DEFROSTER



REAR
WINDOW
DEFOGGER



VENTILATING
FAN



These symbols are used on warning and indicator lights:

ENGINE
COOLANT
TEMP



BATTERY
CHARGING
SYSTEM



BRAKE



COOLANT



ENGINE OIL
PRESSURE



ANTI-LOCK
BRAKES



Here are some other symbols you may see:

FUSE



LIGHTER



HORN



SPEAKER



FUEL



Model Reference

This manual covers these models:

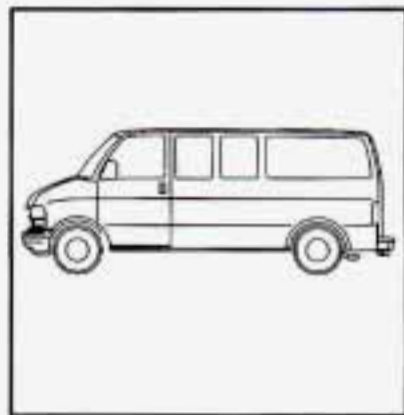

Passenger Van

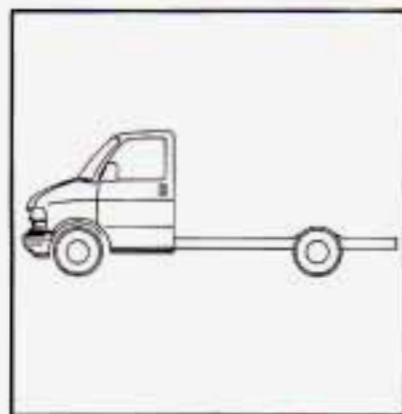

Cab and Chassis

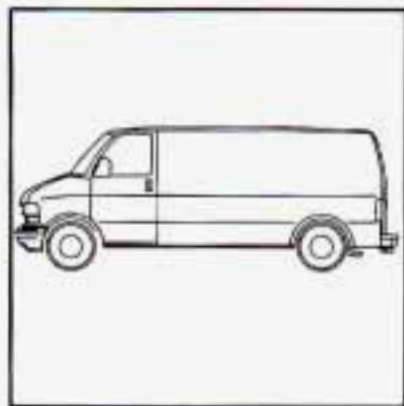

Cargo Van

Section 1 Seats and Restraint Systems

Here you'll find information about the seats in your vehicle and how to use your safety belts properly. You can also learn about some things you should *not* do with air bags and safety belts.

Seats and Seat Controls

This part tells you about the seats -- how to adjust them, take them out and put them back in. It also tells you about reclining front seatbacks.

Manual Front Seats



The bucket seats can be adjusted forward or rearward with the lever at the front of the seat.

To adjust the seat, pull the lever up to release the seat bottom and slide the seat where you want it. Then release the lever and try to move the seat with your body, to make sure the seat is locked into place.

⚠ CAUTION:

You can lose control of the vehicle if you try to adjust a manual driver's seat while the vehicle is moving. The sudden movement could startle and confuse you, or make you push a pedal when you don't want to. Adjust the driver's seat only when the vehicle is not moving.

Power Seat (Option)



If your vehicle has a power seat on the driver or passenger's side, you can adjust it with this switch at the front center cushion of the seat.

You can use the center knob to move the seat where you want it. To raise the seat, move the center knob up. To lower the seat, move the center knob down. To move the seat forward, move the center knob toward the front of the vehicle. To move the seat rearward, move the center knob toward the rear of the vehicle.

You can raise and lower the front and rear of the seat. To raise the front of the seat, move the right lever up. To lower it, move the right lever down. To raise the rear of the seat, move the left lever up. To lower it, move the left lever down.

Reclining Seatbacks



To adjust the seatback, lift the front of this lever which is located at the inner edge of the seat cushion.

Move the seatback with your body and release the lever to lock the seatback where you want it. Lean forward and pull up on the front of the lever and the seatback will go to an upright position.



But don't have a seatback reclined if your vehicle is moving.

CAUTION:

Sitting in a reclined position when your vehicle is in motion can be dangerous. Even if you buckle up, your safety belts can't do their job when you're reclined like this.

The shoulder belt can't do its job because it won't be against your body. Instead, it will be in front of you. In a crash you could go into it, receiving neck or other injuries.

The lap belt can't do its job either. In a crash the belt could go up over your abdomen. The belt forces would be there, not at your pelvic bones. This could cause serious internal injuries.

For proper protection when the vehicle is in motion, have the seatback upright. Then sit well back in the seat and wear your safety belt properly.

Head Restraints

Head restraints are fixed on some models and adjustable on others. Slide an adjustable head restraint up or down so that the top of the restraint is closest to the top of your ears. This position reduces the chance of a neck injury in a crash.

Rear Seats

CAUTION:

A seat that isn't locked into place properly can move around in a collision or sudden stop. People in the vehicle could be injured. Be sure to lock the seat into place properly when installing it.

CAUTION:

A safety belt that is twisted or not properly attached won't provide the protection needed in a crash. The person wearing the belt could be seriously injured. After installing the seat, always check to be sure that the safety belts are not twisted and are properly attached.

Removing the Rear Seat



1. Disconnect the quick release latch plates for the lap shoulder belts on the bench seat to be removed. To do this, press the tip of a key into the release hole of the safety belt end release buckle while pulling up on the safety belt.
2. At the floor, remove the plastic trim covers in front of and behind the seat supports.



3. Lift up on the latch lever located at the front of each seat support. The latch lever will stay in the up position.
4. Roll the seat toward the open slots in both rails. Lift the seat up and out of both rails.
5. Remove the seat from the vehicle.
6. Install long trim covers to the front portion of the floor rails.

Replacing the Rear Seat

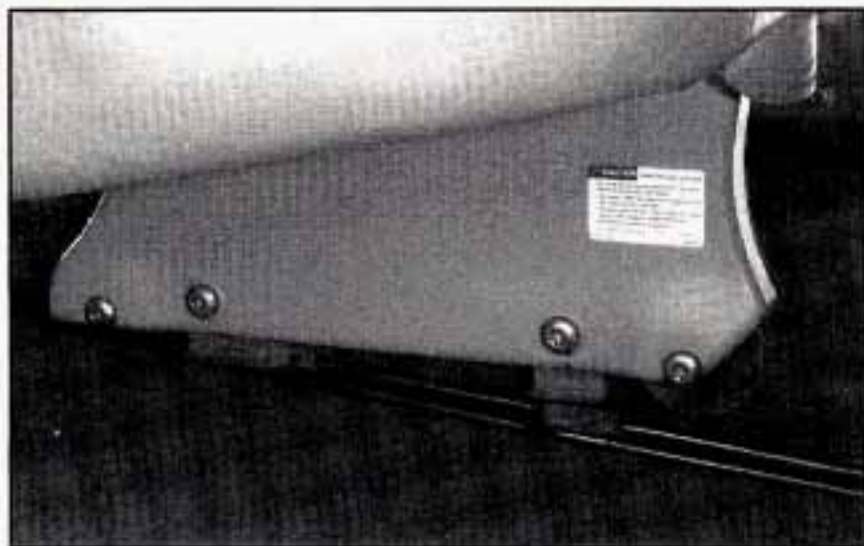

1. Position the seat into the open slots in both rails. Make sure that the latch levers at the front of the seat are in the up position.
2. Roll the seat to the set location and lock into place.



3. Lower the latch lever by lifting up on the release located at the mid-position of each seat support. Check that both sides of the seat are locked securely by trying to move the seat forward and backward. A click should be heard when the seat is locked in place.
4. At the floor, replace the plastic trim covers in front of and behind the seat supports.
5. Connect the quick release latch plates for the lap shoulder belts by inserting the latch plates into the buckles attached at the outboard positions of the bench seat.

Safety Belts: They're for Everyone

This part of the manual tells you how to use safety belts properly. It also tells you some things you should not do with safety belts.

And it explains the Supplemental Inflatable Restraint (SIR), or air bag system.

CAUTION:

Don't let anyone ride where he or she can't wear a safety belt properly. If you are in a crash and you're not wearing a safety belt, your injuries can be much worse. You can hit things inside the vehicle or be ejected from it. You can be seriously injured or killed. In the same crash, you might not be if you are buckled up. Always fasten your safety belt, and check that your passengers' belts are fastened properly too.



Your vehicle has a light that comes on as a reminder to buckle up. (See "Safety Belt Reminder Light" in the Index.)

In most states and Canadian provinces, the law says to wear safety belts. Here's why: *They work.*

You never know if you'll be in a crash. If you do have a crash, you don't know if it will be a bad one.

A few crashes are mild, and some crashes can be so serious that even buckled up a person wouldn't survive. But most crashes are in between. In many of them, people who buckle up can survive and sometimes walk away. Without belts they could have been badly hurt or killed.

After more than 25 years of safety belts in vehicles, the facts are clear. In most crashes buckling up does matter ... a lot!

Why Safety Belts Work

When you ride in or on anything, you go as fast as it goes.

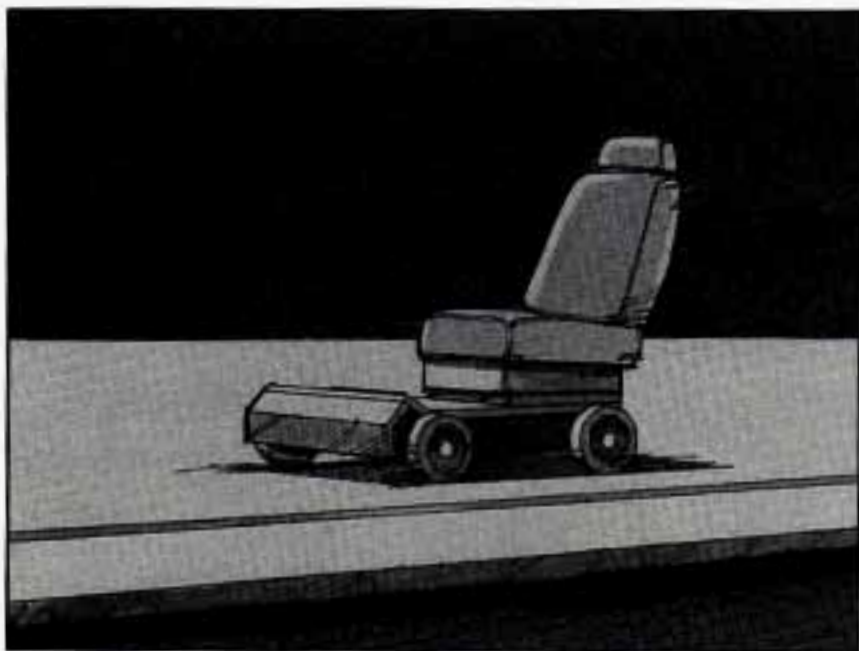

Take the simplest vehicle. Suppose it's just a seat on wheels.

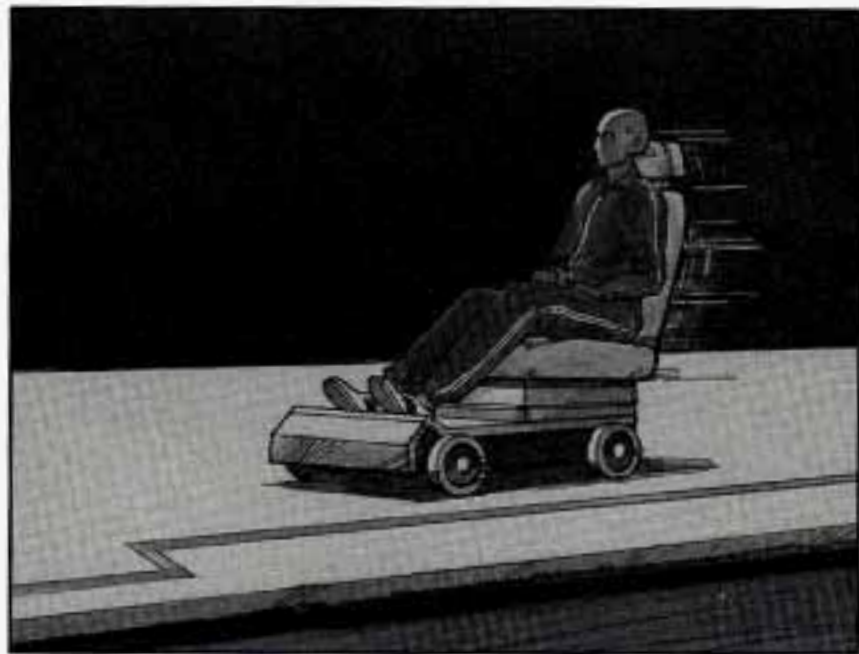

Put someone on it.

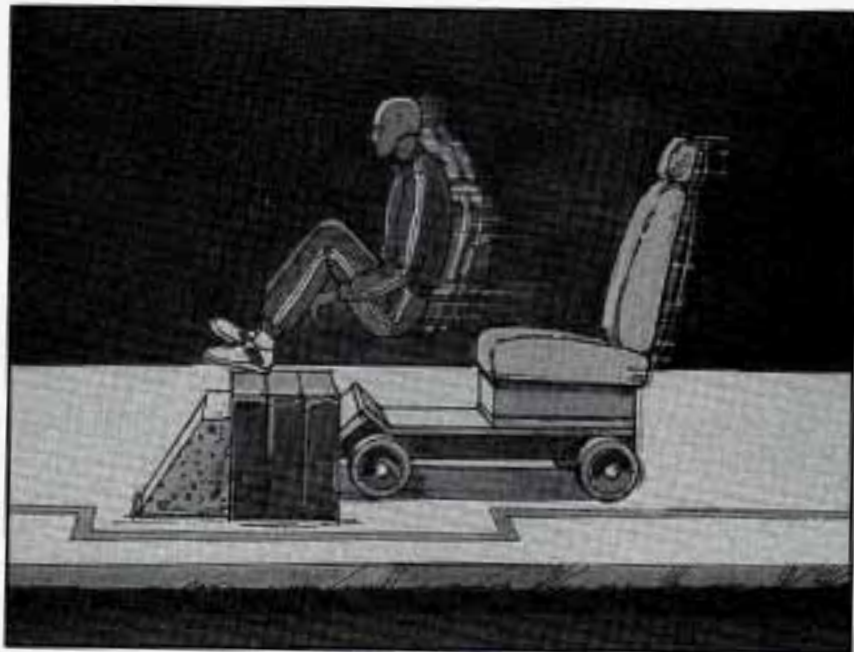

Get it up to speed. Then stop the vehicle. The rider doesn't stop.



The person keeps going until stopped by something. In a real vehicle, it could be the windshield ...

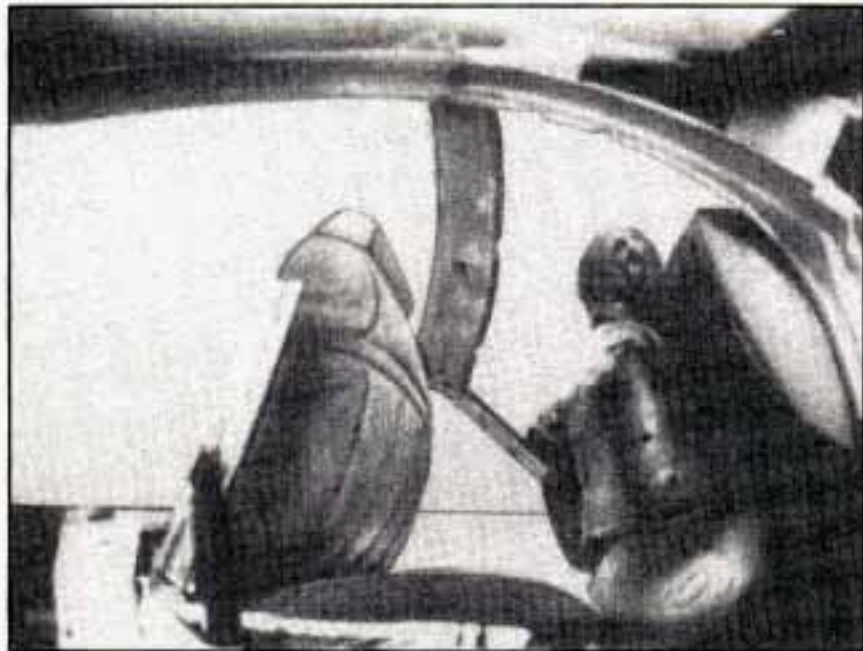

or the instrument panel ...



or the safety belts!

With safety belts, you slow down as the vehicle does. You get more time to stop. You stop over more distance, and your strongest bones take the forces. That's why safety belts make such good sense.

Here Are Questions Many People Ask About Safety Belts -- and the Answers

Q: Won't I be trapped in the vehicle after an accident if I'm wearing a safety belt?

A: You *could* be -- whether you're wearing a safety belt or not. But you can unbuckle a safety belt, even if you're upside down. And your chance of being conscious during and after an accident, so you *can* unbuckle and get out, is *much* greater if you are belted.

Q: If my vehicle has air bags, why should I have to wear safety belts?

A: Air bags are in many vehicles today and will be in most of them in the future. But they are supplemental systems only; so they work *with* safety belts -- not instead of them. Every air bag system ever offered for sale has required the use of safety belts. Even if you're in a vehicle that has air bags, you still have to buckle up to get the most protection. That's true not only in frontal collisions, but especially in side and other collisions.

Q: If I'm a good driver, and I never drive far from home, why should I wear safety belts?

A: You may be an excellent driver, but if you're in an accident -- even one that isn't your fault -- you and your passengers can be hurt. Being a good driver doesn't protect you from things beyond your control, such as bad drivers.

Most accidents occur within 25 miles (40 km) of home. And the greatest number of serious injuries and deaths occur at speeds of less than 40 mph (65 km/h).

Safety belts are for everyone.

How to Wear Safety Belts Properly

Adults

This part is only for people of adult size.

Be aware that there are special things to know about safety belts and children. And there are different rules for smaller children and babies. If a child will be riding in your vehicle, see the part of this manual called “Children.” Follow those rules for everyone’s protection.

First, you’ll want to know which restraint systems your vehicle has.

We’ll start with the driver position.

Driver Position

This part describes the driver’s restraint system.

Lap-Shoulder Belt

The driver has a lap-shoulder belt. Here’s how to wear it properly.

1. Close and lock the door.
2. Adjust the seat (to see how, see “Seats” in the Index) so you can sit up straight.



3. Pick up the latch plate and pull the belt across you. Don't let it get twisted.
4. Push the latch plate into the buckle until it clicks. Pull up on the latch plate to make sure it is secure. If the belt isn't long enough, see “Safety Belt Extender” at the end of this section.

Make sure the release button on the buckle is positioned so you would be able to unbuckle the safety belt quickly if you ever had to.



5. To make the lap part tight, pull down on the buckle end of the belt as you pull up on the shoulder belt.

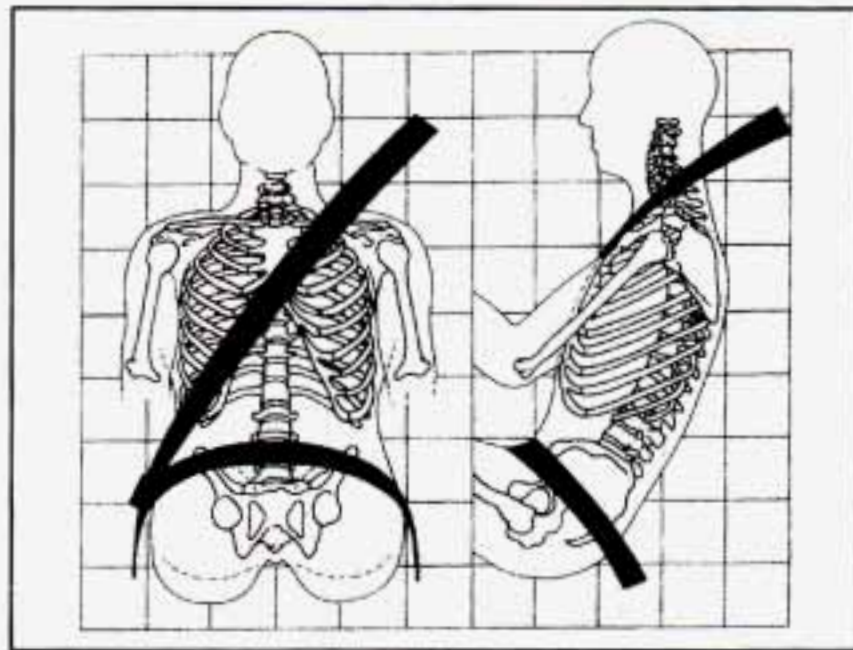

The lap part of the belt should be worn low and snug on the hips, just touching the thighs. In a crash, this applies force to the strong pelvic bones. And you'd be less likely to slide under the lap belt. If you slid under it, the belt would apply force at your abdomen. This could cause serious or even fatal injuries. The shoulder belt should go over the shoulder and across the chest. These parts of the body are best able to take belt restraining forces.

The safety belt locks if there's a sudden stop or a crash.

Shoulder Belt Height Adjuster

Before you begin to drive, move the shoulder belt adjuster to the height that is right for you.



To move it down, push in at the word PRESS and move the height adjuster to the desired position. You can move the adjuster up just by pushing up on the shoulder belt guide. After you move the adjuster to where you want it, try to move it down without pushing in to make sure it has locked into position.

Adjust the height so that the shoulder portion of the belt is centered on your shoulder. The belt should be away from your face and neck, but not falling off your shoulder.

Q: What's wrong with this?

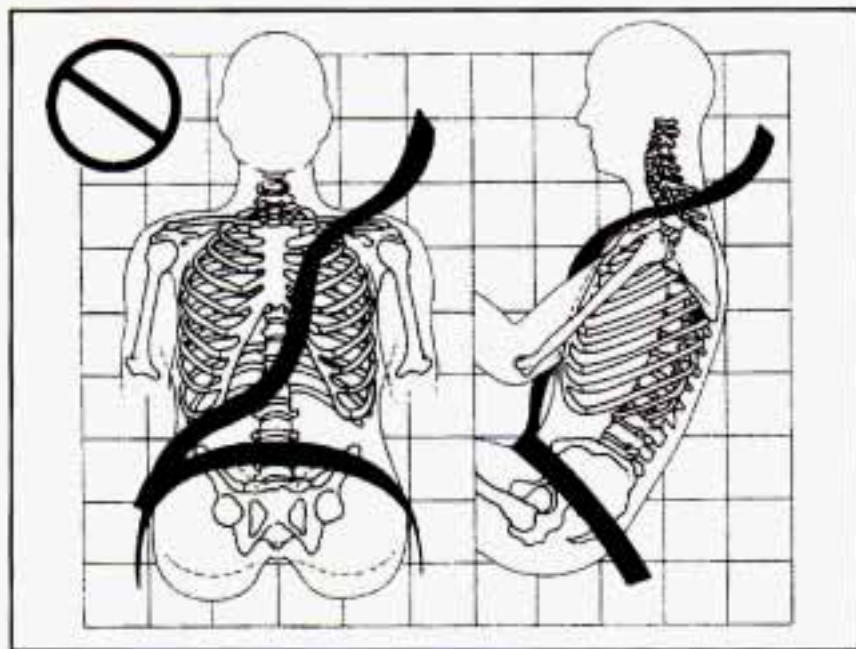

A: The shoulder belt is too loose. It won't give nearly as much protection this way.



CAUTION:

You can be seriously hurt if your shoulder belt is too loose. In a crash, you would move forward too much, which could increase injury. The shoulder belt should fit against your body.

Q: What's wrong with this?

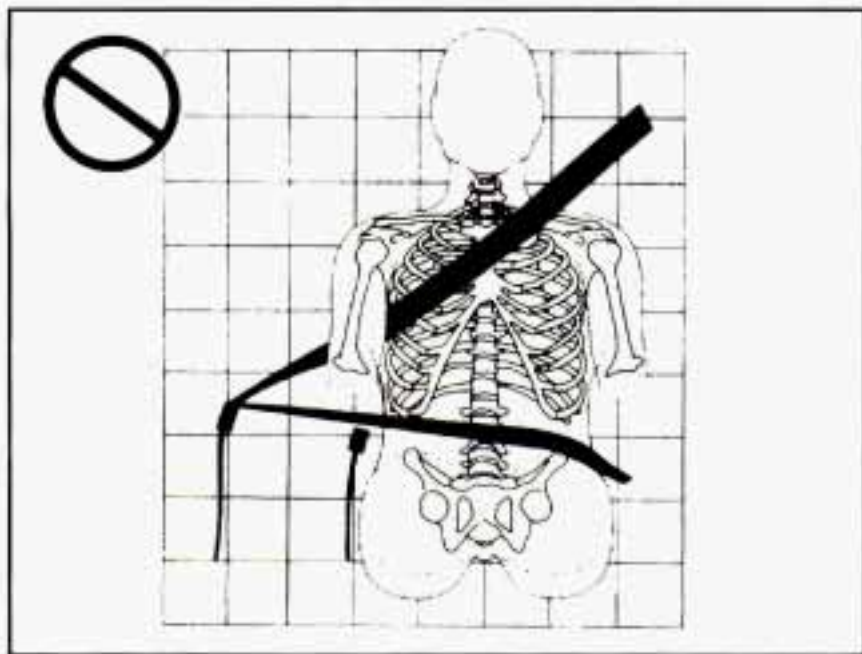

A: The belt is buckled in the wrong place.

⚠ CAUTION:

You can be seriously injured if your belt is buckled in the wrong place like this. In a crash, the belt would go up over your abdomen. The belt forces would be there, not at the pelvic bones. This could cause serious internal injuries. Always buckle your belt into the buckle nearest you.

Q: What's wrong with this?

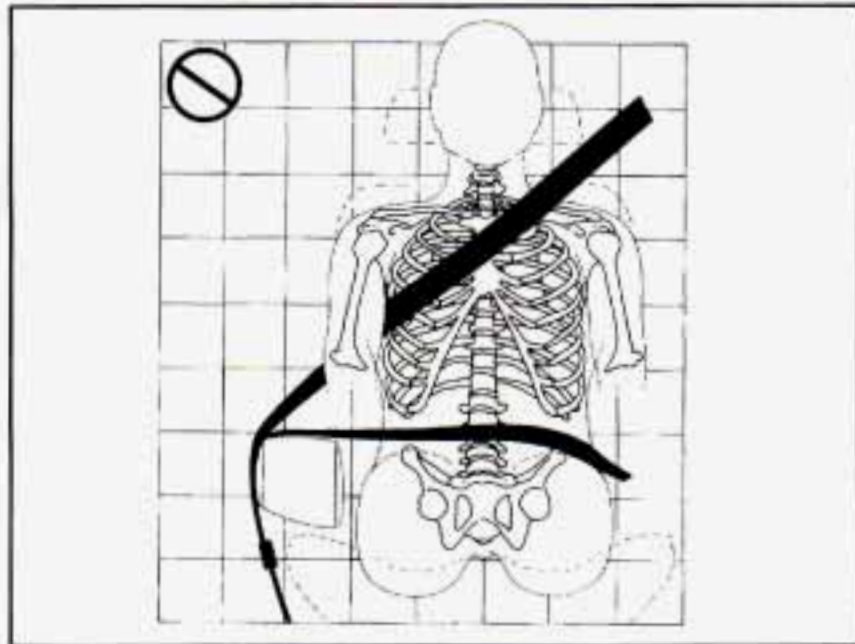

⚠ CAUTION:

You can be seriously injured if your belt goes over an armrest like this. The belt would be much too high. In a crash, you can slide under the belt. The belt force would then be applied at the abdomen, not at the pelvic bones, and that could cause serious or fatal injuries. Be sure the belt goes under the armrests.

A: The belt is over an armrest.

Q: What's wrong with this?

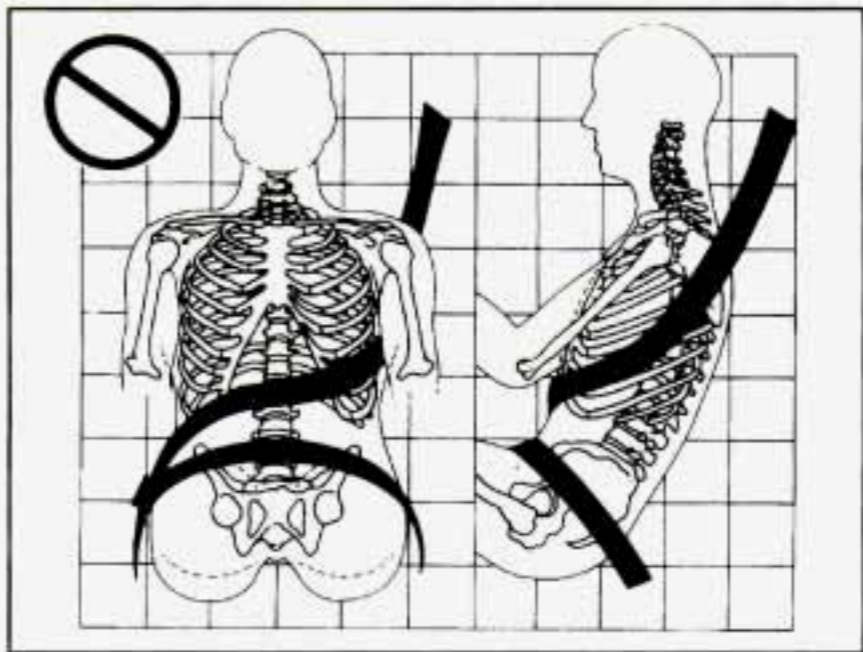

A: The shoulder belt is worn under the arm. It should be worn over the shoulder at all times.

⚠ CAUTION:

You can be seriously injured if you wear the shoulder belt under your arm. In a crash, your body would move too far forward, which would increase the chance of head and neck injury. Also, the belt would apply too much force to the ribs, which aren't as strong as shoulder bones. You could also severely injure internal organs like your liver or spleen.

Q: What's wrong with this?

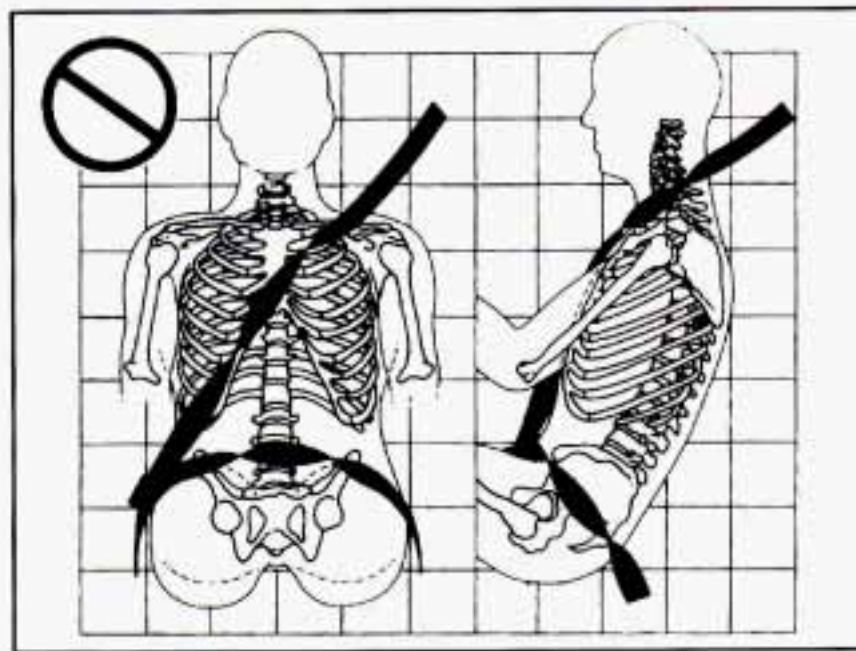

A: The belt is twisted across the body.

⚠ CAUTION:

You can be seriously injured by a twisted belt. In a crash, you wouldn't have the full width of the belt to spread impact forces. If a belt is twisted, make it straight so it can work properly, or ask your dealer to fix it.



To unlatch the belt, just push the button on the buckle. The belt should go back out of the way.

Before you close the door, be sure the belt is out of the way. If you slam the door on it, you can damage both the belt and your vehicle.

Supplemental Inflatable Restraint (SIR) System

This part explains the Supplemental Inflatable Restraint (SIR) system or air bag system.



If it says SUPPLEMENTAL INFLATABLE RESTRAINT on the middle part of the steering wheel and there's a right front passenger seat, your vehicle has two air bags — one air bag for the driver and another air bag for the right front passenger.

If it says **SUPPLEMENTAL INFLATABLE RESTRAINT** on the middle part of the steering wheel but there is no right front passenger seat, your vehicle has an air bag for the driver only.

If it doesn't say **SUPPLEMENTAL INFLATABLE RESTRAINT** on the middle part of the steering wheel, your vehicle doesn't have air bags.

Here are the most important things to know about the air bag system:

 **CAUTION:**

You can be severely injured or killed in a crash if you aren't wearing your safety belt -- even if you have an air bag. Wearing your safety belt during a crash helps reduce your chance of hitting things inside the vehicle or being ejected from it. The air bag is only a "supplemental restraint." That is, it works with safety belts but doesn't replace them.

CAUTION: (Continued)

CAUTION: (Continued)

Air bags are designed to work only in moderate to severe crashes where the front of your vehicle hits something. They aren't designed to inflate at all in rollover, rear, side or low-speed frontal crashes. Everyone in your vehicle, including the driver, should wear a safety belt properly -- whether or not there's an air bag for that person.

 **CAUTION:**

Air bags inflate with great force, faster than the blink of an eye. If you're too close to an inflating air bag, it could seriously injure you. Safety belts help keep you in position for an air bag inflation in a crash. Always wear your safety belt, even with an air bag. The driver should sit as far back as possible while still maintaining control of the vehicle.

If your vehicle has an air bag for the right front passenger, please read this:

 **CAUTION:**

An inflating air bag can seriously injure small children. Always secure children properly in your vehicle. To read how, see the part of this manual called “Children” and the caution label on the right front passenger’s safety belt.

**AIR
BAG**

There is an air bag readiness light on the instrument panel, which shows AIR BAG.

The system checks the air bag’s electrical system for malfunctions. The light tells you if there is an electrical problem. See “Air Bag Readiness Light” in the Index for more information.

How the Air Bag System Works



Where is the air bag?

The driver's air bag is in the middle of the steering wheel.



The right front passenger's air bag is in the instrument panel on the passenger's side.

 **CAUTION:**

Don't put anything on, or attach anything to, the steering wheel or instrument panel. Also, don't put anything (such as pets or objects) between any occupant and the steering wheel or instrument panel. And don't hang anything from the assist handle on the passenger's side of the instrument panel. If something is between an occupant and an air bag, it could affect the performance of the air bag -- or worse, it could cause injury.

When should an air bag inflate?

The air bag is designed to inflate in moderate to severe frontal or near-frontal crashes. The air bag will inflate only if the impact speed is above the system's designed "threshold level." If your vehicle goes straight into a wall that doesn't move or deform, the threshold level is about 11 to 16 mph (18 to 26 km/h). The threshold level can vary, however, with specific vehicle design, so that

it can be somewhat above or below this range. If your vehicle strikes something that will move or deform, such as a parked car, the threshold level will be higher. The air bag is not designed to inflate in rollovers, side impacts or rear impacts, because inflation would not help the occupant.

In any particular crash, no one can say whether an air bag should have inflated simply because of the damage to a vehicle or because of what the repair costs were. Inflation is determined by the angle of the impact and the vehicle's deceleration. Vehicle damage is only one indication of this.

What makes an air bag inflate?

In a frontal or near-frontal impact of sufficient severity, the air bag sensing system detects that the vehicle is suddenly stopping as a result of a crash. The sensing system triggers a chemical reaction of the sodium azide sealed in the inflator. The reaction produces nitrogen gas, which inflates the air bag. The inflator, air bag and related hardware are all part of the air bag modules packed inside the steering wheel and in the instrument panel in front of the right front passenger.

How does an air bag restrain?

In moderate to severe frontal or near-frontal collisions, even belted occupants can contact the steering wheel or the instrument panel. The air bag supplements the protection provided by safety belts. Air bags distribute the force of the impact more evenly over the occupant's upper body, stopping the occupant more gradually. But air bags would not help you in many types of collisions, including rollovers, rear impacts and side impacts, primarily because an occupant's motion is not toward the air bag. Air bags should never be regarded as anything more than a supplement to safety belts, and then only in moderate to severe frontal or near-frontal collisions.

What will you see after an air bag inflates?

After the air bag inflates, it quickly deflates. This occurs so quickly that some people may not even realize the air bag inflated. Some components of the air bag module in the steering wheel hub for the driver's air bag, or the instrument panel for the right front passenger's bag, will be hot for a short time. The part of the bag that comes into contact with you may be warm, but it will never be too hot to touch. There will be some smoke and dust coming from vents in the deflated air bags. Air bag

inflation will not prevent the driver from seeing or from being able to steer the vehicle, nor will it stop people from leaving the vehicle.

CAUTION:

When an air bag inflates, there is dust in the air. This dust could cause breathing problems for people with a history of asthma or other breathing trouble. To avoid this, everyone in the vehicle should get out as soon as it is safe to do so. If you have breathing problems but can't get out of the vehicle after an air bag inflates, then get fresh air by opening a window or door.

- The air bags are designed to inflate only once. After they inflate, you'll need some new parts for your air bag system. If you don't get them, the air bag system won't be there to help protect you in another crash. A new system will include air bag modules and possibly other parts. The service manual for your vehicle covers the need to replace other parts.

- Your vehicle is equipped with a crash sensing and diagnostic module, which records information about the air bag system. The module records information about the readiness of the system, when the sensors are activated and driver's safety belt usage at deployment.
- Let only qualified technicians work on your air bag system. Improper service can mean that your air bag system won't work properly. See your dealer for service.

NOTICE:

If you damage the cover for the driver's or the right front passenger's air bag, they may not work properly. You may have to replace the air bag module in the steering wheel or both the air bag module and the instrument panel for the right front passenger's air bag. Do not open or break the air bag covers.

Servicing Your Air Bag-Equipped Vehicle

Air bags affect how your vehicle should be serviced. There are parts of the air bag system in several places around your vehicle. You don't want the system to inflate while someone is working on your vehicle. Your GM dealer and the service manual have information about servicing your vehicle and the air bag system. To purchase a service manual, see "Service and Owner Publications" in the Index.



CAUTION:

For up to 10 minutes after the ignition key is turned off and the battery is disconnected, an air bag can still inflate during improper service. You can be injured if you are close to an air bag when it inflates. Avoid wires wrapped with yellow tape or yellow connectors. They are probably part of the air bag system. Be sure to follow proper service procedures, and make sure the person performing work for you is qualified to do so.

The air bag system does not need regular maintenance.

Adding Equipment to Your Air Bag-Equipped Vehicle

Q: If I add a push bumper or a bicycle rack to the front of my vehicle, will it keep the air bags from working properly?

A: As long as the push bumper or bicycle rack is attached to your vehicle so that the vehicle's basic structure isn't changed, it's not likely to keep the air bags from working properly in a crash.

Q: Is there anything I might add to the front of the vehicle that could keep the air bags from working properly?

A: Yes. If you add things that change your vehicle's frame, bumper system, front end sheet metal or height, they may keep the air bag system from working properly. Also, the air bag system may not work properly if you relocate any of the air bag sensors. If you have any question about this, you should contact Customer Assistance before you modify your vehicle. (The phone numbers and addresses for Customer Assistance are in Step Two of the Customer Satisfaction Procedure in this manual. See "Customer Satisfaction Procedure" in the Index.)

Safety Belt Use During Pregnancy

Safety belts work for everyone, including pregnant women. Like all occupants, they are more likely to be seriously injured if they don't wear safety belts.



A pregnant woman should wear a lap-shoulder belt, and the lap portion should be worn as low as possible, below the rounding, throughout the pregnancy.

The best way to protect the fetus is to protect the mother. When a safety belt is worn properly, it's more likely that the fetus won't be hurt in a crash. For pregnant women, as for anyone, the key to making safety belts effective is wearing them properly.

Right Front Passenger Position

The right front passenger's safety belt works the same way as the driver's safety belt. See "Driver Position" earlier in this section.

When the shoulder belt is pulled out all the way, it will lock. If it does, let it go back all the way and start again.

Rear Seat Passengers

It's very important for rear seat passengers to buckle up! Accident statistics show that unbelted people in the rear seat are hurt more often in crashes than those who are wearing safety belts.

Rear passengers who aren't safety belted can be thrown out of the vehicle in a crash. And they can strike others in the vehicle who are wearing safety belts.

Rear Seat Outside Passenger Positions

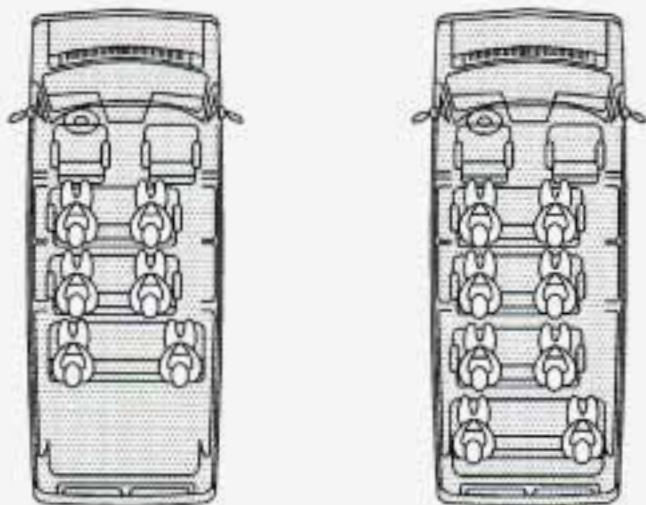

Lap-Shoulder Belt

The positions next to the windows have lap-shoulder belts. Here's how to wear one properly.



1. Pick up the latch plate and pull the belt across you. Don't let it get twisted.
2. Push the latch plate into the buckle until it clicks. Pull up on the latch plate to make sure it is secure. When the shoulder belt is pulled out all the way, it will lock. If it does, let it go back all the way and start again. If the belt is not long enough, see "Safety Belt Extender" at the end of this section.

Make sure the release button on the buckle is positioned so you would be able to unbuckle the safety belt quickly if you ever had to.



3. To make the lap part tight, pull down on the buckle end of the belt as you pull up on the shoulder part.

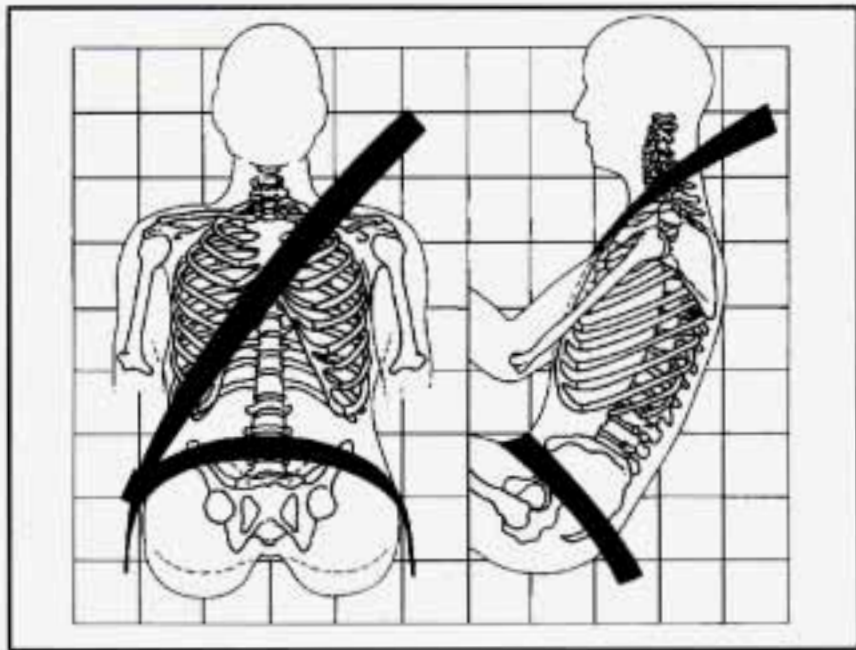

The lap part of the belt should be worn low and snug on the hips, just touching the thighs. In a crash, this applies force to the strong pelvic bones. And you'd be less likely to slide under the lap belt. If you slid under it, the belt would apply force at your abdomen. This could cause serious or even fatal injuries. The shoulder belt should go over the shoulder and across the chest. These parts of the body are best able to take belt restraining forces.

The safety belt locks if there's a sudden stop or a crash.

⚠ CAUTION:

You can be seriously hurt if your shoulder belt is too loose. In a crash, you would move forward too much, which could increase injury. The shoulder belt should fit against your body.



To unlatch the belt, just push the button on the buckle.

Center Passenger Position

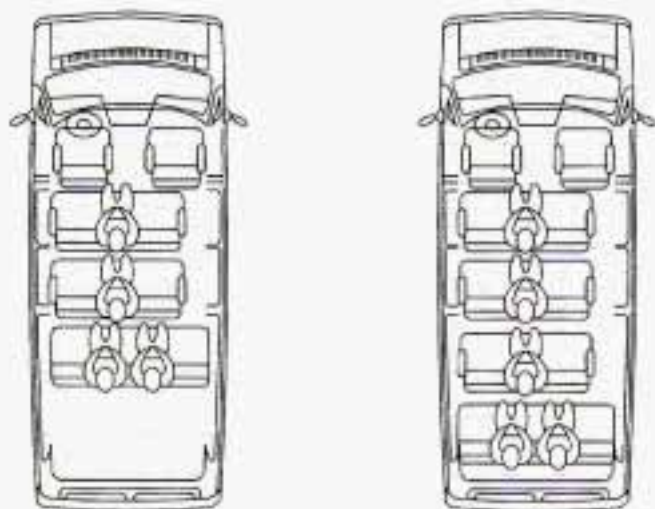

Lap Belt

If your vehicle has rear bench seats, someone can sit in the center positions.

When you sit in a center seating position, you have a lap safety belt, which has no retractor. To make the belt longer, tilt the latch plate and pull it along the belt.



To make the belt shorter, pull its free end as shown until the belt is snug.

Buckle, position and release it the same way as the lap part of a lap-shoulder belt. If the belt isn't long enough, see "Safety Belt Extender" at the end of this section.

Make sure the release button on the buckle is positioned so you would be able to unbuckle the safety belt quickly if you ever had to.

Children

Everyone in a vehicle needs protection! That includes infants and all children smaller than adult size. In fact, the law in every state in the United States and in every Canadian province says children up to some age must be restrained while in a vehicle.

Smaller Children and Babies (Except Cargo Vans with Passenger Air Bags)

CAUTION:

Smaller children and babies should always be restrained in a child or infant restraint. The instructions for the restraint will say whether it is the right type and size for your child. A very young child's hip bones are so small that a regular belt might not stay low on the hips, as it should. Instead, the belt will likely be over the child's abdomen. In a crash, the belt would apply force right on the child's abdomen, which could cause serious or fatal injuries. So, be sure that any child small enough for one is always properly restrained in a child or infant restraint.



⚠ CAUTION:

Never hold a baby in your arms while riding in a vehicle. A baby doesn't weigh much -- until a crash. During a crash a baby will become so

CAUTION: (Continued)

CAUTION: (Continued)

heavy you can't hold it. For example, in a crash at only 25 mph (40 km/h), a 12-lb. (5.5 kg) baby will suddenly become a 240-lb. (110 kg) force on your arms. The baby would be almost impossible to hold.

Secure the baby in an infant restraint.



Smaller Children and Babies (Cargo Vans with Passenger Air Bags)

CAUTION:

A very young child's hip bones are so small that a regular belt might not stay low on the hips, as it should. Instead, the belt will likely be over the child's abdomen. In a crash, the belt would apply force right on the child's abdomen, which could cause serious or fatal injuries. Smaller children and babies should always be restrained in a child restraint. However, infants, who should be restrained in a rear-facing child restraint, cannot ride safely in this vehicle. The instructions for the restraint will say whether it is the right type and size for your child. If a forward-facing child restraint is suitable for your child, be sure the child is always properly restrained while riding in this vehicle.



CAUTION:

Never hold a baby in your arms while riding in a vehicle. A baby doesn't weigh much -- until a crash. During a crash a baby will become so heavy you can't hold it. For example, in a crash

CAUTION: (Continued)

CAUTION: (Continued)

at only 25 mph (40 km/h), a 12-lb. (5.5 kg) baby will suddenly become a 240-lb. (110 kg) force on your arms. The baby would be almost impossible to hold.

Child Restraints

Be sure the child restraint is designed to be used in a vehicle. If it is, it will have a label saying that it meets Federal Motor Vehicle Safety Standards.

Then follow the instructions for the restraint. You may find these instructions on the restraint itself or in a booklet, or both. These restraints use the belt system in your vehicle, but the child also has to be secured within the restraint to help reduce the chance of personal injury. The instructions that come with the infant or child restraint will show you how to do that.

Where to Put the Restraint (Except Cargo Vans and Cab and Chassis Models)

Accident statistics show that children are safer if they are restrained in the rear rather than the front seat. We at General Motors therefore recommend that you put your child restraint in a rear seat. If your vehicle has a front

passenger air bag, *never* put a rear-facing child restraint in the front passenger seat. Here's why:

CAUTION:

A child in a rear-facing child restraint can be seriously injured if the right front passenger's air bag inflates. This is because the back of a rear-facing child restraint would be very close to the inflating air bag. If your vehicle has a right front passenger's air bag, always secure a rear-facing child restraint in a rear seat.

You may, however, secure a forward-facing child restraint in the right front seat. Before you secure a forward-facing child restraint, always move the front passenger seat as far back as it will go. Or, secure the child restraint in a rear seat.

Wherever you install it, be sure to secure the child restraint properly.

Keep in mind that an unsecured child restraint can move around in a collision or sudden stop and injure people in the vehicle. Be sure to properly secure any child restraint in your vehicle -- even when no child is in it.

Where to Put the Restraint (Cargo Vans and Cab and Chassis Models)

The child restraint must be secured properly in the passenger seat. If your vehicle has a passenger air bag, *never* put a rear-facing child restraint in this vehicle. Here's why:

CAUTION:

A child in a rear-facing child restraint can be seriously injured if the passenger's air bag inflates. This is because the back of a rear-facing child restraint would be very close to the inflating air bag. Do not use a rear-facing child restraint in this vehicle.

If a forward-facing child restraint is suitable for your child, always move the passenger seat as far back as it will go.

Keep in mind that an unsecured child restraint can move around in a collision or sudden stop and injure people in the vehicle. Be sure to properly secure any child restraint in your vehicle -- even when no child is in it.

Top Strap

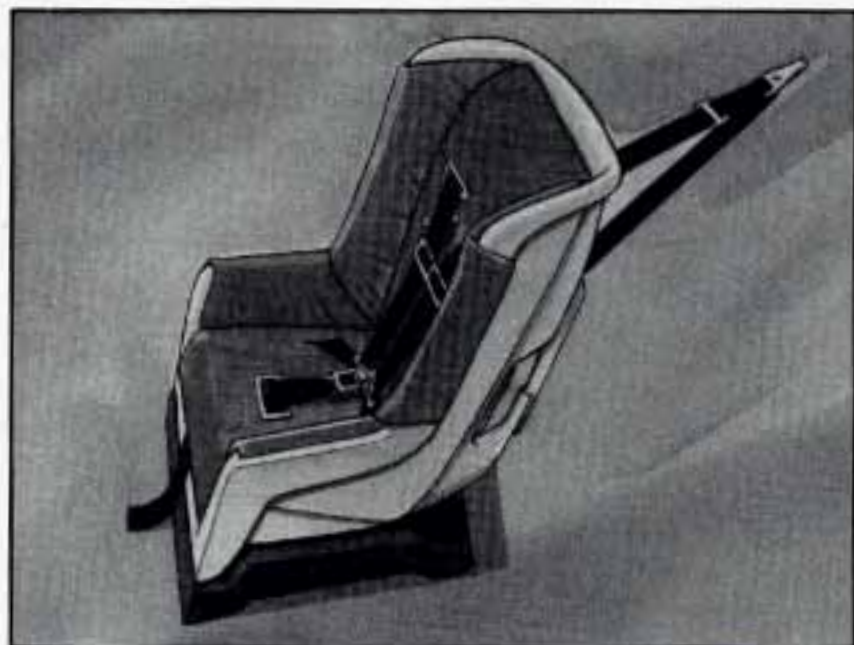

If your child restraint has a top strap, it should be anchored. If you need to have an anchor installed, you can ask your GM dealer to put it in for you. If you want to install an anchor yourself, your dealer can tell you how to do it.

Securing a Child Restraint in a Rear Outside Seat Position

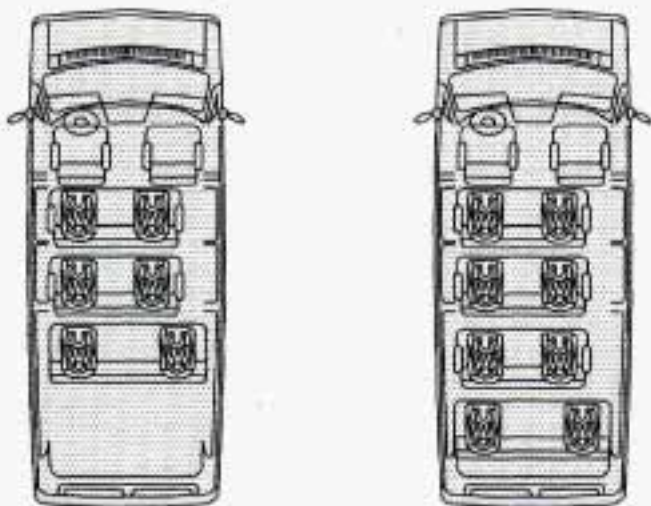

You'll be using the lap-shoulder belt. See the earlier part about the top strap if the child restraint has one.

1. Put the restraint on the seat. Follow the instructions for the child restraint.
2. Secure the child in the child restraint as the instructions say.
3. Pick up the latch plate, and run the lap and shoulder portions of the vehicle's safety belt through or

around the restraint. The child restraint instructions will show you how.

If the shoulder belt goes in front of the child's face or neck, put it behind the child restraint.



4. Buckle the belt. Make sure the release button is positioned so you would be able to unbuckle the safety belt quickly if you ever had to.



5. Pull the rest of the shoulder belt all the way out of the retractor to set the lock.



6. To tighten the belt, feed the shoulder belt back into the retractor while you push down on the child restraint.
7. Push and pull the child restraint in different directions to be sure it is secure.

To remove the child restraint, just unbuckle the vehicle's safety belt and let it go back all the way. The safety belt will move freely again and be ready to work for an adult or larger child passenger.

Securing a Child Restraint in a Center Seat Position

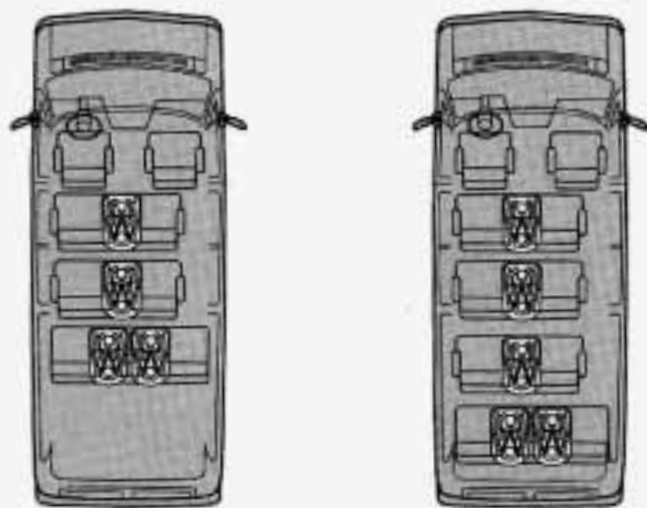

You'll be using the lap belt.

See the earlier part about the top strap if the child restraint has one.



1. Make the belt as long as possible by tilting the latch plate and pulling it along the belt.
2. Put the restraint on the seat. Follow the instructions for the child restraint.
3. Secure the child in the child restraint as the instructions say.

4. Run the vehicle's safety belt through or around the restraint. The child restraint instructions will show you how.



5. Buckle the belt. Make sure the release button is positioned so you would be able to unbuckle the safety belt quickly if you ever had to.
6. To tighten the belt, pull its free end while you push down on the child restraint.

7. Push and pull the child restraint in different directions to be sure it is secure. If it isn't, secure the restraint in a different place in the vehicle and contact the child restraint maker for their advice about how to attach the child restraint properly.

To remove the child restraint, just unbuckle the vehicle's safety belt. It will be ready to work for an adult or larger child passenger.

Securing a Child Restraint in the Right Front Seat Position

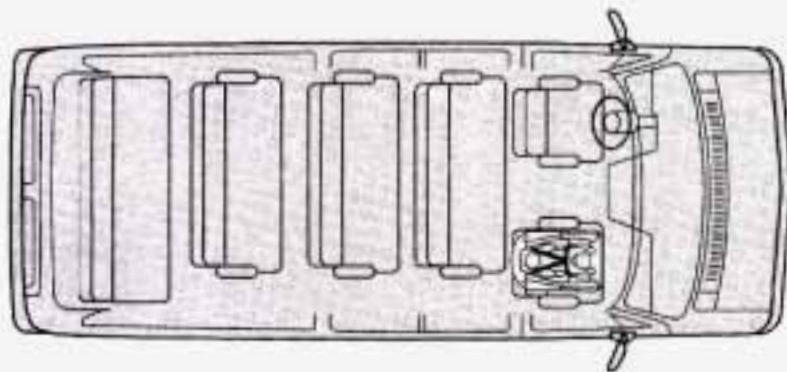

If your vehicle has a front passenger air bag, *never* put a rear-facing child restraint in this seat. Here's why:

 **CAUTION:**

A child in a rear-facing child restraint can be seriously injured if the front passenger's air bag inflates. This is because the back of a rear-facing child restraint would be very close to the inflating air bag. If your vehicle is a passenger van, always secure a rear-facing child restraint in a rear seat.

If your vehicle is a cargo van, do not use a rear-facing child restraint in this vehicle. If a forward-facing child restraint is suitable for your child, always move the passenger seat as far back as it will go.

You'll be using the lap-shoulder belt. See the earlier part about the top strap if the child restraint has one.

1. If your vehicle has a front passenger air bag, always move the seat as far back as it will go before securing a forward-facing child restraint. (See "Seats" in the Index.)
2. Put the restraint on the seat. Follow the instructions for the child restraint.
3. Secure the child in the child restraint as the instructions say.
4. Pick up the latch plate, and run the lap and shoulder portions of the vehicle's safety belt through or around the restraint. The child restraint instructions will show you how.

If the shoulder belt goes in front of the child's face or neck, put it behind the child restraint.



5. Buckle the belt. Make sure the release button is positioned so you would be able to unbuckle the safety belt quickly if you ever had to.



6. Pull the rest of the shoulder belt all the way out of the retractor to set the lock.



7. To tighten the belt, feed the shoulder belt back into the retractor while you push down on the child restraint.
8. Push and pull the child restraint in different directions to be sure it is secure.

To remove the child restraint, just unbuckle the vehicle's safety belt and let it go back all the way. The safety belt will move freely again and be ready to work for an adult or larger child passenger.

Larger Children



Children who have outgrown child restraints should wear the vehicle's safety belts.

If you have the choice, a child should sit next to a window so the child can wear a lap-shoulder belt and get the additional restraint a shoulder belt can provide.

Accident statistics show that children are safer if they are restrained in the rear seat. But they need to use the safety belts properly.

- Children who aren't buckled up can be thrown out in a crash.
- Children who aren't buckled up can strike other people who are.



⚠ CAUTION:

Never do this.

Here two children are wearing the same belt. The belt can't properly spread the impact forces. In a crash, the two children can be crushed together and seriously injured. A belt must be used by only one person at a time.

- Q:** What if a child is wearing a lap-shoulder belt, but the child is so small that the shoulder belt is very close to the child's face or neck?
- A:** Move the child toward the center of the vehicle, but be sure that the shoulder belt still is on the child's shoulder, so that in a crash the child's upper body would have the restraint that belts provide. If the child is so small that the shoulder belt is still very close to the child's face or neck, you might want to place the child in a seat that has a lap belt, if your vehicle has one.



⚠ CAUTION:

Never do this.

Here a child is sitting in a seat that has a lap-shoulder belt, but the shoulder part is behind the child. If the child wears the belt in this way, in a crash the child might slide under the belt. The belt's force would then be applied right on the child's abdomen. That could cause serious or fatal injuries.

Wherever the child sits, the lap portion of the belt should be worn low and snug on the hips, just touching the child's thighs. This applies belt force to the child's pelvic bones in a crash.

Safety Belt Extender

If the vehicle's safety belt will fasten around you, you should use it.

But if a safety belt isn't long enough to fasten, your dealer will order you an extender. It's free. When you go in to order it, take the heaviest coat you will wear, so the extender will be long enough for you. The extender will be just for you, and just for the seat in your vehicle that you choose. Don't let someone else use it, and use it only for the seat it is made to fit. To wear it, just attach it to the regular safety belt.

Checking Your Restraint Systems

Now and then, make sure the safety belt reminder light and all your belts, buckles, latch plates, retractors and anchorages are working properly. Look for any other loose or damaged safety belt system parts. If you see anything that might keep a safety belt system from doing its job, have it repaired.

Torn or frayed safety belts may not protect you in a crash. They can rip apart under impact forces. If a belt is torn or frayed, get a new one right away.

Also look for any opened or broken air bag covers, and have them repaired or replaced. (The air bag system does not need regular maintenance.)

Replacing Restraint System Parts After a Crash

If you've had a crash, do you need new belts?

After a very minor collision, nothing may be necessary. But if the belts were stretched, as they would be if worn during a more severe crash, then you need new belts.

If belts are cut or damaged, replace them. Collision damage also may mean you will need to have safety belt or seat parts repaired or replaced. New parts and repairs may be necessary even if the belt wasn't being used at the time of the collision.

If an air bag inflates, you'll need to replace air bag system parts. See the part on the air bag system earlier in this section.

NOTES

NOTES

Section 2 Features and Controls

Here you can learn about the many standard and optional features on your vehicle, and information on starting, shifting and braking. Also explained are the instrument panel and the warning systems that tell you if everything is working properly -- and what to do if you have a problem.

Keys

CAUTION:

Leaving young children in a vehicle with the ignition key is dangerous for many reasons. A child or others could be badly injured or even killed.

They could operate power windows or other controls or even make the vehicle move. Don't leave the keys in a vehicle with young children.





Your vehicle has one double-sided key for the ignition and all door locks.

If you ever lose your key, your dealer will be able to assist you with obtaining a new one.

The bar-coded tag has a code on it that tells your dealer or a qualified locksmith how to make extra keys. Keep this tag in a safe place. If you lose your key, you'll be able to have a new one made easily using this tag.

NOTICE:

Your vehicle has a number of new features that can help prevent theft. But you can have a lot of trouble getting into your vehicle if you ever lock your key inside. You may even have to damage your vehicle to get in. So be sure you have an extra key.

Door Locks

CAUTION:

Unlocked doors can be dangerous.

Passengers -- especially children -- can easily open the doors and fall out. When a door is locked, the inside handle won't open it.

Outsiders can easily enter through an unlocked door when you slow down or stop your vehicle.

This may not be so obvious: You increase the chance of being thrown out of the vehicle in a crash if the doors aren't locked. Wear safety belts properly, lock your doors, and you will be far better off whenever you drive your vehicle.

There are several ways to lock and unlock your vehicle. From the outside, use your key.



To lock the door from the inside, slide the lever on your door down.

To unlock the door, slide the lever up.

Power Door Locks (Option)



Press the bottom side of the power door lock switch to lock the doors at once.

When a door is locked, the inside door handle will not work.

Child Security Locks

Child security locks are located on the passenger side rear cargo door, the side sliding door or the front portion of the 60/40 side swing out door.



Rear Cargo Door

With this feature, you can lock these doors so they can't be opened from the inside by passengers.

Move the button down to engage the security feature. Move the button up to return the door locks to normal operation.



Side Sliding Door

Move the button to the left to engage the security feature. Move the button to the right to return the door locks to normal operation.

Keyless Entry System

If your vehicle has this option, you can lock and unlock your doors from up to 30 feet (9 m) away using the key chain transmitter supplied with your vehicle.

Your Keyless Entry System operates on a radio frequency subject to Federal Communications Commission (FCC) Rules.

This device complies with Part 15 of the FCC Rules. Operation is subject to the following two conditions: (1) This device may not cause harmful interference, and (2) This device must accept any interference received, including interference that may cause undesired operation.

Should interference to this system occur, try this:

- Check to determine if battery replacement is necessary. See the instructions on battery replacement.
- Check the distance. You may be too far from your vehicle. This product has a maximum range.
- Check the location. Other vehicles or objects may be blocking the signal.
- See your GM dealer or a qualified technician for service.

Changes or modifications to this system by other than an authorized service facility could void authorization to use this equipment.

Operation



To unlock the driver's door, press the UNLOCK button. If you press this button again within five seconds, all the doors will unlock. Press the REAR button to unlock the rear door only. When the UNLOCK or REAR button is pressed, the interior dome lamps are turned on for 40 seconds or until the ignition switch is activated.

Matching Transmitter(s) To Your Vehicle

Each key chain transmitter is coded to prevent another transmitter from unlocking your vehicle. If a transmitter is lost or stolen, a replacement can be purchased through your dealer. Remember to bring any remaining transmitters with you when you go to your dealer. When the dealer matches the replacement transmitter to your vehicle, any remaining transmitters must also be matched. Once the new transmitter is coded, the lost transmitter will not unlock your vehicle. Each vehicle can have only two transmitters matched to it.

Battery Replacement

Under normal use, the batteries in your key chain transmitter should last about two years.

You can tell the batteries are weak if the transmitter won't work at the normal range in any location. If you have to get close to your vehicle before the transmitter works, it's probably time to change the batteries.

Use two Duracell® type DL2016 batteries or a similar type. To replace the batteries:

1. Insert a dime in the side seam of the transmitter housing near the key ring hole.

2. Twist the dime to separate the two halves of the transmitter housing. Separate the housing, bottom half first.



3. Remove and replace the batteries. Put the new batteries in with the printed side down.
4. Align the halves of the housing and snap them together.

Your Doors and How They Work

Front Doors

To open the door from the outside, pull the handle and pull the door open.

To open the door from the inside, pull the lever toward you and push the door open.

60/40 Swing-Out Side Door

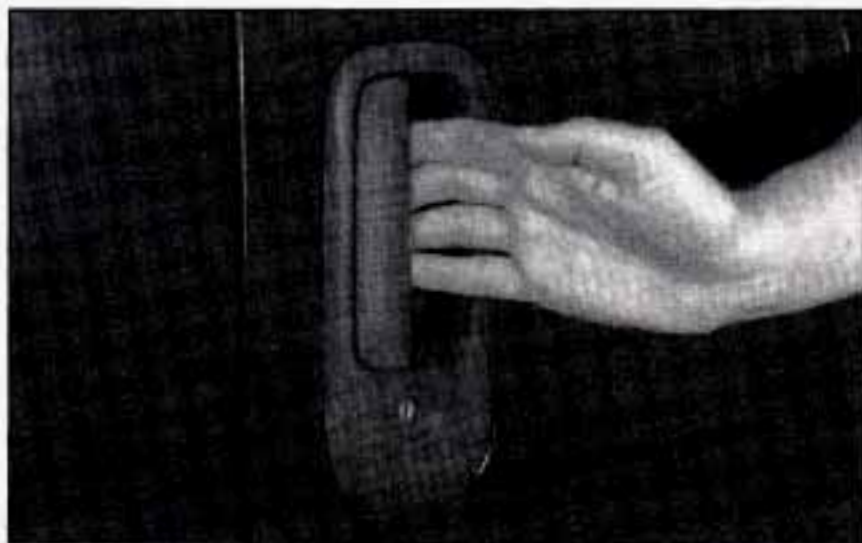

To open the "60" (front) portion of a 60/40 door from the outside, pull up on the handle and pull the handle toward you.



To open the "60" (front) portion of a 60/40 door from the inside, pull the handle toward you and push open the door.



To open the "40" (rear) portion of a 60/40 door from the outside, pull the handle on the side of the rear door and pull it toward you.

To close the side doors, close the "40" (rear) door first. Then close the "60" (front) door. Check to make sure both doors are completely closed.

The front side swing-out door has a check strap assembly in the door frame to keep the door from opening beyond 90 degrees.

To open the door beyond 90 degrees, close the door partially, pull the check strap outward at the spring hole and then open the door. When you close the door, the check strap will automatically re-engage.

Sliding Side Door (Option)



To open the sliding side door from outside, pull the handle toward the rear of the vehicle. Then, slide the door toward the rear of the vehicle to open.



To close the sliding side door from outside, use the outside door handle to slide the door toward the front of the vehicle.

When the door slides shut completely, it will be flush with the side of the body.



To open the sliding door from inside, pull the handle and slide the door toward the rear of the vehicle.



To close the sliding door from inside, grasp the inside handle and slide the door toward the front of the vehicle to a closed position.

Make sure the door is completely shut before driving your vehicle.

Rear Doors



To open the rear doors from the outside, open the passenger side rear door first. Pull the the handle toward you to open the door.

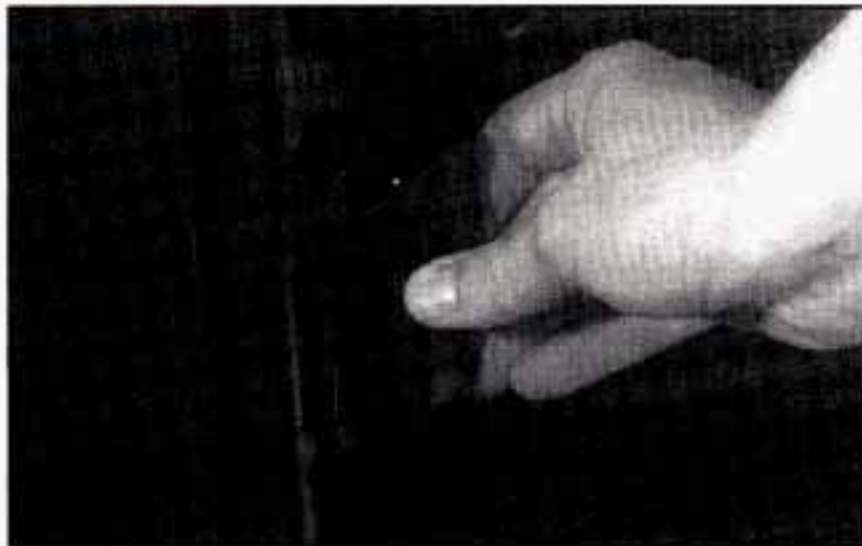

To open the driver side rear door, pull the latch release lever at the inside edge of the door.

Both rear doors can be opened past 90 degrees by opening the doors past the first detent (90 degrees open), then opening fully.

To close the rear doors, close the driver side rear door first. Then, close the passenger side rear door. Check to make sure both doors are completely closed.

CAUTION:

It can be dangerous to drive with the rear doors open because carbon monoxide (CO) gas can come into your vehicle. You can't see or smell CO. It can cause unconsciousness and even death.

If you must drive with the rear doors open or if electrical wiring or other cable connections must pass through the seal between the body and the rear doors:

- Make sure all windows are shut.
- Turn the fan on your heating or cooling system to its highest speed with the setting on VENT, HEAT, BLEND or DEF. Additionally, on vehicles with heating/air conditioning systems, NORM A/C or BI-LEV A/C can be used. That will force outside air into your vehicle. See "Comfort Controls" in the Index.
- If you have air outlets on or under the instrument panel, open them all the way. See "Engine Exhaust" in the Index.

Theft

Vehicle theft is big business, especially in some cities. Although your vehicle has a number of theft-deterrent features, we know that nothing we put on it can make it impossible to steal. However, there are ways you can help.

Key in the Ignition

If you leave your vehicle with the keys inside, it's an easy target for joy riders or professional thieves -- so don't do it.

When you park your vehicle and open the driver's door, you'll hear a tone reminding you to remove your key from the ignition and take it with you. Always do this. Your steering wheel will be locked, and so will your ignition and transmission. And remember to lock the doors.

Parking at Night

Park in a lighted spot, close all windows and lock your vehicle. Remember to keep your valuables out of sight. Put them in a storage area, or take them with you.

Parking Lots

If you park in a lot where someone will be watching your vehicle, it's best to lock it up and take your keys. But what if you have to leave your ignition key? What if you have to leave something valuable in your vehicle?

- Put your valuables in a storage area, like your glove box.
- Lock all the doors except the driver's.

New Vehicle “Break-In”

NOTICE:

Your modern vehicle doesn't need an elaborate “break-in.” But it will perform better in the long run if you follow these guidelines:

- Keep your speed at 55 mph (88 km/h) or less for the first 500 miles (804 km).
- Don't drive at any one speed -- fast or slow -- for the first 500 miles (804 km). Don't make full-throttle starts.
- Avoid making hard stops for the first 200 miles (322 km) or so. During this time your new brake linings aren't yet broken in. Hard stops with new linings can mean premature wear and earlier replacement. Follow this breaking-in guideline every time you get new brake linings.
- Don't tow a trailer during break-in. See “Towing a Trailer” in the Index for more information.

Ignition Switch

Your key lets you turn the ignition switch to five different positions.

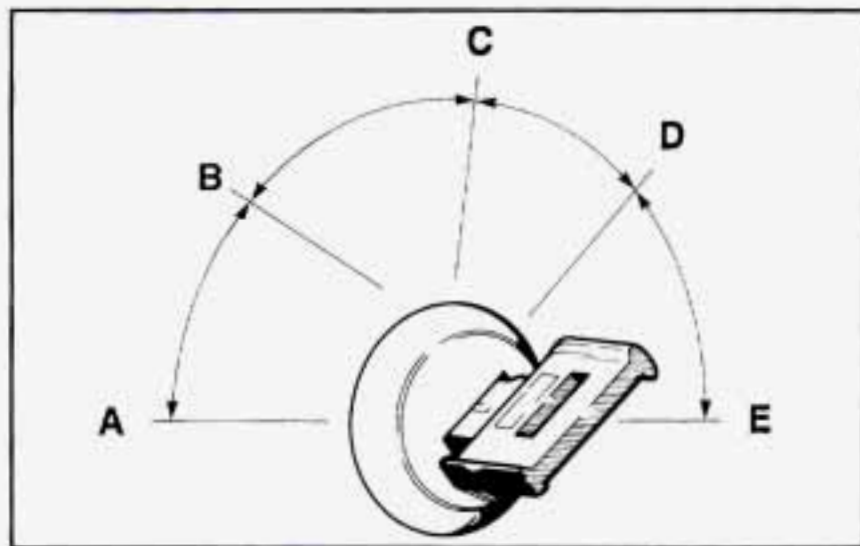

ACCESSORY (A): ACCESSORY lets you use things like the radio, power windows and the windshield wipers when the engine is off. To get into ACCESSORY, push in the key and turn it toward you. Your steering wheel will remain locked, just as it was before you inserted the key.

LOCK (B): This position locks your ignition, steering wheel and transmission. It's a theft-deterrent feature. You will only be able to remove your key when the ignition is turned to LOCK.

OFF (C): This position lets you turn off the engine but still turn the steering wheel. It doesn't lock the steering wheel like LOCK. Use OFF if you must have your vehicle in motion while the engine is off (for example, if your vehicle is being pushed).

RUN (D): This is the position for driving.

START (E): This starts your engine.

NOTICE:

If your key seems stuck in LOCK and you can't turn it, be sure it is all the way in. If it is, then turn the steering wheel left and right while you turn the key hard. But turn the key only with your hand. Using a tool to force it could break the key or the ignition switch. If none of this works, then your vehicle needs service.

Starting Your Gasoline Engine

If you have a diesel engine, see "Starting Your Diesel Engine" in the Diesel Engine Supplement.

Move your shift lever to PARK (P) or NEUTRAL (N). Your engine won't start in any other position -- that's a safety feature. To restart when you're already moving, use NEUTRAL (N) only.

NOTICE:

Don't try to shift to PARK (P) if your vehicle is moving. If you do, you could damage the transmission. Shift to PARK (P) only when your vehicle is stopped.

1. Without pushing the accelerator pedal, turn your ignition key to START. When the engine starts, let go of the key. The idle speed will go down as your engine gets warm.

NOTICE:

Holding your key in START for longer than 15 seconds at a time will cause your battery to be drained much sooner. And the excessive heat can damage your starter motor.

2. If it doesn't start right away, hold your key in START. If it doesn't start in 10 seconds, push the accelerator pedal all the way down for five more seconds, or until it starts.
3. If your engine still won't start (or starts but then stops), wait 15 seconds and start over.

When the engine starts, let go of the key and the accelerator pedal.

NOTICE:

Your engine is designed to work with the electronics in your vehicle. If you add electrical parts or accessories, you could change the way the engine operates. Before adding electrical equipment, check with your dealer. If you don't, your engine might not perform properly.

If you ever have to have your vehicle towed, see the part of this manual that tells how to do it without damaging your vehicle. See "Towing Your Vehicle" in the Index.

Engine Coolant Heater (Option)



In very cold weather, 0°F (-18°C) or colder, the engine coolant heater can help. You'll get easier starting and better fuel economy during engine warm-up. Usually, the coolant heater should be plugged in a minimum of four hours prior to starting your vehicle.

To use the coolant heater:

1. Turn off the engine.
2. Open the hood and unwrap the electrical cord.
3. Plug it into a normal, grounded 110-volt AC outlet.

CAUTION:

Plugging the cord into an ungrounded outlet could cause an electrical shock. Also, the wrong kind of extension cord could overheat and cause a fire. You could be seriously injured. Plug the cord into a properly grounded three-prong 110-volt AC outlet. If the cord won't reach, use a heavy-duty three-prong extension cord rated for at least 15 amps.

4. After you've used the coolant heater, be sure to store the cord as it was before to keep it away from moving engine parts. If you don't, it could be damaged.

How long should you keep the coolant heater plugged in? The answer depends on the outside temperature, the kind of oil you have, and some other things. Instead of trying to list everything here, we ask that you contact a GM dealer in the area where you'll be parking your vehicle. The dealer can give you the best advice for that particular area.

Automatic Transmission Operation

There are several different positions for your shift lever.

If your vehicle is equipped with an automatic transmission, it now features an electronic shift position indicator within the instrument cluster. This display must be powered anytime the shift lever is capable of being moved out of the PARK (P) position. This means that if your key is in the OFF position, but not locked, there will be a small current drain on your battery which could discharge your battery over a period of time. If you have a need to leave your key in the ignition in the OFF position for an extended period for any reason, it is recommended that you disconnect the battery cable from the battery to prevent discharging your battery.

PARK (P): This locks your rear wheels. It's the best position to use when you start your engine because your vehicle can't move easily.



CAUTION:

It is dangerous to get out of your vehicle if the shift lever is not fully in PARK (P) with the parking brake firmly set. Your vehicle can roll. Don't leave your vehicle when the engine is running unless you have to. If you have left the engine running, the vehicle can move suddenly. You or others could be injured. To be sure your vehicle won't move, even when you're on fairly level ground, always set your parking brake and move the shift lever to PARK (P).

See "Shifting Into PARK (P)" in the Index. If you're pulling a trailer, see "Towing a Trailer" in the Index.

Your vehicle has a brake-transmission shift interlock. With the ignition in the RUN position, you must fully apply your regular brakes before you can shift from PARK (P).

If you cannot shift out of PARK (P), ease pressure on the shift lever and push the shift lever all the way into PARK (P) as you continue pressing the brake pedal. Then move the shift lever into the gear you want. If you still cannot shift the shift lever out of PARK (P), see “Shifting Out of PARK (P)” later in this section.

REVERSE (R): Use this gear to back up.

NOTICE:

Shifting into REVERSE (R) while your vehicle is moving forward could damage your transmission. Shift to REVERSE (R) only after your vehicle is stopped.

To rock your vehicle back and forth to get out of snow, ice or sand without damaging your transmission, see “Stuck: In Sand, Mud, Ice or Snow” in the Index.

NEUTRAL (N): In this position, your engine doesn't connect with the wheels. To restart when you're already moving, use NEUTRAL (N) only. Also, use NEUTRAL (N) when your vehicle is being towed.



CAUTION:

Shifting out of PARK (P) or NEUTRAL (N) while your engine is “racing” (running at high speed) is dangerous. Unless your foot is firmly on the brake pedal, your vehicle could move very rapidly. You could lose control and hit people or objects. Don't shift out of PARK (P) or NEUTRAL (N) while your engine is racing.

NOTICE:

Damage to your transmission caused by shifting out of PARK (P) or NEUTRAL (N) with the engine racing isn't covered by your warranty.

DRIVE (D): This position is for normal driving. If you need more power for passing, and you're:

- Going less than about 35 mph (56 km/h), push your accelerator pedal about halfway down.
- Going about 35 mph (56 km/h) or more, push the accelerator all the way down.

You'll shift down to the next gear and have more power.

You should use DRIVE (D) (or, as you need to, a lower gear) when towing a trailer. Operating your vehicle in DRIVE (D) when towing a trailer will minimize heat build-up and extend the life of your transmission.

THIRD (3): This position is also used for normal driving, however, it offers more power and lower fuel economy than DRIVE (D). You should use THIRD (3) when carrying a heavy load or driving on steep hills.

SECOND (2): This position gives you more power but lower fuel economy. You can use SECOND (2) on hills. It can help control your speed as you go down steep mountain roads, but then you would also want to use your brakes off and on. If you manually select SECOND (2), the transmission will drive in second gear. You may use this feature for reducing torque to the rear wheels when you are trying to start your vehicle from a stop on slippery road surfaces.

FIRST (1): This position gives you even more power (but lower fuel economy) than SECOND (2). You can use it on very steep hills, or in deep snow or mud. If the selector lever is put in FIRST (1), the transmission won't shift into first gear until the vehicle is going slowly enough.

NOTICE:

If your rear wheels can't rotate, don't try to drive. This might happen if you are stuck in very deep sand or mud or are up against a solid object. You could damage your transmission. Also, if you stop when going uphill, don't hold your vehicle there with only the accelerator pedal. This could overheat and damage the transmission. Use your brakes or shift into PARK (P) to hold your vehicle in position on a hill.

Locking Rear Axle

If you have this feature, your rear axle can give you additional traction on snow, mud, ice, sand or gravel. It works like a standard axle most of the time, but when one of the rear wheels has no traction and the other does, the locking feature will allow the wheel with traction to move the vehicle.

Parking Brake

To set the parking brake, hold the regular brake pedal down with your right foot. Push down the parking brake pedal with your left foot.

If the ignition is on, the brake system warning light will come on.



To release the parking brake, hold the regular brake pedal down. Pull the handle, located just above the parking brake pedal, marked BRAKE RELEASE to release the parking brake.

If the ignition is on when the parking brake is released, the brake system warning light will go off.

NOTICE:

Driving with the parking brake on can cause your rear brakes to overheat. You may have to replace them, and you could also damage other parts of your vehicle. Always check to be sure your parking brake is fully released before you drive.

If you are towing a trailer and are parking on any hill, see “Towing a Trailer” in the Index. That section shows what to do first to keep the trailer from moving.

Shifting Into PARK (P)



CAUTION:

It can be dangerous to get out of your vehicle if the shift lever is not fully in PARK (P) with the parking brake firmly set. Your vehicle can roll. If you have left the engine running, the vehicle can move suddenly. You or others could be injured. To be sure your vehicle won't move, even when you're on fairly level ground, use the steps that follow. If you're pulling a trailer, see “Towing a Trailer” in the Index.

1. Hold the brake pedal down with your right foot and set the parking brake.

2. Move the shift lever into PARK (P) position like this:

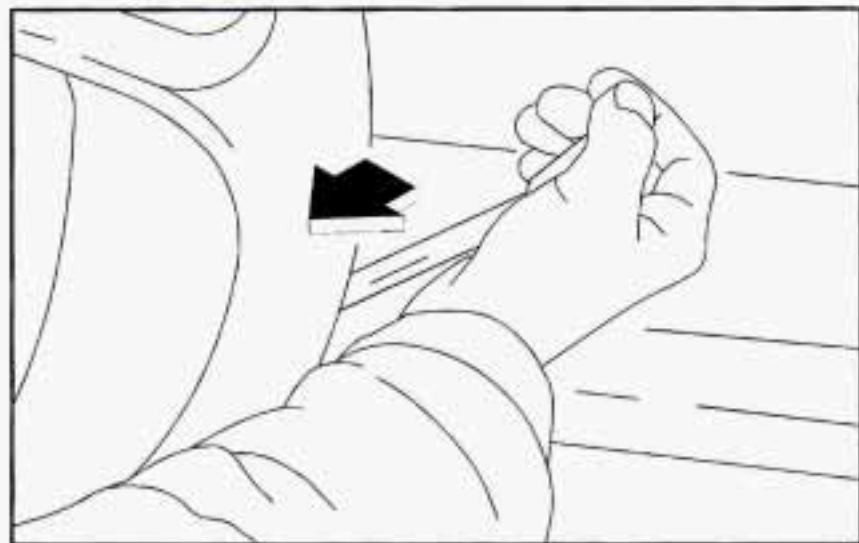

- Pull the lever toward you.

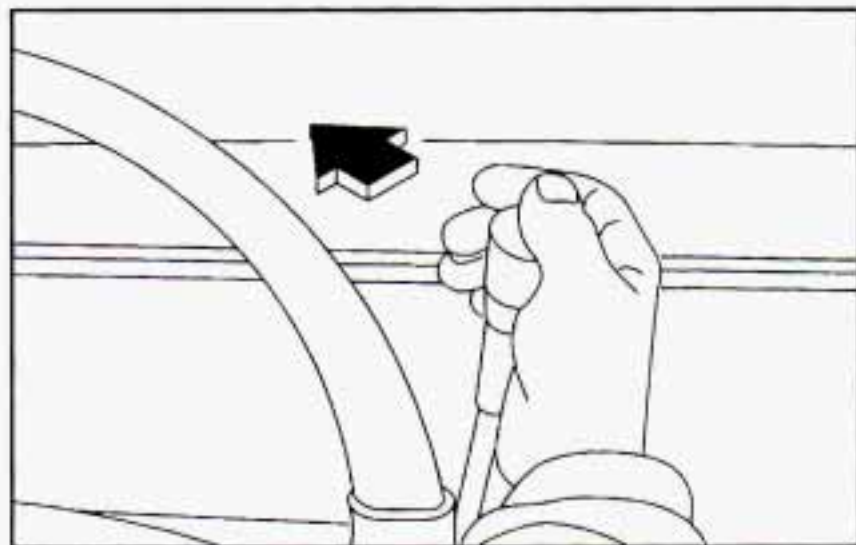

- Move the lever up as far as it will go.
3. Move the ignition key to LOCK.
 4. Remove the key and take it with you. If you can leave your vehicle with the ignition key in your hand, your vehicle is in PARK (P).

Leaving Your Vehicle With the Engine Running

CAUTION:

It can be dangerous to leave your vehicle with the engine running. Your vehicle could move suddenly if the shift lever is not fully in PARK (P) with the parking brake firmly set. And, if you leave the vehicle with the engine running, it could overheat and even catch fire. You or others could be injured. Don't leave your vehicle with the engine running unless you have to.

Torque Lock

If you are parking on a hill and you don't shift your transmission into PARK (P) properly, the weight of the vehicle may put too much force on the parking pawl in the transmission. You may find it difficult to pull the shift lever out of PARK (P). This is called "torque lock." To prevent torque lock, set the parking brake and then shift into PARK (P) properly before you leave the driver's seat. To find out how, see "Shifting Into PARK (P)" in the Index.

When you are ready to drive, move the shift lever out of PARK (P) *before* you release the parking brake.

If torque lock does occur, you may need to have another vehicle push yours a little uphill to take some of the pressure from the transmission, so you can pull the shift lever out of PARK (P).

Shifting Out of PARK (P)

Your vehicle has a brake-transmission shift interlock system. You have to fully apply your regular brakes before you can shift from PARK (P). See "Automatic Transmission" in the Index.

If you cannot shift out of PARK (P), ease pressure on the shift lever and push the shift lever all the way up into PARK (P) as you maintain brake application. Then, move the shift lever into the gear you want.

If you ever hold the brake pedal down but still can't shift out of PARK (P), try this:

1. Turn the key to OFF.
2. Apply and hold the brake until the end of Step 4.
3. Shift to NEUTRAL (N).
4. Start the vehicle and then shift to the drive gear you want.
5. Have the brake-transmission shift interlock system fixed as soon as you can.

Parking Over Things That Burn



CAUTION:

Things that can burn could touch hot exhaust parts under your vehicle and ignite. Don't park over papers, leaves, dry grass or other things that can burn.

Engine Exhaust

CAUTION:

Engine exhaust can kill. It contains the gas carbon monoxide (CO), which you can't see or smell. It can cause unconsciousness and death.

You might have exhaust coming in if:

- Your exhaust system sounds strange or different.
- Your vehicle gets rusty underneath.
- Your vehicle was damaged in a collision.
- Your vehicle was damaged when driving over high points on the road or over road debris.
- Repairs weren't done correctly.
- Your vehicle or exhaust system had been modified improperly.

If you ever suspect exhaust is coming into your vehicle:

- Drive it only with all the windows down to blow out any CO; and
- Have your vehicle fixed immediately.

Running Your Engine While You're Parked

It's better not to park with the engine running. But if you ever have to, here are some things to know.

CAUTION:

Idling the engine with the air system control off could allow dangerous exhaust into your vehicle (see the earlier Caution under "Engine Exhaust").

Also, idling in a closed-in place can let deadly carbon monoxide (CO) into your vehicle even if the fan switch is at the highest setting. One place this can happen is a garage. Exhaust -- with CO -- can come in easily. **NEVER** park in a garage with the engine running.

Another closed-in place can be a blizzard. (See "Blizzard" in the Index.)

CAUTION:

It can be dangerous to get out of your vehicle if the shift lever is not fully in PARK (P) with the parking brake firmly set. Your vehicle can roll. Don't leave your vehicle when the engine is running unless you have to. If you've left the engine running, the vehicle can move suddenly. You or others could be injured. To be sure your vehicle won't move, even when you're on fairly level ground, always set your parking brake and move the shift lever to PARK (P).

Follow the proper steps to be sure your vehicle won't move. See "Shifting Into PARK (P)" in the Index.

If you're pulling a trailer, see "Towing a Trailer" in the Index.

Windows

Manual Windows

To operate your manual windows, turn the hand crank on each door to raise or lower your side door windows.

Power Windows



If you have the optional power windows, the controls are on each of the side doors.

The driver's door has a switch for the passenger window as well. Your power windows will work when the ignition has been turned to the RUN position.

Push the rear of the switch with the power window symbol on it to lower the window.

Push the front of the switch with the power window symbol on it to raise the window.

The driver's window switch also has an express-down feature that allows the window to lower without holding the switch. Press and hold the side of the window switch marked AUTO for one second to activate the express-down mode. The express-down mode can be cancelled at any time by pressing the opposite side of the switch. To open the window part way, lightly tap the switch until the window is at the desired position.

Swing-Out Windows

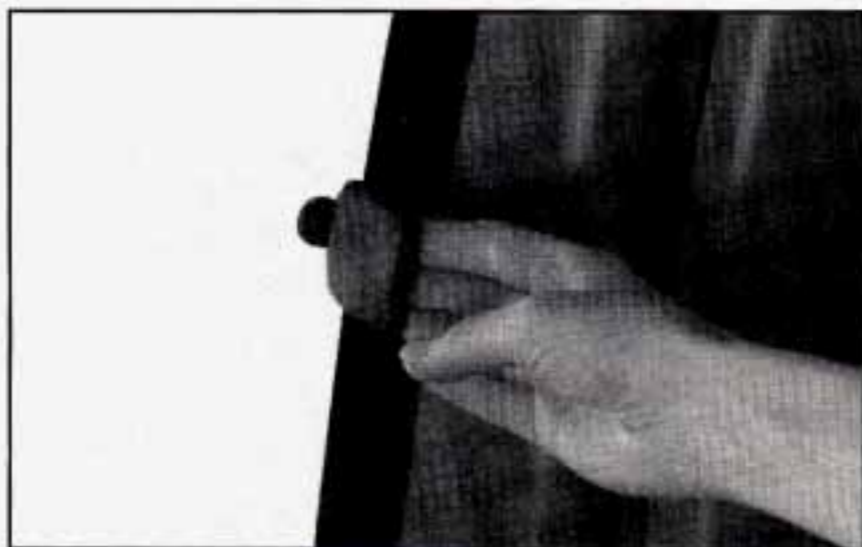

Side Swing-Out Window

To open your side door swing-out windows, pull out the latch at the edge of the window, swing the window out and push down the latch into the locked open position.



Rear Swing-Out Window

To close the window, pull the latch toward you and push down on the latch to lock it. Your rear swing-out windows work the same way, but the latch is at the bottom edge of the window.

CAUTION:

It can be dangerous to drive with the rear swing-out windows or rear door(s) open because carbon monoxide (CO) gas can come into your vehicle. You can't see or smell CO. It can cause unconsciousness and even death.

If you must drive with the rear swing-out windows or rear door(s) open or if electrical wiring or other cable connections must pass through the seal between the body and the rear swing-out windows or rear door(s):

- Make sure all windows are shut.

CAUTION: (Continued)

CAUTION: (Continued)

- Turn the fan on your heating or cooling system to its highest speed with the setting on VENT, HEAT, BLEND or DEF. Additionally, on vehicles with heating/air conditioning systems, NORM A/C or BI-LEV A/C can be used. That will force outside air into your vehicle. See "Comfort Controls" in the Index.
- If you have air outlets on or under the instrument panel, open them all the way. See "Engine Exhaust" in the Index.

Horn

Press one of the horn buttons at each side of the steering wheel to sound the horn.

Tilt Wheel (Option)

A tilt steering wheel allows you to adjust the steering wheel before you drive. You can also raise it to the highest level to give your legs more room when you enter and exit the vehicle.



To tilt the wheel, hold the steering wheel and pull the lever. Move the steering wheel to a comfortable level, then release the lever to lock the wheel in place.

Turn Signal/Multifunction Lever

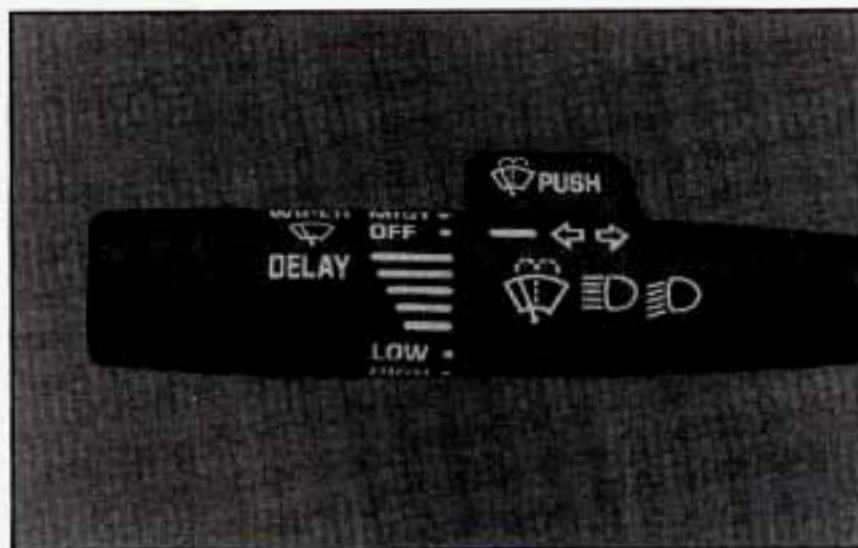

The lever on the left side of the steering column includes your:

- Turn Signal and Lane Changer
- Headlamp High/Low Beam Changer
- Windshield Wipers
- Windshield Washer
- Cruise Control (Option)

Turn Signal and Lane Change Signals

The turn signal has two upward (for right) and two downward (for left) positions. These positions allow you to signal a turn or a lane change.

To signal a turn, move the lever all the way up or down. When the turn is finished, the lever will return automatically.

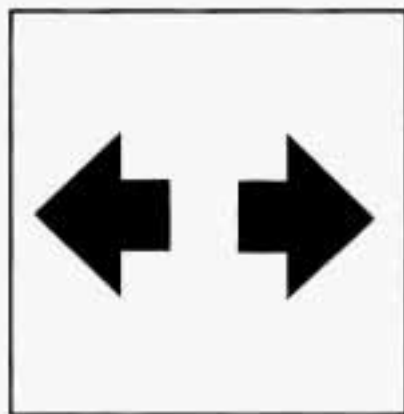

An arrow on the instrument panel will flash in the direction of the turn or lane change.

To signal a lane change, just raise or lower the lever until the arrow starts to flash. Hold it there until you complete your lane change. The lever will return by itself when you release it.

As you signal a turn or a lane change, if the arrows flash at twice the normal rate, a signal bulb may be burned out and other drivers may not see your turn signal.

If a bulb is burned out, replace it to help avoid an accident. If the arrows don't go on at all when you signal a turn, check for burned-out bulbs and a blown fuse (see "Fuses and Circuit Breakers" in the Index).

Headlamp High/Low Beam Changer

To change the headlamps from low beam to high or high to low, pull the multifunction lever all the way toward you. Then release it.

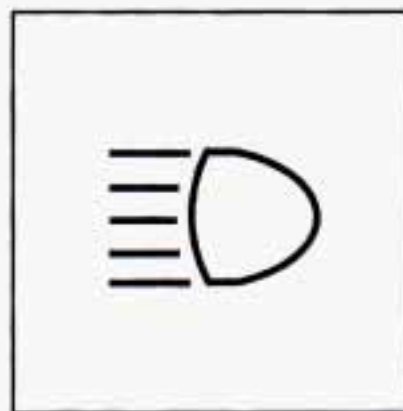

When the high beams are on, this light on the instrument panel also will be on.

Windshield Wipers



You control the windshield wipers by turning the band with the wiper symbol on it.

For a single wiping cycle, turn the band to MIST. Hold it there until the wipers start, then let go. The wipers will stop after one cycle. If you want more cycles, hold the band on MIST longer.

You can set the wiper speed for a long or short delay between wipes. This can be very useful in light rain or snow. Turn the band to choose the delay time. The closer to LOW, the shorter the delay.

For steady wiping at low speed, turn the band to the LOW position. For high-speed wiping, turn the band further, to HIGH. To stop the wipers, move the band to OFF.

Remember that damaged wiper blades may prevent you from seeing well enough to drive safely. To avoid damage, be sure to clear ice and snow from the wiper blades before using them. If they are frozen to the windshield, carefully loosen or thaw them. If your blades do become damaged, get new blades or blade inserts.

Heavy snow or ice can overload your wipers. The windshield wiper motor is protected from overload by a circuit breaker and a fuse. If the motor overheats due to heavy snow, etc., the wiper will stop until the motor cools. Although the circuit is protected from electrical overload, overload due to heavy snow, etc. may cause wiper linkage damage. Always clear ice and heavy snow from the windshield before using your windshield wipers.

Windshield Washer

At the top of the lever, there's a paddle with the word PUSH on it. To spray washer fluid on the windshield, push the paddle.

Washer fluid will spray as long as you push the paddle. When you let go of the paddle, the wipers will continue to wipe for approximately two more wipe cycles and then either stop or return to the preset speed.

Driving without washer fluid can be dangerous. A bad mud splash can block your vision. You could hit another vehicle or go off the road. Check your washer fluid level often.

CAUTION:

In freezing weather, don't use your washer until the windshield is warmed. Otherwise the washer fluid can form ice on the windshield, blocking your vision.

Cruise Control (Option)

With cruise control, you can maintain a speed of about 25 mph (40 km/h) or more without keeping your foot on the accelerator. This can really help on long trips. Cruise control does not work at speeds below about 25 mph (40 km/h).

When you apply your brakes, the cruise control shuts off.

CAUTION:

- **Cruise control can be dangerous where you can't drive safely at a steady speed. So, don't use your cruise control on winding roads or in heavy traffic.**
- **Cruise control can be dangerous on slippery roads. On such roads, fast changes in tire traction can cause needless wheel spinning, and you could lose control. Don't use cruise control on slippery roads.**

Setting Cruise Control

CAUTION:

If you leave your cruise control switch on when you're not using cruise, you might hit a button and go into cruise when you don't want to. You could be startled and even lose control. Keep the cruise control switch OFF until you want to use it.

1. Move the cruise control switch to ON.
2. Get up to the speed you want.
3. Press in the SET button at the end of the lever and release it.



4. Take your foot off the accelerator pedal.

Resuming a Set Speed

Suppose you set your cruise control at a desired speed and then you apply the brake. This, of course, shuts off the cruise control. But you don't need to reset it.

Once you're going about 25 mph (40 km/h) or more, you can move the cruise control switch from ON to R/A (Resume/Accelerate) for about half a second.

You'll go right back up to your chosen speed and stay there.

Remember, if you hold the switch at R/A longer than half a second, the vehicle will keep going faster until you release the switch or apply the brake. You could be startled and even lose control. So unless you want to go faster, don't hold the switch at R/A.

Increasing Speed While Using Cruise Control

There are two ways to go to a higher speed:

- Use the accelerator pedal to get to the higher speed. Push the button at the end of the lever, then release the button and the accelerator pedal. You'll now cruise at the higher speed.
- Move the cruise switch from ON to R/A. Hold it there until you get up to the speed you want, and then release the switch. To increase your speed in very small amounts, move the switch to R/A for less than half a second. Each time you do this, your vehicle will go about 1 mph (1.6 km/h) faster.

Reducing Speed While Using Cruise Control

There are two ways to reduce your speed while using cruise control:

- Push in the button at the end of the lever until you reach the lower speed you want, then release it.
- To slow down in very small amounts, push the button for less than half a second. Each time you do this, you'll go 1 mph (1.6 km/h) slower.

Passing Another Vehicle While Using Cruise Control

Use the accelerator pedal to increase your speed. When you take your foot off the pedal, your vehicle will slow down to the cruise control speed you set earlier.

Using Cruise Control on Hills

How well your cruise control will work on hills depends upon your speed, load and the steepness of the hills. When going up steep hills, you may have to step on the accelerator pedal to maintain your speed. If the steepness of the hill causes the vehicle speed to drop more than 15 mph (9.4 km/h) below the set speed, your cruise control will automatically disengage. When going downhill, you may have to brake or shift to a lower gear to keep your speed down. Of course, applying the brake takes you out of cruise control. Many drivers find this to be too much trouble and don't use cruise control on steep hills.

Ending Cruise Control

There are two ways to turn off the cruise control:

- Step lightly on the brake pedal; or
- Move the cruise switch to OFF.

Erasing Speed Memory

When you turn off the cruise control or the ignition, your cruise control set speed memory is erased.

Lamps



Your parking/headlamp switch is on the driver's side of your instrument panel.

Your instrument panel dimmer wheel has two detent positions.

When the wheel is turned to full brightness, and then into the first detent position, the radio display and PRNDL display will go to the day mode (full intensity). This is known as "parade" mode. The rest of the I/P illumination will stay in the maximum dimming state (full brightness dimming). Turning the wheel up one more detent will activate the interior dome light circuit (with slightly higher effort).

Rotate the switch knob clockwise to the parking lamp symbol to turn on:

- Parking Lamps
- Sidemarker Lamps
- Taillamps
- License Plate Lamps
- Instrument Panel Lights
- Ashtray Lamp
- Glove Box Lamp

Rotate the switch knob clockwise again to the master lighting symbol to turn on all the lamps listed as well as the headlamps.

Rotate the switch counterclockwise to OFF to turn off your lamps.

Rotate the thumb wheel next to the switch knob up to adjust instrument panel lights. Rotate the thumb wheel up to the first notch to return the radio display and gearshift indicator display to full intensity when the headlamps or parking lamps are on.

Rotate the thumb wheel up to the second notch to activate the interior dome lamps.

You can switch your headlamps from high to low beam by pulling on the turn signal/high beam lever.

A circuit breaker protects your headlamps. If you have an electrical overload, your headlamps will flicker on and off. Have your headlamp wiring checked right away if this happens.

Headlamps On Reminder

A buzzer will sound when your headlamps are turned on and your ignition is in OFF, LOCK or ACCESSORY. If you need to use your headlamps when the ignition switch is in OFF, LOCK or ACCESSORY, the buzzer can be turned off by turning the thumb wheel next to the parking lamp/headlamp switch all the way down.

Daytime Running Lamps (If Equipped)

Daytime Running Lamps (DRL) can make it easier for others to see the front of your vehicle during the day. DRL can be helpful in many different driving conditions, but they can be especially helpful in the short periods after dawn and before sunset.

The DRL system will make your headlamps come on at a reduced brightness when:

- The ignition is on,
- The headlamp switch is off and
- The parking brake is released.

If your vehicle was first sold, when new, in Canada, your headlamps will come on at reduced brightness.

If your vehicle was first sold, when new, in the United States, your vehicle may be equipped with DRL. If your vehicle has DRL, you will see the the DRL indicator light on your instrument panel and your low-beam headlamps will come on at reduced brightness.

When the DRL are on, only your headlamps will be on. The taillamps, sidemarker and other lamps won't be on. Your instrument panel won't be lit up either.

When it begins to get dark, your DRL indicator light is a reminder to turn your headlamp switch on. The other lamps that come on with your headlamps will also come on.

When you turn off the headlamp switch, the regular lamps will go off, and your headlamps will change to the reduced brightness of DRL.

To idle your vehicle with the engine on and the DRL off, set the parking brake. The DRL will stay off until you release the parking brake.

As with any vehicle, you should turn on the regular headlamp system when you need it.

Dome Lamps

The dome lamps will come on when you open the doors.

You can also turn the dome lamps on by rotating the thumb wheel, located next to the headlamp knob, all the way up to the second notch. In this position, the dome lamps will remain on whether the doors are opened or closed.



You can use the dome lamp button, located below the headlamp knob, to set the dome lamps to automatically come on when the doors are open, or to remain off.

To turn the lamps off, push the button once. With the button in this position, the dome lamps will remain off when the doors are open. To return the lamps to automatic operation, push the button again and return it to the out position. With the button in this position, the dome lamps will come on when you open the doors.

The delayed entry will allow you to enter or exit your vehicle with the lamps staying on for about 20 seconds, after the door is closed or ignition is cycled.

Reading Lamps (Option)



If your vehicle has reading lamps, press the button next to the lamp to turn the lamp on.

Press the button again to turn the lamp off.

Underhood Reel Lamp (Option)



If you have an underhood reel lamp, it is located on the passenger side of the engine compartment. The lamp can be switched on without unreeling the cord. Also, you can use it as a flashlight.



To use the lamp as a flashlight, pull down on the lever located under the lamp, unlocking the lamp and pull the lamp out. The cord will unreel as you pull the lamp.

When you are done using the lamp, reel the cord back into the housing by turning the handle.

Then, slide the lamp into the holder and press the lever marked **PUSH** at the bottom of the holder to lock into place.

Mirrors

Inside Mirror

Push or pull the tab under the mirror to reduce glare from headlamps behind you after dark.

Outside Mirrors

Adjust your outside mirrors so you can just see the side of your vehicle, and have a clear view of objects behind you. Some mirrors can be folded in to enter narrow doorways.

Electric Outside Rearview Mirrors (Option)

If you have electric mirrors, they can be adjusted to point where you want from inside the vehicle.



Select the mirror you want to move by rotating the switch counterclockwise to adjust the passenger side mirror and clockwise to adjust the driver side mirror. The center position is neutral.

Then, adjust the mirror angle by pressing the outer arrows on the switch until the mirror is adjusted where you want it.



Your electric outside rearview mirrors can be defrosted by pressing the switch next to the heater controls. (See "Comfort Controls" in the Index.)

Convex Outside Mirror

Your passenger's side mirror is convex. A convex mirror's surface is curved so you can see more from the driver's seat.

CAUTION:

A convex mirror can make things (like other vehicles) look farther away than they really are. If you cut too sharply into the right lane, you could hit a vehicle on your right. Check your inside mirror or glance over your shoulder before changing lanes.

Storage Compartments



Your front storage compartment is at the center of the instrument panel extension, by the floor. To open the compartment, squeeze and pull the handle at the top.

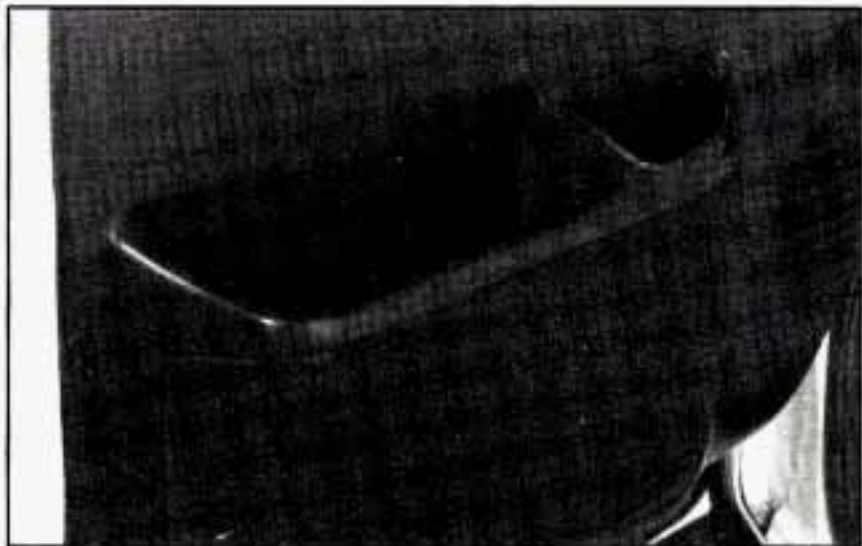

Storage compartments may also be included on the inside of each front door.

Sun Visors

To block out glare, you can swing down the visors. You can also swing them from side to side. Your visors have elastic straps you can use to hold items such as maps.

Visor Vanity Mirror (Option)

Some visors have illuminated mirrors on them. Pull the visor down and lift the mirror cover (if there is one), to use the mirror.

Cigarette Lighter/Ashtrays

The front ashtray is located in the instrument panel extension, at the center of the instrument panel. Lift up on the ashtray door to open it.

NOTICE:

Papers and other things that burn into your ashtrays could be set on fire by cigarettes or other smoking materials. That could cause a fire and possibly damage your vehicle. Do not store papers and other things that burn in your ashtrays.

To use the cigarette lighter, push it in all the way, and let go. When it's ready, it will pop back by itself.

NOTICE:

Holding a cigarette lighter in with your hand while it is heating can make it overload, damaging the lighter and the heating element. Just push the lighter all the way in and let go. When it's done, it will pop back by itself.

To remove the front ashtray, pull up on the tab with a key or screw driver inserted in the tab, and lift the ashtray out.

Instrument Panel

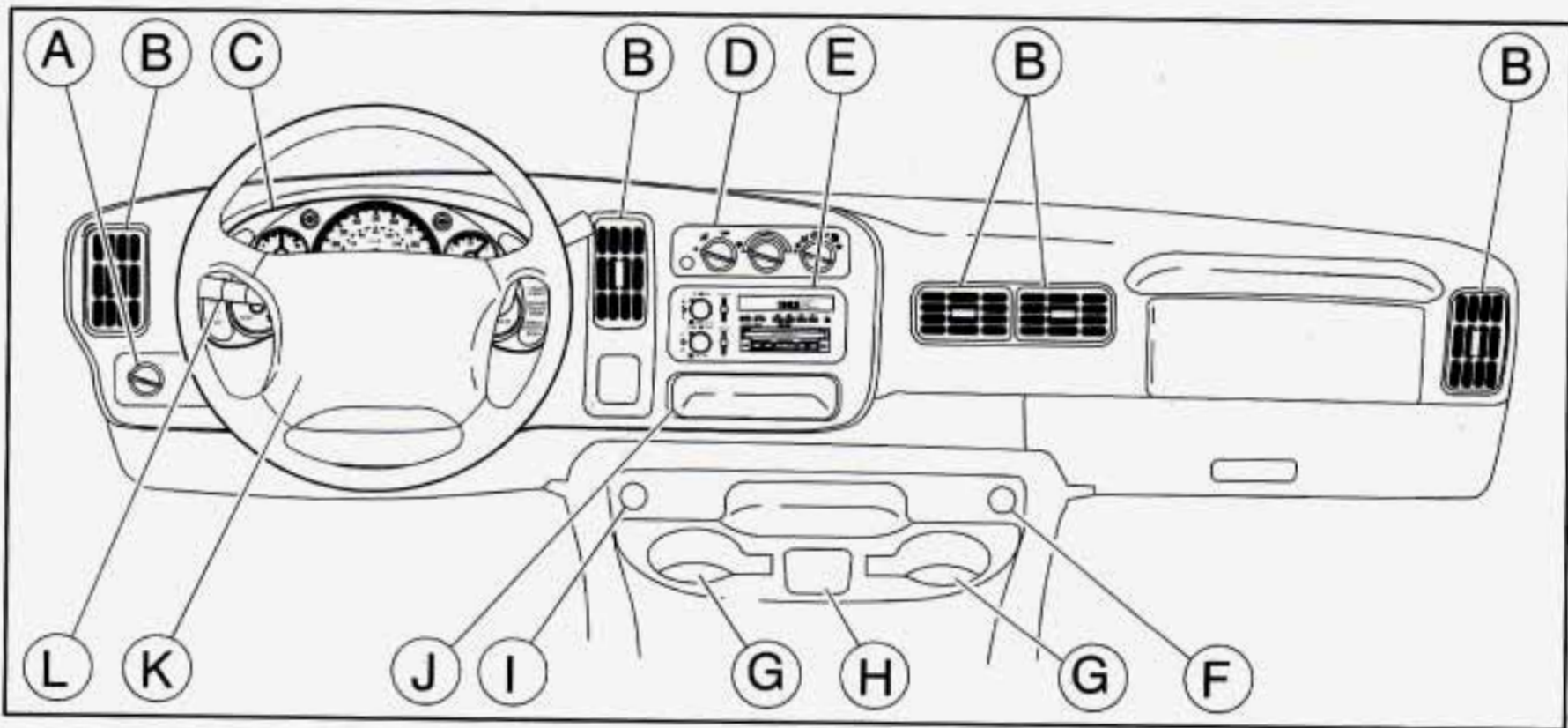

A. Lamp Controls

B. Air Vents

C. Instrument Cluster

D. Comfort Control System

E. Audio System

F. Auxiliary Power Outlet

G. Cupholder

H. Ashtray

I. Cigarette Lighter

J. Convenience Tray

K. Horn/Air Bag

L. Turn Signal/Multifunction Lever

Instrument Cluster

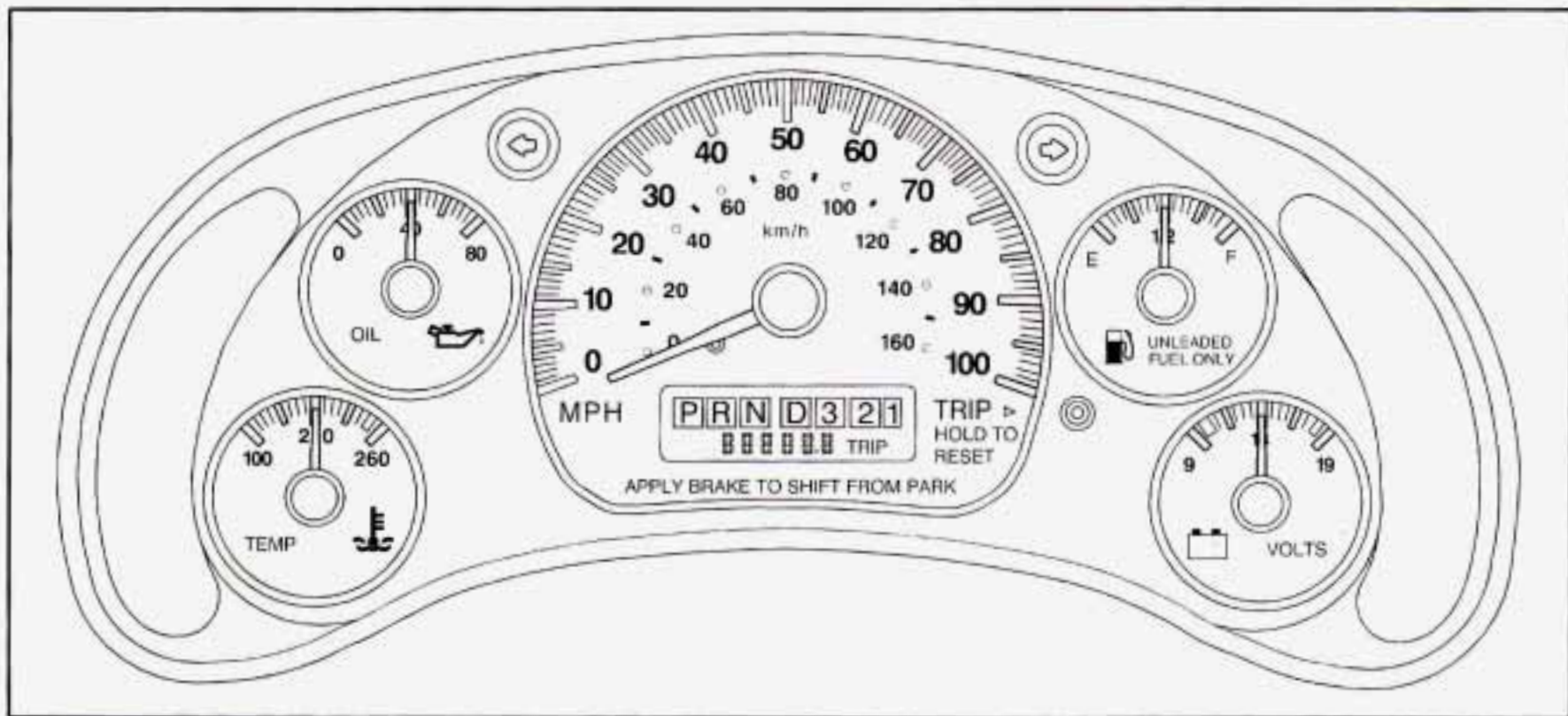

Your instrument cluster is designed to let you know at a glance how your vehicle is running. You'll know how fast you're going, how much fuel you're using, and many other things you'll need to know to drive safely and economically.

Speedometer



Your speedometer lets you see your speed in both miles per hour (mph) and kilometers per hour (km/h). Your odometer shows how far your vehicle has been driven, in either miles (used in the United States) or kilometers (used in Canada).

You may wonder what happens if your vehicle needs a new odometer installed. Laws vary as to the procedure that must be followed, so check with your state or provincial vehicle registration office. But generally, if

the new odometer can be set to the mileage total of the old odometer, then it must be. But if it can't, then it's set at zero, and a label must be put on the driver's door to show the old mileage reading when the new odometer was installed.

Trip Odometer



The trip odometer can tell you how far your vehicle has been driven since you last set the trip odometer to zero.

To reset the trip odometer, fully press the reset button located near the trip odometer readout.

The odometer can show either total miles or trip miles by using the push control in the cluster.

Warning Lights, Gages and Indicators

This part describes the warning lights and gages that may be on your vehicle. The pictures will help you locate them.

Warning lights and gages can signal that something is wrong before it becomes serious enough to cause an expensive repair or replacement. Paying attention to your warning lights and gages could also save you or others from injury.

Warning lights come on when there may be or is a problem with one of your vehicle's functions. As you will see in the details on the next few pages, some warning lights come on briefly when you start the engine just to let you know they're working. If you are familiar with this section, you should not be alarmed when this happens.

Gages can indicate when there may be or is a problem with one of your vehicle's functions. Often gages and warning lights work together to let you know when there's a problem with your vehicle.

When one of the warning lights comes on and stays on when you are driving, or when one of the gages shows there may be a problem, check the section that tells you what to do about it. Please follow this manual's advice.

Waiting to do repairs can be costly -- and even dangerous. So please get to know your warning lights and gages. They're a big help.

Safety Belt Reminder Light

When the key is turned to RUN or START, a tone will come on for about eight seconds to remind people to fasten their safety belts, unless the driver's safety belt is already buckled.



The safety belt light will also come on and stay on for about 20 seconds, then it will flash for about 55 seconds. If the driver's belt is already buckled, neither the tone nor the light will come on.

Air Bag Readiness Light

There is an air bag readiness light on the instrument panel, which shows AIR BAG. The system checks the air bag's electrical system for malfunctions. The light tells you if there is an electrical problem. The system check includes the air bag sensor, the air bag modules, the wiring and the crash sensing and diagnostic module. For more information on the air bag system, see "Air Bag" in the Index.



AIR
BAG

You will see this light flash for a few seconds when you turn your ignition to RUN or START. Then the light should go out. This means the system is ready.

If the air bag readiness light doesn't come on when you start your vehicle, or stays on, or comes on when you are driving, your air bag system may not work properly. Have your vehicle serviced right away.

Charging System Light

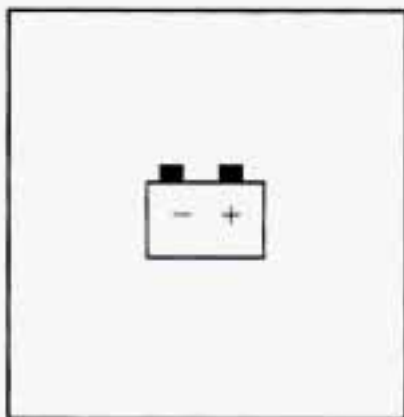

This light should come on briefly when you turn on the ignition, before starting the engine, as a check to show you it is working.

After the engine starts, the light should go out. If it stays on or comes on while you are driving, you may have a problem with your charging system. It could indicate a problem with the alternator drive belt, or some other charging system problem. Have it checked right away. Driving while this light is on could drain your battery.

If you must drive a short distance with this light on, it helps to turn off all your accessories, such as the radio and air conditioner.

Brake System Warning Light

Your vehicle's hydraulic brake system is divided into two parts. If one part isn't working, the other part can still work and stop you. For good braking, though, you need both parts working well.

If the warning light comes on, there could be a brake problem. Have your brake system inspected right away.

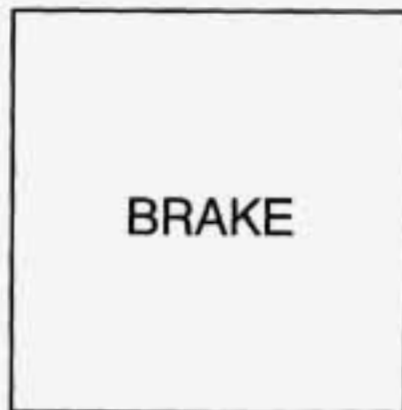

United States

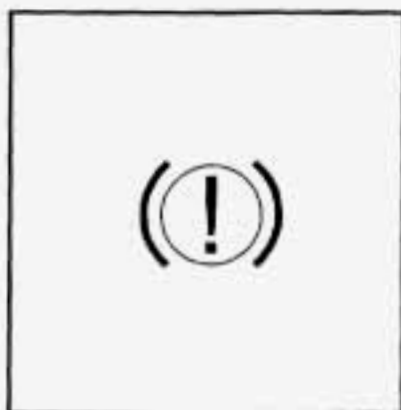

Canada

This light should come on briefly when you turn the ignition key to RUN. If it doesn't come on then, have it fixed so it will be ready to warn you if there's a problem.

If the light comes on while you are driving, pull off the road and stop carefully. You may notice that the pedal is harder to push. Or, the pedal may go closer to the floor. It may take longer to stop. If the light is still on, have the vehicle towed for service. (See "Towing Your Vehicle" in the Index.)

CAUTION:

Your brake system may not be working properly if the brake system warning light is on. Driving with the brake system warning light on can lead to an accident. If the light is still on after you've pulled off the road and stopped carefully, have the vehicle towed for service.

When the ignition is on, the brake system warning light will also come on when you set your parking brake. The light will stay on if your parking brake doesn't release fully. If it stays on after your parking brake is fully released, it means you have a brake problem.

Anti-Lock Brake System Warning Light

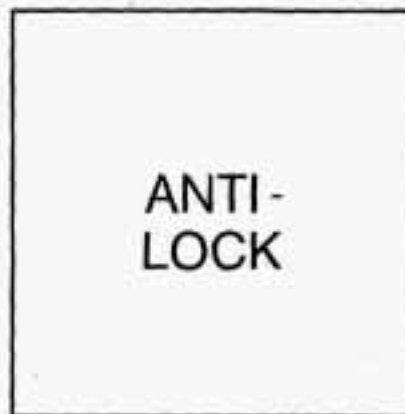

United States

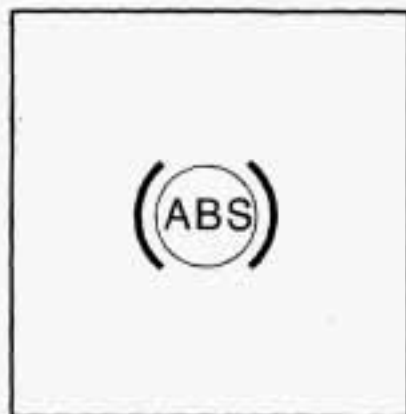

Canada

With the anti-lock brake system, this light will come on when you start your engine and may stay on for several seconds. That's normal.

If the light stays on, or comes on when you're driving, your vehicle needs service. If the regular brake system warning light isn't on, you still have brakes, but you don't have anti-lock brakes. If the regular brake system warning light is also on, you don't have anti-lock brakes and there's a problem with your regular brakes. See "Brake System Warning Light" earlier in this part.

The anti-lock brake system warning light should come on briefly when you turn the ignition key to RUN. If the light doesn't come on then, have it fixed so it will be ready to warn you if there is a problem.

Daytime Running Lamps Indicator Light

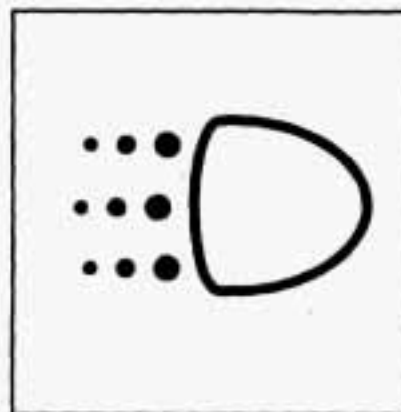

You may have this light on the instrument panel. It will light whenever the DRL are on. It is also a reminder to turn on your headlamps when driving at night. For more details about DRL, see "Headlamps and Vehicle Lighting" in this section.

Malfunction Indicator Lamp (Service Engine Soon Light) (Gasoline Engine)



SERVICE
ENGINE SOON

Your vehicle is equipped with a computer which monitors operation of the fuel, ignition and emission control systems.

This system is called OBD II (On-Board Diagnostics-Second Generation) and is intended to assure that emissions are at acceptable levels for the life of the vehicle, helping to produce a cleaner environment. The SERVICE ENGINE SOON light comes on to indicate that there is a problem and service is required. Malfunctions often will be indicated by the system before any problem is apparent, which may prevent more serious damage to your vehicle. This system is also designed to assist your service technician in correctly diagnosing any malfunction.

NOTICE:

If you keep driving your vehicle with this light on, after a while, your emission controls may not work as well, your fuel economy may not be as good and your engine may not run as smoothly. This could lead to costly repairs that may not be covered by your warranty.

This light should come on, as a check to show you it is working, when the ignition is on and the engine is not running. If the light doesn't come on, have it repaired. This light will also come on during a malfunction in one of two ways:

- **Light Flashing** -- A misfire condition has been detected. A misfire increases vehicle emissions and may damage the emission control system on your vehicle. Dealer or qualified service center diagnosis and service is required.
- **Light On Steady** -- An emission control system malfunction has been detected on your vehicle. Dealer or qualified service center diagnosis and service may be required.

If the Light Is Flashing

The following may prevent more serious damage to your vehicle:

- Reduce vehicle speed.
- Avoid hard accelerations.
- Avoid steep uphill grades.
- If towing a trailer, reduce the amount of cargo being hauled as soon as it is possible.

If the light stops flashing and remains on steady, see “If the Light Is On Steady” following.

If the light continues to flash, when it is safe to do so, *stop the vehicle*. Put your vehicle in PARK (P). Turn the key off, wait at least 10 seconds and restart the engine.

If the light remains on steady, see “If the Light Is On Steady” following. If the light is still flashing follow the previous steps, and drive the vehicle to your dealer or qualified service center for service.

If the Light Is On Steady

You may be able to correct the emission system malfunction by considering the following:

Did you just drive through a deep puddle of water?

If so, your electrical system may be wet. The condition will usually be corrected when the electrical system dries out. A few driving trips should turn the light off.

Are you low on fuel?

As your engine starts to run out of fuel, your engine may not run as efficiently as designed since small amounts of air are sucked into the fuel line causing a misfire. The system can detect this. Adding fuel should correct this condition. Make sure to install the fuel cap properly. It will take a few driving trips to turn the light off.

Have you recently changed brands of fuel?

If so, be sure to fuel your vehicle with quality fuel (see “Fuel” in the Index). Poor fuel quality will cause your engine not to run as efficiently as designed. You may notice this as stalling after start-up, stalling when you put the vehicle into gear, misfiring, hesitation on acceleration or stumbling on acceleration. (These conditions may go away once the engine is warmed up.) This will be detected by the system and cause the light to turn on.

If you experience this condition, change the fuel brand you use. It will require at least one full tank of the proper fuel to turn the light off.

If none of the above steps have made the light turn off, have your dealer or qualified service center check the vehicle. Your dealer has the proper test equipment and diagnostic tools to fix any mechanical or electrical problems that may have developed.

Oil Pressure Gage

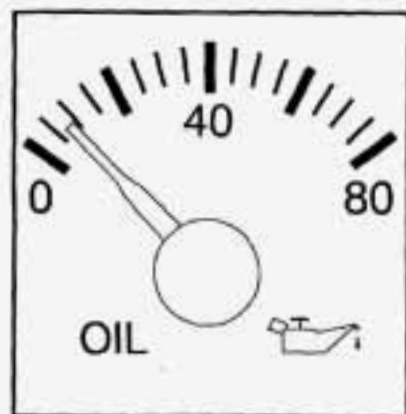

The oil pressure gage shows the engine oil pressure in psi (pounds per square inch) when the engine is running. Canadian vehicles indicate pressure in kPa (kilopascals).

Oil pressure may vary with engine speed, outside temperature and oil viscosity, but readings above the low pressure zone indicate the normal operating range.

A reading in the low pressure zone may be caused by a dangerously low oil level or other problem causing low oil pressure. Check your oil as soon as possible.

CAUTION:

Don't keep driving if the oil pressure is low. If you do, your engine can become so hot that it catches fire. You or others could be burned. Check your oil as soon as possible and have your vehicle serviced.

NOTICE:

Damage to your engine from neglected oil problems can be costly and is not covered by your warranty.

Check Gages Light



The CHECK GAGES light will come on briefly when you are starting the engine.

If the light comes on and stays on while you are driving, check your coolant temperature and engine oil pressure gages to see if they are in the warning zones.

Fuel Gage

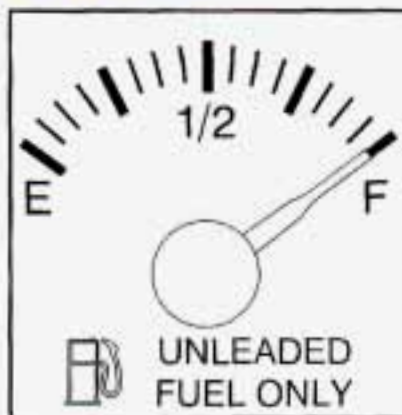

The fuel gage, when the ignition is on, tells you about how much fuel you have left in your tank.

The gage will first indicate EMPTY (E) before you are out of fuel, and you should get more fuel as soon as possible.

Listed are four situations you may experience with your fuel gage:

- At the gas station, the fuel pump shuts off before the gage reads FULL (F).
- It takes a little more or less fuel to fill up than the fuel gage indicated. For example, the gage may have indicated the tank was half full, but it actually took a little more or less than half the tank's capacity to fill the tank.
- The gage moves a little when you turn a corner or speed up.
- The gage doesn't go back to EMPTY (E) when you turn off the ignition.

None of these indicate a problem with the fuel gage.

Engine Coolant Temperature Gage

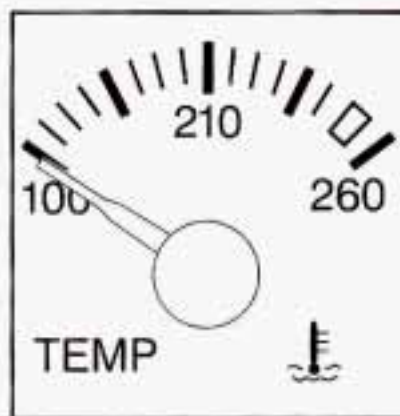

This gage shows the engine coolant temperature. If the gage pointer moves into the red area your engine is too hot!

It means that your engine coolant has overheated. If you have been operating your vehicle under normal operating conditions, you should pull off the road, stop your vehicle, and turn off the engine as soon as possible.

In "Problems on the Road," this manual shows what to do. See "Engine Overheating" in the Index.

Voltmeter

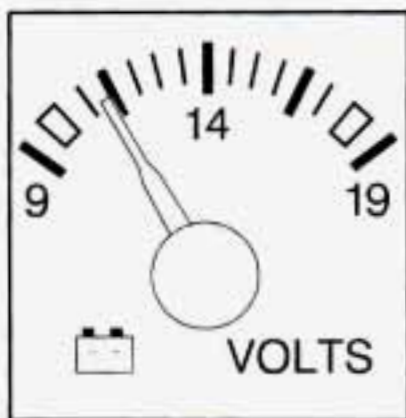

When your engine is not running, but the ignition is on (in the RUN position), this gage shows your battery's state of charge in DC volts.

When the engine is running, the gage shows the condition of the charging system. Readings between the low and high warning zones indicate the normal operating range.

Readings in the low warning zone may occur when a large number of electrical accessories are operating in the vehicle and the engine is left at an idle for an extended period. This condition is normal since the

charging system is not able to provide full power at engine idle. As engine speeds are increased, this condition should correct itself as higher engine speeds allow the charging system to create maximum power.

You can only drive for a short time with the reading in either warning zone. If you must drive, turn off all unnecessary accessories.

Readings in either warning zone indicate a possible problem in the electrical system. Have the vehicle serviced as soon as possible.

Electronic Road-Speed Governor (Gasoline Engines)

This optional system automatically controls vehicle top speed. The system controller receives a signal from the vehicle speed sensor and reduces power when the vehicle speed reaches the maximum 65 mph (105 km/h) governed speed.

Center High-Mounted Stoplamp



Your vehicle's center high-mounted stoplamp is located above the rear doors at the center of the vehicle.

If items are loaded on the roof of the vehicle, as in a luggage carrier, care should be taken not to block or damage the center high-mounted stoplamp unit.

If you tow a trailer that is equipped with provisions for a center high-mounted stoplamp, see your GM dealer for instructions on how to make it operate with your vehicle's electrical system. As with any electrical system modification, have the work performed by a qualified electrical service person.

NOTES

NOTES

Section 3 Comfort Controls and Audio Systems

In this section you'll find out how to operate the comfort control and audio systems offered with your vehicle. Be sure to read about the particular systems supplied with your vehicle.

Comfort Controls

This section tells you how to make your air system work for you. Your comfort control system uses ozone-friendly R-134a refrigerant.

With these systems, you can control the heating, cooling and ventilation in your van. Your vehicle also has a flow-through ventilation system described later in this section.

Heater Controls



If your vehicle does not have air conditioning, your heater controls will look like this.

Fan Knob

The knob on the left side of the heating system control panel controls the fan speed. The knob has four speed positions. To increase airflow, move the knob toward HI. To decrease airflow, move it toward LO. To turn the fan off, move the knob to OFF.

Temperature Knob

The middle knob lets you select the relative temperature of the air flowing into the passenger area of your vehicle. This knob will allow you to adjust the relative air temperature independently of the function knob setting. Move the knob clockwise to the red area for warmer air. Move the knob counter clockwise to the blue area for cooler air.

Mode Knob

The right knob changes the heater setting.



VENT: This setting directs air through the instrument panel vents.



VENT/HEAT: Use this setting to divide airflow between the heater floor vents and instrument panel vents.



HEAT: This setting directs air through the heater floor vents. This setting is useful for cold weather.



HEAT/DEFROST: Use this setting to divide airflow between the heater floor vents and windshield.



DEFROST: This setting with the defrost symbol directs air through the windshield defroster vents. This setting is useful when you have fog or ice on the windshield.

Heater/Air Conditioning Controls



If your vehicle has air conditioning, your heater/air conditioning controls will look like this.

Before using your vehicle's air conditioning, open the windows to clear the vehicle of hot air.

Fan Knob

The knob on the left side of the heating system control panel controls the fan speed. The knob has four speed positions. To increase airflow, move the knob toward HI. To decrease airflow, move it toward LO.

Temperature Knob

The middle knob on the control panel lets you select the relative temperature of the air flowing into the passenger area of your vehicle. This knob will allow you to adjust the relative air temperature independently of the function knob setting. Move the knob clockwise toward the red area for warmer air. Move the knob counterclockwise toward the blue area for cooler air.

Mode Knob

The right knob on the control panel changes the heater/air conditioning setting.

MAX A/C: With A/C on, move the right knob to MAX A/C for maximum cooling. This setting puts the system in the recirculation mode and helps to maximize your air conditioner's performance and your vehicle's fuel economy. This setting also cools the air the fastest. After the vehicle's interior reaches a comfortable temperature, move the knob clockwise to place the air conditioning system in the A/C mode.

A/C: Use for normal cooling on hot days. This setting cools outside air and directs it through the instrument panel outlets.



VENT: This setting, with the arrow pointing at the figure's head, directs air through the instrument panel vents.



VENT/HEAT: Use this setting, with the arrows pointing at the figure's feet and head, to divide airflow between the heater floor vents and instrument panel vents.



HEAT: This setting, with the arrow pointing at the figure's feet, directs air through the heater floor vents. This setting is useful for cold weather.



HEAT/DEFROST: Use this setting, with the arrow pointing at the figure's feet and the defroster symbol near the figure's head, to divide airflow between the heater floor vents and windshield.



DEFROST: This setting with the defrost symbol directs air through the windshield defroster vents. This setting is useful when you have fog or ice on the windshield.

Rear Heater (Without Air Conditioning)

If you have a rear heater (without rear air conditioning), the control switch is located on the instrument panel.



To increase and decrease the flow of heated air to the rear floor vents, move the switch marked REAR HEAT to the blower speed you want.

The knob has three speed positions. To increase the flow of heated air, move the switch toward HIGH. To turn the fan off, move the switch to OFF.

Rear Air Conditioning and Rear Heater

If your vehicle has a rear air conditioning and rear heater system combination, controls are provided to regulate the temperature, location and speed of the air flow.



Front Passenger Control

To adjust the air temperature, turn the temperature knob on the right side of the control panel.

For warmer air, turn the knob clockwise toward the red area, and for cooler air, turn the knob counterclockwise toward the blue area.

To regulate the airflow location, adjust the center knob on the control panel. Turn the knob counterclockwise for floor vent air flow or clockwise for headliner vent air flow. Generally, the upper vents are used for air conditioning and the floor vents for heating. The control knob can be set to any blend setting.

To adjust the air flow speed, turn the fan control knob on the left side of the control panel to the desired blower setting.

To activate the rear control, move the fan knob on the front control to REAR CNTL.



The rear control works just like the front control. It will allow second seat passengers to adjust the controls as they desire.

Air Conditioning

Before using your vehicle's air conditioning, open the windows to clear the vehicle of hot air. This reduces the time it takes for your vehicle to cool down. Then keep your windows closed for the air conditioner to work at its best.

You can use MAX A/C with the temperature knob in the blue area, when it's really hot outside and you need to cool the inside air quickly. MAX A/C lets in only a little air from the outside.

If you first use MAX A/C, you can then use A/C with the temperature knob in the blue area, as soon as the vehicle has cooled down, so outside air will be going through your vehicle.

If your vehicle has rear air conditioning, setting it on LO may enhance front A/C performance by allowing trapped refrigerant in rear lines to circulate.

When the air conditioning, DEFROST or BLEND is on, you may notice a slight increase or decrease in engine speed, due to compressor operation. This is normal because the system is designed to cycle the compressor on and off to keep the desired temperature.

Heating

On cold days, use HEATER with the temperature knob in the red area. Outside air will be brought in through the floor outlets. The heater works best if you keep your windows closed while using it.

If you use the optional engine coolant heater before starting your engine, your heating system will produce warmer air faster to heat the passenger compartment in cold weather. See "Engine Coolant Heater" in the Index.

Ventilation Tips

- Keep the hood and front air inlet free of ice, snow, or any other obstruction (such as leaves). The heater and defroster will work far better, reducing the chance of fogging the inside of your windows.
- When you enter a vehicle in cold weather, turn the blower fan to HI for a few moments before driving off. This helps clear the intake ducts of snow and moisture, and reduces the chance of fogging the inside of your windows.
- Keep the air path under the front seats clear of objects. This helps air to circulate throughout your vehicle.

Your vehicle has air vents in the center and on the sides of your instrument panel.

You can move the vents from side to side or up and down to direct the flow of air, or close the vents altogether. When you close a vent, it will increase the flow of air coming out of any vents that are open.

Rear Window Defogger (Option)

You can tell if your vehicle has this option by looking at the rear window. There will be lines across the glass. These are the wire-like elements which heat your window.

NOTICE:

Scraping the inside of your rear window could cut and damage the defogger. Your warranty would not cover this damage. Don't put decals there; you might have to scrape them off.

Audio Systems

Your Delco® audio system has been designed to operate easily and give years of listening pleasure. You will get the most enjoyment out of it if you acquaint yourself with it first. Find out what your Delco system can do and how to operate all its controls, to be sure you're getting the most out of the advanced engineering that went into it.

Setting the Clock for AM-FM Stereo and AM-FM Stereo with Cassette Tape Player

Press SET. Within five seconds, press and hold the SEEK right arrow until the correct minute appears on the display. Press and hold the SEEK left arrow until the correct hour appears on the display.

Setting the Clock for AM-FM Stereo with Compact Disc Player

Press and hold HR until the correct hour appears on the display. Press and hold MIN until the correct minute appears on the display. To display the clock with the ignition off, press RECALL and the time will be displayed for a few seconds. There is an initial two-second delay before the clock goes into the time-set mode.

AM-FM Stereo



Playing the Radio

VOLUME: Turn the knob clockwise to turn the radio on and counterclockwise to turn it off. To increase volume, turn the knob clockwise. Turn the knob counterclockwise to decrease volume.

RECALL: Display the time with the ignition off by pressing this knob. When the radio is playing, press this knob to recall the station frequency.

Finding a Station

AM-FM: Press the lower knob to get AM or FM.

TUNE: Turn this knob to tune in radio stations.

SEEK: Press the right arrow to tune to the next higher station and the left arrow to tune to the next lower station and stay there.

SCAN: Press both SEEK buttons to listen to a few seconds of each radio station. SCAN will light up on the display. Press the right arrow to tune in the next higher station and press the left arrow to tune to the next lower station. Press VOLUME or both SEEK buttons to stop scanning.

PUSHBUTTONS: The four numbered pushbuttons let you return to your favorite stations. You can set up to 14 stations (seven AM and seven FM).

1. Tune in the desired station.
2. Press SET.
3. Press and hold one of the four pushbuttons, within five seconds. Whenever you press that numbered button, the station you set will return.
4. Repeat these steps for each pushbutton.

In addition to the four stations set as above, up to three additional stations may be preset on each band by pressing two adjoining buttons at the same time. Just:

1. Tune in the desired station.
2. Press SET.
3. Press two adjoining buttons at the same time, within five seconds. Whenever you press the same two buttons, the station you set will return.
4. Repeat these steps for each pair of buttons.

Setting the Tone

BASS: Slide this lever up to increase the bass.

TREB: Slide this lever up to increase the treble. Slide the lever down to reduce noise with a weak or noisy station.

Adjusting the Speakers

BAL: The control behind the upper knob balances the sound between the right and left speakers.

FADE: The control behind the lower knob fades the sound between the front and rear speakers.

AM-FM Stereo with Cassette Tape Player



Playing the Radio

VOLUME: Turn the knob clockwise to turn the radio on and counterclockwise to turn it off. To increase volume, turn the knob clockwise. Turn the knob counterclockwise to decrease volume.

RECALL: Display the time with the ignition off by pressing this knob. When the radio is playing, press this button to recall the station frequency.

Finding a Station

AM-FM: Press the lower knob to get AM or FM.

TUNE: Turn the lower knob to tune in radio stations.

SEEK: Press this button and the radio will tune to the next higher or lower station and stay there.

PUSHBUTTONS: The four numbered pushbuttons let you return to your favorite stations. You can set up to 14 stations (seven AM and seven FM). Just:

1. Tune in the desired station.
2. Press SET.
3. Press and hold one of the four pushbuttons, within five seconds. Whenever you press that numbered button, the station you set will return.
4. Repeat these steps for each pushbutton.

In addition to the four stations set as above, up to three additional stations may be preset on each band by pressing two adjoining buttons at the same time. Just:

1. Tune in the desired station.
2. Press SET.
3. Press two adjoining buttons at the same time, within five seconds. Whenever you press the same two buttons, the station you set will return.
4. Repeat these steps for each pair of buttons.

P.SCAN: Press both SEEK buttons to scan through each of the preset stations. The system will scan through and play each preset station stored on your pushbuttons for a few seconds. Press either SEEK button or RECALL to stop scanning through the preset stations.

Setting the Tone

BASS: Slide this lever up to increase the bass.

TREB: Slide this lever up to increase the treble. Slide the lever down to reduce noise with a weak or noisy station.

Adjusting the Speakers

BAL: The control behind the upper knob balances the sound between the right and left speakers.

FADE: The control behind the lower knob fades the sound between the front and rear speakers.

Playing a Cassette Tape

Your tape player is built to work best with tapes that are 30 to 45 minutes long on each side. Tapes longer than that are so thin they may not work well in this player.

Once the tape is playing, use the knobs for VOLUME, FADE and BAL just as you do for the radio.

FWD: Press the SEEK right arrow to advance the cassette tape. Press the SEEK left arrow to stop forwarding the tape.

REV: Press the SEEK left arrow to reverse the cassette tape. Press the SEEK right arrow to stop reversing the tape.

RECALL: Press this button to switch tape sides.

EJECT: Press this button to remove the tape or stop the tape and play the radio.

CLN: This message may appear on the display. If it does, your cassette tape player needs to be cleaned. It will still play tapes, but you should clean it as soon as possible to prevent damage to your tapes and player. See "Care of Your Cassette Tape Player" in the Index. After you clean the player, press and hold EJECT for five seconds to reset the CLN indicator. The radio will display --- to show the indicator was reset.

AM-FM Stereo with Cassette Tape and Automatic Tone Control



Playing the Radio

PWR-VOL: Press this knob to turn the system on and off. To increase volume, turn the knob clockwise. Turn it counterclockwise to decrease volume. The faster the PWR-VOL knob is rotated, the quicker the volume is increased or decreased.

RECALL: Display the time with the ignition off by pressing this knob. When the radio is playing, press this button to recall the station frequency.

SCV: This is the Speed-Compensated-Volume (SCV) knob. Move the control ring behind the PWR-VOL knob clockwise to adjust the SCV. Set the volume at the desired level. As you drive, the SCV automatically increases the volume, as necessary, to overcome road and wind noise at any particular speed. The volume should always sound the same. Each clockwise position on the control ring allows for more compensation at a faster rate.

Finding a Station

AM-FM: Press this button to switch between AM, FM1 and FM2. The display will show your selection.

TUNE: Press lightly on this knob to release it from its stored position. Rotate the knob clockwise to increase frequency and counterclockwise to decrease frequency. When finished tuning, press the knob again to return it to its stored position.

SEEK: Press the right arrow to tune to the next higher station and the left arrow to tune to the next lower station and stay there. The sound will mute while seeking.

SCAN: Press and hold SEEK for two seconds until SCAN appears on the display. SCAN allows you to listen to stations for a few seconds. The receiver will continue to scan and momentarily stop at each station until you press the button again. The sound will mute while scanning.

PUSHBUTTONS: The six numbered pushbuttons let you return to your favorite stations. You can set up to 18 stations (six AM, six FM1 and six FM2).

1. Press AM-FM to select the band.
2. Tune in the desired station.
3. Press AUTO TONE to select the setting you prefer.
4. Press and hold one of the six pushbuttons. The sound will mute. When it returns, release the button. Whenever you press that numbered button, the station you set will return and the tone you selected will be automatically selected for that button.
5. Repeat these steps for each pushbutton.

P.SCAN: The preset scan button lets you scan through your favorite stations stored on your pushbuttons. Select either the AM, FM1 or FM2 mode and then press P.SCAN. It will scan through each station stored on your pushbuttons and stop for a few seconds before continuing to scan through all of the pushbuttons. Press P.SCAN again or one of the pushbuttons to stop scanning to listen to a specific preset station. P.SCAN will light up on the display while in this mode. If one of the stations stored on a pushbutton is too weak for the location you are in, the radio display will show the channel number (P1-P6) for several seconds before advancing to the next preset station.

Setting the Tone

BASS: Press lightly on this knob to release it from its stored position. Turn the knob clockwise to increase the bass and counterclockwise to decrease the bass. When the BASS control is rotated, the AUTO TONE setting will change to MAN.

TREB: Press lightly on the TREB knob to release it from its stored position. Turn the knob clockwise to increase the treble and counterclockwise to decrease the treble. When the TREB control is rotated, the AUTO TONE setting will change to MAN.

Push these knobs back in to their stored position when you're not using them.

AUTO TONE: Press this button to select among the five preset equalization settings and tailor the sound to the music or voice being heard. Each time you press the button, the selection will switch to one of the preset settings of CLASSIC, NEWS, ROCK, POP or JAZZ. To return to the manual mode, press and release this button until MAN appears on the display. This will return the tone adjustment to the TREB and BASS controls. If a TREB or BASS control is rotated, the AUTO TONE setting will change to MAN.

Adjusting the Speakers

BAL: Press this button to remove the control from its stored position. Turn the control clockwise to adjust sound to the right speakers and counterclockwise to adjust sound to the left speakers. Press the button again to return BAL to its stored position.

FADE: Press this button to remove the control from its stored position. Turn the control clockwise to adjust the sound to the front and counterclockwise for rear speakers. Press the button again to return FADE to its stored position.

Playing a Cassette Tape

Your tape player is built to work best with tapes that are 30 to 45 minutes long on each side. Tapes longer than that are so thin they may not work well in this player.

To load a cassette tape with the ignition off, press EJECT or RECALL. Then, insert the cassette tape. If the ignition is on but the radio is off, the tape will begin playing.

The player automatically senses if the cassette tape is metal or CrO₂ and adjusts for best playback sound. For metal tapes, the double-D symbol will appear on the display.

Once the tape is playing, use the VOL, BAL, FADE, TREB and BASS controls just as you do for the radio. The tape symbol and a direction arrow will be on the display whenever a tape is being played. Anytime a tape is inserted, the top side is selected for play first.

PREV (1): Press the PREV or the SEEK left arrow to search for the previous selection. A minimum three-second blank gap is required for the player to stop at the beginning of the selection. The tape direction arrow will blink during the SEEK operation.

PROG (2): Press this button to switch from one side of the tape to the other.

NEXT (3): Press NEXT or the SEEK right arrow to search for the next selection. A minimum three-second blank gap is required for the player to stop at the beginning of the selection. The tape direction arrow will blink during the SEEK operation.

REV (4): Press this button to rapidly reverse the tape to the beginning of the cassette reel or until you press REV again. The radio will play the last selected station while reversing the tape. The tape direction arrow will blink during REV operation.

□□ (5): Press this button to reduce cassette tape noise. The double-D symbol will appear on the display while the player is in this mode.

Dolby Noise Reduction is manufactured under a license from Dolby Laboratories Licensing Corporation. Dolby and the double-D symbol are trademarks of Dolby Laboratories Licensing Corporation.

FWD (6): Press this button to rapidly forward the tape to the end of the cassette reel or until you press FWD again. The radio will play the last selected station while forwarding the tape. The tape direction arrow will blink during FWD operation.

AM-FM: Press this button to switch from a tape to the radio.

TAPE AUX: Press this button to return to the tape player. The lighted arrow will appear and show the direction of play when a tape is in the active mode.

EJECT: Press this button to remove the tape. The radio will now play. EJECT can be used with either the ignition or radio off. To load a cassette tape with the ignition or radio off, press EJECT before loading the cassette.

CLN: This message may appear on the display. If it does, your cassette tape player needs to be cleaned. It will still play tapes, but you should clean it as soon as possible to prevent damage to your tapes and player. See "Care of Your Cassette Tape Player" in the Index. After you clean the player, press and hold EJECT for five seconds to reset the CLN indicator. The radio will display --- to show the indicator was reset.

CD Adapter Kits

Although this is not a recommended practice, it is possible to use a CD adapter kit with your cassette tape player.

The adapter kit cassette should begin playing like a regular audio cassette tape once inserted. If the cassette immediately ejects, turn the radio off, turn the ignition on and press and hold the TAPE AUX button until the tape icon flashes on the display. Insert the adapter cassette again. It will power up the radio and begin playing.

This override routine will remain active until EJECT is pressed.

Playing a Compact Disc in the Single Remote Disc Player



If you have this option, you can play one compact disc (CD) at a time.

To load a CD into the player, hold the disc with the label side up and insert it carefully into the player (approximately half way). The disc will automatically be pulled into the player. If the radio is off and the ignition is on when a CD is inserted, the radio will turn on and begin playing the CD. It is possible to load and unload CD's with the ignition off. To load a disc with the ignition off, press the EJECT button on the remote player and then insert the disc. To remove the disc, press the EJECT button and remove the disc from the player.

A disc that has been ejected but is still sitting in the remote CD player will be pulled back into the player after approximately 30 seconds. This protects the disc and player from damage. The disc will not start playing. To remove the disc, press the EJECT button and remove the disc from the player.

All of the compact disc functions are controlled by the radio buttons except for EJECT. When a disc is in the player, a CD symbol will appear on the display. When a disc is playing, the letters CD will appear next to the CD symbol in the bottom left corner. The track number will also be displayed.

If the disc comes back out and ERR appears on the display, it could be that:

- The disc is upside down.
- It is dirty, scratched or wet.
- There's too much moisture in the air. (Wait about an hour and try again.)
- You are driving on a very rough road.

Please contact your dealer if any error recurs or cannot be corrected.

PREV (1): Press this button to go back to the start of the current track if more than eight seconds have played. Press PREV again to go to the previous track on the disc.

PROG (2): This button is active only when you have the 12-disc changer.

NEXT (3): Press this button to advance to the next track on the disc.

REV (4): Press and hold this button to quickly reverse within a track (song). As the CD reverses, elapsed time will be displayed to help you find the correct passage.

FWD (6): Press and hold this button to quickly advance within a track (song). As the CD advances, elapsed time will be displayed to help you find the correct passage.

SEEK: Press the left arrow while playing a CD to go back to the start of the current track. It will go back to the current track if more than eight seconds have played. Press the left arrow again to go to previous tracks. Press the right arrow to go to the next higher track on the disc.

TAPE AUX: With a disc loaded in the player and the radio playing, press this button once to play the compact disc. To return to playing the radio, press AM-FM. If both a cassette tape and CD are loaded, press TAPE AUX to switch between the tape and compact disc.

RANDOM: Press P.SCAN to enter the random play mode. RANDOM will appear on the display. While in this mode, the tracks on the discs will be played in random order. If you press SEEK, PREV or NEXT while in the random mode, the PREV or NEXT track will be scanned randomly. Press P.SCAN again to turn off RANDOM and return to normal operation.

RECALL: Press this button to see what track is currently playing. Press RECALL again within five seconds to see how long the track has been playing. When a new track starts to play, the track number will also appear. Press RECALL a third time and the time of day will be displayed.

EJECT: Press this button on the remote player to eject a compact disc.

AM-FM Stereo with Compact Disc Player and Automatic Tone Control



Playing the Radio

PWR-VOL: Press this knob to turn the system on and off. To increase volume, turn the knob clockwise. Turn it counterclockwise to decrease volume. The faster the PWR-VOL knob is rotated, the quicker the volume is increased or decreased.

RECALL: Display the time with the ignition off by pressing this knob. When the radio is playing, press this button to recall the station frequency.

SCV: This is the Speed-Compensated-Volume (SCV) knob. Move the control ring behind the PWR-VOL knob clockwise to adjust the SCV. Set the volume at the desired level. As you drive, the SCV automatically increases the volume, as necessary, to overcome road and wind noise at any particular speed. The volume should always sound the same. Each clockwise position on the control ring allows for more compensation at a faster rate.

Finding a Station

AM-FM: Press this button to switch between AM, FM1 and FM2. The display will show your selection.

TUNE: Press lightly on this knob to release it from its stored position. Rotate the knob clockwise to increase frequency and counterclockwise to decrease frequency. When finished tuning, press the knob again to return it to its stored position.

SEEK: Press the right arrow to tune to the next higher station and the left arrow to tune to the next lower station and stay there. The sound will mute while using the SEEK feature.

SCAN: Press and hold SEEK for two seconds until SCAN appears on the display. SCAN allows you to listen to stations for a few seconds. The receiver will continue to scan and momentarily stop at each station until you press the button again. The sound will mute while using the SCAN feature.

PUSHBUTTONS: The six numbered pushbuttons let you return to your favorite stations. You can set up to 18 stations (six AM, six FM1 and six FM2).

1. Press AM-FM to select the band.
2. Tune in the desired station.
3. Press AUTO TONE to select the setting you prefer.
4. Press and hold one of the four pushbuttons. The sound will mute. When it returns, release the button. Whenever you press that numbered button, the station you set will return and the tone you selected will be automatically selected for that button.
5. Repeat these steps for each pushbutton.

P.SCAN: The preset scan button lets you scan through your favorite stations stored on your pushbuttons. Select either the AM, FM1 or FM2 mode and then press P.SCAN. It will scan through each station stored on your pushbuttons and stop for a few seconds before continuing to scan through all of the pushbuttons. Press P.SCAN again or one of the pushbuttons to stop scanning to listen to a specific stored station. P.SCAN will light up on the display while in this mode. If one of the stations stored on a pushbutton is too weak for the location you are in, the radio display will show the channel number (P1-P6) for several seconds before advancing to the next preset station.

Setting the Tone

BASS: Press lightly on this knob to release it from its stored position. Turn the knob clockwise to increase the bass and counterclockwise to decrease the bass. When the BASS control is rotated, the AUTO TONE setting will change to MAN.

TREB: Press lightly on the TREB knob to release it from its stored position. Turn the knob clockwise to increase the treble and counterclockwise to decrease the treble. When the TREB control is rotated, the AUTO TONE setting will change to MAN.

Push these knobs back in to their stored position when you're not using them.

AUTO TONE: Press this button to select among the five preset equalization settings and tailor the sound to the music or voice being heard. Each time you press the button, the selection will switch to one of the preset settings of CLASSIC, NEWS, ROCK, POP or JAZZ. The display will show which mode the receiver is in. To return to the manual mode, press and release this button until MAN appears on the display. This will return the tone adjustment to the TREB and BASS controls. When a TREB or BASS control is rotated, tone is automatically set to MAN.

Adjusting the Speakers

BAL: Press lightly on this knob to release it from its stored position. Turn the control clockwise to adjust sound to the right speakers and counterclockwise to adjust sound to the left speakers.

FADE: Press lightly on this knob to release it from its stored position. Turn the control clockwise to adjust the sound to the front and counterclockwise for rear speakers.

Push these knobs back in to their stored position when you're not using them.

Playing a Compact Disc

PWR: Press this knob to turn the system on. (Please note that you can also turn the system on when you insert a compact disc into the player with the ignition on.)

Insert a disc partway into the slot, label side up. The player will pull it in. Wait a few seconds and the disc should play. CD and a CD symbol will also appear on the display. Anytime you are playing a CD, the letters CD will be next to the CD symbol.

If the disc comes back out and ERR appears on the display, it could be that:

- You are driving on a very rough road. (The disc should play when the road gets smoother.)
- The disc is upside down.
- It is dirty, scratched or wet.
- It is very humid. (If so, wait about an hour and try again.)
- The disc player is very hot.

Press RECALL to make ERR go off the display.

RECALL: Press this button to see what track is playing. Press it again within five seconds to see how long the CD has been playing that track. Elapsed time is displayed in minutes and tenths of a second. The track number will also appear when a new track begins to play. Press RECALL again to return to the time display.

PREV (1): Press PREV or the SEEK left arrow to search for the previous selection. If you hold this button or press it more than once, the disc will advance further. Sound is muted in this mode.

RDM (2): Press this button to play the tracks on the disc in random (instead of 1, 2, 3. . .) order. While in the RDM mode, RANDOM appears on the display. Press RDM again to return to normal play.

NEXT (3): Press NEXT or the SEEK right arrow to search for the next selection. If you hold this button or press it more than once, the disc will advance further. The next track number will appear on the display. Sound is muted in this mode.

REV (4): Press and hold REV to return rapidly to a favorite passage. You will hear the disc selection play at high speed while you press the REV button. This allows you to listen and find out when the disc is at the desired selection. Release REV to resume playing.

FWD (6): Press and hold this button to advance rapidly within a track. You will hear the disc selection play at high speed while you press the FWD button. This allows you to listen and find out when the disc is at the desired selection. Release FWD to resume playing.

AM-FM: While in the CD mode, press this button to stop playing the CD and play the radio. The CD symbol will still display but the word CD will be replaced with either AM, FM1 or FM2. (If the radio is turned off, the disc stays in the player and will resume playing at the point where it stopped.)

CD AUX: To switch between the player and the radio when a disc is playing, press the AM-FM button. To return to the player, press CD AUX. When a disc is playing, the letters CD and the CD symbol will appear on the display. (If the radio is turned off, the disc stays in the player and will resume playing at the point where it stopped.)

EJECT: Press this button to eject the disc from the player and play the radio. When the same or a new disc is inserted, the disc will start playing on track one. If a compact disc is left sitting in the opening for more than a few seconds, the player will pull the CD back in. The radio will continue playing. When the ignition is off, press this button to load a CD.

Theft-Deterrent Feature

THEFTLOCK™ is designed to discourage theft of your radio. It works by using a secret code to disable all radio functions whenever battery power is removed.

The THEFTLOCK feature for the radio may be used or ignored. If ignored, the system plays normally and the radio is not protected by the feature. If THEFTLOCK is activated, your radio will not operate if stolen.

When THEFTLOCK is activated, the radio will display LOC to indicate a locked condition anytime battery power is removed. If your battery loses power for any reason, you must unlock the radio with the secret code before it will operate.

Activating the Theft-Deterrent Feature

The instructions which follow, explain how to enter your secret code to activate the THEFTLOCK system. It is recommended that you read through all nine steps before starting the procedure.

NOTE: If you allow more than 15 seconds to elapse between any steps, the radio automatically reverts to time and you must start the procedure over at Step 4.

1. Write down any three or four-digit number from 000 to 1999 and keep it in a safe place separate from the vehicle.
2. Turn the ignition to the ACCESSORY or RUN position.
3. Turn the radio off.
4. Press the 1 and 4 buttons together. Hold them down until --- shows on the display. Next you will use the secret code number which you have written down.
5. Press MN and 000 will appear on the display.
6. Press MN again to make the last two digits agree with your code.
7. Press HR to make the first one or two digits agree with your code.
8. Press AM-FM after you have confirmed that the code matches the secret code you have written down. The display will show REP to let you know that you need to repeat Steps 5 through 7 to confirm your secret code.
9. Press AM-FM and this time the display will show SEC to let you know that your radio is secure. The indicator by the volume control will begin flashing when the ignition is turned off.

Unlocking the Theft-Deterrent Feature After a Power Loss

Enter your secret code as follows; pause no more than 15 seconds between steps:

1. LOC appears when the ignition is on.
2. Press MN and 000 will appear on the display.
3. Press MN again to make the last two digits agree with your code.
4. Press HR to make the first one or two digits agree with your code.
5. Press AM-FM after you have confirmed that the code matches the secret code you have written down. The display will show SEC, indicating the radio is now operable and secure.

If you enter the wrong code eight times, INOP will appear on the display. You will have to wait an hour with the ignition on before you can try again. When you try again, you will only have three chances to enter the correct code before INOP appears.

If you lose or forget your code, contact your dealer.

Disabling the Theft-Deterrent Feature

Enter your secret code as follows; pause no more than 15 seconds between steps:

1. Turn the ignition to the ACCESSORY or RUN position.
2. Turn the radio off.
3. Press the 1 and 4 buttons together. Hold them down until SEC shows on the display.
4. Press MN and 000 will appear on the display.
5. Press MN again to make the last two digits agree with your code.
6. Press HR to make the first one or two digits agree with your code.
7. Press AM-FM after you have confirmed that the code matches the secret code you have written down. The display will show ---, indicating that the radio is no longer secured.

If the code entered is incorrect, SEC will appear on the display. The radio will remain secured until the correct code is entered.

When battery power is disconnected from a secured radio, the radio won't turn on and LOC will appear on the display.

To unlock a secured radio, see "Unlocking the Theft-Deterrent Feature After a Power Loss" earlier in this section.

Understanding Radio Reception

FM Stereo

FM stereo will give you the best sound. But FM signals will reach only about 10 to 40 miles (16 to 65 km). Tall buildings or hills can interfere with FM signals, causing the sound to come and go.

AM

The range for most AM stations is greater than for FM, especially at night. The longer range, however, can cause stations to interfere with each other. AM can pick up noise from things like storms and power lines. Try reducing the treble to reduce this noise if you ever get it.

Tips About Your Audio System

Hearing damage from loud noise is almost undetectable until it is too late. Your hearing can adapt to higher volumes of sound. Sound that seems normal can be loud and harmful to your hearing. Take precautions by adjusting the volume control on your radio to a safe sound level before your hearing adapts to it.

To help avoid hearing loss or damage:

- Adjust the volume control to the lowest setting.
- Increase volume slowly until you hear comfortably and clearly.

NOTICE:

Before you add any sound equipment to your vehicle -- like a tape player, CB radio, mobile telephone or two-way radio -- be sure you can add what you want. If you can, it's very important to do it properly. Added sound equipment may interfere with the operation of your vehicle's engine, Delco radio or other systems, and even damage them. Your vehicle's systems may interfere with the operation of sound equipment that has been added improperly.

So, before adding sound equipment, check with your dealer and be sure to check Federal rules covering mobile radio and telephone units.

Care of Your Cassette Tape Player

A tape player that is not cleaned regularly can cause reduced sound quality, ruined cassettes or a damaged mechanism. Cassette tapes should be stored in their cases away from contaminants, direct sunlight and extreme heat. If they aren't, they may not operate properly or may cause failure of the tape player.

Your tape player should be cleaned regularly after every 50 hours of use. Your radio may display CLN to indicate that you have used your tape player for 50 hours without resetting the tape clean timer. If you notice a reduction in sound quality, try a known good cassette to see if the tape or the tape player is at fault. If this other cassette has no improvement in sound quality, clean the tape player.

Cleaning may be done with a scrubbing action, non-abrasive cleaning cassette with pads which scrub the tape head as the hubs of the cleaner cassette turn. It is normal for the cassette to eject while cleaning. Insert the cassette at least three times to ensure thorough cleaning. A scrubbing action cleaning cassette is available through your GM dealer

You may also choose a non-scrubbing action, wet-type cleaner which uses a cassette with a fabric belt to clean the tape head. This type of cleaning cassette will not eject. It may not clean as thoroughly as the scrubbing type cleaner.

Cassettes are subject to wear and the sound quality may degrade over time. Always make sure that the cassette tape is in good condition before you have your tape player serviced.

Care of Your Compact Discs

Handle discs carefully. Store them in their original cases or other protective cases and away from direct sunlight and dust. If the surface of a disc is soiled, dampen a clean, soft cloth in a mild, neutral detergent solution and clean it, wiping from the center to the edge.

Be sure never to touch the signal surface when handling discs. Pick up discs by grasping the outer edges or the edge of the hole and the outer edge.

Power Antenna Mast Care

Your power antenna will look its best and work well if it's cleaned from time to time. To clean the antenna mast:

1. Turn on the ignition and radio to raise the antenna.
2. Dampen a clean cloth with mineral spirits or equivalent solvent.
3. Wipe the cloth over the mast sections, removing any dirt.
4. Wipe dry with a clean cloth.
5. Make the antenna go up and down by turning the radio or ignition off and on.
6. Repeat if necessary.

NOTICE:

Don't lubricate the power antenna. Lubrication could damage it.

NOTICE:

Before entering an automatic car wash, turn off your radio to make the power antenna go down. This will prevent the mast from possibly getting damaged. If the antenna does not go down when you turn the radio off, it may be damaged or need to be cleaned. In either case, lower the antenna by hand by carefully pressing the antenna down.

If the mast portion of your antenna is damaged, you can easily replace it. See your dealer for a replacement kit and follow the instructions in the kit.

Adjustable Mast Antenna

The mast should be fully retracted before entering any automated wash facility to minimize the risk of antenna damage.

If the mast should ever become slightly bent, you can straighten it out by hand. If the mast is badly bent, as it might be by vandals, you should replace it.

Check every once in a while to be sure the antenna is still tightened to the body side panel.

NOTES

NOTES

Section 4 Your Driving and the Road



Here you'll find information about driving on different kinds of roads and in varying weather conditions. We've also included many other useful tips on driving.

Defensive Driving

The best advice anyone can give about driving is: Drive defensively.

Please start with a very important safety device in your vehicle: Buckle up. (See "Safety Belts" in the Index.)

Defensive driving really means "be ready for anything." On city streets, rural roads or freeways, it means "always expect the unexpected."

Assume that pedestrians or other drivers are going to be careless and make mistakes. Anticipate what they might do. Be ready for their mistakes.

Rear-end collisions are about the most preventable of accidents. Yet they are common. Allow enough following distance. It's the best defensive driving maneuver, in both city and rural driving. You never know when the vehicle in front of you is going to brake or turn suddenly.

Drunken Driving

Death and injury associated with drinking and driving is a national tragedy. It's the number one contributor to the highway death toll, claiming thousands of victims every year.

Alcohol affects four things that anyone needs to drive a vehicle:

- Judgment
- Muscular Coordination
- Vision
- Attentiveness.

Police records show that almost half of all motor vehicle-related deaths involve alcohol. In most cases, these deaths are the result of someone who was drinking and driving. In recent years, some 18,000 annual motor vehicle-related deaths have been associated with the use of alcohol, with more than 300,000 people injured.

Many adults -- by some estimates, nearly half the adult population -- choose never to drink alcohol, so they never drive after drinking. For persons under 21, it's against the law in every U.S. state to drink alcohol. There are good medical, psychological and developmental reasons for these laws.

The obvious way to solve this highway safety problem is for people never to drink alcohol and then drive. But what if people do? How much is "too much" if the driver plans to drive? It's a lot less than many might think. Although it depends on each person and situation, here is some general information on the problem.

The Blood Alcohol Concentration (BAC) of someone who is drinking depends upon four things:

- The amount of alcohol consumed
- The drinker's body weight
- The amount of food that is consumed before and during drinking
- The length of time it has taken the drinker to consume the alcohol.

According to the American Medical Association, a 180-lb. (82 kg) person who drinks three 12-ounce (355 ml) bottles of beer in an hour will end up with a BAC of about 0.06 percent. The person would reach the same BAC by drinking three 4-ounce (120 ml) glasses of wine or three mixed drinks if each had 1-1/2 ounces (45 ml) of a liquor like whiskey, gin or vodka.

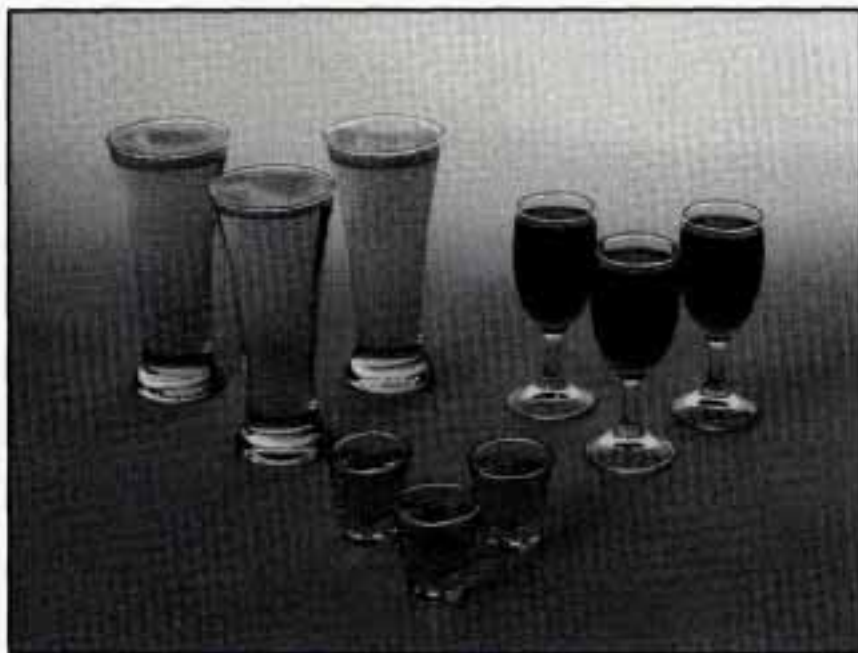

It's the amount of alcohol that counts. For example, if the same person drank three double martinis (3 ounces or 90 ml of liquor each) within an hour, the person's BAC would be close to 0.12 percent. A person who consumes food just before or during drinking will have a somewhat lower BAC level.

There is a gender difference, too. Women generally have a lower relative percentage of body water than men.

Since alcohol is carried in body water, this means that a woman generally will reach a higher BAC level than a man of her same body weight when each has the same number of drinks.

The law in many U.S. states sets the legal limit at a BAC of 0.10 percent. In a growing number of U.S. states, and throughout Canada, the limit is 0.08 percent. In some other countries, it's even lower. The BAC limit for all commercial drivers in the United States is 0.04 percent.

The BAC will be over 0.10 percent after three to six drinks (in one hour). Of course, as we've seen, it depends on how much alcohol is in the drinks, and how quickly the person drinks them.

But the ability to drive is affected well below a BAC of 0.10 percent. Research shows that the driving skills of many people are impaired at a BAC approaching 0.05 percent, and that the effects are worse at night. All drivers are impaired at BAC levels above 0.05 percent. Statistics show that the chance of being in a collision increases sharply for drivers who have a BAC of 0.05 percent or above. A driver with a BAC level of 0.06 percent has doubled his or her chance of having a collision. At a BAC level of 0.10 percent, the chance of this driver having a collision is 12 times greater; at a level of 0.15 percent, the chance is 25 times greater!

The body takes about an hour to rid itself of the alcohol in one drink. No amount of coffee or number of cold showers will speed that up. "I'll be careful" isn't the right answer. What if there's an emergency, a need to take sudden action, as when a child darts into the street? A person with even a moderate BAC might not be able to react quickly enough to avoid the collision.

There's something else about drinking and driving that many people don't know. Medical research shows that alcohol in a person's system can make crash injuries worse, especially injuries to the brain, spinal cord or heart. This means that when anyone who has been drinking -- driver or passenger -- is in a crash, that person's chance of being killed or permanently disabled is higher than if the person had not been drinking.



CAUTION:

Drinking and then driving is very dangerous. Your reflexes, perceptions, attentiveness and judgment can be affected by even a small amount of alcohol. You can have a serious -- or even fatal -- collision if you drive after drinking. Please don't drink and drive or ride with a driver who has been drinking. Ride home in a cab; or if you're with a group, designate a driver who will not drink.

Control of a Vehicle

You have three systems that make your vehicle go where you want it to go. They are the brakes, the steering and the accelerator. All three systems have to do their work at the places where the tires meet the road.

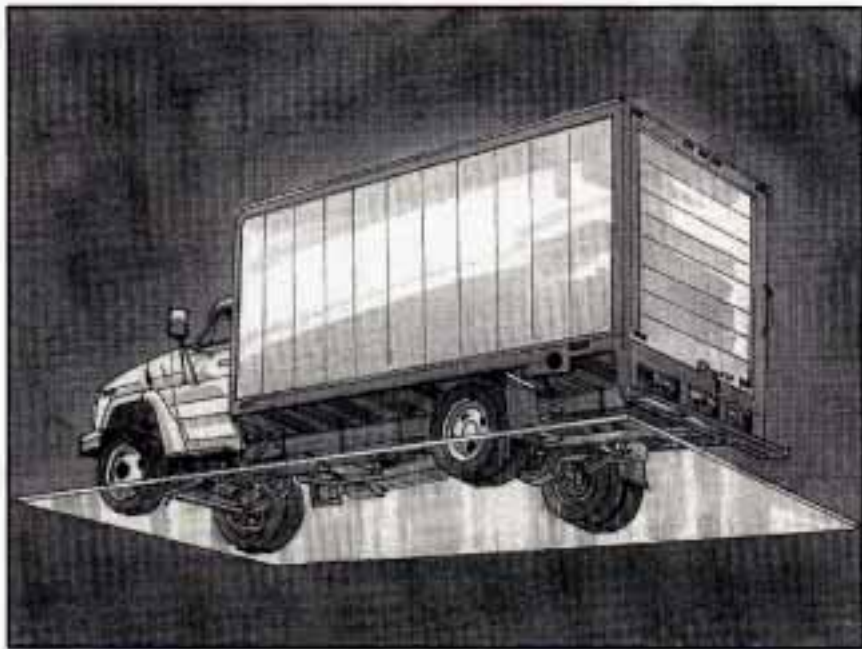

Sometimes, as when you're driving on snow or ice, it's easy to ask more of those control systems than the tires and road can provide. That means you can lose control of your vehicle.

Braking

Braking action involves *perception time* and *reaction time*.

First, you have to decide to push on the brake pedal. That's *perception time*. Then you have to bring up your foot and do it. That's *reaction time*.

Average *reaction time* is about $3/4$ of a second. But that's only an average. It might be less with one driver and as long as two or three seconds or more with another. Age, physical condition, alertness, coordination and eyesight all play a part. So do alcohol, drugs and frustration. But even in $3/4$ of a second, a vehicle moving at 60 mph (100 km/h) travels 66 feet (20 m). That could be a lot of distance in an emergency, so keeping enough space between your vehicle and others is important.

And, of course, actual stopping distances vary greatly with the surface of the road (whether it's pavement or gravel); the condition of the road (wet, dry, icy); tire tread; and the condition of your brakes.

Avoid needless heavy braking. Some people drive in spurts -- heavy acceleration followed by heavy braking -- rather than keeping pace with traffic. This is a mistake. Your brakes may not have time to cool between hard stops. Your brakes will wear out much faster if you do a lot of heavy braking. If you keep pace with the traffic and allow realistic following distances, you will eliminate a lot of unnecessary braking. That means better braking and longer brake life.

If your engine ever stops while you're driving, brake normally but don't pump your brakes. If you do, the pedal may get harder to push down. If your engine stops, you will still have some power brake assist. But you will use it when you brake. Once the power assist is used up, it may take longer to stop and the brake pedal will be harder to push.

Anti-Lock Brakes

Your vehicle has anti-lock brakes (ABS). ABS is an advanced electronic braking system that will help prevent a braking skid.

When you start your engine and begin to drive away, your anti-lock brake system will check itself. You may hear a momentary motor or clicking noise while this test is going on. This is normal.

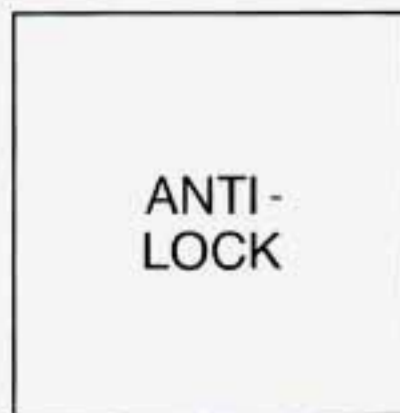

If there's a problem with the anti-lock brake system, this warning light will stay on. See "Anti-Lock Brake System Warning Light" in the Index.

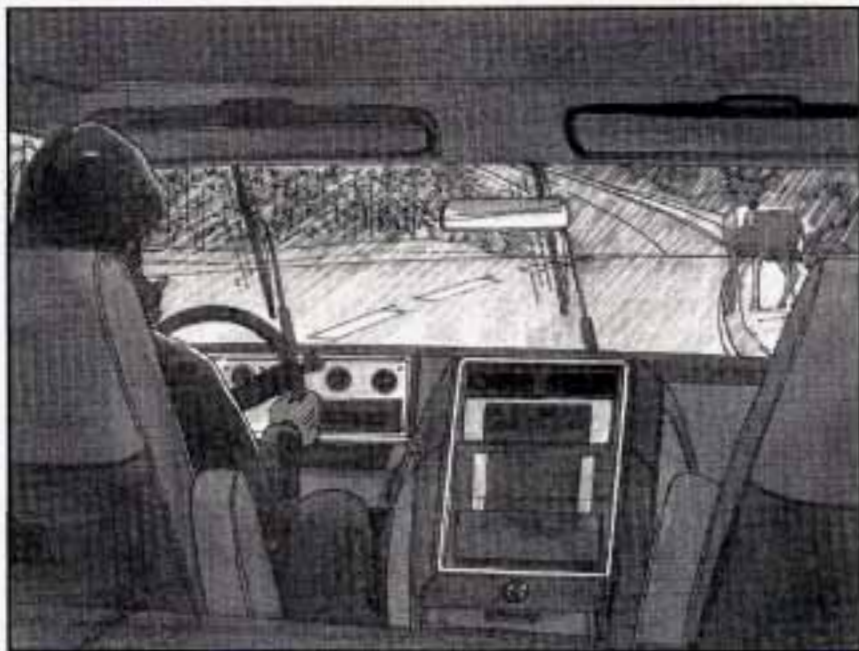

Here's how anti-lock works. Let's say the road is wet. You're driving safely. Suddenly an animal jumps out in front of you.

You slam on the brakes. Here's what happens with ABS. A computer senses that wheels are slowing down. If one of the wheels is about to stop rolling, the computer will separately work the brakes at each front wheel and at the rear wheels.

The anti-lock system can change the brake pressure faster than any driver could. The computer is programmed to make the most of available tire and road conditions.



You can steer around the obstacle while braking hard. As you brake, your computer keeps receiving updates on wheel speed and controls braking pressure accordingly.

Remember: Anti-lock doesn't change the time you need to get your foot up to the brake pedal or always decrease stopping distance. If you get too close to the vehicle in front of you, you won't have time to apply your brakes if that vehicle suddenly slows or stops. Always leave enough room up ahead to stop, even though you have anti-lock brakes.

Using Anti-Lock

Don't pump the brakes. Just hold the brake pedal down and let anti-lock work for you. You may feel the brakes vibrate, or you may notice some noise, but this is normal.

Braking in Emergencies

Use your anti-lock braking system when you need to. With anti-lock, you can steer and brake at the same time. In many emergencies, steering can help you more than even the very best braking.

Steering

Power Steering

If you lose power steering assist because the engine stops or the system is not functioning, you can steer but it will take much more effort.

Steering Tips

Driving on Curves

It's important to take curves at a reasonable speed.

A lot of the "driver lost control" accidents mentioned on the news happen on curves. Here's why:

Experienced driver or beginner, each of us is subject to the same laws of physics when driving on curves. The traction of the tires against the road surface makes it possible for the vehicle to change its path when you turn the front wheels. If there's no traction, inertia will keep the vehicle going in the same direction. If you've ever tried to steer a vehicle on wet ice, you'll understand this.

The traction you can get in a curve depends on the condition of your tires and the road surface, the angle at which the curve is banked, and your speed.

While you're in a curve, speed is the one factor you can control.

Suppose you're steering through a sharp curve. Then you suddenly accelerate. Both control systems -- steering and acceleration -- have to do their work where the tires meet the road. Adding the sudden acceleration can demand too much of those places. You can lose control.

What should you do if this ever happens? Ease up on the accelerator pedal, steer the vehicle the way you want it to go, and slow down.

Speed limit signs near curves warn that you should adjust your speed. Of course, the posted speeds are based on good weather and road conditions. Under less favorable conditions you'll want to go slower.

If you need to reduce your speed as you approach a curve, do it before you enter the curve, while your front wheels are straight ahead.

Try to adjust your speed so you can "drive" through the curve. Maintain a reasonable, steady speed. Wait to accelerate until you are out of the curve, and then accelerate gently into the straightaway.

Steering in Emergencies

There are times when steering can be more effective than braking. For example, you come over a hill and find a truck stopped in your lane, or a car suddenly pulls out from nowhere, or a child darts out from between parked cars and stops right in front of you. You can avoid these problems by braking -- if you can stop in time. But sometimes you can't; there isn't room. That's the time for evasive action -- steering around the problem.

Your vehicle can perform very well in emergencies like these. First apply your brakes. (See "Braking in Emergencies" earlier in this section.) It is better to remove as much speed as you can from a possible collision. Then steer around the problem, to the left or right depending on the space available.



An emergency like this requires close attention and a quick decision. If you are holding the steering wheel at the recommended 9 and 3 o'clock positions, you can turn it a full 180 degrees very quickly without removing either hand. But you have to act fast, steer quickly, and just as quickly straighten the wheel once you have avoided the object.

The fact that such emergency situations are always possible is a good reason to practice defensive driving at all times and wear safety belts properly.

Off-Road Recovery

You may find sometime that your right wheels have dropped off the edge of a road onto the shoulder while you're driving.

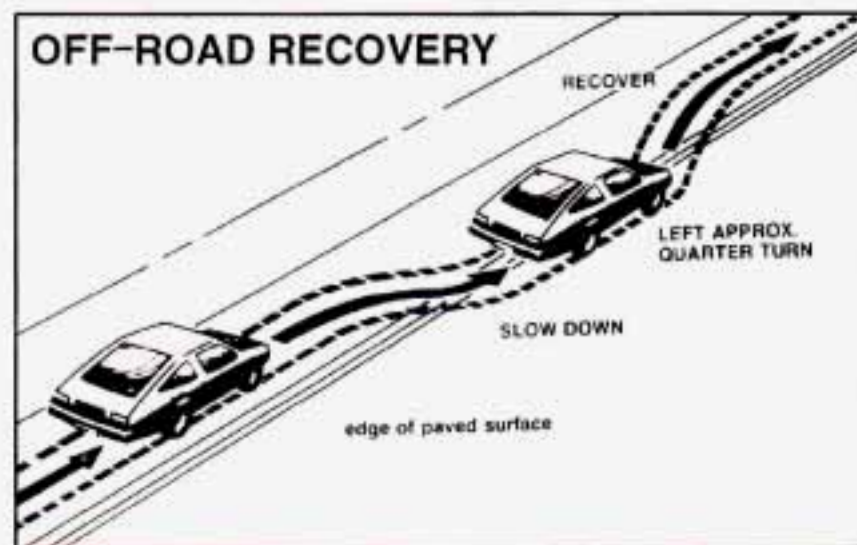

If the level of the shoulder is only slightly below the pavement, recovery should be fairly easy. Ease off the accelerator and then, if there is nothing in the way, steer so that your vehicle straddles the edge of the pavement. You can turn the steering wheel up to one-quarter turn until the right front tire contacts the pavement edge. Then turn your steering wheel to go straight down the roadway.

Passing

The driver of a vehicle about to pass another on a two-lane highway waits for just the right moment, accelerates, moves around the vehicle ahead, then goes back into the right lane again. A simple maneuver?

Not necessarily! Passing another vehicle on a two-lane highway is a potentially dangerous move, since the passing vehicle occupies the same lane as oncoming traffic for several seconds. A miscalculation, an error in judgment, or a brief surrender to frustration or anger can suddenly put the passing driver face to face with the worst of all traffic accidents -- the head-on collision.

So here are some tips for passing:

- "Drive ahead." Look down the road, to the sides and to crossroads for situations that might affect your passing patterns. If you have any doubt whatsoever about making a successful pass, wait for a better time.
- Watch for traffic signs, pavement markings and lines. If you can see a sign up ahead that might indicate a turn or an intersection, delay your pass. A broken center line usually indicates it's all right to pass (providing the road ahead is clear). Never cross a solid line on your side of the lane or a double solid line, even if the road seems empty of approaching traffic.

- Do not get too close to the vehicle you want to pass while you're awaiting an opportunity. For one thing, following too closely reduces your area of vision, especially if you're following a larger vehicle. Also, you won't have adequate space if the vehicle ahead suddenly slows or stops. Keep back a reasonable distance.
- When it looks like a chance to pass is coming up, start to accelerate but stay in the right lane and don't get too close. Time your move so you will be increasing speed as the time comes to move into the other lane. If the way is clear to pass, you will have a "running start" that more than makes up for the distance you would lose by dropping back. And if something happens to cause you to cancel your pass, you need only slow down and drop back again and wait for another opportunity.
- If other cars are lined up to pass a slow vehicle, wait your turn. But take care that someone isn't trying to pass you as you pull out to pass the slow vehicle. Remember to glance over your shoulder and check the blind spot.

- Check your mirrors, glance over your shoulder and start your left lane change signal before moving out of the right lane to pass. When you are far enough ahead of the passed vehicle to see its front in your inside mirror, activate your right lane change signal and move back into the right lane. (Remember that your right outside mirror is convex. The vehicle you just passed may seem to be farther away from you than it really is.)
- Try not to pass more than one vehicle at a time on two-lane roads. Reconsider before passing the next vehicle.
- Don't overtake a slowly moving vehicle too rapidly. Even though the brake lamps are not flashing, it may be slowing down or starting to turn.
- If you're being passed, make it easy for the following driver to get ahead of you. Perhaps you can ease a little to the right.

Loss of Control

Let's review what driving experts say about what happens when the three control systems (brakes, steering and acceleration) don't have enough friction where the tires meet the road to do what the driver has asked.

In any emergency, don't give up. Keep trying to steer and constantly seek an escape route or area of less danger.

Skidding

In a skid, a driver can lose control of the vehicle. Defensive drivers avoid most skids by taking reasonable care suited to existing conditions, and by not "overdriving" those conditions. But skids are always possible.

The three types of skids correspond to your vehicle's three control systems. In the braking skid, your wheels aren't rolling. In the steering or cornering skid, too much speed or steering in a curve causes tires to slip and lose cornering force. And in the acceleration skid, too much throttle causes the driving wheels to spin.

A cornering skid and an acceleration skid are best handled by easing your foot off the accelerator pedal.

If your vehicle starts to slide, ease your foot off the accelerator pedal and quickly steer the way you want the vehicle to go. If you start steering quickly enough, your vehicle may straighten out. Always be ready for a second skid if it occurs.

Of course, traction is reduced when water, snow, ice, gravel or other material is on the road. For safety, you'll want to slow down and adjust your driving to these conditions. It is important to slow down on slippery surfaces because stopping distance will be longer and vehicle control more limited.

While driving on a surface with reduced traction, try your best to avoid sudden steering, acceleration or braking (including engine braking by shifting to a lower gear). Any sudden changes could cause the tires to slide. You may not realize the surface is slippery until your vehicle is skidding. Learn to recognize warning clues -- such as enough water, ice or packed snow on the road to make a "mirrored surface" -- and slow down when you have any doubt.

Remember: Any anti-lock brake system (ABS) helps avoid only the braking skid.

Driving at Night

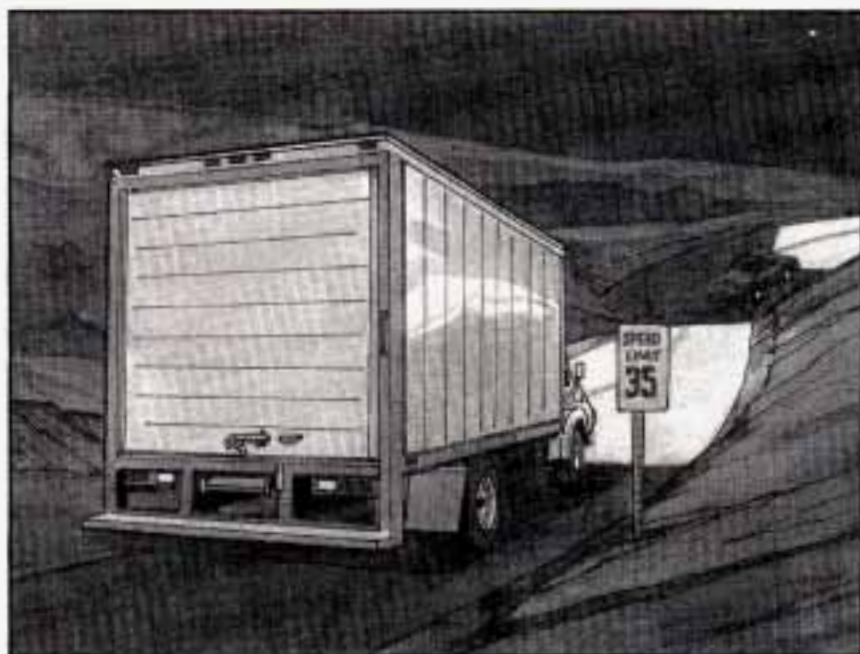

Night driving is more dangerous than day driving. One reason is that some drivers are likely to be impaired -- by alcohol or drugs, with night vision problems, or by fatigue.

Here are some tips on night driving.

- Drive defensively.
- Don't drink and drive.
- Adjust your inside rearview mirror to reduce the glare from headlamps behind you.
- Since you can't see as well, you may need to slow down and keep more space between you and other vehicles.
- Slow down, especially on higher speed roads. Your headlamps can light up only so much road ahead.
- In remote areas, watch for animals.
- If you're tired, pull off the road in a safe place and rest.

Night Vision

No one can see as well at night as in the daytime. But as we get older these differences increase. A 50-year-old driver may require at least twice as much light to see the same thing at night as a 20-year-old.

What you do in the daytime can also affect your night vision. For example, if you spend the day in bright sunshine you are wise to wear sunglasses. Your eyes will

have less trouble adjusting to night. But if you're driving, don't wear sunglasses at night. They may cut down on glare from headlamps, but they also make a lot of things invisible.

You can be temporarily blinded by approaching headlamps. It can take a second or two, or even several seconds, for your eyes to readjust to the dark. When you are faced with severe glare (as from a driver who doesn't lower the high beams, or a vehicle with misaimed headlamps), slow down a little. Avoid staring directly into the approaching headlamps.

Keep your windshield and all the glass on your vehicle clean -- inside and out. Glare at night is made much worse by dirt on the glass. Even the inside of the glass can build up a film caused by dust. Dirty glass makes lights dazzle and flash more than clean glass would, making the pupils of your eyes contract repeatedly.

Remember that your headlamps light up far less of a roadway when you are in a turn or curve. Keep your eyes moving; that way, it's easier to pick out dimly lighted objects. Just as your headlamps should be checked regularly for proper aim, so should your eyes be examined regularly. Some drivers suffer from night blindness -- the inability to see in dim light -- and aren't even aware of it.

Driving in Rain and on Wet Roads



Rain and wet roads can mean driving trouble. On a wet road, you can't stop, accelerate or turn as well because

your tire-to-road traction isn't as good as on dry roads. And, if your tires don't have much tread left, you'll get even less traction. It's always wise to go slower and be cautious if rain starts to fall while you are driving. The surface may get wet suddenly when your reflexes are tuned for driving on dry pavement.

The heavier the rain, the harder it is to see. Even if your windshield wiper blades are in good shape, a heavy rain can make it harder to see road signs and traffic signals, pavement markings, the edge of the road and even people walking.

It's wise to keep your wiping equipment in good shape and keep your windshield washer tank filled with washer fluid. Replace your windshield wiper inserts when they show signs of streaking or missing areas on the windshield, or when strips of rubber start to separate from the inserts.



⚠ CAUTION:

Wet brakes can cause accidents. They won't work well in a quick stop and may cause pulling to one side. You could lose control of the vehicle.

After driving through a large puddle of water or a car wash, apply your brake pedal lightly until your brakes work normally.

Driving too fast through large water puddles or even going through some car washes can cause problems, too. The water may affect your brakes. Try to avoid puddles. But if you can't, try to slow down before you hit them.

Hydroplaning

Hydroplaning is dangerous. So much water can build up under your tires that they can actually ride on the water. This can happen if the road is wet enough and you're going fast enough. When your vehicle is hydroplaning, it has little or no contact with the road.

Hydroplaning doesn't happen often. But it can if your tires haven't much tread or if the pressure in one or more is low. It can happen if a lot of water is standing on the road. If you can see reflections from trees, telephone poles or other vehicles, and raindrops "dimple" the water's surface, there could be hydroplaning.

Hydroplaning usually happens at higher speeds. There just isn't a hard and fast rule about hydroplaning. The best advice is to slow down when it is raining.

Driving Through Deep Standing Water

NOTICE:

If you drive too quickly through deep puddles or standing water, water can come in through your engine's air intake and badly damage your engine. Never drive through water that is slightly lower than the underbody of your vehicle. If you can't avoid deep puddles or standing water, drive through them very slowly.

Some Other Rainy Weather Tips

- Turn on your low-beam headlamps -- not just your parking lamps -- to help make you more visible to others.
- Besides slowing down, allow some extra following distance. And be especially careful when you pass another vehicle. Allow yourself more clear room ahead, and be prepared to have your view restricted by road spray.
- Have good tires with proper tread depth. (See "Tires" in the Index.)

City Driving



One of the biggest problems with city streets is the amount of traffic on them. You'll want to watch out for what the other drivers are doing and pay attention to traffic signals.

Here are ways to increase your safety in city driving:

- Know the best way to get to where you are going. Get a city map and plan your trip into an unknown part of the city just as you would for a cross-country trip.
- Try to use the freeways that rim and crisscross most large cities. You'll save time and energy. (See the next part, "Freeway Driving.")
- Treat a green light as a warning signal. A traffic light is there because the corner is busy enough to need it. When a light turns green, and just before you start to move, check both ways for vehicles that have not cleared the intersection or may be running the red light.

Freeway Driving

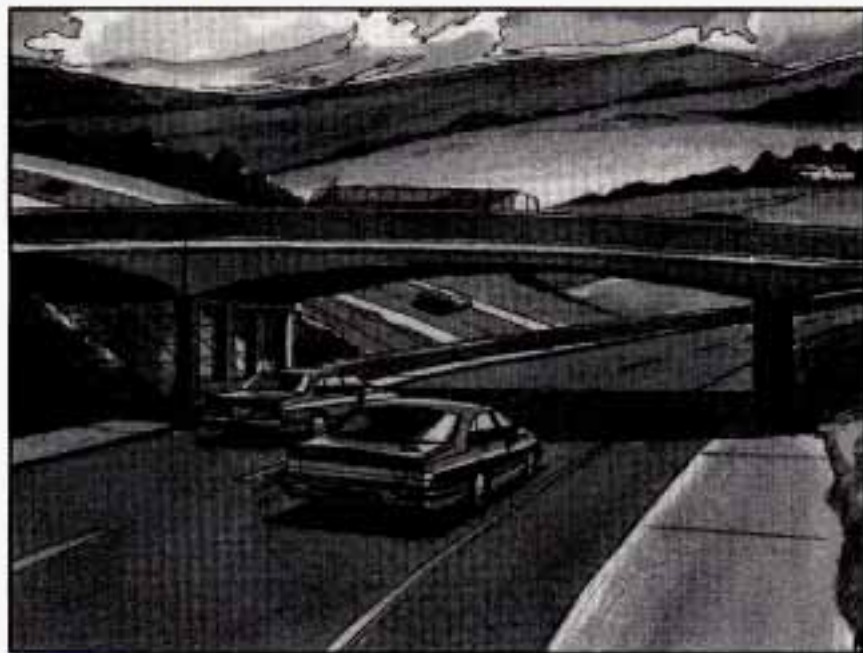

Mile for mile, freeways (also called thruways, parkways, expressways, turnpikes or superhighways) are the safest of all roads. But they have their own special rules.

The most important advice on freeway driving is: Keep up with traffic and keep to the right. Drive at the same speed most of the other drivers are driving. Too-fast or too-slow driving breaks a smooth traffic flow. Treat the left lane on a freeway as a passing lane.

At the entrance, there is usually a ramp that leads to the freeway. If you have a clear view of the freeway as you drive along the entrance ramp, you should begin to check traffic. Try to determine where you expect to blend with the flow. Try to merge into the gap at close to the prevailing speed. Switch on your turn signal, check your mirrors and glance over your shoulder as often as necessary. Try to blend smoothly with the traffic flow.

Once you are on the freeway, adjust your speed to the posted limit or to the prevailing rate if it's slower. Stay in the right lane unless you want to pass.

Before changing lanes, check your mirrors. Then use your turn signal.

Just before you leave the lane, glance quickly over your shoulder to make sure there isn't another vehicle in your "blind" spot.

Once you are moving on the freeway, make certain you allow a reasonable following distance. Expect to move slightly slower at night.

When you want to leave the freeway, move to the proper lane well in advance. If you miss your exit, do not, under any circumstances, stop and back up. Drive on to the next exit.

The exit ramp can be curved, sometimes quite sharply. The exit speed is usually posted.

Reduce your speed according to your speedometer, not to your sense of motion. After driving for any distance at higher speeds, you may tend to think you are going slower than you actually are.

Before Leaving on a Long Trip

Make sure you're ready. Try to be well rested. If you must start when you're not fresh -- such as after a day's work -- don't plan to make too many miles that first part of the journey. Wear comfortable clothing and shoes you can easily drive in.

Is your vehicle ready for a long trip? If you keep it serviced and maintained, it's ready to go. If it needs service, have it done before starting out. Of course, you'll find experienced and able service experts in GM dealers all across North America. They'll be ready and willing to help if you need it.

Here are some things you can check before a trip:

- *Windshield Washer Fluid:* Is the reservoir full? Are all windows clean inside and outside?
- *Wiper Blades:* Are they in good shape?
- *Fuel, Engine Oil, Other Fluids:* Have you checked all levels?
- *Lamps:* Are they all working? Are the lenses clean?
- *Tires:* They are vitally important to a safe, trouble-free trip. Is the tread good enough for long-distance driving? Are the tires all inflated to the recommended pressure?
- *Weather Forecasts:* What's the weather outlook along your route? Should you delay your trip a short time to avoid a major storm system?
- *Maps:* Do you have up-to-date maps?

Highway Hypnosis

Is there actually such a condition as “highway hypnosis”? Or is it just plain falling asleep at the wheel? Call it highway hypnosis, lack of awareness, or whatever.

There is something about an easy stretch of road with the same scenery, along with the hum of the tires on the road, the drone of the engine, and the rush of the wind against the vehicle that can make you sleepy. Don't let it happen to you! If it does, your vehicle can leave the road in *less than a second*, and you could crash and be injured.

What can you do about highway hypnosis? First, be aware that it can happen.

Then here are some tips:

- Make sure your vehicle is well ventilated, with a comfortably cool interior.
- Keep your eyes moving. Scan the road ahead and to the sides. Check your mirrors and your instruments frequently.
- If you get sleepy, pull off the road into a rest, service or parking area and take a nap, get some exercise, or both. For safety, treat drowsiness on the highway as an emergency.

Hill and Mountain Roads



Driving on steep hills or mountains is different from driving in flat or rolling terrain.

If you drive regularly in steep country, or if you're planning to visit there, here are some tips that can make your trips safer and more enjoyable.

- Keep your vehicle in good shape. Check all fluid levels and also the brakes, tires, cooling system and transmission. These parts can work hard on mountain roads.
- Know how to go down hills. The most important thing to know is this: let your engine do some of the slowing down. Shift to a lower gear when you go down a steep or long hill.

 **CAUTION:**

If you don't shift down, your brakes could get so hot that they wouldn't work well. You would then have poor braking or even none going down a hill. You could crash. Shift down to let your engine assist your brakes on a steep downhill slope.

 **CAUTION:**

Coasting downhill in NEUTRAL (N) or with the ignition off is dangerous. Your brakes will have to do all the work of slowing down. They could get so hot that they wouldn't work well. You would then have poor braking or even none going down a hill. You could crash. Always have your engine running and your vehicle in gear when you go downhill.

- Know how to go uphill. You may want to shift down to a lower gear. The lower gears help cool your engine and transmission, and you can climb the hill better.
- Stay in your own lane when driving on two-lane roads in hills or mountains. Don't swing wide or cut across the center of the road. Drive at speeds that let you stay in your own lane.
- As you go over the top of a hill, be alert. There could be something in your lane, like a stalled car or an accident.
- You may see highway signs on mountains that warn of special problems. Examples are long grades, passing or no-passing zones, a falling rocks area or winding roads. Be alert to these and take appropriate action.

Winter Driving

Here are some tips for winter driving:

- Have your vehicle in good shape for winter.
- You may want to put winter emergency supplies in your vehicle.

Include an ice scraper, a small brush or broom, a supply of windshield washer fluid, a rag, some winter outer clothing, a small shovel, a flashlight, a red cloth and a couple of reflective warning triangles. And, if you will be driving under severe conditions, include a small bag of sand, a piece of old carpet or a couple of burlap bags to help provide traction. Be sure you properly secure these items in your vehicle.

Driving on Snow or Ice

Most of the time, those places where your tires meet the road probably have good traction.

However, if there is snow or ice between your tires and the road, you can have a very slippery situation. You'll have a lot less traction or "grip" and will need to be very careful.



What's the worst time for this? "Wet ice." Very cold snow or ice can be slick and hard to drive on. But wet ice can be even more trouble because it may offer the least traction of all. You can get wet ice when it's about freezing (32°F; 0°C) and freezing rain begins to fall. Try to avoid driving on wet ice until salt and sand crews can get there.

Whatever the condition -- smooth ice, packed, blowing or loose snow -- drive with caution.

Accelerate gently. Try not to break the fragile traction. If you accelerate too fast, the drive wheels will spin and polish the surface under the tires even more.

Your anti-lock brakes improve your vehicle's stability when you make a hard stop on a slippery road. Even though you have an anti-lock braking system, you'll want to begin stopping sooner than you would on dry pavement. See "Anti-Lock" in the Index.

- Allow greater following distance on any slippery road.
- Watch for slippery spots. The road might be fine until you hit a spot that's covered with ice. On an otherwise clear road, ice patches may appear in shaded areas where the sun can't reach: around clumps of trees, behind buildings or under bridges. Sometimes the surface of a curve or an overpass may remain icy when the surrounding roads are clear. If you see a patch of ice ahead of you, brake before you are on it. Try not to brake while you're actually on the ice, and avoid sudden steering maneuvers.

If You're Caught in a Blizzard



If you are stopped by heavy snow, you could be in a serious situation. You should probably stay with your vehicle unless you know for sure that you are near help and you can hike through the snow. Here are some things to do to summon help and keep yourself and your passengers safe:

- Turn on your hazard flashers.

- Tie a red cloth to your vehicle to alert police that you've been stopped by the snow.
- Put on extra clothing or wrap a blanket around you. If you have no blankets or extra clothing, make body insulators from newspapers, burlap bags, rags, floor mats -- anything you can wrap around yourself or tuck under your clothing to keep warm.



You can run the engine to keep warm, but be careful.

 **CAUTION:**

Snow can trap exhaust gases under your vehicle. This can cause deadly CO (carbon monoxide) gas to get inside. CO could overcome you and kill you. You can't see it or smell it, so you might not know it is in your vehicle. Clear away snow from around the base of your vehicle, especially any that is blocking your exhaust pipe. And check around again from time to time to be sure snow doesn't collect there.

Open a window just a little on the side of the vehicle that's away from the wind. This will help keep CO out.

Run your engine only as long as you must. This saves fuel. When you run the engine, make it go a little faster than just idle. That is, push the accelerator slightly. This uses less fuel for the heat that you get and it keeps the battery (or batteries) charged. You will need a well-charged battery (or batteries) to restart the vehicle, and possibly for signaling later on with your headlamps. Let the heater run for awhile.

If you have a diesel engine, you may have to run it at a higher speed to get enough heat. Then, shut the engine off and close the window almost all the way to preserve the heat. Start the engine again and repeat this only when you feel really uncomfortable from the cold. But do it as little as possible. Preserve the fuel as long as you can. To help keep warm, you can get out of the vehicle and do some fairly vigorous exercises every half hour or so until help comes.

Loading Your Vehicle

The diagram shows a rectangular label with the following fields:

- Top left: A small square box.
- Top middle: A long horizontal box.
- Below the top middle box: Three smaller boxes labeled "GVWR", "GAWR FRT", and "GAWR RR".
- Below these three boxes: A long horizontal box.
- Below that: A horizontal line.
- Below the line: A horizontal box.
- Bottom left: The text "MODEL:" followed by a box.
- Bottom middle: The text "RIM" followed by a box.
- Bottom right: The text "COLD TIRE PRESSURE" followed by a box.
- Below the "RIM" and "COLD TIRE PRESSURE" boxes: A grid of boxes for "SP" (Speed) and "R" (Rim).
- Bottom center: The text "SEE OWNER'S MANUAL FOR ADDITIONAL INFORMATION." followed by a box.

A large, bold, black "EXAMPLE" watermark is diagonally overlaid across the center of the label.

The Certification/Tire label is found on the rear edge of the driver's door. The label shows the size of your original tires and the inflation pressures needed to obtain the gross weight capacity your vehicle. This is called GVWR (Gross Vehicle Weight Rating). The GVWR includes the weight of the vehicle, all occupants, fuel and cargo.

The Certification/Tire label also tells you the maximum weights for the front and rear axles, called Gross Axle Weight Rating (GAWR). To find out the actual loads on your front and rear axles, you need to go to a weigh station and weigh your vehicle. Your dealer can help you with this. Be sure to spread out your load equally on both sides of the centerline.

Never exceed the GVWR for your vehicle, or the GAWR for either the front or rear axle.

And, if you do have a heavy load, you should spread it out.

 **CAUTION:**

Do not load your vehicle any heavier than the GVWR, or either the maximum front or rear GAWR. If you do, parts on your vehicle can break, or it can change the way your vehicle handles. These could cause you to lose control. Also, overloading can shorten the life of your vehicle.

 **CAUTION:**

Things you put inside your vehicle can strike and injure people in a sudden stop or turn, or in a crash.

- **Put things in the cargo area of your vehicle. Try to spread the weight evenly.**
- **Never stack heavier things, like suitcases, inside the vehicle so that some of them are above the tops of the seats.**
- **Don't leave an unsecured child restraint in your vehicle.**
- **When you carry something inside the vehicle, secure it whenever you can.**
- **Don't leave a seat folded down unless you need to.**

Towing a Trailer

CAUTION:

If you don't use the correct equipment and drive properly, you can lose control when you pull a trailer. For example, if the trailer is too heavy, the brakes may not work well -- or even at all. You and your passengers could be seriously injured. **Pull a trailer only if you have followed all the steps in this section. Ask your GM dealer for advice and information about towing a trailer with your vehicle.**

NOTICE:

Pulling a trailer improperly can damage your vehicle and result in costly repairs not covered by your warranty. To pull a trailer correctly, follow the advice in this part, and see your GM dealer for important information about towing a trailer with your vehicle.

Your vehicle can tow a trailer. To identify what the vehicle trailering capacity is for your vehicle, you should read the information in "Weight of the Trailer" that appears later in this section. But trailering is different than just driving your vehicle by itself. Trailering means changes in handling, durability and fuel economy. Successful, safe trailering takes correct equipment, and it has to be used properly.

That's the reason for this section. In it are many time-tested, important trailering tips and safety rules. Many of these are important for your safety and that of your passengers. So please read this section carefully before you pull a trailer.

If You Do Decide To Pull A Trailer

If you do, here are some important points:

- There are many different laws, including speed limit restrictions, having to do with trailering. Make sure your rig will be legal, not only where you live but also where you'll be driving. A good source for this information can be state or provincial police.
- Consider using a sway control if your trailer will weigh 4,000 lbs. (1 800 kg) or less. You should always use a sway control if your trailer will weigh more than 4,000 lbs. (1 800 kg). You can ask a hitch dealer about sway controls.
- Don't tow a trailer at all during the first 500 miles (800 km) your new vehicle is driven. Your engine, axle or other parts could be damaged.

- Then, during the first 500 miles (800 km) that you tow a trailer, don't drive over 50 mph (80 km/h) and don't make starts at full throttle. This helps your engine and other parts of your vehicle wear in at the heavier loads.
- You should use DRIVE (D) (or, as you need to, a lower gear) when towing a trailer. Operating your vehicle in DRIVE (D) when towing a trailer will minimize heat build-up and extend the life of your transmission.

Three important considerations have to do with weight:
the weight of the trailer,
the weight of the trailer tongue
and the weight on your vehicle's tires.

Weight of the Trailer

How heavy can a trailer safely be?

It depends on how you plan to use your rig. For example, speed, altitude, road grades, outside temperature and how much your vehicle is used to pull a trailer are all important. And, it can also depend on any special equipment that you have on your vehicle.

The following chart shows how much your trailer can weigh, based upon vehicle model and options.

Model	Engine	Axle Ratio	Max. Trailer Weight (lbs.) (kg)	
			Weight (lbs.)	(kg)
G10000	4.3L	3.42	4000	(1816)
		3.73	4500	(2043)
	5.0L	3.42	5000	(2270)
		5.7L	3.42	5500
		3.73	6000	(2724)
G20000	4.3L	3.42	4000	(1816)
		4.10	5000	(2270)
	5.0L	3.42	5000	(2270)
		5.7L	3.42	5500
		3.73	6000	(2724)
		4.10	7500	(3405)
	6.5L	3.73	6500	(2951)
4.10		8000	(3632)	
G30000	5.7L	3.73	6000	(2724)
		4.10	7500	(3405)
	6.5L	3.73	6500	(2951)
		4.10	8000	(3632)
	7.4L	3.42	7000	(3178)
		3.73	8000	(3632)
	4.10	10,000	(4540)	

Maximum trailer weight is calculated assuming the driver and one passenger are in the towing vehicle and it has all the required trailering equipment. The weight of additional equipment, passengers and cargo in the towing vehicle must be subtracted from the above maximum trailer weights.

You can ask your dealer for our trailering information or advice, or you can write us at the address listed in your Warranty and Owner Assistance Information Booklet.

In Canada, write to:

General Motors of Canada Limited
Customer Communication Centre
1908 Colonel Sam Drive
Oshawa, Ontario L1H 8P7

Weight of the Trailer Tongue

The tongue load (A) of any trailer is an important weight to measure because it affects the total or gross weight of your vehicle. The Gross Vehicle Weight (GVW) includes the curb weight of the vehicle, any cargo you may carry in it, and the people who will be riding in the vehicle. And if you will tow a trailer, you must add the tongue load to the GVW because your vehicle will be carrying that weight, too. See "Loading Your Vehicle" in the Index for more information about your vehicle's maximum load capacity.

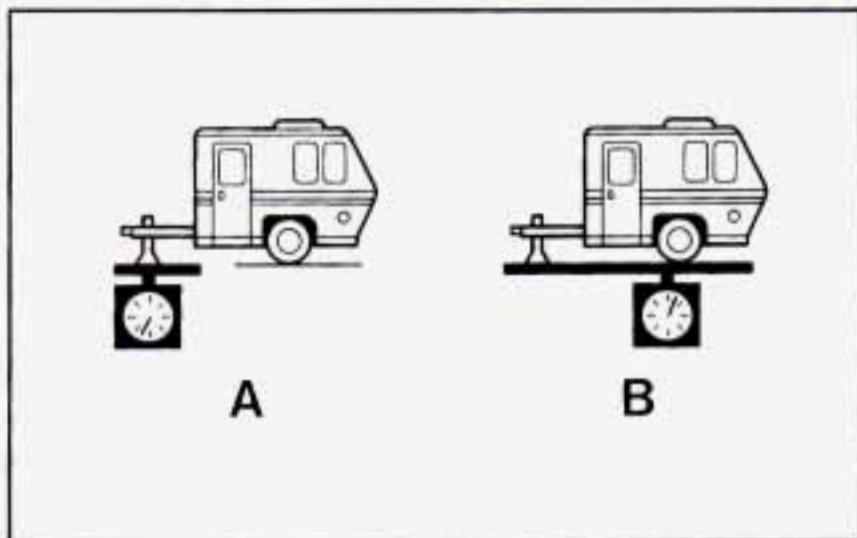

If you're using your platform hitch as a weight-carrying hitch, the trailer tongue (A) should weigh 10 percent of the total loaded trailer weight (B). If you're using your platform hitch as a weight-distributing hitch, the trailer tongue (A) should weigh 12 percent of the total loaded trailer weight (B).

After you've loaded your trailer, weigh the trailer and then the tongue, separately, to see if the weights are proper. If they aren't, you may be able to get them right simply by moving some items around in the trailer.

Total Weight on Your Vehicle's Tires

Be sure your vehicle's tires are inflated to the limit for cold tires. You'll find these numbers on the Certification label at the rear edge of the driver's door or see "Tire Loading" in the Index. Then be sure you don't go over the GVW limit for your vehicle, including the weight of the trailer tongue.

Hitches

It's important to have the correct hitch equipment. Crosswinds, large trucks going by and rough roads are a few reasons why you'll need the right hitch. Here are some rules to follow:

- The bumpers on your vehicle are not intended for hitches. Do not attach rental hitches or other bumper-type hitches to them. Use only a frame-mounted hitch that does not attach to the bumper. Do not use a ball hitch, because it could pull the bumper loose.
- If you'll be pulling a trailer that, when loaded, will weigh more than 4,000 lbs. (1 800 kg), be sure to use a properly mounted, weight-distributing hitch and sway control of the proper size. This equipment is very important for proper vehicle loading and good handling when you're driving.

- Will you have to make any holes in the body of your vehicle when you install a trailer hitch?

If you're using the wiring provided by the factory-installed hitch, you should not need to make any holes in the body of your vehicle. However, if you have an aftermarket hitch installed, you may need to make holes in the body.

If you do, then be sure to seal the holes later when you remove the hitch. If you don't seal them, deadly carbon monoxide (CO) from your exhaust can get into your vehicle (see "Carbon Monoxide" in the Index). Dirt and water can, too.

Safety Chains

You should always attach chains between your vehicle and your trailer. Cross the safety chains under the tongue of the trailer so that the tongue will not drop to the road if it becomes separated from the hitch. Instructions about safety chains may be provided by the hitch manufacturer or by the trailer manufacturer. Follow the manufacturer's recommendation for attaching safety chains and do not attach them to the bumper. Always leave just enough slack so you can turn with your rig. And, never allow safety chains to drag on the ground.

Trailer Brakes

If your trailer weighs more than 1,000 lbs. (450 kg) loaded, then it needs its own brakes -- and they must be adequate. Be sure to read and follow the instructions for the trailer brakes so you'll be able to install, adjust and maintain them properly.

CAUTION:

If you have a rear-most window open and you pull a trailer with your vehicle, carbon monoxide (CO) could come into your vehicle. You can't see or smell CO. It can cause unconsciousness or death. (See "Engine Exhaust" in the Index.) To maximize your safety when towing a trailer:

- Have your exhaust system inspected for leaks, and make necessary repairs before starting on your trip.
- Keep the rear-most windows closed.
- If exhaust does come into your vehicle through a window in the rear or another opening, drive with your front, main heating or cooling system on and with the fan on any speed. This will bring fresh, outside air into your vehicle. Do not use MAX A/C because it only recirculates the air inside your vehicle. (See "Comfort Controls" in the Index.)

Towing a trailer requires a certain amount of experience. Before setting out for the open road, you'll want to get to know your rig. Acquaint yourself with the feel of handling and braking with the added weight of the trailer. And always keep in mind that the vehicle you are driving is now a good deal longer and not nearly as responsive as your vehicle is by itself.

Before you start, check the trailer hitch and platform (and attachments), safety chains, electrical connector, lamps, tires and mirror adjustment. If the trailer has electric brakes, start your vehicle and trailer moving and then apply the trailer brake controller by hand to be sure the brakes are working. This lets you check your electrical connection at the same time.

During your trip, check occasionally to be sure that the load is secure, and that the lamps and any trailer brakes are still working.

Following Distance

Stay at least twice as far behind the vehicle ahead as you would when driving your vehicle without a trailer. This can help you avoid situations that require heavy braking and sudden turns.

Passing

You'll need more passing distance up ahead when you're towing a trailer. And, because you're a good deal longer, you'll need to go much farther beyond the passed vehicle before you can return to your lane.

Backing Up

Hold the bottom of the steering wheel with one hand. Then, to move the trailer to the left, just move that hand to the left. To move the trailer to the right, move your hand to the right. Always back up slowly and, if possible, have someone guide you.

Making Turns

NOTICE:

Making very sharp turns while trailering could cause the trailer to come in contact with the vehicle. Your vehicle could be damaged. Avoid making very sharp turns while trailering.

When you're turning with a trailer, make wider turns than normal. Do this so your trailer won't strike soft shoulders, curbs, road signs, trees or other objects. Avoid jerky or sudden maneuvers. Signal well in advance.

Turn Signals When Towing a Trailer

When you tow a trailer, your vehicle has to have extra wiring and a heavy-duty turn signal flasher (included in the optional trailering package).

The green arrows on your instrument panel will flash whenever you signal a turn or lane change. Properly hooked up, the trailer lamps will also flash, telling other drivers you're about to turn, change lanes or stop.

When towing a trailer, the green arrows on your instrument panel will flash for turns even if the bulbs on the trailer are burned out. Thus, you may think drivers behind you are seeing your signal when they are not. It's important to check occasionally to be sure the trailer bulbs are still working.

Driving On Grades

Reduce speed and shift to a lower gear *before* you start down a long or steep downgrade. If you don't shift down, you might have to use your brakes so much that they would get hot and no longer work well.

On a long uphill grade, shift down and reduce your speed to around 45 mph (70 km/h) to reduce the possibility of engine and transmission overheating.

When towing at high altitude on steep uphill grades, consider the following: Engine coolant will boil at a lower temperature than at normal altitudes. If you turn your engine off immediately after towing at high altitude on steep uphill grades, your vehicle may show signs similar to engine overheating. To avoid this, let the engine run while parked (preferably on level ground) with the automatic transmission in PARK (P) for a few minutes before turning the engine off. If you do get the overheat warning, see "Engine Overheating" in the Index.

Parking on Hills

You really should not park your vehicle, with a trailer attached, on a hill. If something goes wrong, your rig could start to move. People can be injured, and both your vehicle and the trailer can be damaged.

But if you ever have to park your rig on a hill, here's how to do it:

1. Apply your regular brakes, but don't shift into PARK (P) yet. Then turn your wheels into the curb if facing downhill or into traffic if facing uphill.
2. Have someone place chocks under the trailer wheels.
3. When the wheel chocks are in place, release the regular brakes until the chocks absorb the load.
4. Re-apply the regular brakes. Then apply your parking brake and then shift to PARK (P).
5. Release the regular brakes.

When You Are Ready to Leave After Parking on a Hill

1. Apply your regular brakes and hold the pedal down while you:
 - Start your engine;
 - Shift into a gear; and
 - Release the parking brake.
2. Let up on the brake pedal.
3. Drive slowly until the trailer is clear of the chocks.
4. Stop and have someone pick up and store the chocks.

Maintenance When Trailer Towing

Your vehicle will need service more often when you're pulling a trailer. See the Maintenance Schedule for more on this. Things that are especially important in trailer operation are automatic transmission fluid (don't overfill), engine oil, axle lubricant, belt, cooling system and brake adjustment. Each of these is covered in this manual, and the Index will help you find them quickly. If you're trailering, it's a good idea to review these sections before you start your trip.

Check periodically to see that all hitch nuts and bolts are tight.

Trailer Wiring Harness

The eight-wire harness, if you have one, is stored under your vehicle along the rear frame crossmember. It is wrapped and bound with a plastic strap. The harness has a 30-amp battery feed and no connector, and you should have a qualified electrical service person wire your harness for you. Attach the harness to the trailer, then tape or strap it to your vehicle's frame rail. Be sure you leave it loose enough so the wiring doesn't bend or break, but not so loose that it drags on the ground.

Store the harness in its original place. Wrap the harness together and tie it neatly so it won't be damaged.

The five-wire harness, if you have one, is stored inside the vehicle at the passenger side rear corner, behind the jack. This should be wired by a qualified electrical service person. It must be routed out of your vehicle between the rear door and the floor, with enough of the harness left on both sides so that the trailer or the body won't pull it.

Store the harness in its original place. Wrap the harness together and tie it neatly so it won't be damaged.

NOTES

NOTES

Section 5 Problems on the Road

Here you'll find what to do about some problems that can occur on the road.

Hazard Warning Flashers



Your hazard warning flashers let you warn others. They also let police know you have a problem. Your front and rear turn signal lamps will flash on and off.

But they won't flash if you're braking.



Push the button at the top of the steering column all the way down to make your front and rear turn signals flash on and off.

Your hazard warning flashers work no matter what position your key is in, and even if the key isn't in.

To turn off the flashers, push the button until the first click and release.

When the hazard warning flashers are on, your turn signals won't work.

Other Warning Devices

If you carry reflective triangles, you can use them to warn others. Set one up at the side of the road about 300 feet (100 m) behind your vehicle.

Jump Starting

If your battery has run down, you may want to use another vehicle and some jumper cables to start your vehicle. But please use the following steps listed to do it safely.

CAUTION:

Batteries can hurt you. They can be dangerous because:

- They contain acid that can burn you.
- They contain gas that can explode or ignite.
- They contain enough electricity to burn you.

If you don't follow these steps exactly, some or all of these things can hurt you.

NOTICE:

Ignoring these steps could result in costly damage to your vehicle that wouldn't be covered by your warranty.

Trying to start your vehicle by pushing or pulling it won't work, and it could damage your vehicle.

1. Check the other vehicle. It must have a 12-volt battery with a negative ground system.

NOTICE:

If the other system isn't a 12-volt system with a negative ground, both vehicles can be damaged.

If you have a diesel engine vehicle with two batteries (or more) you should know before you begin that, especially in cold weather, you may not be able to get enough power from a single battery in another vehicle to start your diesel engine.

If your vehicle has more than one battery, use the battery that is under the hood of the vehicle -- this will reduce the electrical resistance.

2. Get the vehicles close enough so the jumper cables can reach, but be sure the vehicles aren't touching each other. If they are, it could cause a ground connection you don't want. You wouldn't be able to start your vehicle, and the bad grounding could damage the electrical systems.

Set the parking brake firmly on each vehicle. Put an automatic transmission in PARK (P) or a manual transmission in NEUTRAL (N).

3. Turn off the ignition on both vehicles. Turn off all lamps that aren't needed, and radios. This will avoid sparks and help save both batteries, and could save your radio!

NOTICE:

If you leave your radio on, it could be badly damaged. The repairs would not be covered by your warranty.

4. Open the hoods and locate the batteries. Find the positive (+) and negative (-) terminals on each battery.



CAUTION:

Using a match near a battery can cause battery gas to explode. People have been hurt doing this, and some have been blinded. Use a flashlight if you need more light.

Be sure the battery (or batteries) has enough water. You don't need to add water to the Delco Freedom[®] battery (or batteries) installed in every new GM vehicle. But if a battery has filler caps, be sure the right amount of fluid is there. If it is low, add water to take care of that first. If you don't, explosive gas could be present.

Battery fluid contains acid that can burn you. Don't get it on you. If you accidentally get it in your eyes or on your skin, flush the place with water and get medical help immediately.

5. Check that the jumper cables don't have loose or missing insulation. If they do, you could get a shock. The vehicles could be damaged, too.

Before you connect the cables, here are some basic things you should know. Positive (+) will go to positive (+) and negative (-) will go to negative (-) or a metal engine part. Don't connect positive (+) to negative (-) or you will get a short that would damage the battery and maybe other parts, too.

⚠ CAUTION:

Fans or other moving engine parts can injure you badly. Keep your hands away from moving parts once the engines are running.



6. Connect the red positive (+) cable to the positive (+) terminal of the vehicle with the dead battery. Use a remote positive (+) terminal if the vehicle has one.



7. Don't let the other end touch metal. Connect it to the positive (+) terminal of the good battery. Use a remote positive (+) terminal if the vehicle has one.



8. Now connect the black negative (-) cable to the good battery's negative (-) terminal.

Don't let the other end touch anything until the next step.

9. Make your last connection away from the battery, to the engine block, frame or other metal parts of your vehicle.
10. Now start the vehicle with the good battery and run the engine for a while.
11. Try to start the vehicle with the dead battery. If it won't start after a few tries, it probably needs service.

12. Remove the cables in reverse order to prevent electrical shorting. Take care that they don't touch each other or any other metal.

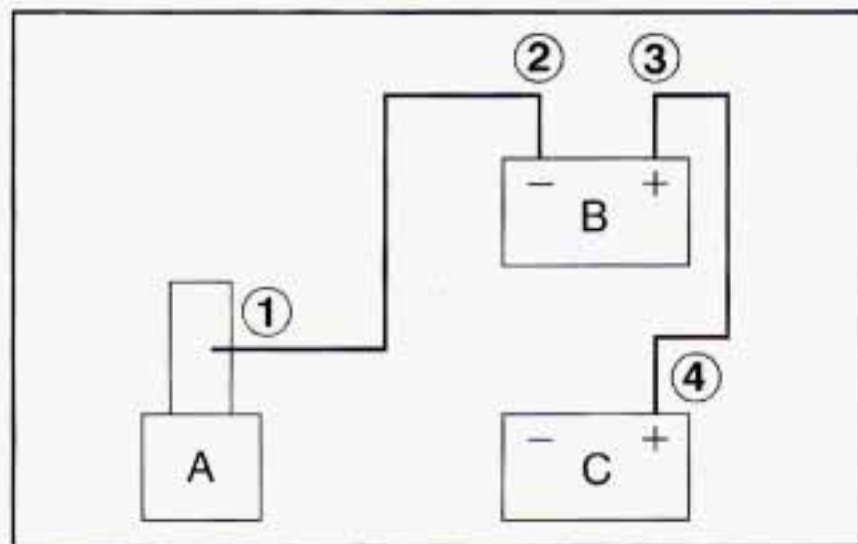

- A. Engine Block, Frame, Heavy Metal Engine Part
B. Good Battery
C. Dead Battery

Towing Your Vehicle

Try to have your GM dealer or a professional towing service tow your vehicle. They can provide the right equipment and know how to tow it without damage. See "Roadside Assistance" in your Index.

If your vehicle has been changed since it was factory-new, by adding things like fog lamps, aero skirting, or special tires and wheels, these things could be damaged during towing.

Before you do anything, turn on the hazard warning flashers.

When you call, tell the towing service:

- That your vehicle has rear wheel drive.
- The make, model and year of your vehicle.
- Whether you can move the shift lever for the transmission.
- If there was an accident, what was damaged.

 **CAUTION:**

To help avoid injury to you or others:

- **Never let passengers ride in a vehicle that is being towed.**
- **Never tow faster than safe or posted speeds.**
- **Never tow with damaged parts not fully secured.**
- **Never get under your vehicle after it has been lifted by the tow truck.**
- **Always use separate safety chains on each side when towing a vehicle.**

 **CAUTION:**

A vehicle can fall from a car carrier if it isn't adequately secured. This can cause a collision, serious personal injury and vehicle damage. The vehicle should be tightly secured with chains or steel cables before it is transported.

Don't use substitutes (ropes, leather straps, canvas webbing, etc.) that can be cut by sharp edges underneath the towed vehicle.

When your vehicle is being towed, have the ignition key off. The steering wheel should be clamped in a straight-ahead position, with a clamping device designed for towing service. Do not use the vehicle's steering column lock for this. The transmission should be in NEUTRAL (N) and the parking brake should be released.

Front Towing

A towing dolly must be used under the drive wheels when towing from the front.

Tow Limits -- 35 mph (56 km/h), 50 miles (80 km)

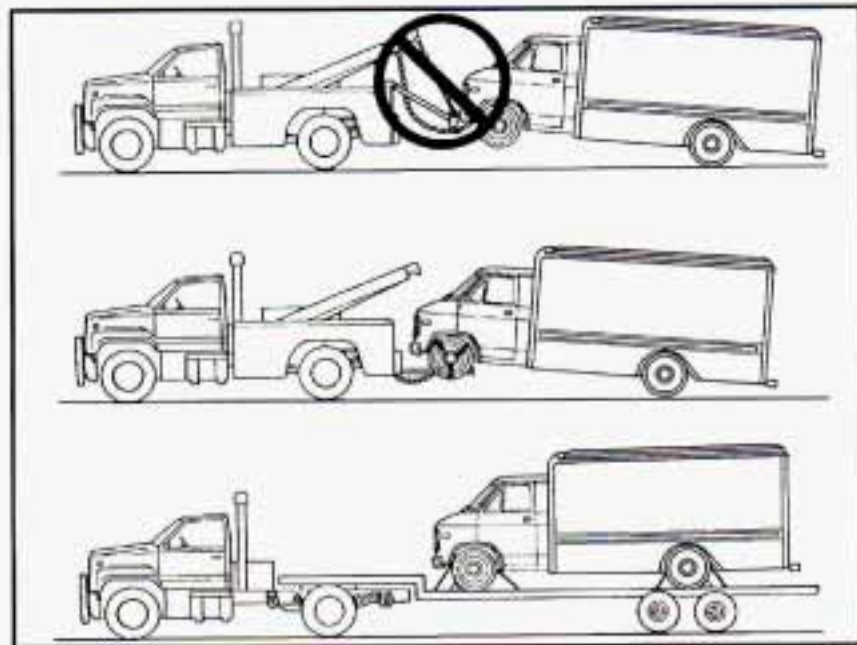

NOTICE:

Do not tow with sling-type equipment or the front bumper system will be damaged. Use wheel-lift or car-carrier equipment. Additional ramping may be required for car-carrier equipment. Use safety chains and wheel straps.

Towing a vehicle over rough surfaces could damage a vehicle or wheel-lift equipment. To help avoid damage, install a towing dolly and raise the vehicle until adequate clearance is obtained between the ground and/or wheel-lift equipment.

Rear Towing

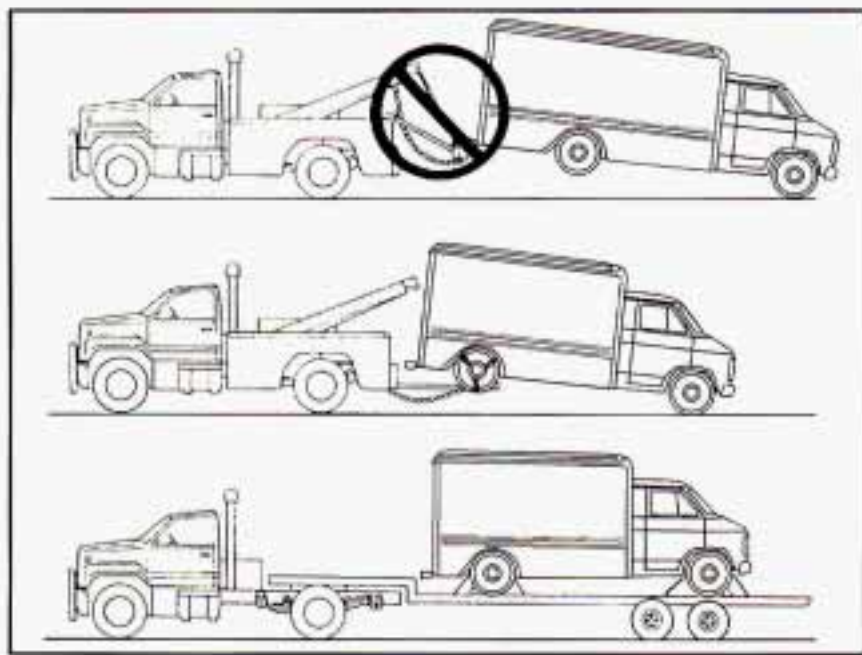

NOTICE:

Do not tow the vehicle from the rear with loads approaching rated GVW as the weight transfer will cause the front suspension to become overloaded.

NOTICE:

Do not tow with the sling-type equipment or the rear bumper will be damaged. Use wheel-lift or car-carrier equipment. Additional ramping may be required for car-carrier equipment. Use safety chains and wheel straps.

Towing a vehicle over rough surfaces could damage a vehicle. To help avoid damage, install a towing dolly and raise the vehicle until adequate clearance is obtained between the ground and/or wheel-lift equipment.

Engine Overheating (Gasoline Engine)

You will find a coolant temperature gage on your vehicle instrument panel. If you have a diesel engine, you will also find a low coolant light on your instrument panel.

If your vehicle has a diesel engine, see “Engine Overheating” in the GM Diesel Engine Supplement.

If Steam Is Coming From Your Engine



CAUTION:

Steam from an overheated engine can burn you badly, even if you just open the hood. Stay away from the engine if you see or hear steam coming from it. Just turn it off and get everyone away from the vehicle until it cools down. Wait until there is no sign of steam or coolant before opening the hood.

If you keep driving when your engine is overheated, the liquids in it can catch fire. You or others could be badly burned. Stop your engine if it overheats, and get out of the vehicle until the engine is cool.

NOTICE:

If your engine catches fire because you keep driving with no coolant, your vehicle can be badly damaged. The costly repairs would not be covered by your warranty.

If No Steam Is Coming From Your Engine

If you get the overheat warning but see or hear no steam, the problem may not be too serious. Sometimes the engine can get a little too hot when you:

- Climb a long hill on a hot day.
- Stop after high-speed driving.
- Idle for long periods in traffic.
- Tow a trailer. See “Driving on Grades” in the Index.

If you get the overheat warning with no sign of steam, try this for a minute or so:

1. If you have an air conditioner, turn it off.
2. Turn on your heater to full hot at the highest fan speed and open the window as necessary.
3. If you're in a traffic jam, shift to NEUTRAL (N); otherwise, shift to the highest gear while driving -- DRIVE (D).

If you no longer have the overheat warning, you can drive. Just to be safe, drive slower for about 10 minutes. If the warning doesn't come back on, you can drive normally.

If the warning continues, pull over, stop, and park your vehicle right away.

If there's still no sign of steam, you can idle the engine for two or three minutes while you're parked, to push the accelerator until the engine speed is about twice as fast as normal idle speed. Bring the engine speed back to normal idle speed after two or three minutes. Now see if the warning stops. But then, if you still have the warning, *turn off the engine and get everyone out of the vehicle* until it cools down.

You may decide not to lift the hood but to get service help right away.

Cooling System

When you decide it's safe to lift the hood, here's what you'll see:

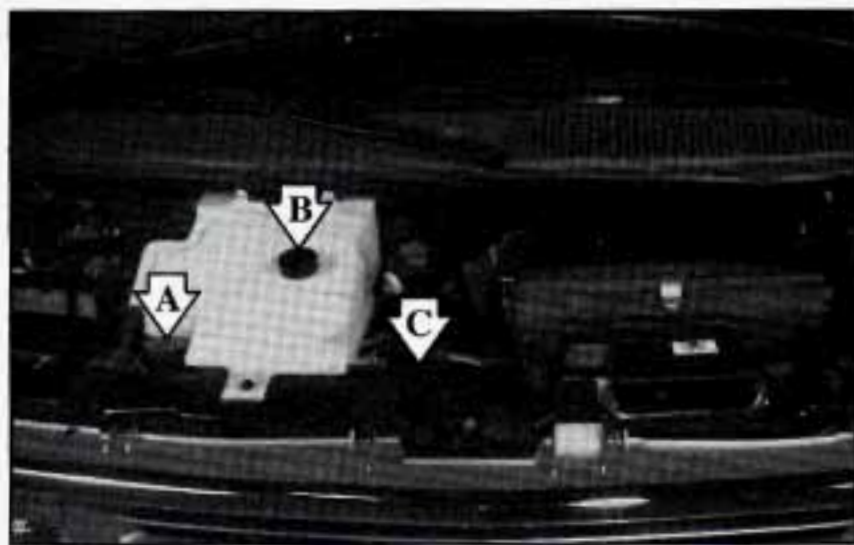

- A. Radiator Pressure Cap
- B. Coolant Recovery Tank
- C. Engine Fan(s)

If the coolant inside the coolant recovery tank is boiling, don't do anything else until it cools down.

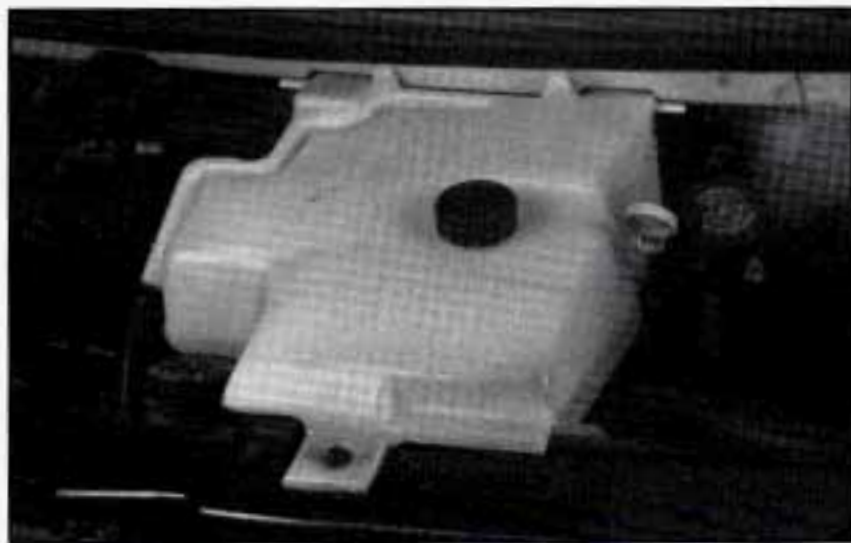

The coolant level should be at or above the FULL COLD mark. If it isn't, you may have a leak in the radiator hoses, heater hoses, radiator, water pump or somewhere else in the cooling system.

 **CAUTION:**

Heater and radiator hoses, and other engine parts, can be very hot. Don't touch them. If you do, you can be burned.

Don't run the engine if there is a leak. If you run the engine, it could lose all coolant. That could cause an engine fire, and you could be burned. Get any leak fixed before you drive the vehicle.

NOTICE:

Engine damage from running your engine without coolant isn't covered by your warranty.

If there seems to be no leak, start the engine again. See if the fan speed increases when idle speed is doubled by pushing the accelerator pedal down. If it doesn't, your vehicle needs service. Turn off the engine.

How to Add Coolant to the Coolant Recovery Tank

If you haven't found a problem yet, but the coolant level isn't at the FULL COLD mark, add a 50/50 mixture of *clean water* (preferably distilled) and DEX-COOL™ (orange-colored, silicate-free) antifreeze at the coolant recovery tank. (See "Engine Coolant" in the Index for more information.)

 **CAUTION:**

Adding only plain water to your cooling system can be dangerous. Plain water, or some other liquid like alcohol, can boil before the proper coolant mix will. Your vehicle's coolant warning system is set for the proper coolant mix. With plain water or the wrong mix, your engine could get too hot but you wouldn't get the overheat warning. Your engine could catch fire and you or others could be burned. Use a 50/50 mix of clean water and DEX-COOL™ antifreeze.

NOTICE:

In cold weather, water can freeze and crack the engine, radiator, heater core and other parts. Use the recommended coolant and the proper coolant mix.

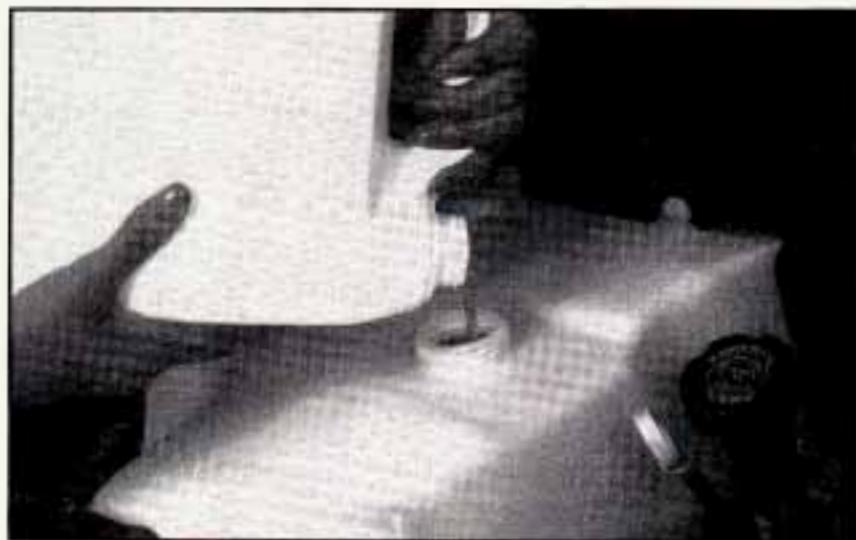

⚠ CAUTION:

You can be burned if you spill coolant on hot engine parts. Coolant contains ethylene glycol and it will burn if the engine parts are hot enough. Don't spill coolant on a hot engine.

When the coolant in the coolant recovery tank is at the FULL COLD mark, start your vehicle.

If the overheat warning continues, there's one more thing you can try. You can add the proper coolant mix directly to the radiator, but be sure the cooling system is cool before you do it.

 **CAUTION:**

Steam and scalding liquids from a hot cooling system can blow out and burn you badly. They are under pressure, and if you turn the pressure cap -- even a little -- they can come out at high speed. Never turn the cap when the cooling system, including the radiator pressure cap, is hot. Wait for the cooling system and radiator pressure cap to cool if you ever have to turn the pressure cap.



How to Add Coolant to the Radiator

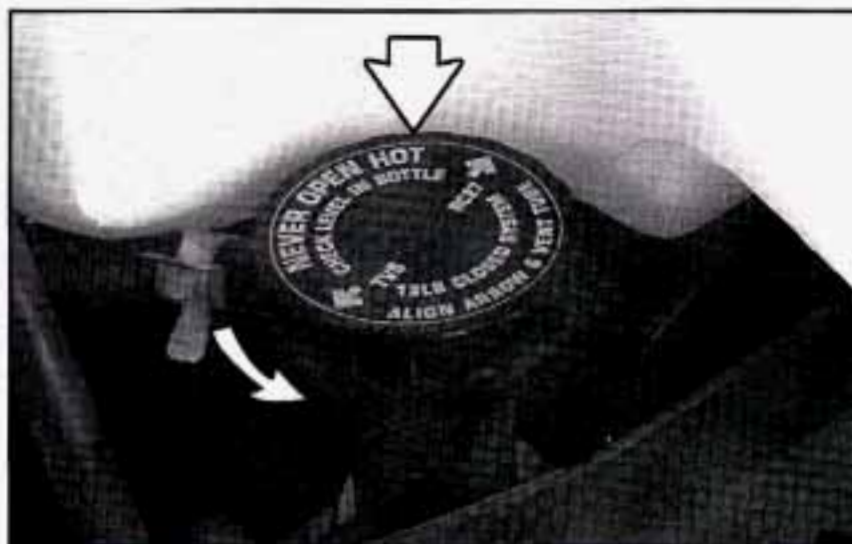

1. You can remove the radiator pressure cap when the cooling system, including the radiator pressure cap and upper radiator hose, is no longer hot. Turn the pressure cap slowly counterclockwise until it first stops. (Don't press down while turning the pressure cap.)

If you hear a hiss, wait for that to stop. A hiss means there is still some pressure left.



2. Then keep turning the pressure cap, but now push down as you turn it. Remove the pressure cap.

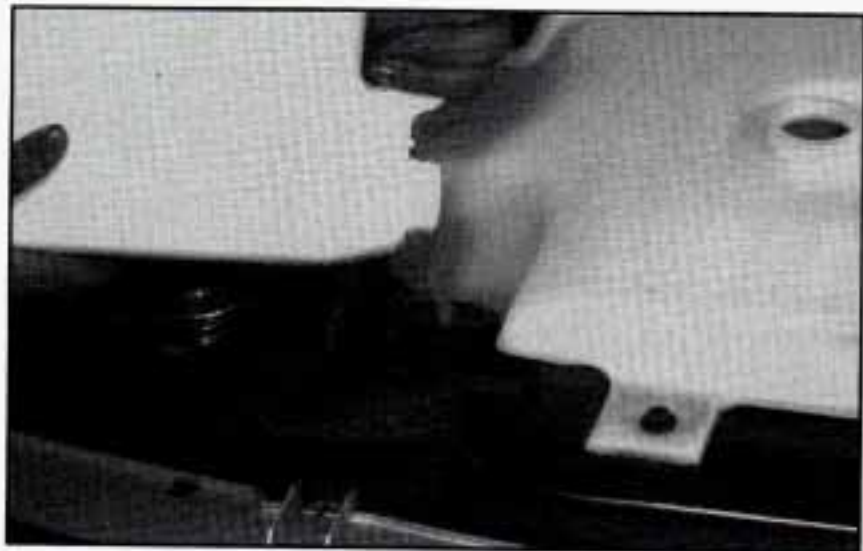

3. Fill the radiator with the proper mix, up to the base of the filler neck.

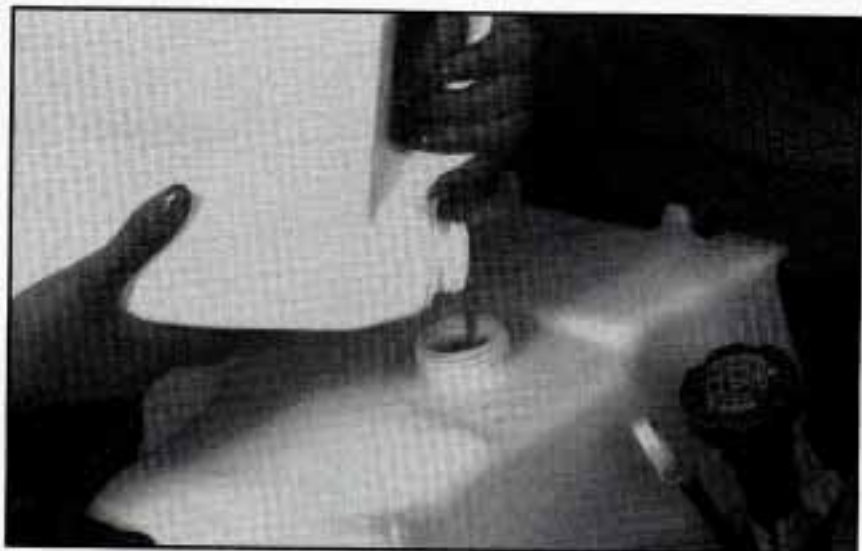

4. Then fill the coolant recovery tank to the **FULL COLD** mark.



5. Put the cap back on the coolant recovery tank, but leave the radiator pressure cap off.



6. Start the engine and let it run until you can feel the upper radiator hose getting hot. Watch out for the engine fan.
7. By this time the coolant level inside the radiator filler neck may be lower. If the level is lower, add more of the proper mix through the filler neck until the level reaches the base of the filler neck.



8. Then replace the pressure cap. At any time during this procedure if coolant begins to flow out of the filler neck, reinstall the pressure cap. Be sure the arrows on the pressure cap line up like this.

Engine Fan Noise

Your vehicle has a clutched engine cooling fan. When the clutch is engaged, the fan spins faster to provide more air to cool the engine. In most every day driving conditions, the fan is spinning slower and clutch is not fully engaged. This improves fuel economy and reduces fan noise.

Under heavy vehicle loading, trailer towing and/or high outside temperatures, the fan speed increases as the clutch more fully engages. So you may hear an increase in fan noise. This is normal and should not be mistaken as the transmission slipping or making extra shifts. It is merely the cooling system functioning properly. The fan will slow down when additional cooling is not required and the clutch partially disengages.

You may also hear this fan noise when you start the engine. It will go away as the fan clutch partially disengages.

If a Tire Goes Flat

It's unusual for a tire to "blow out" while you're driving, especially if you maintain your tires properly. If air goes out of a tire, it's much more likely to leak out slowly. But if you should ever have a "blowout," here are a few tips about what to expect and what to do:

If a front tire fails, the flat tire will create a drag that pulls the vehicle toward that side. Take your foot off the accelerator pedal and grip the steering wheel firmly. Steer to maintain lane position, and then gently brake to a stop well out of the traffic lane.

A rear blowout, particularly on a curve, acts much like a skid and may require the same correction you'd use in a skid. In any rear blowout, remove your foot from the accelerator pedal. Get the vehicle under control by steering the way you want the vehicle to go. It may be very bumpy and noisy, but you can still steer. Gently brake to a stop -- well off the road if possible.

If a tire goes flat, the next part shows how to use your jacking equipment to change a flat tire safely.

Changing a Flat Tire

If a tire goes flat, avoid further tire and wheel damage by driving slowly to a level place. Turn on your hazard warning flashers.

CAUTION:

Changing a tire can cause an injury. The vehicle can slip off the jack and roll over you or other people. You and they could be badly injured. Find a level place to change your tire. To help prevent the vehicle from moving:

- 1. Set the parking brake firmly.**
- 2. Put the shift lever in PARK (P).**
- 3. Turn off the engine.**

To be even more certain the vehicle won't move, you can put blocks at the front and rear of the tire farthest away from the one being changed. That would be the tire on the other side of the vehicle, at the opposite end.

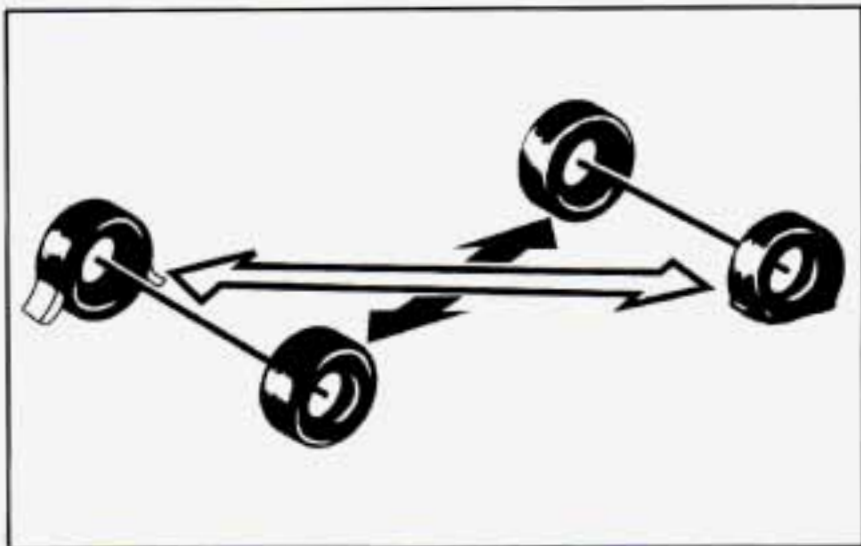

The following steps will tell you how to use the jack and change a tire.

Removing the Spare Tire and Tools



Your spare tire is stored underneath the rear of your vehicle. You will use the ratchet and extension to lower the spare tire.

NOTICE:

Never remove or restore a tire from/to a stowage position under the vehicle while the vehicle is supported by a jack. Always tighten the tire fully against the underside of the vehicle when restowing

A flat rear tire reduces clearance to remove the spare tire. If there is less than 12 inches (30.48 cm) between the ground and the rear bumper or any trailer hitch, jack up the vehicle until the flat tire is off the ground. (See “Removing the Flat Tire” and “Installing the Spare Tire,” Steps 4 through 8, in this section.)

Unless your vehicle has a flat rear tire, do not remove or restore a tire from/to a stowage position under the vehicle while the vehicle is supported by a jack. Always tighten the tire fully against the underside of the vehicle when restowing.

If you have a vehicle which was completed from a cab and chassis, refer to the information from the body supplier/installer.

The spare tire is a full size tire, like the other tires on your vehicle.



For cargo vans, the jack is secured in the rear passenger side corner of the vehicle.

Remove the retaining wing bolt and lift it off the mounting bracket. Set the jack and jacking equipment near the flat tire.



For passenger vans, the jack is secured on the rear passenger side floor of the vehicle.

Remove the retaining wing bolt and lift it out of the mounting bracket. Set the jack and jacking equipment near the flat tire.



The ratchet has an UP side and a DOWN side.



Attach the ratchet, with the DOWN side facing you, to the extension. The extension has a socket end and a flat chisel end.

Put the flat end of the extension on an angle through the hole in the rear door frame, above the bumper. Be sure the flat end connects into the hoist shaft.

Turn the ratchet counterclockwise to lower the spare tire to the ground. If you are changing a flat rear tire and the vehicle is already jacked up, use the jack handle and extension to hook the cable. Then pull the spare from beneath the vehicle. If the retainer pulls out, hook the

inside of the wheel and pull the spare tire out from under the vehicle.

When the tire has been lowered, tilt the retainer at the end of the cable and pull it through the wheel opening.

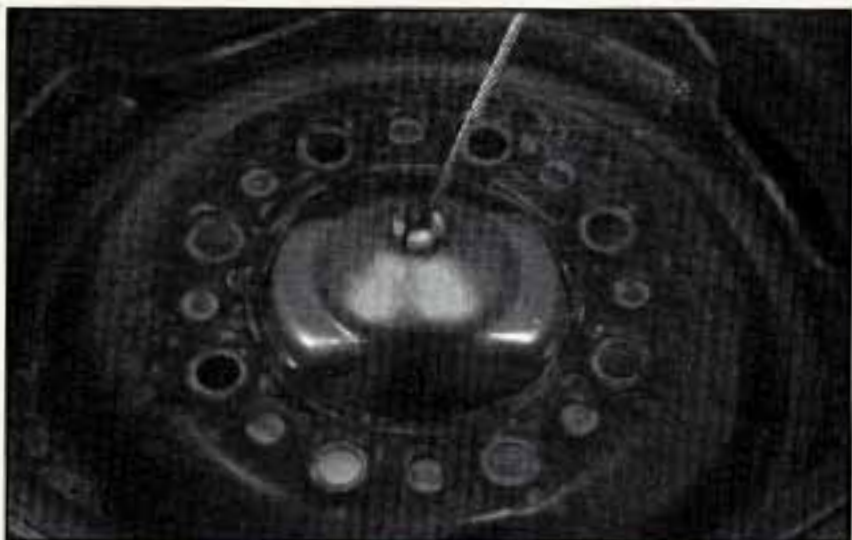

NOTICE:

To help avoid vehicle damage, do not drive vehicle before the cable is restored.

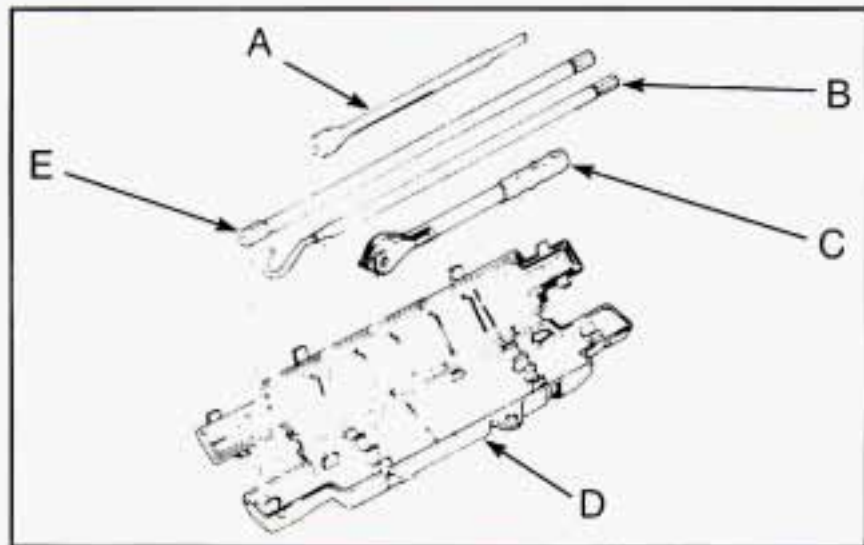

Jacking Tool Storage

- A. Socket
- B. Jack Handle
- C. Ratchet
- D. Jacking Tool Storage Box
- E. Jack Handle Extension

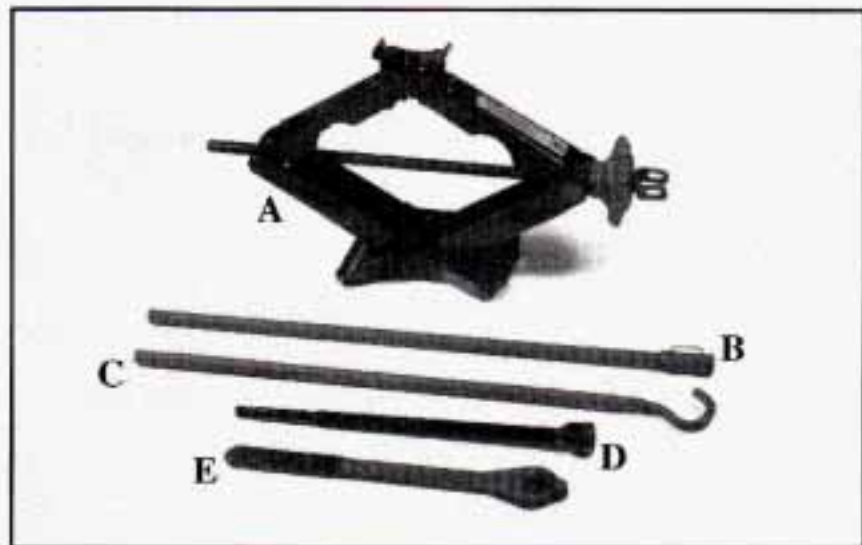

The tools you'll be using include the jack (A), jack handle extension (B), jack handle (C), socket (D) and the ratchet (E).

Removing the Wheel Covers and Locking Wheel Nuts

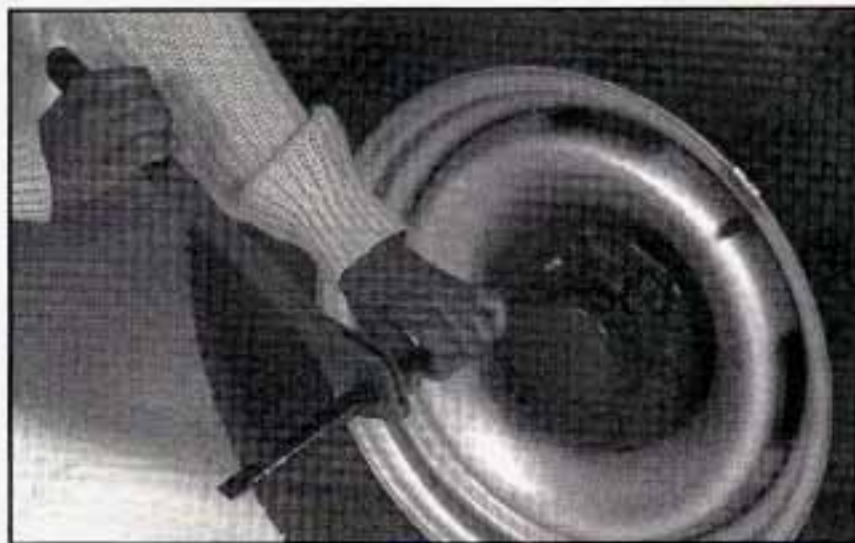

1. You will need to take off the wheel nut caps to reach your wheel nuts.



2. Loosen the plastic nut caps with the ratchet and socket and remove them. Make sure the DOWN side faces you.

Removing the Flat Tire and Installing the Spare Tire



3. Remove the center cap.



1. With the DOWN side facing you, use the ratchet and socket to loosen all the wheel nuts. Don't remove them yet.

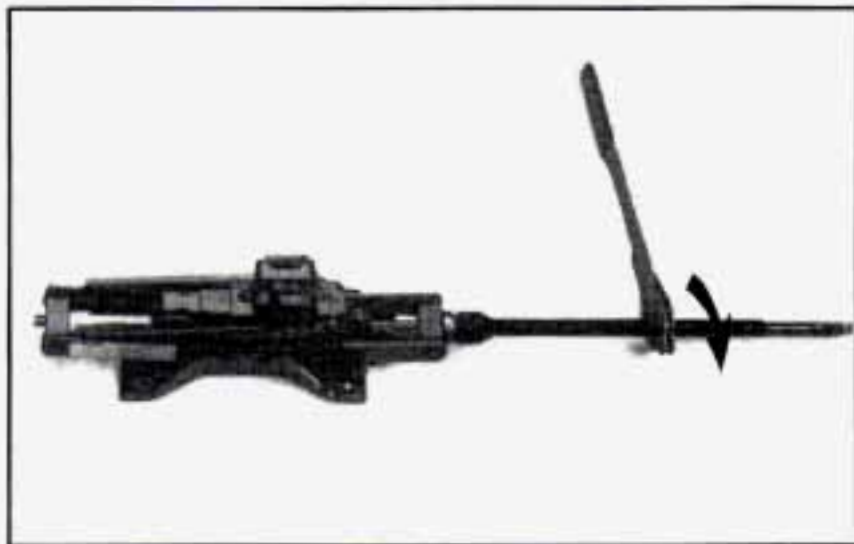

2. The jack has a bolt on the end. Attach the socket end of the extension to the jack bolt.
Attach the ratchet to the extension with the UP side facing you.

3. Rotate the ratchet clockwise. That will raise the jack lift head a little.



Front Position



Rear Position

4. Position jack under the vehicle as shown.



5. Raise the vehicle by rotating the ratchet clockwise. Make sure the UP mark faces you. Raise the vehicle far enough off the ground so there is enough room for the spare tire to fit.

 **CAUTION:**

Getting under a vehicle when it is jacked up is dangerous. If the vehicle slips off the jack, you could be badly injured or killed. Never get under a vehicle when it is supported only by a jack.



6. Remove all the wheel nuts, and take off the flat tire.

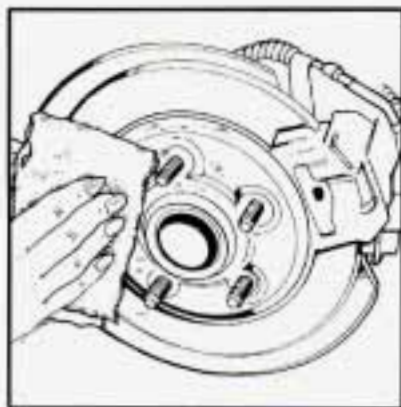

7. Remove any rust or dirt from the wheel bolts, mounting surfaces and spare wheel.

⚠ CAUTION:

Rust or dirt on the wheel, or on the parts to which it is fastened, can make the wheel nuts become loose after a time. The wheel could come off and cause an accident. When you change a wheel, remove any rust or dirt from the places where the wheel attaches to the vehicle. In an emergency, you can use a cloth or a paper towel to do this; but be sure to use a scraper or wire brush later, if you need to, to get all the rust or dirt off.

⚠ CAUTION:

Never use oil or grease on studs or nuts. If you do, the nuts might come loose. Your wheel could fall off, causing a serious accident.



8. Replace the wheel nuts with the rounded end of the nuts toward the wheel. Tighten each wheel nut by hand until the wheel is held against the hub.

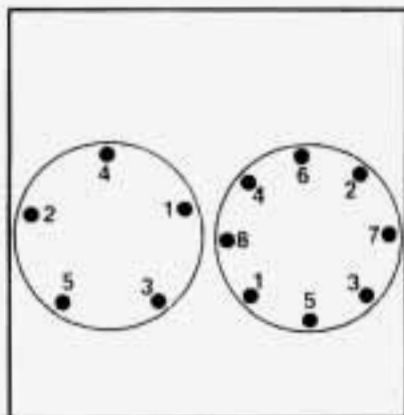

10. Tighten the nuts firmly in a criss-cross sequence as shown. Rotate the wheel wrench clockwise.

9. Lower the vehicle by rotating the jack handle counterclockwise. Lower the jack completely.

 **CAUTION:**

Incorrect wheel nuts or improperly tightened wheel nuts can cause the wheel to become loose and even come off. This could lead to an accident. Be sure to use the correct wheel nuts. If you have to replace them, be sure to get new GM original equipment wheel nuts.

Stop somewhere as soon as you can and have the nuts tightened with a torque wrench to 122 lb-ft (165 N·m).

NOTICE:

Improperly tightened wheel nuts can lead to brake pulsation and rotor damage. To avoid expensive brake repairs, evenly tighten the wheel nuts in the proper sequence and to the proper torque specification.

11. Put the wheel cover back on, if you have one. Remove any wheel blocks.

Remember that the jack, jacking equipment and tire must be properly stored in their original storage position before you begin driving again. The next part will show you how.

Storing a Flat or Spare Tire and Tools

CAUTION:

Storing a jack, a tire or other equipment in the passenger compartment of the vehicle could cause injury. In a sudden stop or collision, loose equipment could strike someone. Store all these in the proper place.

1. Put the tire on the ground at the rear of the vehicle, with the valve stem pointed down.
2. Pull the retaining bar through the center of the wheel, making sure it is properly attached.

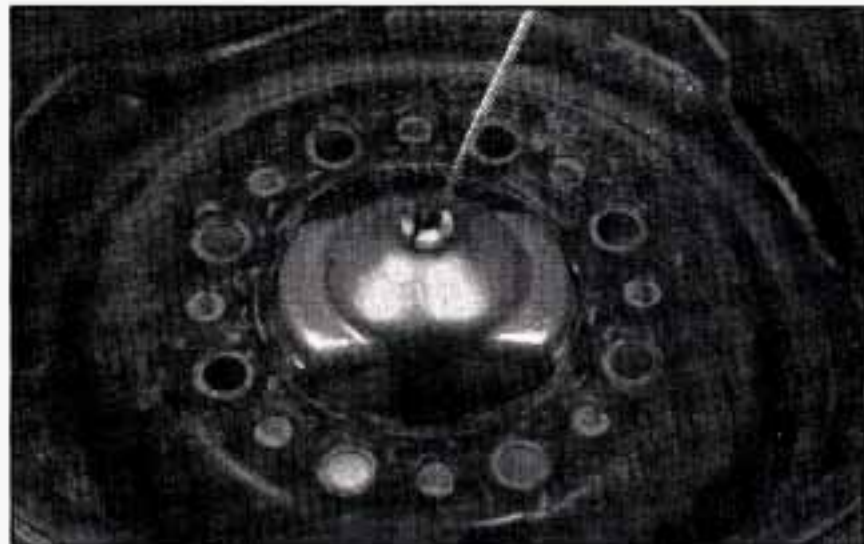

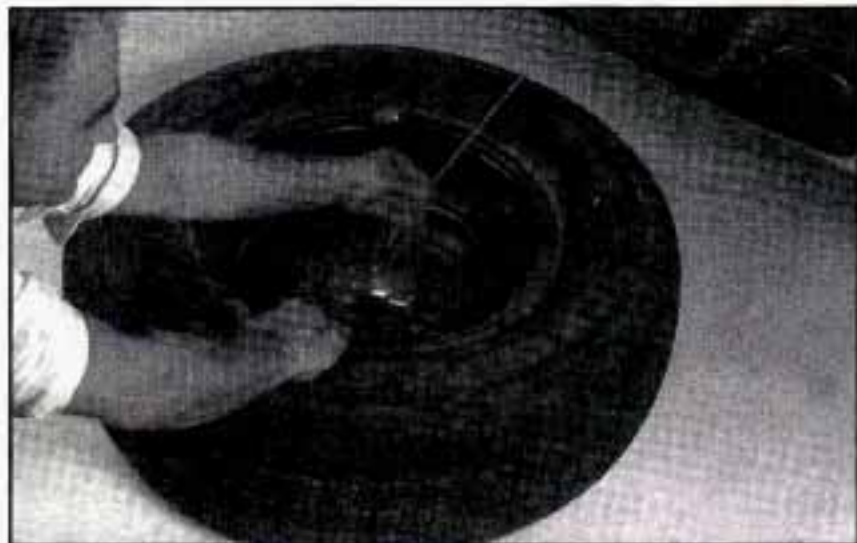

3. Pull the wheel toward the rear of the vehicle keep the cable tight.



4. Attach the ratchet, with the UP side facing you, to the extension.



- Put the flat end of the extension on an angle through the hole in the rear door frame, above the bumper. Turn the ratchet clockwise until the tire is against the underside of the vehicle.

You will hear two “clicks” when the tire is up all the way. Try to move the tire with your hands to make sure it is securely in place.

Return the jacking equipment to the proper location. Secure the items and replace the jack cover.

If You're Stuck: In Sand, Mud, Ice or Snow

What you don't want to do when your vehicle is stuck is to spin your wheels too fast. The method known as “rocking” can help you get out when you're stuck, but you must use caution.

CAUTION:

If you let your tires spin at high speed, they can explode, and you or others could be injured. And, the transmission or other parts of the vehicle can overheat. That could cause an engine compartment fire or other damage. When you're stuck, spin the wheels as little as possible. Don't spin the wheels above 35 mph (55 km/h) as shown on the speedometer.

NOTICE:

Spinning your wheels can destroy parts of your vehicle as well as the tires. If you spin the wheels too fast while shifting your transmission back and forth, you can destroy your transmission.

For information about using tire chains on your vehicle, see “Tire Chains” in the Index.

Rocking your vehicle to get it out:

First, turn your steering wheel left and right. That will clear the area around your front wheels. Then shift back and forth between REVERSE (R) and a forward gear, spinning the wheels as little as possible. Release the accelerator pedal while you shift, and press lightly on the accelerator pedal when the transmission is in gear. If that doesn't get you out after a few tries, you may need to be towed out. If you do need to be towed out, see “Towing Your Vehicle” in the Index.

Section 6 Service and Appearance Care

Here you will find information about the care of your vehicle. This section begins with service and fuel information, and then it shows how to check important fluid and lubricant levels. There is also technical information about your vehicle, and a part devoted to its appearance care.

Service

Your GM dealer knows your vehicle best and wants you to be happy with it. We hope you'll go to your dealer for all your service needs. You'll get genuine GM parts and GM-trained and supported service people.

We hope you'll want to keep your GM vehicle all GM. Genuine GM parts have one of these marks:



Doing Your Own Service Work

If you want to do some of your own service work, you'll want to get the proper GM Service Manual. It tells you much more about how to service your vehicle than this manual can. To order the proper service manual, see "Service and Owner Publications" in the Index.

Your vehicle may have an air bag system. If it does, see “Servicing Your Air Bag-Equipped Vehicle” in the Index before attempting to do your own service work.

You should keep a record with all parts receipts and list the mileage and the date of any service work you perform. See “Maintenance Record” in the Index.

CAUTION:

You can be injured and your vehicle could be damaged if you try to do service work on a vehicle without knowing enough about it.

- **Be sure you have sufficient knowledge, experience, and the proper replacement parts and tools before you attempt any vehicle maintenance task.**
- **Be sure to use the proper nuts, bolts and other fasteners. “English” and “metric” fasteners can be easily confused. If you use the wrong fasteners, parts can later break or fall off. You could be hurt.**

Fuel (Gasoline Engine)

If your vehicle has a diesel engine, see “Diesel Fuel Requirements and Fuel System” in the Diesel Engine Supplement. For vehicles with gasoline engines, please read this.

Use regular unleaded gasoline rated at 87 octane or higher. At a minimum, it should meet specifications ASTM D4814 in the United States and CGSB 3.5-M93 in Canada. Improved gasoline specifications have been developed by the American Automobile Manufacturers Association (AAMA) for better vehicle performance and engine protection. Gasolines meeting the AAMA specification could provide improved driveability and emission control system protection compared to other gasolines.

Be sure the posted octane is at least 87. If the octane is less than 87, you may get a heavy knocking noise when you drive. If it’s bad enough, it can damage your engine.

If you’re using fuel rated at 87 octane or higher and you still hear heavy knocking, your engine needs service. But don’t worry if you hear a little pinging noise when you’re accelerating or driving up a hill. That’s normal, and you don’t have to buy a higher octane fuel to get rid of pinging. It’s the heavy, constant knock that means you have a problem.

If your vehicle is certified to meet California Emission Standards (indicated on the underhood tune-up label), it is designed to operate on fuels that meet California specifications. If such fuels are not available in states adopting California emissions standards, your vehicle will operate satisfactorily on fuels meeting federal specifications, but emission control system performance may be affected. The malfunction indicator lamp on your instrument panel may turn on and/or your vehicle may fail a smog-check test. If this occurs, return to your authorized GM dealer for diagnosis to determine the cause of failure. In the event it is determined that the cause of the condition is the type of fuels used, repairs may not be covered by your warranty.

In Canada, some gasolines contain an octane-enhancing additive called MMT. If you use such fuels, your emission control system performance may deteriorate and the malfunction indicator lamp on your instrument panel may turn on. If this happens, return to your authorized GM dealer for service.

To provide cleaner air, all gasolines are now required to contain additives that will help prevent deposits from forming in your engine and fuel system, allowing your emission control system to function properly. Therefore, you should not have to add anything to the fuel. In addition, gasolines containing oxygenates, such as ethers and ethanol, and reformulated gasolines may be available in your area to help clean the air. General Motors recommends that you use these gasolines if they comply with the specifications described earlier.

NOTICE:

Your vehicle was not designed for fuel that contains methanol. Don't use it. It can corrode metal parts in your fuel system and also damage plastic and rubber parts. That damage wouldn't be covered under your warranty.

Fuels in Foreign Countries -- Gasoline Engines

If you plan on driving in another country outside the United States or Canada, the proper fuel may be hard to find. Never use leaded gasoline or any other fuel not recommended in the previous text on fuel. Costly repairs caused by use of improper fuel wouldn't be covered by your warranty.

To check on fuel availability, ask an auto club, or contact a major oil company that does business in the country where you'll be driving.

You can also write us at the following address for advice. Just tell us where you're going and give your Vehicle Identification Number (VIN).

General Motors Overseas Distribution Corporation,
North American Export Sales (NAES)
1908 Colonel Sam Drive
Oshawa, Ontario L1H 8P7

Filling Your Tank



CAUTION:

Gasoline vapor is highly flammable. It burns violently, and that can cause very bad injuries. Don't smoke if you're near gasoline or refueling your vehicle. Keep sparks, flames and smoking materials away from gasoline.

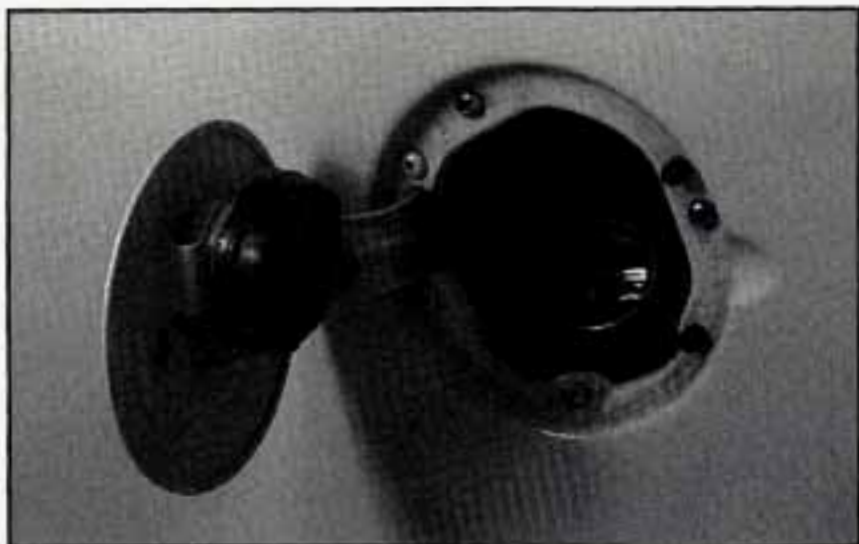

While refueling, hang the cap inside the fuel door.
To take off the cap, turn it slowly to the left
(counterclockwise).

⚠ CAUTION:

If you get gasoline on yourself and then something ignites it, you could be badly burned. Gasoline can spray out on you if you open the fuel filler cap too quickly. This spray can happen if your tank is nearly full, and is more likely in hot weather. Open the fuel filler cap slowly and wait for any “hiss” noise to stop. Then unscrew the cap all the way.

Be careful not to spill gasoline. Clean gasoline from painted surfaces as soon as possible. See “Cleaning the Outside of Your Vehicle” in the Index.

When you put the cap back on, turn it to the right until you hear at least three clicks. Make sure you fully install the cap. The diagnostic system can determine if the fuel cap has been left off or improperly installed. This would allow fuel to evaporate into the atmosphere. See “Malfunction Indicator Lamp” in the Index.

NOTICE:

If you need a new cap, be sure to get the right type. Your dealer can get one for you. If you get the wrong type, it may not fit or have proper venting, and your fuel tank and emissions system might be damaged.

Checking Things Under the Hood



To open the hood, first pull this handle inside the vehicle. It is just in front of the driver's side door frame near the floor.

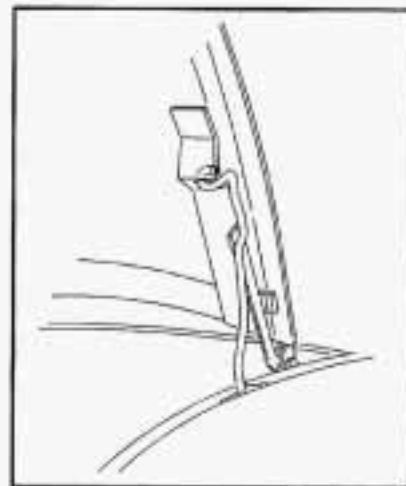
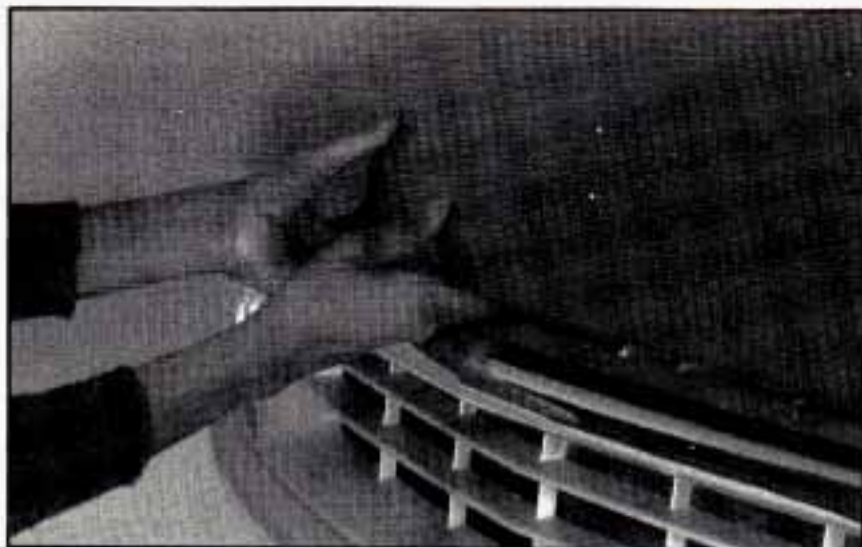

Lift the hood, release the hood prop from its retainer and put the hood prop into the slot in the hood hinge. The underhood lamp will automatically come on and stay on until the hood is closed.

Then go to the front of the vehicle and release the secondary hood release.

When you lift the hood, you'll see these items:

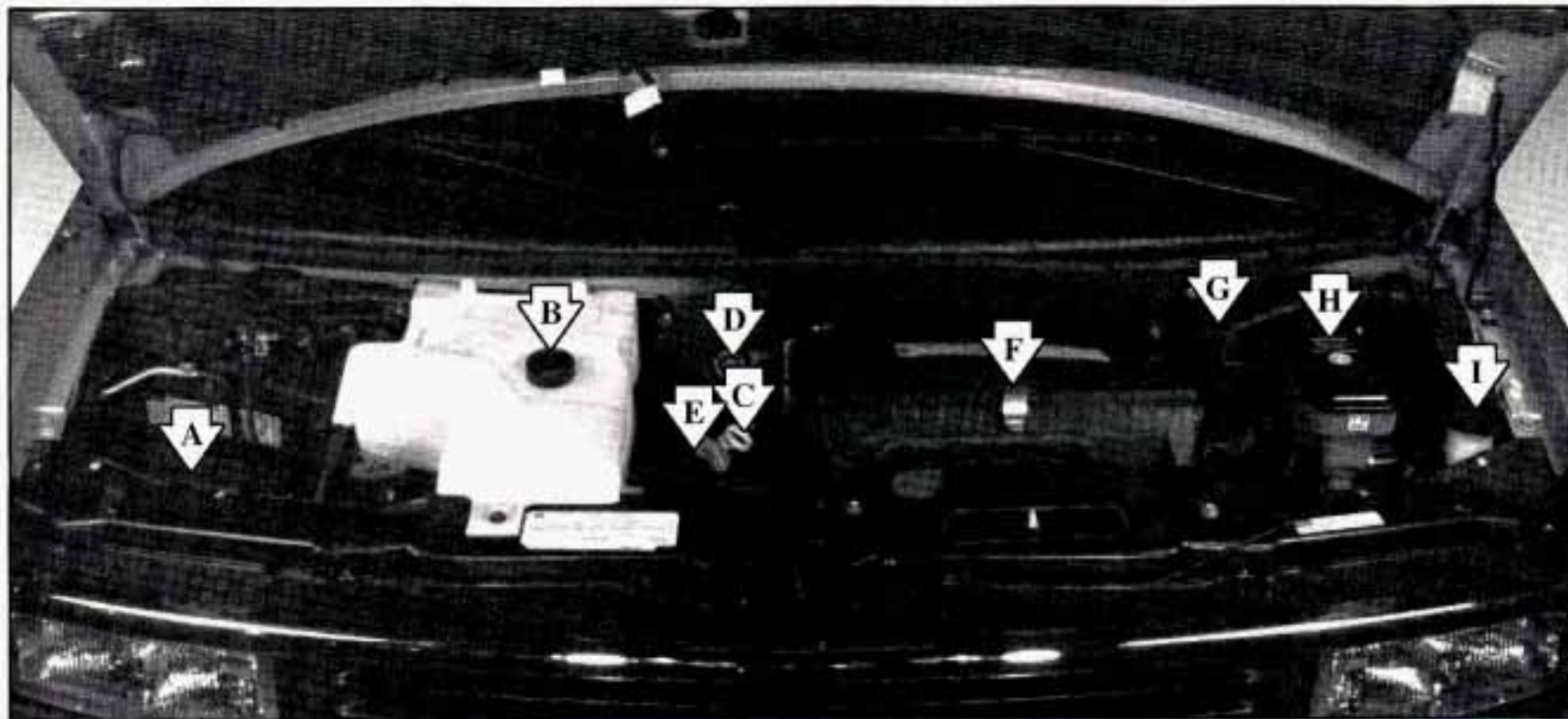

- A. Battery
- B. Coolant Recovery Tank
- C. Engine Oil Dipstick
- D. Engine Oil Fill
- E. Transmission Dipstick

- F. Air Cleaner
- G. Power Steering Reservoir
- H. Brake Master Cylinder
- I. Windshield Washer Fluid

If your vehicle has a 7.4L engine and air conditioning, your vehicle will have a auxiliary engine fan in addition to the belt driven fan.

 **CAUTION:**

If your vehicle has air conditioning, the auxiliary engine fan under the hood can start up and injure you even when the engine is not running. Keep hands, clothing and tools away from any underhood electric fan.

 **CAUTION:**

Things that burn can get on hot engine parts and start a fire. These include liquids like gasoline, oil, coolant, brake fluid, windshield washer and other fluids, and plastic or rubber. You or others could be burned. Be careful not to drop or spill things that will burn onto a hot engine.

Before closing the hood, be sure all the filler caps are on properly.

Then lift the hood to relieve pressure on the hood prop. Remove the hood prop from the slot in the hood and return the prop to its retainer. Then just let the hood down and close it firmly.

Noise Control System

The following information relates to compliance with Federal noise emission standards for vehicles with a Gross Vehicle Weight Rating (GVWR) of more than 10,000 lbs. (4 536 kg). The Maintenance Schedule booklet provides information on maintaining the noise control system to minimize degradation of the noise emission control system during the life of your vehicle. The noise control system warranty is given in your Warranty booklet.

These standards apply only to vehicles sold in the United States.

Tampering With Noise Control System Prohibited

Federal law prohibits the following acts or the causing thereof:

1. The removal or rendering inoperative by any person, other than for purposes of maintenance, repair or replacement, of any device or element of design incorporated into any new vehicle for the purpose of noise control, prior to its sale or delivery to the ultimate purchaser or while it is in use; or
2. The use of the vehicle after such device or element of design has been removed or rendered inoperative by any person.

Among those acts presumed to constitute tampering are the acts listed below.

Insulation:

- Removal of noise shields or underhood insulation.

Engine:

- Removal or rendering engine speed governor (if so equipped) inoperative so as to allow engine speed to exceed manufacturer specifications.

Fan and Drive:

- Removal of fan clutch (if so equipped) or rendering clutch inoperative.
- Removal of fan shroud (if so equipped).

Air Intake:

- Removal of air cleaner silencer.
- Reversing air cleaner cover.

Exhaust:

- Removal of muffler and/or resonator.
- Removal of exhaust pipes and exhaust pipe clamps.

Engine Oil (Gasoline Engine)

If your vehicle has a diesel engine, see “Engine Oil (Diesel Engine)” in the Diesel Engine Supplement.

It's a good idea to check your engine oil every time you get fuel. In order to get an accurate reading, the oil must be warm and the vehicle must be on level ground.



Turn off the engine and give the oil a few minutes to drain back into the oil pan. If you don't, the oil dipstick might not show the actual level.

Checking Engine Oil

Pull out the dipstick and clean it with a paper towel or cloth, then push it back in all the way. Remove it again, keeping the tip down, and check the level.

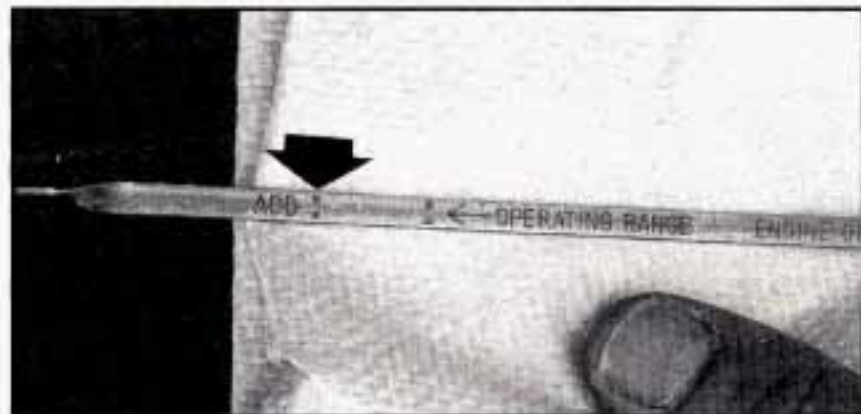

When to Add Oil

If the oil is at or below the ADD mark, then you'll need to add some oil. But you must use the right kind. This part explains what kind of oil to use. For crankcase capacity, see “Capacities and Specifications” in the Index.

NOTICE:

Don't add too much oil. If your engine has so much oil that the oil level gets above the upper mark that shows the proper operating range, your engine could be damaged.



The engine oil filler cap is located between the air cleaner and engine oil dipstick.

Just fill it enough to put the level somewhere in the proper operating range. Push the dipstick all the way back in when you're through.

What Kind of Oil to Use

Oils recommended for your vehicle can be identified by looking for the "Starburst" symbol. This symbol indicates that the oil has been certified by the American Petroleum Institute (API). Do not use any oil which does not carry this Starburst symbol.



If you change your own oil, be sure you use oil that has the Starburst symbol on the front of the oil container. If you have your oil changed for you, be sure the oil put into your engine is American Petroleum Institute certified for gasoline engines.

You should also use the proper viscosity oil for your vehicle, as shown in the following chart:

RECOMMENDED SAE VISCOSITY GRADE ENGINE OILS

FOR BEST FUEL ECONOMY AND COLD STARTING, SELECT THE LOWEST SAE VISCOSITY GRADE OIL FOR THE EXPECTED TEMPERATURE RANGE.

HOT
WEATHER



COLD
WEATHER

LOOK
FOR THIS
SYMBOL



DO NOT USE SAE 20W-50 OR ANY OTHER
GRADE OIL NOT RECOMMENDED

As shown in the chart, SAE 5W-30 is best for your vehicle. However, you can use SAE 10W-30 if it's going to be 0°F (-18°C) or above. These numbers on an oil container show its viscosity, or thickness. Do not use other viscosity oils, such as SAE 20W-50.

NOTICE:

Use only engine oil with the American Petroleum Institute Certified For Gasoline Engines "Starburst" symbol. Failure to use the recommended oil can result in engine damage not covered by your warranty.

GM Goodwrench[®] oil meets all the requirements for your vehicle.

Engine Oil Additives

Don't add anything to your oil. Your GM dealer is ready to advise if you think something should be added.

When to Change Engine Oil

See if any one of these is true for you:

- Most trips are less than 5 to 10 miles (8 to 16 km). This is particularly important when outside temperatures are below freezing.
- Most trips include extensive idling (such as frequent driving in stop-and-go traffic).
- Most trips are through dusty areas.
- You frequently tow a trailer or use a carrier on top of your vehicle.
- The vehicle is used for delivery service, police, taxi or other commercial application.

Driving under these conditions causes engine oil to break down sooner. If any one of these is true for your vehicle, then you need to change your oil and filter every 3,000 miles (5 000 km) or 3 months -- whichever occurs first.

If none of them is true, change the oil and filter every 7,500 miles (12 500 km) or 12 months -- whichever occurs first. Driving a vehicle with a fully warmed engine under highway conditions causes engine oil to break down slower.

What to Do with Used Oil

Did you know that used engine oil contains certain elements that may be unhealthy for your skin and could even cause cancer? Don't let used oil stay on your skin for very long. Clean your skin and nails with soap and water, or a good hand cleaner. Wash or properly throw away clothing or rags containing used engine oil. (See the manufacturer's warnings about the use and disposal of oil products.)

Used oil can be a real threat to the environment. If you change your own oil, be sure to drain all free-flowing oil from the filter before disposal. Don't ever dispose of oil by putting it in the trash, pouring it on the ground, into sewers, or into streams or bodies of water. Instead, recycle it by taking it to a place that collects used oil. If you have a problem properly disposing of your used oil, ask your dealer, a service station or a local recycling center for help.

Air Cleaner

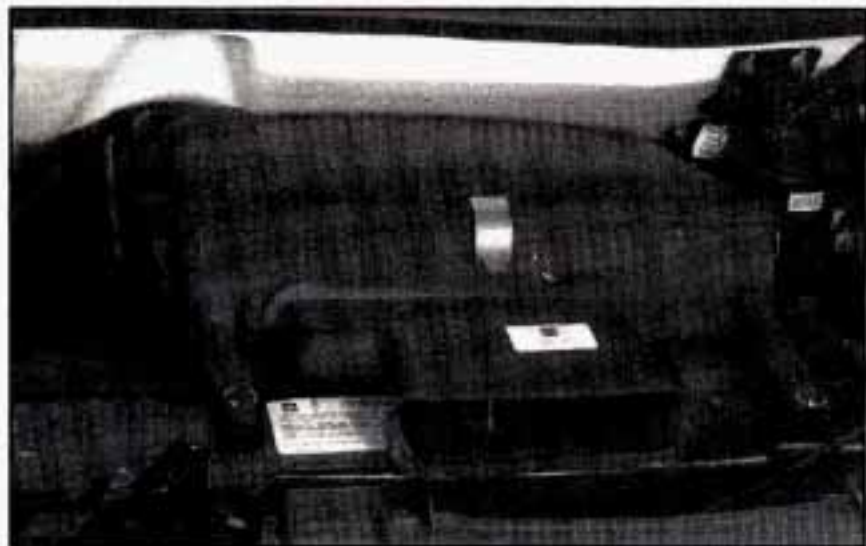

To remove the air cleaner filter:

- loosen screw bolt to air induct hose
- remove the three bolts
- remove the full air cleaner housing
- unsnap the three clips

Then tilt the top cover up and back to expose the filter element. Install a new filter element with the folds in the down position.

See “Normal Replacement Parts” for the proper filter to use.

Refer to the Maintenance Schedule to determine when to replace the air filter and crankcase ventilation filter.

See “Scheduled Maintenance Services” in the Index.

CAUTION:

Operating the engine with the air cleaner off can cause you or others to be burned. The air cleaner not only cleans the air, it stops flame if the engine backfires. If it isn't there, and the engine backfires, you could be burned. Don't drive with it off, and be careful working on the engine with the air cleaner off.

NOTICE:

If the air cleaner is off, a backfire can cause a damaging engine fire. And, dirt can easily get into your engine, which will damage it. Always have the air cleaner in place when you're driving.

Automatic Transmission Fluid

When to Check and Change

A good time to check your automatic transmission fluid level is when the engine oil is changed.

Change both the fluid and filter every 50,000 miles (83 000 km) if the vehicle's GVWR is over 8,600 or if the vehicle is mainly driven under one or more of these conditions:

- In heavy city traffic where the outside temperature regularly reaches 90°F (32°C) or higher.
- In hilly or mountainous terrain.
- When doing frequent trailer towing.
- Uses such as found in taxi, police or delivery service.

If your vehicle's GVWR is not over 8,600 and you do not use your vehicle under any of these conditions, the fluid and filter do not require changing.

See "Scheduled Maintenance Services" in the Index.

How to Check

Because this operation can be a little difficult, you may choose to have this done at your GM dealer Service Department.

If you do it yourself, be sure to follow all the instructions here, or you could get a false reading on the dipstick.

NOTICE:

Too much or too little fluid can damage your transmission. Too much can mean that some of the fluid could come out and fall on hot engine parts or exhaust system parts, starting a fire. Be sure to get an accurate reading if you check your transmission fluid.

Wait at least 30 minutes before checking the transmission fluid level if you have been driving:

- When outside temperatures are above 90°F (32°C).
- At high speed for quite a while.
- In heavy traffic -- especially in hot weather.
- While pulling a trailer.

To get the right reading, the fluid should be at normal operating temperature, which is 180°F to 200°F (82°C to 93°C).

Checking Transmission Fluid Hot

Get the vehicle warmed up by driving about 15 miles (24 km) when outside temperatures are above 50°F (10°C). If it's colder than 50°F (10°C), drive the vehicle in DRIVE (D) until the engine temperature gage moves and then remains steady for 10 minutes. Then follow the hot check procedures.

Checking Transmission Fluid Cold

A cold check is made after the vehicle has been sitting for eight hours or more with the engine off and is used only as a reference. Let the engine run at idle for five minutes if outside temperatures are 50°F (10°C) or more. If it's colder than 50°F (10°C), you may have to idle the engine longer. Should the fluid level be low during a cold check, you *must* perform a hot check before adding fluid. This will give you a more accurate reading of the fluid level.

Checking the Fluid Hot or Cold

- Park your vehicle on a level place. Keep the engine running.
- With the parking brake applied, place the shift lever in PARK (P).
- With your foot on the brake pedal, move the shift lever through each gear range, pausing for about three seconds in each range. Then, position the shift lever in PARK (P).
- Let the engine run at idle for three minutes or more.

Then, without shutting off the engine, follow these steps:



1. Flip the handle up and then pull out the dipstick and wipe it with a clean rag or paper towel.
2. Push it back in all the way, wait three seconds and then pull it back out again.

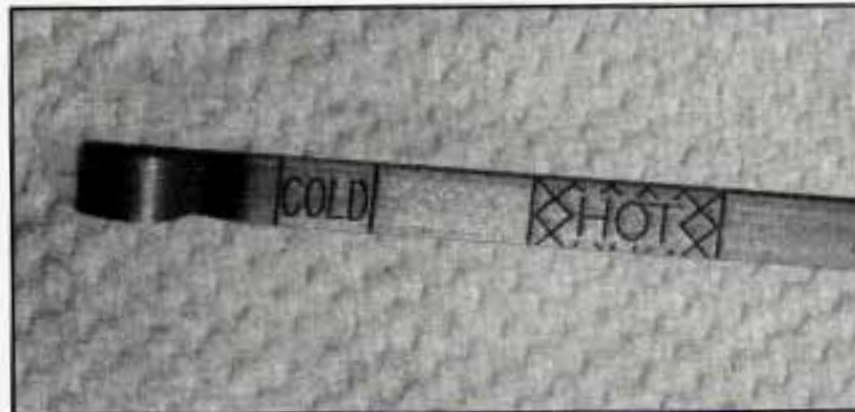

3. Check both sides of the dipstick, and read the lower level. The fluid level must be in the COLD area for a cold check or in the HOT area or cross-hatched area for a hot check.
4. If the fluid level is in the acceptable range, push the dipstick back in all the way; then flip the handle down to lock the dipstick in place.

How to Add Fluid

Refer to the Maintenance Schedule to determine what kind of transmission fluid to use. See “Recommended Fluids and Lubricants” in the Index.

Add fluid only after checking the transmission fluid HOT. (A COLD check is used only as a reference.) If the fluid level is low, add only enough of the proper fluid to bring the level up to the HOT area for a hot check. It doesn't take much fluid, generally less than a pint (0.5 L). *Don't overfill.* We recommend you use only fluid labeled DEXRON®-III, because fluid with that label is made especially for your automatic transmission. Damage caused by fluid other than DEXRON-III is not covered by your new vehicle warranty.

- After adding fluid, recheck the fluid level as described under “How to Check.”
- When the correct fluid level is obtained, push the dipstick back in all the way; then flip the handle down to lock the dipstick in place.

Rear Axle

When to Check and Change Lubricant

Refer to the Maintenance Schedule to determine how often to check the lubricant and when to change it. See “Scheduled Maintenance Services” in the Index.

How to Check Lubricant



If the level is below the bottom of the filler plug hole, you'll need to add some lubricant. Add enough lubricant to raise the level to the bottom of the filler plug hole.

What to Use

Refer to the Maintenance Schedule to determine what kind of lubricant to use. See “Recommended Fluids and Lubricants” in the Index.

Engine Coolant

The cooling system in your vehicle is filled with new DEX-COOL™ (orange-colored, silicate-free) engine coolant. This coolant is designed to remain in your vehicle for 5 years or 100,000 miles (166 000 km), whichever occurs first.

The following explains your cooling system and how to add coolant when it is low. If you have a problem with engine overheating, see “Engine Overheating” in the Index.

A 50/50 mixture of water and the proper coolant for your vehicle will:

- Give freezing protection down to -34°F (-37°C).
- Give boiling protection up to 265°F (129°C).
- Protect against rust and corrosion.
- Help keep the proper engine temperature.
- Let the warning lights and gages work as they should.

NOTICE:

When adding coolant it is important that you use DEX-COOL™ (orange-colored, silicate-free) coolant meeting GM Specification 6277M.

If *silicated* coolant is added to the system, premature engine, heater core or radiator corrosion may result. In addition, the engine coolant will require change sooner -- at 30,000 miles (50 000 km) or 24 months, whichever occurs first.

What to Use

Use a mixture of one-half *clean water* (preferably distilled) and one-half DEX-COOL™ (orange-colored, silicate-free) antifreeze that meets GM Specification 6277M, which won't damage aluminum parts. Use GM Engine Coolant Supplement (sealer) (GM Part No. 3634621) with any complete coolant change. If you use this mixture, you don't need to add anything else.



CAUTION:

Adding only plain water to your cooling system can be dangerous. Plain water, or some other liquid like alcohol, can boil before the proper coolant mix will. Your vehicle's coolant warning system is set for the proper coolant mix. With plain water or the wrong mix, your engine could get too hot but you wouldn't get the overheat warning. Your engine could catch fire and you or others could be burned. Use a 50/50 mix of clean water and DEX-COOL™ (orange-colored, silicate-free) antifreeze.

NOTICE:

If you use an improper coolant mix, your engine could overheat and be badly damaged. The repair cost wouldn't be covered by your warranty. Too much water in the mix can freeze and crack the engine, radiator, heater core and other parts.

If you have to add coolant more than four times a year, have your dealer check your cooling system.

NOTICE:

If you use the proper coolant, you don't have to add extra inhibitors or additives which claim to improve the system. These can be harmful.

Checking Coolant

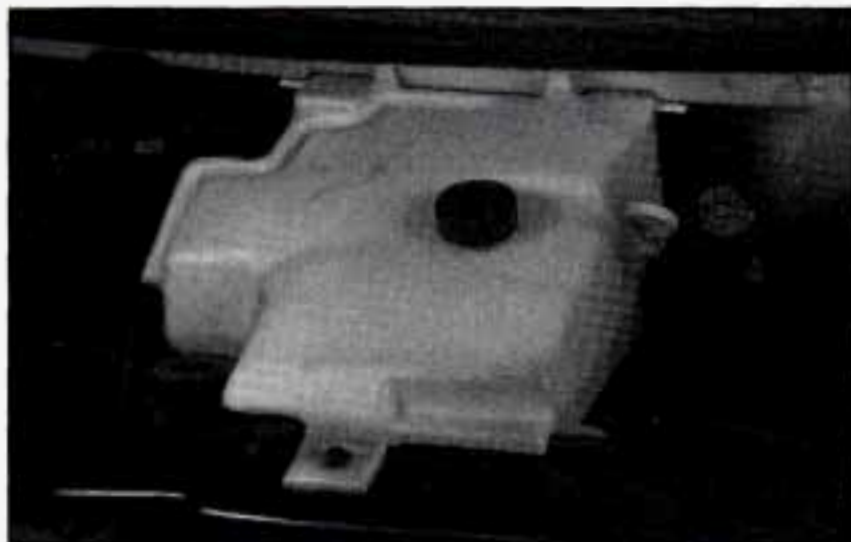

When your engine is cold, the coolant level should be at **FULL COLD**, or a little higher.

Adding Coolant

If you need more coolant, add the proper mix *at the coolant recovery tank*.

CAUTION:

Turning the radiator pressure cap when the engine and radiator are hot can allow steam and scalding liquids to blow out and burn you badly. With the coolant recovery tank, you will almost never have to add coolant at the radiator. Never turn the radiator pressure cap -- even a little -- when the engine and radiator are hot.

Add coolant mix at the recovery tank, but be careful not to spill it.

CAUTION:

You can be burned if you spill coolant on hot engine parts. Coolant contains ethylene glycol, and it will burn if the engine parts are hot enough. Don't spill coolant on a hot engine.

Radiator Pressure Cap

The radiator pressure cap must be tightly installed with the arrows on the cap lined up with the overflow tube on the radiator filler neck.

NOTICE:

Your radiator cap is a pressure-type cap and must be tightly installed to prevent coolant loss and possible engine damage from overheating. Be sure the arrows on the cap line up with the overflow tube on the radiator filler neck.

Thermostat

Engine coolant temperature is controlled by a thermostat in the engine cooling system. The thermostat stops the flow of coolant through the radiator until the coolant reaches a preset temperature.

When you replace your thermostat, an AC® thermostat is recommended.

Power Steering Fluid



When to Check Power Steering Fluid

It is not necessary to regularly check power steering fluid unless you suspect there is a leak in the system or you hear an unusual noise. A fluid loss in this system could indicate a problem. Have the system inspected and repaired.

How To Check Power Steering Fluid

When the engine compartment is cool, unscrew the cap and wipe the dipstick with a clean rag. Replace the cap and completely tighten it. Then remove the cap again and look at the fluid level on the dipstick.

The level should be at the FULL COLD mark. If necessary, add only enough fluid to bring the level up to the mark.

To prevent brake fluid contamination, never check or fill the power steering reservoir with the master cylinder cover off.

What to Use

Refer to the Maintenance Schedule to determine what kind of fluid to use. See "Recommended Fluids and Lubricants" in the Index. Always use the proper fluid. Failure to use the proper fluid can cause leaks and damage hoses and seals.

Windshield Washer Fluid

What to Use

When you need windshield washer fluid, be sure to read the manufacturer's instructions before use. If you will be operating your vehicle in an area where the temperature may fall below freezing, use a fluid that has sufficient protection against freezing.

Adding Washer Fluid



Open the cap labeled WASHER FLUID. Add washer fluid until the tank is full.

NOTICE:

- **When using concentrated washer fluid, follow the manufacturer's instructions for adding water.**
- **Don't mix water with ready-to-use washer fluid. Water can cause the solution to freeze and damage your washer fluid tank and other parts of the washer system. Also, water doesn't clean as well as washer fluid.**
- **Fill your washer fluid tank only three-quarters full when it's very cold. This allows for expansion, which could damage the tank if it is completely full.**
- **Don't use radiator antifreeze in your windshield washer. It can damage your washer system and paint.**

Brakes

Brake Fluid



Your brake master cylinder reservoir is here. It is filled with DOT-3 brake fluid.

There are only two reasons why the brake fluid level in the reservoir might go down. The first is that the brake fluid goes down to an acceptable level during normal brake lining wear. When new linings are put in, the fluid level

goes back up. The other reason is that fluid is leaking out of the brake system. If it is, you should have your brake system fixed, since a leak means that sooner or later your brakes won't work well, or won't work at all.

So, it isn't a good idea to "top off" your brake fluid. Adding brake fluid won't correct a leak. If you add fluid when your linings are worn, then you'll have too much fluid when you get new brake linings. You should add (or remove) brake fluid, as necessary, only when work is done on the brake hydraulic system.

CAUTION:

If you have too much brake fluid, it can spill on the engine. The fluid will burn if the engine is hot enough. You or others could be burned, and your vehicle could be damaged. Add brake fluid only when work is done on the brake hydraulic system.

Refer to the Maintenance Schedule to determine when to check your brake fluid. See "Periodic Maintenance Inspections" in the Index.

Checking Brake Fluid



You can check the brake fluid without taking off the cap.

Just look at the windows on the brake fluid reservoir. The fluid levels should be above MIN. If they aren't, have your brake system checked to see if there is a leak.

After work is done on the brake hydraulic system, make sure the levels are above MIN and below the top of each window.

What to Add

When you do need brake fluid, use only DOT-3 brake fluid -- such as Delco Supreme 11[®] (GM Part No. 1052535). Use new brake fluid from a sealed container only, and always clean the brake fluid reservoir cap before removing it.

CAUTION:

With the wrong kind of fluid in your brake system, your brakes may not work well, or they may not even work at all. This could cause a crash. Always use the proper brake fluid.

NOTICE:

- **Using the wrong fluid can badly damage brake system parts. For example, just a few drops of mineral-based oil, such as engine oil, in your brake system can damage brake system parts so badly that they'll have to be replaced. Don't let someone put in the wrong kind of fluid.**
- **If you spill brake fluid on your vehicle's painted surfaces, the paint finish can be damaged. Be careful not to spill brake fluid on your vehicle. If you do, wash it off immediately. See "Appearance Care" in the Index.**

Brake Wear

Your vehicle has front disc brakes and rear drum brakes.

Disc brake pads have built-in wear indicators that make a high-pitched warning sound when the brake pads are worn and new pads are needed. The sound may come and go or be heard all the time your vehicle is moving (except when you are pushing on the brake pedal firmly).



CAUTION:

The brake wear warning sound means that sooner or later your brakes won't work well. That could lead to an accident. When you hear the brake wear warning sound, have your vehicle serviced.

NOTICE:

Continuing to drive with worn-out brake pads could result in costly brake repair.

Some driving conditions or climates may cause a brake squeal when the brakes are first applied or lightly applied. This does not mean something is wrong with your brakes.

Free movement of brake calipers and properly torqued wheel nuts are necessary to help prevent brake pulsation. When tires are rotated, inspect brake calipers for movement, brake pads for wear, and evenly torque wheel nuts in the proper sequence to GM specifications.

Your rear drum brakes don't have wear indicators, but if you ever hear a rear brake rubbing noise, have the rear brake linings inspected. Also, the rear brake drums should be removed and inspected each time the tires are removed for rotation or changing. When you have the front brakes replaced, have the rear brakes inspected, too.

Brake linings should always be replaced as complete axle sets.

Brake Pedal Travel

See your dealer if the brake pedal does not return to normal height, or if there is a rapid increase in pedal travel. This could be a sign of brake trouble.

Brake Adjustment

Every time you make a brake stop, your disc brakes adjust for wear.

If your brake pedal goes down farther than normal, your rear drum brakes may need adjustment. Adjust them by backing up and firmly applying the brakes a few times.

Replacing Brake System Parts

The braking system on a modern vehicle is complex. Its many parts have to be of top quality and work well together if the vehicle is to have really good braking. Vehicles we design and test have top-quality GM brake parts in them, as your vehicle does when it is new. When you replace parts of your braking system -- for example, when your brake linings wear down and you have to have new ones put in -- be sure you get new genuine GM replacement parts. If you don't, your brakes may no longer work properly. For example, if someone puts in brake linings that are wrong for your vehicle, the balance between your front and rear brakes can change -- for the worse. The braking performance you've come to expect can change in many other ways if someone puts in the wrong replacement brake parts.

Battery

Every new vehicle has a Delco Freedom[®] battery. You never have to add water to one of these. When it's time for a new battery, we recommend a Delco Freedom battery. Get one that has the replacement number shown on the original battery's label.

Vehicle Storage

If you're not going to drive your vehicle for 25 days or more, take off the black, negative (-) cable from the battery. This will help keep your battery from running down.

 **CAUTION:**

Batteries have acid that can burn you and gas that can explode. You can be badly hurt if you aren't careful. See "Jump Starting" in the Index for tips on working around a battery without getting hurt.

Contact your dealer to learn how to prepare your vehicle for longer storage periods.

Also, for your audio system, see "Theft-Deterrent Feature" in the Index.

Bulb Replacement

Before you replace any bulbs, be sure that all the lamps are off and the engine isn't running. See "Replacement Bulbs" in the index for the proper types of bulbs to use.

Halogen Bulbs

 **CAUTION:**

Halogen bulbs have pressurized gas inside and can burst if you drop or scratch the bulb. You or others could be injured. Be sure to read and follow the instructions on the bulb package.

Headlamps

You have either a sealed beam headlamp system or a composite system.

Sealed Beam Headlamps



1. Remove the four screws from the headlamp retainer. Pull the retainer out and set it aside.



2. Unplug the lamp assembly from the connector.
3. Install a new headlamp.
4. Reverse Steps 2 through 3 to reinstall the headlamp.

Composite Headlamps

1. Open the hood.
2. Locate the rear side of each of the headlamps.



3. Without removing the headlamp assembly itself, remove the bulb assembly from the back of the headlamp on the driver's side by turning the bulb counterclockwise one quarter turn.
4. On the passenger side, turn the bulb clockwise one-quarter turn. Also, to remove the bulb on the passenger side, you will need to move the battery.



5. Install a new bulb. Do not handle the glass part of the bulb.
6. Reverse Steps 3 through 4 to reinstall the headlamp.

Front Parking/Turn Signal Lamps

To replace the front parking/turn signal lamps:

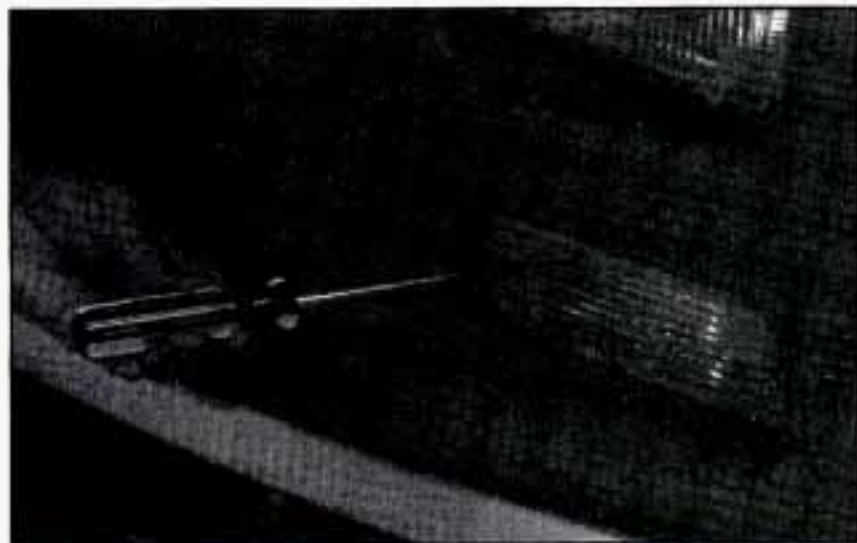

1. Remove the outer screws from the parking/turn signal lamp lens assembly. (There are either two or four screws, depending on your vehicle's trim level.)



2. Remove the lamp from the grille.

Sidemarker Lamps



3. Remove the bulb assembly from the back of the lens and replace the bulb.
4. Follow Steps 2 and 3 to replace the bulb. Turn the socket clockwise to replace it in the lens assembly.



1. Remove the screw from the top of the lens.

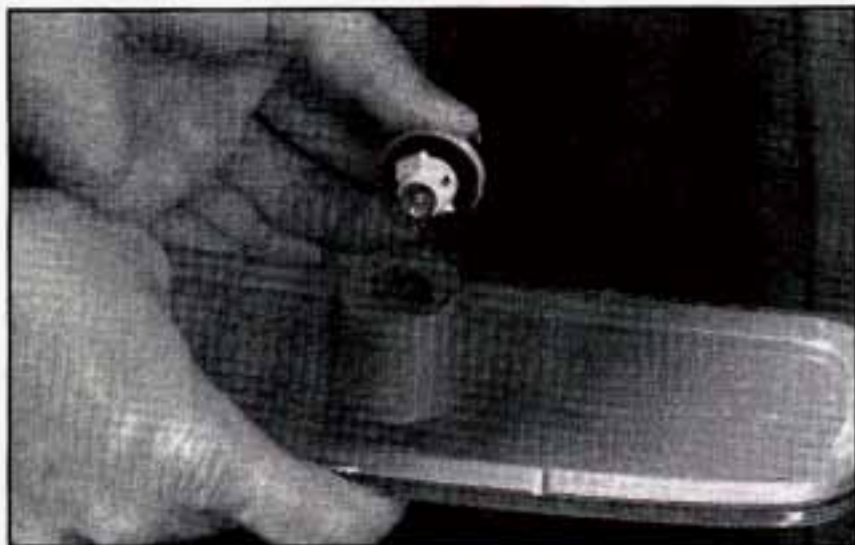

2. Un-clip the bottom of the lamp from the grille.
3. Remove the bulb by twisting it out of the socket. Turn the bulb to remove it. Install the new bulb.
4. Reverse these steps to reinstall the lamp.

Taillamps

1. Open the rear door.



2. Push the socket protector until you can see the fasteners.

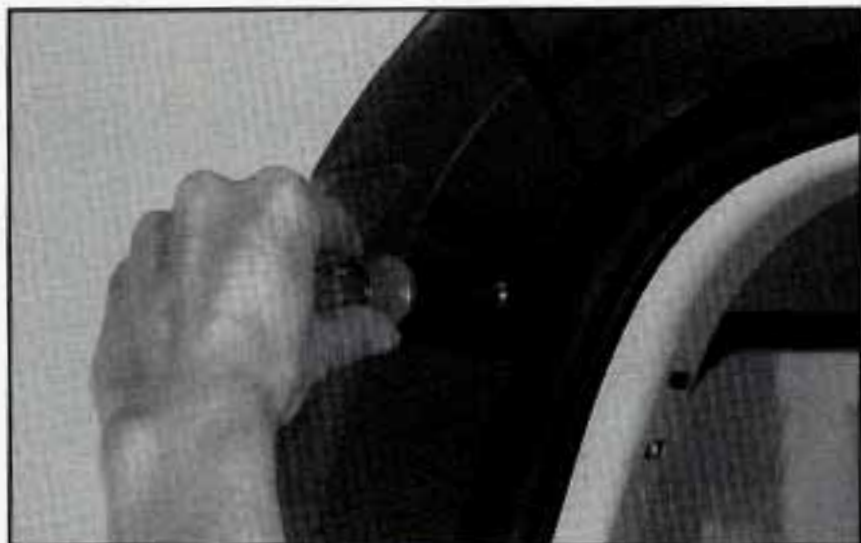

3. Remove the nuts with a deep socket wrench.



4. Remove the hidden upper nuts.



5. Lift the lamp as you rotate it toward the rear of the vehicle.



6. Turn the sockets to the left to remove.



7. With the door open, turn the bulb to the left to remove it. Install the new bulb.
8. Reverse the above steps to reinstall the lamp.

Windshield Wiper Blade Replacement

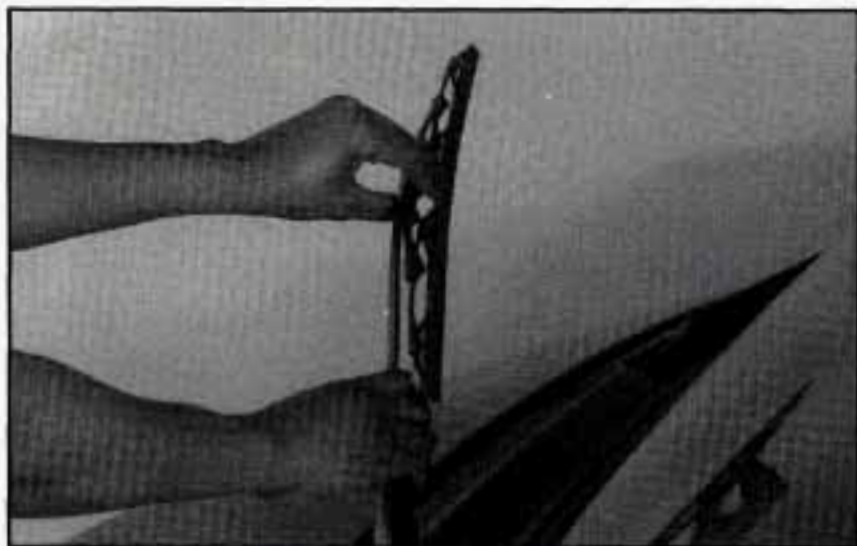

See "Normal Maintenance Replacement Parts" in the Index for the proper type of replacement blade.

Replacement blades come in different types and are removed in different ways. To remove the type with a release clip:

1. To remove the old wiper blades, lift the wiper arm until it locks into a vertical position.
2. Press down on the blade assembly pivot locking tab. Pull down on the blade assembly to release it from the wiper arm hook.
3. Remove the insert from the blade assembly. The insert has two notches at one end that are locked by bottom claws of the blade assembly. At the notched end, pull the insert from the blade assembly.
4. To install the new wiper insert, slide the notched end last, into the end with two blade claws. Slide all the way through the blade claws at the opposite end.
5. Be sure that the notches are locked by the bottom claws. Make sure that all other claws are properly locked on both sides of the insert slots.
6. Put the blade assembly pivot in the wiper arm hook. Pull up until the pivot locking tab locks in the hook slot.
7. Carefully lower the wiper arm and blade assembly into the windshield.

Tires

We don't make tires. Your new vehicle comes with high-quality tires made by a leading tire manufacturer. If you ever have questions about your tire warranty and where to obtain service, see your GM Warranty booklet for details.

CAUTION:

Poorly maintained and improperly used tires are dangerous.

- **Overloading your tires can cause overheating as a result of too much friction. You could have an air-out and a serious accident. See "Loading Your Vehicle" in the Index.**

CAUTION: (Continued)

CAUTION: (Continued)

- **Underinflated tires pose the same danger as overloaded tires. The resulting accident could cause serious injury. Check all tires frequently to maintain the recommended pressure. Tire pressure should be checked when your tires are cold.**
- **Overinflated tires are more likely to be cut, punctured or broken by a sudden impact -- such as when you hit a pothole. Keep tires at the recommended pressure.**
- **Worn, old tires can cause accidents. If your tread is badly worn, or if your tires have been damaged, replace them.**

Inflation -- Tire Pressure

The Certification/Tire label, which is on the rear edge of the driver's door, shows the correct inflation pressures for your tires when they're cold. "Cold" means your vehicle has been sitting for at least three hours or driven no more than 1 mile (1.6 km).

NOTICE:

Don't let anyone tell you that underinflation or overinflation is all right. It's not. If your tires don't have enough air (underinflation), you can get the following:

- Too much flexing
- Too much heat
- Tire overloading
- Bad wear
- Bad handling
- Bad fuel economy.

NOTICE: (Continued)

NOTICE: (Continued)

If your tires have too much air (overinflation), you can get the following:

- Unusual wear
- Bad handling
- Rough ride
- Needless damage from road hazards.

When to Check

Check your tires once a month or more. Also, check the tire pressure of the spare tire.

How to Check

Use a good quality pocket-type gage to check tire pressure. You can't tell if your tires are properly inflated simply by looking at them. Radial tires may look properly inflated even when they're underinflated.

Be sure to put the valve caps back on the valve stems. They help prevent leaks by keeping out dirt and moisture.

Tire Inspection and Rotation

Tires should be inspected every 6,000 to 8,000 miles (10 000 to 13 000 km) for any signs of unusual wear. If unusual wear is present, rotate your tires as soon as possible and check wheel alignment. Also check for damaged tires or wheels. See “When It’s Time for New Tires” and “Wheel Replacement” later in this section for more information. If your vehicle has dual rear wheels, also see “Dual Tire Operation” later in this section.

The purpose of regular rotation is to achieve more uniform wear for all tires on the vehicle. The first rotation is the most important. See “Scheduled Maintenance Services” in the Index for scheduled rotation intervals.

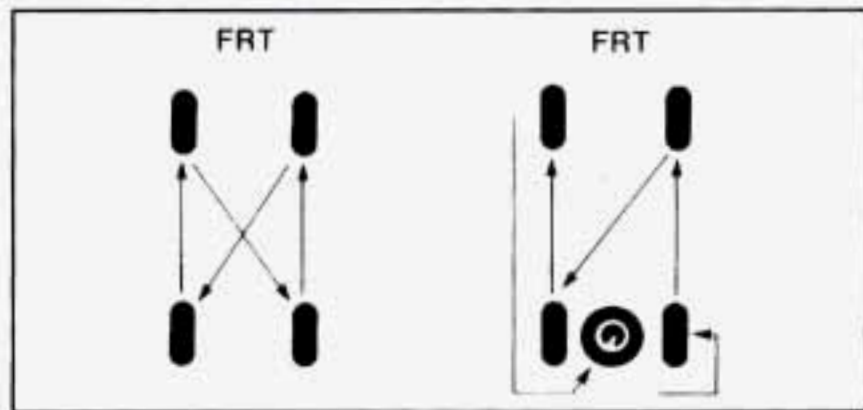

If your vehicle has single rear wheels, always use one of the correct rotation patterns shown here when rotating your tires.

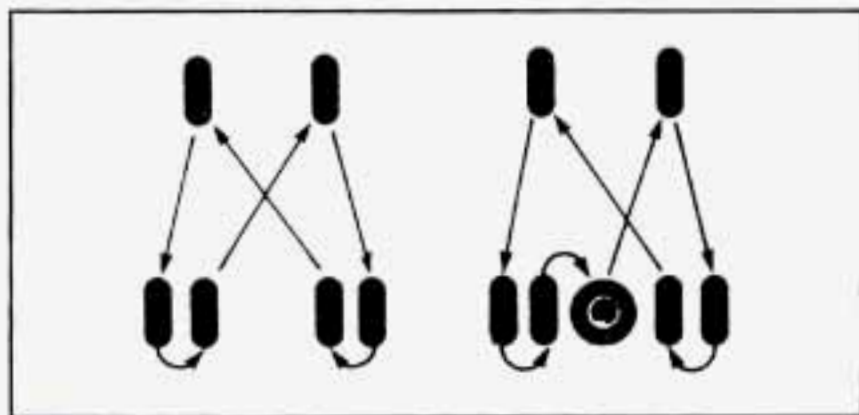

If your vehicle has dual rear wheels, always use one of the correct rotation patterns shown here when rotating your tires.

When you install dual wheels, be sure the vent holes in the inner and outer wheels on each side are lined up.

After the tires have been rotated, adjust the front and rear inflation pressures as shown on the Certification/Tire label. Make certain that all wheel nuts are properly tightened. See “Wheel Nut Torque” in the Index.

CAUTION:

Rust or dirt on a wheel, or on the parts to which it is fastened, can make wheel nuts become loose after a time. The wheel could come off and cause an accident. When you change a wheel, remove any rust or dirt from places where the wheel attaches to the vehicle. In an emergency, you can use a cloth or a paper towel to do this; but be sure to use a scraper or wire brush later, if you need to, to get all the rust or dirt off. (See “Changing a Flat Tire” in the Index.)

When It's Time for New Tires

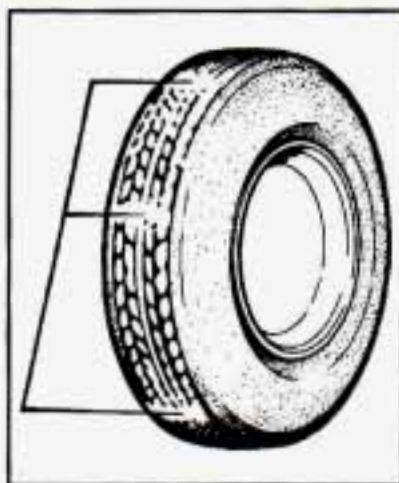

One way to tell when it's time for new tires is to check the treadwear indicators, which will appear when your tires have only 1/16 inch (1.6 mm) or less of tread remaining. Some commercial truck tires may not have treadwear indicators.

You need a new tire if any of the following statements are true:

- You can see the indicators at three or more places around the tire.
- You can see cord or fabric showing through the tire's rubber.
- The tread or sidewall is cracked, cut or snagged deep enough to show cord or fabric.
- The tire has a bump, bulge or split.
- The tire has a puncture, cut or other damage that can't be repaired well because of the size or location of the damage.

Dual Tire Operation

When the vehicle is new, or whenever a wheel, wheel bolt or wheel nut is replaced, check the wheel nut torque after 100, 1,000 and 6,000 miles (160, 1 600 and 10 000 km) of driving. For proper torque, see “Wheel Nut Torque” in the Index.

The outer tire on a dual wheel setup generally wears faster than the inner tire. Your tires will wear more evenly and last longer if you rotate the tires periodically. If you're going to be doing a lot of driving on high-crown roads, you can reduce tire wear by adding 5 psi (35 kPa) to the tire pressure in the outer tires. Be sure to return to the recommended pressures when no longer driving under those conditions. See “Changing a Flat Tire” in the Index for more information.

CAUTION:

If you operate your vehicle with a tire that is badly underinflated, the tire can overheat. An overheated tire can lose air suddenly or catch fire. You or others could be injured. Be sure all tires (including the spare) are properly inflated.

Buying New Tires

To find out what kind and size of tires you need, look at the Certification/Tire label.

The tires installed on your vehicle when it was new had a Tire Performance Criteria Specification (TPC Spec) number on each tire's sidewall. When you get new tires, get ones with that same TPC Spec number. That way your vehicle will continue to have tires that are designed to give proper endurance, handling, speed rating, traction, ride and other things during normal service on your vehicle. If your tires have an all-season tread design, the TPC number will be followed by an “MS” (for mud and snow).

If you ever replace your tires with those not having a TPC Spec number, make sure they are the same size, load range, speed rating and construction type (bias, bias-belted or radial) as your original tires.



CAUTION:

Mixing tires could cause you to lose control while driving. If you mix tires of different sizes or types (radial and bias-belted tires), the vehicle may not handle properly, and you could have a crash. Using tires of different sizes may also cause damage to your vehicle. Be sure to use the same size and type tires on all wheels.

Uniform Tire Quality Grading

The following information relates to the system developed by the United States National Highway Traffic Safety Administration, which grades tires by treadwear, traction and temperature performance. (This applies only to vehicles sold in the United States.) The grades are molded on the sidewalls of most passenger car tires. The Uniform Tire Quality Grading system does not apply to deep tread, winter-type snow tires, space-saver or temporary use spare tires, tires with nominal rim diameters of 10 to 12 inches (25 to 30 cm), or to some limited-production tires.

While the tires available on General Motors passenger cars and light trucks may vary with respect to these grades, they must also conform to Federal safety requirements and additional General Motors Tire Performance Criteria (TPC) standards.

Treadwear

The treadwear grade is a comparative rating based on the wear rate of the tire when tested under controlled conditions on a specified government test course. For example, a tire graded 150 would wear one and a half (1 1/2) times as well on the government course as a tire graded 100. The relative performance of tires depends upon the actual conditions of their use, however, and may depart significantly from the norm due to variations in driving habits, service practices and differences in road characteristics and climate.

Traction -- A, B, C

The traction grades, from highest to lowest, are A, B, and C, and they represent the tire's ability to stop on wet pavement as measured under controlled conditions on specified government test surfaces of asphalt and concrete. A tire marked C may have poor traction performance.

Warning: The traction grade assigned to this tire is based on braking (straight-ahead) traction tests and does not include cornering (turning) traction.

Temperature -- A, B, C

The temperature grades are A (the highest), B, and C, representing the tire's resistance to the generation of heat and its ability to dissipate heat when tested under controlled conditions on a specified indoor laboratory test wheel. Sustained high temperature can cause the material of the tire to degenerate and reduce tire life, and excessive temperature can lead to sudden tire failure. The grade C corresponds to a level of performance which all passenger car tires must meet under the Federal Motor Vehicle Safety Standard No. 109. Grades B and A represent higher levels of performance on the laboratory test wheel than the minimum required by law.

Warning: The temperature grade for this tire is established for a tire that is properly inflated and not overloaded. Excessive speed, underinflation, or excessive loading, either separately or in combination, can cause heat buildup and possible tire failure.

Wheel Alignment and Tire Balance

The wheels on your vehicle were aligned and balanced carefully at the factory to give you the longest tire life and best overall performance.

In most cases, you will not need to have your wheels aligned again. However, if you notice unusual tire wear or your vehicle pulling one way or the other, the alignment may need to be reset. If you notice your vehicle vibrating when driving on a smooth road, your wheels may need to be rebalanced.

Wheel Replacement

Replace any wheel that is bent, cracked, or badly rusted or corroded. If wheel nuts keep coming loose, the wheel, wheel bolts and wheel nuts should be replaced. If the wheel leaks air, replace it (except some aluminum wheels, which can sometimes be repaired). See your GM dealer if any of these conditions exist.

Your dealer will know the kind of wheel you need.

Each new wheel should have the same load-carrying capacity, diameter, width, offset and be mounted the same way as the one it replaces.

If you need to replace any of your wheels, wheel bolts or wheel nuts, replace them only with new GM original equipment parts. This way, you will be sure to have the right wheel, wheel bolts and wheel nuts for your vehicle.

CAUTION:

Using the wrong replacement wheels, wheel bolts or wheel nuts on your vehicle can be dangerous. It could affect the braking and handling of your vehicle, make your tires lose air and make you lose control. You could have a collision in which you or others could be injured. Always use the correct wheel, wheel bolts and wheel nuts for replacement.

NOTICE:

The wrong wheel can also cause problems with bearing life, brake cooling, speedometer or odometer calibration, headlamp aim, bumper height, vehicle ground clearance and tire or tire chain clearance to the body and chassis.

Whenever a wheel, wheel bolt or wheel nut is replaced on a dual wheel setup, check the wheel nut torque after 100, 1,000 and 6,000 miles (160, 1 600 and 10 000 km) of driving. For proper torque, see “Wheel Nut Torque” in the Index.

See “Changing a Flat Tire” in the Index for more information.

Used Replacement Wheels



CAUTION:

Putting a used wheel on your vehicle is dangerous. You can't know how it's been used or how many miles it's been driven. It could fail suddenly and cause an accident. If you have to replace a wheel, use a new GM original equipment wheel.

Tire Chains

NOTICE:

Use tire chains only where legal and only when you must. Use chains that are the proper size for your tires. Install them on the tires of the rear axle.

Tighten them as tightly as possible with the ends securely fastened. Drive slowly and follow the chain manufacturer's instructions. If you can hear the chains contacting your vehicle, stop and retighten them. If the contact continues, slow down until it stops. Driving too fast or spinning the wheels with chains on will damage your vehicle.

Appearance Care

Remember, cleaning products can be hazardous. Some are toxic. Others can burst into flame if you strike a match or get them on a hot part of the vehicle. Some are dangerous if you breathe their fumes in a closed space. When you use anything from a container to clean your vehicle, be sure to follow the manufacturer's warnings and instructions. And always open your doors or windows when you're cleaning the inside.

Never use these to clean your vehicle:

- Gasoline
- Benzene
- Naphtha
- Carbon Tetrachloride
- Acetone
- Paint Thinner
- Turpentine
- Lacquer Thinner
- Nail Polish Remover

They can all be hazardous -- some more than others -- and they can all damage your vehicle, too.

Don't use any of these unless this manual says you can. In many uses, these will damage your vehicle:

- Alcohol
- Laundry Soap
- Bleach
- Reducing Agents

Cleaning the Inside of Your Vehicle

Use a vacuum cleaner often to get rid of dust and loose dirt. Wipe vinyl or leather with a clean, damp cloth.

Your GM dealer has two GM cleaners, a solvent-type spot lifter and a foam-type powdered cleaner. They will clean normal spots and stains very well. Do not use them on vinyl or leather.

Here are some cleaning tips:

- Always read the instructions on the cleaner label.
- Clean up stains as soon as you can -- before they set.
- Use a clean cloth or sponge, and change to a clean area often. A soft brush may be used if stains are stubborn.
- Use solvent-type cleaners in a well-ventilated area only. If you use them, don't saturate the stained area.
- If a ring forms after spot cleaning, clean the entire area immediately or it will set.

Using Foam-Type Cleaner on Fabric

1. Vacuum and brush the area to remove any loose dirt.
2. Always clean a whole trim panel or section. Mask surrounding trim along stitch or welt lines.
3. Mix Multi-Purpose Powdered Cleaner following the directions on the container label.
4. Use suds only and apply with a clean sponge.
5. Don't saturate the material.
6. Don't rub it roughly.
7. As soon as you've cleaned the section, use a sponge to remove the suds.
8. Rinse the section with a clean, wet sponge.
9. Wipe off what's left with a slightly damp paper towel or cloth.
10. Then dry it immediately with a blow dryer.
11. Wipe with a clean cloth.

Using Solvent-Type Cleaner on Fabric

First, see if you have to use solvent-type cleaner at all. Some spots and stains will clean off better with just water and mild soap.

If you need to use a solvent:

- Gently scrape excess soil from the trim material with a clean, dull knife or scraper. Use very little cleaner, light pressure and clean cloths (preferably cheesecloth). Cleaning should start at the outside of the stain, “feathering” toward the center. Keep changing to a clean section of the cloth.
- When you clean a stain from fabric, immediately dry the area with a blow dryer to help prevent a cleaning ring.

Fabric Protection

Your GM has upholstery and carpet that has been treated with Scotchgard™ Fabric Protector, a 3M product. It protects fabrics by repelling oil and water, which are the carriers of most stains. Even with this protection, you still need to clean your upholstery and carpet often to keep it looking new.

Further information on cleaning is available by calling 1-800-433-3296 (in Minnesota, 1-800-642-6167).

Special Cleaning Problems

Greasy or Oily Stains

Stains caused by grease, oil, butter, margarine, shoe polish, coffee with cream, chewing gum, cosmetic creams, vegetable oils, wax crayon, tar and asphalt can be removed as follows:

1. Carefully scrape off excess stain.
2. Follow the solvent-type instructions described earlier.
3. Shoe polish, wax crayon, tar and asphalt will stain if left on a vehicle's seat fabric. They should be removed as soon as possible. Be careful, because the cleaner will dissolve them and may cause them to spread.

Non-Greasy Stains

Stains caused by catsup, coffee (black), egg, fruit, fruit juice, milk, soft drinks, wine, vomit, urine and blood can be removed as follows:

1. Carefully scrape off excess stain, then sponge the soiled area with cool water.
2. If a stain remains, follow the foam-type instructions described earlier.
3. If an odor lingers after cleaning vomit or urine, treat the area with a water/baking soda solution:
1 teaspoon (5 ml) of baking soda to 1 cup (250 ml) of lukewarm water.
4. If needed, clean lightly with solvent-type cleaner.

Combination Stains

Stains caused by candy, ice cream, mayonnaise, chili sauce and unknown stains can be removed as follows:

- Carefully scrape off excess stain, then clean with cool water and allow to dry.
- If a stain remains, clean it with solvent-type cleaner.

Cleaning Vinyl

Use warm water and a clean cloth.

- Rub with a clean, damp cloth to remove dirt. You may have to do it more than once.
- Things like tar, asphalt and shoe polish will stain if you don't get them off quickly. Use a clean cloth and a GM Vinyl/Leather Cleaner or equivalent product.

Cleaning Leather

Use a soft cloth with lukewarm water and a mild soap or saddle soap.

- For stubborn stains, use a GM Vinyl/Leather Cleaner or equivalent product.
- *Never* use oils, varnishes, solvent-based or abrasive cleaners, furniture polish or shoe polish on leather.
- Soiled leather should be cleaned immediately. If dirt is allowed to work into the finish, it can harm the leather.

Cleaning the Top of the Instrument Panel

Use only mild soap and water to clean the top surfaces of the instrument panel. Sprays containing silicones or waxes may cause annoying reflections in the windshield and even make it difficult to see through the windshield under certain conditions.

Care of Safety Belts

Keep belts clean and dry.

CAUTION:

Do not bleach or dye safety belts. If you do, it may severely weaken them. In a crash, they might not be able to provide adequate protection. Clean safety belts only with mild soap and lukewarm water.

Glass

Glass should be cleaned often. GM Glass Cleaner (GM Part No. 1050427) or a liquid household glass cleaner will remove normal tobacco smoke and dust films.

Don't use abrasive cleaners on glass, because they may cause scratches. Avoid placing decals on the inside rear window, since they may have to be scraped off later. If abrasive cleaners are used on the inside of the rear window, an electric defogger element may be damaged. Any temporary license should not be attached across the defogger grid.

Cleaning the Outside of the Windshield and Wiper Blades

If the windshield is not clear after using the windshield washer, or if the wiper blade chatters when running, wax or other material may be on the blade or windshield.

Clean the outside of the windshield with GM Windshield Cleaner, Bon-Ami Powder[®] (GM Part No. 1050011). The windshield is clean if beads do not form when you rinse it with water.

Clean the blade by wiping vigorously with a cloth soaked in full-strength windshield washer solvent. Then rinse the blade with water.

Wiper blades should be checked on a regular basis and replaced when worn.

Weatherstrips

Silicone grease on weatherstrips will make them last longer, seal better, and not stick or squeak. Apply silicone grease with a clean cloth at least every six months. During very cold, damp weather more frequent application may be required. (See "Recommended Fluids and Lubricants" in the Index.)

Cleaning the Outside of Your Vehicle

The paint finish on your vehicle provides beauty, depth of color, gloss retention and durability.

Washing Your Vehicle

The best way to preserve your vehicle's finish is to keep it clean by washing it often with lukewarm or cold water.

Don't wash your vehicle in the direct rays of the sun. Don't use strong soaps or chemical detergents. Use liquid hand, dish or car washing (mild detergent) soaps. Don't use cleaning agents that are petroleum based, or that contain acid or abrasives. All cleaning agents should be flushed promptly and not allowed to dry on the surface, or they could stain. Dry the finish with a soft, clean chamois or a 100% cotton towel to avoid surface scratches and water spotting.

High pressure vehicle washes may cause water to enter your vehicle.

Finish Care

Occasional waxing or mild polishing of your vehicle by hand may be necessary to remove residue from the paint finish. You can get GM-approved cleaning products from your dealer. (See "Appearance Care and Materials" in the Index.)

Your GM manufactured vehicle may have a "basecoat/clearcoat" paint finish. The clearcoat gives more depth and gloss to the colored basecoat. Always use waxes and polishes that are non-abrasive and made for a basecoat/clearcoat paint finish.

NOTICE:

Machine compounding or aggressive polishing on a basecoat/clearcoat paint finish may dull the finish or leave swirl marks.

Foreign materials such as calcium chloride and other salts, ice melting agents, road oil and tar, tree sap, bird droppings, chemicals from industrial chimneys, etc., can damage your vehicle's finish if they remain on painted surfaces. Wash the vehicle as soon as possible. If necessary, use non-abrasive cleaners that are marked safe for painted surfaces to remove foreign matter.

Exterior painted surfaces are subject to aging, weather and chemical fallout that can take their toll over a period of years. You can help to keep the paint finish looking new by keeping your vehicle garaged or covered whenever possible.

Protecting Exterior Bright Metal Parts

Bright metal parts should be cleaned regularly to keep their luster. Washing with water is all that is usually needed. However, you may use GM Chrome Polish on chrome or stainless steel trim, if necessary.

Use special care with aluminum trim. To avoid damaging protective trim, never use auto or chrome polish, steam or caustic soap to clean aluminum. A coating of wax, rubbed to high polish, is recommended for all bright metal parts.

Aluminum Wheels (If So Equipped)

Keep your wheels clean using a soft clean cloth with mild soap and water. Rinse with clean water. After rinsing thoroughly, dry with a soft clean towel. A wax may then be applied.

The surface of these wheels is similar to the painted surface of your vehicle. Don't use strong soaps, chemicals, abrasive polishes, abrasive cleaners or abrasive cleaning brushes on them because you could damage the surface.

Don't take your vehicle through an automatic vehicle wash that has silicon carbide tire cleaning brushes. These brushes can also damage the surface of these wheels.

Tires

To clean your tires, use a stiff brush with a tire cleaner.

NOTICE:

When applying a tire dressing always take care to wipe off any overspray or splash from all painted surfaces on the body or wheels of the vehicle. Petroleum-based products may damage the paint finish.

Sheet Metal Damage

If your vehicle is damaged and requires sheet metal repair or replacement, make sure the body repair shop applies anti-corrosion material to the parts repaired or replaced to restore corrosion protection.

Finish Damage

Any stone chips, fractures or deep scratches in the finish should be repaired right away. Bare metal will corrode quickly and may develop into a major repair expense.

Minor chips and scratches can be repaired with touch-up materials available from your dealer or other service outlets. Larger areas of finish damage can be corrected in your dealer's body and paint shop.

Underbody Maintenance

Chemicals used for ice and snow removal and dust control can collect on the underbody. If these are not removed, accelerated corrosion (rust) can occur on the underbody parts such as fuel lines, frame, floor pan and exhaust system even though they have corrosion protection.

At least every spring, flush these materials from the underbody with plain water. Clean any areas where mud and other debris can collect. Dirt packed in closed areas of the frame should be loosened before being flushed. Your dealer or an underbody vehicle washing system can do this for you.

Chemical Paint Spotting

Some weather and atmospheric conditions can create a chemical fallout. Airborne pollutants can fall upon and attack painted surfaces on your vehicle. This damage can take two forms: blotchy, ringlet-shaped discolorations, and small irregular dark spots etched into the paint surface.

Although no defect in the paint job causes this, GM will repair, at no charge to the owner, the surfaces of new vehicles damaged by this fallout condition within 12 months or 12,000 miles (20 000 km) of purchase, whichever occurs first.

This applies only to materials manufactured and sold by General Motors. Bodies, body conversions or equipment not made or sold by General Motors are not covered.

Appearance Care Materials Chart

PART NUMBER	SIZE	DESCRIPTION	USAGE
1050004	2.75 sq. ft.	Chamois	Shines vehicle without scratching
1050172	16 oz. (0.473 L)	Tar and Road Oil Remover	Also removes old waxes and polishes
1050173	16 oz. (0.473 L)	Chrome Cleaner and Polish	Removes rust and corrosion
1050174	16 oz. (0.473 L)	White Sidewall Tire Cleaner	Removes soil and black marks
1050201	16 oz. (0.473 L)	Magic Mirror Cleaner Polish	Exterior cleaner and polish
1050214	32 oz. (0.946 L)	Vinyl and Leather Cleaner	Spot and stain removal
1050427	23 oz. (0.680 L)	Glass Cleaner	Cleans grease, grime and smoke film
1050429	6 lbs. (2.72 kg)	Multi-Purpose Powdered Cleaner	Cleans vinyl, cloth, tires and mats
1051398*	8 oz. (0.237 L)	Spot Lifter	For cloth
1051515	32 oz. (0.946 L)	Optikleen	Windshield washer solvent and antifreeze
1052870	16 oz. (0.473 L)	Wash and Wax Concentrate	Exterior wash
1052918**	8 oz. (0.237 L)	Armor All™ Protector	Protects vinyl, leather and rubber
1052929	16 oz. (0.473 L)	Wheel Cleaner	Spray on wheel cleaner
1052930	8 oz. (0.237 L)	Capture Dry Spot Remover	Attracts and absorbs soils
12345002**	16 oz. (0.473 L)	Armor All™ Cleaner	Cleans vinyl, leather and rubber
12345725	12 oz. (0.354 L)	Silicone Tire Shine	Shines tires

See your General Motors Parts Department for these products.
See "Fluids and Lubricants" in the Index.

* Not recommended for pigskin suede leather.
**Not recommended for use on instrument panel vinyl.

Vehicle Identification Number (VIN)

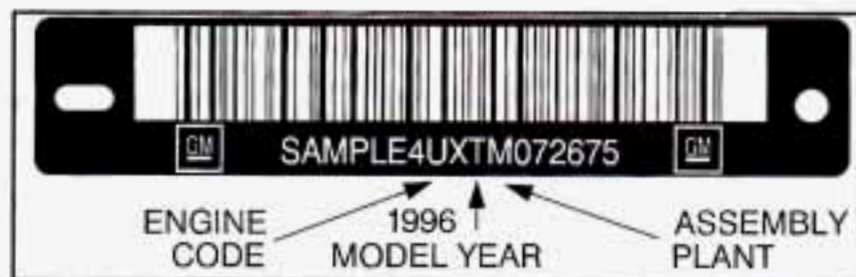

This is the legal identifier for your vehicle. It appears on a plate in the front corner of the instrument panel, on the driver's side. You can see it if you look through the windshield from outside your vehicle. The VIN also appears on the Vehicle Certification and Service Parts labels and the certificates of title and registration.

Engine Identification

The eighth character in your VIN is the engine code. This code will help you identify your engine, specifications and replacement parts.

Service Parts Identification Label

You'll find this label on the front passenger door frame. It's very helpful if you ever need to order parts. On this label is:

- your VIN,
- the model designation,
- paint information, and
- a list of all production options and special equipment.

Be sure that this label is not removed from the vehicle.

Electrical System

Add-On Electrical Equipment

NOTICE:

Don't add anything electrical to your vehicle unless you check with your dealer first. Some electrical equipment can damage your vehicle and the damage wouldn't be covered by your warranty. Some add-on electrical equipment can keep other components from working as they should.

Your vehicle has an air bag system. Before attempting to add anything electrical to your vehicle, see "Servicing Your Air Bag-Equipped Vehicle" in the Index.

Headlamp Wiring

The headlamp wiring is protected by a circuit breaker in the lamp switch. An electrical overload will cause the lamps to flicker on and off, or in some cases to remain off. If this happens, have your headlamp wiring checked right away.

Windshield Wiper Fuses

The windshield wiper motor is protected by a circuit breaker and a fuse. If the motor overheats due to heavy snow, etc., the wiper will stop until the motor cools. Although the circuit is protected from electrical overload, overload due to heavy snow, etc., may cause wiper linkage damage. Always clear ice and heavy snow from the the windshield before using the windshield wipers. If the overload is caused by some electrical problem and not snow, etc., be sure to get it fixed.

Power Windows and Other Power Options

Circuit breakers in the fuse panel protect the power windows and other power accessories. When the current load is too heavy, the circuit breaker opens and closes. This protects the circuit until the current load returns to normal or the problem is fixed.

Instrument Panel Fuse Block



The fuse block access door is on the driver's side of the instrument panel below the hood release lever.

You can remove fuses with a fuse extractor. The fuse extractor is mounted to the fuse block access door.

To remove fuses if you don't have a fuse extractor, hold the end of the fuse between your thumb and index finger and pull straight out.

Be sure to use the correct fuse. If you ever have a problem on the road and don't have a spare fuse, you can "borrow" one of the correct value. Just pick some

feature of your vehicle that you can get along without -- like the radio or cigarette lighter -- and use its fuse, if it is of the value you need. Replace it as soon as you can. See "Fuses and Circuit Breakers" in the Index for more information.

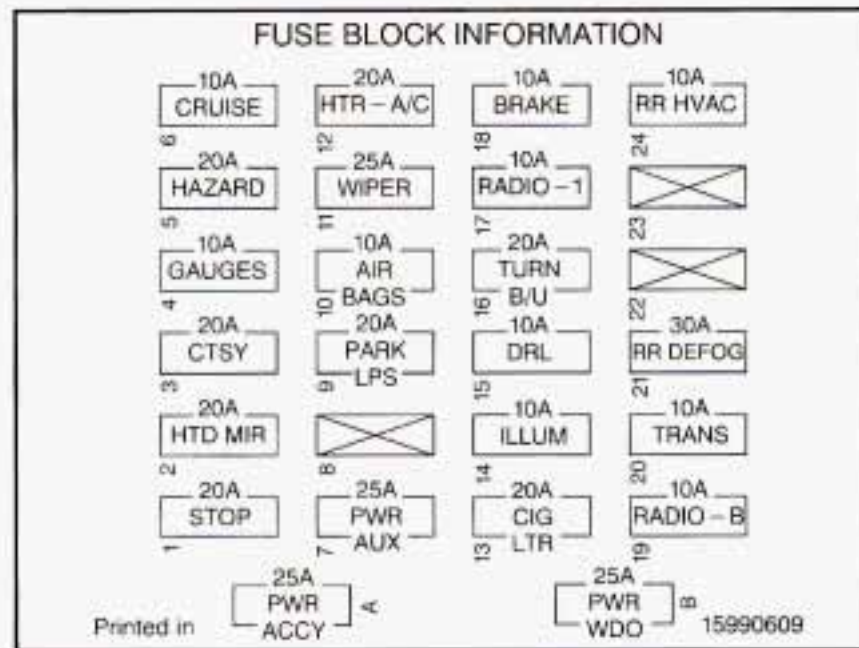

POSITION	NAME	CIRCUITS PROTECTED
1.	STOP	Stop/CHMSL, Stoplamps
2.	HTD MIR	Electric Heated Mirrors
3.	CTSY	Courtesy Lamps, Dome/RDG Lamps, Vanity Mirrors, Power Mirrors
4.	GAUGES	IP Cluster, DRL Relay, DRL Module, HDLP Switch, Keyless Entry Illumination, Low Coolant Module, CHIME Module, DRAB Module
5.	Hazard	Hazard Lamps/CHIME Module
6.	CRUISE	Cruise Control
7.	PWR AUX	Auxiliary Power Outlet, ALDL
8.	Crank	--
9.	PARK LPS	License Plate Lamp, Parking Lamps, Taillamps, Front Sidemarkers, Glove Box Ashtray
10.	AIR BAGS	SDM
11.	WIPER	Wiper Motor, Washer Pump
12.	HTR-A/C	A/C, A/C Blower, High Blower Relay, HTD Mirror
13.	CIG LTR	Power Amp, Cigarette Lighter, Door Lock Relay
14.	ILLUM	LP Cluster, HVAC Controls, RR HVAC Controls, IP Switches, Radio Illumination, Door Switch Illumination
15.	DRL	DRL Relay

POSITION	NAME	CIRCUITS PROTECTED
16.	TURN B/U	Front Turn, RR Turn, Back-up Lamps, BTSI Solenoid
17.	RADIO-1	Radio (Ign, Accy)
18.	BRAKE	4WAL PCM, ABS, Cruise Control
19.	RADIO-B	Radio (Battery), Power Antenna
20.	TRANS	PRNDL, Automatic Transmission
21.	RR FOG	Rear Window Defog
22.	Not Used	--
23.	Not Used	--
24.	RR HVAC	RR HVAC Controls, HIGH, MED, LOW Relays
A.†	PWR ACCY	Power Door Lock, Six-Way Power Seat, Keyless Entry Illumination Module
B.†	PWR WDO	Power Windows

†Circuit Breaker

Do not use fuses of higher amperage than those recommended above. Fuse amperage levels are also imprinted on the fuse panel under the dash.

Capacities and Specifications

Normal Maintenance Replacement Parts

Replacement part numbers listed in this section are based on the latest information available at the time of printing, and are subject to change. If a part listed in this manual is not the same as the part used in your vehicle when it was built, or if you have any questions, please contact your GM truck dealer.

These specifications are for information only. If you have any questions, see the service manual for the chassis or refer to the body manufacturer's publications.

Engine Identification -- Gasoline Engines

Engine	"VORTEC" 4300	"VORTEC" 5000	"VORTEC" 5700	"VORTEC" 7400
Type	V6	V8	V8	V8
VIN Code	W	M	R	J
Fuel System	SFI ¹	SFI ¹	SFI ¹	SFI ²

¹Sequential Central Port Fuel Injection

²Sequential Multi-Port Fuel Injection

Wheel Nut Torque

MODEL	TORQUE
All	122 ft-lb (165 N·m)

Cooling System Capacity

ENGINE	VIN	QTY Without Rear Heater*	QTY With Rear Heater*
"VORTEC" 4300	W	11 quarts (10.4 L)	14 quarts (13.2 L)
"VORTEC" 5000	M	17 quarts (16 L)	20 quarts (18.9 L)
"VORTEC" 5700	R	17 quarts (16 L)	20 quarts (18.9 L)
"VORTEC" 7400	J	23 quarts (21.8 L)	26 quarts (24.6 L)

After refill, the level **MUST** be checked as outlined under "Engine Cooling System" in Section 5.

*All quantities are approximate.

Crankcase Capacity

ENGINE	VIN	Quantity With Filter
"VORTEC" 4300	W	4.5 quarts (4.3 L)
"VORTEC" 5000	M	5 quarts (4.8 L)
"VORTEC" 5700	R	5 quarts (4.8 L)
"VORTEC" 7400	J	7 quarts (6.5 L)

All quantities are approximate.

After refill, the level **MUST** be checked as outlined under "Engine Oil And Filter Recommendations" in Section 5.

*Add an additional quart (1 L) for RPO 5Z1 and RPO KL5 Models.

Fuel Tank Capacity

TYPE	QUANTITY
Standard Tank	31 gallons (117.3 L)
Cutaway Standard Tank	35 gallons (132 L)
Cutaway Optional Tank	55 gallons (208.2 L)

All quantities are approximate.

Normal Replacement Parts

Engine	"VORTEC" 4300	VORTEC" 5000	"VORTEC" 5700	"VORTEC" 7400
VIN	W	M	R	J
Oil Filter	PF52	PF1218	PF1218	PF1218
Air Cleaner Filter*	A917C	A917C	A917C	A917C
PCV Valve	CV789C	CV774C	CV774C	CV774C
Spark Plugs	41-932	41-932	41-932	41-932
Fuel Filter	GF481	GF481	GF481	GF481
Radiator Cap	RC36	RC36	RC36	RC36

*For severe dusty conditions, use AC Air Filter, Part No. 1236C.

Air Conditioning Refrigerants

Not all air conditioning refrigerants are the same. If the air conditioning system in your vehicle needs refrigerant, be sure the proper refrigerant is used. If you're not sure, ask your GM dealer.

TYPE	QTY Front Only	QTY Front and Rear
Refrigerant	3.00 lbs.	4.875 lbs.
R-134a	(1.36 kg)	(2.21 kg)

Lamp and Bulb Data

LAMP OR BULB	TRADE NO.	POWER RATING AT 12.8V, WATTS	QTY
HEADLAMPS			
2 Headlamp System (Sealed Beam System)			
Low/High Beam	H6054	35/65	2
4 Headlamp System (Composite Headlamp System)			
Low/High Beam	6052	51	2
High Beam	9005	60	2
LAMP OR BULB			
EXTERIOR			
Front Sidemarkers Lamp	194	2	
Front Park and Turn Lamp	2357NA	4	
Rear Parking Lamp	3057	2	
Rear Stop and Turn Lamp	3057	2	
Back-up Lamp	3156	2	
Back-up Lamp	1156	2	
Rear Park, Stop and Turn Lamp	1157	2	
CHMSL	921	2	
License Plate Lamp	194	1	
Underhood Lamp	232	1	
Reel Lamp	232	1	

LAMP OR BULB	TRADE NO.	QTY
INTERIOR		
Dome Lamps	211-2	3
Reading Lamps	211-2	6
IP Courtesy Lamp	194	2
Stepwell Lamp	194	2/4
Instrument Panel Compartment Lamp	194	1
Ashtray Lamp	194	1
Sunshade Vanity Mirror	74	4

LAMP OR BULB	TRADE NO.	QTY
INSTRUMENT PANEL		
Daytime Running Lamps Indicator	74	1
Charging System Indicator Lamp	74	1
Instrument Cluster Illumination	194	6
Headlamp Beam Indicator	74	1
Turn Signal Indicator	74	2
Brake Warning Indicator	74	1
SIR (Air Bag)	74	1
Safety Belt Warning	74	1
Check Gages Indicator	74	1
Malfunction Indicator ("Service Engine Soon") Lamp	74	1

NOTES

Section 7 Maintenance Schedule

**IMPORTANT:
KEEP ENGINE OIL
AT THE PROPER
LEVEL AND CHANGE AS
RECOMMENDED**

This section covers the maintenance required for your vehicle. Your vehicle needs these services to retain its safety, dependability and emission control performance.



***Protection
Plan***

Have you purchased the GM Protection Plan? The Plan supplements your new vehicle warranties. See your Warranty and Owner Assistance booklet, or your GM dealer for details.

Introduction

Your Vehicle and the Environment

Proper vehicle maintenance not only helps to keep your vehicle in good working condition, but also helps the environment. All recommended maintenance procedures are important. Improper vehicle maintenance can even affect the quality of the air we breathe. Improper fluid levels or the wrong tire inflation can increase the level of emissions from your vehicle. To help protect our environment, and to keep your vehicle in good condition, please maintain your vehicle properly.

How This Section is Organized

The remainder of this section is divided into five parts:

“Part A: Scheduled Maintenance Services” shows what to have done and how often. Some of these services can be complex, so unless you are technically qualified and have the necessary equipment, you should let your dealer’s service department or another qualified service center do these jobs.

CAUTION:

Performing maintenance work on a vehicle can be dangerous. In trying to do some jobs, you can be seriously injured. Do your own maintenance work only if you have the required know-how and the proper tools and equipment for the job. If you have any doubt, have a qualified technician do the work.

If you are skilled enough to do some work on your vehicle, you will probably want to get the service information GM publishes. See “Service and Owner Publications” in the Index.

“Part B: Owner Checks and Services” tells you what should be checked whenever you stop for fuel. It also explains what you can easily do to help keep your vehicle in good condition.

“Part C: Periodic Maintenance Inspections” explains important inspections that your GM dealer’s service department or another qualified service center should perform.

“Part D: Recommended Fluids and Lubricants” lists some products GM recommends to help keep your vehicle properly maintained. These products, or their equivalents, should be used whether you do the work yourself or have it done.

“Part E: Maintenance Record” provides a place for you to record the maintenance performed on your vehicle. Whenever any maintenance is performed, be sure to write it down in this part. This will help you determine when your next maintenance should be done. In addition, it is a good idea to keep your maintenance receipts. They may be needed to qualify your vehicle for warranty repairs.

Part A: Scheduled Maintenance Services

Using Your Maintenance Schedule

We at General Motors want to help you keep your vehicle in good working condition. But we don't know exactly how you'll drive it. You may drive very short distances only a few times a week. Or you may drive long distances all the time in very hot, dusty weather. You may use your vehicle in making deliveries. Or you may drive it to work, to do errands or in many other ways.

Because of all the different ways people use their GM vehicles, maintenance needs vary. You may even need more frequent checks and replacements than you'll find in the schedules in this section. So please read this section and note how you drive. If you have any questions on how to keep your vehicle in good condition, see your GM dealer.

This part tells you the maintenance services you should have done and when you should schedule them. If you go to your dealer for your service needs, you'll know that GM-trained and supported service people will perform the work using genuine GM parts.

The proper fluids and lubricants to use are listed in Part D. Make sure whoever services your vehicle uses these. All parts should be replaced and all necessary repairs done before you or anyone else drives the vehicle.

These schedules are for vehicles that:

- carry passengers and cargo within recommended limits. You will find these limits on your vehicle's Certification/Tire label. See "Loading Your Vehicle" in the Index.
- are driven on reasonable road surfaces within legal driving limits.
- use the recommended fuel. See "Fuel" in the Index.

Selecting the Right Schedule

First you'll need to decide which of the two schedules is right for your vehicle. Here's how to decide which schedule to follow:

Gasoline engine vehicles and diesel engine vehicles have different maintenance requirements. If you have a diesel engine, follow a schedule designated for diesel engine vehicles only.

See the Diesel Engine Supplement for diesel engine maintenance schedules.

Maintenance Schedule

Short Trip/City Definition -- Gasoline Engines

Follow the Short Trip/City Maintenance Schedule if any one of these conditions is true for your vehicle:

- Most trips are less than 5 to 10 miles (8 to 16 km). This is particularly important when outside temperatures are below freezing.
- Most trips include extensive idling (such as frequent driving in stop-and-go traffic).
- Most trips are through dusty areas.
- You frequently tow a trailer or use a carrier on top of your vehicle.
- You frequently tow a trailer or use a carrier on top of your vehicle. (With some models, you should never tow a trailer. See "Towing a Trailer" in the Index.)
- If the vehicle is used for delivery service, police, taxi or other commercial application.

One of the reasons you should follow this schedule if you operate your vehicle under any of these conditions is that these conditions cause engine oil to break down sooner.

Short Trip/City Intervals -- Gasoline Engines

Every 3,000 Miles (5 000 km): Engine Oil and Filter Change (or 3 months, whichever occurs first). Chassis Lubrication (or 3 months, whichever occurs first). Drive Axle Service (or 3 months, whichever occurs first).

At 6,000 Miles (10 000 km) -- Then Every 12,000 Miles (20 000 km): Tire Rotation.

Every 15,000 Miles (25 000 km): Air Cleaner Filter Inspection, if driving in dusty conditions. Shields and Underhood Insulation Inspection (GVWR above 8,500 lbs. only). Thermostatically Controlled Engine Cooling Fan Check (or every 12 months, whichever occurs first). Front Wheel Bearing Repack (or at each brake relining, whichever occurs first).

Every 30,000 Miles (50 000 km): Air Cleaner Filter Replacement. Fuel Filter Replacement.

Every 50,000 Miles (83 000 km): Automatic Transmission Service (vehicles over 8600 GVWR or driven under severe conditions only).

Maintenance Schedule

Short Trip/City Intervals -- Gasoline Engines

Every 60,000 Miles (100 000 km): Engine Accessory Drive Belt Inspection. Fuel Tank, Cap and Lines Inspection. Exhaust Gas Recirculation System Inspection. Evaporative Control System Inspection.

Every 100,000 Miles (166 000 km): Cooling System Service (or every 60 months, whichever occurs first). Spark Plug Wire Inspection. Spark Plug Replacement. Positive Crankcase Ventilation (PCV) Valve Inspection.

These intervals only summarize maintenance services. Be sure to follow the complete maintenance schedule on the following pages.

Long Trip/Highway Definition -- Gasoline Engines

Follow this maintenance schedule *only* if none of the conditions from the Short Trip/City Maintenance Schedule is true.

Driving a vehicle with a fully warmed engine under highway conditions causes engine oil to break down slower.

Maintenance Schedule

Long Trip/Highway Intervals -- Gasoline Engines

Every 7,500 Miles (12 500 km): Engine Oil and Filter Change (or every 12 months, whichever occurs first). Chassis Lubrication (or every 12 months, whichever occurs first). Drive Axle Service.

At 7,500 Miles (12 500 km) -- Then Every 15,000 Miles (25 000 km): Tire Rotation.

Every 15,000 Miles (25 000 km): Shields and Underhood Insulation Inspection (GVWR above 8,500 lbs. only). Thermostatically Controlled Engine Cooling Fan Check (or every 12 months, whichever occurs first).

Every 30,000 Miles (50 000 km): Fuel Filter Replacement. Air Cleaner Filter Replacement. Front Wheel Bearing Repack (or at each brake relining, whichever occurs first).

Every 50,000 Miles (83 000 km): Automatic Transmission Service (vehicles over 8600 GVWR or driven under severe conditions only).

Long Trip/Highway Intervals -- Gasoline Engines

Every 60,000 Miles (100 000 km): Engine Accessory Drive Belt Inspection. Fuel Tank, Cap and Lines Inspection. Exhaust Gas Recirculation System Inspection. Evaporative Control System Inspection.

Every 100,000 Miles (166 000 km): Cooling System Service (or every 60 months, whichever occurs first). Spark Plug Wire Inspection. Spark Plug Replacement. Positive Crankcase Ventilation (PCV) Valve Inspection.

These intervals only summarize maintenance services. Be sure to follow the complete maintenance schedule on the following pages.

Short Trip/City Maintenance Schedule -- Gasoline Engines

The services shown in this schedule up to 100,000 miles (166 000 km) should be performed after 100,000 miles (166 000 km) at the same intervals.

Footnotes

† The U.S. Environmental Protection Agency or the California Air Resources Board has determined that the failure to perform this maintenance item will not nullify the emission warranty or limit recall liability prior to the completion of the vehicle's useful life. We, however, urge that all recommended maintenance services be performed at the indicated intervals and the maintenance be recorded.

Lubricate the front suspension, kingpin bushings, steering linkage and rear driveline center splines.

** Drive axle service:

- Locking Differential -- Drain fluid and refill at first engine oil change. At subsequent oil changes, check fluid level and add fluid as needed. If driving in dusty areas or towing a trailer, drain fluid and refill every 15,000 miles (25 000 km).
- Standard Differential -- Check fluid level and add fluid as needed at every oil change. If driving in dusty areas or towing a trailer, drain fluid and refill every 15,000 miles (25 000 km).
- More frequent lubrication may be required for heavy-duty use.

Short Trip/City Maintenance Schedule -- Gasoline Engines

3,000 Miles (5 000 km)

- Change engine oil and filter (or every 3 months, whichever occurs first).
An Emission Control Service.
- Lubricate chassis components; see footnote # (or every 3 months, whichever occurs first).
- Check axle fluid level and add fluid as needed. **

DATE	ACTUAL MILEAGE	SERVICED BY:

6,000 Miles (10 000 km)

- Change engine oil and filter (or every 3 months, whichever occurs first).
An Emission Control Service.
- Lubricate chassis components; see footnote # (or every 3 months, whichever occurs first).
- Check axle fluid level and add fluid as needed. **
- Rotate tires. See "Tire Inspection and Rotation" in the Index for proper rotation pattern and additional information. During tire rotation, check brake calipers for freedom of movement. Refer to the appropriate GM service manual for proper caliper service procedures.

DATE	ACTUAL MILEAGE	SERVICED BY:

Short Trip/City Maintenance Schedule -- Gasoline Engines

9,000 Miles (15 000 km)

- Change engine oil and filter (or every 3 months, whichever occurs first).
An Emission Control Service.
- Lubricate chassis components; see footnote # (or every 3 months, whichever occurs first).
- Check axle fluid level and add fluid as needed. **

DATE	ACTUAL MILEAGE	SERVICED BY:

12,000 Miles (20 000 km)

- Change engine oil and filter (or every 3 months, whichever occurs first).
An Emission Control Service.
- Lubricate chassis components; see footnote # (or every 3 months, whichever occurs first).
- Check axle fluid level and add fluid as needed. **

DATE	ACTUAL MILEAGE	SERVICED BY:

Short Trip/City Maintenance Schedule -- Gasoline Engines

15,000 Miles (25 000 km)

- Change engine oil and filter (or every 3 months, whichever occurs first).

An Emission Control Service.

- Lubricate chassis components; see footnote # (or every 3 months, whichever occurs first).

- Inspect air cleaner filter if you are driving in dusty conditions. Replace filter if necessary. *An Emission Control Service.* †

- Check axle fluid level and add fluid as needed. **

- Clean and repack the front wheel bearings (or at each brake relining, whichever occurs first).

- Vehicles With GVWR Above 8,500 lbs.

Only: Inspect shields and underhood insulation for damage or looseness. Adjust or replace as required. This is a Noise Emission Control Service. Applicable only to vehicles sold in the United States.

- If your engine has a thermostatically controlled cooling fan, inspect all hoses and ducts for proper hook-up (or every 12 months, whichever occurs first). Be sure the valve works properly. *This is a Noise Emission Control Service. Applicable only to vehicles sold in the United States.*

DATE	ACTUAL MILEAGE	SERVICED BY:

Short Trip/City Maintenance Schedule -- Gasoline Engines

18,000 Miles (30 000 km)

- Change engine oil and filter (or every 3 months, whichever occurs first).
An Emission Control Service.
- Lubricate chassis components; see footnote # (or every 3 months, whichever occurs first).
- Check axle fluid level and add fluid as needed. **
- Rotate tires. See "Tire Inspection and Rotation" in the Index for proper rotation pattern and additional information. During tire rotation, check brake calipers for freedom of movement. Refer to the appropriate GM service manual for proper caliper service procedures.

DATE	ACTUAL MILEAGE	SERVICED BY:

21,000 Miles (35 000 km)

- Change engine oil and filter (or every 3 months, whichever occurs first).
An Emission Control Service.
- Lubricate chassis components; see footnote # (or every 3 months, whichever occurs first).
- Check axle fluid level and add fluid as needed. **

DATE	ACTUAL MILEAGE	SERVICED BY:

Short Trip/City Maintenance Schedule -- Gasoline Engines

24,000 Miles (40 000 km)

- Change engine oil and filter (or every 3 months, whichever occurs first).
An Emission Control Service.
- Lubricate chassis components; see footnote # (or every 3 months, whichever occurs first).
- Check axle fluid level and add fluid as needed. **

DATE	ACTUAL MILEAGE	SERVICED BY:

27,000 Miles (45 000 km)

- Change engine oil and filter (or every 3 months, whichever occurs first).
An Emission Control Service.
- Lubricate chassis components; see footnote # (or every 3 months, whichever occurs first).
- Check axle fluid level and add fluid as needed. **

DATE	ACTUAL MILEAGE	SERVICED BY:

Short Trip/City Maintenance Schedule -- Gasoline Engines

30,000 Miles (50 000 km)

- Change engine oil and filter (or every 3 months, whichever occurs first).
An Emission Control Service.
- Lubricate chassis components; see footnote # (or every 3 months, whichever occurs first).
- Check axle fluid level and add fluid as needed. **
- Clean and repack the front wheel bearings (or at each brake relining, whichever occurs first).
- Replace fuel filter.
An Emission Control Service. †
- Replace air cleaner filter.
An Emission Control Service.
- Vehicles With GVWR Above 8,500 lbs. Only: Inspect shields and underhood insulation for damage or looseness. Adjust or replace as required. *This is a Noise Emission Control Service. Applicable only to vehicles sold in the United States.*

- If your engine has a thermostatically controlled cooling fan, inspect all hoses and ducts for proper hook-up (or every 12 months, whichever occurs first). Be sure the valve works properly. *This is a Noise Emission Control Service. Applicable only to vehicles sold in the United States.*
- Rotate tires. See "Tire Inspection and Rotation" in the Index for proper rotation pattern and additional information. During tire rotation, check brake calipers for freedom of movement. Refer to the appropriate GM service manual for proper caliper service procedures.

DATE	ACTUAL MILEAGE	SERVICED BY:

Short Trip/City Maintenance Schedule -- Gasoline Engines

33,000 Miles (55 000 km)

- Change engine oil and filter (or every 3 months, whichever occurs first).
An Emission Control Service.
- Lubricate chassis components; see footnote # (or every 3 months, whichever occurs first).
- Check axle fluid level and add fluid as needed. **

DATE	ACTUAL MILEAGE	SERVICED BY:

36,000 Miles (60 000 km)

- Change engine oil and filter (or every 3 months, whichever occurs first).
An Emission Control Service.
- Lubricate chassis components; see footnote # (or every 3 months, whichever occurs first).
- Check axle fluid level and add fluid as needed. **

DATE	ACTUAL MILEAGE	SERVICED BY:

Short Trip/City Maintenance Schedule -- Gasoline Engines

39,000 Miles (65 000 km)

- Change engine oil and filter (or every 3 months, whichever occurs first).
An Emission Control Service.
- Lubricate chassis components; see footnote # (or every 3 months, whichever occurs first).
- Check axle fluid level and add fluid as needed. **

DATE	ACTUAL MILEAGE	SERVICED BY:

42,000 Miles (70 000 km)

- Change engine oil and filter (or every 3 months, whichever occurs first).
An Emission Control Service.
- Lubricate chassis components; see footnote # (or every 3 months, whichever occurs first).
- Check axle fluid level and add fluid as needed. **
- Rotate tires. See "Tire Inspection and Rotation" in the Index for proper rotation pattern and additional information. During tire rotation, check brake calipers for freedom of movement. Refer to the appropriate GM service manual for proper caliper service procedures.

DATE	ACTUAL MILEAGE	SERVICED BY:

Short Trip/City Maintenance Schedule -- Gasoline Engines

45,000 Miles (75 000 km)

- Change engine oil and filter (or every 3 months, whichever occurs first).
An Emission Control Service.
- Lubricate chassis components; see footnote # (or every 3 months, whichever occurs first).
- Check axle fluid level and add fluid as needed. **
- Clean and repack the front wheel bearings (or at each brake relining, whichever occurs first).
- Inspect air cleaner filter if you are driving in dusty conditions. Replace filter if necessary. *An Emission Control Service.* †

- Vehicles With GVWR Above 8,500 lbs. Only: Inspect shields and underhood insulation for damage or looseness. Adjust or replace as required. *This is a Noise Emission Control Service. Applicable only to vehicles sold in the United States.*
- If your engine has a thermostatically controlled cooling fan, inspect all hoses and ducts for proper hook-up (or every 12 months, whichever occurs first). Be sure the valve works properly. *This is a Noise Emission Control Service. Applicable only to vehicles sold in the United States.*

DATE	ACTUAL MILEAGE	SERVICED BY:

Short Trip/City Maintenance Schedule -- Gasoline Engines

48,000 Miles (80 000 km)

- Change engine oil and filter (or every 3 months, whichever occurs first).
An Emission Control Service.
- Lubricate chassis components; see footnote # (or every 3 months, whichever occurs first).
- Check axle fluid level and add fluid as needed. **

DATE	ACTUAL MILEAGE	SERVICED BY:

50,000 Miles (83 000 km)

- Change automatic transmission fluid and filter if the vehicle's GVWR is over 8600 lbs. or if the vehicle is mainly driven under one or more of these conditions:
 - In heavy city traffic where the outside temperature regularly reaches 90°F (32°C) or higher.
 - In hilly or mountainous terrain.
 - When doing frequent trailer towing.
 - Uses such as found in taxi, police or delivery service.

If you do not use your vehicle under any of these conditions, the fluid and filter do not require changing.

DATE	ACTUAL MILEAGE	SERVICED BY:

Short Trip/City Maintenance Schedule -- Gasoline Engines

51,000 Miles (85 000 km)

- Change engine oil and filter (or every 3 months, whichever occurs first).
An Emission Control Service.
- Lubricate chassis components; see footnote # (or every 3 months, whichever occurs first).
- Check axle fluid level and add fluid as needed. **

DATE	ACTUAL MILEAGE	SERVICED BY:

54,000 Miles (90 000 km)

- Change engine oil and filter (or every 3 months, whichever occurs first).
An Emission Control Service.
- Lubricate chassis components; see footnote # (or every 3 months, whichever occurs first).
- Check axle fluid level and add fluid as needed. **
- Rotate tires. See "Tire Inspection and Rotation" in the Index for proper rotation pattern and additional information. During tire rotation, check brake calipers for freedom of movement. Refer to the appropriate GM service manual for proper caliper service procedures.

DATE	ACTUAL MILEAGE	SERVICED BY:

Short Trip/City Maintenance Schedule -- Gasoline Engines

57,000 Miles (95 000 km)

- Change engine oil and filter (or every 3 months, whichever occurs first).
An Emission Control Service.
- Lubricate chassis components; see footnote # (or every 3 months, whichever occurs first).
- Check axle fluid level and add fluid as needed. **

60,000 Miles (100 000 km)

- Change engine oil and filter (or every 3 months, whichever occurs first).
An Emission Control Service.
- Lubricate chassis components; see footnote # (or every 3 months, whichever occurs first).
- Check axle fluid level and add fluid as needed. **
- Clean and repack the front wheel bearings (or at each brake relining, whichever occurs first).
- Vehicles With GVWR Above 8,500 lbs. Only: Inspect shields and underhood insulation for damage or looseness. Adjust or replace as required. *This is a Noise Emission Control Service. Applicable only to vehicles sold in the United States.*

DATE	ACTUAL MILEAGE	SERVICED BY:

(Continued)

Short Trip/City Maintenance Schedule -- Gasoline Engines

60,000 Miles (100 000 km) (Continued)

- If your engine has a thermostatically controlled cooling fan, inspect all hoses and ducts for proper hook-up (or every 12 months, whichever occurs first). Be sure the valve works properly. *This is a Noise Emission Control Service. Applicable only to vehicles sold in the United States.*
- Inspect engine accessory drive belt. *An Emission Control Service.*
- Replace fuel filter. *An Emission Control Service. †*
- Conduct Exhaust Gas Recirculation (EGR) system inspection as described in the service manual. *An Emission Control Service. †*
- Conduct evaporative control system inspection. Check all fuel and vapor lines and hoses for proper hook-up, routing and condition. Check that the purge valve works properly (if equipped). Replace as needed. *An Emission Control Service. †*
- Replace air cleaner filter. *An Emission Control Service.*
- Inspect fuel tank, cap and lines for damage or leaks. Inspect fuel cap gasket for any damage. Replace parts as needed. *An Emission Control Service. †*

DATE	ACTUAL MILEAGE	SERVICED BY:

Short Trip/City Maintenance Schedule -- Gasoline Engines

63,000 Miles (105 000 km)

- Change engine oil and filter (or every 3 months, whichever occurs first).
An Emission Control Service.
- Lubricate chassis components; see footnote # (or every 3 months, whichever occurs first).
- Check axle fluid level and add fluid as needed. **

DATE	ACTUAL MILEAGE	SERVICED BY:

66,000 Miles (110 000 km)

- Change engine oil and filter (or every 3 months, whichever occurs first).
An Emission Control Service.
- Lubricate chassis components; see footnote # (or every 3 months, whichever occurs first).
- Check axle fluid level and add fluid as needed. **
- Rotate tires. See "Tire Inspection and Rotation" in the Index for proper rotation pattern and additional information. During tire rotation, check brake calipers for freedom of movement. Refer to the appropriate GM service manual for proper caliper service procedures.

DATE	ACTUAL MILEAGE	SERVICED BY:

Short Trip/City Maintenance Schedule -- Gasoline Engines

69,000 Miles (115 000 km)

- Change engine oil and filter (or every 3 months, whichever occurs first).
An Emission Control Service.
- Lubricate chassis components; see footnote # (or every 3 months, whichever occurs first).
- Check axle fluid level and add fluid as needed. **

DATE	ACTUAL MILEAGE	SERVICED BY:

72,000 Miles (120 000 km)

- Change engine oil and filter (or every 3 months, whichever occurs first).
An Emission Control Service.
- Lubricate chassis components; see footnote # (or every 3 months, whichever occurs first).
- Check axle fluid level and add fluid as needed. **

DATE	ACTUAL MILEAGE	SERVICED BY:

Short Trip/City Maintenance Schedule -- Gasoline Engines

75,000 Miles (125 000 km)

- Change engine oil and filter (or every 3 months, whichever occurs first).
An Emission Control Service.
- Lubricate chassis components; see footnote # (or every 3 months, whichever occurs first).
- Clean and repack the front wheel bearings (or at each brake relining, whichever occurs first).
- Inspect air cleaner filter if you are driving in dusty conditions. Replace filter if necessary. *An Emission Control Service.* †
- Check axle fluid level and add fluid as needed. **

- Vehicles With GVWR Above 8,500 lbs. Only: Inspect shields and underhood insulation for damage or looseness. Adjust or replace as required. *This is a Noise Emission Control Service. Applicable only to vehicles sold in the United States.*
- If your engine has a thermostatically controlled cooling fan, inspect all hoses and ducts for proper hook-up (or every 12 months, whichever occurs first). Be sure the valve works properly. *This is a Noise Emission Control Service. Applicable only to vehicles sold in the United States.*

DATE	ACTUAL MILEAGE	SERVICED BY:

Short Trip/City Maintenance Schedule -- Gasoline Engines

78,000 Miles (130 000 km)

- Change engine oil and filter (or every 3 months, whichever occurs first).
An Emission Control Service.
- Lubricate chassis components; see footnote # (or every 3 months, whichever occurs first).
- Check axle fluid level and add fluid as needed. **
- Rotate tires. See "Tire Inspection and Rotation" in the Index for proper rotation pattern and additional information. During tire rotation, check brake calipers for freedom of movement. Refer to the appropriate GM service manual for proper caliper service procedures.

DATE	ACTUAL MILEAGE	SERVICED BY:

81,000 Miles (135 000 km)

- Change engine oil and filter (or every 3 months, whichever occurs first).
An Emission Control Service.
- Lubricate chassis components; see footnote # (or every 3 months, whichever occurs first).
- Check axle fluid level and add fluid as needed. **

DATE	ACTUAL MILEAGE	SERVICED BY:

Short Trip/City Maintenance Schedule -- Gasoline Engines

84,000 Miles (140 000 km)

- Change engine oil and filter (or every 3 months, whichever occurs first).
An Emission Control Service.
- Lubricate chassis components; see footnote # (or every 3 months, whichever occurs first).
- Check axle fluid level and add fluid as needed. **

DATE	ACTUAL MILEAGE	SERVICED BY:

87,000 Miles (145 000 km)

- Change engine oil and filter (or every 3 months, whichever occurs first).
An Emission Control Service.
- Lubricate chassis components; see footnote # (or every 3 months, whichever occurs first).
- Check axle fluid level and add fluid as needed. **

DATE	ACTUAL MILEAGE	SERVICED BY:

Short Trip/City Maintenance Schedule -- Gasoline Engines

90,000 Miles (150 000 km)

- Change engine oil and filter (or every 3 months, whichever occurs first).
An Emission Control Service.
- Lubricate chassis components; see footnote # (or every 3 months, whichever occurs first).
- Check axle fluid level and add fluid as needed. **
- Clean and repack the front wheel bearings (or at each brake relining, whichever occurs first).
- Replace fuel filter.
An Emission Control Service, †
- Replace air cleaner filter.
An Emission Control Service.
- Rotate tires. See “Tire Inspection and Rotation” in the Index for proper rotation pattern and additional information. During tire rotation, check brake calipers for freedom of movement. Refer to the appropriate GM service manual for proper caliper service procedures.
- Vehicles With GVWR Above 8,500 lbs. Only: Inspect shields and underhood insulation for damage or looseness. Adjust or replace as required. *This is a Noise Emission Control Service. Applicable only to vehicles sold in the United States.*

Short Trip/City Maintenance Schedule -- Gasoline Engines

- If your engine has a thermostatically controlled cooling fan, inspect all hoses and ducts for proper hook-up (or every 12 months, whichever occurs first). Be sure the valve works properly. *This is a Noise Emission Control Service. Applicable only to vehicles sold in the United States.*

93,000 Miles (155 000 km)

- Change engine oil and filter (or every 3 months, whichever occurs first).
An Emission Control Service.
- Lubricate chassis components; see footnote # (or every 3 months, whichever occurs first).
- Check axle fluid level and add fluid as needed. **

DATE	ACTUAL MILEAGE	SERVICED BY:

DATE	ACTUAL MILEAGE	SERVICED BY:

Short Trip/City Maintenance Schedule -- Gasoline Engines

96,000 Miles (160 000 km)

- Change engine oil and filter (or every 3 months, whichever occurs first).
An Emission Control Service.
- Lubricate chassis components; see footnote # (or every 3 months, whichever occurs first).
- Check axle fluid level and add fluid as needed. **

DATE	ACTUAL MILEAGE	SERVICED BY:

99,000 Miles (165 000 km)

- Change engine oil and filter (or every 3 months, whichever occurs first).
An Emission Control Service.
- Lubricate chassis components; see footnote # (or every 3 months, whichever occurs first).
- Check axle fluid level and add fluid as needed. **

DATE	ACTUAL MILEAGE	SERVICED BY:

Short Trip/City Maintenance Schedule -- Gasoline Engines

100,000 Miles (166 000 km)

- Drain, flush and refill cooling system (or every 60 months since last service, whichever occurs first). See "Engine Coolant" in the Index for what to use. Inspect hoses. Clean radiator, condenser, pressure cap and neck. Pressure test cooling system and pressure cap.

An Emission Control Service. †

- Inspect spark plug wires.

An Emission Control Service.

- Replace spark plugs.

An Emission Control Service.

- Change automatic transmission fluid and filter if the vehicle's GVWR is over 8600 lbs. or if the vehicle is mainly driven under one or more of these conditions:

- In heavy city traffic where the outside temperature regularly reaches 90°F (32°C) or higher.
- In hilly or mountainous terrain.
- When doing frequent trailer towing.
- Uses such as found in taxi, police or delivery service.

If you do not use your vehicle under any of these conditions, the fluid and filter do not require changing.

- Inspect Positive Crankcase Ventilation (PCV) valve. *An Emission Control Service.*

DATE	ACTUAL MILEAGE	SERVICED BY:

Long Trip/Highway Maintenance Schedule -- Gasoline Engines

The services shown in this schedule up to 100,000 miles (166 000 km) should be performed after 100,000 miles (166 000 km) at the same intervals.

Footnotes

† The U.S. Environmental Protection Agency or the California Air Resources Board has determined that the failure to perform this maintenance item will not nullify the emission warranty or limit recall liability prior to the completion of the vehicle's useful life. We, however, urge that all recommended maintenance services be performed at the indicated intervals and the maintenance be recorded.

Lubricate the front suspension, kingpin bushings, steering linkage and rear driveline center splines.

*** Drive axle service:

- Locking Differential -- Drain fluid and refill at first engine oil change. At subsequent oil changes, check fluid level and add fluid as needed. If driving in dusty areas or towing a trailer, drain fluid and refill every 15,000 miles (25 000 km).
- Standard Differential -- Check fluid level and add fluid as needed at every engine oil change. If driving in dusty areas or towing a trailer, drain fluid and refill every 15,000 miles (25 000 km).
- More frequent lubrication may be required for heavy-duty use.

Long Trip/Highway Maintenance Schedule -- Gasoline Engines

7,500 Miles (12 500 km)

- Change engine oil and filter (or every 12 months, whichever occurs first).
An Emission Control Service.
- Lubricate chassis components; see footnote # (or every 12 months, whichever occurs first).
- Check axle fluid level and add fluid as needed. **
- Rotate tires. See "Tire Inspection and Rotation" in the Index for proper rotation pattern and additional information. During tire rotation, check brake calipers for freedom of movement. Refer to the appropriate GM service manual for proper caliper service procedures.

DATE	ACTUAL MILEAGE	SERVICED BY:

15,000 Miles (25 000 km)

- Change engine oil and filter (or every 12 months, whichever occurs first).
An Emission Control Service.
- Lubricate chassis components; see footnote # (or every 12 months, whichever occurs first).
- Check axle fluid level and add fluid as needed. **
- Vehicles With GVWR Above 8,500 lbs. Only: Inspect shields and underhood insulation for damage or looseness. Adjust or replace as required. *This is a Noise Emission Control Service. Applicable only to vehicles sold in the United States.*

(Continued)

Long Trip/Highway Maintenance Schedule -- Gasoline Engines

15,000 Miles (25 000 km) (Continued)

- If your engine has a thermostatically controlled cooling fan, inspect all hoses and ducts for proper hook-up (or every 12 months, whichever occurs first). Be sure the valve works properly. *This is a Noise Emission Control Service. Applicable only to vehicles sold in the United States.*

DATE	ACTUAL MILEAGE	SERVICED BY:

22,500 Miles (37 500 km)

- Change engine oil and filter (or every 12 months, whichever occurs first).
An Emission Control Service.
- Lubricate chassis components; see footnote # (or every 12 months, whichever occurs first).
- Check axle fluid level and add fluid as needed. **
- Rotate tires. See "Tire Inspection and Rotation" in the Index for proper rotation pattern and additional information. During tire rotation, check brake calipers for freedom of movement. Refer to the appropriate GM service manual for proper caliper service procedures.

DATE	ACTUAL MILEAGE	SERVICED BY:

Long Trip/Highway Maintenance Schedule -- Gasoline Engines

30,000 Miles (50 000 km)

- Change engine oil and filter (or every 12 months, whichever occurs first).
An Emission Control Service.
- Lubricate chassis components; see footnote # (or every 12 months, whichever occurs first).
- Check axle fluid level and add fluid as needed. **
- Clean and repack the front wheel bearings (or at each brake relining, whichever occurs first).
- Replace fuel filter.
An Emission Control Service. †
- Replace air cleaner filter.
An Emission Control Service.

- Vehicles With GVWR Above 8,500 lbs. Only: Inspect shields and underhood insulation for damage or looseness. Adjust or replace as required. *This is a Noise Emission Control Service. Applicable only to vehicles sold in the United States.*
- If your engine has a thermostatically controlled cooling fan, inspect all hoses and ducts for proper hook-up (or every 12 months, whichever occurs first). Be sure the valve works properly. *This is a Noise Emission Control Service. Applicable only to vehicles sold in the United States.*

DATE	ACTUAL MILEAGE	SERVICED BY:

Long Trip/Highway Maintenance Schedule -- Gasoline Engines

37,500 Miles (62 500 km)

- Change engine oil and filter (or every 12 months, whichever occurs first).
An Emission Control Service.
- Lubricate chassis components; see footnote # (or every 12 months, whichever occurs first).
- Check axle fluid level and add fluid as needed. **
- Rotate tires. See "Tire Inspection and Rotation" in the Index for proper rotation pattern and additional information. During tire rotation, check brake calipers for freedom of movement. Refer to the appropriate GM service manual for proper caliper service procedures.

DATE	ACTUAL MILEAGE	SERVICED BY:

45,000 Miles (75 000 km)

- Change engine oil and filter (or every 12 months, whichever occurs first).
An Emission Control Service.
- Lubricate chassis components; see footnote # (or every 12 months, whichever occurs first).
- Check axle fluid level and add fluid as needed. **
- Vehicles With GVWR Above 8,500 lbs. Only: Inspect shields and underhood insulation for damage or looseness. Adjust or replace as required. *This is a Noise Emission Control Service. Applicable only to vehicles sold in the United States.*

Long Trip/Highway Maintenance Schedule -- Gasoline Engines

- If your engine has a thermostatically controlled cooling fan, inspect all hoses and ducts for proper hook-up (or every 12 months, whichever occurs first). Be sure the valve works properly. *This is a Noise Emission Control Service. Applicable only to vehicles sold in the United States.*

DATE	ACTUAL MILEAGE	SERVICED BY:

50,000 Miles (83 000 km)

- Change automatic transmission fluid and filter if the vehicle's GVWR is over 8600 lbs. or if the vehicle is mainly driven under one or more of these conditions:
- In heavy city traffic where the outside temperature regularly reaches 90°F (32°C) or higher.
 - In hilly or mountainous terrain.
 - When doing frequent trailer towing.
 - Uses such as found in taxi, police or delivery service.

If you do not use your vehicle under any of these conditions, the fluid and filter do not require changing.

DATE	ACTUAL MILEAGE	SERVICED BY:

Long Trip/Highway Maintenance Schedule -- Gasoline Engines

52,500 Miles (87 500 km)

- Change engine oil and filter (or every 12 months, whichever occurs first).
An Emission Control Service.
- Lubricate chassis components; see footnote # (or every 12 months, whichever occurs first).
- Check axle fluid level and add fluid as needed. **
- Rotate tires. See "Tire Inspection and Rotation" in the Index for proper rotation pattern and additional information. During tire rotation, check brake calipers for freedom of movement. Refer to the appropriate GM service manual for proper caliper service procedures.

DATE	ACTUAL MILEAGE	SERVICED BY:

60,000 Miles (100 000 km)

- Change engine oil and filter (or every 12 months, whichever occurs first).
An Emission Control Service.
- Lubricate chassis components; see footnote # (or every 12 months, whichever occurs first).
- Check axle fluid level and add fluid as needed. **
- Clean and repack the front wheel bearings (or at each brake relining, whichever occurs first).
- Inspect engine accessory drive belt.
An Emission Control Service.
- Replace fuel filter.
An Emission Control Service. †

Long Trip/Highway Maintenance Schedule -- Gasoline Engines

- Replace air cleaner filter.
An Emission Control Service.
- Inspect fuel tank, cap and lines for damage or leaks. Inspect fuel cap gasket for any damage. Replace parts as needed.
An Emission Control Service. †
- Vehicles With GVWR Above 8,500 lbs. Only: Inspect shields and underhood insulation for damage or looseness. Adjust or replace as required. *This is a Noise Emission Control Service. Applicable only to vehicles sold in the United States.*
- If your engine has a thermostatically controlled cooling fan, inspect all hoses and ducts for proper hook-up (or every 12 months, whichever occurs first). Be sure the valve works properly. *This is a Noise Emission Control Service. Applicable only to vehicles sold in the United States.*

- Conduct Exhaust Gas Recirculation (EGR) system inspection as described in the service manual. *An Emission Control Service. †*
- Conduct evaporative control system inspection. Check all fuel and vapor lines and hoses for proper hook-up, routing and condition. Check that the purge valve works properly, if equipped. Replace as needed.
An Emission Control Service. †

DATE	ACTUAL MILEAGE	SERVICED BY:

Long Trip/Highway Maintenance Schedule -- Gasoline Engines

67,500 Miles (112 500 km)

- Change engine oil and filter (or every 12 months, whichever occurs first).
An Emission Control Service.
- Lubricate chassis components; see footnote # (or every 12 months, whichever occurs first).
- Check axle fluid level and add fluid as needed. **
- Rotate tires. See "Tire Inspection and Rotation" in the Index for proper rotation pattern and additional information. During tire rotation, check brake calipers for freedom of movement. Refer to the appropriate GM service manual for proper caliper service procedures.

DATE	ACTUAL MILEAGE	SERVICED BY:

75,000 Miles (125 000 km)

- Change engine oil and filter (or every 12 months, whichever occurs first).
An Emission Control Service.
- Lubricate chassis components; see footnote # (or every 12 months, whichever occurs first).
- Check axle fluid level and add fluid as needed. **
- Vehicles With GVWR Above 8,500 lbs. Only: Inspect shields and underhood insulation for damage or looseness. Adjust or replace as required. *This is a Noise Emission Control Service. Applicable only to vehicles sold in the United States.*

Long Trip/Highway Maintenance Schedule -- Gasoline Engines

- If your engine has a thermostatically controlled cooling fan, inspect all hoses and ducts for proper hook-up (or every 12 months, whichever occurs first). Be sure the valve works properly. *This is a Noise Emission Control Service. Applicable only to vehicles sold in the United States.*

82,500 Miles (137 500 km)

- Change engine oil and filter (or every 12 months, whichever occurs first).
An Emission Control Service.
- Lubricate chassis components; see footnote # (or every 12 months, whichever occurs first).
- Check axle fluid level and add fluid as needed. **
- Rotate tires. See "Tire Inspection and Rotation" in the Index for proper rotation pattern and additional information. During tire rotation, check brake calipers for freedom of movement. Refer to the appropriate GM service manual for proper caliper service procedures.

DATE	ACTUAL MILEAGE	SERVICED BY:

DATE	ACTUAL MILEAGE	SERVICED BY:

Long Trip/Highway Maintenance Schedule -- Gasoline Engines

90,000 Miles (150 000 km)

- Change engine oil and filter (or every 12 months, whichever occurs first).
An Emission Control Service.
- Lubricate chassis components; see footnote # (or every 12 months, whichever occurs first).
- Check axle fluid level and add fluid as needed. **
- Clean and repack the front wheel bearings (or at each brake relining, whichever occurs first).
- Replace fuel filter.
An Emission Control Service. †
- Replace air cleaner filter.
An Emission Control Service.

- Vehicles With GVWR Above 8,500 lbs. Only: Inspect shields and underhood insulation for damage or looseness. Adjust or replace as required. *This is a Noise Emission Control Service. Applicable only to vehicles sold in the United States.*
- If your engine has a thermostatically controlled cooling fan, inspect all hoses and ducts for proper hook-up (or every 12 months, whichever occurs first). Be sure the valve works properly. *This is a Noise Emission Control Service. Applicable only to vehicles sold in the United States.*

DATE	ACTUAL MILEAGE	SERVICED BY:

Long Trip/Highway Maintenance Schedule -- Gasoline Engines

97,500 Miles (162 500 km)

- Change engine oil and filter (or every 12 months, whichever occurs first).
An Emission Control Service.
- Lubricate chassis components; see footnote # (or every 12 months, whichever occurs first).
- Check axle fluid level and add fluid as needed. **
- Rotate tires. See "Tire Inspection and Rotation" in the Index for proper rotation pattern and additional information. During tire rotation, check brake calipers for freedom of movement. Refer to the appropriate GM service manual for proper caliper service procedures.

DATE	ACTUAL MILEAGE	SERVICED BY:

100,000 Miles (166 000 km)

- Drain, flush and refill cooling system (or every 60 months since last service, whichever occurs first). See "Engine Coolant" in the Index for what to use. Inspect hoses. Clean radiator, condenser, pressure cap and neck. Pressure test the cooling system and pressure cap.
An Emission Control Service. †
- Inspect spark plug wires.
An Emission Control Service.
- Replace spark plugs.
An Emission Control Service.

(Continued)

Long Trip/Highway Maintenance Schedule -- Gasoline Engines

100,000 Miles (166 000 km) (Continued)

- Change automatic transmission fluid and filter if the vehicle's GVWR is over 8600 lbs. or if the vehicle is mainly driven under one or more of these conditions:
 - In heavy city traffic where the outside temperature regularly reaches 90°F (32°C) or higher.
 - In hilly or mountainous terrain.
 - When doing frequent trailer towing.

- Uses such as found in taxi, police or delivery service.

If you do not use your vehicle under any of these conditions, the fluid and filter do not require changing.

- Inspect Positive Crankcase Ventilation (PCV) valve. *An Emission Control Service.*

DATE	ACTUAL MILEAGE	SERVICED BY:

Part B: Owner Checks and Services

Listed below are owner checks and services which should be performed at the intervals specified to help ensure the safety, dependability and emission control performance of your vehicle.

Be sure any necessary repairs are completed at once. Whenever any fluids or lubricants are added to your vehicle, make sure they are the proper ones, as shown in Part D.

At the First 100, 1,000 and 6,000 Miles (160, 1 600 and 10 000 km)

For vehicles with dual wheels, check dual wheel nut torque. For proper torque, see “Wheel Nut Torque” in the Index.

At Each Fuel Fill

It is important for you or a service station attendant to perform these underhood checks at each fuel fill.

Engine Oil Level Check

Check the engine oil level and add the proper oil if necessary. See “Engine Oil” in the Index for further details.

Engine Coolant Level Check

Check the engine coolant level and add the proper coolant mix if necessary. See “Engine Coolant” in the Index for further details.

Windshield Washer Fluid Level Check

Check the windshield washer fluid level in the windshield washer tank and add the proper fluid if necessary. See “Windshield Washer Fluid” in the Index for further details.

At Least Once a Month

Tire Inflation Check

Make sure tires are inflated to the correct pressures. See “Tires” in the Index for further details.

Cassette Deck Service

Clean cassette deck. Cleaning should be done every 50 hours of tape play. See “Audio Systems” in the Index for further details.

At Least Twice a Year

Restraint System Check

Make sure the safety belt reminder light and all your belts, buckles, latch plates, retractors and anchorages are working properly. Look for any other loose or damaged safety belt system parts. If you see anything that might keep a safety belt system from doing its job, have it repaired. Have any torn or frayed safety belts replaced.

Also look for any opened or broken air bag covers, and have them repaired or replaced. (The air bag system does not need regular maintenance.)

Automatic Transmission Check

Check the transmission fluid level; add if needed. See “Automatic Transmission” in the Index. A fluid loss may indicate a problem. Check the system and repair if needed.

At Least Once a Year

Key Lock Cylinders Service

Lubricate the key lock cylinders with the lubricant specified in Part D.

Body Lubrication Service

Lubricate all hood hinges, hood prop rod pivot, fuel filler door, rear compartment hinges, latches, locks and any moving seat hardware. Door hinges are lubricated for the life of your vehicle; no additional lubrication is required. Part D tells you what to use. More frequent lubrication may be required when exposed to a corrosive environment.

Starter Switch Check

CAUTION:

When you are doing this check, the vehicle could move suddenly. If it does, you or others could be injured. Follow the steps below.

1. Before you start, be sure you have enough room around the vehicle.
2. Firmly apply both the parking brake (see "Parking Brake" in the Index if necessary) and the regular brake.

NOTE: Do not use the accelerator pedal, and be ready to turn off the engine immediately if it starts.
3. Try to start the engine in each gear. The starter should work only in PARK (P) or NEUTRAL (N). If the starter works in any other position, your vehicle needs service.

Brake-Transmission Shift Interlock (BTSI) Check

CAUTION:

When you are doing this check, the vehicle could move suddenly. If it does, you or others could be injured. Follow the steps below.

1. Before you start, be sure you have enough room around the vehicle. It should be parked on a level surface.
2. Firmly apply the parking brake (see "Parking Brake" in the Index if necessary).

NOTE: Be ready to apply the regular brake immediately if the vehicle begins to move.
3. With the engine off, turn the key to the RUN position, but don't start the engine. Without applying the regular brake, try to move the shift lever out of PARK (P) with normal effort. If the shift lever moves out of PARK (P), your vehicle's BTSI needs service.

Steering Column Lock Check

While parked, and with the parking brake set, try to turn the key to LOCK in each shift lever position.

- The key should turn to LOCK only when the shift lever is in PARK (P).
- The key should come out only in LOCK.

Parking Brake and Automatic Transmission PARK (P) Mechanism Check

CAUTION:

When you are doing this check, your vehicle could begin to move. You or others could be injured and property could be damaged. Make sure there is room in front of your vehicle in case it begins to roll. Be ready to apply the regular brake at once should the vehicle begin to move.

Park on a fairly steep hill, with the vehicle facing downhill. Keeping your foot on the regular brake, set the parking brake.

- To check the parking brake: With the engine running and transmission in NEUTRAL (N), slowly remove foot pressure from the regular brake pedal. Do this until the vehicle is held by the parking brake only.
- To check the PARK (P) mechanism's holding ability: With the engine running, shift to PARK (P). Then release all brakes.

Part C: Periodic Maintenance Inspections

Listed below are inspections and services which should be performed at least twice a year (for instance, each spring and fall). You should let your GM dealer's service department or other qualified service center do these jobs. Make sure any necessary repairs are completed at once.

Proper procedures to perform these services may be found in a service manual. See "Service and Owner Publications" in the Index.

Steering and Suspension Inspection

Inspect the front and rear suspension and steering system for damaged, loose or missing parts, signs of wear or lack of lubrication. Inspect the power steering lines and hoses for proper hook-up, binding, leaks, cracks, chafing, etc.

Exhaust System Inspection

Inspect the complete exhaust system. Inspect the body near the exhaust system. Look for broken, damaged, missing or out-of-position parts as well as open seams, holes, loose connections or other conditions which could cause a heat build-up in the floor pan or could let exhaust fumes into the vehicle. See "Engine Exhaust" in the Index.

Radiator and Heater Hose Inspection

Inspect the hoses and have them replaced if they are cracked, swollen or deteriorated. Inspect all pipes, fittings and clamps; replace as needed.

Throttle Linkage Inspection

Inspect the throttle linkage for interference or binding, and for damage or missing parts. Replace parts as needed. Replace any cables that have high effort or excessive wear. Do not lubricate accelerator and cruise control cables.

Rear Axle Service

Check the gear lubricant level in the rear axle and add if needed. See “Rear Axle” in the Index. A fluid loss may indicate a problem. Check the axle and repair it if needed.

Drive Axle Service

Check rear/front axle fluid level and add as needed.
Check constant velocity joints and axle seals for leaking.

Brake System Inspection

Inspect the complete system. Inspect brake lines and hoses for proper hook-up, binding, leaks, cracks, chafing, etc. Inspect disc brake pads for wear and rotors for surface condition. Also inspect drum brake linings for wear and cracks. Inspect other brake parts, including drums, wheel cylinders, calipers, parking brake, etc. Check parking brake adjustment. You may need to have your brakes inspected more often if your driving habits or conditions result in frequent braking.

Part D: Recommended Fluids and Lubricants

NOTE: Fluids and lubricants identified below by name, part number or specification may be obtained from your GM dealer.

USAGE	FLUID/LUBRICANT
Engine Oil (Gasoline Engine)	Engine oil with the American Petroleum Institute Certified For Gasoline Engines "Starburst" symbol of the proper viscosity. To determine the preferred viscosity for your vehicle's engine, see "Engine Oil" in the Index.
Engine Coolant	50/50 mixture of clean water (preferably distilled) and GM Goodwrench [®] DEX-COOL [™] or Havoline [®] DEX-COOL [™] (orange-colored, silicate-free) antifreeze conforming to GM Specification 6277M. See "Engine Coolant" in the Index.
Coolant Supplement Sealer	GM Part No. 3634621 or equivalent with a complete flush and refill.

USAGE	FLUID/LUBRICANT
Hydraulic Brake System	Delco Supreme 11 [®] Brake Fluid (GM Part No. 1052535 or equivalent DOT-3 brake fluid).
Parking Brake Cable Guides	Chassis lubricant (GM Part No. 1052497 or equivalent) or lubricant meeting requirements of NLGI Grade 2, Category LB or GC-LB.
Power Steering System	GM Power Steering Fluid (GM Part No. 1052884 - 1 pt., 1050017 - 1 qt., or equivalent).
Automatic Transmission	DEXRON [®] -III Automatic Transmission Fluid.
Key Lock Cylinders	Multi-Purpose Lubricant, Superlube [®] (GM Part No. 12346241 or equivalent).
Chassis Lubrication	Chassis lubricant (GM Part No. 1052497 or equivalent) or lubricant meeting requirements of NLGI Grade 2, Category LB or GC-LB.

USAGE	FLUID/LUBRICANT
Front Wheel Bearings	Wheel bearing lubricant meeting requirements of NLGI Grade 2, Category GC or GC-LB (GM Part No. 1051344 or equivalent).
Differential, Rear Axle	Axle Lubricant (GM Part No. 1052271) or SAE 80W-90 GL-5 Gear Lubricant.
Windshield Washer Solvent	GM Optikleen [®] Washer Solvent (GM Part No. 1051515) or equivalent.
Propeller Shaft Spline/Universal Joint and Propeller Shaft	Chassis lubricant (GM Part No. 1052497 or equivalent) or lubricant meeting requirements of NLGI Grade 2, Category LB or GC-LB.
Hood Latch Assembly, Pivots, Spring Anchor and Release Pawl	Lubriplate lubricant aerosol (GM Part No. 12346293 or equivalent) or lubricant meeting requirements of NLGI Grade 2, Category LB or GC-LB.

USAGE	FLUID/LUBRICANT
Hood Hinges and Fuel Door Hinge	Multi-purpose lubricant, Superlube [®] (GM Part No. 12346241 or equivalent).
Weatherstrip Conditioning	Dielectric Silicone Grease (GM Part No. 12345579 or equivalent).
Weatherstrip Squeaks	Multi-purpose lubricant, Superlube [®] (GM Part No. 12346241 or equivalent).
Gas Line	Gas Line De-Icer (GM Part No. 1051516).

See "Replacement Parts" in the Index for recommended replacement filters, valves and spark plugs.

Section 8 Customer Assistance Information

Here you will find out how to contact GMC Truck if you need assistance. This section also tells you how to obtain service publications and how to report any safety defects.

This section includes information on:

- The Customer Satisfaction Procedure
- Customer Assistance for Text Telephone (TTY) Users
- Roadside Assistance
- Courtesy Transportation
- BBB Auto Line -- Alternative Dispute Resolution Program
- Reporting Safety Defects
- Service and Owner Publications

Customer Satisfaction Procedure



Your satisfaction and goodwill are important to your dealer and GMC Truck. Normally, any concern you may have with your vehicle can be handled by your selling or servicing dealer. Your dealer has the facility, trained technicians, special tools and up-to-date information to promptly address any issue which may arise. GMC Truck has empowered its dealers to make decisions and repair vehicles, and they are eager to resolve your concern to your complete satisfaction. If your concern has not been resolved to your satisfaction, take the following steps:

STEP ONE -- Discuss your concern with a member of dealer management. Normally, concerns can be quickly resolved at that level. If the matter has already been reviewed with the Sales, Service or Parts Manager, contact the owner of the dealership or the General Manager.

STEP TWO -- If after contacting a member of dealership management, it appears your concern cannot be resolved by the dealership without further help, contact the GMC Truck Consumer Relations Manager by calling 1-800-GMC-TRUCK (1-800-462-8782, Customer Assistance prompt.) In Canada, contact GM of Canada Customer Communication Centre in Oshawa by calling 1-800-263-3777 (English) or 1-800-263-7854 (French).

For help outside of the United States and Canada, call the following numbers as appropriate:

- In Mexico: (525) 625-3256
- In Puerto Rico: 1-800-496-9992 (English) or 1-800-496-9993 (Spanish)
- In the U.S. Virgin Islands: 1-800-496-9994
- In the Dominican Republic: 1-800-751-4135 (English) or 1-800-751-4136 (Spanish)
- In the Bahamas: 1-800-389-0009
- In Bermuda, Barbados, Antigua and the British Virgin Islands: 1-800-534-0122
- In all other Caribbean countries: (809) 763-1315
- In other overseas locations, call GM North American Export Sales in Canada at (905) 644-4112.

For prompt assistance, please have the following information available to give the Customer Assistance Representative:

- Your name, address, home and business telephone numbers
- Vehicle Identification Number (This is available from the vehicle registration or title, or the plate at the top left of the instrument panel and visible through the windshield.)
- Dealership name and location
- Vehicle delivery date and present mileage
- Nature of concern

We encourage you to call us so we can give your inquiry prompt attention. However, if you wish to write GMC Truck, write to:

GMC Truck Customer Assistance
31 E. Judson Street 1607-04
Pontiac, MI 48342-2230

Refer to your Warranty and Owner Assistance Information booklet for addresses of Canadian and GM Overseas offices.

When contacting GMC Truck, please remember that your concern will likely be resolved in the dealership, using the dealer's facilities, equipment and personnel. That is why we suggest you follow Step One first if you have a concern.

Customer Assistance for Text Telephone (TTY) Users

To assist customers who are deaf, hard of hearing, or speech-impaired and who use Text Telephones (TTYs), GMC Truck has TTY equipment available at its Customer Assistance Center. Any TTY user can communicate with GMC Truck by dialing: 1-800-GMC-8583. (TTY users in Canada can dial 1-800-263-3830.)

Roadside Assistance

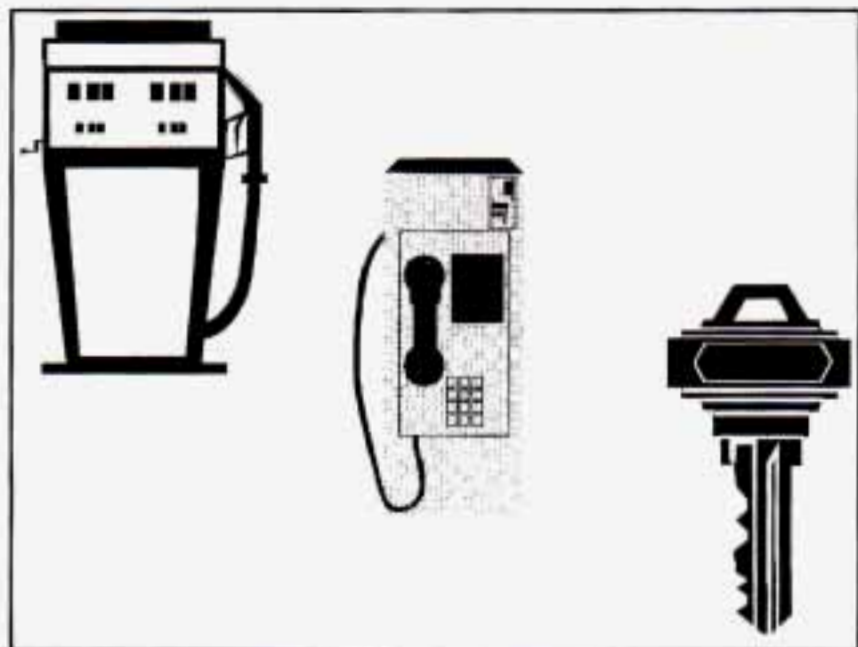

GMC Truck's Roadside Assistance provides stranded owners with over-the-phone roadside repairs, location of the nearest GMC Truck dealer or the following special services:

Flat Tire Change: Installation of spare tire will be covered at no charge (customer is responsible for repair or replacement of tire).

Fuel Delivery: Delivery of enough fuel for the customer to get to the nearest service station (up to \$4.00) will be covered.

Jump Start: No-start situations which require a battery jump start will be covered at no charge.

Lock Out: Replacement keys or locksmith service will be covered at no charge if you are unable to gain entry into your vehicle. Delivery of the replacement key will be covered at no charge within 10 miles (16 km).

Emergency Towing Service: Towing to the nearest GMC Truck dealer for warranty related disablements will be covered.

The Roadside Assistance services listed are available to retail and retail lease customers operating 1997 GMC light duty trucks for a period of 3 years/36,000 miles (60 000 km). All services must be pre-arranged by GMC Truck Roadside Assistance.

Over-the-phone assistance, such as providing the name of the closest dealer or minor technical advice, etc., is available to all owner/operators of GMC trucks, regardless of vehicle or mileage.

Just dial GMC Truck Roadside Assistance at 1-800-GMC-TRUCK (1-800-462-8782, Roadside Assistance prompt) to reach a qualified representative who can assist you.

Your Roadside Assistance representative will ask for the following information when your call is received:

- Vehicle Identification Number (VIN)
- Name and home address
- Telephone number and location from which you are calling
- Location, license plate number and color of your GMC truck
- Mileage of vehicle and description of problem

Roadside Assistance is available 24 hours a day, 7 days a week, 365 days a year, including weekends and holidays. Should you have any questions about roadside assistance, call the GMC Truck Roadside Assistance Center or contact your dealer.

Roadside Assistance is not part of or included in the coverage provided by the New Vehicle Limited Warranty. GMC Truck reserves the right to make any changes or discontinue the Roadside Assistance program at any time without notification.

Canadian Roadside Assistance

Vehicles purchased in Canada have an extensive Roadside Assistance program accessible from anywhere in Canada or the United States. Please refer to the separate brochure provided by the dealer or call 1-800-268-6800 for emergency services.

Courtesy Transportation

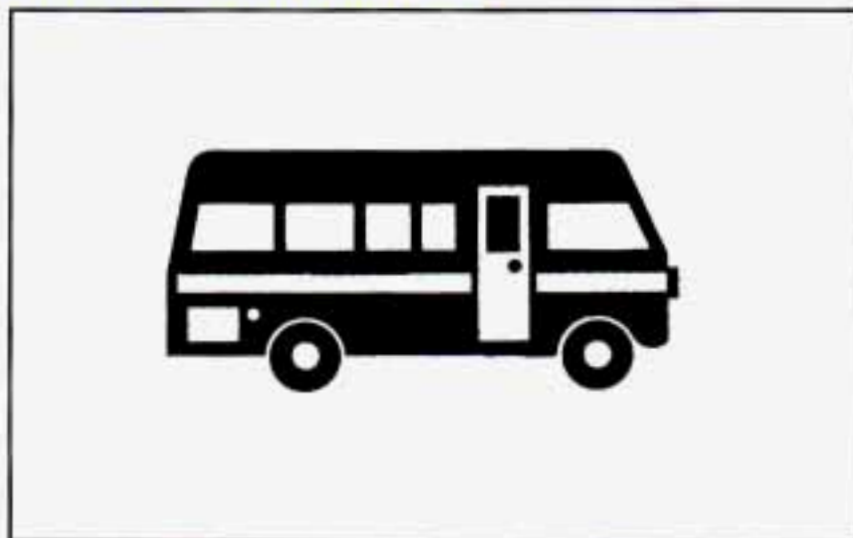

The GMC Truck Commitment Plus Program offers courtesy transportation for customers when obtaining warranty service. The Courtesy Transportation Program is available to retail purchasers of Commitment Plus eligible 1996 GMC light duty trucks.

This program is offered in conjunction with the 3 year/36,000 mile (60 000 km) Bumper to Bumper New Vehicle Limited Warranty.

Courtesy transportation includes:

- One way shuttle ride from the dealership (up to 10 miles (16 km)) for same-day warranty repairs.
- A loaner vehicle will be made available for overnight warranty repairs up to a five day maximum, or up to a \$30 allowance for a rental vehicle, cab, bus or other transportation in lieu of a loaner. (Bringing vehicles in late in the day, for service on the next day, *does not* constitute overnight repairs.)
- Gas allowance of up to \$10 a day for rides provided by another person (i.e., friend, neighbor, etc.) in lieu of rental for overnight warranty repair up to five day maximum.

All Courtesy Transportation arrangements will be administered by your GMC Truck dealership service management. All requests should reflect actual costs up to and not to exceed the maximum allowable dollar limits.

Because of insurance liability considerations, age restrictions exist in some states when loaning dealer owned vehicles or obtaining vehicles from rental establishments. See your dealer for details.

The Commitment Plus Courtesy Transportation Program is not part of the Bumper to Bumper Limited Warranty. GMC Truck reserves the right to make any changes or discontinue the Courtesy Transportation Program at any time without notification.

For additional program details contact your GMC Truck dealer.

For warranty repairs during the Complete Vehicle Coverage period in the New Vehicle Limited Warranty, interim transportation may be available under the Courtesy Transportation Program. Please consult your dealer for details. The Roadside Assistance program is available only in the United States and Canada.

GM Participation in BBB AUTO LINE -- Alternative Dispute Resolution Program*

*This program may not be available in all states, depending on state law. Canadian owners refer to your Warranty and Owner Assistance Information booklet. General Motors reserves the right to change eligibility limitations and/or to discontinue its participation in this program.

Both GMC Truck and your GMC Truck dealer are committed to making sure you are completely satisfied

with your new vehicle. Our experience has shown that, if a situation arises where you feel your concern has not been adequately addressed, the Customer Satisfaction Procedure described earlier in this section is very successful.

There may be instances where an impartial third party can assist in arriving at a solution to a disagreement regarding vehicle repairs or interpretation of the New Vehicle Limited Warranty. To assist in resolving these disagreements, GMC Truck voluntarily participates in BBB AUTO LINE.

BBB AUTO LINE is an out-of-court program administered by the Better Business Bureau system to settle disputes between customers and automobile manufacturers. This program is available free of charge to customers who currently own or lease a GM vehicle.

If you are not satisfied after following the Customer Satisfaction Procedure, you may contact the BBB using the toll-free telephone number, or write them at the following address:

BBB AUTO LINE
Council of Better Business Bureaus
4200 Wilson Boulevard
Suite 800
Arlington, VA 22203
Telephone: 1-800-955-5100

To file a claim, you will be asked to provide your name and address, your Vehicle Identification Number (VIN) and a statement of the nature of your complaint. Eligibility is limited by vehicle age and mileage, and other factors.

We prefer you utilize the Customer Satisfaction Procedure before you resort to AUTO LINE, but you may contact the BBB at any time. The BBB will attempt to resolve the complaint serving as an intermediary between you and GMC Truck. If this mediation is unsuccessful, an informal hearing will be scheduled where eligible customers may present their case to an impartial third-party arbitrator.

The arbitrator will make a decision which you may accept or reject. If you accept the decision, GM will be bound by that decision. The entire dispute resolution procedure should ordinarily take about 40 days from the time you file a claim until a decision is made.

Some state laws may require you to use this program before filing a claim with a state-run arbitration program or in the courts. For further information, contact the BBB at 1-800-955-5100 or the GMC Truck Customer Assistance Center at 1-800-GMC-TRUCK (1-800-462-8782).

REPORTING SAFETY DEFECTS TO THE UNITED STATES GOVERNMENT

If you believe that your vehicle has a defect which could cause a crash or could cause injury or death, you should immediately inform the National Highway Traffic Safety Administration (NHTSA), in addition to notifying General Motors.

If NHTSA receives similar complaints, it may open an investigation, and if it finds that a safety defect exists in a group of vehicles, it may order a recall and remedy campaign. However, NHTSA cannot become involved in individual problems between you, your dealer or General Motors.

To contact NHTSA, you may either call the Auto Safety Hotline toll-free at 1-800-424-9393 (or 366-0123 in the Washington, D.C. area) or write to:

NHTSA, U.S. Department of Transportation
Washington, D.C. 20590

You can also obtain other information about motor vehicle safety from the Hotline.

REPORTING SAFETY DEFECTS TO THE CANADIAN GOVERNMENT

If you live in Canada, and you believe that your vehicle has a safety defect, you should immediately notify Transport Canada, in addition to notifying General Motors of Canada Limited. You may write to:

Transport Canada
Box 8880
Ottawa, Ontario K1G 3J2

REPORTING SAFETY DEFECTS TO GENERAL MOTORS

In addition to notifying NHTSA (or Transport Canada) in a situation like this, we certainly hope you'll notify us. Please call us at 1-800-GMC-TRUCK (1-800-462-8782) or write:

GMC Truck Consumer Relations
31 E. Judson Street 1607-04
Pontiac, MI 48342-2230

In Canada, please call us at 1-800-263-3777 (English) or 1-800-263-7854 (French). Or, write:

General Motors of Canada Limited
Customer Communication Centre
1908 Colonel Sam Drive
Oshawa, Ontario L1H 8P7

Service and Owner Publications



Service manuals, service bulletins, owner's manuals and other service literature are available for purchase for all current and many past model General Motors vehicles.

Toll-free telephone numbers for ordering information:

United States 1-800-551-4123
Canada 1-800-668-5539

Service Manuals

Service manuals contain diagnostic and repair information for all chassis and body systems. They may be useful for owners who wish to get a greater understanding of their vehicle. They are also useful for owners with the appropriate skill level or training who wish to perform “do-it-yourself” service. These are authentic General Motors service manuals meant for professional, qualified technicians.

Service Bulletins

Service bulletins covering various subjects are regularly sent to all General Motors dealerships. GM monitors product performance in the field. When service methods are found which promote better service on GM vehicles, bulletins are created to help the technician perform better service. Service bulletins may involve any

number of vehicles. Some will describe inexpensive service; others will describe expensive service. Some will advise of new or unexpected conditions, and others may help avoid future costly repairs. Service bulletins are meant for qualified technicians. In some cases bulletins refer to service manuals, specialized tools, equipment and safety procedures necessary to service the vehicle. Since these bulletins are issued throughout the model year and beyond, an index is required and published quarterly to help identify specific bulletins. Subscriptions are available. You can order an index at the toll-free numbers listed previously, or ask a GM dealer to see an index or individual bulletin.

Owner Publications

Owner’s manuals, warranty folders and various owner assistance booklets provide owners with general operation and maintenance information.

Section 9 Index

A adjustable Mast Antenna	3-29	Appearance Care Materials	6-59
Air Bag	1-21	Arbitration Program	8-7
Adding Equipment	1-28	Ashtrays	2-42
How Does it Restrain	1-26	Audio Systems	3-9
How it Works	1-24	Transmission	
Location	1-24	Transmission Check	7-44
Readiness Light	1-23, 2-47	Transmission Fluid	6-16
Servicing	1-27	Transmission Operation	2-17
What Makes it Inflate	1-25	Shifting	2-17
What Will You See After it Inflates	1-26	Transmission Park Mechanism Check	7-46
When Should it Inflate	1-25	Axle, Locking Rear	2-20
Air Cleaner	6-15	Axle, Rear	6-19
Air Conditioning	3-7		
Air Conditioning Refrigerants	6-68	B attery	6-30
Air Control, Climate Control System	3-3	Jump Starting	5-2
Alignment and Balance, Tire	6-48	Replacement, Remote Keyless Entry	2-6
Aluminum Wheels, Cleaning	6-57	Warnings	5-2, 5-3
Antenna, Adjustable Mast	3-29	BBB Auto Line	8-7
Antenna, Power	3-29	Before Leaving on a Long Trip	4-20
Antifreeze	6-20	Better Business Bureau Mediation	8-7
Anti-Lock			
Brake System Warning Light	2-49, 4-6		
Brakes	4-5		
Appearance Care	6-50		

Brake			
Adjustment	6-29		
Fluid	6-27		
Master Cylinder	6-27		
Parking	2-20		
Pedal Travel	6-29		
Replacing System Parts	6-30		
System Warning Light	2-48		
Trailer	4-33		
Transmission Shift Interlock Check	7-45		
Wear	6-28		
Brakes, Anti-Lock	4-6		
Braking	4-5		
Braking in Emergencies	4-8		
Break-In, New Vehicle	2-13		
Brightness Control	2-36		
BTSI Check	7-45		
Bulb Replacement	6-31		
C anadian Roadside Assistance	8-6		
Capacities and Specifications	6-65		
Carbon Monoxide	2-25, 4-25, 4-34		
Cassette Deck Service	7-44		
Cassette Tape Player	3-11, 3-13		
Cassette Tape Player Care	3-28		
Center High-Mounted Stoplamp	2-56		
Center Passenger Position	1-33		
Center Rear Passenger Position	1-33		
Certification Label	4-26		
Certification/Tire Label	4-26		
Chains, Safety	4-33		
Chains, Tire	6-50		
Changing a Flat Tire	5-20		
Checking Your Restraint Systems	1-48		
Chemical Paint Spotting	6-58		
Child Restraints	1-37		
Securing in a Rear Outside Seat Position	1-39		
Securing in the Center Front Seat Position	1-41		
Securing in the Center Rear Seat Position	1-41		
Securing in the Center Seat Position	1-41		
Securing in the Passenger Seat Position	1-42		
Securing in the Right Front Seat Position	1-42		
Top Strap	1-38		
Where to Put	1-37, 1-38		
Cigarette Lighter	2-42		
Circuit Breakers and Fuses	6-62		
Cleaner, Air	6-15		
Cleaning			
Aluminum Wheels	6-57		
Fabric	6-51		
Glass	6-54		
Inside of Your GM	6-51		
Instrument Panel	6-54		
Leather	6-53		
Outside of Your GM	6-55		
Special Problems	6-52		
Stains	6-52		
Tires	6-57		
Vinyl	6-53		
Wheels	6-57		
Windshield and Wiper Blades	6-55		
Climate Control, Standard	3-1		

Climate Control System	3-1
Clock, Setting the	3-9
Comfort Controls	3-1
Compact Disc Care	3-28
Compact Disc Player	3-17, 3-19
Console Storage	2-41
Control of a Vehicle	4-5
Convex Outside Mirror	2-40
Coolant	6-20
Recovery Tank	5-13
Cooling System	5-12
Courtesy Transportation	8-6
Cruise Control	2-32
Cupholders	2-41
Customer Assistance for Text Telephone Users	8-3
Customer Assistance Information	8-1
Customer Satisfaction Procedure	8-1

D amage, Finish	6-57
Damage, Sheet Metal	6-57
Daytime Running Lamps	2-36
Daytime Running Lamps Indicator Light	2-49
Dead Battery	5-2
Defects, Reporting Safety	8-8
Defensive Driving	4-1
Defogger, Rear Window	3-8
Defogging	3-2, 3-4
Defrosting	3-2, 3-4
Dome Lamps	2-37
Door	
Locks	2-3

Sliding	2-8
Storage	2-41
Storage Pocket	2-41
Swing-Out Side	2-7
Drive Position, Automatic Transmission	2-19
Driver Position	1-13
Driving	
City	4-18
Defensive	4-1
Drunken	4-2
Freeway	4-19
In a Blizzard	4-24
In Foreign Countries	6-4
In the Rain	4-15
Night	4-13
On Curves	4-8
On Grades While Towing a Trailer	4-36
On Hill and Mountain Roads	4-21
On Snow and Ice	4-23
Through Water	4-17
Wet Roads	4-15
Winter	4-23
With a Trailer	4-34
Drunken Driving	4-2
Dual Tire Operation	6-45

E lectrical Equipment, Adding	6-61
Electrical System	6-61
Electronic Road Speed Governor (Gasoline Engines)	2-55

Engine	6-8	French Language Manual	ii
Coolant	6-20	Front Parking/Turn Signal Lamp Bulb Replacement	6-34
Coolant Level Check	7-43	Front Storage Area	2-41
Coolant Temperature Gage	2-54	Front Towing	5-8
Cooling System	6-66	Fuel	6-2
Exhaust	2-24	Canada	6-3
Identification	6-60, 6-65	Filling Your Tank	6-4
Oil Level Check	7-43	Gage	2-53
Overheating	5-10	In Foreign Countries	6-4
Running While Parked	2-25	Tank Capacity	6-67
Starting Your	2-14	Fuses and Circuit Breakers	6-62
Engine Oil	6-11	G ages	
Adding	6-11	Engine Coolant Temperature	2-54
Additives	6-13	Engine Oil Pressure	2-52
Checking	6-11	Fuel	2-53
Pressure Gage	2-52	Speedometer	2-45
Used	6-14	Voltmeter	2-55
When to Change	6-14	GAWR	4-27
Ethanol	6-3	Gear Positions, Automatic Transmission	2-17
Exhaust, Engine	2-24	Gross Axle Weight Rating	4-27
F abric Cleaning	6-51	Gross Vehicle Weight Rating	4-26
Fan Control, Climate Control System	3-2	Guide en Français	ii
Filling Your Tank	6-4	GVWR	4-26
Filter, Air	6-15	H alogen Bulbs	6-31
Finish Care	6-56	Hazard Warning Flashers	5-1
Finish Damage	6-57	Head Restraints	1-5
First Gear, Automatic Transmission	2-19	Headlamps	2-35
Flashers, Hazard Warning	5-1	Bulb Replacement	6-31
Flat Tire, Changing	5-20	High/Low Beam Changer	2-30
Fluid Capacities	6-65	On Reminder	2-36
Fluids and Lubricants	7-49	Wiring	6-61
Foreign Countries, Fuel	6-4		

Hearing Impaired, Customer Assistance	8-3
Heating	3-7
High-Beam Headlamps	2-30
Highway Hypnosis	4-21
Hill and Mountain Roads	4-21
Hitches, Trailer	4-32
Hood	
Checking Things Under	6-6
Prop	6-7
Release	6-6
Horn	2-28
Hydroplaning	4-17
I gnition Switch	2-13
Inflation, Tire	6-42
Inside Day/Night Rearview Mirror	2-39
Inspections	7-47
Brake System	7-48
Exhaust Systems	7-47
Radiator and Heater Hose	7-47
Rear Axle	7-48
Steering	7-47
Suspension	7-47
Throttle Linkage	7-47
Brightness Control	2-36
Cleaning	6-51
Cluster	2-44
Fuse Block	6-62
Interior Lamps	2-38

J ack, Tire	5-22
Jump Starting	5-2

K ey Lock Cylinders Service	7-44
Keyless Entry System	2-5
Keys	2-1

L abels	
Certification	4-26
Certification/Tire	4-26
Service Parts Identification	6-60
Tire-Loading Information	4-26
Vehicle Identification Number	6-60
Lamps	2-35
Dome	2-37
Interior	2-37
On Reminder	2-36
On Warning	2-36
Panel	2-35
Underhood	2-38
Leaving Your Vehicle with the Engine Running	2-23
Lighter	2-42
Lights	
Air Bag Readiness	1-23, 2-47
Anti-Lock Brake System Warning	2-49, 4-6
Brake System Warning	2-48
Daytime Running Lamps Indicator	2-49
Interior	2-37
Safety Belt Reminder	1-8, 2-46
Service Engine Soon	2-50
Loading Your Vehicle	4-26

Locks	
Cylinders	7-44
Door	2-3
Key Lock Cylinder Service	7-44
Power Door	2-3
Rear Door Security	2-4
Sliding Door Child Security	2-4
Steering Column Lock Check	7-46
Loss of Control	4-12
Lubricants and Fluids	7-49
Lubrication Service, Body	7-44
M aintenance, Normal Replacement Parts	6-65
Maintenance Record	7-51
Maintenance Schedule	7-1
Long Trip/Highway Definition	7-5
Long Trip/Highway Intervals	7-6
Owner Checks and Services	7-43
Periodic Maintenance Inspections	7-47
Recommended Fluids and Lubricants	7-49
Scheduled Maintenance Services	7-3
Short Trip/City Definition	7-4
Short Trip/City Intervals	7-4
Maintenance, Underbody	6-58
Maintenance When Trailer Towing	4-37
Malfunction Indicator Lamp	2-50
Manual Front Seat	1-1
Manual Mirror	2-40
Methanol	6-3
Mirrors	2-40
Convex Outside	2-39
Inside Day/Night Rearview	2-39
Manual	2-40
Power Remote Control	2-39
Visor Vanity	2-42
MMT	6-3
Model Reference	vi
Mountain Roads	4-21
Multifunction Lever	2-29
N eutral, Automatic Transmission	2-18
New Vehicle Break-In	2-13
Night Vision	4-14
Noise Control System	6-9
O dometer	2-45
Odometer, Trip	2-45
Off-Road Recovery	4-10
Oil, Engine	6-11
Overheating Engine	5-10
Owner Checks and Services	7-43
Owner Publications, Ordering	8-9
P aint Spotting, Chemical	6-58
P ark	
Automatic Transmission	2-17
Shifting Into	2-21
Shifting Out of	2-23

Parking	
At Night	2-12
Brake	2-20
Brake Mechanism Check	7-46
Lots	2-12
Over Things That Burn	2-24
With a Trailer	4-36
Passenger Position	1-29
Passenger Temperature Control	3-5
Passing	4-11
Periodic Maintenance Inspections	7-47
Power	
Antenna Mast Care	3-29
Door Locks	2-3
Option Fuses	6-61
Remote Control Mirror	2-39
Seat	1-2
Steering	4-8
Steering Fluid	6-24
Windows	2-26
Power Seat	
Pregnancy, Use of Safety Belts	1-29
Problems on the Road	5-1
Publications, Service and Owner	8-9

R adiator	5-16
Radiator Pressure Cap	6-23
Radio Reception	3-26
Radios	3-9, 3-11, 3-13, 3-19
Rain, Driving In	4-15
Reading Lamps	2-38

Rear	
Axle	6-19
Door Security Locks	2-4
Outside Seat Position	1-30
Seat Passengers	1-29
Storage	2-41
Towing	5-9
Window Defogger	3-8
Rearview Mirror	2-39
Reclining Front Seatbacks	1-3
Recovery Tank, Coolant	5-13
Refrigerants, Air Conditioning	6-68
Remote Compact Disc Player	3-17
Removing the Rear Seat	1-6
Replacement	
Bulbs	6-69
Parts	6-65
Wheel	6-48
Replacing Safety Belts	1-48
Replacing the Rear Seat	1-7
Reporting Safety Defects	8-8
Restraints	
Checking	1-48
Child	1-37
Head	1-5
Replacing Parts After a Crash	1-48
System Check	7-44
Reverse, Automatic Transmission	2-18
Right Front Passenger Position	1-29
Roadside Assistance	8-4
Roadside Assistance, Canadian	8-6
Rocking Your Vehicle	5-36
Rotation, Tires	6-43

Safety Belt Extender	1-48	Rear	1-5
Safety Belts	1-8	Restraint Systems	1-1
Adults	1-13	Seat Controls	1-1
Care	6-54	Securing a Child Restraint	1-39
Center Passenger Position	1-33	Second Gear, Automatic Transmission	2-19
Center Rear Passenger Position	1-33	Service	6-1
Children	1-34	Bulletins, Ordering	8-9
Driver Position	1-13	Engine Soon Light	2-50
Extender	1-48	Manuals, Ordering	8-9
How to Wear Properly	1-13	Parts Identification Label	6-60
Incorrect Usage	1-16, 1-46, 1-47	Publications, Ordering	8-9
Lap Belt	1-33	Work, Doing Your Own	6-1
Lap-Shoulder	1-13, 1-30	Service and Appearance Care	6-1
Larger Children	1-45	Service and Owner Publications	8-9
Passenger Position	1-29	Service Publications	8-9
Questions and Answers	1-12	Serviceing Your Air Bag-Equipped GM	1-27
Rear Seat Outside Passenger Positions	1-30	Sheet Metal Damage	6-57
Rear Seat Passengers	1-30	Shift Lever	2-17, 2-21
Reminder Light	1-8, 2-46	Shifting	
Replacing After a Crash	1-48	Automatic Transmission	2-17
Right Front Passenger Position	1-29	Into Park (P)	2-21
Shoulder Belt Height Adjuster	1-15	Out of Park	2-23
Smaller Children and Babies	1-34, 1-36	Shoulder Belt Height Adjuster	1-15
Use During Pregnancy	1-29	Sidemarket Lamp Bulb Replacement	6-35
Why They Work	1-9	Signaling Turns	2-30
Safety Chains	4-33	SIR	1-21
Safety Defects, Reporting	8-8	Skidding	4-12
Safety Warnings and Symbols	iii	Specifications and Capacities	6-65
Scheduled Maintenance Services	7-3	Speech Impaired, Customer Assistance	8-3
Seatback		Speedometer	2-45
Reclining Front	1-3	Stains, Cleaning	6-53
Seats		Starter Switch Check	7-45
Manual Front	1-1	Starting Your Engine	2-14
Power	1-2	Steam	5-10

Steering	4-8
Column Lock Check	7-46
In Emergencies	4-9
Power	4-8
Tips	4-8
Wheel, Tilt	2-29
Storage Areas	2-41
Storage, Vehicle	6-30
Stuck: In Sand, Mud, Ice or Snow	5-35
Sun Visors	2-41
Supplemental Inflatable Restraint	1-21
Symbols, Vehicle	v

T aillamp Bulb Replacement	6-36
Tape Player Care	3-28
Temperature Control, Climate Control System	3-1
Temperature Control, Passenger	3-5
Theft	2-12
Theft-Deterrent Feature	3-23
Thermostat	6-24
Third Gear, Automatic Transmission	2-19
Tilt Steering Wheel	2-29
Time, Setting the	3-9
Tire Chains	6-50
Tire Loading	4-26
Tire-Loading Information Label	4-26
Tires	6-41
Alignment and Balance	6-48
Buying New	6-45
Chains	6-50
Changing a Flat	5-20
Cleaning	6-54

Dual Operation	6-45
Inflation	6-42
Inflation Check	7-44
Inspection and Rotation	6-43
Loading	4-26
Pressure	6-42
Temperature	6-47
Traction	6-47
Treadwear	6-47
Uniform Quality Grading	6-46
Wear Indicators	6-44
Wheel Replacement	6-48
When It's Time for New	6-44
Top Strap	1-38
Torque Lock	2-23
Torque, Wheel Nut	6-65
Torque, Wheel Nut	5-32
Towing a Trailer	4-28
Towing Your Vehicle	5-6
Trailer	
Brakes	4-33
Driving on Grades	4-36
Driving with	4-34
Hitches	4-32
Maintenance When Towing	4-37
Parking on Hills	4-36
Safety Chains	4-33
Tongue Weight	4-31
Total Weight on Tires	4-32
Towing	4-28
Turn Signals	4-35
Weight	4-30
Wiring Harness	4-37

Transmission Fluid	
Automatic	6-16
Transmitters, Keyless Entry	2-5
Transportation, Courtesy	8-6
Trip Odometer	2-45
TTY Users	8-3
Turn Signal and Lane Change Signals	2-30
Turn Signal/Multifunction Lever	2-29
Turn Signals When Towing a Trailer	4-35

U nderbody Maintenance	6-58
Underhood Lamp	2-38

V ehicle	
Control	4-5
Damage Warnings	iv
Identification Number	6-60
Loading	4-26
Storage	6-30
Ventilation System	3-8
Visor Vanity Mirrors	2-42
Visors, Sun	2-41

W arning Devices	5-2
Warning Lights, Gages and Indicators	2-46
Washer Fluid, Windshield	6-25
Washing Your Vehicle	6-55
Weatherstrips	6-55
W heel	
Alignment	6-48
Nut Torque	6-65
Nut Torque	5-32
Replacement	6-48
Wrench	5-22
Windows	2-26
Power	2-26
Side Latches	2-27
Swing-Out	2-27
Windshield Washer	2-32
Fluid	2-32 6-25
Fluid Level Check	7-43
Windshield Wiper	2-31
Blade Replacement	6-39
Fuses	6-61
Winter Driving	4-23
Wiring, Headlamp	6-61
Wrecker Towing	5-6
Wrench, Wheel	5-22

X-961



THE STRENGTH OF EXPERIENCE



*Keep with vehicle at all times
Contains important Operating, Safety
and Maintenance instructions*