

1993 Accord Sedan Online Reference Owner's Manual

Use these links (and links throughout this manual) to navigate through this reference.
For a printed owner's manual, click on authorized manuals or go to www.helminc.com.

Contents

Owner's Identification Form

Features & Safety	2
What you should know before driving your car.	
Starting & Driving	92
What gas to use, how to change gears, etc.	
Maintenance	110
The Required Maintenance Schedule and some items you can service.	
Emergency Service	148
Changing a flat, jump starting, towing.	
Specifications	158
Dimensions, weights and capacities.	
Consumer Information	160
Reporting Safety Detects, warranty service, vehicle identification numbers, etc.	
Index	169

Gas Station Information

Introduction

This manual contains important information about the safe operation and maintenance of your car.

We urge you to read it carefully, become familiar with the controls it describes, and follow its recommendations, to help make your driving trouble-free and enjoyable.

Statements or labels on the product preceded by the following words are of special significance:

▲ DANGER indicates severe personal injury or death will result if instructions are not followed.

▲ WARNING indicates a strong possibility of severe personal injury or death if instructions are not followed.

CAUTION: means hazards or unsafe practices which could cause minor personal injury or product or property damage.

NOTE: gives helpful information.

Break-in Period

During the first 600 miles (1,000 km) of driving, avoid full throttle starts and cruising for extended periods at a constant speed.

NOTE:

- This break-in procedure also applies to exchanged or overhauled engines.
- During and after the break-in period, drive the car at moderate speeds until the engine is fully warmed up.

During the first 200 miles (300 km), try to avoid severe braking. Brake misuse during this period will reduce future braking efficiency,

Remember, your Honda Automobile dealer knows your car best, and should be consulted for service assistance and advice.

Keys and Locks

Keys

Your car is supplied with a master key that fits the ignition and all locks, and a valet key that fits the ignition and doors but not the trunk, trunk remote release, rear seat trunk access or glove box.

The valet key is provided for times when you must leave the key with a parking attendant or repair person, but still want to keep valuables safely locked-up.

Write down the numbers stamped on both keys and keep the information in your wallet or purse in case you ever need to have duplicates made. Both the master and valet keys are double-edged, so you can insert them in the locks with either side up.

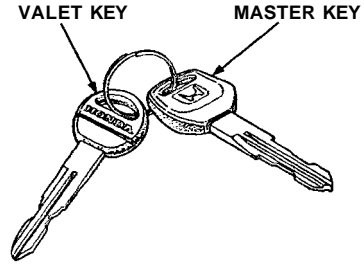

Door Locks

You can lock the doors by pushing the plunger down.

The doors must be unlocked before you can open them. The passenger doors can be locked when open, and will stay locked when you close them; the driver's door cannot be locked when open unless you hold the door handle open. The front doors can be locked and unlocked from the outside with the key.

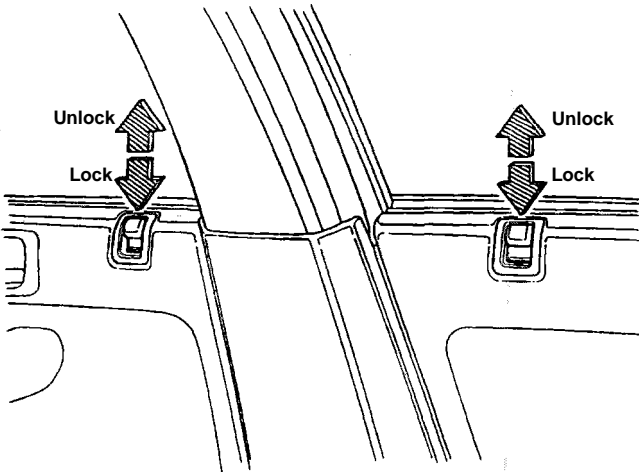

(cont'd)

Keys and Locks (cont'd)

Power Door Locks

(US: LX/EX/SE/Anniversary Edition, Canada: EX/EX-R/SE)

All doors can be simultaneously locked and unlocked by operating the master door lock switch located on each front door.

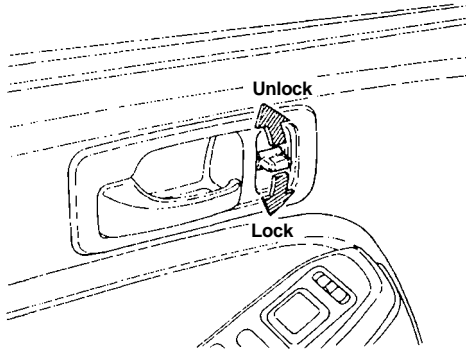

In addition, the passenger doors will lock automatically when the plunger on the driver's door is pushed down, or when the driver's door is locked from the outside with the key.

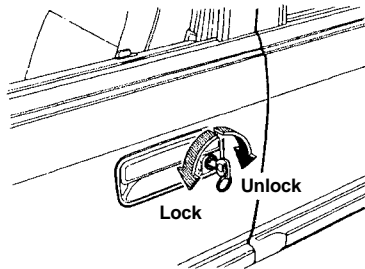
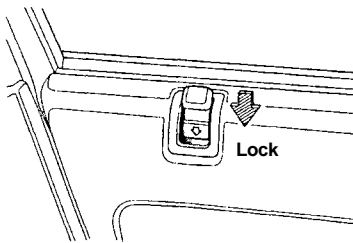

Trunk

The trunk can be opened by pulling up the lever at the left side of the driver's seat.

To open the trunk lid from the outside, put the master key in the lock and turn clockwise. The trunk lid opener lever is lockable with the master key.

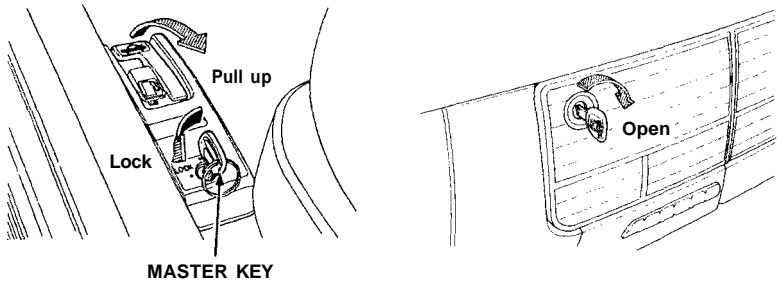

▲ WARNING

Keep the trunk lid closed while driving to keep poisonous carbon monoxide exhaust fumes out of the interior; prolonged exposure can cause unconsciousness that may lead to death.

Child Proof Door Locks

The child proof door locks are designed to prevent accidental opening of the rear doors. To activate the locks, push down the lock tabs located on each rear door, then close the doors. When the rear doors are locked in this way, they can only be opened from the outside.

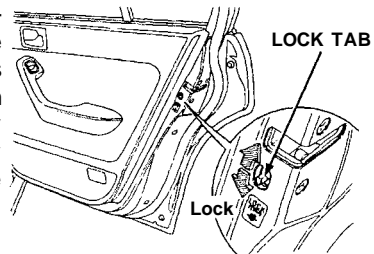

Seats

Front Seat

Adjust the seat position by pulling up on the adjustment lever under the front edge of the seat cushion, and sliding the seat to the desired position. Then release the lever and make sure the seat is locked in position by moving it back and forth.

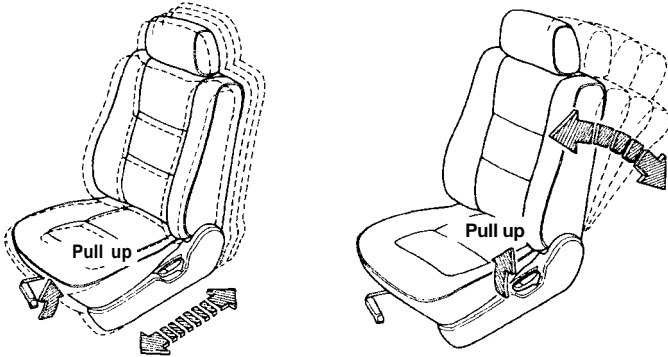

The angle of the seat-back can be changed by pulling up on the lever at the outside edge of the seat and leaning forward or back. Release the lever and let the seat lock into place when it reaches the desired angle.

Seat belts are most effective when the driver and passenger are sitting up straight and well back in each seat.

▲ WARNING

- Do not adjust the driver's seat while the car is moving; the seat could move suddenly, causing loss of vehicle control.
- To reduce the risk of sliding under the seat belts in a collision, adjust the seat-backs to an upright position and sit well back in the seat.

Front Seat Head Restraints

The head restraints are designed to help reduce injuries due to whiplash. They are located at the top of each seat-back and have several height positions. They can be adjusted by pulling up to the recommended position. To lower them, slide the button next to the restraint's height bar, while pushing the restraint down.

Adjust so the top of the restraint is approximately level with the tops of your ears.

If a head restraint must be removed (for cleaning, fabric repair, etc.) pull the restraint up to its highest position, then slide the button while pulling the restraint out.

To reinstall, reverse the above procedure.

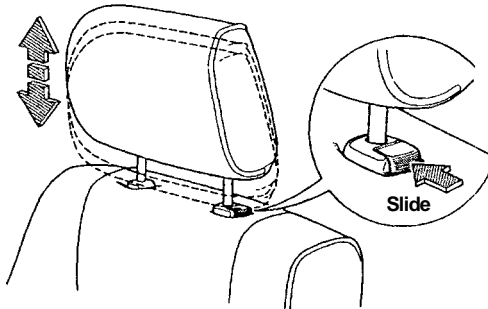

⚠ WARNING

- Do not drive the car with head restraints removed.
- Do not try to adjust head restraints while driving.

(cont'd)

Seats (cont'd)

Driver's Lumbar Support

(US: EX/SE, Canada: EX-R/SE)

Support of the lower back can be adjusted by turning the knob on the driver's armrest to give more or less support.

▲WARNING

Do not try to adjust lumbar support while driving. Make the adjustment while sitting in your normal driving position before driving away.

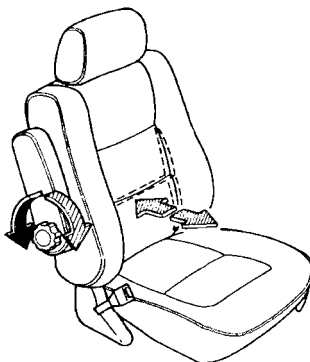

Driver's Seat Center Armrest

(US: LX/EX/SE/Anniversary Edition, Canada: EX/EX-R/SE)

The angle of the driver's armrest on the driver's seat adjusts to five positions. To lower the armrest, push the button on the driver's side of the armrest and lower the armrest.

▲WARNING

Do not try to adjust the armrest while driving. Make the adjustment before driving away.

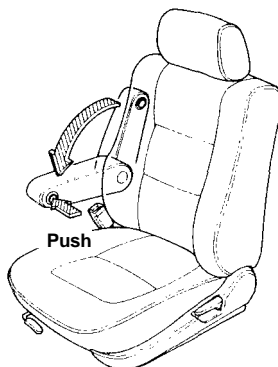

Rear Seat Armrest

(US: LX/EX/SE/Anniversary Edition, Canada: EX/EX-R/SE)

The rear seat armrest is located at the center of the rear seat-back and can be used by pulling the tab out.

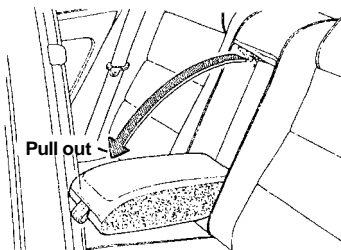

Trunk Access from Rear Seat

The rear seat-back can be released from the rear shelf with the master key and pulling down the top of the seat-back. This allows you access to the trunk and makes it possible to carry long objects inside the car.

The rear seat-back can also be released from inside the trunk by pulling the release.

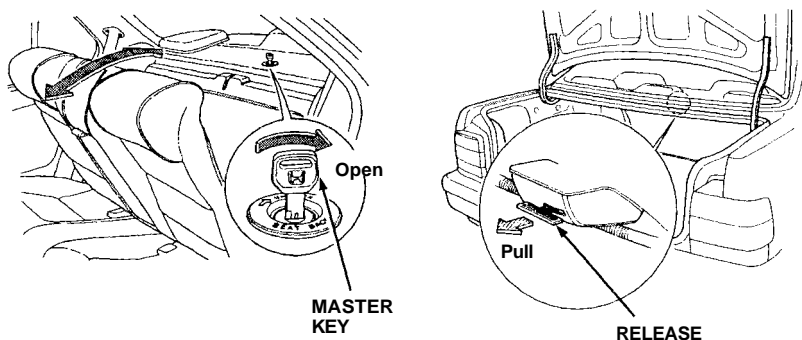

▲ WARNING

- Passengers or pets must not sit on the folded portion of the rear seat.
- Make sure any luggage or cargo within the trunk, or extending through the rear seat trunk access is secured.
- Make sure the seat-back latches engage securely when the seat-back is returned to its normal position.
- Weight limits shown on the label located on the driver's door jamb must be observed. The total weight of passengers and cargo must not exceed the total weight limit on the label.
- Do not store any items on the shelf behind the rear seat; they may become dangerous projectiles in a collision.
- Store any luggage or cargo in the trunk. If you are carrying more items than will fit in the trunk, use the floor space between the front and rear seats.
- Make sure both rear shoulder belts are positioned in front of the rear seat-backs whenever the seat-backs are in their upright position.

When closing the rear seat trunk access, push the seat-back firmly into place, then pull on the top of the seat-back to make sure it is secure.

Your Occupant Protection System

Your Accord is equipped with seat belts and other features that work together to protect you and your passengers during a crash.

Seat belts are the most important part of your occupant protection system. When worn properly, seat belts can reduce the chance of serious injury or death in a crash.

For added protection during a severe frontal collision, all Accords have a Supplemental Restraint System (SRS) with a driver's airbag. The SE model also has a passenger's airbag.

Two indicator lights are also part of your safety system. One reminds you to make sure you and your passengers wear your seat belts. The other alerts you to a possible problem with your supplemental restraint system (see page [22](#)).

The seats, head restraints, and door locks also play a role in occupant safety. For example, reclining your seat-back can decrease the effectiveness of your seat belt. Head restraints can help protect your neck and head, especially during rear-end impacts. Door locks help keep your doors from being accidentally opened during a crash.

To get the maximum protection from your occupant protection system, check the following before you drive away:

- Everyone in the car is wearing a seat belt properly (see page [13](#)).
- Infants and small children are properly secured in child safety seats (see page [27](#)).
- All doors are closed and locked (see page [25](#)).
- Seat-backs are upright and head restraints are properly adjusted (see page [24](#)).
- There are no loose items that could be thrown around and hurt someone during a crash or sudden stop (see page [25](#)).

By following these guidelines, you can reduce injuries to yourself and your passengers in many crash situations. Remember, however, that no safety system can prevent all injuries or deaths that can occur in severe crashes.

The Seat Belt System and How It Works

Why Wear Seat Belts

Wearing seat belts, and wearing them properly, is fundamental to your safety and the safety of your passengers.

During a crash or emergency stop, seat belts can help keep you from being thrown against the inside of the car, against other occupants, or out of the car.

Of course, seat belts cannot completely protect you in every crash. But, in most cases, seat belts reduce your chance of serious injury, and can even save your life. That is why many states and all Canadian provinces require you to wear seat belts.

▲ WARNING

Not wearing a seat belt increases the chance of being killed or seriously hurt in a crash.

Be sure you and your passengers always wear seat belts and wear them properly.

Important Safety Reminders

Seat belts are designed for adults and larger children. All infants and small children must be properly restrained in child safety seats (see page [27](#)).

A pregnant woman needs to wear a seat belt to protect herself and her unborn child (see page [18](#)).

Two people should never use the same seat belt. If they do, they could be very seriously injured in a crash.

Do not place the shoulder portion of a lap/shoulder belt under your arm or behind your back. This could increase the chance of serious injuries in a crash.

Do not put shoulder belt pads or other accessories on seat belts. They can reduce the effectiveness of the belts and increase the chance of injury.

(cont'd)

The Seat Belt System and How It Works (cont'd)

Seat Belt System Components

Your Accord has seat belts in all five seating positions. The front seats and the outside positions of the rear seat have lap/shoulder belts. The center position of the rear seat has a lap belt.

Your seat belt system also includes a light on the instrument panel to remind you to fasten your seat belt, and to make sure your passengers fasten theirs. This light comes on when you turn on the ignition if you have not fastened your seat belt. A beeper also sounds for several seconds (see page 39).

The following pages cover more about the seat belt components and how they work.

Lap/Shoulder Belt

This style of seat belt has a single belt that goes over your shoulder, across your chest, and across your hips.

Each lap/shoulder belt has an emergency locking retractor. In normal driving, the retractor lets you move freely in your seat while it keeps some tension on the belt. During a collision or sudden stop, the retractor automatically locks the belt to help restrain your body.

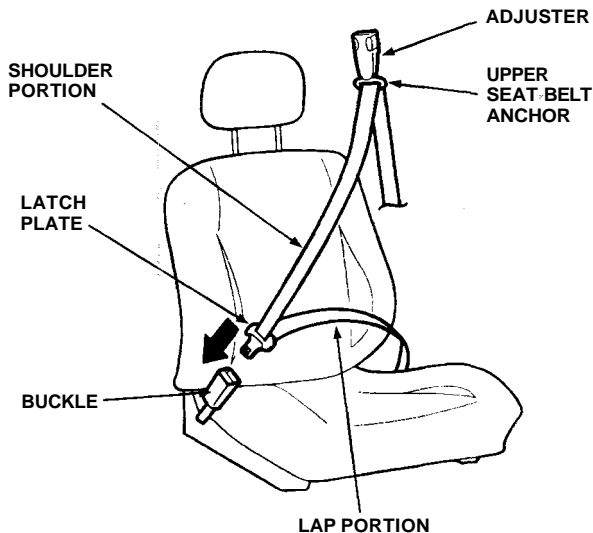

Lap Belt

The lap belt has one manually-adjusted belt that fits across the hips. It is similar to safety belts used in airplanes.

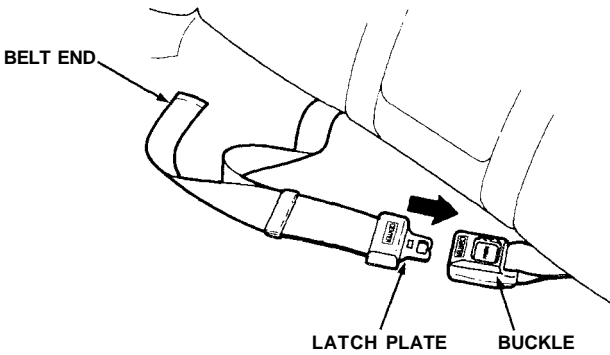

Wearing Seat Belts Properly

You can increase the effectiveness of your seat belts if you take a little time to read the following pages and make sure you know how to wear seat belts properly.

▲ WARNING

Not wearing a seat belt properly increases the chance of serious injury or death in a crash.

Be sure you and your passengers always wear seat belts and wear them properly.

(cont'd)

The Seat Belt System and How It Works (cont'd)

Wearing a Lap/Shoulder Belt

Before putting on a front seat belt, be sure your seat is adjusted forward or backward to a good driving or riding position and the back of your seat is upright (see page 24).

1. Pull the latch plate across your body and insert it into the buckle. Tug on the belt to make sure the latch is securely locked.

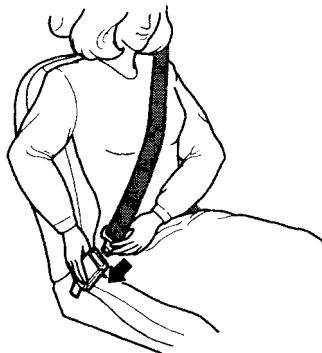

2. Check that the belt is not twisted.
3. Position the lap portion of the belt as low as possible across your hips, not across your stomach. This lets your strong pelvic bones take the force of a crash.



-
4. Pull up on the shoulder part of the belt to remove any slack. Make sure the belt goes over your collarbone and across your chest.



5. If the belt crosses your neck, you need to adjust the belt anchor height or your seating position.

Front seats: Adjust the belt anchor by squeezing the two buttons and sliding the anchor downward (it has four positions).

Rear seat: Move toward the center of the seat until the belt fits over your collarbone.

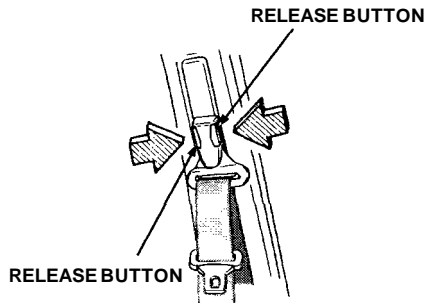

(cont'd)

The Seat Belt System and How It Works (cont'd)

To unlatch the seat belt, push the red PRESS button on the buckle. Guide the belt across your body to the door pillar. If the belt doesn't retract easily, pull it out and check for twists or kinks.

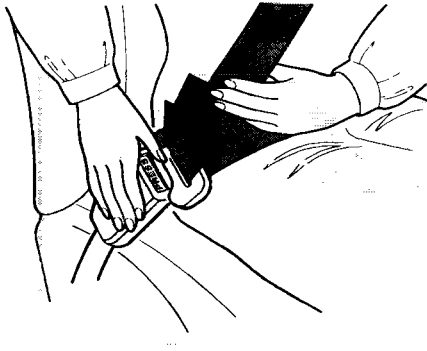

Wearing the Lap Belt

1. Pull the latch plate across your hips and insert it into the buckle marked CENTER.

If the belt is too short, hold the latch plate at a right angle and pull to extend the belt. Insert the latch plate into the buckle.

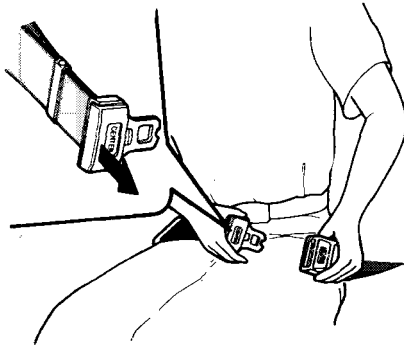

-
2. Position the belt as low as possible across your hips and pelvic bones, not across your stomach. Pull the loose end of the belt to adjust for a snug but comfortable fit.



To unlatch the belt, push the red PRESS button on the buckle.

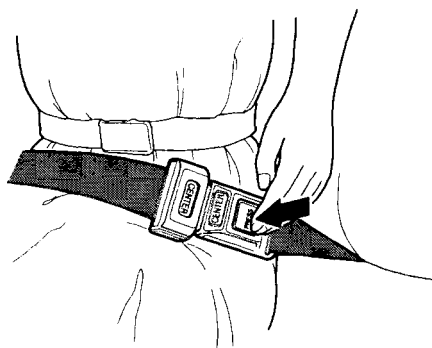

(cont'd)

The Seat Belt System and How It Works (cont'd)

Advice For Pregnant Women

Protecting the mother is the best way to protect her unborn child. Therefore, a pregnant woman should wear a properly-positioned seat belt whenever she drives or rides in a car.

If possible, use a lap/shoulder seat belt, remembering to keep the lap portion as low as possible (see page 14). Each time you have a check-up, ask your doctor if its okay for you to drive and how you should position a lap/shoulder seat belt.

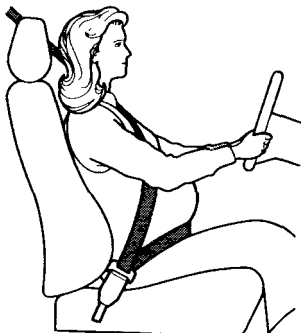

Seat Belt Maintenance

For safety, you should check the condition of your seat belts regularly.

Pull out each belt fully and look for frays, cuts, burns, and wear. Check that the latches work smoothly and the lap/shoulder belts retract easily. Any belt not in good condition or not working properly should be replaced.

If a seat belt is worn during a crash, have your dealer replace the belt and check the anchors for damage.

If your seat belts get dirty, you can use a soft brush with a mixture of mild soap and warm water to clean them. Do not use bleach, dye, or cleaning solvents. They can weaken the belt material. Let the belts air-dry before you use the car.

Dirt build-up in the metal loops of the seat belt anchors can cause the belts to retract slowly. Wipe the inside of the loops with a clean cloth dampened in isopropyl alcohol.

Supplemental Restraint System

All Accords are equipped with a Supplemental Restraint System (SRS) to help protect your head and chest during a severe frontal collision. *This system does not replace your seat belt.* It supplements, or adds to, the protection offered by your seat belt. The system on the SE model also includes a front passenger's airbag.

▲ WARNING

Not wearing a seat belt increases the chance of serious injury or death in a crash, even if you have an airbag.

Be sure you and your passengers always wear seat belts and wear them properly.

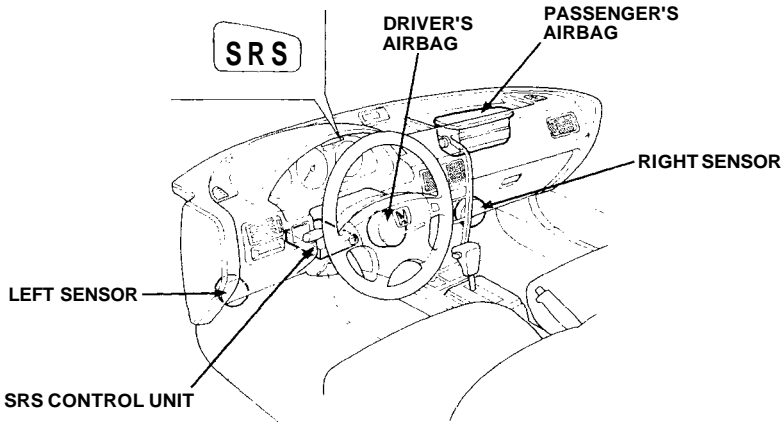

The main components in your SRS are:

- An airbag in the steering wheel for the driver.

(On SE model)

An airbag in the dashboard for the front passenger.

- A diagnostic system that, when the ignition is ON (II), continually monitors the sensors, control unit, airbag activator, and all related wiring.
- An indicator light to warn you of a possible problem with the system.
- Emergency power backup in case your car's electrical system is disconnected in a crash.

(cont'd)

Supplemental Restraint System (cont'd)

Important Safety Reminders

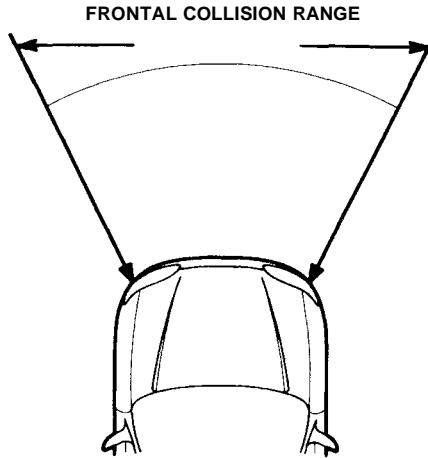

Even with an airbag, you need to wear a seat belt. The reasons are:

- Airbags only inflate in severe frontal collisions. They offer no protection in rear impacts, side impacts, rollovers, or moderate frontal collisions.
- An airbag inflates and deflates very quickly. It cannot protect you during any additional impacts that can occur during a crash.
- A seat belt helps keep you in the proper position when an airbag inflates. An airbag opens with considerable force and can hurt you if you are not in the proper position.

How the Driver's Airbag Works

If you ever have a severe frontal collision, your airbag will instantly inflate to help protect your head and chest.

When the airbag inflates, you may hear a fairly loud noise and you might see smoke and powder. This is normal; it is caused by the inflation of the airbag.

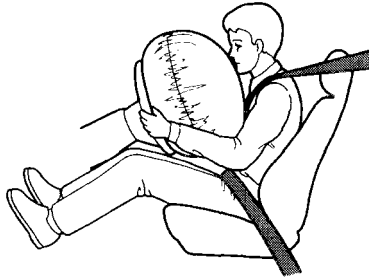

To do its job, the airbag inflates with considerable force. So, while it can reduce serious injuries and even save your life, the airbag might cause some facial or other abrasions.

After the bag completely inflates, it immediately starts deflating so it won't interfere with your visibility, ability to steer, or ability to operate other controls.

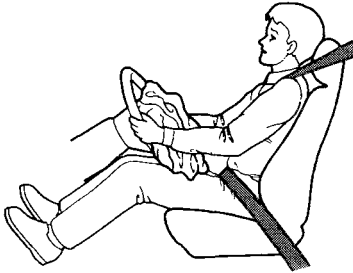

The airbag is stored in the center of the steering wheel. For safety, do not attach any items to the steering wheel. They could interfere with the proper operation of the airbag. Or, if the airbag inflates, they could be propelled inside the car and hurt someone.

(cont'd)

Supplemental Restraint System (cont'd)

How the Passenger's Airbag Works (SE)

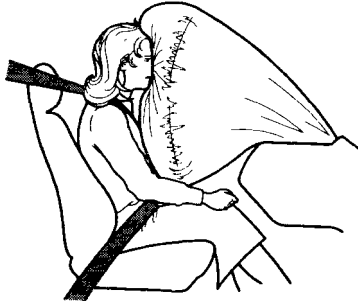

If you ever have a severe frontal collision, the passenger's airbag will inflate at the same time as the driver's airbag.

This airbag is quite large and inflates with considerable force. It can seriously hurt an adult who is not in the proper position and wearing the seat belt properly. The bag's force could also hurt a small child who is not properly restrained in a child seat.

Because of the airbag, we strongly recommend that you do not put an infant seat in the front passenger's seat. If the airbag inflates, it can dislodge the infant seat and seriously injure the infant.

SRS

How the SRS Indicator Light Works

The purpose of the SRS light on your instrument panel is to alert you of a potential problem with your supplemental restraint system.

Have the system checked if:

- The light does not come on when you turn the ignition ON (II).
- The light stays on after the engine starts.
- The light comes on or flashes while you are driving.

System Service

Your supplemental restraint system is virtually maintenance-free. There are no parts you can safely service.

You must have the system serviced by an authorized Honda dealer:

- **If your airbag ever inflates.** The bag must be replaced. Do not try to remove or discard the airbag by yourself. This must be done by a Honda dealer.
- **If the SRS indicator light alerts you of a problem.** Have the supplemental restraint system checked as soon as possible. Otherwise, your airbag might not inflate when you need it.
- **When the car is ten years old.** Have the dealer inspect the system. The production date is on the left rear door jamb for your convenience.

System Service Precautions

Do not modify your steering wheel or any other part of the supplemental restraint system. Modifications could make the system ineffective.

Do not tamper with the system components or wiring. This could cause the airbag to inflate inadvertently, possibly injuring someone very seriously.

Tell anyone who works on your car that you have a supplemental restraint system. Failure to follow the procedures and precautions in the official Honda service manual could result in personal injury or damage to the system.

Scrapping an entire car that has an uninflated airbag can be dangerous. Get assistance from a Honda dealer if your car must be scrapped.

If you sell your car, please be sure to tell the new owner that the car has a supplemental restraint system. Alert them to the information and precautions in this part of the owner's manual.

Additional Safety Information

Your seat belts and airbag are obviously important parts of your occupant protection system.

In addition, you should know that sitting upright, adjusting the head restraints to the proper positions, locking the doors, and stowing things properly can increase your safety and possibly even save your life.

Seat-back Position

The seat-backs should be in an upright position for you and your passengers to get the most protection from the seat belts.

If you recline a seat-back, you will reduce the protective capability of your seat belt. The farther a seat-back is reclined, the greater the risk that you will slide under the belt in a severe crash and be very seriously injured.

For information on how to adjust the seat-back, see page [6](#).

Head Restraint Position

Head restraints can help protect you from whiplash and other injuries. For the best protection, the top of the head restraint should be even with the top of your ears, or as high as possible. For instructions on how to adjust the head restraints, see page [7](#).

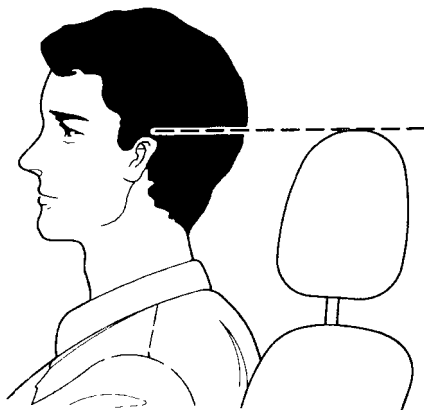

Door Locks

It is not safe to leave your car doors unlocked. A passenger, especially a child, could open a door and accidentally fall out. Also, there is a greater chance of being thrown out of the car during a crash when the doors are not locked.

Storing Cargo Safely

Before you drive, make sure you first securely store or tie down any items that could be thrown around the car and hurt someone, or interfere with your ability to operate the controls.

Do not put any items on top of the rear shelf. They can block your view and they could be thrown about the car in a crash.

Be sure to keep compartment doors closed when the car is moving. If a front passenger hits the door of an open glove box, for example, he could injure his knees.

(cont'd)

Additional Safety Information (cont'd)

Driving With Pets

Loose pets can be a hazard while you are driving. An unrestrained pet can interfere with your ability to drive the car. In a crash or sudden stop, loose pets or cages can be thrown around inside the car and hurt you or your passengers. It is also for their safety that pets should be properly restrained in your car.

The recommended way to restrain a medium-sized or larger dog is with a special traveling harness. This harness can be secured to the rear seat with a seat belt. Travel harnesses are available at pet stores.

A small dog, cat, or other small animal will be safest in a pet carrier with rigid sides. Choose a style that allows you to secure it to the car's seat by routing a seat belt through the carrier's handle.

For further information, contact your veterinarian or local animal protection society.

Children depend on adults to protect them. To help make sure we do, every state and Canadian province has laws requiring infants and young children to be properly restrained whenever they ride in a car.

▲ WARNING

An infant or child who is not properly restrained can be killed or seriously injured in a crash.

Be sure any child too small for seat belts is properly secured in a child restraint.

Where Should Children Sit?

According to accident statistics, children of all sizes and ages are safer when they are properly restrained in the rear seat rather than the front seat.

We recommend that, whenever possible, you secure your child's infant or toddler seat in the center position of the rear seat with the lap belt.

For cars with passenger airbags, we strongly recommend that you do not put an infant seat in the front passenger seat. If the airbag inflates, it can hit the seat with great force. The infant seat can be dislodged and the baby seriously injured.

We also recommend that any child who is too large to use an infant or toddler seat ride in one of the outside positions of the rear seat. The child should then wear the lap/shoulder belt properly for protection.



(cont'd)

Child Safety (cont'd)

Important Safety Reminders

Never hold a baby or child on your lap when riding in a car. If you are wearing your seat belt, the violent forces created during a crash will tear the child from your arms. The child could be seriously hurt or killed.

If you are holding a child and not wearing a seat belt in a crash, you could crush the child against the inside of the car.

Never put your seat belt over yourself and a child. During a crash, the belt could press deep into the child, causing serious internal injuries.

Two children should never use the same seat belt. If they do, they could be very seriously injured in a crash.

If you are driving with small children in the car, you should use the childproof door locks to prevent them from opening the rear doors (see page 5).

General Guidelines for Restraining Children Under 40 Pounds (18kg)

Use an approved child seat. The seat must meet Federal Motor Vehicle Safety Standard 213 (FMVSS-213) or Canadian Motor Vehicle Safety Standards. Look for the manufacturer's statement of compliance on the box and seat.

Use a seat of the right size. Make sure the seat fits your child. Check the seat's instructions and labels for height and weight limits.

Secure the child seat to the car. All approved child seats are designed to be secured in the car seat by the lap belt or the lap belt portion of a lap/shoulder belt. A child whose seat is not properly secured to the car can be endangered in a crash.

To properly route a seat belt through a child seat, follow the seat maker's instructions. If you use a lap/shoulder belt, be sure you install a locking clip on the belt (see page 32).

Secure the child in the child seat. Make sure the infant or child is firmly secured to the child seat. Use the straps provided, and carefully follow the manufacturer's instructions.

Restraining an Infant Who Weighs Less Than 20 Pounds (9 kg)

An infant up to about 20 pounds (9 kg) must be restrained in an infant seat or a convertible seat designed for a baby. Because infants must ride in a reclining position, be sure the infant seat always faces the REAR of the car as shown.

We recommend that, whenever possible, you put the infant seat in the center position of the rear seat and secure it to the car with the lap belt.

If you decide to put an infant seat in any other seating position, you must use a locking clip with the car's lap/shoulder belt (see page [32](#)).

Special Precaution for SE models

We strongly recommend that you do not put an infant seat in the front passenger's seat.

In a severe frontal collision, the inflating airbag can hit the infant seat with considerable force.

The infant seat can be dislodged, causing serious injury to the infant.

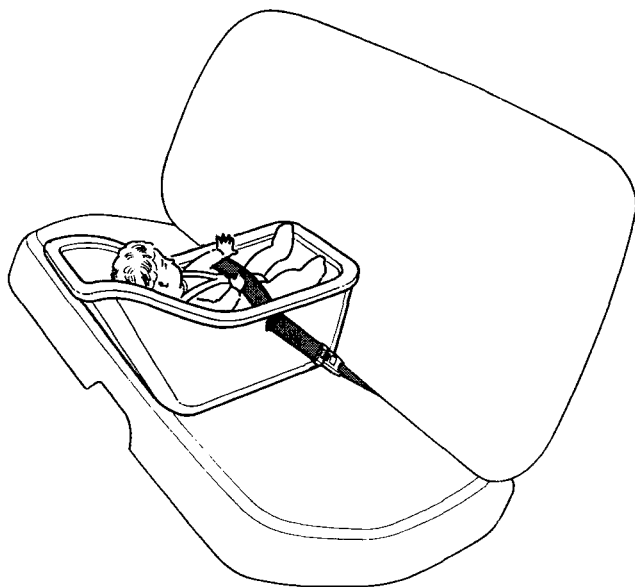

(cont'd)

Child Safety (cont'd)

Restraining a Child Who Weighs Between 20 and 40 Pounds (9 — 18 kg)



Toddler seats are designed for children who weigh between 20 and 40 pounds (9 — 18 kg). The preferred place to put a toddler seat is the center position of the rear seat. Use the car's lap belt to secure the seat to the car.

If you decide to put a toddler seat in any other seating position, you must use a locking clip with the lap/shoulder belt (see page [32](#)).

Restraining a Child Who Weighs Over 40 Pounds (18 kg)

We recommend that, whenever possible, a child who has outgrown a toddler seat ride in one of the outside positions of the rear seat and use a lap/shoulder belt.

Put the lap/shoulder belt on your child and check its fit. The shoulder belt should fit over the collarbone and across the chest. The lap belt should sit low on your child's hips, not across the stomach.



If the shoulder belt crosses the neck, have your child move toward the center of the rear seat until the belt fits properly. If the belt still crosses the child's neck, you should use a booster seat.

Several styles of booster seats are available. We recommend a design that allows the child to use the car's lap/shoulder belt.

Whatever style is used, follow the booster seat manufacturer's instructions.

(cont'd)

Child Safety (cont'd)

Using a Seat Belt Locking Clip

Always use a seat belt locking clip when you secure a child seat to your car with a lap/shoulder seat belt. This helps prevent a child seat from shifting position or overturning.

A locking clip is usually included with the child seat. If you need a clip, contact the seat's manufacturer or a store that sells child restraints.

To install a locking clip, do the following:

1. Place the child restraint in the desired position. Route the lap/shoulder belt through the restraint according to the seat manufacturer's instructions.
2. Insert the latch plate into the buckle. Pull on the shoulder part of the belt to make sure there is no slack in the lap portion.
3. Tightly grasp the belt near the latch plate. Pinch both parts of the belt together so they won't slip through the latch plate. Unbuckle the seat belt.

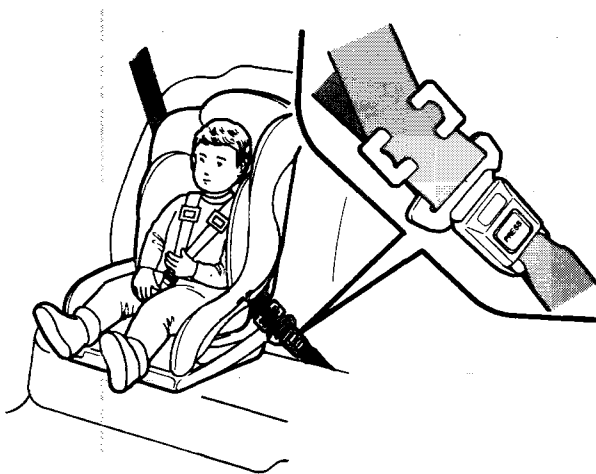

4. Install the locking clip as shown. Position the clip as close as possible to the latch plate.
5. Insert the latch plate into the buckle. Push and pull on the child seat to verify that it is held firmly in place. If it is not, repeat these steps until the restraint is secure.

Using Child Restraints With Tethers

Your Honda has three attachment points for tether-style child seats. Remove the plug cover from the attachment points shown in the illustration, then install the tether hardware that came with the child seat. Tighten the bolt to:

22 N-m(2.2 kg-m , 16 lb-ft)

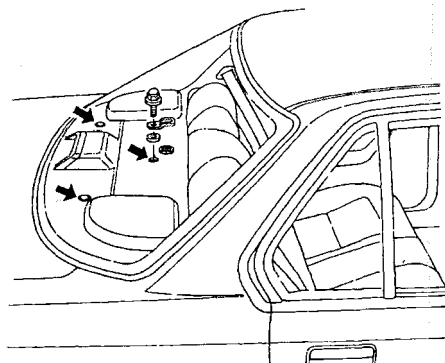

If you are not sure how to install the bracket, have it installed by your Honda dealer.

If you need an anchor plate and mounting hardware, you can obtain them by writing to:

American Honda Motor Co., Inc.
Consumer Affairs
1919 Torrance Blvd.
Torrance, CA 90501-2746

Canadian Cars

The anchor plate and mounting hardware for a top tether are supplied with the car. When installing, make sure the toothed washer is on the bottom of the bolt.

The supplied anchor plate is designed only for mounting a child restraint. Do not use it for any other purpose.

Storing a Child Seat

When you are not using an infant seat or other child restraint, either remove it or make sure it is properly secured so it cannot be thrown around the car during a crash.

Anti-lock Brake System (ABS)

Anti-lock Brakes

(US: EX/SE/Anniversary Edition, Canada: EX-RISE)

Your car has an Anti-lock Brake System (ABS). This system helps you to maintain stopping and steering control. It does this by helping to prevent the wheels from locking up and skidding.

The ABS is always "ON". It requires no special effort or driving technique. You will feel a pulsation in the brake pedal when the ABS activates.

Activation varies with the amount of traction your tires have. On dry pavement, you will need to press on the brake pedal very hard before you feel the pedal pulsation that means the ABS has activated.

However, you may feel the ABS activate immediately if you are trying to stop on snow or ice.

Under all conditions, the ABS is helping to prevent the wheels from locking so you can retain steering control. You should continue to press on the brake pedal with the same force.

You may feel a slight movement of the brake pedal just after you start the engine. This is the ABS working.

The ABS is self-checking. If anything goes wrong, the ABS indicator on the instrument panel comes on (see page 41). This means the Anti-lock function of the braking system has shut down. The brakes still work like a conventional system providing normal stopping ability. You should have the dealer inspect your car as soon as possible.

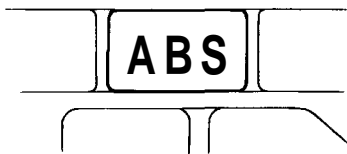

The ABS works by comparing the speed of the wheels. When replacing tires, use the same size originally supplied with the car. Tire size and construction can affect wheel speed and may cause the system to work inconsistently.

A car with an ABS may require a longer distance to stop on loose or uneven surfaces than an equivalent car without ABS. The ABS cannot make up for road conditions or bad judgment. It is still your responsibility to drive at reasonable speeds for weather and traffic conditions, and to leave a margin of safety.

CAUTION:

Be careful not to damage the wiring or the speed sensors at the back of each wheel when removing mud or snow from the wheel housings.

Instrument Panel

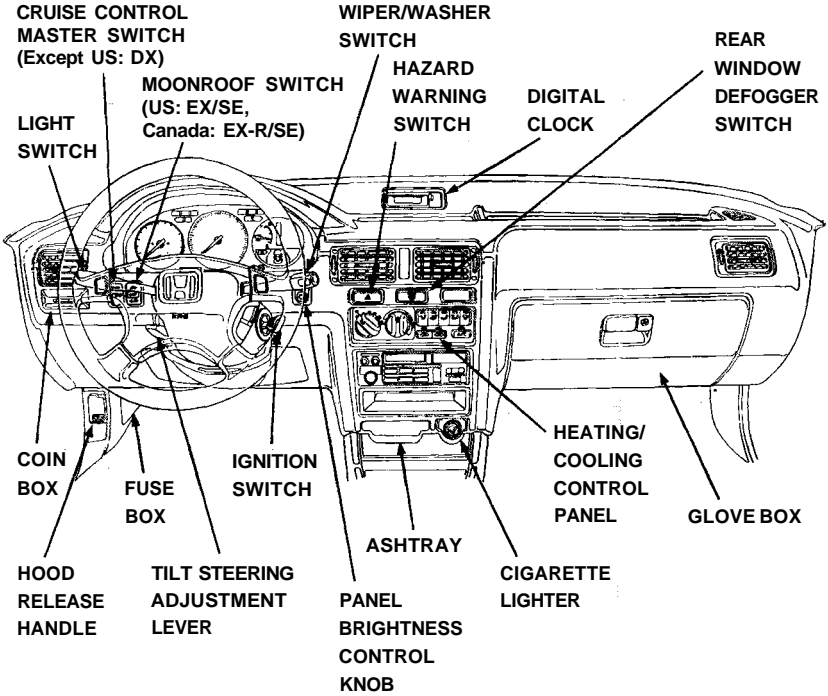

US Car Shown:

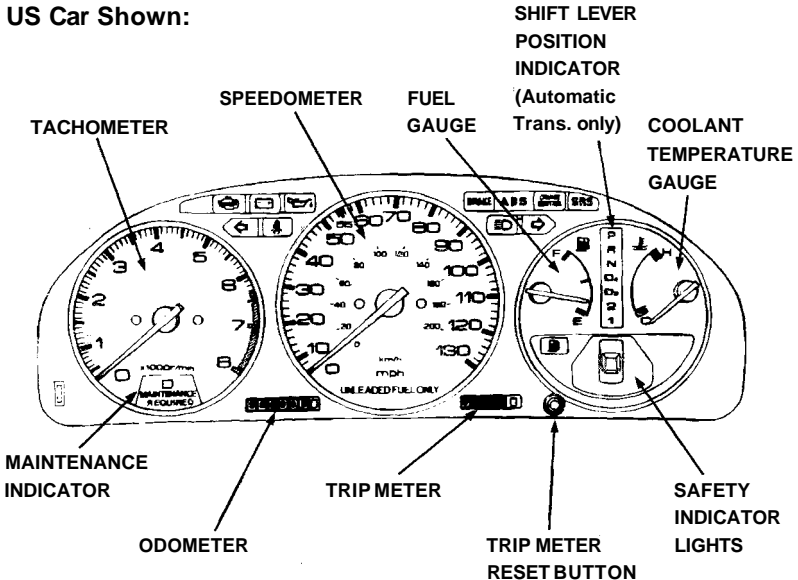

Gauges

Speedometer

US Cars:

The speed is indicated in miles per hour (outer scale) and kilometers per hour (inner scale).

Canada Cars:

The speed is indicated in kilometers per hour (outer scale) and miles per hour (inner scale).

Odometer

The numbers on the odometer indicate miles (US Cars) or kilometers (Canadian Cars).

The odometer registers total distance traveled, and serves as your guide for determining when periodic maintenance is due.

US Cars:

Federal law makes it illegal to alter the odometer of any motor vehicle with the intent to change the number of miles indicated.

Trip Meter

The numbers on the trip meter indicate miles (US Cars) or kilometers (Canadian Cars).

The trip meter can be returned to zero by pushing in the reset button. Use it for checking fuel consumption or distance traveled per trip.

Tachometer

The tachometer indicates engine speed in revolutions per minute.

The beginning of the RED ZONE indicates the maximum allowable engine R.P.M. Do not run the engine with the tachometer indicator needle in the RED ZONE.

Fuel Gauge

FUEL TANK CAPACITY:

Approx. 64.5 ℓ (17.04 US gal, 14.19 Imp gal)

As a convenience, the gauge continues to show the same fuel level as when the ignition was last on. After refueling, the gauge will slowly change to the new fuel level when the ignition is switched on. When the needle first indicates E (empty), you have a usable reserve left in the tank of about:

4 ℓ (1.1 US gal, 0.9 Imp gal)

Coolant Temperature Gauge

▲ WARNING

Do not remove the radiator cap when the engine is hot. The coolant is under pressure and may blow out and scald you.

This gauge shows the temperature of the engine coolant. During normal operation, the needle should stay in the middle of the white range. Under severe driving conditions, such as hot weather or driving uphill for a long period, the needle may rise toward the upper section of the white range.

If the needle reaches the red line at "H" (Hot), pull safely off the road and stop the engine.

Wait until the engine is cool and check the coolant level in the reserve tank on the passenger side of the radiator under the hood. (See pages [122](#) — [123](#).)

Warning and Indicator Lights

US Car
Shown:

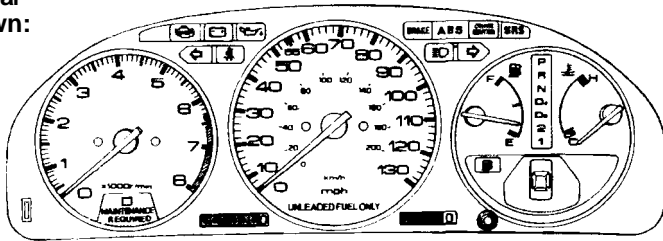

Shift Lever Position Indicator (Automatic Transmission only)

A lighted indicator between the fuel and coolant temperature gauges shows which gear you have selected.



D4 Indicator Light (Automatic Transmission only)

The D4 indicator light in the instrument panel also serves a second function. If the light flashes while driving (in any gear range) it indicates a possible malfunction in the transmission; avoid rapid acceleration and have the transmission checked by an authorized Honda dealer as soon as possible.



Turn Signal and Hazard Warning Indicators

When the turn signal lever is pushed for left or right turns, the appropriate green indicator arrow on the instrument panel will blink along with the signal. Pushing the hazard warning switch will make all turn signals and both arrows blink (see page 49).



High Beam Indicator

This blue indicator light will go on whenever the high beams are switched on (see page 49).

(Canada Cars)

It will also go on with a reduced brightness when the Daytime Running Lights (DRL) are on (see page 51).



Cruise Control Indicator (Except US: DX)

When the cruise control system is on, this indicator light is on (see pages 52 and 53).



Seat Belt Reminder Light

The seat belt reminder light comes on if the driver's seat belt is not fastened, when the ignition switch is turned on. It stays on until the driver fastens his seat belt. (See page 12)



Charging System Light

The charging system light comes on when there is a problem with the electrical charging system or when the ignition switch is turned on with the engine not running. If the light comes on while driving, get off the road, stop the car and turn off the ignition. Then check the alternator belt for proper tension.

To check the belt tension, push with about 98 N (22 lb) of force on the middle of the belt as shown. The belt should deflect about:
10 — 12 mm (0.4 — 0.5 in)

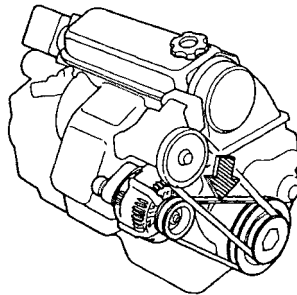

▲ WARNING

- If the engine has been running, some engine components may be hot enough to burn you.
- Keep hands away from the radiator fan. The fan may start automatically without warning and run for up to 15 minutes, even after the engine is turned off.

NOTE:

If necessary, have the charging system checked by an authorized Honda dealer.

(cont'd)

Warning and Indicator Lights (cont'd)

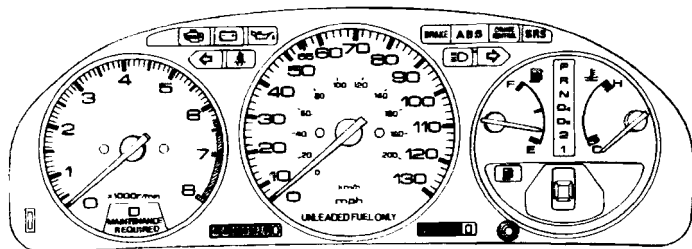

US



Malfunction Indicator Lamp

Canada



Check Engine Light

This light comes on for a couple of seconds each time the ignition is turned on. It will also come on, and remain on, if there is a malfunction in the emission control system. If the light comes on while driving, avoid driving at high speed, and have the system checked by a Honda dealer as soon as possible.



Low Oil Pressure Light

A severe fluctuation in engine oil pressure will cause this light to flash on and off. You should pull safely off the road and stop the car. When the engine has cooled down, check the oil level, and add oil if necessary.

The low oil pressure light will come on, and remain on, if there is insufficient oil pressure or when the ignition switch is turned on with the engine not running. If the light should come on while driving, get the car off the road as soon as you can, turn the engine off and check the engine oil level (see page 117).

Even if the oil level is correct, the engine should be checked by a Honda dealer before the car is driven again.

NOTE:

The low oil pressure light will only light as a result of low oil pressure. It is not directly an oil level indicator.

CAUTION:

Running the engine while the low oil pressure light is on constantly may cause immediate and severe engine damage.

US **Canada**

BRAKE



Parking Brake and Brake System Light

Check this light every time you start the car.

With the parking brake set, this light should go on when the ignition switch is turned to II or III. With the parking brake released, the light should go on for a few seconds when the ignition switch is turned to III. If the light goes on at any other time, it means the brake fluid level in the master cylinder reservoir is too low; add fluid (see page 126) and have your dealer check for leaks immediately.



Low Fuel Indicator

If this indicator glows, it means you should refuel, because the tank contains less than:

8.0 ℓ (2.11 US gal, 1.76 Imp gal)

ABS

Anti-lock Brake System (ABS) Indicator **(US: EX/SE/Anniversary Edition, Canada: EX-R/SE)**

The ABS indicator will come on, and remain on, if there is a malfunction in the ABS or when the ignition switch is turned on with the engine not running. If the light comes on while driving, stop the car at a safe place and shut off the engine. If the light does not go out or lights again while driving, have the system checked by an authorized Honda dealer as soon as possible.

NOTE:

- The light does not indicate a failure of the normal brake system. The light only indicates a malfunction in the ABS. In such a case, the ABS is automatically shut down but normal braking capability continues.
- After jump-starting the car, there is a possibility that the ABS indicator may come on due to insufficient battery voltage. After the battery is sufficiently recharged and the engine is turned off and restarted, the ABS indicator should indicate that the ABS is OK, by coming on for a few seconds each time the engine is started. If the indicator remains on after recharging, have it checked by a Honda dealer.

(cont'd)

Warning and Indicator Lights (cont'd)



Supplemental Restraint System Indicator

When the key is turned to the II position, the SRS indicator will come on for about six seconds, to show normal system operation, and then turn off.

See Supplemental Restraint System section on page [19-23](#).



"Daytime Running Lights" Indicator (Canada Cars)

This indicator light comes on when the ignition switch is ON (position II), the headlight switch OFF, and the parking brake set. This indicates that the "Daytime Running Lights" are off. The indicator light goes off when the parking brake is released. If the parking brake is reapplied without switching the ignition off, the indicator light will remain off. See page [51](#).

If the light does not go off when the parking brake is released with the ignition ON, or if it comes on while driving, it indicates a burnt-out high-beam bulb.

Have the bulb checked and replaced by your Honda dealer.

Safety Indicator Lights :

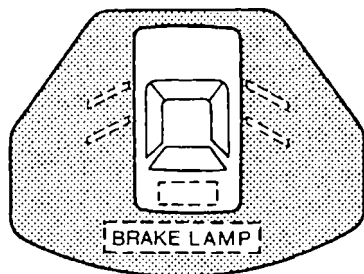

Door and Trunk Lid Warning Lights

If a door or the trunk lid is open when the ignition is switched on, the appropriate indicator will light, and stay lit, until the door or trunk lid is closed.

BRAKE LAMP Brake Lamp Warning Light

If a brake light does not work, the **BRAKE LAMP** indicator will go on when you push the brake pedal with the ignition on; the indicator will stay on until you have the lamp repaired or replaced. Have the brake lights checked as soon as possible.

▲ WARNING

It is hazardous to drive your car with a problem in either the brake electrical or hydraulic system; have your dealer check both systems if you suspect brake trouble.

Checking the Safety Indicator Lights

The door, trunk lid and brake lamp warning lights should come on for about two seconds when the ignition switch is turned on. If they don't, have the system checked by a Honda dealer.

Maintenance Indicator

When the total mileage of your car approaches the specified maintenance interval for engine oil change, oil filter change or other required service, the indicator will change from green to yellow. The indicator will change to red if it is not reset before you reach the mileage interval. The indicator marked MAINTENANCE REQUIRED is to be used as a reminder that there are items in addition to the engine oil and filter that require service each 7,500 miles (12,000 km). See the maintenance schedule on page 112. After the maintenance is done, be sure to reset the switch below the tachometer by inserting the ignition key in the slot. The color of the indicator will change to green and repeat its cycle.

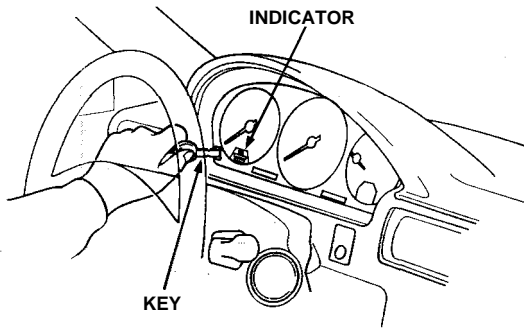

▲ WARNING

Do not reset the maintenance indicator while driving; your hand may impair steering which can result in an accident.

Tilt Steering

The steering wheel position can be adjusted to suit the driver preference.

1. Push the lever located under the dash, on the left side of the steering column, all the way down and hold it while adjusting the steering wheel to the desired position.

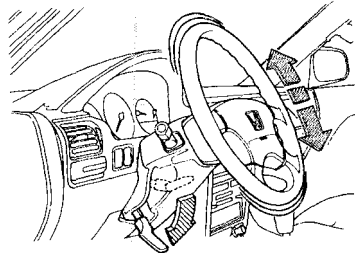

Push down

2. Hold the steering wheel in the desired position and pull the lever all the way up to lock it in place.

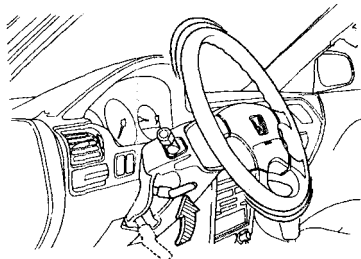

Pull up

▲ WARNING

- Do not adjust the steering wheel position while driving.
- After adjusting the steering wheel position, make sure it is securely locked in place by "rocking" it up and down slightly.

Windshield Wipers/Washer/Defogger

Windshield Wipers

Switch the wipers to INT for intermittent operation, LO for low speed operation, and HI for high speed operation.

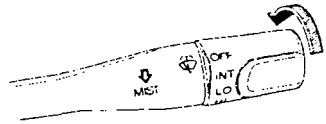

In fog or very light rain, push the lever down to the MIST position for temporary high speed operation of the wipers. The wipers will return to the rest position and the motor will shut off as soon as you release the lever.

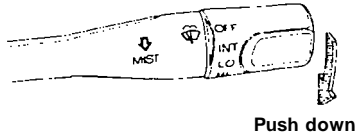

Washer

Pull the wiper switch lever toward you to turn on the washer.

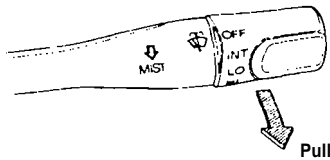

(Except US: DX)

The windshield wipers will sweep when the washer is operated.

Check the washer fluid regularly, especially during bad weather, or whenever the washer has been in frequent use. The float in the neck of the reservoir indicates the fluid level.

WINDSHIELD WASHER RESERVOIR CAPACITY:

US Cars: 2.5 l (2.6 US qt, 2.2 Imp qt)

Canada Cars: 4.5 l (4.8 US qt, 4.0 Imp qt)

Use a good quality commercial washer fluid for all-weather cleaning.

WASHER FLUID RESERVOIR

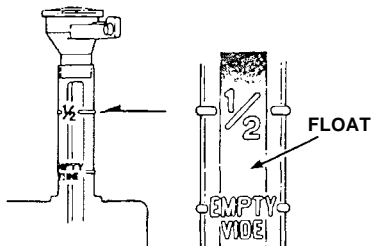
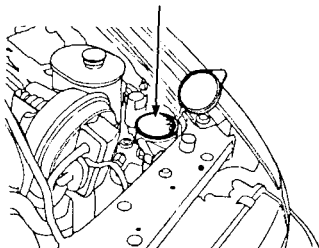

CAUTION:

- Do not use radiator antifreeze in the windshield washer; it will damage the paint.
- Do not use a vinegar/water combination in the windshield washer; it will damage the pump.
- Prolonged operation of the washer without fluid may damage the pump.

In freezing weather, warm the windshield with the defrosters before using the washer. This will help prevent icing which could seriously impair visibility.

Rear Window Defogger

Push the switch to turn the defogger on or off. The indicator will light when the defogger is on. The defogger will turn off automatically 25 minutes after it is turned on.

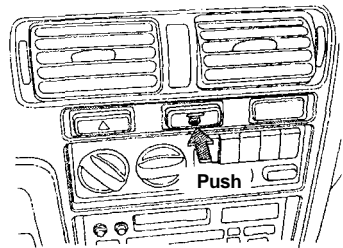

CAUTION:

When cleaning the inside of the rear window, be careful not to damage the printed heater wires on the rear window. Wipe the window horizontally along the wires, not up and down.

**Door Mirror Defoggers
(Canada: SE)**

Push the switch to defog or defrost the door mirrors. The indicator light will come on and remain lit until it is pushed again to turn them off.

**DOOR MIRROR
DEFOGGER SWITCH**

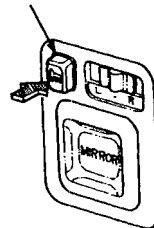

Mirrors

Rearview Mirrors

Keep the inside and outside mirrors clean and adjusted for best visibility.

Be sure to adjust mirror angles before you start driving.

The inside mirror has day and night positions. The night position reduces glare from the headlights of vehicles behind you. Flip the small tab on the bottom of the mirror forward or backward to select day or night position.

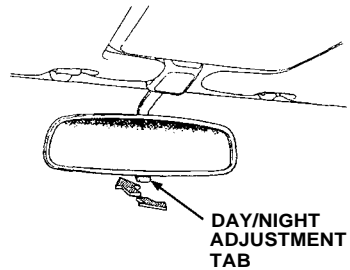

Manual Mirrors

(US: DX, Canada: LX)

The outside mirrors can be adjusted by moving the knob located on each door (driver's side only for US cars).

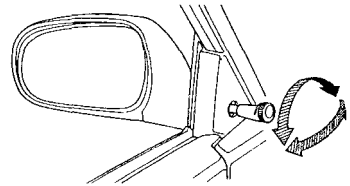

Power Mirrors

(US: LX/EX/SE/Anniversary Edition, Canada: EX/EX R/SE)

With the ignition switch in the "I" position, move the main switch to L (for driver's side) or R (for passenger's side), then use the adjustment switch to adjust the outside mirrors to the correct angle. After the mirrors have been adjusted, return the main switch to the center (off) position.

NOTE:

Be sure to adjust mirror angles before you start driving.

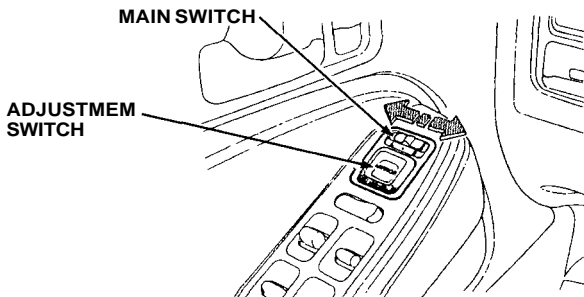

Turn Signals

Push the turn signal lever down to signal a left turn, and up for a right turn. The indicator and appropriate signal lights will blink. The lever will return automatically to its original position when the steering wheel is returned to straight ahead.

For lane changing, you can signal by pushing the lever part way up or down (to the first stop) and holding it there; the lever will return to its original position when you release it. If either turn signal indicator lights up but does not blink, blinks faster than usual or does not light up at all, check for a burned out bulb or fuse.

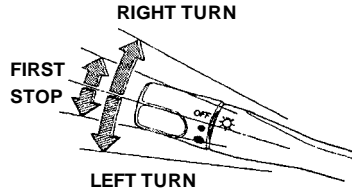

Headlights

Turn the light switch to the first position (•) for taillights, side marker lights, position lights, license plate lights, and instrument panel lights. Turn to the second position (●) to add the headlights.

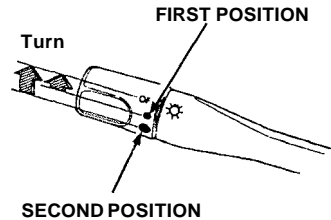

If the driver's door is opened when the light switch is turned to either "on" position, a chime will sound to remind you to turn off your lights.

High Beam/Low Beam Switch

The headlights may be switched between low beam and high beam by pulling the turn signal lever toward you. The blue high beam indicator light will be on when the high beam is on.

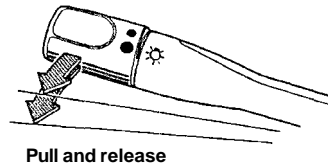



Headlight Flasher

To flash the headlights, pull lightly on the turn signal lever and release.

(cont'd)

Lights (cont'd)

Hazard Warning System

This system should be used only when your car is stopped under emergency or hazardous conditions. To activate, push the hazard warning switch (). The front and rear turn signals will blink simultaneously and both indicator lights will flash. Push the switch () again to turn the system off.

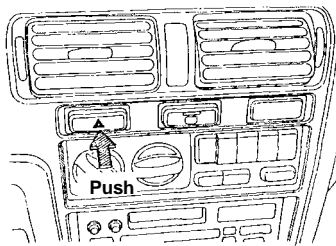

Panel Brightness Control

When the light switch is in either of the two "on" positions, the intensity of the instrument lights can be adjusted. Push the panel brightness control knob so it pops out, then turn the knob to adjust the brightness.

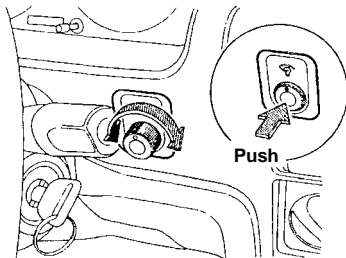

Ignition Switch Light (US: LX/EX/SE/Anniversary Edition, Canada: EX/EX-R/SE)

This light will illuminate the switch for several seconds after the driver's door is closed.

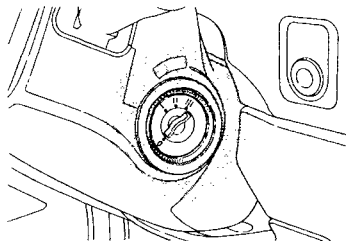

Interior Light

The interior light has a three position switch. The light is off all the time in the OFF position. In the middle position, it goes on only when a door is opened. In the ON position, it is on all the time.

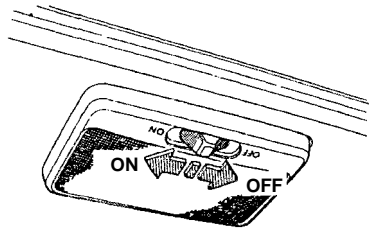

Daytime Running Lights (Canada Cars)

With the ignition ON (position II) and the headlight switch OFF, the high beam headlights will come on at one-half power when the parking brake is released. This type of lighting is called "Daytime Running Lights" or DRL. The DRL turns off when you turn the ignition switch off.

If the parking brake is reapplied without switching the ignition off, the "Daytime Running Lights" will remain on.

Cruise Control (Except US: DX)

Cruise Control

Cruise control allows you maintain a set speed above 25 mph (40 km/h) without keeping your foot on the accelerator pedal. It is not recommended for conditions such as city driving, winding roads, slippery roads, heavy rain, or bad weather. You should have full control of the car under those conditions.

▲ WARNING

Improper use of the cruise control can lead to a crash.

Use the cruise control only when traveling on open highways in good weather.

CAUTION:

The cruise control, as it operates, moves the accelerator pedal. You can damage your car's accelerator mechanism by resting your foot under the pedal and blocking the movement.

To Set the Cruise Control:

Push in the Cruise Control master switch to the left of the steering column. The indicator in the switch will light.

Accelerate to the desired cruising speed above 25 mph (40 km/h). Press and hold the SET/decel button on the steering wheel until the CRUISE CONTROL light on the instrument panel comes on.

This shows the system is now activated.

The set speed may vary slightly, particularly on hills.

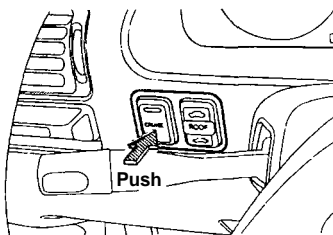

Changing the Set Speed

To increase the set cruising speed:

- Press and hold the RESUME/accel button. The car will accelerate slowly. Release the button when the desired speed is reached.
- Push on the accelerator pedal. Accelerate to the desired cruising speed and press the SET/decel button.

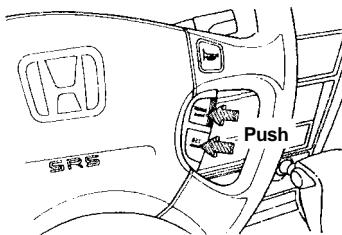

To decrease the set cruising speed:

- Press and hold the SET/decel button. The car will decelerate. Release the button when the desired speed is reached.
- Tap the brake or clutch pedal lightly with your foot. The CRUISE CONTROL light on the instrument panel will go out. When the car slows to the desired speed, press the SET/decel button. The car will then maintain the desired speed.

Even with the cruise control turned on, you can still use the accelerator pedal to speed up for passing. After completing the pass, take your foot off the accelerator pedal. The car will return to the set cruising speed.

Resting your foot on the brake or clutch pedal will cause the cruise control to cancel.

To Cancel the Cruise Control:

Any of these actions cause the cruise control to cancel.

- Tap the brake or clutch pedal.
- Press the SET/decel and RESUME/accel buttons at the same time.
- Press the Cruise Control Master Switch.

When you tap the brake or clutch pedal, or press the SET and RESUME buttons at the same time, the CRUISE CONTROL light on the instrument panel will go out and the car will begin to slow down. You can use the accelerator pedal in the normal way.

If you use the brake or clutch pedal to cancel cruise control, the system retains the previously-set cruising speed. To return to that speed, accelerate to above 25 mph (40 km/h) and press the RESUME/accel button until the CRUISE CONTROL light comes on. The car will accelerate to the same cruising speed as before.

If you cancel the CRUISE CONTROL by pressing the SET and RESUME buttons at the same time, the previously-set cruising speed is erased. To use the cruise control, accelerate to the desired cruising speed and press the SET/decel button.

Pressing the Cruise Control Master Switch turns the system completely off and erases the previous cruising speed from memory. To use the system again, see page [52](#).

Hood and Parking Brake

Hood

To open the hood, pull back on the handle located under the dash on the driver's side.

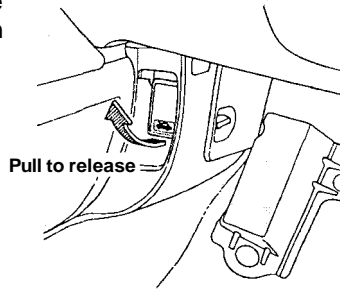

The hood latch is spring-loaded, so the hood will pop up slightly. Release the safety catch under the front center of the hood by pushing the rubber-tipped handle up.

Lift the hood and prop it open with the support rod.

To close, take the support rod down, place it back in its holder, lower the hood until it is approximately one foot from the closed position, then let it drop. Be sure the hood is securely latched before driving away.

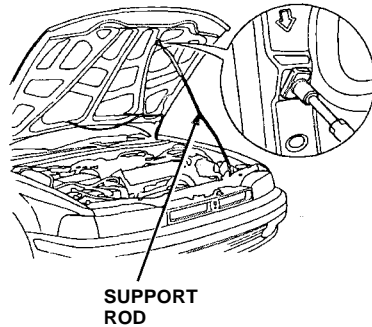
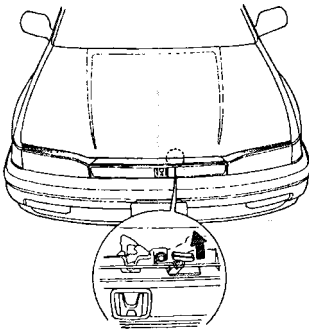

Parking Brake

To apply the parking brake, pull up on the lever. To release it, pull up slightly, push the button, and lower the lever; when fully released, the BRAKE (US cars), or  (Canadian cars) indicator will go out.

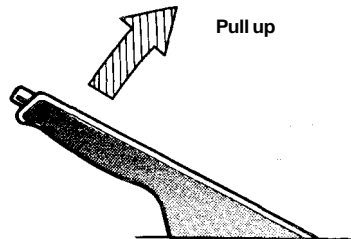

(US: LX/EX/SE/Anniversary Edition,
Canada: EX/EX-R/SE)

The power windows can be operated only when the ignition switch is in the "II" position.

The operation of the windows is controlled by the main switch located in the master control panel on the armrest of the driver's door. When the main switch is off, only the driver's door window can be opened and closed.

When the main switch is on, all door windows can be opened and closed by the driver, using the appropriate switch in the master control panel, and the passenger windows can be opened and closed by the passengers, using the switch located on each passenger door.

When opening or closing a window, push and hold either the "up" or "down" side of the switch until the window reaches the desired position, then release.

NOTE:

The driver's window can be opened fully, without the driver having to hold the switch down, simply by pushing the switch past the first "stop."

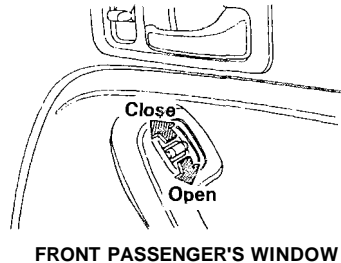
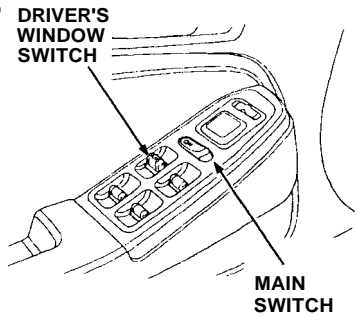

FRONT PASSENGER'S WINDOW

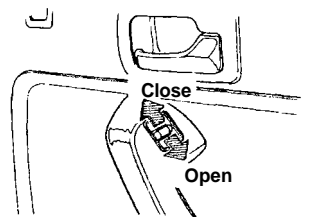

REAR PASSENGER'S WINDOW

Power Window Key-off Operation

The power windows can still be operated for about 10 minutes after the ignition is turned from the "II" to the "I" or "0" position as long as neither front door has been opened.

▲ WARNING

- Be sure, before closing any window, that all hands, arms and other obstructions are clear of the window frame and glass; severe personal injury could result.
- Always keep the main switch in the off position when children are in the car; injury may result from unintentional window operation.

Glove Box and Clock

Glove Box

Open by pulling the handle. Close with a firm push. The glove box door can be locked by using the master key.

The glove box light will go on when the glove box door is opened and the headlights are on.

▲ WARNING

Do not drive the car with the glove box door open; it could cause injury in an accident.

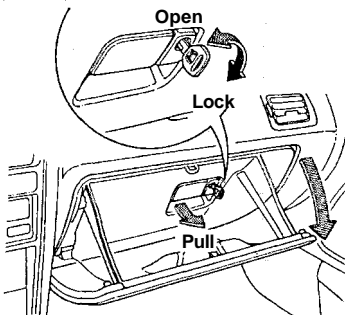

Digital Clock

The time is displayed continuously when the ignition is switched to II or III. At all other times, push in on the lid to display the time.

To adjust the time:

1. Lower the lid.
2. To set the minutes, push and hold the M button until the numbers advance to the desired minute or minutes.
3. To set the hour, push and hold the H button until the hour advances to the desired hour.
4. The RESET button allows you to synchronize your clock to the closest hour. If the time on the clock is before the half hour, pressing the RESET button will return the time to the previous hour. If the time is beyond the half hour, the RESET button will change the time to the next hour.

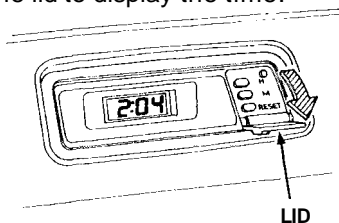

NOTE:

Be careful not to push the H, M or RESET buttons accidentally. Pushing any of them will change the clock's time setting.

Beverage Holder

(US: LX/EX/SE/Anniversary Edition, Canada: EX/EX-R/SE)

Your car is equipped with a beverage holder for use while the car is stopped. Drinking while driving or driving with a beverage in the holder may be hazardous.

Open the holder by pushing it.

NOTE:

Use only lidded cups or containers that fit snugly in the beverage holder.

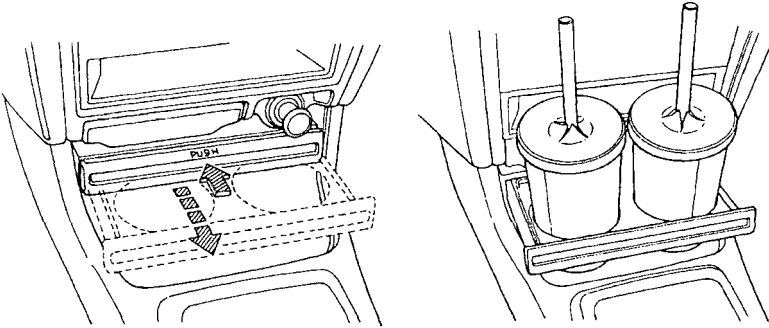

▲ WARNING

- Spilling even a small amount while driving, especially if the liquid is hot, may distract the driver's attention from the road and could result in a serious collision.
- Alcohol and driving don't mix. For your safety, and the safety of others, please do not drink and drive.

Cigarette Lighter and Ashtrays

Cigarette Lighter

Push in the lighter to heat up. It will automatically release when the element is hot. DO NOT hold it in while it is heating up, it may overheat and damage the lighter and the heating element.

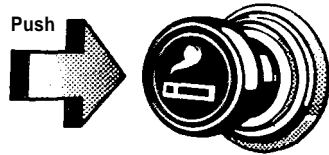

NOTE:

The cigarette lighter will operate with the key in the "I" or "II" position.

Front Ashtray

Open the ashtray by pulling its bottom edge toward you.

To remove it, pull it out further while pushing down on the spring-loaded plate inside.

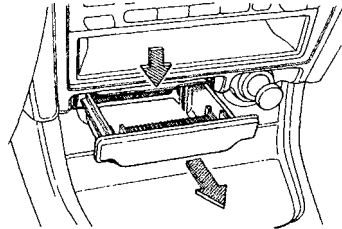

Rear Ashtray

The rear ashtray is located at the rear of the center console. It is opened by pulling out the top edge.

To remove it, open the ashtray and release its bottom edge by pulling up, then out. To install, reverse the removal procedure.

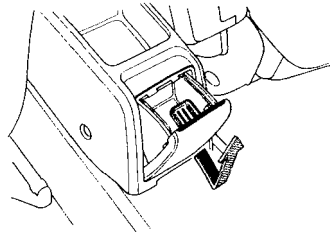

To remove, pull up and out.

CAUTION:

Do not use the ashtrays as trash containers; use them only for extinguished cigarettes. Putting lit cigarettes or matches in an ashtray with other combustible materials may cause a fire.

Heating and Cooling

The vents, heater and air conditioning are combined in one system; adjusting four basic controls to different settings can provide a full range of interior temperatures for safe and comfortable driving. (Air conditioning is optional on US: DX, Canada: LX.)

Ventilation

The flow-through ventilation system can provide fresh air to the interior when the car is moving or stopped, even with the windows closed.

NOTE:

For proper air flow, the flow-through vents must not be covered. Keep the air inlet at the base of the windshield free of leaves or other debris.

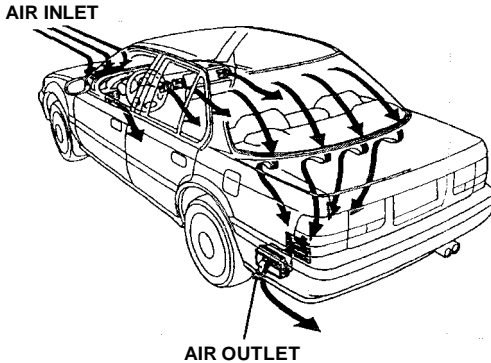

You can adjust the controls to direct cool or warm outside air throughout the car for defogging windows, heating, or cooling by turning on the fan.

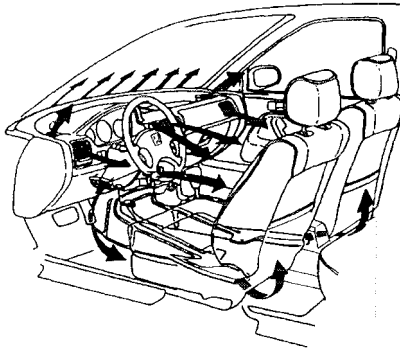

(cont'd)

Heating and Cooling (cont'd)

Dash Vents

The corner vents can be used for flow-through ventilation, or during the heating and air conditioning operation.

The corner and center vents can be tilted up or down, and their louvers turned right or left, to change the direction of air flow.

The amount of air flow from the corner and center vents can be regulated by the control located beside each vent.

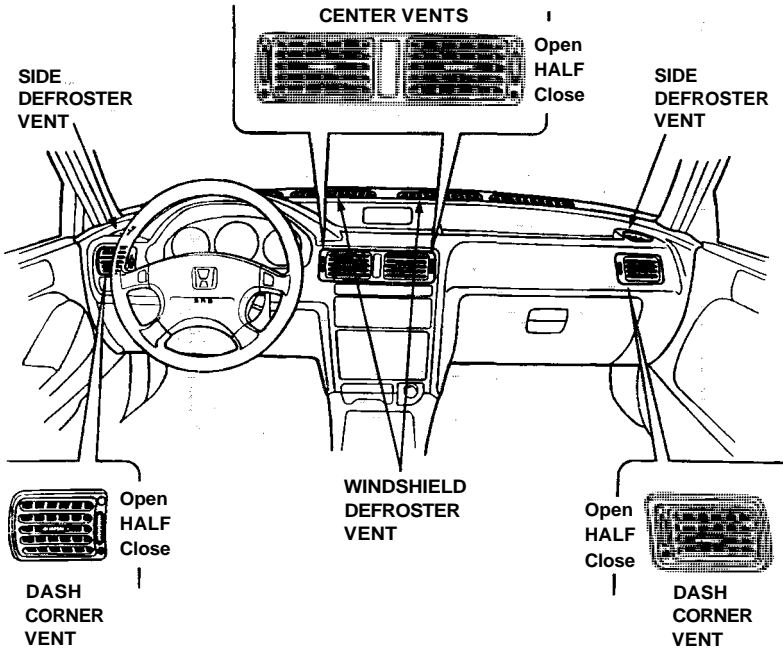

What the Controls Do
(US: DX, Canada: LX)

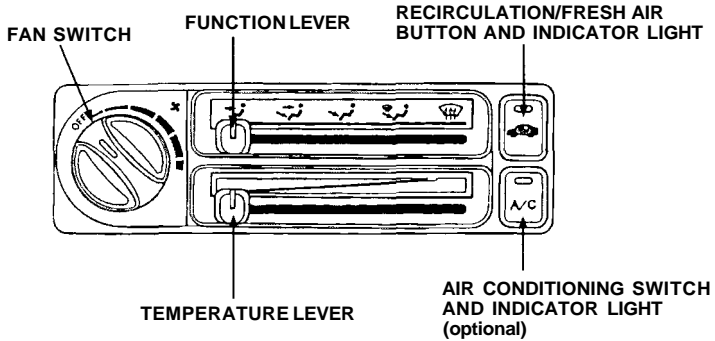

(US: LX/EX/SE/Anniversary Edition, Canada: EX/EX-R/SE)

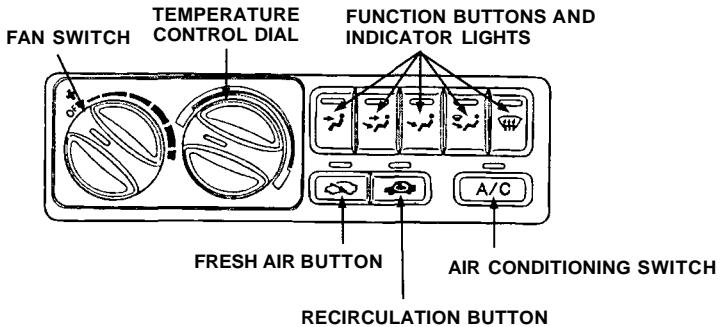

Fan Switch

Turning the switch clockwise will increase the fan speed, and the fan will circulate warm, cool, or outside air, depending on where the temperature lever/control dial and function lever/buttons are set. Whenever the fan is switched on, air flows from the dash corner vents regardless of function lever/button position.

Function Lever/Buttons

Slide the lever (US: DX, Canada: LX) or push the appropriate button (US: LX/EX/SE/Anniversary Edition, Canada: EX/EX-R/SE) to direct air to and from the heater, defroster and vents. There is an indicator light in each function button that comes on when the button is pushed.

(cont'd)

Heating and Cooling (cont'd)

Temperature Lever/Control Dial

Slide the lever from left to right or turn the dial clockwise to make air warmer when the appropriate function is selected.

Air Conditioning Switch (optional on US: DX, Canada: LX)

With the fan on, push the A/C switch to operate the air conditioning. The indicator light will come on.

Push the switch again to turn the air conditioning off.

Fresh Air () and Recirculation () Buttons (US: DX, Canada: LX)

When the  button's indicator light is out, outside air will be allowed to circulate inside the car.

When the  button is pushed in and the indicator light comes on, outside air is shut off and the air inside the car is recirculated.

If the heater or air conditioning is on and you want to warm up or cool down the interior more quickly, or keep smoke or dust out of the car without losing the heat or cool function, simply push the  button.

(US: LX/EX/SE/Anniversary Edition, Canada: EX/EX-R/SE)

When the  button is pushed, the indicator light will go on and outside air will be allowed to circulate inside the car.

When the  button is pushed, the indicator light comes on, outside air is shut off and the air inside the car is recirculated.

If the heater or air conditioning is on and you want to warm up or cool down the interior more quickly, or keep smoke or dust out of the car without losing the heat or cool function, simply push the  button.

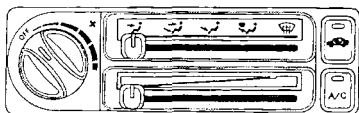

(US: DX, Canada: LX)

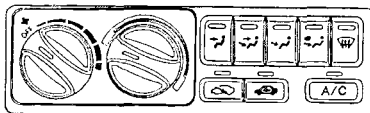

(US: LX/EX/SE/
Anniversary Edition,
Canada: EX/EX-R/SE)





NOTE:

The windows may become fogged if the system is in the  setting for an extended period of time with the air conditioning off. As soon as the interior is warmed, switch to  setting.

How to Use the Controls To Ventilate



(US: DX, Canada: LX)

Move the temperature lever to the left, select the  position and push the  button off.

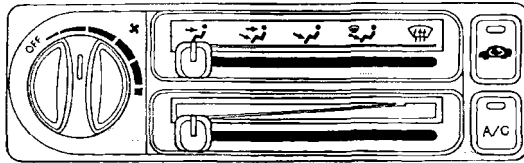
Switch the fan on and outside air will flow through the corner and center vents. To change air distribution, switch to the  position and outside air will also flow from the heater ducts at the floor level.



(US: LX/EX/SE/Anniversary Edition, Canada: EX/EX-R/SE)

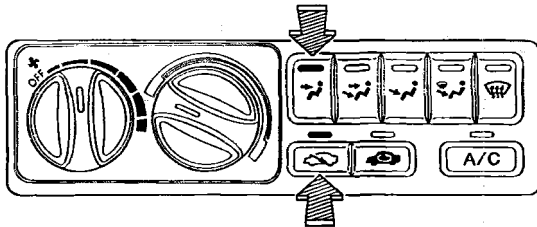

Turn the temperature control dial counterclockwise, and push the  and  buttons. Switch the fan on and outside air will flow through the corner and center vents. To change air distribution, switch to the  position and outside air will also flow from the heater ducts at the floor level.



(cont'd)

Heating and Cooling (cont'd)

To Cool with A/C (optional on US: DX, Canada: LX)

To cool the car down quickly, start the engine, turn the fan to high, push the A/C switch and open the windows briefly. Then close the windows, slide the temperature lever all the way to the left or turn the temperature control dial counterclockwise all the way, select the  position and push the  button on, so inside air will recirculate to the air conditioning for maximum cooling.

When the interior has cooled sufficiently, switch the fan to the desired speed, then change to the  setting to direct fresh (outside) air to the air conditioning.

(US: DX, Canada: LX)

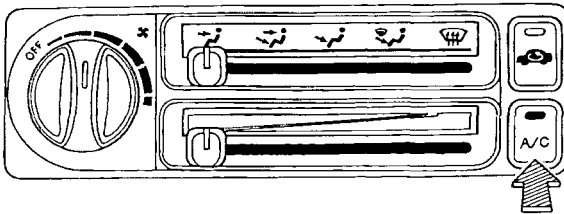

(US: LX/EX/SE/Anniversary Edition, Canada: EX/EX-R/SE)

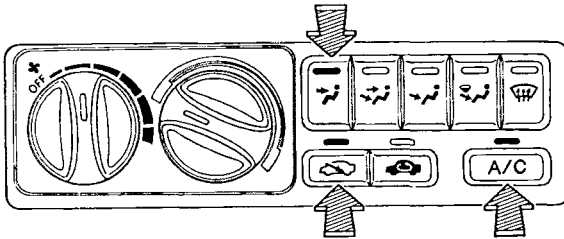

When using the air conditioning in heavy traffic, or while driving up long hills, watch the coolant temperature gauge: if the needle moves near the "H" end of the scale, turn the air conditioning off by pushing the A/C switch; leave it off until the needle goes back into the middle of the scale.

To Heat

Switch the fan on, slide the temperature lever to the right or turn the temperature control dial clockwise, select the  position, and warmed air will begin flowing from the floor outlets.

(US: LX/EX/SE/Anniversary Edition, Canada: EX/EX-R/SE)

A small amount of warmed air will also flow from the windshield defroster vent.

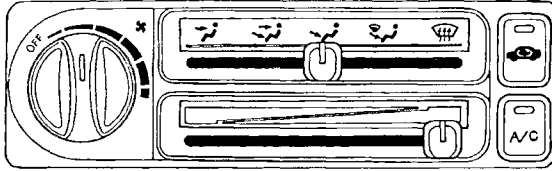

(US: DX, Canada: LX)

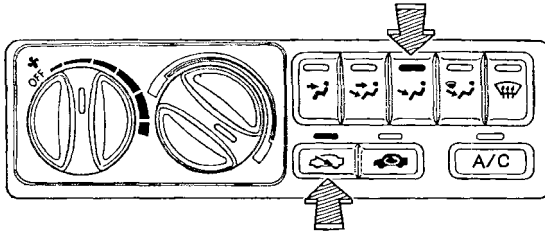

(US: LX/EX/SE/Anniversary Edition, Canada: EX/EX-R/SE)



To warm up the interior quickly, push the  button so the inside air will be recirculated to the heater.

If the windows begin to fog while heating in the  setting, switch to  to allow outside air to enter.

(cont'd)

Heating and Cooling (cont'd)

To Dehumidify with A/C (optional on US: DX, Canada: LX)

Because air conditioning dehumidifies as it works, you can use it in cool or cold weather to help defog the windows. Just switch the fan on, push the A/C switch on, select the desired function and adjust the temperature lever/control dial to a comfortable setting.

NOTE:

This setting is desirable for most operating conditions in ambient temperatures above approximately 32°F (0°C).

(US: DX, Canada: LX)

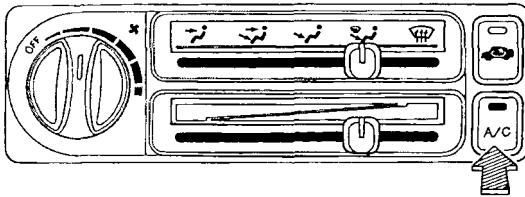

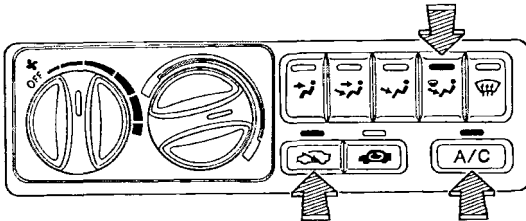

(US: LX/EX/SE/Anniversary Edition, Canada: EX/EX-R/SE)



To Defrost

To defrost or defog the windshield and door windows, slide the temperature lever to the right or turn the temperature control dial clockwise, select the  function, and switch the fan on.

If there is actual frost on the windows, first select the  position.

If the windows are fogged, select the  setting. Warmed air will then flow from the windshield and side defroster vents.

(US: DX, Canada: LX)





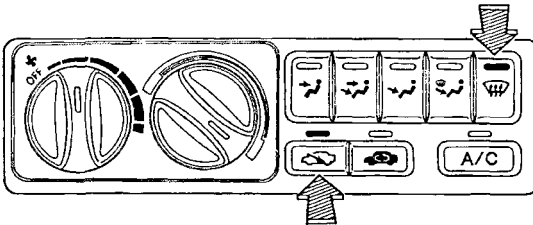

(US: LX/EX/SE/Anniversary Edition, Canada: EX/EX-R/SE)





(cont'd)

Heating and Cooling (cont'd)

For extra door window defrosting or defogging, select either the  ,  , or  function, switch to the  setting, and turn the fan on.

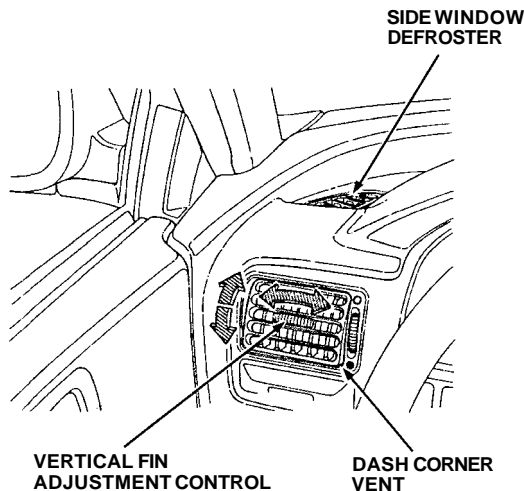
Air will flow to the side door windows from the vents at each end of the dash when the vertical fins of the dash corner vents are pointed toward the windows, and the horizontal fins are moved upward.



After the windows are sufficiently defrosted, you may wish to select the  or  mode for more comfort. Sliding the temperature lever to the left or turning the temperature control dial counterclockwise will reduce the temperature of the air exiting the dash corner vents without appreciably affecting the heat to your leg and foot area. Continue to adjust the temperature and fan speed to find the most comfortable setting.

To Turn Everything OFF

Slide the temperature lever to the left or turn the temperature control dial counterclockwise all the way, turn the fan switch off and push the  button on.

NOTE:

This setting should only be used in cold weather for the first few minutes of driving to prevent cold air from blowing into the cabin. Under normal operating conditions, the fan should always be kept ON to prevent the accumulation of stale air in the system.

Seat Heater (Canada: SE)

Both front seats in your car are equipped with seat heaters. The ignition must be in the II (ON) position when using the seat heaters. Push the seat heater switch, the light in the switch will come on and remain on while the heaters are working.

To turn the system off, push the switch, the light in the indicator should go off.

CAUTION:

As the unit draws considerable current, it should not be used when idling for an extended period of time. Doing so can cause a weak battery, resulting in hard starting.

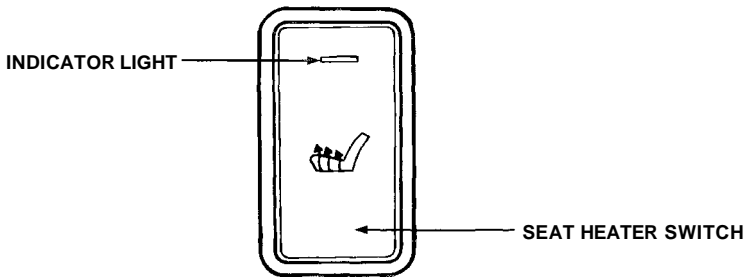

Moonroof (US: EX/SE, Canada: EX-R/SE)

To open or close the moonroof, push and hold the switch. Release the switch when the moonroof reaches the desired position. Do not hold the switch on after the moonroof has fully opened or closed, or you may damage the moonroof motor.

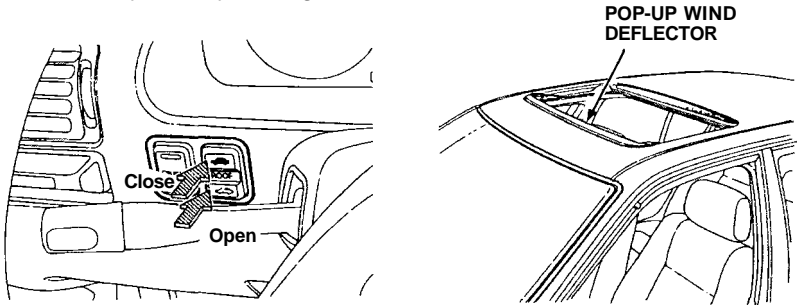

▲ WARNING

- Do not allow any part of your body to extend through the moonroof while the vehicle is in motion. In the event of a collision or sudden application of the brakes, severe personal injury could result.
- To avoid the possibility of injury while closing the moonroof, never allow any part of your body to extend through the opening.

CAUTION:

Operating the moonroof in severe cold or when it is covered with snow or ice may cause damage to the moonroof.

Sunshade

As well as the moonroof, there is a sliding sunshade which you can adjust to let in light with the roof closed, or to block out light entirely. The sunshade automatically opens as you open the moonroof.

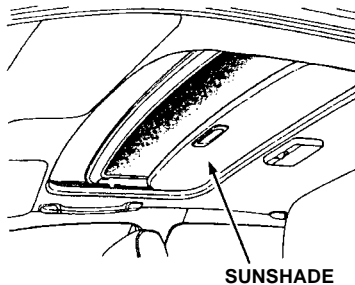

If the Moonroof Won't Close

The moonroof can be closed manually, if the control switch will not close it.

1. Remove the round plug near the rear center of the headliner.
2. Insert the moonroof wrench (from the tool kit) into the socket.
3. Turn the wrench until the moonroof seats in the closed position.
4. Replace the plug.

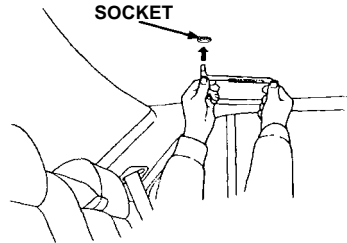
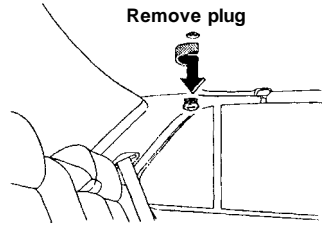

Maintenance

Periodically pour a little water down the drain holes to make sure they are not plugged. If they are free, water should drop on the ground behind each front wheel.

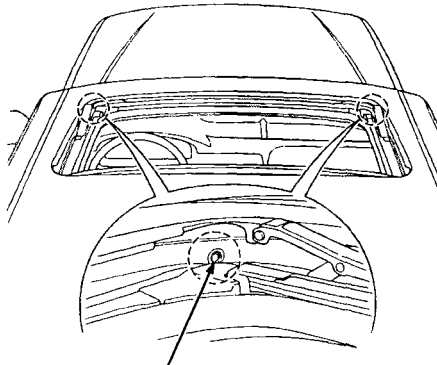

DRAIN HOLE

CAUTION:

Do not put weight on the moonroof or force it open or closed, you may damage the mechanism.

Stereo Sound System

(Canada: LX)

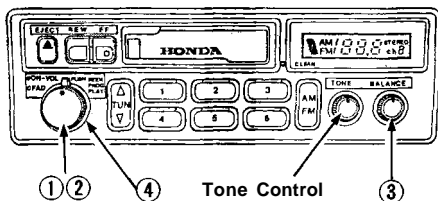

(US: LX/Anniversary Edition,
Canada:EX)

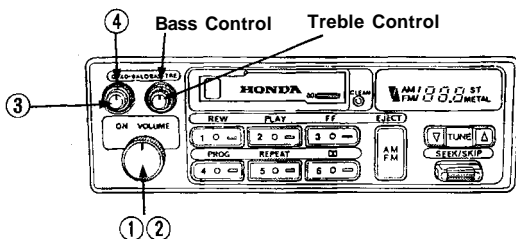

(US: EX,
Canada: EX-R)

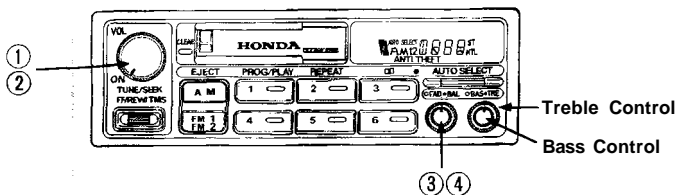

(SE)

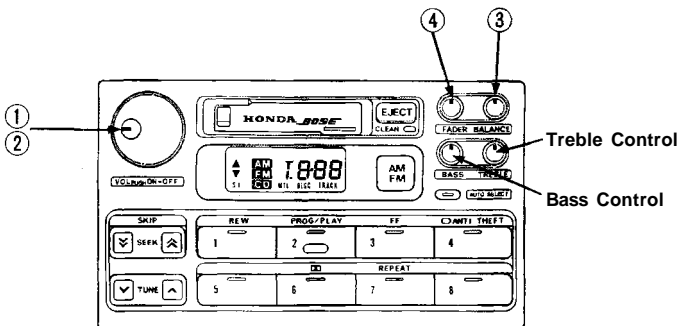

① **ON/OFF Switch**

Turn the switch clockwise to turn the unit on; turn it counterclockwise to turn the unit off.

(SE)

Push the switch to turn the unit on; push it again to turn the unit off.

NOTE:

The antenna will rise or retract automatically when the unit is turned on or off. It will also retract automatically if the ignition is switched off.

② **Volume Control**

Turn the ON/OFF switch clockwise to increase volume and counterclockwise to decrease volume.

③ **Balance Control**

Balances sound between left and right speakers.

(Except Canada: LX)

To use the control, push on the knob to get it to pop out, adjust the balance to your liking and push the knob back in when you are done.

NOTE:

(Except Canada: LX)

When the headlights are on, the radio panel illumination is on, even if the radio is turned off.

The panel lighting can be turned off by first pushing the Balance Control knob to its out position and then pulling it out slightly further.

④ **Fader Control**

Balances sound between front and rear speakers.

(Except Canada: LX)

To use the control, push on the knob to get it to pop out, adjust the sound to your liking and push the knob back in when you are done.

(cont'd)

Stereo Sound System (cont'd)

Radio Operation

(Canada: LX)

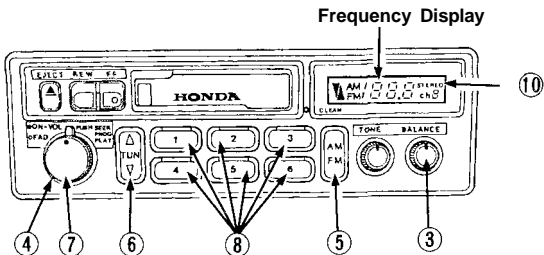

(US: LX/Anniversary Edition,
Canada: EX)

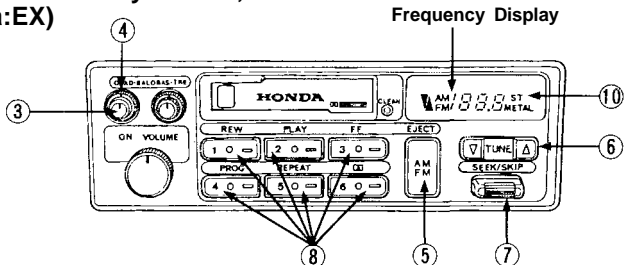

(US: EX,
Canada: EX-R)

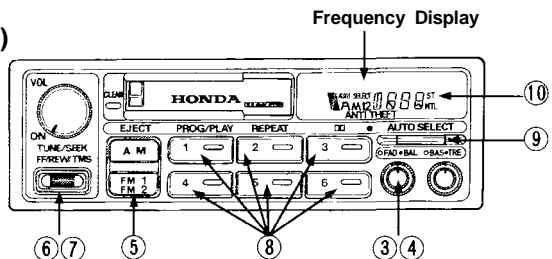

(SE)

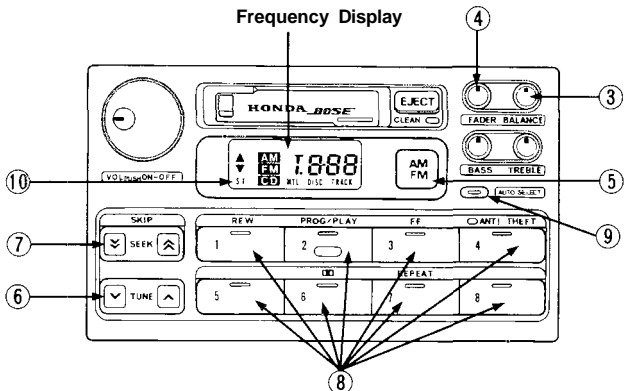

⑤ AM/FM Band Selector

Push to select AM or FM band. The corresponding band indicator will light.

⑥ Manual Tuning

(US: LX/Anniversary Edition, Canada: LX/EX)

Push the ▼ button to tune to a lower frequency station.

Push the ▲ button to tune to a higher frequency station.

(US: EX, Canada: EX-R)

Push the TUNE/SEEK switch up to change to a higher frequency, and down to change to a lower frequency.

To change the frequency up or down a single increment, push and release the TUNE/SEEK switch.

(SE)

Use the TUNE bar to change frequencies. Push ^ to tune to a higher frequency, and v to tune to a lower frequency.

NOTE:

(US: LX/Anniversary Edition, Canada: LX/EX)

If you hold either button for more than half a second, the tuning frequency will count up or down rapidly.

(US: EX, Canada: EX-R)

To go to a frequency that is farther away, push the switch and hold it. You will hear a beep and the frequency display will begin to count rapidly.

(SE)

The frequency will continue changing for as long as you push on the bar.

⑦ Seek Tuning

(Canada: LX)

Each time you push this button, the tuner will automatically seek the next higher frequency station.

(US: LX/Anniversary Edition, Canada: EX)

Each time you push this button up or down, the tuner will automatically seek the next higher or lower frequency station.

(US: EX, Canada: EX-R)

Depending on which way you push the TUNE/SEEK switch, the system searches up or down from the current frequency. Push the switch until you hear a beep, then release it. The system searches until it finds a station with a strong signal, then stops.

(cont'd)

Stereo Sound System (cont'd)

(Canada: LX)

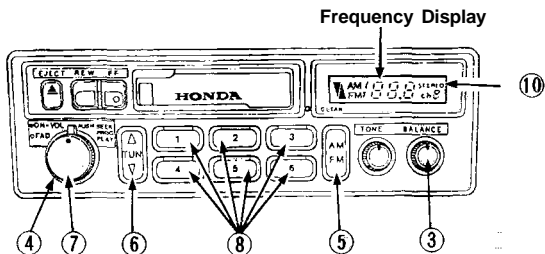

(US: LX/Anniversary Edition,
Canada: EX)

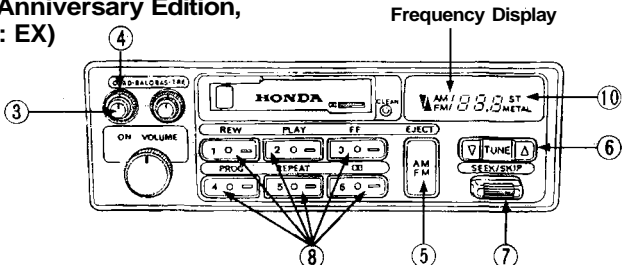

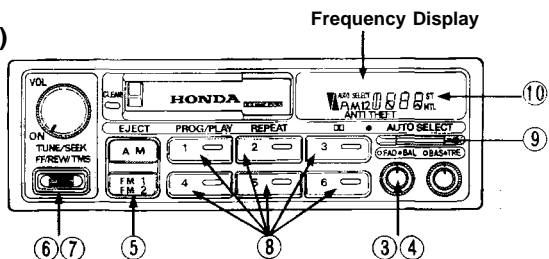

(US:EX,
Canada: EX-R)

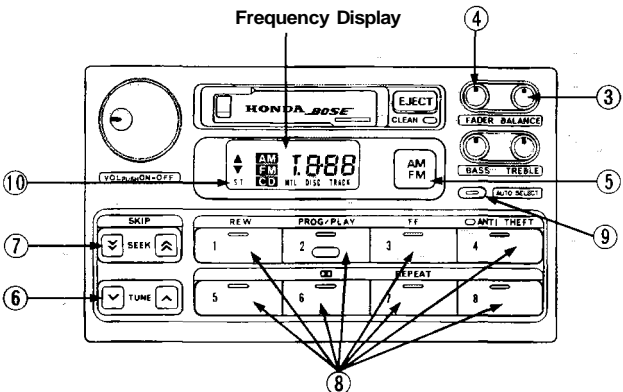

(SE)



(SE)

When you push the SEEK bar, the radio scans the selected band and stops on the next station with a strong signal. Push  to scan higher frequencies, and  to scan lower frequencies.

⑧ **Preset Station Selection**

1. Make sure the Band Selector is on the band you want ... AM or FM. Then, find the station you want by Manual Tuning or Seek Tuning.
2. Press and hold one of the Preset Buttons.
3. In a few seconds, a beep will sound and the light in the button will come on. The station is now preset in the memory. You may preset 1 AM and 1 FM station per button, (total, 6 of each on US: LX/Anniversary Edition, Canada: LX/EX, and 8 of each on SE).
(US: EX, Canada: EX-R)
Each button will store one frequency on the AM band, and two on the FM band by pushing the FM1, and FM2 switch. You can store a total of 6 stations on AM and 12 on FM.
4. You can tune to a preset station by pushing its corresponding preset button.

NOTE:

(US: EX/SE, Canada: EX-R/SE)

The Auto Select Button must be off before the Preset Station Selection can be used.

⑨ **Auto Select Button (US: EX/SE, Canada: EX-R/SE)**

If you are visiting a new broadcast area, you can quickly enter into memory the stronger stations in that area by simply pushing the Auto Select Button. The radio will then automatically scan both the AM and FM bands and temporarily memorize up to 6 stations (8 stations on SE) in each. With the Auto Select Button on, these stations can then be tuned by pushing the preset buttons. Manually-preset stations remain memorized for use when you return to your normal broadcast area, but are only selectable with the Auto Select Button off.

⑩ **Stereo Indicator**

This lights up when a FM broadcast in stereo is being received. It will flash when the signal strength diminishes. If it flashes, good stereo reception cannot be expected. Stereo reception is available only for FM stereo broadcasts, not for AM stereo broadcasts.

(cont'd)

Stereo Sound System (cont'd)

Tape Operation

(Canada: LX)

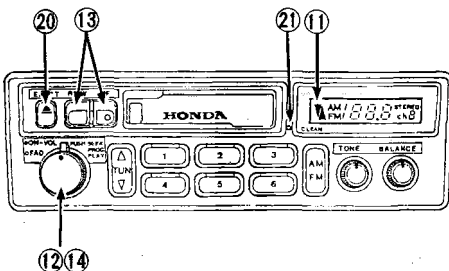

(US: LX/Anniversary Edition,
Canada: EX)

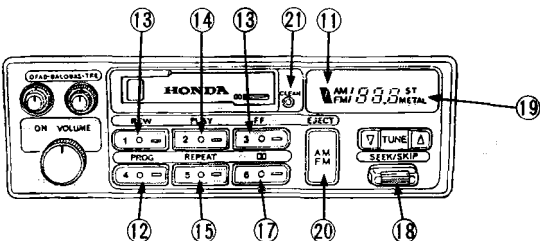

(US: EX,
Canada: EX-R)

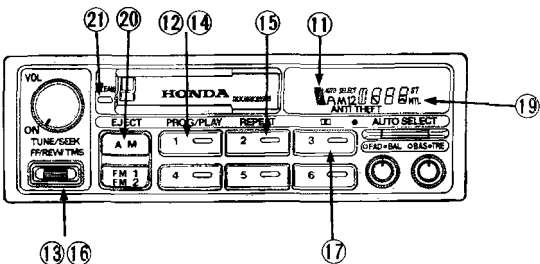

(SE)

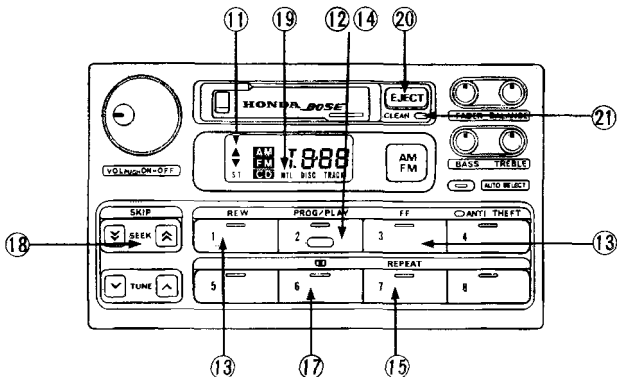

⑪ **Tape Direction Indicator**

Load the cassette into the slot with the tape opening to the right. The (▲) will light when the upper side is playing. The (▼) will light when the bottom side is playing.

⑫ **Program Selector (PROG)**

Push to change the direction of tape play.

Auto Reverse Feature: The tape direction automatically reverses when the end of the tape is reached in play or FF mode and plays the other side.

⑬ **Fast Forward/Rewind (FF/REW)**

Note which Tape Direction Indicator is lighted, then push the appropriate button to rapidly wind the tape in the same direction (FF) or in the opposite direction (REW).

(US: EX, Canada: EX-R)

To rewind the tape, push the FF/REW/TMS button down then release it. You will see REW in the display. To fast forward the tape, push the button up then release it. You will see FF displayed. To stop rewind or fast forward, press the PROG/PLAY button or push the FF/REW/TMS switch again.

⑭ **Play (PLAY)**

Push the PLAY button to resume tape play and stop rewind or fast forward operation.

(On US: LX/EX/SE/Anniversary Edition, Canada: EX/EX-R/SE, the indicator will light.)

⑮ **Repeat Button (REPEAT)**

(US: LX/EX/SE/Anniversary Edition, Canada: EX/EX-R/SE)

Push the REPEAT button (indicator on) to return to the beginning of a song or section of programming and repeat its play. Push the button again (indicator off) to cancel the repeat function and resume normal play.

(cont'd)

Stereo Sound System (cont'd)

(Canada: LX)

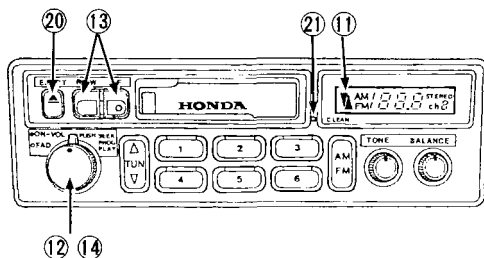

(US: LX/Anniversary Edition,
Canada: EX)

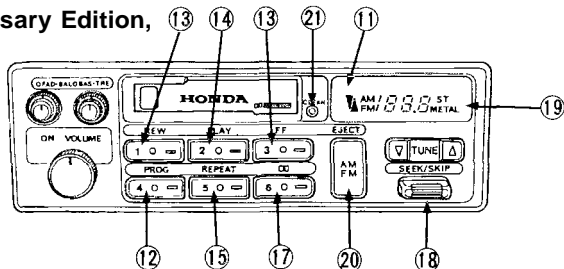

(US: EX,
Canada: EX-R)

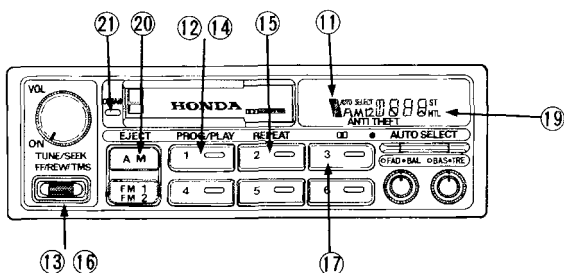

(SE)

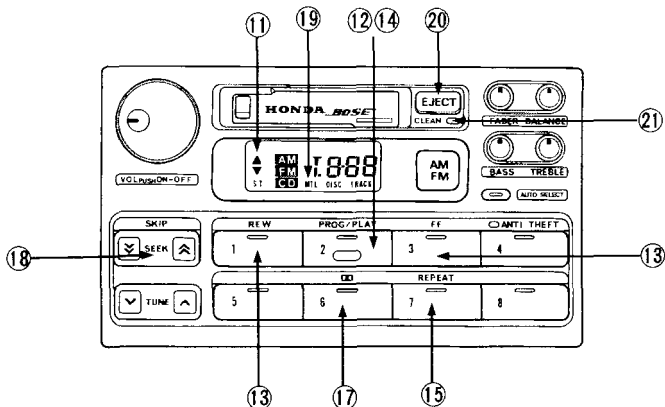

⑩ **TMS function (US: EX, Canada: EX-R)**

The TMS function lets you skip to the beginning of a song or other passage. The tape skips forward or backward, depending on which direction you push the FF/REW/TMS switch.

Activate TMS by pushing the FF/REW/TMS button and holding it until you hear a beep. If you push the button down, you will see REW blinking in the display as the tape rewinds. If you push the button up, you will see FF blinking in the display as the tape fast forwards. When the system senses a silent period on the tape, it goes back to PLAY mode.

NOTE:

(US: LX/EX/SE/Anniversary Edition, Canada: EX/EX-R/SE)

The REPEAT and TMS functions use silent periods on the tape to find the end of a selection. These features may not work satisfactorily on tapes that have almost no gap between songs, a high noise level between songs, or silent periods in the middle of songs.

⑪ **Dolby® Noise Reduction ()**

(US: LX/Anniversary Edition, Canada: EX)

Push when playing tapes recorded in Dolby NR (the Dolby NR indicator will light). Push again when playing tapes not recorded in Dolby NR. Use of the wrong setting will affect high frequency response.

(US: EX/SE, Canada: EX-R/SE)

Dolby noise reduction turns on when you insert a cassette. If the tape is not recorded with Dolby "B" noise reduction, turn it off by pressing the button.

NOTE:

- The Dolby NR circuit will not operate during radio reception.
- Dolby noise reduction manufactured under license from Dolby Laboratories Licensing Corporation.
"DOLBY" and the double-D symbol  are trademarks of Dolby Laboratories Licensing Corporation.

(cont'd)

Stereo Sound System (cont'd)

(Canada: LX)

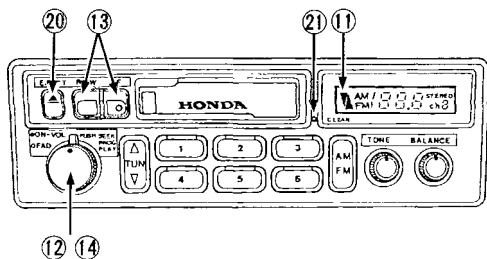

(US: LX/Anniversary Edition,
Canada: EX)

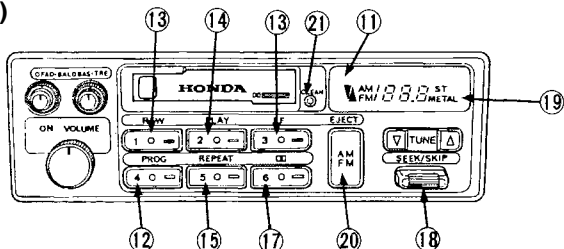

(US: EX,
Canada: EX-R)

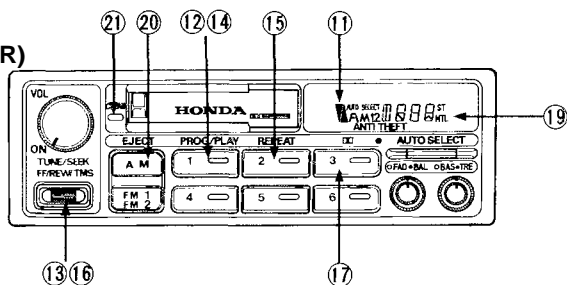

(SE)

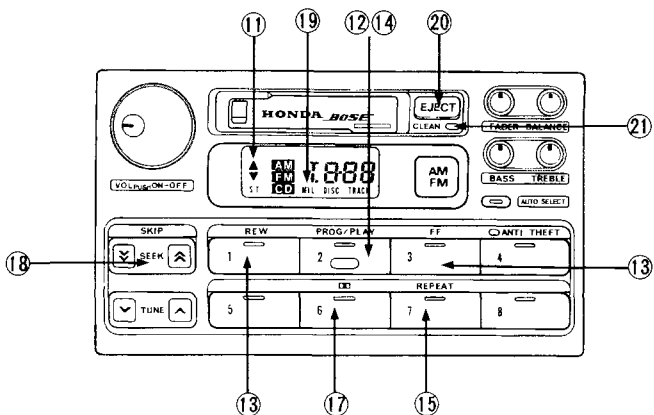



⑮ Skip Function

(US: LX/Anniversary Edition, Canada: EX)

The circuit senses silent passages between songs or programs on a tape. Push upward to automatically advance to the beginning of the next song, or downward to return to the beginning of the song just played.

(SE)

SKIP function lets you skip over a song or other passage. Press  to SKIP backward, and  to SKIP forward. The light in the REW or FF button will flash as the system advances the tape. When it senses a silent period, the system goes back to PLAY.

NOTE:

Tapes that contain short silent passages between songs, a high level of noise between songs, or silent passages within a song may not be suitable for this function.

⑯ Metal Indicator (METAL/MTL) (Except Canada: LX)

Most metal or CrO₂ cassettes are coded with slots on their back edge. If such a cassette is inserted, the player will detect the slots and automatically switch to the proper equalization for full enjoyment of metal/CrO₂ tapes. The indicator light will go on when coded cassettes are played.

⑰ Eject (EJECT)

Push this button to stop and eject the tape.

Ignition Key-OFF Eject: The cassette being played will be automatically ejected when the ignition or the unit is turned off.

NOTE:

When one side of the tape ends, "Auto-Reverse" will automatically begin playing the other side, therefore, you must push the eject button to stop or remove the tape.

(cont'd)

Stereo Sound System (cont'd)

(Canada:LX)

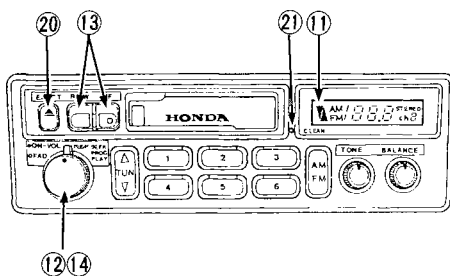

(US: LX/Anniversary Edition,
Canada:EX)

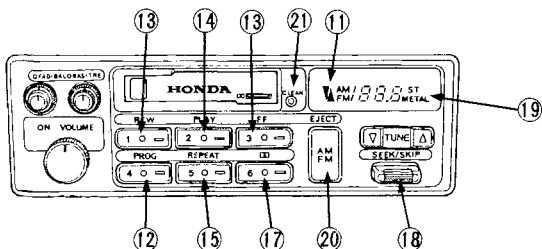

(US: EX,
Canada: EX-R)

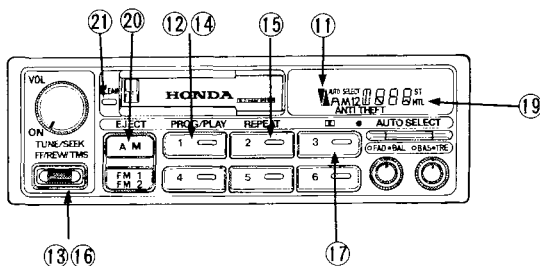

(SE)

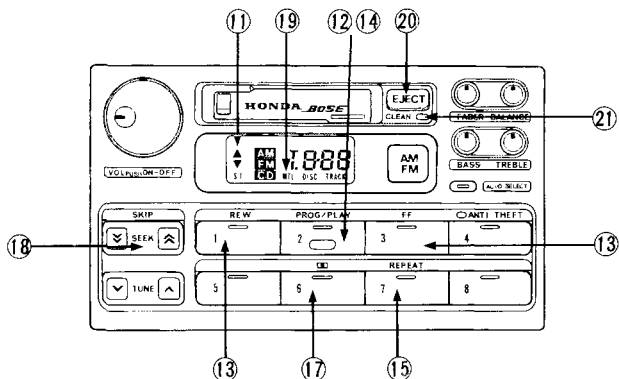

① **CLEAN Indicator Light**

(US: SE, Canada: LX/SE)

After 50 hours of cassette tape play, the CLEAN indicator light will come on as a reminder to clean the tape heads. If the light comes on and the tape heads were not cleaned at the recommended 30 hours of usage (see maintenance section on the next page), they should be cleaned immediately. To reset, push the indicator with a pointed instrument such as a ball-point pen until the light goes off (about 5 seconds).

(US: LX/EX/Anniversary Edition, Canada: EX/EX-R)

After 30 hours of cassette tape play, the CLEAN indicator light will come on as a reminder to clean the tape heads. If the light comes on and the tape heads were not cleaned at the recommended 30 hours of usage (see maintenance section on the next page), they should be cleaned immediately. To reset, push the indicator with a pointed instrument such as a ball-point pen until the light goes off (about 3 seconds).

Defective Tape Eject

The tape player includes a protection mechanism to automatically eject defective tapes (warped housing, loose label, faulty tape movement) immediately upon insertion. If a tape malfunctions while in play, the tape direction will change back and forth and then eject the cassette. Tapes ejected before play should be considered faulty and discarded; tapes ejected during play may only be unevenly wound and could be re-usable if fully rewound, manually, outside the player.

NOTE:

The tape player may repeat cycle through the loading and unloading motion several times in an effort to eject a faulty tape. During this process the tape will either eject fully or rise to the loading level and have to be pulled out manually. In either case, discard the tape; re-use may damage the tape player.

(cont'd)

Stereo Sound System (cont'd)

Maintenance

The head in the cassette tape player can pick up dirt or tape deposits each time a cassette is played. The result is low or "muddy" sound from one or both channels, as if the treble tone control were turned all the way down. To prevent this, you should periodically clean the head with a commercially available cleaning cassette.

As preventive maintenance, clean the head about every 30 hours of use. If you wait until the head becomes very dirty (noticeably poor sound), it may not be possible to remove all deposits with a simple cleaning cassette.

The use of 120 minute tapes is not recommended.

CAUTION:

Storing cassettes out of their cases, or touching the magnetic tape with your fingers will increase the amount of dirt that gets to the tape head. Using low-quality "off-brand" tape will increase the amount of tape deposits that get on the head. Both of these practices may eventually lead to damage of the head and playing mechanism.

Operating the CD Changer (Optional for SE)

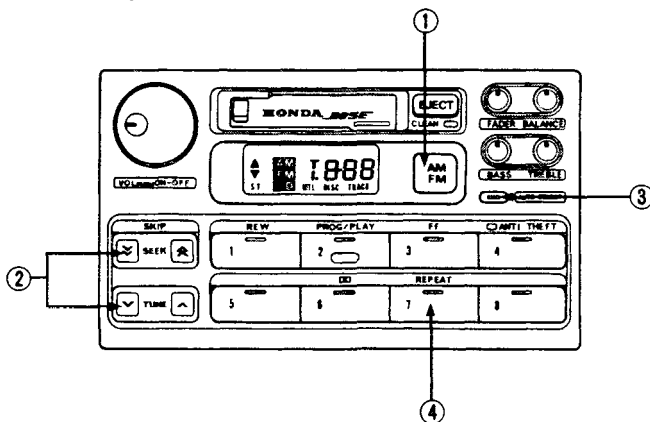

A trunk-mounted Compact Disc changer is available for your car. It holds up to six discs, providing several hours of continuous programming. You operate the CD changer with the same buttons, used for the radio and cassette player.

Load the desired CD's in the magazine and load the magazine in the changer according to the instructions that came with the unit.

To operate the CD changer, the ignition key must be in the ACCESSORY (I) or ON (II) position.

If you are listening to a cassette tape, eject it before playing a CD.

① AM/FM Button

Press the AM/FM button until "CD" appears on the display. Once in the CD mode, the system will start to play the first track of the first disc in the magazine.

When that disc ends, the next disc in the magazine is loaded and played.

After disc 6 has completed, the system will return to disc 1. To make your own disc selection, push one of the first six preset buttons. Your selection will appear in the display and start playing.

(cont'd)

Stereo Sound System (cont'd)

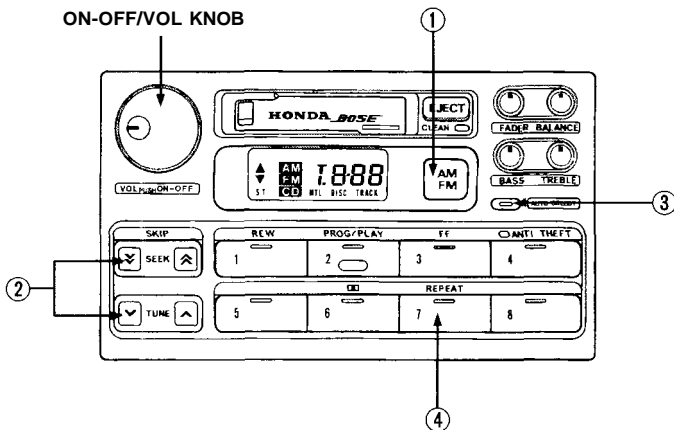

② SEEK/TUNE Bar

You can use the SEEK bar or TUNE bar while a disc is playing to select passages and change tracks.

To move rapidly within a track, press and hold the \wedge side of the TUNE bar to move forward or the \vee side to move backward. This continues until you release the bar.

Each time you press the \wedge side of the SEEK bar, the system skips forward to the beginning of the next track on that CD. Press the \vee side to skip backward to the beginning of the current track.

If you press \vee again, the system skips backward to the beginning of the previous track.

③ Auto Select Button

You can get the CD player to randomly select tracks by pressing the AUTO SELECT button. The indicator in the button lights as a reminder. With this active, the system selects and plays the tracks randomly, rather than sequentially, on each disc. When the system has played all the tracks on that disc, it loads the next disc and starts to play it randomly. The system continues to select and play tracks randomly on each of the six discs until you press the AUTO SELECT button again.

④ Repeat Button (REPEAT)

If you push the REPEAT button, the system will continuously play the track you are listening to. The light in the button stays on as a reminder.

- If you change modes to radio or tape while a CD is playing, then change back to CD mode, the same disc and track will play.
- If you turn off the system while a CD is playing, either with the ON-OFF/VOL knob or by turning off the ignition, the system will begin at the same disc and track when you turn it back on.
- If you try to select an empty slot in the magazine, the system will select and play the first track of the next disc in the magazine.

To return to the radio function, press the AM/FM button.

(cont'd)

Stereo Sound System (cont'd)

CD Error Indications

If you see an error indication on the display, find the cause in the chart to the right. If you cannot clear the error indication, take the car to your Honda dealer.

Indication	Cause	Solution
E 01	Disc changer malfunction	Consult Honda dealer
E 02	Disc is in changer mechanism	Press the magazine eject button, and insert an empty magazine
E 03 E 04 E 05	Disc-changer malfunction	If the code disappears within a few seconds, unit is OK. If it does not, consult your Honda dealer.
E 06	Disc-changer malfunction	Press the magazine eject button and pull out the magazine, check for error indication. Insert the magazine again. If the magazine can not be pulled out, consult your Honda dealer.
E 07	CD Magazine ejection impossible	Press the magazine eject button. If the magazine does not eject, consult your Honda dealer.
- - H	High temperature	Will disappear when the temperature returns to normal.
E E E	Misconnection or disconnection of CD changer	See your Honda dealer.
- - -	No CD magazine in the CD changer	Insert CD magazine.

Entering the Security Code for the Anti-theft Radio

(US: EX, Canada: EX-R/SE)

The Honda anti-theft radio will not operate if the radio is stolen. Even if the radio is electrically reconnected, it will be inoperable unless a five-digit security code is entered.

The code for your radio is printed on each of the two cards that came with your radio. Keep these cards in a secure place away from the car. The radio cannot be reprogrammed without the code.

- Enter the five-digit code using the preset station selector buttons. The radio must be on and the word "Code" must be in the display.
- When entering the five-digit code, be sure to complete the number sequence even if an error was made. For instance if the code number is 43215 and 42 was mistakenly entered for the first two numbers instead of 43, continue entering 215. A beep will sound after five digits are entered.
- The word "Code" will appear in the display.
- Re-enter the correct code number sequence. The word "Code" will no longer appear, and the radio should resume normal operation.
- If the correct code is not entered in three successive tries, the radio will not accept entry at this time. You must wait one hour with the radio ON to re-enter the correct code.

If the voltage supply is interrupted and reconnected, the word "Code" will appear in the radio's display and the radio will not work. When your car requires electrical repairs, the code number must be re-entered for radio operation.

Gasoline

Gasoline

Your Honda operates most effectively on unleaded gasoline with a pump octane number of 86 or higher. Use of a lower octane gasoline can cause a persistent, heavy metallic rapping noise in the engine that can lead to mechanical damage.

We recommend gasolines containing detergent additives that help prevent fuel system and engine deposits.

Using gasoline containing lead will damage your car's emission controls. This contributes to air pollution and can void certain parts of your warranty.

Oxygenated Fuels

Some conventional gasolines are being blended with alcohol or an ether compound. These gasolines are collectively referred to as oxygenated fuels. To meet clean air standards, some areas of the United States and Canada use oxygenated fuels to help reduce emissions.

If you use an oxygenated fuel, be sure it is unleaded and meets the minimum octane rating requirement.

Before using an oxygenated fuel, try to confirm the fuel's contents. Some states/provinces require this information to be posted on the pump.

The following are the EPA — approved percentages of oxygenates:

ETHANOL (ethyl or grain alcohol)

You may use gasoline containing up to 10% ethanol by volume. Gasoline containing ethanol may be marketed under the name "Gasohol."

MTBE (Methyl Tertiary Butyl Ether)

You may use gasoline containing up to 15% MTBE by volume.

METHANOL (methyl or wood alcohol)

You may use gasoline containing up to 5% methanol by volume as long as it also contains cosolvents and corrosion inhibitors to protect the fuel system.

Gasoline containing more than 5% methanol by volume may cause starting and/or performance problems. It may also damage metal, rubber, and plastic parts of your fuel system.

If you notice any undesirable operating symptoms, try another service station or switch to another brand of gasoline.

Fuel system damage or performance problems resulting from the use of an oxygenated fuel containing more than the percentages of oxygenates given above are not covered under warranty.

Operation In Foreign Countries

In order to comply with U.S. and Canada Federal Emissions Regulations, you must use unleaded fuels of the recommended octane rating. These fuels may not be available in other countries. If you intend taking your car outside the U.S. or Canada, write to Honda (stating the year and model of your car) at the address shown for information regarding modifications you may need to have done.

U.S. Owners: American Honda Motor Co., Inc.
Consumer Affairs
1919 Torrance Blvd.
Torrance, CA 90501-2746

Canadian Owners: Honda Canada Inc.
715 Milner Ave.
Scarborough, Ontario M1B-2K8

(cont'd)

Gasoline (cont'd)

Fuel Fill Door and Cap

▲ WARNING

Gasoline is extremely flammable and is explosive under certain conditions. Perform this operation in a well-ventilated area with the engine stopped. Do not smoke or allow open flames or sparks in the area or where gasoline is stored.

The fuel fill door is opened by pulling up on the lever at the left side of the driver's seat.

The door will lock automatically when closed; push it until it clicks.

CAUTION:

You may hear a hiss when you open the fuel fill cap. This sound is residual pressure escaping from the fuel tank. Open the cap slowly and remove the cap after the hissing stops. Fuel spray may cause injury. Do not overfill the tank; fill only until the gas pump clicks off automatically and never top off.

NOTE:

The fuel fill cap is a screw-in ratchetting type. Tighten the cap clockwise until ratchetting clicks are heard.

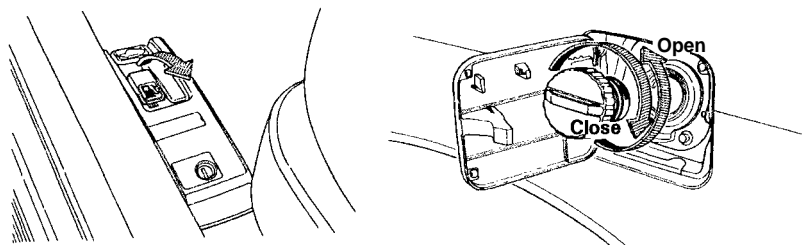

The removed fuel fill cap can be placed on the inside of the door.

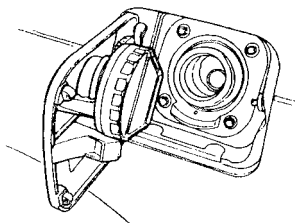

▲ WARNING

Fuel vapor is extremely hazardous under certain conditions. Always stop the engine before refueling, and never refuel near sparks or open flames.

CAUTION:

If you replace the cap, use only a genuine Honda replacement part or its equivalent. Failure to use the proper part could cause serious fuel system problems.

How to Improve Your fuel Mileage:

- Drive at a smooth, steady pace to avoid unnecessary deceleration and stops — accelerating back to speed uses more fuel.
- Plan trips to avoid rush hour traffic if possible.
- Make sure the parking brake is completely released.
- Consolidate trips whenever possible.
- Keep vehicle weight to a minimum by removing unnecessary items from the luggage area.
- Whenever possible, use fresh air from the dash vents to keep cool when driving; open windows, or use of the air conditioning both affect fuel economy.

(Air conditioning is optional on US: DX, Canada: LX.)

- Keep the tires adjusted to the recommended pressure.

Tire Pressure(measured cold):

Front/Rear:

US: DX/LX, Canada: LX/EX 200 kPa (29 psi)

US: EX/SE/Anniversary Edition, Canada: EX-R/SE

220 kPa (32 psi)

Condition of Your Car

You can only get maximum fuel economy if your car is in top running condition. Have all required maintenance done at the proper intervals. Check tire pressures and tire wear frequently. If tire wear is uneven, have the alignment checked by your Honda dealer. Proper alignment saves gasoline and prolongs tire life.

Ignition Switch

The combined ignition switch/anti-theft lock is located on the right side of the steering column and has four positions:

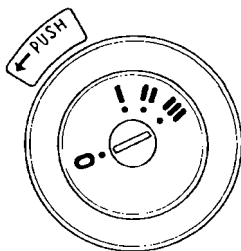

- **0-LOCK position:** The key can be removed or inserted in this position. To remove the key, push it in at position I, then turn it to 0 and pull it out. When the key is removed, the steering column will lock.

NOTE:

On cars equipped with automatic transmissions, the transmission must be in Park before pushing and turning the key to the 0-LOCK position.

▲ WARNING

Never turn the ignition switch to the lock position or remove the key while the car is in motion; the steering wheel can lock causing a loss of directional control, and an accident could result.

- **I-ACCESSORY position:** In this position, the accessory circuit is on, but the ignition circuit is off.
If the key is difficult to turn from the 0 to the I position, turn the steering wheel slightly to relieve pressure on the lock.
- **II-ON position:** This is the normal running position.

Canada Cars:

The "Daytime Running Lights" will come on in this position (see page 51).

- **III-START position:** The starter will engage when the key is turned to this position.

To remind you to remove the ignition key when leaving your car, a beeper will sound if the key is still in the ignition when you open the driver's door. The beeper system is deactivated when you turn the ignition to 0 (Lock) and fully remove the key.

Before Starting

When starting in cold weather, keep all unnecessary electrical circuits off (lights, defogger, etc.) for the best battery output.

Manual Transmission:

1. Apply the parking brake.
2. Push the clutch pedal all the way in (see NOTE below).
3. Shift the transmission to neutral.

NOTE:

On cars equipped with manual transmissions, the engine will not crank unless the clutch pedal is fully depressed.

Automatic Transmission:

1. Make sure the shift lever is in Park (P).
2. Apply the parking brake and the foot brake.

Starting the Engine

During the following starting procedures, do not crank the engine for more than 15 seconds at a time. If the engine won't start, wait 10 seconds before going to the next step.

1. With your foot off the accelerator, start the engine by turning the key to the III position.
2. If the engine won't start within 15 seconds or starts but fails to continue to run, push the accelerator pedal halfway, and hold it there while cranking the engine. If the engine starts, release the accelerator gradually.
3. If it doesn't start within 15 seconds, push the accelerator pedal down to the floor and hold it there while cranking. If the engine starts, release the accelerator gradually. If it doesn't start, repeat step 2.

Cold Weather at High Altitude Starting

1. When starting in cold weather at high altitude (above 8,000 feet), push the accelerator pedal about halfway and hold it there while cranking the engine. If the engine starts, release the accelerator gradually.
2. If it doesn't start within 15 seconds, push the accelerator pedal down to the floor and hold it there while cranking. If the engine starts, release the accelerator gradually. If it doesn't start, repeat step 1.

NOTE:

If the outside temperature is below freezing, or if your car has not been driven for several days, warm up the engine for a few minutes before driving.

Safety Items

Before driving away, check that:

- The doors are closed properly.
- The mirrors are properly adjusted, and the windows clean.
- The driver and passengers are wearing properly adjusted seat belts.
- The front seat head restraints are properly adjusted.
- The warning and indicator lights are operating properly.
- The brake pedal feels normal.
- All luggage and cargo is secured.
- Nothing is interfering with the driver's feet or blocking vision to the rear.

While driving remember to:

- Always drive defensively; expect the unexpected.
- Reduce your speed during night hours and bad weather.
- Follow at a safe distance; don't tailgate.
- Get off the highway when you are tired; stop and take a rest.

When stopping for repairs:

- Park the car well off the road.
- Turn on the hazard warning flasher.
- Use flares or other warning devices to warn other motorists.

After parking your car:

- Apply the parking brake and shift to first gear if your car is equipped with manual transmission, or PARK on automatic transmission equipped cars.
- Make sure the moonroof and windows are closed and the doors are locked.
(The moonroof is standard for US: EX/SE, Canada: EX-R/SE.)
- If parked on a hill:
 1. Turn the front wheels away from the curb if facing uphill.
 2. Turn the front wheels toward the curb if facing downhill.
- Never leave children unattended in a parked car.
- Take your keys.





Engine Exhaust Gas Warning

A properly maintained car is your best protection against exhaust gas entering the passenger compartment.

The exhaust system should be thoroughly inspected by a competent mechanic whenever:

- The car is raised for oil change.
- You notice a change in the sound of the exhaust.
- The exhaust system or the rear or underside of the car is damaged.

WARNING

- **Avoid breathing exhaust gases. They contain carbon monoxide, which is a colorless, odorless gas that can cause loss of consciousness and eventual death. If you suspect that exhaust gas is entering the passenger compartment, have the cause determined and corrected as soon as possible. If you must drive under these conditions, drive only with all windows fully open.**
- **Do not drive with the trunk lid open. An open trunk lid may draw exhaust gases into the passenger compartment. If you must drive with the trunk lid open, drive only with all the windows wide open.**
- **Do not run the engine in confined areas, such as garages, any longer than necessary to move the car in or out.**
- **If you must sit in a parked car with the engine running for more than a short time, adjust the heating/ventilation system as follows:**
 1. (US: DX, Canada: LX)
Slide the function lever to  and push the  button off.
(US: LX/EX/SE/Anniversary Edition, Canada: EX/EX-R/SE)
Select the  and  positions.
 2. Set the temperature lever/control dial for best comfort.
 3. Turn the fan to the highest speed.

NOTE:

To insure proper operation of the car's ventilation system, keep the front air inlet clear of snow, mud, leaves, or other obstructions.

Shifting the 5-Speed Manual Transmission

The fully synchronized manual transmission is very easy to shift up or down. When you slow down for traffic, steep hills, or corners, shift to a lower gear before the engine starts to labor. When descending steep grades, select a lower gear to help maintain a safe speed and to prevent the brakes from overheating.

When shifting, depress the clutch pedal fully, shift gears and then release the clutch gradually. Do not speed-shift; allow time for the gears to synchronize.

To prevent grinding the gears when shifting into reverse, hold the clutch pedal depressed briefly before shifting, or shift the lever into one of the forward gears before selecting reverse.

A safety lockout prevents accidental shifting straight from 5th to Reverse.

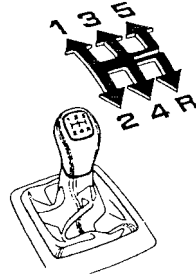

▲ WARNING

Avoid rapid acceleration or sudden deceleration when either or both driving wheels are on a slippery surface. Decreased traction could cause loss of directional control.

CAUTION:

- Do not drive with your foot on the clutch pedal as this will cause premature wear of clutch components.
- Do not shift into reverse while the car is moving.

Recommended Shift Speeds

For best fuel economy, and effective emission control, shift at the speeds shown:

Shift up	Normal Acceleration
1st to 2nd	15 mph (24 km/h)
2nd to 3rd	28 mph (45 km/h)
3rd to 4th	41 mph (66 km/h)
4th to 5th	52 mph (83 km/h)

Shift up	Cruise From Acceleration
1st to 2nd	7 mph (11 km/h)
2nd to 3rd	22 mph (35 km/h)
3rd to 4th	33 mph (53 km/h)
4th to 5th	48 mph (77 km/h)

Maximum Allowable Speeds



The speeds shown are the maximum at which the car can be driven or downshifted in each gear without over-revving the engine.

	US: DX/LX Canada: LX/EX	US: EX Canada: EX-R
1st	31 mph (50 km/h)	31 mph (50 km/h)
2nd	56 mph (90 km/h)	56 mph (90 km/h)
3rd	87 mph (140 km/h)	84 mph (135 km/h)

Shifting the Automatic

The automatic transmission shift lever has a locking mechanism to prevent accidental shifting into Reverse (R), Park (P), 2nd (2), or 1st (1). Also, an Automatic Shift Lock prevents you from shifting out of Park unless the brake pedal is already depressed and the ignition switch is in the II position.

Push the button on the shift handle to shift into 2nd, 1st, Reverse, or Park; depress the brake pedal and then push the button on the shift handle to shift out of Park.

-  : Depress the brake pedal first and push the button, then shift.
-  : Push the button, then shift.
-  : Shift as desired.

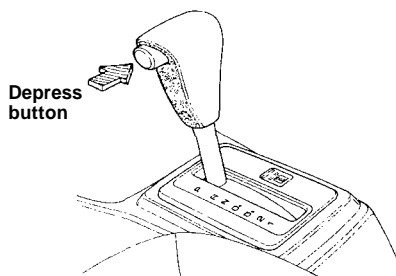
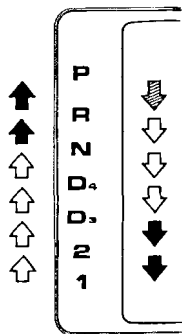

If you cannot shift out of Park with the brake pedal depressed and the ignition switch in the II position:

1. Turn the ignition switch off and remove the key.
2. Insert the key in the Shift Lock Release located to the right of the shift lever.
3. Press and hold the key down, then push the button on the shift handle and move the shift lever to Neutral.
4. Return the key to the ignition switch, depress the brake pedal and restart the engine.

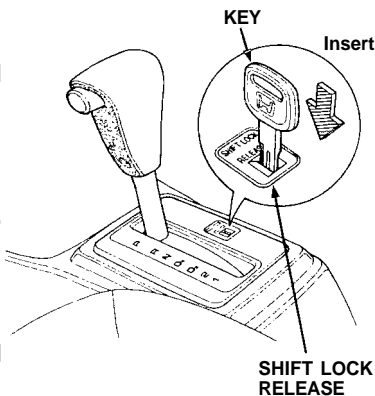

NOTE:

If you encounter any problem shifting out of Park, have your authorized Honda dealer check the system as soon as possible.

Operating Tips

For smoother operation, apply the brakes when shifting from Neutral or Park to a forward or reverse gear.

When parking: bring the car to a stop with the foot brake, hold the brake on, and shift into Park, set the hand brake and then turn off the engine.

NOTE:

Your 4 speed automatic transmission is equipped with a torque converter lock-up clutch. Because of this, you may notice what feels like an extra shift as the clutch engages.

CAUTION:

- **Shift into P only after the car has come to a complete stop.**
- **Shift into or out of R only after the car has come to a complete stop.**
- **Do not "rev-up" the engine when the brake is on and the shift lever is in D₄, D₃, 2, 1, or R.**
- **When stopped on a hill, use the brakes to hold your position, not the accelerator pedal.**
- **Do not shift from N or P into D₄, D₃, 2, 1, or R when the engine is above idle speed. Before shifting into gear, make sure your foot is firmly on the brake pedal.**
- **Do not rest your hand on the shift lever or push the lock-out button while driving.**

(cont'd)

Shifting the Automatic (cont'd)

Driving Technique

D4-4th

Use the D₄ range for normal in-town and highway driving. The car will start off in 1st and shift automatically to 2nd, 3rd, and 4th. The further down you push the accelerator, the later the transmission will shift and the faster the car will accelerate.

D3-3rd

Use of D₃ will allow the transmission to start off in 1st and shift automatically to 2nd and 3rd. Use D₃ when climbing grades to prevent the transmission from "hunting" between 3rd and 4th gear; or when increased braking is needed.

NOTE:

If rapid acceleration is necessary, depress the accelerator to the floor; the transmission will automatically shift down according to load and engine speed. This applies to both D₄ and D₃ ranges.

2-2nd

Use 2nd gear for increased engine braking when driving downhill, and increased power when driving uphill; also for driving on slippery roads, and freeing the car from mud or sand, where 1st gear could provide too much power and cause skidding or wheelspin. The maximum recommended speed in 2nd gear is: 69 mph (110 km/h).

1-1st

This position is to be used when stronger engine braking is needed. The maximum recommended speed in 1st gear is: 31 mph (50 km/h).

R-Reverse

CAUTION:

Shift into or out of reverse only after the car has come to a complete stop; the transmission may be damaged if you shift while the car is moving.

P-Park

CAUTION:

Use this position when starting the engine, or when parking. Shift into Park only when the car is COMPLETELY stopped.

N-Neutral

Use when starting the engine or during prolonged idling in traffic.

Towing a Trailer

Your car is designed primarily to carry passengers and a normal amount of luggage. Although your car is capable of towing a trailer, there will be an effect on handling, performance, braking, general vehicle and tire durability and fuel economy.

▲WARNING

- The weight of the trailer plus its cargo must not exceed a total of 1,000 lbs. (450 kg).
- The gross vehicle weight must not exceed the Gross Vehicle Weight Rating (GVWR) indicated on the Certification label (see page 160). The gross vehicle weight is the total weight of the car, driver, passengers, luggage, hitch, and trailer tongue load.
- The total weight supported by each axle must not exceed the Gross Axle Weight Rating (GAWR). The front and rear GAWR's are shown on the Certification label (see page 160). The distribution of luggage and passengers in the car, as well as the tongue load and hitch weight should also be considered in terms of the GAWR, which is the maximum amount of weight that should be supported over the front and the rear axles. You should have your car and trailer weighed at a commercial weighing station to check both the GVWR and GAWR's to confirm that the total weight and weight distribution are within safe driving limits.
- The maximum trailer tongue load must not exceed 100 lbs. (45 kg). Cargo should be distributed so that the tongue load is approximately 10% of the total weight of the trailer and its cargo. This is done by distributing approximately 60% of cargo weight toward the front of the trailer and 40% toward the rear.

TRAILER WEIGHT

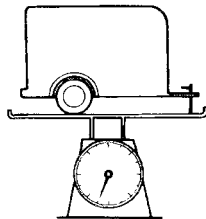

Maximum: 1,000 lbs (450 kg)

TONGUE LOAD

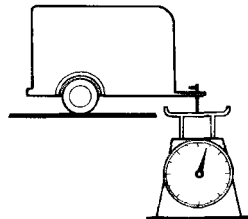

Maximum: 100 lbs (45 kg)

- Never load the trailer so that the back is heavier than the front. This will seriously affect vehicle handling. Be sure the cargo is secured so that it will not move during driving.

(cont'd)

Towing a Trailer (cont'd)

Hitches

Use only a hitch recommended by your Honda dealer. The hitch should be bolted securely to the car and installed by a qualified technician. Do not use a hitch designed for temporary installation and never use one that attaches only to the bumper.

Trailer Brakes and Safety Chains

The Honda Automobile Division recommends that trailers equipped with brakes should conform to any applicable federal and state/provinces regulations. When using a trailer equipped with electric brakes, a trailer brake controller that connects to the car's electrical system is recommended. Installing a brake controller that connects to the car's brake hydraulic system could result in brake fluid contamination or leaks. A safety chain must always be used between the car and the trailer. Leave sufficient slack in the chain so that it does not bind in sharp turns. The chain should cross under the trailer tongue to prevent the tongue from dropping to the ground.

Tires

Make sure your car's tires are properly inflated. Adjust tire pressure to the recommended tire pressure indicated on the label attached to the driver's door jamb. The trailer tires should be of the proper size, load rating and inflated to the pressure recommended by the trailer manufacturer.

Trailer Lights

Trailer lights must comply with federal, state/province and local regulations. See your local recreational vehicle dealer or rental agency for the correct type of lighting and wiring for your trailer. Check for correct operation of the turn signals and stop lights each time you hitch up.

A trailer lighting connector is provided behind the left garnish by the taillight access door in the trunk. The wiring color codes are described on the next page.

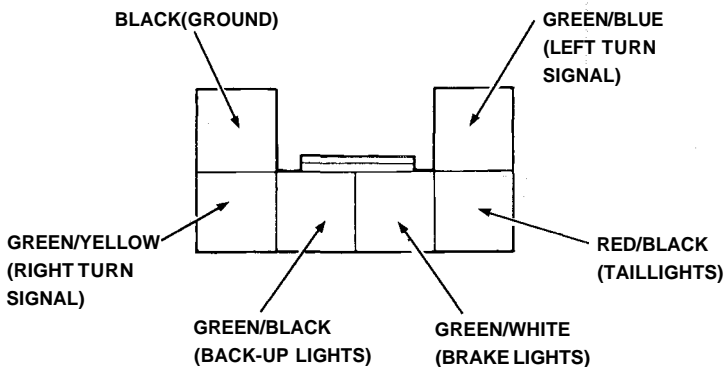

To connect your car's taillights to a trailer, an electrical converter must be installed in the car. Your car has separate bulbs for brake (red) and turn signal lights (amber), while most trailers use the same bulb for brake and turn signal lights. A converter, available at most trailer supply stores, should be installed according to the instructions supplied by the converter manufacturer.

For information regarding trailer hitch and trailer electrical wiring availability, contact your Honda dealer or American Honda Motor Co., Inc. (for US cars), or Honda Canada (for Canada cars). See page [93](#) for American Honda and Honda Canada addresses.

CAUTION:

Connections to your car's electrical system should be made by your Honda dealer or a qualified electrician. Improper installation may damage your vehicle's electrical system and cause a malfunction of the lights.

Break-in Schedule

Do not tow a trailer during the 600 miles (1,000 km) break-in period (see page [2](#)).

Maintenance

If you tow a trailer, your vehicle will require more frequent maintenance due to the additional load. Refer to the "Maintenance schedule under severe driving conditions" on page [114](#) for specific information.

(cont'd)

Towing a Trailer (cont'd)

Before Towing

With the car and trailer completely loaded and parked on a level surface, confirm that the tongue loading is correct. If the car has an abnormal nose-up or nose-down attitude, check for improper cargo distribution. Check also for excessive cargo weight, worn suspension or other causes and correct the problem before driving.

Be sure the cargo is secured so it will not shift while driving. Check that your rearview mirrors conform to any federal, state or province, or local regulations. If not, install rearview mirrors designed for towing. Before towing a trailer, practice turning, stopping, and reversing with a trailer in an area away from traffic until you learn the technique.

Towing Safety

▲ WARNING

- Stopping distance will be increased when towing a trailer. For each 10 mph (16 km/h) of speed, allow at least two car lengths between you and the vehicle ahead. Avoid sudden braking which may cause trailer jackknifing and loss of control.
- Avoid jerky starts and rapid acceleration. If your car has a manual transmission, always start out in first gear and release the clutch at moderate engine rpm.
- Avoid rapid lane changing and sharp turns. The trailer could hit your car in a tight turn. Slow down before making a turn. Remember, the total length of your car plus trailer will require a wider turning circle.
- Crosswinds may adversely affect handling of your car and trailer. Use the rearview mirrors frequently to warn you of approaching large vehicles that may pass you, causing your car and trailer to sway. When being passed, firmly grip the steering wheel and be prepared to reduce speed immediately but gradually. Never increase speed. Steer straight ahead.
- Towing a trailer in bad weather will magnify any difficulty in controlling the car caused by the weather itself. Avoid sudden maneuvers: slow down and use extra caution.
- Be careful when passing other vehicles. Passing requires considerable distance because of the added weight and length of your trailer.

CAUTION:

- Before starting out, check the operation of the lights and all car/trailer connections. After driving a short distance, stop and recheck the lights and connections.
- Reversing is difficult and requires practice. While backing-up, the trailer may pivot off-course. To correct for this, grip the bottom of the steering wheel and move your hand to the left to move the trailer to the left; or to the right to move the trailer to the right. Turn the steering wheel a little at a time, and keep the speed very low. Have someone guide you when backing.
- To help prevent overheating of the brakes, shift into a lower gear to make use of engine braking before descending steep or long grades. Do not make sudden downshifts.
- Pay strict attention to the coolant temperature gauge when going up hills. Because of the added load of the trailer, your car's engine may overheat on hot days. Turning off the air conditioning will reduce the load on the cooling system.
- On cars equipped with automatic transmission.
 - Do not hold the car stationary on an incline by using the accelerator pedal; this can cause the transmission fluid to overheat. Instead, use the handbrake or footbrake.
 - When towing trailers, avoid high transmission fluid temperatures (caused by the transmission frequently shifting between 3rd and 4th gears) by driving in D3.

NOTE:

Be sure to check state/province and local laws concerning maximum speed or other driving restrictions for cars towing trailers. If you are driving across several states/provinces, or countries, check all requirements before leaving home, because restrictions may vary.

Parking with a Trailer

Whenever parking your car on an incline with a trailer attached, place and seat chocks at each wheel of the car and trailer. This is in addition to the normal parking preparations of firmly applying the parking brake and placing the transmission in first or reverse (manual transmission) or P (automatic transmission).

CAUTION:

Parking on an incline is not recommended and should be done only if it cannot be avoided. Follow all precautions mentioned above and turn the wheels to point towards a curb if facing downhill, away from a curb if facing uphill. When leaving an inclined parking place, move the car slightly to unseat the chocks. Then, while keeping the foot brakes firmly applied, have an assistant remove the chocks.

Maintenance Schedule and Records

Your Honda automobile must be properly maintained to ensure that it is in peak operating condition and the emission levels are within the standards set by the Federal Clean Air Act**.

The following instructions and maintenance procedures are based on the assumption that your car will be used exclusively for the purpose for which it was designed:

1. To carry passengers and cargo within the load limits shown on the label on the driver's door jamb.
2. To be driven on reasonable road surfaces within legal limits.
3. To generally be driven daily over a distance of several miles (kilometers).
4. To use gasoline from pumps labeled unleaded, with a pump octane number of 86 or higher.

NOTE:

Failures which occur due to a lack of maintenance will not be covered under warranty.

The Required Maintenance Schedule* specifies all maintenance required to keep your car in peak operating condition. Work should be done by a Honda dealer but may be done by any qualified service facility or individual who is competent in this type of work.

US Cars:

Maintenance, replacement, or repair of emission control devices and systems may be done by any automotive repair establishment or individual using parts that are "certified" to EPA standards.

After the maintenance has been done, be sure to have your servicing dealer complete the Maintenance Record on pages 113 — 115. All required maintenance is considered normal owner operating cost and you will be charged for it by your dealer.

* For vehicles sold in California, maintenance operations indicated by *3 on page 112 are recommended by the manufacturer. Other maintenance operations are required by California regulations and condition the emission warranty.

** In Canada, Schedule E (S1101, S1102, S1103, and S1105) of the Canada Motor Vehicle Safety Standard, legislated in 1971 and as amended.

Check the following items at each fuel stop:

1. Engine oil level.
2. Engine coolant level.

Check the following items periodically:

1. Brakes: for braking efficiency, brake pedal travel and hydraulic fluid level.
2. Lights: for operation of headlights, taillights, side marker lights, stoplights, turn signals, and back-up lights.
3. Tires: for correct pressures (including spare), inspect for cuts and uneven or excessive wear. Rotate every 7,500 miles (12,000 km) in the pattern shown on page 140.
4. Steering: for excessive play or vibration while driving.
5. Exhaust system: for leaks or loose mounts.
6. Wipers: for operation of windshield wipers and washer, and condition of wiper blades.
7. Seat belts: for condition of fabric and buckles, and operation of the restraint mechanism.
8. Battery condition.

The Supplemental Restraint System (SRS) must be inspected by an authorized Honda dealer ten years after the date of manufacture printed on the certification label attached to the left rear door jamb. To serve as a reminder, note the date of manufacture and SRS inspection date here:

• Manufactured: _____

• SRS Inspection: _____
(add ten years to date of manufacture)

(cont'd)

Maintenance Schedule and Records (cont'd)

Service at the interval listed x 1,000 miles (or km) or after that number of months, whichever comes first.	R— Replace	*2 Thereafter, replace every 2 years or 30,000 miles (48,000 km), whichever comes first.					
	C— Clean						
	I— Inspect	*3 For cars sold in California, this service is recommended only; other areas, it is required.					
	After inspection, clean, adjust, repair or replace if necessary.						
*1 This service is recommended only.	*4 US: EX/SE/Anniversary Edition, Canada: EX-R/SE						
x 1,000 miles	15	30	45	60	75	90	105
x 1,000 km	24	48	72	96	120	144	168
months	12	24	36	48	60	72	84
Idle speed				I	*3		
Valve clearance	I	I	I	I	I	I	I
Alternator drive belt		I		I		I	
Timing belt and timing balancer belt						R	*1
Water pump						I	
◆ Engine oil and oil filter *	Replace every 7,500 miles (12,000 km) or 6 months.						
◆ Transmission oil		R		R		R	
Engine coolant *			R		R		R *2
Cooling system hoses and connections		I *3		I *3		I *3	
◆ Air cleaner element		R		R		R	
Fuel filter				R *3			
Fuel pipes, hoses, and connections		I *3		I *3		I *3	
Spark plugs		R		R		R	
Distributor ignition cap and rotor				I *3			
Ignition wires				I			
Positive crankcase ventilation valve				I			
Brake hoses and lines (Including Anti-lock brake system) *4	I	I	I	I	I	I	I
Brake fluid (Including Anti-lock brake system) *4		R		R		R	
◆ Front brake discs and calipers	I	I	I	I	I	I	I
Front brake pads	Inspect every 7,500 miles (12,000 km) or 6 months.						
◆ Rear brake discs, calipers and pads *4	I	I	I	I	I	I	I
Rear brake drums, wheel cylinders and linings	I	I	I	I	I	I	I
Parking brake	I	I		I		I	
Exhaust pipe (before catalytic converter)		I *3		I *3		I *3	
Exhaust pipe and muffler (after catalytic converter)	I	I	I	I	I	I	I
Suspension mounting bolts	I	I	I	I	I	I	I
Front wheel alignment	I	I	I	I	I	I	I
Steering operation, tie rod ends, steering gear box and boots	I	I		I		I	
Anti-lock brake system high pressure hose *4				R			
Anti-lock brake system operation *4		I		I		I	
◆ Power steering system	I	I	I	I	I	I	I
Power steering pump belt		I		I		I	
Three way catalytic converter heat shield				I			
Supplemental Restraint System	Inspect system 10 years after production (see page 23).						

● Check oil and coolant level at each fuel stop.

◆ Under severe driving conditions, service These items **more often**. (See page 114.)

Required Maintenance Record

- Have your servicing dealer record all Required Maintenance below.
- Keep receipts for all work done on your car.

7,500 Mi. 12,000 km (or 6 Mo.)	(Sign or Stamp)	Mileage (km)
		Date
15,000 Mi. 24,000 km (or 12 Mo.)	(Sign or Stamp)	Mileage (km)
		Date
22,500 Mi. 36,000 km (or 18 Mo.)	(Sign or Stamp)	Mileage (km)
		Date
30,000 Mi. 48,000 km (or 24 Mo.)	(Sign or Stamp)	Mileage (km)
		Date
37,500 Mi. 60,000 km (or 30 Mo.)	(Sign or Stamp)	Mileage (km)
		Date
45,000 Mi. 72,000 km (or 36 Mo.)	(Sign or Stamp)	Mileage (km)
		Date
52,500 Mi. 84,000 km (or 42 Mo.)	(Sign or Stamp)	Mileage (km)
		Date
60,000 Mi. 96,000 km (or 48 Mo.)	(Sign or Stamp)	Mileage (km)
		Date
67,500 Mi. 108,000 km (or 54 Mo.)	(Sign or Stamp)	Mileage (km)
		Date
75,000 Mi. 120,000 km (or 60 Mo.)	(Sign or Stamp)	Mileage (km)
		Date
82,500 Mi. 132,000 km (or 66 Mo.)	(Sign or Stamp)	Mileage (km)
		Date
90,000 Mi. 144,000 km (or 72 Mo.)	(Sign or Stamp)	Mileage (km)
		Date
97,500 Mi. 156,000 km (or 78 Mo.)	(Sign or Stamp)	Mileage (km)
		Date
105,000 Mi. 168,000 km (or 84 Mo.)	(Sign or Stamp)	Mileage (km)
		Date

(cont'd)

Maintenance Schedule and Records (cont'd)

Severe Driving Conditions

CAUTION:

The following items must be serviced more frequently on cars normally used under severe driving conditions. Refer to the chart below for the appropriate maintenance intervals.

Severe driving conditions include:

- A: Repeated short distance driving
- B: Driving in dusty conditions
- C: Driving in severe cold weather
- D: Driving in areas with road salt or other corrosive materials
- E: Driving on rough or muddy roads
- F: Towing a trailer

Condition	Maintenance item	Maintenance operation	Interval
• B • • E •	Air cleaner element	R	Every 15,000 miles (24,000 km) or 12 months
A B • • • F	Engine oil and oil filter	R	Every 3,750 miles (6,000 km) or 3 months
• • • • • F	Transmission oil	R	Every 15,000 miles (24,000 km) or 12 months
A B • D E F	Front brake discs and calipers, and rear brake discs, calipers and pads	I	Every 7,500 miles (12,000 km) or 6 months
• B C • E •	Power steering system	I	Every 7,500 miles (12,000 km) or 6 months

R-Replace

I -Inspect

After inspection, clean, adjust, repair or replace if necessary.

Non-Scheduled Maintenance Record

Record additional maintenance for severe driving conditions or non-scheduled maintenance on this page. (See page 112.)

Maintenance Performed:	(Sign or Stamp)	Mileage (km)
		Date
Maintenance Performed:	(Sign or Stamp)	Mileage (km)
		Date
Maintenance Performed:	(Sign or Stamp)	Mileage (km)
		Date
Maintenance Performed:	(Sign or Stamp)	Mileage (km)
		Date

Maintenance Performed:	(Sign or Stamp)	Mileage (km)
		Date
Maintenance Performed:	(Sign or Stamp)	Mileage (km)
		Date
Maintenance Performed:	(Sign or Stamp)	Mileage (km)
		Date
Maintenance Performed:	(Sign or Stamp)	Mileage (km)
		Date
Maintenance Performed:	(Sign or Stamp)	Mileage (km)
		Date
Maintenance Performed:	(Sign or Stamp)	Mileage (km)
		Date
Maintenance Performed:	(Sign or Stamp)	Mileage (km)
		Date
Maintenance Performed:	(Sign or Stamp)	Mileage (km)
		Date
Maintenance Performed:	(Sign or Stamp)	Mileage (km)
		Date
Maintenance Performed:	(Sign or Stamp)	Mileage (km)
		Date
Maintenance Performed:	(Sign or Stamp)	Mileage (km)
		Date
Maintenance Performed:	(Sign or Stamp)	Mileage (km)
		Date
Maintenance Performed:	(Sign or Stamp)	Mileage (km)
		Date

Fluid Locations

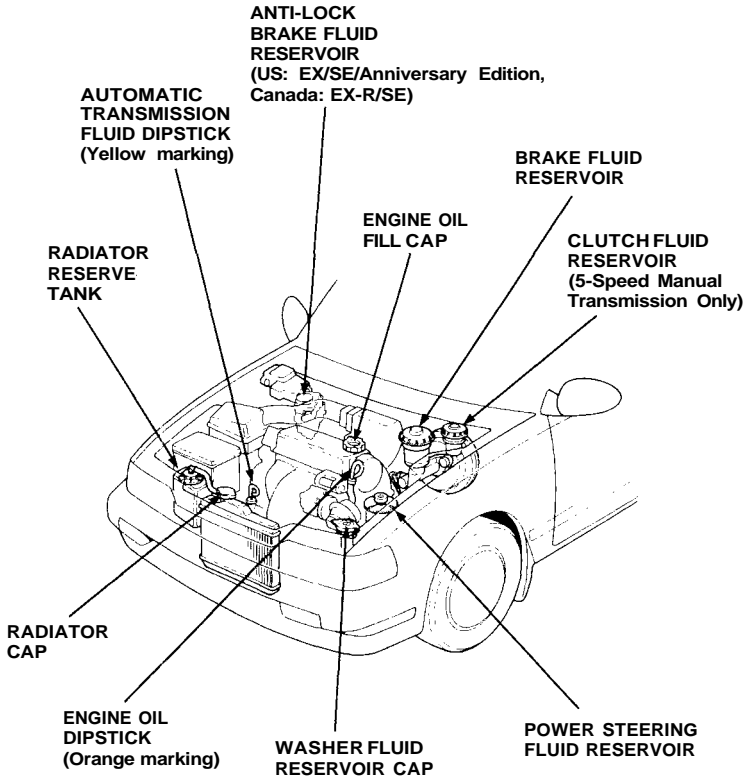

Engine Oil and Filter

Checking

Check the engine oil a couple of minutes after shutting the engine off, with the car parked on level ground. Remove the dipstick (orange marking) and wipe it clean. Re-insert it all the way down, then pull it out and read the level. The level should be between the upper and lower marks.

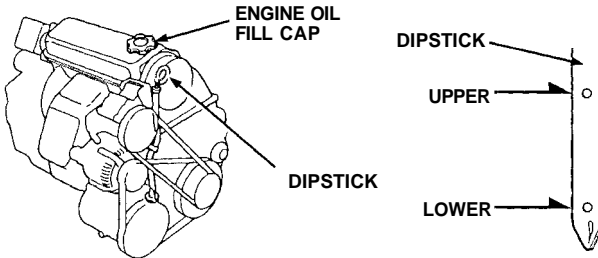

Adding

If the level has dropped close to the lower mark, add oil until it is even with the upper mark.

1. Turn the engine oil fill cap counterclockwise to remove. Add oil, then check the level again. Do not overfill.
2. Reinstall the cap and twist clockwise until it stops.

CAUTION:

Be sure the engine oil fill cap is correctly replaced before starting the engine.

Recommended Oil

Oil is a major contributor to your engine's performance and longevity. Always use a premium-grade detergent oil. You can determine an oil's SAE viscosity and Service Classification from the API Service label on the oil container. It should look like this:

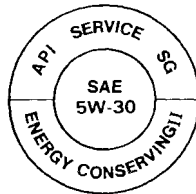

(cont'd)

Engine Oil and Filter (cont'd)

The numbers in the middle tell you the oil's SAE viscosity or weight. Select the oil for your car according to this chart:

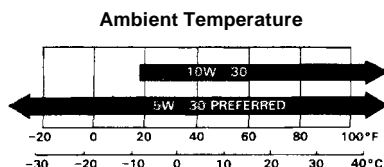

An oil with a viscosity of 5W-30 is preferred for improved fuel economy and year-round protection in your Honda. You may use a 10W-30 oil if the climate in your area is limited to the temperature range shown on the chart.

A fuel-efficient oil is recommended for your Honda. This is shown on the API Service label by the words "Energy Conserving II." This oil is formulated to help your engine use less fuel.

The API Service label also tells you the service classification of the oil.

Always use an oil that says "API Service SG." This service rating may also include other designations, such as CD. These additional classifications are not a problem, as long as the label also carries the SG classification. An oil that is only classified SF is not recommended.

Changing Oil and Filter

Engine oil and the filter should be changed together every 6 months or 7,500 miles (12,000 km), whichever comes first. The filter is located on the engine block, below the intake manifold.

CAUTION:

The oil filter cannot easily be removed from above the engine. For this reason it is recommended that the oil filter change be done by a skilled mechanic.

1. Start the car to warm up the engine, then shut it off.
2. Remove the engine oil fill cap and drain bolt, and drain the oil.

▲ WARNING

A warmed-up engine and the oil in it are hot; be careful not to burn yourself.

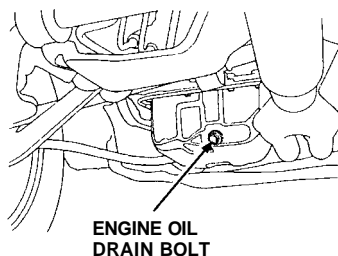

-
3. Remove the oil filter and let the remaining oil drain out.
 4. Install a new filter according to the instructions on or with the filter.
 5. Reinstall the drain bolt with a new washer and tighten it securely. Refill the engine with the recommended oil, to the upper mark on the dipstick.

ENGINE OIL CHANGE CAPACITY
(including filter):

3.8 ℓ (4.0 US qt, 3.3 Imp qt)

6. Reinstall the engine oil fill cap securely.
7. Start the engine and make sure oil is not leaking from the drain bolt or the filter.
8. Shut off the engine and recheck the oil level.

NOTE:

Please dispose of used motor oil in a manner that is compatible with the environment. We suggest you take it in a sealed container to your local service station for reclamation. Do not throw it in the trash or pour it on the ground.

CAUTION:

Used motor oil may cause skin cancer if repeatedly left in contact with the skin for prolonged periods. Although this is unlikely unless you handle used oil on a daily basis, it is still advisable to thoroughly wash your hands with soap and water as soon as possible after handling used oil.

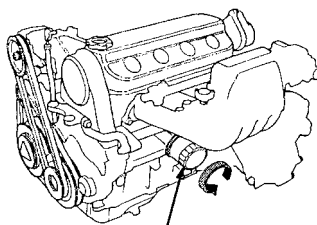

OIL FILTER

Transmission Oil/Fluid Check

Transmission oil/fluid must be checked with the engine off and the car on level ground.

⚠ WARNING

- If the engine has been running, some engine components may be hot enough to burn you.
- Keep hands away from the radiator fan. The fan may start automatically without warning and run for up to 15 minutes, even after the engine is turned off.

CAUTION:

If the oil/fluid level is low, check for possible leaks before adding oil. Do not overfill.

Since the transmission and differential are in the same housing, you are actually checking both oil/fluid levels in one procedure. Change transmission oil/fluid according to the Maintenance Schedule on page 112.

5-Speed Manual Transmission

Remove the oil filler bolt (beside the right axle). Feel inside the bolt hole with your finger. If the oil is up to the bottom edge of the hole, the oil level is correct. If it is not, slowly add oil until it runs out of the hole, then reinstall the bolt and tighten it securely with a wrench.

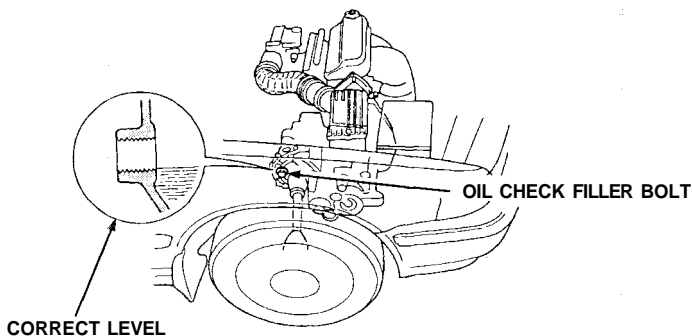

5-SPEED MANUAL TRANSMISSION

OIL CHANGE CAPACITY: 1.9 ℓ (2.0 US qt, 1.7 Imp qt)

Use only API Service SF or SG grade motor oil when adding or changing transmission oil.

Use the proper SAE viscosity oil for the climate in which you drive:

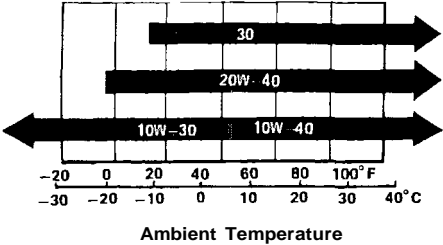

Automatic Transmission

The automatic transmission fluid level is checked (with the engine off and the car on level ground) using the dipstick (with the yellow marking) in the right end of the transmission housing. Remove the dipstick and wipe it off.

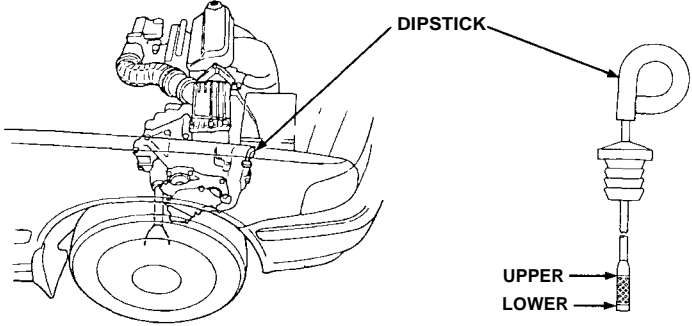

Insert the dipstick and remove it. The fluid level should be between the upper and lower marks.

If necessary, add fluid and recheck. Use Honda Premium Formula Automatic Transmission Fluid or an equivalent DEXRON® II Automatic Transmission Fluid (ATF) only when adding or changing fluid. After checking the fluid level, push the dipstick in securely.

AUTOMATIC TRANSMISSION

FLUID CHANGE CAPACITY: 2.4ℓ (2.5 US qt, 2.1 Imp qt)

Cooling System

The engine in your Honda contains a number of aluminum parts. Therefore, it requires an antifreeze/coolant specifically formulated to protect the aluminum parts from corrosion. Failure to use a suitable antifreeze/coolant may seriously shorten the life of the engine as the result of rapid corrosion damage. Some antifreeze/coolants, although labeled for use in engines containing aluminum, may not provide adequate protection for your engine.

Therefore, use only a Honda-recommended antifreeze/coolant.

CHECK WITH YOUR AUTHORIZED HONDA DEALER.

For best corrosion protection, the mixture of coolant and water must be maintained year-round at 50/50. Concentrations less than 50% coolant may not provide sufficient protection against corrosion and freezing. Concentrations of greater than 60% coolant will impair cooling efficiency and are not recommended. Low-mineral drinking water or distilled water should be mixed with the antifreeze/coolant. Coolant loss should be replenished by a mixture containing the proper concentration of antifreeze and water.

Do not mix different antifreeze/coolants.

Do not use additional rust inhibitors or anti-rust products, as they may not be compatible with the coolant.

ENGINE DAMAGE CAUSED BY IMPROPER COOLANT USAGE IS NOT COVERED BY THE NEW CAR WARRANTY.

Checking Engine Coolant

Check the coolant level in the reserve tank when the engine is at normal operating temperature.

- If the level is below the MAX mark, but still visible, add a 50/50 solution of antifreeze and water to bring it up to MAX.
- If there is no coolant in the reserve tank, the cooling system should be checked for leaks and repaired if necessary. Coolant must then be added to the radiator.

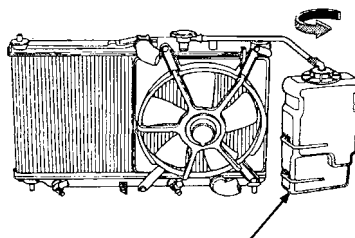

RESERVE TANK

▲ WARNING

- Do not remove the radiator cap when the engine is hot; the coolant is under pressure and could severely scald you.
- Keep hands away from the radiator fan. The fan may start automatically without warning and run for up to 15 minutes, even after the engine is turned off.

CAUTION:

Engine coolant will damage paint. Quickly rinse any spilled coolant from painted surfaces.

Wait until the engine is cool, then turn the radiator cap counterclockwise until it stops. **DO NOT PRESS DOWN WHILE TURNING THE CAP.** After any remaining pressure has been relieved, remove the cap by pressing down and again turning it counterclockwise. Add enough coolant to fill the radiator, and reinstall the cap. Be sure to tighten it securely. Fill the reserve tank up to the **MAX** mark with the engine cold.

Maintenance

1. Check the freeze protection level of the coolant with a hydrometer.
2. Keep the front of the radiator free of dirt and debris.
3. Check hoses and hose clamps regularly.

Replacing Engine Coolant

Replace coolant at 36 months or 45,000 miles (72,000 km), whichever comes first. Thereafter, replace every 2 years or 30,000 miles (48,000 km), whichever comes first.

ENGINE COOLANT**REFILL CAPACITY:**

(including reserve tank)

Reserve tank capacity: 0.6 ℓ (0.16 US gal, 0.13 Imp gal)

5-speed manual transmission: 3.0 ℓ (0.79 US gal, 0.66 Imp gal)

Automatic transmission: 3.5 ℓ (0.92 US gal, 0.77 Imp gal)

(cont'd)

Cooling System (cont'd)

1. Set the heater temperature control dial/lever to maximum heat.
2. Remove the radiator cap and loosen the drain plug when the radiator is cool, and drain the radiator.

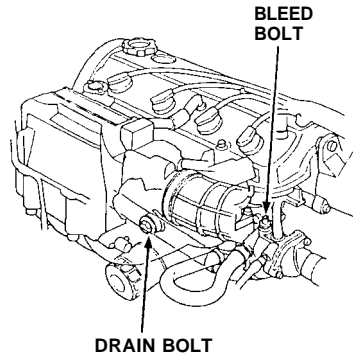
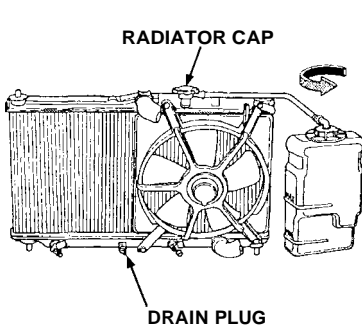

3. Remove the drain bolt from the rear side of the cylinder block, and drain the engine and heater.
4. Apply non-hardening sealant to the drain bolt threads, then reinstall the bolt and tighten it securely.
5. Tighten the radiator drain plug securely.
6. Mix the recommended antifreeze with an equal amount of low-mineral or distilled water and fill the reservoir to maximum, as illustrated.

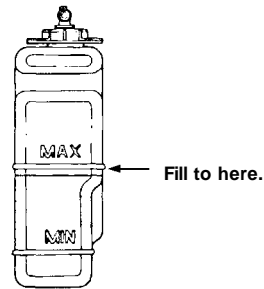

7. Loosen the air bleed bolt in the water outlet, then fill the radiator to the filler neck with the coolant mixture. Tighten the bleed bolt as soon as coolant starts to run out in a steady stream without bubbles.

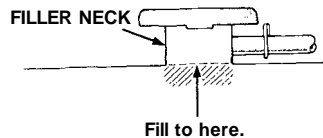

8. With the radiator cap off, start the engine and let it run until warmed up (fan goes on at least twice). Then, if necessary, add more coolant mix to bring the level back up to the filler neck.
9. Put the radiator cap on, then run the engine again and check for leaks.

Brake System Design

The diagonally-separated dual service brake system is designed so half the system will still provide braking action if the other half fails.

Stopping the car after losing the brake fluid from half the system will require more pedal pressure and pedal travel than normal. Also, the

distance required to stop will be longer using only half the brake system. If the brakes fail suddenly, downshift to a lower gear for increased engine braking, and pull off the road as soon as possible.

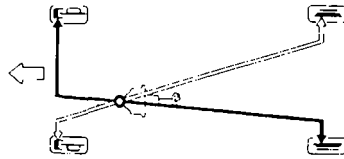

▲ WARNING

- It is hazardous to drive your car with a problem in either the brake electrical or hydraulic system; have your dealer check both systems if you suspect brake trouble.
- Do not ride the brakes. In other words, don't put your foot on the brake pedal unless you intend to brake. This causes excessive brake wear and can damage, or lead to loss of braking effectiveness through overheating. Your brake lights may also confuse drivers behind you.
- Driving through deep water may affect the brakes. Check their effectiveness by pressing the brake pedal gently. If the car does not slow down at the normal rate, continue gently applying the brakes, while maintaining a safe speed, until they dry out and normal performance returns.

Brake Wear

Both front and rear brakes should be inspected for wear at the intervals shown in the Maintenance Schedule on page 112.

When the brakes require maintenance, use only genuine Honda replacement parts or their equivalent.

Brake Wear Indicators

Your car is equipped with audible brake wear indicators. When the brake pads need to be replaced, the wear indicators will make a "screching" sound or a high-pitched chirp.

NOTE:

Due to some driving habits or climates, brakes may "squeal" when you first apply them or when you have them partially applied; this is normal, and does not indicate excessive wear. The wear indicator makes a "screching" sound while the brakes are applied.

(cont'd)

Brakes (cont'd)

Brake Fluid

Check the fluid level in the brake reservoir periodically; it should be between the MAX and MIN marks on the reservoir.

If the level is near the MIN mark, add fluid to raise it to the MAX mark. Do not overfill. Use only brake fluid manufactured to DOT 3 or DOT 4 specifications (see reservoir cap) from a sealed container. Follow the manufacturer's instructions printed on the can.

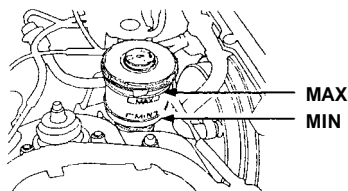

NOTE:

A low brake fluid level may be an indication of brake pad wear or of brake fluid leakage. You should have your brakes checked if the brake fluid level in the reservoir is low before re-filling it.

CAUTION:

The arrow on the reservoir cap must be pointing forward after the cap is installed. Make sure the brake warning switch wiring doesn't get caught between the cap and top edge of the reservoir.

Anti-lock Brake Fluid (US: EX/SE/Anniversary Edition, Canada: EX-R/SE)

Check the fluid level in the ABS reservoir periodically.

To check, drive the car for a few minutes to equalize fluid pressure in the system.

The level should be between the MAX and MIN marks on the reservoir. If the level is near the MIN mark, add fluid to raise it to the MAX mark.

Do not overfill. Use only brake fluid manufactured to DOT 3 or DOT 4 specifications from a sealed container.

Follow the manufacturer's instructions printed on the can.

If the level is more than 10 mm (0.4 in) above the MAX mark, it may indicate a malfunction of ABS. Have an authorized Honda dealer check the system as soon as possible.

ANTI-LOCK BRAKE FLUID RESERVOIR

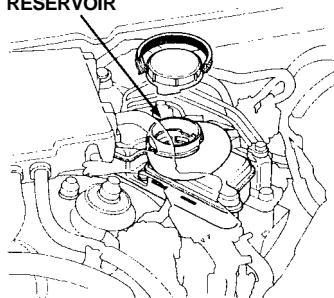

Clutch Fluid (5-Speed Manual Transmission)

Check the fluid level in the clutch reservoir periodically; it should be between the MAX and MIN marks on the reservoir.

If the level is near the MIN mark, add fluid to raise it to the MAX mark. Do not overfill. Use only brake fluid manufactured to DOT 3 or DOT 4 specifications from a sealed container. Follow the manufacturer's instructions printed on the can.

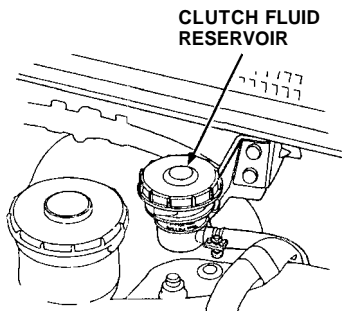

NOTE:

A low clutch fluid level may be an indication of clutch fluid leakage. You should have your clutch checked if the clutch fluid level in the reservoir is low.

Power Steering

The power steering on your car helps provide easy handling while parking and maneuvering in traffic, without loss of road "feel" at highway speeds. An engine-driven hydraulic pump provides full power assist at low speeds and decreasing assist as the car goes faster.

CAUTION:

If the power steering system should fail, or if the engine should stall, the car can still be steered. However, much greater effort will be required, particularly in sharp turns at low speed.

NOTE:

You may feel a slight clunk or knock when turning the wheel with the engine off. This is a normal condition due to the design of the system.

Power Steering Fluid

Check the power steering fluid level with the engine cold and the car parked on level ground. Make sure the fluid level is between the upper and lower marks on the reservoir. If the level has dropped close to or below the lower mark, check for leaks before adding fluid to the upper mark. Do not overfill.

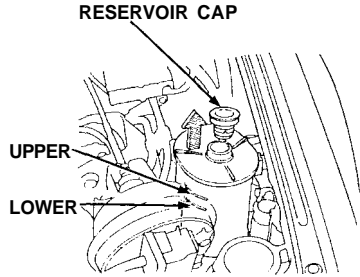

CAUTION:

Use only GENUINE HONDA Power Steering Fluid-V. The use of other fluids such as A.T.F. or other manufacturer's power steering fluid will damage the system.

Air Cleaner and Fuel Filters

Air Cleaner

Replace the air cleaner element every 24 months or 30,000 miles (48,000 km), whichever comes first (more often in extremely dusty conditions).

Loosen the attaching bolts, then remove the air cleaner housing cover.

Remove the air cleaner element and replace it with a new air cleaner element. Reinstall the cover and tighten the bolts.

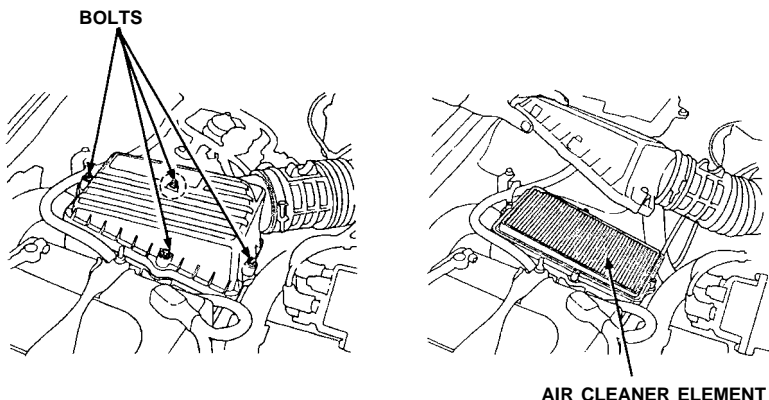

Fuel Filters

The fuel filter is located in the engine compartment, on the right center of the lower dashboard. It should be replaced at 60,000 miles (96,000 km) or 48 months whichever comes first, or any time you suspect contaminated fuel may have clogged it.

▲ WARNING

Because the fuel system is under pressure, the filter should be replaced only by a qualified Honda technician.

Spark Plugs

Spark plugs should be replaced every 24 months or 30,000 miles (48,000 km), whichever comes first.

Recommended spark plugs:

ZFR5F-11 (NGK) KJ16CR-L11 (NIPPONDENSO)

(for all normal driving)

ZFR6F-11 (NGK) KJ20CR-L11 (NIPPONDENSO)

(for hot climates or continuous high speed driving)

▲ WARNING

Keep hands away from the radiator fan. The fan may start automatically without warning and run for up to 15 minutes, even after the engine is turned off.

CAUTION:

Never use spark plugs with an improper heat range; they will adversely affect engine performance and durability.

Replace plugs one at a time, so you don't get the wires mixed up.

1. Clean any dirt from around the spark plug base.
2. Disconnect the plug cap, then remove and discard the old plug.
3. Check the gap of the new spark plug before installation.

Plug gap should be:

1.1 mm (0.04 in)

4. Thread the new spark plug in by hand to prevent cross-threading.
5. After the plug seats against the cylinder head, tighten 1/2 turn with a spark plug wrench to compress the washer.
6. Reinstall the spark plug cap.

CAUTION:

The spark plugs must be securely tightened, but not overtightened. A plug that's too loose can get very hot and possibly damage the engine; one that's too tight could damage the threads in the cylinder head.

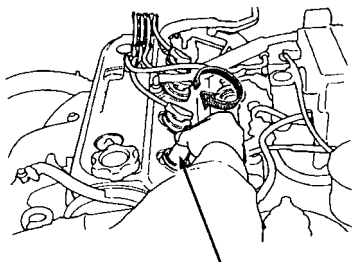

Thread in by hand.

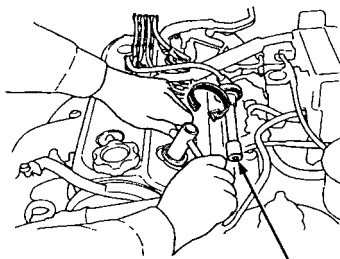

PLUG CAP

Wiper Blades

For maximum visibility, replace worn or cracked wiper blades when you notice they do not wipe the windshield cleanly or smoothly.

To Replace Worn-out Blades

1. Detach the blade assembly from the arm by pressing the lock tab in, then pushing the blade toward the base of the arm.

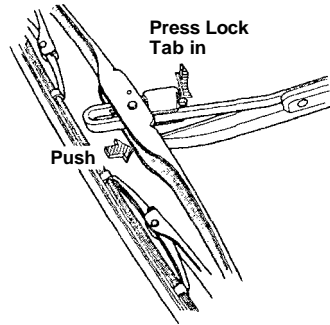

2. Firmly grasp the end of the blade rubber and pull until the tabs are free of the metal support.

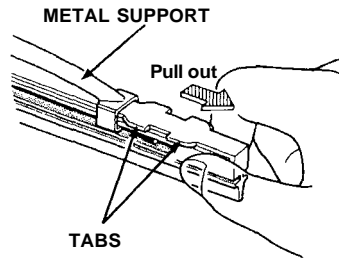

3. Remove the metal retainers from the worn-out blade rubber and put them in a new blade rubber.

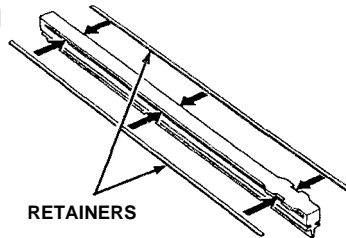

4. Insert the new blade rubber from the opposite side of the blade tabs and position the tabs in the metal support.

5. Reinstall the blade assembly on the wiper arm.

Battery

The condition of the battery can be determined by checking the test indicator. Service as required according to the label on the battery.

Any corrosion around the positive and negative terminals should be washed off with a solution of baking soda and warm water. Dry the terminals and then coat them with grease.

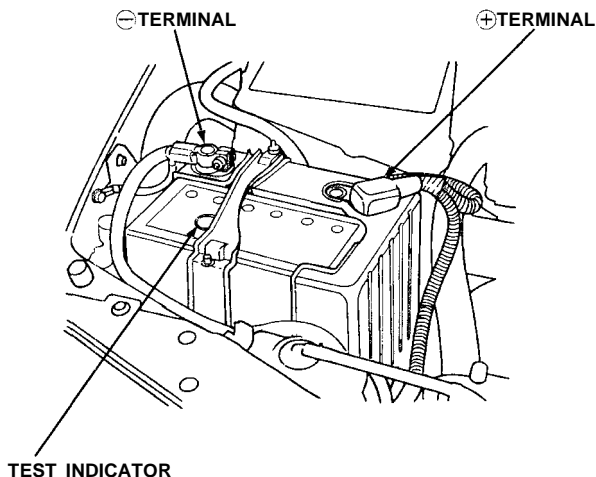

▲ WARNING

- The battery gives off explosive gases; keep sparks, flames, and cigarettes away. Provide adequate ventilation when charging or using the battery in an enclosed space.
- The battery contains sulfuric acid (electrolyte). Contact with skin or eyes may cause severe burns. Wear protective clothing and a face shield.
 - If electrolyte gets on your skin, flush with water.
 - If electrolyte gets in your eyes, flush with water for at least 15 minutes and call a physician immediately.
- Electrolyte is poisonous.
 - If swallowed, drink large quantities of water or milk and follow with milk of magnesia or vegetable oil and get immediate medical assistance.

KEEP OUT OF REACH OF CHILDREN.

Fuse Replacement

One of the two fuse boxes in your car is located under the dashboard on the driver's side. The circuits protected by each fuse are listed inside the fuse box cover. To open the fuse box, turn the knob as shown.

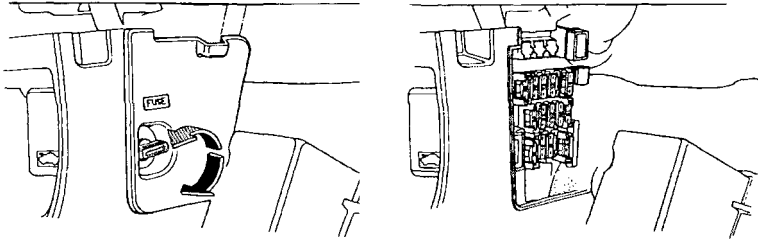

If any of your car's lights, accessories, or controls don't work, check their fuses. If a fuse has blown, the wire inside it will be burned through.

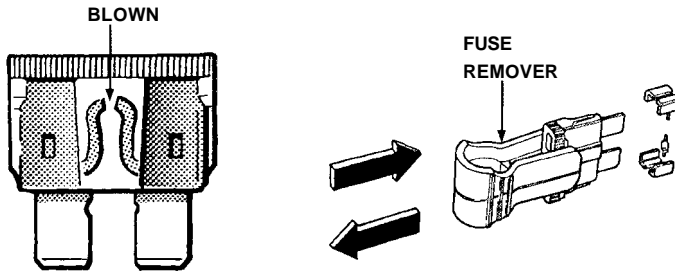

Checking the fuses:

1. Turn off the ignition and all other switches.
2. If you find a blown or possibly faulty fuse, use the fuse remover stored beside the spare fuse to pull the blown fuse out of its clips.
3. Check all other fuses as well as the one you suspect.
4. Push in a new fuse of the same rating, and make sure it fits tightly in the clips. If it fits loosely, have your dealer fix it.

If you don't have a spare, take a fuse of the same rating (or lower) out of a circuit you may not need, like the radio or cigarette lighter. Remember to replace the borrowed fuse and the missing spares.

(cont'd)

Fuse Replacement (cont'd)

CAUTION:

A blown fuse may be just a symptom of some other problem. If a new fuse blows right away, the cause should be diagnosed and corrected by a qualified Honda technician. Never replace a fuse with anything but another fuse of the same or lower rating. A higher capacity fuse could cause damage and even start a fire.

The main fuses and some primary fuses are installed in the fuse box on the right front fender in the engine compartment.

If the circuits from the battery are ever overloaded (by a short in the system drawing too much current for example), a main fuse will blow preventing damage to the entire wiring harness. If the main fuse blows, have a Honda dealer check the system, repair the cause, and replace the fuse.

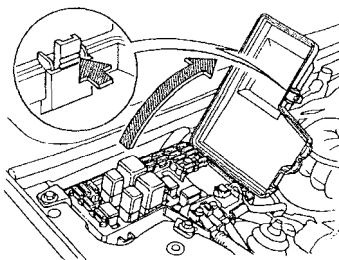

(US: EX/SE/Anniversary Edition,
Canada: EX-R/SE)

The fuses for Anti-lock brake system are installed next to the air cleaner housing.

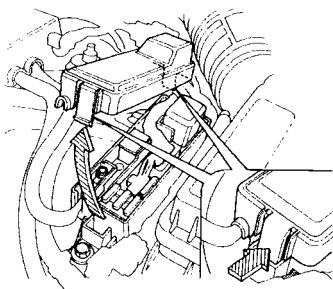

CAUTION:

- The electrical system is protected by fuses that are designed to fail and prevent damage to the wire harness. Always replace blown fuses with the same rating as specified to prevent wiring damage that can result in a possible fire.
- For proper electrical contact after replacing these fuses, make sure all screws are tight.

Bulb Replacement

See page 159 for bulb specifications.

Front turn signal lights

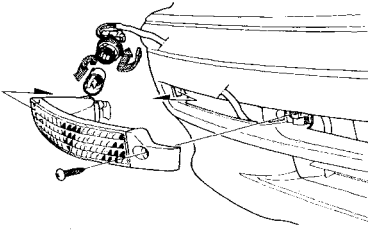

Front side marker and turn signal lights/position lights

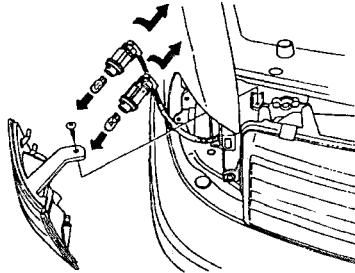

Rear turn signal/brake and taillights

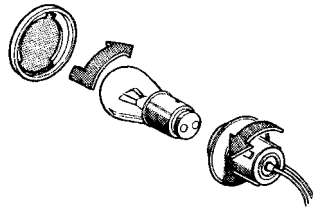
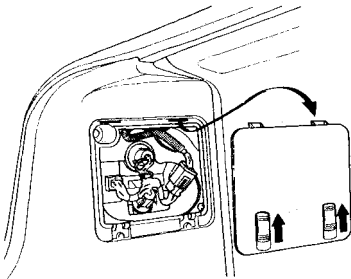

Brake and taillights/
back-up lights

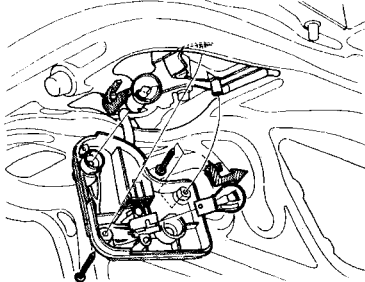

License plate lights

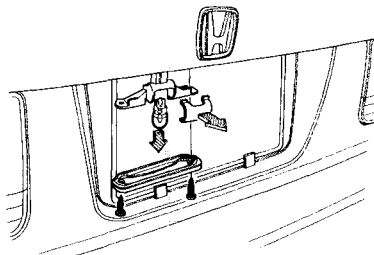

(cont'd)

Bulb Replacement (cont'd)

Interior light

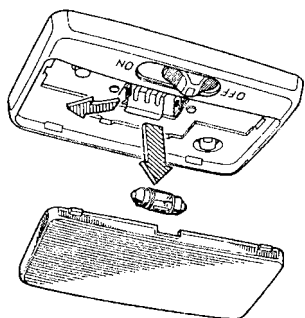

Vanity mirror light
(US: LX/EX/SE/Anniversary Edition,
Canada: EX/EX-R/SE)

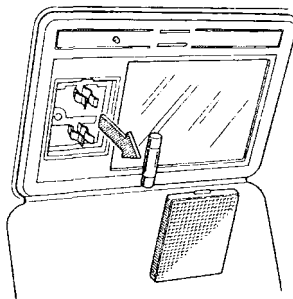

Door courtesy lights

(US: LX/EX/SE/Anniversary Edition, Canada: EX/EX-R/SE)

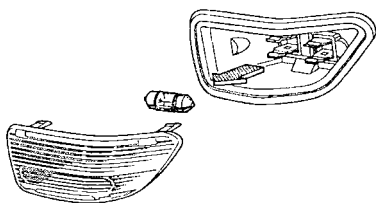

(Front)

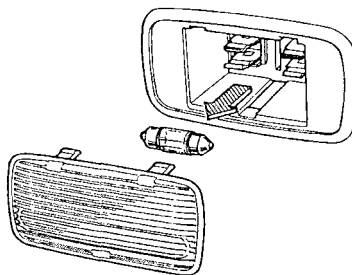

(Rear)

High-mount brake light

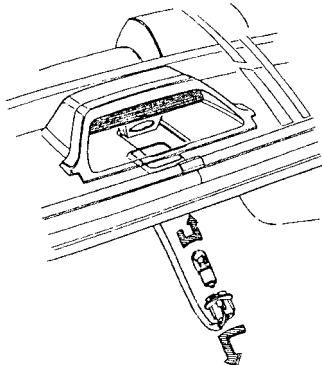

Trunk light

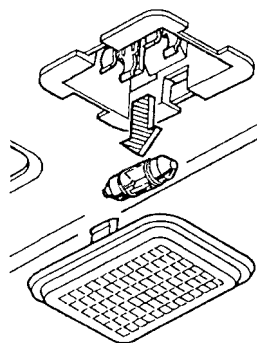

The factory installed tires on your car were selected to match the car's performance capabilities and to provide the best combination of handling, ride comfort, and tread wear.

We recommend that you get the same size, type, and grade of tires when replacement is necessary. If your tires have an all-season tread design, the model name will be followed by the marking: "M + S" (mud and snow) or "all-season".

If you decide not to get the same brand of tires as those originally installed, you should make sure that the replacements are the radial type, of the same size, load range, and speed rating as the original tires.

If you have any questions about your car's tires, please contact your Honda dealer.

Inflation Pressures

The tire label on the driver's door jamb shows recommended tire pressures for carrying loads up to the limit shown.

These pressures were chosen to provide you with the best combination of tread life, riding comfort and stability under normal driving conditions.

Improper inflation can reduce both tire life and load carrying capacity.

Check the tire pressures at least once a month, including the spare. Lower pressure than recommended lets the tread and sidewalls flex too much, causing increased tire temperatures, uneven wear, and poor handling. Pressure higher than recommended can make the tire too stiff, increasing the chance of damage from road hazards, and also causing uneven wear.

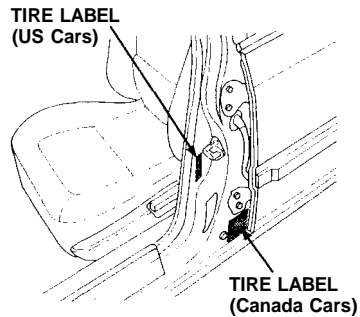

CAUTION:

- **Check tire pressure when the tires are cold.**
(After the car has been parked for more than 3 hours or driven less than 1 mile/1.6 km.)
- **Tire pressure may increase as much as 41 kPa (6 psi) when the tire is hot, so NEVER ADJUST tire pressure when the tires are hot.**
- **Never inflate load range B tires to more than 220 kPa (32 psi) cold.**
- **Cars with luggage racks or cartop carriers DO NOT have greater load limits than those on the label.**

(cont'd)

Tires (cont'd)

Winter Driving

Tires marked "M + S" or "all season" have an all-weather tread design and should be suitable for most driving conditions. However, snow tires and tire chains may be required under some conditions. If your tires do not have these markings, they may not be suitable for winter driving conditions. We recommend snow tires or tire chains for snow and icy conditions.

Snow Tires

If you use snow tires, they should be of the same size, construction and load capacity as the original tires on your car. Snow tires must be installed in sets of four, or they may cause poor handling. Driving with snow tires on dry roads can reduce your car's performance during acceleration, turning, and stopping.

If you need further information on snow tires, please contact your Honda dealer.

Tire Chains

Use chains only when conditions require them. Check with local authorities for requirements prior to installing tire chains. Make sure the chains are the right size for your tires. Install them only on the drive wheels of your car, and do so as tightly as possible, following the manufacturer's instructions. If metal chains are used, they must be SAE Class "S." Cable type traction devices can also be used. Drive slowly with chains installed. If you hear the chains contacting your car's body or chassis, stop and tighten them.

CAUTION:

- **If the contact continues, slow down until it stops or your car can be damaged.**
- **Chains that are the wrong size or improperly installed can damage your car's brake lines, suspension, body, and wheels.**

If you need further information on tire chains, please see your Honda dealer.

Remove the chains as soon as the road is clear of ice and snow.

Tire Replacement

Honda recommends that you replace tires in sets of four, or in pairs, front or rear. If you need to replace only one tire, mount the new tire opposite the tire showing the least amount of wear.

For instance, if the left front tire shows the least amount of wear, mount the new tire on the front right side.

The original tires on your car have tread wear indicators to indicate when they should be replaced. The indicators appear as bands about 12.7 mm (1/2 in) wide when the tire tread depth is less than 1.6 mm (1/16 in). When indicators appear across two or more grooves in a row, you should replace the tire.

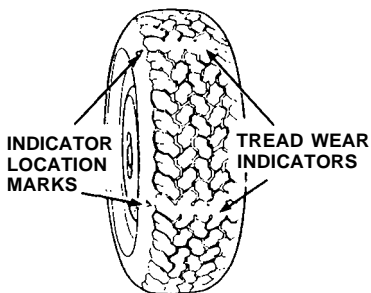

▲ WARNING

Driving on worn-out tires is very hazardous, and will reduce braking effectiveness, steering accuracy and traction.

When replacing tires, use only the recommended tire size. Wheel rim widths and offsets must be those recommended by Honda Motor Co., Ltd. Contact the Zone Office nearest you as shown on the inside of the back cover.

▲ WARNING

Tires and wheels other than those recommended may be unsafe. Do not mix radial and bias ply tires on the same car.

(cont'd)

Tires (cont'd)

Tire Balancing

▲ WARNING

Unbalanced tires may affect handling and tire wear. A tire should always be rebalanced after it has been dismantled from the wheel.

Your original tires were properly balanced before the car left the factory, but may need rebalancing at some time during the life of the tire. Tire balancing for the COMPACT spare is not necessary.

CAUTION:

Use only Genuine Honda aluminum wheel weights if your car is equipped with aluminum wheels. Non genuine Honda wheel weights may corrode and damage the aluminum wheel.

Tire Rotation

Tires may wear unevenly when used for a long time in the same position on the car. To avoid this, rotate the tires every 7,500 miles (12,000 km). If abnormal or uneven wear develops between rotations, the cause should be found and corrected as soon as possible. The illustration shows how the tires can be rotated. The COMPACT spare tire must not be included in tire rotation.

NOTE:

Brake pads should be inspected for wear whenever the tires are rotated.

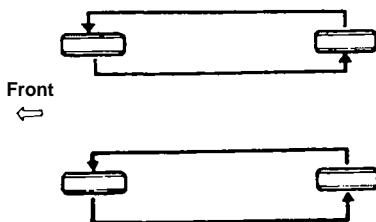

Tire Traction

▲ WARNING

Worn tires or slippery road surfaces can reduce driving, cornering and braking traction. To reduce the possibility of losing traction, slow down when the road gets slippery, replace tires when wear indicators are visible, and KEEP TIRES PROPERLY INFLATED.

Condenser and Radiator

Check the engine radiator and the air conditioning condenser (in front of the radiator) for accumulated dirt, insects or leaves. Carefully brush or hose them off to assure maximum cooling performance.

CAUTION:

Radiator and condenser fins are very thin and easily damaged; do not bend them with the high water pressure or brush.

Compressor Drive Belt

Check the compressor belt tension monthly, during periods when you use the air conditioning a lot.

▲ WARNING

If the engine has been running, some engine components may be hot enough to burn you.

When pushed with 98 N (22 lb) of force midway between the alternator pulley and the engine crankshaft pulley, the belt should deflect about:

10—12 mm (0.4—0.5 in)

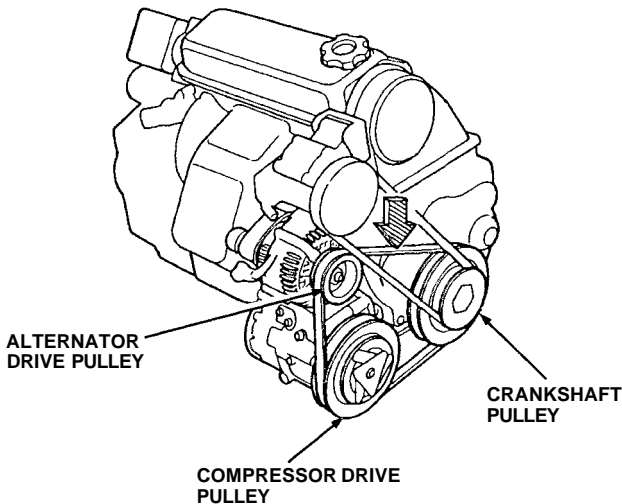

(cont'd)

Air Conditioning Care (cont'd)

System Maintenance

Run your air conditioning at least once a week for about ten minutes, even during the off season, to lubricate the seals and the inside of the compressor and, to verify that the system is functional.

If the air conditioning is not cooling properly, it may indicate an undercharged system. Have your dealer check the system for leaks, then evacuate and charge the system with refrigerant 12.

Charging quantity:

800-850 g (28.3-30.1 oz)

CAUTION:

Prolonged use of an undercharged system may damage the compressor.

Interior Trim

Remove dust and loose dirt with a vacuum cleaner. Wipe the vinyl with a clean, damp cloth or sponge. Stains can be removed with a commercially available vinyl cleaner.

Leather Upholstery (SE)

Clean the leather upholstery with a mild soap and lukewarm water; wipe with a damp cloth, then dry with a soft cloth. Never use varnish or furniture polish on the interior.

▲WARNING

Do not use thinner, gasoline, kerosene, naphtha, or other solvents on the interior. They are toxic, flammable, and hazardous and could damage the material you're cleaning.

Windows

A 10 to 1 mix of water and white vinegar, or a commercially available glass cleaner may be used to clean windows and to remove the dust film sometimes caused by the ingredients used in interior vinyls and plastics.

NOTE:

Do not put this solution in the windshield washer reservoir, it will damage the windshield washer pump.

Be careful not to scratch or damage the defogger wires when cleaning the inside of the rear window; wipe the window horizontally along the wires, not up and down.

Dry the windows with a lint-free cloth or paper towel. Keep all the windows clean for maximum visibility.

Appearance Care (cont'd)

Exterior Care

Washing

Rinse all loose dirt off the car by spraying it with lukewarm or cold water. Do not use hot water.

Wash using a soft-bristle brush, sponge, or cloth with water containing a mild detergent such as a liquid dishwashing detergent.

Remove oil, tar, tree sap, etc., with tar remover or turpentine. Remove road salt, insects, etc., with mild detergent and lukewarm water. Any of these substances may damage the finish if left on painted surfaces.

Rinse the car well. Promptly wipe with a chamois or soft towel to prevent water-spotting. Do not let water or soap air-dry on painted surfaces.

During wiping, inspect the surface for stone chips and scratches; paint them with touch-up paint so they won't rust (touch-up paint is available through your Honda dealer).

For further instructions on corrosion protection, refer to the Rust Prevention section on the next pages.

Waxing

Wax the car when water will no longer "bead" on the paint.

Always wash and dry the car before you wax it.

Use a good quality liquid or paste wax, and follow the manufacturer's instructions. Wax all the metal trim to keep its luster.

NOTE:

Removing oil, tar, etc., with a spot remover will usually strip the wax from the surrounding finish. Be sure to re-wax these areas even if the rest of the car does not yet need waxing.

Power Antenna Cleaning

Clean the antenna mast twice a year. Use mild dish detergent on a dry cloth. Scrub the antenna in upward strokes to avoid bending it. Rinse with water. The antenna does not need lubricating oil.

Aluminum Alloy Wheels

(US: EX/SE/Anniversary Edition, Canada: EX-R/SE)

CAUTION:

- **Wash the wheels after driving on snowy or icy roads where salt has been applied.**
- **Avoid off-road driving. Brush, rocks, dirt, and severe impact may damage the wheels.**
- **Install tire chains carefully. Improperly installed chains can cause damage to the wheels.**
- **Honda aluminum wheels are treated with a protective finish. Wash them with a low-phosphate detergent and sponge. Do not use abrasive cleaners or stiff brushes.**
- **Always install aluminum wheels in sets of four. If mixed with other types, the car's handling may be affected.**

Rust Prevention

Rusting is likely to occur in parts of the car where water is trapped or where there is continual dampness.

- Water will collect inside doors and body panels if drain holes become clogged.
- Water which seeps under or soaks floor mats will subject floor sections to prolonged wetness or dampness.
- Road dirt or sand, which collects and fills recesses on the underside of the car, retains moisture long after the rest of the car has dried.

The removal of paint and undercoating by stones, gravel, and minor accidents immediately exposes metal to air and moisture.

Rusting is increased by high humidity and by the presence of corrosive substances in the air or on the roads.

- Salt used for road de-icing will coat the bottom of the car and hasten rusting.
- Localities with high humidity have greater potential for rust problems, especially where salt is also present on the road or in moist sea air.
- Industrial pollution will accelerate the deterioration of paint finishes and promote rusting.

(cont'd)

Appearance Care (cont'd)

Preventive Service

Check all drain holes in the doors and body panels for clogging and clear if necessary. When washing your car, also clean the underside of the car by using high pressure water; ① above subframe, ② inside front fender, ③ rear suspension, ④ inside rear wheel housing, and ⑤ under rear bumper.

After washing your car or after heavy rain, check for leaks. Dry any wet areas of your car's interior. Have leaks repaired as soon as possible.

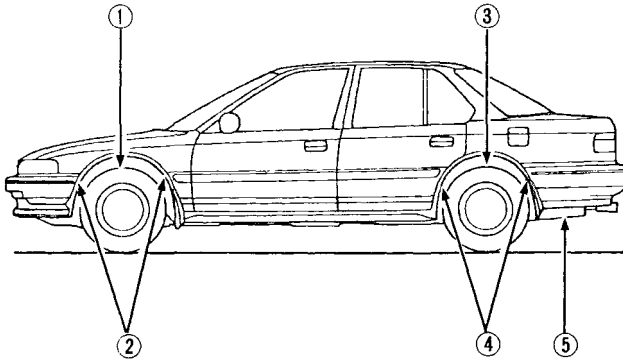

CAUTION:

Cars with ABS have a speed detection device mounted at each wheel. Care should be taken when clearing mud, snow, etc., from the wheels not to damage the detectors.

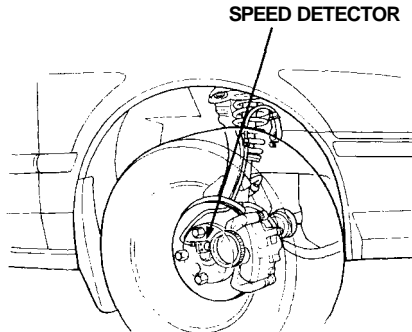

Replacement Body and Fender Parts

If your vehicle incurs body damage and requires replacement parts, we encourage you to use only Genuine Honda sheet metal body and fender parts. Many insurance companies are specifying imitation sheet metal parts for collision repairs in an effort to reduce claim costs; however, if imitation parts are used the following conditions may apply:

- There is no assurance that imitation parts will equal the fit and finish of Genuine Honda sheet metal parts; and in our experience they often do not.
- There is no assurance that imitation parts will resist corrosion as well as Genuine Honda sheet metal parts.
- Imitation sheet metal parts are not covered by the Honda Limited Warranty.

To ensure your continued satisfaction with your Honda vehicle in the event of an accident, contact your insurance adjuster and insist on Genuine Honda parts in the repair of your vehicle.

Spare Tire

COMPACT Spare Tire

Your car is supplied with a COMPACT spare tire and wheel for temporary use only in the event of a flat tire. Use the COMPACT spare only when you have to, and only to go as far as the next garage or dealer to have the regular tire repaired and reinstalled.

Because you will rarely use the COMPACT spare, be sure to regularly check its condition and air pressure (415 kPa, 60 psi), so it will be ready when you need it. This type of tire holds less air at higher pressure than a regular tire, so it will inflate (or deflate if there is a leak) more rapidly; check its pressure often and add air gradually if it needs any.

▲ WARNING

- The COMPACT spare tire has a different tire size, air pressure requirement, tread life and maximum speed rating than the four regular tires on your car. Disregarding these warnings may result in tire failure, loss of vehicle control and possible injury to vehicle occupants.
- Do not exceed 50 mph (80 km/h) under any circumstances when using the COMPACT spare.
- Do not mount snow chains on the COMPACT spare. They will not fit properly and will damage the tire and possibly your car. If you must use the COMPACT spare when driving on roads covered with snow or ice, use it as one of the rear tires and mount chains only on the front two regular tires.

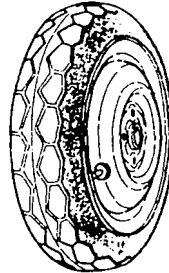

⚠ WARNING

- The COMPACT spare tire has a much shorter tread life than regular tires. Replace the tire as soon as tread wear indicators appear as solid bands across the tread. Replace with a tire of exactly the same size and construction.
- The COMPACT spare tire and wheel set was designed especially for your car; do not use it on any other vehicle; do not install any other tire on this wheel which is not identical to the original in size and construction, and do not use the COMPACT spare tire on any other wheel.
- Because the COMPACT spare is smaller in size and higher in air pressure than a regular tire, it will ride more harshly with less ground clearance and may have less traction on some road surfaces. Drive cautiously.

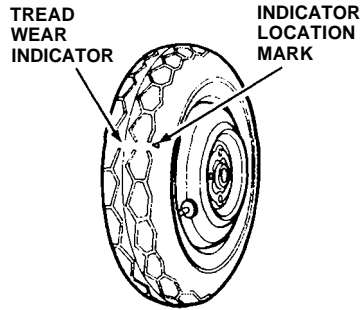

Changing a Flat Tire

▲ WARNING

Do not attempt to change a tire unless the car is on firm, level ground and well out of the flow of traffic.

Park the car on a firm, level surface, apply the parking brake, turn on the hazard warning switch, turn the ignition off and put the transmission in gear (Park for automatic transmission).

1. Remove the cover.
2. Remove the jack.

NOTE:

Turn the connector on the end of the jack counterclockwise to loosen it from its mount.

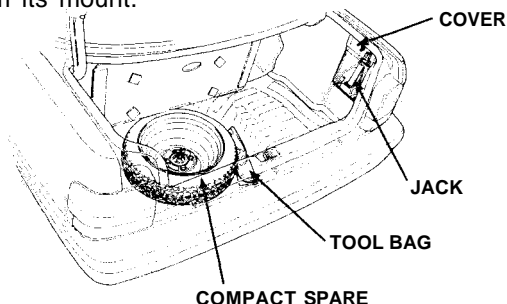

3. Remove the lug wrench/jack handle and jack handle extension from the tool bag.
4. Remove the spare tire.
5. Place blocks in front and back of the wheel diagonally opposite the tire you are changing.
6. Use the lug wrench to loosen the wheel lug nuts counterclockwise one-half turn.

(US: EX/SE/Anniversary Edition, Canada: EX-R/SE)

First remove the center cap from the wheel by prying it off with a common flat screwdriver (not included in the tool kit).

CAUTION:

Hold the center cap with your hand then pry it off using a rag to protect the cap and the wheel.

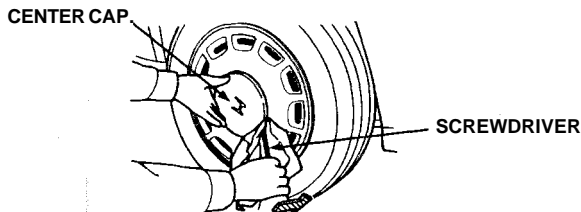

▲ WARNING

Follow tire changing preparations and procedures carefully to reduce the possibility of injury. The jack is designed for changing tires only. **STAND CLEAR, DO NOT** get under the car and **DO NOT** run the engine when the car is supported only by the jack.

7. Place the jack under the car as shown and raise the car by turning the handle clockwise until the tire is slightly off the ground.

▲ WARNING

To reduce the possibility of injury, be sure to use the jack provided with the car and the correct jacking points; never use any other part of the car for jack support.

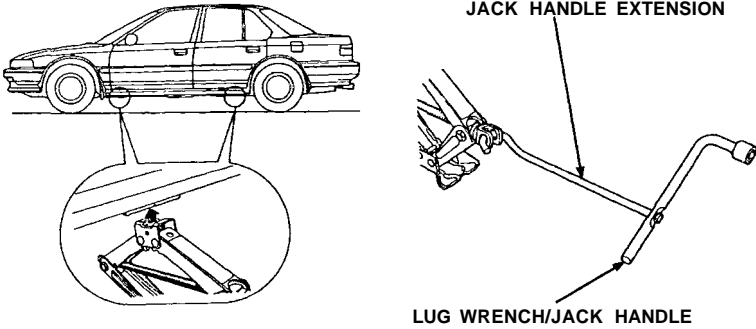

8. Remove the lug nuts and wheel.
(US: DX / LX, Canada: LX/ EX)
Remove the lug nuts, wheel cover, and wheel.

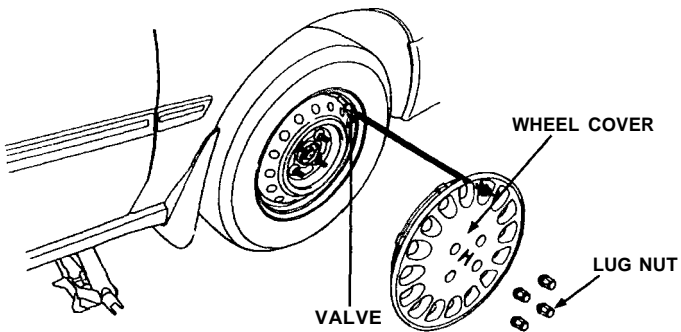

(cont'd)

Changing a Flat Tire (cont'd)

9. Everytime you install the wheel on the brake hub, use a clean rag to wipe any dirt off the mounting surface of the hub and the wheel. This will assure a tight, even contact between the wheel and hub.

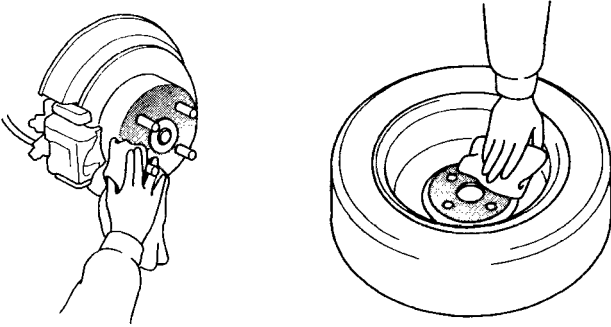

- 10. Install the spare, and lug nuts hand tight.
- 11. Lower the car, remove the jack, then tighten the lug nuts securely in an "X" pattern as shown.
- 12. Tighten the lug nuts to the recommended torque:
110 N.m (11 kg-m, 80 lb-ft)
If a torque wrench was not used, ask an authorized Honda dealer to verify the torque as soon as possible.

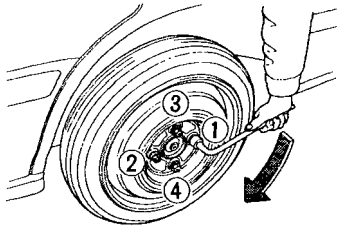

TIGHTENING TORQUE
110 N.m (11 kg-m, 80 lb-ft)

13. Repair or replace the damaged tire as soon as you can, reinstall it in its original position, then put the spare back in the car.

CAUTION:

Always stow the jack, tools, and tire securely to prevent them from becoming dangerous projectiles in an accident.

14. Secure the tire and the spacer as shown in the illustration.

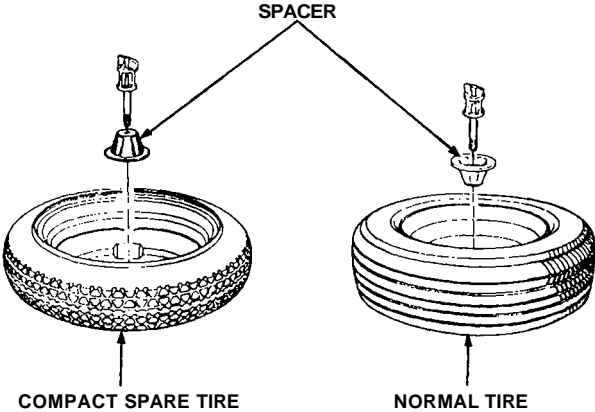

Jump Starting

To start a car with a dead battery, use another battery of the same voltage, and the proper jumper cables.

⚠ WARNING

- Procedures other than those below could cause injury or damage from battery acid spray, explosion or charging system overload.
- Never connect the jumper cable directly to the negative post of the "dead" battery.
- Never allow the two cars to touch each other.
- Never allow the jumper cable clamps to touch each other.
- Never lean over the battery when making connections.
- Never attempt to jump start a vehicle with a frozen battery. The battery could rupture and explode. If you suspect a frozen battery, remove the vent caps and check the fluid. If there seems to be no fluid, or if you see ice, do not attempt a jump start until the fluid thaws.

CAUTION:

If jumper cables are connected backwards, the car's main fuse may blow.

1. Turn off all lights, heater and other electrical loads, set the parking brake, and shift the transmission to Neutral or Park.
2. Use one cable to connect the positive terminal of the booster battery to the positive terminal of the "dead" battery.

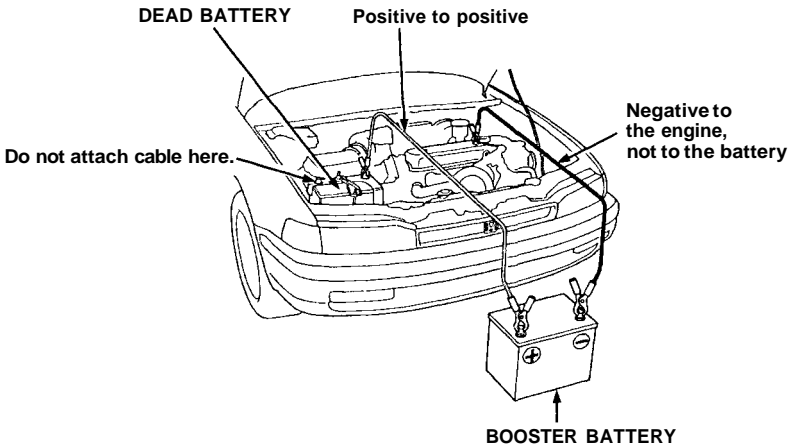

-
3. Use the other cable to connect the negative terminal of the booster battery to the engine at the ground cable as shown.
 4. To remove the cables, reverse the above procedures exactly.

▲ WARNING

DO NOT push or tow a car to start it. The forward surge when the engine starts could cause a collision. Also, under some conditions, the three way catalytic converter could be damaged. A car equipped with an automatic transmission cannot be started by pushing or towing.

NOTE:

(US: EX/SE/Anniversary Edition, Canada: EX-R/SE)

After jump-starting the car, there is a possibility that the ABS indicator may come on due to insufficient battery voltage. After the battery is sufficiently recharged and the engine is turned off and restarted, the ABS indicator should indicate that the ABS is OK, by coming on for a few seconds each time the engine is started. If the indicator remains on after recharging, have it checked by a Honda dealer.

Towing

If towing is necessary, contact a professional towing service. Your authorized Honda dealer can assist you with detailed towing instructions.

▲ WARNING

Never use tow chains or rope to tow a car; your ability to safely control the car may be adversely affected.

We recommend the following:

Flat Bed Equipment—Entire car is winched on a flat bed vehicle. This is the best way of transporting your Honda.

Wheel Lift Type—Tow with the front wheels off the ground.

If the car can only be towed with the front wheels on the ground, make sure the transmission is full of fluid (see pages [120](#)—[121](#)), and tow with the transmission in neutral (N) and the ignition key in the I position.

CAUTION:

To avoid serious damage on automatic transmission cars, first start the engine and shift to D₄, then to N and shut the engine off. If the engine does not run, or the transmission cannot be shifted while the engine is running, the car must be transported on flat bed equipment.

Check local regulations for towing.

CAUTION:

- Do not exceed 35 mph (55 km/h) or tow for distances of more than 50 miles (80 km).
- If a sling type tow is used, the tow truck driver should position wood spacer blocks between your car's frame and the chains and lift straps to avoid damaging the bumper and the body.
- Do not use the bumpers to lift the car or to support the car's weight while towing.

If Your Car Gets Stuck

If your car gets stuck in sand, mud, or snow, call a professional towing service for assistance in getting your car out.

CAUTION:

- **Do not rev up the engine and allow the wheels to spin freely at high speed. Severe transmission damage may result if the wheels are allowed to spin for more than a few seconds.**
- **DO NOT try to free a car with automatic transmission from snow, etc. by rocking the car alternately between forward and reverse gears. Severe transmission damage may result from shifting into gear with the wheels moving.**

Specifications

Dimensions

Length		4,705 mm (185.2 in)
Width		1,705 mm (67.1 in)
Height		1,390 mm (54.7 in)
Wheelbase		2,720 mm (107.1 in)
Track	Front	1,475 mm (58.1 in)
	Rear	1,480 mm (58.3 in)

Weights

Gross Vehicle Weight Rating	See the certification label attached to the left rear door jamb.
-----------------------------	------------------------------------------------------------------

Tires

Size/Pressure	See the tire label attached to the driver's door jamb.
---------------	--------------------------------------------------------

Capacities

Fuel tank		Approx. 64.5 ℓ (17.04 US gal , 14.19 Imp gal)	
Engine coolant	Manual transmission	Change *1	3.0 ℓ (0.79 US gal , 0.66 Imp gal)
		Total	6.6 ℓ (1.74 US gal , 1.45 Imp gal)
	Automatic transmission	Change *1	3.5 ℓ (0.92 US gal , 0.77 Imp gal)
		Total	7.1 ℓ (1.88 US gal , 1.56 Imp gal)
Engine oil	Change*2	Including filter	3.8 ℓ (4.0 US qt , 3.3 Imp qt)
		Without filter	3.5 ℓ (3.7 US qt , 3.1 Imp qt)
	Total		4.9 ℓ (5.2 US qt , 4.3 Imp qt)
Manual trans- mission oil	Change		1.9 ℓ (2.0 US qt , 1.7 Imp qt)
	Total		2.0 ℓ (2.1 US qt , 1.8 Imp qt)
Automatic trans- mission fluid	Change		2.4 ℓ (2.5 US qt , 2.1 Imp qt)
	Total		6.0 ℓ (6.3 US qt , 5.3 Imp qt)
Windshield washer reservoir			2.5 ℓ (2.6 US qt , 2.2 Imp qt) *3
			4.5 ℓ (4.8 US qt , 4.0 Imp qt)*4

*1 Including the coolant in the reserve tank 0.6 ℓ (0.16 US gal, 0.13 Imp gal) and that remaining in the engine.

*2 Excluding the oil remaining in the engine.

*3 US Cars

*4 Canada Cars

Engine

Type	Water cooled 4-stroke OHC gasoline engine
Bore x Stroke	85.0 x 95.0 mm (3.35 x 3.74 in)
Displacement	2,156 cm ³ (131.5 cu-in)
Compression ratio	8.8
Spark plug	See spark plug maintenance section page 130 .

Alignment

Toe-in	Front	0 mm (0.0 in)
	Rear	2.0 mm (0.08 in)
Camber	Front	0°
	Rear	-0° 30'
Caster	Front	3°

Battery

Capacity	12V — 52AH
----------	------------

Fuses

Under-hood	See the relay box cover under the hood.
Under-dash	See the fuse label attached to the inside of the fuse compartment door under the dashboard.

Lights

Headlights	12V — 65/55W	
Front turn signal lights	12V — 45CP (SAE3497)	
Front position lights	12V — 5W (6CP) (SAE3652)	
Rear turn signal lights	12V — 32CP (SAE1156)	
Stop/Taillights	12V — 32/2CP (SAE2057)	
Side marker lights	Front	12V — 5W
	Rear	12V — 3.4W (3CP)
Back-up lights	12V — 32CP (SAE1156)	
High-mount brake lamp	12V — 45CP (SAE3497)	
License plate lights	12V — 8W (4CP)	
Interior light	12V — 8W	
Trunk light	12V — 3.4W	
Vanity mirror light	12V — 1.8W	
Door courtesy lights	12V — 3.4W	

Identification Numbers

The Vehicle Identification Number (V.I.N.) is stamped on a plate attached to the top left side of the dashboard.

It also appears on the Certification label (Canada cars: Canada Motor Vehicle Safety Standard Compliance Label) attached to the left rear door jamb, as well as under the hood on the body, directly behind the engine.

NOTE:

The V.I.N. is also provided in bar code on the Certification label.

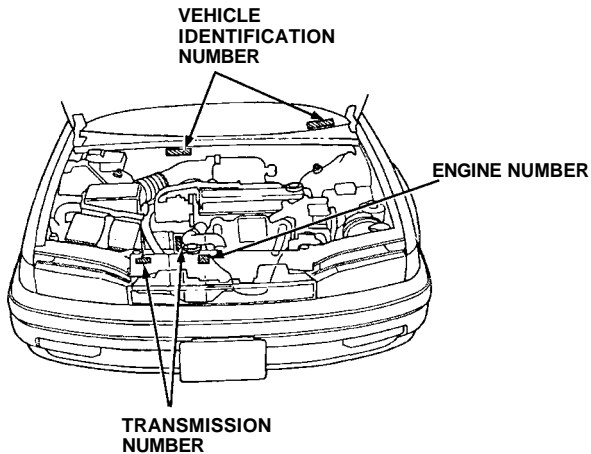
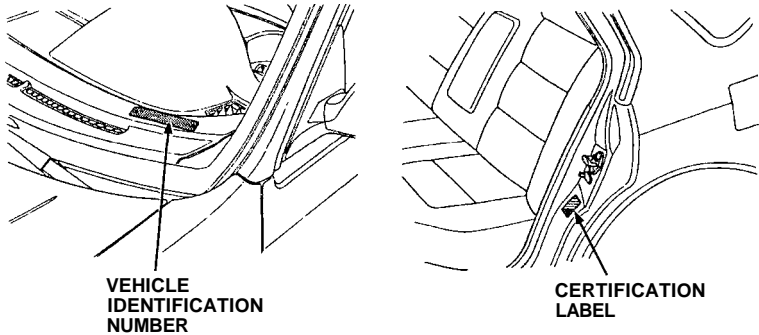

The Engine Number is stamped on the right front side of the engine block.

The Transmission Number appears on a label on top of the transmission.

DOT Tire Quality Grades

US Cars

The tires on your car meet Federal Safety Requirements. All tires are also "graded" according to Department of Transportation (DOT) standards for tread wear, traction and temperature.

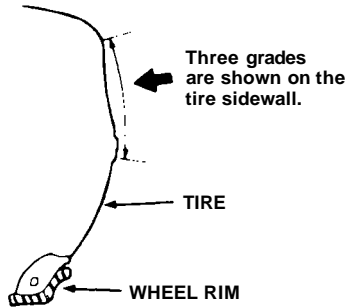

Tread Wear

The tread wear grade is a comparative rating based on the wear rate of the tire when tested under controlled conditions on a specified government test course. For example, a tire graded 150 would wear one and one half (1-1/2) times as well on the government course as a tire graded 100.

The relative performance of tires depends upon the actual conditions of their use, however, and may depart significantly from the norm due to variations in driving habits, service practices and differences in road characteristics and climate.

Traction

The traction grades, from highest to lowest, are A, B, and C, and they represent the tire's ability to stop on wet pavement as measured under controlled conditions on specified government test surfaces of asphalt and concrete. A tire marked C may have poor traction performance.

▲ WARNING

The traction grades assigned are based on braking (straight ahead) traction tests and do not include cornering (turning) traction.

(cont'd)

DOT Tire Quality Grades (cont'd)

Temperature

The temperature grades are A (the highest), B and C representing the tire's resistance to the generation of heat and its ability to dissipate heat when tested under controlled conditions on a specified indoor laboratory test wheel. Sustained high temperature can cause the material of the tire to degenerate and reduce tire life, and excessive temperature can lead to sudden tire failure. The grade C corresponds to a level of performance which all passenger car tires must meet under the Federal Motor Vehicle Safety Standard No. 109. Grades B and A represent higher levels of performance on the laboratory test wheel than the minimum required by law.

▲ WARNING

The tire temperature grade is established for a tire that is properly inflated and not overloaded. Excessive speed, underinflation, or excessive loading, either separately or in combination, can cause heat buildup and possible tire failure.

Sources of Emissions

The combustion process produces carbon monoxide, oxides of nitrogen, and hydrocarbons. The evaporation of fuel in the fuel tank also produces hydrocarbons. Control of oxides of nitrogen and hydrocarbons is very important since, under certain conditions, when subjected to sunlight, they react to form photochemical smog. Carbon monoxide does not react to form smog, but it is toxic.

The Clean Air Act

The Clean Air Act* requires all vehicle manufacturers to explain in writing the operation and maintenance of their emission control systems.

Maintenance instructions are included on pages 110—112; the operation of each system is explained below and on the following page.

Replacement Parts

The emission control systems on your new Honda were designed, built and certified to conform with the Federal regulations implementing the Clean Air Act. Honda recommends only the use of new, Genuine Honda parts or their equivalent. The use of other replacement parts which are not of equivalent quality may impair the effectiveness of your car's emission control systems.

Crankcase Emission Control System

To prevent crankcase emissions, your car is equipped with a Positive Crankcase Ventilation (PCV) System which routes blowby gases from the crankcase, through the Positive Crankcase Ventilation valve and intake manifold, into the combustion chamber.

Evaporative Emission Control System

The Evaporative Emission Control System is designed to prevent fuel vapors from escaping into the atmosphere.

Fuel vapors from the fuel tank are directed into the evaporative emission control canister where they are adsorbed and stored while the engine is stopped or idling. When the engine coolant temperature rises to a certain value, the vapors are drawn into the engine through the throttle body and the intake manifold during normal engine operation.

* In Canada, Honda vehicles comply with the Canadian Motor Vehicle Safety Standards (CMVSS) on Emissions valid at the time they are manufactured.

(cont'd)

Emission Controls (cont'd)

Engine Exhaust Controls

The engine exhaust emission control systems are designed to control combustion during idle, acceleration, cruise, and deceleration. These systems are entirely separate from the crankcase and evaporative emission control systems described previously.

- **PGM-FI System**

The PGM-FI system on this model is a sequential multiport fuel injection. The PGM-FI system consists of three independent sub-systems; Air Intake, Engine Control, and Fuel Control, thus allowing more accurate control of air/fuel ratios under all operating conditions. The Engine Control Module (ECM) detects the amount of air drawn into the cylinders and determines the amount of fuel to be injected to provide the optimum air/fuel ratio for all engine needs.

- **Ignition Timing Control System**

This system automatically controls the ignition timing to reduce the amount of HC and NOx.

- **Three Way Catalytic Converter**

The catalyst is used to convert hydrocarbons (HC), carbon monoxide (CO) and oxides of nitrogen (NOx) in the exhaust gas, to carbon dioxide (CO₂), dinitrogen (N₂) and water vapor.

- **Exhaust Gas Recirculation (EGR) System**

The EGR system is designed to control the formation of oxides of nitrogen (NOx) caused when fuel mixture burns at high temperature. It works by recirculating exhaust gas through the Exhaust Gas Recirculation valve and intake manifold into the combustion chambers where it reduces peak temperature by diluting the air/fuel mixture.

Three Way Catalytic Converter

A three way catalytic converter is installed in the exhaust system to help clean-up the harmful exhaust gases that can cause air pollution. To be effective, the three way catalytic converter must work at high temperature, so don't park your car over dry grass, leaves or anything else that could burn easily.

To stay effective, the three way catalytic converter must not be contaminated by leaded gasoline; use only unleaded gasoline as explained on page [92](#) .

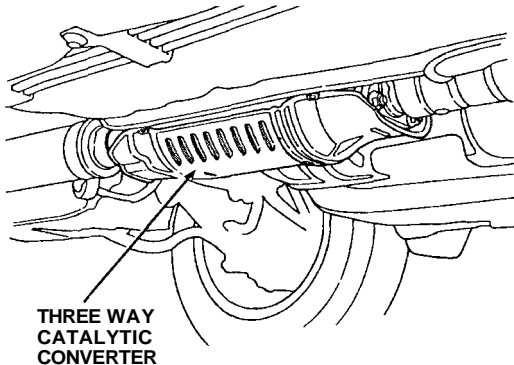

CAUTION:

The three way catalytic converter can be overheated and damaged if it's fed too much unburned fuel mixture from the engine, so:

- Don't push or tow the car to start it; if the battery is dead, jump start the car as shown on page [154](#).
- Don't turn the key off while the engine is running above idle speed.
- Don't change the ignition timing, or remove any emission control parts.
- Use only the spark plugs specified in this manual.
- Don't keep driving your car if it isn't running properly, or if its CHARGING system light comes on; have it checked by your Honda dealer.

Warranty Service

Warranty (US Cars)

The following warranties are provided with every new vehicle:

1. New Car Limited Warranty
2. Emission Control Systems Defects Warranty
3. Emissions Performance Warranty
4. Original Equipment Battery Limited Warranty
5. Rust Perforation Limited Warranty
6. Accessory Limited Warranty
7. Replacement Parts Limited Warranty
8. Replacement Muffler Lifetime Limited Warranty
9. Seat Belt Limited Warranty
10. Replacement Battery Limited Warranty

Your car's original tires are covered by their manufacturer. Tire warranty information is in a separate tire warranty booklet.

All warranty details pertaining to your car can be found in the Warranty booklet provided with your new car except the required maintenance schedule which is contained here in the Owner's Manual.

If you are unable to obtain warranty service or are dissatisfied with the warranty decision or service you received at an authorized Honda dealership, you should review the matter with that dealership's Service Manager. This will normally resolve your problem. If it does not resolve your problem you should appeal the decision with the owner of the dealership. Please bear in mind that your problem will likely be resolved at the dealership, using the dealer's facilities, equipment, and personnel. So it is very important that your initial contact be with the dealer or his management.

After following these steps, if you wish to have the matter reviewed by American Honda you should contact the Zone Office serving your area, as shown on the map on the inside of the back cover. When contacting American Honda, please provide the Zone Office with the following information:

- Vehicle Identification Number
- Servicing Dealer Name and Address
- Date of Purchase
- Mileage on your Car
- Your Name, Address, and Phone Number
- Nature of Problem
- Selling Dealer

After a review of the facts, you will be advised of what can be done.

(Canada Cars)

Please refer to the 1993 Warranty and Maintenance Guide that came with your car.

Reporting Safety Defects

(US Cars)

If you believe that your vehicle has a defect which could cause a crash or could cause injury or death, you should immediately inform the National Highway Traffic Safety Administration (NHTSA) in addition to notifying American Honda Motor Co., Inc..

If NHTSA receives similar complaints, it may open an investigation, and if it finds that a safety defect exists in a group of vehicles, it may order a recall and remedy campaign.

However, NHTSA cannot become involved in individual problems between you, your dealer, or American Honda Motor Co., Inc.

To contact NHTSA, you may either call the Auto Safety Hotline toll-free at 1-800-424-9393 (or 366-0123 in Washington, D.C. area) or write to:

NHTSA, U.S. Department of Transportation
Washington, D.C. 20590.

You can also obtain other information about motor vehicle safety from the Hotline.

A

Airbag.....	
See "Supplemental Restraint System"	
Air Conditioning	
Care.....	141
Operation.....	64
Air Cleaner.....	129
Air Pressure, Tires	137
Aluminum Alloy Wheels.....	145
Antenna.....	73
Cleaning.....	144
Antifreeze	See "Engine coolant"
Anti-lock Brake System (ABS).....	34
Anti-lock Brake Fluid	126
ABS Indicator.....	41
Anti-theft Radio.....	91
Anti-theft Steering Column Lock System	96
Appearance Care	143
Ashtrays	58
Audio System.....	72
Automatic Transmission	
Driving Technique.....	104
Fluid.....	121
Operation	103
Shift Lever Position Indicator.	38

B

Battery	
Charging System Light.....	39
Jump Starting	154
Maintenance.....	132
Specification.....	159
Beeper System	
Fasten Seat Belt Beeper.....	12
Key Reminder.....	96
Light Reminder Chime.....	49
Belt, Seat	
See "The Seat Belt System"	
Beverage Holder.....	57
Body Repair.....	147
Brake System Light.....	41
Brakes	
Anti-lock Brake System (ABS).....	34
Anti-lock Brake Fluid.....	126
ABS Indicator.....	41
Brake System Light.....	41

Brake Fluid.....	126
Brake System Design	125
Brake Wear	125
Brake Wear Indicators.....	125
Parking Brake.....	54
Parking Brake Light.....	41
Break-in Period.....	2
Bulb	
Replacement.....	135
Specification	159
Buzzer.....	See "Beeper System"

C

Capacities.....	158
Care and Cleaning.....	143
Certification Label.....	160
Chains, Tires.....	138
Check Engine Light.....	40
Child Proof Door Locks	5
Child Safety	27-33
Child Seat Locking Clip.....	32
Child Seat Storage.....	33
Guidelines.....	28-31
Infant Seats.....	29
Safety Reminders	28
Seating Location	27
Tethers	33
Toddler Seats.....	30
Cigarette Lighter.....	58
Clock.....	56
Clutch Fluid.....	127
COMPACT Spare Tire.....	148
Coolant Temperature Gauge	37
Cooling (with A/C).....	64
Cooling System.....	122
Crankcase Emission Control System	163
Cruise Control	
Indicator.....	38
Operation	52

D

Daytime Running Light (DRL).....	51
DRL Indicator.....	42
Defogger.....	47
Defroster.....	67
Dimmer Switch, Headlights.....	49
Door Mirror Defoggers.....	47

(cont'd)

Index (cont'd)

Doors

- Child Proof Door Lock 5
- Locks.....3
- Power Door Locks..... 4
- Warning Light..... 43

E

Emergency

- Changing Flat Tire 150
- Hazard Warning System 50
- If Your Car Gets Stuck..... 157
- Jump Starting 154
- Towing..... 156
- Warning and Indicator Lights.. 38

Emission Controls..... 164

Engine Coolant..... 122

Engine

- Coolant..... 122
- Coolant Temperature Gauge .. 37
- Exhaust Controls..... 164
- Identification Number..... 160
- Low Oil Pressure Light..... 40
- Oil and Filter..... 117
- Specification 159

Engine Exhaust Gas Warning..... 99

Evaporative Emission Control System..... 163

Exhaust Gas Recirculation..... 164

Exterior Care 144

F

Filters

- Engine Oil..... 118
- Fuel..... 129

Fluid..... See "Oil"

Foreign Countries, Operation in 93

Front Seat

- Adjustment..... 6
- Head Restraints..... 7

Fuel

- Fill Door and Cap..... 94
- Filter..... 129
- Gasohol..... 92
- Gasoline 92
- Gauge.....36
- Low Fuel Indicator..... 41
- Requirement..... 92

Fuse

- Checking and Replacing..... 133
- Specification..... 159

G

Gasoline..... See "Fuel"

Gas Station Information. [Back cover](#)

Gauges..... 36

Glove Box..... 56

H

Hazard Warning System 50

Headlights

- Flasher..... 49
- High Beam Indicator..... 38
- High Beam/Low Beam Switch
..... 49
- Reminder Chime 49
- Switch 49

Head Restraints..... 7

Heating..... 65

High Beam Indicator..... 38

High Beam

- Indicator..... 38
- Switch 49

Hood Latch..... 54

I

Identification Numbers..... 160

Ignition

- Keys..... 3
- Switch 96

Ignition Switch Light..... 50

Important Safety Reminders

..... 11, 20, 28

Indicator Lights 38

Inflation Pressures, Tire..... 137

Instrument Panel..... 35

Instrument Panel Brightness Control 50

Interior Light..... 51

Interior Trim Care..... 143

J

Jack 150

Jump Starting 154

K

Keys	
Door Locks.....	3
Glove Box	56
Ignition	96
Key Reminder Beeper	96
Keys.....	3
Trunk Lock	5

L

Lap Belt.....	13
Lap/Shoulder Belt.....	12
Lights	
Bulb Replacement.....	135
Daytime Running Lights	51
Fuse Replacement.....	133
Light Reminder Chime.....	49
Operation.....	49
Warning and Indicator Light....	38
Locks	
Anti-theft Steering Column Lock	96
Child Proof Door Locks	5
Doors.....	3
Fuel Fill Door.....	94
Glove Box	56
Power Door Lock.....	4
Trunk.....	5
Lumbar Support.....	8

M

Maintenance	
Indicator.....	44
Records	113
Schedule.....	110
Malfunction Indicator Lamp.....	40
Manual Transmission	
Maximum Allowable Speeds	101
Oil.....	120
Recommended Shift Speeds	101
Shifting	100
Meters, Gauges..... See "Gauges"	
Mirrors	
Door Mirror Defoggers	47
Manual Mirrors	48
Power Mirrors.....	48

Rearview Mirrors.....	48
Moonroof	
If the Moonroof Won't Close..	71
Maintenance.....	71
Operation.....	70

N

Numbers, Identification.....	160
------------------------------	-----

O

Octane Rating,	
Gasoline..... See "Fuel"	
Odometer.....	36
Oil	
Clutch Fluid.....	127
Engine Oil.....	117
Fluid Locations.....	116
Low Oil Pressure Light.....	40
Power Steering Fluid	128
Transmission Oil/Fluid	120
Operation In Foreign Countries	93

P

Panel Brightness Control.....	50
Parking Brake.....	54
PGM-FI	
Check Engine Light.....	40
Malfunction Indicator Lamp....	40
System	164
Power	
Door Locks.....	4
Mirrors.....	48
Steering.....	128
Windows.....	55
Pressures, Tire Inflation.....	137
Preventive Service.....	146

R

Radio	72
Rearview Mirrors.....	48
Rear Window Defogger.....	47
Reminder Lights	See "Warning lights"

(cont'd)

Index (cont'd)

Replacement	
Air Cleaner.....	129
Bulbs.....	135
Engine Coolant.....	123
Engine Oil.....	118
Fuel Filter.....	129
Fuses	133
Oil Filter.....	118
Spark Plugs	130
Tires.....	139
Wiper Blades.....	131
Rust Prevention.....	145

S

Safety Defects, Reporting.....	168
Safety Indicator Lights.....	43
Safety Items.....	98
Seat-back Position.....	24
Seat Belt System.....	11
Components.....	12
Lap/Shoulder Belt.....	12, 14
Lap Belt.....	13, 16
Maintenance.....	18
Operation.....	11
Pregnant Women.....	18
Safety Reminders	11, 24-26
Warning Lights and Beeper.....	12
Seat Heater.....	69
Seats	
Driver's Center Armrest.....	8
Driver's Lumbar Support.....	8
Front Seat.....	6
Head Restraints.....	7
Heater.....	69
Rear Seat Armrest.....	8
Trunk Access from Rear Seat..	9
Shift Lever Position Indicator.....	38
Shifting	
Automatic	102
5-Speed Manual.....	100
Spare Tire	
Changing a Flat Tire	150
COMPACT Spare Tire.....	148
Specifications.....	158
Spark Plugs.....	130
Specifications	158
Speedometer.....	36
SRS Indicator.....	42
Starting the Engine	97

Steering	
Anti-theft Column Lock	96
Power Steering.....	128
Tilt Steering.....	45
Stereo Sound System	
Operation.....	72
Stuck Car.....	157
Sunshade.....	70
Supplemental Restraint	
System(SRS).....	19-23
Components.....	20
Indicator Light.....	22
Operation.....	21
Safety Reminders.....	20
System Service.....	23
Precautions.....	23

T

Tachometer.....	36
Temperature Gauge, Coolant.....	37
The Seat Belt System and	
How it Works.....	11
Advice For Pregnant Women .	18
Important Safety Reminders ..	11
Lap Belt.....	13
Lap/Shoulder Belt.....	12
Seat Belt Maintenance	18
Seat Belt System Components	
.....	12
Wearing Seat Belts Properly...	13
Wearing the Lap Belt.....	16
Wearing the Lap/Shoulder Belt	
.....	14
Why Wear Seat Belts.....	11
Three Way Catalytic Converter	
.....	165
Tilt Steering.....	45
Tire	
Air Pressure	137
Balancing.....	140
Chains.....	138
Changing a Flat Tire	150
COMPACT Spare	148
DOT Tire Quality Grades	161
Inflation Pressures.....	137
Requirement.....	161
Rotation.....	140
Snow Tires.....	138
Spare Tire.....	148
Specification	158

Tools.....	150
Towing.....	156
Towing a Trailer.....	105
Transmission	
Capacity.....	158
Identification Number.....	160
Oil/Fluid.....	120
Shifting the Automatic.....	102
Shifting the Manual.....	100
Tread Wear.....	161
Trip Meter.....	36
Trunk	
Access From Rear Seat.....	9
Lid.....	5
Lid Warning Light.....	43
Turn Signals.....	49

V

Vehicle Identification Number ...	160
Ventilation.....	59

W

Warning Lights.....	38
Warranty Service.....	166
Washer	
Reservoir Capacity.....	46
Windshield Washer.....	46
Washing.....	144
Waxing.....	144
Wearing Seat Belts Properly	13
Wearing the Lap Belt	16
Wearing the Lap/Shoulder Belt....	14
Wheels.....	145
Windows	
Appearance Care	143
Power Windows	55
Windshield Defogger.....	47
Windshield Washer.....	46
Windshield Wipers	46
Wiper Blades.....	131
Wipers.....	46

Y

Your Occupant Protection System.....	10
-----------------------------------------	----

Authorized Manuals

Purchasing Factory Authorized Manual (U.S. only)

The following publications covering the operation and servicing of your vehicle can be obtained from Helm Incorporated, either by filling out the reverse side of this form or, for credit card holders, calling the toll-free phone number on the form. For manuals prior to the year shown below, contact Helm Inc., P.O. Box 07280, Detroit, Michigan 48207, or call (313) 883-1430.

Publication Form Number	Form Description	Price Each*
61SM405	1993 Accord Service Manual	\$56.00
61SM405EL	1993 Accord Electrical Troubleshooting Manual	\$32.00
61SM430	1990-1993 Accord Body Repair Manual	\$32.00
31SM4630	1993 Accord 4Door Owner's Manual	\$18.00
HON-R	Order Form for Previous Years- Indicate Year and Model Desired.	FREE

*Prices are subject to change without notice and without incurring obligation. If order is to be placed after April 1993, contact Helm for current prices and availability.

Service Manual

This manual covers maintenance and recommended procedures for repair to engine and chassis components. It is written for the journeyman mechanic, but is simple enough for most mechanically-inclined owners to understand.

Electrical Troubleshooting Manual

This manual compliments the Service Manual by providing in-depth troubleshooting information for each electrical circuit in your car.

Body Repair Manual

This manual describes the procedures involved in the replacement of damaged body parts.

Authorized Manuals

Valid only for sales within the U.S. Canadian owners should contact their authorized Honda dealer.

ORDER TOLL FREE: 1-800-782-4356 (NOTE: For Credit Card Holder Orders Only) Monday – Friday 8:00 A.M. – 6:00 P.M. EST
(MINIMUM CREDIT CARD PURCHASE \$10.00)

(OR)

By completing this form you can order the materials desired. You can pay by check or money order, or charge to your credit card. Mail to Helm, Incorporated at the address shown below.

1 9 9 3 H O N D A	PUBLICATION FORM NUMBER	VEHICLE MODEL		QTY.	PRICE EACH*	TOTAL PRICE	
		NAME	YEAR				
*Prices are effective until April '93. After that date contact Helm, Incorporated for current prices and stock availability. Orders are mailed within 10 days. Please allow adequate time for delivery.					TOTAL MATERIAL		
					MICH. PURCHASES ADD 6% SALES TAX		
					HANDLING CHARGE		\$4.00
					GRAND TOTAL		

S H I P T O	NOTE: Dealers and Companies please provide dealer or company name, and also the name of the person to whose attention the shipment should be sent. For purchases outside U.S.A. please write to the address below for a quotation.	
	Customer Name _____	Attention _____
	Street Address-No. P.O. Box Number _____	Apartment Number _____
	City _____	State _____ Zip Code _____
	Daytime Telephone Number _____	Area Code () _____

P A Y M E N T	<input type="checkbox"/> Check or money order enclosed payable to Helm Inc. U.S. funds only Do not send cash	
	<input type="checkbox"/> Master Card	<input type="checkbox"/> VISA
	<input type="checkbox"/> Check here if your billing address is different from the shipping address shown below.	
	Account Number <input style="width: 20px; height: 15px; border: 1px solid black;" type="text"/> <input style="width: 20px; height: 15px; border: 1px solid black;" type="text"/> <input style="width: 20px; height: 15px; border: 1px solid black;" type="text"/> <input style="width: 20px; height: 15px; border: 1px solid black;" type="text"/> <input style="width: 20px; height: 15px; border: 1px solid black;" type="text"/> <input style="width: 20px; height: 15px; border: 1px solid black;" type="text"/> <input style="width: 20px; height: 15px; border: 1px solid black;" type="text"/> <input style="width: 20px; height: 15px; border: 1px solid black;" type="text"/> <input style="width: 20px; height: 15px; border: 1px solid black;" type="text"/> <input style="width: 20px; height: 15px; border: 1px solid black;" type="text"/> <input style="width: 20px; height: 15px; border: 1px solid black;" type="text"/> <input style="width: 20px; height: 15px; border: 1px solid black;" type="text"/>	Expiration Mo-Yr <input style="width: 20px; height: 15px; border: 1px solid black;" type="text"/> <input style="width: 20px; height: 15px; border: 1px solid black;" type="text"/> <input style="width: 20px; height: 15px; border: 1px solid black;" type="text"/> <input style="width: 20px; height: 15px; border: 1px solid black;" type="text"/>
CUSTOMER SIGNATURE _____		DATE _____

These publications cannot be returned for credit without receiving advance authorization within 14 days of delivery. On returns, a restocking fee may be applied against the original order.



P.O. BOX 07280 • DETROIT, MICHIGAN 48207 • (313)-883-1430

Zone Office Locations

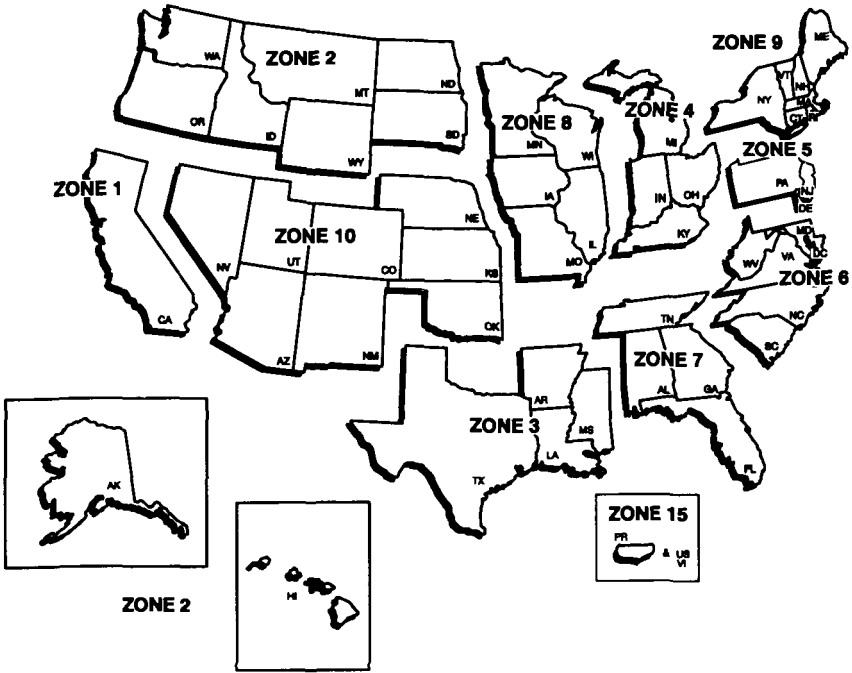

1 Western Zone
 P.O. Box 2260
 700 Van Ness Avenue
 Torrance, California
 90509-2260
 (310) 781-4565

2 Northwestern Zone
 P.O. Box 20186
 12439 N.E. Airport Way
 Portland, Oregon 97220
 (503) 256-0943
 (also includes Alaska
 and Hawaii)

3 South Central Zone
 4529 Royal Lane
 Irving, Texas 75063
 (214)929-5481

4 Central Zone
 101 South Stanfield Road
 Troy, Ohio 45373
 (513) 332-6250

5 Northeastern Zone
 P.O. Box 337
 Eastgate Industrial Park
 115 Gaither Drive
 Moorestown, New Jersey 08057
 (609) 235-5533
 Includes: NYC Metro area and
 Fairfield County, CT area

6 Mid-Atlantic Zone
 902 Wind River Ln., Suite 200
 Gaithersburg, Maryland 20878
 (301) 990-2020

7 Southeastern Zone
 1500 Morrison Parkway
 Alpharetta, Georgia 30201
 (770) 442-2045

8 North Central Zone
 601 Campus Drive, Suite A-9
 Arlington Heights, Illinois 60004
 (847) 870-5600

9 New England Zone
 555 Old County Road
 Windsor Locks, Connecticut 06096
 (203) 623-3310
 See Zone 5 for: NYC Metro area
 and Fairfield County, CT area

10 West Central Zone
 1600 South Abilene Street, Suite D
 Aurora, Colorado 80012
 (303) 696-3935

15 Puerto Rico and U.S. V.I.
 Bella International
 P.O. Box 190816
 San Juan, PR 00919-0816
 (809) 250-8070

The above addresses and telephone numbers are subject to change. If you cannot reach your Zone office, ask your Honda dealer for the current information.

Canada Zone Office Map



Western Zone

Honda Canada Inc.
13240 Worster Court
Richmond, B.C.
V6V 2B8
(604) 278-7121

Quebec Zone

Honda Canada Inc.
1750 rue Eiffel
Boucherville, Quebec
J4B 7W1
(514) 655-6161

Central Zone

Honda Canada Inc.
126 Milner Avenue
Scarborough, Ontario
M1S 3R2
(416) 299-3400

Atlantic Zone

Honda Canada Inc.
800 Windmill Road
Dartmouth, N.S.
B3B 1L1
(902) 468-4416

Gas Station Information

Gasoline UNLEADED only
Pump octane of 86 or higher.

Fuel Tank-Capacity 64.5 ℓ (17.04 US gal, 14.19 Imp gal)

Tire Pressure (measured cold) front/rear
US: DX/LX, Canada: LX/EX 200 kPa (29 psi)
US: EX/SE/Anniversary Edition, Canada: EX-R/SE
220 kPa (32 psi)
COMPACT spare tire, 415 kPa (60 psi)

Other Tire Information Label on driver's door jamb

Hood Release Pull handle under left side of dash.

Engine Oil Use "Energy Conserving II" SG grade oil.
5W-30 preferred (see page 118 for complete
viscosity recommendations).
Capacity (including filter):
3.8ℓ (4.0 US qt, 3.3 Imp qt)

5-Speed Manual Transmission Oil
Use SF or SG grade oil.
10W-30 or 10W-40 Preferred (see page 121 for
complete viscosity recommendations).
Capacity (including differential):
1.9ℓ (2.0 US qt, 1.7 Imp qt)

Automatic Transmission Fluid
Honda Premium Formula Automatic Transmission
Fluid or an equivalent DEXRON® II type
Automatic Transmission Fluid (ATF).
Capacity (including differential):
2.4ℓ (2.5 US qt, 2.1 Imp qt)

Power Steering Fluid
Use only GENUINE HONDA Power Steering Fluid-V:
do not use ATF or any other brand of power steering
fluid because it will damage the system.

AMERICAN HONDA MOTOR CO., INC.
1919 Torrance Blvd., Torrance California 90501



© 1992 Honda Motor Co., Ltd. - All Rights Reserved

4D