

1995 Accord Wagon Online Reference Owner's Manual

Use these links (and links throughout this manual) to navigate through this reference.
For a printed owner's manual, click on authorized manuals or go to www.helminc.com.

Contents

Owner's Identification Form

Introduction	i
A Few Words About Safety	ii
Driver and Passenger Safety	3
Proper use and care of your vehicle's seat belts, and Supplemental Restraint System.	
Instruments and Controls	27
Instrument panel indicator and gauge, and how to use dashboard and steering column controls.	
Comfort and Convenience Features	59
How to operate the climate control system, the audio system, and other convenience features.	
Before Driving	77
What gasoline to use, how to break-in your new vehicle, and how to load luggage and other cargo.	
Driving	87
The proper way to start the engine, shift the transmission, and park, plus towing a trailer.	
Maintenance	103
The Maintenance Schedule shows you when you need to take your vehicle to the dealer.	
Appearance Care	145
Tips on cleaning and protecting your vehicle. Things to look for if your vehicle ever needs body repairs.	
Taking Care of the Unexpected	151
This section covers several problems motorists sometimes experience, and how to handle them.	
Technical Information	171
ID numbers, dimensions, capacities, and technical information.	
Warranty and Customer Relations (U.S. and Canada)	181
A summary of the warranties covering your new Acura, and how to contact us.	
Authorized Manuals (U.S. only)	187
How to order manuals and other technical literature.	
Index	I

Gas Station Information

Information you need when you pull up to the fuel pump.

Congratulations! Your selection of a 1995 Honda Accord Wagon was a wise investment. It will give you years of driving pleasure.

To enhance the enjoyment of your new car, take time to study this manual. In it, you will learn about your car's many conveniences and useful features. Following the service interval and maintenance recommendations will help keep your driving trouble-free while preserving your investment.

Keep this owner's manual in your car so you can refer to it at any time. Please make sure the manual stays with the car if you sell it. The next owner will find it just as helpful.

Several other booklets in the glove box explain the warranties that protect your Honda. We suggest you read them carefully so you understand the coverages and the responsibilities of ownership.

When your car needs scheduled maintenance, keep in mind that your Honda dealer's service staff is specially trained in the service and maintenance of the many systems unique to your Honda. Your Honda dealer is dedicated to your satisfaction and will be pleased to answer any questions and concerns.

Safety Messages

Your safety and the safety of others is very important. We have provided many important safety messages in this manual and on the vehicle. Please read these messages carefully.

A safety message alerts you to potential hazards that could hurt you or others. Each safety message is preceded by a safety alert symbol  and one of three words, **DANGER**, **WARNING** or **CAUTION**. These mean:

You **WILL** be **KILLED** or **SERIOUSLY HURT** if you don't follow instructions.

You **CAN** be **KILLED** or **SERIOUSLY HURT** if you don't follow instructions.

You **CAN** be **HURT** if you don't follow instructions.

Each safety message tells you what the hazard is, what can happen, and what you can do to avoid or reduce injury.

You will also see another important symbol:

NOTICE

Your Honda or other property can be damaged if you don't follow instructions.

The purpose of these messages is to help prevent damage to your Accord, other property, or the environment.

This section gives you important information about occupant protection. It shows how to use seat belts properly. It explains the Supplemental Restraint System that is standard in Accords. And it gives useful information about how to protect infants and children in your car.

Your Occupant Protection System	4
The Seat Belt System and How It Works	5
Why Wear Seat Belts	5
Important Safety Reminders	5
Seat Belt System	
Components	5
Lap/Shoulder Belt	6
Lap Belt	6
Wearing Seat Belts Properly	7
Wearing a Lap/Shoulder Belt.....	7
Wearing the Lap Belt	9

Advice for Pregnant Women	9
Seat Belt Maintenance	10
Supplemental Restraint System	10
SRS Components	11
What Happens in a Crash ..	11
Important Facts About	
Airbags	12
How the Driver's Airbag Works	12
How the Passenger's Airbag Works	14
How the SRS Indicator Light Works	14
System Service	15
System Service Precautions	15
Additional Safety Information	16
Seat-Back Position	16
Head Restraint Position ...	16
Door Locks	16
Storing Cargo Safely	16
Driving With Pets	17
Child Safety	17
Where Should Children Sit?	18

Important Safety	
Reminders	18
General Guidelines for Restraining Children Under 40 lb (18 kg)	19
Restraining an Infant Who Weighs Less Than 20 lb (9 kg)	19
Restraining a Child Who Weighs Between 20 and 40 lb (9 and 18 kg)	20
Restraining a Child Who Weighs Over 40 lb (18 kg)	20
Using a Seat Belt	
Locking Clip	21
Using Child Restraints	
With Tethers	22
Storing a Child Seat	23
Carbon Monoxide Hazard	24
Safety Labels	25

Your Occupant Protection System

Your Honda is equipped with seat belts and other features that work together to protect you and your passengers during a crash.

Seat belts are the most important part of your occupant protection system. When worn properly, seat belts can reduce the chance of serious injury or death in a crash.

For added protection during a severe frontal collision, your Accord has a Supplemental Restraint System (SRS) with a driver's airbag and a front passenger's airbag.

Two indicator lights are also part of your safety system. One reminds you to make sure you and your passengers wear your seat belts. The other alerts you to a possible problem with your

supplemental restraint system (see page 14).

The seats, head restraints, and door locks also play a role in occupant safety. For example, reclining the seat-back can decrease the effectiveness of your seat belt. Head restraints can help protect your neck and head, especially during rear-end impacts. Door locks help keep your doors from being accidentally opened during a crash.

To get the maximum protection from your occupant protection system, check the following before you drive away:

- Everyone in the car is wearing a seat belt properly (see page 7).

- Infants or small children are properly secured in a child safety seat (see page 18).
- All doors and the tailgate are closed and locked (see page 16).
- Seat-backs are upright and head restraints are properly adjusted (see pages 16 and 49).
- There are no loose items that could be thrown around and hurt someone during a crash or sudden stop (see page 16).

By following these guidelines, you can reduce injuries to yourself and your passengers in many crash situations. Remember, however, that no safety system can prevent all injuries or deaths that can occur in severe crashes.

Why Wear Seat Belts

Wearing seat belts and wearing them properly is fundamental to your safety and the safety of your passengers.

During a crash or emergency stop, seat belts can help keep you from being thrown against the inside of the car, against other occupants, or out of the car.

Of course, seat belts cannot completely protect you in every crash. But, in most cases, seat belts reduce your chance of serious injury. They can even save your life. That is why many states and all Canadian provinces require you to wear seat belts.

Not wearing a seat belt increases the chance of being killed or seriously hurt in a crash.

Be sure you and your passengers always wear seat belts and wear them properly.

Important Safety Reminders

Seat belts are designed for adults and larger children. All infants and small children must be properly restrained in child safety seats (see page 17).

A pregnant woman needs to wear a seat belt to protect herself and her unborn child (see page 9).

Two people should never use the same seat belt. If they do, they could be very seriously injured in a crash.

Do not place the shoulder portion of a lap/shoulder belt under your arm or behind your back. This could increase the chance of serious injuries in a crash.

Do not put shoulder belt pads or other accessories on seat belts. They can reduce the effectiveness of the belts and increase the chance of injury.

Seat Belt System Components

Your Honda has seat belts in all five seating positions. The front seats and the outside positions of the rear seat have lap/shoulder

continued

The Seat Belt System and How It Works

belts. The center position of the rear seat has a lap belt.

Your seat belt system also includes a light on the instrument panel to remind you to fasten your seat belt and to make sure your passengers fasten theirs. This light comes on when you turn on the ignition if you have not fastened your seat belt. A beeper also sounds for several seconds (see page 30).

The following pages cover more about the seat belt components and how they work.

Lap/Shoulder Belt

This style of seat belt has a single belt that goes over your shoulder, across your chest and across your hips.

Each lap/shoulder belt has an emergency locking retractor. In normal driving, the retractor lets you move freely in your seat while it keeps some tension on the belt. During a collision or sudden stop, the retractor automatically locks the belt to help restrain your body.

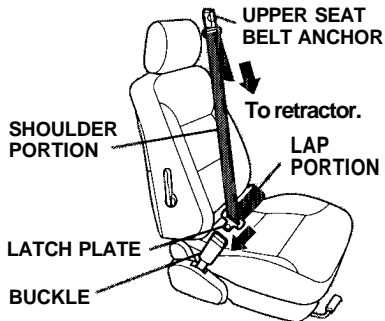

Lap Belt

The lap belt has one manually adjusted belt that fits across the hips. It is similar to safety belts used in airplanes.

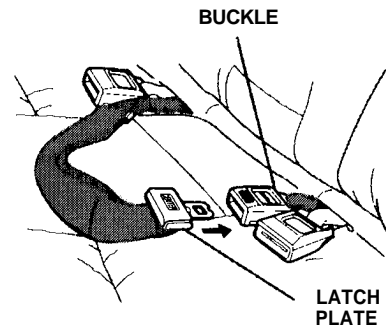

Wearing Seat Belts Properly

You can increase the effectiveness of your seat belts if you take a little time to read the following pages and make sure you know how to wear seat belts properly.

Not wearing a seat belt properly increases the chance of serious injury or death in a crash.

Be sure you and your passengers always wear seat belts and wear them properly.

Wearing a Lap/Shoulder Belt

Before putting on the seat belt, move the driver's seat back as far as is practical while still

allowing you to maintain full control of the vehicle. Make sure the seat-back is upright (see page 16). The front seat passenger should move the seat as far back as possible.

1. Pull the latch plate across your body, and insert it into the buckle. Tug on the belt to make sure the latch is securely locked.

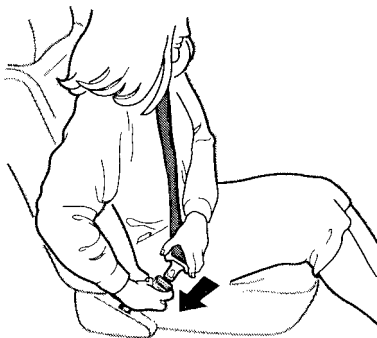

2. Check to see that the belt is not twisted.
3. Position the lap portion of the belt as low as possible across your hips, not across your stomach. This lets your strong pelvic bones take the force of a crash.

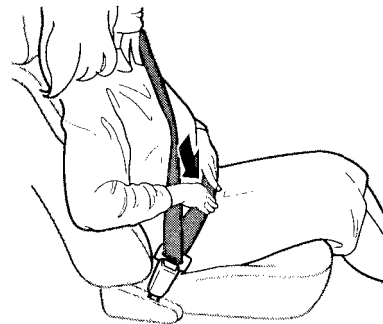

continued

The Seat Belt System and How It Works

4. Pull up on the shoulder part of the belt to remove any slack. Make sure the belt goes over your collarbone and across your chest.



5. If the shoulder belt crosses your neck, you need to adjust the belt anchor height or your seating position.

Front seats: Adjust the belt anchor by squeezing the two buttons and sliding the anchor downward (it has four positions).

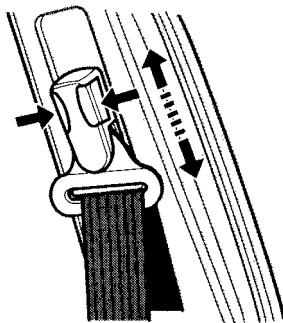

Rear seats: Move toward the center of the seat until the belts fits over your collarbone.

To unlatch the seat belt, push the red PRESS button on the buckle. Guide the belt across your body to the door pillar. After you exit the vehicle, make sure the seat belt is out of the way and will not get closed in the door.

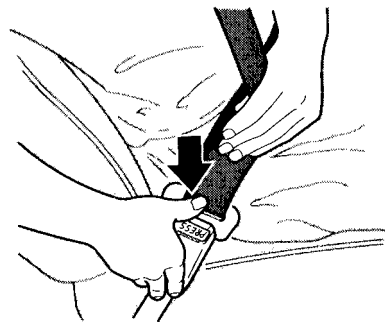

Wearing the Lap Belt

1. Pull the latch plate across your hips, and insert it into the buckle marked CENTER.

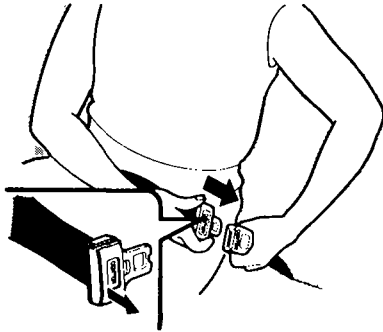

If the belt is too short, hold the latch plate at a right angle, and pull to extend the belt. Insert the latch plate into the buckle.

2. Position the belt so it fits as low as possible across your hips and pelvic bones, not across your stomach. Pull the loose end of the belt to adjust for a snug but comfortable fit.

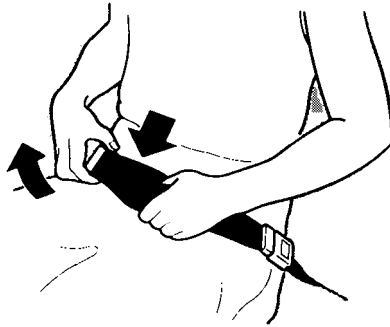

To unlatch the belt, push the red PRESS button on the buckle.



Advice for Pregnant Women

Protecting the mother is the best way to protect her unborn child. Therefore, a pregnant woman should wear a properly positioned seat belt whenever she drives or rides in a car.

continued

The Seat Belt System and How It Works, Supplemental Restraint System

If possible, use the lap/shoulder seat belt, remembering to keep the lap portion as low as possible (see page 7).

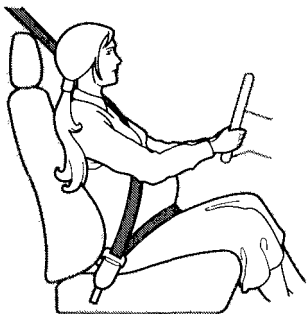

Each time you have a check-up, ask your doctor if it's okay for you to drive and how you should position a lap/shoulder seat belt.

Seat Belt Maintenance

For safety, you should check the condition of your seat belts regularly.

Pull out each belt fully and look for frays, cuts, burns, and wear. Check to see that the latches work smoothly and the lap/shoulder belts retract easily. Any belt not in good condition or not working properly should be replaced.

If a seat belt is worn during a crash, have your dealer replace the belt and check the anchors for damage.

For information on how to clean your seat belts, see page 148.

Supplemental Restraint System

Your Accord is equipped with a Supplemental Restraint System (SRS) to help protect the head and chest of the driver and a front seat passenger during a severe frontal collision.

This system does not replace your seat belts. It supplements, or adds to, the protection offered by seat belts and other occupant protection features.

Not wearing a seat belt properly increases the chance of serious injury or death in a crash.

Be sure you and your passengers always wear seat belts and wear them properly.

SRS Components

Your supplement restraint system includes:

- One airbag in the steering wheel for the driver and another in the dashboard for the passenger.
- Sensors that can detect a severe frontal collision.
- A sophisticated electronic system that continually monitors the sensors, control unit, airbag activators, and all related wiring when the ignition is ON (II).
- An indicator light on the instrument panel to alert you to a possible problem with the system.
- Emergency backup power in case your car's electrical system is disconnected in a crash.

What Happens in a Crash

If you ever have a severe frontal collision, the sensors will detect rapid deceleration and signal the control unit to instantly inflate the airbags.

During a crash, your seat belts will help to restrain your lower body and torso. The airbags will provide a cushion to absorb crash energy and help keep the head and chest of the driver and front passenger from striking the interior of the car.

After inflating, the airbags will immediately deflate. The entire process, from detection to deflation, takes a fraction of a second. This process occurs so quickly that you may not hear the loud noise created by the airbag inflators or realize what has happened.

After the crash, you may see what looks like smoke. This is actually powder from the airbag's surface. People with respiratory problems may experience some temporary discomfort from the chemicals used by the airbag's activators.

Important Facts

About Airbags

Airbags inflate only when needed; **in a severe frontal collision**. A severe collision would be similar to a crash into a parked car at 25 mph. Airbags will not inflate in a moderate frontal collision, or during a rear impact, side impact, or rollover - even if the impact is severe.

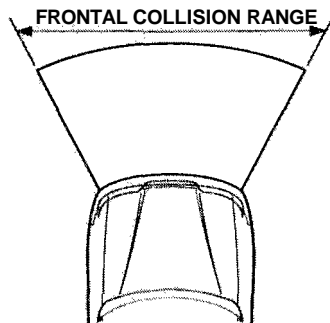

Airbags inflate and deflate only once. They cannot protect you during any additional impacts that occur during a crash sequence.

Injuries, including fatal injuries, can occur in a severe collision, even if seat belts are worn properly and the airbags inflate. No safety system can provide complete protection in a severe crash.

Just from viewing the vehicle damage after a crash, it is very difficult to accurately determine if the airbags should or should not have inflated. In some cases where the airbag did not inflate, extensive visible damage indicated that the car absorbed much of the crash energy, and the airbags were not needed. In other cases, a severe jolt, such as an impact to the

undercarriage, may not cause extensive body damage but may cause the airbags to inflate.

How the Driver's Airbag Works

If you ever have a severe frontal collision, your airbag will instantly inflate to help protect your head and chest.

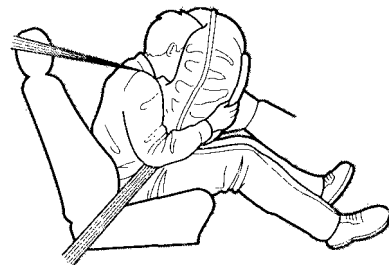

To do its job, the airbag inflates with considerable force. So, while it can reduce serious injuries and even save your life, the airbag might cause some facial abrasions or other injuries. To reduce the possibility of injury, you should always sit as far from the steering wheel as practical while still maintaining full vehicle control.

After the bag completely inflates, it immediately starts deflating so it won't interfere with your visibility, ability to steer, or ability to operate other controls.

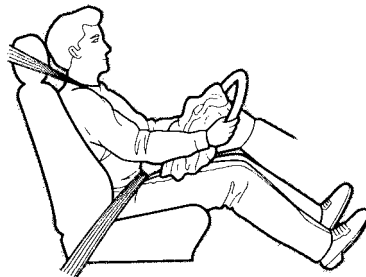

The total time for inflating and deflating is a fraction of a second. You may not even be aware that the airbag has been fully inflated.

The airbag is stored in the center of the steering wheel. For safety, do not attach any items to the steering wheel. They could interfere with the proper operation of the airbag. Or, if the airbag inflates, the items could be propelled inside the car and hurt someone.

How the Passenger's Airbag Works

If you have a severe frontal collision, the passenger's airbag will inflate at the same time as the driver's airbag.

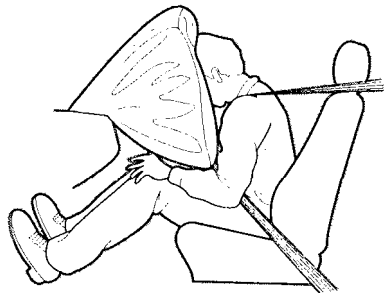

This airbag is quite large and inflates with considerable force. It can seriously hurt a front seat passenger who is not in the proper position and wearing the seat belt properly.

Front seat passengers should move the seat as far back as practical and sit well back in the seat.

We strongly recommend that you do not put an infant seat in the front passenger's seat. If the airbag inflates, it can hit the infant with great force. The infant seat can be dislodged or struck with enough force to cause serious injury to the infant.

If a toddler seat is used in the front passenger's seat, the vehicle seat should be moved as far back as possible. If the passenger bag inflates, it could seriously hurt a toddler who is not in the proper position or properly restrained.

The passenger's airbag is stored near the top of the dashboard, under a lid marked SRS. Do not

place any objects on top of this lid. If the airbag inflates, those objects can be propelled inside the car and possibly hurt someone.

SRS How the SRS Indicator Light Works

The purpose of the SRS light on your instrument panel is to alert you to a potential problem with your supplemental restraint system.

Have the system checked if:

- The light does not come on when you turn the ignition ON (II).
- The light stays on after the engine starts.
- The light comes on or flashes while you are driving.

System Service

Your supplemental restraint system is virtually maintenance-free. There are no parts you can safely service.

You must have the system serviced by an authorized Honda dealer:

- *If your airbags ever inflate.* The airbags and control unit must be replaced. Do not try to remove or discard the airbags by yourself. This must be done by a Honda dealer.
- *If the SRS indicator light alerts you of a problem.* Have the supplemental restraint system checked as soon as possible. Otherwise, your airbags might not inflate when you need them.

- *When the car is 10 years old.* Have the dealer inspect the system. The production date is on the driver's doorjamb for your convenience.

System Service Precautions

Do not modify your steering wheel or any other part of the supplemental restraint system. Modifications could make the system ineffective.

Do not tamper with the system's components or wiring. This could cause the airbags to inflate inadvertently, possibly injuring someone very seriously.

Tell anyone who works on your car that you have a supplemental restraint system. Failure to follow the procedures and precautions in the official Honda service manual could result in

personal injury or damage to the system.

Scrapping an entire car that has uninflated airbags can be dangerous. Get assistance from a Honda dealer if your car must be scrapped.

If you sell your car, please be sure to tell the new owner that the car has a supplemental restraint system. Alert them to the information and precautions in this part of the Owner's Manual.

Additional Safety Information

The seat belts and airbags are obviously important parts of your occupant protection system.

In addition, you should know that sitting upright, adjusting the head restraint properly, locking the doors, and stowing things properly can also increase your safety and possibly even save your life.

Seat-Back Position

The seat-backs should be in an upright position for you and your passengers to get the most protection from the seat belts.

If you recline a seat-back, you reduce the protective capability of your seat belt. The farther a seat-back is reclined, the greater the risk that you will slide under the belt in a severe crash and be very seriously injured.

For information on how to adjust the seat-back, see page [48](#).

Head Restraint Position

Head restraints can help protect you from whiplash and other injuries. For the best protection, adjust the top of the restraint so it is even with the tops of your ears, or as high as possible. For instructions on adjusting the head restraints, see page [49](#).

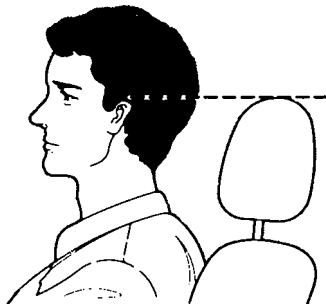

Door Locks

It is not safe to leave your car doors unlocked. A passenger, especially a child, could open a door and accidentally fall out. Also, there is a greater chance of being thrown out of the car during a crash when the doors are not locked.

Storing Cargo Safely

Before you drive, make sure you first securely store or tie down any items that could be thrown around the car and hurt someone or interfere with your ability to operate the controls.

Do not put any items on top of the tonneau cover. They can block your view, and they could be thrown about the car in a crash.

Be sure to keep compartment doors closed when the car is moving. If a front passenger hits the door of an open glove box, for example, he could injure his knees.

For information on loading cargo, see page [84](#).

Driving With Pets

Loose pets can be a hazard while you are driving. An unrestrained pet can interfere with your ability to drive the car. In a crash or sudden stop, loose pets or cages can be thrown around inside the car and hurt you or your passengers. It is also for their safety that pets should be properly restrained in your car.

The recommended way to restrain a medium-sized or larger dog is with a special traveling

harness. This harness can be secured to the rear seat with a seat belt. Travel harnesses are available at pet stores.

A small dog, cat, or other small animal will be safest in a pet carrier with rigid sides. Choose a style that allows you to secure it to the car's seat by routing a seat belt through the carrier's handle.

For further information, contact your veterinarian or local animal protection society.

Child Safety

Children depend on adults to protect them. To help make sure we do, every state and Canadian province has laws requiring infants and young children to be properly restrained whenever they ride in a car.

An infant or child who is not properly restrained can be killed or seriously injured in a crash.

Be sure any child too small for seat belts is properly secured in a child restraint.

Where Should Children Sit?

According to accident statistics, children of all sizes and ages are safer when they are properly restrained in the rear seat rather than the front seat.

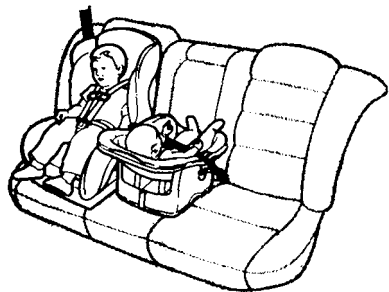

We recommend that, whenever possible, you secure your child's infant or toddler seat in the center position of the rear seat with the lap belt.

We strongly recommend that you do not put an infant seat in the front passenger's seat. If the airbag inflates, it can hit the infant with great force. The infant seat can be dislodged or struck with enough force to cause very serious injury to the infant.

If a toddler seat is used in the front passenger's seat, the vehicle seat should be moved as far back as possible. If the passenger bag inflates, it could seriously hurt a toddler who is not in the proper position or properly restrained.

We also recommend that any child who is too large to use an infant or toddler seat ride in one of the outside positions of the rear seat. The child should then wear the lap/shoulder belt properly for protection.

Important Safety Reminders

Never hold a baby or child on your lap when riding in a car. If you are wearing your seat belt, the violent forces created during a crash will tear the child from your arms. The child could be seriously hurt or killed.

If you are holding a child and not wearing a seat belt in a crash, you could crush the child against the car's interior.

Never put your seat belt over yourself and a child. During a crash, the belt could press deep into the child causing serious internal injuries.

Two children should never use the same seat belt. If they do, they could be very seriously injured in a crash.

If you are driving with small children in the car, you should use the childproof door locks to prevent them from opening the rear doors (see page 46).

For their safety, do not leave children alone in your car without adult supervision.

General Guidelines for Restraining Children Under 40 lb (18kg)

Use an approved child seat. The seat must meet Federal Motor Vehicle Safety Standard 213 (FMVSS-213) or Canadian Motor Vehicle Safety Standards. Look for the manufacturer's statement of compliance on the box and seat.

Use a seat of the right size. Make sure the seat fits your child.

Check the seat's instructions and labels for height and weight limits.

Secure the child seat to the car. All approved child seats are designed to be secured in the car seat by the lap belt or the lap belt portion of a lap/shoulder belt. A child whose seat is not properly secured to the car can be endangered in a crash.

To properly route a seat belt through a child seat, follow the seat-maker's instructions. If you use a lap/shoulder belt, be sure you install a locking clip on the belt (see page 21).

Secure the child in the child seat. Make sure the infant or child is firmly secured to the child seat. Use the straps provided, and carefully follow the manufacturer's instructions.

Restraining an Infant Who Weighs Less Than 20 lb (9 kg)

An infant up to about 20 lb (9 kg) must be restrained in an infant seat or a convertible seat designed for a baby. Because infants must ride in a reclining position, be sure the infant seat always faces the REAR of the car as shown.

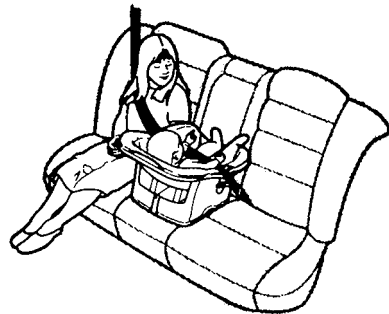

continued

We recommend that, whenever possible, you put the infant seat in the center position of the rear seat and secure it to the car with the lap belt.

If you decide to put an infant seat in any other seating position, you must use a locking clip on the car's lap/shoulder belt (see page 21).

We strongly recommend that you do not put an infant seat in the front passenger's seat. If the airbag inflates, it can hit the infant with great force. The infant seat can be dislodged or struck with enough force to cause serious injury to the infant.

Restraining a Child Who Weighs Between 20 and 40 lb (9 and 18 kg)

Toddler seats are designed for children who weigh between 20 and 40 lb (9 and 18kg).

The preferred place to put a toddler seat is in the center position of the rear seat. Use the car's lap belt to secure the seat to the car.

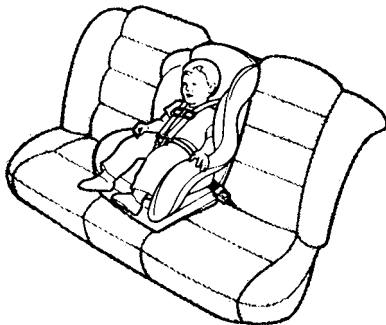

If you decide to put a toddler seat in any other seating position, you must use a locking clip on the car's lap/shoulder belt (see page 21).

If you are using a toddler seat in the front passenger's seat, move the passenger's seat as far back as possible before installing the child seat. If the passenger bag inflates, it could seriously hurt a toddler who is not in the proper position or properly restrained.

Restraining a Child Who Weighs Over 40 lb (18 kg)

We recommend that, whenever possible, a child who has outgrown a toddler seat ride in one of the outside positions of the rear seat and use a lap/shoulder belt.

Put the lap/shoulder belt on your child and check its fit. The shoulder belt should fit over the collarbone and across the chest. The lap belt should sit low on your child's hips, not across the stomach.

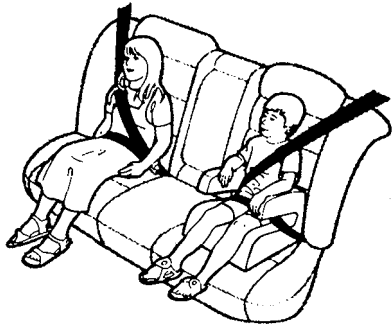

If the shoulder belt crosses the neck, have your child move toward the center of the rear seat until the belt fits properly. If the belt still crosses the child's

neck, you should use a booster seat.

Several styles of booster seats are available. We recommend a design that allows the child to use the car's lap/shoulder belt.

Whichever style you select, follow the booster seat manufacturer's instructions.

Using a Seat Belt Locking Clip

Always use a seat belt locking clip when you secure a child seat to your car with a lap/shoulder belt. This helps prevent the seat from shifting position or overturning.

A locking clip is usually included with the child seat. If you need a clip, contact the seat's manufacturer or a store that sells child restraints.

To install a locking clip, do the following:

1. Place the child restraint in the desired position. Route the lap/shoulder belt through the restraint according to the seat manufacturer's instructions.
2. Insert the latch plate into the buckle. Pull on the shoulder part of the belt to make sure there is no slack in the lap portion.
3. Tightly grasp the belt near the latch plate. Pinch both parts of the belt together so they won't slip through the latch plate. Unbuckle the seat belt.

continued

4. Install the locking clip as shown. Position the clip as close as possible to the latch plate.

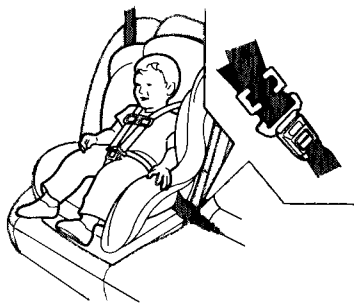

5. Insert the latch plate into the buckle. Push and pull on the child seat to verify that it is held firmly in place. If it is not, repeat these steps until the restraint is secure.

Using Child Restraints With Tethers

Your Honda has three attachment points for tether-style child seats. Two are on the floor behind each rear seat. A third attachment point is at the headliner at the tailgate opening. To access, remove the plug cap.

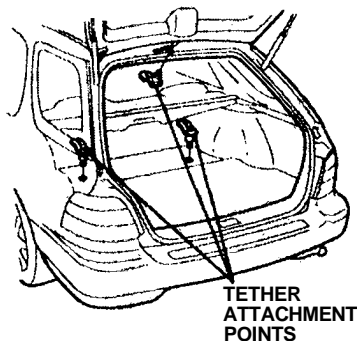

If you are not sure how to install the bracket, have it installed by your authorized Honda dealer.

If you need an anchor plate and mounting hardware, you can obtain them by writing to:

American Honda Motor Co., Inc.
Consumer Affairs
1919 Torrance Blvd.
Torrance, CA 90501-2746

Canadian Cars

The anchor plate and mounting hardware for a top tether are supplied with the car. When installing, make sure the toothed washer is on the bottom of the bolt.

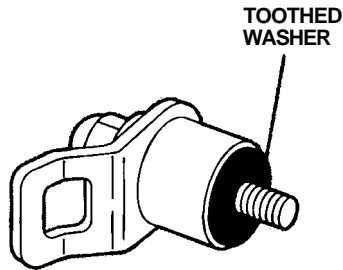

The supplied anchor plate is designed only for mounting a child restraint. Do not use it for any other purpose.

Storing a Child Seat

When you are not using an infant seat or other child restraint, either remove it or make sure it is properly secured so it cannot be thrown around the car during a crash.

Carbon Monoxide Hazard

Your car's exhaust contains carbon monoxide gas. You should have no problem with carbon monoxide entering the car in normal driving if you maintain your car properly. Have the exhaust system inspected for leaks whenever:

- The car is raised for an oil change.
- You notice a change in the sound of the exhaust.
- The car was in an accident that may have damaged the underside.

Carbon monoxide gas is toxic. Breathing it can cause unconsciousness and can even kill you.



Avoid any enclosed areas or activities that expose you to Carbon monoxide.

High levels of carbon monoxide can collect rapidly in enclosed areas, such as a garage. Do not run the engine with the garage door closed. Even with the door open, run the engine only long enough to move the car out of the garage.

With the tailgate open, air flow can pull exhaust gas into your car's interior and create a hazardous condition. If you must

drive with the tailgate open, open all the windows and set the heating and cooling system as shown below.

If you must sit in your parked car, even in an unconfined area, with the engine running, adjust the heating and cooling system as follows:

1. Push the  button.
2. Select the  mode.
3. Turn the fan on high speed.
4. Set the temperature control to a comfortable setting.

These labels are in the locations shown. They warn you of potential hazards that could cause serious injury. Read these labels carefully, and don't remove them.

If a label comes off or becomes hard to read, contact your Honda dealer for a replacement.

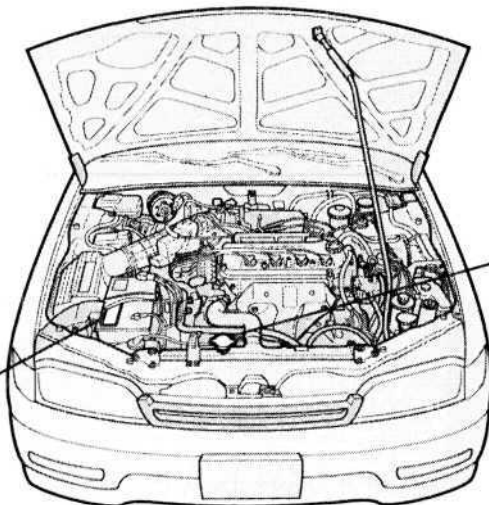

RADIATOR CAP



BATTERY

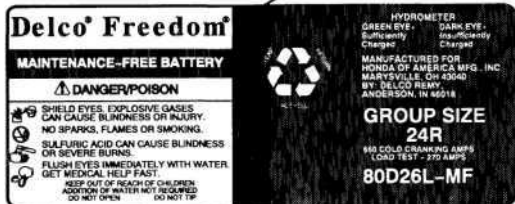

This section gives information about the controls and displays that contribute to the daily operation of your Honda. All the essential controls are within easy reach.

Control Locations	28
Indicator Lights	29
Gauges	33
Speedometer	33
Tachometer	33
Odometer	33
Trip Meter	33
Fuel Gauge	34
Temperature Gauge	34
Maintenance Required Indicator	34
Controls Near the Steering Wheel	35
Headlights	36
Daytime Running Lights ...	36
Instrument Panel Brightness	37

Turn Signals	37
Windshield Wipers	37
Rear Window Wiper/Washer	38
Windshield Washers	38
Hazard Warning	39
Rear Window Defogger ...	39
Steering Wheel Adjustment	40
Steering Wheel Controls	40
Cruise Control	40
Keys and Locks	43
Keys	43
Ignition Switch	44
Power Door Locks	45
Door Locks	45
Remote Transmitter	45
Childproof Door Locks ...	46
Glove Box	47
Tailgate	47

Seat Adjustments	48
Front Seat Adjustments ...	48
Driver's Seat Power Height Adjustment	49
Driver's Lumbar Support ..	49
Head Restraints	49
Folding Rear Seat	50
Rear Seat Armrest	50
Power Windows	50
Moonroof	52
Mirrors	53
Power Mirrors	53
Parking Brake	54
Digital Clock.....	54
Beverage Holder	55
Console Compartment.....	56
Coin Box	56
Cigarette Lighter	56
Ashtrays	57
Interior Light	57
Courtesy Lights	58

Control Locations

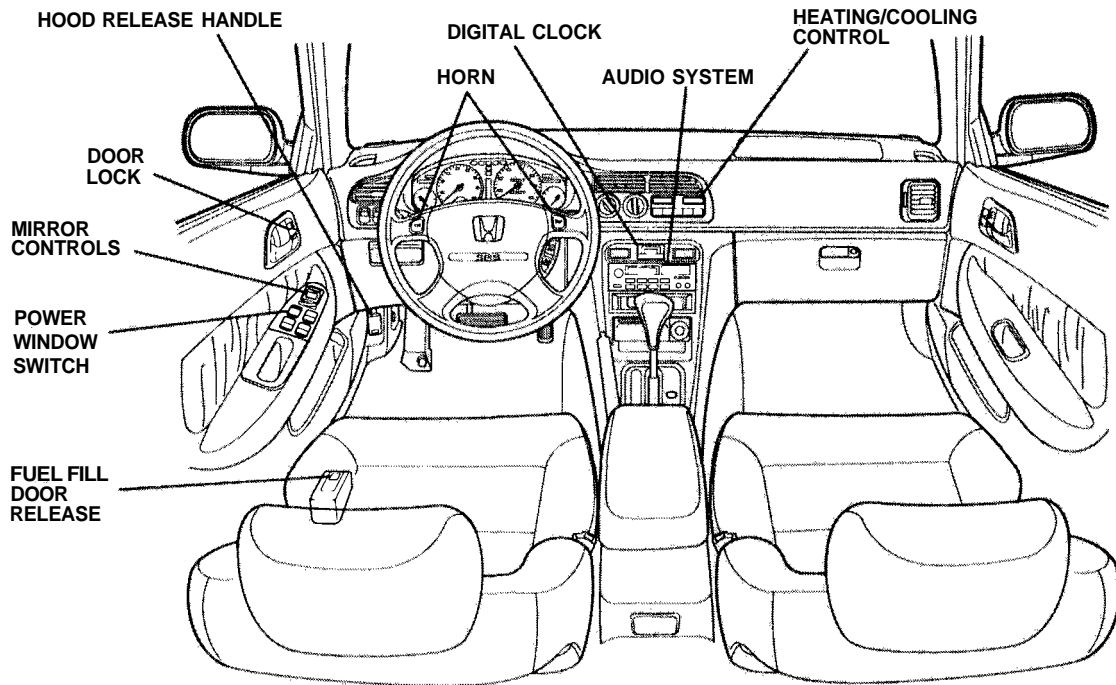

The instrument panel has many indicators to give you important information about your car.

Lamp Check

Many of the indicator lights come on when you turn the ignition switch ON (II), allowing you to see that they are working. If an indicator does not light during this test, it cannot alert you if that system develops a problem. Have the dealer check your car for burned-out bulbs or other problems.

* The U.S. EX instrument panel is shown. Differences for the Canadian model are noted in the text.

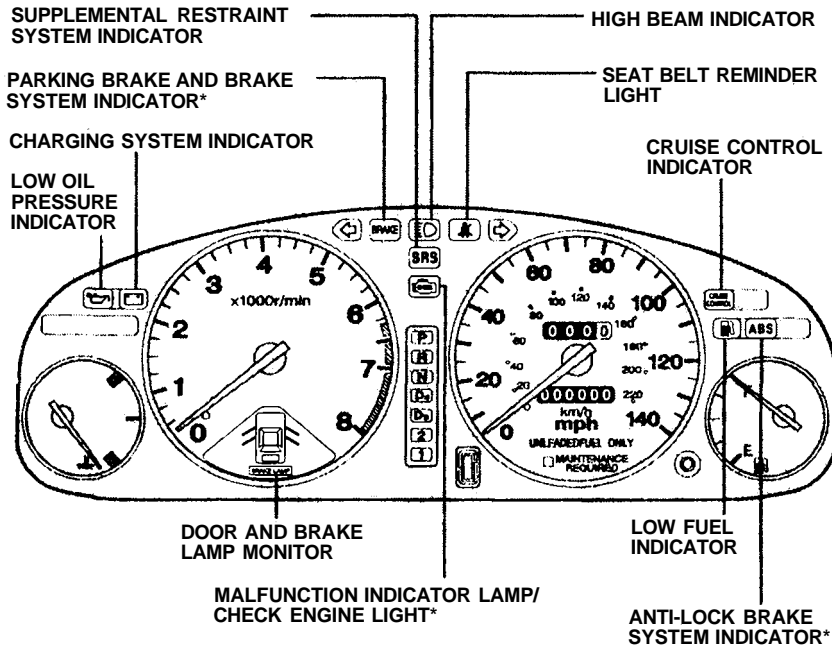

U.S. EX WITH AUTOMATIC TRANSMISSION SHOWN



Seat Belt Reminder Light

This indicator lights when you turn the ignition ON (II). It is a reminder to you and your passengers to protect yourselves by fastening the seat belts. A beeper also sounds if you have not fastened your seat belt.

If you do not fasten your seat belt, the beeper will stop after a few seconds but the light stays on until you do. Both the light and the beeper stay off if you fasten your seat belt before turning on the ignition.



Charging System Indicator

The battery is not being charged if this light comes on when the engine is running.



Low Oil Pressure Indicator

The engine can be severely damaged if this light comes on when the engine is running. For complete information, see page 162.

U.S.	Canada	Parking Brake and Brake System Indicator Light
BRAKE	(P) (P)	

This light has two functions:

1. It lights as a reminder that you have set the parking brake. Driving with the parking brake set can damage the brakes and tires, and cause the anti-lock brake system to turn off on cars equipped with ABS.

2. It can indicate the brake fluid level is low if it remains lit after you release the parking brake or comes on while driving. This is normally due to worn brake pads. Have your dealer check the braking system for worn pads or fluid leaks.

SRS	Supplemental Restraint System Indicator
------------	--

The SRS light normally comes on for a few seconds when you turn the ignition ON (II). If it doesn't, or it stays on after the engine starts, something is wrong with the Supplemental Restraint System. It may also flash on and off to indicate a problem.

If you see any of these indications, the airbags may not work when needed in an accident. Take the car to your dealer promptly for diagnosis and service.

U.S.



Anti-Lock Brake System (ABS)

Canada



Indicator

On cars equipped with ABS

This light normally comes on when you turn the ignition ON (II) and goes off after the engine starts. If it comes on at any other time, there is a problem in the ABS. If this happens, stop the car in a safe place, and turn off the engine. Reset the system by restarting the engine. Watch the ABS light.

If it does not go off, or comes back on again while driving, take the car to your dealer to have it checked. With the light on, your car still has normal braking ability but no anti-lock.



U.S.: Malfunction Indicator Lamp



Canada: Check Engine Light

This light comes on for a few seconds when you turn the ignition switch ON (II). If it comes on at any other time, it indicates one of the engine's emissions control systems may have a problem. Turn to page [163](#) for information about what to do.

Door and Brake Lamp Monitor

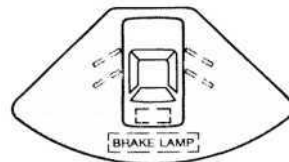

The appropriate light comes on in this display if the tailgate or any door is not closed tightly. If a brake lamp (except for the high-mount stoplight) does not work, the **BRAKE LAMP** indicator comes on when you push the brake pedal with the ignition switch ON (II).

A burned out brake light is a hazard when drivers behind you cannot tell you are braking. Have your brake lights repaired right away.

continued

Indicator Lights

All the lights in the monitor display come on for a few seconds when you turn the ignition switch ON (II).



Turn Signal and Hazard Warning Indicators

The left or right turn signal light blinks when you signal a lane change or turn. If the light does not blink or blinks rapidly, it usually means one of the turn signal bulbs is burned out (see page 138). Replace it as soon as possible, since other drivers cannot see that you are signaling.

When you turn on the Hazard Warning switch, both turn signal lights blink. All turn signals on the outside of the car should flash.



High Beam Indicator

This light comes on with the high beam headlights. See page 36 for information on the headlight controls.

Canada



Daytime Running Lights (DRL) Indicator

Canadian models only

This indicator lights when you turn the ignition ON (II) with the headlight switch off and the parking brake set. It should go

off if you turn on the headlights or release the parking brake. If it comes on at any other time, it means there is a problem with the DRL. There may also be a problem with the high beam headlights.



Cruise Control Indicator

This lights when you set the cruise control. See page 40 for information on operating the cruise control.



Low Fuel Indicator

This light comes on as a reminder that you must refuel soon.

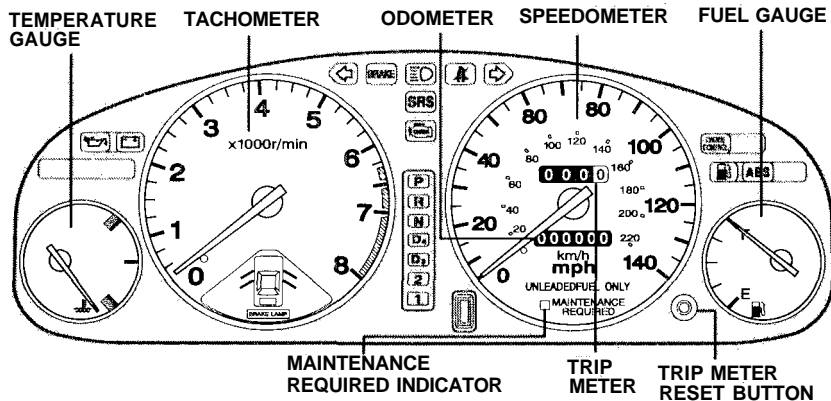

Odometer

The odometer shows the total distance your car has been driven. It measures miles in U.S. models and kilometers in Canadian models. It is illegal under federal law (in the U.S.) and provincial regulations (in Canada) to disconnect, reset, or alter the odometer with the intent to change the number of miles or kilometers indicated.

Trip Meter

This meter shows the number of miles (U.S.) or kilometers (Canada) driven since you last reset it. To reset it, push the trip meter reset button.

Speedometer

U.S. Models

This shows your speed in miles per hour. The smaller inner numbers are the speed in kilometers per hour.

Canadian Models

This shows your speed in kilometers per hour. The smaller

inner numbers are the speed in miles per hour.

Tachometer

The tachometer shows the engine speed in revolutions per minute (rpm). To protect the engine from damage, never drive with the tachometer needle in the red zone.

Fuel Gauge

This shows how much fuel you have. It is most accurate when the car is on level ground. It may show slightly more or less than the actual amount when you are driving on curvy or hilly roads.

The gauge stays at the same fuel level reading after you turn off the ignition. When you add fuel, the gauge slowly changes to the new reading after you turn the ignition back ON (II).

Temperature Gauge

This shows the temperature of the engine's coolant. During normal operation, the pointer should rise from the bottom white mark to about the middle of the gauge. In severe driving conditions, such as very hot weather or a long period of uphill driving, the pointer may

rise to the upper white mark. If it reaches the red (hot) mark, pull safely to the side of the road. Turn to page 117 for instructions and precautions on checking the engine's cooling system.

Maintenance Required Indicator

The indicator reminds you when it is time for scheduled maintenance. When it nears 7,500 miles (12,000 km) since the last maintenance, the indicator will turn yellow. If you exceed 7,500 miles (12,000 km), the indicator will turn red. Your dealer will reset the indicator when he performs the scheduled maintenance. If someone else performs the maintenance, reset the indicator by inserting your key in the slot next to the indicator.

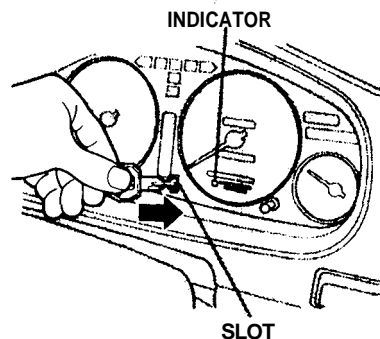

Controls Near the Steering Wheel

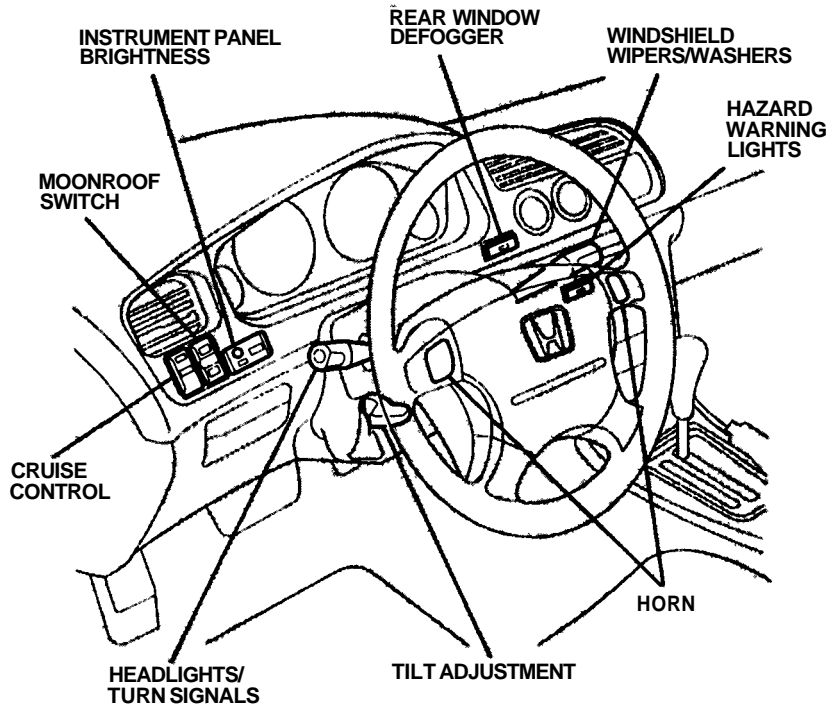

The two levers on the steering column contain controls for driving features you use most often. The left lever controls the turn signals, headlights, and high beams. The right lever controls the windshield washers and wipers.

The rear window defogger switch is on the dashboard to the right of the steering column.

The controls under the left air vent are for the moonroof, cruise control, and instrument panel brightness.

The tilt adjustment lever on the underside of the steering column allows you to tilt the steering wheel.

Headlights

The rotating switch on the left lever controls the lights. Turning this switch to the first position “●” turns on the parking lights, tail lights, instrument panel lights, side-marker lights, and rear license plate lights. Turning the switch to the second position “●” turns on the headlights.

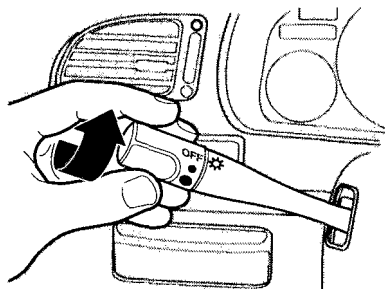

If you leave the lights on with the ignition switch in ACCESSORY (I) or LOCK (0), you will hear a reminder chime when you open the driver's door.

To change between low beams and high beams, pull the turn signal lever toward you until you hear a click, and then let go. The high beam indicator will light (see page 32).

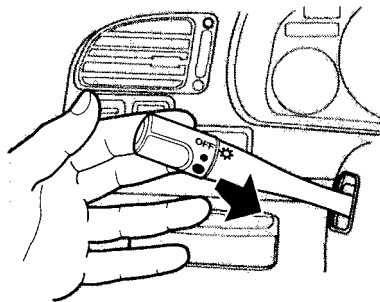

To flash the high beams, pull back and hold the turn signal lever. Release the lever, and the high beams will go off.

The high beams will stay on for as long as you hold the lever, no matter what position the headlight switch is in.

Daytime Running Lights

Canadian models

With the headlight switch off, the high beam headlights come on with reduced brightness when you turn the ignition switch to ON (II) and release the parking brake. They remain on until you turn the ignition off, even if you set the parking brake.

The headlights revert to normal operation when you turn them on with the switch.

Instrument Panel Brightness

The knob on the dashboard to the left of the instrument panel controls the brightness of the instrument panel lights. Push the knob to get it to pop out. Turn the knob to adjust the brightness. Push the knob back in to lock your adjustment.

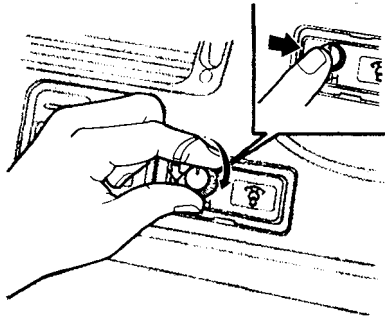

Turn Signals

Signal a turn or lane change with this lever. Push down on the lever to signal a left turn, and up to signal a right turn. If you push it up or down all the way, the turn signal continues to blink even when you release the lever. It shuts off automatically as you complete the turn.

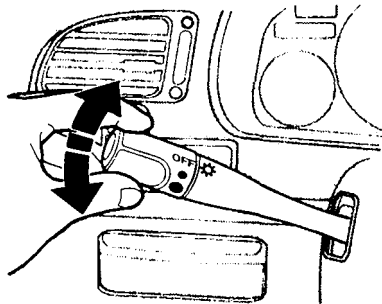

To signal a lane change, push lightly on the turn signal lever in

the proper direction, and hold it; The lever will return to the center position as soon as you release it.

Windshield Wipers

The right lever controls the windshield wipers and washers. The rotary switch at the end of the lever has three positions: INT - intermittent LO - low speed HI - high speed

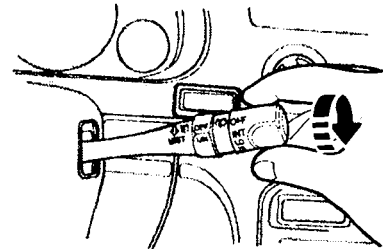

continued

Controls Near the Steering Wheel

To operate the wipers in mist mode, push the control lever down. The wipers run at high speed until you release the lever. This gives you a quick way to clear the windshield.

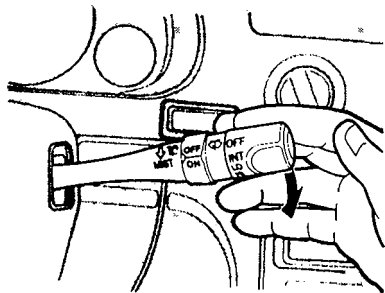

Rear Window Wiper/Washer

The rear window wiper switch is located next to the windshield wiper switch.

To activate the rear windshield wiper, turn the switch "ON." If you wish to use the wiper and washer, turn and hold the switch one position up from "ON." To use the washer only, turn and hold the switch one position down from "OFF."

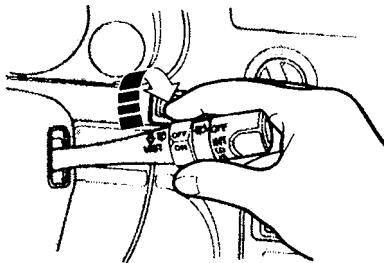

Windshield Washers

To clean the front windshield, pull back on the wiper control lever. The washers spray until you release the lever. The wipers run at low speed while you're pulling the lever, then complete one more sweep of the windshield after you release it.

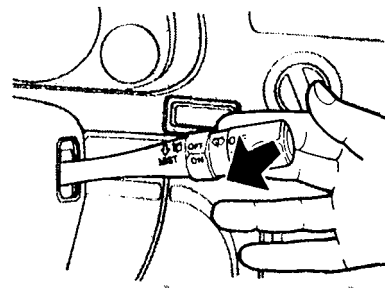

Hazard Warning

Push the red button to the left of the clock to turn on the hazard warning lights (four-way flashers). This causes all four outside turn signals and both indicators in the instrument panel to flash. Use the hazard warning lights if you need to park in a dangerous area near heavy traffic or if your car is disabled.

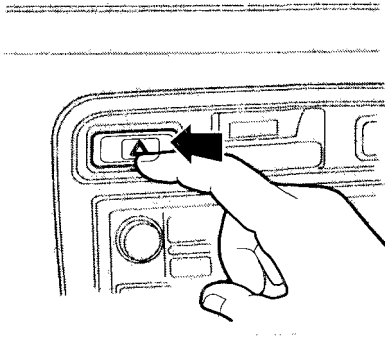

Rear Window Defogger

The rear window defogger will clear fog, frost, and thin ice from the window. Push the defogger button to turn it on and off. The light in the button lights to show the defogger is on. If you do not turn it off, the defogger will shut itself off after about 25 minutes. It also shuts off when you turn off the ignition. You have to turn it on again when you restart the car.

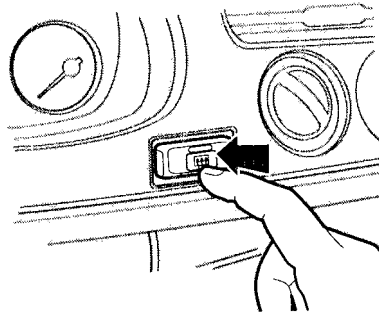

Make sure the rear window is clear and you have good visibility before starting to drive.

The defogger wires on the inside of the rear window can be accidentally damaged. When cleaning the glass, always wipe side to side.

Controls Near the Steering Wheel, Steering Wheel Controls

Steering Wheel Adjustment

You can adjust the steering wheel height to suit your preference. Do this before you begin driving.

Adjusting the steering wheel position while driving may cause you to lose control of the car and be seriously injured in a crash.

Adjust the steering wheel when the car is stopped.

1. Adjust the seat so you are a comfortable distance from the pedals and can operate them safely.

2. The lever to tilt the steering wheel is under the steering column to the left. Push this lever all the way down.

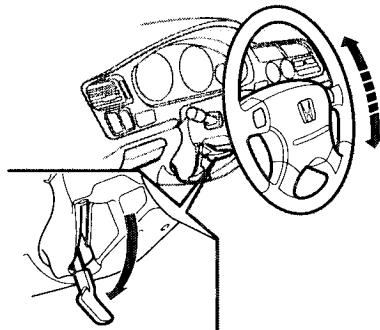

3. Move the steering wheel up or down to the desired position. Position the wheel so you can see all the instrument panel gauges and warning lights. Push the lever up to lock the steering wheel in that position.

4. Make sure you have securely locked the steering wheel in place by trying to move it up and down.

Steering Wheel Controls

Cruise Control

Cruise control allows you to maintain a set speed above 25 mph (40 km/h) without keeping your foot on the accelerator pedal. It is for cruising on straight, open highways. It is not recommended for conditions such as city driving, winding roads, slippery roads, heavy rain, or bad weather. You should have full control of the car under those conditions.

Improper use of the cruise control can lead to a crash.

Use the cruise control only when traveling on open highways in good weather.

NOTICE

The cruise control, as it operates, moves the accelerator pedal. You can damage your car's accelerator mechanism by resting your foot under the pedal and blocking the movement.

Using the Cruise Control

1. Push in the Cruise Control Master Switch to the left of the steering column. The indicator in the switch will light.

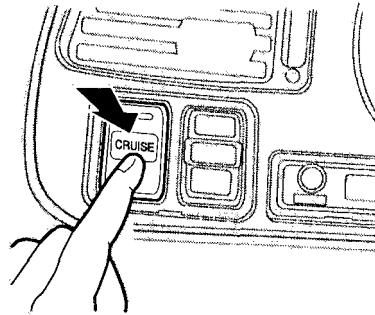

2. Accelerate to the desired cruising speed above 25 mph (40 km/h).

3. Press and hold the SET/decel button on the steering wheel until the CRUISE CONTROL light on the instrument panel comes on. This shows the system is now activated.

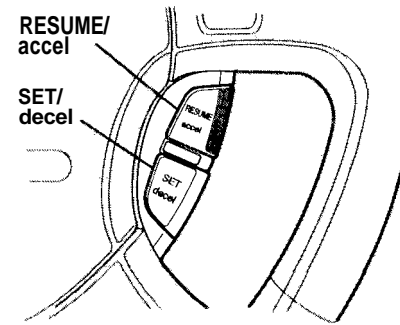

The set speed may vary slightly, particularly on hills.

Changing the Set Speed

You can increase the set cruising speed in either of two ways:

- Press and hold the RESUME/accel button. The car will accelerate slowly. When you reach the desired cruising speed, release the button.
- Push on the accelerator pedal. Accelerate to the desired cruising speed, and press the SET/decel button.

You can decrease the set cruising speed in either of two ways:

- Press and hold the SET/decel button. The car will decelerate. Release the button when you reach the desired speed.
- Tap the brake or clutch pedal lightly with your foot. The

CRUISE CONTROL light on the instrument panel will go out. When the car slows to the desired speed, press the SET/decel button. The car will then maintain the desired speed.

Even with the cruise control turned on, you can still use the accelerator pedal to speed up for passing. After completing the pass, take your foot off the accelerator pedal. The car will return to the set cruising speed.

Resting your foot on the brake or clutch pedal will cause the cruise control to cancel.

Canceling the Cruise Control

You can cancel the cruise control in any of these ways:

- Tap the brake or clutch pedal.

- Press the SET/decel and RESUME/accel buttons at the same time.
- Press the Cruise Control Master Switch.

When you tap the brake or clutch pedal (manual transmission cars), or press the SET and RESUME buttons at the same time, the CRUISE CONTROL light on the instrument panel will go out and the car will begin to slow down. You can use the accelerator pedal in the normal way.

If you use the brake or clutch pedal to cancel cruise control, the system retains the previously set cruising speed. To return to that speed, accelerate to above 25 mph (40 km/h), and press the RESUME/accel button until the CRUISE CONTROL light comes

on. The car will accelerate to the same cruising speed as before.

If you cancel cruise control by pressing the SET and RESUME BUTTONS at the same time, the previously set cruising speed is erased. To use the cruise control, accelerate to the desired cruising speed, and press the SET/decel button.

Pressing the Cruise Control Master Switch turns the system completely off and erases the previous cruising speed from memory. To use the system again, refer to **Using the Cruise Control**.

Keys

Your car comes with two kinds of keys: a master key and a valet key. The master key fits all locks on your car:

- Ignition
- Doors
- Tailgate
- Glove box

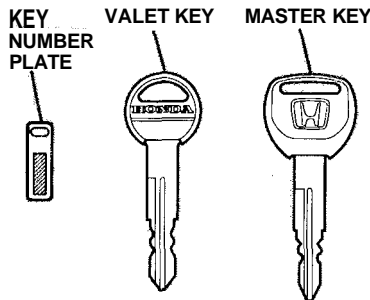

The valet key works only in the ignition and the door locks. You can keep the glove box locked when you leave your car and valet key at a parking facility.

You should have received a key number plate with your set of keys. You will need this number if you have to get a lost key replaced. Keep the plate stored in a safe place. When replacing keys, use only Honda-approved key blanks.

Remote Transmitter

On U.S. EX model

Your car also comes with a remote transmitter; see page 45 for operation.

Ignition Switch

The ignition switch is on the right side of the steering column. It has four positions:

- LOCK (0)
- ACCESSORY (I)
- ON (II)
- START (III)

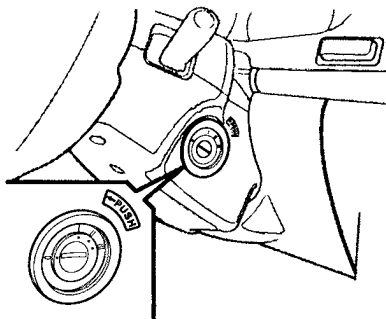

LOCK (0) — You can insert or remove the key only in this

position. When you turn the key from LOCK to ACCESSORY, you may have to turn the steering wheel to release the anti-theft lock. To switch from ACCESSORY to LOCK, you must push the key in slightly as you turn it. If your car has an automatic transmission, it must also be in Park. The anti-theft lock will lock the steering column when you remove the key.

Removing the key from the ignition switch while driving locks the steering. This can cause you to lose control.

Remove the key from the ignition switch only when parked.

ACCESSORY (I) — In this position, you can operate the audio system and cigarette lighter.

ON (II) — This is the normal key position when driving. All features and accessories on the car are usable. Several of the lights on the instrument panel come on as a test when you turn the ignition switch from ACCESSORY to ON (see page 29).

START (III) — Use this position only to start the engine. The switch returns to ON when you let go of the key.

You will hear a reminder beeper if you open either front door with the key in the LOCK or ACCESSORY position. Remove the key to turn it off.

Power Door Locks

Each door has a lock tab on top of the door panel. Push the lock tab down to lock the door, and pull it up to unlock.

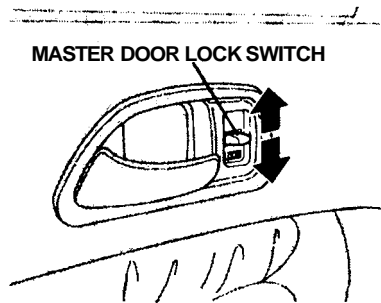

To lock the passenger's door when getting out of the car, push the lock tab down, and close the door. To lock the driver's door, pull the outside door handle, and

push the lock tab down. Release the handle; then close the door.

Door Locks

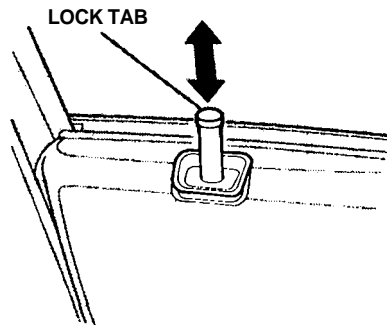

The master door lock switch allows control of all door locks and the tailgate from the driver's door. Push the master door lock switch down to lock all doors

including the tailgate, and pull up to unlock them.

The front doors can be locked and unlocked from the outside with the key.

In addition, all doors lock or unlock when you use the key to lock or unlock any door from the outside. To unlock all doors from the driver's door with the key, turn the key clockwise and hold it there for several seconds.

To lock any passenger door without the key, push the lock tab down and close the door.

Remote Transmitter

EX models

You can lock and unlock your car using the remote transmitter. If

continued

Keys and Locks

you push "Lock," on the transmitter, all doors and the tailgate will lock.

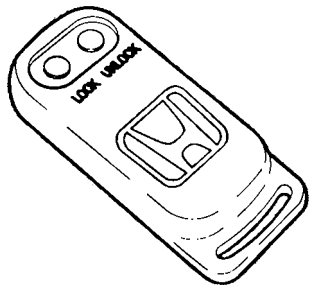

One push on "Unlock" unlocks the driver's door and turns on the interior light; if you push "Unlock" again, all doors and the tailgate will unlock.

If you use the unlock feature on the remote transmitter and a door or the tailgate is not opened within 20 seconds, all doors and the tailgate will

automatically lock. If the key is in the ignition, the remote transmitter will not work.

This device complies with Part 15 of the FCC rules. Operation is subject to the following two conditions: (1) This device may not cause harmful interference, and (2) this device must accept any interference received, including interference that may cause undesired operation.

Changes or modifications not expressly approved by the party responsible for compliance should void the user's authority to operate the equipment.

Childproof Door Locks

The childproof door locks are designed to prevent children seated in the rear from accidentally opening the rear doors. Each

rear door has a lock lever near the edge. With the lever in the LOCK position, the rear doors cannot be opened from the inside regardless of the position of the lock tab. To open either rear door, pull the lock tab up and use the outside door handle.

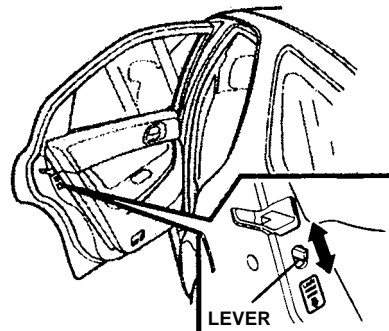

Glove Box

Open the glove box by pulling the bottom of the handle. Close it with a firm push. Lock or unlock the glove box with the master key.

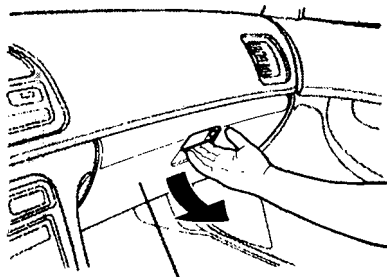

GLOVE BOX

The glove box light comes on only when the instrument panel lights are on.

An open glove box can cause serious injury to your passenger in a crash, even if the passenger is wearing a seat belt.

Always keep the glove box closed while driving.

Tailgate

Use your key to lock and unlock the tailgate. (For U.S. EX models, your remote transmitter will also lock and unlock the tailgate.)

To open the tailgate, pull the handle, and then lift up the tailgate.

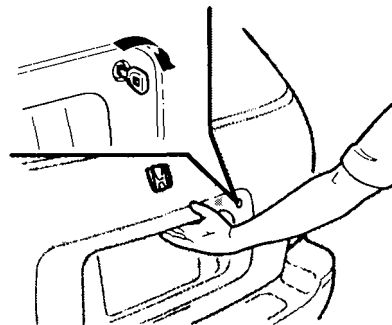

Seat Adjustments

Adjust the seat before you start driving.

Front Seat Adjustments

To adjust the seat forward and backward, pull up on the lever under the seat cushion's front edge. Move the seat to the desired position, and release the lever. Try to move the seat to make sure it is locked in position.

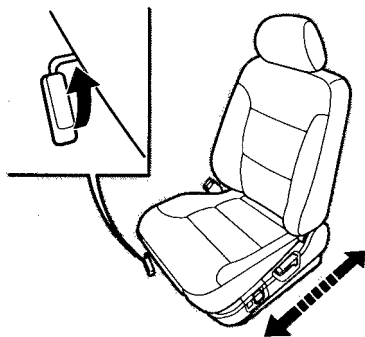

To change the angle of the seat-back, pull up on the lever on the outside of the seat bottom. Move the seat-back to the desired position, and release the lever. Let the seat-back latch in the new position.

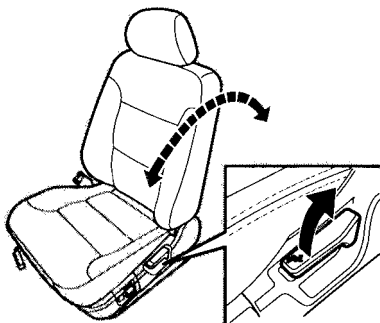

Reclining the seat-back can decrease the protection you get from your seat belt in a crash.

You can slide under the seat belt and be seriously injured.

Adjust the seat-back to an upright position, and sit well back in the seat.

Driver's Seat Power Height Adjustment

On U.S. EX models

The height of your driver's seat is power adjustable. Pull up on the switch to raise the seat. Push it down to lower the seat.

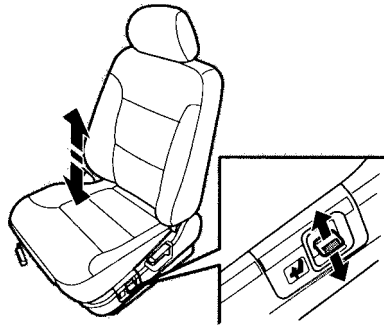

Driver's Lumbar Support

On U.S. EX models

Vary the lumbar support by moving the lever on the right

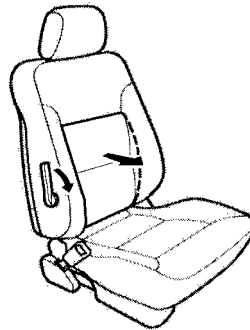

side of the seat-back. Pivot the lever forward until it stops, then let it return. Doing this several times adjusts the lumbar support through its full range.

Head Restraints

The front head restraints help protect you and your passenger from whiplash and other injuries. They are most effective when you adjust them so the top of the

restraint is even with the top of your ears.

The front head restraints adjust for height. You need both hands to adjust the restraint. Do not attempt to adjust it while driving. To raise it, pull upward. To lower the restraint, press the release button and push the restraint down.

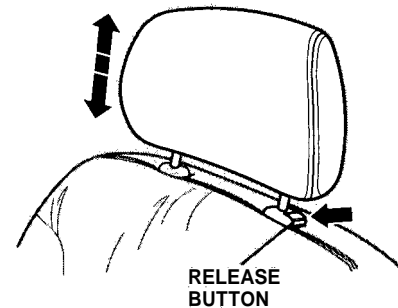

continued

Seat Adjustments, Power Windows

To remove a head restraint for cleaning or repair, pull it up as far as it will go. Press the release button and pull the restraint out of the seat-back.

Driving your car without head restraints can lead to serious injury to you and your passenger in a crash.

Make sure the head restraints are in place and adjusted properly before driving.

Folding Rear Seat

The backs of the rear seats fold down to provide more cargo space.

Pull up the release button at the top of the seat-back, and move the seat-back forward.

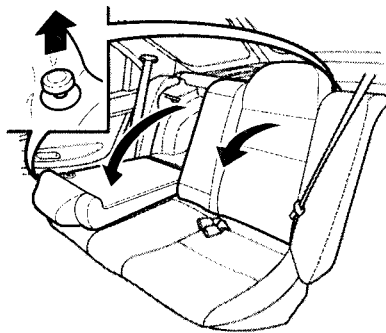

Rear Seat Armrest

On U.S. EX models

The rear seat armrest is located at the center of the rear seat.

Pivot it down to use it.

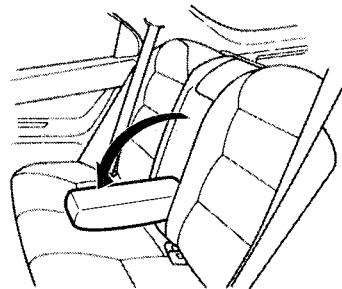

Power Windows

Your car's windows are electrically powered. Turn the ignition switch to ON (II) to raise or lower a window.

Each door has a switch that controls its window. To open the window, push the switch down and hold it. Release the switch when you want the window to stop. Close the window by pushing the switch up and

holding it. The rear windows open only halfway.

The driver's armrest has a master power window control panel. To open the passenger's window, push down on the appropriate switch, and hold it down until the window reaches the desired position. To close the window, push up on the window switch. Release the switch when the window gets to the position you want.

DRIVER'S WINDOW SWITCH

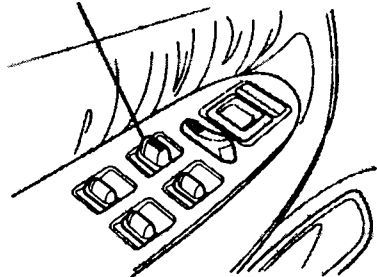

The master control panel also contains these extra features:

AUTO — To open the driver's window fully, push the window switch firmly down and release it. The window automatically goes all the way down. To stop the window from going all the way down, push the window switch up briefly.

To open the driver's window only partially, push the window switch down lightly and hold it. The window will stop as soon as you release the switch.

The AUTO function only works to lower the driver's window. To raise the window, you must push the window switch up and hold it until the window reaches the desired position.

The MAIN switch controls power to the passengers' windows. With this switch off, the passengers' windows cannot be raised or lowered. The MAIN switch does not affect the driver's window. Keep the MAIN switch off when you have children in the car so they do not injure themselves by operating the window unintentionally.

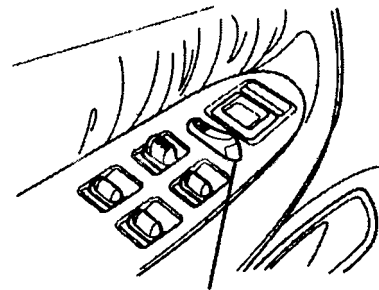

MAIN SWITCH

continued

Power Windows, Moonroof



The power window system has a key-off delay function. The windows will still operate for up to 10 minutes after you turn off the ignition. Opening either front door cancels the delay function. You must turn the ignition ON (II) again before you can raise or lower the windows.

Closing a power window on a child's hands or fingers can cause serious injury.

Make sure children are away from the windows before closing them.

Moonroof

On U.S. EX models

Use the switches on the dashboard under the left vent to operate the moonroof. The ignition must be ON (II). Push and hold the  switch to open the moonroof. Release the switch when the moonroof reaches the desired position. To close the moonroof, press and hold the  switch.

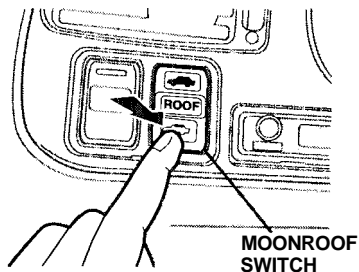

The moonroof has a key-off delay. You can still open and

close the moonroof for up to 10 minutes after you turn off the ignition. The key-off delay cancels as soon as you open either front door. You must then turn the ignition ON (II) for the moonroof to operate.

Closing the moonroof on someone's hands or fingers can cause serious injury.

Make sure passengers are clear of the moonroof before closing it.

NOTICE

If you try to open the moonroof in below-freezing temperatures, or when it is covered with snow or ice, you can damage the moonroof panel or motor.

Mirrors

Keep the inside and outside mirrors clean and adjusted for best visibility. Be sure to adjust the mirrors before you start driving.

The inside mirror has day and night positions. The night position reduces glare from headlights behind you. Flip the tab on the bottom edge of the mirror to select the day or night position.

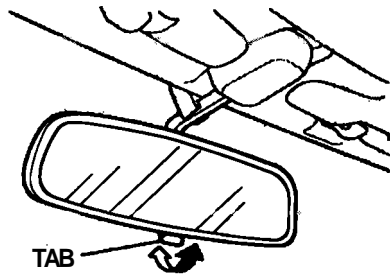

Adjusting the Power Mirrors

Adjust the outside mirrors with the adjustment switch on the driver's door armrest.

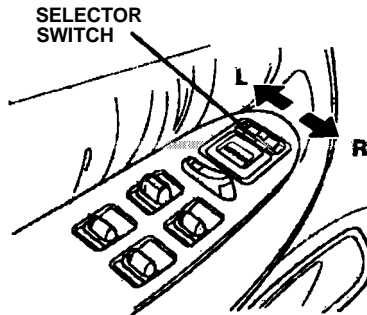

1. Turn the ignition switch ON (II).
2. Move the selector switch to L (driver's side) or R (passenger's side).

3. Push the appropriate edge of the adjustment switch to move the mirror right, left, up, or down.

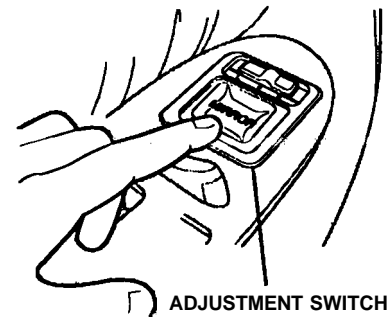

4. When you finish, move the selector switch to the center (OFF) position. This turns off the adjustment switch so you can't move a mirror out of position by accidentally bumping the switch.

Parking Brake

To apply the parking brake, pull the lever up fully. To release it, pull up slightly, push the button, and lower the lever. The parking brake light on the instrument panel should go out when the parking brake is fully released (see page 30). If you try to drive the car without releasing the parking brake, the ABS cannot work properly.

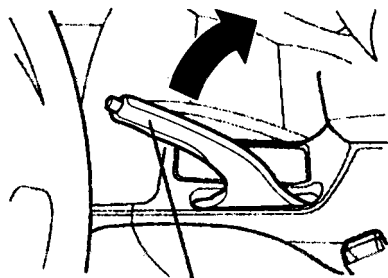

PARKING BRAKE LEVER

NOTICE

Driving the car with the parking brake applied can damage the rear brakes and axles.

Digital Clock

The digital clock displays the time with the ignition switch ON (II). To see the time with the ignition off, press and hold the front cover under the clock.

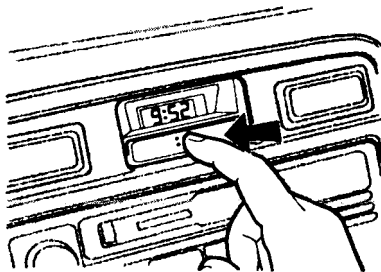

To set the clock:

1. Turn the ignition switch ON (II) to display the time.

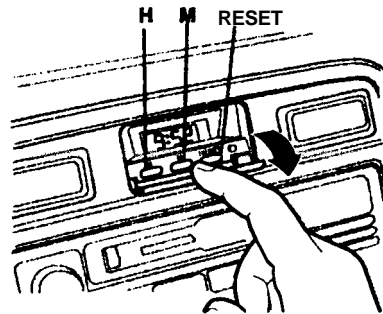

2. Swing down the front cover of the wide button under the clock display. You will see H, M, and RESET buttons.
3. Press and hold the H button until the hour advances to the desired time.

4. Press and hold the M button until the minutes advance to the desired time.

You can use the RESET button to quickly set the time to the nearest hour. If the displayed time is before the half hour, pressing RESET sets the clock back to the previous hour. If the displayed time is after the half hour, pressing RESET sets the clock forward to the beginning of the next hour.

For example:

- 1:06 would RESET backward to 1:00.
- 1:52 would RESET forward to 2:00.

Beverage Holder

To open the beverage holder, push on the top. The beverage holder lid is spring-loaded and

will pop open. To close it, push it down until it latches.

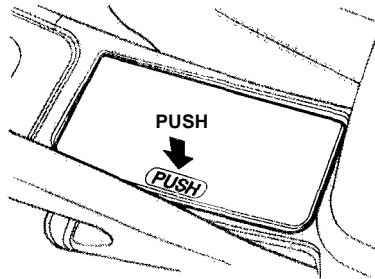

Use the beverage holder only when the car is parked. If you place cups in the holder while driving, the liquid may spill when you go over bumps or around corners.

Be careful when you are using the beverage holder. Spilled liquids can damage the

upholstery, carpeting, and electrical components in the interior. If the liquid is very hot, it can scald you or your passengers.

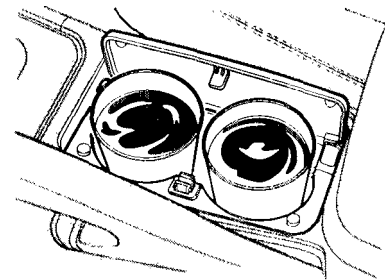

Console Compartment, Coin Box, Cigarette Lighter

Console Compartment

To open the console compartment, pull up the front edge of the lid.

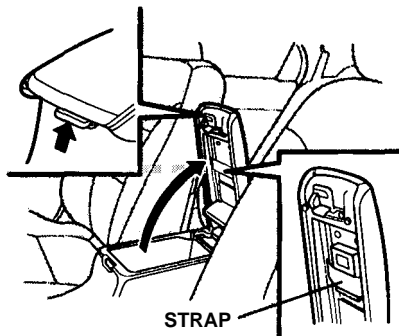

A strap is provided under the console cover to hold your garage door opener.

Coin Box

To open the coin box, pull the upper edge. Close it with a firm push.

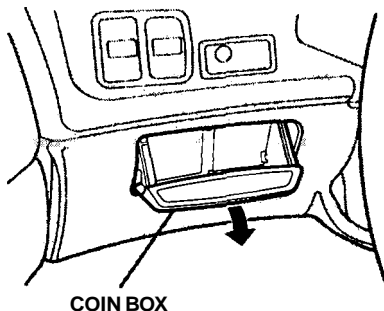

Cigarette Lighter

The ignition switch must be in ACCESSORY (I) or ON (II) for the cigarette lighter to work. To heat up the lighter, push it in. It will pop out when it is ready for use. Do not hold the lighter in while it is heating up, you could cause it to overheat.

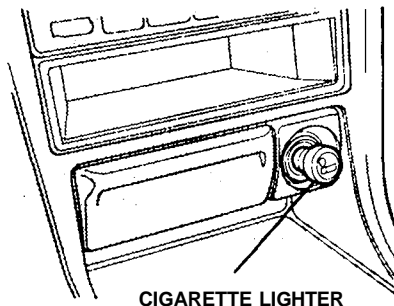

Ashtrays

Open the front ashtray by swinging the lid down. Push it in to close it.

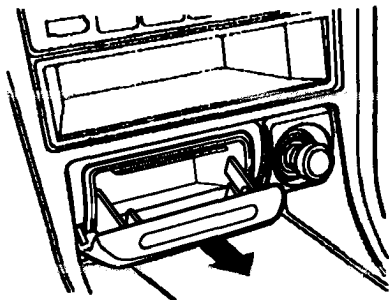

ASHTRAY

To remove the ashtray for emptying, open the lid, and then pull the ashtray straight out.

The rear ashtray is at the rear end of the center console. Open the ashtray by swinging the upper edge of the lid down. To

remove the ashtray for emptying, open it, and then lift up and out.

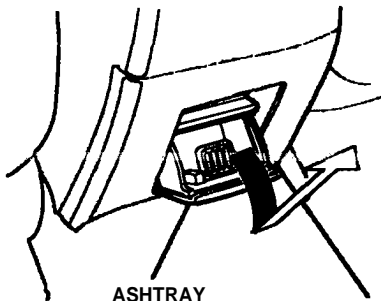

ASHTRAY

NOTICE

Use the ashtray only for cigarettes, cigars, and other smoking materials. To prevent a possible fire and damage to your car, don't put paper or other things that can burn in the ashtrays.

Interior Light

The interior light has a three-position switch. In the OFF (forward) position, the light does not come on. In the center position, the interior light comes on when you open either front door. In the ON (rearward) position, the interior light stays on continuously.

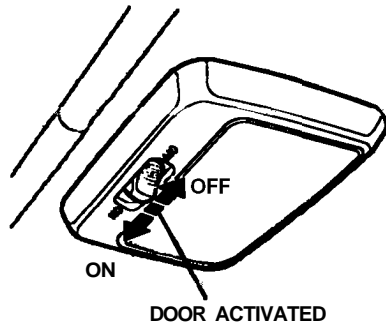

Courtesy Lights

Each front and rear door has a courtesy light. This light (with the front interior light switch in the center position) comes on when you open either front door.

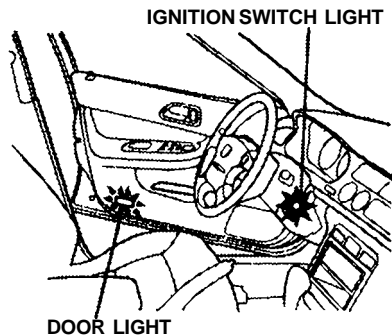

Your car also has a courtesy light in the ignition switch. This light comes on when you open the driver's door. It remains on for several seconds after the door is closed.

The heating/air conditioning system in your car provides a comfortable driving environment in all weather conditions.

The standard audio system is very versatile. To get the most benefit from this system, read its description in this manual.

The anti-theft feature on your radio disables the system. To get the system working again you must enter a code number as described in this manual.

Heating and Cooling	60
What Each Control Does ..	62
How to Use the System	62
Controlling Air	
Flow Direction	63
Ventilation	63
To Cool With A/C	63
To Heat	64
To Heat and Dehumidify with Air Conditioning ..	64
To Defog and Defrost ...	65
To Turn Everything Off	65
Audio System.....	66
AM/FM/Cassette Stereo	
Audio System	66
Operating the Radio	66
Finding the Radio Station ..	67
Presetting Radio Stations ..	67
Adjusting the Sound	68
Radio Frequencies	69
Operating the	
Cassette Player	69
Cassette Search Functions ..	70
Caring for the	
Cassette Player	71

Operating the CD	
Player/Changer	72
CD Error Indications	74
Anti-Theft Feature	75

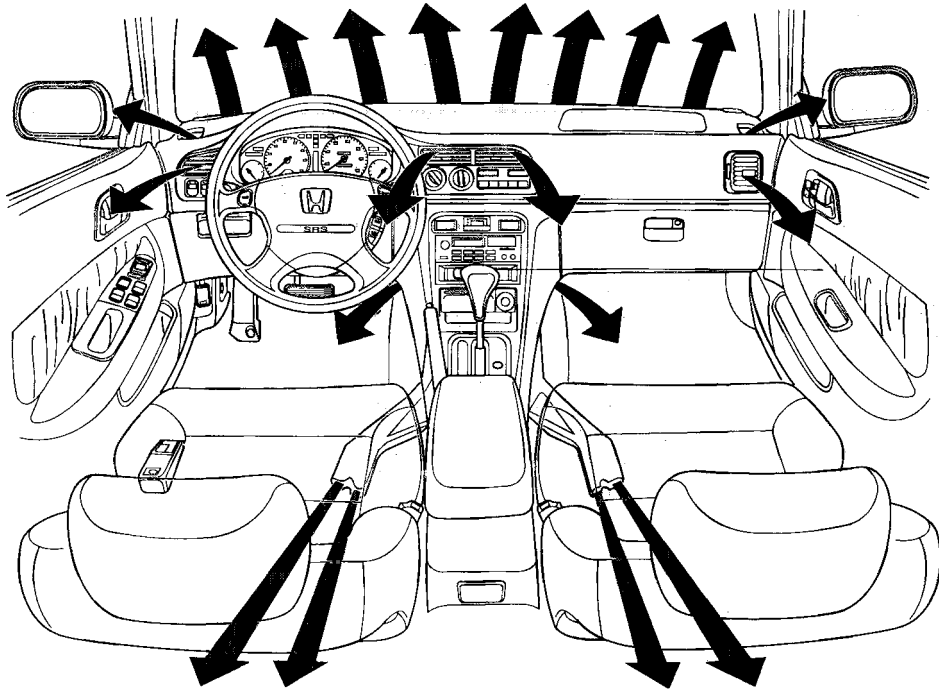

This system has full heating, ventilation, and air conditioning capabilities. You can adjust the system controls to mix these in various combinations. The air flows into the interior at three possible levels that you can select.

The direction of air flow from the vents in the center and each side of the dashboard is adjustable. Move the tab in the center of each vent up and down and side to side.

CENTER VENT

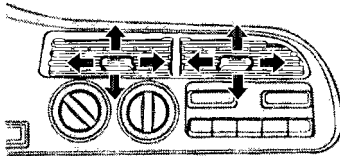

Each side vent can be opened and closed with the dials next to them.

SIDE VENT

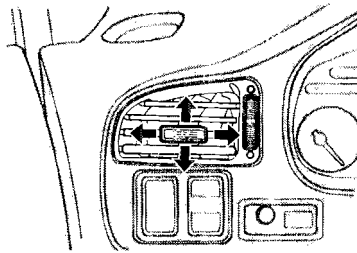

The heating and cooling system draws air through the exterior vents at the bottom of the windshield. Keep these vents clear of leaves and other debris.

Heating and Cooling

What Each Control Does

Fan Control Dial

Turning this dial clockwise increases the fan speed, which increases air flow.

Temperature Control Dial

Turning this dial clockwise increases the temperature of air flowing from the system.

Mode Buttons

These buttons control the direction of air flow. The indicator light shows which button is controlling air flow.

Air Conditioning (A/C) Switch

This switch turns the air conditioner ON and OFF. The indicator in the switch lights when the A/C is ON.

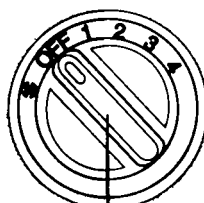

FAN CONTROL DIAL

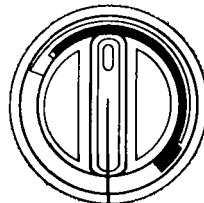

TEMPERATURE CONTROL DIAL

RECIRCULATION/
FRESH AIR BUTTON

AIR CONDITIONING
SWITCH

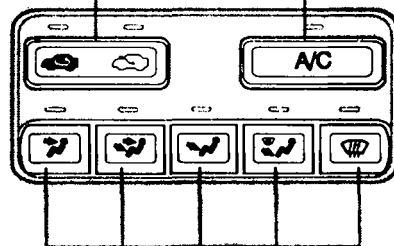



MODE BUTTONS

Recirculation/Fresh Air Button

This button controls the source of air going into the system. In recirculation mode, the interior air recycles through the system. In fresh air mode, air comes from outside the car.

How to Use the System



This section covers the best way to use the system for ventilation, cooling, dehumidifying, defrosting and heating. In most cases, the mode and air source selections are only recommendations. You may prefer different settings.

Use  mode to heat or cool the interior more quickly, or to keep out smoke and dust. Leaving the system in recirculation mode with the air conditioning off can cause the windows to fog up. Switch to  mode as soon as the interior reaches a comfortable temperature or the outside smoky, dusty condition clears.

The engine must be running for the heater and air conditioning system to provide hot and cold air. The heater uses engine coolant to warm the air. If the engine is cold, it will be several minutes before you feel warm air circulating.

Air conditioning does not depend on engine temperature. It can produce cold air almost immediately.

Controlling Air Flow Direction

Air flows into the interior at three levels: Toward the floor , through the dash vents , and toward the windshield and side windows . You select the air flow level or combination of levels with the five mode buttons.



Ventilation

Your car has a flow-through ventilation system. Air enters the car through vents in front of the windshield. It circulates through the interior and then exits through vents near the rear window. This system provides fresh air even when the car is standing still. To bring in outside air, press the  button. Set the fan at a comfortable speed.

To Cool With A/C

To operate the air conditioning system, press the air conditioning switch. Set the fan to the desired speed. You can also use the  mode button to direct air out of the dash and heater vents.

To cool the interior down rapidly after the car has been sitting in the sun:

1. Start the engine.
2. Turn on the A/C by pressing the switch.
3. Set the fan to maximum speed.
4. Open the windows partially.
5. Select  and .

When the interior reaches a comfortable temperature, close

continued



Heating and Cooling

the windows, and set the system for cooling as described above.

Air conditioning places an extra load on the engine. Watch the coolant temperature gauge (see page 34) when using the A/C in heavy traffic or driving up long hills. If it moves near the red zone, turn off the air conditioning until the gauge reads normal.

To Heat

To warm the interior, do this:

1. Start the engine.
2. Select  and .
3. Switch the fan to the desired speed.
4. Adjust the warmth of the air with the temperature control lever.

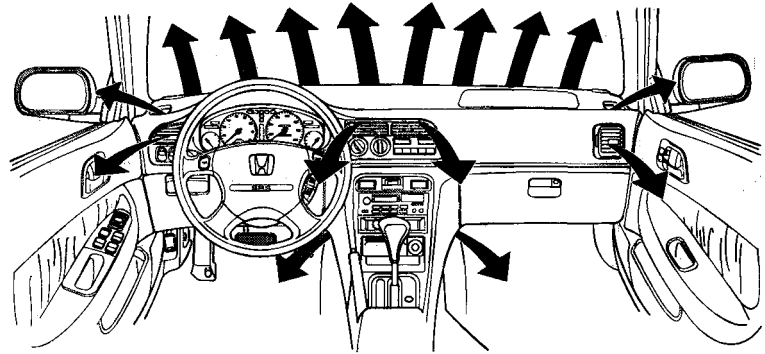

To Heat and Dehumidify With Air Conditioning

Air conditioning removes moisture from the air as it operates. When used in combination with the heater, it makes the interior warm and dry. To dehumidify, do this:



1. Switch the fan on.
2. Turn on the air conditioning.

3. Select  and any desired mode button.
4. Adjust the temperature control dial so the mixture of heated and cooled air feels comfortable.



This setting is suitable for all driving conditions whenever the outside temperature is above 32° F (0°C).

To Defog and Defrost



To remove fog from the inside of the windows, do this:

1. Switch the fan on.
2. Turn on the air conditioning.
3. Select  and  .
4. Adjust the temperature control lever so the airflow from the defroster vents feels warm.
5. Turn on the rear window defogger to help clear the rear window.

To remove exterior frost or ice from the windshield and side windows after the car has been sitting out in cold weather:

1. Start the engine.
2. Select  and  .

3. Switch the fan and temperature controls to maximum.

To rapidly remove exterior frost or ice from the windshield (on very cold days), first select  . Once the windshield is clear, select  to avoid fogging the windows.

These settings direct all the air flow to the defroster vents at the base of the windshield and each front door window. The air flow will get warmer and clear the windows faster as the engine warms up. You can close the side vents with the dial beside each vent. This will send more warm air to the windshield defroster vents.

For safety, make sure you have a clear view through all the windows before driving away.

To Turn Everything Off

To shut off the system temporarily, turn the fan control and temperature control dials all the way off.

You should only shut the system completely off for the first few minutes of driving in cold weather, until the engine coolant warms up enough to operate the heater. Keep the fan on at all other times so stale air does not build up in the interior.

Audio System

AM/FM/Cassette Stereo Audio System

Your Honda audio system is easy to use and will give clear AM/FM reception. The preset buttons allow you to select six stations on AM and 12 stations on FM.

The cassette system uses Dolby B* noise reduction to give excellent sound reproduction. The system also senses when a metal or a chromium dioxide (CrO₂) tape is being played and adjusts accordingly.

*Dolby noise reduction manufactured under license from Dolby Laboratories Licensing Corporation. "Dolby" and the  symbol are trademarks of Dolby Laboratories Licensing Corporation.

On U.S. EX model

The anti-theft feature disables the system if it is disconnected

U.S.: EX

ON/OFF/VOL KNOB

STEREO INDICATOR

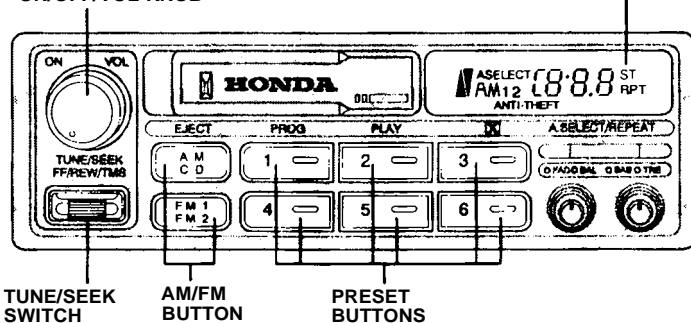

TUNE/SEEK SWITCH

AM/FM BUTTON

PRESET BUTTONS

from the car's battery. To get the system working again, you must enter a code number. See page 75.

Operating the Radio

The ignition switch must be in ACCESSORY (I) or ON (II) to operate the audio system. Turn the system on by turning the ON/OFF/VOL knob clockwise.

The radio comes on and displays the frequency of the station it was last tuned to.

Adjust the volume by turning the ON/OFF/VOL knob.

Select the band you want to listen to by pressing the AM or FM1/FM2 button. You will see the selected band and the frequency in the display.

STEREO will be displayed next to the frequency if the station is broadcasting in FM stereo. The AM stereo feature is not available.

Finding the Radio Station

You can use any of three methods to find radio stations on the selected band: TUNE, SEEK, or the Preset buttons.

The TUNE function lets you find a desired frequency. Push the TUNE/SEEK switch up to change to a higher frequency and down to change to a lower frequency.

To change the frequency up or down a single increment, push and release the TUNE/SEEK switch.

The SEEK function searches the band for a station with a strong signal. Depending on which way you push the TUNE/SEEK switch,

the system searches up or down from the current frequency. Push the switch until you hear a beep, and then release it. The system searches until it finds a station with a strong signal and then stops.

Presetting Radio Stations

The Preset buttons allow you to store radio frequencies for later selection. Each button will store one frequency on the AM band and two on the FM band. To store a frequency, do this:

1. Select the desired band, AM or FM. FM1 and FM2 allow you to store two frequencies with each Preset button.
2. Use the TUNE or SEEK function to tune the radio to a desired station.

3. Pick the Preset button you want for that station. Press the button and hold it until you hear a beep. The light in the indicator will come on and the station selected will show in the display.
4. Repeat steps 1 through 3 to store a total of six stations on AM and 12 on FM.

Once a station's frequency is stored, simply press and release the proper Preset button to tune to it. If you want to change any Preset button's selection, store another frequency as described. The frequencies you preset will be lost if your car's battery goes dead or is disconnected.

○ FAD • BAL ○ BAS • TRE

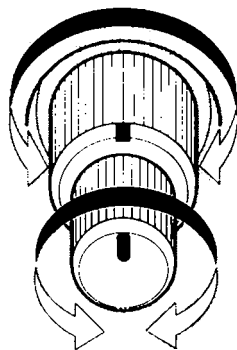
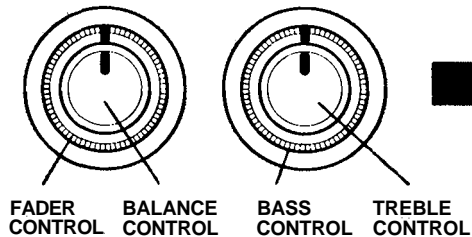

Adjusting the Sound

Use the Balance and Fader controls to adjust the sound "direction." The Balance control moves sound left to right. The Fader control moves it front to back.

To use either control, push on the knob to get it to pop out.

Adjust the front-to-back sound with the outer ring.

Adjust the side-to-side sound balance with the knob. Push the knob back in when you are done.

The illumination for the radio controls comes on with the instrument panel lights, even if the radio is off. You can use the

Balance control to turn off the radio panel illumination even with the radio on. Push the control knob so it pops out, and then pull it out slightly farther. Check this control if the control panel lights do not come on with the instrument panel lights.

Use the Bass and Treble controls to adjust the tone quality to your liking. Push on the knob to get the controls to pop out. Adjust the bass level with the outer ring and the treble level with the knob.

When finished, push the knob back in to prevent accidentally changing your settings.

Radio Frequencies

Your Honda's radio can tune in all frequencies in both the AM and FM bands. Those bands cover these frequencies:

AM band

530 to 1710 kilohertz

FM band

87.7 to 107.9 megahertz

Radio stations on the AM band are assigned frequencies at least 10 kilohertz apart (530, 540, 550). Those on the FM band are assigned frequencies at least 0.2 megahertz apart (87.9, 88.1, 88.3).

Stations must use these exact frequencies. It is fairly common for stations to round-off the frequency in their advertising, so your radio will show a frequency of 100.9 even though the announcer may call the station "FM101."

U.S.: EX

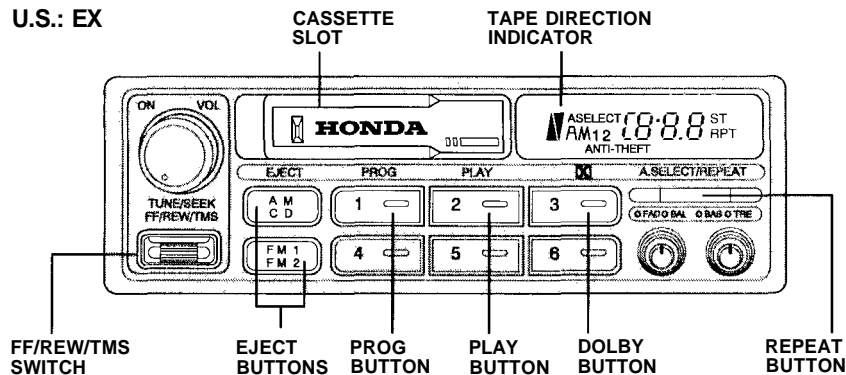

Operating the Cassette Player

Turn the system ON. Insert the cassette into the slot with the tape opening to the right. Push the cassette in most of the way. The drive pulls it in the rest of the way and begins to play.

The ▲ or ▼ lights to show you which side of the cassette is

playing. The ▲ indicates the side you inserted facing upward is now playing. To play the other side of the tape, press the PROG button.

The system also has an auto-reverse feature. It automatically reverses direction when it reaches the end of the cassette.

continued

Audio System

Dolby noise reduction turns on when you insert a cassette. If the tape was not recorded with Dolby "B" noise reduction, turn it off by pressing the  button.

To remove the cassette from the drive, press one of the EJECT buttons (AM/CD or FM1/FM2). If the AM/CD button is pushed, the system returns to the function last selected with that button. If the FM1/FM2 button is pushed, the system returns to the FM band last selected.

A cassette automatically ejects whenever you turn off the system or the ignition switch.

Cassette Search Functions

Once a cassette is playing, you can use the FF, REW, or TMS, or REPEAT function to look for desired songs or passages.

To rewind the tape, push the FF/REW/TMS switch down and then release it. You will see REW in the display. To fast forward a tape, push the switch up and then release it. You will see FF in the display. To stop rewind or fast forward, press the PLAY button. If the system reaches the end of the cassette while in fast forward or rewind, it automatically stops that function, reverses direction, and begins to play.

Press the REPEAT button to replay the current passage. You will see RPT in the display. When the system reaches the end of the song or passage that is being played, it automatically goes to rewind.

When it senses the beginning of that passage, it goes back to play. The system will continue repeating this passage until you

turn off REPEAT by pressing the button again.

The TMS function lets you skip to the beginning of a song or other passage. The tape skips forward or backward, depending on which direction you push the FF/REW/TMS switch.

Activate TMS by pushing the FF/REW/TMS switch and holding it until you hear a beep. If you push the switch down, you will see REW blinking in the display as the tape rewinds. If you push the switch up, you will see FF blinking in the display as the tape fast forwards. When the system senses a silent period on the tape, it goes back to PLAY mode.

The REPEAT and TMS functions use silent periods on the tape to find the end of a selection. These features may not work satisfactorily on tapes that have

almost no gap between songs, a high noise level between songs, or silent periods in the middle of songs.

Caring for the Cassette Player

The cassette drive picks up dirt and oxides whenever you play a tape. This builds up over time and causes the sound quality to degrade. To prevent this, you should clean the cassette drive after every 30 hours of use. Your Honda dealer has a cleaning kit available for this purpose.

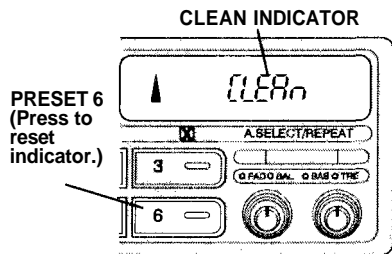

After 30 hours of tape use, you will see CLEAN flashing for 5 seconds in the display when you insert a tape into the tape slot. If you are already regularly cleaning the tape drive at least every 30 hours, reset the indicator by pressing the Preset 6 button while the system is the tape operation mode. Hold the button until you hear a beep and the CLEAN indicator goes out.

If you do not clean the cassette drive regularly, it may eventually become impossible to remove the deposits with a normal cleaning kit.

The cassette player automatically ejects cassettes that do not play normally. If it ejects a cassette before it begins to play, it is probably defective and should not be inserted again. You may have a cassette

suddenly stop playing, reverse directions once or twice and then eject. This is normally an indication the tape is wound unevenly. It should play normally after being manually rewound.

Use 100-minute or shorter cassettes. Cassettes longer than 100 minutes use thinner tape that may break or jam the drive.

Look at a cassette before you insert it. If the tape is loose, tighten it by turning one of the hubs with a pencil or your finger.

If the label is peeling off, do not put it in the player. It may cause the cassette to jam in the drive mechanism when you try to eject it.

Damaged cassettes can jam inside the drive or cause other problems. Do not leave cassettes

continued

sitting where they are exposed to high heat or humidity, such as on top of the dashboard or in the player. If a cassette is exposed to extreme heat or cold, let it reach a moderate temperature before putting it in the player.

Operating the CD Player or CD Changer (Optional)

Your dealer has a Honda in-dash Compact Disc player or a trunk-mounted CD changer available for your car.

The trunk-mounted changer holds up to six discs, providing several hours of continuous programming. Load the CDs in the changer's magazine and load the magazine into the changer according to the instructions that came with the changer unit.

To operate the CD player or CD changer, the ignition key must be in the ACCESSORY (I) or ON (II) position. If you were listening to a cassette tape, eject it before listening to a CD. You operate the CD player and changer with the same controls used for the radio.

CD Player

Insert the disc in the player. Push the CD button on the player; "CD" will show in the display, and the disc will start to play.

CD Changer

Push the CD button on the radio; the display will show "CD," and the track last listened to will play. When that disc ends, the next disc in the magazine is loaded and played.

After disc 6 has played completely, the system will return to disc 1. To make your

own disc selection, push one of the corresponding Preset buttons. Your selection will appear in the display and start playing.

You can use the TUNE/SEEK switch while a disc is playing to select passages and change tracks. To move rapidly forward within a track, push up and hold the TUNE/SEEK switch. Push down and hold the switch to move rapidly backward within a track. You will hear a beep a half second after you push the switch up or down. Keep pushing the switch until you think the track has advanced or returned to the desired position. The disc will start playing when you release the switch.

If you push the TUNE/SEEK switch up and release it before you hear a beep, the system will skip forward to the beginning of

the next track on the CD. It will skip backward to the beginning of the current track if you push the switch down and release it.

If you push the REPEAT button on the U.S. LX or Canada EX models, or the A.SELECT/REPEAT button on the U.S. EX model, the system will continuously play the track you are listening to. You will see RPT in the display. Push the switch again to turn off the REPEAT mode.

On U.S. EX models

You can get the CD player/changer to randomly select tracks by pressing the A.SELECT/REPEAT button. You will see A.SELECT in the display. With this active, the system selects and plays the tracks randomly, rather than sequentially on the disc in the

player or on each disc in the changer.

When A.SELECT is used with the disc changer unit, the system plays all the tracks randomly on that disc; it loads the next disc and plays randomly again. The system continues to select and play tracks randomly on each of the six discs until you press the A.SELECT/REPEAT button again.

To turn on the random play mode while the system is in the REPEAT mode, turn off the REPEAT mode first by pressing the A.SELECT/REPEAT button. Then, press the button until A.SELECT is displayed.

- If you change modes to radio or tape while a CD is playing, and then change back to CD mode, the same disc and track will play.

- If you turn off the audio system while a CD is playing, either with the ON/OFF/VOL knob or by turning off the ignition, the system will begin at the same disc and track when you turn it back on.
- If you select an empty slot in the disc changer's magazine, the system will select and play the first track of the next disc in the magazine.

To return to the radio function, press either the AM/CD button or the FM1/FM2 button. If the AM/CD button is pushed, the system will return to the AM band. If the FM1/FM2 button is pushed, the system will return to the FM band you last listened to.

CD Error Indications

If you see an error indication on the display, find the cause in the chart to the right. If you cannot clear the error indication, take the car to your Honda dealer.

Indication	Cause	Solution
<i>E - 01</i>	Disc-changer malfunction.	Consult your Honda dealer.
<i>E - 02</i>	Disc is in changer mechanism.	Press the magazine eject button, and insert an empty magazine.
<i>E - 03</i> <i>E - 04</i> <i>E - 05</i>	Disc-changer malfunction.	If the code disappears within a few seconds, unit is OK. If it does not, consult your Honda dealer.
<i>E - 06</i>	Disc-changer malfunction.	Press the magazine eject button and pull out the magazine, check for error indication. Insert the magazine again. If the magazine cannot be pulled out, consult your Honda dealer.
<i>E - 07</i>	CD magazine ejection impossible.	Press the magazine eject button. If the magazine does not eject, consult your Honda dealer.
<i>---H</i>	High temperature.	Will disappear when the temperature returns to normal.
<i>E - EE</i>	Misconnection or disconnection of CD changer.	See your Honda dealer.
<i>----</i>	No CD magazine in the CD changer.	Insert CD magazine.

Anti-Theft Feature

On U.S. EX models

Your car's audio system will disable itself if it is disconnected from electrical power for any reason. To make it work again, the user must enter a specific five-digit code in the Preset buttons. Because many combinations are possible using five digits, making the system work without knowing the exact code is nearly impossible.

You should have received two copies of a card that lists your audio system's code number and serial number. It is best to store one of these cards in a safe place at home and to keep the other in your wallet or purse. In addition, you should write the audio system's serial number in this Owner's Manual. If you should happen to lose both cards, you must obtain the code number by

having your Honda dealer contact American Honda. To do this, he will need the system's serial number.

If your car's battery is disconnected or goes dead, the audio system will disable itself. If this happens, you will see "Code" in the frequency display the next time you turn on the system. Use the Preset buttons to enter the five-digit code. If it is entered correctly, the radio will start playing.

If you make a mistake entering the code, do not start over or try to correct your mistake. Complete the five-digit sequence, and then enter the correct code. You have three tries to enter the correct code. If you are unsuccessful in three attempts, you must then leave the system

on for one hour before trying again.

You will have to store your favorite stations in the Preset buttons after the system begins working. Your original settings were lost when power was disconnected.

Before you begin driving your Honda, you should know what gasoline to use, and how to check the levels of important fluids. You also need to know how to properly store luggage or packages. The information in this section will help you.

Break-in Period	78
Gasoline	78
Oxygenated Fuels	78
Driving in Foreign Countries	79
Service Station Procedures ..	80
Filling the Fuel Tank	80
Opening the Hood	81
Oil Check	82
Engine Coolant Check ..	83
Fuel Economy	83
Vehicle Condition	83
Driving Habits	83
Loading Cargo	84
Cargo Area	85
Storage Compartments	85
Cargo Area Tonneau Cover	85

Break-in Period

Help assure your car's future reliability and performance by paying extra attention to how you drive during the first 600 miles (1,000 km). During this period:

- Avoid full-throttle starts and rapid acceleration.
- If you need to add oil, use the engine oil recommended in this Owner's Manual.
- Avoid hard braking. New brakes need to be broken-in by moderate use for the first 200 miles (300 km).

You should follow these same recommendations with an overhauled or exchanged engine, or when the brakes are replaced.

Gasoline

Your Honda is designed to operate most effectively on unleaded gasoline. Use an unleaded gasoline with a pump octane number of 86 or higher. Use of a lower octane gasoline can cause a persistent, heavy metallic rapping noise in the engine that can lead to mechanical damage.

We recommend using gasoline containing detergent additives that help prevent fuel system and engine deposits.

Using gasoline containing lead will damage your car's emission controls. This contributes to air pollution and can void certain parts of your warranty.

Oxygenated Fuels

Some conventional gasolines are being blended with alcohol or an ether compound. These gasolines are collectively referred to as oxygenated fuels. To meet clean air standards, some areas of the United States and Canada use oxygenated fuels to help reduce emissions.

If you use an oxygenated fuel, be sure it is unleaded and meets the minimum octane rating requirement.

Before using an oxygenated fuel, try to confirm the fuel's contents. Some states/provinces require this information to be posted on the pump.

The following are the EPA-approved percentages of oxygenates:

ETHANOL (ethyl or grain alcohol)— You may use gasoline containing up to 10% ethanol by volume. Gasoline containing ethanol may be marketed under the name "Gasohol."

MTBE (Methyl Tertiary Butyl Ether)— You may use gasoline containing up to 15% MTBE by volume.

METHANOL (methyl or wood alcohol)— You may use gasoline containing up to 5% methanol by volume as long as it also contains cosolvents and corrosion inhibitors to protect the fuel system. Gasoline containing more than 5% methanol by volume may cause starting and/or performance

problems. It may also damage metal, rubber, and plastic parts of your fuel system.

If you notice any undesirable operating symptoms, try another service station or switch to another brand of gasoline.

Fuel system damage or performance problems resulting from the use of an oxygenated fuel containing more than the percentages of oxygenates given previously are not covered under warranty.

Driving in Foreign Countries

Using any type of leaded gasoline in your Honda will affect performance and damage its emission controls. Unleaded gasoline may not be available in other countries. If you are planning to take your car outside

the U.S. or Canada, write to Honda at the address shown for information about any modifications your car may need. Be sure to include the year and model of your car.

U.S. Owners:

American Honda Motor Co., Inc.
Consumer Affairs
1919 Torrance Blvd.
Torrance, CA 90501-2746

Canadian Owners:

Honda Canada Inc.
715 Milner Ave.
Scarborough, Ontario M1B 2K8

Service Station Procedures

Filling the Fuel Tank

1. Because the fuel fill cap is on the driver's side of the car, park with that side closest to the service station pumps.
2. Open the fuel fill door by pulling on the handle to the left of the driver's seat.

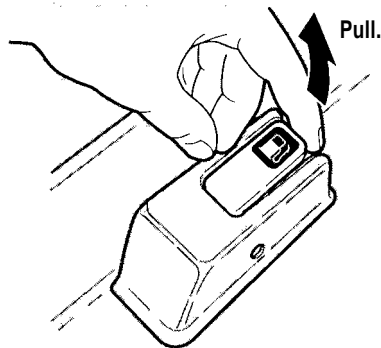

3. Remove the fuel fill cap slowly. You may hear a hissing sound as pressure inside the tank escapes.

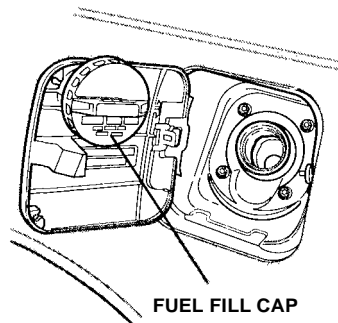

- Gasoline is highly flammable and explosive. You can be burned or seriously injured when handling fuel.
- Stop the engine and keep heat, sparks, and flame away.
 - Handle fuel only outdoors.
 - Wipe up spills immediately.
4. Stop filling the tank after the gas pump automatically clicks off. Do not try to "top off" the tank; leave some room for the fuel to expand with temperature changes.
 5. Screw the fuel fill cap back on; tighten it until it clicks.

6. Push the fuel fill door closed until it latches.

Opening the Hood

1. Shift to Park or Neutral, and set the parking brake. Pull the hood release handle located under the left lower corner of the dashboard. The hood will pop up slightly.



2. Standing in front of the car, put your fingers under the front edge of the hood to the right of center. Slide your hand to the left until you feel the hood latch handle. Push this handle to the left until it releases the hood. Lift the hood.

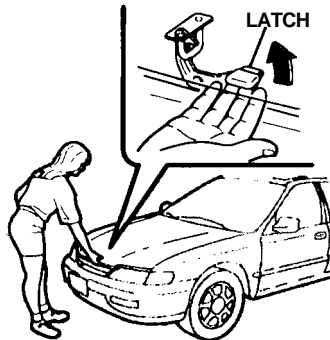

3. Pull the support rod out of its clip, and insert the end into the hole on the driver's side of the hood.

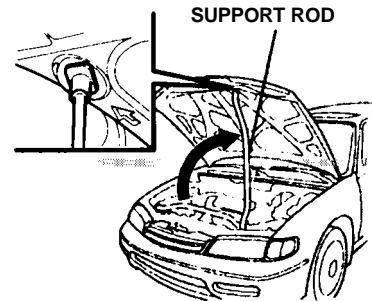

To close the hood, lift it up slightly to remove the support rod from the hole. Put the support rod back into its holding clip. Lower the hood to about a foot above the fender, and then let it drop.

Service Station Procedures

Oil Check

Check the engine oil level every time you fill the car with fuel. Wait at least two minutes after turning the engine off before you check the oil.

1. Remove the dipstick (orange handle).

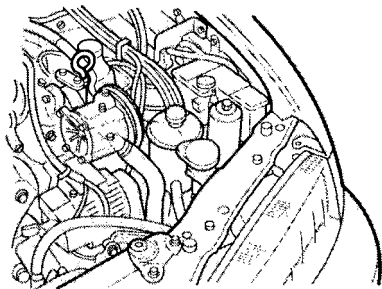

DIPSTICK

2. Wipe the dipstick with a clean cloth or paper towel.

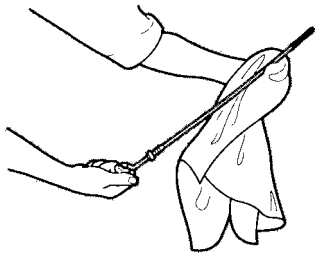

3. Insert it all the way back in its tube.

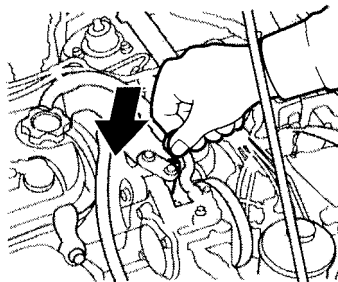

4. Remove the dipstick again, and check the level. It should be between the upper and lower marks.

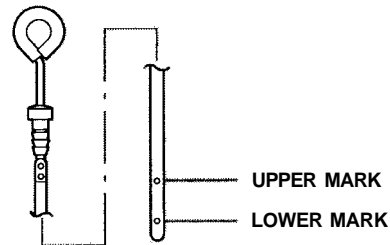

If it is near or below the lower mark, see page 114 for information on the proper oil and how to add it.

Engine Coolant Check

Look at the coolant level in the radiator reserve tank. Make sure it is between the MAX and MIN lines. If it is below the MIN line, see **Adding Engine Coolant** on page 117 for information on adding the proper coolant.

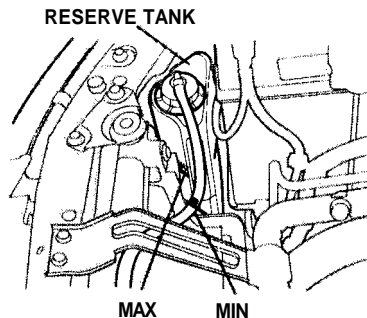

Refer to **Periodic Checks** on page 112 for information on checking other items in your Honda.

Fuel Economy

The condition of your car and your driving habits are the two most important things that affect the fuel mileage you get.

Vehicle Condition

Always maintain your car according to the maintenance schedule. This will keep it in top operating condition.

An important part of that maintenance is the **Periodic Checks** (see page 112). For example, an underinflated tire causes more "rolling resistance," which uses fuel. It also wears out faster, so check the tire pressure at least monthly.

In winter the buildup of snow on your car's underside adds weight and rolling resistance. Frequent cleaning helps your fuel mileage

and reduces the chance of corrosion.

Driving Habits

You can improve fuel economy by driving moderately. Rapid acceleration, cornering, and hard braking use more fuel.

Always drive in the highest gear that allows the engine to run and accelerate smoothly.

Depending on traffic conditions, try to maintain a constant speed. Every time you slow down and speed up, your car uses extra fuel. Use the cruise control, when appropriate, to increase fuel economy.

A cold engine uses more fuel than a warm engine. It is not necessary to "warm-up" a cold engine by letting it idle for a long

continued

time. You can drive away within 30 seconds, no matter how cold it is outside. The engine will warm up faster, and you get better fuel economy. To cut down on the number of "cold starts," try to combine several short trips into one.

Air conditioning puts an extra load on the engine which makes it use more fuel. Turn off the A/C to cut down on air conditioning use. Use the flow-through ventilation when the outside air temperature is moderate.

Loading Cargo

The maximum load you can carry in your Honda is 950 lb (430 kg). It includes the total weight of all passengers and their belongings, and any accessories. This 950 lb (430 kg)

figure is shown as the Vehicle Capacity Weight on the tire information label attached to the driver's side doorjamb.

To figure out how much cargo you can carry, do this:

- Figure the total "occupant weight" you will be transporting. To do this, multiply the number of people (driver and all passengers) by 150 lb (70 kg).
- Subtract this number from the Vehicle Capacity Weight (950 lb/430 kg).
- If you are towing a trailer, subtract the tongue weight. See **Towing a Trailer** on page 97.

This final number is the total weight of cargo you can load in or on the car. With five occupants (driver and four

passengers), the maximum recommended weight for cargo is 200 lb (90 kg).

Where you store cargo and how well you secure it are just as important as how much it weighs. Make sure you load cargo so it will not shift while driving. Items stored in the cargo area should be placed as far forward as possible. You could store additional items on the floor behind the front seats. Make sure they cannot roll under the front seat and interfere with the pedals.

If you must carry large objects that prevent you from closing the tailgate, be aware that exhaust gas can enter the interior. See **Carbon Monoxide Hazard** on page 24.

Cargo Area

A passenger should never sit in the open cargo area while the car is moving. They should sit in one of the seats and wear their seat belt. With the rear seats folded, the length of the cargo area is 64.5 inches (1,640 mm). The width at the tailgate opening is 43 inches (1,107 mm). The width between the wheelwells is 33 inches (846 mm). The rear opening height is 27 inches (710 mm).

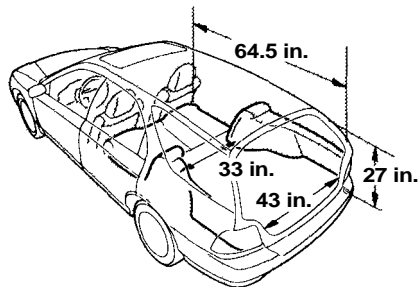

Storage Compartments

You can store smaller items in any of the three storage compartments in the cargo area. Two compartments are on either side of the tire compartment. The third is in the right side panel.

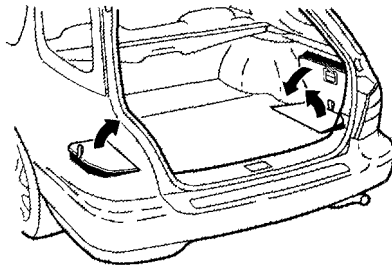

Cargo Area Tonneau Cover

When extended, the tonneau cover conceals your parcels and protects them from direct sunlight. To extend the tonneau cover, pull the cover's leading

edge out of its housing, and slip the brackets in the hooks provided at both sides of the tailgate opening.

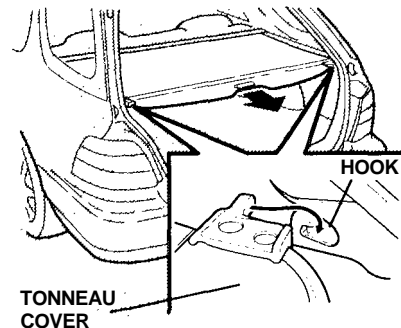

To retract the cover, slip the brackets out of the hooks, and guide the cover so it rolls back fully into its housing.

NOTICE: Do not store parcels on the tonneau cover. The tonneau cover may break if weight is placed on it.

continued

Loading Cargo

To remove the tonneau cover housing unit, press the release on one side, carefully lift it out of the holder, and rest it on the trim.

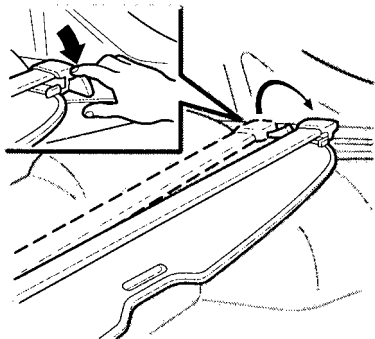

Release the other side, then remove the unit. Store the unit in an area where it will not be damaged.

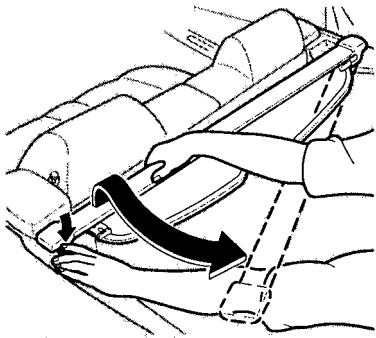

NOTICE

If you lift the housing unit more than 6 inches (150 mm) or pull it too far rearward, you may risk damaging the unit.

This section gives you tips on starting the engine under various conditions and how to operate the 5-speed manual and automatic transmissions. It also includes important information on your car's braking system and facts you need if you are planning to tow a trailer.

Preparing to Drive	88
Starting the Engine	88
Starting in Cold Weather at High Altitude	89
5-Speed Manual	
Transmission	90
Recommended Shift Points	91
Maximum Speeds	91
Automatic Transmission	91
Shift Lever Position Indicator	92
Shift Lever Positions	92
Maximum Speeds	94
Shift Lock Release	94
The Braking System	95
Brake Wear Indicators	95
Brake System Design	96
Anti-Lock Brakes	96
Towing a Trailer	97

Preparing to Drive, Starting the Engine

You should do the following checks and adjustments every day before you drive your car.

1. Make sure all windows, mirrors, and outside lights are clean and unobstructed. Remove frost, snow, or ice.
2. Check that the hood and trunk are fully closed.
3. Visually check the tires. If a tire looks low, use a gauge to check its pressure.
4. Check that any items you may be carrying with you inside are stored properly or fastened down securely.
5. Check the adjustment of the seat (see page 48).

6. Check the adjustment of the inside and outside mirrors (see page 53).
7. Check the adjustment of the steering wheel (see page 40).
8. Make sure the doors are securely closed and locked;
9. Fasten your seat belt. Check that your passengers have fastened their seat belts (see page 7).
10. Turn the ignition ON (II). Check the indicator lights in the instrument panel.
11. Start the engine.
12. Check the gauges and indicator lights in the instrument panel (see page 29).

Starting the Engine

1. Apply the parking brake.
2. In cold weather, turn off all electrical accessories to reduce the drain on the battery.
3. *Manual transmission:* Push the clutch pedal all the way down. START (III) does not function unless the clutch pedal is depressed.
Automatic transmission: Make sure the shift lever is in Park. Push on the brake pedal.
4. Without touching the accelerator pedal, turn the ignition key to the START (III) position. If the engine does not start right away, do not hold the key in START (III) for more than 15 seconds at a

time. Pause for at least 10 seconds before trying again.

5. If the engine does not start within 15 seconds or starts but stalls right away, push the accelerator pedal halfway down, and turn the ignition key to the START (III) position. If the engine starts, release pressure on the accelerator pedal so the engine does not race.
6. If the engine still does not start, push the accelerator pedal all the way down and hold it there while starting to clear any flooding. As before, keep the ignition key in the START (III) position for no more than 15 seconds. Return to step 5 if the engine does not start. If it starts, lift your foot off the accelerator pedal so the engine does not race.

Starting in Cold Weather at High Altitude (Above 8,000 feet/2,400 Meters)

An engine is harder to start in cold weather. The thinner air found at high altitude above 8,000 feet (2,400 meters) adds to the problem. Use the following procedure:

1. Turn off all electrical accessories to reduce the drain on the battery.
2. Push the accelerator pedal halfway down, and hold it there while starting the engine. Do not hold the ignition key in START (III) for more than 15 seconds. When the engine starts, release the accelerator pedal gradually as the engine speeds up and smooths out.

3. If the engine fails to start in step 2, push the accelerator pedal all the way down, and hold it there while you try to start the engine for no more than 15 seconds. If the engine does not start, return to step 2.

5-Speed Manual Transmission

The manual transmission is synchronized in all forward gears for smooth operation. It has a lockout so you cannot shift directly from Fifth to Reverse. When shifting up or down, make sure you push the clutch pedal down all the way, shift to the next gear, and let the pedal up gradually. When you are not shifting, do not rest your foot on the clutch pedal. This can cause your clutch to wear out faster.

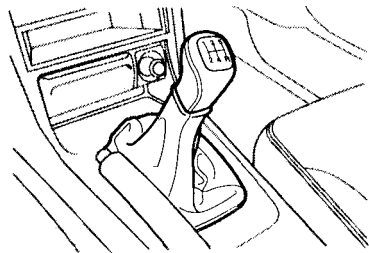

Come to a full stop before you shift into reverse. You can damage the transmission by trying to shift into reverse with the car moving. Push down the clutch pedal, and pause for a few seconds before shifting into reverse, or shift into one of the forward gears for a moment. This stops the gears so they won't "grind."

When slowing down, you can get extra braking from the engine by shifting to a lower gear. This extra braking can help you maintain a safe speed and prevent your brakes from overheating while going down a steep hill. Before downshifting, make sure engine speed will not go into the red zone in the lower gear. Refer to the Maximum Speeds chart.

Rapid slowing or speeding up can cause loss of control on slippery surfaces. If you crash, you can be injured.

Use extra care when driving on slippery surfaces.

Recommended Shift Points

Drive in the highest gear that lets the engine run and accelerate smoothly. This will give you the best fuel economy and effective emissions control. The following shift points are recommended:

Shift up	Normal acceleration
1 st to 2 nd	15 mph (24 km/h)
2 nd to 3 rd	28 mph (45 km/h)
3 rd to 4 th	41 mph (66 km/h)
4 th to 5 th	52 mph (84 km/h)

Shift up	Cruise from acceleration
1 st to 2 nd	7 mph (11 km/h)
2 nd to 3 rd	22 mph (35 km/h)
3 rd to 4 th	33 mph (53 km/h)
4 th to 5 th	48 mph (77 km/h)

Maximum Speeds

The speeds in these tables are the maximums for the given gears. If you exceed these speeds, the engine speed will enter, into the tachometer's red zone. If this occurs, you may feel the engine cut in and out. This is caused by a limiter in the engine's computer controls. The engine will run normally when you reduce the rpm below the red zone.

Gear	Maximum speeds
1 st	30 mph (49 km/h)
2 nd	56 mph (91 km/h)
3 rd	86 mph (139 km/h)
4 th	113 mph (182 km/h)
5 th	Top speed

Automatic Transmission

Your Honda's transmission has four forward speeds and is electronically controlled for smoother shifting. It also has a "lock-up" torque converter for better fuel economy. You may feel what seems like another shift when the converter locks.

Shift Lever Position Indicator

This indicator between the tachometer and speedometer shows which shift position the shift lever is in. The "D4" indicator comes on for a few seconds when you turn the ignition switch ON (II). If it flashed while driving (in any shift position), it indicates a possible problem in the transmission. Avoid rapid acceleration and have the transmission checked by an authorized Honda dealer as soon as possible.

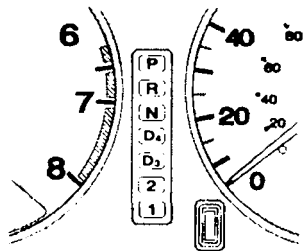

Shift Lever Positions

The shift lever has seven positions. It must be in Park or Neutral to start the engine. When you are stopped in D4, D3, 2, 1 or R, press firmly on the brake pedal, and keep your foot off the accelerator pedal.

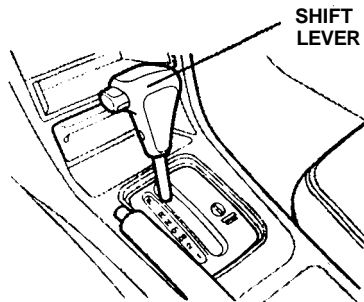

To shift from:	Do this:
P to R	Press the brake pedal, and press the release button.
R to P N to R D3 to 2 2 to 1	Press the release button.
1 to 2 2 to D3 D3 to D4 D4 to N D4 to D3 N to D4 R to N	Move the lever.

Park (P) — This position mechanically locks the transmission. Use Park whenever you are turning off or starting the engine. To shift out of Park, you must press on the brake pedal and have your foot off the accelerator pedal. Press the release button on the side of the shift lever to move it.

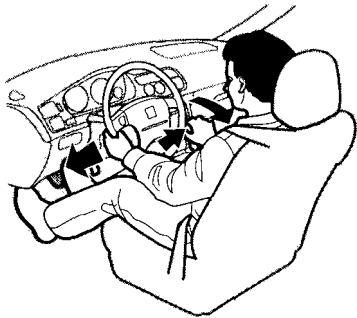

If you have done all of the above and still cannot move the lever

out of Park, see **Shift Lock Release** on page 94.

You must also press the release button to shift into Park. To avoid transmission damage, come to a complete stop before shifting into Park. The shift lever must be in Park before you can remove the key from the ignition switch.

Reverse (R) — To shift to Reverse from Park, see the explanation under Park. To shift to Reverse from Neutral, come to a complete stop and then shift. Press the release button before shifting into Reverse from Neutral.

Neutral (N) — Use Neutral if you need to restart a stalled engine or you need to stop briefly with the engine idling. Shift to Park position if you need to leave the

car for any reason. Press on the brake pedal when you are moving the shift lever from Neutral to another gear.

Drive (D4) — Use this position for your normal driving. The transmission automatically selects a suitable gear for your speed and acceleration. You may notice the transmission shifting up at higher speeds when the engine is cold. This helps the engine warm up faster.

Drive (D3) — This position is similar to D4, except only the first three gears may be selected. Use D3 when towing a trailer in hilly terrain or to provide engine braking when going down a steep hill. D3 can also keep the transmission from cycling between third and fourth gears in stop-and-go driving.

continued

For faster acceleration when in D₃ or D₄, you can get the transmission to automatically downshift by pushing the accelerator pedal to the floor. The transmission will shift down one or two gears, depending on your speed.

Second (2) — To shift to Second, press the release button on the side of the shift lever. This position locks the transmission in second gear. It does not downshift to first gear when you come to a stop. Second gives you more power when climbing, and increased engine braking when going down steep hills. Use second gear when starting out on a slippery surface or in deep snow. It will help reduce wheel spin.

Whenever you move the shift lever to a lower gear, the

transmission downshifts only if the engine's redline will not be exceeded in the lower gear.

First (1) — To shift from Second to First, press the release button on the side of the shift lever. With the lever in this position, the transmission locks in First gear. By upshifting and downshifting through 1, 2, D₃, and D₄, you can operate this transmission much like a manual transmission without a clutch pedal.

Maximum Speeds

The speeds in these tables are the maximums for the given position. If you exceed these speeds, the engine speed will enter into the tachometer's red zone. If this occurs, you will feel the engine cut in and out. This is caused by a limiter in the

engine's computer controls. The engine will run normally when you reduce the rpm below the red zone.

Position	Maximum speeds
1	33 mph (54 km/h)
2	61 mph (99 km/h)
D ₃	100 mph (160 km/h)
D ₄	Top speed

Shift Lock Release

This allows you to move the shift lever out of Park if the normal method of pushing on the brake pedal and pressing the release button does not work.

1. Set the parking brake.
2. Remove the key from the ignition switch.

3. Insert the key in the Shift Lock Release slot next to the shift lever.
4. Push down on the key while you press the release button and move the shift lever out of Park to Neutral.
5. Remove the key from the Shift Lock Release slot. Return the key to the ignition switch, depress the brake pedal, and restart the engine.

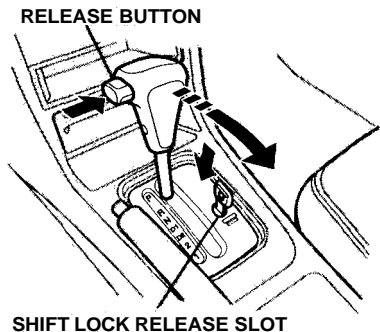

If you need to use the Shift Lock Release, it could mean your car is developing a problem. Have the car checked by your Honda dealer.

The Braking System

Your Honda is equipped with front disc brakes. The brakes on the rear wheels may be disc or drum, depending on the model. The braking system is power assisted to reduce the effort needed on the brake pedal.

Put your foot on the brake pedal only when you intend to brake. Resting your foot on the pedal keeps the brakes applied lightly, causing them to build up heat. Heat buildup can reduce how well your brakes work. It also keeps your brake lights on all the time, confusing drivers behind you.

Constant application of the brakes when going down a long hill builds up heat and reduces their effectiveness. Use the engine to assist the brakes by downshifting to a lower gear and taking your foot off the accelerator pedal.

Brake Wear Indicators

The front disc brakes and rear brakes of ABS-equipped cars have audible brake wear indicators. When the brake pads need replacing, you will hear a distinctive metallic "screeching" sound when you apply the brakes. If you do not have the brake pads replaced, they will screech all the time.

Your brakes may sometimes squeal or squeak when you apply them lightly. Do not

continued

The Braking System

confuse this with the brake wear indicators. They make a very audible "screeching."

Brake System Design

The hydraulic system that operates the brakes has two separate circuits. Each circuit works diagonally across the car (the left-front brake is connected with the right-rear brake, etc.). If one circuit should develop a problem, you will still have braking at two wheels.

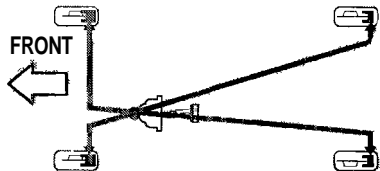

If this happens, you will notice that the brake pedal goes down

much farther and you need to press on it much harder. A much longer distance will be needed to stop the car.

Slow the car by downshifting to a lower gear and removing your foot from the accelerator pedal. Pull to the side of the road as soon as it is safe. Because of the longer stopping distance needed, brake system failure is very hazardous. You should have your car towed, but if you must drive the car in this condition, be extremely cautious. Have your car repaired as soon as possible.

Anti-Lock Brakes

ABS-equipped models

Your car has an anti-lock brake system (ABS). ABS helps you to maintain steering control during hard braking. It does this by helping to prevent the wheels from locking up and skidding.

The ABS is always "ON." It requires no special effort or driving technique. You will feel a pulsation in the brake pedal when the ABS activates.

Activation varies with the amount of traction your tires have. On dry pavement, you will need to press on the brake pedal very hard before you feel the pedal pulsation that means the ABS has activated. However, you may feel the ABS activate immediately if you are trying to stop on snow or ice. Under all conditions, the ABS is helping to prevent the wheels from locking so you can retain steering control. You should continue to press on the brake pedal with the same force.

You may feel a slight movement of the brake pedal just after you start the engine. This is the ABS working.

The ABS is self-checking. If anything goes wrong, the ABS indicator on the instrument panel comes on (see page 31). This means the anti-lock function of the braking system has shut down. The brakes still work like a conventional system, providing normal stopping ability. You should have the dealer inspect your car as soon as possible.

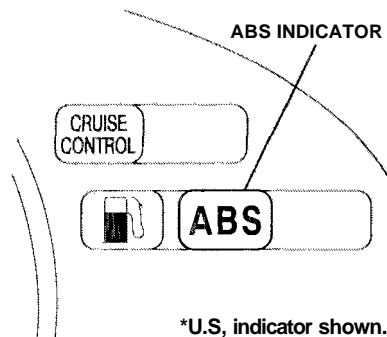

A car with ABS may require a longer distance to stop on loose or uneven surfaces than an equivalent car without anti-lock brakes. The ABS cannot make up for road conditions or bad judgment. It is still your responsibility to drive at reasonable speeds for weather and traffic conditions and to leave a margin of safety.

Towing a Trailer

Your Honda is designed primarily to carry passengers and their cargo. You can use it to tow a trailer if you carefully observe some general rules.

- The total weight of the trailer and everything loaded in it must not exceed 1,000 lb (450 kg).

- The "tongue load" should never exceed 100 lb (45 kg). This is the amount of weight the trailer puts on the hitch when it is fully loaded. As a rule of thumb, the tongue load should be 10% of the total trailer package.

For example, if the trailer and its load weigh 500 lb (225 kg), the tongue load should be 50 lb (22.5 kg). Adjust the trailer's cargo to change the tongue load. Start by putting approximately 60% of the cargo toward the front and 40% toward the rear. Never load the trailer so the back is heavier than the front. This takes weight off your car's rear axle and reduces traction.

- The combined weight of the car, all passengers and their luggage, and tongue load must

continued

not exceed the Gross Vehicle Weight Rating. The GVWR is printed on the Certification Label attached to the driver's doorjamb (see page 172).

- The combined weight of the car, all passengers and their luggage, and tongue load also must not exceed the Gross Axle Weight Rating. The GAWR is also shown on the Certification label. It tells you the maximum load for the front and rear axles. It is possible that your towing package does not exceed the GVWR but does exceed the GAWR. Improper trailer loading, and/or too much luggage in the trunk can overload the rear axle. Redistribute the load, and check the axle weights again.

Improperly loading your car and trailer can seriously affect its steering and braking performance, causing a crash in which you can be seriously injured.

Check the loading of your car and trailer carefully before starting to drive.

The best way to confirm that your total towing package is within these specifications is to get it weighed. Load the car and trailer as you normally would while towing, and take them to a public scale. Have them check the total weight and the weight at each axle, and then compare them to the specifications.

Trailer Hitches

Your Honda dealer, or the Honda Customer Relations Zone Office, can give you advice on the proper hitch for your car. Never use a hitch that mounts only to the rear bumper. The bumper is not designed to handle that type of load. The hitch should bolt to the under-body of the car and distribute the load over a wide area. Always have a trailer hitch installed by a qualified technician.

NOTICE

A trailer hitch that is not adequate for the size of the trailer, or a hitch that is improperly installed, can cause damage to the underside of your car.

Mirrors

Many states and provinces have laws requiring special outside

mirrors when you are towing a trailer. Check the laws in your area. You may want to install mirrors, even if they are not required. Hook up the trailer and see how much it obscures your ability to see behind you with the standard mirrors. If you cannot see directly behind you, or have a large blind spot next to the trailer or the car, you should install mirrors intended for towing.

Connecting the Trailer

Most trailers that have a gross weight of 1,000 lb (450 kg) do not have their own braking system. If you are thinking of getting a trailer that does have brakes, make sure they are electrically operated. There are no provisions in your car to tap into its hydraulic braking system. Any attempt to attach the

trailer's brakes to your car's hydraulic system, no matter how successful it may seem, will lower braking effectiveness and create a potential hazard.

Always use a safety chain when towing a trailer. Connect the safety chain securely at both ends. Make sure the chain crosses under the tongue so it will catch the trailer if it becomes unhitched. Leave enough slack in the chain so it

can't bind in a sharp turn. Do not let it drag on the ground.

Your car has a trailer lighting connector under the cargo area floor. To use the connector, lift the floor and attach the hook at the end of the strap to the roof line.

You will find the connector under the left side box. Refer to the drawing below for the wiring color code and purpose of each connector pin.

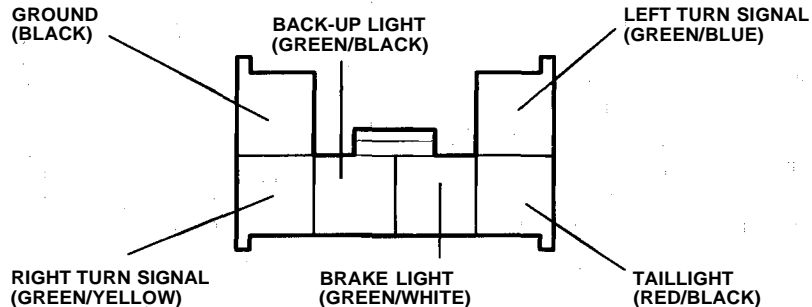

Towing a Trailer

Before Starting Out

As you are preparing to tow your trailer, do the following:

- Measure the trailer's tongue load. You can do this with a bathroom scale.
- Verify that the hitch and safety chain are securely fastened.
- Check the condition and air pressure of all tires on the trailer and your car. Low tire pressure can seriously affect the handling. Also, check the spare tire.
- With everything loaded and the trailer connected, check that the rear of the car is not sagging. If so, redistribute the load in the car.
- Check that all lights on the car and trailer are working properly.

Towing Safety

Your car will not stop as quickly with a trailer in tow. Leave extra distance between your car and other vehicles. Avoid braking or turning suddenly. This could cause the trailer to jackknife or possibly turn over.

Keep in mind that your total vehicle is now much longer. Leave more room when making turns. The trailer tracks a smaller arc than the car and can hit or run over something that the car misses. When passing another vehicle, make sure the trailer is clear before changing lanes.

The car/trailer combination is more affected by crosswinds and buffeting. When being passed by a large vehicle, keep a constant speed and steer straight ahead. If there is too much wind buffeting,

slow down to get out of the other vehicle's air turbulence.

Towing a trailer puts an extra load on your car. You should have your car serviced according to the maintenance schedule under severe driving conditions on page [109](#).

This extra load is magnified when you are driving in hilly terrain. Watch the temperature gauge closely when climbing hills. If it gets near the hot area, turn off the air conditioning (if it is on). If this does not reduce the heat, it may be necessary to pull to the side of the road and wait for the engine to cool. If the automatic transmission shifts frequently between 3rd and 4th gears, put it in D3. This will help prevent the transmission from overheating. Help keep the brakes from overheating by

shifting to a lower gear when going downhill.

If you have to stop while going uphill, do not hold the car in place by pressing the accelerator. This can cause the automatic transmission to overheat. Use the parking brake or footbrake.

When parking your car and trailer, especially on a hill, be sure to follow all the normal precautions. Turn your front wheels into the curb, set the parking brake firmly, and put the transmission in 1st or Reverse (manual) or Park (automatic). In addition, place wheel chocks at each of the trailer's tires.

Backing up with a trailer is difficult and takes practice. Drive slowly, make small movements with the steering wheel, and have someone stand outside to

guide you. Grip the steering wheel on the bottom (rather than the usual position near the top). Move your hand to the left to get the trailer to move to the left, and right to move the trailer right.

This section explains why it is important to keep your car well maintained and to follow basic maintenance safety precautions.

This section also includes Maintenance Schedules for normal driving and severe driving conditions, a Maintenance Record, and instructions for simple maintenance tasks you may want to take care of yourself.

If you have the skills and tools to perform more complex maintenance tasks on your Honda, you may want to purchase the Service Manual. See page 187 for information on how to obtain a copy, or see your Honda dealer.

Maintenance Safety	104
Maintenance Schedule	106
Maintenance Record	110

Periodic Checks	112
Fluid Locations	113
Engine Oil	114
Adding Oil	114
Recommended Oil	114
Additives	115
Changing the Oil and Filter	115
Cooling System	117
Engine Coolant	117
Adding Engine Coolant ...	117
Replacing Engine Coolant	118
Windshield Washers	120
Transmission Oil	121
Automatic Transmission .	121
5-Speed Manual Transmission	122
Brake and Clutch Fluid	122
Brake System	123
Anti-Lock Brake System ..	123
Clutch System	124
Power Steering	124
Air Cleaner Element	125

Spark Plugs	126
Replacement	126
Specifications	127
Battery	127
Windshield Wipers	129
Air Conditioning System	130
Drive Belts	131
Tires	132
Inflation	132
Inspection	133
Maintenance	134
Tire Rotation	134
Replacing Tires and Wheels	135
Wheels and Tires	135
Winter Driving	135
Snow Tires	136
Tire Chains	136
Lights	136
Replacing Bulbs	137
Storing Your Car	143

Regularly maintaining your car is the best way to protect your investment. Proper maintenance is essential to your safety and the safety of your passengers. It will also reward you with more economical, trouble-free driving and help reduce air pollution.

Improperly maintaining this car or failing to correct a problem before driving can cause a crash in which you can be seriously hurt and killed.

Always follow the inspection and maintenance recommendations and schedules in this owner's manual.

This section includes instructions for simple maintenance tasks, such as checking and adding oil. Any service items not detailed in this section should be performed by a Honda technician or other qualified mechanic.

Some of the most important safety precautions are given below. However, we cannot warn you of every conceivable hazard that can arise in performing maintenance. Only you can decide whether or not you should perform a given task.

Failure to properly follow maintenance instructions and precautions can cause you to be seriously hurt or killed.

Always follow the procedures and precautions in this owner's manual.

Important Safety Precautions

Before you begin any maintenance, make sure that your car is parked on level ground and the parking brake is set. Also, be sure the engine is off. This will help to eliminate several potential hazards:

- **Carbon monoxide poisoning from engine exhaust.** Be sure there is adequate ventilation whenever you operate the engine.
- **Burns from hot parts.** Let the engine and exhaust system cool before touching any parts.
- **Injury from moving parts.** Do not run the engine unless instructed to do so.

Read the instructions before you begin, and make sure you have the tools and skills required.

To reduce the possibility of fire or explosion, be careful when working around gasoline or batteries. Use a nonflammable solvent, not gasoline, to clean parts. Keep cigarettes, sparks and flames away from the battery and all fuel-related parts. You should wear eye protection and protective clothing when working near the battery or when using compressed air.

Maintenance Schedule

The Maintenance Schedule specifies how often you should have your car serviced and what things need attention. It is essential that your car be serviced as scheduled to retain its high level of safety, dependability, and emissions control performance.

The services and time or mileage intervals shown in the maintenance schedule assume you will use your car as normal transportation for passengers and their possessions. You should also follow these recommendations:

- Avoid exceeding your car's load limit. This puts excess strain on the engine, brakes, and many other parts of your car. The load limit is shown on the label on the driver's doorjamb.
- Operate your car on reasonable roads within the legal speed limit.
- Drive your car regularly over a distance of several miles (kilometers).
- Always use unleaded gasoline with a pump octane number of 86 or higher (see page 78).

Which Schedule to Follow

Service your car according to the time and mileage periods on one of the Maintenance Schedules on the following pages. Select the schedule for "Severe Conditions" if most of your driving is done under one or more of the conditions listed on that page. Otherwise, follow the schedule for "Normal Conditions."

Your authorized Honda dealer knows your car best and can provide competent, efficient service. However, service at a dealer is not mandatory to keep your warranties in effect.

Maintenance may be done by any qualified service facility or person who is skilled in this type of automotive service. Keep all the receipts as proof of completion, and have the person who does the work fill out the Maintenance Record. Check your warranty booklet for more information.

We recommend the use of Genuine Honda parts and fluids whenever you have maintenance done. These are manufactured to the same high quality standards as the original components, so you can be confident of their performance and durability.

U.S. Cars:

Maintenance, replacement, or repair of emissions control devices and systems may be done by any automotive repair establishment or individual using parts that are "certified" to EPA standards.

According to state and federal regulations, failure to perform maintenance on the items marked with an asterisk (*) will not void your emissions warranties. However, Honda recommends that all maintenance services be performed at the recommended time or mileage period to ensure long-term reliability.

Maintenance Schedule (Normal Conditions)

Service at the indicated distance or time – whichever comes first.	miles x 1,000	15	30	45	60	75	90	105
	months	12	24	36	48	60	72	84
	km x 1,000	24	48	72	96	120	144	168
Replace engine oil and oil filter	Replace every 7,500 mi (12,000 km) or 6 mos							
Check engine oil and coolant	Check oil and coolant at each fuel stop							
Replace air cleaner element			●		●		●	
Inspect valve clearance		●			●		●	
Replace spark plugs		●			●		●	
Inspect distributor cap*, rotor*, and ignition wires					●			
Replace timing belt*, balancer belt*, and inspect water pump							●	
Inspect and adjust drive belts		●			●		●	
Inspect idle speed*					●			
Inspect PCV valve					●			
Replace engine coolant				●		●		●
Replace transmission fluid			●		●		●	
Inspect front and rear brakes	●	●	●	●	●	●	●	●
Replace brake fluid (including ABS)		●	●	●	●	●	●	●
Check parking brake adjustment	●	●	●	●	●	●	●	●
Rotate tires (Check tire inflation and condition at least once per month)	Rotate tires every 7,500 miles (12,000 km)							
Visually inspect the following items:								
Brake hoses and lines								
All fluid levels								
Tie rod ends, steering gear box, and boots								
Suspension components								
Driveshaft boots	●	●	●	●	●	●	●	●
Cooling system hoses and connections								
Exhaust system*								
Fuel pipes, hoses, and connections*								
Inspect supplemental restraint system	10 years after production							

Follow the Normal Conditions Maintenance Schedule if the severe driving conditions specified in the Severe Conditions Maintenance Schedule on the next page do not apply.

For Canadian Owners:

This Maintenance Schedule outlines the *minimum* required maintenance that you should perform to ensure the trouble-free operation of your vehicle. Due to regional and climatic differences, some additional servicing may be required. Please consult your warranty handbook for a more detailed description.

Maintenance Schedule (Severe Conditions)

Service at the indicated distance or time – whichever comes first.	miles x 1,000	15	30	45	60	75	90	105
	months	12	24	36	48	60	72	84
	km x 1,000	24	48	72	96	120	144	168
Replace engine oil and oil filter	Replace every 3,750 mi (6,000 km) or 3 mos							
Check engine oil and coolant	Check oil and coolant at each fuel stop							
Clean (○) or replace (●) air cleaner element	○	●	○	●	○	●	○	
Inspect valve clearance		●		●		●		
Replace spark plugs		●		●		●		
Inspect distributor cap*, rotor*, and ignition wires				●				
Replace timing belt*, balancer belt*, and inspect water pump	Replace every 60,000 mi (96,000 km)							
Inspect and adjust drive belts		●		●		●		
Inspect idle speed*				●				
Inspect PCV valve				●				
Replace engine coolant			●		●		●	
Replace transmission fluid		●	●	●	●	●	●	●
Inspect front and rear brakes	Inspect every 7,500 miles (12,000 km) or 6 mos							
Replace brake fluid (including ABS)		●		●		●		●
Check parking brake adjustment	●	●	●	●	●	●	●	●
Rotate tires (Check tire inflation and condition at least once per month)	Rotate tires every 7,500 miles (12,000 km)							
Visually inspect the following items:								
Tie rod ends, steering gear box, and boots Suspension components Driveshaft boots	Every 7,500 miles (12,000 km) or 6 mos							
Brake hoses and lines All fluid levels Cooling system hoses and connections Exhaust system*	●	●	●	●	●	●	●	●
Fuel pipes, hoses, and connections*								
Inspect supplemental restraint system	10 years after production							

Follow the Severe Conditions Maintenance Schedule if you drive your vehicle *MAINLY* under one or more of the following conditions:

- Driving less than 5 miles per trip or, in freezing temperatures, driving less than 10 miles per trip.
- Driving in extremely hot (over 90°F) conditions.
- Extensive idling or long periods of stop-and-go driving.
- Trailer towing, driving with a car-top carrier, or driving in mountainous conditions.
- Driving on muddy, dusty, or de-iced roads.

NOTE: If you only *OCCASIONALLY* drive under a "severe" condition, you should follow the Normal Conditions Maintenance Schedule on the previous page.

Required Maintenance Record

Have your servicing dealer record all Required Maintenance below. Keep receipts for all work done on your car.

7,500 Mi. 12,000 km (or 6 Mo.)	(Sign or Stamp)	Mi. (km)
		Date
15,000 Mi. 24,000 km (or 12 Mo.)	(Sign or Stamp)	Mi. (km)
		Date
22,500 Mi. 36,000 km (or 18 Mo.)	(Sign or Stamp)	Mi. (km)
		Date
30,000 Mi. 48,000 km (or 24 Mo.)	(Sign or Stamp)	Mi. (km)
		Date
37,500 Mi. 60,000 km (or 30 Mo.)	(Sign or Stamp)	Mi. (km)
		Date
45,000 Mi. 72,000 km (or 36 Mo.)	(Sign or Stamp)	Mi. (km)
		Date
52,500 Mi. 84,000 km (or 42 Mo.)	(Sign or Stamp)	Mi. (km)
		Date

60,000 Mi. 96,000 km (or 48 Mo.)	(Sign or Stamp)	Mi. (km)
		Date
67,500 Mi. 108,000 km (or 54 Mo.)	(Sign or Stamp)	Mi. (km)
		Date
75,000 Mi. 120,000 km (or 60 Mo.)	(Sign or Stamp)	Mi. (km)
		Date
82,500 Mi. 132,000 km (or 66 Mo.)	(Sign or Stamp)	Mi. (km)
		Date
90,000 Mi. 144,000 km (or 72 Mo.)	(Sign or Stamp)	Mi. (km)
		Date
97,500 Mi. 156,000 km (or 78 Mo.)	(Sign or Stamp)	Mi. (km)
		Date
105,000 Mi. 168,000 km (or 84 Mo.)	(Sign or Stamp)	Mi. (km)
		Date

Non-Scheduled Maintenance Record

Record additional maintenance for severe driving conditions or non-scheduled maintenance on this page (see page 109).

Maintenance Performed:	(Sign or Stamp)	Mi. (km)
		Date
Maintenance Performed:	(Sign or Stamp)	Mi. (km)
		Date
Maintenance Performed:	(Sign or Stamp)	Mi. (km)
		Date
Maintenance Performed:	(Sign or Stamp)	Mi. (km)
		Date
Maintenance Performed:	(Sign or Stamp)	Mi. (km)
		Date
Maintenance Performed:	(Sign or Stamp)	Mi. (km)
		Date

Maintenance Performed:	(Sign or Stamp)	Mi. (km)
		Date
Maintenance Performed:	(Sign or Stamp)	Mi. (km)
		Date
Maintenance Performed:	(Sign or Stamp)	Mi. (km)
		Date
Maintenance Performed:	(Sign or Stamp)	Mi. (km)
		Date
Maintenance Performed:	(Sign or Stamp)	Mi. (km)
		Date
Maintenance Performed:	(Sign or Stamp)	Mi. (km)
		Date

MAINTENANCE RECORD

Periodic Checks

You should check the following items at the specified intervals. If you are unsure of how to perform any check, turn to the page given.

- Engine oil level — Check every time you fill the fuel tank. See page [82](#).
 - Engine coolant level — Check the radiator reserve tank every time you fill the fuel tank. See page [83](#).
 - Windshield washer fluid — Check the level in the reservoir monthly. If weather conditions cause you to use the washers frequently, check the reservoir each time you stop for fuel. See page [120](#).
 - Automatic transmission — Check the fluid level monthly. See page [121](#).
- Brakes, clutch, and power steering — Check the fluid level monthly. See pages [122](#) — [124](#).
 - Battery — Check its condition and the terminals for corrosion monthly. See pages [127](#) — [129](#).
 - Air conditioning — Check its operation weekly. See page [131](#).
 - Tires — Check the tire pressure monthly. Examine the tread for wear and foreign objects. See page [133](#).
 - Lights — Check the operation of the headlights, parking lights, taillights, high-mount brake light, turn signals, brake lights, and license plate lights monthly. See page [136](#).

BRAKE FLUID
(Gray cap)

CLUTCH FLUID
(Gray cap)
(5-Speed Manual
Transmission only)

**ENGINE OIL
FILLER CAP**

ENGINE OIL DIPSTICK
(Orange loop)

**COOLANT
RESERVOIR**

**ANTI-LOCK BRAKE
RESERVOIR**
(Gray cap)
(For cars equipped
with ABS)

**AUTOMATIC
TRANSMISSION
FLUID DIPSTICK**
(Yellow loop)

**POWER STEERING
FLUID (Red cap)**

WASHER FLUID
(Blue cap)

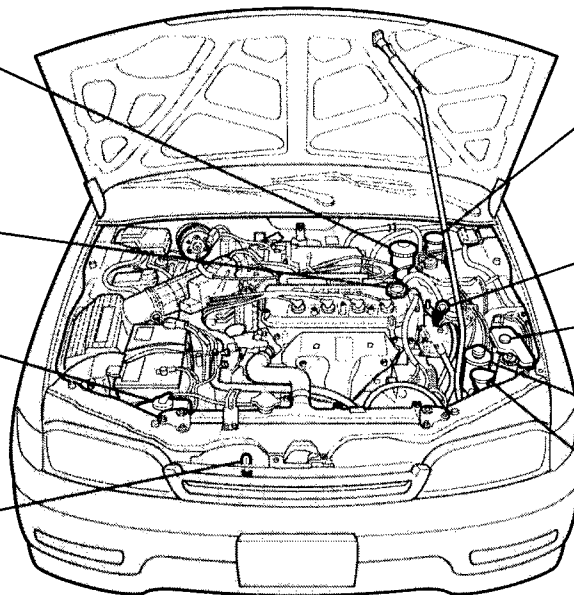

Engine Oil

Adding Oil

To add oil, unscrew and remove the engine oil fill cap on top of the valve cover. Pour in the oil, and replace the fill cap. Tighten it securely. Wait a few minutes, and recheck the oil level. Do not fill above the upper mark; you could damage the engine.

ENGINE OIL FILL CAP

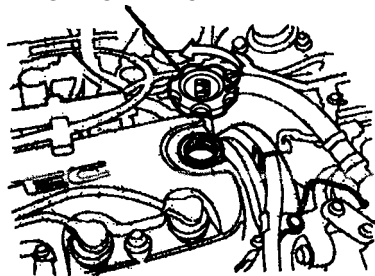

Recommended Oil

Oil is a major contributor to your engine's performance and

longevity. Always use a premium-grade detergent oil.

You can determine an oil's SAE viscosity and Service Classification from the API Service label on the oil container.

A fuel-efficient oil is recommended for your Honda. This is shown on the API Service label by the words "Energy Conserving II." This oil is formulated to help your engine use less fuel.

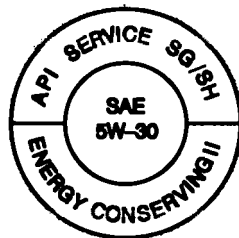

API SERVICE LABEL

The oil container may also display the API Certification seal. Make sure it says "For Gasoline Engines."

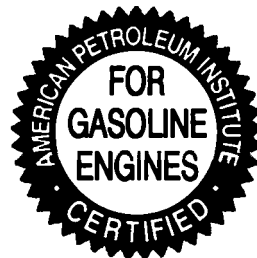

API CERTIFICATION SEAL

- Remove the oil filter, and let the remaining oil drain. A special wrench (available from your Honda dealer) is required to remove the filter.

OIL FILTER WRENCH

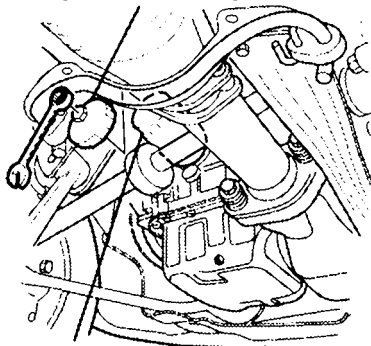

OIL FILTER

- Install a new oil filter according to the instructions that come with it.
- Put a new washer on the drain bolt with the flat side toward the engine, and then reinstall the drain bolt. Tighten it to 33 lb-ft (4.5 kg-m, 44 N.m).
- Refill the engine with the recommended oil. Engine oil capacity (including filter):
U.S.: LX, Canada: EX
4.0 U.S. qt (3.8 ℓ, 3.3 Imp. qt.)
U.S.: EX
4.5 U.S. qt (4.3 ℓ, 3.8 Imp. qt.)
- Replace the oil fill cap. Start the engine. The indicator light should go out within five seconds. If it does not, turn off the engine and inspect your work.
- Let the engine run for several minutes; then, check the drain bolt and washer and the oil filter for leaks.

- Turn off the engine, and wait for several minutes; then, check the oil level. If necessary, add oil to bring the level to the upper mark on the dipstick.

NOTICE

If you change your own oil, please dispose of the used oil properly. Put it in a sealed container, and take it to a recycling center. Do not discard it in a waste bin or dump it on the ground.

The oil and filter should be changed every 6 months or 7,500 miles (12,000 km), whichever comes first. Under severe driving conditions, they should be changed every 3 months or 3,750 miles (6,000 km). See page [109](#) for a description of severe driving conditions.

Engine Coolant

Check the level of the engine coolant by looking at the radiator reserve tank next to the air cleaner element housing. If the level is at or below the MIN line, add coolant to bring it up to the MAX line. This coolant should always be a mixture of 50 percent antifreeze and 50 percent water. Never add straight antifreeze or plain water.

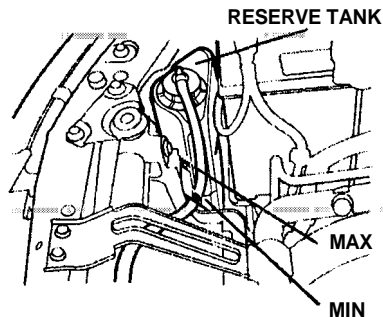

Always use Genuine Honda Antifreeze/Coolant. The cooling system contains many aluminum components that can corrode if an improper antifreeze is used. Some antifreeze, even though labeled as safe for aluminum parts, may not provide adequate protection.

Adding Engine Coolant

If the reserve tank is completely empty, you should also check the coolant level in the radiator.

Removing the radiator cap while the engine is hot can cause the coolant to spray out, seriously scalding you.

Always let the engine and radiator cool down before removing the radiator cap.

1. Make sure the engine and radiator are cool.
2. Turn the radiator cap counterclockwise, without pressing down on it, until it stops. This relieves any pressure remaining in the cooling system.

RADIATOR CAP

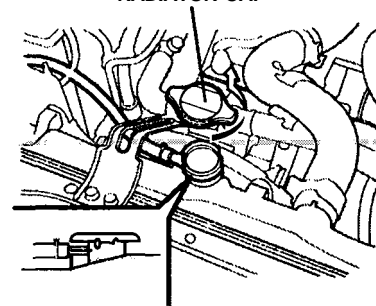

3. Remove the radiator cap by pushing down and turning counterclockwise.

continued

Cooling System

4. The coolant level should be up to the base of the filler neck. Add coolant if it is low.

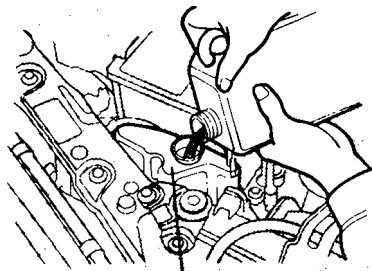

RESERVE TANK

5. Put the radiator cap back on. Tighten it fully.
6. Pour coolant into the reserve tank. Fill it to halfway between the MAX and MIN marks. Put the cap back on the reserve tank.

Do not add any rust inhibitors or other additives to your car's cooling system. They may not be compatible with the coolant or engine components.

Replacing Engine Coolant

The cooling system should be completely drained and refilled with new coolant according to the time and mileage recommendations in the maintenance schedule. Only use the recommended antifreeze.

Draining the coolant requires access to the underside of the car. Unless you have the tools and knowledge, you should have this maintenance done by a skilled mechanic.

1. Turn the heater temperature control lever to maximum heat. Open the hood. Make sure the engine and radiator are cool to the touch.
2. Remove the radiator cap.

RADIATOR CAP

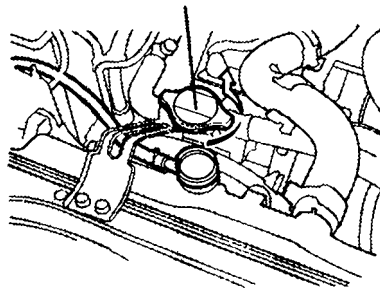

3. Loosen the drain plug in the bottom of the radiator. The coolant will drain through the splash guard. Remove the

drain bolt from the engine block.

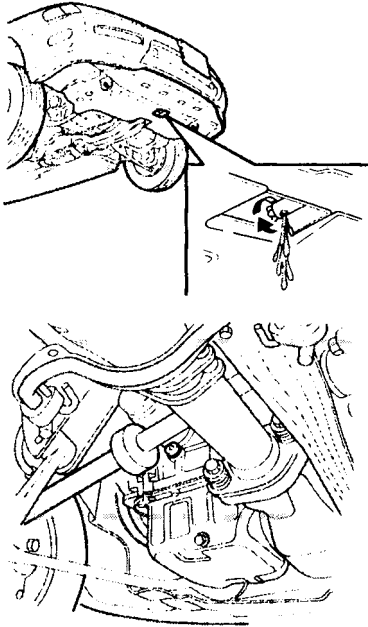

4. Remove the reserve tank from its holder by pulling it straight up. Drain the coolant, and then put the tank back in its holder.

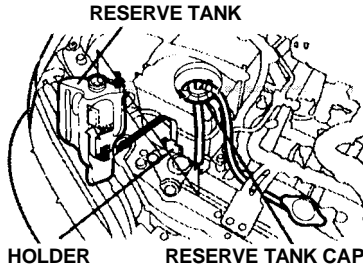

5. When the coolant stops draining, tighten the drain plug in the bottom of the radiator. Apply non-hardening sealant to the drain bolt threads, and reinstall the bolt in the engine block. Tighten the bolt to 61 lb-ft (8.5 kg-m, 83 N.m).

6. Mix the recommended antifreeze with an equal amount of purified or distilled water in a clean container. The cooling system capacity is:

With 5-speed manual transmission:

5.7 U.S. qt (5.4ℓ , 4.8 Imp qt)

With automatic transmission:

5.6 U.S. qt (5.3ℓ , 4.7 Imp qt)

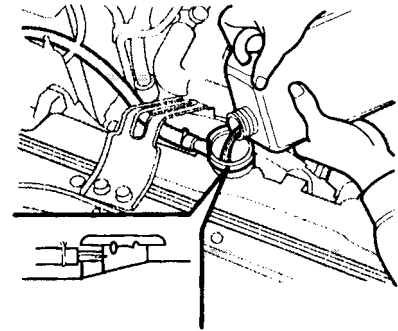

continued

7. Pour coolant into the radiator up to the base of the filler neck.
8. Loosen the bleeder bolt on top of the engine. Tighten it again when coolant comes out in a steady stream with no bubbles.

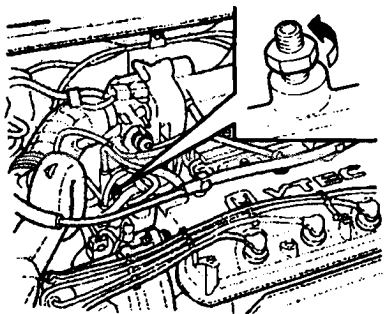

9. Refill the radiator to the base of the filler neck. Put the cap on the radiator, and tighten it only to the first stop. Start

the engine, and let it run until it warms up (the radiator cooling fan comes on at least twice).

10. Turn off the engine. Check the level in the radiator, and add coolant if needed. Install the radiator cap, and tighten it fully.
11. Fill the reserve tank to the MAX mark. Install the reserve tank cap.

RESERVE TANK

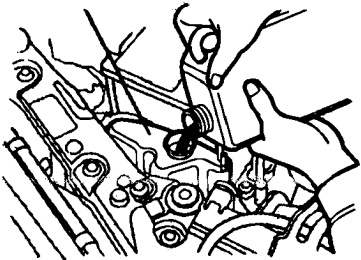

Windshield Washers

Check the level in the windshield washer reservoir at least monthly during normal usage. In bad weather, when you use the washers often, check the level every time you stop for gas.

The windshield washer reservoir is located behind the driver's side headlight. Check the reservoir's fluid level by removing the cap and looking at the dipstick.

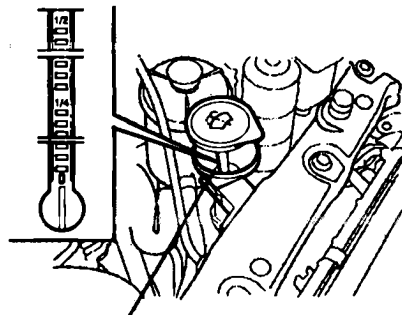

LEVEL GAUGE

NOTICE

Do not use engine antifreeze or a vinegar/water solution in the windshield washer reservoir.

Antifreeze can damage your car's paint, while a vinegar/water solution can damage the windshield washer pump.

Use only commercially available windshield washer fluid.

Transmission Oil

Automatic Transmission

Check the fluid level with the engine at normal operating temperature.

1. Park the car on level ground. Shut off the engine.

2. Remove the dipstick (yellow loop) from the transmission, and wipe it with a clean cloth.

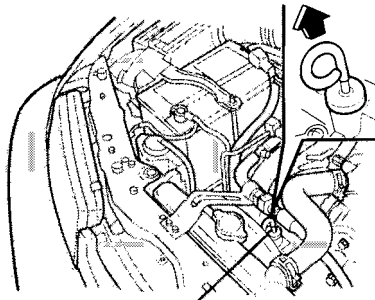

DIPSTICK

3. Insert the dipstick into the transmission.

4. Remove the dipstick and check the fluid level. It should be between the upper and lower marks.

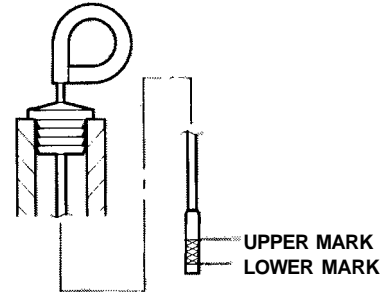

5. If the level is below the lower mark, add fluid into the tube to bring it to the upper mark. Use Honda Premium Formula Automatic Transmission Fluid or an equivalent DEXRON II Automatic Transmission Fluid (ATF) only.

continued

6. Insert the dipstick all the way back in the transmission. Make sure that the notch fits in the dipstick guide and the dipstick is all the way down.

The transmission should be drained and refilled with new fluid every 24 months or 30,000 miles (48,000 km), whichever comes first. Shorten this to every 12 months or 24,000 km (15,000 miles) under severe driving conditions (see page 109.)

5-Speed Manual Transmission

Check the oil level a couple of minutes after shutting off the engine. Make sure the car is on level ground. Remove the transmission filler bolt. The oil level should be up to the edge of the bolt hole. Feel inside the bolt hole with your finger. If you do not feel any oil, slowly add oil until it starts to run out of the

hole. Reinstall the filler bolt, and tighten it securely.

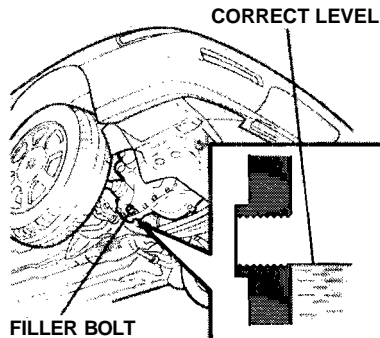

Only use an API Service SF or SG grade motor oil with a viscosity of SAE 10W-30 or 10W-40.

The transmission should be drained and refilled with new oil every 24 months or 30,000 miles (48,000 km), whichever comes first. Shorten the service interval to every 12 months or 24,000 km

(15,000 miles) under severe driving conditions (see page 109).

Brake and Clutch Fluid

Check the fluid level in the reservoirs monthly. There are up to three reservoirs, depending on which model. They are:

- Brake fluid reservoir (all models)
- Clutch fluid reservoir (5-speed manual transmission only)
- ABS reservoir for cars with ABS option

The brake fluid in the brake and anti-lock brake systems should be replaced every 2 years or 30,000 miles (48,000 km), whichever comes first.

Brake System

The fluid level should be between the MIN and MAX marks on the side of the reservoir. If the level is at or below the MIN mark, your brake system needs attention. Have the brake system inspected for leaks or worn brake pads.

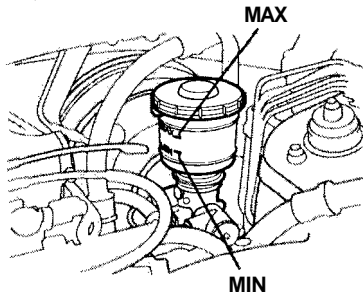

If you add brake fluid to bring it up to the MAX mark, use Genuine Honda Brake Fluid or an equivalent from a sealed container that is marked DOT 3

or DOT 4 only. Brake fluid marked DOT 5 is not compatible with your car's braking system.

Anti-Lock Brake System

The fluid should be between the MIN and MAX marks on the side of the reservoir. If it is at or below the MIN mark, it may indicate a problem in ABS. Have the dealer inspect the system and add fluid.

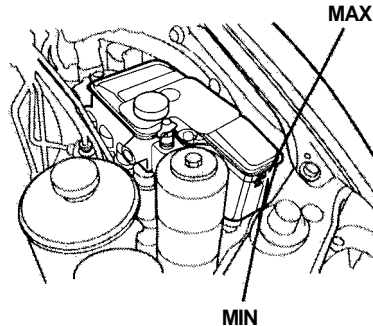

If the fluid level is half an inch or more above the MAX mark, it may indicate a problem in the ABS. Have your dealer inspect the system as soon as possible.

If you add brake fluid to bring it up to the MAX mark, use the same DOT 3 or DOT 4 brake fluid from a sealed container specified for the brake system.

Clutch System

The fluid level should be between the MIN and MAX marks on the side of the reservoir. If it is not, add brake fluid to bring it up to that level. Use the same DOT 3 or DOT 4 brake fluid specified for the brake system.

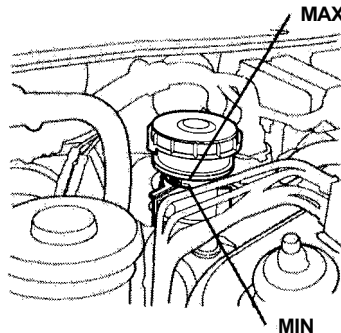

Low fluid level can indicate a leak in the clutch system. Have this system inspected as soon as possible.

Power Steering

You should check the fluid level in the power steering reservoir monthly. Check the level when the engine is cold. Look at the side of the reservoir. The fluid should be between the UPPER LEVEL and LOWER LEVEL. If it is below the LOWER LEVEL, add power steering fluid to the UPPER LEVEL.

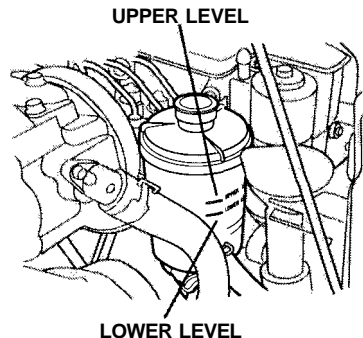

NOTICE

Using automatic transmission fluid or another brand of power steering fluid will damage the system. Use only Genuine Honda Power Steering Fluid-V.

A low power steering fluid level can indicate a leak in the system. Check the fluid level frequently and have the system inspected as soon as possible.

NOTICE

Turning the steering wheel to full left or right lock and holding it there can damage the power steering pump.

Air Cleaner Element

The air cleaner element should be replaced every 2 years or 30,000 miles (48,000 km), whichever comes first. Under severe driving conditions, it should be replaced every 12 months or 15,000 miles (24,000 km), whichever comes first.

Cleaning (Severe Conditions)

Clean the air cleaner element by blowing compressed air through it in the opposite direction to normal air flow. If you do not have access to compressed air (such as a gas station), ask your Honda dealer to do this service.

Follow the replacement procedure for removal and reinstallation.

Replacement

The air cleaner element is inside the air cleaner housing on the passenger's side of the engine compartment. To replace it:

1. Remove the air cleaner duct by pulling it straight out.

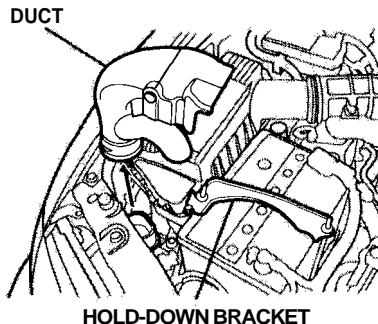

2. Loosen the screws from the battery hold-down bracket, and push the bracket away from the air cleaner.

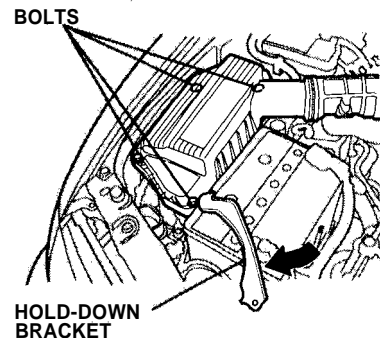

3. Loosen the four bolts, and remove the air cleaner housing cover.

continued

Air Cleaner Element, Spark Plugs

4. Remove the old air cleaner element. Clean the inside of the housing with a damp rag.

AIR CLEANER ELEMENT

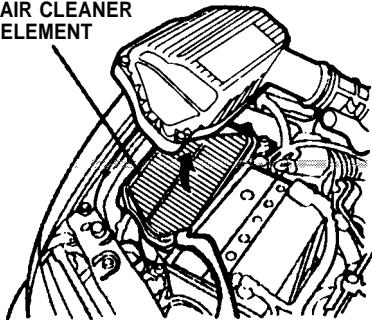

5. Place the new air cleaner element in the housing.
6. Reinstall the housing cover and the duct, and tighten the four bolts.
7. Resinstall the battery hold-down bracket, and tighten the screws.

Spark Plugs

The original spark plugs in your car need to be replaced every 2 years or 30,000 miles (48,000 km), whichever comes first.

Replacement

1. Clean up any dirt and oil that have collected around the spark plug caps.
2. Remove the spark plug cap by pulling it straight out.

SPARK PLUG CAP

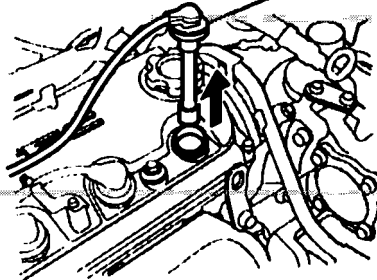

3. Remove the spark plug, using a 16 mm (5/8 inch) spark plug socket.
4. Put the new spark plug into the socket; then screw it into the hole. Screw it in by hand so you do not crossthread it.

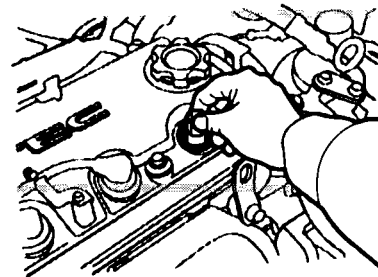

5. Torque the spark plug. (If you do not have a torque wrench, tighten the spark plug two-thirds turn after it contacts the cylinder head.)

Tightening torque: 13 lb-ft
(1.8 kg-m, 18 N.m).

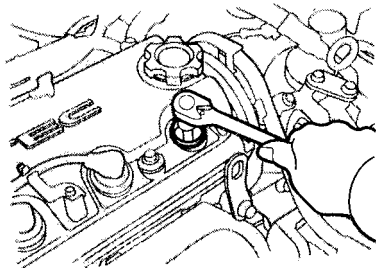

NOTICE

Tighten the spark plugs carefully. A spark plug that is too loose can overheat and damage the engine. Overtightening can cause damage to the threads in the cylinder head.

6. Install the spark plug cap.
7. Repeat this procedure for the other three spark plugs.

Spark Plug Specifications

Normal driving conditions

NGK: **ZFR5F-11**

Nippondenso: **KJ16CR-L11**

Hot climates or continuous high speed driving

NGK: **ZFR6F-11**

Nippondenso: **KJ20CR-L11**

Spark plug gap
0.039—0.043 in. (1.0—1.1 mm)

Battery

Check the condition of the battery monthly. You should check for proper electrolyte level and corrosion on the terminals.

The battery contains sulfuric acid (electrolyte) which is highly corrosive and poisonous.

Getting electrolyte in your eyes or on your skin can cause serious burns.

Wear protective clothing and eye protection when working on or near the battery.

Emergency Procedures

Eyes — Flush with water from a cup or other container for at least 15 minutes. (Water under pressure can damage the eye.) Immediately call a physician or 911.

Skin — Remove contaminated clothing. Flush the skin with large quantities of water. Call a physician immediately.

continued

Battery

Swallowing - Drink water or milk. Call your local Poison Control Center or a physician immediately.

Check the battery condition by looking at the test indicator window on the battery. The label on the battery explains the test indicator's colors.

TEST INDICATOR WINDOW

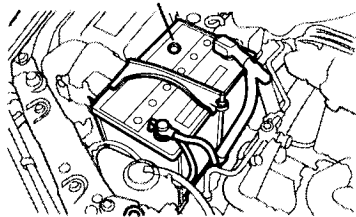

Check the battery terminals for corrosion (a white or yellowish powder). To remove it, cover the terminals with a solution of baking soda and water. It will bubble up and turn brown. When

this stops, wash it off with plain water. Dry off the battery with a cloth or paper towel. Coat the terminals with grease to help prevent future corrosion.

If the terminals are severely corroded, clean them with baking soda and water. Then use a wrench to loosen and remove the cables from the terminals. Always disconnect the negative (-) cable first and reconnect it last.

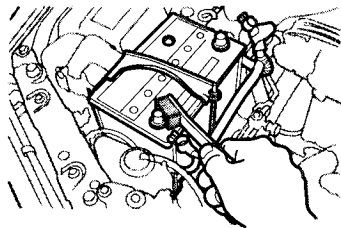

Clean the battery terminals with a terminal cleaning tool or wire brush. Reconnect and tighten

the cables, and then coat the terminals with grease.

If you need to connect the battery to a charger, disconnect both cables to prevent damage to the car's electrical system.

The battery gives off explosive hydrogen gas during normal operation.

A spark or flame can cause the battery to explode with enough force to kill or seriously hurt you.

Wear protective clothing and a face shield, or have a skilled mechanic do the battery maintenance.

If your car's battery is disconnected or goes dead, the audio system will disable itself. The next time you turn on the radio you will see "Code" in the frequency display. Use the Preset buttons to enter the five-digit code (see page 75).

NOTICE

Charging the battery with the cables connected can seriously damage your car's electronic controls. Detach the battery cables before connecting the battery to a charger.

Windshield Wipers

Check the condition of the windshield wiper blades at least every six months. Look for signs of cracking in the rubber or areas that are getting hard. Replace the blades if you find these signs, or they leave streaks and unwiped areas when used.

To replace the blade, do this:

1. Raise the wiper arm off the windshield.

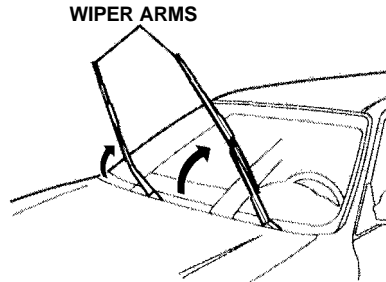

2. Disconnect the blade assembly from the wiper arm by pushing in the lock tab. Hold it in while you push the blade assembly toward the base of the arm.

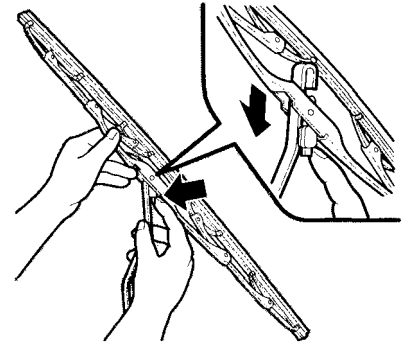

continued

Windshield Wipers, Air Conditioning System

3. Remove the blade from its holder by grasping the tabbed end of the blade. Pull firmly until the tabs come out of the holder.

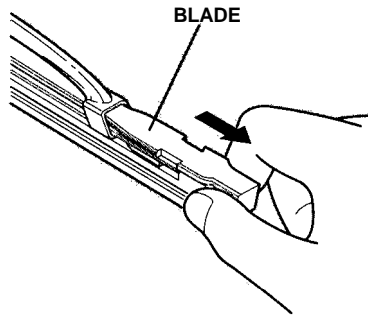

4. Examine the new wiper blades. If they have no plastic or metal reinforcement along the back edge, remove the metal reinforcement strips from the old wiper blade, and

install them in the slots along the edge of the new blade.

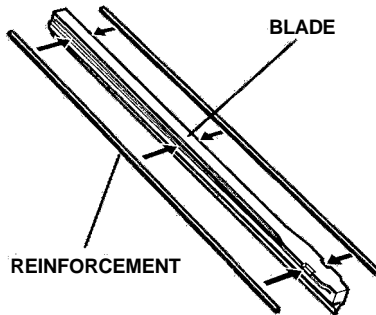

5. Slide the new wiper blade into the holder until the tabs lock.
6. Slide the new blade assembly onto the wiper arm. Make sure it locks in place.
7. Lower the wiper arm down against the windshield.

Air Conditioning System (Optional)

Your car's air conditioning is a sealed system. Any major maintenance, such as recharging, should be done by a qualified technician. You can do a couple of things to make sure the air conditioning works efficiently.

AIR
CONDITIONING
CONDENSER

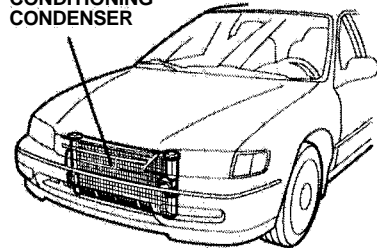

Periodically check the engine's radiator and air conditioning condenser for leaves, insects,

and dirt stuck to the front surface. These block the air flow and reduce cooling efficiency. Use a light spray from a hose or a soft brush to remove them.

NOTICE

The condenser and radiator fins bend easily. Only use a low-pressure spray or soft-bristle brush to clean them.

Run the air conditioning at least once a week during the cold weather months. Run it for at least 10 minutes while you are driving at a steady speed with the engine at normal operating temperature. This circulates the lubricating oil contained in the refrigerant.

If the air conditioning does not get as cold as before, have your dealer check the system.

Recharge the system with Refrigerant HFC-134a (R-134a). See **Specifications** on page 175.

NOTICE

Whenever you have the air conditioning system serviced, make sure the service facility uses a refrigerant recycling system. This system captures the refrigerant for reuse. Releasing refrigerant into the atmosphere can damage the environment.

Drive Belts

POWER STEERING BELT

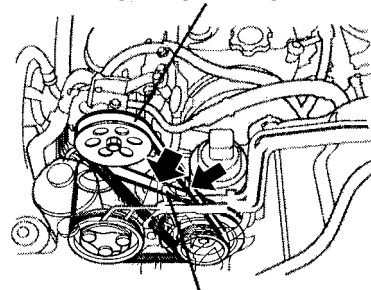

ALTERNATOR BELT

Check the condition of the two drive belts. Examine the edges of each belt for cracks or fraying. Check the tension of each belt by pushing on it with your thumb midway between the pulleys.

continued

Drive Belts, Tires

The belts should have the following "play" or deflection.

Alternator belt:

(on cars without A/C)

0.41—0.49 in. (10.5—12.5 mm)

(on cars with A/C)

0.31—0.41 in. (8.0—10.5 mm)

Power steering belt:

0.51—0.63 in. (13.0—16.0 mm)

If you see signs of wear or looseness, have your dealer adjust or replace the belts.

Tires

To safely operate your car, your tires must be the proper type and size, in good condition with adequate tread, and correctly inflated. The following pages give more detailed information on how and when to check air pressure, how to inspect your

tires for damage, and what to do when your tires need to be replaced.

Using tires that are excessively worn or improperly inflated can cause a crash in which you can be seriously hurt or killed.

Follow all instructions in this owner's manual regarding tire inflation and maintenance.

Inflation

Keeping the tires properly inflated provides the best combination of handling, tread life, and riding comfort. Underinflated tires wear unevenly, adversely affect

handling and fuel economy, and are more likely to fail from being overheated. Overinflated tires can make your car ride more harshly, are more prone to damage from road hazards, and wear unevenly.

We recommend that you visually check your tires every day and use a gauge to measure the air pressure at least once a month. If you think a tire might be low, check it immediately. Remember to check the spare tire at the same time you check all the other tires.

Check the pressure in the tires when they are cold. This means the car has been parked for at least three hours. If you have to drive the car before checking the tire pressure, the tires can still be considered "cold" if you drive less than one mile (1.6 km).

If you check the pressure when the tires are hot (the car has been driven several miles), you will see readings four to six psi higher than the cold reading. This is normal. Do not let air out to match the specified cold pressure. The tire will be underinflated.

Recommended Tire Pressures for Normal Driving

The following chart shows the recommended cold tire pressures for most normal driving conditions and speeds. Tire pressures for high speed driving are shown on page 176.

Tire Size	Cold Tire Pressure for Normal Driving
195/60 R15 88H	32 psi (2.2 kg/cm ² , 220 kpa)

These pressures are also given on the tire information label on the driver's doorjamb.

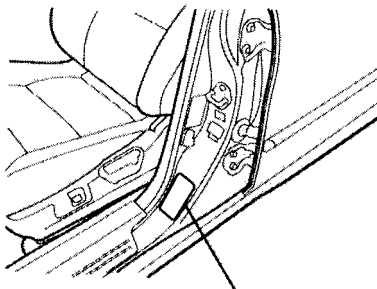

TIRE INFORMATION LABEL

You should get your own tire pressure gauge and use it whenever you check your tire pressures. This will make it easier for you to tell if a pressure loss is due to a tire problem and not due to a variation between gauges.

Tubeless tires have some ability to self-seal if they are punctured. However, because leakage is often very slow, you should look closely for punctures if a tire starts losing pressure.

Inspection

Every time you check inflation, you should also examine the tires for damage, foreign objects, and wear.

You should look for:

- Bumps or bulges in the tread or side of the tire. Replace the tire if you find either of these conditions.
- Cuts, splits, or cracks in the side of the tire. Replace the tire if you can see fabric or cord.
- Excessive tread wear.

continued

Tires

Your car's tires have wear indicators molded into the tread. When the tread wears down to that point, you will see a 1/2 inch (12.7 mm) wide band running across the tread. This shows there is less than 1/16 inch (1.6 mm) of tread left on the tire. A tire that is this worn gives very little traction on wet roads. You should replace the tire if you can see the tread wear indicator in three or more places around the tire.

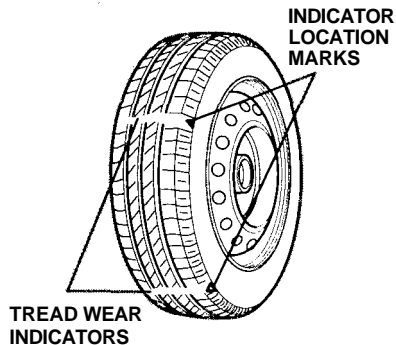

Maintenance

In addition to proper inflation, correct wheel alignment helps to decrease tire wear. You should get your car's wheel alignment checked every 12 months or 15,000 miles (24,000 km).

The tires were properly balanced by the factory. They may need to be rebalanced at some time before they are worn out. Have your dealer check the tires if you feel a consistent vibration while driving. A tire should always be rebalanced if it is removed from the wheel for repair.

Make sure the installer balances the wheels when you have new tires installed. This increases riding comfort and tire life. Your car's original tires were dynamic or "spin" balanced at the factory. For best results, have the installer perform a dynamic balance.

NOTICE

Improper wheel weights can damage your car's aluminum wheels. Use only genuine Honda wheel weights for balancing.

Tire Rotation

To help increase tire life and distribute wear more evenly, you should have the tires rotated every 7,500 miles (12,000 km). Move the tires to the positions shown in the chart each time they are rotated.

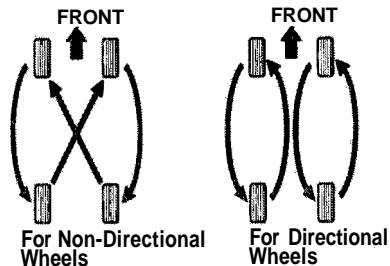

Replacing Tires and Wheels

The tires that came with your car were selected to match the performance capabilities of the car and provide the best combination of handling, ride comfort, and long life. You should replace them with radial tires of the same size, load range, and speed rating. Mixing radial and bias-ply or bias-belted tires on your car can reduce its braking ability, traction, and steering accuracy.

Installing improper tires on your car can affect handling and stability. This can cause a crash in which you can be seriously hurt or killed.

Always use the size and type of tires recommended in this owner's manual.

It is best to replace all four tires at the same time. If that is not possible or necessary, then replace the two front tires or the two rear tires as a pair. Replacing just one tire can seriously affect your car's handling.

The ABS works by comparing the speed of the wheels. When replacing tires, use the same size originally supplied with the car. Tire size and construction can affect wheel speed and may cause the system to work inconsistently.

If you ever need to replace a wheel, make sure the wheel's specifications match those of the original wheel that came on your car. Replacement wheels are available at your Honda dealer.

Wheels and Tires

Wheel:

U.S. EX

15 x 5 1/2 JJ (AL)

U.S. LX, Canada EX

15 x 5 1/2 JJ

Tire:

195/60 R15 88H

See **Tire Information** on page [176](#) for additional information about tire and wheel size designations. See page [177](#) for information about DOT Tire Quality Grading.

Winter Driving

Tires that are marked "M + S" or "All Season" on the sidewall have an all-weather tread design. They should be suitable for most winter driving conditions. Tires

continued

without these markings are designed for optimum traction in dry conditions. They may not provide adequate performance in winter driving. For the best performance in snowy or icy conditions, you should install snow tires or tire chains. They may be required by local laws under certain conditions.

Snow Tires

If you mount snow tires on your Honda, make sure they are radial tires of the same size and load range as the original tires. Mount snow tires on all four wheels to balance your car's handling in all weather conditions. Keep in mind the traction provided by snow tires on dry roads may not be as high as your car's original equipment tires. You should drive cautiously even when the roads are clear. Check with the

tire dealer for maximum speed recommendations.

Tire Chains

Mount snow chains on your car when warranted by driving conditions or required by local laws. Make sure the chains are the correct size for your tires. Install them only on the front tires. If metal chains are used, they must be SAE class "S." Cable-type traction devices can also be used.

When installing chains, follow the manufacturer's instructions and mount them as tightly as you can. Drive slowly with chains installed. If you hear the chains contacting the body or chassis, stop and tighten them. If they still make contact, slow down until it stops. Remove the chains

as soon as you begin driving on cleared roads.

NOTICE

Chains of the wrong size or that are improperly installed can damage your car's brake lines, suspension, body, and wheels. Stop driving if you hear the chains hitting any part of the car.

Lights

Check the operation of your car's exterior lights at least once a month. A burned out bulb can create an unsafe condition by reducing your car's visibility and the ability to signal your intentions to other drivers.

Check the following:

- Headlights (low and high beam)

- Parking lights
- Taillights
- Brake lights
- High-mount brake light
- Turn signals
- Back-up lights
- Hazard light function
- License plate light
- Side marker lights
- Daytime running lights
(Canada cars)

If you find any bulbs are burned out, replace them as soon as possible. Refer to the chart on page 175 to determine what type of replacement bulb is needed.

Replacing a Headlight Bulb

Your car has halogen headlight bulbs, two on each side. When replacing a bulb, handle it by its

steel base, and protect the glass from contact with your skin or hard objects. If you touch the glass, clean it with denatured alcohol and a clean cloth.

NOTICE

Halogen headlight bulbs get very hot when lit. Oil, perspiration, or a scratch on the glass can cause the bulb to overheat and shatter.

1. Open the hood. If you need to change the headlight bulb on the passenger's side, remove the radiator reserve tank and the intake air tube.
2. Remove the electrical connector from the bulb by squeezing the connector to unlock the tab while you push down on the connector.

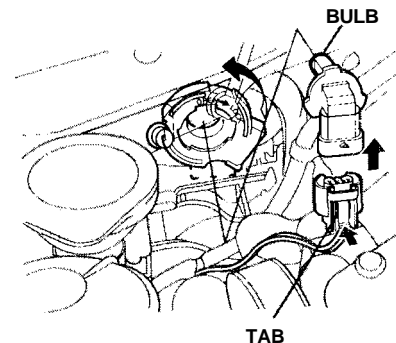

3. Remove the bulb by turning it one-quarter turn counterclockwise.
4. Insert the new bulb into the hole, and turn the bulb in one-quarter turn clockwise.
5. Push the electrical connector back onto the bulb. Make sure it is on all the way.
6. Turn on the headlights to test the new bulb.

continued

7. (Passenger's side)
Reinstall the radiator reserve tank and the intake air tube.

Replacing a Front Turn Signal Light Bulb

1. Use a long-handled, #2 Phillips screwdriver to loosen the turn signal assembly mounting screw.

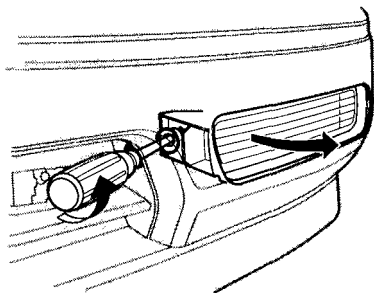

2. Remove the turn signal assembly from the bumper.
3. Remove the bulb holder from the turn signal assembly by turning it counterclockwise.

TURN SIGNAL ASSEMBLY

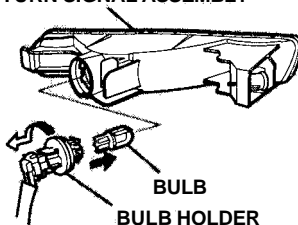

4. Remove the burned out bulb from the socket by pushing it in and turning counterclockwise until it unlocks. Install the new bulb.
5. Push the bulb holder into the turn signal assembly, and turn it clockwise until it locks.

6. Test the turn signals to make sure the new bulb is working.
7. Put the turn signal assembly into the bumper. Make sure the tabs on the turn signal assembly fit into the bumper slots. Tighten the mounting screw.

Replacing Front Side Marker and Parking Light Bulbs

1. Use a Phillips screwdriver to remove the screw from the top of the fender.

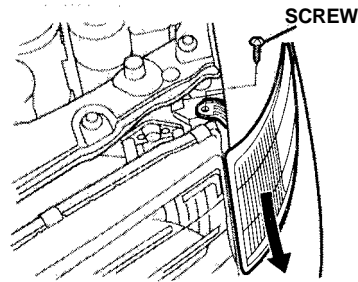

2. Move the side marker light assembly forward until it pops out of the body.
3. Turn the bulb holder one-quarter turn counterclockwise to remove it from the lens.

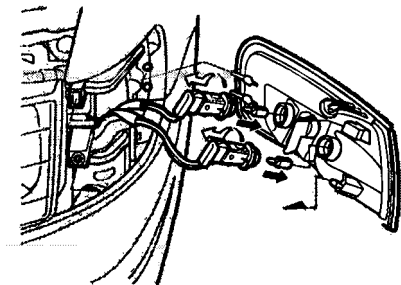

4. Pull the bulb straight out of its socket. Push the new bulb straight into the socket until it bottoms.

5. Put the bulb holder back into its hole in the lens, and turn it clockwise until it locks.
6. Turn on the parking lights, and check that the new bulb is working.
7. Put the side marker assembly back into the body. Push on the front edge until it snaps into place. Install the mounting screw, and tighten it securely.

Replacing Rear Bulbs

1. Open the tailgate, and remove the taillight assembly cover.
2. Pull the taillight assembly out of the body.
3. To open the tabs on the taillight assembly, push in on the tab and lift it up. (You may use a flat-tip screwdriver

to gently pry it open.) Remove the screws under each tab. Then, slide the taillight assembly diagonally out.

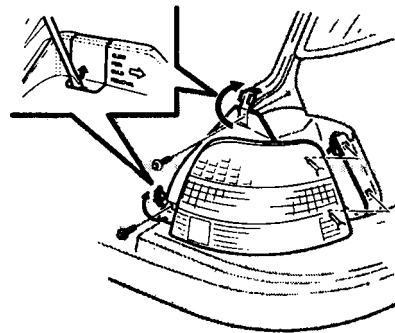

4. Determine which of the three bulbs is burned out: tail/stoplight, back-up light, or turn signal. Remove that bulb by turning it one-quarter turn

continued

counterclockwise and pulling it out of the socket.

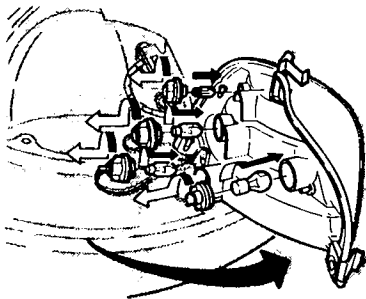

5. Install the new bulb in the socket.
6. Reinstall the bulb holder assembly by lining up the bulbs with their holes in the lens assembly; then turn the assembly one-quarter turn clockwise to lock it in place.
7. Test the lights to make sure the new bulb is working.

8. When reinstalling the taillight assembly, align and pop the snap fasteners in place. Install and then tighten the screws. Lock the tabs in place.

Replacing a High-Mount Brake Light Bulb

1. Open the tailgate. Undo the two fasteners on the side of the cover by pushing on the center of each fastener's head until the center pops in.

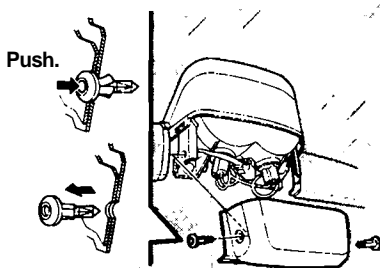

2. Use a thin, flat blade to wedge the fastener's head out. When both fasteners are out, remove the high-mount brake light cover.
3. Remove the socket by turning it one-quarter turn counterclockwise.

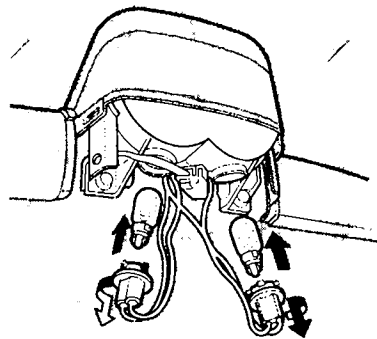

4. Pull the bulb out of its socket. Push the new bulb into the socket.

5. Test the brake light to make sure the new bulb is working.
6. Reinstall the cover.
7. Reset the center section of the fastener through the fastener's head. Make sure that the fingers on the fastener are folded and flush to the fastener and that the center section protrudes beyond the head.
8. Install each reset fastener into the cover. Secure each fastener by pushing on the center until it locks (the center is flush with the head).

Replacing a Rear License Bulb

1. Open the tailgate. Remove the assembly cover and the bulb assembly.

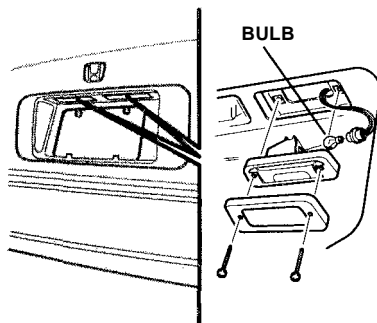

2. Remove the socket from the light assembly by turning it one-quarter turn counterclockwise.

3. Pull the bulb straight out of the socket.
4. Install the new bulb in the socket.
5. Turn on the parking lights, and check that the new bulb is working.
6. Reinstall the socket. Turn it clockwise until it locks.

Replacing Bulbs in the Interior Courtesy Lights

The courtesy lights in the doors and roof come apart in the same way. They do not use the same bulb.

continued

Lights

1. Remove the lens by carefully prying on the edge of the lens with a fingernail file or a small flat-tip screwdriver. Do not pry on the edge of the housing around the lens.

Door Light:

Pry on the top middle of the lens.

DOOR LIGHT

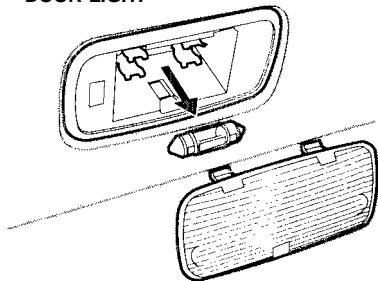

Interior/Cargo Light:

Pry on the front edge of the lens in the middle.

INTERIOR LIGHT/CARGO LIGHT

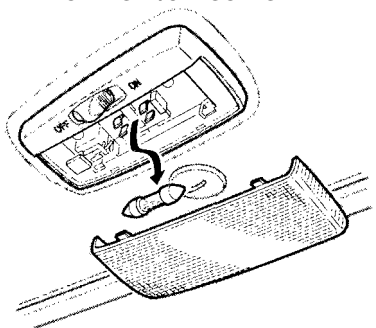

2. Remove the bulb by pulling it straight out of its metal tabs.
3. Push the new bulb into the metal tabs. Snap the lens back in place.

SUN VISOR

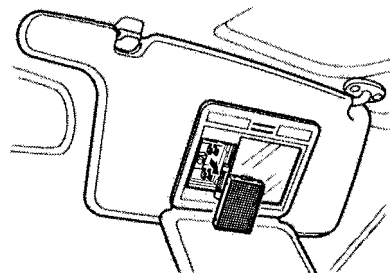

If you need to park your car for an extended period (more than one month), you should do several things to prepare it for storage. Proper preparation helps prevent deterioration and makes it easier to get your car back on the road. If possible, store your car indoors.

- Fill the fuel tank.
- Change the engine oil and filter (see page 115).
- Wash and dry the exterior completely.
- Clean the interior. Make sure the carpeting, floor mats, etc. are completely dry.
- Leave the parking brake off. Put the transmission in Reverse (5-speed manual) or Park (automatic).
- Block the rear wheels.

- If the car is to be stored for a longer period, it should be supported on jackstands so the tires are off the ground.
- Leave one window open slightly (if the car is being stored indoors).
- Disconnect the battery.
- Cover the car with a "breathable" car cover, one made from a porous material such as cotton. Nonporous materials, such as plastic sheeting, trap moisture, which can damage the paint.
- If possible, periodically run the engine for a while (preferably once a month).
- Support the front and rear wiper blade arms with a folded towel or rag so they do not touch the windshield.

- To minimize the seal sticking, apply a silicone spray lubricant to all door and trunk seals. Also, apply a car body wax to the painted surfaces that mate with the door and trunk seals.

If you store your car for 12 months or longer, have your Honda dealer perform the inspections called for in the 24 months/30,000 miles (48,000 km) maintenance schedule as soon as you take it out of storage (see pages 106 — 109). The replacements called for in the maintenance schedule are not needed unless the car has actually reached that time or mileage.

Regular cleaning and polishing of your Honda helps to keep it "new" looking. This section gives you hints on how to clean your car and preserve it's appearance: the paint, brightwork, wheels, and interior. Also included are several things you can do to help prevent corrosion.

Exterior Care	146
Washing	146
Power Antenna Cleaning .	146
Waxing	147
Aluminum Wheels	147
Touch-Up Paint.....	147
Interior Care	148
Carpeting	148
Fabric	148
Vinyl	148
Seat Belts	148
Windows	149
Air Fresheners	149
Corrosion Protection	149
Body Repairs	150

Exterior Care

Washing

Frequent washing helps preserve your car's beauty. Dirt and grit can scratch the paint, while tree sap and bird droppings can permanently ruin the finish.

Wash your car in a shady area, not in direct sunlight. If the car is parked in the sun, move it into the shade and let the exterior cool down before you start.

NOTICE

Chemical solvents and strong cleaners can damage the paint, metal and plastic on your car.

- Rinse the car thoroughly with cool water to remove loose dirt.
- Fill a bucket with cool water. Mix in a mild detergent, such as dishwashing liquid or a

product made especially for car washing.

- Wash the car, using the water and detergent solution and a soft-bristle brush, sponge, or soft cloth. Start at the top and work your way down. Rinse frequently.
- Check the body for road tar, tree sap, etc. Remove these stains with tar remover or turpentine. Rinse it off immediately so it does not harm the finish. Remember to re wax these areas, even if the rest of the car does not need waxing.
- When you have washed and rinsed the whole exterior, dry it with a chamois or soft towel. Letting it air-dry will cause dulling and water spots.

As you dry the car, inspect it for chips and scratches that could allow corrosion to start. Repair them with touch-up paint (see page [147](#)).

Power Antenna Cleaning

Every time you wash your car, clean the antenna mast with a dry cloth and mild detergent. Scrub the antenna in upward strokes to avoid bending it.

Make sure the antenna works smoothly by turning the stereo off and on several times with the ignition switch ON (II). The antenna does not need lubricating. If you use a "drive-through" car wash, make sure you turn the stereo off first. This retracts the antenna to prevent damage from the brushes in the car wash.

Waxing

Always wash and dry the whole car before waxing it. You should wax your car, including the metal trim, whenever water sits on the surface in large patches. It should form into beads or droplets after waxing.

You should use a quality liquid or paste wax. Apply it according to the instructions on the container. In general, there are two types of products:

Waxes - A wax coats the finish and protects it from damage by exposure to sunlight, air pollution, etc. You should use a wax on your Honda when it is new.

Polishes - Polishes and cleaner/waxes can restore the shine to paint that has oxidized and lost some of its shine. They normally

contain mild abrasives and solvents that remove the top layer of the finish. You should use a polish on your Honda if the finish does not have its original shine after using a wax.

Cleaning tar, insects, etc. with removers also takes off the wax. Remember to re wax those areas, even if the rest of the car does not need waxing.

Aluminum Wheels

U.S. EX models

Clean your Honda's aluminum alloy wheels as you do the rest of the exterior. Wash them with the same solution, and rinse them thoroughly.

The wheels have a protective clear-coat that keeps the aluminum from corroding and tarnishing. Using harsh

chemicals, including some commercial wheel cleaners or stiff brushes can damage this clear-coat. Only use a mild detergent and soft brush or sponge to clean the wheels.

Touch-Up Paint

Your dealer has touch-up paint to match your car's color. The color code is printed on a sticker on the driver's doorjamb. Take this code to your dealer so you are sure to get the correct color.

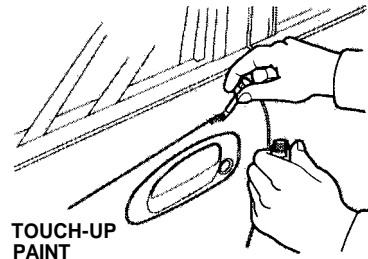

continued

Inspect your car for chips or scratches in the paint frequently. Repair them right away to prevent corrosion of the metal underneath. Use the touch-up paint on small chips and scratches. More extensive damage should be repaired by a professional.

Examine the chip or scratch closely before repairing it. If it does not go down to bare metal, clean it with soap and water and apply the touch-up paint. If it does go to the metal, apply a coat of primer first. After this dries, apply the touch-up paint. Build up the paint in the damaged area to the level of the surrounding paint. Several thin coats of paint are better than one thick coat.

Carpeting

Vacuum the carpeting frequently to remove dirt. Ground-in dirt will make the carpet wear out faster. Periodically shampoo the carpet to keep it looking new. Use one of the foam-type carpet cleaners on the market: Follow the instructions that come with the cleaner, applying it with a sponge or soft brush. Keep the carpeting as dry as possible by not adding water to the foam.

Fabric

Vacuum dirt and dust out of the material frequently. For general cleaning, use a solution of mild soap and lukewarm water, letting it air dry. To clean off stubborn spots, use a commercially available fabric cleaner. Test it on a hidden area of the fabric first, to make sure it does not

bleach or stain the fabric. Follow the instructions that come with the cleaner.

Vinyl

Remove dirt and dust with a vacuum cleaner. Wipe the vinyl with a soft cloth dampened in a solution of mild soap and water. Use the same solution with a soft-bristle brush on more difficult spots. You can also use commercially available spray or foam-type vinyl cleaners.

Seat Belts

If your seat belts get dirty, you can use a soft brush to clean them with a mixture of mild soap and warm water. Do not use bleach, dye, or cleaning solvents. They can weaken the belt

material. Let the belts air-dry before you use the car.

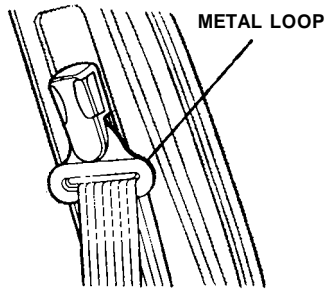

Dirt buildup in the metal loops of the seat belt anchors can cause the belts to retract slowly. Wipe the insides of the loops with a clean cloth dampened in mild soap and warm water or isopropyl alcohol.

Windows

Clean the windows, inside and out, with a commercially

available glass cleaner. You can also use a mixture of one part white vinegar to ten parts water. This will remove the haze that builds up on the inside of the windows. Use a soft cloth or paper towels to clean all glass and clear plastic surfaces.

NOTICE

The rear window defogger wires are bonded to the inside of the glass. Wiping vigorously up and down can dislodge and break the defogger wires. When cleaning the rear window, use gentle pressure and wipe side to side.

Air Fresheners

If you want to use an air freshener/deodorizer in the interior of your Accord, you should use a solid type. Some liquid air fresheners contain

chemicals that may cause parts of the interior trim and fabric to crack or discolor.

If you use a liquid air freshener, make sure you fasten it securely so it does not spill as you drive.

Corrosion Protection

Two factors normally contribute to causing corrosion in your car:

1. Moisture trapped in body cavities. Dirt and road salt that collects in hollows on the underside of the car stays damp, promoting corrosion in that area.
2. Removal of paint and protective coatings from the exterior and underside of the car.

Many corrosion-preventive measures are built into your

continued

Corrosion Protection, Body Repairs

Honda. You can help keep your car from corroding by performing some simple periodic maintenance:

- Repair chips and scratches in the paint as soon as you discover them.
- Inspect and clean out the drain holes in the bottom of the doors and body.
- Check the floor coverings for dampness. Carpeting and floor mats may remain damp for a long time, especially in winter. This dampness can eventually cause the floor panels to corrode.
- Have the corrosion-preventive coatings on the underside of your car inspected and repaired periodically.

Body Repairs

Body repairs Can affect your car's resistance to corrosion. If your car needs repairs after a collision, pay close attention to the parts used in the repair and the quality of the work.

Make sure the repair facility uses genuine Honda replacement body parts. Some companies make sheet metal pieces that seem to duplicate the original Honda body parts, but are actually inferior in fit, finish, and corrosion resistance. Once installed, they do not give the same high-quality appearance.

When reporting your collision to the insurance company, tell them you want genuine Honda parts used in the repair. Although most insurers recognize the quality of original parts, some may try to specify that the repairs be done

with other available parts. You should investigate this before any repairs are begun.

Take your car to your authorized Honda dealer for inspection after the repairs are completed. He can make sure that quality materials were used and that corrosion-preventive coatings were applied to all repaired and replaced parts.

This section covers the more common problems that motorists experience with their cars. It gives you information about how to safely evaluate the problem and what to do to correct it. If the problem has stranded you on the side of the road, you may be able to get going again. If not, you will also find instructions on getting your car towed.

Changing a Flat Tire	152
If Your Engine Won't Start ...	156
Nothing Happens or the Starter Motor Operates Very Slowly	156
The Starter Operates Normally	157
Jump Starting	158
If Your Engine Overheats	159
Low Oil Pressure Indicator ..	162
Charging System Indicator ...	162
Malfunction Indicator Lamp (Check Engine Light)	163
Closing the Moonroof	164
Fuses	165
Checking and Replacing ..	165
Towing	170

Changing a Flat Tire

If you have a flat tire while driving, stop in a safe place to change it. Stopping in traffic or on the shoulder of a busy road is dangerous. Drive slowly along the shoulder until you get to an exit or an area to stop that is far away from the traffic lanes.

The car can easily roll off the jack, seriously injuring anyone underneath.

Follow the directions for changing a tire exactly, and never get under the car when it is supported only by the jack.

1. Park the car on firm, level ground away from traffic. Turn on the hazard warning

lights, and turn the ignition to LOCK (0).

2. Put the transmission in Park (automatic) or Reverse (5-speed). Set the parking brake. Have all of the passengers get out of the car when you change the tire.
3. Open the tailgate. Raise the cargo area floor by lifting up on the back edge. Attach the hook to the roof line.

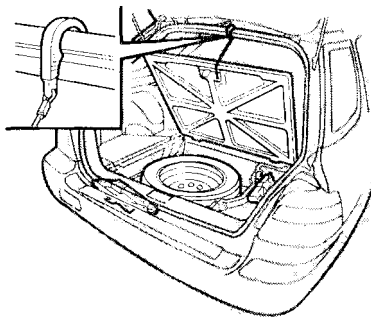

4. Take the tool kit out of the cargo area.
5. Unscrew the wing bolt, and take the spare tire out of its well.

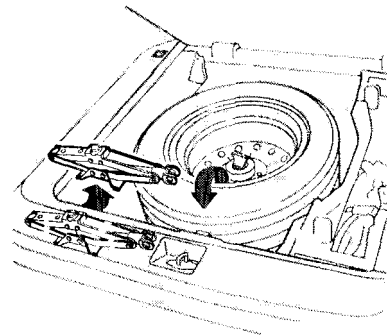

6. Turn the end bracket on the jack counterclockwise to loosen it, and then remove the jack.

7. *U.S. EX models*

Remove the center cap from the wheel with a screwdriver (not included in tool kit) or coin.

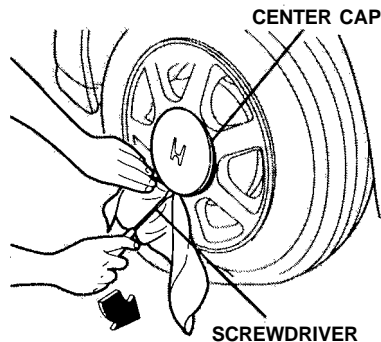

8. Loosen the four wheel nuts one-half turn with the wheel wrench.

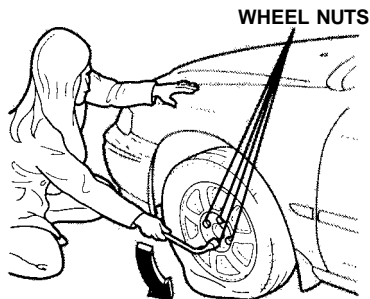

9. Locate the jacking point nearest the tire you need to change. It is pointed to by an arrow molded into the underside of the body. Place the jack under the jacking point. Turn the end bracket clockwise until the top of the jack contacts the jacking

point. Make sure the jacking point tab is resting in the jack notch.

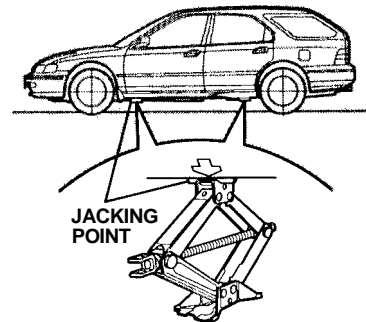

continued

Changing a Flat Tire

10. Use the extension and wheel wrench as shown to raise the car until the flat tire is off the ground.

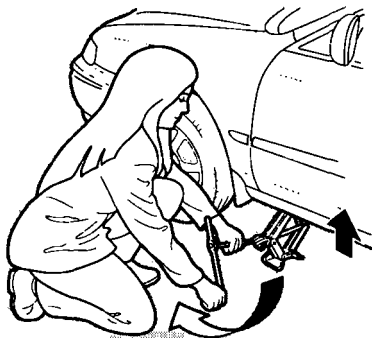
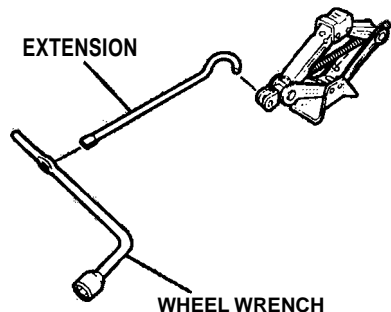

11. Remove the wheel nuts and flat tire. Temporarily place the flat tire on the ground with the outside surface of the wheel facing up. Putting

the wheel face down could mar the wheel's finish.

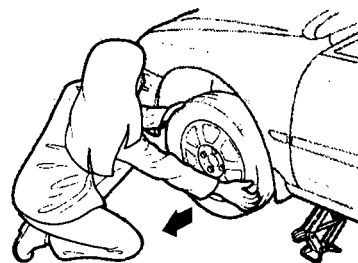

12. Before mounting the spare tire, wipe any dirt off the mounting surface of the wheel and hub with a clean cloth.

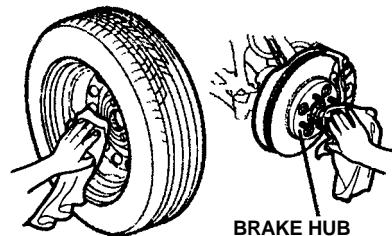

13. Put on the spare tire. Put the wheel nuts back on finger-tight, and tighten them in a crisscross pattern with the wheel wrench until the wheel is firmly against the hub. Do not try to tighten them fully.

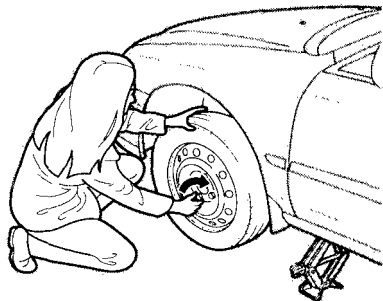

14. Lower the car to the ground, and remove the jack.

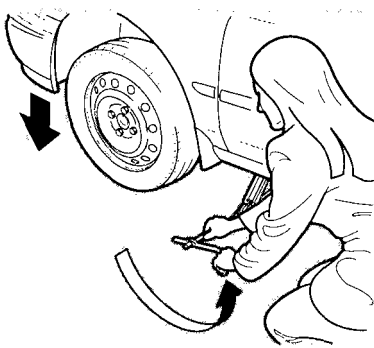

15. Tighten the wheel nuts securely in the same crisscross pattern. Have the wheel nut torque checked at the nearest automotive service facility. Tighten the wheel nuts to 110 N.m (11 kg-m, 80 lb-ft).

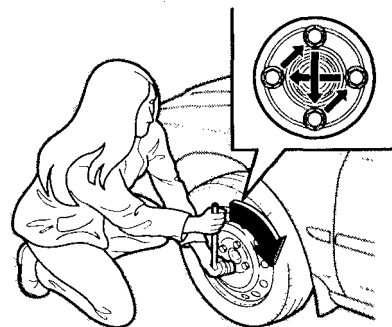

16. Remove the wheel cover or center cap. Place the flat tire face down in the spare tire well.

continued

Changing a Flat Tire, If Your Engine Won't Start

17. Remove the spacer cone from the wing bolt, turn it over, and put it back on the bolt.

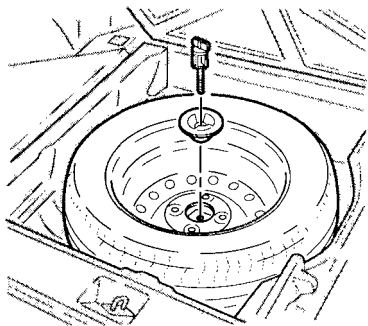

18. Secure the flat tire by screwing the wing bolt back into its hole.

Loose items can fly around the interior in a crash and could seriously injure the occupants.

Store the wheel, jack and tools securely before driving.

19. Store the jack in the cargo area with the end bracket on the right side. Turn the end bracket on the jack clockwise to lock it in place. Store the tool kit.

20. Store the wheel cover or center cap in the trunk. Make sure it does not get scratched or damaged.

If Your Engine Won't Start

Diagnosing why your engine won't start falls into two areas,

depending on what you hear when you turn the key to START (III):

- You hear nothing, or almost nothing. The engine's starter motor does not operate at all, or operates very slowly.
- You can hear the starter motor operating normally, but the engine does not start up and run.

Nothing Happens or the Starter Motor Operates Very Slowly

When you turn the ignition switch to START (III), you do not hear the normal noise of the engine trying to start. You may hear a clicking sound or series of clicks, or nothing at all. Check these things:

- Check the transmission interlock. If you have a 5-speed, the clutch pedal must be pushed all the way to the floor or the starter will not operate. With an automatic transmission, it must be in Park or Neutral.
- Turn the ignition switch to ON (II). Turn on the headlights and check their brightness. If the headlights are very dim or don't light at all, the battery is discharged. See **Jump Starting**.

- Turn the ignition switch to START (III). If the headlights do not dim, check the condition of the fuses. If the fuses are OK, there is probably something wrong with the electrical circuit for the ignition switch or starter motor. You will need a qualified technician to determine the problem. See **Towing** on page 170.

If the headlights dim noticeably or go out when you try to start the engine, either the battery is discharged or the connections are corroded. Check the condition of the battery and terminal connections (see page 129). You can then try jump starting the car from a booster battery (see page 158).

The Starter Operates Normally

In this case, the starter motor sounds normal when you turn the ignition switch to START (III), but the engine does not run.

- Are you using the proper starting procedure? Refer to **Starting the Engine** on page 88.
- Do you have fuel? Turn the ignition switch to ON (II) for a minute, and watch the fuel gauge.
- There may be an electrical problem, such as no power to the fuel pump. Check all the fuses (see page 165).

If you find nothing wrong, you will need a qualified technician to find the problem. See **Towing** on page 170.

Jump Starting

If your car's battery has run down, you may be able to start the engine by using a booster battery. Although this seems like a simple procedure, you should take several precautions.

A battery can explode if you do not follow the correct procedure, seriously injuring anyone nearby.

Keep all sparks, open flames, and smoking materials away from the battery.

You cannot start a Honda with an automatic transmission by pushing or pulling it.

To jump start your car follow these directions closely:

1. Open the hood and check the physical condition of the battery (see page 127). In very cold weather, check the condition of the electrolyte. If it seems slushy or like ice, do not try jump starting until it thaws.

NOTICE

If a battery sits in extreme cold, the electrolyte inside can freeze. Attempting to jump start with a frozen battery can cause it to rupture or explode.

2. Turn off all the electrical accessories: heater, A/C, stereo system, lights, etc. Put the transmission in Neutral or Park, and set the parking brake.

3. Connect one jumper cable to the positive (+) terminal on the booster battery. Connect the other end to the positive (+) terminal on your Honda's battery.

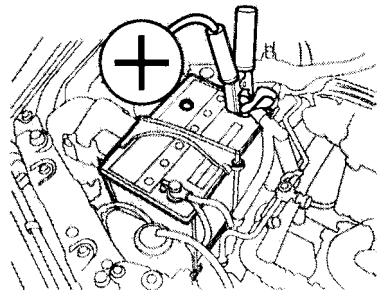

Jump Starting, If Your Engine Overheats

4. Connect the second jumper cable to the negative (—) terminal on the booster battery. Connect the other end to the grounding strap as shown. Do not connect this jumper cable to any other part of the engine.

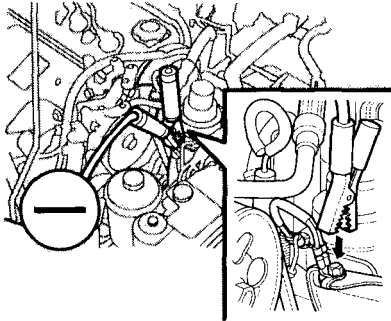

5. If the booster battery is in another car, have an assistant start that car and run it at a fast idle.

6. Start your car. If the starter motor still operates slowly, check the jumper cable connections to make sure they have good metal-to-metal contact.

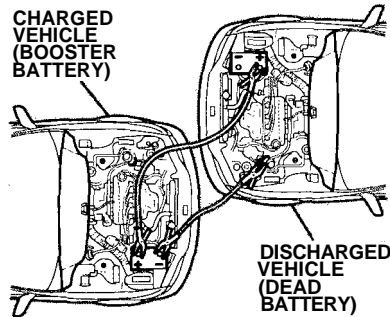

7. Once your car is running, disconnect the negative cable from your car and then from the booster battery. Disconnect the positive cable from your car and then from the booster battery.

If Your Engine Overheats

The pointer of your car's temperature gauge should stay in the midrange under most conditions. It may go higher if you are driving up a long steep hill on a very hot day. If it climbs to the red mark, you should determine the reason.

NOTICE

Driving with the temperature gauge pointer at the red mark can cause serious damage to your engine.

continued

If Your Engine Overheats

Your car can overheat for several reasons, such as lack of coolant or a mechanical problem. The only indication may be the temperature gauge climbing to or above the red mark. Or you may see steam or spray coming from under the hood. In either case, you should take immediate action.

Steam and spray from an overheated engine can seriously scald you.

Do not open the hood if steam is coming out.

1. Safely pull to the side of the road. Put the transmission in Neutral or Park, and set the parking brake. Turn off the heating and cooling system and all other accessories. Turn on the hazard warning indicators.
2. If you see steam and/or spray coming from under the hood, turn off the engine.
3. If you do not see steam or spray, leave the engine running and watch the temperature gauge. If the high heat is due to overloading (climbing a long, steep hill on a hot day with the A/C running, for example), the engine should start to cool down almost immediately. If it does, wait until the temperature gauge comes down to the midpoint, and then continue driving.
4. If the temperature gauge stays at the red mark, turn off the engine.
5. Wait until you see no more signs of steam or spray; then open the hood.
6. Look for any obvious coolant leaks, such as a split radiator hose. Everything is still extremely hot, so use caution. If you find a leak, it must be repaired before you continue driving (see [Towing on page 170](#)).
7. If you don't find an obvious leak, check the coolant level in the radiator reserve tank (see [page 83](#)). If the level is below the MIN mark, add coolant to halfway between the MIN and MAX marks.

8. If you see no coolant in the reserve tank, you may also have to add coolant to the radiator.

Let the engine cool down until the pointer reaches the middle of the temperature gauge, or lower, before checking the radiator.

Removing the radiator cap while the engine is hot can cause the coolant to spray out, seriously scalding you.

Always let the engine and radiator cool down before removing the radiator cap.

9. Using gloves or a large heavy cloth, turn the radiator cap counterclockwise, without

pushing down, to the first stop. This releases any remaining pressure in the cooling system. After the pressure releases, push down on the cap and turn it until it comes off.

10. Start the engine and set the heater control lever to maximum. Add coolant to the radiator up to the base of the fill neck. If you do not have the proper coolant mixture available, you can add plain water. Remember to have the cooling system drained and refilled with the proper mixture as soon as you can.
11. Put the radiator cap back on tightly. Run the engine and watch the temperature gauge. If it goes back to the red mark, the engine needs repair. (See **Towing** on page 170.)

12. If the temperature stays normal, check the coolant level in the radiator reserve tank. If it has gone down, add coolant to the MAX mark. Put the cap back on tightly.

Low Oil Pressure Indicator, Charging System Indicator

Low Oil Pressure Indicator

LOW OIL PRESSURE INDICATOR

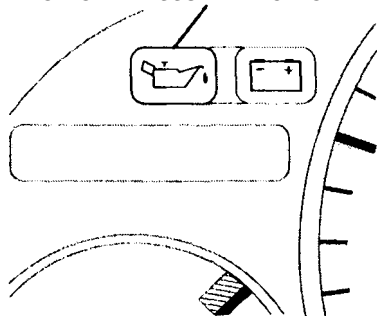

NOTICE

Running the engine with low oil pressure can cause serious mechanical damage almost immediately. Turn off the engine as soon as you can safely get the car stopped.

1. Safely pull off the road and shut off the engine.

2. Let the car sit for a minute. Open the hood and check the oil level (see page 82), Although oil level and oil pressure are not directly connected, an engine that is very low on oil can lose pressure during cornering and other driving maneuvers.
3. If necessary, add oil to bring the level back to the full mark on the dipstick (see page 114).
4. Start the engine and watch the oil pressure indicator. If the indicator does not go out within 10 seconds, turn off the engine. You need to have the mechanical problem repaired before you can continue driving. (See **Towing** on page 170.)

Charging System Indicator

This light indicates the battery is not being charged. It should come on when the ignition is ON (II), and go out after the engine starts. If it comes on brightly with the engine running, the alternator is no longer charging the battery.

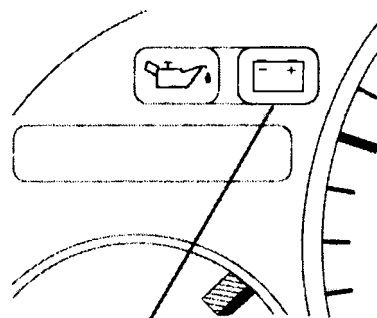

CHARGING SYSTEM INDICATOR

Immediately turn off all electrical accessories: radio, heater, A/C, rear defogger, cruise control, etc.

Try not to use other electrically operated controls such as the power windows. Keep the engine running and take extra care not to stall it. Starting the engine will discharge the battery rapidly.

By eliminating as much of the electrical load as possible, you can drive several miles before the battery is too discharged to keep the engine running. Drive to a service station or garage where you can get technical assistance.

Malfunction Indicator Lamp

This indicator comes on for a few seconds when you turn the switch ON (II). If it comes on at any other time, it indicates one of the engine's emissions control systems may have a problem. Even though you may feel no difference in your car's performance, it can reduce your

fuel economy and cause your car to put out excessive emissions. Continued operation may cause serious damage.

U.S. INDICATOR SHOWN

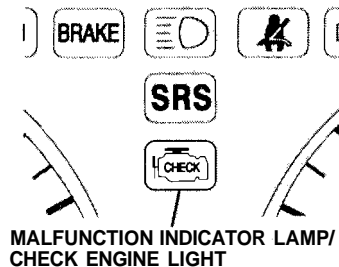

If this indicator comes on, safely pull off the road and turn off the engine. Restart the engine and watch the indicator. If it stays on, have your car checked by the dealer as soon as possible. Drive moderately until the dealer has inspected the problem. Avoid

full-throttle acceleration and driving at high speed.

You should also have the dealer inspect your car if the indicator comes on frequently, even though it goes off when you follow the above procedure.

NOTICE

If you keep driving with the malfunction indicator lamp/check engine light on, you can damage your car's emission controls and engine. Those repairs may not be covered by your car's warranties.

Closing the Moonroof

If the electric motor will not close the moonroof, do the following:

1. Check the fuse for the moonroof motor (see page 165). If the fuse is blown, replace it with one of the same or lower rating.
2. Try closing the moonroof. If the new fuse blows immediately or the moonroof motor still does not operate, you can close the moonroof manually.
3. Get the tool out of the tool kit located under the cargo area floor.

4. Use a screwdriver or coin to remove the round plug in the center of the headliner.

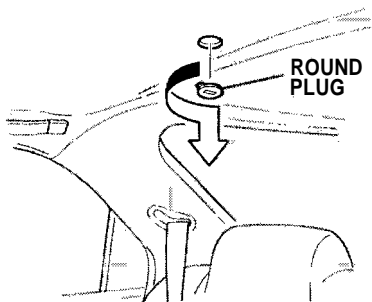

5. Insert the moonroof wrench into the socket behind this plug. Turn the wrench until the moonroof is fully closed.

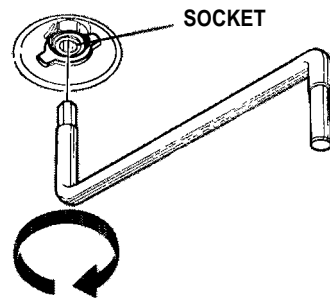

6. Remove the wrench. Replace the round plug.

Fuses

All the electrical circuits in your car have fuses to protect them from a short circuit or overload. These fuses are located in two or three fuse boxes.

The under-hood fuse box is located in the front of the engine compartment on the passenger's side. To open, push the tab as shown.

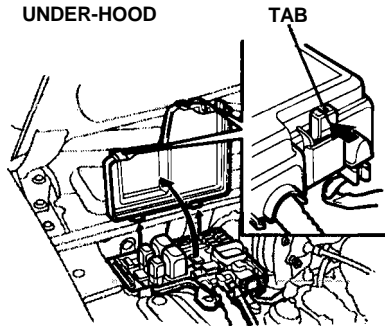

Only cars equipped with ABS have an ABS fuse box. It is in the front of the engine compartment on the passenger's side.

ABS FUSE BOX

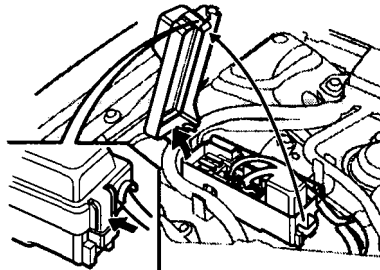

The interior fuse box is underneath the dashboard on the driver's side. To open, turn the knob.

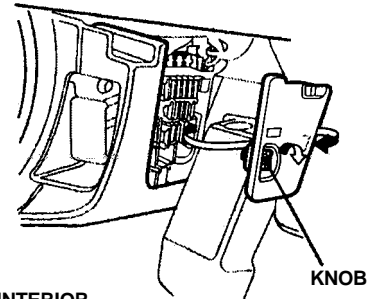

Checking and Replacing

If something electrical in your car stops working, the first thing you should check for is a blown fuse. Determine from the chart on the fuse box cover or inside the fuse box which fuse or fuses control that component. Check

continued

Fuses

those fuses first, but check all the fuses before deciding that a blown fuse is not the cause. Replace any blown fuses, and check the component's operation.

1. Turn the ignition switch to LOCK (0). Make sure the headlights and all other accessories are off.
2. Remove the cover from the fuse box.
3. Check each of the large fuses in the under-hood fuse box by looking through the top at the wire inside. Removing these fuses requires a Phillips screwdriver.

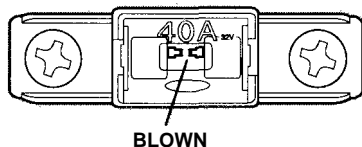

4. Check the smaller fuses in the under-hood fuse box and all the fuses in the interior fuse box by pulling out each fuse with the fuse puller provided in the interior fuse box.

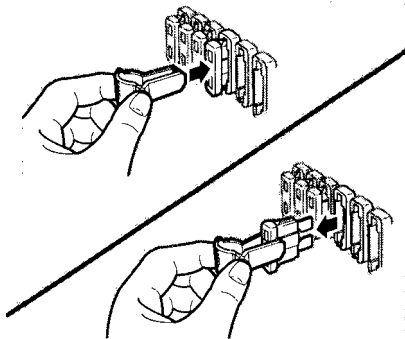

5. Look for a burned wire inside the fuse. If it is burned out, replace it with one of the spare fuses of the same rating or lower.

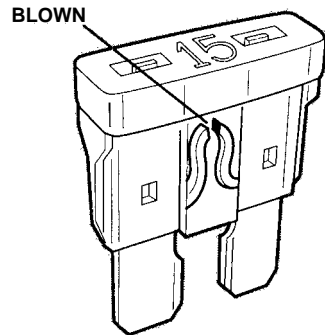

If you cannot drive the car without fixing the problem, and you do not have a spare fuse, take a fuse of the same rating or a lower rating from one of the other circuits. Make sure you can do without that circuit

temporarily (such as the cigarette lighter or radio).

If you replace the burned out fuse with a spare fuse that has a lower rating, it might blow out again. This does not indicate anything wrong. Replace the fuse with one of the correct rating as soon as you can.

NOTICE

Replacing a fuse with one that has a higher rating greatly increases the chances of damaging the electrical system. If you do not have a replacement fuse with the proper rating for the circuit, install one with a lower rating.

6. If the replacement fuse of the same rating burns out in a short time, your car probably has a serious electrical problem. Leave the burned-out fuse in that circuit, and have your car checked by a qualified technician.

continued

Fuses

UNDERHOOD FUSE BOX

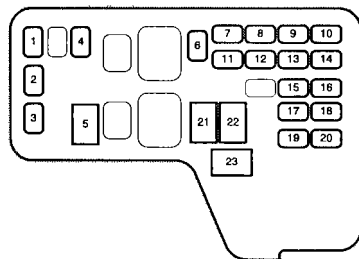

No.	Amps.	Circuits Protected
1	20A	Cooling Fan
2	20A	Right Headlight
3	20A	Left Headlight
4	10A	Daytime Running Light *1
5	50A	Ignition Switch
6	20A	Rear Right Power Window
7	20A	Front Right Power Window
8	30A	Sunroof
9	15A	Condenser Fan
10	7.5A	Back Up (Radio)
11	20A	Rear Left Power Window
12	20A	Front Left Power Window
13	15A	ECU (Injector) (ECM)
14	20A	Door Lock
15	15A	Parking Light

No.	Amps.	Circuits Protected
16	7.5A	Interior Light
17	20A	Power Seat Height
18	15A	Radio, Cigarette Lighter
19	20A	Stop Light, Horn
20	10A	Hazard
21	40A	Heater Blower
22	30A	Rear Defroster
23	80A 100A*2	Battery

*1 On Canadian cars

*2 U.S.: EX

ABS FUSE BOX

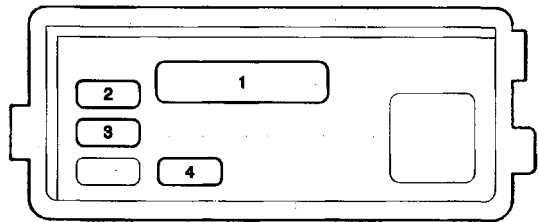

No.	Amps.	Circuits Protected
1	40A	ABS Motor
2	20A	ABS B1
3	15A	ABS B2
4	10A	ABS Unit

INTERIOR FUSE BOX

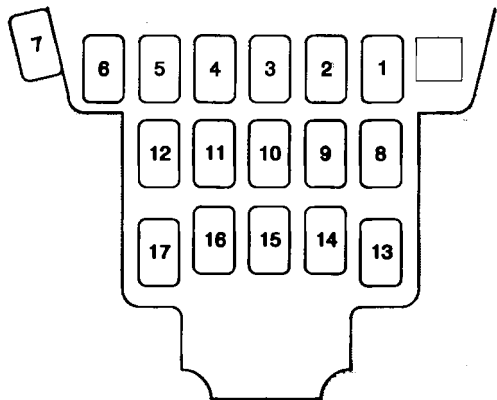

No.	Amps.	Circuits Protected
1	10A	Radio Motor Antenna
2	7.5A	Day Light
3	7.5A	Starter Signal
4	7.5A	Heater Control, AC Clutch, and Cooling Fan Relays
5	7.5A	Power Mirror
6	10A	Spare Fuse
7	7.5A	Turn Signals
8	10A	Spare Fuse
9	30A	Wiper, Washer
10	10A	Power Window Relay, Rear Wiper, Moonroof Relay
11	7.5A	ECU (Cruise Control), Electronic A/T (ECU)
12	20A	Spare Fuse
13	7.5A	Spare Fuse
14	10A	SRS
15	15A	Fuel Pump
16	10A	Back-Up Lights, Meter Lights (Turn Signals)
17	15A	Spare Fuse

Towing

If your car needs to be towed, call a professional towing service or, if you belong to one, an organization that provides roadside assistance. Never tow your car behind another car with just a rope or chain. It is very dangerous.

Emergency Towing

There are three popular methods of towing a car:

Flatbed Equipment — The operator loads your car on the back of a truck. This is the best way of transporting your Honda.

Wheel Lift Equipment — The tow truck uses two pivoting arms that go under the tires (front or rear) and lift them off the ground. The other two wheels remain on the ground.

Sling-Type Equipment — The tow truck uses metal cables with hooks on the ends. These hooks go around parts of the frame or suspension, and the cables lift that end of the car off the ground. Your car's suspension and body can be seriously damaged if this method of towing is attempted.

If your Honda cannot be transported on a flatbed truck, it should be towed with the front wheels off the ground. If, due to damage, your car must be towed with the front wheels on the ground, do the following:

5-Speed Manual Transmission

- Release the parking brake.
- Shift the transmission to Neutral.

Automatic Transmission

- Release the parking brake.
- Start the engine.

- Shift to D4, then to N.
- Turn off the engine.

NOTICE

Improper towing preparation will damage the transmission. Follow the above procedure exactly. If you cannot shift the transmission or start the engine (automatic transmission), your car must be transported on a flatbed.

- It is best to tow the car no farther than 50 miles (80 km), and keep the speed below 35 mph (55 km/h).

NOTICE

Trying to lift or tow your car by the bumpers will cause serious damage. The bumpers are not designed to support the car's weight.

The diagrams in this section give you the dimensions and capacities of your Honda and the locations of the identification numbers. The explanations of several electronic and mechanical systems on your Honda are for the more technically oriented owner.

Identification Numbers	172
Specifications	174
Tire Information	176
Tire Size Designation	176
Wheel Size Designation.....	176
Tire Speed Ratings	176
Tire Pressure Adjustment for High Speed Driving ..	176
DOT Tire Quality Grading (U.S. Cars)	177
Treadwear	177
Traction	177
Temperature	178
Emissions Controls	178
The Clean Air Act	178
Crankcase Emissions Control System	179
Evaporative Emissions Control System	178

Exhaust Emissions Controls	179
PGM-FI System	179
Ignition Timing Control System	179
Three-Way Catalytic Converter	179
Exhaust Gas Recirculation (EGR) System	180
Replacement Parts	180
Three-Way Catalytic Converter	180

Identification Numbers

Your car has several identifying numbers located in various places.

The Vehicle Identification Number (VIN) is the 17-digit number your Honda dealer uses to register your car for warranty purposes. It is also necessary for licensing and insuring your car.

The easiest place to find the VIN is on a plate fastened to the top of the dashboard. You can see it by looking through the windshield on the driver's side. It is also on the Certification Label attached to the driver's doorjamb, and it is stamped on the engine compartment bulkhead. The VIN is also provided in bar code on the Certification Label.

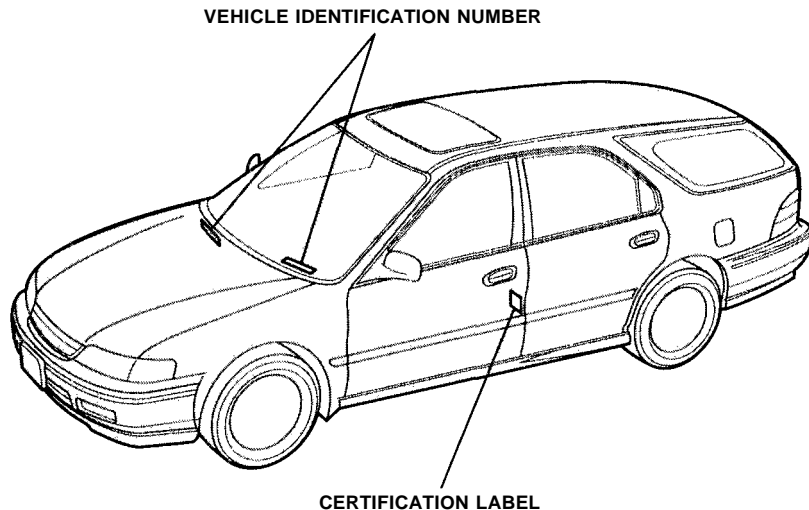

The Engine Number is stamped into the engine block.

The Transmission Number is on a label on top of the transmission.

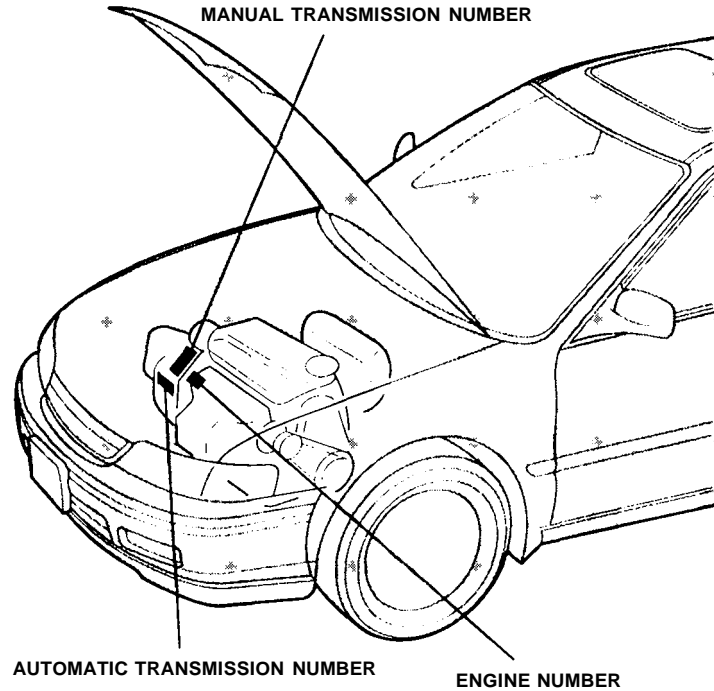

Specifications

Dimensions

Length	187.8 in. (4,770 mm)	
Width	70.1 in. (1,780 mm)	
Height	55.9 in. (1,420 mm)	
Wheelbase	106.9 in. (2,715 mm)	
Track	Front	59.6 in. (1,515 mm)
	Rear	59.1 in. (1,500 mm)

Weights

Gross vehicle weight rating	See the Certification Label attached to the driver's doorjamb.
-----------------------------	--

Engine

Type	Water cooled 4-stroke SOHC ^{*1} , SOHC VTEC ^{*2} 4-cylinder gasoline engine
Bore x Stroke	3.35 x 3.74 in. (85.0 x 95.0 mm)
Displacement	132 cu-in. (2,156 cm ³)
Compression ratio	8.8:1
Spark plugs	See spark plug maintenance section page 126.

*1 U.S.: LX, Canada EX

*2 U.S.: EX, EX w/ABS option

Capacities

Fuel tank		Approx. 17.0 U.S. gal. (64.5 ℓ, 14.2 Imp gal.)
Radiator coolant	Change ^{*1} 5-Speed	5.7 U.S. qt (5.4 ℓ, 1.19 Imp gal.)
	Automatic	5.6 U.S. qt. (5.3 ℓ, 1.16 Imp gal.)
	Total 5-Speed	1.82 U.S. gal. (6.9 ℓ, 1.52 Imp gal.)
	Automatic	1.80 U.S. gal. (6.8 ℓ, 1.50 Imp gal.)
Engine oil	Change ^{*4} Incl. filter	4.0 U.S. qt (3.8 ℓ, 3.3 Imp qt) ^{*2} 4.5 U.S. qt (4.3 ℓ, 3.8 Imp qt) ^{*3}
	W/O filter	3.7 U.S. qt (3.5 ℓ, 3.1 Imp qt) ^{*2} 4.2 U.S. qt (4.0 ℓ, 3.5 Imp qt) ^{*3}
	Total	5.2 U.S. qt (4.9 ℓ, 4.3 Imp qt) ^{*2} 5.9 U.S. qt (5.6 ℓ, 4.9 Imp qt) ^{*3}
5-speed manual transmission oil	Change	2.0 U.S. qt (1.9 ℓ, 1.7 Imp qt)
	Total	2.1 U.S. qt (2.0 ℓ, 1.8 Imp qt)
Automatic transmission fluid	Change	3.4 U.S. qt (3.2 ℓ, 2.8 Imp qt)
	Total	6.3 U.S. qt (6.0 ℓ, 5.3 Imp qt)
Windshield washer reservoir	U.S. cars	2.6 U.S. qt (2.5 ℓ, 2.2 Imp qt)
	Canadian cars	4.8 U.S. qt (4.5 ℓ, 4.0 Imp qt)

*1 Including the coolant in the reserve tank and that remaining in the engine. Reserve tank capacity: 0.6 U.S. qt. (.06ℓ, 0.13 Imp gal.)

*2 U.S.: LX, Canada EX

*3 U.S.: EX

*4 Excluding the oil remaining in the engine.

Lights

Headlights (HI/LO)	12V – 60/55 W
Front turn signal lights	12V – 21W
Front parking lights	12V – 3CP (4.9W)
Rear turn signal lights	12V – 45CP (27W)
Stop/Taillights	12V – 43/3CP (27/5W)
High-mount brake light	12V – 18W
Front side marker lights	12V – 21W
Back-up lights	12V – 32 CP (21W)
License plate lights	12V – 8W
Interior lights (front/rear)	12V – 8W
Cargo area light	12V – 5W
Door courtesy lights	12V – 3.4W
Vanity mirror light	12V – 1.8W

Battery

Capacity	12V – 65AH 20HR
----------	-----------------

Fuses

Interior	See the fuse label attached to the inside of the fuse box door under the dashboard.
Under-hood	See the fuse box cover.

Alignment

Toe-in	Front	0 ± 0.08 in. (0 ± 2 mm)
	Rear	0.08 ± 0.08 in. (2 ± 2 mm)
Camber	Front	$0^{\circ}00' \pm 1^{\circ}$
	Rear	$-0^{\circ}25' \pm 30'$
Caster	Front	$3^{\circ}00' \pm 1^{\circ}$

Tires

Size	Front/Rear	195/60R15 88H
	Spare	195/60R15 88H
Pressure	Front/Rear	32 psi (220 kPa, 2.2 kg/cm ²)
	Spare	32 psi (220 kPa, 2.2 kg/cm ²)

Air Conditioning

Refrigerant Type	HFC-134a (R-134a)
Charge Quantity	21–23 oz. (600-650g)
Lubricant Type	ND oil 8 *1 (N.D. Compressor) Dn. S10X *2 (HADSYS Compressor)

*1 U.S.: LX, Canada EX

*2 U.S.: EX

Tire Information

Tire Size Designation

A tire's sidewall is marked with a tire size designation. You will need this information when selecting replacement tires for your car. The following explains what the letters and numbers in the tire size designation mean.

Example tire size designation:

195/60R15 88H

195—Tire width in millimeters.

60—Aspect ratio. The tire's section height as a percentage of its width.

R—Tire construction code (Radial).

15—Rim diameter in inches.

88—Load Index, a numerical code associated with the maximum load the tire can carry.

H—Speed Rating Symbol. See the speed rating chart in this section for additional information.

Wheel Size Designation

Wheels are also marked with important information that you need if you ever have to replace one. The following explains what the letters and numbers in the wheel size designation mean.

Example wheel size designation:

15 X 5¹/₂JJ

15—Rim diameter in inches.

5¹/₂—Rim width in inches.

JJ—Rim contour designation.

Tire Speed Ratings

The chart shows many of the different speed ratings currently being used for passenger car

tires. The speed rating symbol is part of the tire size designation on the sidewall of the tire. This symbol corresponds to that tire's designed maximum safe operating speed.

Speed Rating Symbol	Maximum Speed
S	112 mph (180 km/h)
T	118 mph (190 km/h)
H	130 mph (210 km/h)
V	149 mph (240 km/h)
Z	Above 149 mph (240 km/h)

Tire Pressure Adjustment for High Speed Driving

Honda strongly recommends that you not drive faster than posted speed limits and

conditions allow. If you decide it is safe to drive at high speeds, be sure to adjust the cold tire pressures as shown below. If you do not adjust the tire pressure, excessive heat can build up and cause sudden tire failure.

Tire Size	Cold Tire Pressure for Speeds Over 100 mph (160 km/h)
195/60R15 88H	35 psi (240 kPa, 2.4 kg/cm ²)

Be sure to readjust the pressure for normal driving speeds. You should wait until the tires are cold before adjusting the tire pressure (see page [132](#)).

DOT Tire Quality Grading (US. Cars)

The tires on your car meet all U.S. Federal Safety Requirements. All tires are also graded for treadwear, traction, and temperature performance according to Department of Transportation (DOT) standards. The following explains these gradings.

Treadwear

The treadwear grade is a comparative rating based on the wear rate of the tire when tested under controlled conditions on a specified government test course. For example, a tire graded 150 would wear one-and-one-half (1-1/2) times as well on the government course as a tire graded 100. The relative performance of tires depends upon the actual conditions of

their use, however, and may depart significantly from the norm due to variations in driving habits, service practices, and differences in road characteristics and climate.

Traction

The traction grades, from highest to lowest, are A, B, and C, and they represent the tire's ability to stop on wet pavement as measured under controlled conditions on specified government test surfaces of asphalt and concrete. A tire marked C may have poor traction performance.

Warning: The traction grade assigned to this tire is based on braking (straight ahead) traction tests and does not include cornering (turning) traction.

Temperature

The temperature grades are A (the highest), B, and C, representing the tire's resistance to the generation of heat and its ability to dissipate heat when tested under controlled conditions on a specified indoor laboratory test wheel. Sustained high temperature can cause the material of the tire to degenerate and reduce tire life, and excessive temperature can lead to sudden tire failure. The grade C corresponds to a level of performance which all passenger car tires must meet under the Federal Motor Vehicle Safety Standard No. 109. Grades B and A represent higher levels of performance on the laboratory test wheel than the minimum required by law.

Warning: The temperature grade for this tire is established for a tire that is properly inflated and not overloaded. Excessive speed, underinflation, or excessive loading, either separately or in combination, can cause heat buildup and possible tire failure.

Emissions Controls

The burning of gasoline in your car's engine produces several byproducts. Some of these are carbon monoxide (CO), oxides of nitrogen (NOx), and hydrocarbons (HC). Gasoline evaporating from the tank also produces hydrocarbons. Controlling the production of CO, NOx, and HC is important to the environment. Under certain conditions of sunlight and climate, NOx and HC react to form photochemical "smog."

Carbon monoxide does not contribute to smog Creation, but it is a poisonous gas.

The Clean Air Act

The Clean Air Act* sets standards for automobile emissions. It also requires that automobile manufacturers explain to owners how their emissions controls work and what to do to maintain them. This section summarizes how the emissions controls work. Scheduled maintenance is on page [120](#).

* In Canada, Honda vehicles comply with the Canadian Motor Vehicle Safety Standards (CMVSS) for Emissions valid at the time they are manufactured.

Crankcase Emissions Control System

Your car has a Positive Crankcase Ventilation (PCV) System. This keeps gasses that build up in the engine's crankcase from going into the atmosphere. The PCV valve routes them from the crankcase back to the intake manifold. They are then drawn into the engine and burned.

Evaporative Emissions Control System

As fuel evaporates in the fuel tank, an evaporative emissions control Canister filled with charcoal adsorbs the vapor. It is stored in this canister while the engine is off. After the engine is started and warmed up, the vapor is drawn into the engine and burned during driving.

Exhaust Emissions Controls

The exhaust emissions controls include three systems: PGM-FI, ignition timing control, and three-way catalytic converter. These three systems work together to control the engine's combustion and minimize the amount of HC, CO, and NOx that comes out the tailpipe. The exhaust emissions control systems are separate from the crankcase and evaporative emissions control systems.

PGM-FI System

The PGM-FI system uses a sequential multiport fuel injection. It has three sub-systems: air intake, engine control, and fuel control. The engine control module (ECM) uses various sensors to determine how much air is going into the engine. It then controls

how much fuel to inject under all operating conditions.

Ignition Timing Control System

This system constantly adjusts the ignition timing, reducing the amount of HC, CO and NOx produced.

Three-Way Catalytic Converter

The three-way catalytic converter is in the exhaust system. Through chemical reactions, it converts HC, CO, and NOx in the engine's exhaust to carbon dioxide (CO₂), dinitrogen (N₂), and water vapor.

Exhaust Gas Recirculation (EGR) System

The Exhaust Gas Recirculation (EGR) system takes some of the exhaust gas and routes it back into the intake manifold. Adding exhaust gas to the air/fuel mixture reduces the amount of NO_x produced when the fuel is burned.

Replacement Parts

The emissions control systems are designed and certified to work together in reducing emissions to levels that comply with the Clean Air Act. To make sure the emissions remain low, you should use only new Genuine Honda replacement parts or their equivalent for repairs. Using lower quality parts may increase the emissions from your car.

The emissions control systems are covered by warranties

separate from the rest of your manual for more information.

Three-Way Catalytic Converter

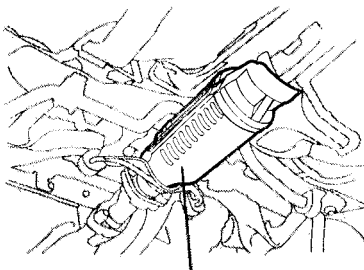

THREE-WAY CATALYTIC CONVERTER

The three-way catalytic converter contains precious metals that serve as catalysts, promoting chemical reactions to convert the exhaust gases without affecting the metals. The catalytic converter is referred to as a three-way catalyst, because it acts on HC, CO, and NO_x. A

replacement unit must be an original Honda part or its equivalent.

The three-way catalytic converter must operate at a high temperature for the chemical reactions to take place. It can set on fire any combustible materials that come near it. Park your car away from high grass, dry leaves, or other flammables.

- Always use unleaded gasoline. Even a small amount of leaded gasoline can contaminate the catalyst metals, making the converter ineffective.
- Keep the engine tuned up.
- Have your car diagnosed and repaired if it is misfiring, backfiring, continuing to run after you turn off the engine, stalling, or otherwise not running properly.

Warranty Coverages	182
Customer Relations Information	183
Reporting Safety Defects	183
U.S. Zone Office Map	184
Canada Zone Office Map	185
Authorized Manuals	187

Warranty Coverages

U.S. Cars

Your new Honda is covered by these warranties:

New Car Limited Warranty — Covers your new car, except for the battery, emissions control systems and accessories, against defects in materials and workmanship.

Emission Control Systems Defects Warranty and Emissions Performance Warranty — These two warranties cover your car's emission control systems. Time, mileage, and coverage are conditional. Please read the warranty manual for exact information.

Original Equipment Battery Limited Warranty — This warranty gives up to 100 percent credit toward a replacement battery.

Seat Belt Limited Warranty — A seat belt that fails to function properly is covered for the useful life of the car.

Rust Perforation Limited Warranty — All exterior body panels are covered for rust-through from the inside for the specified time period with no mileage limit.

Accessory Limited Warranty — Genuine Honda Accessories are covered under this warranty. Time and mileage limits depend on the type of accessory and other factors. Please read your warranty manual for details.

Replacement Parts Limited Warranty — Covers all Genuine Honda replacement parts against defects in materials and workmanship.

Replacement Battery Limited Warranty- Provides prorated coverage for a replacement battery purchased from a Honda dealer.

Replacement Muffler Lifetime Limited Warranty — Provides coverage for as long as the purchaser of the muffler owns the car.

Restrictions and exclusions apply to all these warranties. Please read the 1995 Honda Warranty booklet that came with your car for precise information on warranty coverages. Your Honda's original tires are covered by their manufacturer. Tire warranty information is in a separate booklet.

Canada Cars

Please refer to the 1995 Warranty and Maintenance Guide that came with your car.

Customer Relations Information

Honda dealership personnel are trained professionals. They should be able to answer all your questions. If you encounter a problem that your dealership does not solve to your satisfaction, please discuss it with the dealership's management. The Service Manager or General Manager can help. Almost all problems are solved in this way.

If you are dissatisfied with the decision made by the dealership's management, contact your Honda Customer Relations Zone Office. Refer to the U.S. and Canada Zone Office maps on the following pages.

When you call or write, please give us this information:

- Vehicle Identification Number (see page 172)
- Name and address of the dealer who services your car
- Date of purchase
- Mileage on your car
- Your name, address, and telephone number
- A detailed description of the problem
- Name of the dealer who sold the car to you

Reporting Safety Defects (U.S. Cars)

If you believe that your vehicle has a defect that could cause a crash or could cause injury or death, you should immediately inform the National Highway Traffic Safety Administration

(NHTSA) in addition to notifying American Honda Motor Co., Inc.

If NHTSA receives similar complaints, it may open an investigation, and if it finds that a safety defect exists in a group of vehicles, it may order a recall and remedy campaign. However, NHTSA cannot become involved in individual problems between you, your dealer, or American Honda Motor Co., Inc.

To contact NHTSA, you may either call the Auto Safety Hotline toll-free at (800) 424-9393, or (202) 366-0123 in the Washington, D.C. area, or write to this address: NHTSA, U.S. Department of Transportation, Washington, D.C. 20590. You can also obtain other information about motor vehicle safety from the Hotline.

U.S. Zone Office Map

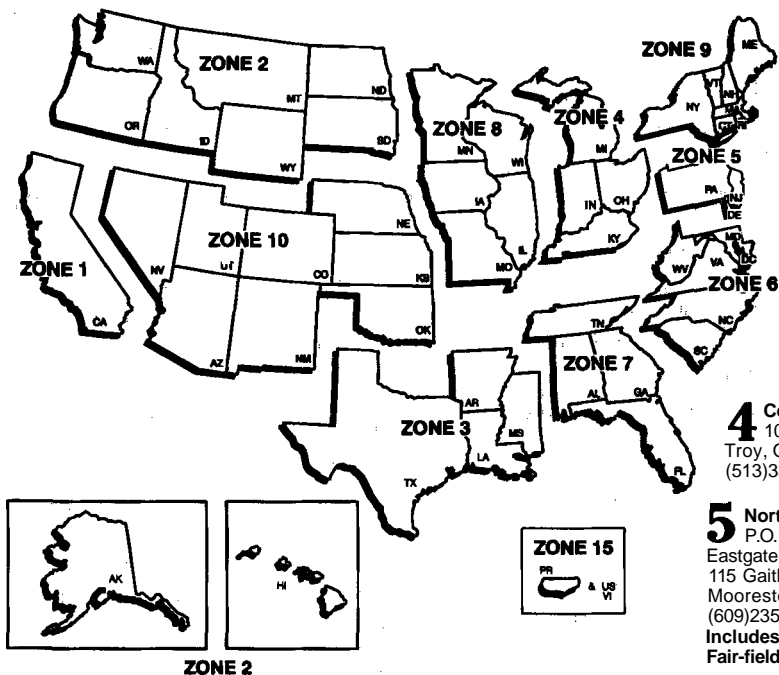

1 Western Zone
P.O. Box 2260
700 Van Ness Avenue
Torrance, California
90501-2260
(310) 781-4565

2 Northwestern Zone
P.O. Box 20186
12439 N.E. Airport Way
Portland, Oregon 97220
(503) 256-0943
(also includes
Alaska and Hawaii)

3 South Central Zone
4529 Royal Lane
Irving, Texas 75063
(214)929-5481

4 Central Zone
101 South Stanfield Road
Troy, Ohio 45373
(513)332-6250

5 Northeastern Zone
P.O. Box 337
Eastgate Industrial Park
115 Gaither Drive
Moorestown, New Jersey 08057
(609)235-5533
**Includes: NYC Metro area and
Fairfield County, CT area**

6 Mid-Atlantic Zone
902 Wind River Ln., Suite 200
Gaithersburg, Maryland 20878
(301)990-2020

7 Southeastern Zone
1500 Morrison Parkway
Alpharetta, Georgia 30201
(404) 442-2045

8 North Central Zone
601 Campus Drive, Suite A-9
Arlington Heights, Illinois 60004
(708) 870-5600

9 New England Zone
555 Old County Road
Windsor Locks, Connecticut 06096
(203)623-3310
**See Zone 5 for: NYC Metro area
and Fairfield County, CT area**

10 West Central Zone
1600 South Abilene Street, Suite D
Aurora, Colorado 80012
(303)696-3935

15 Puerto Rico and U.S. V.I.
Bella International
P.O. Box 190816
San Juan, PR 00919-0816
(809) 250-8070

The above addresses and telephone numbers are subject to change. If you cannot reach your Zone office, ask your Honda dealer for the current information.

**Western Zone**

Honda Canada Inc.
13240 Worster Court
Richmond, B.C.
V6V 2B8
(604) 278-7121

Quebec Zone

Honda Canada Inc.
1750 rue Eiffel
Boucherville, Quebec
J4B 7W1
(514) 655-6161

Central Zone

Honda Canada Inc.
126 Milner Avenue
Scarborough, Ontario
M1S 3R2
(416) 299-3400

Atlantic Zone

Honda Canada Inc.
800 Windmill Road
Dartmouth, N.S.
B3B 1L1
(902) 468-4416

Purchasing Factory-Authorized Manuals (U.S. only)

The following publications covering the operation and servicing of your vehicle can be obtained from Helm Incorporated, either by filling out the form or, for credit card holders, by calling toll free. For manuals prior to the year shown below, contact Helm Incorporated, P.O. Box 07280, Detroit, MI 48207 or call 1-800-782-4356.

Publication Form Number	Form Description	Price Each
61SV401	1995 Accord Service Manual (base manual)	\$54.00
61SV401EL	1995 Accord Electrical Troubleshooting Manual	\$30.00
61SV431	1995 Accord Body Repair Manual	\$30.00
31SV5610	1995 Accord Wagon Owner's Manual	\$16.00
HON-R	Order form for previous years – Indicate year and model desired.	FREE

*Prices are subject to change without notice and without incurring obligation.

Valid only for sales within the U.S. Canadian owners should contact their authorized Honda dealer.

ORDER TOLL FREE: 1-800-782-4356
(NOTE: For Credit Card Holder Orders Only)
 Monday – Friday 8:00 a.m. – 6:00 p.m. EST
 MINIMUM CREDIT CARD PURCHASE \$10.00

OR

By completing this form you can order the materials desired. You can pay by check or money order or charge to your credit card. Mail to Helm, Incorporated at the address shown on the back of the order form.

1991 HONDA	PUBLICATION FORM NUMBER	VEHICLE MODEL		QTY.	PRICE EACH*	TOTAL PRICE	
		NAME	YEAR				
*Prices are subject to change without notice and without incurring obligation. Orders are mailed within 10 days. Please allow adequate time for delivery.					TOTAL MATERIAL		
					MICH. PURCHASES ADD 4% SALES TAX		
					HANDLING CHARGE		\$4.00
					GRAND TOTAL		

A

- ABS. *See* *Anti-Lock Brakes*
- ACCESSORY,
(Ignition Key Position) 44
- Adding
 - Automatic Transmission
 - Fluid 121
 - Brake Fluid 123
 - Clutch Fluid 124
 - Engine Coolant 117
 - Engine Oil 114
 - Manual Transmission
 - Fluid 122
 - Power Steering Fluid 124
 - Radiator Coolant 117
 - Windshield Washer Fluid 120
- Additional Safety Information 16
 - Door Locks 16
 - Driving With Pets 17
 - Head Restraint Position .. 16
 - Seat-Back Position 16
 - Storing Cargo Safely 16
- Additives, Engine Oil 115
- Adjustments
 - Head Restraints 49
 - Mirrors.....53
 - Seats 48
 - Steering Wheel 35, 40
- Air Cleaner Element 125
- Air Conditioning
 - Maintenance 130
 - Usage 62, 63
- Air Filter. *See* Air Cleaner
Element
- Air Outlets (Vents) 61
- Air Pressure, Tires 175
- Airbag (SRS) 12
- Alcohol in Gasoline 78
- Alternator Belt. *See*
Engine Belts
- Anchor Plate, Child Seat 23
- Antenna, Cleaning 146
- Anti-Lock Brakes
 - Indicator Light 31, 97
 - Operation 96
- Anti-Theft Steering
 - Column Lock 44
- Antifreeze 117
- Appearance Care 145
- Ashtrays 57
- Audio System 66
- Automatic Cruise Control ... 40
- Automatic Transmission 91
 - Capacity, Fluid 174, XIII
 - Checking Fluid Level.... 121
 - Shift Lever Position
 - Indicator 92
 - Shift Lever Positions 92
 - Shift Lock Release 94
 - Shifting.....92

B

Battery	127
Charging System	
Indicator	30
Jump Starting	158
Maintenance	127
Specifications	175
Before Driving	77
Belts, Seat	4
Beverage Holder	55
Body Repair	150
Brakes	
Anti-Lock Brake System ..	96
Break-in, New Linings	78
Fluid	123
Light, Burned-out	137
Parking	54
System Indicator	30
Wear Indicators	95

Brakes, ABS	
Operation	96
System Indicator	97
Braking System	95
Break-in, New Car	78
Brightness Control,	
Instruments	37
Brights, Headlights	36
Bulb Replacement	
Back-up Lights	139
Brake Lights	139
Front Parking Lights	138
Front Side Marker Lights	138
Headlights	137
High-Mount Brake Light .	140
Interior Courtesy Lights .	141
License Plate Lights	141
Parking Light Bulbs	138
Specifications	175
Turn Signal Lights	138
Bulbs, Halogen	137

C

Cables, Jump Starting With	158
Capacities Chart	174
Carbon Monoxide Hazard ...	24
Cargo, Loading	84
Cassette Player	
Care	71
CLEAN Indicator	71
Operation	69
Catalytic Converter,	
Three-Way	180
CAUTION, Explanation of	ii
CD Player	72
Certification Label	172
Chains, Tire	136
Change Oil	
How to	115
When	108, 109
Changing a Flat Tire	152

- Changing Engine Coolant ... 118
- Charging System Indicator .. 30
- Charging System Light 162
- Check Engine Light
(Canada) 31
- Checking
- Automatic Transmission
 - Fluid 121
 - Battery Condition 127
 - Brake Fluid 122
 - Clutch Fluid 122
 - Drive Belts 131
 - Engine Coolant 117
 - Engine Oil 82
 - Fuses 165
 - Manual Transmission
 - Fluid 122
 - Power Steering Fluid 124
 - Radiator Coolant 117
 - Tire Pressure 132
 - Windshield Wipers 129
- Checklist, Before Driving ... 88
- Child Safety 17
- Guidelines for Restraining Infants/Children 19
 - Important Safety Reminders 18
 - Where Should Children Sit..... 18
- Cigarette Lighter 56
- CLEAN Indicator 71
- Cleaner, Air 125
- Cleaning
- Aluminum Wheels 147
 - Antenna 146
 - Carpeting..... 148
 - Exterior 146
 - Interior..... 148
 - Seat Belts 148
 - Vinyl 148
- Clock, Setting the 54
- Clutch Fluid 124
- CO in the Exhaust..... 24, 179
- Coin Box 56
- Cold Weather, Starting in ... 89
- Compact Disc Player 72
- Consumer Information 183
- Control Locations 28
- Controls Near the Steering
- Wheel 35
 - Daytime Running Lights .. 36
 - Hazard Warning 39
 - Headlights 36
 - Instrument Panel
 - Brightness 37
 - Rear Window Defogger ... 39
 - Steering Wheel
 - Adjustment..... 40
 - Turn Signals 37
 - Windshield Washers 38
 - Windshield Wipers 37
- Controls, Instruments and .. 27
- Coolant
- Adding 117

Index

Capacity	174
Checking	117
Proper Solution	117
Temperature Gauge	34
Corrosion Protection	149
Crankcase Emission Control System	179
Cruise Control Operation	40, 41
Cup Holder. See Beverage Holder	
Customer Relations Information	183
Customer Relations Office	184, 185

D

DANGER, Explanation of	ii
Dashboard	28
Daytime Running Lights	36

Dead Battery, What to Do ..	158
Defects, Reporting Safety ..	183
Defogger, Rear Window	39
Defrosting the Windows	65
DEXRON II Automatic Transmission Fluid	121
Dimensions	174
Dimming the Headlights	36
Dipstick, Automatic Transmission	121
Directional Signals	32
Disabled, Towing Your Car If	170
Disc Brake Wear Indicators ..	95
Disposal of Used Oil	116
Door and Brake Lamp Monitor	31
Doors Childproof Door Locks ...	46

Glove Box	47
Locking and Unlocking ...	45
Power Door Locks	45
Tailgate	47
DOT Tire Quality Grading ..	177
Downshifting, 5-Speed Manual Transmission	90
Drive Belts	131
Driving Fuel Economy	83
In Foreign Countries	79

E

Economy, Fuel	83
Emergencies on the Road ..	151
Battery, Jump Starting ..	158
Changing a Flat Tire	152
Charging System Indicator	30
Check Engine Light (Canada)	31

Checking the Fuses 165
 Malfunction Indicator
 Lamp (U.S.) 31
 Manually Closing
 Moonroof 164
 Oil Pressure Indicator 30
 Overheated Engine 159
 Emergency Brake 54
 Emergency Flashers 32, 39
 Emissions Control 178
 Engine
 Check Light (Canada) 31
 Coolant Temperature
 Gauge 34
 Drive Belts 131
 Identification Number ..173
 Malfunction Indicator
 Lamp (U.S.) 31
 Oil
 Capacity 174, XIII
 What Kind to Use 114, XIII
 Oil Pressure Indicator 30

Overheating 159
 Specifications 174
 Ethanol in Gasoline 79
 Evaporative Emissions
 Control 179
 Exhaust Fumes 24
 Expectant Mothers, Use of
 Seat Belts by 9
 Exterior, Cleaning the 146

F

Fabric, Cleaning 148
 Fan, Interior 62
 Features, Comfort and
 Convenience 59
 Filling the Fuel Tank 80
 Filters
 Air. See Air Cleaner Element
 Oil 115

First Gear, Shifting 91
 5-Speed Manual Transmission,
 Shifting the 90
 5-Speed Manual Transmission,
 Checking Fluid Level 122
 Flashers, Hazard Warning 32, 39
 Flat Tire, Changing a 152
 Fluids
 Automatic
 Transmission .121, 174, XIII
 Brake 123
 Clutch 124
 5-Speed Manual
 Transmission . 122, 174, XIII
 Power Steering 124
 Windshield Washer 174
 FM Stereo Radio Reception . 66
 Folding Rear Seat 50
 Foreign Countries, Driving in 79
 Four-Way Flashers 32, 39

Front End, Towing by Emergency Wrecker	170
Fuel	
Fill Door and Cap	80
Filling the Fuel Tank	80
Gauge	34
Octane Requirement	78
Oxygenated	78
Tank, Capacity	174, XIII
Fuses, Checking the	165

G

Gas Mileage, Improving	83
Gas Station Procedures	80
Gasohol	78
Gasoline	78, XIII
<i>See also</i> Fuel	
Gauge	34
Octane Requirement	XIII
Tank, Filling the	80

Gauges	
Engine Coolant Temperature	34
Fuel	34
Gearshift Lever Positions	
Automatic Transmission ..	92
5-Speed Transmission ...	91
Glass Cleaning	149
Glove Box	47

H

Halogen Headlight Bulbs ..	137
Hazard Warning Flashers	32, 39
Head Restraints	49
Headlights	36
Daytime Running Lights ..	36
High Beam Indicator	32
High Beams, Turning on ..	36
Low Beams, Turning on ..	36
Reminder Chime	36

Replacing Halogen Bulbs	137
Turning on	36
Heating and Cooling	61
High Altitude, Starting at ...	89
High Beam Indicator	32
High-Low Beam Switch	36
Hood, Opening the	81
Hot Coolant, Warning	
About	117
Hydraulic Clutch	124

I

Identification Number, Vehicle	172
---	-----

If Your Car Has to Be Towed	170
Ignition	
Keys	43
Switch	44
Timing Control System ..	179
Indicator Lights, Instrument Panel.....	29
Infant Restraint	19
Inflation, Proper Tire	132
Inside Mirror	53
Inspection, Tire	133
Instrument Panel	28
Instrument Panel Brightness	37
Interior Cleaning	148
Interior Light	57
Introduction	i

J

Jack, Tire	152
Jacking up the Car	153
Jump Starting	158

K

Keys	43
------------	----

L

Label, Certification	172
Labels, Safety, Location of ..	25
Lane Change, Signaling	37
Lap Belt	9
Lap/Shoulder Belts	7
Leaking of Exhaust Into Car ..	24
Lighter, Cigarette	56

Lights

Bulb Replacement	136
Indicator	29
Parking.....	36
Reminder Chime	36
Turn Signal	37
Loading Cargo	84
LOCK (Ignition Key Position)	44
Locking Clip, Seat Belt.....	21
Locks	
Anti-Theft Steering Column	44
Childproof Door Locks ...	46
Fuel Filler Door	80
Glove Box	47
Power Door	45
Tailgate	47
Low Coolant Level	117
Low Oil Pressure Indicator ..	30

- Lower Gear, Downshifting
to a 90
- Lubricant Specifications
Chart 174
- Luggage, Loading 84

M

- Maintenance
 - Periodic Items 112
 - Record 110, 111
 - Required Indicator 34
 - Safety 105
 - Schedule 108, 109
- Malfunction Indicator Lamp
(U.S.) 31
- Manual Transmission 90
- Manually Closing Moonroof 164
- Maximum Shift Speeds 91
- Meters, Gauges 33

- Methanol in Gasoline 79
- Mirrors, Adjusting 53
- Moonroof
 - Closing Manually 164
 - Operation 52

N

- Neutral Gear Position 93
- New Vehicle Break-in 78
- Normal Shift Speeds 91
- NOTICE, Explanation of ii
- Numbers, Identification ... 172

O

- Occupant Protection System . 4
- Octane Requirement,
Gasoline 78
- Odometer 33

- Odometer, Trip 33

Oil

- Change, How to 115
- Change, When to ... 108, 109
- Pressure Indicator 30
- Selecting Proper
Viscosity 115
- ON (Ignition Key Position) .. 44
- Opening the Hood 81
- Operation in Foreign
Countries 79
- Outside Mirrors 53
- Overheating, Engine 159

P

- Panel Brightness Control ... 37
- Park Gear Position 93
- Parking Brake 54

Parking Brake and Brake System Light	30
Parking Lights	36
Parking Over Things That Burn	180
PGM-FI System	179
Polishing and Waxing	147
Power	
Door Locks	45
Mirrors	53
Steering	124
Windows	50
Power Steering Belt. See Engine Belts	
Pregnancy, Using Seat Belts ..	9
Proper Seat Belt Usage	7

R

Radiator Overheating	159
----------------------------	-----

Radio/Cassette/CD Sound System	66
Rear End Towing	170
Rear Lights, Bulb Replacement	139
Rear Seat, Folding	50
Rear View Mirror	53
Rear Window Defogger	39
Reclining the Seat-Backs .	16, 48
Recommended Shift Speeds	91
Remote Transmitter	43, 45
Replacement Information	
Air Cleaner Element	125
Coolant	118
Engine Oil and Filter	115
Fuses	165
Light Bulbs	136
Spark Plugs	126
Tires	135
Wiper Blades	129

Replacing Seat Belts After a Crash	10
Reporting Safety Defects ..	183
Reserve Tank, Coolant	117
Restraint, Child	17
Reverse Gear Position	93
Rotation, Tire	134

S

Safety Belts	4
Safety Defects, Reporting ..	183
Safety Labels, Location of...	25
Safety Messages	ii
Seat Adjustments	
Driver's Lumbar Support .	49
Driver's Seat Power Height Adjustment	49
Front Seat Adjustments ..	48
Head Restraints	49

Index

Rear Seat Armrest	50	Setting the Clock	54	Speed Control	40
Seat Belts		Shift Lever Position		Speedometer	33
Advice for Pregnant		Indicator	92	SRS	10
Women	9	Shifting		START (Ignition Key	
Child Seat Anchor Plate ..	23	The Automatic		Position)	44
Cleaning	148	Transmission	91, 92	Starting the Engine	
Frayed or Torn	10	The 5-Speed		In Cold Weather at High	
Locking Clip	21	Transmission	90	Altitude	89
Maintenance	10	Side Marker Lights, Bulb		With a Dead Battery	158
Reminder Light	30	Replacement in	138	Steam Coming From Engine	159
Replacement.....	10	Signaling Turns	37	Steering Wheel	
System Components	5	Snow Chains	136	Adjustment	40
Tether Attachment Points	22	Snow Tires	136	Anti-Theft Column Lock ..	44
Use During Pregnancy	9	Solvent-Type Cleaners	146	Steering Wheel Controls,	
Wearing a Lap/Shoulder		Sound System	66	Cruise Control	40
Belt	7	Spare Tire, Specifications ..	175	Stereo Sound System	66
Wearing the Lap Belt.....	9	Spark Plugs		Storing Your Car	143
Seats, Adjusting the	48	Replacing	126	Supplemental Restraint	
Serial Number	172	Specifications	127	System	10
Service Intervals	108, 109	Specifications Charts ..	174, 175	Service Precautions	15
Service Manual	187				
Service Station Procedures .	80				

Servicing 15
 SRS Indicator 14, 30
 System Components 11

T

Tachometer 33
 Taillights, Changing
 Bulbs in 139
 Taking Care of the
 Unexpected 151
 Tape Player 69
 Technical Descriptions
 Emissions Control
 Systems 178
 Three-Way Catalytic
 Converter 180
 Tire Information 176
 Temperature Gauge 34
 Tether Attachment Points .. 22

Three-Way Catalytic
 Converter 180
 Time, Setting the 54
 Tire, How to Change a Flat . 152
 Tire Chains 136
 Tires 132
 See *also* label in glove box
 Air Pressure XIII
 Checking Wear 133
 DOT Tire Quality
 Grading 177
 Inflation 132
 Inspection 133
 Replacing 135
 Rotating 134
 Snow 136
 Spare 152
 Specifications 175, XIII
 Tools, Tire Changing 152
 Torn Seat Belts 10

Towing
 A Trailer 97
 Emergency Wrecker
 (Tow Truck) 170
 Transmission
 Checking Fluid Level
 Automatic
 Transmission 121
 5-Speed Manual
 Transmission..... 122
 Fluid Selection 121
 Identification Number ..173
 Shifting the Automatic ... 92
 Shifting the 5-Speed
 Manual..... 90
 Transmitter, Remote 45
 Treadwear 177
 Trip Meter 33
 Turn Signals 37

U

- Unexpected, Taking Care of the 151
- Uniform Tire Quality Grading 177
- Unleaded Gasoline 78
- Upholstery Cleaning 148
- Used Oil, How to Dispose of 116

V

- Vehicle Capacity Load 84
- Vehicle Dimensions 174
- Vehicle Identification Number 172
- Vehicle Storage 143
- Ventilation 63
- VIN..... 172

- Vinyl Cleaning 148
- Viscosity, Oil 115

W

- Warning BEEPERS
 - Key in Ignition 44
 - Seat Belts 30
- Warning Labels, Location of. 25
- WARNING, Explanation of ii
- Warranty Coverages 182
- Washer, Windshield
 - Checking the Fluid Level 120, 174
 - Operation 38
- Washing 146
- Waxing and Polishing 147
- Wheels
 - Adjusting the Steering ... 40
 - Alignment and Balance . 134

- Wrench 153
- Windows
 - Cleaning..... 149
 - Operating the Power 50
 - Rear, Defogger 39
- Windshield
 - Cleaning 38
 - Defroster 65
- Wipers, Windshield
 - Changing Blades 129
 - Operation 37
- Worn Tires 134
- Wrecker, Emergency
 - Towing 170

Gasoline

UNLEADED gasoline
Pump octane of 86 or higher

Fuel Tank Capacity

17.0 U.S. gal. (64.5 l, 14.2 Imp gal.)

Recommended Engine Oil

API SH or SH grade
"Energy Conserving II" oil
SAE 5W-30 viscosity

Engine Oil Capacity

including filter

(U.S.: LX, Canada: EX)

4.0 U.S. qt (3.8 l, 3.3 Imp qt)

(U.S.: EX)

4.5 U.S. qt (4.3 l, 3.8 Imp qt)

without filter

(U.S.: LX, Canada: EX)

3.7 U.S. qt (3.5 l, 3.1 Imp qt)

(U.S.: EX)

4.2 U.S. qt (4.0 l, 3.5 Imp qt)

Tire Pressure

(measured cold):

Front/Rear — up to 475 lb:
32 psi (2.2 kg/cm², 220 kpa)

Front — up to 950 lb:
32 psi (2.2 kg/cm², 220 kpa)

Rear — up to 950 lb:
38 psi (2.6 kg/cm², 260 kpa)

Tire Size (Front and Rear):

195/60R15 88H

Other Tire Size Information

See label in the driver's
doorjamb.

5 Speed Manual

Transmission Oil:

SAE 10W-30 or 10W-40 viscosity
API SF or SG grade recommended

Capacity:
2.0 U.S. qt (1.9ℓ, 1.7 Imp qt)

Automatic

Transmission Fluid:

Honda Premium Formula
Automatic Transmission Fluid or
an equivalent DEXRON II type
Automatic Transmission Fluid
(ATF)

Capacity:
3.4 U.S. qt (3.2 l, 2.8 Imp qt)