

1995 Civic Coupe Online Reference Owner's Manual

Use these links (and links throughout this manual) to navigate through this reference.
For a printed owner's manual, click on authorized manuals or go to www.helminc.com.

Contents

Owner's Identification

Introduction	i
A Few Words About Safety	ii
Driver and Passenger Safety	3
Proper use and care of your vehicle's seat belts, and Supplemental Restraint System.	
Instruments and Controls	25
Instrument panel indicator and gauge, and how to use dashboard and steering column controls.	
Comfort and Convenience Features	55
How to operate the climate control system, the audio system, and other convenience features.	
Before Driving	73
What gasoline to use, how to break-in your new vehicle, and how to load luggage and other cargo.	
Driving	83
The proper way to start the engine, shift the transmission, and park, plus towing a trailer.	
Maintenance	95
The Maintenance Schedule shows you when you need to take your vehicle to the dealer.	
Appearance Care	137
Tips on cleaning and protecting your vehicle. Things to look for if your vehicle ever needs body repairs.	
Taking Care of the Unexpected	143
This section covers several problems motorists sometimes experience, and how to handle them.	
Technical Information	163
ID numbers, dimensions, capacities, and technical information.	
Warranty and Customer Relations (U.S. and Canada)	173
A summary of the warranties covering your new Acura, and how to contact us.	
Authorized Manuals (U.S. only)	179
How to order manuals and other technical literature.	
Index	I

Gas Station Information

Information you need when you pull up to the fuel pump.

Congratulations! Your selection of a 1995 Honda Civic was a wise investment. It will give you years of driving pleasure.

To enhance the enjoyment of your new car, take time to study this manual. In it, you will learn about your car's many conveniences and useful features. Following the service interval and maintenance recommendations will help keep your driving trouble-free while preserving your investment.

Keep this owner's manual in your car so you can refer to it at any time. Please make sure the manual stays with the car if you sell it. The next owner will find it just as helpful.

Several other booklets in the glove box explain the warranties that protect your Honda. We suggest you read them carefully so you understand the coverages and the responsibilities of ownership.

When your car needs scheduled maintenance, keep in mind that your Honda dealer's service staff is specially trained in the service and maintenance of the many systems unique to your Honda. Your Honda dealer is dedicated to your satisfaction and will be pleased to answer any questions and concerns.

Safety Messages

Your safety and the safety of others is very important. We have provided many important safety messages in this manual and on the vehicle. Please read these messages carefully.

A safety message alerts you to potential hazards that could hurt you or others. Each safety message is preceded by a safety alert symbol  and one of three words, **DANGER**, **WARNING** or **CAUTION**. These mean:

**You WILL be KILLED or
SERIOUSLY HURT if you don't
follow instructions.**

**You CAN be KILLED or
SERIOUSLY HURT if you don't
follow instructions.**

**You CAN be HURT if you don't
follow instructions.**

Each safety message tells you what the hazard is, what can happen and what you can do to avoid or reduce injury.

You will also see another important symbol:

NOTICE

Your Civic or other property can be damaged if you don't follow instructions.

The purpose of these messages is to help prevent damage to your Civic, other property, or the environment.

This section gives you important information about occupant protection. It shows how to use seat belts properly. It explains the Supplemental Restraint System that is standard in Civics. And it gives useful information about how to protect infants and children in your car.

Your Occupant Protection System	4
The Seat Belt System and How It Works	5
Why Wear Seat Belts	5
Important Safety Reminders	5
Seat Belt System Components	5
Lap/Shoulder Belt	6
Lap Belt	6
Wearing Seat Belts Properly.....	7
Wearing a Lap/Shoulder Belt	7
Wearing the Lap Belt	8

Advice for Pregnant Women	9
Seat Belt Maintenance	10
Supplemental Restraint System	10
What Happens in a Crash ..	11
Important Facts About Airbags	11
How the Driver's Airbag Works	12
How the Passenger's Airbag Works	13
How the SRS Indicator Light Works	14
System Service	14
System Service Precautions	14
Additional Safety Information	15
Seat-Back Position	15
Door Locks	15
Storing Cargo Safely	15
Driving With Pets	16
Child Safety	17
Where Should Children Sit?	17
Important Safety Reminders	18

General Guidelines for Restraining Children Under 40 lb (18 kg)	18
Restraining an Infant Who Weighs Less Than 20 lb (9 kg)	19
Restraining a Child Who Weighs Between 20 and 40 lb (9 and 18 kg)	19
Restraining a Child Who Weighs Over 40 lb (18 kg)	20
Using a Seat Belt Locking Clip	20
Using Child Restraints With Tethers	21
Storing a Child Seat	22
Carbon Monoxide Hazard	23
Safety Labels	24

Your Occupant Protection System

Your Honda is equipped with seat belts and other features that work together to protect you and your passengers during a crash.

Seat belts are the most important part of your occupant protection system. When worn properly, seat belts can reduce the chance of serious injury or death in a crash.

For added protection during a severe frontal collision, your Civic has a Supplemental Restraint System (SRS) with a driver's airbag and a passenger's airbag.

Two indicator lights are also part of your safety system. One reminds you to make sure you and your passengers wear your seat belts. The other alerts you to a possible problem with your

supplemental restraint system (see page 14).

The seats, head restraints, and door locks also play a role in occupant safety. For example, reclining the seat-back can decrease the effectiveness of your seat belt. Head restraints can help protect your neck and head, especially during rear-end impacts. Door locks help keep your doors from being accidentally opened during a crash.

To get the maximum protection from your occupant protection system, check the following before you drive away:

- Everyone in the car is wearing a seat belt properly (see page 7).

- Infants or small children are properly secured in a child safety seat (see page 17).
- Both doors are closed and locked (see page 15).
- Seat-backs are upright (see page 15).
- There are no loose items that could be thrown around and hurt someone during a crash or sudden stop (see page 15).

By following these guidelines, you can reduce injuries to yourself and your passengers in many crash situations. Remember, however, that no safety system can prevent all injuries or deaths that can occur in severe crashes.

Why Wear Seat Belts

Wearing seat belts and wearing them properly is fundamental to your safety and the safety of your passengers.

During a crash or emergency stop, seat belts can help keep you from being thrown against the inside of the car, against other occupants, or out of the car.

Of course, seat belts cannot completely protect you in every crash. But, in most cases, seat belts reduce your chance of serious injury. They can even save your life. That is why many states and all Canadian provinces require you to wear seat belts.

Not wearing a seat belt increases the chance of being killed or seriously hurt in a crash.

Be sure you and your passengers always wear seat belts and wear them properly.

Important Safety Reminders

Seat belts are designed for adults and larger children. All infants and small children must be properly restrained in child safety seats (see page 18).

A pregnant woman needs to wear a seat belt to protect herself and her unborn child (see page 9).

Two people should never use the same seat belt. If they do, they could be very seriously injured in a crash.

Do not place the shoulder portion of a lap/shoulder belt under your arm or behind your back. This could increase the chance of serious injuries in a crash.

Do not put shoulder belt pads or other accessories on seat belts. They can reduce the effectiveness of the belts and increase the chance of injury.

Seat Belt System Components

Your Honda has seat belts in all five seating positions. The front seats and the outside positions of the rear seat have lap/shoulder belts. The center

The Seat Belt System and How It Works

position of the rear seat has a lap belt.

Your seat belt system also includes a light on the instrument panel to remind you to fasten your seat belt and to make sure your passengers fasten theirs. This light comes on when you turn on the ignition if you have not fastened your seat belt. A beeper also sounds for several seconds (see page 28).

The following pages cover more about the seat belt components and how they work.

Lap/Shoulder Belt

This style of seat belt has a single belt that goes over your shoulder, across your chest and across your hips.

Each lap/shoulder belt has an emergency locking retractor. In normal driving, the retractor lets you move freely in your seat while it keeps some tension on the belt. During a collision or sudden stop, the retractor automatically locks the belt to help restrain your body.

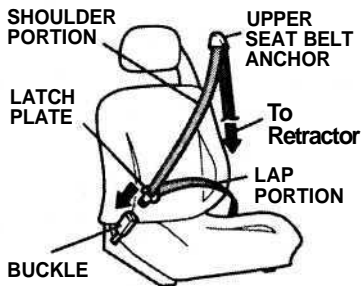

Lap Belt

The lap belt has one manually adjusted belt that fits across the hips. It is similar to safety belts used in airplanes.

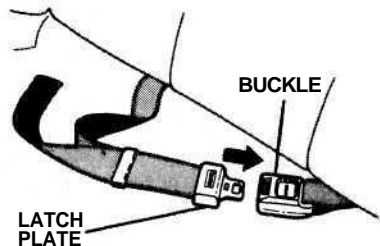

Wearing Seat Belts Properly

You can increase the effectiveness of your seat belts if you take a little time to read the following pages and make sure you know how to wear seat belts properly.

Not wearing a seat belt properly increases the chance of serious injury or death in a crash.

Be sure you and your passengers always wear seat belts and wear them properly.

Wearing a Lap/Shoulder Belt

Before putting on the seat belt, move the driver's seat as far back as is practical while still

allowing you to maintain full control of the vehicle. Make sure the seat-back is upright (see page 43). The front seat passenger should move the seat as far back as possible.

1. Pull the latch plate across your body, and insert it into the buckle. Tug on the belt to make sure the latch is securely locked.

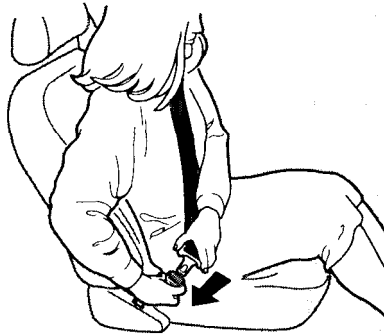

2. Check to see that the belt is not twisted.
3. Position the lap portion of the belt as low as possible across your hips, not across your stomach. This lets your strong pelvic bones take the force of a crash.

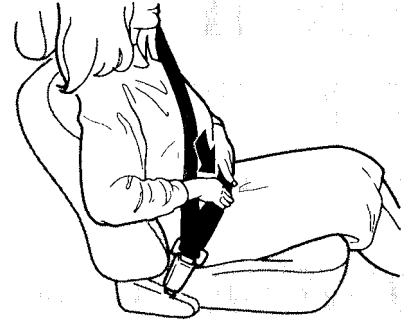

The Seat Belt System and How It Works

4. Pull up on the shoulder part of the belt to remove any slack. Make sure the belt goes over your collarbone and across your chest.



5. If the shoulder belt crosses your neck while you are sitting in one of the outside rear seating positions, you need to adjust your seating

position. Move toward the center of the seat until the belt fits over your collarbone.

To unlatch the seat belt, push the red **PRESS** button on the buckle. Guide the belt across your body to the door pillar. If the belt doesn't retract easily, pull it out and check for twists or kinks.

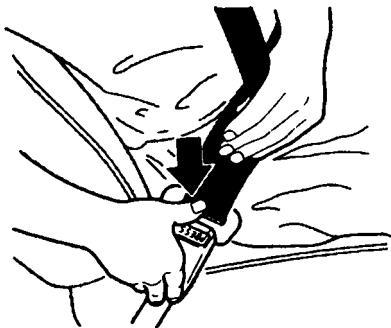

Wearing the Lap Belt

1. Pull the latch plate across your hips, and insert it into the buckle marked **CENTER**.

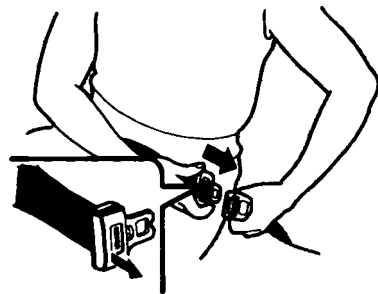

If the belt is too short, hold the latch plate at a right angle, and pull to extend the belt. Insert the latch plate into the buckle.

2. Position the belt so it fits as low as possible across your hips and pelvic bones, not across your stomach. Pull the loose end of the belt to adjust for a snug but comfortable fit.

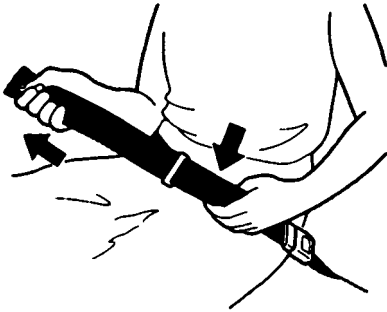

To unlatch the belt, push the red **PRESS** button on the buckle.



Advice for Pregnant Women

Protecting the mother is the best way to protect her unborn child. Therefore, a pregnant woman should wear a properly positioned seat belt whenever she drives or rides in a car.

If possible, use the lap/shoulder seat belt, remembering to keep the lap portion as low as possible (see page 7).

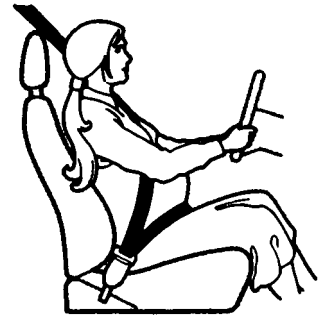

Each time you have a check-up, ask your doctor if it's okay for you to drive and how you should position a lap/shoulder seat belt.

The Seat Belt System and How It Works, Supplemental Restraint System

Seat Belt Maintenance

For safety, you should check the condition of your seat belts regularly.

Pull out each belt fully and look for frays, cuts, burns and wear. Check to see that the latches work smoothly and the lap/shoulder belts retract easily. Any belt not in good condition or not working properly should be replaced.

If a seat belt is worn during a crash, have your dealer replace the belt and check the anchors for damage.

For information on how to clean your seat belts, see page [140](#).

Supplemental Restraint System

Your Civic is equipped with a Supplemental Restraint System

(SRS) to help protect the head and chest of the driver and front seat passenger during a severe frontal collision.

This system does not replace your seat belts. It supplements, or adds to, the protection offered by the seat belts and other occupant protection features.

Not wearing a seat belt increases the chance of serious injury or death in a crash, even if you have airbags.

Be sure you and your passengers always wear seat belts and wear them properly.

SRS Components

Your supplemental restraint system includes:

- One airbag in the steering wheel for the driver, and another in the dashboard for the passenger.
- Sensors that can detect a severe frontal collision.
- A sophisticated electronic system that continually monitors the sensors, control unit, airbag activators, and all related wiring when the ignition is ON (II).
- An indicator light on the instrument panel to alert you to a possible problem with the system.
- Emergency backup power in case your car's electrical system is disconnected in a crash.

What Happens in a Crash

If you ever have a severe frontal collision, the sensors will detect rapid deceleration and signal the control unit to instantly inflate the airbags.

During a crash, your seat belts will help to restrain your lower body and torso. The airbags will provide a cushion to absorb crash energy and help keep the head and chest of the driver and front passenger from striking the interior of the car.

After inflating, the airbags will immediately deflate. The entire process, from detection to deflation, takes a fraction of a second. This process occurs so quickly that you may not hear the loud noise created by the airbag inflators or realize what has happened.

After the crash, you may see what looks like smoke. This is actually powder from the airbag's surface. People with respiratory problems may experience some temporary discomfort from the chemicals used by the airbag's activators.

Important Facts About Airbags

Airbags inflate only when needed; ***in a severe frontal collision***. A severe collision would be similar to a crash into a parked car at 25 mph. Airbags will not inflate in a moderate frontal collision, or during a rear impact, side impact, or rollover - even if the impact is severe.

FRONTAL COLLISION RANGE

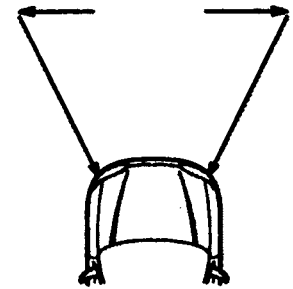

Airbags inflate and deflate only once. They cannot protect you during any additional impacts that can occur during a crash sequence.

Injuries, including fatal injuries, can occur in a severe collision, even if seat belts are worn properly and the airbags inflate. No safety system can provide complete protection in a severe crash.

Supplemental Restraint System

Just from viewing the vehicle damage after a crash, it is very difficult to accurately determine if the airbags should or should not have inflated. In some cases where the airbag did not inflate, extensive visible damage indicated that the car absorbed much of the crash energy, and the airbags were not needed. In other cases, a severe jolt, such as an impact to the undercarriage, may not cause extensive body damage but cause the airbags to inflate.

How the Driver's Airbag Works

If you ever have a severe frontal collision, your airbag will instantly inflate to help protect your head and chest.

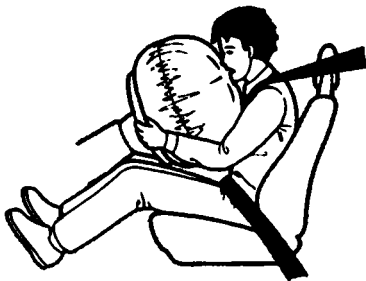

To do its job, the airbag inflates with considerable force. So, while it can reduce serious injuries and even save your life,

the airbag might cause some facial abrasions or other injuries. To reduce the possibility of injury, you should always sit back as far from the steering wheel as is practical while still maintaining full vehicle control.

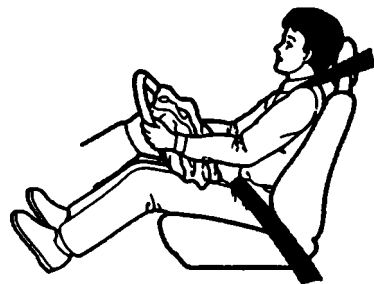

After the bag completely inflates, it immediately starts deflating so it won't interfere with your visibility, ability to steer or ability to operate other controls.

The total time for inflating and deflation takes a fraction of a second. You may not even be aware that the airbag has been fully inflated.

The airbag is stored in the center of the steering wheel. For safety, do not attach any items to the steering wheel. They could interfere with the proper operation of the airbag. Or, if the airbag inflates, the items could be propelled inside the car and hurt someone.

How the Passenger's Airbag Works

If you have a severe frontal collision, the passenger's airbag will inflate at the same time as the driver's airbag.



The airbag is quite large and inflates with considerable force. It can seriously hurt a front seat passenger who is not in the

proper position and wearing the seat belt properly. Front seat passengers should move the seat as far back as practical and sit well back in the seat.

We strongly recommend that you do not put an infant seat in the front passenger's seat. If the airbag inflates, it can hit the infant seat with great force. The infant seat can be dislodged or struck with enough force to cause very serious injury to the infant.

If a toddler seat is used in the front passenger's seat, the vehicle seat should be moved as far back as possible. If the passenger bag inflates, it could seriously hurt a toddler who is not in the proper position or properly restrained.

Supplemental Restraint System

The passenger's airbag is stored near the top of the dashboard, under a lid marked SRS. Do not place any objects on top of this lid. If the airbag inflates, those objects can be propelled inside the car and possibly hurt someone.

SRS How the SRS Indicator Light Works

The purpose of the SRS light on your instrument panel is to alert you to a potential problem with your supplemental restraint system.

Have the system checked if:

- The light does not come on when you turn the ignition ON (II).

- The light stays on after the engine starts.
- The light comes on or flashes while you are driving.

System Service

Your supplemental restraint system is virtually maintenance-free. There are no parts you can safely service.

You must have the system serviced by an authorized Honda dealer:

- *If your airbags ever inflate.* The airbags and control unit must be replaced. Do not try to remove or discard the airbags by yourself. This must be done by a Honda dealer.
- *If the SRS indicator light alerts you of a problem.* Have the supplemental restraint system checked as soon as possible. Otherwise, your airbags might

not inflate when you need them.

- *When the car is 10 years old.* Have the dealer inspect the system. The production date is on the driver's doorjamb for your convenience.

System Service Precautions

Do not modify your steering wheel or any other part of the supplemental restraint system. Modifications could make the system ineffective.

Do not tamper with the system components or wiring. This could cause the airbags to inflate inadvertently, possibly injuring someone very seriously.

Tell anyone who works on your car that you have a supplemental restraint system. Failure to follow the procedures and

precautions in the official Honda service manual could result in personal injury or damage to the system.

Scrapping an entire car that has uninflated airbags can be dangerous. Get assistance from a Honda dealer if your car must be scrapped.

If you sell your car, please be sure to tell the new owner that the car has a supplemental restraint system. Alert them to the information and precautions in this part of the Owner's Manual.

Additional Safety Information

The seat belts and airbags are obviously important parts of your occupant protection system.

In addition, you should know that sitting upright, locking the doors, and stowing things properly can also increase your safety and possibly even save your life.

Seat-Back Position

The seat-backs should be in an upright position for you and your passengers to get the most protection from the seat belts.

If you recline a seat-back, you reduce the protective capability of your seat belt. The farther a seat-back is reclined, the greater the risk that you will slide under

the belt in a severe crash and be very seriously injured.

For information on how to adjust the seat-back, see page 43.

Door Locks

It is not safe to leave your car doors unlocked. A passenger, especially a child, could open a door and accidentally fall out. Also, there is a greater chance of being thrown out of the car during a crash when the doors are not locked.

Storing Cargo Safely

Before you drive, make sure you first securely store or tie down any items that could be thrown around the car and hurt someone or interfere with your ability to operate the controls.

Additional Safety Information

Do not put any items on top of the rear shelf. They can block your view and they could be thrown about the car in a crash.

Be sure to keep compartment doors closed when the car is moving. If a front passenger hits the door of an open glove box, for example, he could injure his knees.

For information on **Loading Cargo**, see page [81](#).

Driving With Pets

Loose pets can be a hazard while you are driving. An unrestrained pet can interfere with your ability to drive the car. In a crash or sudden stop, loose pets or cages can be thrown around inside the car and hurt you or your passengers. It is also for

their safety that pets should be properly restrained in your car.

The recommended way to restrain a medium-sized or larger dog is with a special traveling harness. This harness can be secured to the rear seat with a seat belt. Travel harnesses are available at pet stores.

A small dog, cat, or other small animal will be safest in a pet carrier with rigid sides. Choose a style that allows you to secure it to the car's seat by routing a seat belt through the carrier's handle.

For further information, contact your veterinarian or local animal protection society.

Children depend on adults to protect them. To help make sure we do, every state and Canadian province has laws requiring infants and young children to be properly restrained whenever they ride in a car.

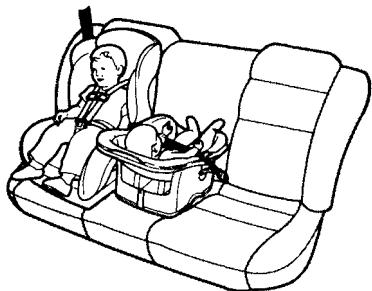

An infant or child who is not properly restrained can be killed or seriously injured in a crash.

Be sure any child too small for seat belts is properly secured in a child restraint.

Where Should Children Sit?
According to accident statistics, children of all sizes and ages are safer when they are properly restrained in the rear seat rather than the front seat.

We recommend that, whenever possible, you secure your child's infant or toddler seat in the center position of the rear seat with the lap belt.

We strongly recommend that you do not put an infant seat in the front passenger's seat. If the airbag inflates, it can hit the infant seat with great force. The infant seat can be dislodged or struck with enough force to cause very serious injury to the infant.

If a toddler seat is used in the front passenger's seat, the vehicle seat should be moved as far back as possible. If the passenger bag inflates, it could seriously hurt a toddler who is not in the proper position or properly restrained.

We also recommend that any child who is too large to use an infant or toddler seat ride in one of the outside positions of the rear seat. The child should then

wear the lap/shoulder belt properly for protection.

Important Safety Reminders

Never hold a baby or child on your lap when riding in a car. If you are wearing your seat belt, the violent forces created during a crash will tear the child from your arms. The child could be seriously hurt or killed.

If you are holding a child and not wearing a seat belt in a crash, you could crush the child against the car's interior.

Never put your seat belt over yourself and a child. During a crash, the belt could press deep into the child causing serious internal injuries.

Two children should never use the same seat belt. If they do,

they could be very seriously injured in a crash.

For their safety, do not leave children alone in your car without adult supervision.

General Guidelines for Restraining Children Under 40 lb (18kg)

Use an approved child seat. The seat must meet Federal Motor Vehicle Safety Standard 213 (FMVSS-213) or Canadian Motor Vehicle Safety Standards. Look for the manufacturer's statement of compliance on the box and seat.

Use a seat of the right size. Make sure the seat fits your child. Check the seat's instructions and labels for height and weight limits.

Secure the child seat to the car. All approved child seats are designed to be secured in the car seat by the lap belt or the lap belt portion of a lap/shoulder belt. A child whose seat is not properly secured to the car can be endangered in a crash.

To properly route a seat belt through a child seat, follow the seat-maker's instructions. If you use a lap/shoulder belt, be sure you install a locking clip on the belt (see page 20).

Secure the child in the child seat. Make sure the infant or child is firmly secured to the child seat. Use the straps provided, and carefully follow the manufacturer's instructions.

Restraining an Infant Who Weighs Less Than 20 lb (9 kg)

An infant up to about 20 lb (9 kg) must be restrained in an infant seat or a convertible seat designed for a baby. Because infants of that size must ride in a reclining position, be sure the infant seat always faces the REAR of the car as shown.

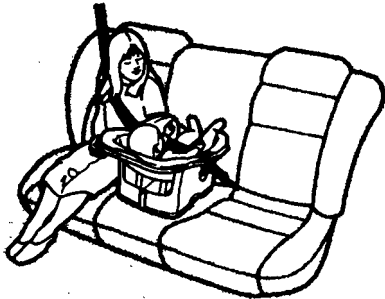

We recommend that, whenever possible, you put the infant seat in the center position of the rear seat and secure it to the car with the lap belt.

If you decide to put an infant seat in any other seating position, you must use a locking clip on the car's lap/shoulder belt (see page 20).

We strongly recommend that you do not put an infant seat in the front passenger's seat. If the airbag inflates, it can hit the infant seat with great force. The infant seat can be dislodged or struck with enough force to cause very serious injury to the infant.

Restraining a Child Who Weighs Between 20 and 40 lb (9 and 18 kg)

Toddler seats are designed for children who weigh between 20 and 40 lb (9 and 18 kg).

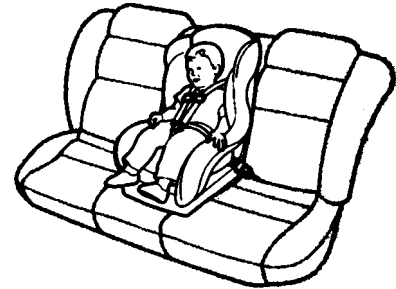

The preferred place to put a toddler seat is in the center position of the rear seat. Use the

Child Safety

car's lap belt to secure the seat to the car.

If you decide to put a toddler seat in any other seating position, you must use a locking clip on the car's lap/shoulder belt (see page 20).

If you are using a toddler seat in the front passenger's seat, move the passenger's seat as far back as possible before installing the child seat. If the passenger airbag inflates, it could seriously hurt a toddler who is not in the proper position or properly restrained.

Restraining a Child Who Weighs Over 40 lb (18 kg)

We recommend that, whenever possible, a child who has outgrown a toddler seat ride in one of the outside positions of the

rear seat and use a lap/shoulder belt.

Put the lap/shoulder belt on your child and check its fit. The shoulder belt should fit over the collarbone and across the chest. The lap belt should sit low on your child's hips, not across the stomach.

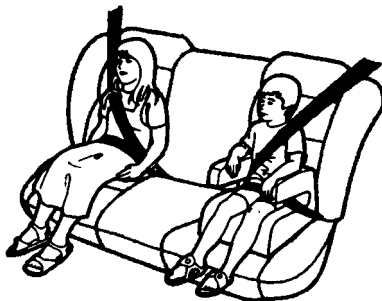

If the shoulder belt crosses the neck, have your child move toward the center of the rear seat until the belt fits properly. If the belt still crosses the child's neck, you should use a booster seat.

Several styles of booster seats are available. We recommend a design that allows the child to use the car's lap/shoulder belt.

Whichever style you select, follow the booster seat manufacturer's instructions.

Using a Seat Belt Locking Clip

Always use a seat belt locking clip when you secure a child seat to your car with a lap/shoulder belt. This helps prevent the seat from shifting position or overturning.

A locking clip is usually included with the child seat. If you need a clip, contact the seat's manufacturer or a store that sells child restraints.

To install a locking clip, do this:

1. Place the child restraint in the desired position. Route the lap/shoulder belt through the restraint according to the seat manufacturer's instructions.
2. Insert the latch plate into the buckle. Pull on the shoulder part of the belt to make sure there is no slack in the lap portion.
3. Tightly grasp the belt near the latch plate. Pinch both parts of the belt together so they won't slip through the latch plate. Unbuckle the seat belt.

4. Install the locking clip as shown. Position the clip as close as possible to the latch plate.

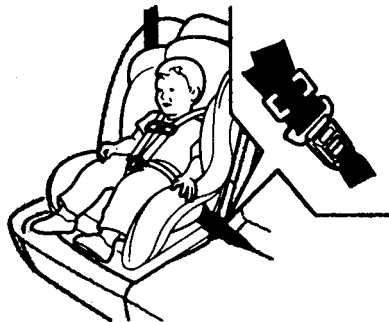

5. Insert the latch plate into the buckle. Push and pull on the child seat to verify that it is held firmly in place. If it is not, repeat these steps until the restraint is secure.

Using Child Restraints With Tethers

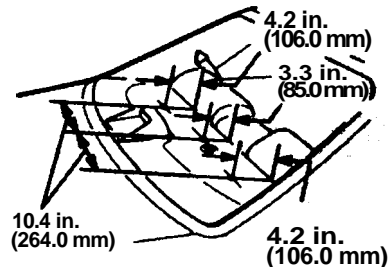

Your Honda has three attachment points for tether-style child seats. Use the dimensions in the above illustration to locate the attachment point you want to use.

Child Safety

Cut a 1/2 inch (12.7 mm) diameter hole in the rear shelf, then install the tether hardware that came with the child seat. Tighten the bolt to: 16 lb-ft (2.2 kg-m, 22 N.m).

If you are not sure how to install the bracket, have it installed by your authorized Honda dealer.

If you need an anchor plate and mounting hardware, you can obtain them by writing to:

American Honda Motor Co., Inc.
Consumer Affairs
1919 Torrance Blvd.
Torrance, CA 90501-2746

Canadian Cars

The anchor plate and mounting hardware for a top tether are supplied with the car. When installing, make sure the toothed washer is on the bottom of the bolt.

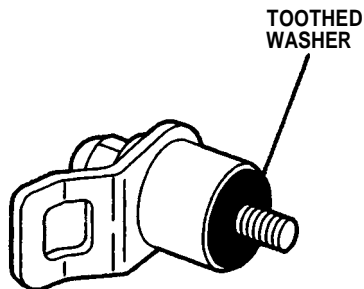

The supplied anchor plate is designed only for mounting a child restraint. Do not use it for any other purpose.

Storing a Child Seat

When you are not using an infant seat or other child restraint, either remove it or make sure it is properly secured so it cannot be thrown around the car during a crash.

Your car's exhaust contains carbon monoxide gas. You should have no problem with carbon monoxide entering the car in normal driving if you maintain your car properly. Have the exhaust system inspected for leaks whenever:

- The car is raised for an oil change.
- You notice a change in the sound of the exhaust.
- The car was in an accident that may have damaged the underside.



Carbon monoxide gas is toxic. Breathing it can cause unconsciousness and can even kill you.

Avoid any enclosed areas or activities that expose you to carbon monoxide.

High levels of carbon monoxide can collect rapidly in enclosed areas, such as a garage. Do not run the engine with the garage door closed. Even with the door open, run the engine only long enough to move the car out of the garage.

With the trunk lid open, air flow can pull exhaust gas into the trunk. This can get into your car's interior and create a hazardous condition. If you must drive with the trunk lid open, open all the windows and set the heating and cooling system as shown below.

If you must sit in your parked car, even in an unconfined area, with the engine running, adjust the heating and cooling system as follows:

1. Push the  button.
2. Select the  mode.
3. Turn the fan on high speed.
4. Set the temperature control to a comfortable setting.

Safety Labels

These labels are in the locations shown. They warn you of potential hazards that could cause serious injury. Read these labels carefully and don't remove them.

If a label comes off or becomes hard to read, contact your Honda dealer for a replacement.

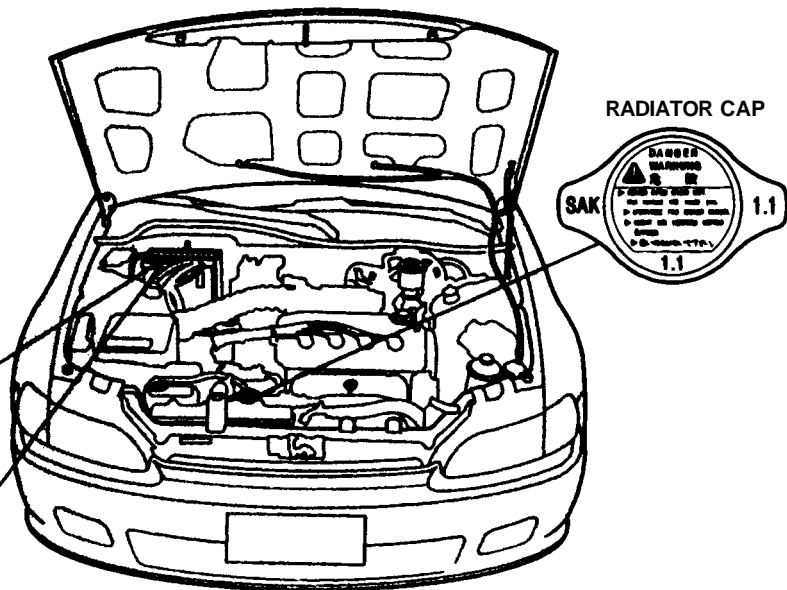

BATTERY



This section gives information about the controls and displays that contribute to the daily operation of your Honda. All the essential controls are within easy reach.

Control Locations	26	Keys and Locks	40
Indicator Lights	27	Keys	40
Gauges	30	Ignition Switch	40
Speedometer	30	Door Locks	41
Tachometer	30	Power Door Locks	42
Odometer	31	Trunk	42
Trip Meter	31	Seat Adjustments	43
Fuel Gauge	31	Front Seat Adjustments . . .	43
Temperature Gauge	31	Folding Rear Seat	45
Controls Near the		Power Windows	46
Steering Wheel	32	Moonroof	47
Headlights	33	Mirrors	48
Daytime Running Lights . . .	33	Parking Brake	49
Instrument Panel		Glove Box	50
Brightness	34	Digital Clock	50
Turn Signals	34	Beverage Holder	51
Windshield Wipers	34	Cigarette Lighter	52
Windshield Washers	35	Ashtrays	52
Hazard Warning	35	Interior Light	53
Rear Window Defogger . . .	36		
Steering Wheel Adjustment	36		
Steering Wheel Controls	37		
Cruise Control	37		

Control Locations

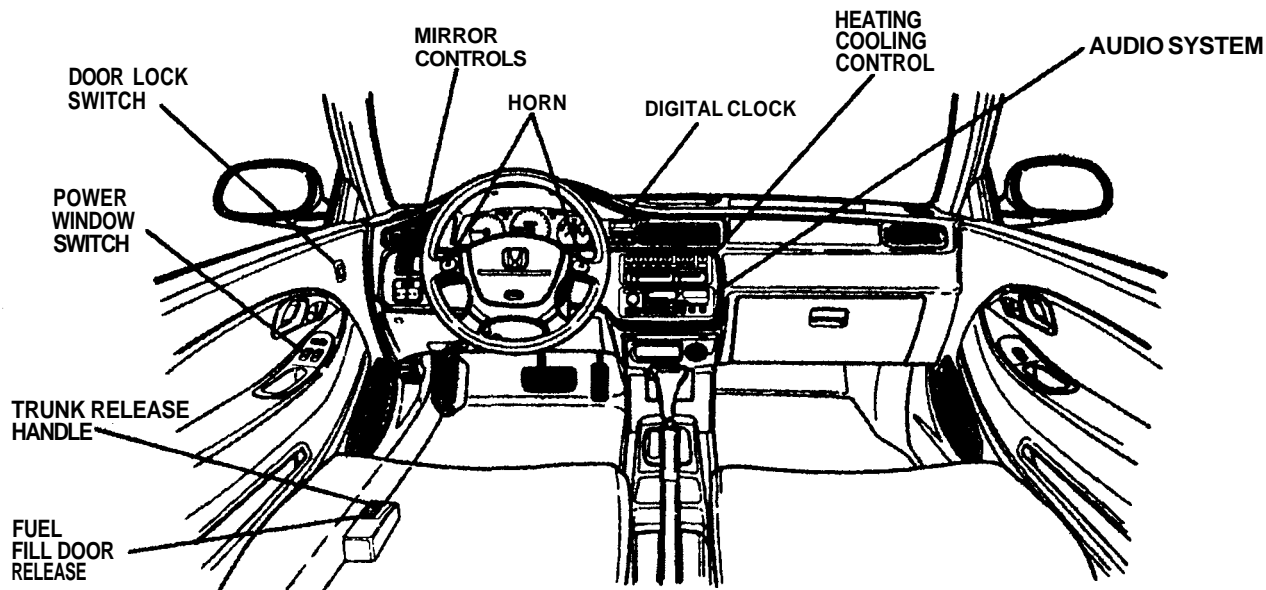

U.S. EX, Canada Si Shown

The instrument panel has many indicators to give you important information about your car.

Lamp Check

Many of the indicator lights come on when you turn the ignition switch ON (II), allowing you to see that they are working. If an indicator does not light during this test, it cannot alert you if that system develops a problem. Have the dealer check your car for burned-out bulbs or other problems.

* The U.S. EX with ABS option instrument panel is shown. Differences for the Canadian model are noted in the text.

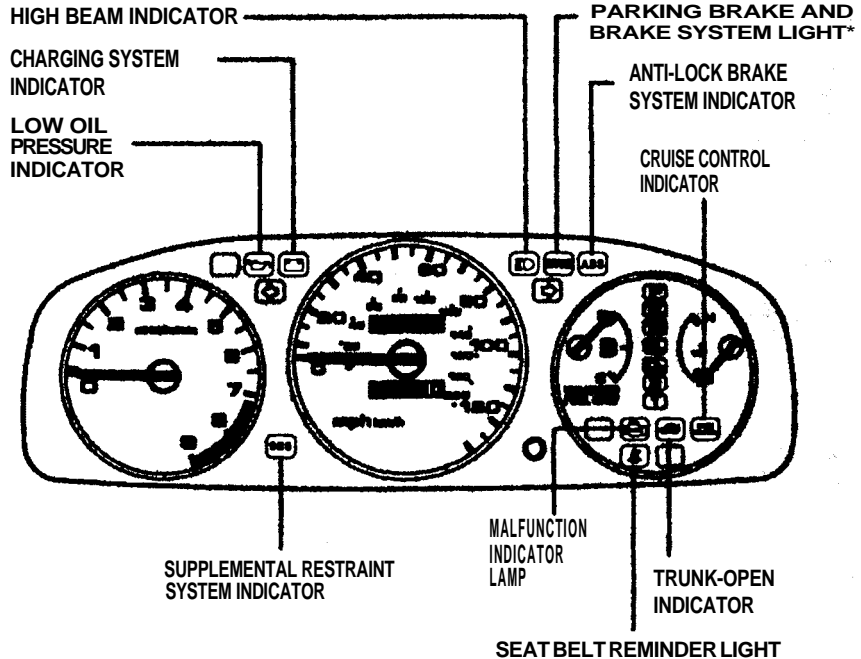

U.S. EX Automatic Transmission Shown

Indicator Lights



Seat Belt Reminder Light

This indicator lights when you turn the ignition ON (II). It is a reminder to you and your passengers to protect yourselves by fastening the seat belts. A beeper also sounds if you have not fastened your seat belt.

If you do not fasten your seat belt, the beeper will stop after a few seconds but the light stays on until you do. Both the light and the beeper stay off if you fasten your seat belt before turning on the ignition.



Charging System Indicator

The battery is not being charged if this light comes on when the engine is running.



Low Oil Pressure Indicator

The engine can be severely damaged if this light comes on when the engine is running. For complete information, see page [154](#).

U.S. Canada **Parking Brake and Brake System Indicator Light**



This light has two functions:

1. It lights as a reminder that you have set the parking brake. Driving with the parking brake set can damage the brakes and tires. It will also cause the anti-lock brake system to turn off on cars with the ABS option. (See page [92](#)).

2. It can indicate the brake fluid level is low if it remains lit after you release the parking brake or comes on while driving. This is normally due to worn brake pads. Have your dealer check the braking system for worn pads or fluid leaks.



Supplemental Restraint System Indicator

The SRS light normally comes on for a few seconds when you turn the ignition ON (II). If it doesn't, or if it stays on after the engine starts, something is wrong with the Supplemental Restraint System. It may also flash on and off to indicate a problem.

If you see any of these indications, the airbags may not work when needed in an accident. Take the car to your dealer promptly for diagnosis and service.

ABS Anti-Lock Brake System (ABS) Indicator

On U.S. EX with ABS option (see page 92)

This light normally comes on when you turn the ignition ON (II) and goes off after the engine starts. If it comes on at any other time, there is a problem in the ABS. If this happens, stop the car in a safe place, and turn off the engine. Reset the system by restarting the engine. Watch the ABS light. If it does not go off, or comes back on again while driving, take

the car to your dealer to have it checked. With the light on, your car still has normal braking ability but no anti-lock.



U.S.: Malfunction Indicator Lamp



Canada: Check Engine Light

This light comes on for a few seconds when you turn the ignition switch ON (II). If it comes on at any other time, it indicates one of the engine's emissions control systems may have a problem. Turn to page 155 for information about what to do.



Trunk-Open Indicator

This light comes on if the trunk lid is not closed tightly.



Turn Signal and Hazard Warning Indicators

The left or right turn signal light blinks when you signal a lane change or turn. If the light does not blink or blinks rapidly, it usually means one of the turn signal bulbs is burned out (see page 131). Replace it as soon as possible, since other drivers cannot see that you are signaling.

When you turn on the Hazard Warning switch, both turn signal lights blink. All turn signals on the outside of the car should flash.

Indicator Lights, Gauges



High Beam Indicator

This light comes on with the high beam headlights. See page 33 for information on the headlight controls.

Canada



Daytime Running Lights (DRL) Indicator

On Canadian models, this indicator comes on with reduced brightness when the Daytime Running Lights (DRL) are on (see page 33).



Cruise Control Indicator

Only on cars equipped with cruise control system

This lights when you set the cruise control. See page 37 for information on operating the cruise control.

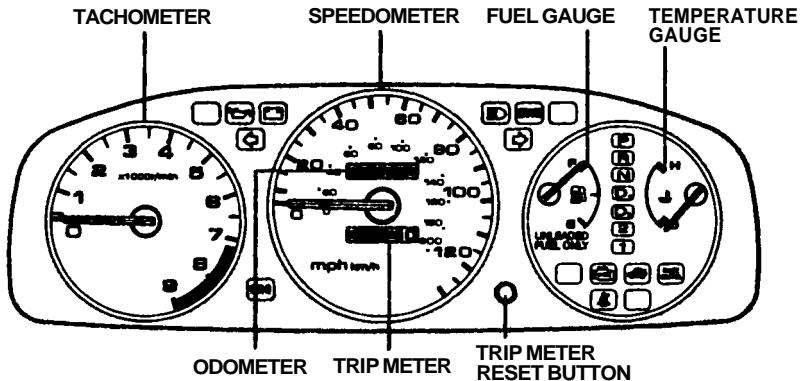

Automatic Transmission Shown

Speedometer

U.S. Models

This shows your speed in miles per hour. The smaller inner numbers are the speed in kilometers per hour.

Canadian Models

This shows your speed in kilometers per hour. The smaller

inner numbers are the speed in miles per hour.

Tachometer

The tachometer shows the engine speed in revolutions per minute (rpm). To protect the engine from damage, never drive with the tachometer needle in the red zone.

Odometer

The odometer shows the total distance your car has been driven. It measures miles in U.S. models and kilometers in Canadian models. It is illegal under federal law (in the U.S.) and provincial regulations (in Canada) to disconnect, reset, or alter the odometer with the intent to change the number of miles or kilometers indicated.

Trip Meter

This meter shows the number of miles (U.S.) or kilometers (Canada) driven since you last reset it. To reset it, push the trip meter reset button.

Fuel Gauge

This shows how much fuel you have. It is most accurate when the car is on level ground. It may show slightly more or less than the actual amount when you are driving on curvy or hilly roads.

The gauge stays at the same fuel level reading after you turn off the ignition. When you add fuel, the gauge slowly changes to the new reading after you turn the ignition back ON (II).

Temperature Gauge

This shows the temperature of the engine's coolant. During normal operation, the pointer should rise from the bottom white mark to about the middle of the gauge. In severe driving conditions, such as very hot weather or a long period of uphill driving, the pointer may rise to the upper white mark. If it reaches the red (hot) mark, pull safely to the side of the road. Turn to page [152](#) for instructions and precautions on checking the engine's cooling system.

Controls Near the Steering Wheel

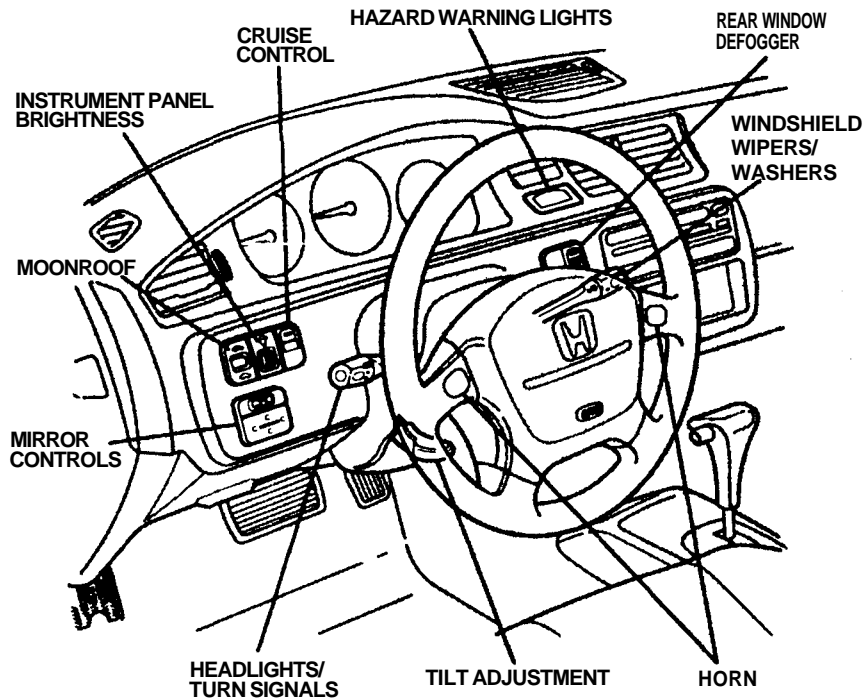

The two levers on the steering column contain controls for driving features you use most often. The left lever controls the turn signals, headlights, and high beams. The right lever controls the windshield wipers.

The rear window defogger switch is on the dashboard to the right of the steering column.

The controls under the left air vent are for the moonroof, mirrors, cruise control, and instrument panel brightness.

The lever on the underside of the steering column allows you to tilt the steering wheel.

Headlights

The rotating switch on the left lever controls the lights. Turning this switch to the first position "●" turns on the parking lights, tail lights, instrument panel lights, side-marker lights, and rear license plate lights. Turning the switch to the second position "●" turns on the headlights.

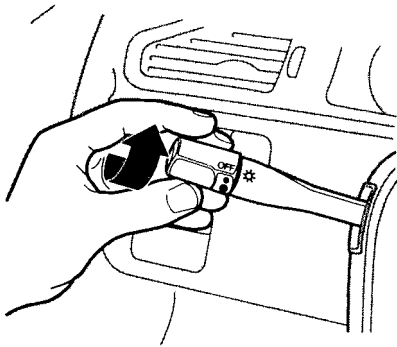

To change between low beams and high beams, pull the turn signal lever toward you until you hear a click, then let go. The high beam indicator will light (see page 30).

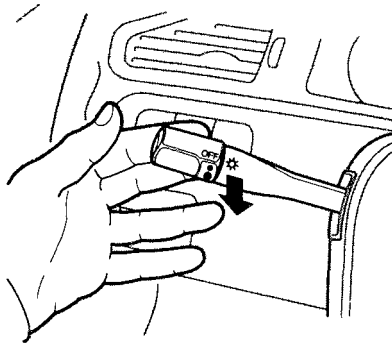

To flash the high beams, pull back and hold the turn signal lever. Release the lever, and the high beams will go off.

The high beams will stay on for as long as you hold the lever, no matter what position the headlight switch is in.

Daytime Running Lights

Canadian Models

With the headlight switch off, the high beam headlights come on with reduced brightness when you turn the ignition switch to ON (II) and release the parking brake. They remain on until you turn the ignition off, even if you set the parking brake.

The headlights revert to normal operation when you turn them on with the switch.

Controls Near the Steering Wheel

Instrument Panel Brightness

The dial on the dashboard to the left of the instrument panel controls the brightness of the instrument panel lights. Turn the dial to adjust the brightness.

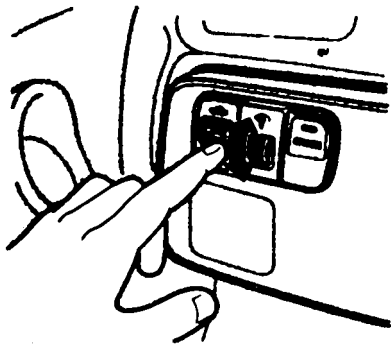

Turn Signals

Signal a turn or lane change with this lever. Push down on the lever to signal a left turn, and up

to signal a right turn. If you push it up or down all the way, the turn signal continues to blink even when you release the lever. It shuts off automatically as you complete the turn.

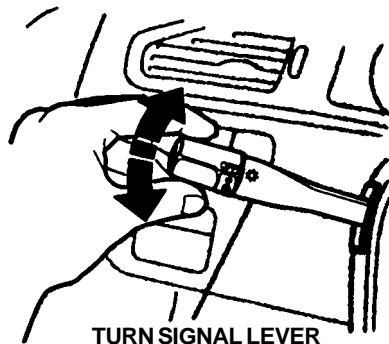

To signal a lane change, push lightly on the turn signal lever in the proper direction, and hold it. The lever will return to the

center position as soon as you release it.

Windshield Wipers

The right lever controls the windshield wipers and washers. The rotary switch at the end of the lever has three positions: INT - intermittent, LO - low speed, HI - high speed

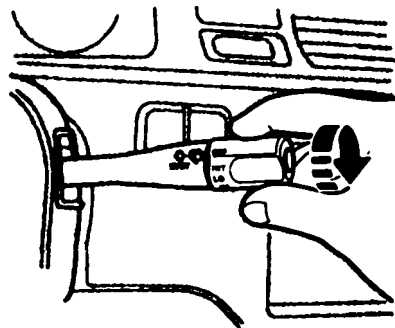

In intermittent, the wipers operate every few seconds. In low speed and high speed, the wipers run continuously.

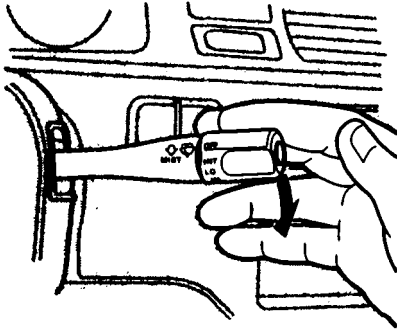

To operate the wipers in mist mode, push the control lever down. The wipers run at high speed until you release the lever. This gives you a quick way to clear the windshield.

Windshield Washers

U.S. Models

To clean the windshield, pull the wiper control lever toward you. The washers spray until you release the lever.

Canadian Models

The wipers run at low speed while you're pulling the lever, then complete one more sweep of the windshield after you release it.

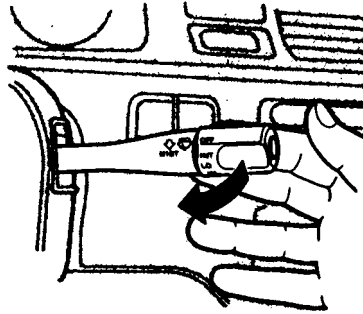

Hazard Warning

Push the red button under the clock to turn on the hazard warning lights (four-way flashers). This causes all four outside turn signals and both indicators in the instrument panel to flash. Use the hazard warning lights if you need to park in a dangerous area near heavy traffic or if your car is disabled.

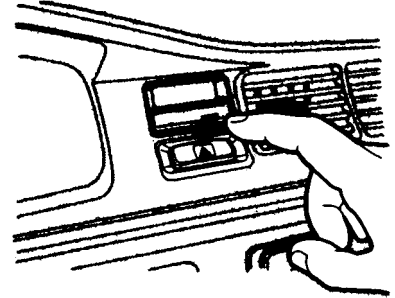

Controls Near the Steering Wheel

Rear Window Defogger

The rear window defogger will clear fog, frost, and thin ice from the window. Push the defogger button to turn it on and off. The light in the button lights to show the defogger is on. If you do not turn it off, the defogger will shut itself off after about 25 minutes. It also shuts off when you turn off the ignition. You have to turn it on again when you restart the car.

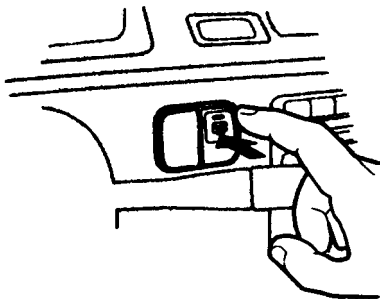

Make sure the rear window is clear and you have good visibility before starting to drive.

The defogger wires on the inside of the rear window can be accidentally damaged. When cleaning the glass, always wipe side to side.

Steering Wheel Adjustment

You can adjust the steering wheel height to suit your preference. Do this before you begin driving.

Adjusting the steering wheel position while driving may cause you to lose control of the car and be seriously injured in a crash.

Adjust the steering wheel when the car is stopped.

1. Adjust the seat so you are a comfortable distance from the pedals and can operate them safely.
2. The lever to tilt the steering wheel is under the steering column to the left. Push this lever all the way down.

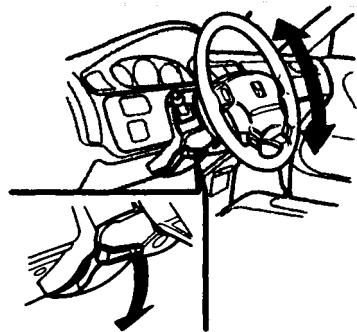

3. Move the steering wheel up or down to the desired

position. Position the wheel so you can see all the instrument panel gauges and warning lights. Push the lever up to lock the steering wheel in that position.

4. Make sure you have securely locked the steering wheel in place by trying to move it up and down.

Cruise Control

Available only on EX in the U.S., and Si model in Canada

Cruise control allows you to maintain a set speed above 25 mph (40 km/h) without keeping your foot on the accelerator pedal. It is for cruising on straight, open highways. It is not recommended for conditions such as city driving, winding roads, slippery roads, heavy rain, or bad

weather. You should have full control of the car under those conditions.

Improper use of the cruise control can lead to a crash.

Use the cruise control only when traveling on open highways in good weather.

NOTICE

The cruise control, as it operates, moves the accelerator pedal. You can damage your car's accelerator mechanism by resting your foot under the pedal and blocking the movement.

Using the Cruise Control

1. Push in the Cruise Control Master Switch to the left of the steering column. The indicator in the switch will light.

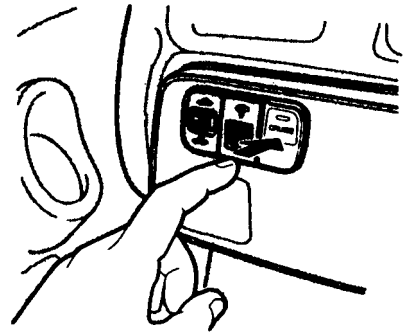

2. Accelerate to the desired cruising speed above 25 mph (40 km/h).

Steering Wheel Controls

3. Press and hold the SET/decel button on the steering wheel until the CRUISE CONTROL light on the instrument panel comes on. This shows the system is now activated.

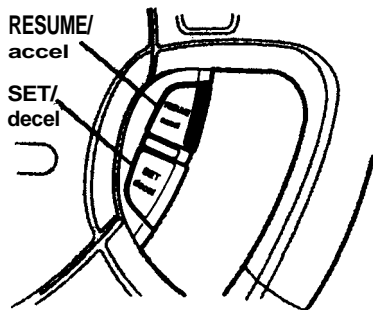

The set speed may vary slightly, particularly on hills.

Changing the Set Speed

You can increase the set cruising speed in either of two ways:

- Press and hold the RESUME/accel button. The car will accelerate slowly. When you reach the desired cruising speed, release the button.
- Push on the accelerator pedal. Accelerate to the desired cruising speed and press the SET/decel button.

You can decrease the set cruising speed in either of two ways:

- Press and hold the SET/decel button. The car will decelerate. Release the button when you reach the desired speed.

- Tap the brake or clutch pedal lightly with your foot. The CRUISE CONTROL light on the instrument panel will go out. When the car slows to the desired speed, press the SET/decel button. The car will then maintain the desired speed.

Even with the cruise control turned on, you can still use the accelerator pedal to speed up for passing. After completing the pass, take your foot off the accelerator pedal. The car will return to the set cruising speed.

Resting your foot on the brake or clutch pedal will cause the cruise control to cancel.

Canceling the Cruise Control

You can cancel the cruise control in any of these ways:

- Tap the brake or clutch pedal.
- Press the SET/decel and RESUME/accel buttons at the same time.
- Press the Cruise Control Master Switch.

When you tap the brake or clutch pedal (manual transmission cars) or press the SET and RESUME buttons at the same time, the CRUISE CONTROL light on the instrument panel will go out and the car will begin to slow down. You can use the accelerator pedal in the normal way.

If you use the brake or clutch pedal to cancel cruise control, the system retains the previously set cruising speed. To return to that speed, accelerate to above 25 mph (40 km/h), and press the RESUME/accel button until the CRUISE CONTROL light comes on. The car will accelerate to the same cruising speed as before.

If you cancel cruise control by pressing the SET and RESUME BUTTONS at the same time, the previously set cruising speed is erased. To use the cruise control, accelerate to the desired cruising speed, and press the SET/decel button.

Pressing the Cruise Control Master Switch turns the system completely off and erases the previous cruising speed from memory. To use the system again, refer to ***Using the Cruise Control***.

Keys and Locks

Keys

Your car comes with two kinds of keys: a master key and a valet key. The master key fits all locks on your car:

- Ignition
- Doors
- Trunk
- Trunk release handle
- Rear seat trunk access

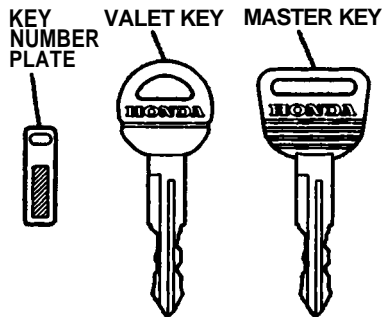

The valet key works only in the ignition and the door locks. You can keep the glove box locked when you leave your car and valet key at a parking facility.

You should have received a key number plate with your set of keys. You will need this number if you have to get a lost key replaced. Keep the plate stored in a safe place. When replacing keys, use only Honda-approved key blanks.

Ignition Switch

The ignition switch is on the right side of the steering column. It has four positions:

- LOCK (0)
- ACCESSORY (I)
- ON (II)
- START (HI)

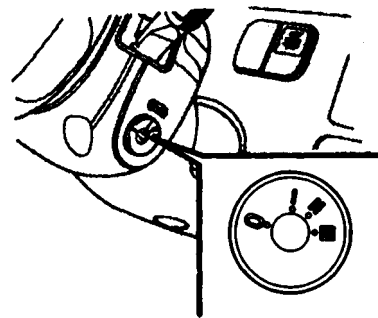

LOCK (0) — You can insert or remove the key only in this

position. When you turn the key from LOCK to ACCESSORY, you may have to turn the steering wheel to release the anti-theft lock. To switch from ACCESSORY to LOCK, you must push the key in slightly as you turn it. If your car has an automatic transmission, it must also be in Park. The anti-theft lock will lock the steering column when you remove the key.

Removing the key from the ignition switch while driving locks the steering. This can cause you to lose control.

Remove the key from the ignition switch only when parked.

ACCESSORY (I) — In this position, you can operate the audio system and cigarette lighter.

ON (II) — This is the normal key position when driving. All features and accessories on the car are usable. Several of the lights on the instrument panel come on as a test when you turn the ignition switch from ACCESSORY to ON (see page 27).

START (III) — Use this position only to start the engine. The switch returns to ON when you let go of the key.

You will hear a reminder beeper if you open either front door with the key in the LOCK or ACCESSORY position. Remove the key to turn it off.

Door Locks

Each door has a lock tab next to the inside door handle. Push the tab forward to lock the door, and pull it backward to unlock.

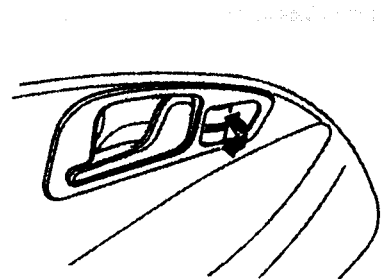

To lock the passenger's door when getting out of the car, push the lock tab forward, and close the door. To lock the driver's door, pull the outside door

Keys and Locks

handle, and push the lock tab forward. Release the handle; then close the door.

Power Door Locks

Available on U.S. EX model

This allows control of both door locks from the driver's door. Push the master door lock switch down to lock both doors and up to unlock them.

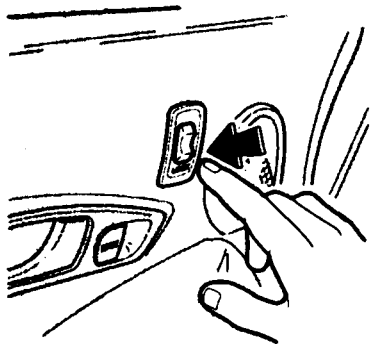

Both doors lock when you push the lock tab on the driver's door. Only the driver's door unlocks when you use the key or lock tab. To unlock the passenger's door, use the master door lock switch or the lock tab on each door.

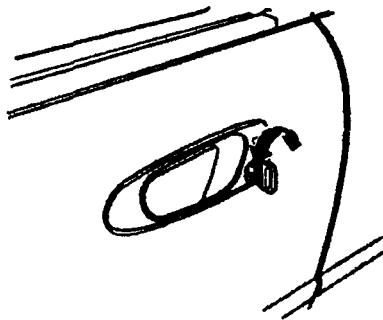

The doors can also be locked and unlocked from the outside with the key.

Trunk

You can open the trunk in two ways:

- Pull the trunk release handle to the left of the driver's seat.

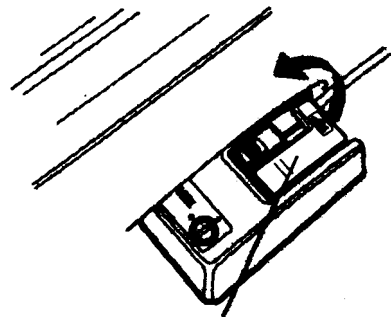

TRUNK RELEASE HANDLE

- Use the master key to open the trunk lock. The valet key does not work in this lock.

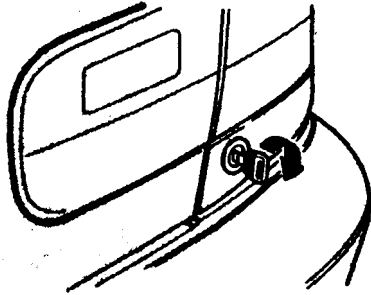

See page [81](#) for cargo loading and weight-limit information. Keep the trunk lid closed at all times while driving to avoid damaging the lid and getting exhaust gas in the interior. See Carbon Monoxide Hazard on page [23](#).

To protect items in the trunk when you need to give the key to someone else, lock the trunk release handle with the master key, and give the other person the valet key.

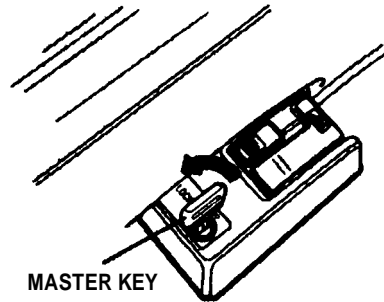

Seat Adjustments

Adjust the seat before you start driving.

Front Seat Adjustments

To adjust the seat forward and backward, pull up on the lever under the seat cushion's front edge. Move the seat to the desired position, and release the lever. Try to move the seat to make sure it is locked in position.

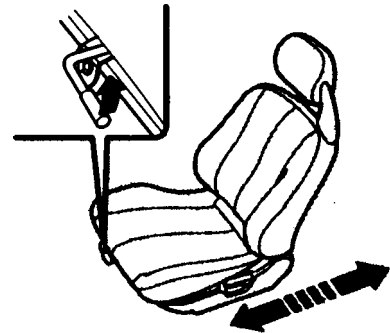

Seat Adjustments

To change the angle of the seat-back, pull up on the lever on the outside of the seat bottom. Move the seat-back to the desired position, and release the lever. Let the seat-back latch in the new position.

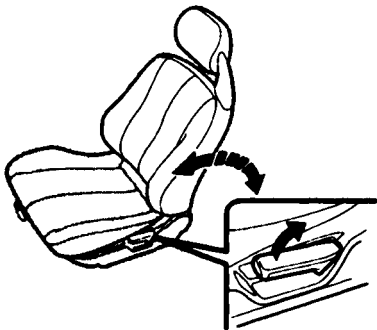

Reclining the seat-back can decrease the protection you get from your seat belt in a crash.

You can slide under the seat belt and be seriously injured.

Adjust the seat-back to an upright position, and sit well back in the seat.

Rear Seat Access

On the U.S. EX and Canada Si (Passenger side only)

To get in or out of the rear seat, pull up on the lever at the side of the front passenger's seat. The seat-back will fold down, and the front passenger's seat will move forward.

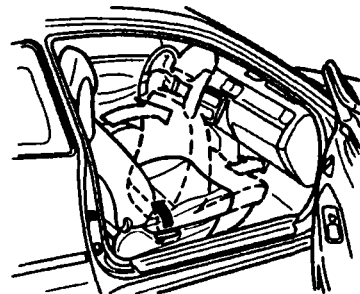

The seat will lock in place when it is pushed back.

Folding Rear Seat

The back of the rear seat folds down, giving you direct access to the trunk. The seat-back can be released from inside the car or inside the trunk.

To fold down the seat-back from inside the car, insert the master key in the lock on the rear shelf. Turn the key clockwise, and pull down the top of the seat-back; then release the key.

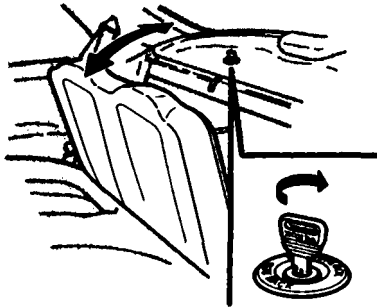

To release the seat-back from inside the trunk, pull the release loop under the rear shelf. Push the seat-back down; then let go of the loop.

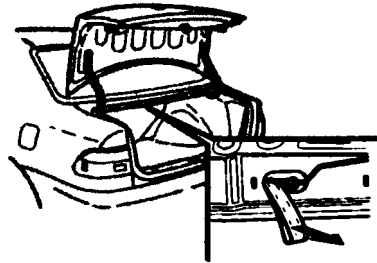

To lock the seat-back upright, push it firmly against the rear shelf. Make sure it is latched in place by pulling on the top of the seat.

Make sure all items in the trunk, or items extending through the opening into the back seat, are tied down. Loose items can fly forward and cause injury if you have to brake hard. See **Loading Cargo** on page 81.

Never drive with the seat-back folded down and the trunk lid open. See **Carbon Monoxide Hazard** on page 23.

Power Windows

On U.S. EX model

Your car's windows are electrically powered. Turn the ignition switch to ON (II) to raise or lower a window.

Each door has a switch that controls its window. To open the window, push the switch down and hold it. Release the switch when you want the window to stop. Close the window by pushing the switch up and holding it.

The driver's armrest has a master power window control panel. To open the passenger's window, push down on the appropriate switch, and hold it down until the window reaches the desired position. To close the window, push up on the window switch. Release the switch when

the window gets to the position you want.

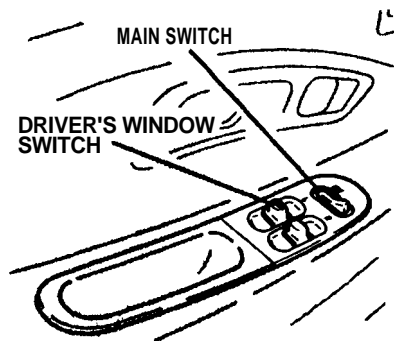

The master control panel also contains these extra features:

AUTO — To open the driver's window fully, push the window switch firmly down and release it. The window automatically goes all the way down. To stop

the window from going all the way down, push the window switch up briefly.

To open the driver's window only partially, push the window switch down lightly and hold it. The window will stop as soon as you release the switch.

The AUTO function only works to lower the driver's window. To raise the window, you must push the window switch up and hold it until the window reaches the desired position.

The MAIN switch controls power to the passengers' windows. With this switch off, the passengers' windows cannot be raised or lowered. The MAIN switch does not affect the driver's window. Keep the MAIN switch off when you have

children in the car so they do not injure themselves by operating the window unintentionally.

Closing a power window on a child's hands or fingers can cause serious injury.

Make sure children are away from the windows before closing them.

Moonroof

On EX in the U.S. and Si model in Canada

Use the switches on the dashboard under the left vent to operate the moonroof. The ignition must be ON (II).

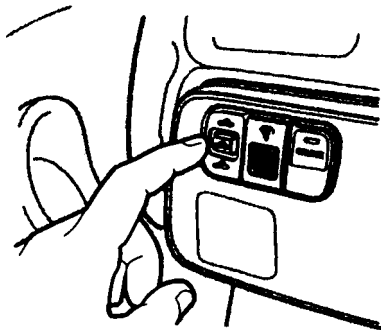

To lift the rear of the moonroof for ventilation, push the  button. To slide the moonroof

back, push the  switch. Hold it until the moonroof reaches the desired position, and then release the switch.

To close the moonroof, press and hold the  switch.

Closing the moonroof on someone's hands or fingers can cause serious injury.

Make sure passengers are clear of the moonroof before closing it.

NOTICE

If you try to open the moonroof in below-freezing temperatures, or when it is covered with snow or ice, you can damage the moonroof panel or motor.

Mirrors

Keep the inside and outside mirrors clean and adjusted for best visibility. Be sure to adjust the mirrors before you start driving.

The inside mirror has day and night positions. The night position reduces glare from headlights behind you. Flip the tab on the bottom edge of the mirror to select the day or night position.

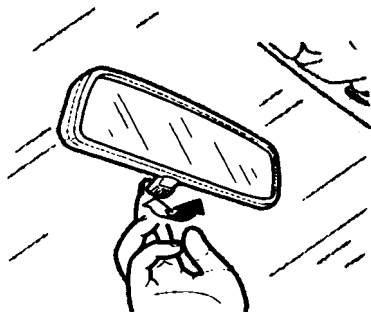

Manual Door Mirrors

Only on DX models

The outside mirrors can be adjusted by moving the knob on the inside of the door.

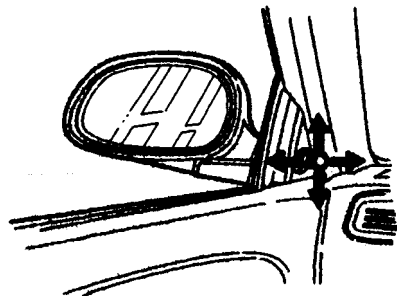

Adjusting the Power Mirrors

On the EX in the U.S. and Si in Canada

Adjust the outside mirrors with

the adjustment switch on the left side of the dashboard:

1. Turn the ignition switch ON (II).
2. Move the selector switch to L (driver's side) or R (passenger's side).

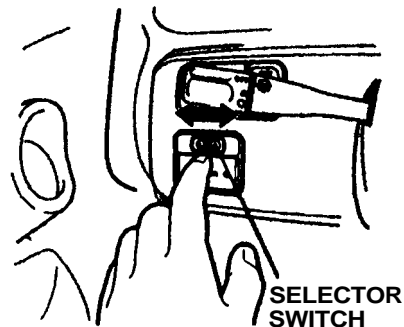

3. Push the appropriate edge of the adjustment switch to

move the mirror right, left, up, or down.

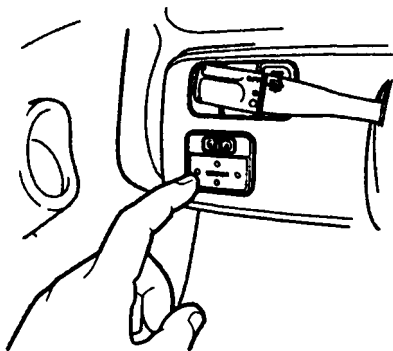

4. When you finish, move the selector switch to the center (OFF) position. This turns off the adjustment switch so you can't move a mirror out of position by accidentally bumping the switch.

Parking Brake

To apply the parking brake, pull the lever up fully. To release it, pull up slightly, push the button, and lower the lever. The parking brake light on the instrument panel should go out when the parking brake is fully released (see page 28).

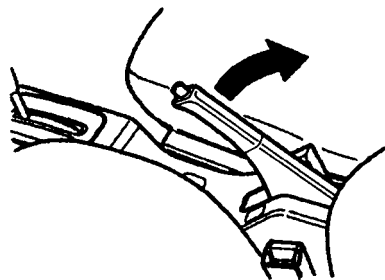

NOTICE

Driving the car with the parking brake applied can damage the rear brakes and axles.

Glove Box, Digital Clock

Glove Box

Open the glove box by pulling the handle. Close it with a firm push.

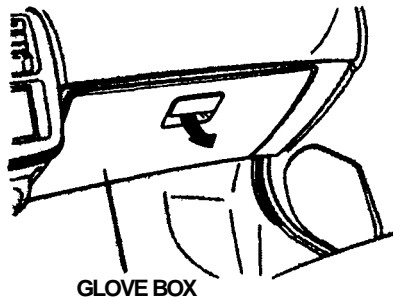

An open glove box can cause serious injury to your passenger in a crash, even if the passenger is wearing the seat belt.

Always keep the glove box closed while driving.

Digital Clock

EX models in the U.S. and Si models in Canada

The digital clock displays the time with the ignition switch ON (II). To see the time with the ignition off, press and hold the wide button under the clock.

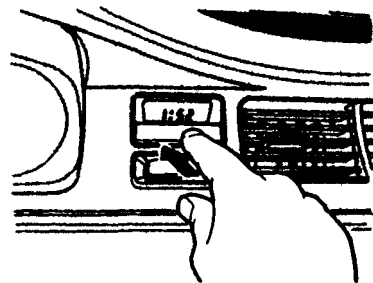

Use the buttons to set the clock:

1. Turn the ignition switch ON (II) to display the time.
2. Swing down the front cover of the wide button under the clock display. You will see H, M, and RESET buttons.

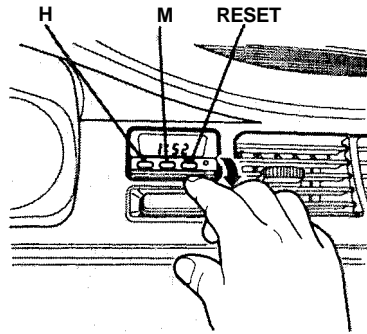

3. Press and hold the H button until the number advances to the desired hour.

4. Press and hold the M button until the numbers advance to the desired time.

You can use the RESET button to quickly set the time to the nearest hour. If the displayed time is before the half hour, pressing RESET sets the clock back to the previous hour. If the displayed time is after the half hour, pressing RESET sets the clock forward to the beginning of the next hour.

For example

- 1:06 would RESET backward to 1:00.
- 1:52 would RESET forward to 2:00.

Beverage Holder

To open the beverage holder, push on the top. The beverage holder lid is spring-loaded and will pop open. To close it, push it down until it latches.

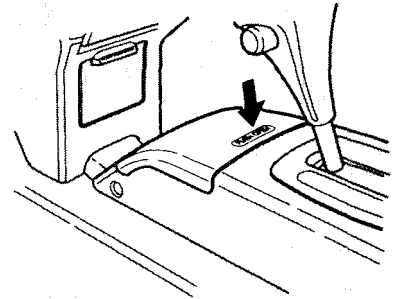

Use the beverage holder only when the car is parked. If you place cups in the holder while driving, the liquid may spill when

Beverage Holder, Cigarette Lighter, Ashtrays

you go over bumps or around corners.



Be careful when you are using the beverage holder. Spilled liquids can damage the upholstery, carpeting, and electrical components in the interior. If the liquid is very hot, it can scald you or your passengers.

Cigarette Lighter

The ignition switch must be in ACCESSORY (I) or ON (II) for the cigarette lighter to work. To heat up the lighter, push it in. It will pop out when it is ready for use. Do not hold the lighter in while it is heating up, you could cause it to overheat.

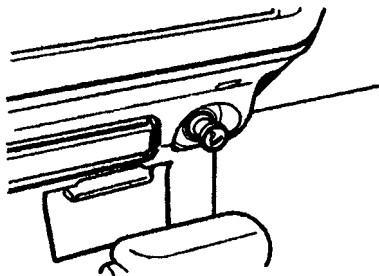

Ashtrays

Open the front ashtray by pulling on the bottom edge. Push it in to close it.

To remove the ashtray for emptying, push down on the metal plate inside, then pull the ashtray out completely.

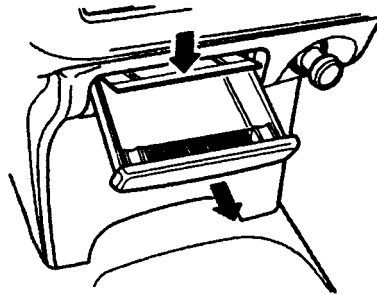

The rear ashtray is at the rear end of the center console. Open the ashtray by swinging the

upper edge of the lid down. To remove the ashtray for emptying, open it, and then lift up and out.

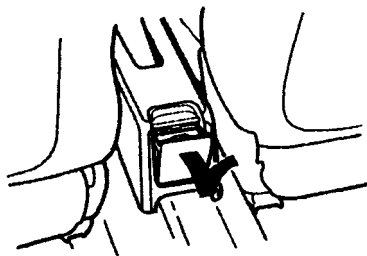

NOTICE

Use the ashtray only for cigarettes, cigars and other smoking materials. To prevent a possible fire and damage to your car, don't put paper or other things that can burn in the ashtrays.

Interior Light

The interior light has a three-position switch. In the OFF (forward) position, the light does not come on. In the center position, the interior light comes on when you open either front door. In the ON (rearward) position, the interior light stays on continuously.

DOOR ACTIVATED

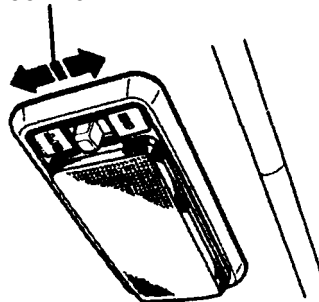

The heating/ventilation system in your car, when combined with the optional air conditioner, provides a comfortable driving environment in all weather conditions.

U.S. EX and Canada Si models

The standard audio system is very versatile. To get the most benefit from this system, read its description in this manual.

The anti-theft feature on your radio disables the system. To get the system working again you must enter a code number as described in this manual.

For other models

Refer to the operating instructions that came with the optional audio system you selected.

Heating and Cooling	56
What Each Control Does ..	58
How to Use the System	58
Controlling Air	
Flow Direction	59
Ventilation	59
To Cool With A/C	59
To Heat	60
To Heat and Dehumidify	
With Air Conditioning .	60
To Defog and Defrost ...	60
To Turn Everything Off	61
Audio System	62
Operating the Radio	62
Presetting Radio Stations ..	63
Adjusting the Sound	64
Radio Frequencies	65
Operating the	
Cassette Player	65
Caring for the	
Cassette Player	66
Operating the	
CD Player/Changer	67

Heating and Cooling

This system has full heating, ventilation, and air conditioning (optional) capabilities. You can adjust the system controls to mix these in various combinations. The air flows into the interior at three possible levels that you can select.

A Genuine Honda air conditioning system is available from your dealer. It meets Honda's high quality standards and is designed to fit your car. If you purchased your car without air conditioning, it can be installed at a later time. Please contact your dealer for more information.

The direction of air flow from the vents in the center and each side

Move the tab in the center of each vent up and down and side to side.

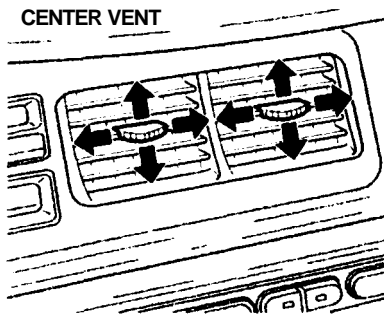

SIDE VENT

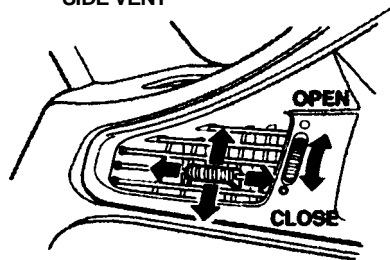

The side and upper vents can be opened and closed with the dials next to them.

UPPER VENT

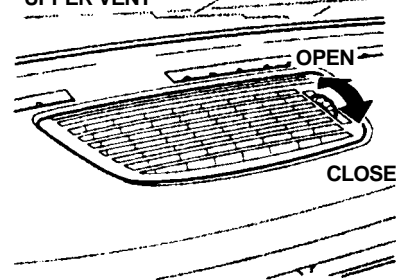

The heating and cooling system draws air through the exterior vents at the bottom of the windshield. Keep these vents clear of leaves and other debris.

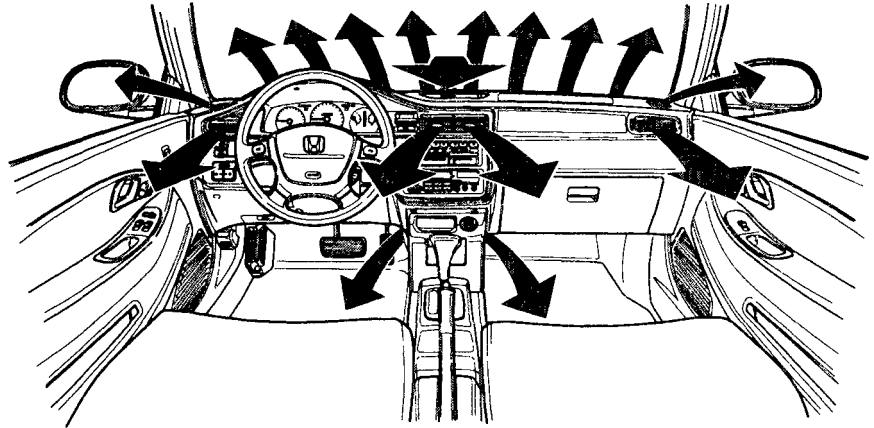

Heating and Cooling

What Each Control Does

Fan Control Lever

Sliding this lever to the right increases the fan speed, which increases air flow.

Temperature Control Lever

Sliding this lever to the right increases the temperature of air flowing through the system.

Mode Buttons

These buttons control the direction of air flow. The indicator light shows which button is controlling air flow.

Air Conditioning (A/C) Switch (Optional)

This switch turns the air conditioner ON and OFF. The indicator in the switch lights when the A/C is ON.

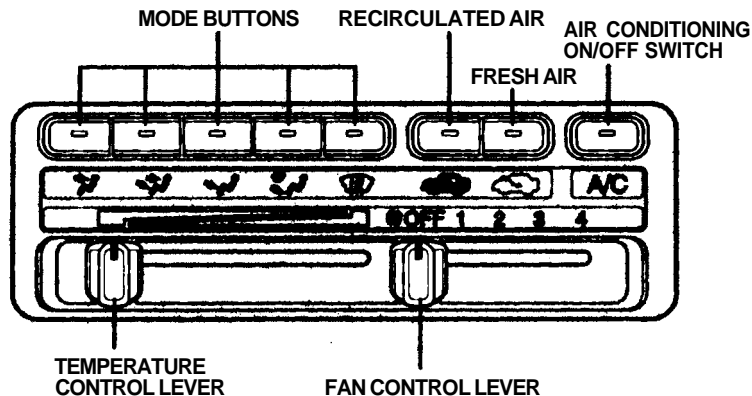



Fresh Air and Recirculation Buttons

These two buttons control the source of air going into the system. In Fresh Air mode, air comes from outside the car. In Recirculation mode, the interior air recycles through the system.

How to Use the System

This section covers the best way to use the system for ventilation, cooling, dehumidifying, defrosting, and heating. In most cases, the mode and air source selections are only recommendations. You may prefer different settings.

Use  mode to heat or cool the interior more quickly, or to keep out smoke and dust.

Leaving the system in recirculation mode with the air conditioning off can cause the windows to fog up. Switch to  mode as soon as the interior reaches a comfortable temperature or the outside smoky, dusty condition clears.

The engine must be running for the heater and air conditioning system to provide hot and cold air. The heater uses engine coolant to warm the air. If the engine is cold, it will be several minutes before you feel warm air circulating.

Air conditioning does not depend on engine temperature. It can produce cold air almost immediately.

Controlling Air Flow Direction

Air flows into the interior at three levels: Toward the floor



, through the dash vents



, and toward the windshield

and side windows .

You select the air flow level or combination of levels with the five mode buttons.



Ventilation

Your car has a flow-through ventilation system. Air enters the car through vents in front of the windshield. It circulates through the interior then exits through vents near the rear window. This system provides fresh air even when the car is standing still. To bring in outside air, press the  button. Set the fan at a comfortable speed.

To Cool With A/C (Optional)

To operate the air conditioning system, press the air conditioning switch. Set the fan to the desired speed. You can also use the  mode button to direct air out of the dash and heater vents.

After your car has been sitting in the sun, cool the interior down rapidly.

1. Start the engine.
2. Turn on the A/C by pressing the switch.
3. Set the fan to maximum speed.
4. Open the windows partially.
5. Select  and .

When the interior reaches a comfortable temperature, close



Heating and Cooling

the windows, and set the system for cooling as described above.

The air conditioning places an extra load on the engine. Watch the coolant temperature gauge (see page 31) when using the A/C in heavy traffic or driving up long hills. If it moves near the red zone, turn off the air conditioning until the gauge reads normal.

To Heat

To warm the interior:

1. Start the engine.
2. Select  and .
3. Switch the fan to the desired speed.
4. Adjust the warmth of the air with the temperature control lever.

To Heat and Dehumidify With Air Conditioning



Air conditioning removes moisture from the air as it operates. When used in combination with the heater, it makes the interior warm and dry.

1. Switch the fan on.
2. Turn on the air conditioning.
3. Select  and press any desired mode button.
4. Adjust the temperature control lever so the mixture of heated and cooled air feels comfortable.



This setting is suitable for all driving conditions whenever the outside temperature is above 32°F (0°C).

To Defog and Defrost

To remove fog from the inside of the windows:

1. Switch the fan on.
2. Turn on the air conditioning.
3. Select  and .
4. Adjust the temperature control lever so the airflow from the defroster vents feels warm.
5. Turn on the rear window defogger to help clear the rear window.

To remove exterior frost or ice from the windshield and side windows after the car has been sitting out in cold weather:

1. Start the engine.
2. Select  and .

3. Switch the fan and temperature controls to maximum.

To rapidly remove exterior frost or ice from the windshield (on very cold days), first select



. Once the windshield is clear, select  to avoid fogging the windows.

These settings direct all the air flow to the defroster vents at the base of the windshield and each front door window. The air flow will get warmer and clear the windows faster as the engine warms up. You can close the side vents with the dial beside each vent. This will send more warm air to the windshield defroster vents.

For safety, make sure you have a clear view through all the windows before driving away.

To Turn Everything Off

To shut off the system temporarily, slide the fan speed and temperature control levers all the way to the left.

You should only shut the system completely off for the first few minutes of driving in cold weather, until the engine coolant warms up enough to operate the heater. Keep the fan on at all other times so stale air does not build up in the interior.

Audio System

AM/FM/Cassette Stereo

Audio System

U.S. EX and Canada Si Models
Your Honda audio system is easy to use and will give clear AM/FM reception. The preset buttons allow you to select six stations on AM and 12 stations on FM.

The anti-theft feature disables the system if it is disconnected from the car's battery. To get the system working again, you must enter a code number. See page 71.

The cassette system uses Dolby B* noise reduction to give excellent sound reproduction. The system also senses when a metal or a chromium dioxide (CrO₂) tape is being played and adjusts accordingly.

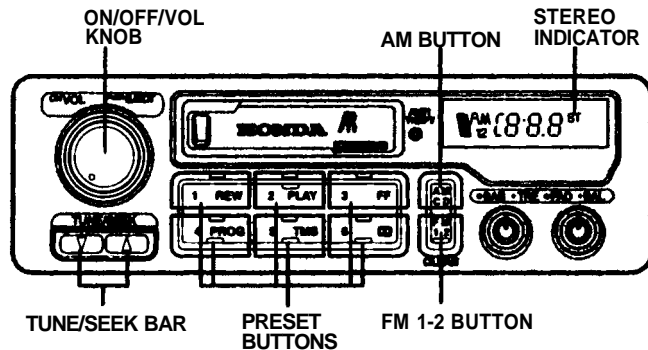

*Dolby noise reduction manufactured under license from Dolby Laboratories Licensing Corporation. "Dolby" and the  symbol are trademarks of Dolby Laboratories Licensing Corporation.

Operating the Radio

The ignition switch must be in ACCESSORY (I) or ON (II) to

operate the audio system. Turn the system on by turning the ON/OFF/VOL knob clockwise. The radio comes on and displays the frequency of the station it was last tuned to.

Adjust the volume by turning the ON/OFF/VOL knob.

Select the band you want to listen to by pressing the AM or FM 1-2 button. You will see the selected band and the frequency in the display.

ST will be displayed next to the frequency if the station is broadcasting in FM stereo. The AM stereo feature is not available.

You can use any of three methods to find radio stations on the selected band: TUNE, SEEK, or the Preset buttons.

The TUNE function lets you find a desired frequency. Push the right side (▲) of the TUNE/SEEK bar to change to a higher frequency, and push the left side (▼) of the bar to change to a lower frequency.

To change the frequency up or down a single increment, push and release the TUNE/SEEK bar.

The SEEK function searches the band for a station with a strong signal. Depending on which way you push the TUNE/SEEK bar, the system searches up or down from the current frequency. Push the bar until you hear a beep, then release it. The system searches until it finds a station with a strong signal, then stops.

Presetting Radio Stations

The preset buttons allow you to store radio frequencies for later selection. Each button will store one frequency on the AM band and two on the FM band. To store a frequency do this:

1. Select the desired band, AM or FM. FM 1-2 allows you to

store two frequencies with each Preset button.

2. Use the TUNE or SEEK function to tune the radio to a desired station.
3. Pick the Preset button you want for that station. Press the button and hold it until you hear a beep. The light in the indicator will come on and the station selected will show in the display.
4. Repeat steps 1 through 3 to store a total of six stations on AM and 12 on FM.

Once a station's frequency is stored, simply press and release the proper Preset button to tune to it. If you want to change any Preset button's selection, store another frequency as described. The frequencies you preset will be lost if your car's battery goes dead or is disconnected.

Audio System

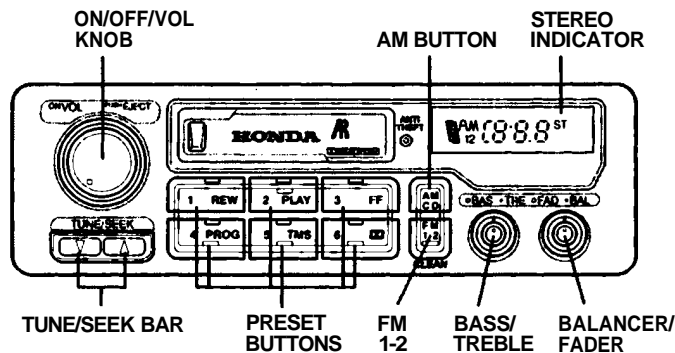

Adjusting the Sound

Use the Balance and Fader controls to adjust the sound "direction." The Balance control moves sound left to right. The Fader control moves it front to back.

To use either control, push on the knob to get it to pop out.

Adjust the front-to-back sound to your liking with the outer ring.

Adjust the side-to-side sound balance with the knob. Push the knob back in when you are done.

The illumination for the radio controls comes on with the instrument panel lights, even if

the radio is off. You can use the Balance control to turn off the radio panel illumination even with the radio on. Push the control knob so it pops out, then pull it out slightly farther. Check this control if the control panel lights do not come on with the instrument panel lights.

Use the Bass and Treble controls to adjust the tone quality to your liking. Push on the knob to get the controls to pop out. Adjust the bass level with the outer ring and the treble level with the inner knob. When finished, push the knob back in to prevent accidentally changing your settings.

Radio Frequencies

Your Honda's radio can tune in all frequencies in both the AM and FM bands. Those bands cover these frequencies:

AM band

530 to 1710 kilohertz

FM band

87.7 to 107.9 megahertz

Radio stations on the AM band are assigned frequencies at least 10 kilohertz apart (530, 540, 550). Those on the FM band are assigned frequencies at least 0.2 megahertz apart (87.9, 88.1, 88.3).

Stations must use these exact frequencies. It is fairly common for stations to round-off the frequency in their advertising, so your radio will show a frequency of 100.9 even though the announcer may call the station "FM101."

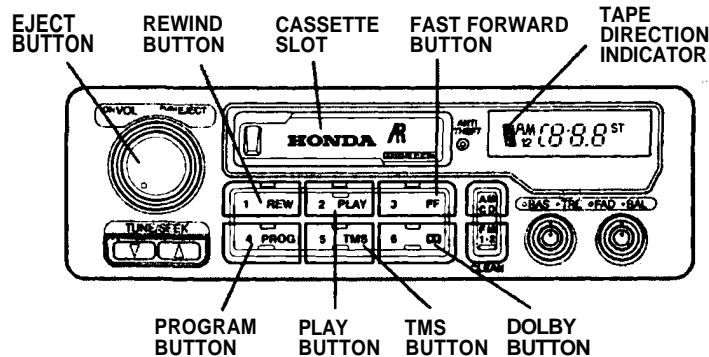

Operating the Cassette Player

Turn the system ON. Insert the cassette into the slot with the tape opening to the right. Push the cassette in most of the way. The drive pulls it in the rest of the way and begins to play.

The ▲ or ▼ lights to show you which side of the cassette is playing. The ▲ indicates the side you inserted facing upward is now playing. To play the other side of the tape, press the PROG button.

The system also has an auto-reverse feature. It automatically

reverses direction when it reaches the end of the cassette.

If the tape was recorded with Dolby "B" noise reduction, turn it on by pressing the button.

To remove the cassette from the drive, press the EJECT knob. The system automatically ejects the cassette whenever you turn off the system or the ignition switch.

Cassette Search Functions

Once a cassette is playing, you can use the REW, FF, or TMS function to look for desired songs or passages.

Press the REW button to rewind the cassette. Press the FF button to fast forward. The cassette will stop playing and will rewind or fast forward. To stop rewind or

fast forward, press the PLAY button. If the system reaches the end of the cassette while in fast forward or rewind, it automatically stops that function, reverses direction, and begins to play.

The TMS function lets you skip to the beginning of a song or other passage.

Press the TMS button and then the FF button or REW button. The tape will automatically advance to the beginning of the next song or return to the beginning of the song just played. When the system senses a silent period on the tape, it goes back to PLAY mode.

The TMS function uses silent periods on the tape to find the end of a selection. This feature may not work satisfactorily on

tapes that have almost no gap between songs, a high noise level between songs, or silent periods in the middle of songs.

Caring for Cassettes

Damaged cassettes can jam inside the drive or cause other problems. See page 67 for information on cassette care and protection.

Caring for the Cassette Player

The cassette drive picks up dirt and oxides whenever you play a tape. This builds up over time and causes the sound quality to degrade. To prevent this, you should clean the cassette drive after every 30 hours of use. Your Honda dealer has a cleaning kit available for this purpose.

After 30 hours of tape use, you will see CLEAN flashing for five

seconds in the display when you insert a tape into the tape slot. If you are already regularly cleaning the tape drive at least every 30 hours, reset the indicator by pressing the FM1 button while the system is in the tape operation mode. Hold the button until you hear a beep and the CLEAN indicator goes out.

If you do not clean the cassette drive regularly, it may eventually become impossible to remove the deposits with a normal cleaning kit.

The cassette player automatically ejects cassettes that do not play normally. If it ejects a cassette before it begins to play, it is probably defective and should not be inserted again. You may have a cassette

suddenly stop playing, reverse directions once or twice and then eject. This is normally an indication the tape is wound unevenly. It should play normally after being manually rewound.

Use 100-minute or shorter cassettes. Cassettes longer than 100 minutes use thinner tape that may break or jam the drive.

Look at a cassette before you insert it. If the tape is loose, tighten it by turning one of the hubs with a pencil or your finger.

If the label is peeling off, do not put it in the player. It may cause the cassette to jam in the drive mechanism when you try to eject it.

Do not leave cassettes sitting where they are exposed to high

heat or humidity, such as on top of the dashboard or in the player. If a cassette is exposed to extreme heat or cold, let it reach a moderate temperature before putting it in the player.

Operating the CD Player/Changer (Optional)

Your dealer has an in-dash Honda Compact Disc player or a trunk-mounted changer available for your car. The changer holds up to six discs, providing several hours of continuous programming. You operate the CD player and the changer with the same controls used for the radio.

Loading the CD Changer

Load the CDs in the magazine and load the magazine into the changer according to the instructions that came with the changer unit.

Audio System

To operate the CD player or changer, the ignition key must be in the ACCESSORY (I) or ON (II). If you were listening to a cassette tape, eject it before listening to a CD.

CD Player

Insert the disc in the player. Push the CD button on the player, "CD" will show in the display and the disc will start to play.

CD Changer

Push the CD button on the radio, the display will show "CD" and the track last listened to will play. When that disc ends, the next disc in the magazine is loaded and played.

After disc 6 has completed, the system will return to disc 1. To make your own disc selection,

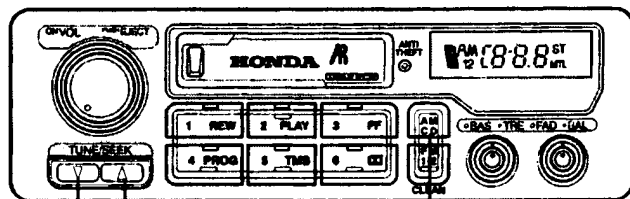

push one of the corresponding Preset buttons. Your selection will appear in the display and start playing.

- If you try to select an empty slot in the magazine, the system will select and play the first track of the next disc in the magazine.

You can use the TUNE/SEEK bar while a disc is playing to select passages and change tracks. To move rapidly forward within a track, press and hold the ▲ side of the TUNE/SEEK bar. Press and hold the ▼ side to move rapidly backward within a track. You will hear a beep a half second after you press either side of the bar.

Keep pressing the bar until you think the track has advanced or returned to the desired position. The disc will start playing when you release the bar.

If you press the ▲ side and release it before you hear a beep, the system will skip forward to the beginning of the next track on the CD. It will skip backward to the beginning of the current track if you press the ▼ side and release it.

- If you change modes to radio or tape while a CD is playing, then change back to CD mode, the same disc and track will play.
- If you turn off the system while a CD is playing, either with the ON/OFF/VOL knob or by turning off the ignition, the system will begin playing the

same disc and track when you turn it back on.

To return to the radio function, press the AM/FM button.

Audio System

CD Error Indications

If you see an error indication on the display, find the cause in the chart to the right. If you cannot clear the error indication, take the car to your Honda dealer.

Indication	Cause	Solution
<i>E - 01</i>	Disc-changer malfunction.	Consult Honda dealer.
<i>E - 02</i>	Disc is in changer mechanism.	Press the magazine eject button, and insert an empty magazine.
<i>E - 03</i> <i>E - 04</i> <i>E - 05</i>	Disc-changer malfunction.	If the code disappears within a few seconds, unit is OK. If it does not, consult your Honda dealer.
<i>E - 06</i>	Disc-changer malfunction.	Press the magazine eject button and pull out the magazine, check for error indication. Insert the magazine again. If the magazine can not be pulled out, consult your Honda dealer.
<i>E - 07</i>	CD magazine ejection impossible.	Press the magazine eject button. If the magazine does not eject, consult your Honda dealer.
<i>---H</i>	High temperature.	Will disappear when the temperature returns to normal.
<i>E - EE</i>	Misconnection or disconnection of CD changer.	See your Honda dealer.
<i>----</i>	No CD magazine in the CD changer.	Insert CD magazine.

On U.S. EX and Canada Si models
Your car's audio system will disable itself if it is disconnected from electrical power for any reason. To make it work again, the user must enter a specific five-digit code in the Preset buttons. Because there are hundreds of number combinations possible from five digits, making the system work without knowing the exact code is nearly impossible.

You should have received a card that lists your audio system's code number and serial number. Store the card in a safe place at home. In addition, you should write the audio system's serial number in this Owner's Manual. If you should happen to lose the card, you must obtain the code number by having your Honda dealer contact American Honda.

To do this, he will need the system's serial number.

If your car's battery is disconnected or goes dead, the audio system will disable itself. If this happens, you will see "Code" in the frequency display the next time you turn on the system. Use the Preset buttons to enter the five-digit code. If it is entered correctly, the radio will start playing.

If you make a mistake entering the code, do not start over or try to correct your mistake. Complete the five-digit sequence, then enter the correct code. You have three tries to enter the correct code. If you are unsuccessful in three attempts, you must then leave the system on for one hour before trying again.

You will have to store your favorite stations in the Preset buttons after the system begins working. Your original settings were lost when power was disconnected.

Before you begin driving your Honda, you should know what gasoline to use and how to check the levels of important fluids. You also need to know how to properly store luggage or packages.

Break-in Period	74
Gasoline	74
Oxygenated Fuels	74
Driving in Foreign Countries	75
Service Station Procedures ..	76
Filling the Fuel Tank	76
Opening the Hood	77
Oil Check	78
Engine Coolant Check	79
Fuel Economy	80
Vehicle Condition	80
Driving Habits	80
Loading Cargo	81

Break-in Period

Help assure your car's future reliability and performance by paying extra attention to how you drive during the first 600 miles (1,000 km). During this period:

- Avoid full-throttle starts and rapid acceleration.
- If you need to add oil, use the engine oil recommended in this owner's manual.
- Avoid hard braking. New brakes need to be broken-in by moderate use for the first 200 miles (300 km).

You should follow these same recommendations with an overhauled or exchanged engine, or when the brakes are replaced.

Gasoline

Your Honda is designed to operate most effectively on unleaded gasoline. Use an unleaded gasoline with a pump octane number of 86 or higher. Use of a lower-octane gasoline can cause a persistent, heavy metallic rapping noise in the engine that can lead to mechanical damage.

Gasolines containing detergent additives designed to help prevent fuel system and engine deposits are recommended. Using gasoline containing lead will damage your car's emission controls. This contributes to air pollution and can void certain parts of your warranty.

Oxygenated Fuels

Some conventional gasolines are being blended with alcohol or an

ether compound. These gasolines are collectively referred to as oxygenated fuels. To meet clean air standards, some areas of the United States and Canada use oxygenated fuels to help reduce emissions.

If you use an oxygenated fuel, be sure it is unleaded and meets the minimum octane rating requirement.

Before using an oxygenated fuel, try to confirm the fuel's contents. Some states/provinces require this information to be posted on the pump.

The following are the EPA-approved percentages of oxygenates:

ETHANOL (ethyl or grain alcohol) — You may use gasoline containing up to 10% ethanol by

volume. Gasoline containing ethanol may be marketed under the name "Gasohol."

MTBE (Methyl Tertiary Butyl Ether) — You may use gasoline containing up to 15% MTBE by volume.

METHANOL (methyl or wood alcohol) — You may use gasoline containing up to 5% methanol by volume as long as it also contains cosolvents and corrosion inhibitors to protect the fuel system. Gasoline containing more than 5% methanol by volume may cause starting and/or performance problems. It may also damage metal, rubber, and plastic parts of your fuel system.

If you notice any undesirable operating symptoms, try another

service station or switch to another brand of gasoline.

Fuel system damage or performance problems resulting from the use of an oxygenated fuel containing more than the EPA approved percentages of oxygenates are not covered under warranty.

Driving in Foreign Countries

Using any type of leaded gasoline in your Honda will affect performance and damage its emissions controls. Unleaded gasoline may not be available in other countries. If you are planning to take your car outside the U.S. or Canada, write to Honda at the address shown for information about any modifications your car may need. Be sure to include the year and model of your car.

U.S. Owners:

American Honda Motor Co., Inc.
Consumer Affairs
1919 Torrance Blvd.
Torrance, CA 90501-2746

Canadian Owners:

Honda Canada Inc.
715 Milner Ave.
Scarborough, Ontario M1B 2K8

Service Station Procedures

Filling the Fuel Tank

To fill the tank, do this:

1. Because the fuel fill is on the driver's side of the car park with that side closest to the service station pumps.
2. Open the fuel fill door by pulling on the handle to the left of the driver's seat.

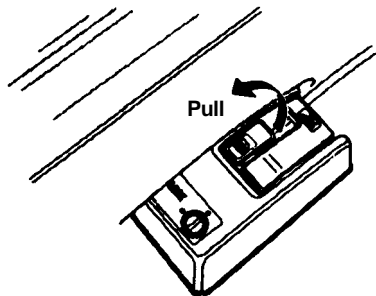

3. Remove the fuel fill cap slowly. You may hear a hissing sound as pressure inside the tank escapes.

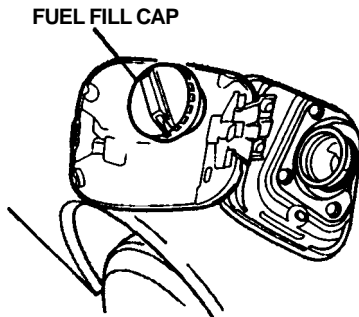

4. Stop filling the tank after the gas pump automatically clicks off. Do not try to "top off" the tank; leave some room for the fuel to expand with temperature changes.

Gasoline is highly flammable and explosive. You can be burned or seriously injured when handling fuel.

- Stop the engine and keep heat, sparks, and flame away.
 - Handle fuel only outdoors.
 - Wipe up spills immediately.
5. Screw the fuel fill cap back on; tighten it until it clicks.
 6. Push the fuel fill door until it latches.

Opening the Hood

1. Shift to Park or Neutral, and set the parking brake. Pull the hood release handle located under the left lower corner of the dashboard. The hood will pop up slightly.



2. Standing in front of the car, put your fingers under the

front edge of the hood to the right of center. Slide your hand to the left until you feel the hood latch handle. Push this handle to the left until it releases the hood. Lift the hood.

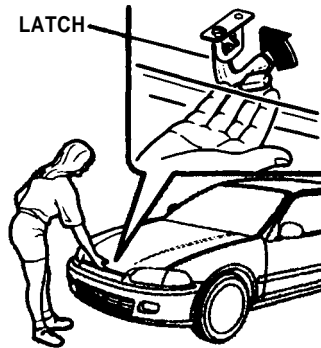

3. Pull the support rod out of its clip, and insert the end into

the hole on the left side of the hood.

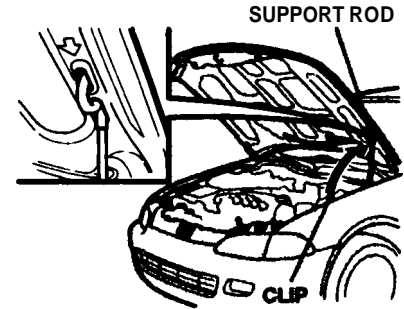

To close the hood, lift it up slightly to remove the support rod from the hole. Put the support rod back into its holding clip. Lower the hood to about a foot above the fender, and then let it drop.

Service Station Procedures

On Check

Check the engine oil level every time you fill the car with fuel. Wait at least two minutes after turning the engine off before you check the oil.

1. Remove the dipstick (orange handle).

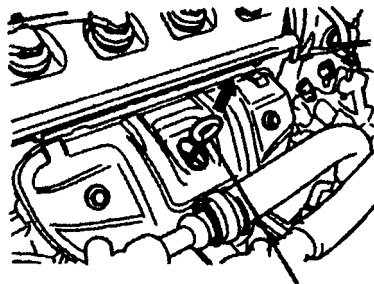

DIPSTICK

2. Wipe the dipstick with a clean cloth or paper towel.



3. Insert it all the way back in its tube.

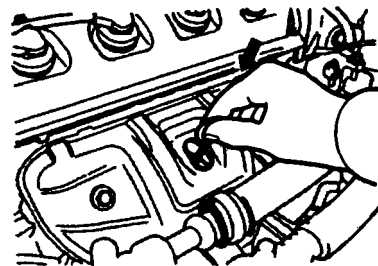

- Remove it again and check the level. It should be between the upper and lower marks.

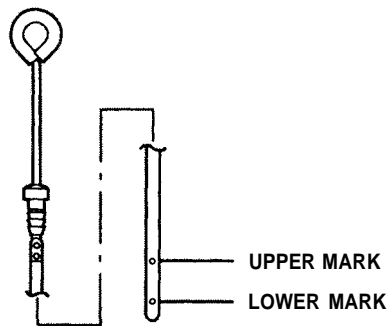

- If it is near or below the lower mark, see page 106 for information on the proper oil and how to add it.

Engine Coolant Check

Look at the coolant level in the radiator reserve tank. Make sure it is between the MAX and MIN lines. If it is below the MIN line, see **Adding Engine Coolant** on page 109 for information on adding the proper coolant.

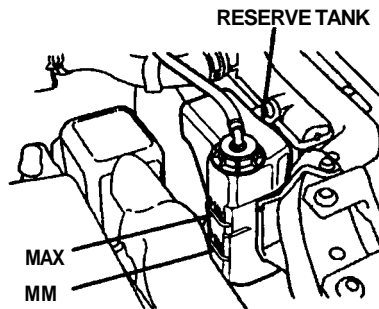

Refer to **Periodic Checks** on page 104 for information on checking other items in your Honda.

Fuel Economy

The condition of your car and your driving habits are the two most important things that affect the fuel mileage you get.

Vehicle Condition

Always maintain your car according to the maintenance schedule. This will keep it in top operating condition.

An important part of that maintenance is the **Periodic Checks** (see page 104). For example, an underinflated tire causes more "rolling resistance," which uses fuel. It also wears out faster, so check the tire pressure at least monthly.

In winter the build-up of snow on your car's underside adds weight and rolling resistance. Frequent cleaning helps your fuel mileage

and reduces the chance of corrosion.

Driving Habits

You can improve fuel economy by driving moderately. Rapid acceleration, cornering, and hard braking use more fuel. Always drive in the highest gear that allows the engine to run and accelerate smoothly. Maintain a constant speed while cruising, depending on traffic conditions. Every time you slow down and speed up, your car uses extra fuel. Use the cruise control, when appropriate, to increase fuel economy.

A cold engine uses more fuel than a warm engine. It is not necessary to "warm-up" a cold engine by letting it idle for a long time. You can drive away within 30 seconds, no matter how cold

it is outside. The engine will warm up faster, and you get better fuel economy. To cut down on the number of "cold starts," try to combine several short trips into one.

Air conditioning puts an extra load on the engine, which makes it use more fuel. Turn off the A/C to cut down on air conditioning use. Use the flow-through ventilation when the outside air temperature is moderate.

Loading Cargo

The maximum load you can carry in your Honda is 850 lb (385 kg). It includes the total weight of all passengers and their belongings, and any accessories. This 850 lb (385 kg) figure is shown as the Vehicle Capacity Weight on the tire information label attached to the inside of the glove box.

To figure out how much cargo you can carry, do this:

- Figure the total "occupant weight" you will be transporting. To do this, multiply the number of people (driver and all passengers) by 150 lb (70 kg).
- Subtract this number from the Vehicle Capacity Weight (850 lb/385 kg).

This final number is the total weight of cargo you can load in or on the car. With five occupants (driver and four passengers), the maximum recommended weight for cargo is 100 lb (45 kg).

Where you store cargo and how well you secure it are just as important as how much it weighs. Make sure you load cargo so it will not shift while driving. Items stored in the trunk should be placed as far forward as possible. You could store additional items on the floor behind the front seats. Make sure they cannot roll under the front seat and interfere with the pedals.

If you must carry large objects that prevent you from closing the trunk lid, be aware that exhaust gas can enter the interior. See Carbon Monoxide Hazard on page 23.

Never place items on the shelf behind the back seat. Those items can fly forward and injure you or your passengers if you brake hard or are involved in a collision.

This section gives you tips on starting the engine under various conditions and how to operate the 5-speed manual and automatic transmissions. It also includes important information on your car's braking system.

Preparing to Drive	84
Starting the Engine	84
Starting in Cold Weather at High Altitude	85
5-Speed Manual	
Transmission	86
Recommended Shift Points	86
Maximum Speeds	87
Automatic Transmission	87
Shift Lever Positions	88
Maximum Speeds	90
Shift Lock Release	90
The Braking System	91
Brake Wear Indicators	91
Brake System Design	92
Anti-Lock Brakes	92
Towing a Trailer	93

Preparing to Drive, Starting the Engine

You should do the following checks and adjustments every day before you drive your car.

1. Make sure all windows, mirrors, and outside lights are clean and unobstructed. Remove frost, snow, or ice.
2. Check that the hood and trunk are fully closed.
3. Visually check the tires. If a tire looks low, use a gauge to check its pressure.
4. Check that any items you may be carrying with you inside are stored properly or fastened down securely.
5. Check the adjustment of the seat (see page 43).
6. Check the adjustment of the inside and outside mirrors (see page 48).
7. Check the adjustment of the steering wheel (see page 36).
8. Make sure the doors are securely closed and locked.
9. Fasten your seat belt. Check that your passengers have fastened their seat belts (see page 7).
10. Turn the ignition ON (II). Check the indicator lights in the instrument panel.
11. Start the engine (see this page).
12. Check the gauges and indicator lights in the instrument panel (see page 27).

Starting the Engine

1. Apply the parking brake.
2. In cold weather, turn off all electrical accessories to reduce the drain on the battery.
3. *Manual transmission:* Push the clutch pedal down all the way. START (III) does not function unless the clutch pedal is depressed.
Automatic transmission: Make sure the shift lever is in Park. Press on the brake pedal.
4. Without touching the accelerator pedal, turn the ignition key to the START (III) position. If the engine does not start right away, do not hold the key in START (III) for more than 15 seconds at a time. Pause for at least 10 seconds before trying again.

5. If the engine does not start within 15 seconds or starts but stalls right away, press the accelerator pedal halfway down, and turn the ignition key to the START (III) position. If the engine starts, release pressure on the accelerator pedal so the engine does not race.
6. If the engine still does not start, to clear flooding, press the accelerator pedal all the way down, and hold it there while starting. As before, keep the ignition key in the START (III) position for no more than 15 seconds. Return to step 5 if the engine does not start. If it starts, lift your foot off the accelerator pedal so the engine does not race.

Starting in Cold Weather at High Altitude (Above 8,000 feet/2,400 meters)

An engine is harder to start in cold weather. The thinner air found at high altitude above 8,000 feet (2,400 meters) adds to the problem. Use the following procedure:

1. Turn off all electrical accessories to reduce the drain on the battery.
 2. Push the accelerator pedal halfway to the floor, and hold it there while starting the engine. Do not hold the ignition key in START (III) for more than 15 seconds. When the engine starts, release the accelerator pedal gradually as the engine speeds up and smooths out.
3. If the engine fails to start in step 2, push the accelerator pedal all the way down and hold it there while you try to start the engine for no more than 15 seconds. If the engine does not start, return to step 2.

5-Speed Manual Transmission

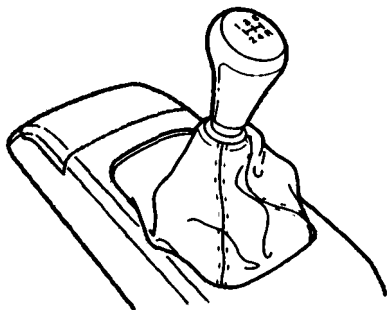

The manual transmission is synchronized in all forward gears for smooth operation. It has a lockout so you cannot shift directly from Fifth to Reverse. When shifting up or down, make sure you push the clutch pedal down all the way, shift to the next gear, and let the pedal up gradually. When you are not shifting, do not rest your foot on the clutch pedal. This can cause your clutch to wear out faster.

Rapid slowing or speeding up can cause loss of control on slippery surfaces. If you crash, you can be injured.

Use extra care when driving on slippery surfaces.

Come to a full stop before you shift into reverse. You can damage the transmission by trying to shift into reverse with the car moving. Depress the clutch pedal, and pause for a few seconds before shifting into reverse, or shift into one of the forward gears for a moment. This stops the gears so they won't "grind."

When slowing down, you can get extra braking from the engine by shifting down to a lower gear.

This extra braking can help you maintain a safe speed and prevent your brakes from overheating while going down a steep hill. Before downshifting, make sure engine speed will not go into the red zone in the lower gear. Refer to the Maximum Speeds chart.

Recommended Shift Points

Drive in the highest gear that lets the engine run and accelerate smoothly. This will give you the best fuel economy and effective emissions control. The following shift points are recommended:

Shift up	Normal acceleration
1 st to 2 nd	15 mph (24 km/h)
2 nd to 3 rd	27 mph (43 km/h)
3 rd to 4 th	39 mph (62 km/h)
4 th to 5 th	53 mph (85 km/h)

Shift up	Cruise from acceleration
1 st to 2 nd	9 mph (14 km/h)
2 nd to 3 rd	20 mph (32 km/h)
3 rd to 4 th	33 mph (53 km/h)
4 th to 5 th	48 mph (77 km/h)

Maximum Speeds

The speeds in these tables are the maximums for the given gears. If you exceed these speeds, the engine speed will enter into the tachometer's red zone. If this occurs, you may feel the engine cut in and out. This is caused by a limiter in the engine's computer controls. The engine will run normally when you reduce the rpm below the red zone.

DX

Gear	Maximum speeds
1 st	32 mph (51 km/h)
2 nd	59 mph (95 km/h)
3 rd	88 mph (142 km/h)
4 th	112 mph (181 km/h)
5 th	Top speed

U.S.: EX, Canada: Si

Gear	Maximum speeds
1 st	34 mph (55 km/h)
2 nd	58 mph (94 km/h)
3 rd	89 mph (143 km/h)
4 th	Top speed
5 th	Top speed

Automatic Transmission

Your Honda's transmission has four forward speeds. It has a "lock-up" torque converter for

better fuel economy. You may feel what seems like another shift when the converter locks.

Shift Lever Position Indicator

This display is on the instrument panel. It shows you the position of the shift lever.

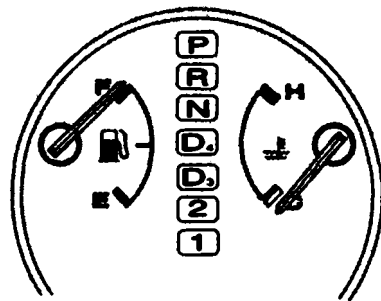

Automatic Transmission

Shift Lever Positions

The shift lever has seven positions. It must be in Park or Neutral to start the engine. When you are stopped in D₄, D₃, 2, 1 or R, press firmly on the brake pedal, and keep your foot off the accelerator pedal.

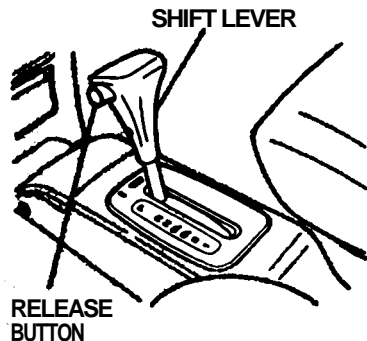

To shift from:	Do this:
P to R	Press the brake pedal, and press the release button.
R to P N to R D ₃ to 2 2 to 1	Press the release button.
1 to 2 2 to D ₃ D ₃ to D ₄ D ₄ to N D ₄ to D ₃ N to D ₄ R to N	Move the lever.

Park (P) - This position mechanically locks the transmission. Use Park whenever you are turning off or starting the engine. To shift out of Park, you must press on the brake pedal and have your foot off the accelerator pedal.

Press the release button on the side of the shift lever to move it.

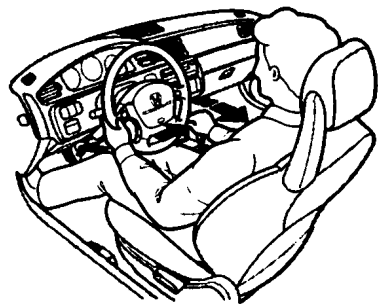

If you have done all of the above and still cannot move the lever out of Park, see **Shift Lock Release** on page 90.

You must also press the release button to shift into Park. To avoid transmission damage,

come to a complete stop before shifting into Park. The shift lever must be in Park before you can remove the key from the ignition switch.

Reverse (R) — To shift to Reverse from Park, see the explanation under Park. To shift to Reverse from Neutral, come to a complete stop and then shift. Press the release button before shifting into Reverse from Neutral.

Neutral (N) — Use Neutral if you need to restart a stalled engine or you need to stop briefly with the engine idling. Shift to Park position if you need to leave the car for any reason. Press on the brake pedal when you are moving the shift lever from Neutral to another gear.

Drive (D₄) — Use this position for your normal driving. The transmission automatically selects a suitable gear for your speed and acceleration. You may notice the transmission shifting up at higher speeds when the engine is cold. This helps the engine warm up faster.

Drive (D₃) — This position is similar to D₄, except only the first three gears may be selected. Use D₃ to provide engine braking when going down a steep hill. D₃ keeps the transmission from cycling between third and fourth gears in stop-and-go driving.

For faster acceleration when in D₃ or D₄, you can get the transmission to automatically downshift by pushing the accelerator pedal to the floor. The transmission will shift down

one or two gears, depending on your speed.

Second (2) — To shift to Second, press the release button on the side of the shift lever. This position locks the transmission in second gear. It does not downshift to first gear when you come to a stop. Second gives you more power when climbing, and increased engine braking when going down steep hills. Use second gear when starting out on a slippery surface or in deep snow. It will help reduce wheel spin.

Whenever you move the shift lever to a lower gear, the transmission downshifts only if the engine's redline will not be exceeded in the lower gear.

Automatic Transmission

First (1)—To shift from Second to First, press the release button on the side of the shift lever.

With the lever in this position, the transmission locks in First gear. By upshifting and downshifting through 1, 2, D₃, and D₄, you can operate this transmission much like a manual transmission without a clutch pedal.

Maximum Speeds

The speeds in these tables are the maximums for the given position. If you exceed these speeds, the engine speed will enter into the tachometer's red zone. If this occurs, you will feel the engine cut in and out. This is caused by a limiter in the engine's computer controls. The engine will run normally when you reduce the rpm below the red zone.

DX

Position	Maximum speeds
1	37 mph (60 km/h)
2	66 mph (106 km/h)
D ₃	99 mph (160 km/h)
D ₄	Top speed

U.S.: EX, Canada: Si

Position	Maximum speeds
1	42 mph (67 km/h)
2	75 mph (120 km/h)
D ₃	112 mph (180 km/h)
D ₄	Top speed

Shift Lock Release

This allows you to move the shift lever out of Park if the normal method of pushing on the brake pedal and pressing the release button does not work.

1. Set the Parking brake.

2. Remove the key from the ignition switch.
3. Insert the key in the Shift Lock Release slot next to the shift lever.
4. Push down on the key while you press the release button and move the shift lever out of Park to Neutral.

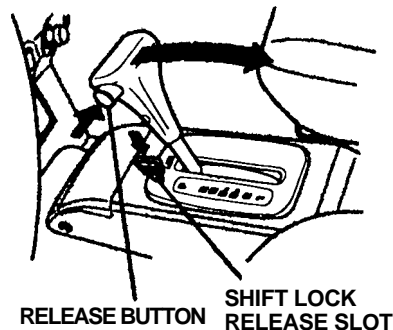

5. Remove the key from the Shift Lock Release slot. Return the key to the ignition switch, depress the brake pedal, and restart the engine.

If you need to use the Shift Lock Release, it could mean your car is developing a problem. Have the car checked by your Honda dealer.

The Braking System

All Civics are equipped with front disc brakes. The brakes on the rear wheels may be disc or drum, depending on the model. The braking system is power-assisted to reduce the effort needed on the brake pedal.

Put your foot on the brake pedal only when you intend to brake. Resting your foot on the pedal keeps the brakes applied lightly, causing them to build up heat.

Heat buildup can reduce how well your brakes work. It also keeps your brake lights on all the time, confusing drivers behind you.

Constant application of the brakes when going down a long hill builds up heat and reduces their effectiveness. Use the engine to assist the brakes by downshifting to a lower gear and taking your foot off the accelerator pedal.

Check your brakes after driving through deep water. Apply the brakes moderately to see if they feel normal. If not, apply them gently and frequently until they do. Since a longer distance is needed to stop with wet brakes, be extra cautious and alert in your driving.

Brake Wear Indicators

The front disc brakes on all cars have audible brake wear indicators. They are also on the rear brakes of cars with ABS. When the brake pads need replacing, you will begin to hear a distinctive metallic "screeching" sound when you apply the brakes. If you do not have the brake pads replaced, they will screech all the time.

Your brakes may sometimes squeal or squeak when you apply them lightly. Do not confuse this with the brake wear indicators. They make a very audible "screeching."

The Braking System

Brake System Design

The hydraulic system that operates the brakes has two separate circuits. Each circuit works diagonally across the car (the left-front brake is connected with the right-rear brake, etc.). If one circuit should develop a problem, you will still have braking at two wheels.

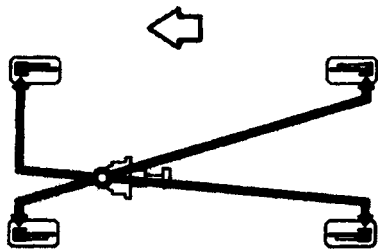

If this happens, you will notice that the brake pedal goes down much farther and you need to press on it much harder. A much longer distance will be needed to stop the car.

Slow the car by downshifting to a lower gear and removing your foot from the accelerator pedal. Pull to the side of the road as soon as it is safe. Because of the longer stopping distance needed, brake system failure is very hazardous. It is best to have your car towed, but if you must drive the car in this condition, be extremely cautious. Have your car repaired as soon as possible.

Anti-Lock Brakes

For U.S. EX with ABS option

Your car has an Anti-lock Brake System (ABS). ABS helps you to maintain steering control. It does

this by helping to prevent the wheels from locking up and skidding.

The ABS is always "ON." It requires no special effort or driving technique. You will feel a pulsation in the brake pedal when the ABS activates.

Activation varies with the amount of traction your tires have. On dry pavement, you will need to press on the brake pedal very hard before you feel the pedal pulsation that means the ABS has activated. However, you may feel the ABS activate immediately if you are trying to stop on snow or ice.

Under all conditions, the ABS is helping to prevent the wheels from locking so you can retain steering control. You should

continue to press on the brake pedal with the same force.

You may feel a slight movement of the brake pedal just after you start the engine. This is the ABS working.

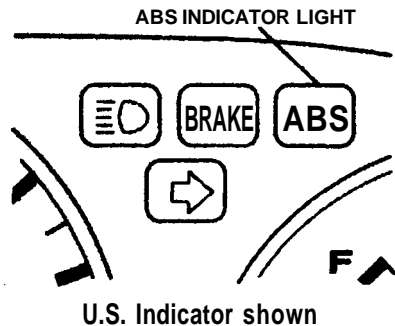

The ABS is self-checking. If anything goes wrong, the ABS indicator on the instrument

panel comes on (see page 29). This means the anti-lock function of the braking system has shut down. The brakes still work like a conventional system, providing normal stopping ability. You should have the dealer inspect your car as soon as possible.

A car with ABS may require a longer distance to stop on loose or uneven surfaces than an equivalent car without anti-lock brakes. The ABS cannot make up for road conditions or bad judgment. It is still your responsibility to drive at reasonable speeds for weather and traffic conditions and leaving a margin of safety.

Towing a Trailer

Your car is not designed to tow a trailer; attempting to do so can void your warranties.

This section explains why it is important to keep your car well maintained and to follow basic maintenance safety precautions.

This section also includes Maintenance Schedules for normal driving and severe driving conditions, a Maintenance Record, and instructions for simple maintenance tasks you may want to take care of yourself.

If you have the skills and tools required to perform more complex maintenance tasks on your Civic, you may want to purchase the Service Manual. See page 180 for information on how to obtain a copy, or see your Honda Dealer.

Maintenance Safety	96	Air Cleaner Element	117
Maintenance Schedule	100	Spark Plugs	118
Maintenance Record	102	Replacement	118
Periodic Checks	104	Specifications	119
Engine Oil	106	Battery	120
Adding Oil	106	Windshield Wipers	122
Recommended Oil	106	Air Conditioning	123
Additives	107	Drive Belts	124
Oil and Filter Changes	107	Tires	124
Cooling System	109	Inflation	125
Adding Engine Coolant ...	109	Inspection	126
Replacing Engine Coolant	110	Maintenance	127
Windshield Washers	113	Tire Rotation	128
Transmission Oil	114	Replacing Tires and Wheels	127
Automatic Transmission. ...	114	Wheels and Tires	129
5-Speed Manual		Winter Driving	128
Transmission	114	Snow Tires	129
Brake and Clutch Fluid	115	Tire Chains	129
Brake System	115	Lights	129
Anti-Lock Brake System ...	116	Replacing Bulbs	130
Clutch System	116	Storing Your Car	135
Power Steering	117		

Maintenance Safety

Regularly maintaining your car is the best way to protect your investment. Proper maintenance is essential to your safety and the safety of your passengers. It will also reward you with more economical, trouble-free driving and help reduce air pollution.

Improperly maintaining this car or failing to correct a problem before driving can cause a crash in which you can be seriously hurt or killed.

Always follow the inspection and maintenance recommendations and schedules in this owner's manual.

This section includes instructions for simple maintenance tasks, such as checking and adding oil. Any service items not detailed in this section should be performed by a Honda technician or other qualified mechanic.

Some of the most important safety precautions are given below. However, we cannot warn you of every conceivable hazard that can arise in performing maintenance. Only you can decide whether or not you should perform a given task.

Failure to properly follow maintenance instructions and precautions can cause you to be seriously hurt or killed.

Always follow the procedures and precautions in this owner's manual.

Important Safety Precautions

Before you begin any maintenance, make sure your car is parked on level ground and that the parking brake is on. Also, be sure the engine is off. This will help to eliminate several potential hazards:

- **Carbon monoxide poisoning from engine exhaust.** Be sure there is adequate ventilation whenever you operate the engine.
- **Burns from hot parts.** Let the engine and exhaust system cool before touching any parts.
- **Injury from moving parts.** Do not run the engine unless instructed to do so.

Read the instructions before you begin, and make sure you have the tools and skills required.

To reduce the possibility of fire or explosion, be careful when working around gasoline or batteries. Use a nonflammable solvent, not gasoline, to clean parts. Keep cigarettes, sparks, and flames away from the battery and all fuel-related parts. You should wear eye protection and protective clothing when working near the battery or when using compressed air.

Maintenance Schedule

Maintenance Schedule

The Maintenance Schedule specifies how often you should have your car serviced and what things need attention. It is essential that you have your car serviced as scheduled to retain its high level of safety, dependability, and emissions control performance.

The services and time or distance intervals shown in the maintenance schedule assume you will use your car as normal transportation. You should:

- Avoid exceeding your car's load limit. This puts excess stress on the engine, brakes, and many other parts of your car. The load limit is shown on the label on the driver's doorjamb.
- Operate your car on reasonable roads within the legal speed limit.
- Drive your car regularly over a distance of several miles (kilometers).
- Always use unleaded gasoline with the proper octane rating (see page [74](#)).

Which Schedule to Follow

Service your car according to the time and mileage periods on one of the Maintenance Schedules on the following pages. Select the schedule for "Severe Conditions" if most of your driving is done under one or more of the conditions listed on that page. Otherwise, follow the schedule for "Normal Conditions."

Your authorized Honda dealer knows your car best and can provide competent, efficient service. However, service at a dealer is not mandatory to keep your warranties in effect. Maintenance may be done by any qualified service facility or person who is skilled in this type of automotive service. Keep all the receipts as proof of completion, and have the person who does the work fill out the Maintenance Record. Check your warranty booklet for more information.

We recommend the use of Genuine Honda parts and fluids whenever you have maintenance done. These are manufactured to the same high-quality standards as the original components, so you can be confident of their performance and durability.

U.S. Cars:

Maintenance, replacement or repair of emissions control devices and systems may be done by any automotive repair establishment or individual using parts that are "certified" to EPA standards.

According to state and federal regulations, failure to perform maintenance on the items marked with an asterisk (*) will not void your emissions warranties. However, Honda recommends that all maintenance services be performed at the recommended time or mileage period to ensure long-term reliability.

Maintenance Schedule (Normal Conditions)

Service at the indicated distance or time – whichever comes first.	miles x 1,000	15	30	45	60	75	90	105
	months	12	24	36	48	60	72	84
	km x 1,000	24	48	72	96	120	144	168
Replace engine oil and oil filter	Replace every 7,500 mi (12,000 km) or 6 mos							
Check engine oil and coolant	Check oil and coolant at each fuel stop							
Replace air cleaner element		●		●		●		●
Inspect valve clearance		●		●		●		●
Replace spark plugs		●		●		●		●
Inspect distributor cap*, rotor*, and ignition wires				●				
Replace timing belt* and inspect water pump							●	
Inspect and adjust drive belts		●			●		●	
Inspect idle speed*				●		●		
Inspect PCV valve				●		●		
Replace engine coolant			●		●		●	●
Replace transmission fluid		●		●		●		●
Inspect front and rear brakes	●	●	●	●	●	●	●	●
Replace brake fluid (including ABS)		●		●		●		●
Check parking brake adjustment	●	●	●	●	●	●	●	●
Rotate tires (Check tire inflation and condition at least once per month)	Rotate tires every 7,500 miles (12,000 km)							
Replace ABS high pressure hose				●				
Visually inspect the following items:								
Brake hoses and lines								
All fluid levels								
Tie rod ends, steering gear box, and boots								
Suspension components								
Driveshaft boots	●	●	●	●	●	●	●	●
Cooling system hoses and connections								
Exhaust system*								
Fuel pipes, hoses, and connections*								
Inspect supplemental restraint system	10 years after production							

Follow the Normal Maintenance Schedule if the severe driving conditions specified in the Severe Conditions Maintenance Schedule on the next page do not apply.

For Canadian Owners

This Maintenance Schedule outlines the *minimum* required maintenance that you should perform to ensure the trouble-free operation of your vehicle. Due to regional and climatic differences, some additional servicing may be required. Please consult your warranty handbook for a more detailed description.

Maintenance Schedule (Severe Conditions)

Service at the indicated distance or time -- whichever comes first.	miles x 1,000	15	30	45	60	75	90	105
	months	12	24	36	48	60	72	84
	km x 1,000	24	48	72	96	120	144	168
Replace engine oil and oil filter	Replace every 3,750 mi (6,000 km) or 3 mos							
Check engine oil and coolant	Check oil and coolant at each fuel stop							
Clean (○) or replace (●) air cleaner element	○	●	○	●	○	●	○	
Inspect valve clearance		●		●		●		
Replace spark plugs		●		●		●		
Inspect distributor cap*, rotor*, and ignition wires				●				
Replace timing belt* and inspect water pump	Replace every 60,000 mi (96,000 km)							
Inspect and adjust drive belts		●		●		●		
Inspect idle speed*				●				
Inspect PCV valve				●				
Replace engine coolant				●		●		●
Replace transmission fluid	●	●	●	●	●	●	●	●
Inspect front and rear brakes	Inspect every 7,500 miles (12,000 km) or 6 mos							
Replace brake fluid (including ABS)		●		●		●		●
Check parking brake adjustment	●	●	●	●	●	●	●	●
Rotate tires (Check tire inflation and condition at least once per month)	Rotate tires every 7,500 miles (12,000 km)							
Replace ABS high pressure hose				●				
Visually inspect the following items:								
Tie rod ends, steering gear box, and boots Suspension components Driveshaft boots	Every 7,500 miles (12,000 km) or 6 mos							
Brake hoses and lines All fluid levels Cooling system hoses and connections Exhaust system* Fuel pipes, hoses, and connections*	●	●	●	●	●	●	●	●
Inspect supplemental restraint system	10 years after production							

Follow the Severe Maintenance Schedule if you drive your vehicle *MAINLY* under one or more of the following conditions:

- Driving less than 5 miles per trip or, in freezing temperatures, driving less than 10 miles per trip.
- Driving in extremely hot (over 90°F) conditions.
- Extensive idling or long periods of stop-and-go driving.
- Trailer towing, driving with a car-top carrier or driving in mountainous conditions.
- Driving on muddy, dusty, or de-iced roads.

NOTE: If you only *OCCASIONALLY* drive under a "severe" condition, you should follow the Normal Conditions Maintenance Schedule on the previous page.

Required Maintenance Record

Have your servicing dealer record all Required Maintenance below. Keep receipts for all work done on your car.

7,500 Mi. 12,000 km (or 6 Mo.)	(Sign or Stamp)	Mi. (km)
		Date
15,000 Mi. 24,000 km (or 12 Mo.)	(Sign or Stamp)	Mi. (km)
		Date
22,500 Mi. 36,000 km (or 18 Mo.)	(Sign or Stamp)	Mi. (km)
		Date
30,000 Mi. 48,000 km (or 24 Mo.)	(Sign or Stamp)	Mi. (km)
		Date
37,500 Mi. 60,000 km (or 30 Mo.)	(Sign or Stamp)	Mi. (km)
		Date
45,000 Mi. 72,000 km (or 36 Mo.)	(Sign or Stamp)	Mi. (km)
		Date
52,500 Mi. 84,000 km (or 42 Mo.)	(Sign or Stamp)	Mi. (km)
		Date

60,000 Mi. 96,000 km (or 48 Mo.)	(Sign or Stamp)	Mi. (km)
		Date
67,500 Mi. 108,000 km (or 54 Mo.)	(Sign or Stamp)	Mi. (km)
		Date
75,000 Mi. 120,000 km (or 60 Mo.)	(Sign or Stamp)	Mi. (km)
		Date
82,500 Mi. 132,000 km (or 66 Mo.)	(Sign or Stamp)	Mi. (km)
		Date
90,000 Mi. 144,000 km (or 72 Mo.)	(Sign or Stamp)	Mi. (km)
		Date
97,500 Mi. 156,000 km (or 78 Mo.)	(Sign or Stamp)	Mi. (km)
		Date
105,000 Mi. 168,000 km (or 84 Mo.)	(Sign or Stamp)	Mi. (km)
		Date

Non-Scheduled Maintenance Record

Record additional maintenance for severe driving conditions or non-scheduled maintenance on this page (see page 101).

Maintenance Performed:	(Sign or Stamp)	Mi. (km)
		Date
Maintenance Performed:	(Sign or Stamp)	Mi. (km)
		Date
Maintenance Performed:	(Sign or Stamp)	Mi. (km)
		Date
Maintenance Performed:	(Sign or Stamp)	Mi. (km)
		Date
Maintenance Performed:	(Sign or Stamp)	Mi. (km)
		Date
Maintenance Performed:	(Sign or Stamp)	Mi. (km)
		Date

Maintenance Performed:	(Sign or Stamp)	Mi. (km)
		Date
Maintenance Performed:	(Sign or Stamp)	Mi. (km)
		Date
Maintenance Performed:	(Sign or Stamp)	Mi. (km)
		Date
Maintenance Performed:	(Sign or Stamp)	Mi. (km)
		Date
Maintenance Performed:	(Sign or Stamp)	Mi. (km)
		Date
Maintenance Performed:	(Sign or Stamp)	Mi. (km)
		Date

MAINTENANCE RECORD

Periodic Checks

You should check the following items at the specified intervals. If you are unsure of how to perform any check, turn to the page given.

- Engine oil level - Check every time you fill the fuel tank. See page [78](#).
- Engine coolant level - Check the radiator reserve tank every time you fill the fuel tank. See page [109](#).
- Windshield washer fluid - Check the level in the reservoir monthly. If weather conditions cause you to use the washers frequently, check the reservoir each time you stop for fuel. See page [113](#).
- Automatic transmission - Check the fluid level monthly. See page [114](#).
- Brakes, clutch, and power steering - Check the fluid level monthly. See pages [115-117](#).
- Battery - Check its condition and the terminals for corrosion monthly. See page [120](#).
- Air conditioning - Check its operation weekly. See page [123](#).
- Tires - Check the tire pressure monthly. Examine the tread for wear and foreign objects. See page [126](#).
- Lights - Check the operation of the headlights, parking lights, taillights, high-mount brake light, turn signals, brake lights, and license plate lights monthly. See page [129](#).

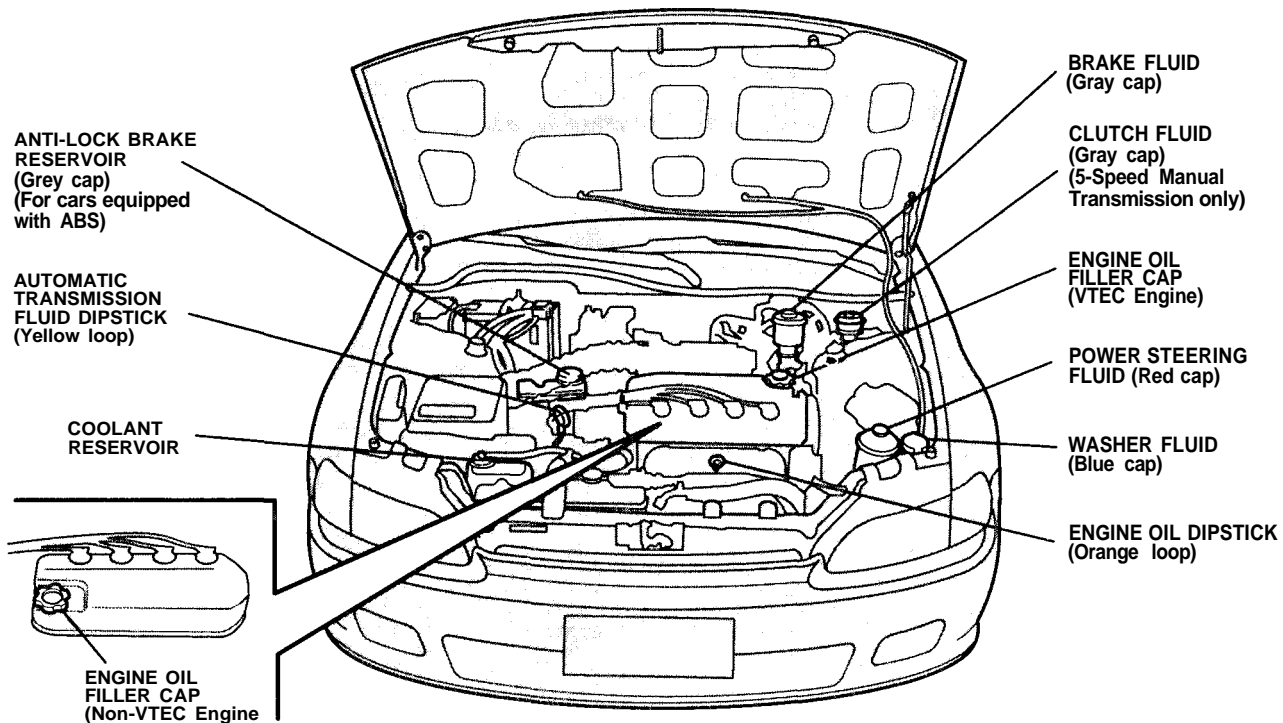

Engine Oil

Adding Oil

To add oil, unscrew and remove the engine oil fill cap on top of the valve cover. Pour in the oil, and replace the fill cap. Tighten it securely. Wait a few minutes and recheck the oil level. Do not fill above the upper mark; you could damage the engine.

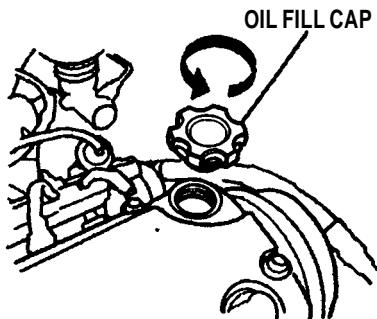

Recommended Oil

Oil is a major contributor to your engine's performance and longevity. Always use a premium-grade detergent oil.

You can determine an oil's SAE viscosity and Service Classification from the API Service label on the oil container.

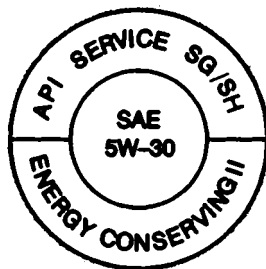

API SERVICE LABEL

A fuel-efficient oil is recommended for your Honda. This is shown on the API Service label by the words "Energy Conserving II." This oil is formulated to help your engine use less fuel.

The API Service label also tells you the service classification of the oil. Always use an oil that says "API Service SG or SH." This service rating may also include other designations, such as CD. These additional classifications are not a problem, as long as the label also carries the SG or SH classification. An oil that is only classified SF is not recommended.

The oil container may also display the API Certification seal. Make sure it says "For Gasoline Engines."



API CERTIFICATION SEAL

The SAE numbers tell you the oil's viscosity or weight. Select the oil for your car according to this chart:

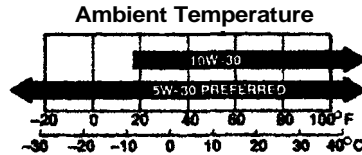

An oil with a viscosity of 5W-30 is preferred for improved fuel economy and year-round protection in your Honda. You may use a 10W-30 oil if the temperature in your area never goes below 20°F (-7°C).

Additives

Your Honda does not need any oil additives. Purchasing additives for the engine or transmission will not increase your car's performance or longevity. It only increases the cost of operating your car.

Oil and Filter Changes

Always change the oil and filter according to the time and distance (miles/kilometers) recommendations on the maintenance schedule. The oil and filter collect contaminants that can damage your engine if they are not removed regularly.

Changing the oil and filter requires special tools and access from underneath the car. The car should be raised on a service station-type hydraulic lift for this service. Unless you have the knowledge and proper

Engine Oil

equipment, you should have this maintenance done by a skilled mechanic.

1. Run the engine until it reaches normal operating temperature; then shut it off.
2. Open the hood and remove the oil fill cap. Remove the oil drain bolt and washer from the bottom of the engine. Drain the oil into an appropriate container.

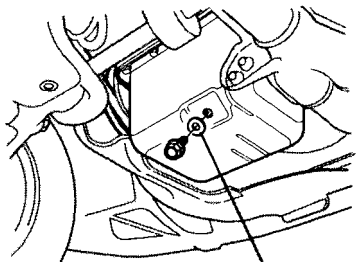

OIL DRAIN BOLT
AND WASHER

3. Remove the oil filter and let the remaining oil drain. A special wrench (available from your Honda dealer) is required to remove the filter.

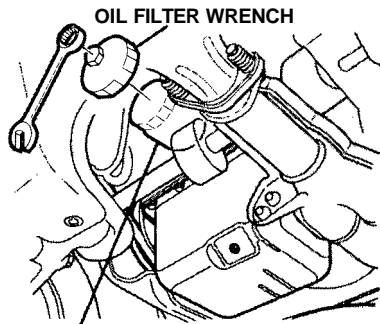

OIL FILTER

4. Install a new oil filter according to the instructions that come with it.
5. Put a new washer on the drain bolt; then reinstall the

drain bolt. Tighten it to 40 N.m (4.0 kg-m, 29 lb-ft).

6. Refill the engine with the recommended oil. Engine oil capacity (including filter): 3.5 U.S. qt (2.9 Imp. qt, 3.3ℓ).
7. Replace the oil fill cap. Start the engine. The indicator light should go out within five seconds. If it does not, turn off the engine and inspect your work.
8. Let the engine run for several minutes and check for leaks at the drain bolt and washer and at the oil filter.
9. Turn off the engine, let it sit for several minutes, and then check the oil level. If necessary, add oil to bring the level to the upper mark on the dipstick.

NOTICE

If you change your own oil, please dispose of the used oil properly. Put it in a sealed container and take it to a recycling center. Do not discard it in a waste bin or dump it on the ground.

The oil and filter should be changed every 6 months or 7,500 miles (12,000 km), whichever comes first. Under severe driving conditions, they should be changed every 3 months or 3,750 miles (6,000 km). See page 101 for a description of severe driving conditions.

Adding Engine Coolant

Check the level of the engine coolant by looking at the radiator reserve tank next to the air cleaner element box. If the level is at or below the MIN line,

add coolant to bring it up to the MAX line. This coolant should always be a mixture of 50% antifreeze and 50% water. Never add straight antifreeze or plain water.

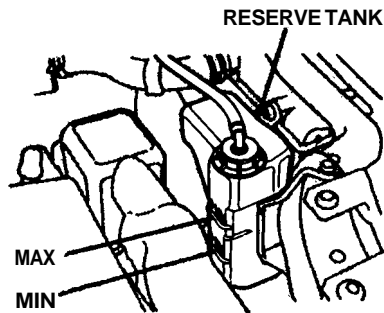

Always use Genuine Honda Antifreeze/Coolant. The cooling system contains many aluminum components that can corrode if an improper antifreeze is used.

Some antifreeze, even though labeled as safe for aluminum parts, may not provide adequate protection.

If the reserve tank is completely empty, you should also check the coolant level in the radiator.

Removing the radiator cap while the engine is hot can cause the coolant to spray out, seriously scalding you.

Always let the engine and radiator cool down before removing the radiator cap.

1. Make sure the engine and radiator are cool.

Cooling System

- Turn the radiator cap counterclockwise, without pressing down on it, until it stops. This relieves any pressure remaining in the cooling system.

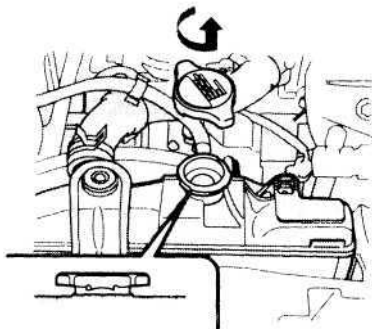

- Remove the radiator cap by pushing down and turning counterclockwise.

- The coolant level should be up to the base of the filler neck. Add coolant if it is low.

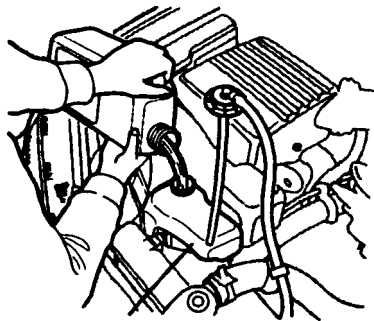

RESERVE TANK

- Put the radiator cap back on. Tighten it fully.
- Pour coolant into the reserve tank. Fill it to halfway between the MAX and MIN marks. Put the cap back on the reserve tank.

Do not add any rust inhibitors or other additives to your car's cooling system. They may not be compatible with the coolant or engine components.

Replacing Engine Coolant

The cooling system should be completely drained and refilled with new coolant according to the time and mileage recommendations in the maintenance schedule. Only use the recommended antifreeze.

Draining the coolant requires access to the underside of the car. Unless you have the tools and knowledge, you should have this maintenance done by a skilled mechanic.

- Slide the heater temperature control lever to maximum

heat. Open the hood. Make sure the engine and radiator are cool to the touch.

2. Remove the radiator cap.

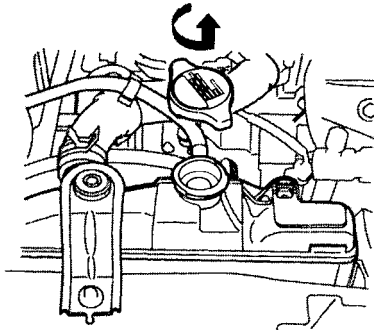

3. Loosen the drain plug in the bottom of the radiator. The coolant will drain through the splash guard. Remove the

drain bolt from the engine block.

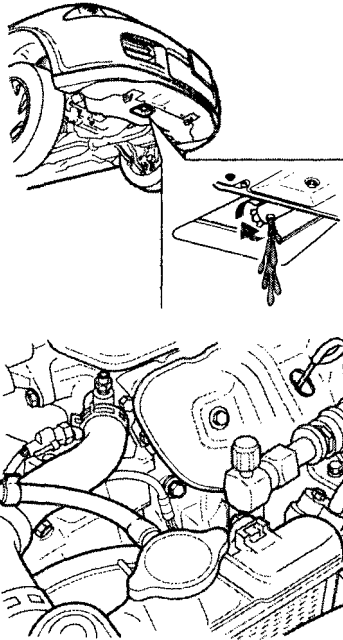

4. Remove the reserve tank from its holder by pulling it straight up. Drain the coolant, then put the tank back in its holder.

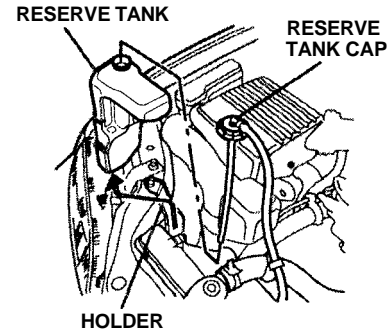

5. When the coolant stops draining, tighten the drain plug in the bottom of the radiator. Apply non-hardening sealant to the

Cooling System

drain bolt threads and reinstall the bolt in the engine block. Tighten it securely.

6. Mix the recommended antifreeze with an equal amount of purified or distilled water in a clean container. The cooling system capacity is:

With 5-speed manual transmission:

0.95 U.S. gal. (0.79 Imp. gal., 3.6 ℓ)

With automatic transmission:

DX

0.92 U.S. gal. (0.77 Imp. gal., 3.5 ℓ)

U.S.: EX, EX w/ABS option,
Canada: Si

1.00 U.S. gal. (0.84 Imp. gal., 3.8 ℓ)

7. Pour coolant into the radiator up to the base of the filler neck.

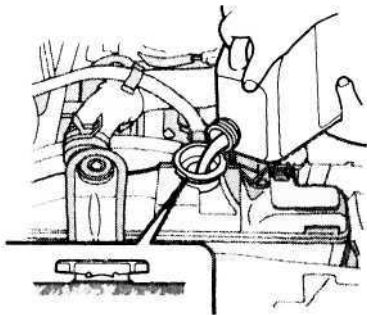

8. Loosen the bleeder bolt on top of the engine. Tighten it again when coolant comes out in a steady stream with no bubbles.

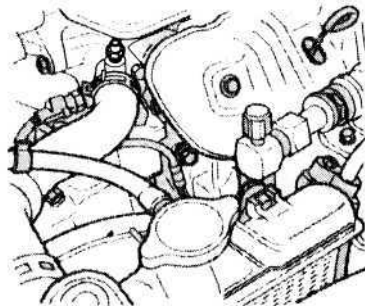

9. Refill the radiator to the base of the filler neck. Put the cap on the radiator, only tighten it to the first stop. Start the engine and let it run until it warms up (the radiator cooling fan comes on at least twice).
10. Turn off the engine. Check the level in the radiator, add

coolant if needed. Install the radiator cap, tighten it fully.

11. Fill the reserve tank to the MAX mark. Install the reserve tank cap.

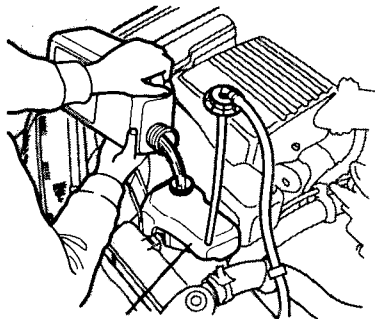

RESERVE TANK

Windshield Washers

Check the level in the windshield washer reservoir at least monthly during normal usage. In bad weather, when you use the washers often, check the level every time you stop for gas.

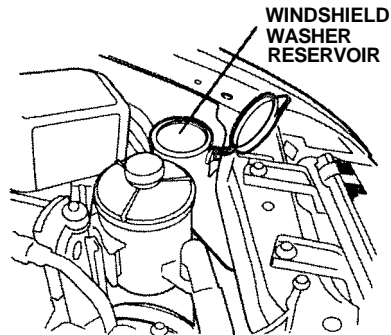

The windshield washer reservoir is located behind the driver's side headlight. Check the

reservoir's fluid level by removing the cap and looking at the dipstick.

Fill the reservoir with a good-quality windshield washer fluid. This increases the cleaning capability and prevents freezing in cold weather.

NOTICE

Do not use engine antifreeze or a vinegar/water solution in the windshield washer reservoir.

Antifreeze can damage your car's paint, while a vinegar/water solution can damage the windshield washer pump.

Use only commercially available windshield washer fluid.

Transmission Oil

Automatic Transmission

Check the fluid level with the engine at normal operating temperature.

1. Park the car on level ground. Shut off the engine.
2. Remove the dipstick (yellow loop) from the transmission and wipe it with a clean cloth.

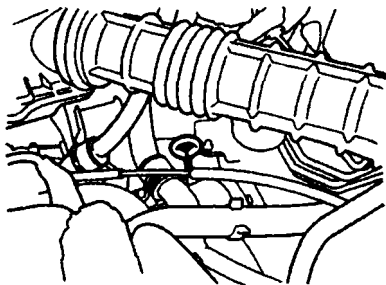

3. Insert the dipstick into the transmission.
4. Remove the dipstick and check the fluid level. It should be between the upper and lower marks.

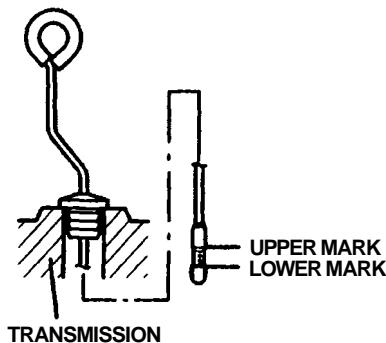

5. If the level is below the lower mark, add fluid into the tube to bring it to the upper mark. Use Honda Premium Formula

Automatic Transmission Fluid or an equivalent DEXRON II Automatic Transmission Fluid (ATF) only.

6. Insert the dipstick all the way back into the transmission securely as shown. Rotate the dipstick slightly to make sure it is squarely in the hole.

The transmission should be drained and refilled with new fluid every 24 months or 30,000 miles (48,000 km), whichever comes first. Shorten this to every 12 months or 24,000 km (15,000 miles) under severe driving conditions (see page 101.)

5-Speed Manual Transmission

Check the oil level a couple of minutes after shutting off the engine. Make sure the car is on level ground. Remove the

transmission filler bolt. The oil level should be up to the edge of the bolt hole. Feel inside the bolt hole with your finger. If you do not feel any oil, slowly add oil until it starts to run out of the hole. Reinstall the filler bolt, and tighten it securely.

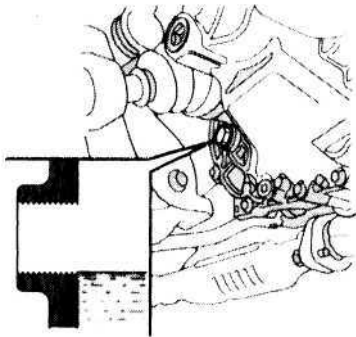

Only use an API Service SF or SG grade motor oil with a viscosity of SAE 10W-30 or 10W-40.

The transmission should be drained and refilled with new oil every 24 months or 30,000 miles (48,000 km), whichever comes first.

Shorten the service interval to every 12 months or 24,000 km (15,000 miles) under severe driving conditions (see page [101](#)).

Brake and Clutch Fluid

Check the fluid level in the reservoirs monthly. There are up to three reservoirs, depending on which model. They are:

- Brake fluid reservoir (all models)
- Clutch fluid reservoir (5-speed manual transmission only)
- ABS reservoir for cars with ABS option

The brake fluid in the brake and anti-lock brake systems should be replaced every 2 years or 30,000 miles (48,000 km), whichever comes first.

Brake System

The fluid level should be between the MIN and MAX marks on the side of the reservoir. If the level is at or below the MIN mark, it is an indication that your brake system needs attention. Have the brake system inspected for leaks or worn brake pads.

Brake and Clutch Fluid

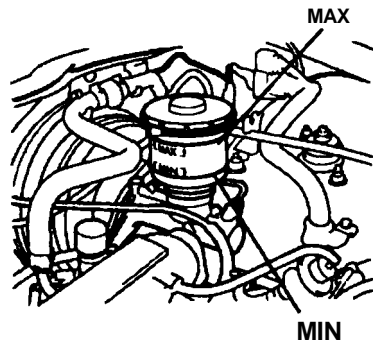

If you add brake fluid to bring it up to the MAX mark, use Genuine Honda Brake Fluid or an equivalent from a sealed container that is marked DOT 3 or DOT 4 only. Brake fluid marked DOT 5 is not compatible with your car's braking system.

Anti-Lock Brake System

The fluid should be between the MIN and MAX marks on the side of the reservoir. If it is at or below the MIN mark, it may

indicate a problem in the braking system. Have the dealer inspect your car.

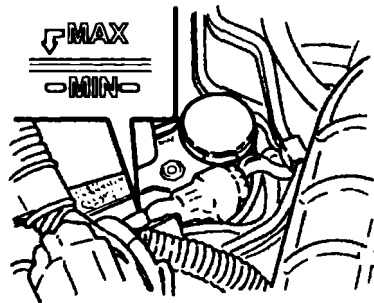

If the fluid level is half an inch or more above the MAX mark, it may indicate a problem in the ABS. Have your dealer inspect the system as soon as possible.

If you add brake fluid to bring it up to the MAX mark, use the same DOT 3 or DOT 4 brake fluid from a sealed container specified for the brake system.

Clutch System

The fluid level should be between the MIN and MAX marks on the side of the reservoir. If it is not, add brake fluid to bring it up to that level. Use the same DOT 3 or DOT 4 brake fluid specified for the brake system.

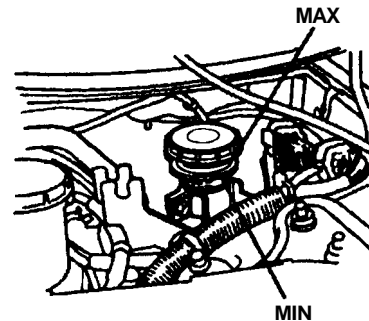

Low fluid level can indicate a leak in the clutch system. Have this system inspected as soon as possible.

Power Steering *(Only on cars equipped with Power Steering)*

You should check the fluid level in the power steering reservoir monthly. Check the level when the engine is cold. Look at the side of the reservoir. The fluid should be between the UPPER LEVEL and LOWER LEVEL. If it is below the LOWER LEVEL, add power steering fluid to the UPPER LEVEL.

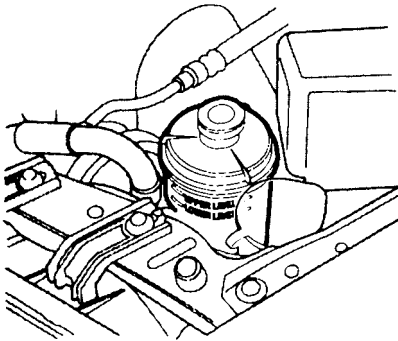

NOTICE

Using automatic transmission fluid or another brand of power steering fluid will damage the system. Use only Genuine Honda Power Steering Fluid-V.

A low power steering fluid level can indicate a leak in the system. Check the fluid level frequently and have the system inspected as soon as possible.

NOTICE

Turning the steering wheel to full left or right lock and holding it there can damage the power steering pump.

Air Cleaner Element

The air cleaner element should be replaced every 2 years or 30,000 miles (48,000 km), whichever comes first. Under severe driving conditions, it

should be cleaned every 12 months or 15,000 miles (24,000 km), whichever comes first.

Follow the replacement procedure for removal and reinstallation.

The air cleaner element is inside the air cleaner housing on the passenger's side of the engine compartment. To replace it:

1. Loosen the four bolts and remove the air cleaner housing cover.

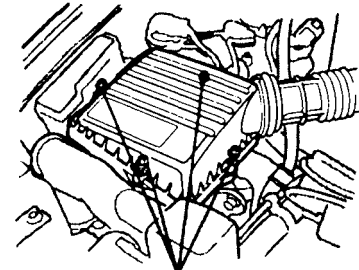

BOLTS

Air Cleaner Element, Spark Plugs

2. Remove the old air cleaner element. Clean the inside of the housing with a damp rag.

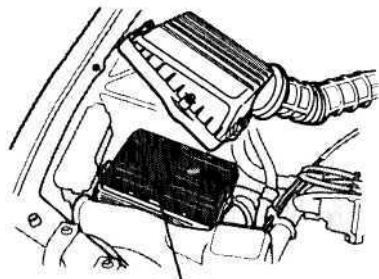

FILTER ELEMENT

3. Place the new air cleaner element in the housing.
4. Reinstall the housing cover, and tighten the four bolts.

Spark Plugs

The original spark plugs in your car need to be replaced every 2 years or 48,000 km (30,000 miles), whichever comes first.

Replacement

1. Clean up any dirt and oil that have collected around the spark plug caps.
2. Remove the spark plug cap by pulling it straight out.

SPARK PLUG CAP

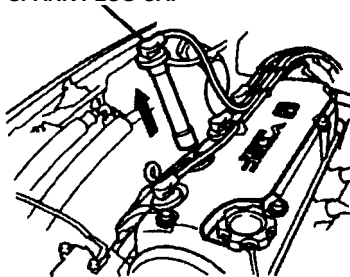

3. Remove the spark plug, using a 16 mm (5/8 inch) spark plug socket.
4. Put the new spark plug into the socket; then screw it into the hole. Screw it in by hand so you do not crosstread it.

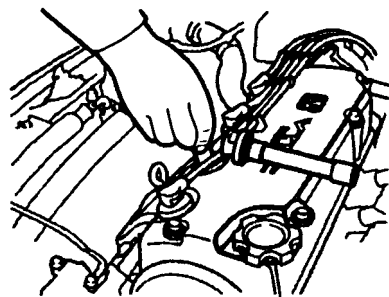

5. Torque the spark plug. (If you do not have a torque wrench, tighten the spark plug

two-thirds turn after it contacts the cylinder head.)
Tightening torque: (18 N.m,
1.8 kg-m).

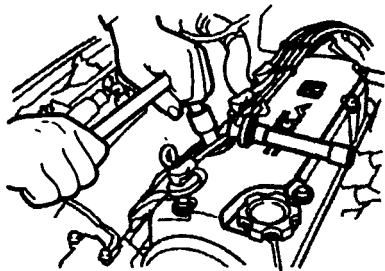

NOTICE

Tighten the spark plugs carefully. A spark plug that is too loose can overheat and damage the engine. Overtightening can cause damage to the threads in the cylinder head.

6. Install the spark plug cap.
7. Repeat this procedure for the other three spark plugs.

Spark Plug Specifications

Normal driving conditions

NGK: **ZFR5F-11**

Nippondenso: **KJ16CR-L11**

Hot climates or continuous high speed driving

NGK: **ZFR6F-11**

Nippondenso: **KJ20CR-L11**

Spark plug gap

0.035 — 0.040 in.

(1.0 — 1.1 mm)

Battery

Check the condition of your car's battery monthly. You should check for proper electrolyte level and corrosion on the terminals.

The battery contains sulfuric acid (electrolyte), which is highly corrosive and poisonous.

Getting electrolyte in your eyes or on your skin can cause serious burns.

Wear protective clothing and eye protection when working near the battery.

Emergency Procedures

Eyes - Flush with water from a cup or other container for at least 15 minutes. (Water under pressure can damage the eye.) Immediately call a physician or 911.

Skin - Remove contaminated clothing. Flush the skin with large quantities of water. Call a physician immediately.

Swallowing - Drink water or milk. Call your local Poison Control Center or a physician immediately.

Check the battery condition by looking at the test indicator window on the battery.

TEST INDICATOR WINDOW

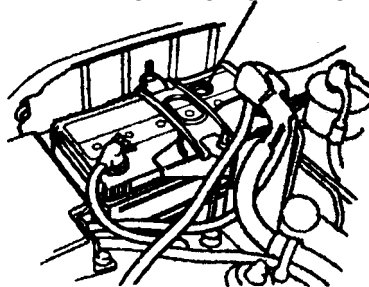

The label on the battery explains the test indicator's colors.

Check the battery terminals for corrosion (a white or yellowish powder). To remove it, cover the terminals with a solution of baking soda and water. It will bubble up and turn brown. When this stops, wash it off with plain water. Dry off the battery with a cloth or paper towel. Coat the terminals with grease to help prevent future corrosion.

If the terminals are severely corroded, clean them with baking soda and water. Then use a wrench to loosen and remove the cables from the terminals. Always disconnect the negative (-) cable first and reconnect it last. Clean the battery terminals with a terminal cleaning tool or wire brush. Reconnect and

tighten the cables; then coat the terminals with grease.

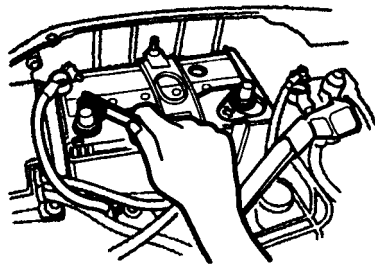

If you need to connect the battery to a charger, disconnect both cables to prevent damage to the car's electrical system.

The battery gives off explosive hydrogen gas during normal operation.

A spark or flame can cause the battery to explode with enough force to kill or seriously hurt you.

Wear protective clothing and a face shield, or have a skilled mechanic do the battery maintenance.

If your car's battery is disconnected or goes dead, the audio system will disable itself. The next time you turn on the radio you will see "Code" in the frequency display. Use the Preset buttons to enter the five-digit code (see page 71).

NOTICE

Charging the battery with the cables connected can seriously damage your car's electronic controls. Detach the battery cables before connecting the battery to a charger.

Windshield Wipers

Check the condition of the windshield wiper blades at least every six months. Look for signs of cracking in the rubber or areas that are getting hard. If you find these signs, or the wipers leave streaks and unwiped areas when used, replace the blades.

To replace:

1. Raise the wiper arm off the windshield.

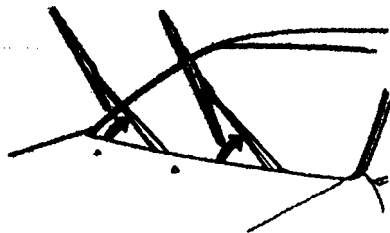

2. Disconnect the blade assembly from the wiper arm by pushing in the lock tab. Hold it in while you push the blade assembly toward the base of the arm.

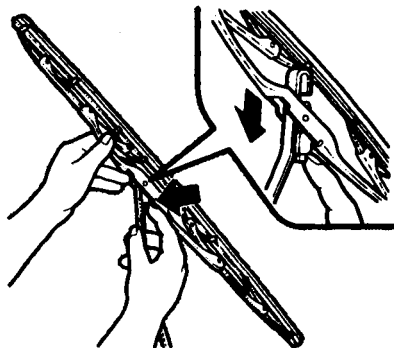

3. Remove the blade from its holder by grasping the tabbed end of the blade. Pull firmly until the tabs come out of the holder.

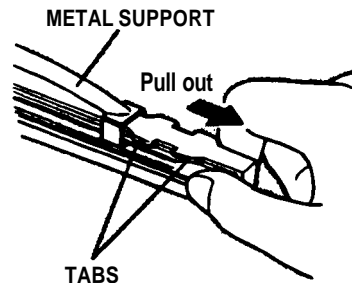

4. Examine the new wiper blades. If they have no plastic or metal reinforcement along the back edge, remove the metal reinforcement strips

from the old wiper blade, and install them in the slots along the edge of the new blade.

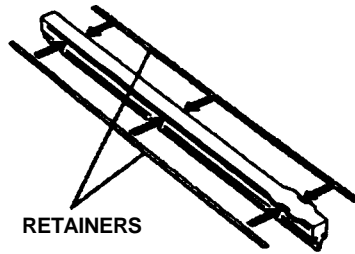

5. Slide the new wiper blade into the holder until the tabs lock.
6. Slide the new blade assembly onto the wiper arm. Make sure it locks in place.
7. Lower the wiper arm down against the windshield.

Air Conditioning System (Optional)

Your car's air conditioning is a sealed system. Any major maintenance, such as recharging, should be done by a qualified technician. You can do a couple of things you can do to make sure the air conditioning works efficiently.

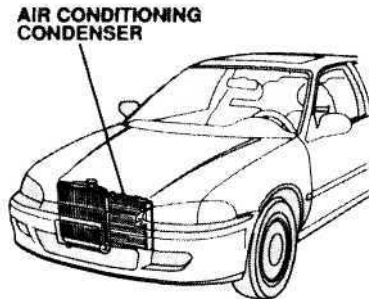

Periodically check the engine's radiator and air conditioning condenser for leaves, insects, and dirt stuck to the front surface. These block the air flow and reduce cooling efficiency. Use a light spray from a hose or a soft brush to remove them.

NOTICE

The condenser and radiator fins bend easily. Only use a low-pressure spray or soft-bristle brush to clean them.

Run the air conditioning at least once a week during the cold weather months. Run it for at least 10 minutes while you are driving at a steady speed with the engine at normal operating temperature. This circulates the lubricating oil contained in the refrigerant.

Air Conditioning System (Optional), Drive Belts, Tires

If the air conditioning does not get as cold as before, have your dealer check the system. Recharge the system with Refrigerant HFC-134a (R-134a). See **Specifications** on page 167.

NOTICE

Whenever you have the air conditioning system serviced, make sure the service facility uses a refrigerant recycling system. This system captures the refrigerant for reuse. Releasing refrigerant into the atmosphere can damage the environment.

Drive Belts

Check the condition of the two engine belts. Examine the edges of each belt for cracks or fraying. Check the tension of each belt by pushing on it with your thumb midway between the pulleys.

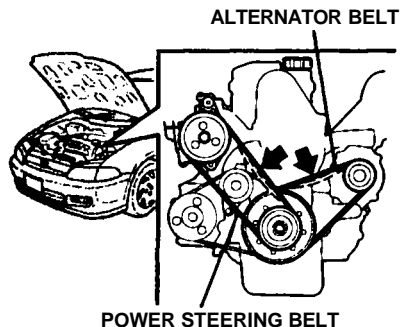

The belts should have the following "play" or deflection:

Alternator belt:

0.28 — 0.41 in. (7.0 — 10.5 mm)

Power steering belt:

0.31 — 0.47 in. (8.0 — 12.0 mm)

If you see signs of wear or looseness, have your dealer adjust or replace the belts.

Tires

To safely operate your car, your tires must be the proper type and size, in good condition with adequate tread, and correctly inflated. The following pages give more detailed information on how and when to check air pressure, how to inspect your tires for damage, and what to do when your tires need to be replaced.

Using tires that are excessively worn or improperly inflated can cause a crash in which you can be seriously hurt or killed.

Follow all instructions in this owner's manual regarding tire inflation and maintenance.

Inflation

Keeping the tires properly inflated provides the best combination of handling, tread life and riding comfort. Underinflated tires wear unevenly, adversely affect handling and fuel economy, and are more likely to fail from being overheated. Overinflated tires can make your car ride more harshly, are more prone to

damage from road hazards, and wear unevenly.

We recommend that you visually check your tires every day and use a gauge to measure the air pressure at least once a month. If you think a tire might be low, check it immediately. Remember to check the spare tire at the same time you check all the other tires.

Check the pressure in the tires when they are cold. This means the car has been parked for at least three hours. If you have to drive the car before checking the tire pressure, the tires can still be considered "cold" if you drive less than one mile (1.6 km).

If you check the pressure when the tires are hot (the car has been driven several miles), you will see readings four to six psi

higher than the cold reading. This is normal. Do not let air out to match the specified cold pressure. The tire will be underinflated.

Recommended Tire Pressures for Normal Driving

The following chart shows the recommended cold tire pressures for most normal driving conditions and speeds. Tire pressures for high speed driving are shown on page [169](#).

DX

Tire Size	Cold Tire Pressure for Normal Driving
P175/70 R13 82S	32 psi (222 kPa, 2.2 kg/cm ²)

U.S.: EX, Canada: Si

Tire Size	Cold Tire Pressure for Normal Driving
P185/60 R14 82H	29 psi (200 kPa, 2.0 kg/cm ²)

Tires

The compact spare tire pressure is 60 psi (415 kPa, 4.15 kg/cm²).

These pressures are also given on the tire information label in the glove box.

TIRE INFORMATION LABEL —
U.S.: EX with option package

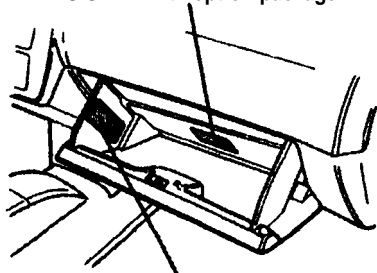

TIRE INFORMATION LABEL — DX, EX, SI

You should get your own tire pressure gauge and use it whenever you check your tire pressures. This will make it

easier for you to tell if a pressure loss is due to a tire problem and not due to a variation between gauges.

Tubeless tires have some ability to self-seal if they are punctured. However, because leakage is often very slow, you should look closely for punctures if a tire starts losing pressure.

Inspection

Every time you check inflation, you should also examine the tires for damage, foreign objects, and wear.

You should look for:

- Bumps or bulges in the tread or side of the tire. Replace the tire if you find either of these conditions.
- Cuts, splits, or cracks in the side of the tire. Replace the

tire if you can see fabric or cord.

- Excessive tread wear.

Your car's tires have wear indicators molded into the tread.

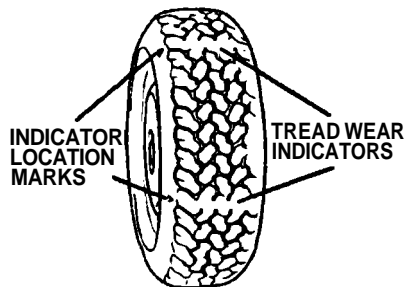

When the tread wears down to that point, you will see a 1/2 inch (12.7 mm) wide band running across the tread. This shows

there is less than 1/16 inch (1.6 mm) of tread left on the tire. A tire that is this worn gives very little traction on wet roads. You should replace the tire if you can see the tread wear indicator in three or more places around the tire.

Maintenance

In addition to proper inflation, correct wheel alignment helps to decrease tire wear. You should get your car's wheel alignment checked every 12 months or 15,000 miles (24,000 km).

The tires were properly balanced by the factory. They may need to be rebalanced at some time before they are worn out. Have your dealer check the tires if you feel a consistent vibration while driving. A tire should always be

rebalanced if it is removed from the wheel for repair.

Make sure the installer balances the wheels when you have new tires installed. This increases riding comfort and tire life. Your car's original tires were dynamic or "spin" balanced at the factory. For best results, have the installer perform a dynamic balance.

NOTICE

Improper wheel weights can damage your car's aluminum wheels. Use only genuine Honda wheel weights for balancing.

Tire Rotation

To help increase tire life and distribute wear more evenly, you should have the tires rotated every 7,500 miles (12,000 km). Move the tires to the positions shown in the chart each time they are rotated.

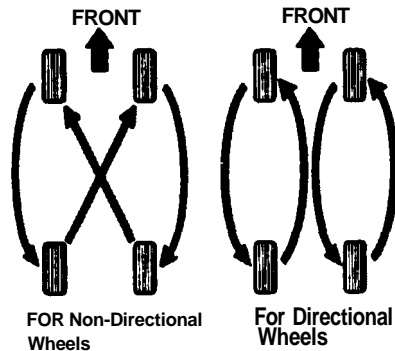

Replacing Tires and Wheels

The tires that came with your car were selected to match the

Tires

performance capabilities of the car and provide the best combination of handling, ride comfort, and long life. You should replace them with radial tires of the same size, load range, and speed rating. Mixing radial and bias-ply or bias-belted tires on your car can reduce its braking ability, traction, and steering accuracy.

Installing improper tires on your car can affect handling and stability. This can cause a crash in which you can be seriously hurt or killed.

Always use the size and type of tires recommended in this owner's manual.

It is best to replace all four tires at the same time. If that is not possible or necessary, then replace the two front tires or the two rear tires as a pair. Replacing just one tire can seriously affect your car's handling.

The ABS works by comparing the speed of the wheels. When replacing tires, use the same size originally supplied with the car. Tire size and construction can affect wheel speed and may cause the system to work inconsistently.

If you ever need to replace a wheel, make sure the wheel's specifications match those of the original wheel that came on your car. Replacement wheels are available at your Honda dealer.

Wheels and Tires

Wheel:

DX

13 x 5 J

U.S.: EX, Canada Si

14 x 5 J

Tire:

DX

P175/70R13 82S

U.S.: EX, Canada Si

P185/60R14 82H

See **Tire Information** on page [168](#) for additional information about tire and wheel size designations. See page [169](#) for information about DOT Tire Quality Grading.

Winter Driving

Tires that are marked "M + S" or "All Season" on the sidewall have an all-weather tread design. They should be suitable for most

winter driving conditions. Tires without these markings are designed for optimum traction in dry conditions. They may not provide adequate performance in winter driving. For the best performance in snowy or icy conditions, you should install snow tires or tire chains. They may be required by local laws under certain conditions.

Snow Tires

If you mount snow tires on your Honda, make sure they are radial tires of the same size and load range as the original tires. Mount snow tires on all four wheels to balance your car's handling in all weather conditions. Keep in mind the traction provided by snow tires on dry roads may not be as high as your car's original equipment tires. You should drive cautiously even when the

roads are clear. Check with the tire dealer for maximum speed recommendations.

Tire Chains

Mount snow chains on your car when warranted by driving conditions or required by local laws. Make sure the chains are the correct size for your tires. Install them only on the front tires. If metal chains are used, they must be SAE class "S." Cable-type traction devices can also be used.

When installing chains, follow the manufacturer's instructions and mount them as tightly as you can. Drive slowly with chains installed. If you hear the chains contacting the body or chassis, stop and tighten them. If they still make contact, slow down until it stops. Remove the chains as soon as you begin driving on cleared roads.

NOTICE

Chains of the wrong size or that are improperly installed can damage your car's brake lines, suspension, body, and wheels. Stop driving if you hear the chains hitting any part of the car.

Lights

Check the operation of your car's exterior lights at least once a month. A burned out bulb can create an unsafe condition by reducing your car's visibility and the ability to signal your intentions to other drivers. Check the following:

- Headlights (low and high beam)
- Parking lights
- Taillights
- Brake lights

Lights

- Turn signals
- Back-up lights
- Hazard light function
- License plate light
- Side marker lights
- Daytime running lights
(Canada cars)

If you find any bulbs are burned out, replace them as soon as possible. Refer to the chart on page 167 to determine what type of replacement bulb is needed.

Replacing a Headlight Bulb

Your car has halogen headlight bulbs, one on each side. When replacing a bulb, handle it by its steel base, and protect the glass from contact with your skin or hard objects. If you touch the glass, clean it with denatured alcohol and a clean cloth.

NOTICE

Halogen headlight bulbs get very hot when lit. Oil, perspiration, or a scratch on the glass can cause the bulb to overheat and shatter.

1. Open the hood. If you need to change the headlight bulb on the passenger's side, remove the air intake tube by pulling it straight up.

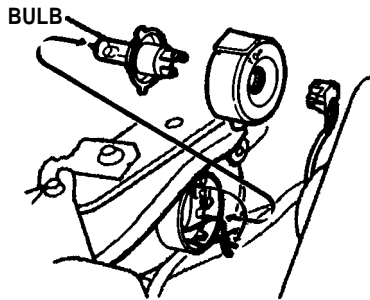

2. Remove the electrical connector from the bulb by squeezing the connector to unlock the tab on each side. Pull the connector straight back.
3. Remove the rubber weather seal by pulling on the tab.
4. Unclip the end of the hold-down wire from its slot. Pivot it out of the way, and remove the bulb.
5. Insert the new bulb into the hole, making sure the tabs are in their slots. Pivot the hold-down wire back in place, and clip the end into the slot.
6. Push the rubber weather seal over the bulb. Make sure the tab is on the top.
7. Push the electrical connector onto the tabs of the new bulb. Turn on the headlights to test the new bulb.

8. (Passenger's side)
Reinstall the air intake tube.

Replacing the Front Side Marker/Turn Signal and Parking Light Bulb

1. Use a Phillips-head screwdriver to remove the screw from the top of the fender.

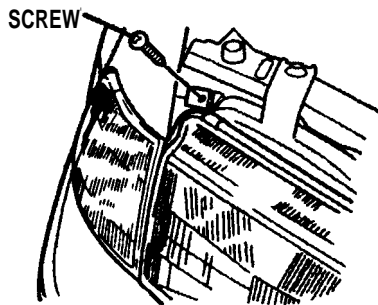

2. Move the side marker light assembly forward until it slides out of the body.

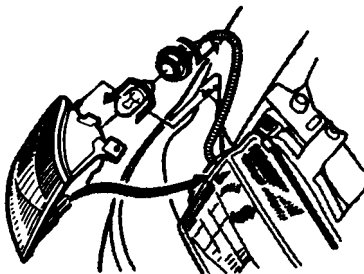

3. Turn the socket one-quarter turn counterclockwise to remove it from the lens.
4. Remove the bulb by pushing it in slightly and turning it counterclockwise.

5. Install the new bulb in the socket. Turn it clockwise to lock it in place.
6. Insert the socket back into the lens. Turn it clockwise to lock it in place.
7. Turn on the parking lights to make sure the new bulb works.
8. To reinstall the light assembly in the fender, line up the guide on the assembly with the metal tab next to the headlight, and line up the fingers on the light assembly with the holes in the fender. Push the light assembly straight back.
9. Install the mounting screw, and tighten it securely.

Replacing Rear Bulbs (in Fenders)

1. Open the trunk.
2. Remove the cover from the inside of the taillight assembly by pushing on the tab.

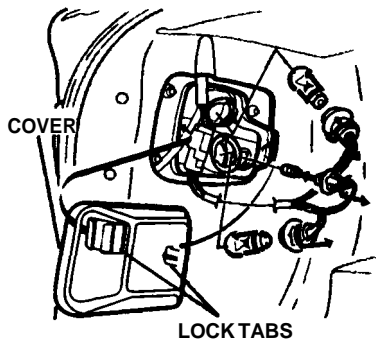

3. Determine which of the three bulbs is burned out: tail/stoplight, turn signal, or side marker. Remove the

socket for that bulb by turning it counterclockwise.

4. To remove either the tail/stoplight bulb or the turn signal bulb, push it in slightly and turn it counterclockwise. To remove the side marker bulb, pull it straight out of the socket.
5. Install the new bulb in the socket. Insert the socket back in the taillight assembly and turn it clockwise to lock it in place.
6. Test the new bulb. Reinstall the cover over the taillight assembly.

Replacing Rear Bulbs (in Trunk Lid)

1. Open the trunk.
2. Remove the electrical connector from its hold-down clip by sliding it sideways toward the center of the car.

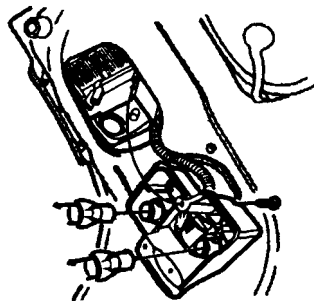

3. Use a Phillips-head screwdriver to remove the two screws from the bulb holder. Remove the holder from the taillight assembly.

4. Try the taillights and back-up lights to verify which bulb needs replacing. Remove that bulb from the socket by pushing it in slightly and turning it counterclockwise.
5. Install the new bulb in the socket. Test it to make sure it works.
6. Reinstall the bulb holder assembly. Install the two screws and tighten them securely.

High-Mount Brake Light

1. Open the trunk and remove the socket from the light assembly by turning it one-quarter turn counterclockwise.

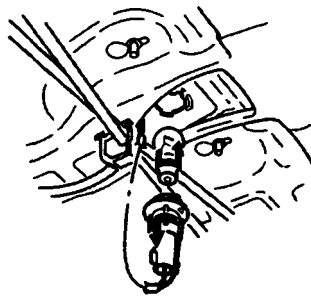

2. Remove the bulb by turning it one-quarter turn counterclockwise.
3. Install the new bulb and reinstall the socket. Make sure the new bulb is working.

Replacing a Rear License Bulb

1. Remove the two screws and remove the lens.

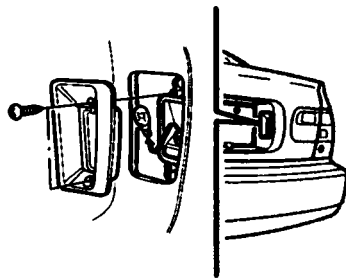

2. Pull the bulb straight out of its socket. Push the new bulb in until it bottoms in the socket.
3. Turn on the parking lights and check that the new bulb is working.

Lights

4. Reinstall the lens. Reinstall the two screws and tighten them securely.

Replacing Interior and Trunk Light Bulbs

1. Remove the lens by carefully prying on the edge of the lens in the middle with a fingernail or a small flat-tip screwdriver. Do not pry on the edge of the housing around the lens.

2. Remove the bulb by pulling it straight out of its metal tabs.

INTERIOR LIGHT

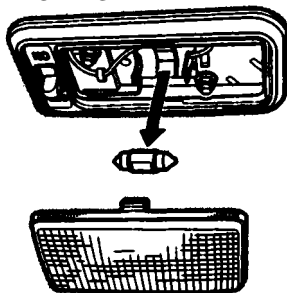

3. Push the new bulb into the metal tabs.

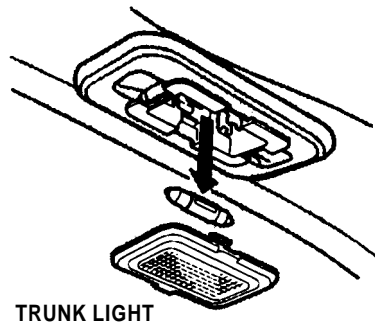

If you need to park your car for an extended period (more than 1 month), there are several things you should do to prepare it for storage. Proper preparation helps prevent deterioration and makes it easier to get your car back on the road. If at all possible, you should store your car indoors.

- Fill the fuel tank.
 - Change the engine oil and filter (see page 107).
 - Wash and dry the exterior completely.
 - Clean the interior. Make sure the carpeting, floor mats, etc. are completely dry.
 - Leave the parking brake off. Put the transmission in Reverse (5-speed manual) or Park (automatic).
 - Block the rear wheels.
- If the car is to be stored for a longer period, it should be supported on jackstands so the tires are off the ground.
 - Leave one window open slightly (if the car is being stored indoors).
 - Disconnect the battery.
 - Cover the car with a "breathable" car cover, one made from a porous material such as cotton. Nonporous materials, such as plastic sheeting, trap moisture, which can damage the paint.
 - If possible, periodically run the engine for a while (preferably once a month).
 - Support the front and rear wiper blade arms with a folded towel or rag so they do not touch the windshield.

- To minimize the seal sticking, apply a silicone spray lubricant to all door and trunk seals. Also, apply a car body wax to the painted surfaces that mate with the door and trunk seals.

If you store your car for 12 months or longer, have your Honda dealer perform the inspections called for in the 24 months/30,000 miles (48,000 km) maintenance schedule as soon as you take it out of storage (see pages 98—101). The replacements called for in the maintenance schedule are not needed unless the car has actually reached that time or mileage.

Regular cleaning and polishing of your Honda helps to keep it "new" looking. This section gives you hints on how to clean your car and preserve its appearance: the paint, brightwork, wheels, and interior. Also included are several things you can do to help prevent corrosion.

Exterior Care	138
Washing	138
Waxing	138
Touch-Up Paint.....	139
Interior Care	139
Carpeting	139
Fabric	139
Vinyl	139
Windows	140
Air Fresheners	140
Seat Belts	140
Corrosion Protection	141
Body Repairs	142

Washing

Frequent washing helps preserve your car's beauty. Dirt and grit can scratch the paint, while tree sap and bird droppings can permanently ruin the finish.

Wash your car in a shady area, not in direct sunlight. If the car is parked in the sun, move it into the shade and let the exterior cool down before you start.

NOTICE

Chemical solvents and strong cleaners can damage the paint, metal and plastic on your car.

- Rinse the car thoroughly with cool water to remove loose dirt.
- Fill a bucket with cool water. Mix in a mild detergent, such

as dishwashing liquid or a product made especially for car washing.

- Wash the car, using the water and detergent solution and a soft-bristle brush, sponge, or soft cloth. Start at the top and work your way down. Rinse frequently.
- Check the body for road tar, tree sap, etc. Remove these stains with tar remover or turpentine. Rinse it off immediately so it does not harm the finish. Remember to re wax these areas, even if the rest of the car does not need waxing.
- When you have washed and rinsed the whole exterior, dry it with a chamois or soft towel. Letting it air-dry will cause dulling and water spots.

As you dry the car, inspect it for chips and scratches that could allow corrosion to start. Repair them with touch-up paint (see page 139).

Waxing

Always wash and dry the whole car before waxing it. You should wax your car, including the metal trim, whenever water sits on the surface in large patches. It should form into beads or droplets after waxing.

You should use a quality liquid or paste wax. Apply it according to the instructions on the container. In general, there are two types of products:

Waxes - A wax coats the finish and protects it from damage by exposure to sunlight, air pollution, etc. You should use a

wax on your Honda when it is new.

Polishes - Polishes and cleaner/waxes can restore the shine to paint that has oxidized and lost some of its shine. They normally contain mild abrasives and solvents that remove the top layer of the finish. You should use a polish on your Honda if the finish does not have its original shine after using a wax.

Cleaning tar, insects, etc. with removers also takes off the wax. Remember to re wax those areas, even if the rest of the car does not need waxing.

Touch-Up Paint

Your dealer has touch-up paint to match your car's color. The color code is printed on a sticker on the driver's doorjamb. Take

this code to your dealer so you are sure to get the correct color.

Inspect your car for chips or scratches in the paint frequently. Repair them right away to prevent corrosion of the metal underneath. Use touch-up paint only on small chips and scratches. More extensive paint damage should be repaired by a professional.

Carpeting

Vacuum the carpeting frequently to remove dirt. Ground-in dirt will make the carpet wear out faster. Periodically shampoo the carpet to keep it looking new. Use one of the foam-type carpet cleaners on the market. Follow the instructions that come with the cleaner, applying it with a sponge or soft brush. Keep the

carpeting as dry as possible by not adding water to the foam.

Fabric

Vacuum dirt and dust out of the material frequently. For general cleaning, use a solution of mild soap and lukewarm water, letting it air dry. To clean off stubborn spots, use a commercially available fabric cleaner. Test it on a hidden area of the fabric first, to make sure it does not bleach or stain the fabric. Follow the instructions that come with the cleaner.

Vinyl

Remove dirt and dust with a vacuum cleaner. Wipe the vinyl with a soft cloth dampened in a solution of mild soap and water. Use the same solution with a soft-bristle brush on more difficult spots. You can also use

Interior Care

commercially available spray or foam-type vinyl cleaners.

Windows

Clean the windows, inside and out, with a commercially available glass cleaner. You can also use a mixture of one part white vinegar to ten parts water. This will remove the haze that builds up on the inside of the windows. Use a soft cloth or paper towels to clean all glass and clear plastic surfaces.

NOTICE

The rear window defogger wires are bonded to the inside of the glass. Wiping vigorously up and down can dislodge and break the defogger wires. When cleaning the rear window, use gentle pressure and wipe side to side.

Air Fresheners

If you want to use an air freshener/deodorizer in the interior of your Civic, you should use a solid type. Some liquid air fresheners contain chemicals that may cause parts of the interior trim and fabric to crack or discolor.

If you use a liquid air freshener, make sure you fasten it securely so it does not spill as you drive.

Seat Belts

If your seat belts get dirty, you can use a soft brush to clean them with a mixture of mild soap and warm water. Do not use bleach, dye, or cleaning solvents. They can weaken the belt material. Let the belts air-dry before you use the car.

Dirt buildup in the metal loops of the seat belt anchors can cause the belts to retract slowly. Wipe the insides of the loops with a clean cloth dampened in either isopropyl alcohol or a solution of mild soap and warm water.

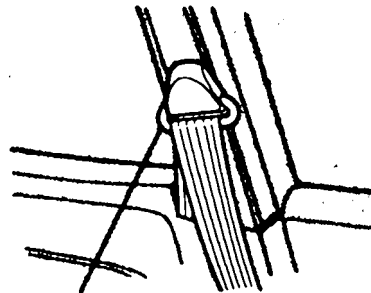

METAL LOOP

Corrosion Protection

Two factors normally contribute to causing corrosion in your car:

1. Moisture trapped in body cavities. Dirt and road salt that collects in hollows on the underside of the car stays damp, promoting corrosion in that area.
2. Removal of paint and protective coatings from the exterior and underside of the car.

Many corrosion-preventive measures are built into your Honda. You can help keep your car from corroding by performing some simple periodic maintenance:

- Repair chips and scratches in the paint as soon as you discover them.

- Inspect and clean out the drain holes in the bottom of the doors and body.
- Check the floor coverings for dampness. Carpeting and floor mats may remain damp for a long time, especially in winter. This dampness can eventually cause the floor panels to corrode.
- Use a high-pressure spray to clean the underside of your car. This is especially important in areas that use road salt in winter. It is also a good idea in humid climates and areas subject to salt air. Cars with ABS have a sensor and wiring at each wheel. Be careful not to damage them.
- Have the corrosion-preventive coatings on the underside of your car inspected and repaired periodically.

Body Repairs

Body Repairs

Body repairs can affect your car's resistance to corrosion. If your car needs repairs after a collision, pay close attention to the parts used in the repair and the quality of the work.

Make sure the repair facility uses genuine Honda replacement body parts. Some companies make sheet metal pieces that seem to duplicate the original Honda body parts, but are actually inferior in fit, finish, and corrosion resistance. Once installed, they do not give the same high-quality appearance.

When reporting your collision to the insurance company, tell them you want genuine Honda parts used in the repair. Although most insurers recognize the quality of original parts, some may try to

specify that the repairs be done with other available parts. You should investigate this before any repairs are begun.

Take your car to your authorized Honda dealer for inspection after the repairs are completed. He can make sure that quality materials were used and that corrosion-preventive coatings were applied to all repaired and replaced parts.

This section covers the more common problems that motorists experience with their cars. It gives you information about how to safely evaluate the problem and what to do to correct it. If the problem has stranded you on the side of the road, you may be able to get going again. If not, you will also find instructions on getting your car towed.

Compact Spare Tire	144
Changing a Flat Tire	144
If Your Engine Won't Start ...	149
Nothing Happens	149
The Starter Operates Normally	150
Jump Starting	150
If Your Engine Overheats	152
Low Oil Pressure Indicator ..	154
Charging System Indicator ..	155
Malfunction Indicator Lamp/ Check Engine Light	155
Closing the Moonroof	156
Fuses	157
Checking and Replacing ..	158
Location	160
Towing	162

Compact Spare Tire, Changing a Flat Tire

Your car has a compact spare tire that takes up less space. Use this spare tire as a temporary replacement only. Get your regular tire repaired or replaced and put back on your car as soon as you can.

Check the inflation of the compact spare tire every time you check the other tires. It should be inflated to 60 psi (4.15 kg/cm², 415 kPa).

Whenever you are using the compact spare tire, follow these precautions.

- Do not exceed 50 mph (80 km/h) under any circumstances.
- This tire gives a harsher ride and less traction on some road surfaces than the regular tire. Use greater caution while driving on this tire.

- Do not mount snow chains on the compact spare.
- Because the wheel of the compact spare tire is specifically designed to fit your car, do not use your spare tire on another car unless it is the same make and model.

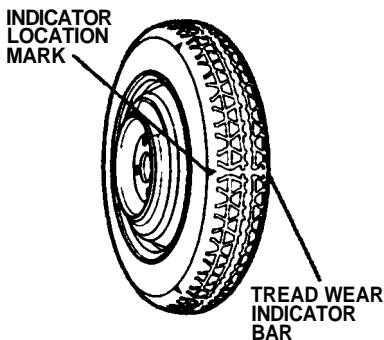

The compact spare tire has a shorter tread life than a regular tire. Replace it when you can see the tread wear indicator bars. The replacement should be the same size and design tire, mounted on the same wheel.

The compact spare tire is not designed to be mounted on a regular wheel, and the compact wheel is not designed for mounting a regular tire.

Changing a Flat Tire

If you have a flat tire while driving, stop in a safe place to change it. Stopping in traffic or on the shoulder of a busy road is dangerous. Drive slowly along the shoulder until you get to an exit or an area to stop that is far away from the traffic lanes.

The car can easily roll off the jack, seriously injuring anyone underneath.

Follow the directions for changing a tire exactly, and never get under the car when it is supported only by the jack.

1. Park the car on firm, level ground away from traffic. Turn on the hazard warning lights, and turn the ignition to LOCK (0).
2. Put the transmission in Park (automatic) or Reverse (5-speed). Set the parking

brake. Have your passengers get out of the car.

3. Open the trunk. Raise the trunk floor by lifting up on the back edge.

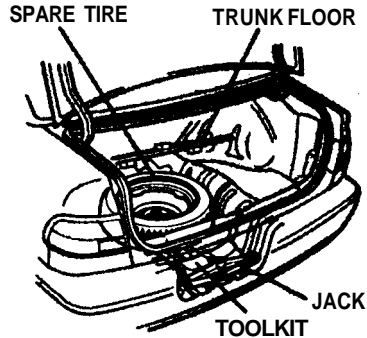

4. Take the tool kit out of the trunk.

5. Unscrew the wing bolt and take the spare tire out of the trunk.
6. Turn the jack's end bracket counterclockwise to loosen it, and remove the jack.

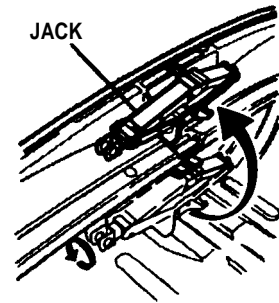

Changing a Flat Tire

7. Loosen the four wheel nuts 1/2 turn with the wheel wrench.

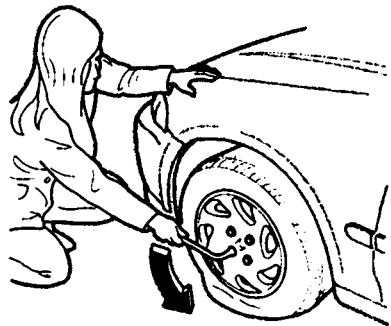

clockwise until the top of the jack contacts the jacking point. Make sure the jacking point tab is resting in the jack notch.

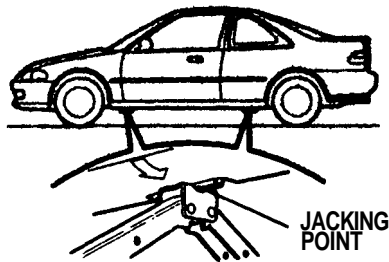

8. Locate the jacking point nearest the tire you need to change. It is pointed to by an arrow molded into the underside of the body. Place the jack under the jacking point. Turn the end bracket

9. Use the extension and wheel wrench as shown to raise the car until the flat tire is off the ground.

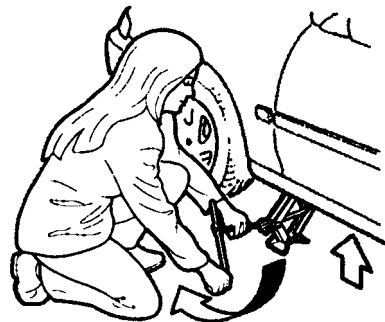
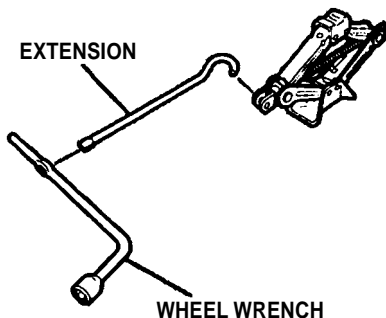

10. Remove the wheel nuts and flat tire. Temporarily place the flat tire on the ground with the outside of the wheel facing up. Placing the wheel face down could mar the wheel's finish.

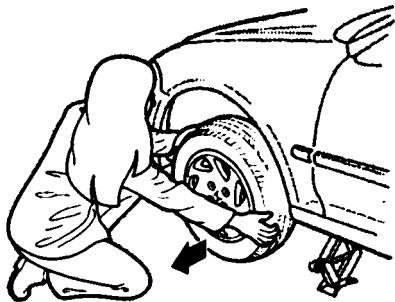

11. Before mounting the spare tire, wipe any dirt off the mounting surface of the wheel and hub with a cloth.

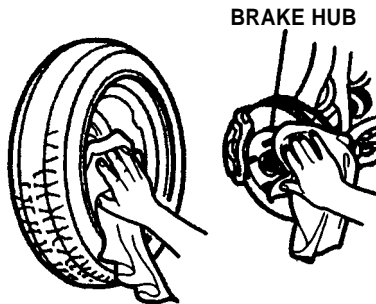

12. Put on the spare tire. Put the wheel nuts back on finger-tight; then tighten them in a crisscross pattern with the wheel wrench until the wheel

is firmly against the hub. Do not try to tighten them fully.

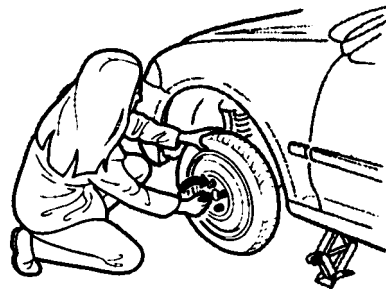

Changing a Flat Tire

13. Lower the car to the ground and remove the jack.

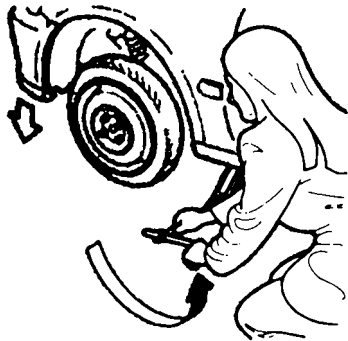

14. Tighten the wheel nuts securely in the same crisscross pattern. Have the wheel nut torque checked at the nearest automotive service facility. Tighten the

wheel nuts to 110 N·m (11 kg·m, 80 lb·ft).

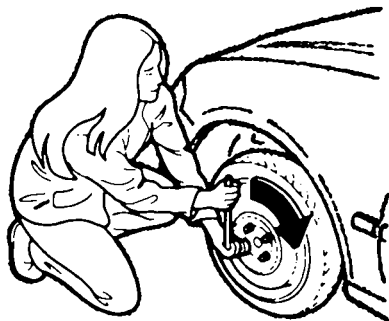

15. Remove the wheel cover or center cap. Place the flat tire face down in the trunk well.
16. Remove the spacer cone from the wing bolt, turn it

over, and put it back on the bolt.

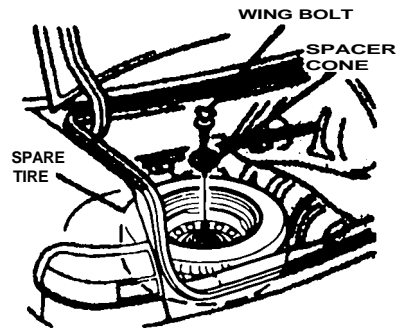

17. Secure the flat tire by screwing the wing bolt back into its hole.
18. Store the jack in the trunk with the end bracket on the right side. Turn the jack's end bracket to lock it in place. Store the tool kit.

19. Store the wheel cover or center cap in the trunk. Make sure it does not get scratched or damaged.

If Your Engine Won't Start

Diagnosing why your engine won't start falls into two areas, depending on what you hear when you turn the key to START (III):

- You hear nothing or almost nothing. The engine's starter motor does not operate at all or operates very slowly.
- You can hear the starter motor operating normally, but the engine does not start up and run.

Nothing Happens or the Starter Motor Operates Very Slowly

When you turn the ignition switch to START (III), you do not hear the normal noise of the engine trying to start. You may hear a clicking sound or series of clicks or nothing at all. Check these things:

- Check the transmission interlock. If you have a 5-speed, the clutch pedal must be pushed all the way to the floor or the starter will not operate. With an automatic transmission, it must be in Park or Neutral.
- Turn the ignition switch to ON (II). Turn on the headlights and check their brightness. If the headlights are very dim or don't light at all, the battery is discharged.

See **Jump Starting** on page 150.

- Turn the ignition switch to START (III). If the headlights do not dim, check the condition of the fuses. If the fuses are OK, there is probably something wrong with the electrical circuit for the ignition switch or starter motor. You will need a qualified technician to determine the problem. (See **Towing** on page 162.)

If the headlights dim noticeably or go out when you try to start the engine, either the battery is discharged or the connections are corroded. Check the condition of the battery and terminal connections (see page 120). You can then try jump starting the car from a booster battery (see page 150).

If Your Engine Won't Start, Jump Starting

The Starter Operates Normally

In this case, the starter motor sounds normal when you turn the ignition switch to START (III), but the engine does not run.

- Are you using the proper starting procedure? Refer to **Starting the Engine** on page 84.
- Do you have gas? Turn the ignition switch to ON (II) for a minute, and watch the fuel gauge.
- There may be an electrical problem, such as no power to the fuel pump. Check all the fuses (see page 157).

If you find nothing wrong, you will need a qualified technician to find the problem. See **Towing** on page 162.

Jump Starting

If your car's battery has run down, you may be able to start the engine by using a booster battery. Although this seems like a simple procedure, you should take several precautions. Follow these directions closely.

A battery can explode if you do not follow the correct procedure, seriously injuring anyone nearby.

Keep all sparks, open flames, and smoking materials away from the battery.

You cannot start a Honda with an automatic transmission by pushing or pulling it.

To jump start your car, follow these directions closely.

1. Open the hood and check the condition of the battery (see page 120). In very cold weather, check the condition of the electrolyte. If it seems slushy or like ice, do not try jump starting until it thaws.

NOTICE

If a battery sits in extreme cold, the electrolyte inside can freeze. Attempting to jump start with a frozen battery can cause it to rupture or explode.

2. Turn off all the electrical accessories: heater, A/C, stereo system, lights, etc. Put the transmission in Neutral or Park, and set the parking brake.

3. Connect one jumper cable to the positive (+) terminal on the booster battery. Connect the other end to the positive terminal on your Honda's battery.

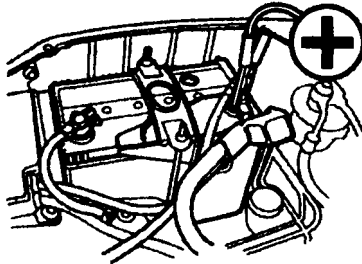

end to the grounding strap as shown. Do not connect this jumper cable to any other part of the engine.

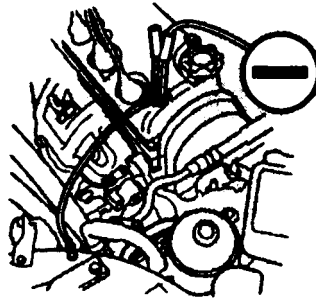

4. Connect the second jumper cable to the negative (-) terminal on the booster battery. Connect the other

5. If the booster battery is in another car, have an assistant start that car and run it at a fast idle.

**CHARGED VEHICLE
(BOOSTER BATTERY)**

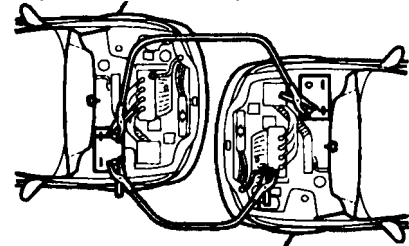

**DISCHARGED VEHICLE
(DEAD BATTERY)**

6. Start your car. If the starter motor still operates slowly, check the jumper cable connections to make sure they have good metal-to-metal contact.

Jump Starting, If Your Engine Overheats

7. Once your car is running, disconnect the negative cable from your car, and then from the booster battery. Disconnect the positive cable from your car, then the booster battery.

If Your Engine Overheats

The pointer of your car's temperature gauge should stay in the midrange under most conditions. It may go higher if you are driving up a long steep hill on a very hot day. If it climbs to the red mark, you should determine the reason.

NOTICE

Driving with the temperature gauge pointer at the red mark can cause serious damage to your engine.

Your car can overheat for several reasons, such as lack of coolant or a mechanical problem. The

only indication may be the temperature gauge climbing to or above the red mark. Or you may see steam or spray coming from under the hood. In either case, you should take immediate action.

Steam and spray from an overheated engine can seriously scald you.

Do not open the hood if steam is coming out.

1. Safely pull to the side of the road. Put the transmission in Neutral or Park and set the parking brake. Turn off the climate control and all other accessories. Turn on the hazard warning indicators.

2. If you see steam and/or spray coming from under the hood, turn off the engine.
3. If you do not see steam or spray, leave the engine running and watch the temperature gauge. If the high heat is due to overloading (climbing a long, steep hill on a hot day with the A/C running, for example), the engine should start to cool down almost immediately. If it does, wait until the temperature gauge comes down to the midpoint then continue driving.
4. If the temperature gauge stays at the red mark, turn off the engine.
5. Wait until you see no more signs of steam or spray, then open the hood.

6. Look for any obvious coolant leaks, such as a split radiator hose. Everything is still extremely hot, so use caution. If you find a leak, it must be repaired before you continue driving (see **Towing** on page 162).
7. If you don't find an obvious leak, check the coolant level in the radiator reserve tank (see page 79). If the level is below the MIN mark, add coolant to halfway between the MIN and MAX marks.
8. If you see no coolant in the reserve tank, you may also have to add coolant to the radiator.

Let the engine cool down until the pointer reaches the middle of the temperature gauge, or lower, before checking the radiator.

Removing the radiator cap while the engine is hot can cause the coolant to spray out, seriously scalding you.

Always let the engine and radiator cool down before removing the radiator cap.

9. Using gloves or a large heavy cloth, turn the radiator cap counterclockwise, without pushing down, to the first stop. This releases any remaining pressure in the cooling system. After the pressure releases, push down on the cap, and turn it until it comes off.
10. Start the engine and set the heater control lever to

maximum. Add coolant to the radiator up to the base of the fill neck. If you do not have the proper coolant mixture available, you can add plain water. Remember to have the cooling system drained and refilled with the proper mixture as soon as you can.

11. Put the radiator cap back on tightly. Run the engine and watch the temperature gauge. If it goes back to the red mark, the engine needs repair. (See **Towing** on page 162.)
12. If the temperature stays normal, check the coolant level in the radiator reserve tank. If it has gone down, add coolant to the MAX mark. Put the cap back on tightly.

Low Oil Pressure Indicator

Low Oil Pressure Indicator

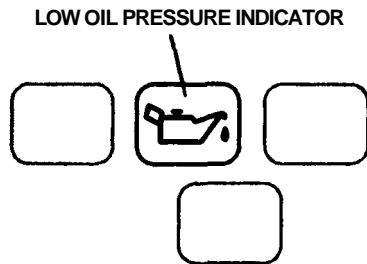

This indicator lights when the oil pressure in the engine drops low enough to cause damage. It should light when the ignition is ON (II) and go out after the engine starts. If it comes on when the engine is running, serious engine damage could happen.

NOTICE

Running the engine with low oil pressure can cause serious mechanical damage almost immediately. Turn off the engine as soon as you can safely get the car stopped.

1. Safely pull off the road and shut off the engine.
2. Let the car sit for a minute. Open the hood and check the oil level (see page 78). Although oil level and oil pressure are not directly connected, an engine that is very low on oil can lose pressure during cornering and other driving maneuvers.
3. If necessary, add oil to bring the level back to the full mark on the dipstick (see page 106).

4. Start the engine and watch the oil pressure indicator. If the indicator does not go out within 10 seconds, turn off the engine. You need to have the mechanical problem repaired before you can continue driving. (See **Towing** on page 162.)

Charging System Indicator, Malfunction Indicator Lamp

Charging System Indicator

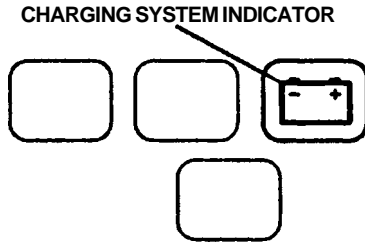

The U.S. instrument panel is shown. This light indicates the battery is not being charged. It should come on when the ignition is ON (II) and go out after the engine starts. If it comes on brightly with the engine running, the alternator is no longer charging the battery.

Immediately turn off all electrical accessories: radio, heater, A/C, rear defogger, cruise control, etc. Try not to use other electrically operated controls such as the power windows. Keep the engine running and take extra care not to stall it. Starting the engine will discharge the battery rapidly.

By eliminating as much of the electrical load as possible, you can drive several miles before the battery is too discharged to keep the engine running. Drive to a service station or garage where you can get technical assistance.

U.S.: Malfunction Indicator Lamp

Canada: Check Engine Light

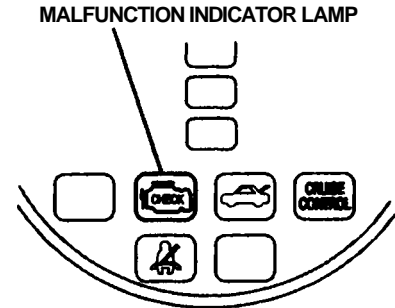

U.S. Car Shown

This indicator comes on for a few seconds when you turn the ignition switch ON (II). If it comes on at any other time, it indicates one of the engine's emissions control systems may have a problem. Even though

Malfunction Indicator Lamp. Closing the Moonroof

you may feel no difference in your car's performance, it can reduce your fuel economy and cause your car to put out excessive emissions. Continued operation may cause serious damage.

If this indicator comes on, safely pull off the road and turn off the engine. Restart the engine and watch the indicator. If it stays on, have your car checked by the dealer as soon as possible. Drive moderately until the dealer has inspected the problem. Avoid full-throttle acceleration and driving at high speed.

You should also have the dealer inspect your car if the indicator comes on frequently, even though it goes off when you follow the above procedure.

NOTICE

If you keep driving with the malfunction indicator lamp/check engine light on, you can damage your car's emission controls and engine. Those repairs may not be covered by your car's warranties.

Closing the Moonroof

If the electric motor will not close the moonroof, do this:

1. Check the fuse for the moonroof motor (see page 157). If the fuse is blown, replace it with one of the same or lower rating.
2. Try closing the moonroof. If the new fuse blows immediately or the moonroof motor still does not operate,

you can close the moonroof manually.

3. Get the tool kit out of the trunk.
4. Use a screwdriver or coin to remove the round plug between the sun visors.

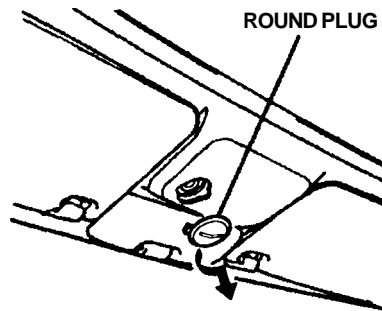

5. Insert the moonroof wrench into the socket behind this plug. Turn the wrench until the moonroof is fully closed.

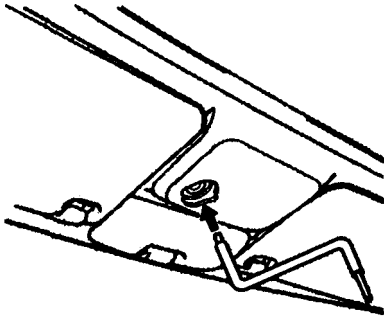

6. Remove the wrench. Replace the round plug.

Fuses

All the electrical circuits in your car have fuses to protect them from a short circuit or overload. These fuses are located in two or three fuse boxes.

The under-hood fuse box is in the engine compartment next to the battery. To open, push the tab as shown.

UNDER-HOOD

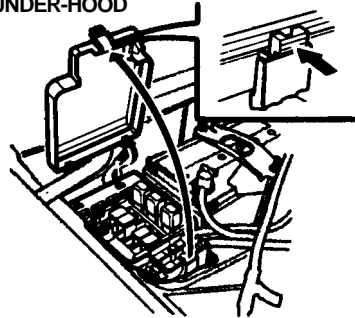

The interior fuse box is underneath the dashboard on the driver's side. Remove the fuse box lid by swinging the lid down and pulling it straight out of its hinges.

INTERIOR

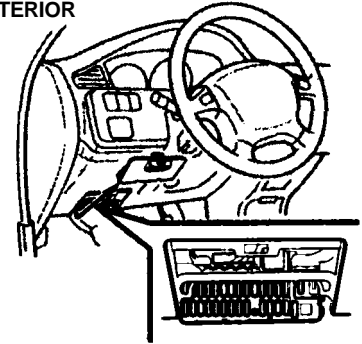

Fuses

Cars equipped with ABS have a fuse box for the ABS. It is in the front of the engine compartment on the passenger's side.

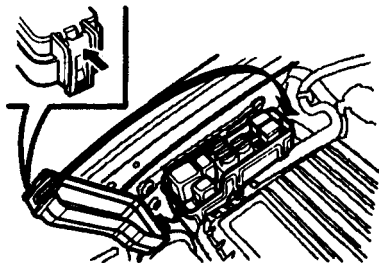

Checking and Replacing

If something electrical in your car stops working, the first thing you should check for is a blown fuse. Determine from the chart on the fuse box cover or inside the fuse box which fuse or fuses control that component.

Check those fuses first, but check all the fuses before deciding that is not the cause. Replace any blown fuses and check the component's operation.

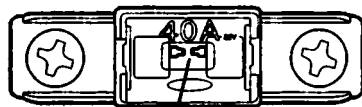

BLOWN

1. Turn the ignition switch to LOCK (0). Make sure the headlights and all other accessories are off.
2. Remove the cover from the fuse box.

3. Check each of the large fuses in the underhood fuse box by looking through the top at the wire inside. Removing these fuses requires a Phillips-head screwdriver.
4. Check the smaller fuses in the under-hood fuse box and all the fuses in the interior fuse box by pulling out each fuse with the fuse puller provided in the interior fuse box.

FUSE PULLER

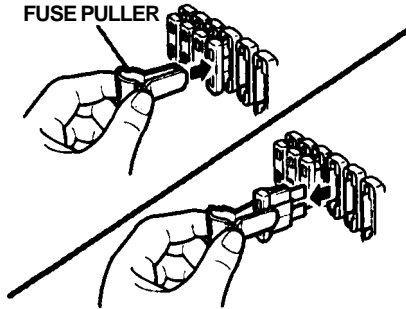

5. Look for a burned wire inside the fuse. If it is burned out, replace it with one of the spare fuses of the same rating or lower.

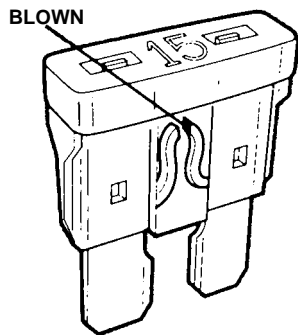

If you cannot drive the car without fixing the problem and you do not have a spare fuse, take a fuse of the same rating or a lower rating from one of the other circuits. Make sure you can

do without that circuit temporarily (such as the cigarette lighter or radio).

If you replace the burned out fuse with a spare fuse that has a lower rating, it might blow out again. This does not indicate anything wrong. Replace the fuse with one of the correct rating as soon as you can.

NOTICE

Replacing a fuse with one that has a higher rating greatly increases the chances of damaging the electrical system. If you do not have a replacement fuse with the proper rating for the circuit, install one with a lower rating.

6. If the replacement fuse of the same rating burns out in a short time, your car probably has a serious electrical problem. Leave the burned-out fuse in that circuit, and have your car checked by a qualified technician.

Fuses

Interior Fuse Box

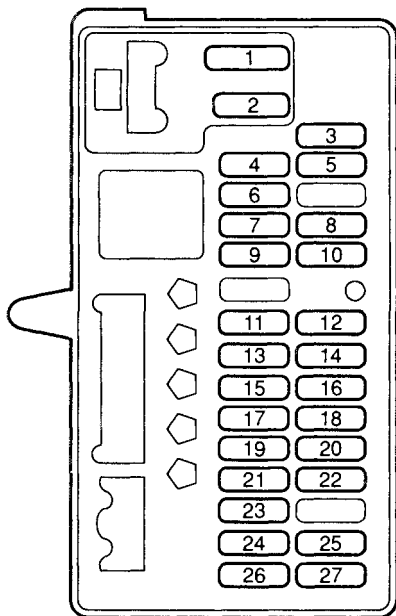

No.	Amps.	Circuits Protected
1	10A	S.R.S. *1
2	15A	ACG (S)
3	30A	Spare Fuse
4	20A	Spare Fuse
5	15A	Spare Fuse
6	15A	Radio, Cigarette Lighter
7	10A	Left Headlight Low Beam
8	10A	Left Headlight High Beam
9	10A	Right Headlight Low Beam
10	10A	Right Headlight High Beam
11	10A	Taillight, Instrument Panel Light, License Plate Light
12	20A	Front Left Power Window
13	7.5A	Starter Signal
14	20A	
15	10A	Daytime Running Light *2

No.	Amps.	Circuits Protected
16	20A	Power Door Lock
17	7.5A	Daytime Running Light *2
18	20A	Front Right Power Window
19	10A	Back-up Light
20	20A	
21	20A	Wiper, Washer, Power Window Relay, Moonroof Relay
22	7.5A	Interior Light
23	7.5A	Rear Defroster Relay, Heater Motor Relay, Cooling Fan Motor Relay
24	15A	ACG (S)*2
25	30A	Moonroof
26	10A	Spare Fuse
27	7.5A	Spare Fuse

*1 Optional for Canadian LX model

*2 On Canadian cars

Underhood Fuse Box

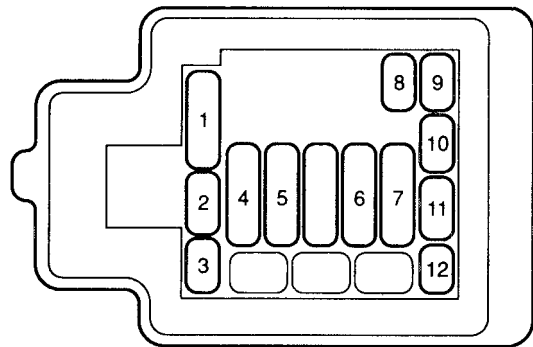

No.	Amps.	Circuits Protected
1	80A	Main Fuse Battery
2	20A	Stop, Horn
3	10A	Hazard
4	40A	Main Fuse Light
5	50A	Main Fuse Ignition
6	30A	Main Fuse Heater Motor
7	50A	Main Fuse Option
8	20A	Condenser Fan
9	15A	ECM
10	7.5A	Back Up
11	15A	Cooling Fan
12	30A	Main Fuse Rear Defroster

ABS Fuse Box

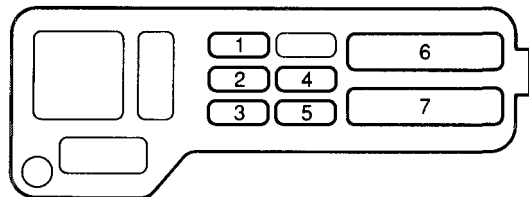

No.	Amps.	Circuits Protected
1	7.5A	ABS Clutch Monitor
2	7.5A	Motor Check
3	7.5A	ABS Clutch (Main)
4	15A	ABS + B2
5	20A	ABS + B1
6	50A	ABS Pump Motor
7	40A	ABS Clutch (Back up)

Towing

If your car needs to be towed, call a professional towing service or, if you belong to one, an organization that provides roadside assistance. Never tow your car behind another car with just a rope or chain. It is very dangerous.

Emergency Towing

There are three popular methods of towing a car:

Flatbed Equipment—The operator loads your car on the back of a truck. This is the best way of transporting your Honda.

Wheel Lift Equipment—The tow truck uses two pivoting arms that go under the tires (front or rear) and lift them off the ground. The other two tires remain on the ground.

Sling-Type Equipment—The tow truck uses metal cables with

hooks on the ends. These hooks go around parts of the frame or suspension, and the cables lift that end of the car off the ground. Your car's suspension and body can be seriously damaged if this method of towing is attempted.

If your Honda cannot be transported on a flatbed truck, it should be towed with the front wheels off the ground. If, due to damage, your car must be towed with the front wheels on the ground, do the following:

5-Speed Manual Transmission

- Release the parking brake.
- Shift the transmission to Neutral.

Automatic Transmission

- Release the parking brake.
- Start the engine.
- Shift to D4, then to N.
- Turn off the engine.

NOTICE

Improper towing preparation will damage the transmission. Follow the above procedure exactly. If you cannot shift the transmission or start the engine (automatic transmission), your car must be transported on a flat-bed.

- It is best to tow the car no farther than 50 miles (80 km), and keep the speed below 35 mph (55 km/h).

NOTICE

Trying to lift or tow your car by the bumpers will cause serious damage. The bumpers are not designed to support the car's weight.

The diagrams in this section give you the dimensions and capacities of your Honda and the locations of the identification numbers. The explanations of several electronic and mechanical systems on your Honda are for the more technically oriented owner.

Identification Numbers	164
Specifications	166
Tire Information	168
Tire Size Designation	168
Wheel Size Designation ..	168
Tire Speed Ratings	168
Tire Pressure Adjustment for High Speed Driving ..	169
DOT Tire Quality Grading (U.S. Cars)	169
Traction	169
Temperature	170
Emissions Controls	170
The Clean Air Act	170
Crankcase Emission Control System	171
Evaporative Emission Control System	171

Exhaust Emission Controls	171
PGM-FI System	171
Ignition Timing Control System	171
Three-Way Catalytic Converter	171
Replacement Parts	171
Three-Way Catalytic Converter	172

Identification Numbers

Your car has several identifying numbers located in various places.

The Vehicle Identification Number (VIN) is the 17-digit number your Honda dealer uses to register your car for warranty purposes. It is also necessary for licensing and insuring your car.

The easiest place to find the VIN is on a plate fastened to the top of the dashboard. You can see it by looking through the windshield on the driver's side. It is also on the Certification Label attached to the driver's doorjamb, and it is stamped on the engine compartment bulkhead. The VIN is also provided in bar code on the Certification Label.

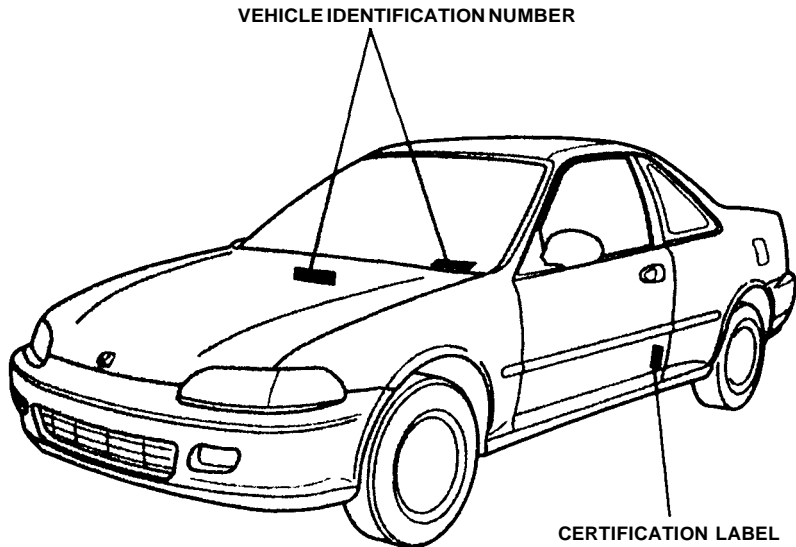

The Engine Number is stamped into the engine block.

The Transmission Number is on a label on top of the transmission.

TRANSMISSION NUMBER
(MANUAL)

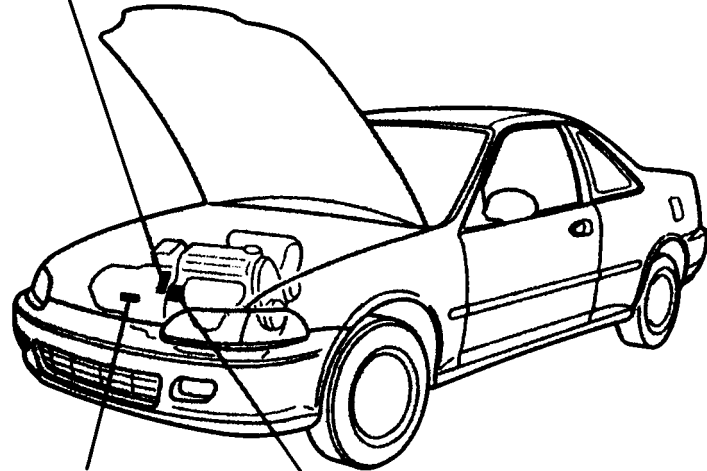

TRANSMISSION NUMBER
(AUTOMATIC)

ENGINE NUMBER

Specifications

Dimensions

Length	172.8 in (4,390 mm)	
Width	66.9 in (1,700 mm)	
Height	50.9 in (1,294 mm)	
Wheelbase	103.2 in (2,622 mm)	
Track	Front	58.1 in (1,475 mm)
	Rear	57.7 in (1,465 mm)

Weights

Gross vehicle weight rating	See the certification label attached to the driver's doorjamb.
-----------------------------	--

Engine

Type	Water cooled 4-stroke SOHC ^{*1} , SOHC VTEC ^{*2} 4-cylinder gasoline engine
Bore x Stroke	2.95 x 3.33 in (75.0 x 84.5mm) ^{*1} 2.95 x 3.54 in (75.0 x 90.0mm) ^{*2}
Displacement	91.1 cu-in (1,493 cm ³) ^{*1} 97.0 cu-in (1,590 cm ³) ^{*2}
Compression ratio	9.2:1
Spark plugs	See spark plug maintenance section page 118 .

^{*1} DX

^{*2} U.S.: EX, EX w/ABS option
Canada: Si

Capacities

Fuel tank		Approx. 11.9 U.S. gal (45 ℓ, 9.9 Imp gal)
Radiator coolant	Change ^{*1}	
	5-Speed	0.95 U.S. gal (3.6 ℓ, 0.79 Imp gal)
	Automatic	0.92 U.S. gal (3.5 ℓ, 0.77 Imp gal) ^{*2} 1.00 U.S. gal (3.8 ℓ, 0.84 Imp gal) ^{*3}
	Total	
	5-Speed	1.19 U.S. gal (4.5 ℓ, 0.99 Imp gal)
	Automatic	1.16 U.S. gal (4.4 ℓ, 0.97 Imp gal) ^{*2} 1.24 U.S. gal (4.7 ℓ, 1.03 Imp gal) ^{*3}
Engine oil	Change ^{*4}	
	Incl. filter	3.5 U.S. qt (3.3 ℓ, 2.9 Imp qt)
	W/O filter	3.2 U.S. qt (3.0 ℓ, 2.6 Imp qt)
	Total	4.2 U.S. qt (4.0 ℓ, 3.5 Imp qt)
5-speed manual transmission oil	Change	1.9 U.S. qt (1.8 ℓ, 1.6 Imp qt)
	Total	2.0 U.S. qt (1.9 ℓ, 1.7 Imp qt)
Automatic transmission fluid	Change	2.9 U.S. qt (2.7 ℓ, 2.4 Imp qt)
	Total	6.1 U.S. qt (5.9 ℓ, 5.3 Imp qt)
Windshield washer reservoir	U.S. cars	2.6 U.S. qt (2.5 ℓ, 2.2 Imp qt)
	Canadian cars	4.8 U.S. qt (4.5 ℓ, 4.0 Imp qt)

^{*1} Including the coolant in the reserve tank and that remaining in the engine. Reserve tank capacity: 0.4 ℓ (0.11 U.S. gal, 0.09 Imp gal)

^{*2} DX

^{*3} U.S.: EX, EX w/ABS option, Canada: Si

^{*4} Excluding the oil remaining in the engine.

Lights

Headlights (HI/LO)	12V – 60/55 W
Front turn signal/ side marker lights	12V – 43/3 CP (SAE 3497)
Rear turn signal lights	12V – 32CP (SAE1156)
Stop/Taillights	12V – 32/2CP (SAE 2057)
Rear side marker lights	12V – 3 CP (SAE 168)
Back-up lights	12V – 32 CP (SAE 1156)
High-mount brake light	12V – 45CP
License plate lights	12V – 8W
Interior light	12V – 8W
Trunk light	12V – 3.4W

Battery

Capacity	12V – 52AH/5HR
----------	----------------

Fuses

Interior	See the fuse label attached to the inside of the fuse box door under the dashboard.
Underhood	See the fuse box cover.

Alignment

Toe-in	Front	0.00 in (0.0 mm)
	Rear	0.08 in (2.0 mm)
Camber	Front	0°
	Rear	-0°20'
Caster	Front	1°10'

Tires

Size	Front/Rear	P175/70R13 82S *1 P185/60R14 82H *2
	Spare	T105/80D13 *1 T105/70D14 U.S.: EX, Canada: Si T135/70D15 (For cars w/ABS option)
Pressure	Front/Rear	32 psi (2.2 kg/cm ² , 220 kPa) *1 29 psi (2.0 kg/cm ² , 200 kPa) *2
	Spare	60 psi (4.15 kg/cm ² , 415 kPa)

Air Conditioning

Refrigerant Type	HFC-134a (R-134a)
Charge Quantity	17.6–19.4 oz. (500–550g)
Lubricant Type	SP10

*1DX

*2U.S.: EX, EX w/ABS option, Canada: Si

Tire Information

Tire Size Designation

A tire's sidewall is marked with a tire size designation. You will need this information when selecting replacement tires for your car. The following explains what the letters and numbers in the tire size designation mean.

(Example tire size designation)
P175/70R13 82S

P—Applicable vehicle type (tires marked with the prefix "P" are intended for use on passenger cars; however, not all tires have this marking).

175—Tire width in millimeters.

70—Aspect ratio. The tire's section height as a percentage of its width.

R—Tire construction code (Radial).

13—Rim diameter in inches.

82—Load Index, a numerical code associated with the maximum load the tire can carry.

S—Speed Rating Symbol. See the speed rating chart in this section for additional information.

Wheel Size Designation

Wheels are also marked with important information that you need if you ever have to replace one. The following explains what the letters and numbers in the wheel size designation mean.

(Example wheel size designation)
13 x 5J

13—Rim diameter in inches.

5—Rim width in inches.

J—Rim contour designation.

Tire Speed Ratings

The chart below shows many of the different speed ratings currently being used for passenger car tires. The speed rating symbol is part of the tire size designation on the sidewall of the tire. This symbol corresponds to that tire's designed maximum safe operating speed.

Speed Rating Symbol	Maximum Speed
S	112 mph (180 km/h)
T	118 mph (190 km/h)
H	130 mph (210 km/h)
V	149 mph (240 km/h)
Z	Above 149 mph (240 km/h)

Tire Pressure Adjustment for High Speed Driving

Honda strongly recommends that you not drive faster than posted speed limits and conditions allow. If you decide it is safe to drive at high speeds, be sure to adjust the cold tire pressures as shown below. If you do not adjust the tire pressure, excessive heat can build up and cause sudden tire failure.

DX

Tire Size	Cold Tire Pressure for Speeds Over 100 mph (160 km/h)
P175/70R13 82S	35 psi (240 kPa, 2.4 kg/cm ²)

U.S.: EX, Canada: Si

Tire Size	Cold Tire Pressure for Speeds Over 100 mph (160 km/h)
P185/60R14 82H	35 psi (240 kPa, 2.4 kg/cm ²)

Be sure to readjust the pressure for normal driving speeds. You should wait until the tires are cold before adjusting the tire pressure (see page 125).

DOT Tire Quality Grading (U.S. Cars)

The tires on your car meet all U.S. Federal Safety Requirements. All tires are also graded for treadwear, traction, and temperature performance according to Department of Transportation (DOT) standards. The following explains these gradings.

Treadwear

The treadwear grade is a comparative rating based on the wear rate of the tire when tested under controlled conditions on a specified government test course. For example, a tire graded 150

would wear one-and-one-half (1-1/2) times as well on the government course as a tire graded 100. The relative performance of tires depends upon the actual conditions of their use, however, and may depart significantly from the norm due to variations in driving habits, service practices and differences in road characteristics and climate.

Traction

The traction grades, from highest to lowest, are A, B, and C, and they represent the tire's ability to stop on wet pavement as measured under controlled conditions on specified government test surfaces of asphalt and concrete. A tire marked C may have poor traction performance.

Tire Information, Emissions Controls

Warning: The traction grade assigned to this tire is based on braking (straight ahead) traction tests and does not include cornering (turning) traction.

Temperature

The temperature grades are A (the highest), B, and C, representing the tire's resistance to the generation of heat and its ability to dissipate heat when tested under controlled conditions on a specified indoor laboratory test wheel. Sustained high temperature can cause the material of the tire to degenerate and reduce tire life, and excessive temperature can lead to sudden tire failure. The grade C corresponds to a level of performance which all passenger car tires must meet under the Federal Motor Vehicle Safety Standard No. 109. Grades B and

A represent higher levels of performance on the laboratory test wheel than the minimum required by law.

Warning: The temperature grade for this tire is established for a tire that is properly inflated and not overloaded. Excessive speed, underinflation, or excessive loading, either separately or in combination, can cause heat buildup and possible tire failure.

Emissions Controls

The burning of gasoline in your car's engine produces several by-products. Some of these are carbon monoxide (CO), oxides of nitrogen (NOx), and hydrocarbons (HC). Gasoline evaporating from the tank also produces hydrocarbons. Controlling the production of CO, NOx, and HC is important to the

environment. Under certain conditions of sunlight and climate, NOx and HC react to form photochemical "smog." Carbon monoxide does not contribute to smog creation, but it is a poisonous gas.

The Clean Air Act

The Clean Air Act* sets standards for automobile emissions. It also requires that automobile manufacturers explain to owners how their emissions controls work and what to do to maintain them. This section summarizes how the emissions controls work. Scheduled maintenance is on page [100](#) and [101](#).

* In Canada, Honda vehicles comply with the Canadian Motor Vehicle Safety Standards (CMVSS) for Emissions valid at

the time the vehicles are manufactured.

Crankcase Emission Control System

Your car has a Positive Crankcase Ventilation (PCV) System. This keeps gasses that build up in the engine's crankcase from going into the atmosphere. The PCV valve routes them from the crankcase back to the intake manifold. They are then drawn into the engine and burned.

Evaporative Emission Control System

As fuel evaporates in the fuel tank, an evaporative emission control canister filled with charcoal adsorbs the vapor. It is stored in this canister while the engine is off. After the engine is started and warmed up, the vapor is drawn

into the engine and burned during driving.

Exhaust Emission Controls

The exhaust emission controls include three systems: PGM-FI, Ignition Timing Control, and Three-Way Catalytic Converter. These three systems work together to control the engine's combustion and minimize the amount of HC, CO, and NO_x that comes out the tailpipe. The exhaust emission control systems are separate from the crankcase and evaporative emission control systems.

PGM-FI System

The PGM-FI System uses a sequential multiport fuel injection. It has three sub-systems: Air Intake, Engine Control, and Fuel Control. The Engine Control Module (ECM)

uses various sensors to determine how much air is going into the engine. It then controls how much fuel to inject under all operating conditions.

Ignition Timing Control System

This system constantly adjusts the ignition timing, reducing the amount of HC, CO, and NO_x produced.

Three-Way Catalytic Converter

The Three-Way Catalytic Converter is in the exhaust system. Through chemical reactions, it converts HC, CO, and NO_x in the engine's exhaust to carbon dioxide (CO₂), dinitrogen (N₂), and water vapor.

Replacement Parts

The emissions control systems are designed and certified to

Emissions Controls, Three-Way Catalytic Converter

work together in reducing emissions to levels that comply with the Clean Air Act. To make sure the emissions remain low, you should use only new Genuine Honda replacement parts or their equivalent for repairs. Using lower quality parts may increase the emissions from your car.

The emissions control systems are covered by warranties separate from the rest of your car. Read your warranty booklet for more information.

Three-Way Catalytic Converter

The Three-Way Catalytic Converter contains precious metals that serve as catalysts, promoting chemical reactions to convert the exhaust gasses without affecting the metals. The catalytic converter is referred to

as a three-way catalyst, because it acts on HC, CO, and NOx. A replacement unit must be an original Honda part or its equivalent.

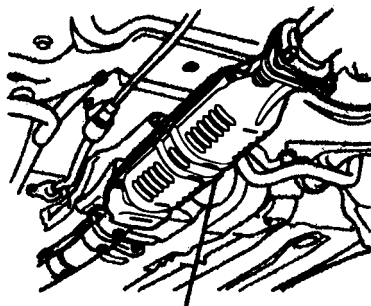

CATALYTIC CONVERTER

The Three-Way Catalytic Converter must operate at a high temperature for the chemical reactions to take place. It can set on fire any combustible materials that come near it. Park

your car away from high grass, dry leaves, or other flammables.

A defective catalytic converter contributes to air pollution and can impair your engine's performance. To protect your car's catalytic converter, follow these guidelines.

- Always use unleaded gasoline. Even a small amount of leaded gasoline can contaminate the catalyst metals, making the converter ineffective.
- Keep the engine tuned up.
- Have your car diagnosed and repaired if it is misfiring, backfiring, continuing to run after you turn off the engine, stalling, or otherwise not running properly.

Warranty Coverages	174
Customer Relations Information	175
Reporting Safety Defects	175
U.S. Zone Office Map	176
Canada Zone Office Map	177
Authorized Manuals	179

Warranty Coverages

U.S. Cars

Your new Honda is covered by these warranties:

New Car Limited Warranty — Covers your new car, except for the battery, emissions control systems and accessories, against defects in materials and workmanship.

Emission Control Systems Defects Warranty and Emissions Performance Warranty — These two warranties cover your car's emission control systems. Time, mileage, and coverage are conditional. Please read the warranty manual for exact information.

Original Equipment Battery Limited Warranty — This warranty gives up to 100% credit toward a replacement battery.

Seat Belt Limited Warranty — A seat belt that fails to function properly is covered for the useful life of the car.

Rust Perforation Limited Warranty — All exterior body panels are covered for rust-through from the inside for the specified time period with no mileage limit.

Accessory Limited Warranty — Genuine Honda Accessories are covered under this warranty. Time and mileage limits depend on the type of accessory and other factors. Please read your warranty manual for details.

Replacement Parts Limited Warranty — Covers all Genuine Honda replacement parts against defects in materials and workmanship.

Replacement Battery Limited Warranty — Provides prorated coverage for a replacement battery purchased from a Honda dealer.

Replacement Muffler Lifetime Limited Warranty — Provides coverage for as long as the purchaser of the muffler owns the car.

Restrictions and exclusions apply to all these warranties. Please read the 1995 Honda Warranty booklet that came with your car for precise information on warranty coverages. Your Honda's original tires are covered by their manufacturer. Tire warranty information is in a separate booklet.

Canada Cars

Please refer to the 1995 Warranty and Maintenance Guide that came with your car.

Customer Relations Information

Honda dealership personnel are trained professionals. They should be able to answer all your questions. If you encounter a problem that your dealership does not solve to your satisfaction, please discuss it with the dealership's management. The Service Manager or General Manager can help. Almost all problems are solved in this way.

If you are dissatisfied with the decision made by the dealership's management, contact your Honda Customer Relations Zone Office. Refer to the U.S. and Canada Zone Office maps on the following pages.

When you call or write, please give us this information:

- Vehicle Identification Number (see page 164).
- Name and address of the dealer who services your car.
- Date of purchase.
- Mileage on your car.
- Your name, address, and telephone number.
- A detailed description of the problem.
- Name of the dealer who sold the car to you.

Reporting Safety Defects

If you believe that your vehicle has a defect that could cause a crash or could cause injury or death, you should immediately inform the National Highway Traffic Safety Administration (NHTSA) in addition to notifying American Honda Motor Co., Inc.

If NHTSA receives similar complaints, it may open an investigation, and if it finds that a safety defect exists in a group of vehicles, it may order a recall and remedy campaign. However, NHTSA cannot become involved in individual problems between you, your dealer, or American Honda Motor Co., Inc.

To contact NHTSA, you may either call the Auto Safety Hotline toll-free at (800) 424-9393 (or (202) 366-0123 in Washington D.C. area), or write to: NHTSA, U.S. Department of Transportation, Washington, D.C. 20590. You can also obtain other information about motor vehicle safety from the Hotline.

A

- ABS. See Anti-Lock Brakes
- ACCESSORY,
(Ignition Key Position) 41
- Adding
 - Automatic Transmission
 - Fluid 114
 - Brake Fluid 116
 - Clutch Fluid 116
 - Engine Oil 106
 - Manual Transmission
 - Fluid 114
 - Power Steering Fluid ... 117
 - Radiator Coolant 109
 - Windshield Washer
Fluid..... 113
- Additional Safety
 - Information 15
 - Door Locks 15
 - Driving With Pets 16
 - Seat-Back Position 15
 - Storing Cargo Safely 15

- Additives, Engine Oil 107
- Adjustments
 - Mirrors 48
 - Seats 43
 - Steering Wheel 32, 36
- Air Cleaner Element 117
- Air Conditioning
 - Maintenance 123
 - Usage 58
- Air Filter.
See Air Cleaner Element
- Air Outlets (Vents) 56
- Air Pressure, Tires 167
- Airbag (SRS) 12
- Alcohol in Gasoline 74
- Alternator Belt. See Drive Belts
- Anchor Plate, Child Seat ... 22
- Anti-Theft Steering
 - Column Lock 41

- Anti-Lock Brakes
 - Indicator Light 29, 93
 - Operation 92
- Antifreeze 109
- Appearance Care 137
- Ashtrays 52
- Audio System 62
- Automatic Cruise Control .. 37
- Automatic Transmission ... 87
 - Capacity, Fluid 166
 - Checking Fluid Level ... 114
 - Shift Lever Positions 88
 - Shift Lock Release 90
 - Shifting..... 88

B

- Battery 120
 - Charging System
 - Indicator 28

Index

- Jump Starting 150
- Maintenance 120
- Specifications 167
- Before Driving 73
- Belts, Seat 4
- Beverage Holder 51
- Body Repair 142
- Brakes
 - Anti-Lock Brake System . 92
 - Break-in 74
 - Fluid 115
 - Light, Burned out 129
 - Parking 49
 - System Indicator 28
 - Wear Indicators 91
- Braking System 91
- Break-in, New Car 74
- Brightness Control,
Instruments 34
- Brights, Headlights 33
- Bulb Replacement
 - Back-up Lights 132
 - Brake Lights 132
 - Front Parking Lights ... 131
 - Front Side Marker
Lights 131
 - Headlights 130
 - High-Mount Brake
Light 133
 - License Plate Lights ... 133
 - Rear Side Marker
Lights 132
 - Specifications 167
 - Turn Signal Lights 131
- Bulbs, Halogen 130
- C**
 - CD Player/Changer 67
 - Cables,
Jump Starting With 150
 - Capacities Chart 166
 - Carbon Monoxide Hazard .. 23
 - Cargo, Loading 81
 - Cassette Player
 - Care 66
 - Operation 65
 - Catalytic Converter,
Three-Way 172
 - CAUTION, Explanation of ... ii
 - Certification Label 164
 - Chains, Tire 129
 - Change Oil, How to 108
 - Changing a Flat Tire 144
 - Changing Engine Coolant . 110
 - Charging System Indicator . 28
 - Charging System Light ... 155
 - Check Engine Light
(Canada) 29

Checking		
Automatic Transmission		
Fluid	114	
Battery Condition	120	
Brake Fluid	115	
Clutch Fluid	115	
Drive Belts	124	
Fuses	158	
Manual Transmission		
Fluid	114	
Power Steering Fluid	117	
Radiator Coolant	109	
Tire Pressure	125	
Windshield Wipers	122	
Checklist, Before Driving	84	
Child Safety	17	
Guidelines for Restraining		
Infants/Children	18	
Important Safety		
Reminders	18	
Where Should Children		
Sit	17	
Cigarette Lighter	52	
CLEAN Indicator	66	
Cleaner, Air	117	
Cleaning		
Exterior	138	
Interior	139	
Seat Belts	140	
Vinyl	139	
Clock, Setting the	50	
Clutch Fluid	116	
CO in the Exhaust	170	
Cold Weather, Starting in	85	
Compact Spare	144	
Consumer Information	175	
Control Locations	26	
Controls Near the Steering		
Wheel	32	
Daytime Running Lights	33	
Hazard Warning	35	
Headlights	33	
Instrument Panel		
Brightness	34	
Rear Window Defogger	36	
Steering Wheel		
Adjustment	36	
Turn Signals	34	
Windshield Washers	35	
Windshield Wipers	34	
Controls, Instruments and	25	
Coolant		
Adding	109	
Capacity	166	
Proper Solution	109	
Temperature Gauge	31	
Corrosion Protection	141	
Crankcase Emission		
Control System	171	
Cruise Control Operation	37	
Cup Holder. See Beverage		
Holder		

Index

- Customer Relations Information 175
- Customer Relations Office 176

D

- DANGER, Explanation of ii
- Dashboard 26
- Daytime Running Lights ... 33
- Dead Battery, What to Do . 150
- Defects, Reporting Safety . 175
- Defogger, Rear Window 36
- Defrosting the Windows ... 60
- DEXRON II Automatic Transmission Fluid 114
- Dimensions 166
- Dimming the Headlights ... 33

- Dipstick, Automatic Transmission 114
- Directional Signals 29
- Disabled, Towing Your Car If 162
- Disc Brake Wear Indicators 91
- Disposal of Used Oil 109
- Doors
 - Locking and Unlocking .. 41
 - Power Door Locks 42
- DOT Tire Quality Grading .. 169
- Downshifting, 5-Speed Manual Transmission 86
- Drive Belts 124
- Driving
 - Fuel Economy 80
 - In Foreign Countries 75

E

- Economy, Fuel 80
- Emergencies on the Road . 143
 - Battery, Jump Starting . 150
 - Changing a Flat Tire ... 144
 - Charging System Indicator 28
 - Check Engine Light (Canada) 29
 - Checking the Fuses 158
 - Malfunction Indicator Lamp (U.S.) 29
 - Manually Closing Moonroof 156
 - Oil Pressure Indicator ... 28
 - Overheated Engine 152
- Emergency Brake 49
- Emergency Flashers 29
- Emissions Control 170

Engine	
Belts	124
Check Light (Canada)...	29
Coolant Temperature	
Gauge	31
Identification Number ..	165
Malfunction Indicator	
Lamp (U.S.).....	29
Oil, Capacity	166
Oil Pressure Indicator ...	28
Oil, What Kind to Use ..	106
Overheating	153
Specifications	166
Ethanol in Gasoline	74
Evaporative Emission	
Controls	171
Exhaust Fumes	23
Expectant Mothers, Use of	
Seat Belts by	9
Exterior, Cleaning the	138

F

Fabric, Cleaning	139
Fan, Interior	58
Features, Comfort and	
Convenience	55
Filling the Fuel Tank	76
Filters	
Air. See Air Cleaner Element	
Oil	107
First Gear, Shifting	86
5-Speed Manual Transmission,	
Checking Fluid Level	114
5-Speed Manual Transmission	
Fluid	115
5-Speed Manual Transmission,	
Shifting the	86
Flashers, Hazard Warning ..	29
Flat Tire, Changing a	144

Fluids	
5-Speed Manual	
Transmission,	
Capacity	166
Automatic	
Transmission	114
Capacity	166
Brake	116
Clutch	116
Manual Transmission ..	114
Power Steering	117
Windshield Washer	113
Capacity	166
FM Stereo Radio	
Reception	62
Folding Rear Seat	45
Foreign Countries,	
Driving in	75
Four-Way Flashers	35
Front End, Towing by	
Emergency Wrecker	162

Index

Fuel	
Fill Door and Cap	76
Filling the Fuel Tank	76
Gauge	31
Octane Requirement	74
Oxygenated	74
Tank, Capacity	166
Fuses, Checking the	158

G

Gas Mileage, Improving	80
Gas Station Procedures	76
Gasohol	75
Gasoline	74
<i>See also</i> Fuel	
Gauge	31
Tank, Filling the	76
Gauges	
Engine Coolant Temperature	31

Fuel.....	31
Gearshift Lever Positions	
5-Speed Transmission ..	86
Automatic Transmission	87
Glass Cleaning.....	140

H

Halogen Headlight Bulbs ..	130
Hazard Warning Flashers ..	35
Headlights	33
Daytime Running Lights ..	33
High Beam Indicator	30
High Beams	33
Low Beams	33
Replacing Halogen Bulbs	130
Turning on	33
Heating and Cooling	56

High Altitude, Starting at ..	85
High-Low Beam Switch	33
Hood, Opening the	77
Hot Coolant, Warning About.....	109

I

Identification Number, Vehicle	164
If Your Car Has to Be Towed.....	162
Ignition	
Keys	40
Switch	40
Timing Control System ..	171
Indicator Lights, Instrument Panel	27
Infant Restraint	19
Inflation, Proper Tire	125

Inside Mirror	48
Inspection, Tire	126
Instrument Panel	26
Instrument Panel Brightness	34
Interior Cleaning	139
Interior Light	53
Introduction	i

J

Jack, Tire	145
Jacking up the Car	146
Jump Starting	150

K

Keys	40
------------	----

L

Label, Certification	164
Labels, Safety, Location of ..	24
Lane Change, Signaling	34
Lap Belt	8
Lap/Shoulder Belts	7
Leaking of Exhaust Into Car	23
Lighter, Cigarette	52
Lights	
Bulb Replacement .	129, 130
Indicator	27
Parking	33
Turn Signal	34
Loading Cargo	81
LOCK (Ignition Key Position)	40
Locking Clip, Seat Belt.....	20

Locks

Anti-Theft Steering Column	41
Fuel Filler Door	76
Power Door	42
Low Coolant Level	109
Lower Gear, Downshifting to a	86
Lubricant Specifications Chart	166
Luggage, Loading	81

M

Maintenance	
Periodic Items	104
Record	102, 103
Malfunction Indicator Lamp (US.)	29

Index

Manual Transmission	
Fluid	114
Manually Closing	
Moonroof	156
Maximum Shift Speeds	87
Meters, Gauges	30
Methanol in Gasoline	75
Mirrors, Adjusting	48
Moonroof	
Closing Manually	156
Operation	47

N

Neutral Gear Position	89
New Vehicle Break-in	74
Normal Shift Speeds	86
NOTICE, Explanation of	ii
Numbers, Identification ..	164

O

Occupant Protection	
System	4
Octane Requirement,	
Gasoline	74
Odometer	31
Odometer, Trip	31
Oil	
Change, How to	108
Pressure Indicator	28
Selecting Proper	
Viscosity Chart	107
ON (Ignition Key Position) .	41
Opening the Hood	77
Outside Mirrors	48
Overheating, Engine	152

P

Panel Brightness Control ..	34
Park Gear Position	88
Parking Brake	49
Parking Brake and Brake	
System Light	28
Parking Lights	33
Parking Over Things That	
Burn	172
PGM-FISystem	171
Polishing and Waxing	139
Power	
Door Locks	42
Mirrors	48
Steering	117
Windows	46
Power Steering Belt. See Drive	
Belts	
Pregnancy, Using Seat Belts .	9

Proper Seat Belt Usage 7

R

Radiator Overheating 152

Radio/Cassette Sound System 62

Rear End Towing 162

Rear Lights, Bulb Replacement 132

Rear Seat, Folding 45

Rear View Mirror 48

Rear Window Defogger 36

Reclining the Seat-Back . 15, 44

Recommended Shift Speeds 86

Replacement Information
 Air Cleaner Element ... 117
 Coolant 110

Engine Oil and Filter ... 107

Fuses 158

Light Bulbs 130

Spark Plugs 118

Tires 127

Wiper Blades 122

Replacing Seat Belts After a Crash 10

Reporting Safety Defects . 175

Reserve Tank, Coolant ... 109

Restraint, Child 17

Reverse Gear Position 89

Rotation, Tire 127

S

Safety Belts 5

Safety Defects, Reporting . 175

Safety Labels, Location of.. 24

Safety Messages ii

Seat Adjustments, Front Seat Adjustments 43

Seat Belts Advice for Pregnant Women 9

Child Seat Anchor Plate . 22

Cleaning..... 140

Frayed or Torn 10

Locking Clip 20

Maintenance 10

Reminder Light 28

Replacement..... 10

System Components 5

Tether Attachment Points 21

Use During Pregnancy ... 9

Wearing a Lap/Shoulder Belt 7

Wearing the Lap Belt..... 8

Seats, Adjusting the 43

Serial Number 164

Index

Service Intervals 100, 101
Service Manual 179
Service Station
 Procedures 76
Setting the Clock 50
Shift Lever Position
 Indicator 87
Shifting
 The 5-Speed
 Transmission 86
 The Automatic
 Transmission 87, 88
Side Marker Lights, Bulb
 Replacement in 131
Signaling Turns 34
Snow Chains 129
Snow Tires 129
Solvent-Type Cleaners 138
Sound System 62

Spare Tire
 Inflating 144
 Specifications 167
Spark Plugs
 Replacing 118
 Specifications 119
Speed Control 37
Speedometer 30
START (Ignition Key
 Position) 41
Starting the Engine 84
 In Cold Weather at High
 Altitude 85
 With a Dead Battery ... 150
Steam Coming From
 Engine 152
Steering Wheel
 Adjustment 36
 Anti-Theft Column Lock . 41

Steering Wheel Controls,
 Cruise Control 37
Stereo Sound System 62
Storing Your Car 135
Supplemental Restraint
 System
 Service Precautions 14
 Servicing 14
 SRS Indicator 14, 28

T

Tachometer 30
Taillights, Changing
 Bulbs in 132
Taking Care of the
 Unexpected 143
Tape Player 65

Technical Descriptions			
Emission Control			
Systems	170		
Three-Way Catalytic Converter	172		
Tire Information	169		
Temperature Gauge	31		
Tether Attachment Points ..	21		
Time, Setting the	50		
Tire, How to Change a Flat	144		
Tire Chains	129		
Tires	124		
Checking Wear	126		
Compact Spare	144		
DOT Tire Quality Grading	169		
Inflation	125		
Inspection	126		
Replacing	127		
Rotating	127		
Snow	129		
Specifications	167		
Tools, Tire Changing	145		
Torn Seat Belts	10		
Towing			
A Trailer	93		
Emergency Wrecker (Tow Truck)	162		
Transmission			
Checking Fluid Level			
5-Speed Manual			
Transmission	114		
Automatic			
Transmission	114		
Fluid Selection	114		
Identification Number ..	165		
Shifting the 5-Speed			
Manual	86		
Shifting the Automatic ..	88		
Tread Wear	169		
Trip Meter	31		
Trunk-Open Indicator			
Light	29		
Turn Signals	34		
U			
Underside, Cleaning.....	138		
Unexpected, Taking Care of the	143		
Uniform Tire Quality Grading	169		
Unleaded Gasoline	74		
Upholstery Cleaning	139		
Used Oil, How to Dispose of	109		

Index

V

Vehicle Capacity Load	81
Vehicle Dimensions	166
Vehicle Identification Number	164
Vehicle Storage	135
Ventilation	59
VIN	164
Vinyl Cleaning	139
Viscosity, Oil	106

W

Warning Beepers Key in Ignition	41
Seat Belts	28
Warning Labels, Location of	24

WARNING, Explanation of ...	ii
Warranty Coverages	174
Washer, Windshield, Fluid Capacity	166
Washer, Windshield Checking the Fluid Level	113
Operation	35
Washing	138
Waxing and Polishing	138
Wheels Adjusting the Steering ..	36
Alignment and Balance	127
Compact Spare	144
Wheel Wrench	146
Wrench	146
Windows Cleaning	140
Operating the Power	46
Rear, Defogger	36

Windshield Cleaning	35
Defroster	60
Wipers, Windshield Changing Blades	122
Operation	34
Worn Tires	126
Wrecker, Emergency Towing	162

Gasoline

UNLEADED gasoline
Pump octane of 86 or higher

Fuel Tank Capacity

11.9 U.S. gal (45 l, 9.9 Imp gal)

Recommended Engine Oil

API SG or SH grade
"Energy Conserving II" oil
SAE 5W-30 viscosity

Engine Oil Capacity

including filter

3.5 U.S. qt (3.3 l, 2.9 Imp qt)

without filter

3.2 U.S. qt (3.0 l, 2.6 Imp qt)

Tire Pressure

(measured cold)

DX: 32 psi (2.2 kg/cm², 220 kPa)

U.S.: EX, Canada: Si
29 psi (2.0 kg/cm², 200 kPa)

Spare Tire Pressure

60 psi (4.15 kg/cm², 415 kPa)

Tire Size (Front and Rear)

DX: P175/70R1382S

U.S.: EX, Canada: Si
P185/60R14 82H

Spare Tire

DX: T105/80D13

U.S.: EX, Canada: Si
T105/70D14

U.S.: EX with ABS option
T135/70D15

Other Tire Size Information

See label in the glove box.

5 Speed Manual

Transmission Oil

SAE 10W-30 or 10W-40 viscosity
API SF or SG grade
recommended
Capacity:
1.9 U.S. qt (1.8 l, 1.6 Imp qt)

Automatic

Transmission Fluid

Honda Premium Formula
Automatic Transmission Fluid or
an equivalent DEXRON[®] II type
Automatic Transmission Fluid
(ATF)
Capacity:
2.9 U.S. qt (2.7 l, 2.4 Imp qt)