

1998 Accord Coupe Online Reference Owner's Manual

Use these links (and links throughout this manual) to navigate through this reference.
For a printed owner's manual, click on authorized manuals or go to www.helminc.com.

Contents

Owner's Identification Form

Introduction	i
A Few Words About Safety	ii
Driver and Passenger Safety	3
Proper use and care of your vehicle's seat belts, and Supplemental Restraint System.	
Instruments and Controls	47
Instrument panel indicator and gauge, and how to use dashboard and steering column controls.	
Comfort and Convenience Features	103
How to operate the climate control system, the audio system, and other convenience features.	
Before Driving	153
What gasoline to use, how to break-in your new vehicle, and how to load luggage and other cargo.	
Driving	167
The proper way to start the engine, shift the transmission, and park, plus towing a trailer.	
Maintenance	191
The Maintenance Schedule shows you when you need to take your vehicle to the dealer.	
Appearance Care	259
Tips on cleaning and protecting your vehicle. Things to look for if your vehicle ever needs body repairs.	
Taking Care of the Unexpected	267
This section covers several problems motorists sometimes experience, and how to handle them.	
Technical Information	293
ID numbers, dimensions, capacities, and technical information.	
Warranty and Customer Relations (U.S. and Canada)	309
A summary of the warranties covering your new Acura, and how to contact us.	
Authorized Manuals (U.S. only)	315
How to order manuals and other technical literature.	
Index	I

Service Information Summary

A summary of information you need when you pull up to the fuel pump.

Congratulations ! Your selection of a 1998 Honda Accord was a wise investment. It will give you years of driving pleasure.

One of the best ways to enhance the enjoyment of your new Honda is to read this manual. In it, you will learn how to operate its driving controls and convenience items. Afterwards, keep this owner's manual in your vehicle so you can refer to it at any time.

Several warranties protect your new Honda. Read the warranty booklet thoroughly so you understand the coverages and are aware of your rights and responsibilities.

Maintaining your vehicle according to the schedules given in this manual helps to keep your driving trouble-free while it preserves your investment. When your vehicle needs maintenance, keep in mind that your Honda dealer's staff is specially trained in servicing the many systems unique to your Honda. Your Honda dealer is dedicated to your satisfaction and will be pleased to answer any questions and concerns.

As you read this manual, you will find information that is preceded by a **NOTICE** symbol. This information is intended to help you avoid damage to your Honda, other property, or the environment.

A Few Words About Safety

Your safety, and the safety of others, is very important. And operating this vehicle safely is an important responsibility.

To help you make informed decisions about safety, we have provided operating procedures and other information on labels and in this manual. This information alerts you to potential hazards that could hurt you or others.

Of course, it is not practical or possible to warn you about all the hazards associated with operating or maintaining your vehicle. You must use your own good judgement.

You will find this important safety information in a variety of forms, including:

- **Safety Labels** — on the vehicle.
- **Safety Messages** — preceded by a safety alert symbol  and one of three signal words: **DANGER**, **WARNING**, or **CAUTION**.
These signal words mean:

You **WILL** be **KILLED** or **SERIOUSLY HURT** if you don't follow instructions.

You **CAN** be **KILLED** or **SERIOUSLY HURT** if you don't follow instructions.

You **CAN** be **HURT** if you don't follow instructions.

- **Safety Headings** — such as Important Safety Reminders or Important Safety Precautions.
- **Safety Section** — such as Driver and Passenger Safety.
- **Instructions** — how to use this vehicle correctly and safely.

This entire book is filled with important safety information — please read it carefully.

This section gives you important information about how to protect yourself and your passengers. It shows you how to use seat belts properly. It explains your Supplemental Restraint System. And it tells you how to properly restrain infants and children in your car.

Important Safety Precautions	4
Your Car's Safety Features.....	5
Seat Belts.....	6

Airbags.....	7
Seats & Seat-Backs.....	8
Head Restraints.....	8
Door Locks.....	8
Pre-Drive Safety Checklist.....	9
Protecting Adults.....	10
1. Close and Lock the Doors.....	10
2. Adjust the Front Seats.....	10
3. Adjust the Seat-Backs.....	11
4. Adjust the Head Restraints....	12
5. Fasten and Position the Seat Belts.....	13
6. Adjust the Steering Wheel....	14
7. Maintain a Proper Sitting Position.....	15
Advice for Pregnant Women.....	15
Additional Safety Precautions....	16
Protecting Children.....	17
All Children Must Be Restrained.....	17
Children Should Sit in the Back Seat.....	18
The Passenger's Airbag Poses Serious Risks to Children.....	18
If You Must Drive with Several Children.....	19

If a Child Requires Close Attention.....	20
Additional Safety Precaution.....	20
General Guidelines for Using Child Seats.....	21
Protecting Infants.....	25
Protecting Small Children.....	29
Protecting Larger Children.....	32
Using Child Seats with Tethers.....	35
Additional Information About Your Seat Belts.....	38
Seat Belt System Components...	38
Lap/Shoulder Belt.....	38
Seat Belt Maintenance.....	39
Additional Information About Your SRS.....	40
SRS Components.....	40
How Your Airbags Work.....	40
How Your SRS Indicator Light Works.....	42
SRS Service.....	42
Additional Safety Precautions....	43
Carbon Monoxide Hazard.....	44
Safety Labels.....	45

Important Safety Precautions

You'll find many safety recommendations throughout this section, and throughout this manual. Following are a few recommendations we consider most important.

Always Wear Your Seat Belt

A seat belt is your best protection in all types of collisions. Airbags supplement seat belts, but airbags are designed to inflate only in a severe frontal collision. So even with airbags, make sure you and your passengers always wear your seat belts, and wear them properly. (See page 13.)

Restrain All Children

Children are safest when they are properly restrained in the back seat, not the front seat. A child who is too small for a seat belt must be properly restrained in a child safety seat. (See page 17.)

Be Aware of Airbag Hazards

While airbags save lives, they can cause serious or fatal injuries to occupants who sit too close to them, or are not properly restrained. Infants, young children, and short adults are at the greatest risk. Be sure to follow all instructions and warnings in this manual. (See page 7.)

Don't Drink and Drive

Alcohol and driving don't mix. Even one drink can reduce your ability to respond to changing conditions. Reaction time gets worse with every additional drink. So don't drink and drive, and don't let your friends drink and drive, either.

Control Your Speed

Excessive speed is a major factor in crash injuries and deaths. Generally, the higher the speed the greater the risk, but serious accidents can also occur at lower speeds. Never drive faster than is safe for current conditions, regardless of the maximum speed posted.

Keep Your Vehicle in Safe Condition

Having a tire blowout or a mechanical failure can be extremely hazardous. To reduce the possibility of such problems, check your tire pressures and condition frequently, and perform all regularly scheduled maintenance. (See page 194.)

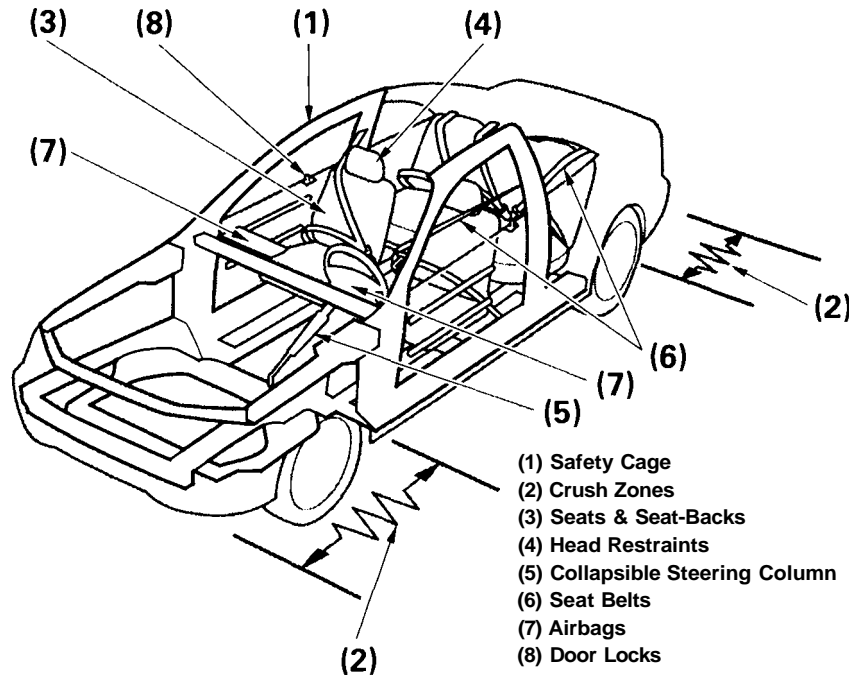

Your car is equipped with many features that work together to protect you and your passengers during a crash.

Some safety features do not require any action on your part. These include a strong steel framework that forms a safety cage around the passenger compartment; front and rear crush zones that are designed to crumple and absorb energy during a crash; and a collapsible steering column.

These safety features are designed to reduce the severity of injuries in a crash. However, you and your passengers can't take full advantage of these safety features unless you remain sitting in a proper position and ***always wear your seat belts properly***. In fact, some safety features can contribute to injuries if they are not used properly.

Your Car's Safety Features

Seat Belts

For your safety, and the safety of your passengers, your car is equipped with seat belts in all seating positions.



Your seat belt system also includes a light on the instrument panel to remind you and your passengers to fasten your seat belts.

Why Wear Seat Belts

Seat belts are the single most effective safety device for adults and larger children. (Infants and smaller children must be properly restrained in child seats.)

Not wearing a seat belt properly increases the chance of serious injury or death in a crash, even though your car has airbags.

In addition, most states and all Canadian provinces require you to wear seat belts.

Not wearing a seat belt properly increases the chance of serious injury or death in a crash, even if you have airbags.

Be sure you and your passengers always wear seat belts and wear them properly.

When properly worn, seat belts:

- Keep you connected to the vehicle so you can take advantage of the vehicle's built-in safety features.
- Help protect you in almost every type of crash, including side and rear impacts and rollovers. (Your airbags can only be helpful in a severe frontal collision.)

- Help keep you from being thrown against the inside of the car and against other occupants.
- Keep you from being thrown outside of the car.
- Help keep you in a good position should the airbags ever deploy. A good position reduces the risk of injury from an inflating airbag, and allows you to get the best advantage from the airbags.

Of course, seat belts cannot completely protect you in every crash. But in most cases, seat belts can reduce your risk of serious injury.

What you should do: Always wear your seat belt, and make sure you wear it properly.

Airbags

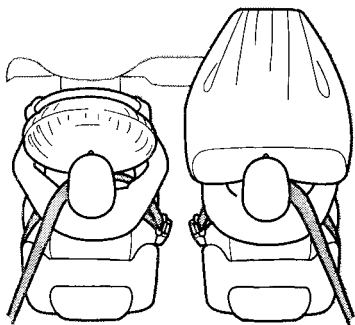

Your car has a Supplemental Restraint System (SRS) with frontal airbags to help protect the driver and a front seat passenger.

SRS This system also includes an indicator light on the instrument panel to alert you to a possible problem with the system.

Following are the most important things you need to know about your airbags:

- **Airbags do not replace seat belts.** They supplement seat belts by providing extra protection for the heads and chests of front seat occupants.
- **Airbags offer no protection in side impacts, rear impacts, rollovers, or minor or moderate collisions.**

Airbags are designed to deploy only during a severe frontal collision (such as a 25 mph [40 km/h] crash into a parked car of similar size and weight).

- **Airbags can pose serious hazards.** To do their job, airbags must inflate with tremendous force and speed. So while airbags save lives, they can cause serious injuries to adults and larger children who are not wearing seat belts, are not wearing them properly, are sitting too close to the airbag, or are not sitting in a proper position. Infants and small children are at an even greater risk of injury or death.

What you should do: Always wear your seat belt properly and sit upright and as far back as possible from the steering wheel or dashboard.

Your Car's Safety Features

Seats & Seat-Backs

Your vehicle's seats are designed to keep you in a comfortable, upright position so you can take full advantage of the protection offered by seat belts and the seats' energy absorbing materials.

How you adjust your seats and seat-backs can also affect your safety. For example, sitting too close to the steering wheel or dashboard increases your risk of being injured by striking the inside of the car or being injured by an inflating airbag.

Reclining a seat-back too far makes your seat belt less effective and increases your chance of sliding under the seat belt and being seriously injured in a crash.

What you should do: Move the front seats as far back as possible, and keep adjustable seat-backs in an upright position whenever the car is moving.

Head Restraints

Head restraints can help protect you from whiplash and other injuries. For maximum protection, the back of your head should rest against the center of the head restraint.

Door Locks

Keeping your doors locked reduces the chance of being thrown out of the car during a crash. It also helps prevent occupants from accidentally opening a door and falling out, and outsiders from unexpectedly opening your doors.

Pre-Drive Safety Checklist

To make sure you and your passengers get the maximum protection from your car's safety features, check the following each time before you drive away:

- All adults, and children who have outgrown child safety seats, are wearing their seat belts and wearing them properly (see page 13).
- Any infant or small child is properly restrained in a child seat in the back seat (see page 17).
- Front seat occupants are sitting as far back as possible from the steering wheel and dashboard (see page 10).
- Seat-backs are upright (see page 11).

- Head restraints are properly adjusted (see page 12).
- Both doors are closed and locked (see page 10).
- All cargo is properly stored or secured (see page 164).

The rest of this section gives more detailed information about how you can maximize your safety.

Remember, however, that no safety system can prevent all injuries or deaths that can occur in severe crashes, even when seat belts are properly worn and the airbags deploy.

Protecting Adults

Introduction

The following pages provide instructions on how to properly protect the driver and other adult occupants.

These instructions also apply to children who have outgrown child seats and are large enough to wear lap/shoulder belts. (See page 32 for important additional guidelines on how to properly protect larger children.)

1 .Close and Lock the Doors

After everyone has entered the vehicle, be sure the doors are closed and locked.

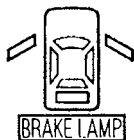

Your car has a door monitor light on the instrument panel to indicate when a specific door is not tightly closed.

For safety, locking the doors reduces the chance of a passenger, especially a child, opening a door while the vehicle is moving and accidentally falling out. It also reduces the chance of someone being thrown out of the vehicle during a crash.

For security, locked doors can prevent an outsider from unexpectedly opening a door when you come to a stop.

See page 71 for how to lock the doors.

2.Adjust the Front Seats

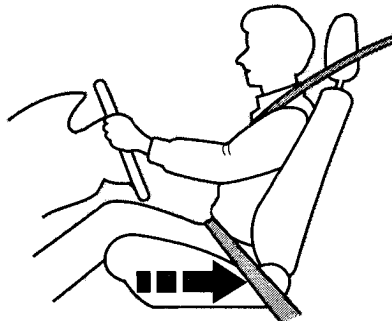

Any driver who sits too close to the steering wheel is at risk of being seriously injured or killed by striking the steering wheel or being struck by an inflating airbag during a crash.

To reduce the chance of injury, wear your seat belt properly, sit upright with your back against the seat, and move the seat as far back as possible from the steering wheel while still maintaining full control of the car. Also make sure your front seat passenger moves their seat as far to the rear as possible.

Sitting too close to an airbag can result in serious injury or death if the airbags inflate.

Always sit as far back from the airbags as possible.

Most shorter drivers can get far enough away from the steering wheel and still reach the pedals. However, if you are concerned about sitting too close, we recommend that you investigate whether some type of adaptive equipment may help.

Once your seat is adjusted correctly, rock it forward and back to make sure the seat is locked in position.

See page [82](#) for how to adjust the front seats.

3. Adjust the Seat-Backs

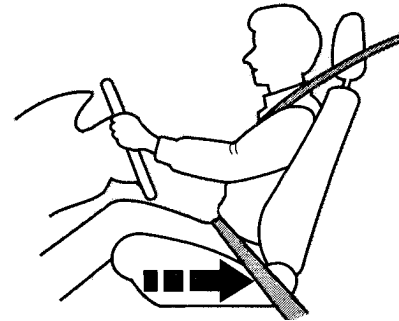

Adjust the driver's seat-back to a comfortable, upright position, leaving ample space between your chest and the airbag cover in the center of the steering wheel. If you sit too close to the steering wheel, you could be injured if the airbag inflates.

CONTINUED

A front passenger should also adjust the seat-back to an upright position, but as far from the dashboard as possible. If the passenger sits too close to the dashboard, they could be injured if the airbag inflates.

Reclining a seat-back so that the shoulder part of the belt no longer rests against an occupant's chest reduces the protective capability of the belt. It also increases the chance of sliding under the belt and being seriously injured in a crash. The farther a seat-back is reclined, the greater the risk of injury.

Reclining the seat-back too far can result in serious injury or death in a crash.

Adjust the seat-back to an upright position and sit well back in the seat.

See page [82](#) for how to adjust seat-backs.

4. Adjust the Head Restraints

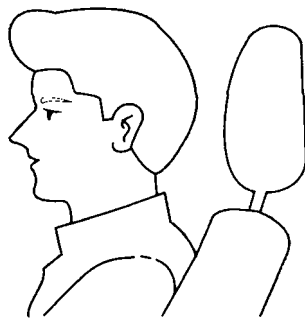

Before driving, make sure everyone with an adjustable head restraint has properly positioned the head restraint. The restraint should be positioned so the back of the occupant's head rests against the center of the restraint. A taller person should adjust the restraint as high as possible.

Improperly positioning head restraints reduces their effectiveness and you can be seriously injured in a crash.

Make sure head restraints are in place and positioned properly before driving.

Properly adjusted head restraints will help protect you from whiplash and other crash injuries.

See page [87](#) for how to adjust the head restraints.

5. Fasten and Position the Seat Belts

Insert the latch plate into the buckle, then tug on the belt to make sure the belt is securely latched. Also check that the belt is not twisted, because a twisted belt can cause serious injuries in a crash.



Position the lap part of the belt as low as possible across your hips, then pull up on the shoulder part of the belt so the lap part fits snugly. This lets your strong pelvic bones take the force of a crash and reduces the chance of internal injuries.

CONTINUED

Protecting Adults

If necessary, pull up on the belt again to remove any slack from the shoulder part, then check that the belt rests across the center of your chest and over your shoulder. This spreads the forces of a crash over the strongest bones in your upper body.

Improperly positioning the seat belts can cause serious injury or death in a crash.

Make sure all seat belts are properly positioned before you drive.

An improperly positioned seat belt can cause severe neck injuries if the belt is positioned too high, or serious chest or internal injuries if the belt is positioned too low.

Never place the shoulder portion of a lap/shoulder belt under your arm or behind your back. This could cause very serious injuries in a crash.

If a Seat Belt Doesn't Work Properly
If your seat belt does not seem to work as it should, it may not protect you in a crash. Anyone using an inoperative seat belt can be seriously injured or killed. **No one should sit in a seat with an inoperative seat belt.** Have your Honda dealer check the belt as soon as possible.

See page 38 for additional information about your seat belt system and how to take care of your belts.

6. Adjust the Steering Wheel

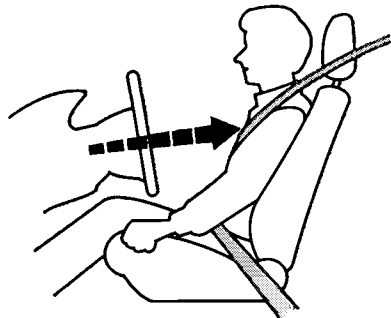

Adjust the steering wheel, if needed, so that the wheel points toward your chest, not toward your face.

Pointing the steering wheel toward your face decreases the protective capability of the driver's airbag.

See page 63 for how to adjust the steering wheel.

7. Maintain a Proper Sitting Position

After all occupants have adjusted their seats and put on seat belts, it is very important that they continue to sit upright, with their bodies well back in their seats and both feet on the floor, until the car is parked and the engine is off.

Sitting improperly can increase the chance of injury during a crash. For example, if an occupant slouches, lies down, turns sideways, sits forward, leans forward, or puts one or both feet up, their chance of injury during a crash is greatly increased.

In addition, if an occupant is out of position in the front seat, they can be seriously or fatally injured by striking interior parts of the vehicle, or by being struck by an inflating airbag.

Sitting improperly or out of position can result in serious injury or death in a crash.

Always sit upright, well back in the seat, with your feet on the floor.

Remember, to get the best protection from your car's airbags and other safety features, you must sit properly and wear your seat belt properly.

Advice for Pregnant Women

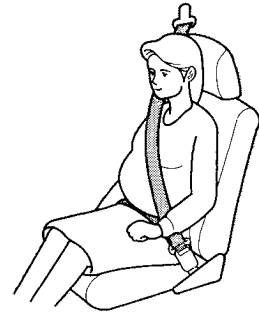

Because protecting the mother is the best way to protect her unborn child, a pregnant woman should always wear a seat belt whenever she drives or rides in a car.

Remember to keep the lap portion of the belt as low as possible across your hips.

CONTINUED

Protecting Adults

Pregnant women should also sit as far back as possible from the steering wheel or dashboard. This will reduce the risk of injuries to both the mother and her unborn child that can be caused by a crash or an inflating airbag.

Each time you have a checkup, ask your doctor if it's okay for you to drive.

Additional Safety Precautions

- **Two people should never use the same seat belt.** If they do, they could be very seriously injured in a crash.
- **Do not put any accessories on seat belts.** Devices intended to improve occupant comfort, or reposition the shoulder part of a seat belt, can severely compromise the protective capability of seat belts and increase the chance of serious injury in a crash.
- **Do not place hard or sharp objects between yourself and an airbag.** Carrying hard or sharp objects on your lap, or driving with a pipe or other sharp object in your mouth, can result in injuries if your airbags inflate.
- **Keep your hands and arms away from the airbag covers.** If your hands or arms are close to the SRS covers in the center of the steering wheel and on top of the dashboard, they could be injured if the airbags inflate.

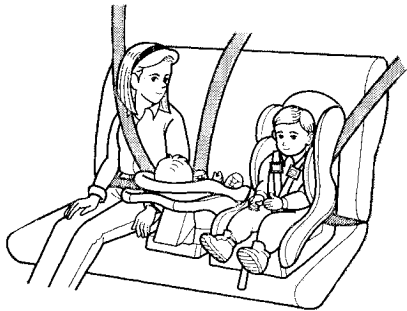

Children depend on adults to protect them. However, despite their best intentions, many parents and other adults do not know how to *properly* protect young passengers.

So if you have children, or if you ever need to drive with a grandchild or other children in your car, be sure to read this section.

Children who are unrestrained or improperly restrained can be seriously injured or killed in a crash.

Any child too small for a seat belt should be properly restrained in a child seat. Larger children should be properly restrained with seat belts.

All Children Must Be Restrained

Each year, many children are injured or killed in car crashes because they are either unrestrained or not properly restrained. In fact, car accidents are the number one cause of death of children ages 12 and under.

To reduce the number of child deaths and injuries, every state and Canadian province requires that infants and children be restrained whenever they ride in a car.

Any child who is too small to wear a seat belt should be properly restrained in a child seat. (See page [25.](#))

Larger children should always be restrained with a seat belt. (See page [32.](#))

Children Should Sit in the Back Seat

According to accident statistics, children of all ages and sizes are safer when they are restrained in the back seat, not the front seat. The National Highway Traffic Safety Administration and Transport Canada recommend that all children ages 12 and under ride in the back seat, properly restrained.

In the back seat, children are less likely to be injured by striking hard interior car parts during a collision or hard braking. Also, children cannot be injured by an inflating airbag when they ride in the back.

The Passenger's Airbag Poses Serious Risks to Children

Airbags have been designed to help protect adults in a severe frontal collision. To do this, the passenger's airbag is quite large, and it inflates with tremendous speed.

Infants

Never put a rear-facing child seat in the front seat of a vehicle equipped with a passenger's airbag. If the airbag inflates, it can hit the back of the child seat with enough force to kill or very seriously injure an infant.

Small Children

Placing a forward-facing child seat in the front seat of a car equipped with a passenger's airbag can be hazardous. If the car seat is too far forward, or the child's head is thrown forward during a collision, an inflating airbag can strike the child with enough force to kill or very seriously injure a small child.

Larger Children

Children who have outgrown child seats are also at risk of being injured or killed by an inflating passenger airbag. Whenever possible, larger children should sit in the back seat, properly restrained with a seat belt. (See page 32 for important information about protecting larger children.)

U.S. Models

To remind you of the passenger's airbag hazards, and that children must be properly restrained in the back seat, your car has warning labels on the dashboard and on the driver's and front passenger's visors. Please read and follow the instructions on these labels.



If You Must Drive with Several Children

Your vehicle has three seating positions in the back seat where children can be properly restrained.

If you ever have to carry more than three children in your car:

- Place the largest child in the front seat, provided the child is large enough to wear a seat belt properly (see page 32).
- Move the vehicle seat as far to the rear as possible (see page 10).
- Have the child sit upright and well back in the seat (see page 15).
- Make sure the seat belt is properly positioned and secured (see page 13).

If a Child Requires Close Attention

Many parents say they prefer to put an infant or small child in the front passenger seat so they can watch the child, or because the child requires attention.

Placing a child in the front seat exposes them to hazards from the airbag, and paying close attention to a child distracts the driver from the important tasks of driving, creating serious safety risks.

If a child requires physical attention or frequent visual contact, we strongly recommend that another adult ride with the child in the back seat. The back seat is far safer for a child than the front.

Additional Safety Precaution

- ***Do not leave children alone in your vehicle.*** Leaving children without adult supervision is illegal in most states and can be very hazardous. For example, infants and small children left in a vehicle on a hot day can die from heatstroke. And children left alone with the key in the ignition can accidentally set the vehicle in motion, possibly injuring themselves or others.

General Guidelines for Using Child Seats

The following pages give general guidelines for selecting and installing child seats for infants and small children.

Selecting a Child Seat

To provide proper protection, a child seat should meet three requirements:

- 1. The child seat should meet safety standards.** The child seat should meet Federal Motor Vehicle Safety Standard 213 (FMVSS 213) or Canadian Motor Vehicle Safety Standards. Look for the manufacturer's statement of compliance on the box and seat.
- 2. The child seat should be of the proper type and size to fit the child.**

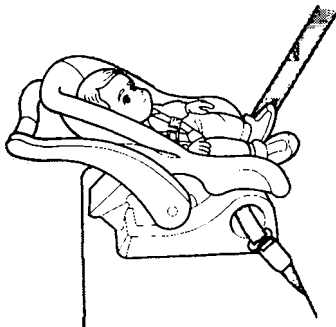

Infants: Children up to about one year old should be restrained in a rear-facing, reclining child seat. Only rear-facing seats provide the support an infant needs to protect their head, neck, and back. See page 25 for additional information on protecting infants.



Small Children: A child who is too large for a rear-facing child seat, and who can sit up without support, should be restrained in a forward-facing child seat. See page 29 for additional information on protecting small children.

CONTINUED

3. *The child seat should fit the vehicle seating position (or positions) where it will be used.*

Due to variations in the design of child seats, vehicle seats, and seat belts, all child seats will not fit all vehicle seating positions.

However, Honda is confident that one or more child seat models can fit and be properly installed in all recommended seating positions in your car.

Whenever possible, we recommend that parents test a child seat in the specific vehicle seating position (or positions) where they intend to use the seat before making a purchase. If a previously purchased child seat does not fit, you may need to buy a different one that will fit.

Placing a Child Seat

This page briefly summarizes Honda's recommendations on where to place rear-facing and forward-facing child seats in your vehicle.

Airbags Pose Serious Risks to Children

The passenger's airbag inflates with enough force to kill or seriously injure an infant in a rear-facing child seat.

A small child in a forward-facing child seat is also at risk. If the vehicle seat is too far forward, or the child's head is thrown forward during a collision, an inflating airbag can kill or seriously injure the child.

If a small child must ride in the front, follow the instructions provided.

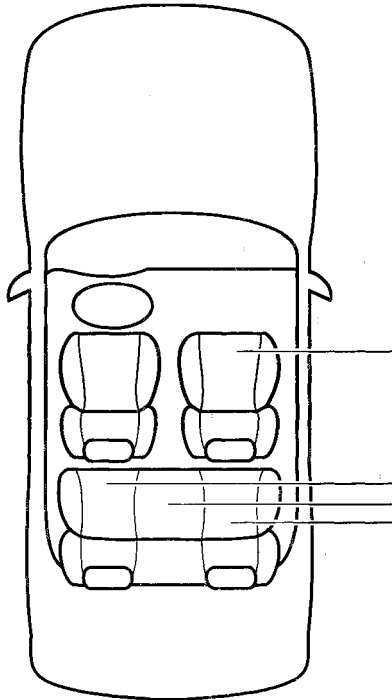

Front Passenger's Seat

Infants: Never in the front seat, due to the passenger's airbag *hazard*.

Small children: Not recommended, due to the passenger's airbag hazard. If a small child must ride in front, move the vehicle seat to the rear-most position and secure a front-facing child seat with the seat belt (see page 30).

Back Seats

Infants: Recommended positions. Secure a rear-facing child seat with the seat belt (see page 26).

Small children: Recommended positions. Secure a front-facing child seat with the seat belt (see page 30).

CONTINUED

Installing a Child Seat

After selecting a proper child seat, and a good position to install the seat, there are three main steps in installing the seat:

- 1. *Secure the child seat to the car with a seat belt.*** All child seats must be secured to the car with the lap part of a lap/shoulder belt. A child whose seat is not properly secured to the car can be endangered in a crash. See pages [26](#) and [30](#) for instructions on how to secure child seats in this car.
- 2. *Make sure the child seat is firmly secured.*** After installing a child seat, push and pull the seat forward and from side to side to verify that it is secure.

To provide security during normal driving maneuvers, as well as during a collision, we recommend that parents secure a child seat as firmly as possible.

However, a child seat does not need to be "rock solid." In some cars or seating positions, it may be difficult to install a child seat so that it does not move at all. Some side-to-side or forward-and-back movement can be expected and should not reduce the child seat's effectiveness.

If the child seat is not secure, try installing it in a different seating position, or use a different style of child seat that can be firmly secured in the desired seating position.

3. *Secure the child in the child seat.*

Make sure the child is properly strapped in the child seat according to the child seat maker's instructions. A child who is not properly secured in a child seat can be thrown out of the seat and be seriously injured in a crash.

Storing a Child Seat

When you are not using a child seat, either remove it and store it in a safe place, or make sure it is properly secured. An unsecured child seat can be thrown around the car during a crash or sudden stop and injure someone.

Protecting Infants

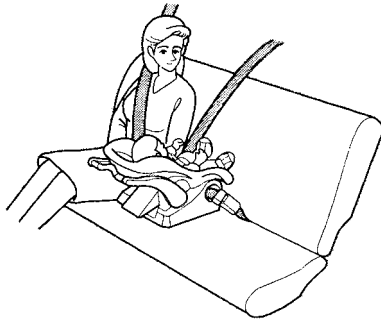

Child Seat Type

To provide proper support for a baby's head, neck and back, infants up to about one year of age must be restrained in a rear-facing child seat.

Two types of seats may be used: a seat designed exclusively for infants, or a convertible seat used in the rear-facing, reclining mode.

Placing a rear-facing child seat in the front seat can result in serious injury or death if the airbags inflate.

Always place a rear-facing child seat in the back seat, not the front.

We recommend that an infant stay in a rear-facing child seat as long as possible, until they reach the seat maker's weight or height limit and are able to sit up without support.

Infant Seat Placement

In this vehicle, a rear-facing child seat can be placed in any seating position in the back seat, but not in the front seat.

Never put a rear-facing child seat in the front seat. If the passenger's airbag inflates, it can hit the back of the child seat with enough force to kill or seriously injure an infant. If an infant must be closely watched, we recommend that another adult sit in the back seat with the baby.

Do not put a rear-facing child seat in a forward-facing position. If an infant faces forward, they could be very seriously injured during a frontal collision.

CONTINUED

Infant Seat Installation

The lap/shoulder belts in the back seats have a locking mechanism that must be activated to secure a child seat.

The following pages provide instructions and tips on how to secure a rear-facing child seat with this type of seat belt.

See page [28](#) for tips on installing an infant seat with this type of seat belt.

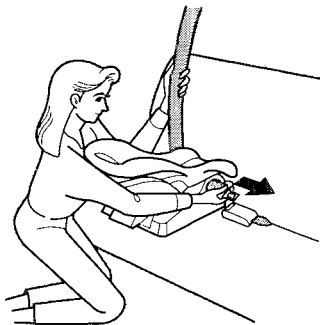

1. With the child seat in the desired back seating position, route the belt through the child seat according to the seat maker's instructions, then insert the latch plate into the buckle.

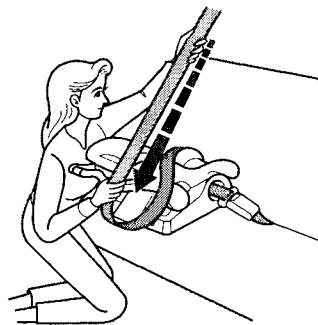

2. To activate the lockable retractor, slowly pull the shoulder part of the belt all the way out until it stops, then let the belt feed back into the retractor (you might hear a clicking noise as the belt retracts).
3. After the belt has retracted, tug on it. If the belt is locked, you will not be able to pull it out. If you can pull the belt out, it is not locked and you will need to repeat these steps.

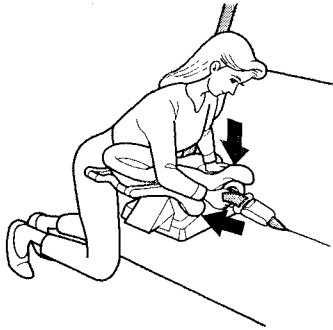

4. After confirming that the belt is locked, grab the shoulder part of the belt near the buckle and pull up to remove any slack from the lap part of the belt. Remember, if the lap part of the belt is not tight, the child seat will not be secure. To remove slack, it may help to put weight on the child seat, or push on the back of the seat while pulling up on the belt.

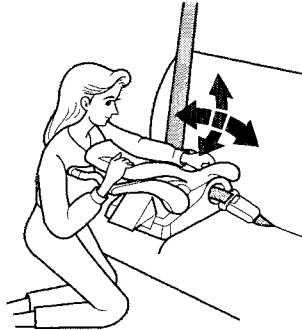

5. Push and pull the child seat forward and from side to side to verify that it is secure enough to stay upright during normal driving maneuvers. If the child seat is not secure, unlatch the belt, allow it to retract fully, then repeat these steps.

To deactivate the locking mechanism in order to remove a child seat, unlatch the buckle, unroute the seat belt, and let the belt fully retract.

CONTINUED

Infant Seat Installation Tips

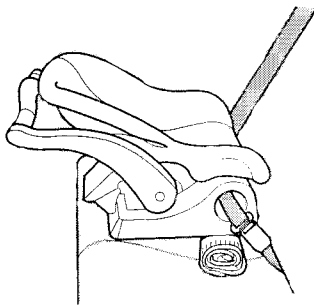

For proper protection, an infant must ride in a reclined, or semi-reclined position. To determine the proper reclining angle, check with the baby's doctor or follow the seat maker's recommendations.

To achieve the desired reclining angle, it may help to put a rolled up towel under the toe of (he child seat, as shown above.

When properly installed, a rear-facing child seat may prevent the driver or a front-seat passenger from moving their seat as far back as recommended (see page 10). Or it may prevent the seat-back from locking in the desired position (see page 11).

In either case, we recommend that you place the child seat directly behind the front passenger seat, move the front seat as far forward as needed, and leave it unoccupied. You may also wish to get a smaller child seat that allows you to safely carry a front passenger.

Additional Precautions for Infants

- **Never hold a baby on your lap.** If you are not wearing a seat belt in a crash, you could be thrown forward into the dashboard and crush the child.

If you are wearing a seat belt, the baby can be torn from your arms. For example, if the car crashes into a parked car at 30 mph (48 km/h), a 20 lb (9 kg) baby will become a 600 lb (275 kg) force, and you will not be able to hold it.

- **Never put a seat belt over yourself and a baby.** During a crash, the belt could press deep into the child and cause very serious injuries.

Protecting Small Children



Child Seat Type

A child who can sit up without support, and who fits within the child seat maker's weight and height limits, should be restrained in a forward-facing, upright child seat.

Of the different seats available, we recommend those that have a five-point harness system as shown above.

We also recommend that a small child stay in the child seat as long as possible, until they reach the weight or height limit for the seat.

Child Seat Placement

In this car, the best place to install a forward-facing child seat is in one of the seating positions in the back seat.

Placing a forward-facing child seat in the front seat of a car equipped with a passenger airbag can be hazardous.

If the car seat is too far forward, or the child's head is thrown forward during a collision, an inflating passenger's airbag can strike the child with enough force to cause very serious or fatal injuries. If a small child must be closely watched, we recommend that another adult sit in the back seat with the child.

Improperly placing a forward-facing child seat in the front seat can result in serious injury or death if the airbags inflate.

If you must place a forward-facing child seat in front, move the vehicle seat as far back as possible and properly restrain the child.

If it is necessary to put a forward-facing child seat in the front, move the car seat as far to the rear as possible, be sure the child seat is firmly secured to the car, and that the child is properly strapped in the seat.

CONTINUED

Protecting Children

Child Seat Installation

The lap/shoulder belts in the back and front passenger seating positions have a locking mechanism that must be activated to secure a child seat.

The following pages provide instructions on how to secure a forward-facing child seat with this type of seat belt.

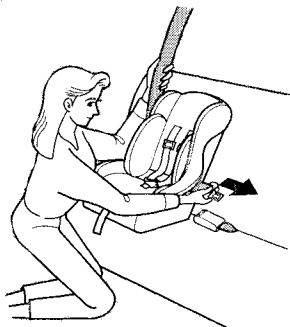

1. With the child seat in the desired seating position, route the belt through the child seat according to the seat maker's instructions, then insert the latch plate into the buckle.

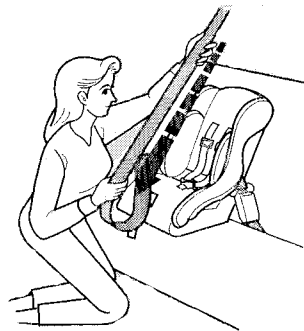

2. To activate the lockable retractor, slowly pull the shoulder part of the belt all the way out until it stops, then let the belt feed back into the retractor (you might hear a clicking noise as the belt retracts).
3. After the belt has retracted, tug on it. If the belt is locked, you will not be able to pull it out. If you can pull the belt out, it is not locked and you will need to repeat these steps.

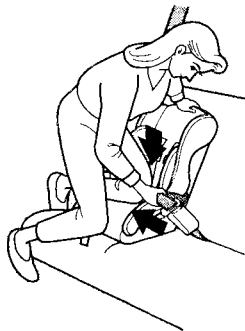

4. After confirming that the belt is locked, grab the shoulder part of the belt near the buckle and pull up to remove any slack from the lap part of the belt. Remember, if the lap part of the belt is not tight, the child seat will not be secure. It may help to put weight on the child seat, or push on the back of the seat while pulling up on the belt.

5. Push and pull the child seat

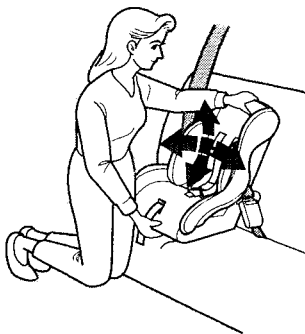

forward and from side to side to verify that it is secure enough to stay upright during normal driving maneuvers. If the child seat is not secure, unlatch the belt, allow it to retract fully, then repeat these steps.

To deactivate the locking mechanism in order to remove a child seat, unlatch the buckle, unrout the seat belt, and let the belt fully retract.

Additional Precautions for Small Children

- **Never hold a small child on your lap.** If you are not wearing a seat belt in a crash, you could be thrown forward into the dashboard and crush the child.

If you are wearing a seat belt, the child can be torn from your arms during a crash. For example, if the car crashes into a parked car at 30 mph (48 km/h), a 30 lb (14 kg) child will become a 900 lb (410 kg) force, and you will not be able to hold it.

- **Never put a seat belt over yourself and a child.** During a crash, the belt could press deep into the child and cause very serious injuries.

Protecting Children

Protecting Larger Children

When a child reaches the recommended weight or height limit for a forward-facing child seat, the child should sit in the back seat and wear a lap/shoulder belt.

If a child is too short for the shoulder part of the belt to properly fit, we recommend that the child use a booster seat until they are tall enough to use the seat belt without a booster.

The following pages give instructions on how to check proper seat belt fit, what kind of booster seat to use if one is needed, and important precautions for children who must sit in the front seat.

Allowing a larger child to sit improperly in the front seat can result in injury or death if the airbags inflate.

If a larger child must sit in front, they should move the seat as far back as possible and wear their seat belt properly.

Checking Seat Belt Fit

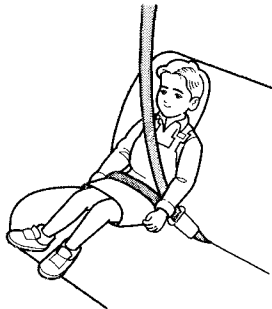

To determine whether a lap/shoulder belt properly fits a child, first have the child put on the seat belt, following the instructions on page 13. Then check how the belt fits.

If the shoulder part of the belt rests over the child's collarbone and against the center of the chest, as shown above, the child is large enough to wear the seat belt.

However, if the belt touches or crosses the child's neck, the child needs to use a booster seat.

Do not let a child wear a seat belt across their neck. This could result in serious neck injuries during a crash.

Do not let a child put the shoulder part of a seat belt behind their back or under their arm. This could cause very serious injuries during a crash. It also increases the chance of a child sliding under the belt and being injured in a crash.

Do not put any accessories on a seat belt. Devices intended to improve occupant comfort, or reposition the shoulder part of a seat belt, severely compromise the protective capability of seat belts and increase the chance of serious injury in a crash.

Two children should never use the same seat belt. If they do, they could be very seriously injured in a crash.

Using a Booster Seat



If a child needs a booster seat, we recommend choosing a style that allows the child to use the lap/shoulder belt directly, without a shield, as shown above.

Whichever style you select, follow the booster seat maker's instructions.

CONTINUED

A child may continue using a booster seat until the tops of their ears are even with the top of the seat-back. When a child reaches this height, they should be tall enough to use the lap/shoulder belt without a booster.

When Can a Larger Child Sit in Front

The National Highway Traffic Safety Administration and Transport Canada recommend that all children ages 12 and under ride in the back seat, properly restrained.

The back seat is the safest place for a child of any age or size.

In addition, the passenger's airbag poses serious risks to children. If the seat is too far forward, or the child's head is thrown forward during a collision, or the child is unrestrained or out of position, an inflating airbag can kill or seriously injure the child.

Of course, children vary widely. And while age may be one indicator of when a child can safely ride in the front, there are other important factors you should consider.

Physical Size

Physically, a child must be large enough for the lap/shoulder belt to properly fit over their hips, chest, and shoulder (see pages [13](#) and [32](#)). If the seat belt does not fit properly, the child should not sit in the front.

Maturity

To safely ride in front, a child must be able to follow the rules, including sitting properly and wearing their seat belt properly throughout a ride.

If you decide that a child can safely ride up front, be sure to:

- Carefully read the owner's manual, and make sure you understand all seat belt instructions and all safety information.
- Move the vehicle seat to the rear-most position.
- Have the child sit up straight with their back against the seat and their feet on, or near, the floor.
- Check that the child's seat belt is properly positioned and secured.
- Closely supervise the child. Even mature children sometimes need to be reminded to fasten their seat belt or sit properly.

Using Child Seats with Tethers

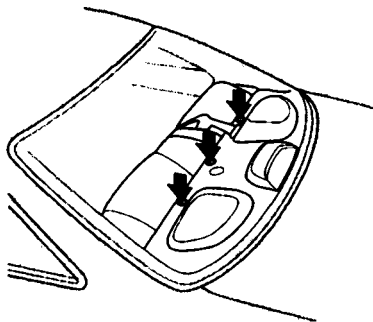

Your car has three attachment points on the rear shelf for securing a tether-style child seat to the car.

Since a tether can provide additional security, we recommend using a tether whenever one is required or available. (Tethers are required in Canada. U.S. owners may check with the child seat maker to determine whether a tether is available for a particular child seat.)

CONTINUED

Protecting Children

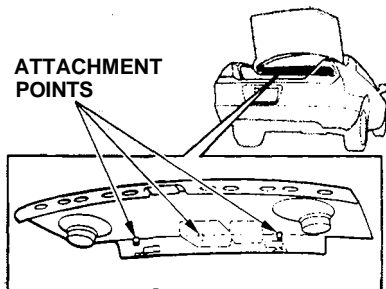

Locate the attachment points by looking in the trunk at the underside of the rear shelf. Select the attachment point you want to use. Take a thin, pointed object, such as an awl or ice pick, insert it into that attachment point, and poke a marker hole in the rear shelf fabric.

Working from inside the car, push down on the fabric around the marker hole you made. You should feel a 7/8-inch (22 mm) diameter depression in the panel underneath. Use a razor blade to cut the fabric at the edge of this depression. Use a pair of pliers to remove the cutout in the panel underneath the fabric.

To attach the tether to the car, you need to purchase the anchor plate and mounting hardware from your Honda dealer (Part Number 82410-SE3-C01).

To attach the tether to the child seat, follow the child seat maker's instructions.

Canadian Models

The anchor plate and mounting hardware for a top tether are supplied with the car. When installing, make sure the toothed washer is on the bottom of the bolt.

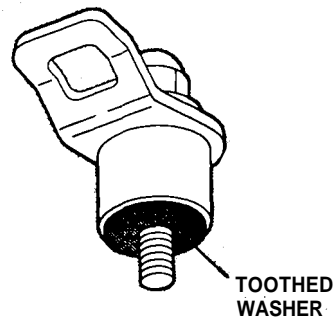

The supplied anchor plate is designed only for mounting a child restraint. Do not use it for any other purpose.

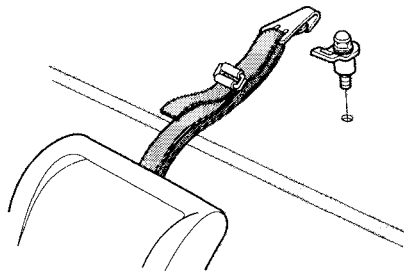

When installing tether hardware, make sure the toothed washer is on the bottom of the bolt. Tighten the bolt to:

16 lbf-ft (22 N·m, 2.2 kgf·m)

If a torque wrench was not used, see your Honda dealer as soon as possible to verify proper installation.

To attach the tether to the child seat, follow the child seat maker's instructions.

If you are not sure how to install the tether, or you need mounting hardware, contact your Honda dealer.

Additional Information About Your Seat Belts

Seat Belt System Components

Your seat belt system includes lap/shoulder belts in all five seating positions.



The system also includes a light on the instrument panel to remind you and your passengers to fasten your belts. If the driver's seat belt is not fastened before the ignition is turned ON (II), the light will come on and a beeper will also sound. The beeper will stop after a few seconds, but the light will stay on until the driver's seat belt is fastened.

Lap/Shoulder Belt

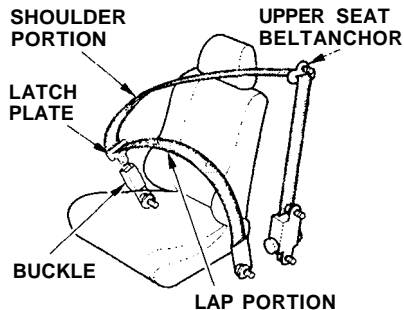

This seat belt has a single belt that goes over your shoulder, across your chest and across your hips.

To fasten the belt, insert the latch plate into the buckle, then tug on the belt to make sure the buckle is latched.

To unlock the belt, push the red PRESS button on the buckle. Guide the belt across your body to the door pillar. After exiting the car, be sure the belt is out of the way and will not get closed in the door.

All seat belts have an emergency locking retractor. In normal driving, the retractor lets you move freely in your seat while it keeps some tension on the belt. During a collision or sudden stop, the retractor automatically locks the belt to help restrain your body.

The seat belts in all seating positions except the driver's have an additional locking mechanism that must be activated to secure a child seat. (See pages 26 and 30 for instructions on how to secure child seats with this type of seat belt.)

If the shoulder part of the belt is pulled all the way out, the locking mechanism will activate. The belt will retract, but it will not allow a passenger to move freely.

To deactivate the locking mechanism, unlatch the buckle and let the seat belt fully retract. To refasten the belt, pull it out only as far as needed.

See page [13](#) for instructions on how to wear the lap/shoulder belt properly.

Seat Belt Maintenance

For safety, you should check the condition of your seat belts regularly.

Pull each belt out fully and look for frays, cuts, burns, and wear. Check that the latches work smoothly and that the lap/shoulder belts retract easily. Any belt not in good condition or not working properly will not provide good protection and should be replaced as soon as possible.

U.S. Owners

Honda provides a lifetime warranty on seat belts. Honda will repair or replace any seat belt component that fails to function properly during normal use.

Please see your *Honda Warranty Information* booklet for details.

Not checking or maintaining seat belts can result in serious injury or death if the seat belts do not work properly when needed.

Check your seat belts regularly and have any problem corrected as soon as possible.

If a seat belt is worn during a crash, you should have your dealer inspect the belt, and replace it if necessary. A belt that has been worn during a crash may not provide the same level of protection in a subsequent crash. The dealer should also inspect the anchors for damage and replace them if needed.

For information on how to clean your seat belts, see page [263](#).

SRS Components

Your Supplemental Restraint System (SRS) includes:

- Two frontal airbags. The driver's airbag is stored in the center of the steering wheel; the front passenger's airbag is stored in the dashboard. Both are marked "SRS."
- Sensors that can detect a severe frontal collision.
- A sophisticated electronic system that continually monitors the sensors, control unit, the airbag activators, and all related wiring when the ignition is ON (II).

- An indicator light on the instrument panel to alert you to a possible problem with the system (see page [42](#)).
- Emergency backup power in case your car's electrical system is disconnected in a crash.

How Your Airbags Work

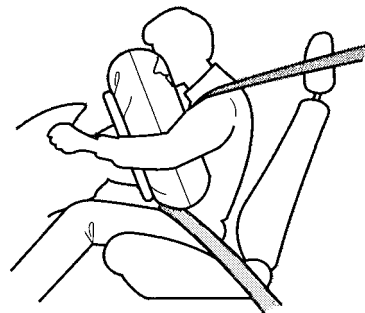

If you ever have a severe frontal collision, the sensors will detect rapid deceleration and signal the control unit to instantly inflate the airbags.

During a crash, your seat belt helps restrain your lower body and torso. Your airbag provides a cushion to help restrain and protect your head and chest.

Since both airbags use the same sensors, both airbags normally inflate at the same time. However, it is possible for only one airbag to inflate.

This can occur when the severity of a collision is at the margin, or threshold, that determines whether or not the airbags will deploy. In such cases, the seat belt will provide sufficient protection, and the supplemental protection offered by the airbag would be minimal.

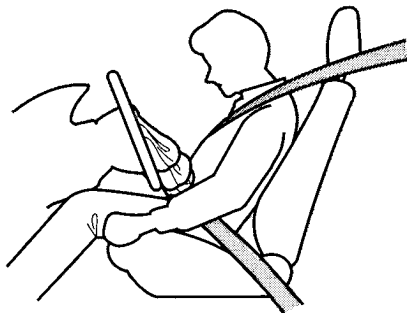

After inflating, the airbags immediately deflate, so they won't interfere with the driver's visibility, or the ability to steer or operate other controls.

The total time for inflation and deflation is approximately one-tenth of a second, so fast that most occupants are not aware that the airbags deployed until they see them lying in their laps.

After a crash, you may see what looks like smoke. This is actually powder from the airbag's surface. Although the powder is not harmful, people with respiratory problems may experience some temporary discomfort. If this occurs, get out of the car as soon as it is safe to do so.

U.S. Owners

For additional information on how your airbags work, see the booklet titled *SRS: What You Need to Know About Airbags* that came with your owner's manual.

How Your SRS Indicator Light Works

SRS The purpose of the SRS indicator light is to alert you to a potential problem with your Supplemental Restraint System.

When you turn the ignition ON (II), this indicator will light up briefly then go out. This tells you that the system is working properly.

However, if the light comes on at any other time, you should have your system checked by your dealer. For example:

- If the SRS indicator light does not come on after you turn the ignition ON (II).
- If the light stays on after the engine starts.

- If the light comes on or flashes on and off while you drive.

If you see any of these indications, your airbags may not deploy when you need them. See your Honda dealer as soon as possible.

Ignoring the SRS indicator light can result in serious injury or death if the airbags do not inflate when needed.

Have your vehicle checked by a dealer as soon as possible if the SRS light alerts you to a potential problem.

SRS Service

Your Supplemental Restraint System is virtually maintenance-free, and there are no parts you can safely service. However, you must have your vehicle serviced if:

- ***Your airbags ever inflate. The*** airbags and the control unit must be replaced. Do not try to remove or replace the airbags yourself. This must be done by a Honda dealer or a knowledgeable body shop.
- ***The SRS indicator light alerts you to a problem.*** Take your vehicle to an authorized Honda dealer as soon as possible. If you ignore this indication, the airbags might not inflate when you need them.

Additional Safety Precautions

- Do not attempt to deactivate your airbags. Together, airbags and seat belts provide the best protection in a severe frontal collision.
- Do not tamper with SRS components or wiring for any reason. Tampering could cause the airbags to deploy, possibly causing very serious injury.

See page [163](#) for further information and precautions relating to your SRS.

Carbon Monoxide Hazard

Your car's exhaust contains carbon monoxide gas. You should have no problem with carbon monoxide entering the car in normal driving if you maintain your car properly. Have the exhaust system inspected for leaks whenever:

- The car is raised for an oil change.
- You notice a change in the sound of the exhaust.
- The car was in an accident that may have damaged the underside.

Carbon monoxide gas is toxic. Breathing it can cause unconsciousness and even kill you.

Avoid any enclosed areas or activities that expose you to carbon monoxide.

High levels of carbon monoxide can collect rapidly in enclosed areas, such as a garage. Do not run the engine with the garage door closed. Even with the door open, run the engine only long enough to move the vehicle out of the garage.

With the trunk lid open, air flow can pull exhaust gas into your car's interior and create a hazardous condition. If you must drive with the trunk lid open, open all the windows and set the heating and cooling system/climate control system as shown below.

If you must sit in your parked vehicle, even in an unconfined area, with the engine running, adjust the heating and cooling system/climate control system as follows:

1. Select the Fresh Air mode.
2. Select the  mode.
3. Turn the fan on high speed.
4. Set the temperature control to a comfortable setting.

These labels are in the locations shown. They warn you of potential hazards that could cause serious injury. Read these labels carefully.

If a label comes off or becomes hard to read, contact your Honda dealer for a replacement.

HOOD

⚠ WARNING

The airbag inflator is explosive and, if accidentally deployed, can seriously hurt you. Follow Service Manual instructions carefully.

⚠ ATTENTION

Le gonfleur SRS est explosible, et s'il se déploie accidentellement, il risque de provoquer des blessures graves ou de tuer. Suivre attentivement les instructions du manuel d'entretien.

RADIATOR CAP



DASH BOARD

U.S. models only



SUN VISOR

U.S. models

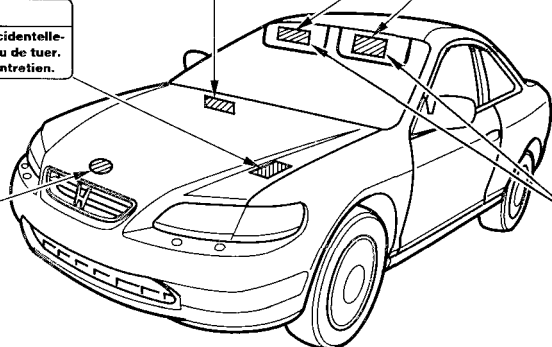

Canadian models

<p>CAUTION TO AVOID SERIOUS INJURY</p> <ul style="list-style-type: none"> • FOR MAXIMUM SAFETY PROTECTION IN ALL TYPES OF CRASHES, YOU MUST ALWAYS WEAR YOUR SAFETY BELT • DO NOT INSTALL REARWARD-FACING CHILD SEAT IN ANY FRONT • PASSENGER AIR BAG POSITION • CHILD NOT SIT OR LEAN UNNECESSARILY CLOSE TO THE AIR BAG • DO NOT PLACE ANY OBJECTS OVER THE AIR BAG OR BETWEEN THE AIR BAG AND YOURSELF • SEE THE OWNER'S MANUAL FOR FURTHER INFORMATION AND EXPLANATIONS 	<p>PRECAUTIONS: POUR EVITER DES BLESSURES GRAVES</p> <ul style="list-style-type: none"> • POUR PROFITER D'UNE PROTECTION MAXIMALE TOUS JOURS D'UNE COLLISION BOULEZ TOUS JOURS VOTRE CEINTURE DE SECURITE • N'INSTALLEZ JAMAIS UN SIEGE POUR ENFANTS / ENFANTS FACE A L'ARRIERE D'UN LE SIEGE DU PASSAGER AVANT • NE VOUS APPROVEZ PAS ET NE VOUS ASSOYEZ PAS PRES DU COUSSIN CONFLABLE • NE VOUS APPUYEZ PAS ET NE VOUS ASSOYEZ PAS PRES DU COUSSIN CONFLABLE • NE VOUS APPUYEZ PAS ET NE VOUS ASSOYEZ PAS PRES DU COUSSIN CONFLABLE • LISEZ LE GUIDE UTILISATEUR POUR DE PLUS AMPLES RENSEIGNEMENTS
--	--

This section gives information about the controls and displays that contribute to the daily operation of your Honda. All the essential controls are within easy reach.

Control Locations.....	48	Instrument Panel Brightness.....	60	Driver's Seat Power Adjustments.....	84
Indicator Lights.....	49	Turn Signals.....	60	Driver's Lumbar Support.....	85
Gauges.....	54	Windshield Wipers.....	61	Rear Seat Access.....	86
Speedometer.....	54	Windshield Washers.....	62	Head Restraints.....	87
Tachometer.....	54	Hazard Warning.....	62	Folding Rear Seat.....	88
Odometer.....	54	Rear Window Defogger.....	63	Seat Heaters.....	90
Trip Meter.....	55	Steering Wheel Adjustment.....	63	Power Windows.....	91
Temperature Gauge.....	55	Steering Wheel Controls	65	Moonroof.....	93
Fuel Gauge.....	55	Cruise Control.....	65	Mirrors.....	94
Maintenance Required Indicator.....	56	Remote Audio Controls	67	Adjusting the Power Mirrors....	94
Controls Near the Steering Wheel.....	57	Keys and Locks.....	68	Parking Brake.....	95
Headlights.....	58	Keys.....	68	Digital Clock.....	96
Automatic Lighting Off Feature.....	59	Immobilizer System.....	69	Sunglasses Holder.....	96
Daytime Running Lights.....	59	Ignition Switch.....	70	Beverage Holder.....	97
		Power Door Locks.....	71	Console Compartment.....	98
		Lockout Prevention.....	72	Sun Visor.....	99
		Remote Transmitter.....	73	Vanity Mirror.....	99
		Trunk.....	76	Coin Box.....	100
		Glove Box.....	77	Center Pocket.....	100
		Homelink Universal Transmitter...	78	Accessory Power Socket.....	100
		Seat Adjustments.....	82	Interior Lights.....	101
		Front Seat Adjustments.....	82	Ceiling Light.....	101
		Driver's Seat Manual Height Adjustment.....	83	Spotlights.....	101
		Driver's Seat Power Height Adjustment.....	83	Courtesy Lights.....	102

Control Locations

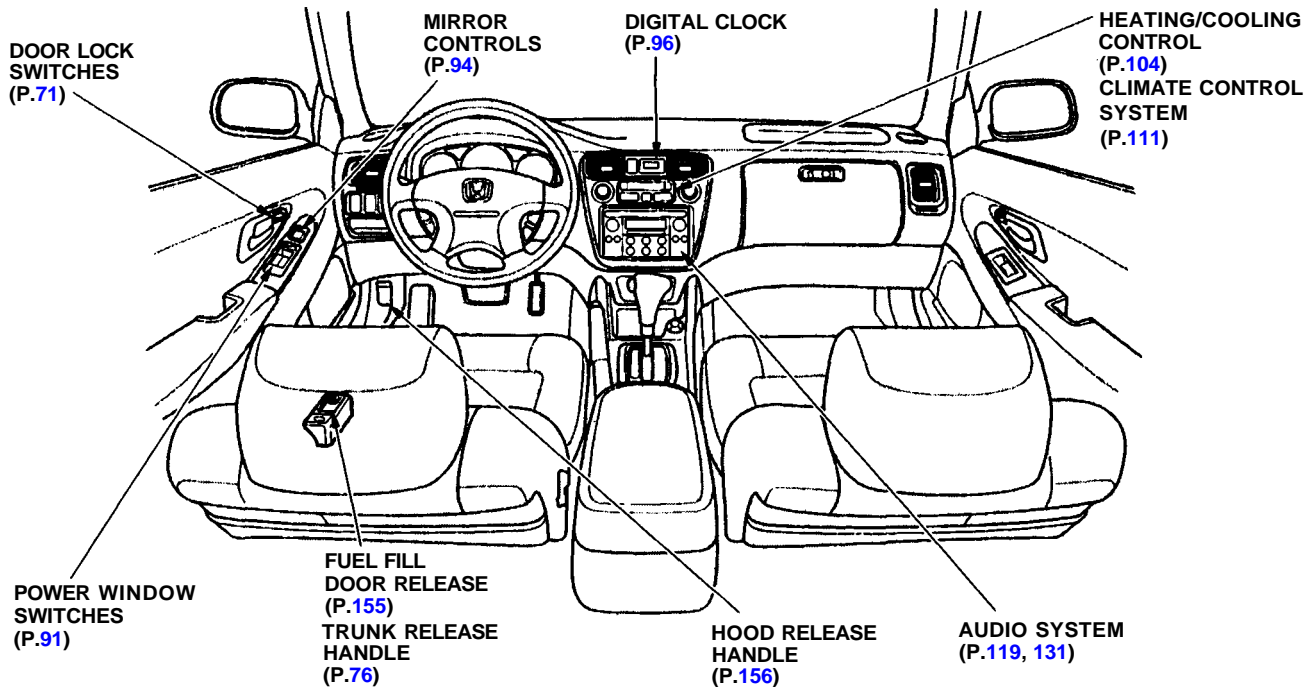

The instrument panel has many indicators to give you important information about your vehicle.

Lamp Check

These indicator lights come on when you turn the ignition switch ON (II), allowing you to see that they are working:

- SRS Indicator
- Malfunction Indicator Lamp
- Charging System Indicator
- Low Oil Pressure Indicator
- Anti-lock Brake System Indicator
- Seat Belt Reminder Light
- D4 Lamp
- Immobilizer System Indicator
- Maintenance Required Indicator
- Parking Brake and Brake System Indicator
- Door and Brake Lamp Monitor

If an indicator does not light during this test, it cannot alert you if that system develops a problem. Have the dealer check your vehicle for burned-out bulbs or other problems.

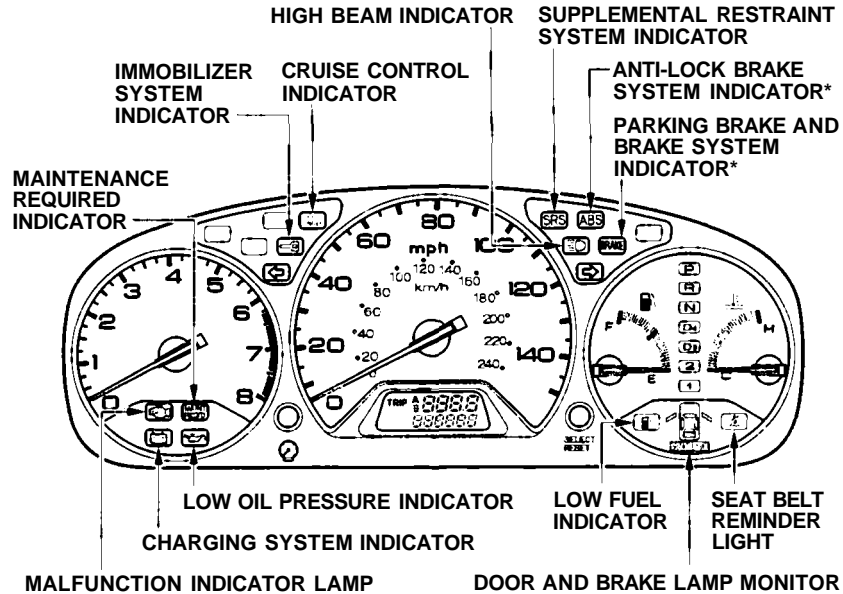

* The U.S. instrument panel is shown. Differences for the Canadian model are noted in the text.



Seat Belt Reminder Light

This indicator lights when you turn the ignition switch ON (II). It is a reminder to you and your passengers to protect yourselves by fastening the seat belts. A beeper also sounds if you have not fastened your seat belt.

If you do not fasten your seat belt, the beeper will stop after a few seconds but the light stays on until you do. Both the light and the beeper stay off if you fasten your seat belt before turning on the ignition.



Low Oil Pressure Indicator

The engine can be severely damaged if this light flashes or stays on when the engine is running. For complete information, see page [281](#).



Charging System Indicator

If this light comes on when the engine is running, the battery is not being charged. For complete information, see page [282](#).

U.S.

BRAKE

Canada



Parking Brake and Brake System Indicator

This light has two functions:

1. It lights as a reminder that you have not released the parking brake. Driving with the parking brake applied can damage the brakes and tires.
2. If it remains lit after you release the parking brake while the engine is running, or comes on while driving, it can indicate a problem in the brake system. For complete information, see page [284](#).

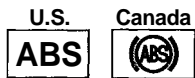

Anti-lock Brake System (ABS) Indicator

Only on cars equipped with ABS (see page 180)

This light normally comes on for a few seconds when you turn the ignition switch ON (II), and when the ignition switch is turned to START (III). If this light comes on at any other time, there is a problem in the ABS. If this happens, take the vehicle to your dealer to have it checked. With the light on, your vehicle still has normal braking ability but no anti-lock.

SRS Supplemental Restraint System Indicator

This indicator lights when you turn the ignition switch ON (II). If it comes on at any other time, it indicates a problem in the supplemental restraint system. For complete information, see page 42 .

Malfunction Indicator Lamp

See page 283 .

Immobilizer System Indicator

This indicator comes on for a few seconds when you turn the ignition switch ON (II). It will then go off if you have inserted a properly-coded ignition key. If it is not a properly-coded key, the indicator will blink and the engine will not start (see page 69).

This indicator also blinks several times when you turn the ignition switch from ON (II) to ACCESSORY (I) or LOCK (0).

Indicator Lights

Door and Brake Lamp Monitor



The appropriate light comes on in this display if the trunk or either door is not closed tightly. If a brake light does not work, the **BRAKE LAMP** indicator comes on when you push the brake pedal with the ignition switch ON (II).

A burned out brake light is a hazard when drivers behind you cannot tell you are braking. Have your brake lights repaired right away.

All the lights in the monitor display come on when you turn the ignition switch ON (II). The lights go off after the engine starts and the trunk and both doors are closed tightly.



Turn Signal and Hazard Warning Indicators

The left or right turn signal light blinks when you signal a lane change or turn. If the light does not blink or blinks rapidly, it usually means one of the turn signal bulbs is burned out (see page 249). Replace the bulb as soon as possible, since other drivers cannot see that you are signalling.

When you turn on the Hazard Warning switch, both turn signal lights blink. All turn signals on the outside of the vehicle should flash.

DRL

"Daytime Running Lights" Indicator

Canadian models only

This indicator lights when you turn the ignition switch to ON (II) with the headlight switch off and the parking brake set. It should go off if you turn on the headlights or release the parking brake. If it comes on at any other time, it means there is a problem with the DRL. There may also be a problem with the high beam headlights.



High Beam Indicator

This light comes on with the high beam headlights. See page [58](#) for information on the headlight controls.

On Canadian models, this indicator comes on with reduced brightness when the Daytime Running Lights (DRL) are on (see page [59](#)).



Cruise Control Indicator

This lights when you set the cruise control. See page [65](#) for information on operating the cruise control.



Low Fuel Indicator

This light comes on as a reminder that you must refuel soon.



Washer Level Indicator

Canadian models only

This light comes on when the washer fluid level is low. Add washer fluid when you see this light come on (see page [218](#)).

Gauges

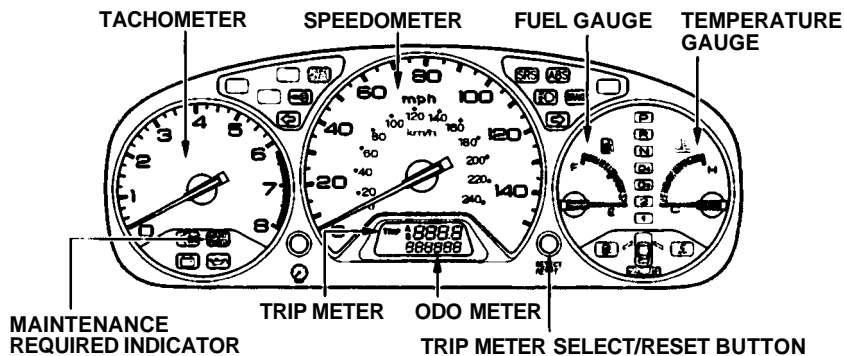

Speedometer

U.S. Models

This shows your speed in miles per hour (mph). The smaller inner numbers are the speed in kilometers per hour (km/h).

Canadian Models

This shows your speed in kilometers per hour (km/h). The smaller inner numbers are the speed in miles per hour (mph).

Tachometer

The tachometer shows the engine speed in revolutions per minute (rpm). To protect the engine from damage, never drive with the tachometer needle in the red zone.

Odometer

The odometer shows the total distance your vehicle has been driven. It measures miles in U.S. models and kilometers in Canadian models. The total number is displayed when you turn the ignition switch ON (II). It is illegal under federal law (in the U.S.) and provincial regulations (in Canada) to disconnect, reset, or alter the odometer with the intent to change the number of miles or kilometers indicated.

Trip Meter

This meter shows the number of or miles (U.S.) or kilometers (Canada) driven since you last reset it. When you turn the ignition switch to ON (II), the number is displayed.

There are two trip meters. Trip A and Trip B. Switch between these displays by pressing the Select/Reset button repeatedly. Each trip meter works independently, so you can keep track of two different distances.

To reset a trip meter, display it and then press and hold the Select/Reset button until the number resets to "0.0".

6-cylinder models

Both trip meters will reset if the vehicle's battery goes dead or is disconnected.

Temperature Gauge

This shows the temperature of the engine's coolant. During normal operation, the pointer should rise from the bottom white mark to about the middle of the gauge. In severe driving conditions, such as very hot weather or a long period of uphill driving, the pointer may rise to near the upper grey zone. If it reaches the red (Hot) mark, pull safely to the side of the road. Turn to page [279](#) for instructions and precautions on checking the engine's cooling system.

Fuel Gauge

This shows how much fuel you have. It is most accurate when the vehicle is on level ground. It may show slightly more or less than the actual amount when you are driving on curvy or hilly roads.

4-cylinder models

The gauge stays at the same fuel level reading after you turn off the ignition. When you add fuel, the gauge slowly changes to the new reading after you turn the ignition switch back ON (II).

6-cylinder models

The needle returns to the bottom after you turn off the ignition. The gauge shows the fuel level reading immediately after you turn the ignition switch back ON (II).

Maintenance Required Indicator

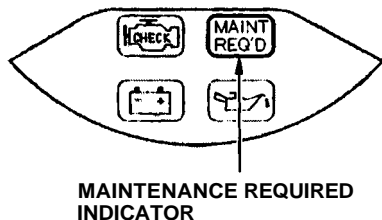

This indicator reminds you that it is time to take your vehicle in for scheduled maintenance.

Refer to the Maintenance Schedules for Normal and Severe Driving Conditions on pages [196](#) — [200](#).

For the first 6,000 miles (9,600 km) after the Maintenance Required Indicator is reset, it will come on for two seconds when you turn the ignition switch ON (II).

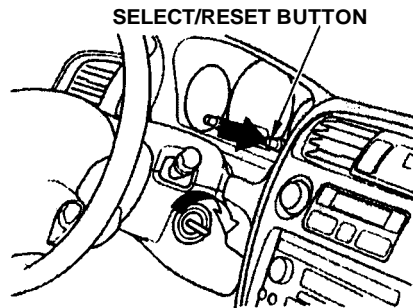

Between 6,000 miles (9,600 km) and 7,500 miles (12,000 km) this indicator will light for two seconds when you first turn the ignition switch ON (II), and then flash for ten seconds.

If you exceed 7,500 miles (12,000 km) without having the scheduled maintenance performed, this indicator will remain on as a constant reminder.

Your dealer will reset this indicator after completing the scheduled maintenance. If this maintenance is done by someone other than your Honda dealer, reset the indicator as follows.

1. Turn off the engine.
2. Press and hold the select/reset button in the instrument panel, then turn the ignition switch ON (II).
3. Hold the button for about ten seconds, until the indicator resets.

The two levers on the steering column contain controls for driving features you use most often. The left lever controls the turn signals, headlights, and high beams. The right lever controls the windshield washers and wipers.

The switches for the hazard warning lights and rear window defogger are located to the right of the steering column.

The switches under the left air vent are for the moonroof and the cruise control.

The tilt adjustment lever on the underside of the steering column allows you to tilt the steering wheel.

* To use the horn, press the pad around the "H" logo.

HEADLIGHTS/
TURN SIGNALS

WINDSHIELD
WIPERS/WASHERS

REAR WINDOW
DEFOGGER

MOONROOF
SWITCH

CRUISE
CONTROL

TILT ADJUSTMENT

HORN*

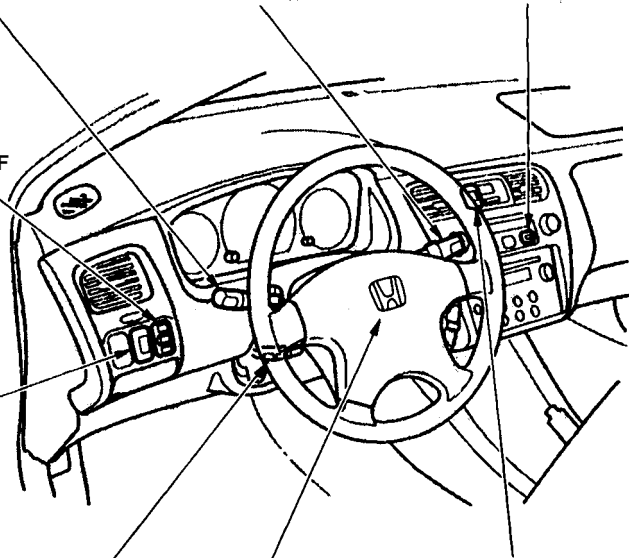

HAZARD WARNING LIGHTS

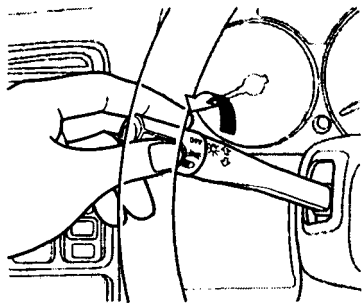

Controls Near the Steering Wheel

Headlights



The rotating switch on the left lever controls the lights. Turning this switch to the “” position turns on the parking lights, taillights, instrument panel lights, side-marker lights, and rear license plate lights. Turning the switch to the “” position turns on the headlights.

If you leave the lights on with the ignition switch in ACCESSORY (I) or LOCK (0), you will hear a reminder chime when you open the driver's door.

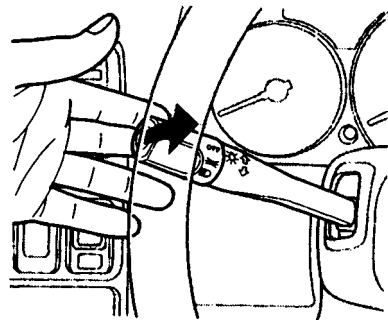

To change between low beams and high beams, pull the turn signal lever until you hear a click, then let go. The blue high beam indicator will light (see page [53](#)).

To flash the high beams, pull the turn signal lever back lightly, then release it. The high beams will come on and go off.

The high beams will stay on for as long as you hold the lever back, no matter what position the headlight switch is in.

Automatic Lighting Off Feature

On EX and EX- V6 models

The Automatic Lighting Off feature turns off the headlights, parking lights, taillights, side marker lights, license plate lights and instrument panel lights within 15 seconds of closing the driver's door.

The lights will turn on again when you unlock or open the driver's door. If you unlock the door, but do not open it within 15 seconds, the lights will go off. With the driver's door open, you will hear a lights-on reminder chime.

Daytime Running Lights (Canadian Models)

With the headlight switch off, the high beam headlights come on with reduced brightness when you turn the ignition switch to ON (II) and release the parking brake. They remain on until you turn the ignition off, even if you set the parking brake.

The headlights revert to normal operation when you turn them on with the switch.

Controls Near the Steering Wheel

Instrument Panel Brightness

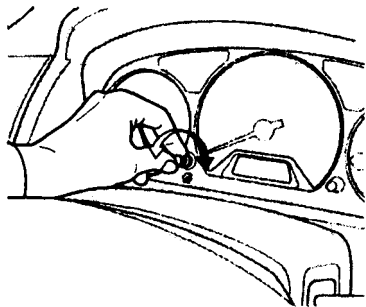

The knob on the instrument panel controls the brightness of the instrument panel lights. Turn the knob to adjust the brightness.

Turn Signals

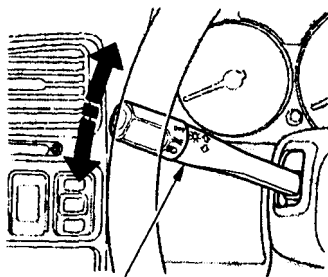

TURN SIGNAL LEVER

Signal a turn or lane change with this lever. Push down on the lever to signal a left turn, and up to signal a right turn. If you push it up or down all the way, the turn signal continues to blink even when you release the lever. It shuts off automatically as you complete the turn.

To signal a lane change, push lightly on the turn signal lever in the proper direction and hold it. The lever will return to the center position as soon as you release it.

Windshield Wipers

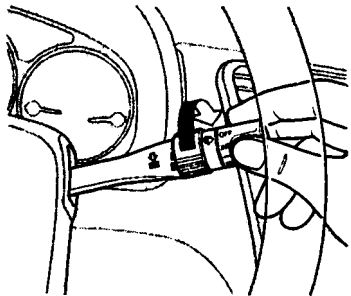

The right lever controls the windshield wipers and washers. The rotary switch at the end of the lever has three positions:

INT: intermittent

— : low speed

≡ : high speed

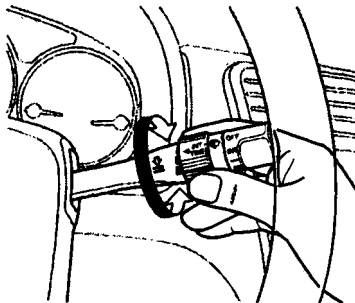

In intermittent, the wipers operate every few seconds. The sweep interval will change slightly with speed; getting shorter as you drive faster. In low speed and high speed, the wipers run continuously.

You can vary how often the wipers sweep the windshield by turning the INT TIME ring next to the rotary switch.

If you turn the INT TIME ring to the shortest delay, the wipers will change from intermittent to low speed operation when vehicle speed exceeds 12 mph (20 km/h).

CONTINUED

Controls Near the Steering Wheel

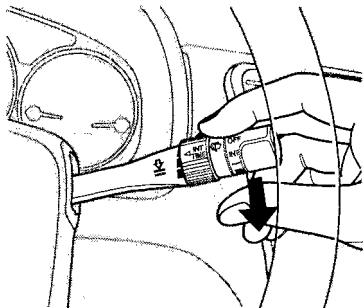

To operate the wipers in mist mode, push the control lever down. The wipers run at high speed until you release the lever. This gives you a quick way to clear the windshield.

Windshield Washers

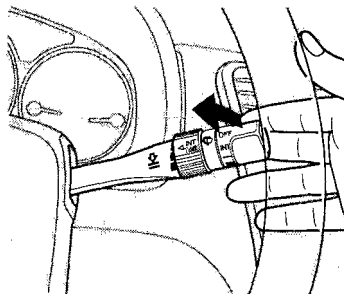

To clean the windshield, pull back on the wiper control lever. The washers spray until you release the lever. The wipers run at low speed while you're pulling the lever, then complete one more sweep of the windshield after you release it.

Hazard Warning

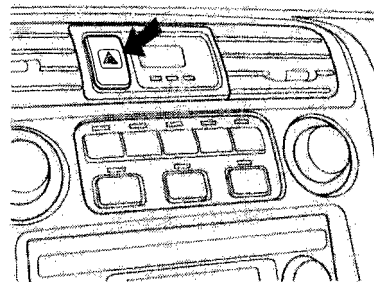

Push the red button to the left of the clock to turn on the hazard warning lights (four-way flashers). This causes all four outside turn signals and both indicators in the instrument panel to flash. Use the hazard warning lights if you need to park in a dangerous area near heavy traffic, or if your vehicle is disabled.

Rear Window Defogger

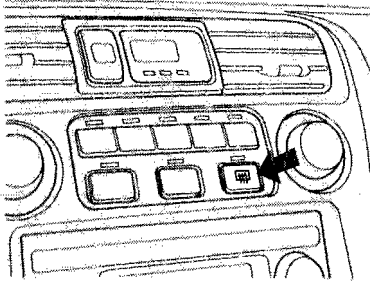

The rear window defogger will clear fog, frost, and thin ice from the window. Push the defogger button to turn it on and off. The light above the button lights to show the defogger is on. If you do not turn it off, the defogger will shut itself off after about 15 minutes. It also shuts off when you turn off the ignition. You have to turn it on again when you restart the vehicle.

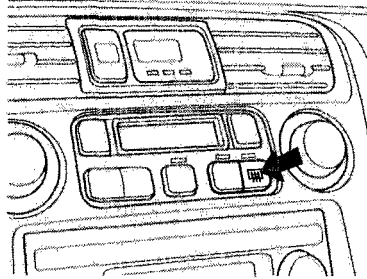

EX-V6 model

Make sure the rear window is clear and you have good visibility before starting to drive.

The defogger and antenna wires on the inside of the rear window can be accidentally damaged. When cleaning the glass, always wipe side to side.

Steering Wheel Adjustment

See page 14 for important safety information about how to properly position the steering wheel.

Make any steering wheel adjustment before you start driving.

Adjusting the steering wheel position while driving may cause you to lose control of the vehicle and be seriously injured in a crash.

Adjust the steering wheel only when the vehicle is stopped.

CONTINUED

Controls Near the Steering Wheel

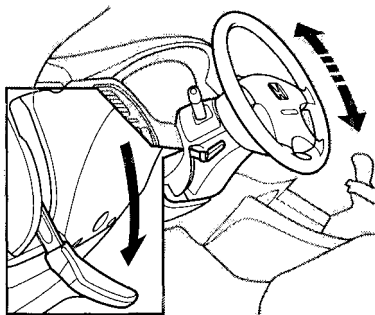

To adjust the steering wheel upward or downward:

1. Push the lever under the steering column all the way down.
2. Move the steering wheel to the desired position, making sure the wheel points toward your chest, not toward your face. Make sure you can see the instrument panel gauges and the indicator lights.

3. Push the lever up to lock the steering wheel in that position.
4. Make sure you have securely locked the steering wheel in place by trying to move it up and down.

Cruise Control

Cruise control allows you to maintain a set speed above 25 mph (40 km/h) without keeping your foot on the accelerator pedal. It should be used for cruising on straight, open highways. It is not recommended for conditions such as city driving, winding roads, slippery roads, heavy rain, or bad weather. You should have full control of the vehicle under those conditions.

Improper use of the cruise control can lead to a crash.

Use the cruise control only when traveling on open highways in good weather.

Using the Cruise Control

CRUISE CONTROL MASTER SWITCH

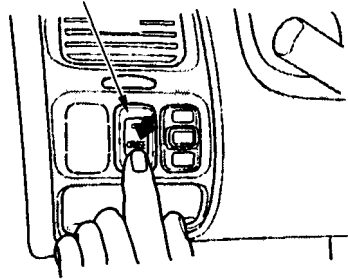

Switch to the left of the steering column. The indicator in the switch will light.

2. Accelerate to the desired cruising speed above 25 mph (40 km/h).
3. Press and hold the SET/decel button on the steering wheel until the CRUISE CONTROL light on the instrument panel comes on.

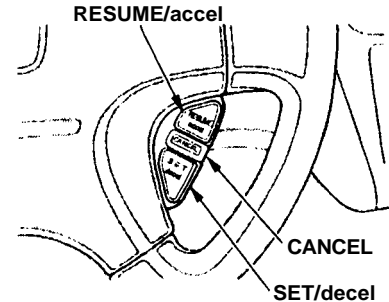

This shows the system is now activated.

The cruise control may not hold the set speed when you are going up or down hills.

When climbing a steep hill, the automatic transmission may downshift to hold the set speed.

CONTINUED

Changing the Set Speed

You can increase the set cruising speed in either of two ways:

- Press and hold the RESUME/accel button. The vehicle will accelerate slowly. When you reach the desired cruising speed, release the button.
- Push on the accelerator pedal. Accelerate to the desired cruising speed and press the SET/decel button.

You can decrease the set cruising speed in either of two ways:

- Press and hold the SET/decel button. The vehicle will decelerate. Release the button when you reach the desired speed.
- Tap the brake or clutch pedal lightly with your foot. The CRUISE CONTROL light on the instrument panel will go out. When the vehicle slows to the desired speed, press the SET/decel button. The vehicle will then maintain the desired speed.

Even with the cruise control turned on, you can still use the accelerator pedal to speed up for passing. After completing the pass, take your foot off the accelerator pedal. The vehicle will return to the set cruising speed.

Resting your foot on the brake or clutch pedal will cause the cruise control to cancel.

Cancelling the Cruise Control

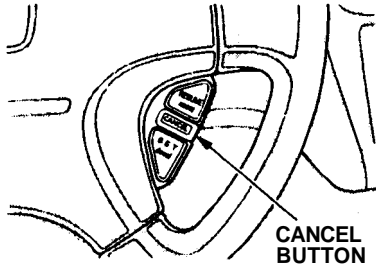

You can cancel the cruise control in any of these ways:

- Tap the brake or clutch pedal.
- Push the CANCEL button on the steering wheel.
- Press the Cruise Control Master Switch.

When you push the CANCEL button, or tap the brake or clutch pedal, the CRUISE CONTROL light on the instrument panel will go out and the vehicle will begin to slow down. You can use the accelerator pedal in the normal way. The system remembers the previously-set cruising speed. To return to that speed, accelerate to above 25 mph (40 km/h) and then press the RESUME/accel button until the CRUISE CONTROL light comes on. The vehicle will accelerate to the same cruising speed as before.

Pressing the Cruise Control Master Switch turns the system completely off and erases the previous cruising speed from memory. To use the system again, refer to ***Using the Cruise Control.***

Remote Audio Controls

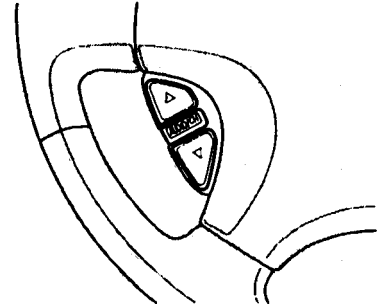

On EX-V6 model

These buttons let you control some functions of the audio system without removing your hands from the wheel. Refer to page [149](#) for a complete explanation.

Keys and Locks

Keys

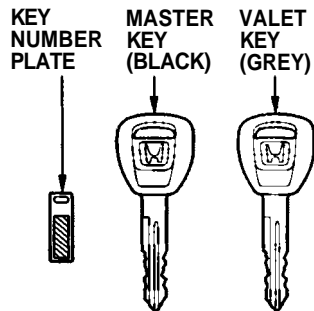

Your vehicle comes with two kinds of keys: a master key and a valet key. The master key fits all the locks on your vehicle:

- Ignition
- Doors
- Trunk
- Trunk release handle
- Rear seat trunk access
- Glove box

The valet key works only in the ignition and the door locks. You can keep the trunk, trunk release handle, rear seat trunk access and the glove box locked when you leave your vehicle and the valet key at a parking facility.

You should have received a key number plate with your keys. You will need this key number if you ever have to get a lost key replaced. Keep the plate stored in a safe place. If you need to replace a key, use only Honda-approved key blanks.

These keys contain electronic circuits that are activated by the Immobilizer System. They will not work to start the engine if the circuits are damaged.

- Protect the keys from direct sunlight, high temperature, and high humidity.
- Do not drop the keys or set heavy objects on them.
- Keep the keys away from liquids. If they get wet, dry them immediately with a soft cloth.

The keys do not contain batteries. Do not try to take them apart.

Remote Transmitter

Some models also come with two remote transmitters; see page [73](#) for an explanation of the operation.

Immobilizer System

The Immobilizer System protects your vehicle from theft. A properly-coded master or valet key must be used in the ignition switch for the engine to start. If an improperly-coded key (or other device) is used, the engine's starting circuit is disabled.

When you turn the ignition switch to ON (II), the Immobilizer System indicator should come on for a few seconds, then go out. If the indicator starts to blink, it means the system does not recognize the coding of the key. Turn the ignition switch to LOCK (0), remove the key, reinsert it, and turn the switch to ON (II) again.

If the system repeatedly does not recognize the coding of your key, contact your Honda dealer.

This indicator will also blink several times when you turn the ignition switch from ON (II) to ACCESSORY (I) or LOCK (0).

The system may not recognize your key's coding if the key is in contact with a key from another immobilizer system. If you have a key from another vehicle's immobilizer system, keep it separate.

Do not attempt to alter this system or add other devices to it. Electrical problems could result that may make your vehicle undrivable.

If you have lost your key and you cannot start the engine, contact your Honda dealer.

As required by the FCC:

This device complies with Part 15 of the FCC rules. Operation is subject to the following two conditions: (1) This device may not cause harmful interference, and (2) this device must accept any interference received, including interference that may cause undesired operation.

This device complies with DOC rules in Canada.

Changes or modifications not expressly approved by the party responsible for compliance could void the user's authority to operate the equipment.

Ignition Switch

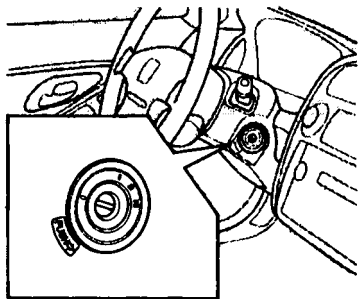

The ignition switch is on the right side of the steering column. It has four positions:

- LOCK (0)
- ACCESSORY (I)
- ON (II)
- START (III)

LOCK (0) — You can insert or remove the key only in this position. To switch from ACCESSORY to LOCK, you must push the key in slightly as you turn it. If your vehicle has an automatic transmission, it must also be in Park. The anti-theft lock will lock the steering column when you remove the key.

If the front wheels are turned, the anti-theft lock may sometimes make it difficult to turn the key from LOCK to ACCESSORY. Firmly turn the steering wheel to the left or to the right as you turn the key.

Removing the key from the ignition switch while driving locks the steering. This can cause you to lose control.

Remove the key from the ignition switch only when parked.

ACCESSORY (I) — In this position, you can operate the audio system and the accessory power socket.

ON (II) — This is the normal key position when driving. All features and accessories on the vehicle are usable. Several of the lights on the instrument panel come on as a test when you turn the ignition switch from ACCESSORY to ON (see page [49](#)).

START (III) — Use this position only to start the engine. The switch returns to ON (II) when you let go of the key.

The engine will not start if the Immobilizer System does not recognize the key's coding (see page 69).

You will hear a reminder beeper if you leave the key in the ignition switch in the LOCK (0) or ACCESSORY (I) position and open the driver's door. Remove the key to turn off the beeper.

Power Door Locks

MASTER DOOR LOCK SWITCH

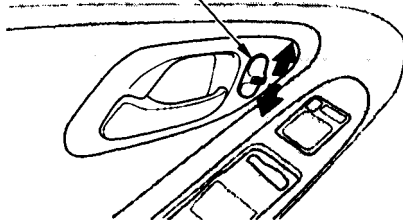

Each door has a master door lock switch. This switch locks and unlocks both doors. Push the switch down to lock both doors and up to unlock them.

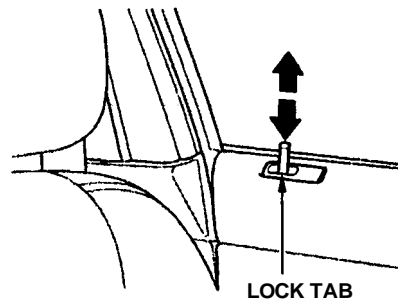

Each door has a lock tab at the top of the door. When you push down the lock tab on the driver's door, both doors lock. Pulling up the lock tab on the driver's door only unlocks that door. The lock tab on the passenger's door only locks and unlocks that door.

CONTINUED

Keys and Locks

To lock the passenger's door when getting out of the vehicle, push the lock tab down and close the door. To lock the driver's door, remove the key from the ignition switch and push the lock tab down or push the master switch down, then close the door.

Both doors can be locked from the outside by using the key in either door.

To unlock only the driver's door from the outside, insert the key in the driver's door lock, turn the key and release it. If you turn the key and hold it, both doors will unlock. Both doors will unlock when you unlock the passenger's door with the key.

Lockout Prevention

If you forget and leave the key in the ignition switch, Lockout Prevention will not allow you to lock the driver's door. With the driver's door open and the key in the ignition, both master door lock switches are disabled. However, if the driver's door is not open, the master door lock switches are not disabled. Pushing the switch down on the open passenger's door will lock both doors. If you try to lock an open driver's door by pushing down the lock tab, the tabs on both doors pop up. Pushing down the lock tab on the passenger's door only locks that door.

Remote Transmitter

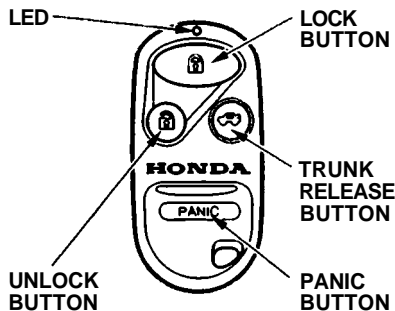

On EX and EX-V6 models

You can lock and unlock your vehicle with the remote transmitter. When you push the LOCK button, both doors lock. The parking lights, side marker lights, and taillights flash once.

When you push the UNLOCK button once, only the driver's door unlocks. The passenger's door unlocks when you push the button a second time. The parking lights, side marker lights, and taillights flash twice.

The ceiling light (if the ceiling light switch is in the center position) will come on when you press the UNLOCK button. If you do not open either door, the light stays on for about 10 seconds, then fades out. If you relock the doors with the remote transmitter before 10 seconds have elapsed, the light will go off immediately.

If you unlock the doors with the remote transmitter, but do not open either door within 30 seconds, the doors automatically relock and the security system sets.

You cannot lock or unlock the doors with the remote transmitter if either

door is not fully closed or the key is in the ignition switch.

When you push the LOCK button a second time within 5 seconds after you have locked the doors, the horn will sound once to verify that the security system will be set.

To open the trunk, push the Trunk Release button for approximately one second. The trunk will not open if the key is in the ignition switch.

CONTINUED

Panic Mode

Panic mode allows you to remotely activate your vehicle's security system to attract attention. When activated, the horn will sound, and the exterior lights will flash, for about 30 seconds. To activate panic mode, press and hold the PANIC button for about one second.

To cancel Panic mode before 30 seconds, press any button on the remote transmitter. You can also turn the ignition switch to ON (II).

Panic mode will not activate if the key is in the ignition switch.

Replacing the Battery

When the remote transmitter's battery begins to get weak, it may take several pushes on the button to lock or unlock the doors, and the LED will not light. Replace the battery as soon as possible.

Battery type: CR2025

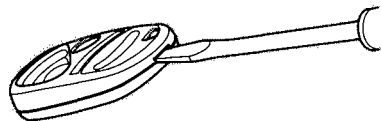

To replace the battery, place a cloth on the edge of the transmitter and remove the upper half by carefully prying on the edge with a small flat-tip screwdriver.

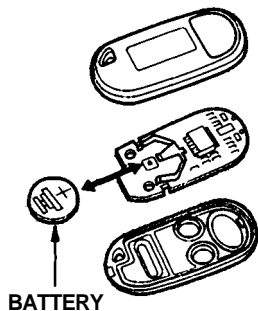

Remove the old battery and note the polarity. Make sure the polarity of the new battery is the same (+ side facing up), then insert it in the transmitter.

Reinstall the upper half securely.

Transmitter Care

Avoid severe shock to the transmitter, such as dropping or throwing it. Also, protect it from extreme hot or cold temperatures.

Clean the transmitter case with a soft cloth. Do not use strong cleaners or solvents that could harm the case. Immersing the transmitter in any liquid will harm the transmitter and cause it to not function properly.

If you lose a transmitter, you will need to have the replacement programmed to your vehicle's system by your Honda dealer. Any other transmitters you have will also need to be reprogrammed.

As required by the FCC:

This device complies with Part 15 of the FCC rules. Operation is subject to the following two conditions: (1) This device may not cause harmful interference, and (2) this device must accept any interference received, including interference that may cause undesired operation.

This device complies with DOC rules in Canada.

Changes or modifications not expressly approved by the party responsible for compliance could void the user's authority to operate the equipment.

Trunk

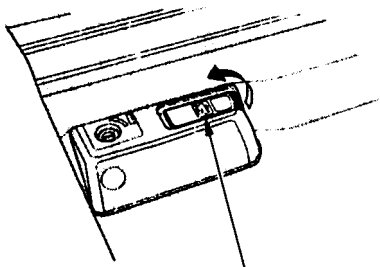

TRUNK RELEASE HANDLE

You can open the trunk in two or three ways:

- Pull the trunk release handle to the left of the driver's seat.
- Use the master key to open the trunk lock. The valet key does not work in this lock.
- Press the trunk release button on the remote transmitter (EX and EX-V6 models only).

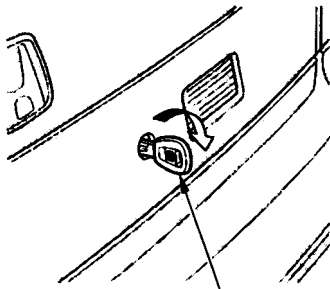

MASTER KEY

To close the trunk, press down on the trunk lid.

See page [164](#) for cargo loading and weight limit information. Keep the trunk lid closed at all times while driving to avoid damaging the lid, and to prevent exhaust gas from getting into the interior. See **Carbon Monoxide Hazard** on page [44](#).

MASTER KEY

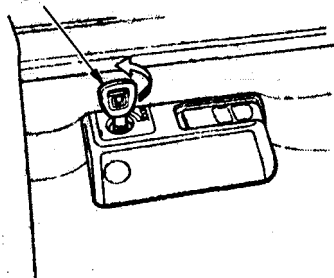

Glove Box

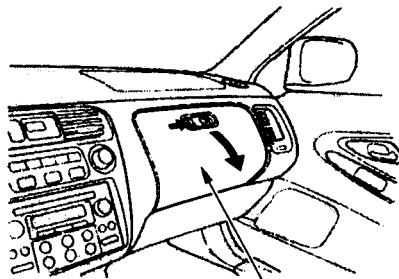

GLOVE BOX

To protect items in the trunk when you need to give the key to someone else:

1. Lock the trunk release handle with the master key.
2. Give the person the valet key.

Open the glove box by squeezing the handle. Close it with a firm push. Lock or unlock the glove box with the master key.

The glove box light comes on only when the instrument panel lights are on.

An open glove box can cause serious injury to your passenger in a crash, even if the passenger is wearing the seat belt.

Always keep the glove box closed while driving.

Homelink Universal Transmitter

On EX-V6 model

The Homelink® Universal Transmitter built into your vehicle can be programmed to operate remotely-controlled devices around your home, such as garage doors, lighting, or home security systems. It can replace up to three remote transmitters.

Customer Assistance

If you have problems with training the Homelink® Universal Transmitter, or would like information on home products that can be operated by the transmitter, call (800) 355-3515.

Important Safety Precautions

Always refer to the operating instructions and safety information that came with your garage door opener or other equipment you intend to operate with the Homelink® Universal Transmitter. If you do not have this information, you should

contact the manufacturer of the equipment.

While training or using the transmitter, make sure you have a clear view of the garage door or gate, and that no one will be injured by its movement.

If your garage door opener was manufactured before April 1982, you may not be able to program the Homelink® Universal Transmitter to operate it. Garage door openers manufactured before that date do not have a safety feature that causes them to stop and reverse if an obstacle is detected during closing, increasing the risk of injury. If you have questions, call (800) 355-3515.

Training the Transmitter

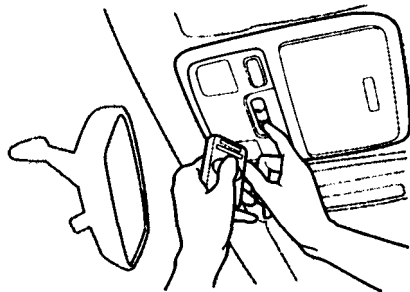

Before you can use the Homelink® Universal Transmitter to operate devices around your home, it must "learn" the proper codes. For example, to train the transmitter to open and close the garage door:

1. *Perform this step before training the transmitter for the very first time.* Press and hold the two outside buttons until the red light in the

transmitter flashes (approximately 20 seconds). Release the buttons.

2. Hold the end of the garage door opener remote control against the Homelink® transmitter. Make sure you are not blocking your view of the red light in the transmitter.
3. Select the transmitter button you want to train.
4. Press the button on the remote control and the button on the transmitter at the same time. Hold down both buttons.
5. The red light in the transmitter should begin flashing. It will flash slowly at first, then rapidly.

6. When the red light flashes rapidly, release both buttons. The transmitter should have learned the code from the remote control.
7. Test the transmitter button by pushing it. It should operate the garage door.
8. Repeat these steps to train the other two transmitter buttons to operate any other remotely-controlled devices around your home (lighting, automatic gate, security system, etc.).

Canadian Owners. The remote control you are training from may stop transmitting after two seconds. This is not long enough for the Homelink® transmitter to learn the code. Release and press the button on the remote control every two seconds until the transmitter has learned the code.

The Homelink® transmitter stores the code in a permanent memory. There should be no need to retrain the transmitter if your vehicle's battery goes dead or is disconnected.

Retraining a Button

To train an already programmed transmitter button to operate a new device:

1. Select the transmitter button you want to train.

2. Press and hold the transmitter button until the red light begins to flash slowly (approximately 20 seconds).
3. While continuing to hold the transmitter button, place the remote control for the device against the Homelink® transmitter.
4. Press and hold the button on the remote control. Hold both buttons until the red light begins to flash rapidly.
5. Release both buttons. The transmitter should now be trained to operate the device.

Training With a Rolling Code System

For security purposes, newer garage door opening systems use a "rolling" or variable code. If you know that your garage door opener has a rolling code, or you have been unable to train the transmitter after several attempts, use the following procedure. You will need someone to help you.

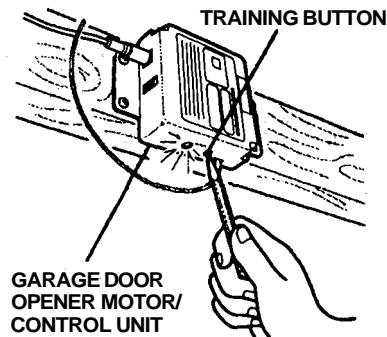

1. Find the "Training" button on your garage door opener motor/control unit. The location will vary, depending on the manufacturer. The manufacturer's documentation may help.
2. Press the Training button on the motor/control unit until the light next to the button starts flashing, then release it.

3. Press and hold the desired button on the Homelink® transmitter until the training light on the motor/control unit stops flashing and remains lit.
4. Release the Homelink® transmitter button, then press it again. This should turn off the training light on the motor/control unit.
5. Release the transmitter button.
6. Press the transmitter button again. It should operate the garage door.

Erasing Codes

To erase the codes stored in all three buttons, press and hold the two outside buttons until the red light begins to flash, then release the buttons.

You should erase all three codes before selling the vehicle.

As required by the FCC:

This device complies with Part 15 of the FCC rules. Operation is subject to the following two conditions: (1) This device may not cause harmful interference, and (2) this device must accept any interference received, including interference that may cause undesired operation.

This device complies with DOC rules in Canada.

Changes or modifications not expressly approved by the party responsible for compliance could void the user's authority to operate the equipment.

Seat Adjustments

Front Seat Adjustments

See pages 10 — 11 for important safety information and warnings about how to properly position seats and seat-backs.

Make all seat adjustments before you start driving.

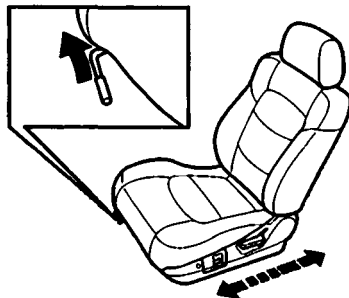

To adjust the seat forward and backward, pull up on the lever under the seat cushion's front edge. Move the seat to the desired position and release the lever. Try to move the seat to make sure it is locked in position.

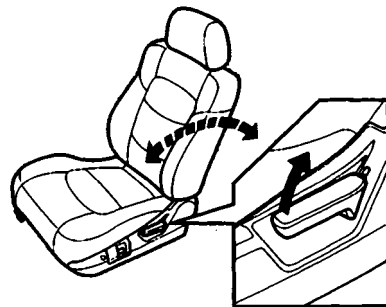

To change the angle of the seat-back, pull up on the lever on the outside of the seat bottom. Move the seat-back to the desired position and release the lever. Let the seat-back latch in the new position.

Driver's Seat Manual Height Adjustment

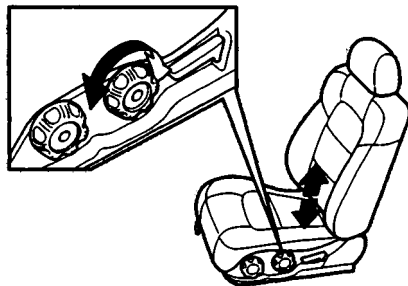
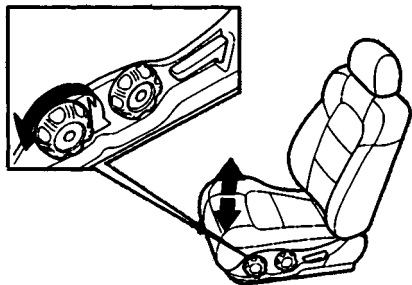

On LX model

The height of your driver's seat is adjustable. Turn the front dial on the outside of the seat cushion to raise the front of the seat bottom and turn the rear dial to raise the rear.

Make all adjustments before you start driving.

Driver's Seat Power Height Adjustment

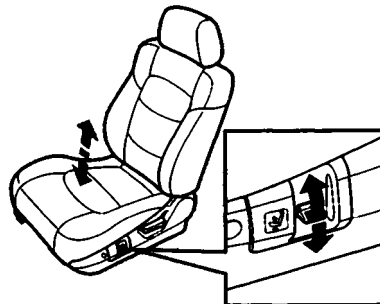

On EX model

The height of your driver's seat is power adjustable. Pull up on the switch to raise the seat. Push it down to lower the seat.

Make all adjustments before you start driving.

Seat Adjustments

Driver's Seat Power Adjustments

Standard on LX-V6 and EX-V6 models

Optional on EX model

See pages 10 — 11 for important safety information and warnings about how to properly position seats and seat-backs.

The two power seat adjustment switches are on the outside edge of the seat bottom. The horizontal switch adjusts the seat bottom in several directions. The short vertical switch adjusts the seat-back angle.

You can adjust the seat with the ignition switch in any position. Make all seat adjustments before you start driving.

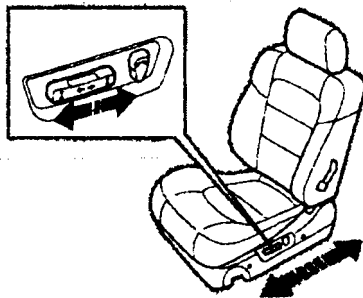

Push the horizontal switch forward or backward to move the seat forward or backward.

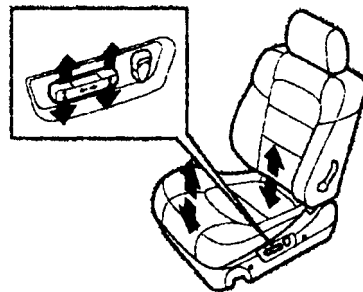

Pull up or push down on the front of the switch to move the seat bottom's front edge up or down. Pull up or push down on the rear of the switch to move the rear of the seat bottom up or down.

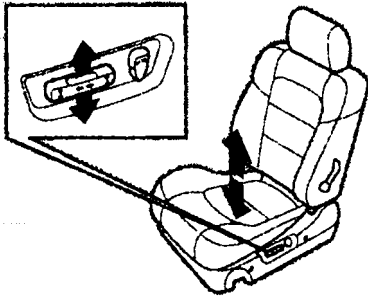

Pull the center of the horizontal switch up to raise the seat. Push it down to lower the seat

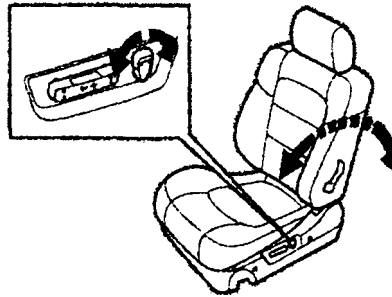

Adjust the seat-back angle by pushing the rear switch in the direction you want to move.

Driver's Lumbar Support

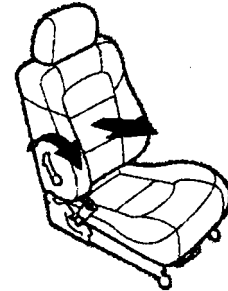

ON EX and EX V-6 models
Vary the lumbar support by moving the lever on the right side of the seat-back. Pivot the lever forward until it stops, then let it return. Doing this several times adjusts the lumbar support through its full range.

Seat Adjustments

Rear Seat Access Driver's Side

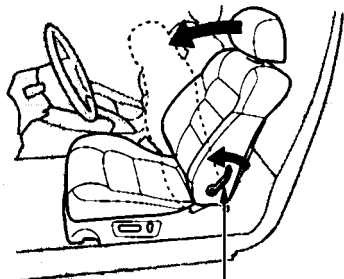

RELEASE LEVER

*On LX-V6 and EX-V6 models
On EX model with optional
power driver's seat*

To get into the back seat on the driver's side, push the release lever forward on the side of the seat-back. The seat-back will tilt forward to allow easier entry to the back seat.

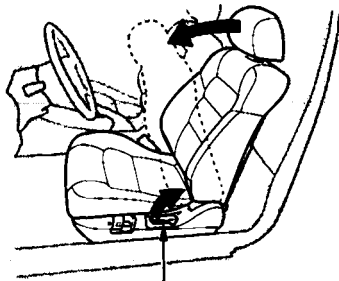

SEAT-BACK ADJUSTMENT LEVER

On LX and EX models
To get into the back seat on the driver's side, pull up on the seat-back adjustment lever. The seat-back will tilt forward to allow easier entry to the back seat.

Passenger's Side

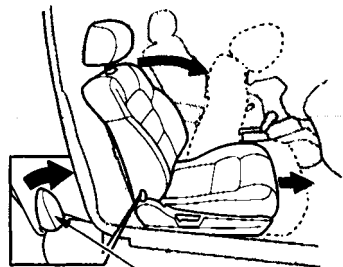

RELEASE LEVER

To get into the back seat on the passenger's side, push forward on the release lever at the base of the seat-back. The seat-back will tilt forward and the entire seat will move forward to allow easier entry to the back seat. After you return the seat-back to the upright position, push the whole seat backwards until it latches. Make sure the seat is fully latched before sitting in it.

Head Restraints

See page 12 for important safety information and a warning about how to properly position the head restraints.

The front head restraints help protect you and your passenger from whiplash and other injuries. They are most effective when you adjust them so the back of the occupant's head rests against the center of the restraint. A taller person should adjust the restraint as high as possible.

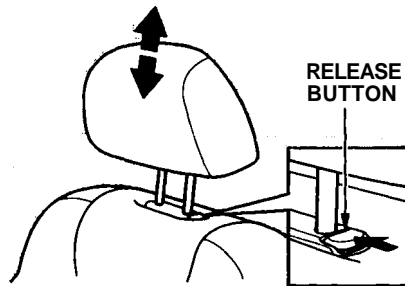

The front head restraints adjust for height. You need both hands to adjust the restraint. Do not attempt to adjust it while driving. To raise it, pull upward. To lower the restraint, push the release button sideways and push the restraint down.

To remove a head restraint for cleaning or repair, pull it up as far as it will go. Push the release button and pull the restraint out of the seat-back.

Seat Adjustments

Folding Rear Seat

The back of the rear seat folds down to give you direct access to the trunk. Each side folds down separately. With only half the seat folded, you can still carry a passenger in the back seat. The seat-back can be released from inside the vehicle or inside the trunk.

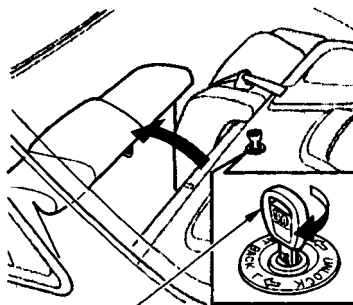

MASTER KEY

To fold down either side of the seat-back from inside the vehicle, insert the master key in the lock on the rear shelf. To fold down the driver's side, turn the key clockwise, pull down the top of the seat-back, then release the key. To fold down the passenger's side, turn the key counterclockwise and perform the same procedure.

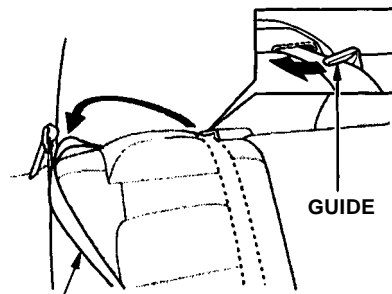

CENTER SHOULDER BELT

When storing cargo, you can move the rear center shoulder belt out of the way by removing the belt from the guide.

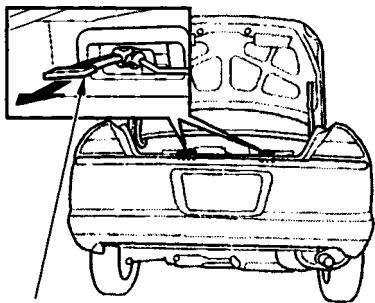

RELEASE

To release the seat-back from inside the trunk, pull the release under the rear shelf. Push the seat-back down, then let go of the release.

To lock the seat-back upright, push it firmly against the rear shelf. Make sure it is latched in place by pulling on the top of the seat.

Make sure all rear shoulder belts are positioned in front of the rear seat-back whenever the seat-back is in its upright position.

Make sure all items in the trunk, or items extending through the opening into the back seat are tied down. Loose items can fly forward and cause injury if you have to brake hard. See **Carrying Cargo** on page [164](#).

Never drive with the seat-back folded down and the trunk lid open. See **Carbon Monoxide Hazard** on page [44](#).

Seat Heaters

SEAT HEATERS

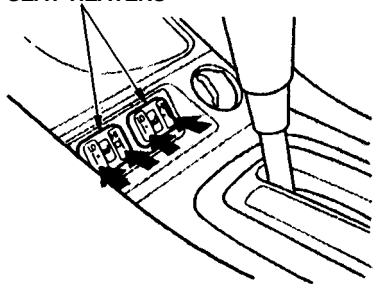

*Standard on EX-V6 model in Canada
Optional on EX model in Canada*

Both front seats are equipped with seat heaters. The ignition must be ON (II) to use them. Push the right side of the switch, HI, to rapidly heat up the seat. After the seat reaches a comfortable temperature, select LO by pushing the left side of the switch. This will keep the seat warm.

The HI or LO indicator lights and remains lit until you turn it off by pushing the opposite side of the switch lightly. The indicator will turn off.

In HI, the heater turns off when the seat gets warm, and turns back on after the seat's temperature drops. It continues to cycle as long as you leave it set on HI. The HI indicator remains lit as a reminder that you have the heater on.

In LO, the heater runs continuously. It does not cycle with temperature changes.

Follow these precautions whenever you use the seat heaters:

- Use the HI setting only to heat the seats quickly. Select the LO setting when the seats feel warm. The HI setting draws large amounts of current from the battery.
- Do not use the seat heaters, even on the LO setting, if the engine is left idling for an extended period. They can weaken the battery, causing hard starting.

Your vehicle's windows are electrically-powered. Turn the ignition switch to ON (II) to raise or lower any window.

Each door has a switch that controls its window. To open the window, push the switch down and hold it. Release the switch when you want the window to stop. Close the window by pulling back on the switch and holding it.

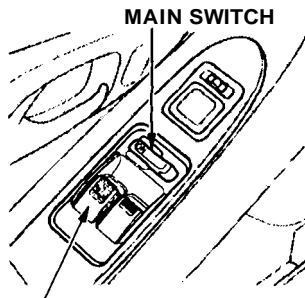

DRIVER'S WINDOW SWITCH

The driver's armrest has a master power window control panel. To open the passenger's window, push down on the switch and hold it down until the window reaches the desired position. To close the window, pull back on the window switch. Release the switch when the window gets to the position you want.

Closing a power window on a child's hands or fingers can cause serious injury.

Make sure your children are away from the windows before closing them.

CONTINUED

Power Windows

The master control panel also contains these extra features:

AUTO — To open the driver's window fully, push the window switch firmly down and release it. The window automatically goes all the way down. To stop the window from going all the way down, pull back on the window switch briefly.

To open the driver's window only partially, push the window switch down lightly and hold it. The window will stop as soon as you release the switch.

The AUTO function only works to lower the driver's window. To raise the window, you must pull back on the window switch and hold it until the window reaches the desired position.

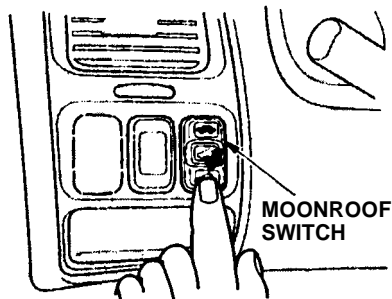

The MAIN switch controls power to the passenger's window. With this switch off, the passenger's window cannot be raised or lowered. The MAIN switch does not affect the driver's window. Keep the MAIN switch off when you have children in the vehicle so they do not injure themselves by operating the window unintentionally.

The power window system has a key-off delay function. The windows will still operate for up to ten minutes after you turn off the ignition. Opening either door cancels the delay function. You must turn the ignition ON (II) again before you can raise or lower the windows.



On EX and EX-V6 models

The moonroof has two positions: it can be tilted up in the back for ventilation, or it can be slid back into the roof. Use the switch under the left dashboard vent to operate the moonroof. The ignition switch must be ON (II).

To tilt up the back of the moonroof, press and hold the center button (). To close the moonroof, press and hold the top of the switch (). To open the moonroof, press and hold the bottom of the switch (). Release the switch when the moonroof gets to the desired position. Make sure everyone's hands are away from the moonroof before opening or closing it.

Opening or closing the moonroof on someone's hands or fingers can cause serious injury.

Make sure all hands and fingers are clear of the moonroof before opening or closing it.

The moonroof has a key-off delay. You can still open and close the moonroof for up to ten minutes after you turn off the ignition. The key-off delay cancels as soon as you open either door. You must then turn the ignition ON (II) for the moonroof to operate.

NOTICE

If you try to open the moonroof in below-freezing temperatures, or when it is covered with snow or ice, you can damage the moonroof panel or motor.

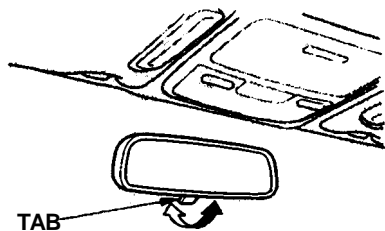

Keep the inside and outside mirrors clean and adjusted for best visibility. Be sure to adjust the mirrors before you start driving.

The inside mirror has day and night positions. The night position reduces glare from headlights behind you. Flip the tab on the bottom edge of the mirror to select the day or night position.

Adjusting the Power Mirrors

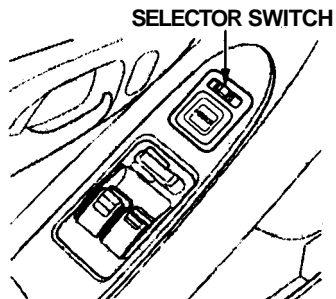

Adjust the outside mirrors with the adjustment switch on the driver's door armrest:

1. Turn the ignition switch ON (II).
2. Move the selector switch to L (driver's side) or R (passenger's side).

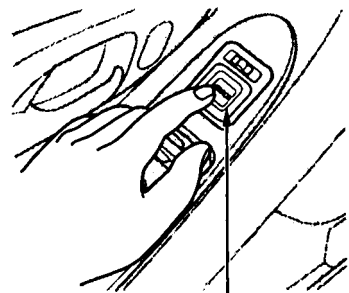

3. Push the appropriate edge of the adjustment switch to move the mirror right, left, up or down.
4. When you finish, move the selector switch to the center (off) position. This turns off the adjustment switch so you can't move a mirror out of position by accidentally bumping the switch.

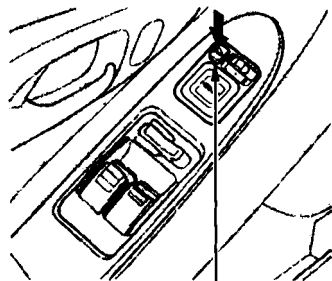

HEATED MIRROR BUTTON

Available on all Canadian models
The outside mirrors are heated to remove fog and frost. With the ignition switch ON (II), turn on the heaters by pressing the button. The light in the button comes on as a reminder. Press the button again to turn the heaters off.

Parking Brake

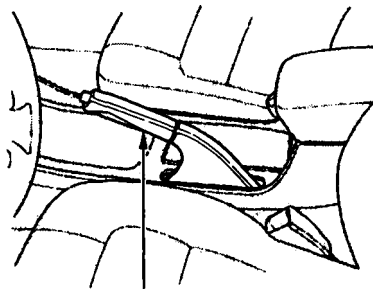

PARKING BRAKE LEVER

To apply the parking brake, pull the lever up fully. To release it, pull up slightly, push the button, and lower the lever. The parking brake light on the instrument panel should go out when the parking brake is fully released with the engine running (see page 50).

NOTICE

Driving the vehicle with the parking brake applied can damage the rear brakes and axles.

Digital Clock

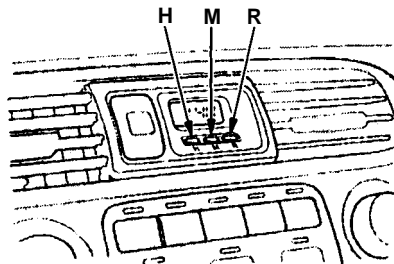

The digital clock displays the time with the ignition switch in any position.

To set the clock:

1. Press and hold the H button until the hour advances to the desired hour.

2. Press and hold the M button until the numbers advance to the desired minutes.

You can use R to quickly set the time to the nearest hour. If the displayed time is before the half hour, pressing R sets the clock back to the previous hour. If the displayed time is after the half hour, pressing R sets the clock forward to the beginning of the next hour.

For example:

- 1:06 would RESET to 1:00.
- 1:52 would RESET to 2:00.

Sunglasses Holder

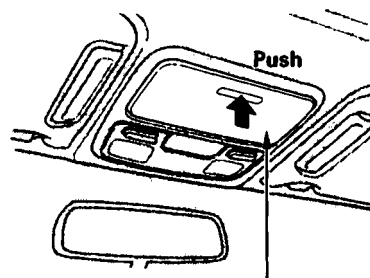

SUNGLASSES HOLDER

To open the sunglasses holder, push on the front edge. It will unlatch and swing down. To close it, push it until it latches. Make sure the holder is closed while you are driving.

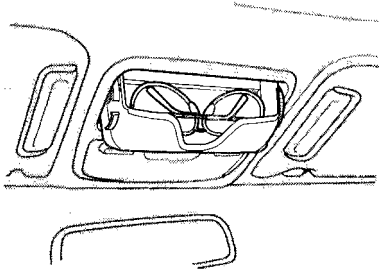

Some larger styles of sunglasses may not fit in the holder.

Beverage Holder

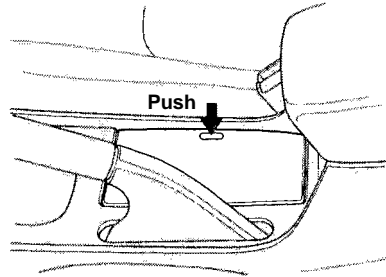

To open the beverage holder, push on the top. The beverage holder lid is spring-loaded and will swing open. To close it, push it down until it latches.

The inner liner can be removed if you want to hold a larger cup.

Use the beverage holder only when the vehicle is parked. If you place cups in the holder while driving, the

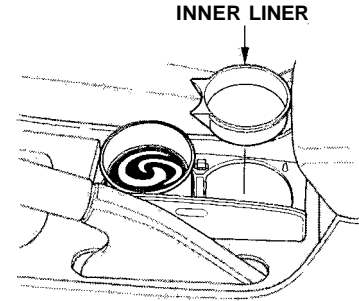

liquid may spill when you go over bumps or around corners.

Be careful when you are using the beverage holder. A spilled liquid that is very hot can scald you or your passengers. Spilled liquids can also damage the upholstery, carpeting, and electrical components in the interior.

Console Compartment

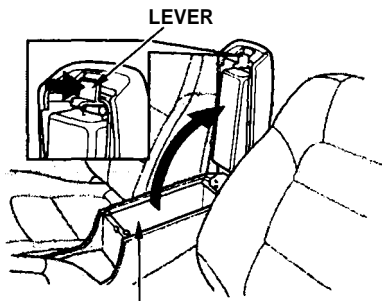

CONSOLE COMPARTMENT

To open the console compartment, pull up on the lower lever and lift the lid.

To close, lower the lid and push it down until it latches.

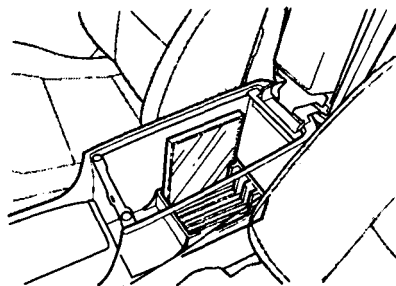

On EX and EX-V6 models
The console compartment has a Compact Disc holder.

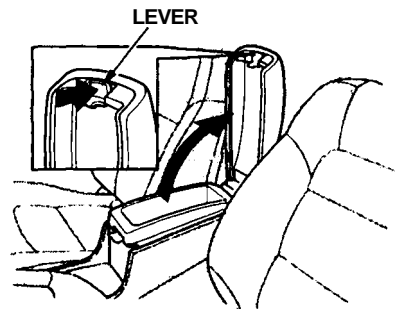

You can put small items in the tray located in the console compartment lid. To use the tray, pull up on the upper lever and lift up the armrest pad.

Sun Visor

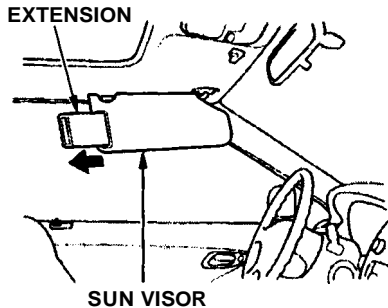

Make sure you put the sun visor back in place when you are getting into or out of the vehicle. Do not use the sun visor extension over the rear view mirror.

To use the sun visor, pull it down. You can also use the sun visor at the side window. Remove the support rod from the clip and swing the sun visor toward the side window. In this position, the sun visor can be extended by sliding out the extension.

Vanity Mirror

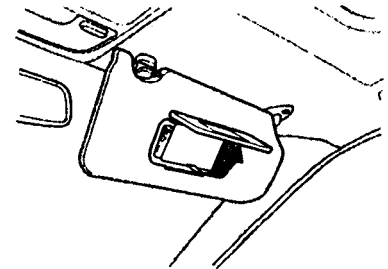

To use a vanity mirror on the back of the sun visor, pull up the cover.

The light beside the mirror comes on only when the parking lights are on.

Coin Box, Center Pocket, Accessory Power Socket

Coin Box

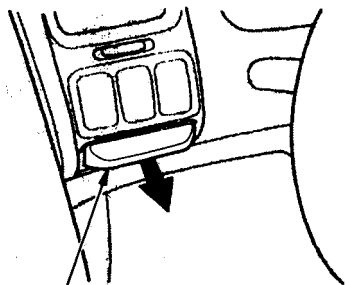

COIN BOX

The coin box is located under the air vent. To open the coin box, pull the bottom edge. Close it with a firm push.

Center Pocket

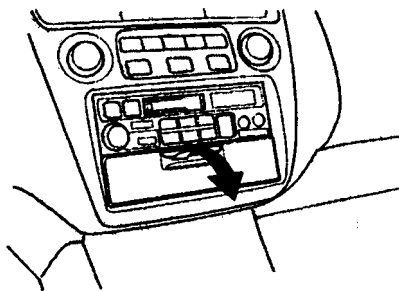

On LX and LX-V6 models
The center pocket is located under the audio system. To open the lid, pull it down. Close it with a firm push.

Accessory Power Socket

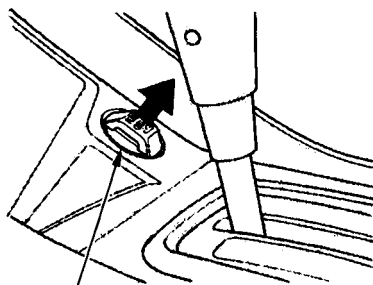

ACCESSORY POWER SOCKET

To use the accessory power socket, pull out on the cover. The ignition switch must be in ACCESSORY (I) or ON (II).

This socket is intended to supply power for 12 volt DC accessories that are rated 120 watts or less (10 amps).

It will not power an automotive type cigarette lighter element.

Ceiling Light

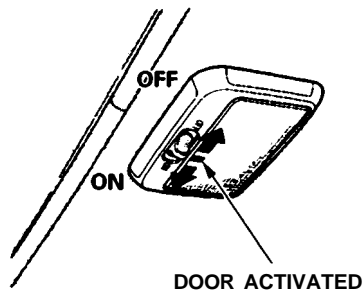

The ceiling light has a three-position switch. In the OFF position, the light does not come on. In the center position, the ceiling light comes on when you open either door. After both doors are closed tightly, the light dims slightly, then fades out in about 10 seconds. In the ON position, the ceiling light stays on continuously.

On EX and EX-V6 models

The ceiling light (with the switch in the center position) also comes on when you unlock the door with the remote transmitter (see page 73). The light fades out after both doors are closed.

Spotlights

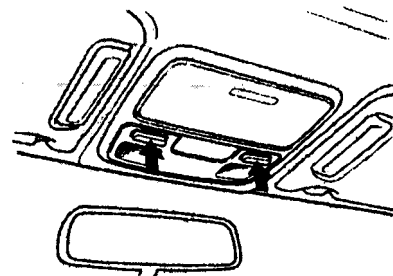

Turn on the spotlight by pushing the button next to each light. Push the button again to turn it off. You can use the spotlights at all times.

Interior Lights

Courtesy Lights

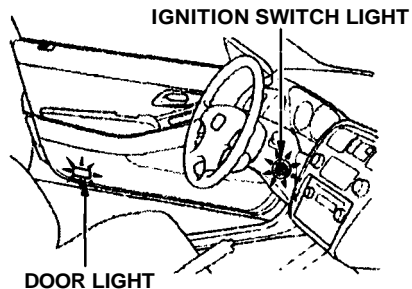

The courtesy light in each door comes on when the door is opened, and goes out when the door is closed.

Your vehicle also has a courtesy light in the ignition switch. This light comes on when you open the driver's door.

It remains on for several seconds after the door is closed.

The heating and air conditioning systems in your Honda provide a comfortable driving environment in all weather conditions.

The standard audio system has many features. This section describes those features and how to use them. (If you selected an optional audio system, refer to the operating instructions that came with it.)

On EX and EX-V6 models

Your Honda has an anti-theft audio system that requires a code number to enable it.

The security system helps to discourage vandalism and theft of your Honda.

Heating and Cooling.....	104	Audio System (EX, EX-V6).....	131
What Each Control Does.....	104	AM/FM/CD Audio System.....	131
How to Use the System.....	107	Operating the Radio.....	132
To Turn Everything Off.....	110	Adjusting the Sound.....	136
Climate Control System.....	111	Audio System Lighting.....	137
Fully-automatic Operation.....	113	Radio Frequencies.....	137
Semi-automatic Operation.....	114	Radio Reception.....	137
Sunlight Sensor/ Temperature Sensor.....	118	Operating the CD Player.....	139
Audio System (LX, LX-V6).....	119	Operating the CD Changer.....	141
AM/FM/Cassette Stereo Audio System.....	119	Protecting Compact Discs.....	142
Operating the Radio.....	120	CD Player Error Indications.....	143
Adjusting the Sound.....	123	CD Changer Error Indications.....	144
Audio System Lighting.....	124	Operating the Cassette Player.....	145
Operating the Cassette Player.....	124	Tape Search Functions.....	146
Tape Search Functions.....	124	Caring for the Cassette Player.....	148
Operating the Optional CD Changer.....	127	Remote Audio Controls	149
CD Changer Error Indications.....	130	Theft Protection.....	150
		Security System.....	151

Heating and Cooling

On LX, LX-V6 and EX models
Proper use of the Heating and Cooling system can make the interior dry and comfortable, and keep the windows clear for best visibility.

What Each Control Does

Fan Control Dial

Turning this dial clockwise increases the fan's speed, which increases air flow.

Temperature Control Dial

Turning this dial clockwise increases the temperature of the air flow.

Air Conditioning (A/C) Button

This button turns the air conditioning ON and OFF. The indicator above the button lights when the A/C is on.

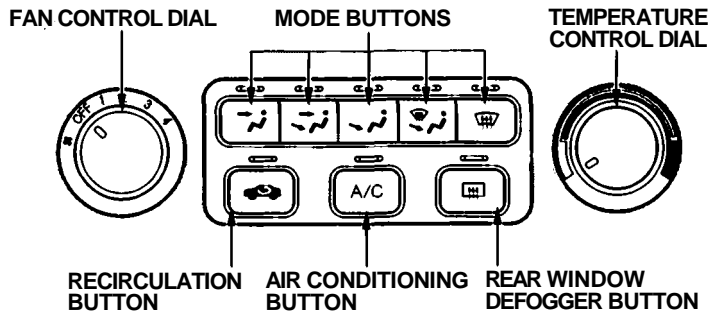

Recirculation Button

This button controls the source of the air going into the system. When the indicator above this button is lit, air from the vehicle's interior is sent through the system again (Recirculation mode). When the indicator is off, air is brought in from outside the vehicle (Fresh Air mode).

Rear Window Defogger Button

This button turns the rear window defogger on and off (see page 63).

Mode Buttons



Use the MODE buttons to select the vents the air flows from. Some air will flow from the dashboard corner vents in all modes.

 Air flows from the center and corner vents in the dashboard.

 Air flow is divided between the vents in the dashboard and the floor vents.

 Air flows from the floor vents.

 Air flow is divided between the floor vents and the defroster vents at the base of the windshield.

 Air flows from the defroster vents at the base of the windshield. When you select  or , the system automatically switches to Fresh Air mode and turns on the A/C.

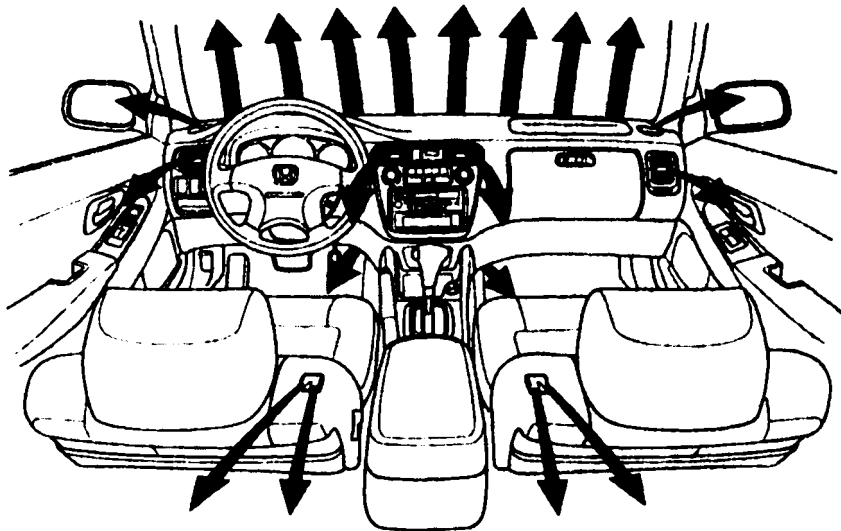

Heating and Cooling

Vent Controls

CENTER VENT

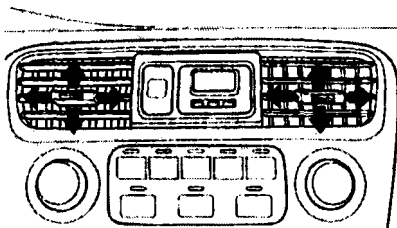

The direction of air flow from the vents in the center and each side of the dashboard is adjustable.

To adjust the air flow from the center vent, move the tab up-and-down and side-to-side.

DRIVER'S-SIDE VENT

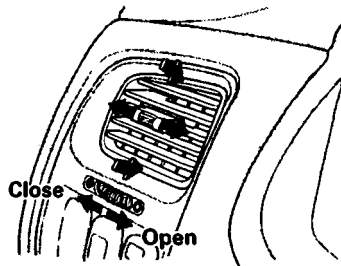

On the driver's-side vent, move the vent up-and-down and move the tab side-to-side. On the passenger's-side vent, move the tab up-and-down and move the vent side-to-side.

PASSENGER'S-SIDE VENT

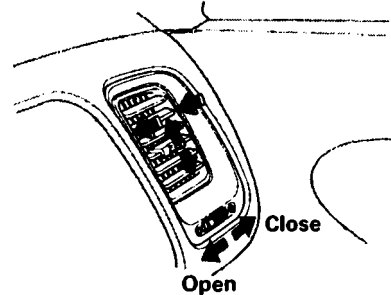

The vents in the corners of the dashboard can be opened and closed with the dials underneath them.

How to Use the System

This section covers how to set up the system controls for ventilation, heating, cooling, dehumidifying, and defrosting.

The engine must be running for the heater and air conditioning to generate hot and cold air. The heater uses engine coolant to warm the air. If the engine is cold, it will be several minutes before you feel warm air coming from the system.

The air conditioning does not rely on engine temperature.

It is best to leave the system in Fresh Air mode under almost all conditions. Keeping the system in Recirculation mode, particularly with the A/C off, can cause the windows to fog up. Switch to Recirculation mode when you are driving through smoky or dusty conditions, then switch back to Fresh Air mode when the condition

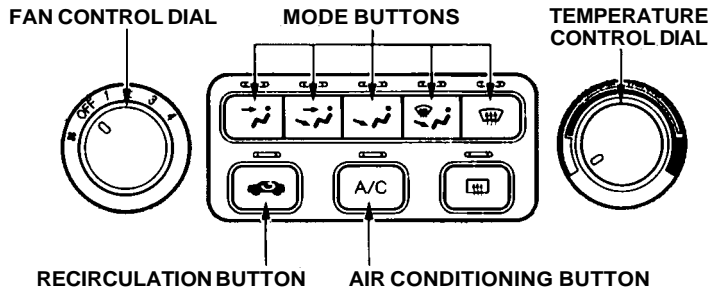

clears.

The outside air intakes for the heating and cooling system are at the base of the windshield. Keep these clear of leaves and other debris.

Ventilation

The flow-through ventilation system draws in outside air, circulates it through the interior, then exhausts it through vents near the rear window.

1. Turn the temperature control dial all the way to the left.
Make sure the A/C is off.
2. Select  and Fresh Air mode.
3. Set the fan to the desired speed.

CONTINUED

Heating and Cooling

To Cool with A/C

1. Turn on the A/C by pressing the button. The light above the button should come on when a fan speed is selected.
2. Make sure the temperature control dial is all the way to the left.
3. Select .
4. If the outside air is humid, select Recirculation mode. If the outside air is dry, select Fresh Air mode.
5. Set the fan to the desired speed.

If the interior is very warm from being parked in the sun, you can cool it down more rapidly by setting up the controls this way:

1. Start the engine.
2. Turn on the A/C by pressing the button. Make sure the temperature control dial is all the way counterclockwise.
3. Set the fan to maximum speed.
4. Open the windows partially. Select  and Fresh Air mode.

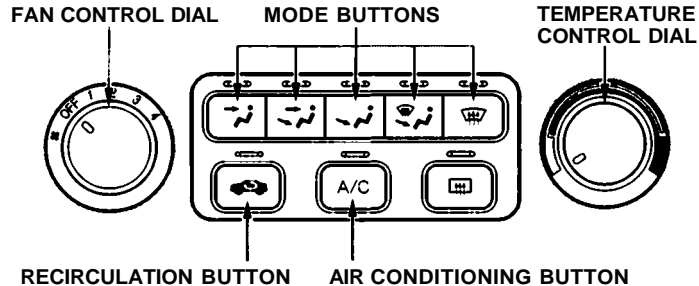

When the interior has cooled down to a more comfortable temperature, close the windows and set the controls as described for normal cooling.

Air conditioning places an extra load on the engine. Watch the engine coolant temperature gauge (see page 55) when driving in stop-and-go traffic or climbing a long, steep hill. If it moves near the red zone, turn off the A/C until the gauge reads normally.

To Heat

To warm the interior:

1. Start the engine.
2. Select  and Fresh Air mode.
3. Set the fan to the desired speed.
4. Adjust the warmth of the air with the temperature control dial.

To Heat and Dehumidify with Air Conditioning



Air conditioning, as it cools, removes moisture from the air. When used in combination with the heater, it makes the interior warm and dry.

1. Switch the fan on.
2. Turn on the air conditioning.
3. Select  and Fresh Air mode.
4. Adjust the temperature control dial so the mixture of heated and cooled air feels comfortable.

This setting is suitable for all driving conditions whenever the outside temperature is above 32°F (0°C).

To Defog and Defrost

To remove fog from the inside of the windows:

1. Switch the fan on.
2. Select  .
When you select  , the system automatically switches to Fresh Air mode and turns on the A/C.
3. Adjust the temperature control dial so the air flow from the defroster vents feels warm.
4. Turn on the rear window defogger to help clear the rear window.
When you switch to another mode from  , the A/C stays on.
Press the A/C button to turn it off.

CONTINUED

To remove exterior frost or ice from the windshield and side windows after the vehicle has been sitting out in cold weather:

1. Start the engine.

2. Select .

When you select , the system automatically switches to Fresh Air mode and turns on the A/C.

3. Switch the fan and temperature controls to maximum.

To rapidly remove exterior frost or ice from the windshield (on very cold days), first select the Recirculation mode. Once the windshield is clear, select the Fresh Air mode to avoid fogging the windows.

These settings direct all the air flow to the defroster vents at the base of the windshield and the side window defroster vents. The air flow will get warmer and clear the windows faster as the engine warms up. You can close the side vents with the dial underneath each vent. This will send more warm air to the windshield defroster vents.

For safety, make sure you have a clear view through all the windows before driving away.

To Turn Everything Off

To shut off the system temporarily, turn the fan speed and temperature control dials all the way to the left.

You should shut the system completely off only for the first few minutes of driving in cold weather, until the engine coolant warms up enough to operate the heater. Keep the fan on at all other times so stale air does not build up in the interior.

On EX-V6 model

The automatic climate control system in your Honda picks the proper combination of air conditioning, heating, and ventilation to maintain the interior temperature you select. The system also adjusts the fan speed and air flow levels.

The direction of air flow from the vents in the center and each side of the dashboard is adjustable.

To adjust the air flow from the center vent, move the tab up-and-down and side-to-side.

On the driver's-side vent, move the vent up-and-down and move the tab side-to-side. On the passenger's-side vent, move the tab up-and-down and move the vent side-to-side.

The side vents can be opened and closed with the dials underneath them.

CENTER VENTS

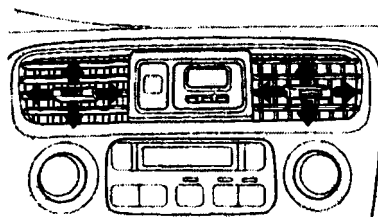

The climate control system draws air through the exterior vents at the bottom of the windshield. Keep these vents clear of leaves and other debris.

DRIVER'S-SIDE VENT

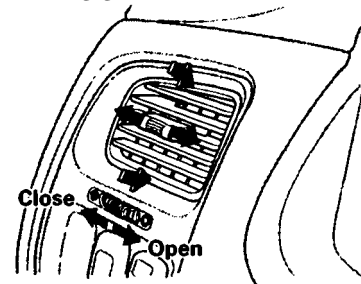

For the climate control system to provide heating and cooling, the engine must be running.

CONTINUED

Climate Control System

PASSENGER'S-SIDE VENT

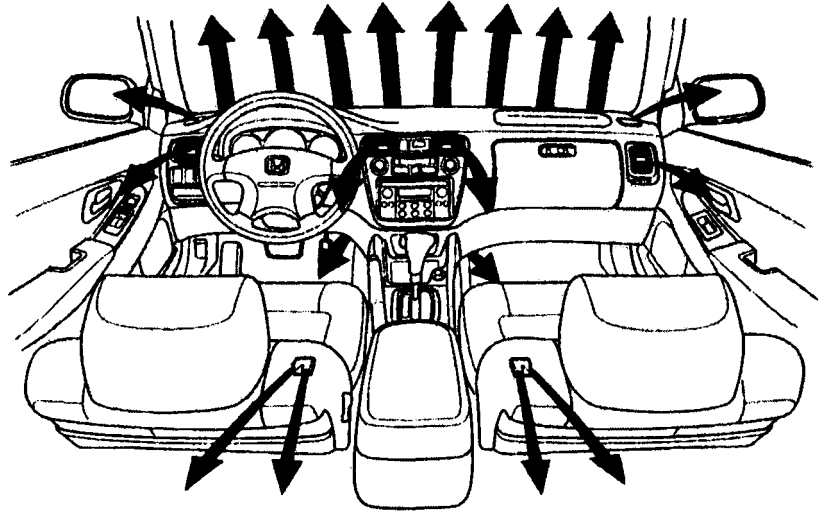
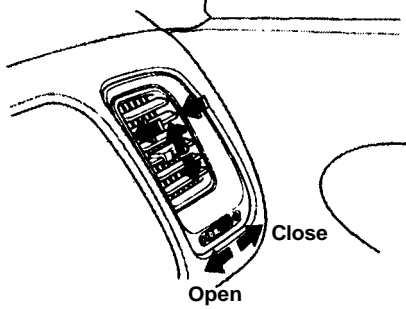

Fully-automatic Operation

To put the Automatic Climate Control in fully-automatic mode, press the AUTO button and set the fan control dial to AUTO, then set the desired temperature by turning the temperature control dial. You will see FULL AUTO in the system's display. The light above the  button also goes on or off to show you which mode, Recirculation or Fresh Air, is selected.

The system automatically selects the proper mix of conditioned and/or heated air that will, as quickly as possible, raise or lower the interior temperature from its current level to the set temperature.

When you set the temperature to its lower limit (60°F/18°C) or its upper limit (90°F/32°C), the system runs at full cooling or heating only. It does not regulate the interior temperature. When the temperature is set

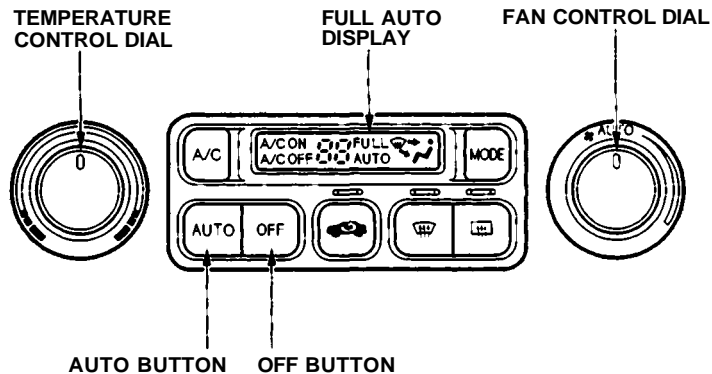

between the lower and upper limits, the system regulates the interior temperature to the set value.

In cold weather, the fan will not come on automatically until the vehicle has been driven for a short time and the heater starts to develop warm air.

Pressing the OFF button shuts the climate control system completely off. Keep the system completely off only for short periods. To keep stale air and mustiness from collecting, you should have the fan running at all times.

Climate Control System

Semi-automatic Operation

You can manually select various functions of the Climate Control system when it is in FULL AUTO. All other features remain automatically controlled. Making any manual selection causes the word FULL to go out.

Air Conditioning (A/C) Button

Press the A/C button to turn the air conditioning on and off. You will see A/C ON or A/C OFF in the display.

When you turn the A/C off, the system cannot regulate the inside temperature if you set the dial below the outside temperature. With the A/C on, use the temperature control dial to adjust the temperature of the air flow to a comfortable setting.

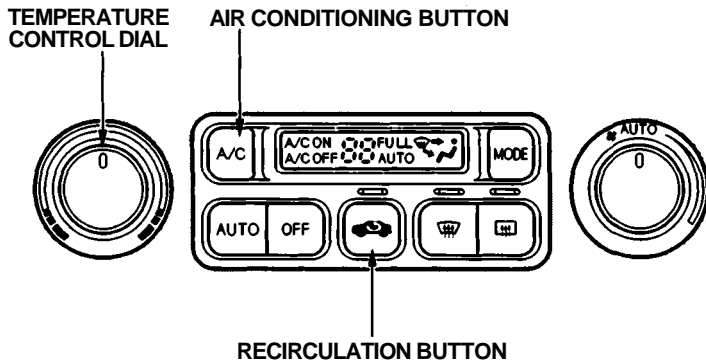

Recirculation Button

This button controls the source of the air going into the system. When the indicator above this button is lit, air from the vehicle's interior is sent through the system again (Recirculation mode). When the indicator is off, air is brought in from outside the vehicle (Fresh Air mode).

You can, for example, manually put the system in recirculation mode when driving through an area of smoke or fumes.

Fan Control Dial

You can manually select the fan speed by turning the fan control dial. When you turn the dial clockwise, the fan is taken out of automatic mode and starts to run at its lowest speed. Turning the dial fully clockwise increases the fan's speed, which increases air flow.

Mode Button

Use the MODE button to select the vents the air flows from. Some air will flow from the dashboard corner vents in all modes. Each time you press the MODE button, the display shows the mode selected. Press the button four times to see all the modes.

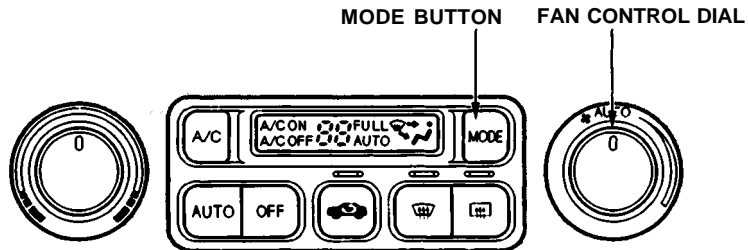



CONTINUED

Climate Control System

 The main air flow is divided between the floor vents and defroster vents at the base of the windshield.

 The main air flow comes from the floor vents.

 The main air flow is divided between the dashboard vents and the floor vents.

 The main air flow comes from the dashboard vents.

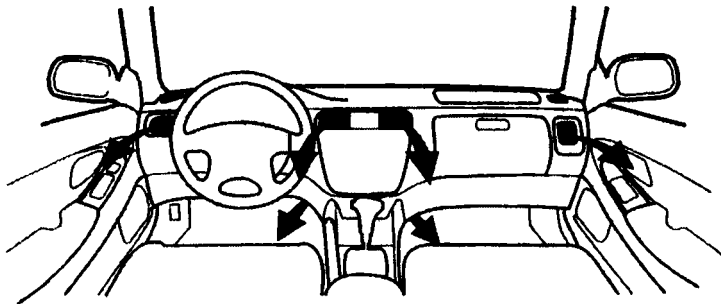
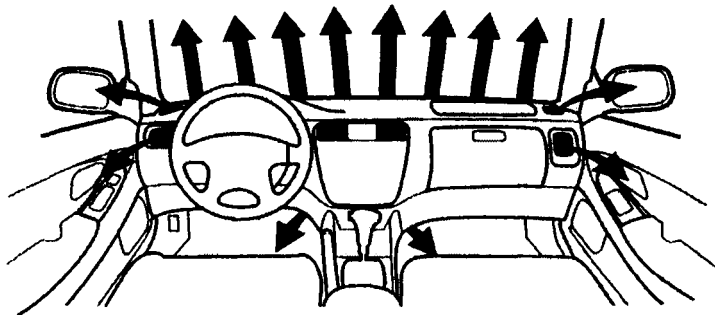

The  button directs the main air flow to the windshield for faster defrosting. It also overrides any MODE selection you may have made.

When you select , the A/C turns on automatically and the system selects Fresh Air mode. For faster defrosting, manually set the fan speed to high. You can also increase air flow to the windshield by closing the side vents in the dashboard.

When you turn off  by pressing the button again, the system returns to its former settings.

Rear Window Defogger Button

This button turns the rear window defogger on and off (see page 63).

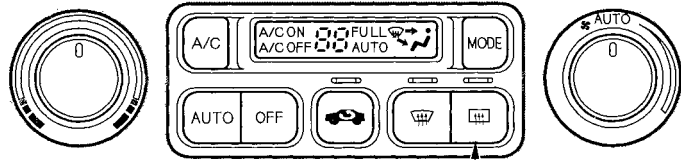
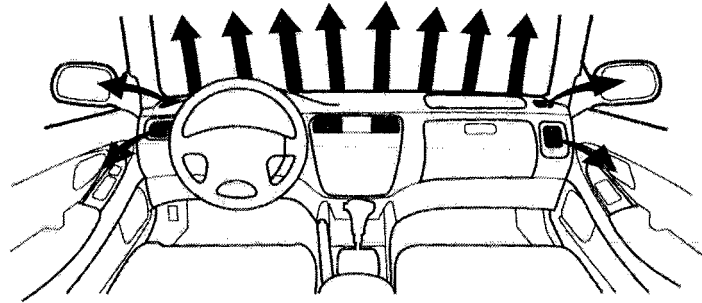

REAR WINDOW DEFOGGER BUTTON

Climate Control System

Sunlight Sensor/Temperature Sensor

SUNLIGHT SENSOR

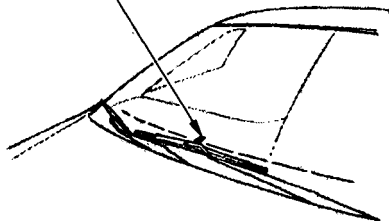

TEMPERATURE SENSOR

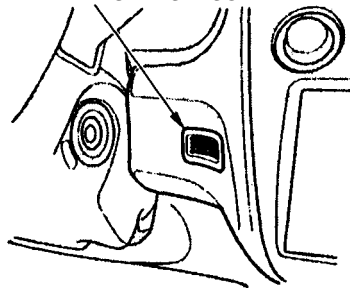

The climate control system has two sensors. A sunlight sensor is located in the top of the dashboard and a temperature sensor is next to the steering column. Do not cover the sensors or spill any liquid on them.

AM/FM/Cassette Stereo Audio System

For LX and LX-V6 models

Your Honda's audio system provides clear reception on both AM and FM bands, while the preset buttons allow you to easily select your favorite stations.

The cassette system features Dolby B* noise reduction, automatic sensing of chromium-dioxide (CrO₂) tape, and autoreverse for continuous play.

*Dolby noise reduction manufactured under license from Dolby Laboratories Licensing Corporation. "DOLBY" and the double-D symbol  are trademarks of Dolby Laboratories Licensing Corporation.

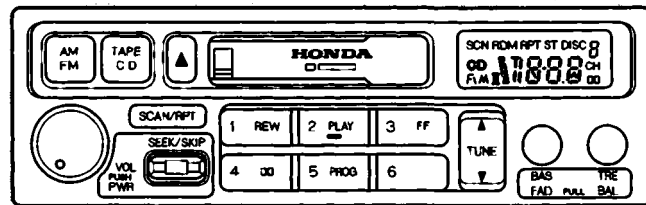

Audio System

Operating the Radio

The ignition switch must be in ACCESSORY (I) or ON (II) to operate the audio system. Turn the system on by pushing the PWR/VOL knob.

Adjust the volume by turning the PWR/VOL knob.

The band and frequency that the radio was last tuned to is displayed. To change bands, press the AM/FM button. On the FM band, ST will be displayed if the station is broadcasting in stereo. Stereo reproduction on AM is not available.

You can use any of four methods to find radio stations on the selected band: TUNE, SEEK, SCAN or the Preset buttons.

TUNE — Use the TUNE bar to tune the radio to a desired frequency. Press the upper part (▲) to tune to a higher frequency, or the lower part (▼) to tune to a lower frequency. The frequency numbers will start to change rapidly. Release the bar when the display reaches the desired frequency. To change the frequency in small increments, press and release the TUNE bar quickly.

SEEK — The SEEK function searches the band for a station with a strong signal. To activate it, push the SEEK switch up or down, then release it. Depending on which way you push the switch, the system scans upward or downward from the current frequency. It stops when it finds a station with a strong signal.

SCAN — The SCAN function samples all the stations with strong signals on the selected band. To activate it, press the SCAN button, then release it. The system will scan up the band for a station with a strong signal. When the system is in the SCAN mode, SCN shows in the display. When it finds one, it will stop and play that station for approximately five seconds. If you do nothing, the system will then scan for the next strong station and play that for five seconds. When it plays a station that you want to continue listening to, press the SCAN button again.

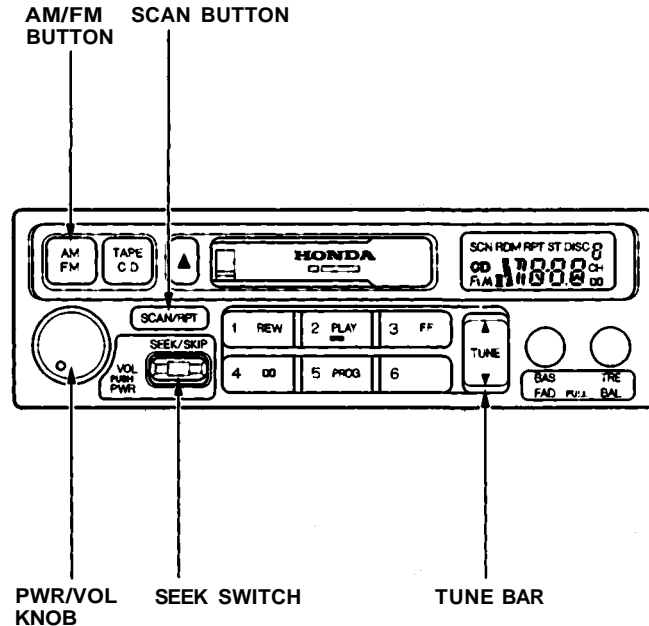

CONTINUED

Audio System

Preset — You can store the frequencies of your favorite radio stations in the six preset buttons. Each button will store one frequency on the AM band, and two on the FM band.

To store a frequency:

1. Select the desired band, AM or FM. FM1 and FM2 let you store two frequencies with each Preset button.
2. Use the TUNE or SEEK function to tune the radio to a desired station.
3. Pick the Preset button you want for that station. Press the button and hold it until you hear a beep.
4. Repeat steps 1 to 3 to store a total of six stations on AM and twelve on FM.

AM/FM BUTTON

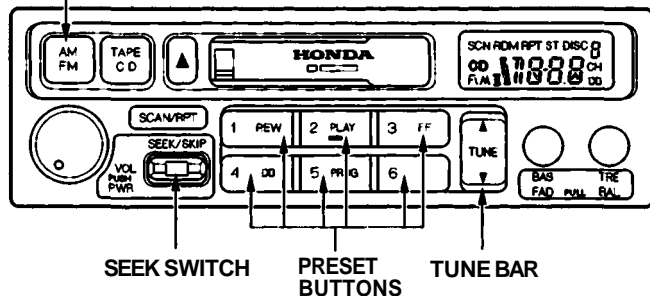

Once a station's frequency is stored, simply press and release the proper preset button to tune to it. The preset frequencies will be lost if your vehicle's battery goes dead, is disconnected, or the radio fuse is removed.

Adjusting the Sound

Balance/Fader — These two controls adjust the strength of the sound coming from each speaker. The Balance control adjusts the side-to-side strength, while the Fader control adjusts the front-to-back strength.

To adjust the fader, push on the BASS/FADER control knob to get it to pop out. Pull it out slightly farther, and adjust the front-to-back sound to your liking. Push the knob back in when you are done so you cannot change the setting by accidentally bumping it.

To adjust the balance, push on the TREBLE/BALANCE control knob to get it to pop out. Pull it out slightly farther, and adjust the side-to-side sound to your liking. Push the knob back in when you are done so you cannot change the setting by accidentally bumping it.

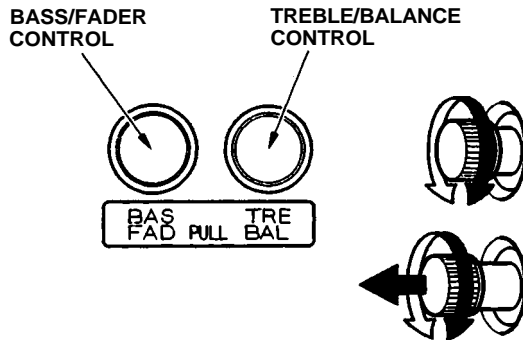

Treble/Bass — Use these controls to adjust the tone to your liking.

To adjust the Treble level, push on the TREBLE/BALANCE control knob to get it to pop out. Without pulling it out farther, turn the knob to adjust the treble level. Push the knob back in when you are done so you cannot change the setting by accidentally bumping it.

To adjust the Bass level, push on the BASS/FADER control knob to get it to pop out. Without pulling it out farther, turn the knob to adjust the bass level. Push the knob back in when you are done so you cannot change the setting by accidentally bumping it.

Radio Frequencies and Reception

For information, See page [137](#).

Audio System

Audio System Lighting

You can use the instrument panel brightness control knob to adjust the illumination of the audio system (see page 60). The audio system illuminates when the parking lights are on, even if the radio is turned off.

Operating the Cassette Player

Turn the audio system ON. Make sure the tape opening on the cassette is facing to the right, then insert the cassette most of the way into the slot. The system will pull it in the rest of the way, and begin to play.

The tape direction indicator will light to show you which side of the cassette is playing. The ▲ indicates the side you inserted facing upward is now playing. If you want to play the other side, press the PROG button.

Dolby B noise reduction turns on when you insert a cassette. If the tape was not recorded with Dolby B noise reduction, turn it off by pressing the  button.

When the system reaches the end of the tape, it will automatically reverse direction and play the other side. If you want to remove the cassette from the drive, press the EJECT button.

Tape Search Functions

With a cassette playing, you can use the FF, REW, SKIP, or REPEAT function to find a desired program.

FF/REW — Fast Forward and Re-wind move the tape rapidly. To re-wind the tape, push the REW button. You will see REW in the display. To fast forward the tape, push the FF button. You will see FF displayed. Press the PLAY button to take the system out of rewind or fast forward.

If the system reaches the end of the tape while in fast forward or rewind, it automatically stops that function, reverses direction, and begins to play.

SKIP — The Skip Function allows you to find the beginning of a song or passage. To find the beginning of the song or passage currently playing, push the SKIP switch down. You will see REW flashing in the display as the tape rewinds. To find the beginning of the next song, push the SKIP switch up. You will see FF flashing in the display as the tape fast forwards. When the system finds the beginning of a song or passage, it goes back to PLAY mode.

REPEAT — The Repeat function continuously replays the current song or passage. Press the RPT button to activate it; you will see RPT displayed as a reminder. When the system reaches the end of the song or passage currently playing, it will automatically go into rewind. When it senses the beginning of the same song or passage, the system returns to PLAY mode. It will continue to repeat this same program until you deactivate REPEAT by pressing the button again.

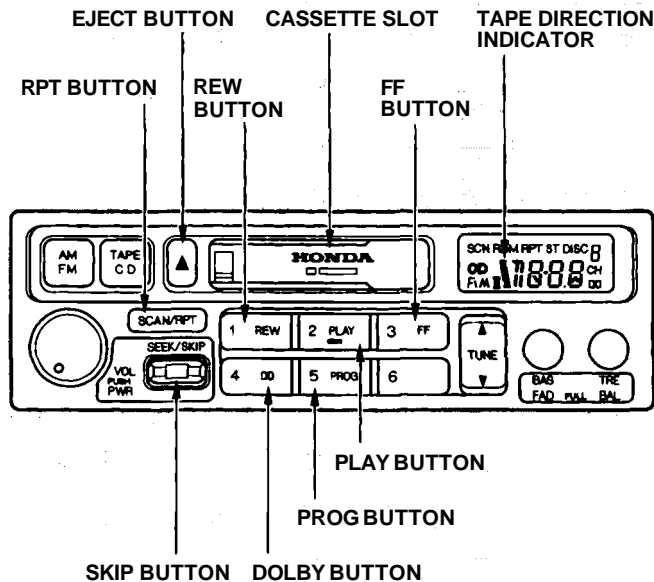

CONTINUED

Audio System

The SKIP and REPEAT functions use silent periods on the tape to find the end of a song or passage. These features may not work to your satisfaction if there is almost no gap between selections, a high noise level between selections, or a silent period in the middle of selection.

Caring for Cassettes

Damaged cassettes can jam inside the drive or cause other problems. See page 148 for information on cassette care and protection.

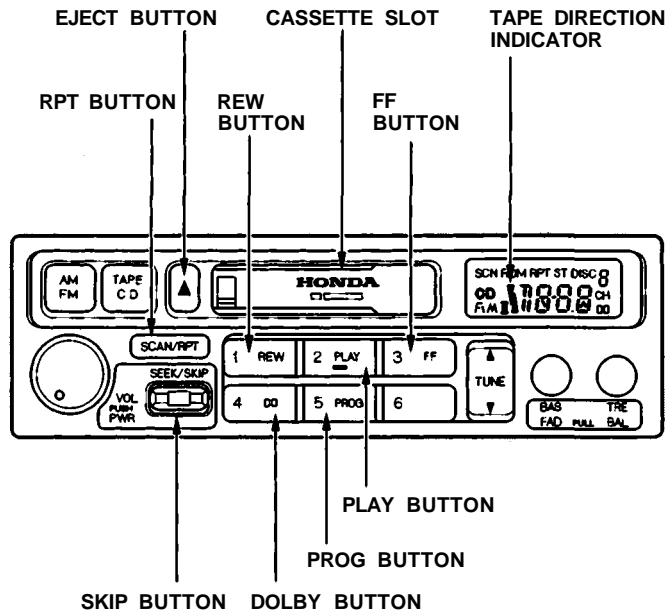

Operating the Optional CD Changer

A Compact Disc changer is available from your dealer. It holds up to six discs, providing several hours of continuous entertainment. You operate the CD changer with the same controls used for the radio and cassette player.

Your dealer also has an accessory in-dash single CD player available that is operated by the radio controls. To operate this unit, use the instructions (except for those relating to multiple discs) in this section.

Using the instructions that came with the changer, load the desired CDs in the magazine, and load the magazine in the changer. Play only standard round discs. Odd-shaped CDs may jam in the drive or cause other problems.

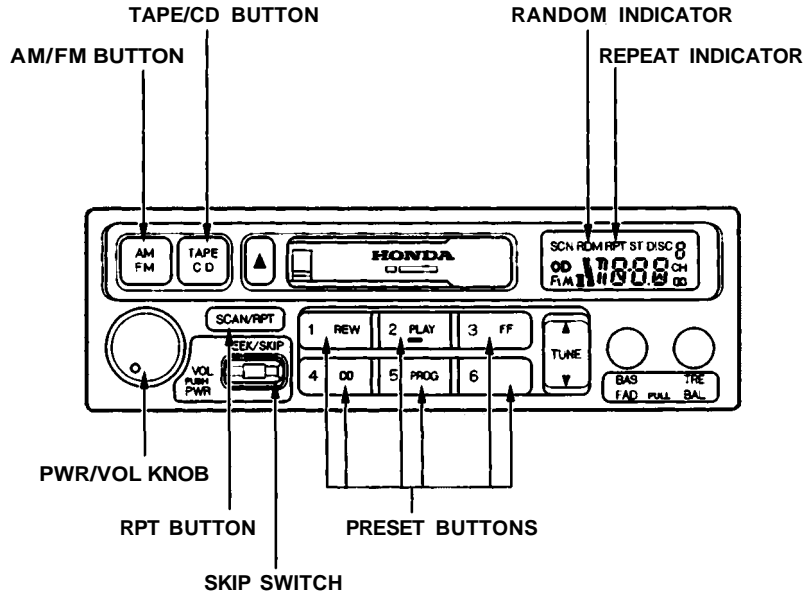

CONTINUED

Audio System

To operate the CD changer or player, the ignition must be in ACCESSORY (I) or ON (II) and the audio system must be on.

Press the CD button until "CD" appears in the display. The system will start to play the first track of the first disc in the magazine.

When that disc ends, the next disc in the magazine is loaded and played. After the last disc finishes, the system returns to disc 1.

To select a different disc, press the appropriate preset button (1 — 6). If you select an empty slot in the magazine, the changer will, after finding that slot empty, try to load the CD in the next slot. This continues until it finds a CD to load and play.

You can use the SKIP switch to select tracks within a disc. If you push and release the SKIP switch, the system will move to the beginning of a track. Push the switch up to move to the beginning of the next track, and push the switch down to move to the beginning of the current track.

If you push and hold the SKIP switch, you will hear a beep and the system will continue to move across tracks. Release the switch when you think it has reached the desired place on the disc.

REPEAT — When you activate the Repeat feature by pressing the RPT button, the system continuously replays the current track. You will see RPT in the display as a reminder. Press the RPT button again to turn it off.

RANDOM PLAY — This feature, when activated, plays the tracks on a CD in random order, rather than in the order they are recorded on the CD. To activate Random Play, press and hold the RPT button until you see RDM in the display. The system will then select and play tracks randomly on the current disc. When all tracks on that disc have been played, the next disc is loaded and played randomly. This continues until you deactivate Random Play by pressing RPT again.

If the system is in Repeat mode, you must turn it off by pressing RPT before you can select Random Play. Then press the button again until you see RDM displayed.

To take the system out of CD mode, press the AM/FM button or insert a cassette in the player. If a tape is already in the cassette player, press the TAPE button. When you return to CD mode, play will continue at the same disc and track.

If you turn the system off while a CD is playing, either with the PWR/VOL knob or the ignition switch, play will continue at the same disc and track when you turn it back on.

Protecting Compact Discs

For information on how to handle and protect Compact discs, see page [142](#).

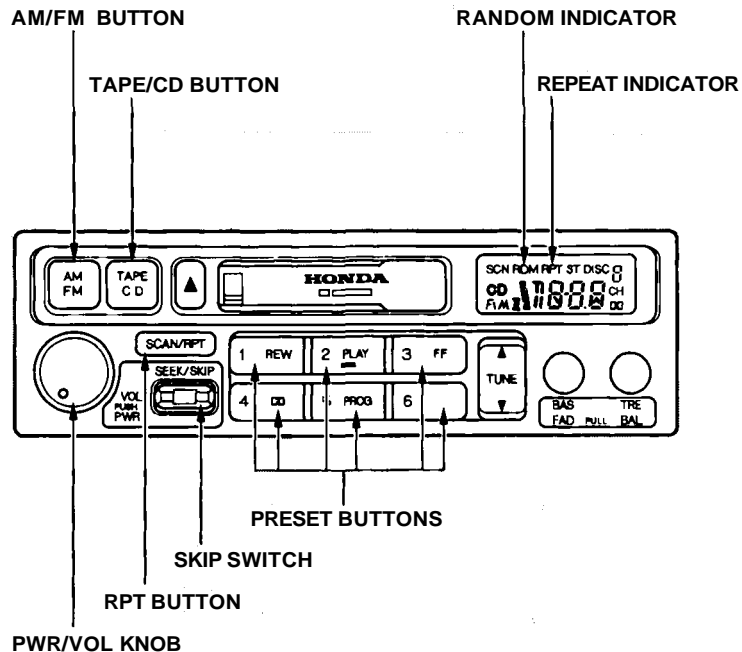

Audio System

CD Changer Error Indications

If you see an error indication in the display while operating the CD changer, find the cause in the chart to the right. If you cannot clear the error indication, take the vehicle to your Honda dealer.

Indication	Cause	Solution
CD E01	Disc-changer malfunction.	If the code disappears within a few seconds, unit is OK. Press the magazine eject button and pull out the magazine, check for error indication. Insert the magazine again. If the code does not disappear or the magazine cannot be pulled out, consult your Honda dealer.
	CD magazine ejection impossible.	Press the magazine eject button. If the magazine does not eject, consult your Honda dealer.
CD E02	Disc is in changer mechanism.	Press the magazine eject button, and insert an empty magazine.
CD --H	High temperature.	Will disappear when the temperature returns to normal.
CD EEE	Misconnection or disconnection of CD changer.	See your Honda dealer.
CD ---	No CD magazine in the CD changer.	Insert CD magazine.
CD 1-00 ^{DISC}	No CD in magazine.	Insert a CD in the magazine.

AM/FM/CD Audio System

For EX and EX- V6 models

Your Honda's audio system provides clear reception on both AM and FM bands, while the preset buttons allow you to easily select your favorite stations.

The Anti-theft feature will disable the system if it is disconnected from the vehicle's battery. To get the system working again, you must enter a code number (see page 150).

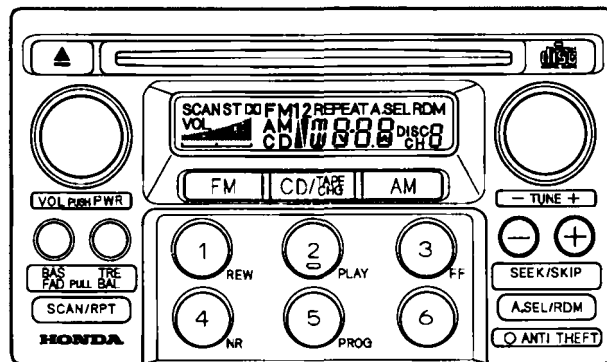

Audio System

Operating the Radio

The ignition switch must be in ACCESSORY CD or ON (II) to operate the audio system. Turn the system on by pushing the PWR/VOL knob. Adjust the volume by turning the same knob.

The band and frequency that the radio was last tuned to is displayed. To change bands, press the AM or FM button. On the FM band, ST will be displayed if the station is broadcasting in stereo. Stereo reproduction on AM is not available.

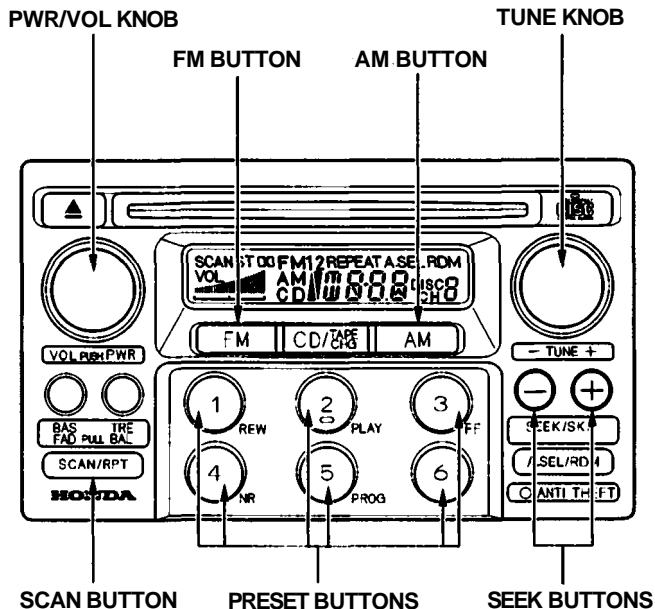

You can use any of four methods to find radio stations on the selected band: TUNE, SEEK, SCAN or the Preset buttons.

TUNE — Use the TUNE knob to tune the radio to a desired frequency. Turn the TUNE knob to the right to tune to a higher frequency, or to the left to tune to a lower frequency. Turn the knob right or left until the display reaches the desired frequency.

SEEK — The SEEK function searches the band for a station with a strong signal. To activate it, press either SEEK button (⊖ or ⊕), then release it. Depending on which SEEK button you press, the system scans upward or downward from the current frequency. It stops when it finds a station with a strong signal.

SCAN — The SCAN function samples all the stations with strong signals on the selected band. To activate it, press the SCAN button, then release it. The system will scan up the band for a station with a strong signal. When it finds one, it will stop and play that station for approximately five seconds. If you do nothing, the system will then scan for the next strong station and play that for five seconds. When it plays a station that you want to continue listening to, press the SCAN button again.

Preset — You can store the frequencies of your favorite radio stations in the six preset buttons. Each button will store one frequency on the AM band, and two on the FM band.

To store a frequency:

1. Select the desired band, AM or FM. FM1 and FM2 let you store two frequencies with each Preset button.
2. Use the TUNE or SEEK function to tune the radio to a desired station.
3. Pick the Preset button you want for that station. Press the button and hold it until you hear a beep.
4. Repeat steps 1 to 3 to store a total of six stations on AM and twelve on FM.

Once a station's frequency is stored, simply press and release the proper preset button to tune to it. The preset frequencies will be lost if your vehicle's battery goes dead, is disconnected, or the radio fuse is removed.

CONTINUED

Audio System

AUTO SELECT — If you are traveling far from home and can no longer receive the stations you preset, you can use the Auto Select feature to find stations in the local area.

To activate Auto Select, press the A. SEL button. A. SEL will flash in the display, and the system will go into scan mode for several seconds. It automatically scans both bands, looking for stations with strong signals; It stores the frequencies of six AM stations and twelve FM stations in the preset buttons. You can then use the preset buttons to select those stations.

If you are in a remote area, Auto Select may not find six strong AM stations or twelve strong FM stations. If this happens, you will see a "0" displayed when you press any preset button that does not have a station stored.

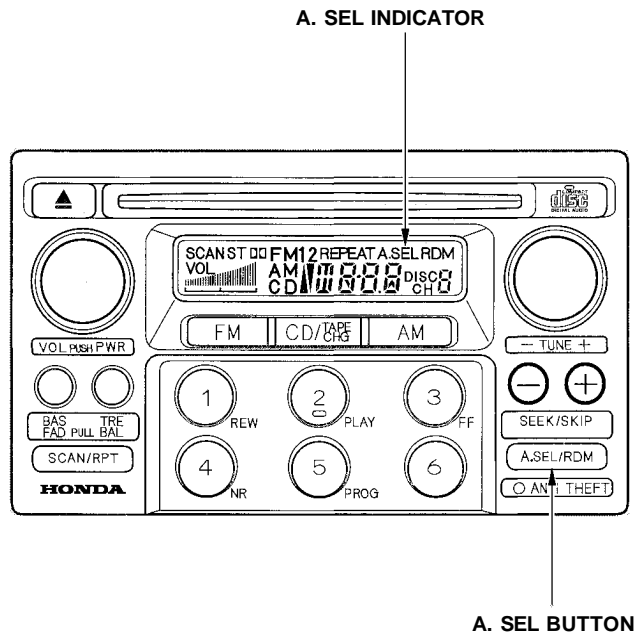

If you do not like the stations Auto Select has stored, you can store other frequencies in the preset buttons. Use the TUNE, SEEK, or SCAN function to find the desired frequencies, then store them in the selected preset buttons as described previously.

Auto Select does not erase the frequencies that you preset previously. When you return home, turn off Auto Select by pressing the A. SEL button. The preset buttons will then select the frequencies you originally set.

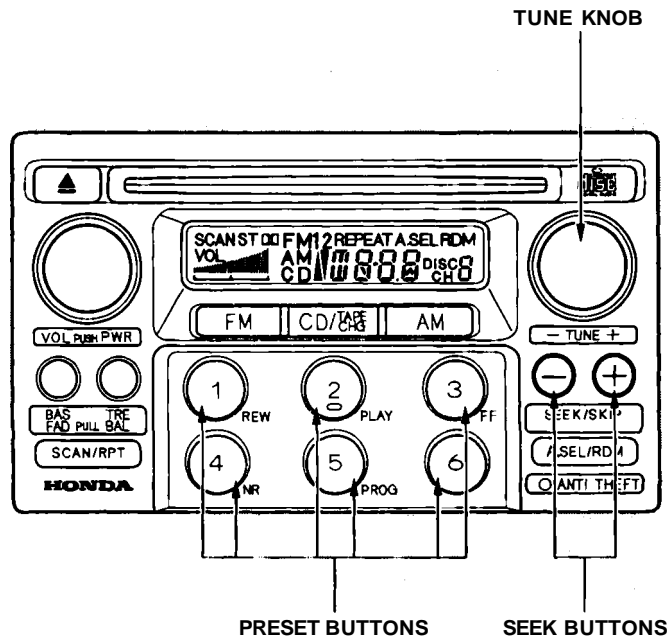

Audio System

Adjusting the Sound

Balance/Fader — These two controls adjust the strength of the sound coming from each speaker. The Balance control adjusts the side-to-side strength, while the Fader control adjusts the front-to-back strength.

To adjust the fader, push on the BASS/FADER control knob to get it to pop out. Pull it out slightly farther, and adjust the front-to-back sound to your liking. Push the knob back in when you are done so you cannot change the setting by accidentally bumping it.

To adjust the balance, push on the TREBLE/BALANCE control knob to get it to pop out. Pull it out slightly farther, and adjust the side-to-side sound to your liking. Push the knob back in when you are done so you cannot change the setting by accidentally bumping it.

BASS/FADER
CONTROL



TREBLE/BALANCE
CONTROL

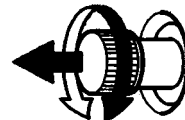

Treble/Bass — Use these controls to adjust the tone to your liking.

To adjust the Treble level, push on the TREBLE/BALANCE control knob to get it to pop out. Without pulling it out farther, turn the knob to adjust the treble level. Push the knob back in when you are done so you cannot change the setting by accidentally bumping it.

To adjust the Bass level, push on the BASS/FADER control knob to get it to pop out. Without pulling it out farther, turn the knob to adjust the bass level. Push the knob back in when you are done so you cannot change the setting by accidentally bumping it.

Audio System Lighting

You can use the instrument panel brightness control knob to adjust the illumination of the audio system (see page 60). The audio system illuminates when the parking lights are on, even if the radio is turned off.

Radio Frequencies

Your Honda's radio can receive the complete AM and FM bands. Those bands cover these frequencies:

AM band:
530 to 1,710 kilohertz
FM band:
87.7 to 107.9 megahertz

Radio stations on the AM band are assigned frequencies at least ten kilohertz apart (530, 540, 550). Stations on the FM band are assigned frequencies at least 0.2 megahertz apart (87.9, 88.1, 88.3).

Stations must use these exact frequencies. It is fairly common for stations to round-off the frequency in their advertising, so your radio could display a frequency of 100.9 even though the announcer may identify the station as "FM101."

Radio Reception

How well your Honda's radio receives stations is dependent on many factors, such as the distance from the station's transmitter, nearby large objects, and atmospheric conditions.

A radio station's signal gets weaker as you get farther away from its transmitter. If you are listening to an AM station, you will notice the sound volume becoming weaker, and the station drifting in and out. If you are listening to an FM station, you will see the stereo indicator flickering off and on as the signal weakens. Eventually, the stereo indicator will go off and the sound will fade completely as you get out of range of the station's signal.

CONTINUED

Audio System

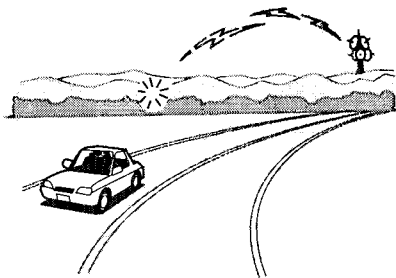

Driving very near the transmitter of a station that is broadcasting on a frequency close to the frequency of the station you are listening to can also affect your radio's reception. You may temporarily hear both stations, or hear only the station you are close to.

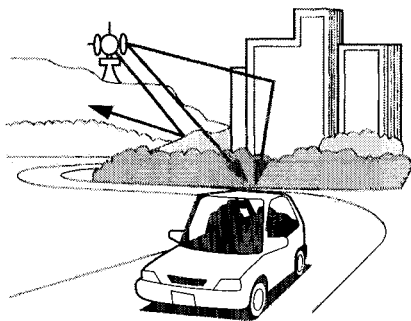

Radio signals, especially on the FM band, are deflected by large objects such as buildings and hills. Your radio then receives both the direct signal from the station's transmitter, and the deflected signal. This causes the sound to distort or flutter. This is a main cause of poor radio reception in city driving.



Radio reception can be affected by atmospheric conditions such as thunderstorms, high humidity, and even sunspots. You may be able to receive a distant radio station one day and not receive it the next day because of a change in conditions.

Electrical interference from passing vehicles and stationary sources can cause temporary reception problems.

Operating the CD Player

You operate the CD player with the same controls used for the radio.

With the system on, insert the disc into the CD slot. Push the disc in halfway, the drive will pull it in the rest of the way and begin to play. The number of the track that is playing is shown in the display.

Do not play 3-inch (8-cm) discs in this system. Play only standard round discs. Odd-shaped CDs may jam in the drive or cause other problems.

When the system reaches the end of the disc, it will return to the beginning and play that disc again.

You can switch to the radio while a CD is playing by pressing the AM or FM button. Press the CD button to return to playing the CD. The CD will begin playing where it left off.

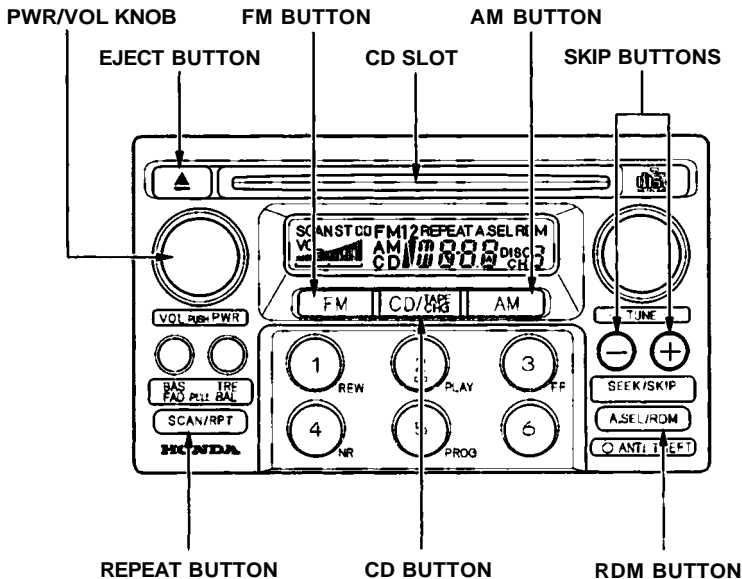

CONTINUED

Audio System

If you turn the system off while a CD is playing, either with the PWR/VOL knob or by turning off the ignition, the disc will stay in the drive. When you turn the system back on, the CD will begin playing where it left off.

Press the eject button to remove the disc from the drive.

If you eject the disc, but do not remove it from the slot, the system will automatically reload the disc after 15 seconds and put the CD player in pause mode. To begin playing the disc, press the CD button.

You can use the SKIP buttons while a disc is playing to select passages and change tracks.

To move rapidly within a track, press and hold an appropriate SKIP button. Press the \oplus button to move forward, or the \ominus button to move backward. Release the button when the system reaches the point you want. Each time you press the \oplus button and release it, the system skips forward to the beginning of the next track. Press and release the \ominus button to skip backward to the beginning of the current track. Press and release it again to skip to the beginning of the previous track.

REPEAT — To activate the Repeat feature, press and release the Repeat button. You will see REPEAT in the display. The system continuously replays the current track. Press the Repeat button again to turn it off.

RANDOM PLAY — This feature, when activated, plays the tracks on the CD in random order, rather than in the order they are recorded on the CD. To activate Random Play, press the RDM button. You will see RDM in the display. The system will then select and play tracks randomly. This continues until you deactivate Random Play by pressing the RDM button again.

Operating the CD Changer (Optional)

A Compact Disc changer is available for your vehicle. It holds up to six discs, providing several hours of continuous entertainment. You operate this CD changer with the same controls used for the in-dash CD player.

Load the desired CD's in the magazine and load the magazine in the changer according to the instructions that came with the unit. Play only standard round discs. Odd-shaped CDs may jam in the drive or cause other problems.

To select the CD changer, press the CD button. The disc and track numbers will be displayed.

To select a different disc, press the appropriate preset button (1—6). If you select an empty slot in the magazine, the changer will, after finding that slot empty, try to load the CD in the next slot. This continues until it finds a CD to load and play.

If you load a CD in the in-dash player while the changer is playing a CD, the system will stop the changer and begin playing the in-dash CD. To select the changer again, press the CD button. Play will begin where it left off. Use the CD button to switch between the player and the changer.

If you eject the in-dash CD while it is playing, the system will automatically switch to the CD changer and begin play where it left off. If there are no CDs in the changer, the display will flash. You will have to select another mode (AM or FM) with the FM or AM button.

When you switch back to CD mode, the system selects the same unit (in-dash or changer) that was playing when you switched out of CD mode.

To use the SKIP, REPEAT, and RANDOM functions, refer to the in-dash player operating instructions.

Audio System

Protecting Compact Discs

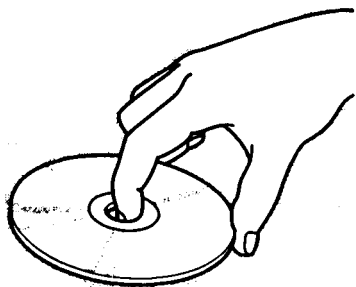

Handle a CD by its edges; never touch either surface. Contamination from fingerprints, liquids, felt-tip pens, and labels can cause the CD to not play properly, or possibly jam in the drive.

When a CD is not being played, store it in its case to protect it from dust and other contamination. To prevent warpage, keep CDs out of direct sunlight and extreme heat.

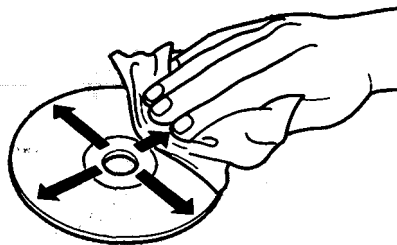

To clean a disc, use a clean soft cloth. Wipe across the disc from the center to the outside edge.

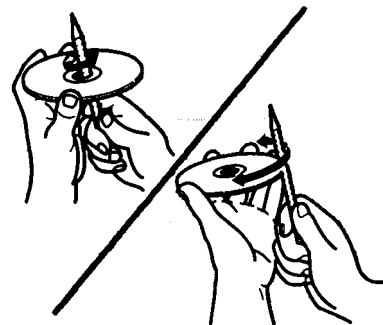

A new CD may be rough on the inner and outer edges. The small plastic pieces causing this roughness can flake off and fall on the recording surface of the disc, causing skipping or other problems. Remove these pieces by rubbing the inner and outer edges with the side of a pencil or pen.

Never try to insert foreign objects in the CD player or the magazine.

CD Player Error Indications

If you see an error indication in the display while operating the CD player, find the cause in the chart to the right. If you cannot clear the error indication, take the vehicle to your Honda dealer.

Indication	Cause	Solution
CD Err	Mechanical Error	Press the EJECT button and pull out the disc. Check the disc for damage or deformation. If the CD cannot be pulled out or the error indication does not disappear after the disc is ejected, see your Honda dealer. Do not try to force the disc out of the player.
CD --H	High temperature	Will disappear when the temperature returns to normal.

CD Changer Error Indications

If you see an error indication in the display while operating the CD changer, find the cause in the chart to the right. If you cannot clear the error indication, take the vehicle to your Honda dealer.

Indication	Cause	Solution
CD E01	Disc-changer malfunction.	Consult your Honda dealer.
CD E02	Disc is in changer mechanism.	Press the magazine eject button, and insert an empty magazine.
CD E03 CD E04 CD E05	Disc-changer malfunction.	If the code disappears within a few seconds, unit is OK. If it does not, consult your Honda dealer.
CD E06	Disc-changer malfunction.	Press the magazine eject button and pull out the magazine, check for error indication. Insert the magazine again. If the magazine cannot be pulled out, consult your Honda dealer.
CD E07	CD magazine ejection impossible.	Press the magazine eject button. If the magazine does not eject, consult your Honda dealer.
CD --H	High temperature.	Will disappear when the temperature returns to normal.
CD EEE	Misconnection or disconnection of CD changer.	See your Honda dealer.
CD ---	No CD magazine in the CD changer.	Insert CD magazine.
CD 7-00 ^{DISC}	No CD in magazine.	Insert a CD in the magazine.

Operating the Cassette Player (Optional)

The cassette system features Dolby B* noise reduction, automatic sensing of chromium-dioxide (CrO₂) tape, and autoreverse for continuous play.

Make sure the tape opening on the cassette is facing to the right, then insert the cassette most of the way into the slot. The system will pull it in the rest of the way, and begin to play.

* Dolby noise reduction manufactured under license from Dolby Laboratories Licensing Corporation. "DOLBY" and the double-D symbol  are trademarks of Dolby Laboratories Licensing Corporation.

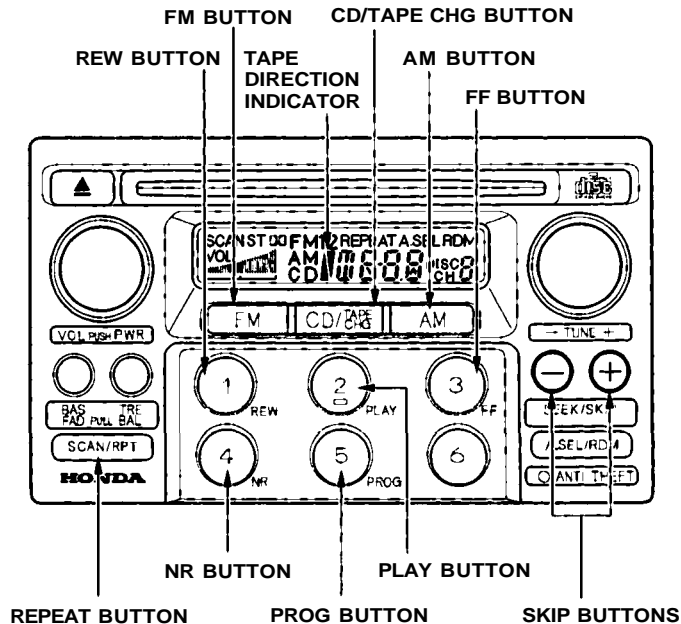

CONTINUED

Audio System

The tape direction indicator will light to show you which side of the cassette is playing. The ▲ indicates the side you inserted facing upward is now playing. If you want to play the other side, press the PROG button.

Dolby B noise reduction turns on when you insert a cassette. If the tape was not recorded with Dolby B noise reduction, turn it off by pressing the NR button.

When the system reaches the end of the tape, it will automatically reverse direction and play the other side. If you want to remove the cassette from the drive, press the EJECT button on the cassette player.

If you turn the system off while a tape is playing, either with the PWR/VOL knob or by turning off the ignition, the cassette will remain in the drive. When you turn the system back on, the tape will begin playing where it left off.

To switch to the radio or CD player while a tape is playing, press the AM, FM, or CD/TAPE CHG button. To change back to the cassette player, push the CD/TAPE CHG button.

Tape Search Functions

With a cassette playing, you can use the FF, REW, SKIP, or REPEAT function to find a desired program.

FF/REW — Fast Forward and Rewind move the tape rapidly. To rewind the tape, push the REW button. You will see REW in the display. To fast forward the tape, push the FF button. You will see FF displayed. Press the PLAY button to take the system out of rewind or fast forward. If the system reaches the end of the tape while in fast forward or rewind, it automatically stops that function, reverses direction, and begins to play.

SKIP — The skip function allows you to find the beginning of a song or passage. To skip to the beginning of a song or passage currently playing, push the \ominus button. You will see REW flashing in the display as the tape rewinds. To skip to the beginning of the next song, push the \oplus button. You will see FF flashing in the display as the tape fast forwards. When the system finds the beginning of a song or passage, it goes back to PLAY.

REPEAT — The Repeat function continuously replays the current song or passage. Press the REPEAT button to activate it; you will see REPEAT displayed as a reminder. When the system reaches the end of the song or passage currently playing, it will automatically go into rewind. When it senses the beginning of the same song or passage, the system returns to PLAY mode. It will continue to repeat this same program until you deactivate REPEAT by pressing the button again.

The SKIP and REPEAT functions use silent periods on the tape to find the end of a song or passage. These features may not work to your satisfaction if there is almost no gap between selections, a high noise level between selections, or a silent period in the middle of selection.

Caring for the Cassette Player

The cassette player picks up dirt and oxides from the tape. This contamination builds up over time and causes the sound quality to degrade. To prevent this, you should clean the player after every 30 hours of use. Your dealer has a cleaning kit available.

If you do not clean the cassette player regularly, it may eventually become impossible to remove the contamination with a normal cleaning kit.

Use 100-minute or shorter cassettes. Cassettes longer than that use thinner tape that may break or jam the drive.

Look at the cassette before you insert it. If the tape is loose, tighten it by turning a hub with a pencil or your finger.

If the label is peeling off, remove it from the cassette or it could cause the cassette to jam in the player. Never try to insert a warped or damaged cassette in the player.

When they are not in use, store cassettes in their cases to protect them from dust and moisture. Never place cassettes where they will be exposed to direct sunlight, high heat, or high humidity. If a cassette is exposed to extreme heat or cold, let it reach a moderate temperature before inserting it in the player.

Never try to insert foreign objects into the cassette player.

If you see the error indication "TAPER" on the display, press the EJECT button and remove the cassette from the unit. Make sure the tape is not damaged. If the cassette will not eject or the error indication stays on after the cassette ejects, take the vehicle to your Honda dealer.

If a problem develops in the connection between the cassette player and the radio, you will see "TEEE" in the display. Take the vehicle to your Honda dealer.

Remote Audio Controls

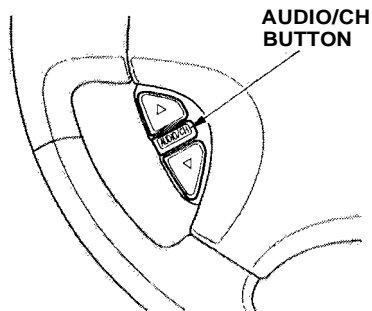

On EX-V6 model
Two controls for the audio system are mounted in the steering wheel hub. These let you control basic functions without removing your hand from the wheel.

The top and bottom buttons adjust the volume up (▲) or down (▼). Press the proper button and hold it until the desired volume is reached, then release it.

The AUDIO/CH button has three functions, depending on whether you are listening to the radio, or playing a cassette or CD.

If you are listening to the radio, use the AUDIO/CH button to change stations. Each time you press this button, the system advances to the next preset station on the band you are listening to. You will see the number of the selected Preset button in the display. To change bands, press the AM or FM button on the audio system's front panel.

If you are playing a cassette, use the AUDIO/CH button to advance to the next selection. You will see "FF" blinking in the display when you press the AUDIO/CH button. The system fast forwards until it senses a silent period, then goes back to PLAY.

If you are playing a CD, the system skips to the beginning of the next track each time you push the AUDIO/CH button. You will see the disc and track number in the display.

Audio System

Theft Protection

On EX and EX-V6 models

Your vehicle's audio system will disable itself if it is disconnected from electrical power for any reason. To make it work again, the user must enter a specific five-digit code in the Preset buttons. Because there are hundreds of number combinations possible from five digits, making the system work without knowing the exact code is nearly impossible.

You should have received a card that lists your audio system's code number and serial number. It is best to store this card in a safe place at home. In addition, you should write the audio system's serial number in this Owner's Manual. If you should happen to lose the card, you must obtain the code number from your Honda dealer. To do this, you will need the system's serial number.

If your vehicle's battery is disconnected or goes dead, the audio system will disable itself. If this happens, you will see "Code" in the frequency display the next time you turn on the system. Use the Preset buttons to enter the five-digit code. If it is entered correctly, the radio will start playing.

If you make a mistake entering the code, do not start over or try to correct your mistake. Complete the five-digit sequence, then enter the correct code. You have ten tries to enter the correct code. If you are unsuccessful in ten attempts, you must then leave the system on for one hour before trying again.

You will have to store your favorite stations in the Preset buttons after the system begins working. Your original settings were lost when power was disconnected.

*Standard on EX and EX-V6 models
Optional on LX and LX-V6 models*

The security system helps to protect your vehicle and valuables from theft. The horn sounds and a combination of headlights, parking lights, side marker lights and taillights flashes if someone attempts to break into your vehicle or remove the radio. This alarm continues for two minutes, then the system resets. To reset an alarming system before the two minutes have elapsed, unlock either door with the key or the remote transmitter.

The security system sets automatically fifteen seconds after you lock the doors, hood, and trunk. For the system to activate, you must lock the doors from the outside with the key, lock tab, door lock switch, or remote transmitter. The security system light next to the driver's door lock starts blinking immediately to show you the system is setting itself.

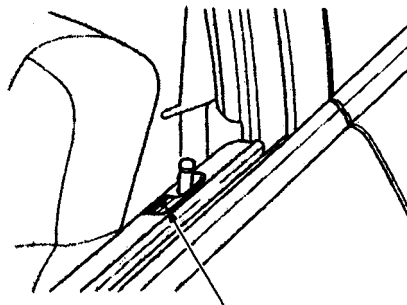

SECURITY SYSTEM LIGHT

Once the security system is set, opening either door (without using the key or the remote transmitter), or the hood, will cause it to alarm. It also alarms if the radio is removed from the dashboard or the wiring is cut.

With the system set, you can still open the trunk with the master key or the remote transmitter without triggering the alarm. The alarm will sound if the trunk lock is forced, or the trunk is opened with the trunk release handle.

The security system will not set if the hood, trunk, or either door is not fully closed. If the system will not set, check the Door and Brake Lamp Monitor on the instrument panel (see page 52), to see if the doors and trunk are fully closed. Since it is not part of the monitor display, manually check the hood.

Before you begin driving your Honda, you should know what gasoline to use, and how to check the levels of important fluids. You also need to know how to properly store luggage or packages. The information in this section will help you. If you plan to add any accessories to your vehicle, please read the information in this section first.

Break-in Period.....	154
Gasoline.....	154
Service Station Procedures	155
Filling the Fuel Tank.....	155
Opening the Hood.....	156
Oil Check.....	158
Engine Coolant Check.....	160
Fuel Economy.....	161
Vehicle Condition.....	161
Driving Habits.....	161
Accessories and Modifications....	162
Carrying Cargo.....	164

Break-in Period, Gasoline

Break-in Period

Help assure your vehicle's future reliability and performance by paying extra attention to how you drive during the first 600 miles (1,000 km). During this period:

- Avoid full-throttle starts and rapid acceleration.
- Avoid hard braking. New brakes need to be broken-in by moderate use for the first 200 miles (300 km).

You should follow these same recommendations with an overhauled or exchanged engine, or when the brakes are relined.

Gasoline

Your Honda is designed to operate on unleaded gasoline with a pump octane number of 86 or higher. Use of a lower octane gasoline can cause a persistent, heavy metallic rapping noise in the engine that can lead to mechanical damage.

We recommend gasolines containing detergent additives that help prevent fuel system and engine deposits.

Using gasoline containing lead will damage your vehicle's emissions controls. This contributes to air pollution.

In Canada, some gasolines contain an octane-enhancing additive called MMT. If you use such gasolines, your emission control system performance may deteriorate and the Malfunction Indicator Lamp on your instrument panel may turn on. If this happens, contact your authorized Honda dealer for service.

Filling the Fuel Tank

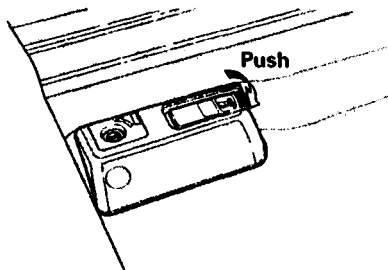

1. Because the fuel fill cap is on the driver's side of the vehicle, park with that side closest to the service station pumps.
2. Open the fuel fill door by pushing on the handle to the left of the driver's seat.

Gasoline is highly flammable and explosive. You can be burned or seriously injured when handling fuel.

- Stop the engine and keep heat, sparks, and flame away.
- Handle fuel only outdoors.
- Wipe up spills immediately.

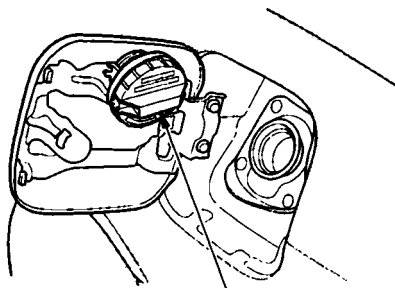

FUEL FILL CAP

3. Remove the fuel fill cap slowly. You may hear a hissing sound as pressure inside the tank escapes. Place the cap in the holder on the fuel fill door.
4. Stop filling the tank after the fuel pump automatically clicks off. Do not try to "top off" the tank, leave some room for the fuel to expand with temperature changes.

Your vehicle has an on-board refueling vapor recovery system to help keep fuel vapors from going into the atmosphere. If the fuel pump keeps clicking off even though the tank is not full, there may be a problem with this system. Consult your dealer.

CONTINUED

5. Screw the fuel fill cap back on, tighten it until it clicks. If you do not properly tighten the cap, the Malfunction Indicator Lamp may come on (see page 283).
6. Push the fuel fill door closed until it latches.

Opening the Hood

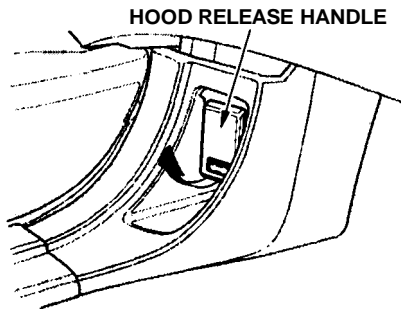

1. Shift to Park or Neutral and set the parking brake. Pull the hood release handle located under the lower left corner of the dashboard. The hood will pop up slightly.

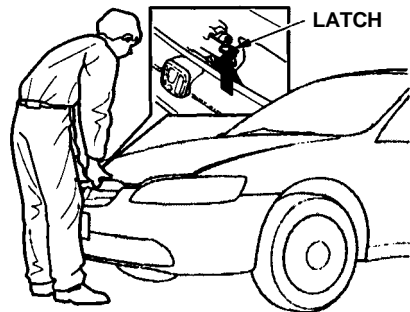

2. Standing in front of the vehicle, put your fingers under the front edge of the hood to the right of center. Slide your hand to the left until you feel the hood latch handle. Push this handle up until it releases the hood. Lift the hood.

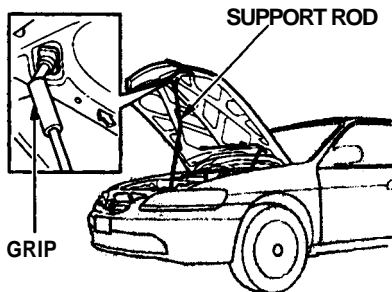

4-cylinder models

3. 4-cylinder models

Pull the support rod out of its clip by holding the grip and insert the end into the hole on the front of the hood around the center.

To close the hood, lift it up slightly to remove the support rod from the hole. Put the support rod back into its holding clip. Lower the hood to about a foot (30 cm) above the fender, then let it drop. After closing the hood, make sure it is securely latched.

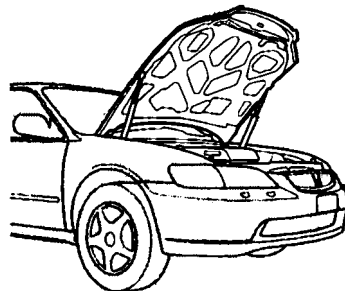

6-cylinder models

6-cylinder models

Lift the hood up most of the way. The hydraulic supports will lift it up the rest of the way and hold it up.

To close the hood, lower it to about a foot (30 cm) above the fender, then press down firmly with your hands. After closing the hood, make sure it is securely latched.

CONTINUED

Oil Check

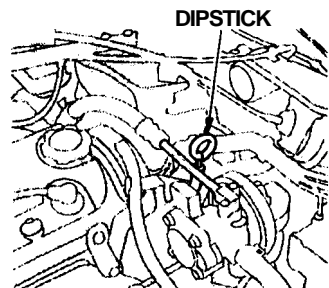

4-cylinder models

Check the engine oil level every time you fill the vehicle with fuel. Wait a few minutes after turning the engine off before you check the oil.

1. Remove the dipstick (orange handle).

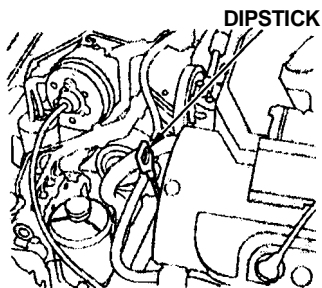

6-cylinder models

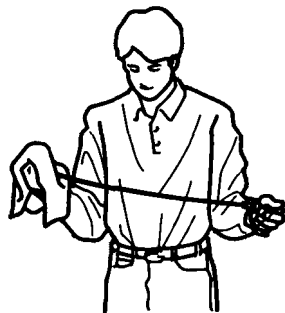

2. Wipe the dipstick with a clean cloth or paper towel.

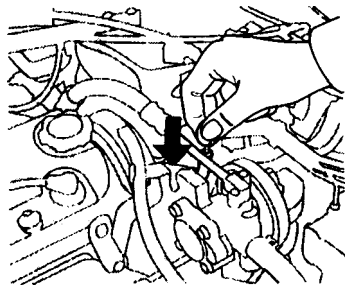

4-cylinder models

3. Insert it all the way back in its tube.

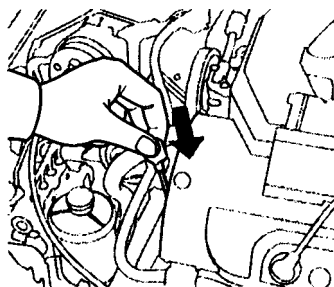

6-cylinder models

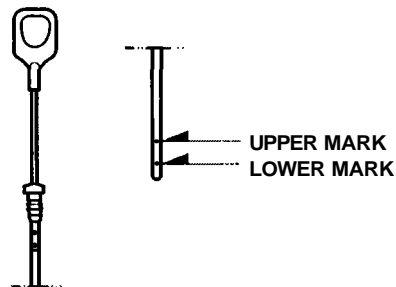

4. Remove the dipstick again and check the level. It should be between the upper and lower marks.

If it is near or below the lower mark, see **Adding Oil** on page [206](#) .

CONTINUED

Service Station Procedures

Engine Coolant Check

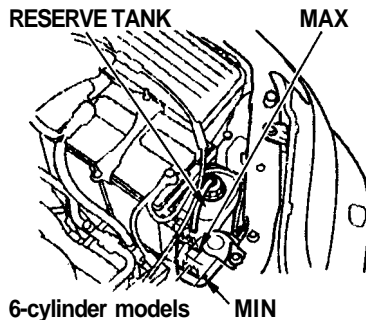
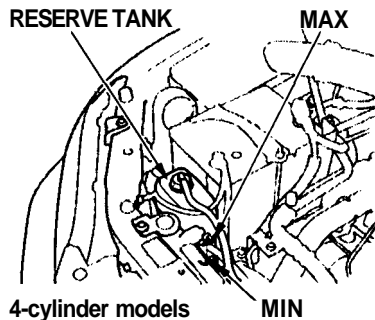

Look at the coolant level in the radiator reserve tank. Make sure it is between the MAX and MIN lines. If it is below the MIN line, see **Adding Engine Coolant** on page 211 for information on adding the proper coolant.

Refer to **Owner Maintenance Checks** on page 203 for information on checking other items in your Honda.

The condition of your vehicle and your driving habits are the two most important things that affect the fuel mileage you get.

Vehicle Condition

Always maintain your vehicle according to the maintenance schedule. This will keep it in top operating condition.

An important part of that maintenance is the **Owner Maintenance Checks** (see page 203). For example, an underinflated tire causes more "rolling resistance," which uses fuel. It also wears out faster, so check the tire pressure at least monthly.

In winter, the build-up of snow on your vehicle's underside adds weight and rolling resistance. Frequent cleaning helps your fuel mileage and reduces the chance of corrosion.

Driving Habits

You can improve fuel economy by driving moderately. Rapid acceleration, abrupt cornering, and hard braking use more fuel.

Always drive in the highest gear that allows the engine to run and accelerate smoothly.

Depending on traffic conditions, try to maintain a constant speed. Every time you slow down and speed up, your vehicle uses extra fuel. Use the cruise control, when appropriate, to increase fuel economy.

A cold engine uses more fuel than a warm engine. It is not necessary to "warm-up" a cold engine by letting it idle for a long time. You can drive away in about a minute, no matter how cold it is outside. The engine will warm up faster, and you get better fuel economy. To cut down on the number of "cold starts," try to combine several short trips into one.

The air conditioning puts an extra load on the engine which makes it use more fuel. Turn off the A/C to cut down on air conditioning use. Use the flow-through ventilation when the outside air temperature is moderate.

Modifying your vehicle, or installing some non-Honda accessories, can make your vehicle unsafe. Before you make any modifications or add any accessories, be sure to read the following information.

Accessories

Your dealer has Genuine Honda accessories that allow you to personalize your vehicle. These accessories have been designed and approved for your vehicle, and are covered by warranty.

Non-Honda accessories are usually designed for universal applications. Although aftermarket accessories may fit on your vehicle, they may not meet factory specifications, and could adversely affect your vehicle's handling and stability. (See "Modifications" on the page [163](#) for additional information.)

Improper accessories or modifications can affect your vehicle's handling, stability and performance, and cause a crash in which you can be hurt or killed.

Follow all instructions in this owner's manual regarding accessories and modifications.

When properly installed, car phones, alarms, two-way radios, and low-powered audio systems should not interfere with your vehicle's computer-controlled systems, such as the SRS and anti-lock brake system.

However, if electronic accessories are improperly installed, or exceed your vehicle's electrical system capacity, they can interfere with the

operation of your vehicle, or even cause the airbags to deploy.

Before installing any accessory:

- Make sure the accessory does not obscure any lights, or interfere with proper vehicle operation or performance.
- Be sure electronic accessories do not overload electrical circuits (see page [286](#)).
- Have the installer contact your Honda dealer for assistance before installing any electronic accessory.

If possible, have your dealer inspect the final installation.

Modifications

Do not remove any original equipment or modify your vehicle in any way that would alter its design or operation. This could make your vehicle unsafe and illegal to drive.

For example, do not make any modifications that would change the ride height of your vehicle, or install wheels and tires with a different overall diameter.

Such modifications can adversely affect handling, and interfere with the operation of the vehicle's anti-lock brakes and other systems.

In addition, any modifications that decrease ground clearance increase the chance of undercarriage parts striking a curb, speed bump, or other raised object, which could cause your airbags to deploy.

Do not modify your steering wheel or any other part of your Supplemental Restraint System. Modifications could make the system ineffective.

Additional Safety Precaution

Do not attach or place objects on the airbag covers. Any object attached to or placed on the covers marked "SRS," in the center of the steering wheel and on top of the dashboard, could interfere with the proper operation of the airbags. Or, if the airbags inflate, the objects could be propelled inside the vehicle and hurt someone.

Carrying Cargo

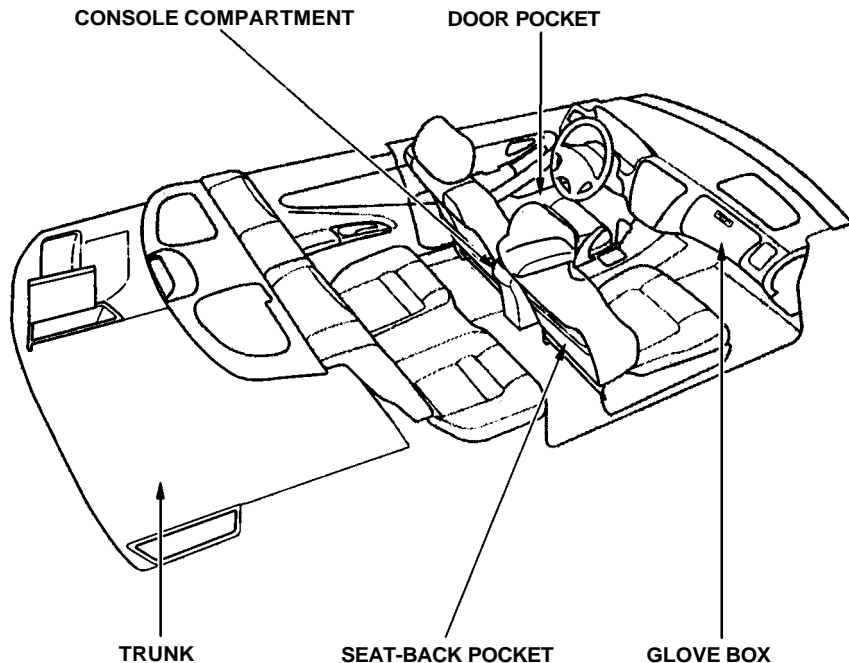

Your vehicle has several convenient storage areas so you can stow cargo safely.

The glove box, and the pockets in the doors and seat-backs, are designed for small, lightweight items. The trunk is intended for larger, heavier items. In addition, the back seat can be folded down to allow you to carry more cargo or longer items.

However, carrying too much cargo, or improperly storing it, can affect your vehicle's handling, stability and operation and make it unsafe. Before carrying any type of cargo, be sure to read the following pages.

Load Limit

The maximum load for your vehicle is 850 lb (395 kg).

This figure includes the total weight of all occupants, cargo, accessories, and the tongue weight if you are towing a trailer.

To figure out how much cargo you can carry:

- Add up the weight of all occupants.
- If you are towing a trailer, add the tongue weight to the number above.
- Subtract the total from 850 lb (395 kg).

The final number is the total weight of cargo you can carry.

Overloading or improper loading can affect handling and stability and cause a crash in which you can be hurt or killed.

Follow all load limits and other loading guidelines in this manual.

Carrying Items in the Passenger Compartment

- Store or secure all items that could be thrown around and hurt someone during a crash.
- Do not put any items on top of the rear shelf. They can block your view and be thrown around the vehicle during a crash.
- Be sure items placed on the floor behind the front seats cannot roll under the seats and interfere with the driver's ability to operate the pedals, or with the proper operation of the seats.
- Keep the glove box closed while driving. If the lid is open, a passenger could injure their knees during a crash or sudden stop.

Carrying Cargo in the Trunk or on a Roof Rack

- Distribute cargo evenly on the floor of the trunk, placing the heaviest items on the bottom and as far forward as possible.
- If you fold down the back seat, tie down items that could be thrown about the vehicle during a crash or sudden stop.
- If you carry large items that prevent you from closing the trunk, exhaust gas can enter the passenger area. To avoid the possibility of carbon monoxide poisoning, follow the instructions on page [44](#) .
- If you can carry any items on a roof rack, be sure the total weight of the rack and the items does not exceed the maximum allowable weight. Please contact your Honda dealer for further information.

Cargo Net

On EX and EX-V6 models

You can use the cargo net to secure small items in the trunk.

This section gives you tips on starting the engine under various conditions, and how to operate the 5-speed manual and automatic transmissions. It also includes important information on parking your vehicle, the braking system, and facts you need if you are planning to tow a trailer.

Preparing to Drive.....	168
Starting the Engine.....	169
Starting in Cold Weather at High Altitude	170
5-speed Manual Transmission.....	170
Recommended Shift Points.....	171
Maximum Allowable Speeds....	172
Automatic Transmission.....	172
Shift Lever Position Indicator..	173
Shift Lever Positions.....	173
Maximum Allowable Speeds....	176
Shift Lock Release.....	177
Parking.....	178
The Braking System.....	179
Brake Wear Indicators.....	179
Brake System Design.....	180
Anti-lock Brakes.....	180
Important Safety Reminders.....	181
ABS Indicator.....	181
Driving in Bad Weather.....	182
Towing a Trailer.....	184

Preparing to Drive

You should do the following checks and adjustments every day before you drive your vehicle.

1. Make sure all windows, mirrors, and outside lights are clean and unobstructed. Remove frost, snow, or ice.
2. Check that the hood and trunk are fully closed.
3. Visually check the tires. If a tire looks low, use a gauge to check its pressure.
4. Check that any items you may be carrying with you inside are stored properly or fastened down securely.
5. Check the adjustment of the seat (see page 82).
6. Check the adjustment of the inside and outside mirrors (see page 94).
7. Check the adjustment of the steering wheel (see page 63).
8. Make sure the doors are securely closed and locked.
9. Fasten your seat belt. Check that your passengers have fastened their seat belts (see page 13).
10. Turn the ignition switch ON (II). Check the indicator lights in the instrument panel.
11. Start the engine (see page 169).
12. Check the gauges and indicator lights in the instrument panel (see page 49).

1. Apply the parking brake.
2. In cold weather, turn off all electrical accessories to reduce the drain on the battery.
3. *Manual Transmission:*
Push the clutch pedal down all the way. START (III) does not function unless the clutch pedal is depressed.

Automatic Transmission:
Make sure the shift lever is in Park. Press on the brake pedal.
4. Without touching the accelerator pedal, turn the ignition key to the START (III) position. If the engine does not start right away, do not hold the key in START (III) for more than 15 seconds at a time. Pause for at least 10 seconds before trying again.
5. If the engine does not start within 15 seconds, or starts but stalls right away, repeat step 4 with the accelerator pedal pressed half-way down. If the engine starts, release pressure on the accelerator pedal so the engine does not race.
6. If the engine still does not start, press the accelerator pedal all the way down and hold it there while starting in order to clear flooding. As before, keep the ignition key in the START (III) position for no more than 15 seconds. Return to step 5 if the engine does not start. If it starts, lift your foot off the accelerator pedal so the engine does not race.

Starting the Engine, 5-speed Manual Transmission

Starting in Cold Weather at High Altitude (Above 8,000 feet/ 2,400 meters)

An engine is harder to start in cold weather. The thinner air found at high altitude above 8,000 feet (2,400 meters) adds to the problem.

Use the following procedure:

1. Turn off all electrical accessories to reduce the drain on the battery.
2. Push the accelerator pedal half-way to the floor and hold it there while starting the engine. Do not hold the ignition key in START (III) for more than 15 seconds. When the engine starts, release the accelerator pedal gradually as the engine speeds up and smooths out.

3. If the engine fails to start in step 2, push the accelerator pedal to the floor and hold it there while you try to start the engine for no more than 15 seconds. If the engine does not start, return to step 2.

5-speed Manual Transmission

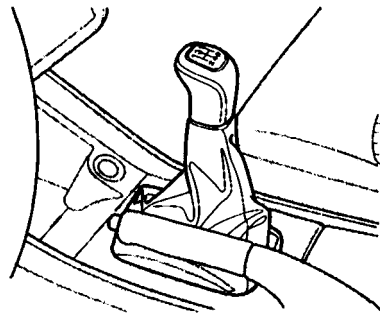

The manual transmission is synchronized in all forward gears for smooth operation. It has a lockout so you cannot shift directly from Fifth to Reverse. When shifting up or down, make sure you push the clutch pedal down all the way, shift to the next gear, and let the pedal up gradually. When you are not shifting, do not rest your foot on the clutch pedal. This can cause your clutch to wear out faster.

Come to a full stop before you shift into Reverse. You can damage the transmission by trying to shift into Reverse with the vehicle moving. Push down the clutch pedal, and pause for a few seconds before shifting into Reverse, or shift into one of the forward gears for a moment. This stops the gears so they won't "grind."

When slowing down, you can get extra braking from the engine by shifting to a lower gear. This extra braking can help you maintain a safe speed and prevent your brakes from overheating while going down a steep hill. Before downshifting, make sure engine speed will not go into the tachometer's red zone in the lower gear. Refer to the Maximum Allowable Speeds chart.

Rapid slowing or speeding-up can cause loss of control on slippery surfaces. If you crash, you can be injured.

Use extra care when driving on slippery surfaces.

Recommended Shift Points

Drive in the highest gear that lets the engine run and accelerate smoothly. This will give you the best fuel economy and effective emissions control. The following shift points are recommended:

Shift up	Normal acceleration
1st to 2nd	15 mph (24 km/h)
2nd to 3rd	28 mph (45 km/h)
3rd to 4th	41 mph (66 km/h)
4th to 5th	52 mph (84 km/h)

Shift up	Cruise acceleration
1st to 2nd	7 mph (11 km/h)
2nd to 3rd	22 mph (35 km/h)
3rd to 4th	33 mph (53 km/h)
4th to 5th	48 mph (77 km/h)

Maximum Allowable Speeds

The speeds in this table are the maximum allowable speeds in each gear. If you exceed these speeds, the engine speed will enter into the tachometer's red zone. If this occurs, you may feel the engine cut in and out. This is caused by a limiter in the engine's computer controls. The engine will run normally when you reduce the RPM below the red zone.

Before downshifting, make sure the vehicle will not exceed the maximum allowable speed in the chart in the lower gear to avoid engine damage.

Gear	Maximum allowable speeds
1st	33 mph (54 km/h)
2nd	61 mph (98 km/h)
3rd	92 mph (149 km/h)
4th	122 mph (197 km/h)

Automatic Transmission

Your Honda's transmission has four forward speeds, and is electronically controlled for smoother shifting. It also has a "lock-up" torque converter for better fuel economy. You may feel what seems like another shift when the converter locks.

Shift Lever Position Indicator

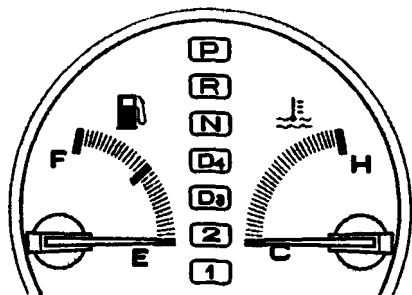

This indicator between the fuel gauge and temperature gauge shows which position the shift lever is in.

The "D4" indicator comes on for a few seconds when you turn the ignition switch ON (II). If it flashes while driving (in any shift position), it indicates a possible problem in the transmission. Avoid rapid acceleration and have the transmission checked by an authorized Honda dealer as soon as possible.

Shift Lever Positions

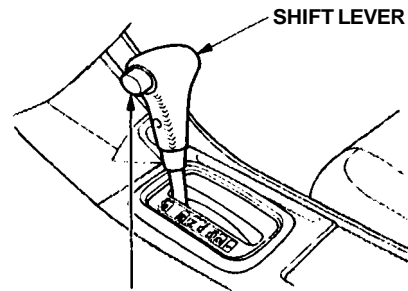

RELEASE BUTTON

The shift lever has seven positions. It must be in Park or Neutral to start the engine. When you are stopped in D4, D3, 2, 1, N or R, press firmly on the brake pedal, and keep your foot off the accelerator pedal.

CONTINUED

Automatic Transmission

To shift from:	Do this:
P to R	Press the brake pedal and press the release button.
R to P N to R D ₃ to 2 2 to 1	Press the release button.
1 to 2 2 to D ₃ D ₃ to D ₄ D ₄ to N D ₄ to D ₃ N to D ₄ R to N	Move the lever.

Park (P) — This position mechanically locks the transmission. Use Park whenever you are turning off or starting the engine. To shift out of Park, you must press on the brake pedal and have your foot off the accelerator pedal. Press the release button on the side of the shift lever to move it.

If you have done all of the above and still cannot move the lever out of Park, see Shift Lock Release on page [177](#).

You must also press the release button to shift into Park. To avoid transmission damage, come to a complete stop before shifting into Park. The shift lever must be in Park before you can remove the key from the ignition switch.

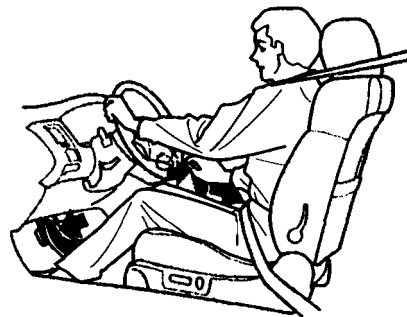

Reverse (R) — To shift to Reverse from Park, see the explanation under Park. To shift to Reverse from Neutral, come to a complete stop and then shift. Press the release button before shifting into Reverse from Neutral.

Neutral (N) — Use Neutral if you need to restart a stalled engine, or if it is necessary to stop briefly with the engine idling. Shift to Park position if you need to leave the vehicle for any reason. Press on the brake pedal when you are moving the shift lever from Neutral to another gear.

Drive (D4) — Use this position for your normal driving. The transmission automatically selects a suitable gear for your speed and acceleration. You may notice the transmission shifting up at higher speeds when the engine is cold. This helps the engine warm up faster.

Drive (D3) — This position is similar to D4, except only the first three gears are selected. Use D3 when towing a trailer in hilly terrain, or to provide engine braking when going down a steep hill. D3 can also keep the transmission from cycling between third and fourth gears in stop-and-go driving.

For faster acceleration when in D3 or D4, you can get the transmission to automatically downshift by pushing the accelerator pedal to the floor. The transmission will shift down one or two gears, depending on your speed.

Second (2) — To shift to Second, press the release button on the side of the shift lever. This position locks the transmission in second gear. It does not downshift to first gear when you come to a stop. Second gives you more power when climbing, and increased engine braking when going down steep hills. Use second gear when starting out on a slippery surface or in deep snow. It will help reduce wheelspin.

CONTINUED

Automatic Transmission

First (1) — To shift from Second to First, press the release button on the side of the shift lever. With the lever in this position, the transmission locks in First gear. By upshifting and downshifting through 1, 2, D3 and D4, you can operate this transmission much like a manual transmission without a clutch pedal.

Maximum Allowable Speeds

The speeds in this table are the maximum allowable speeds in each position. If you exceed these speeds, the engine speed will enter into the tachometer's red zone. If this occurs, you will feel the engine cut in and out. This is caused by a limiter in the engine's computer controls. The engine will run normally when you reduce the RPM below the red zone.

Before downshifting, make sure the vehicle will not exceed the maximum allowable speed in the chart in the lower gear to avoid engine damage.

4-cylinder models

Position	Maximum allowable speeds
1	39 mph (62 km/h)
2	71 mph (114 km/h)
D3	109 mph (176 km/h)

6-cylinder models

Position	Maximum allowable speeds
1	42 mph (68 km/h)
2	72 mph (116 km/h)
D3	115 mph (185 km/h)

Shift Lock Release

This allows you to move the shift lever out of Park if the normal method of pushing on the brake pedal and pressing the release button does not work.

1. Set the Parking brake.
2. Remove the key from the ignition switch.
3. Place a cloth on the edge of the shift lever console outer frame. Remove the frame by carefully prying on the edge with a small flat-tipped screwdriver (not included in the tool kit).

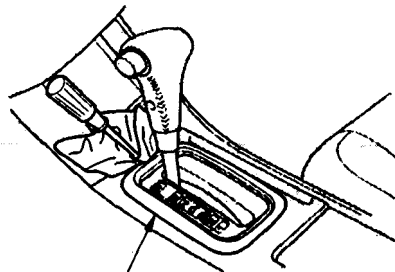

SHIFT LEVER CONSOLE
OUTER FRAME

4. Insert the key in the shift lock release slot.
5. Push down on the key while you press the release button on the shift lever and move the shift lever out of Park to Neutral.

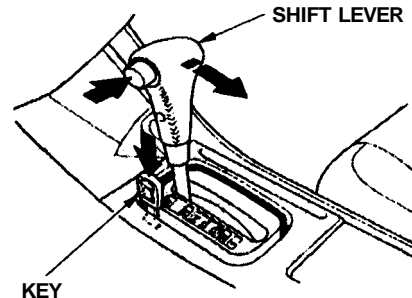

6. Remove the key from the Shift Lock Release. Reinstall the outer frame. Depress the brake pedal and restart the engine.

If you need to use the Shift Lock Release, it means your vehicle is developing a problem. Have the vehicle checked by your Honda dealer.

Parking

Always use the parking brake when you park your vehicle. The indicator on the instrument panel shows that the parking brake is not fully released; it does not indicate that the parking brake is firmly set. Make sure the parking brake is set firmly or your vehicle may roll if it is parked on an incline.

If your vehicle has an automatic transmission, set the parking brake before you put the transmission in Park. This keeps the vehicle from moving and putting pressure on the parking mechanism in the transmission — making it easier to move the shift lever out of Park when you want to drive away.

If the vehicle is facing uphill, turn the front wheels away from the curb. If you have a manual transmission, put it in first gear.

If the vehicle is facing downhill, turn the front wheels toward the curb. If you have a manual transmission, put it in reverse gear.

Make sure the parking brake is fully released before driving away. Driving with the parking brake partially set can overheat or damage the rear brakes.

Parking Tips

- Make sure the moonroof and the windows are closed.
- Turn off the lights.
- Place any packages, valuables, etc., in the trunk or take them with you.
- Lock the doors.

On EX and EX-V6 models

Lock the doors with the key or the remote transmitter. Check the indicator on the driver's door to verify that the security system is set.

- Never park over dry leaves, tall grass, or other flammable materials. The three way catalytic converter gets very hot, and could cause these materials to catch on fire.

Your Honda is equipped with front disc brakes. The brakes on the rear wheels may be disc or drum, depending on model. A power assist helps reduce the effort needed on the brake pedal. The ABS helps you retain steering control when braking very hard.

Put your foot on the brake pedal only when you intend to brake. Resting your foot on the pedal keeps the brakes applied lightly, causing them to build up heat. Heat build-up can reduce how well your brakes work. It also keeps your brake lights on all the time, confusing drivers behind you.

Constant application of the brakes when going down a long hill builds up heat and reduces their effectiveness. Use the engine to assist the brakes by downshifting to a lower gear and taking your foot off the accelerator pedal.

Check your brakes after driving through deep water. Apply the brakes moderately to see if they feel normal. If not, apply them gently and frequently until they do. Since a longer distance is needed to stop with wet brakes, be extra cautious and alert in your driving.

Brake Wear Indicators

The front disc brakes on all vehicles have audible brake wear indicators. They are also on the rear brakes of vehicles equipped with ABS as standard equipment. When the brake pads need replacing, you will hear a distinctive metallic "screeching" sound when you apply the brakes. If you do not have the brake pads replaced, they will begin screeching all the time.

Your brakes may sometimes squeal or squeak when you apply them lightly. Do not confuse this with the brake wear indicators. They make a very audible "screeching."

The Braking System

Brake System Design

The hydraulic system that operates the brakes has two separate circuits. Each circuit works diagonally across the vehicle (the left-front brake is connected with the right-rear brake, etc.). If one circuit should develop a problem, you will still have braking at two wheels.

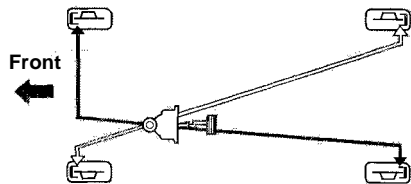

Anti-lock Brakes

The EX, EX-V6 and EX-V6 models have an Anti-lock Brake System (ABS) as standard equipment. It is optional on LX model.

ABS (Anti-lock Brake System) helps to prevent the wheels from locking up and skidding during hard braking, allowing you to retain steering control.

When the front tires skid, you lose steering control; the vehicle continues straight ahead even though you turn the steering wheel. The ABS helps to prevent lock-up and helps you retain steering control by pumping the brakes rapidly; much faster than a person can do it.

You should never pump the

brake pedal, this defeats the purpose of the ABS. Let the ABS work for you by always keeping firm, steady pressure on the brake pedal as you steer away from the hazard. This is sometimes referred to as *"stomp and steer."*

You will feel a pulsation in the brake pedal when the ABS activates, and you may hear some noise. This is normal, it is the ABS rapidly pumping the brakes.

Activation varies with the amount of traction your tires have. On dry pavement, you will need to press on the brake pedal very hard before you activate the ABS. However, you may feel the ABS activate immediately if you are trying to stop on snow or ice.

Important Safety Reminders

ABS does not reduce the time or distance it takes to stop the vehicle, it only helps with steering control during braking. You should always maintain a safe following distance from other vehicles.

ABS will not prevent a skid that results from changing direction abruptly, such as trying to take a corner too fast or making a sudden lane change. Always drive at a safe, prudent speed for the road and weather conditions.

ABS cannot prevent a loss of stability. Always steer moderately when you are braking hard. Severe or sharp steering wheel movement can still cause your vehicle to veer into oncoming traffic or off the road.

A vehicle with ABS may require a longer distance to stop on loose or uneven surfaces, such as gravel or snow, than a vehicle without anti-lock. Slow down and allow a greater distance between vehicles under those conditions.

ABS Indicator

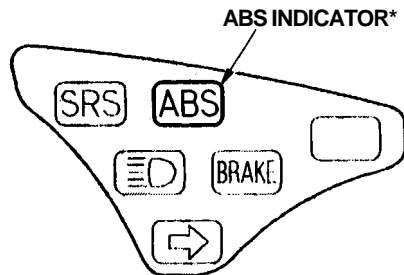

***U.S. indicator shown**

The ABS is self-checking. It also checks itself whenever you use the brakes.

CONTINUED

If anything goes wrong, the ABS indicator on the instrument panel comes on (see page 50). This means the anti-lock function of the braking system has shut down. The brakes still work like a conventional system without anti-lock, providing normal stopping ability. You should have the dealer inspect your vehicle as soon as possible.

Driving in Bad Weather

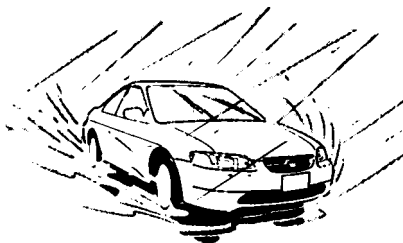

Rain, fog, and snow conditions require a different driving technique because of reduced traction and visibility. Keep your vehicle well-maintained and exercise greater caution when you need to drive in bad weather. The cruise control should not be used in these conditions.

Driving Technique—Always drive slower than you would in dry weather. It takes your vehicle longer to react, even in conditions that may seem just barely damp. Apply smooth, even pressure to all the controls. Abrupt steering wheel movements or sudden, hard application of the brakes can cause loss of control in wet weather. Be extra cautious for the first few miles (kilometers) of driving while you adjust to the change in driving conditions. This is especially true in snow. A person can forget some snow-driving techniques during the summer months. Practice is needed to relearn those skills.

Exercise extra caution when driving in rain after a long dry spell. After months of dry weather, the first rains bring oil to the surface of the roadway, making it slippery.

Visibility — Being able to see clearly in all directions and being visible to other drivers are important in all weather conditions. This is more difficult in bad weather. To be seen more clearly during daylight hours, turn on your headlights.

Inspect your windshield wipers and washers frequently. Keep the windshield washer reservoir full of the proper fluid. Have the windshield wiper blades replaced if they start to streak the windshield or leave parts unwiped. Use the defroster and air conditioning to keep the windows from fogging up on the inside (see pages [109](#) and [117](#)).

Traction — Check your tires frequently for wear and proper pressure. Both are important in preventing "hydroplaning" (loss of traction on a wet surface). In the winter, mount snow tires on all four wheels for the best handling.

Watch road conditions carefully, they can change from moment to moment. Wet leaves can be as slippery as ice. "Clear" roads can have patches of ice. Driving conditions can be very hazardous when the outside temperature is near freezing. The road surface can become covered with areas of water puddles mixed with areas of ice, so your traction can change without warning.

Be careful when downshifting. If traction is low, you can lock up the drive wheels for a moment and cause a skid.

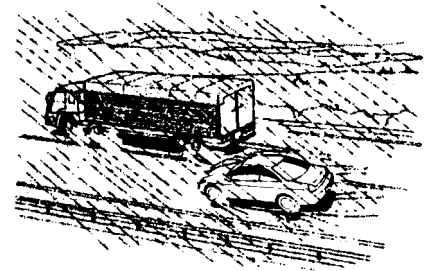

Be very cautious when passing, or being passed by other vehicles. The spray from large vehicles reduces your visibility, and the wind buffeting can cause you to lose control.

Towing a Trailer

Your Honda is designed primarily to carry passengers and their cargo. You can use it to tow a trailer if you carefully observe some general rules.

- The total weight of the trailer and everything loaded in it must not exceed 1,000 lbs (450 kg).
- The "tongue load" should never exceed 100 lbs (45 kg). This is the amount of weight the trailer puts on the hitch when it is fully-loaded. As a rule of thumb, the tongue load should be 10 percent of the total trailer package. For example, if the trailer and its load weigh 500 lbs (225 kg), the tongue load should be 50 lbs (22.5 kg). Adjust the trailer's cargo to change the tongue load. Start by putting approximately 60 percent of the cargo toward the front and 40 percent toward the rear. Never load the trailer so the back is heavier than the front. This takes weight off your vehicle's rear axle and reduces traction.
- The combined weight of the vehicle, all passengers and their luggage, and tongue load must not exceed the Gross Vehicle Weight Rating. The GVWR is printed on the Certification label attached to the driver's doorjamb (see pages [296](#) and [298](#)).
- The combined weight of the vehicle, all passengers and their luggage, and tongue load also must not exceed the Gross Axle Weight Rating. The GAWR is also shown on the Certification label. It tells you the maximum load for the front and rear axles. It is possible that your towing package does not exceed the GVWR but does exceed the GAWR. Improper trailer loading, and/or too much luggage in the trunk can overload the rear axle. Redistribute the load and check the axle weights again.

Improperly loading your vehicle and trailer can seriously affect its steering and braking performance, causing a crash in which you can be seriously injured.

Check the loading of your vehicle and trailer carefully before starting to drive.

The best way to confirm that your total towing package is within these specifications is to get it weighed. Load the vehicle and trailer as you normally would while towing, and take them to a public scale. Have them check the total weight and the weight at each axle, then compare the weights to the specifications.

Trailer Hitches

The trailer hitch must be the proper size and construction for your vehicle and the trailer you intend to tow. Consult with an expert before you purchase a trailer hitch, and have it installed by a qualified mechanic.

The hitch should bolt to the underbody of the vehicle, and distribute the load over a wide area. Never use a hitch that mounts only to the rear bumper. The bumper is not designed to handle that type of load.

NOTICE

A trailer hitch that is not adequate for the size of the trailer, or a hitch that is improperly installed, can cause damage to the underside of your vehicle.

Towing a Trailer

Mirrors

Many states and provinces have laws requiring special outside mirrors when you are towing a trailer. Check the laws in your area. You may want to install mirrors, even if they are not required. Hook up the trailer and see how much it obscures your ability to see behind you with the standard mirrors. If you cannot see directly behind you, or have a large blind spot next to the trailer or the vehicle, you should install mirrors intended for towing.

Connecting the Trailer

Most trailers that have a gross weight of 1,000 lbs (450 kg) do not have their own braking system. If you are thinking of getting a trailer that does have brakes, make sure they are electrically-operated. There are no provisions in your vehicle to tap into its hydraulic braking system. Any attempt to attach the trailer's brakes to your vehicle's hydraulic system, no matter how successful it may seem, will lower braking effectiveness and create a potential hazard.

Always use a safety chain when towing a trailer. Connect the safety chain securely at both ends. Make sure the chain crosses under the tongue so it will catch the trailer if it becomes unhitched. Leave enough slack in the chain so it can't bind in a sharp turn. Do not let it drag on the ground.

Trailer Light

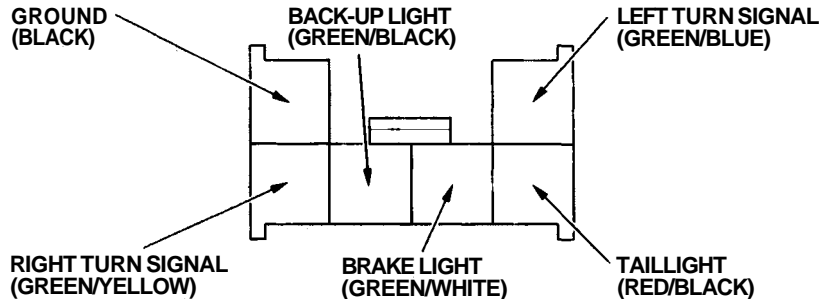

Your vehicle has a trailer lighting connector in the trunk lid by the left stop/taillight. Refer to the drawing above for the wiring color code and purpose of each connector pin.

Since the lighting and wiring can be different for various brands of trailers, have a technician who is familiar with your trailer modify its lighting plug. A converter may be required between the vehicle and trailer for the lights to work correctly.

Before Starting Out

As you are preparing to tow your trailer, do the following:

- Measure the trailer's tongue load. You can do this with a bathroom scale.
- Verify that the hitch and safety chain are securely fastened.
- Check the condition and air pressure of all tires on the trailer and your vehicle. Low tire pressure can seriously affect the handling. Also check the spare tire.
- With everything loaded and the trailer connected, check that the rear of the vehicle is not sagging. If so, redistribute the load in the vehicle.
- Check that all lights on the vehicle and trailer are working properly.

Towing a Trailer

Towing Safety

Your vehicle will not stop as quickly with a trailer in tow. Leave extra distance between your vehicle and other vehicles. Avoid braking or turning suddenly. This could cause the trailer to jackknife or possibly turn over.

Keep in mind that your total vehicle is now much longer. Leave more room when making turns. The trailer tracks a smaller arc than the vehicle and can hit or run over something that the vehicle misses. When passing another vehicle, make sure the trailer is clear before changing lanes.

The vehicle/trailer combination is more affected by crosswinds and buffeting. When being passed by a large vehicle, keep a constant speed and steer straight ahead. If there is too much wind buffeting, slow down to get out of the other vehicle's air turbulence.

Towing a trailer puts an extra load on your vehicle. You should have your vehicle serviced according to the "Maintenance Schedule under severe driving conditions" on page [198](#).

This extra load is magnified when you are driving in hilly terrain. Watch the temperature gauge closely when climbing hills. If it gets near the hot area, turn off the air conditioning (if it is on). If this does not reduce the heat, it may be necessary to pull to the side of the road and wait for the engine to cool. If the automatic transmission shifts frequently between 3rd and 4th gears, put it in D3. This will help prevent the transmission from overheating. Help keep the brakes from overheating by shifting to a lower gear when going downhill.

If you have to stop while going uphill, do not hold the vehicle in place by pressing on the accelerator. This can cause the automatic transmission to overheat. Use the parking brake or footbrake.

When parking your vehicle and trailer, especially on a hill, be sure to follow all the normal precautions. Turn your front wheels into the curb, set the parking brake firmly, and put the transmission in 1st or Reverse (manual) or Park (automatic). In addition, place wheel chocks at each of the trailer's tires.

Backing up with a trailer is difficult and takes practice. Drive slowly, make small movements with the steering wheel, and have someone stand outside to guide you. Grip the steering wheel on the bottom (rather than the usual position near the top). Move your hand to the left to get the trailer to move to the left, and right to move the trailer right.

This section explains why it is important to keep your vehicle well maintained and to follow basic maintenance safety precautions.

This section also includes Maintenance Schedules for normal driving and severe driving conditions, a Maintenance Record, and instructions for simple maintenance tasks you may want to take care of yourself.

If you have the skills and tools to perform more complex maintenance tasks on your Honda, you may want to purchase the Service Manual. See page 315 for information on how to obtain a copy, or see your Honda dealer.

Maintenance Safety.....	192
Important Safety Precautions..	193
Maintenance Schedule.....	194

Maintenance Record.....	201
Owner Maintenance Checks.....	203
Fluid Locations.....	204
Engine Oil.....	206
Adding Oil.....	206
Recommended Oil.....	206
Synthetic Oil.....	208
Additives.....	208
Changing the Oil and Filter.....	208
Cooling System.....	211
Adding Engine Coolant.....	211
Replacing Engine Coolant.....	213
Windshield Washers.....	218
Transmission Fluid.....	219
Automatic	
Transmission.....	219
5-speed Manual	
Transmission.....	220
Brake and Clutch Fluid.....	221
Brake System.....	221
Clutch System.....	222
Power Steering.....	223
Air Cleaner Element.....	224
Spark Plugs	
(4-cylinder Models).....	226
Replacement.....	226

Specifications.....	227
Spark Plugs	
(6-cylinder Models).....	228
Replacement.....	228
Specifications.....	229
Battery.....	230
Wiper Blades.....	233
Air Conditioning System.....	235
Air Conditioning Filter.....	236
Drive Belts.....	236
Timing Belt.....	237
Tires.....	238
Inflation.....	238
Inspection.....	239
Maintenance.....	240
Tire Rotation.....	241
Replacing Tires and Wheels....	241
Wheels and Tires.....	242
Winter Driving.....	242
Snow Tires.....	243
Tire Chains.....	243
Lights.....	244
Headlight Aiming.....	246
Replacing Bulbs.....	247
Storing Your Vehicle.....	258

Maintenance Safety

Regularly maintaining your vehicle is the best way to protect your investment. Proper maintenance is essential to your safety and the safety of your passengers. It will also reward you with more economical, trouble-free driving and help reduce air pollution.

Improperly maintaining this vehicle or failing to correct a problem before driving can cause a crash in which you can be seriously hurt or killed.

Always follow the inspection and maintenance recommendations and schedules in this owner's manual.

This section includes instructions for simple maintenance tasks, such as checking and adding oil. Any service items not detailed in this section should be performed by a Honda technician or other qualified mechanic.

Some of the most important safety precautions are given here. However, we cannot warn you of every conceivable hazard that can arise in performing maintenance. Only you can decide whether or not you should perform a given task.

Failure to properly follow maintenance instructions and precautions can cause you to be seriously hurt or killed.

Always follow the procedures and precautions in this owner's manual.

Important Safety Precautions

Before you begin any maintenance, make sure your vehicle is parked on level ground and that the parking brake is set. Also, be sure the engine is off. This will help to eliminate several potential hazards:

- **Carbon monoxide poisoning from engine exhaust.** Be sure there is adequate ventilation whenever you operate the engine.
- **Burns from hot parts.** Let the engine and exhaust system cool before touching any parts.
- **Injury from moving parts.** Do not run the engine unless instructed to do so.

Read the instructions before you begin, and make sure you have the tools and skills required.

To reduce the possibility of fire or explosion, be careful when working around gasoline or batteries. Use a nonflammable solvent, not gasoline, to clean parts. Keep cigarettes, sparks, and flames away from the battery and all fuel-related parts.

You should wear eye protection and protective clothing when working near the battery or when using compressed air.

Maintenance Schedule

The Maintenance Schedule specifies how often you should have your vehicle serviced and what things need attention. It is essential that you have your vehicle serviced as scheduled to retain its high level of safety, dependability, and emissions control performance.

The services and time or distance intervals shown in the maintenance schedule assume you will use your vehicle as normal transportation for passengers and their possessions. You should also follow these recommendations:

- Avoid exceeding your vehicle's load limit. This puts excess stress on the engine, brakes, and many other parts of your vehicle. The load limit is shown on the label on the driver's doorjamb.
- Operate your vehicle on reasonable roads within the legal speed limit.
- Drive your vehicle regularly over a distance of several miles (kilometers).
- Always use unleaded gasoline with the proper octane rating (see page [154](#)).

Which Schedule to Follow:

Service your vehicle according to the time and mileage periods on one of the Maintenance Schedules on the following pages. Select the schedule for "Severe Conditions" if most of your driving is done under one or more of the conditions listed on that page. Otherwise, follow the schedule for "Normal Conditions."

Your authorized Honda dealer knows your vehicle best and can provide competent, efficient service. However, service at a dealer is not mandatory to keep your warranties in effect. Maintenance may be done by any qualified service facility or person who is skilled in this type of automotive service. Keep all the receipts as proof of completion, and have the person who does the work fill out the Maintenance Record. Check your warranty booklet for more information.

We recommend the use of Genuine Honda parts and fluids whenever you have maintenance done. These are manufactured to the same high-quality standards as the original components, so you can be confident of their performance and durability.

U.S. Vehicles:

Maintenance, replacement or repair of emissions control devices and systems may be done by any automotive repair establishment or individual using parts that are "certified" to EPA standards.

According to state and federal regulations, failure to perform maintenance on the items marked with # will not void your emissions warranties. However, Honda recommends that all maintenance services be performed at the recommended time or mileage period to ensure long-term reliability.

Maintenance Schedule (Normal Conditions)

Service at the indicated distance or time – whichever comes first.	miles x 1,000	15	30	45	60	75	90	105	120
	km x 1,000	24	48	72	96	120	144	168	192
	months	12	24	36	48	60	72	84	96
Replace engine oil	Replace every 7,500 miles (12,000 km) or 12 months								
Replace engine oil filter		•	•	•	•	•	•	•	•
Check engine oil and coolant	Check oil and coolant at each fuel stop								
Replace air cleaner element			•		•		•		•
Inspect valve clearance	Adjust only if noisy								
Replace spark plugs	For 4-cylinder models		•		•		•		•
	For 6-cylinder models							•	
Replace timing belt, timing balancer belt ^{*1} , and inspect water pump								•	
Inspect and adjust drive belts		•			•		•		•
Inspect idle speed								•	
Replace engine coolant				•		•		•	
Replace transmission fluid							•		
Inspect front and rear brakes		•	•	•	•	•	•	•	•
Replace brake fluid				•			•		
Check parking brake adjustment		•	•	•	•	•	•	•	•
Replace air conditioning filter			•		•		•		•
Rotate tires (Check tire inflation and condition at least once per month)	Rotate tires every 7,500 miles (12,000 km)								
Visually inspect the following items:									
Tie rod ends, steering gear box, and boots									
Suspension components									
Driveshaft boots									
Brake hoses and lines (including ABS)	•	•	•	•	•	•	•	•	•
All fluid levels and condition of fluids									
Cooling system hoses and connections									
[#] Exhaust system									
[#] Fuel lines and connections									

* 1 : Balancer belt applies to 4-cylinder models only.

: See page 195.

Follow the Normal Conditions Maintenance Schedule if the severe driving conditions specified in the Severe Conditions Maintenance Schedule do not apply.

NOTE: If you only OCCASIONALLY drive under a "severe" condition, you should follow the Normal Conditions Maintenance Schedule.

Schedule for Normal Conditions (listed by distance/time)

Service at the indicated distance or time, whichever comes first. Do the items in A, B, C as required for each distance/time interval. Follow this schedule if the severe driving conditions described in the Severe Conditions Schedule on the next page do not apply.

Canadian owners: Follow the schedule for Severe Conditions.

7,500 mi/12,000 km/	Do items in A.
15,000 mi/24,000 km/1 yr	Do items in A, B.
22,500 mi/36,000 km/	Do items in A.
30,000 mi/48,000 km/2 yrs	Do items in A, B, C.
37,500 mi/60,000 km/	Do items in A.
45,000 mi/72,000 km/3 yrs	<input type="checkbox"/> Replace coolant. <input type="checkbox"/> Replace brake fluid. Do items in A, B.
52,500 mi/84,000 km/	Do items in A.
60,000 mi/96,000 km/4 yrs	Do items in A, B, C.
67,500 mi/108,000 km/	Do items in A.
75,000 mi/120,000 km/5 yrs	<input type="checkbox"/> Replace coolant. Do items in A, B.
82,500 mi/132,000 km/	Do items in A.
90,000 mi/144,000 km/6 yrs	<input type="checkbox"/> Replace brake fluid. <input type="checkbox"/> Replace transmission fluid. Do items in A, B, C.
97,500 mi/156,000 km/	Do items in A.
105,000 mi/168,000 km/7 yrs	<input type="checkbox"/> Replace timing belt ^{*1} , timing balancer belt ^{*2} , inspect water pump. <input type="checkbox"/> Replace coolant. <input type="checkbox"/> Check idle speed. <input type="checkbox"/> Replace spark plugs (6-cylinder models). Do items in A, B.
112,500 mi/180,000 km/	Do items in A.
120,000 mi/192,000 km/8 yrs	Do items in A, B, C.

A	<input type="checkbox"/> Replace engine oil. <input type="checkbox"/> Rotate tires (follow pattern on page 241).
B	<input type="checkbox"/> Replace engine oil filter. <input type="checkbox"/> Inspect front and rear brakes. <input type="checkbox"/> Check parking brake adjustment. <input type="checkbox"/> Inspect tie rod ends, steering gear box and boots. <input type="checkbox"/> Inspect suspension components. <input type="checkbox"/> Inspect driveshaft boots. <input type="checkbox"/> Inspect brake hoses and lines (including ABS). <input type="checkbox"/> Check all fluid levels, condition of fluids, and check for leaks. <input type="checkbox"/> Inspect cooling system hoses and connections. <input type="checkbox"/> * Inspect exhaust system. <input type="checkbox"/> * Inspect fuel lines and connections.
C	<input type="checkbox"/> Replace air cleaner element. <input type="checkbox"/> Replace spark plugs (4-cylinder models). <input type="checkbox"/> Inspect and adjust drive belts. <input type="checkbox"/> Replace air conditioning filter.

: See maintenance and emissions warranty info, last column, page 195.

* 1 : See Timing Belt on page 237 to determine need for replacement,

* 2 : Balancer belt applies to 4-cylinder models only.

Note:

- Check engine oil and coolant at each fuel stop.

Maintenance Schedule (Severe Conditions)

Service at the indicated distance or time — whichever comes first.	miles x 1,000	15	30	45	60	75	90	105	120
	km x 1,000	24	48	72	96	120	144	168	192
	months	12	24	36	48	60	72	84	96
Replace engine oil and oil filter	Replace every 3,750 miles (6,000 km) or 6 months								
Check engine oil and coolant	Check oil and coolant at each fuel stop								
Clean (○) or replace (●) air cleaner element — Use normal schedule except in dusty conditions	○	●	○	●	○	●	○	●	
Inspect valve clearance	Adjust only if noisy								
Replace spark plugs	For 4-cylinder models		●		●		●		●
	For 6-cylinder models							●	
Replace timing belt* ² , timing balancer belt* ^{1,2} , and inspect water pump								●	
Inspect and adjust drive belts		●		●		●		●	
Inspect idle speed								●	
Replace engine coolant			●		●			●	
Replace transmission fluid		●		●		●		●	
Inspect front and rear brakes	Inspect every 7,500 miles (12,000 km) or 6 months								
Replace brake fluid			●		●		●		●
Check parking brake adjustment	●	●	●	●	●	●	●	●	●
Replace air conditioning filter* ³		●		●		●		●	
Lubricate locks and hinges	●	●	●	●	●	●	●	●	●
Rotate tires (Check tire inflation and condition at least once per month)	Rotate tires every 7,500 miles (12,000 km)								
Visually inspect the following items:									
Tie rod ends, steering gear box, and boots Suspension components, Driveshaft boots	Every 7,500 miles (12,000 km) or 6 months								
Brake hoses and lines (including ABS) All fluid levels and conditions of fluids Cooling system hoses and connections * Exhaust system, † Fuel lines and connections Lights and controls, Vehicle underbody	●	●	●	●	●	●	●	●	●

: See page 195 .

Follow the Severe Maintenance Schedule if you drive your vehicle *MAINLY* under one or more of the following conditions:

- Driving less than 5 miles (8 km) per trip or, in freezing temperatures, driving less than 10 miles (16 km) per trip.
- Driving in extremely hot [over 90°F (32°C)] conditions.
- Extensive idling or long periods of stop-and-go driving.
- Trailer towing, driving with a roof top carrier, or driving in mountainous conditions.
- Driving on muddy, dusty, or de-iced roads.

*1 : Balancer belt applies to 4-cylinder models only.

*2 : Refer to page 237 for replacement information under special driving conditions.

*3 : Refer to page 236 for replacement information under special driving conditions.

For Canadian Owners
Follow the Maintenance Schedule for Severe Conditions.

Maintenance Schedule for Severe Conditions (listed by distance/time)

Use this schedule if your vehicle is MAINLY driven in any of the following Severe Conditions, or normally driven in Canada; otherwise use the Normal Schedule. Service at the indicated distance or time, whichever comes first. Do the items in **A, B, C, D** as required for each distance/time.

Severe Conditions:

- Driving less than 5 mi (8 km) per trip or, in freezing temperatures, driving less than 10 mi (16 km) per trip.
- Driving in extremely hot (over 90°F/32°C) conditions.
- Extensive idling or long periods of stop-and-go driving.
- Trailer towing, driving with a roof top carrier, or driving in mountainous conditions.
- Driving on muddy, dusty, or de-iced roads.

3,750 mi/6,000 km/6 mos	Do items in A.
7,500 mi/12,000 km/-	Do items in A, B.
11,250 mi/18,000 km/-	Do items in A.
15,000 mi/24,000 km/1 yr	<input type="checkbox"/> Clean air cleaner element. Do items in A, B, C.
18,750 mi/30,000 km/-	Do items in A.
22,500 mi/36,000 km/1½ yrs	Do items in A, B.
26,250 mi/42,000 km/-	Do items in A.
30,000 mi/48,000 km/2 yrs	Do items in A, B, C, D.
33,750 mi/54,000 km/-	Do items in A.
37,500 mi/60,000 km/2½ yrs	Do items in A, B.
41,250 mi/66,000 km/-	Do items in A.
45,000 mi/72,000 km/3 yrs	<input type="checkbox"/> Replace coolant. <input type="checkbox"/> Replace brake fluid. <input type="checkbox"/> Clean air cleaner element. Do items in A, B, C.
48,750 mi/78,000 km/-	Do items in A.
52,500 mi/84,000 km/3½ yrs	Do items in A, B.
56,250 mi/90,000 km/-	Do items in A.
60,000 mi/96,000 km/4 yrs	<input type="checkbox"/> *Replace timing belt*, timing balancer belt*, inspect water pump*. Do items in A, B, C, D.
63,750 mi/102,000 km/-	Do items in A.

A	<input type="checkbox"/> Replace engine oil and filter.
B	<input type="checkbox"/> Inspect front and rear brakes. <input type="checkbox"/> Rotate tires (follow pattern on page 241). <input type="checkbox"/> Inspect tie rod ends, steering gear box and boots. <input type="checkbox"/> Inspect suspension components. <input type="checkbox"/> Inspect driveshaft boots.
C	<input type="checkbox"/> Check parking brake adjustment. <input type="checkbox"/> Lubricate door locks and hinges with multipurpose grease. <input type="checkbox"/> Inspect brake hoses and lines (including ABS). <input type="checkbox"/> Check all fluid levels, condition of fluids, and check for leaks. <input type="checkbox"/> Inspect cooling system hoses and connections. <input type="checkbox"/> ² Inspect exhaust system. <input type="checkbox"/> ² Inspect fuel lines and connections. <input type="checkbox"/> Check all lights. <input type="checkbox"/> Inspect the underbody.

CONTINUED

Maintenance Schedule for Severe Conditions (listed by distance/time)

67,500 mi/108,000 km/4½ yrs	Do items in A, B.
71,250 mi/114,000 km/-	Do items in A.
75,000 mi/120,000 km/5 yrs	<input type="checkbox"/> Replace coolant. <input type="checkbox"/> Clean air cleaner element. Do items in A, B.
78,750 mi/126,000 km/-	Do items in A.
82,500 mi/132,000 km/5½ yrs	Do items in A, B.
86,250 mi/138,000 km/-	Do items in A.
90,000 mi/144,000 km/6 yrs	<input type="checkbox"/> Replace brake fluid. Do items in A, B, C, D.
93,750 mi/150,000 km/-	Do items in A.
97,500 mi/156,000 km/6½ yrs	Do items in A, B.
101,250 mi/162,000 km/-	Do items in A.
105,000 mi/168,000 km/7 yrs	<input type="checkbox"/> Replace timing belt ^{*1} , timing balancer belt ^{*3} , and inspect water pump ^{*1} . <input type="checkbox"/> Replace coolant. <input type="checkbox"/> Check idle speed. <input type="checkbox"/> Clean air cleaner element. <input type="checkbox"/> Replace spark plugs (6-cylinder models). Do items in A, B, C.
108,750 mi/174,000 km/-	Do items in A.
112,500 mi/180,000 km/7½ yrs	Do items in A, B.
116,250 mi/186,000 km/-	Do items in A.
120,000 mi/192,000 km/8 yrs	<input type="checkbox"/> Replace timing belt, timing balancer belt ^{*3} , inspect water pump ^{*1} . Do items in A, B, C, D.

- D** Replace air cleaner element.
 Replace spark plugs (4-cylinder models).
 Inspect and adjust drive belts.
 Replace transmission fluid.
 Replace air conditioning filter^{*2}.

: See maintenance and emissions warranty info, last column, page 195.

* 1 : See Timing Belt on page 237 to determine need for replacement.

* 2 : See Air Conditioning Filter on page 236 for information under special conditions.

* 3 : Balancer belt applies to 4-cylinder models only.

NOTE:

- Check engine oil and coolant at each fuel stop.
- Check and adjust valve clearance, cold engine, if noisy.

Required Maintenance Record (for Normal and Severe Schedules)

You or the servicing dealer can record all completed maintenance here, whether you follow the schedule for normal conditions (page 196) or severe conditions (page 198). Keep the receipts for all work done on your vehicle.

3,750 mi 6,000 km (or 6 mo)	Signature or dealer stamp	mi/km ----- Date
7,500 mi 12,000 km		mi/km ----- Date
11,250 mi 18,000 km		mi/km ----- Date
15,000 mi 24,000 km (or 1 year)		mi/km ----- Date
18,750 mi 30,000 km		mi/km ----- Date
22,500 mi 36,000 km (or 1½ years)		mi/km ----- Date
26,250 mi 42,000 km		mi/km ----- Date
30,000 mi 48,000 km (or 2 years)		mi/km ----- Date

33,750 mi 54,000 km	Signature or dealer stamp	mi/km ----- Date
37,500 mi 60,000 km (or 2½ years)		mi/km ----- Date
41,250 mi 66,000 km		mi/km ----- Date
45,000 mi 72,000 km (or 3 years)		mi/km ----- Date
48,750 mi 78,000 km		mi/km ----- Date
52,500 mi 84,000 km (or 3½ years)		mi/km ----- Date
56,250 mi 90,000 km		mi/km ----- Date
60,000 mi 96,000 km (or 4 years)		mi/km ----- Date

Required Maintenance Record (for Normal and Severe Schedules)

63,750 mi 102,000 km	Signature or dealer stamp	mi/km
		Date
67,500 mi 108,000 km (or 4½ years)		mi/km
		Date
71,250 mi 114,000 km		mi/km
		Date
75,000 mi 120,000 km (or 5 years)		mi/km
		Date
78,750 mi 126,000 km		mi/km
		Date
82,500 mi 132,000 km (or 5½ years)		mi/km
		Date
86,250 mi 138,000 km		mi/km
		Date
90,000 mi 144,000 km (or 6 years)		mi/km
		Date

93,750 mi 150,000 km	Signature or dealer stamp	mi/km
		Date
97,500 mi 156,000 km (or 6½ years)		mi/km
		Date
101,250 mi 162,000 km		mi/km
		Date
105,000 mi 168,000 km (or 7 years)		mi/km
		Date
108,750 mi 174,000 km		mi/km
		Date
112,500 mi 180,000 km (or 7½ years)		mi/km
		Date
116,250 mi 186,000 km		mi/km
		Date
120,000 mi 192,000 km (or 8 years)		mi/km
		Date

You should check the following items at the specified intervals. If you are unsure of how to perform any check, turn to the page given.

- Engine oil level — Check every time you fill the fuel tank. See page [158](#).
- Engine coolant level — Check the radiator reserve tank every time you fill the fuel tank. See page [160](#).
- Windshield washer fluid — Check the level in the reservoir monthly. If weather conditions cause you to use the washers frequently, check the reservoir each time you stop for fuel. See page [218](#).
- Automatic transmission — Check the fluid level monthly. See page [219](#).
- Brakes — Check the fluid level monthly. See page [221](#).
- Tires — Check the tire pressure monthly. Examine the tread for wear and foreign objects. See page [238](#).
- Lights — Check the operation of the headlights, parking lights, taillights, high-mount brake light, turn signals, brake lights, and license plate lights monthly. See page [244](#).

Fluid Locations

4-cylinder Models

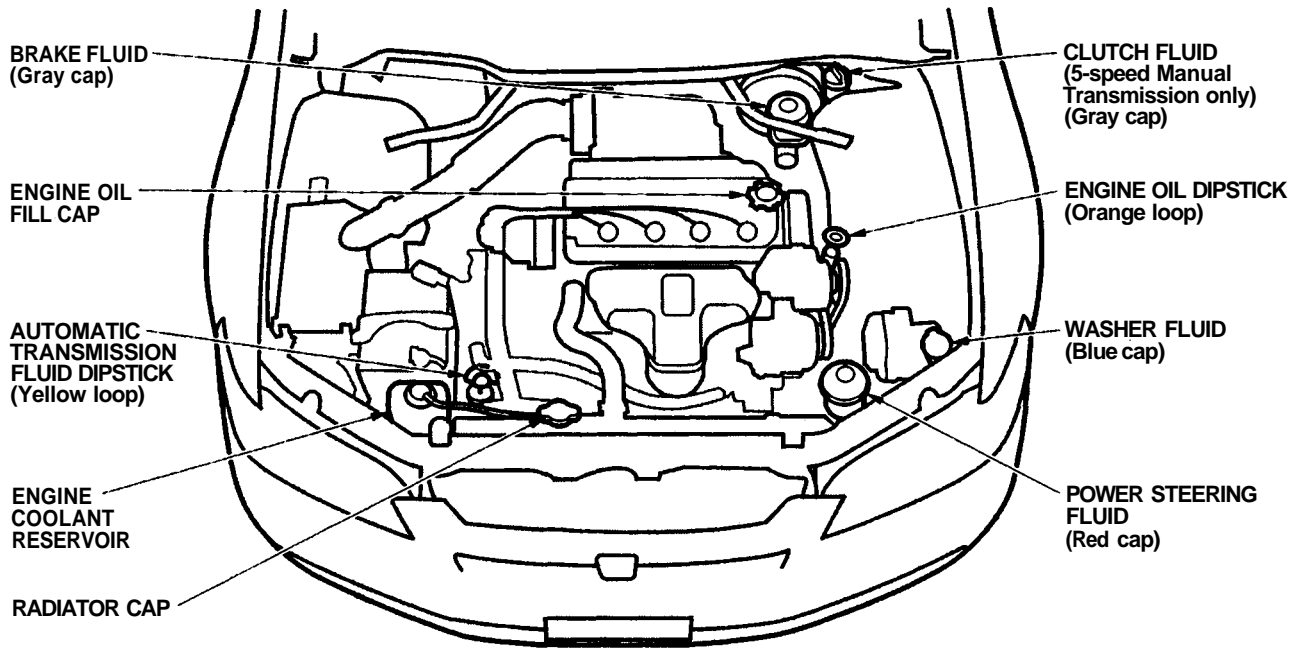

6-cylinder Models

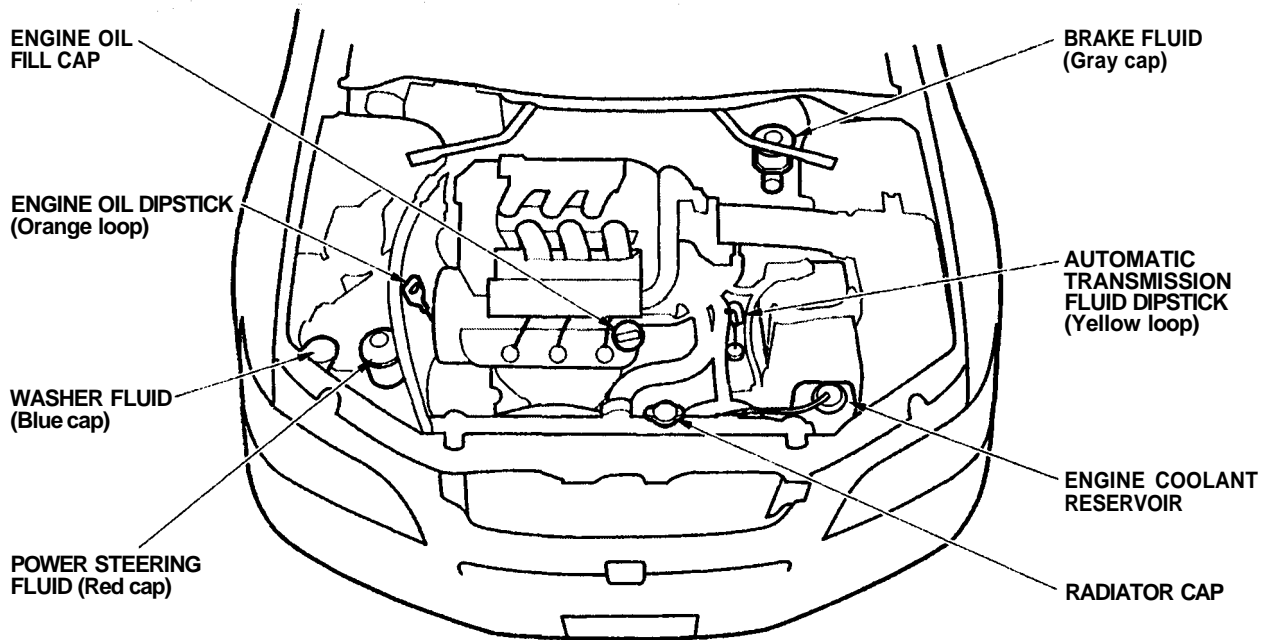

Engine Oil

Adding Oil

ENGINE OIL FILL CAP

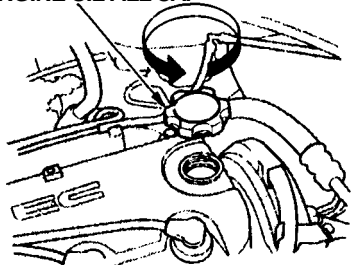

4-cylinder models

To add oil, unscrew and remove the engine oil fill cap on top of the valve cover. Pour in the oil, and replace the engine oil fill cap. Tighten it securely. Wait a few minutes and recheck the oil level. Do not fill above the upper mark; you could damage the engine.

ENGINE OIL FILL CAP

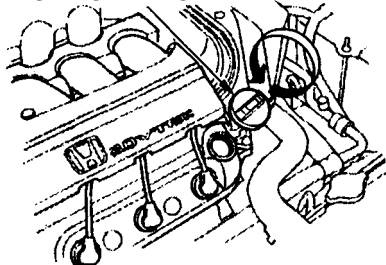

6-cylinder models

Recommended Oil

Oil is a major contributor to your engine's performance and longevity. Always use a premium-grade detergent oil.

You can determine an oil's SAE viscosity and Service Classification from the API Service label on the oil container.

A fuel-efficient oil is recommended for your Honda. This is shown on the API Service label by the words "Energy Conserving". This oil is formulated to help your engine use less fuel.

The API Service label also tells you the service classification of the oil. Always use an oil that is labeled "API Service SJ." This service rating may include other classifications, such as CD. These additional classifications are not a problem, as long as the label also carries the SJ classification.

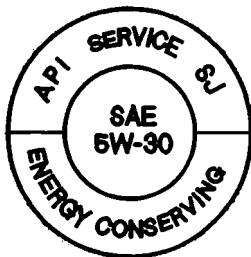

API SERVICE LABEL

The oil container may also display the API Certification seal. Make sure it says "For Gasoline Engines."



API CERTIFICATION MARK

The SAE numbers tell you the oil's viscosity or weight. Select the oil for your vehicle according to this chart.



Ambient Temperature

An oil with a viscosity of 5W-30 is preferred for improved fuel economy and year-round protection in your Honda. You may use a 10W-30 oil if the temperature in your area never goes below 20°F (— 7°C).

Engine Oil

Synthetic Oil

You may use a synthetic motor oil if it meets the same requirements given for conventional motor oil; energy conserving, a service classification of SJ, and the proper weight as shown on the chart. When using synthetic oil, you must follow the oil and filter change intervals given in the maintenance schedule.

Additives

Your Honda does not need any oil additives. Purchasing additives for the engine or transmission will not increase your vehicle's performance or longevity. It only increases the cost of operating your vehicle.

Changing the Oil and Filter

Always change the oil and filter according to the time and distance (miles/kilometers) recommendations in the maintenance schedule. The oil and filter collect contaminants that can damage your engine if they are not removed regularly.

Changing the oil and filter requires special tools and access from underneath the vehicle. The vehicle should be raised on a service station-type hydraulic lift for this service. Unless you have the knowledge and proper equipment, you should have this maintenance done by a skilled mechanic.

1. Run the engine until it reaches normal operating temperature, then shut it off.

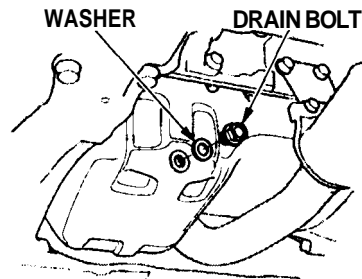

4-cylinder models

2. Open the hood and remove the engine oil fill cap. Remove the oil drain bolt and washer from the bottom of the engine. Drain the oil into an appropriate container.

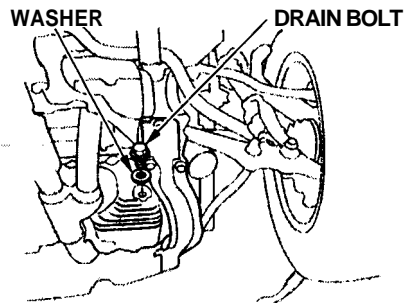

6-cylinder models

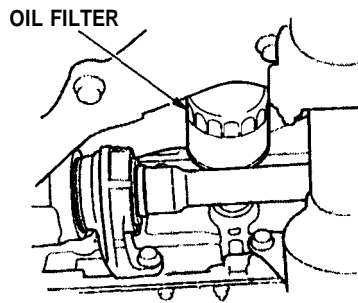

4-cylinder models

3. Remove the oil filter and let the remaining oil drain. A special wrench (available from your Honda dealer) is required to remove the filter.

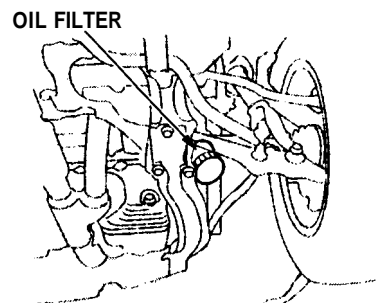

6-cylinder models

4. Install a new oil filter according to instructions that come with it.

CONTINUED

Engine Oil

5. Put a new washer on the drain bolt, then reinstall the drain bolt.

Tighten it to:

(LX, EX)

33 lbf.ft (44 N.m , 4.5 kgf.m)

(LX-V6, EX-V6)

29 lbf.ft (39 N.m, 4.0 kgf.m)

6. Refill the engine with the recommended oil.

Engine oil change capacity
(including filter):

(LX, EX)

4.5 US qt (4.3 ℓ , 3.8 Imp qt)

(LX-V6, EX-V6)

4.6 US qt (4.4 ℓ , 3.9 Imp qt)

7. Replace the engine oil fill cap.

Start the engine. The oil pressure indicator light should go out within five seconds. If it does not, turn off the engine and reinspect your work.

8. Let the engine run for several minutes and check the drain bolt and oil filter for leaks.

9. Turn off the engine, let it sit for several minutes, then check the oil level. If necessary, add oil to bring the level to the upper mark on the dipstick.

NOTICE

Improper disposal of engine oil can be harmful to the environment. If you change your own oil, please dispose of the used oil properly. Put it in a sealed container and take it to a recycling center. Do not discard it in a trash bin or dump it on the ground.

Adding Engine Coolant

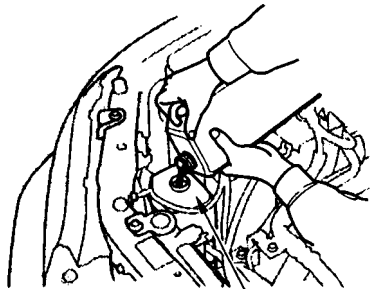

4-cylinder models RESERVE TANK

If the coolant level in the reserve tank is at or below the MIN line, add coolant to bring it up to the MAX line. Inspect the cooling system for leaks. This coolant should always be a mixture of 50 percent antifreeze and 50 percent water. Never add straight antifreeze or plain water.

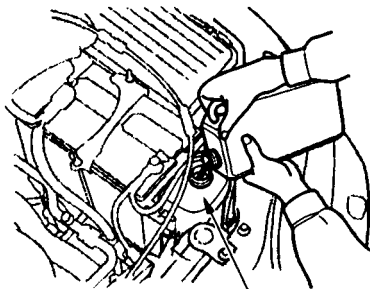

6-cylinder models RESERVE TANK

Always use Genuine Honda antifreeze/coolant. If it is not available, you may use another major-brand non-silicate coolant as a temporary replacement. Make sure it is a high-quality coolant recommended for aluminum engines. However, continued use of any non-Honda coolant can result in corrosion, causing the cooling system to malfunction or fail. Have the cooling system flushed and

refilled with Honda antifreeze/coolant as soon as possible.

If the reserve tank is completely empty, you should also check the coolant level in the radiator.

Removing the radiator cap while the engine is hot can cause the coolant to spray out, seriously scalding you.

Always let the engine and radiator cool down before removing the radiator cap.

1. Make sure the engine and radiator are cool.

CONTINUED

Cooling System

RADIATOR CAP

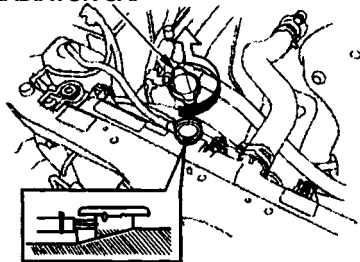

4-cylinder models

2. Turn the radiator cap counter-clockwise, without pressing down on it, until it stops. This relieves any pressure remaining in the cooling system.
3. Remove the radiator cap by pushing down and turning counterclockwise.

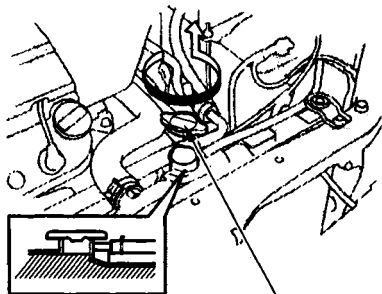

6-cylinder models

RADIATOR CAP

4. The coolant level should be up to the base of the filler neck. Add coolant if it is low.
5. Put the radiator cap back on. Tighten it fully.

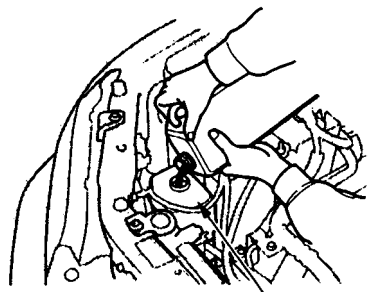

4-cylinder models

RESERVE TANK

6. Pour coolant into the reserve tank. Fill it to halfway between the MAX and MIN marks. Put the cap back on the reserve tank.

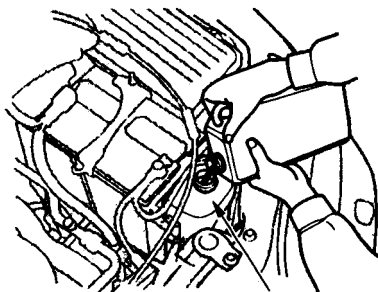

6-cylinder models RESERVE TANK

Do not add any rust inhibitors or other additives to your vehicle's cooling system. They may not be compatible with the coolant or engine components.

Replacing Engine Coolant

The cooling system should be completely drained and refilled with new coolant according to the time and distance recommendations in the maintenance schedule. Only use Genuine Honda antifreeze/coolant.

Draining the coolant requires access to the underside of the vehicle. Unless you have the tools and knowledge, you should have this maintenance done by a skilled mechanic.

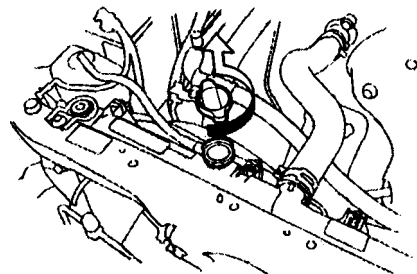

4-cylinder models

1. Turn the ignition ON (II). Turn the heater temperature control dial to maximum heat (climate control to 90°F / 32°C). Turn off the ignition and remove the key. Open the hood. Make sure the engine and radiator are cool to the touch.
2. Remove the radiator cap.

CONTINUED

Cooling System

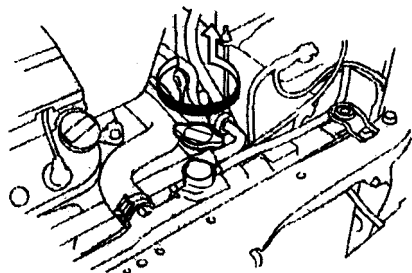

6-cylinder models

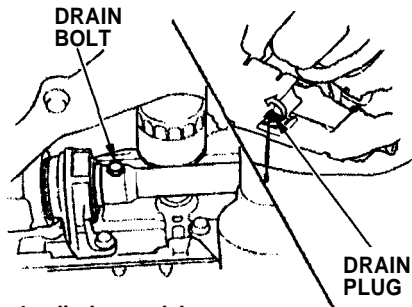

4-cylinder models

3. 4-cylinder models

Loosen the drain plug on the bottom of the radiator. The coolant will drain through the splash guard. Remove the drain bolt and washer from the engine block.

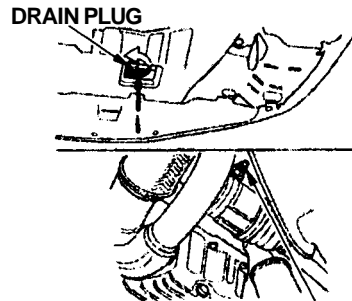

6-cylinder models

DRAIN BOLT

6-cylinder models

Loosen the drain plug on the bottom of the radiator. The coolant will drain through the splash guard. Loosen the drain bolt.

RESERVE TANK RESERVE TANK CAP

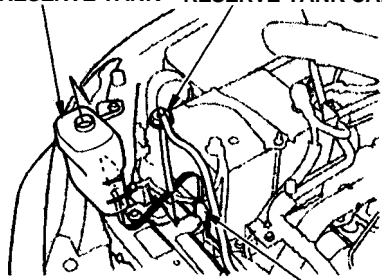

4-cylinder models

HOLDER

GROUND CABLE

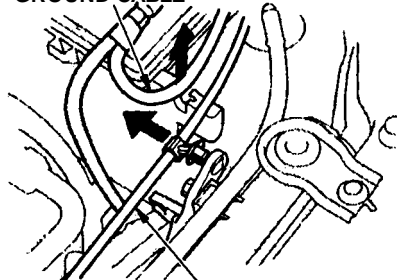

CRUISE CONTROL CABLE

RESERVE TANK RESERVE TANK CAP

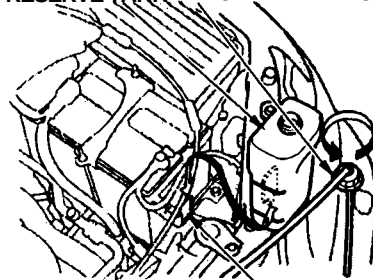

6-cylinder models

HOLDER

4. Remove the reserve tank from its holder by pulling it straight up. Drain the coolant, then put the tank back in its holder.

6-cylinder models

When removing the reserve tank, first remove the cruise control cable and the ground cable from their clips. After installing the tank back in place, put the cables back in their clips.

CONTINUED

Cooling System

5. When the coolant stops draining, tighten the drain plug in the bottom of the radiator.

6. 4-cylinder models

Put a new washer on the drain bolt, then reinstall the drain bolt in the engine block. Tighten it securely. Tightening torque:
61 lbf.ft (83 N.m , 8.5 kgf.m)

6-cylinder models

Tighten the drain bolt at the rear of the engine cylinder block securely. Tightening torque:
7 lbf.ft (10 N.m , 1.0 kgf.m)

FILLER NECK

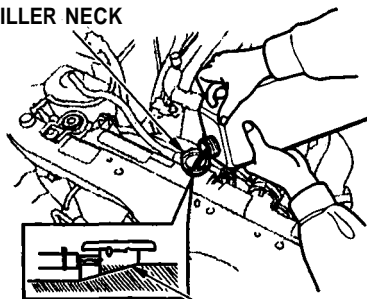

4-cylinder models

Fill up to here

7. Mix the recommended antifreeze with an equal amount of purified or distilled water in a clean container. The cooling system capacity is:

4-cylinder models

With 5-speed manual transmission:

1.45 US gal (5.5 ℓ , 1.21 Imp gal)

With automatic transmission:

1.43 US gal (5.4 ℓ , 1.19 Imp gal)

FILLER NECK

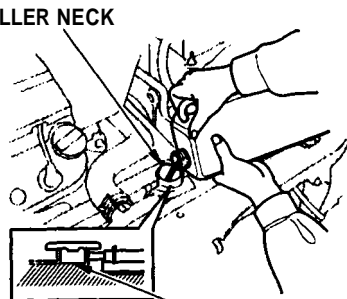

6-cylinder models

Fill up to here

6-cylinder models

1.48 US gal (5.6 ℓ , 1.23 Imp gal)

8. Pour coolant into the radiator up to the base of the filler neck.

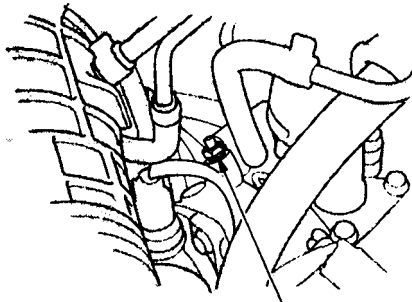

BLEEDER BOLT

9. 4-cylinder models only

Loosen the bleeder bolt on top of the engine. Tighten it again when coolant comes out in a steady stream with no bubbles.

RESERVE TANK

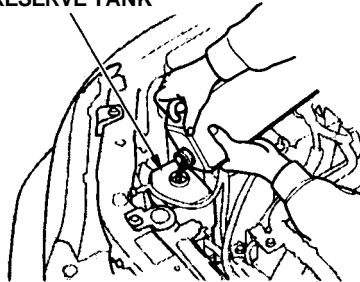

4-cylinder models

10. Refill the radiator to the base of the filler neck. Start the engine and let it run until it warms up (the radiator cooling fan comes on at least twice).

RESERVE TANK

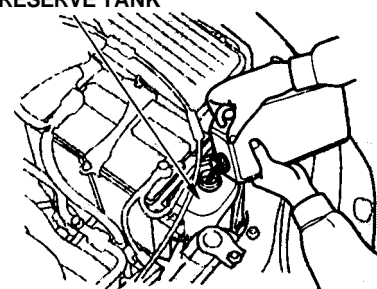

6-cylinder models

11. Turn off the engine. Check the level in the radiator, add coolant if needed. Install the radiator cap, and tighten it fully.

12. Fill the reserve tank to the MAX mark. Install the reserve tank cap.

Windshield Washers

Check the level in the windshield washer reservoir at least monthly during normal usage. In bad weather, when you use the washers often, check the level every time you stop for fuel.

4-cylinder models

The windshield washer reservoir is located behind the driver's side headlight.

6-cylinder models

The windshield washer reservoir is located behind the passenger's side headlight.

On Canadian models

The low washer level indicator will light when the level is low (see page 53).

Check the reservoir's fluid level by removing the cap and looking at the level gauge attached to the cap.

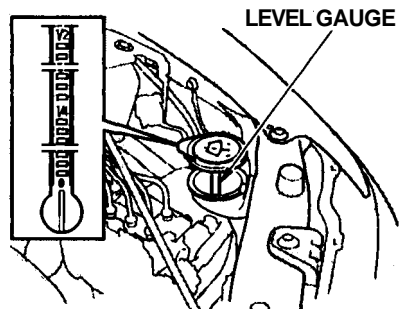

4-cylinder models

Fill the reservoir with a good-quality windshield washer fluid. This increases the cleaning capability and prevents freezing in cold weather.

When you refill the reservoir, clean the edges of the windshield wiper blades with windshield washer fluid on a clean cloth. This will help to condition the blade edges.

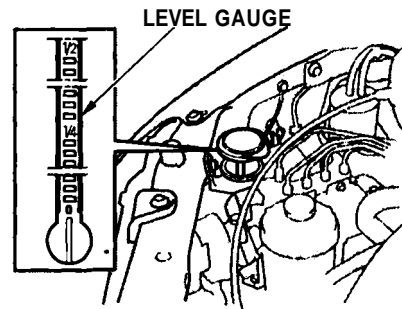

6-cylinder models

NOTICE

Do not use engine antifreeze or a vinegar/water solution in the windshield washer reservoir.

Antifreeze can damage your vehicle's paint, while a vinegar/water solution can damage the windshield washer pump.

Use only commercially-available windshield washer fluid.

Automatic Transmission

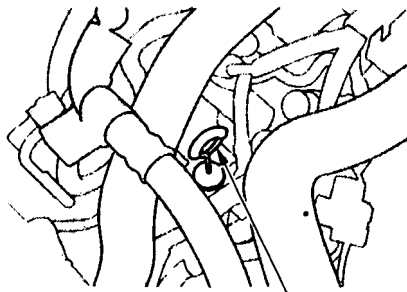

4-cylinder models **DIPSTICK**

Check the fluid level with the engine at normal operating temperature.

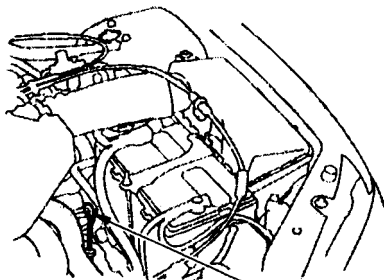

6-cylinder models **DIPSTICK**

1. Park the vehicle on level ground. Shut off the engine.
2. Remove the dipstick (yellow loop) from the transmission and wipe it with a clean cloth.

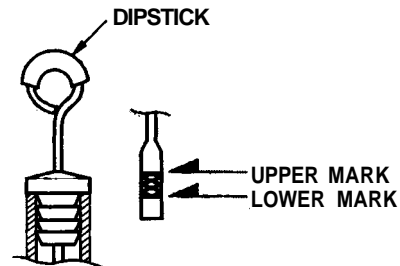

3. Insert the dipstick all the way into the transmission securely as shown in the illustration.
4. Remove the dipstick and check the fluid level. It should be between the upper and lower marks.

CONTINUED

Transmission Fluid

5. If the level is below the lower mark, add fluid into the tube to bring it to the upper mark. Always use Honda Premium Formula Automatic Transmission Fluid (ATF). If it is not available, you may use a DEXRON® III automatic transmission fluid as a temporary replacement. However, continued use can affect shift quality. Have the transmission drained and refilled with Honda ATF as soon as it is convenient.

6. Insert the dipstick all the way back into the transmission securely as shown in the illustration.

The transmission should be drained and refilled with new fluid according to the time and distance recommendations in the maintenance schedule.

5-speed Manual Transmission

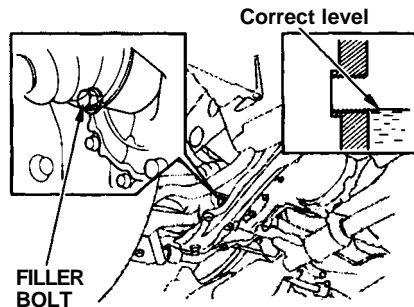

Check the fluid level with the transmission at normal operating temperature and the vehicle sitting on level ground. Remove the transmission filler bolt and carefully feel inside the bolt hole with your finger. The fluid level should be up to the edge of the bolt hole. If it is not, add Genuine Honda Manual Transmission Fluid (MTF) until it starts to run out of the hole. Reinstall the filler bolt and tighten it securely.

If Honda MTF is not available, you may use an API service SG, SH or SJ grade motor oil with a viscosity of SAE 10W-30 or 10W-40 as a temporary replacement. An SG grade is preferred, but an SH or SJ grade may be used if SG is not available. However, motor oil does not contain the proper additives and continued use can cause stiffer shifting. Replace as soon as convenient.

The transmission should be drained and refilled with new fluid according to the time and distance recommendations in the maintenance schedule.

Check the fluid level in the reservoirs monthly. There are up to two reservoirs, depending on model. They are:

- Brake fluid reservoir (all models)
- Clutch fluid reservoir (manual transmission only)

The brake fluid in the brake system should be replaced according to the time and distance recommendations in the maintenance schedule.

Always use Genuine Honda DOT 3 brake fluid. If it is not available, you should use only DOT 3 or DOT 4 fluid, from a sealed container, as a temporary replacement. However, the use of any non-Honda brake fluid can cause corrosion and decrease the life of the system. Have the brake system flushed and refilled with Honda DOT 3 brake fluid as soon as possible.

Brake fluid marked DOT 5 is not compatible with your vehicle's braking system and can cause extensive damage.

Brake System

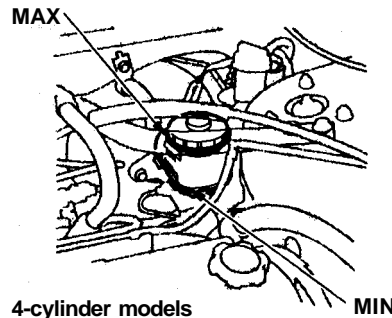

The fluid level should be between the MIN and MAX marks on the side of the reservoir. If the level is at or below the MIN mark, your brake system needs attention. Have the brake system inspected for leaks or worn brake pads.

CONTINUED

Brake and Clutch Fluid

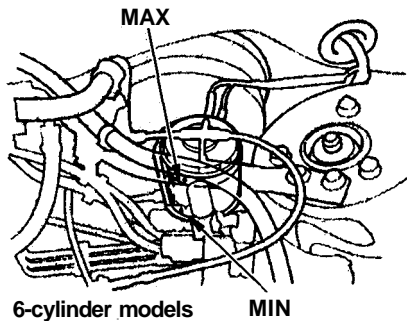

Clutch System

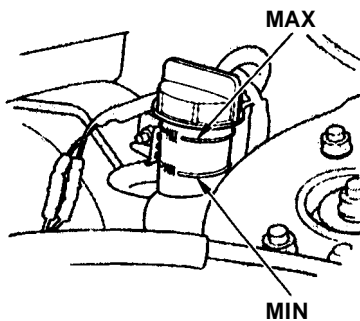

The fluid should be between the MIN and MAX marks on the side of the reservoir. If it is not, add brake fluid to bring it up to that level. Use the same fluid specified for the brake system.

Low fluid level can indicate a leak in the clutch system. Have this system inspected as soon as possible.

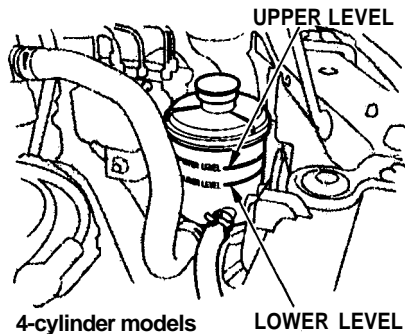

Check the level when the engine is cold. Look at the side of the reservoir. The fluid should be between the UPPER LEVEL and LOWER LEVEL. If it is below the LOWER LEVEL, add power steering fluid to the UPPER LEVEL.

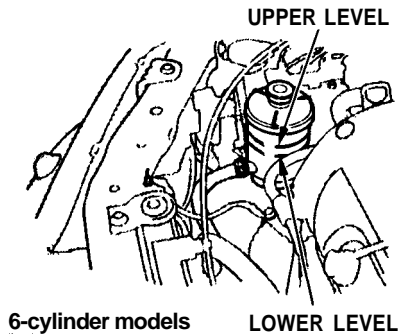

Always use Genuine Honda Power Steering Fluid. If it is not available, you may use another power steering fluid as an emergency replacement. However, continued use can cause increased wear and poor steering in cold weather. Have the power steering system flushed and refilled with Honda PSF as soon as possible.

A low power steering fluid level can indicate a leak in the system. Check the fluid level frequently and have the system inspected as soon as possible.

NOTICE

Turning the steering wheel to full left or right lock and holding it there can damage the power steering pump.

Air Cleaner Element

The air cleaner element should be cleaned or replaced according to the time and distance recommendations in the maintenance schedule.

Cleaning (Severe Conditions)

Clean the air cleaner element by blowing compressed air through it in the opposite direction to normal air flow. If you do not have access to compressed air (such as a service station), ask your Honda dealer to do this service.

Follow the replacement procedure for removal and reinstallation.

Replacement *4-cylinder Models*

HOLD-DOWN CLAMPS

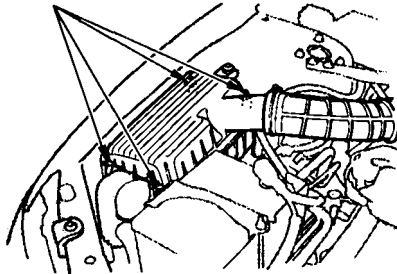

The air cleaner element is inside the air cleaner housing on the passenger's side of the engine compartment.

To replace it:

1. Unsnap the four hold-down clamps and remove the air cleaner housing cover.
2. Remove the old air cleaner element.

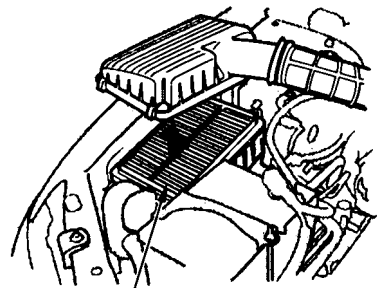

AIR CLEANER ELEMENT

3. Clean the inside of the air cleaner housing with a damp rag.
4. Place the new air cleaner element in the air cleaner housing.
5. Reinstall the air cleaner housing cover, snap the four hold-down clamps back into place.

Replacement

6-cylinder Models

The air cleaner element is inside the air cleaner housing on the driver's side of the engine compartment.

To replace it:

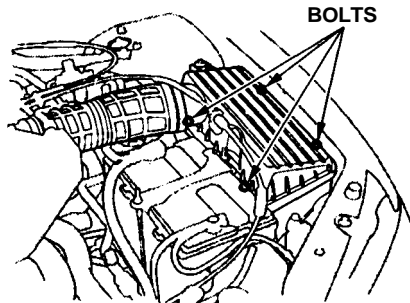

1. Loosen the four bolts and remove the air cleaner housing cover.
2. Remove the old air cleaner element.
3. Clean the inside of the air cleaner housing with a damp rag.

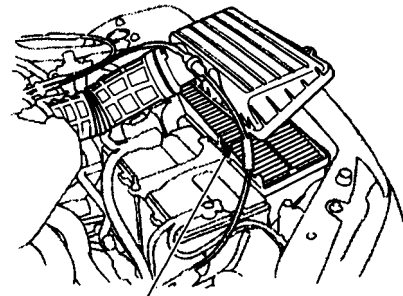

AIR CLEANER ELEMENT

4. Place the new air cleaner element in the air cleaner housing.
5. Reinstall the air cleaner housing cover, tighten the four bolts.

Spark Plugs (4-cylinder Models)

The spark plugs in your vehicle should be replaced according to the time and distance recommendations in the maintenance schedule.

Replacement

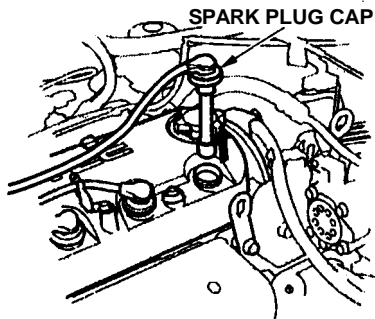

1. Clean up any dirt and oil around the spark plug caps.
2. Remove the spark plug cap by pulling it straight out.
3. Remove the spark plug with a five-eighths inch (16 mm) spark plug socket.

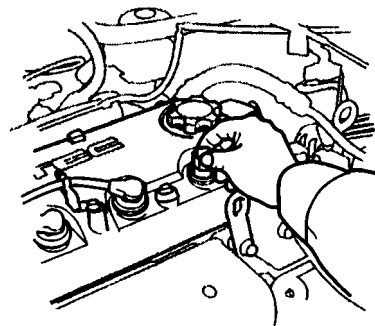

4. Put the new spark plug into the socket; then screw it into the hole. Screw it in by hand so you do not crossthead it.

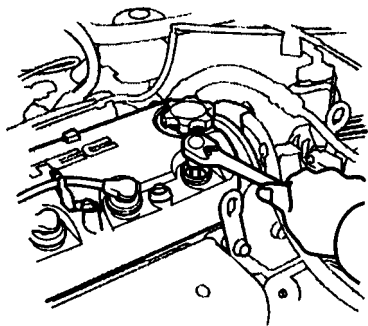

NOTICE

Tighten the spark plugs carefully. A spark plug that is too loose can overheat and damage the engine. Overtightening can cause damage to the threads in the cylinder head.

6. Install the spark plug cap.
7. Repeat this procedure for the other three spark plugs.

5. Torque the spark plug. (If you do not have a torque wrench, tighten the spark plug two-thirds of a turn after it contacts the cylinder head.)

Tightening torque:

13 lbf.ft (18 N.m, 1.8 kgf.m)

Specifications:

NGK: ZFR5F-11

DENSO: KJ16CR-L11

Spark Plug Gap:

0.04 in (1.1 mm)⁺⁰_{-0.1 mm}

Spark Plugs (6-cylinder Models)

The spark plugs in your vehicle are a special platinum-tipped design for longer life. The spark plugs should be replaced according to the time and distance recommendations in the maintenance schedule.

Replacement

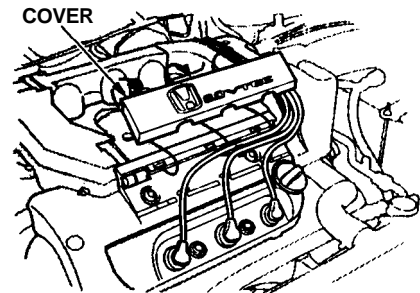

1. Remove the cover on the front cylinder bank by pulling on the front edge.

SPARK PLUG CAP

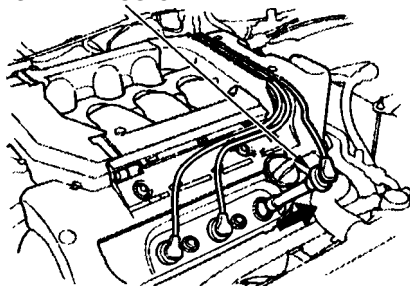

2. Clean up any dirt and oil around the spark plug caps.
3. Remove the spark plug cap by pulling it straight out.
4. Remove the spark plug with a five-eighths inch (16 mm) spark plug socket.

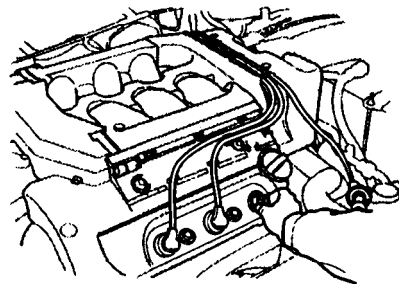

5. Put the new spark plug into the socket; then screw it into the hole. Screw it in by hand so you do not crossthead it.

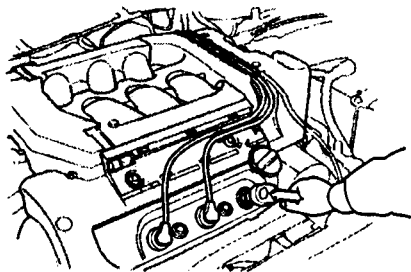

6. Torque the spark plug. (If you do not have a torque wrench, tighten the spark plug two-thirds of a turn after it contacts the cylinder head.)
Tightening torque:
13 lbf.ft (18 N.m, 1.8 kgf.m)

NOTICE

Tighten the spark plugs carefully. A spark plug that is too loose can overheat and damage the engine. Overtightening can cause damage to the threads in the cylinder head.

1. Install the spark plug cap.
8. Repeat this procedure for the other five spark plugs.
9. Reinstall the cover on the front cylinder bank.

Specifications:

NGK: PZFR5F-11
DENSO: PKJ16CR-L11

Spark Plug Gap:
0.04 in (1.1 mm)⁺⁰_{-0.1 mm}

Battery

Check the condition of your vehicle's battery monthly. You should check the color of the test indicator window, and for corrosion on the terminals.

TEST INDICATOR WINDOW

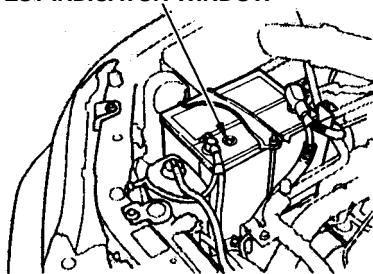

4-cylinder models

Check the battery condition by looking at the test indicator window on the battery. The label on the battery explains the test indicator's colors.

TEST INDICATOR WINDOW

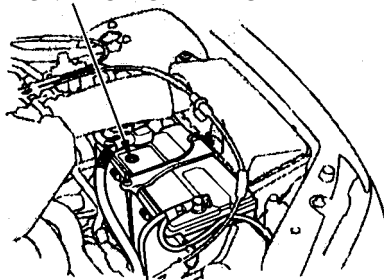

6-cylinder models

Check the battery terminals for corrosion (a white or yellowish powder). To remove it, cover the terminals with a solution of baking soda and water. It will bubble up and turn brown. When this stops, wash it off with plain water. Dry off the battery with a cloth or paper towel. Coat the terminals with grease to help prevent future corrosion.

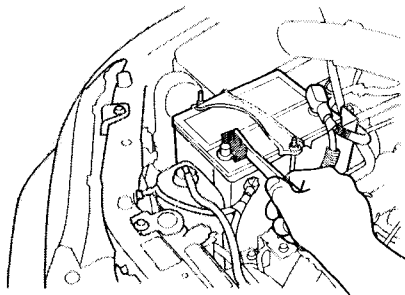

4-cylinder models

If the terminals are severely corroded, clean them with baking soda and water. Then use a wrench to loosen and remove the cables from the terminals. Always disconnect the negative (—) cable first and reconnect it last. Clean the battery terminals with a terminal cleaning tool or wire brush. Reconnect and tighten the cables, then coat the terminals with grease.

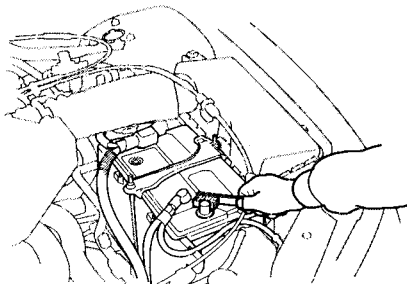

6-cylinder models

If you need to connect the battery to a charger, disconnect both cables to prevent damage to the vehicle's electrical system.

The battery gives off explosive hydrogen gas during normal operation.

A spark or flame can cause the battery to explode with enough force to kill or seriously hurt you.

Wear protective clothing and a face shield, or have a skilled mechanic do the battery maintenance.

CONTINUED

Battery

On EX and EX-V6 models

If your vehicle's battery is disconnected or goes dead, the audio system will disable itself. The next time you turn on the radio you will see "Code" in the frequency display. Use the Preset buttons to enter the five-digit code (see page [150](#)).

NOTICE

Charging the battery with the cables connected can seriously damage your vehicle's electronic controls. Detach the battery cables before connecting the battery to a charger.

Check the condition of the wiper blades at least every six months. Look for signs of cracking in the rubber, or areas that are getting hard. Replace the blades if you find these signs, or they leave streaks and unwiped areas when used.

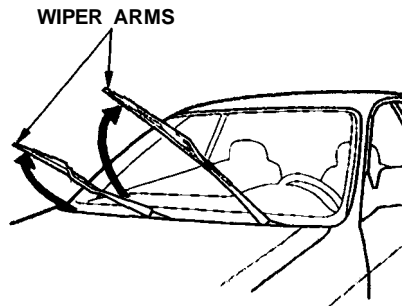

To replace the blade:

1. Raise the wiper arm off the windshield.
Raise the driver's side first, then the passenger's side.

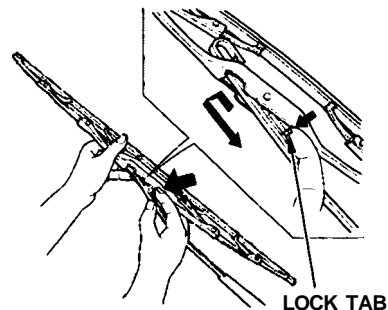

2. Disconnect the blade assembly from the wiper arm by pushing in the lock tab. Hold it in while you push the blade assembly toward the base of the arm.

CONTINUED

Wiper Blades

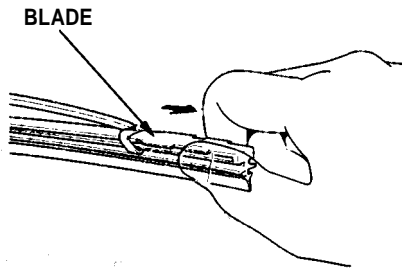

3. Remove the blade from its holder by grasping the tabbed end of the blade. Pull firmly until the tabs come out of the holder.

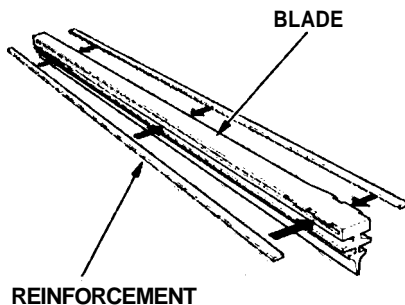

4. Examine the new wiper blades. If they have no plastic or metal reinforcement along the back edge, remove the metal reinforcement strips from the old wiper blade and install them in the slots along the edge of the new blade.

5. Slide the new wiper blade into the holder until the tabs lock.
6. Slide the wiper blade assembly onto the wiper arm. Make sure it locks in place.
7. Lower the wiper arm down against the windshield. Lower the passenger's side first, then the driver's side.

Your vehicle's air conditioning is a sealed system. Any major maintenance, such as recharging, should be done by a qualified mechanic. You can do a couple of things to make sure the air conditioning works efficiently.

Periodically check the engine's radiator and air conditioning condenser for leaves, insects, and dirt stuck to the front surface. These block the air flow and reduce cooling efficiency. Use a light spray from a hose or a soft brush to remove them.

NOTICE

The condenser and radiator fins bend easily. Only use a low-pressure spray or soft-bristle brush to clean them.

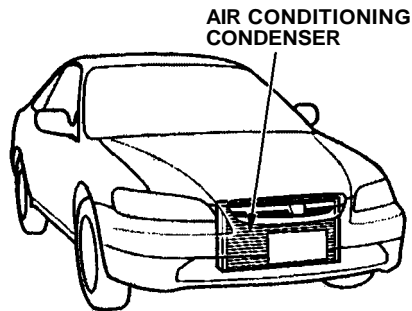

Run the air conditioning at least once a week during the cold weather months. Run it for at least ten minutes while you are driving at a steady speed with the engine at normal operating temperature. This circulates the lubricating oil contained in the refrigerant.

If the air conditioning does not get as cold as before, have your dealer check the system. Recharge the system with Refrigerant HFC-134a (R-134a). (See Specifications on pages [296](#) and [298](#).)

NOTICE

Whenever you have the air conditioning system serviced, make sure the service facility uses a refrigerant recycling system. This system captures the refrigerant for reuse. Releasing refrigerant into the atmosphere can damage the environment.

Air Conditioning Filter, Drive Belts

Air Conditioning Filter

The air conditioning filter removes pollen and dust that is brought in from the outside through the heating and cooling system/climate control system.

This filter should be replaced every 30,000 miles (48,000 km) under normal conditions. It should be replaced every 15,000 miles (24,000 km) if you drive primarily in urban areas that have high concentrations of soot in the air from industry and diesel-powered vehicles. Replace it more often if air flow from the heating and cooling system/climate control system becomes less than usual. Have the air conditioning filter replaced by your Honda dealer.

Drive Belts

ALTERNATOR BELT

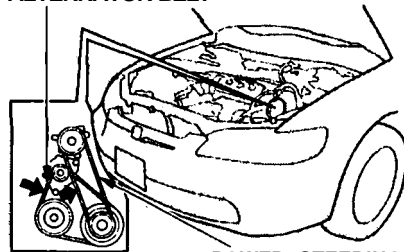

4-cylinder models

POWER STEERING BELT

Check the condition of the drive belts (two on 4-cylinder models, one on 6-cylinder models). Examine the edges of each belt for cracks or fraying.

POWER STEERING BELT

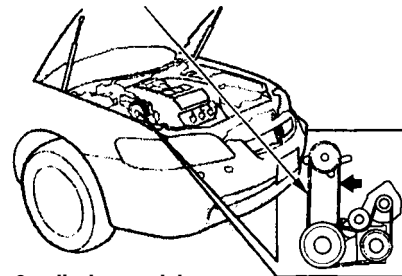

6-cylinder models

Check the tension of each belt by pushing on it with your thumb midway between the pulleys.

The belts should have the following "play" or deflection.

4-cylinder models

Alternator belt:

0.28 — 0.35 in (7.0 — 9.0 mm)

Power steering belt:

0.51 — 0.63 in (13.0 — 16.0 mm)

6-cylinder models

Power steering belt:

0.51 — 0.65 in (13.0 — 16.5 mm)

If you see signs of wear or looseness, have your dealer adjust or replace the belts.

Timing Belt

The timing belt and balancer belt (4-cylinder models only) should normally be replaced at the intervals shown in the maintenance schedule.

Replace these belts at 60,000 miles (U.S.) or 100,000 km (Canada) if you regularly drive your vehicle in one or more of these conditions:

- In very high temperatures (over 110°F, 43°C).
- In very low temperatures (under —20°F, —29°C).

To safely operate your vehicle, your tires must be the proper type and size, in good condition with adequate tread, and correctly inflated. The following pages give more detailed information on how and when to check air pressure, how to inspect your tires for damage and wear, and what to do when your tires need to be replaced.

Using tires that are excessively worn or improperly inflated can cause a crash in which you can be seriously hurt or killed.

Follow all instructions in this owner's manual regarding tire inflation and maintenance.

Inflation

Keeping the tires properly inflated provides the best combination of handling, tread life and riding comfort. Underinflated tires wear unevenly, adversely affect handling and fuel economy, and are more likely to fail from being overheated. Overinflated tires can make your vehicle ride more harshly, are more prone to damage from road hazards, and wear unevenly.

We recommend that you visually check your tires every day. If you think a tire might be low, check it immediately with a tire gauge.

Use a gauge to measure the air pressure at least once a month. Even tires that are in good condition may lose 1 to 2 psi (7 to 15 kPa, 0.07 to 0.15 kgf/cm²) per month. Remember to check the spare tire at the same time you check all the other tires.

Check the pressure in the tires when they are cold. This means the vehicle has been parked for at least three hours. If you have to drive the vehicle before checking the tire pressure, the tires can still be considered "cold" if you drive less than 1 mile (1.6 km).

If you check the pressure when the tires are hot (the vehicle has been driven several miles), you will see readings 4 to 6 psi (30 to 40 kPa, 0.3 to 0.4 kgf/cm²) higher than the cold reading. This is normal. Do not let air out to match the specified cold pressure. The tire will be underinflated.

You should get your own tire pressure gauge and use it whenever you check your tire pressures. This will make it easier for you to tell if a pressure loss is due to a tire problem and not due to a variation between gauges.

Recommended Tire Pressures for Normal Driving

The following chart shows the recommended cold tire pressures for most normal driving conditions and speeds. Tire pressures for high speed driving are the same as for normal driving.

(LX, EX)

Tire Size	Cold Tire Pressure for Normal Driving
P195/65R15 89H	29 psi (200 kPa , 2.0 kgf/cm ²)

(LX-V6)

Tire Size	Cold Tire Pressure for Normal Driving
P205/65R15 92V	30 psi (210 kPa , 2.1 kgf/cm ²)

(EX-V6)

Tire Size	Cold Tire Pressure for Normal Driving
P205/60R16 91V	32 psi (220 kPa , 2.2 kgf/cm ²)

The compact spare tire pressure is:
60 psi (420 kPa , 4.2 kgf/cm²)

These pressures are also given on the tire information label on the driver's doorjamb.

Tubeless tires have some ability to self-seal if they are punctured. However, because leakage is often very slow, you should look closely for punctures if a tire starts losing pressure.

Inspection

Every time you check inflation, you should also examine the tires for damage, foreign objects, and wear.

You should look for:

- Bumps or bulges in the tread or side of the tire. Replace the tire if you find either of these conditions.
- Cuts, splits, or cracks in the side of the tire. Replace the tire if you can see fabric or cord.
- Excessive tread wear.

CONTINUED

INDICATOR LOCATION MARKS

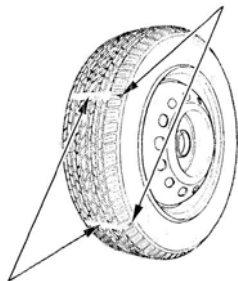

TREAD WEAR INDICATORS

Your vehicle's tires have wear indicators molded into the tread. When the tread wears down to that point, you will see a 1/2 inch (12.7 mm) wide band running across the tread. This shows there is less than 1/16 inch (1.6 mm) of tread left on the tire. A tire that is this worn gives very little traction on wet roads. You should replace the tire if you can see the tread wear indicator in three or more places around the tire.

Maintenance

In addition to proper inflation, correct wheel alignment helps to decrease tire wear. If you find a tire is worn unevenly, have your dealer check the wheel alignment.

The tires were properly balanced by the factory. They may need to be rebalanced at some time before they are worn out. Have your dealer check the tires if you feel a consistent vibration while driving. A tire should always be rebalanced if it is removed from the wheel for repair.

Make sure the installer balances the wheels when you have new tires installed. This increases riding comfort and tire life. Your vehicle's original tires were dynamic or "spin" balanced at the factory. For best results, have the installer perform a dynamic balance.

NOTICE

(On some models)
Improper wheel weights can damage your vehicle's aluminum wheels. Use only Genuine Honda wheel weights for balancing.

Tire Rotation

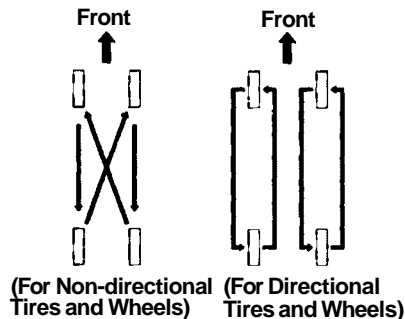

To help increase tire life and distribute wear more evenly, you should have the tires rotated every 7,500 miles (12,000 km). Move the tires to the positions shown in the chart each time they are rotated.

When shopping for replacement tires, you may find that some tires are "directional." This means they are designed to rotate only in one direction. If you use directional tires, they should be rotated only front-to-back.

Replacing Tires and Wheels

The tires that came with your vehicle were selected to match the performance capabilities of the vehicle while providing the best combination of handling, ride comfort, and long life. You should replace them with radial tires of the same size, load range, speed rating, and maximum cold tire pressure rating (as shown on the tire's sidewall). Mixing radial and bias-ply tires on your vehicle can reduce its braking ability, traction, and steering accuracy.

Installing improper tires on your vehicle can affect handling and stability. This can cause a crash in which you can be seriously hurt or killed.

Always use the size and type of tires recommended in this owner's manual.

It is best to replace all four tires at the same time. If that is not possible or necessary, then replace the two front tires or the two rear tires as a pair. Replacing just one tire can seriously affect your vehicle's handling.

CONTINUED

The ABS works by comparing the speed of the wheels. When replacing tires, use the same size originally supplied with the vehicle. Tire size and construction can affect wheel speed and may cause the system to work inconsistently.

If you ever need to replace a wheel, make sure the wheel's specifications match those of the original wheel that came on your vehicle. Replacement wheels are available at your Honda dealer.

Wheels and Tires

Wheel:

(LX, EX)

15 x 6 JJ

(LX-V6)

15 x 6 1/2 JJ

(EX-V6)

16 x 6 1/2 JJ

Tire:

(LX, EX)

P195/65R15 89H

(LX-V6)

P205/65R15 92V

(EX-V6)

P205/60R16 91V

See *Tire Information* on page [300](#) for additional information about tire and wheel size designations. See page [301](#) for information about DOT Tire Quality Grading.

Winter Driving

Tires that are marked "M + S" or "All Season" on the sidewall have an all-weather tread design. They should be suitable for most winter driving conditions. Tires without these markings are designed for optimum traction in dry conditions. They may not provide adequate performance in winter driving. For the best performance in snowy or icy conditions, you should install snow tires or tire chains. They may be required by local laws under certain conditions.

Snow Tires

If you mount snow tires on your Honda, make sure they are radial tires of the same size and load range as the original tires. Mount snow tires on all four wheels to balance your vehicle's handling in all weather conditions. Keep in mind the traction provided by snow tires on dry roads may not be as high as your vehicle's original equipment tires. You should drive cautiously even when the roads are clear. Check with the tire dealer for maximum speed recommendations.

Tire Chains

Mount snow chains on your vehicle when warranted by driving conditions or required by local laws. Make sure the chains are the correct size for your tires. Install them only on the front tires.

4-cylinder models

If metal chains are used, they must be SAE class "S". Cable-type traction devices can also be used.

6-cylinder models

Use only SAE class "S" cable-type traction devices.

When installing chains, follow the manufacturer's instructions and mount them as tightly as you can. Drive slowly with chains installed. If you hear the chains contacting the body or chassis, stop and investigate. Make sure the chains are installed tightly, and that they are not contacting the brake lines or suspension. Remove the chains as soon as you begin driving on cleared roads.

NOTICE

Chains of the wrong size or that are improperly installed can damage your vehicle's brake lines, suspension, body, and wheels. Stop driving if you hear the chains hitting any part of the vehicle.

Lights

Check the operation of your vehicle's exterior lights at least once a month. A burned out bulb can create an unsafe condition by reducing your vehicle's visibility and the ability to signal your intentions to other drivers.

HEADLIGHT HIGH BEAM

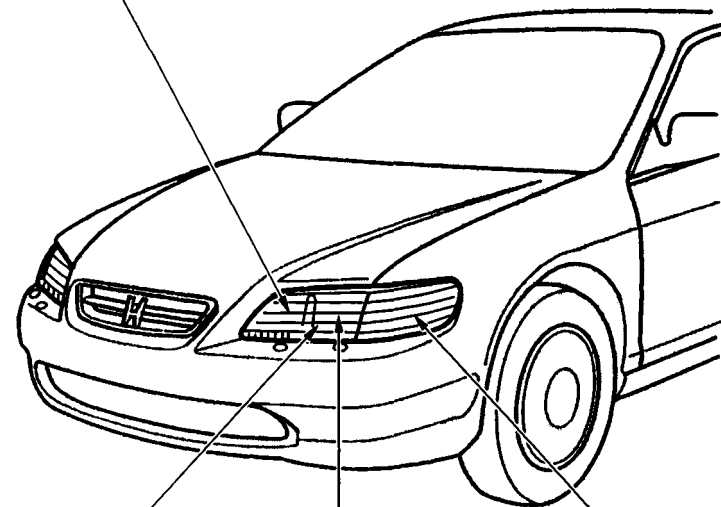

PARKING LIGHT

HEADLIGHT LOW BEAM

TURN SIGNAL/SIDE
MARKER LIGHT

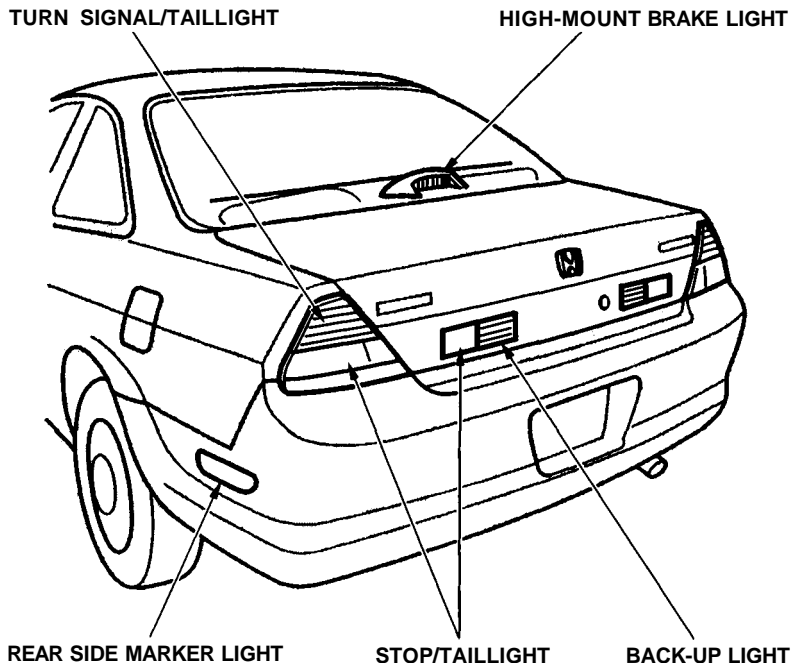

Check the following:

- Headlights (low and high beam)
- Parking lights
- Taillights
- Brake lights
- High-mount brake light
- Turn signals
- Back-up lights
- Hazard light function
- License plate light
- Side marker lights
- Daytime running lights (Canadian models)

If you find any bulbs are burned out, replace them as soon as possible. Refer to the chart on pages [297](#) and [299](#) to determine what type of replacement bulb is needed.

Headlight Aiming

The headlights were properly aimed when your vehicle was new. You should check their aim if you regularly carry heavy items in the trunk or pull a trailer. Each headlight assembly has horizontal and vertical adjustment indicators. These are set to their standard positions after the headlights are aimed at the factory.

To check these settings:

1. Make sure the fuel tank is full.
Park the vehicle on level ground.
2. The driver or someone who weighs the same should be sitting in the driver's seat for all checks and adjustments.
Load the trunk with the items you normally carry.

HORIZONTAL ANGLE GAUGE

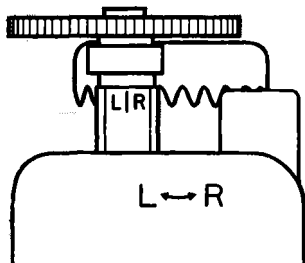

If you usually pull a trailer, load it as you would normally and attach it to the vehicle. Push down on the front and rear bumpers several times to make sure the vehicle is sitting normally.

3. Open the hood.
4. Check the horizontal angle gauge. The line on the adjustment screw indicator should line up with the mark on the gauge.

VERTICAL ANGLE GAUGE

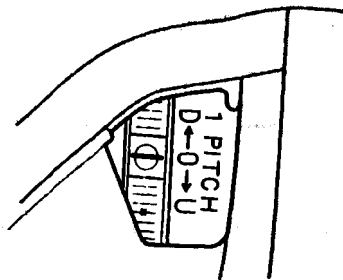

5. Check the vertical angle gauge. The bubble should be located underneath the "0" mark on the gauge.

HORIZONTAL ADJUSTMENT

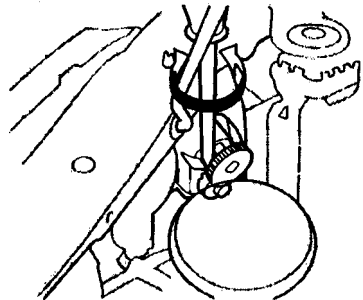

6. If either indicator is not aligned with its mark as described, an adjustment can be made using a Phillips-head screwdriver to realign it with the mark. Please refer to the illustrations.

VERTICAL ADJUSTMENT

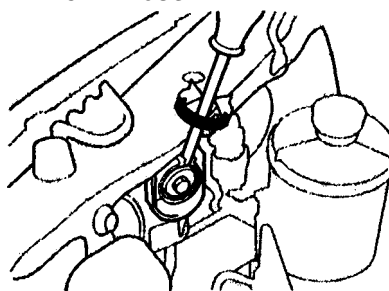

7. If you cannot get an indicator to align, have your Honda dealer inspect the vehicle for body damage or suspension problems.

Replacing a Headlight Bulb

Your vehicle has two bulbs on each side, four in total. Make sure you are replacing the bulb that is burned out. Your vehicle uses halogen headlight bulbs. When replacing a bulb, handle it by its plastic case and protect the glass from contact with your skin or hard objects. If you touch the glass, clean it with denatured alcohol and a clean cloth.

NOTICE

Halogen headlight bulbs get very hot when lit. Oil, perspiration, or a scratch on the glass can cause the bulb to overheat and shatter.

CONTINUED

Lights

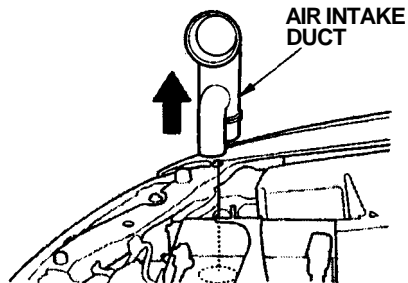

4-cylinder models

1. Open the hood.

4-cylinder models

If you need to change the headlight bulb on the passenger's side, remove the radiator reserve tank and the air intake duct.

6-cylinder models

If you need to change the headlight bulb on the driver's side, remove the radiator reserve tank.

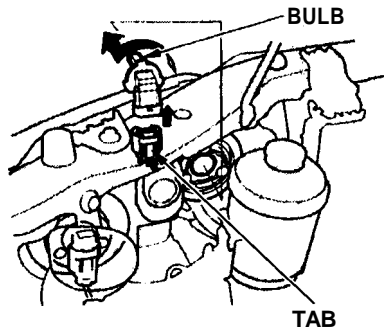

2. Remove the electrical connector from the bulb by squeezing the connector to unlock the tab, then slide the connector off the bulb.
3. Remove the bulb by turning it approximately one-quarter turn counterclockwise.
4. Insert the new bulb into the hole and turn it one-quarter turn clockwise to lock it in place.

5. Push the electrical connector back onto the bulb. Make sure it is on all the way.

6. Turn on the headlights to test the new bulb.

7. *4-cylinder models*

(Passenger's side)

Reinstall the radiator reserve tank and the air intake duct.

6-cylinder models

(Driver's side)

Reinstall the radiator reserve tank.

Replacing Front Turn Signal and Side Marker Light Bulbs

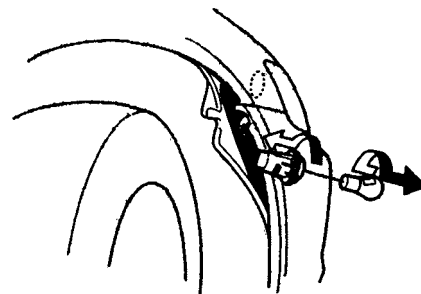
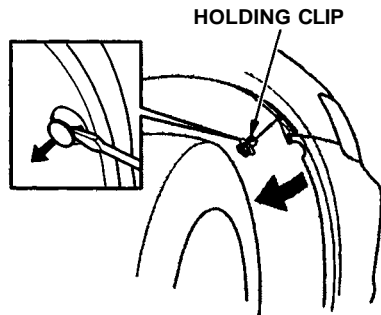

1. If you are changing the bulb on the driver's side, start the engine, turn the steering wheel all the way to the right, and turn off the engine. If you are changing the bulb on the passenger's side, turn the steering wheel to the left.

2. Use a flat-tipped screwdriver to remove the holding clip from the inner fender.
3. Pull the inner fender away from the fender and bumper.
4. Remove the socket from the headlight assembly by turning it one-quarter turn counterclockwise.

5. Remove the burned out bulb from the socket by pushing it in and turning counterclockwise until it unlocks.
6. Install the new bulb in the socket. Turn it clockwise to lock it in place.
7. Insert the socket back into the headlight assembly. Turn it clockwise to lock it in place.
8. Test the lights to make sure the new bulb is working.
9. Put the inner fender in place. Install the holding clip. Lock it in place by pushing on the center.

Replacing a Parking Light Bulb

POWER STEERING FLUID TANK

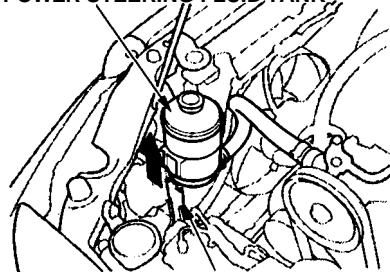

HOLDER

1. Open the hood. The front parking light is next to the headlight bulb.

4-cylinder models

If you need to change a bulb on the passenger's side, remove the radiator reserve tank. On the driver's side, remove the power steering fluid tank.

6-cylinder models

If you need to change a bulb on

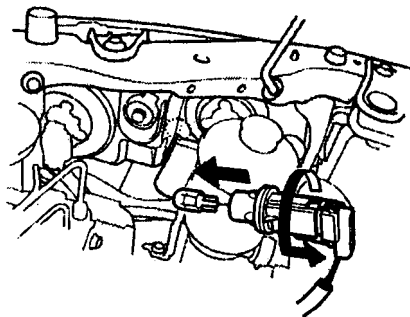

2. Remove the socket from the headlight assembly by turning it one-quarter turn counterclockwise.

3. Pull the bulb straight out of its socket.

Push the new bulb straight into the socket until it bottoms.

4. Insert the socket back into the headlight assembly. Turn it clockwise to lock it in place.

5. Turn on the parking lights to make sure the new bulb works.

6-cylinder models

(Passenger's side)

Reinstall the radiator reserve tank.

(Driver's side)

Reinstall the power steering fluid tank.

6-cylinder models

(Driver's side)

Reinstall the radiator reserve tank.

Replacing Rear Bulbs (in Fenders)

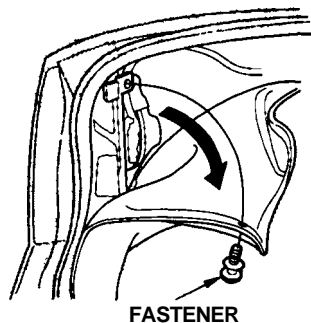

1. Open the trunk.
2. Remove the fastener on the side of the trunk lining by turning it counterclockwise. Pull the lining back.

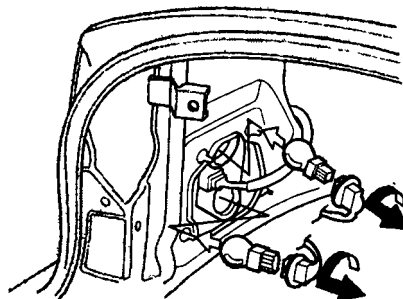

3. Determine which of the two bulbs is burned out: stop/taillight or turn signal/taillight.

4. Remove the socket by turning it one-quarter turn counterclockwise.
5. Pull the bulb straight out of its socket. Push the new bulb straight into the socket until it bottoms.
6. Reinstall the socket into the light assembly by turning it clockwise until it locks.
7. Test the lights to make sure the new bulb is working.
8. Reinstall the trunk lining. Make sure it is installed under the edge of the trunk seal.

CONTINUED

9. Reinstall the rear panel.
Put each fastener in the hole on the rear panel and push on the center until it locks (the center is flush with the head).
10. Put the fastener in the hole of the side of the trunk lining and push on the center until it locks (the center is flush with the head).

Replacing Rear Bulbs (in Trunk Lid)

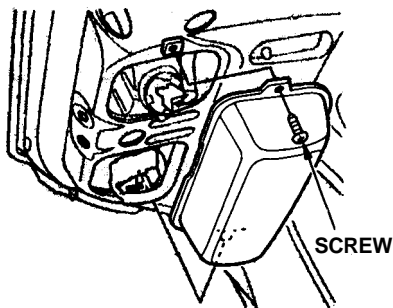

1. Open the trunk.
2. Remove the screw securing the plastic cover. Then remove the plastic cover.

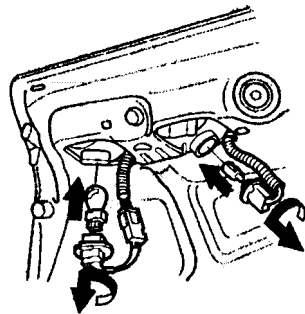

3. Determine which of the two bulbs is burned out: stop/taillight or back-up light.

4. Remove the socket by turning it one-quarter turn counterclockwise.
5. Pull the bulb straight out of its socket.
Push the new bulb straight into the socket until it bottoms.
6. Reinstall the socket into the light assembly.
7. Test the lights to make sure the new bulb is working.
8. Reinstall the plastic cover and secure it with the screw.

Replacing a Rear Side Marker Light Bulb

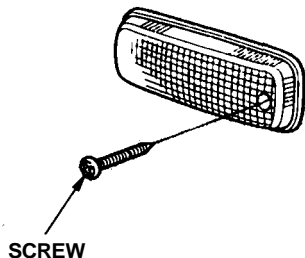

1. Use a Phillips-head screwdriver to loosen the side marker assembly mounting screw.
2. Remove the assembly from the fender by pulling out the back edge and sliding the assembly backwards.

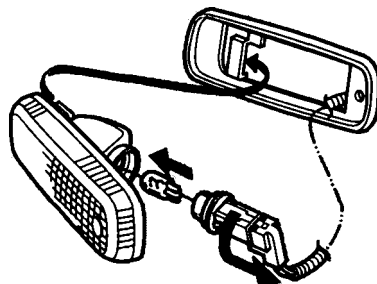

3. Remove the socket from the light assembly by turning it counterclockwise.
4. Remove the bulb from the socket by pulling it straight out.
Install the new bulb. Turn on the headlights to test the bulb.

CONTINUED

5. Insert the socket in the assembly.
Turn it clockwise to lock it in place.
6. Reinstall the side marker assembly in the bumper. Tighten the mounting screw securely.

Replacing a High-mount Brake Light Bulb

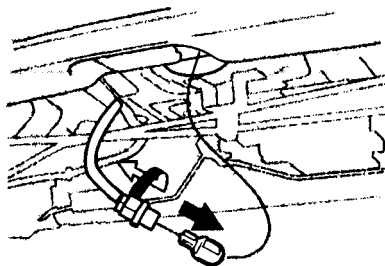

1. Open the trunk and remove the socket from the light assembly by turning it one-quarter turn counter-clockwise.
2. Remove the burned-out bulb by pulling it straight out of the socket.

3. Install the new bulb and reinstall the socket. Make sure the new bulb is working.

Replacing a Rear License Bulb

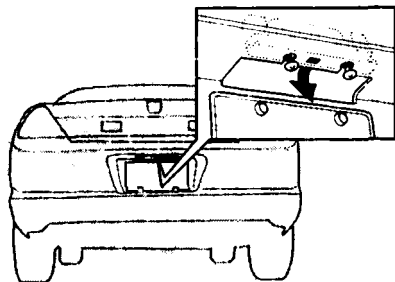

1. Use a Phillips-head screwdriver to loosen the two screws holding the license plate light bracket. Slide the bracket out from the bumper.

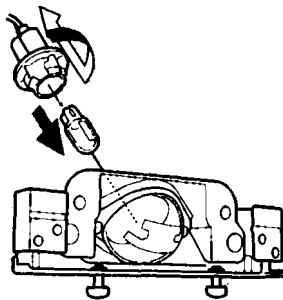

2. Remove the socket from the light assembly by turning it one-quarter turn counterclockwise.
3. Pull the bulb straight out of its socket. Push the new bulb in until it bottoms in the socket.

4. Turn on the parking lights and check that the new bulb is working.
5. Put the license light bracket in place. Tighten the two screws securely.

Lights

Replacing Bulbs in the Interior Courtesy Lights

The ceiling light, door light and vanity mirror light come apart the same way. They do not all use the same bulb.

CEILING LIGHT

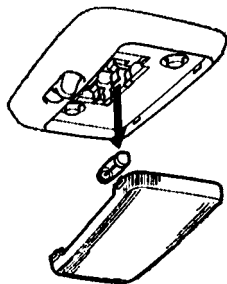

1. Remove the lens by carefully prying on the edge of the lens with a fingernail file or a small flat-tip screwdriver. Do not pry on the edge of the housing around the lens.

DOOR LIGHT

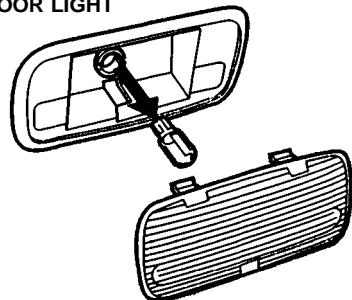

Door light:

Pry on the top middle of the lens.

Ceiling light:

pry on the front edge of the lens near both sides.

SPOTLIGHT

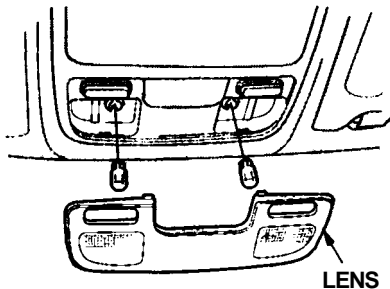

Spotlight:
pry on the front edge in front of
both spotlights.

VANITY MIRROR LIGHT

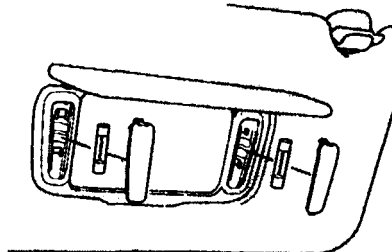

2. Remove the bulb by pulling it straight out of its metal tabs.
3. Push the new bulb into the metal tabs. Snap the lens back in place.

Replacing the Trunk Light Bulb

TRUNK LIGHT

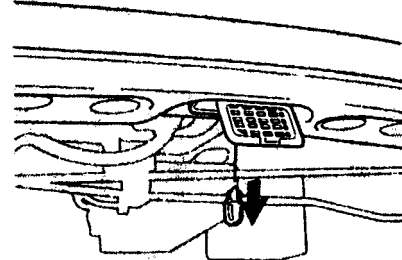

1. Open the trunk. Pull down the trunk light cover.
2. Remove the bulb by pulling it straight out of its metal tabs.
3. Push the new bulb into the metal tabs.
4. Push the cover back in place.

Storing Your Vehicle

If you need to park your vehicle for an extended period (more than one month), there are several things you should do to prepare it for storage. Proper preparation helps prevent deterioration and makes it easier to get your vehicle back on the road. If possible, store your vehicle indoors.

- Fill the fuel tank.
- Change the engine oil and filter (see page 208).
- Wash and dry the exterior completely.
- Clean the interior. Make sure the carpeting, floor mats, etc. are completely dry.
- Leave the parking brake off. Put the transmission in Reverse (5-speed manual) or Park (automatic).

- Block the rear wheels.
- If the vehicle is to be stored for a longer period, it should be supported on jackstands so the tires are off the ground.
- Leave one window open slightly (if the vehicle is being stored indoors).
- Disconnect the battery.
- Support the front wiper blade arms with a folded towel or rag so they do not touch the windshield.
- To minimize sticking, apply a silicone spray lubricant to all door and trunk seals. Also, apply a vehicle body wax to the painted surfaces that mate with the door and trunk seals.

- Cover the vehicle with a "breathable" vehicle cover, one made from a porous material such as cotton. Nonporous materials, such as plastic sheeting, trap moisture, which can damage the paint.
- If possible, run the engine for a while periodically (preferably once a month).

If you store your vehicle for 12 months or longer, have your Honda dealer perform the inspections called for in the 24 months/30,000 miles (48,000 km) maintenance schedule (Normal Conditions) as soon as you take it out of storage (see page 196). The replacements called for in the maintenance schedule are not needed unless the vehicle has actually reached that time or mileage.

Regular cleaning and polishing of your Honda helps to keep it "new" looking. This section gives you hints on how to clean your vehicle and preserve its appearance: the paint, brightwork, wheels and interior. Also included are several things you can do to help prevent corrosion.

Exterior Care.....	260
Washing.....	260
Waxing.....	261
Aluminum Wheels.....	261
Paint Touch-up.....	261
Interior Care.....	262
Carpeting.....	262
Fabric.....	262
Vinyl.....	262
Leather.....	262
Seat Belts.....	263
Windows.....	263
Air Fresheners.....	263
Corrosion Protection.....	264
Body Repairs.....	265

Exterior Care

Washing

Frequent washing helps preserve your vehicle's beauty. Dirt and grit can scratch the paint, while tree sap and bird droppings can permanently ruin the finish.

Wash your vehicle in a shady area, not in direct sunlight. If the vehicle is parked in the sun, move it into the shade and let the exterior cool down before you start.

Only use the solvents and cleaners recommended in this Owner's Manual.

NOTICE

Chemical solvents and strong cleaners can damage the paint, metal, and plastic on your vehicle.

- Rinse the vehicle thoroughly with cool water to remove loose dirt.
 - Fill a bucket with cool water. Mix in a mild detergent, such as dishwashing liquid or a product made especially for vehicle washing.
 - Wash the vehicle using the water and detergent solution and a soft-bristle brush, sponge, or soft cloth. Start at the top and work your way down. Rinse frequently.
 - Check the body for road tar, tree sap, etc. Remove these stains with tar remover or turpentine. Rinse it off immediately so it does not harm the finish. Remember to re-wax these areas, even if the rest of the vehicle does not need waxing.
- When you have washed and rinsed the whole exterior, dry it with a chamois or soft towel. Letting it air-dry will cause dulling and water spots.

As you dry the vehicle, inspect it for chips and scratches that could allow corrosion to start. Repair them with touch-up paint (see page [261](#)).

Waxing

Always wash and dry the whole vehicle before waxing it. You should wax your vehicle, including the metal trim, whenever water sits on the surface in large patches. It should form into beads or droplets after waxing.

You should use a quality liquid or paste wax. Apply it according to the instructions on the container. In general, there are two types of products:

Waxes — A wax coats the finish and protects it from damage by exposure to sunlight, air pollution, etc. You should use a wax on your Honda when it is new.

Polishes — Polishes and cleaner/waxes can restore the shine to paint that has oxidized and lost some of its shine. They normally contain mild abrasives and solvents that remove

the top layer of the finish. You should use a polish on your Honda if the finish does not have its original shine after using a wax.

Cleaning tar, insects, etc. with removers also takes off the wax. Remember to re-wax those areas, even if the rest of the vehicle does not need waxing.

Aluminum Wheels

On some models

Clean your Honda's aluminum alloy wheels as you do the rest of the exterior. Wash them with the same solution, and rinse them thoroughly.

The wheels have a protective clear-coat that keeps the aluminum from corroding and tarnishing. Using harsh chemicals, including some commercial wheel cleaners, or stiff brushes can damage this clear-coat. Only use a mild detergent and soft brush or sponge to clean the wheels.

Paint Touch-up

Your dealer has touch-up paint to match your vehicle's color. The color code is printed on a sticker on the driver's doorjamb. Take this code to your dealer so you are sure to get the correct color.

Inspect your vehicle frequently for chips or scratches in the paint. Repair them right away to prevent corrosion of the metal underneath. Use the touch-up paint only on small chips and scratches. More extensive paint damage should be repaired by a professional.

Carpeting

Vacuum the carpeting frequently to remove dirt. Ground-in dirt will make the carpet wear out faster.

Periodically shampoo the carpet to keep it looking new. Use one of the foam-type carpet cleaners on the market. Follow the instructions that come with the cleaner, applying it with a sponge or soft brush. Keep the carpeting as dry as possible by not adding water to the foam.

Fabric

Vacuum dirt and dust out of the material frequently. For general cleaning, use a solution of mild soap and lukewarm water, letting it air dry. To clean off stubborn spots, use a commercially-available fabric cleaner. Test it on a hidden area of the fabric first, to make sure it does not bleach or stain the fabric. Follow the instructions that come with the cleaner.

Vinyl

Remove dirt and dust with a vacuum cleaner. Wipe the vinyl with a soft cloth dampened in a solution of mild soap and water. Use the same solution with a soft-bristle brush on more difficult spots. You can also use commercially-available spray or foam-type vinyl cleaners.

Leather

On EX and EX-V6 models

Vacuum dirt and dust from the leather frequently. Pay particular attention to the pleats and seams. Clean the leather with a soft cloth dampened with clear water, then buff it with a clean, dry cloth. If further cleaning is needed, use a soap specifically for leather, such as saddle soap. Apply this soap with a damp, soft cloth. Wipe down and buff as described above.

Seat Belts

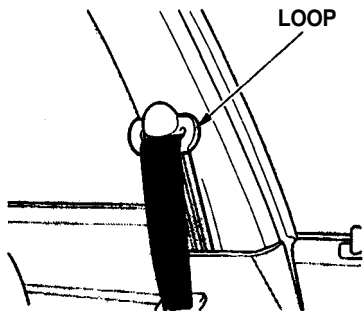

If your seat belts get dirty, you can use a soft brush with a mixture of mild soap and warm water to clean them. Do not use bleach, dye, or cleaning solvents. They can weaken the belt material. Let the belts air-dry before you use the vehicle.

Dirt build-up in the loops of the seat belt anchors can cause the belts to retract slowly. Wipe the insides of the loops with a clean cloth dampened in mild soap and warm water or isopropyl alcohol.

Windows

Clean the windows, inside and out, with a commercially-available glass cleaner. You can also use a mixture of one part white vinegar to ten parts water. This will remove the haze that builds up on the inside of the windows. Use a soft cloth or paper towels to clean all glass and clear plastic surfaces.

NOTICE

The rear window defogger and antenna wires are bonded to the inside of the glass. Wiping vigorously up-and-down can dislodge and break these wires. When cleaning the rear window, use gentle pressure and wipe side-to-side.

Air Fresheners

If you want to use an air freshener/deodorizer in the interior of your vehicle, it is best to use a solid type. Some liquid air fresheners contain chemicals that may cause parts of the interior trim and fabric to crack or discolor.

If you use a liquid air freshener, make sure you fasten it securely so it does not spill as you drive.

Corrosion Protection

Two factors normally contribute to causing corrosion in your vehicle:

1. Moisture trapped in body cavities. Dirt and road salt that collects in hollows on the underside of the vehicle stays damp, promoting corrosion in that area.
2. Removal of paint and protective coatings from the exterior and underside of the vehicle.

Many corrosion-preventive measures are built into your Honda. You can help keep your vehicle from corroding by performing some simple periodic maintenance:

- Repair chips and scratches in the paint as soon as you discover them.
- Inspect and clean out the drain holes in the bottom of the doors and body.
- Check the floor coverings for dampness. Carpeting and floor mats may remain damp for a long time, especially in winter. This dampness can eventually cause the floor panels to corrode.

- Use a high-pressure spray to clean the underside of your vehicle. This is especially important in areas that use road salt in winter. It is also a good idea in humid climates and areas subject to salt air. Vehicles equipped with ABS have a sensor and wiring at each wheel. Be careful not to damage them.
- Have the corrosion-preventive coatings on the underside of your vehicle inspected and repaired periodically.

Body repairs can affect your vehicle's resistance to corrosion. If your vehicle needs repairs after a collision, pay close attention to the parts used in the repair and the quality of the work.

Make sure the repair facility uses Genuine Honda replacement body parts. Some companies make sheet metal pieces that seem to duplicate the original Honda body parts, but are actually inferior in fit, finish, and corrosion resistance. Once installed, they do not give the same high-quality appearance.

When reporting your collision to the insurance company, tell them you want Genuine Honda parts used in the repair. Although most insurers recognize the quality of original parts, some may try to specify that the repairs be done with other available parts. You should investigate this before any repairs are begun.

Take your vehicle to your authorized Honda dealer for inspection after the repairs are completed. He can make sure that quality materials were used, and that corrosion-preventive coatings were applied to all repaired and replaced parts.

This section covers the more-common problems that motorists experience with their vehicles. It gives you information about how to safely evaluate the problem and what to do to correct it. If the problem has stranded you on the side of the road, you may be able to get going again. If not, you will also find instructions on getting your vehicle towed.

Compact Spare Tire.....	268
Changing a Flat Tire.....	269
If Your Engine Won't Start.....	274
Nothing Happens or the Starter Motor Operates Very Slowly.....	275
The Starter Operates Normally.....	276
Jump Starting.....	276
If Your Engine Overheats.....	279
Low Oil Pressure Indicator.....	281
Charging System Indicator.....	282
Malfunction Indicator Lamp	283
Brake System Indicator.....	284
Closing the Moonroof.....	285
Fuses.....	286
Checking and Replacing.....	287
Towing.....	291

Compact Spare Tire

Your vehicle has a compact spare tire that takes up less space. Use this spare tire as a temporary replacement only. Get your regular tire repaired or replaced and put back on your vehicle as soon as you can.

Check the inflation pressure of the compact spare tire every time you check the other tires. It should be inflated to:
60 psi (420 kPa , 4.2 kgf/cm²)

Follow these precautions whenever you are using the compact spare tire:

- Do not exceed 50 mph (80 km/h) under any circumstances.
- This tire gives a harsher ride and less traction on some road surfaces than the regular tire. Use greater caution while driving on this tire.
- Do not mount snow chains on the compact spare.
- The wheel of the compact spare tire is designed especially to fit your vehicle. Do not use your spare tire on another vehicle unless it is the same make and model.

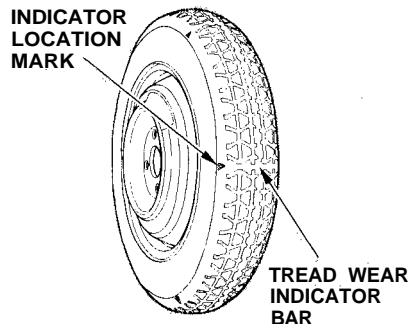

The compact spare tire has a shorter tread life than a regular tire. Replace it when you can see the tread wear indicator bars. The replacement should be the same size and design tire, mounted on the same wheel. The compact spare tire is not designed to be mounted on a regular wheel, and the compact wheel is not designed for mounting a regular tire.

If you have a flat tire while driving, stop in a safe place to change it. Stopping in traffic or on the shoulder of a busy road is dangerous. Drive slowly along the shoulder until you get to an exit or an area to stop that is far away from the traffic lanes.

The vehicle can easily roll off the jack, seriously injuring anyone underneath.

Follow the directions for changing a tire exactly, and never get under the vehicle when it is supported only by the jack.

1. Park the vehicle on firm, level ground away from traffic. Turn on the hazard warning lights and turn the ignition switch to LOCK (0).

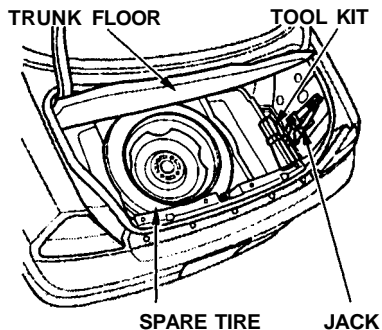

2. Put the transmission in Park (automatic) or Reverse (manual). Apply the parking brake. Have all of the passengers get out of the vehicle while you change the tire.
3. Open the trunk. Raise the trunk floor by lifting up on the back edge.
4. The tools are in the tool box on the right side of the trunk. Take the tools out of the tool box.

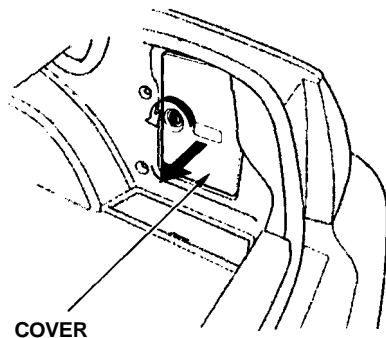

5. Unscrew the wing bolt and take the spare tire out of its well.
6. The jack is behind a cover in the right fender. Remove the cover by turning the handle counterclockwise, then pulling on the cover.

CONTINUED

Changing a Flat Tire

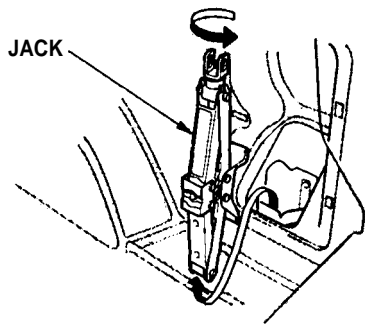

7. Turn the jack's end bracket counterclockwise to loosen it, then remove the jack.

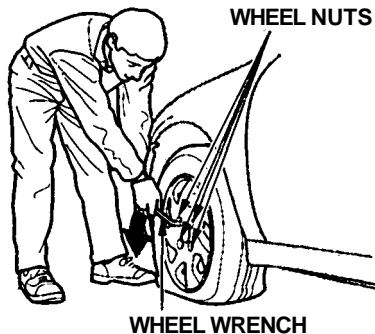

8. Loosen the four wheel nuts (4-cylinder) or five (V-6) 1/2 turn with the wheel wrench.

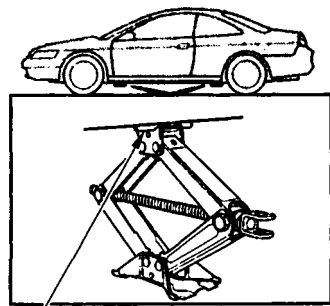

9. Find the jacking point nearest the wheel you are removing. Place the jack under the jacking point. Turn the end bracket clockwise until the top of the jack contacts the jacking point. Make sure the jacking point tab is resting in the jack notch.

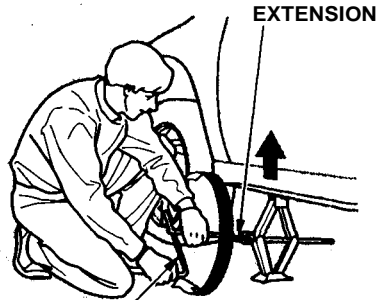

WHEEL WRENCH

10. Use the extension and wheel wrench as shown to raise the vehicle until the flat tire is off the ground.

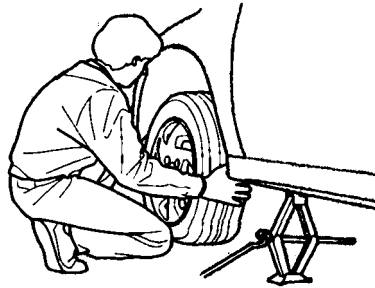

11. Remove the wheel nuts and flat tire. Temporarily place the flat tire on the ground with the outside surface of the wheel facing up. You could scratch the wheel if you put it face down.

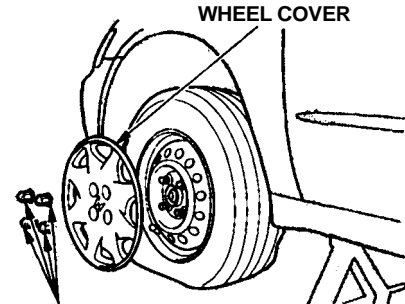

WHEEL NUTS

- On LX and LX-V6 models*
Do not attempt to forcibly pry the wheel cover off with a screwdriver or other tool. The wheel cover cannot be removed without first removing the wheel nuts.

CONTINUED

Changing a Flat Tire

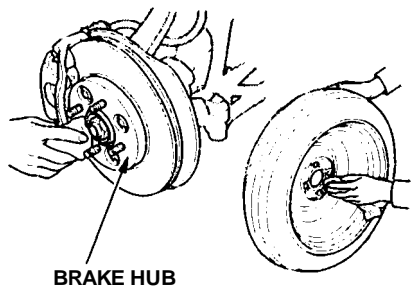

12. Before mounting the spare tire, wipe any dirt off the mounting surface of the wheel and hub with a clean cloth. Wipe the hub carefully, it may be hot from driving.

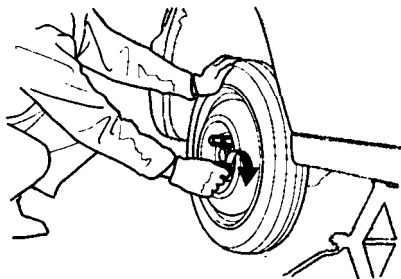

13. Put on the spare tire. Put the wheel nuts back on finger-tight, then tighten them in a crisscross pattern with the wheel wrench until the wheel is firmly against the hub. Do not try to tighten them fully.

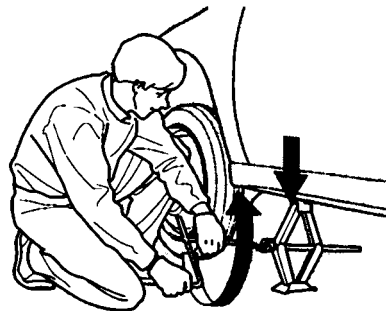

14. Lower the vehicle to the ground and remove the jack.

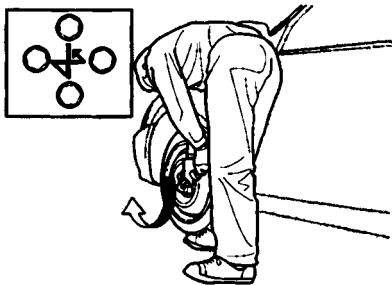

4-cylinder models

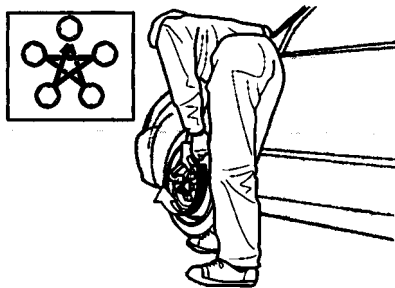

6-cylinder models

15. Tighten the wheel nuts securely in the same crisscross pattern. Have the wheel nut torque checked at the nearest automotive service facility.

Tighten the wheel nuts to:
80 lbf.ft (108 N.m, 11 kgf.m)

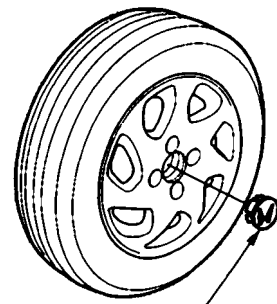

CENTER CAP

16. *On EX and EX-V6 models*
Remove the center cap before storing the flat tire in the trunk well.

CONTINUED

Changing a Flat Tire, If Your Engine Won't Start

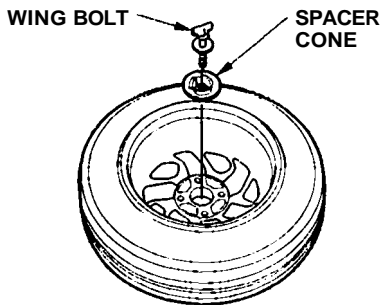

17. Place the flat tire face down in the spare tire well.
18. Remove the spacer cone from the wing bolt, turn it over, and put it back on the bolt.
19. Secure the flat tire by screwing the wing bolt back into its hole.

20. Store the jack in its holder. Turn the jack's end bracket to lock it in place. Replace the cover. Store the tools.

Loose items can fly around the interior in a crash and could seriously injure the occupants.

Store the wheel, jack and tools securely before driving.

21. Store the wheel cover or center cap in the trunk. Make sure it does not get scratched or damaged.
22. Lower the trunk floor, then close the trunk lid.

If Your Engine Won't Start

Diagnosing why your engine won't start falls into two areas, depending on what you hear when you turn the key to START (III):

- You hear nothing, or almost nothing. The engine's starter motor does not operate at all, or operates very slowly.
- You can hear the starter motor operating normally, or the starter motor sounds like it is spinning faster than normal, but the engine does not start up and run.

Nothing Happens or the Starter Motor Operates Very Slowly

When you turn the ignition switch to START (III), you do not hear the normal noise of the engine trying to start. You may hear a clicking sound or series of clicks, or nothing at all. Check these things:

- Your vehicle has the Immobilizer System. You should use a properly-coded master or valet key to start the engine (see page 69). A key that is not properly coded will cause the immobilizer system indicator in the dash panel to blink rapidly.

- Check the transmission interlock. If you have a manual transmission, the clutch pedal must be pushed all the way to the floor or the starter will not operate. With an automatic transmission, it must be in Park or Neutral.
- Turn the ignition switch to ON (II). Turn on the headlights and check their brightness. If the headlights are very dim or don't light at all, the battery is discharged. See **Jump Starting** on page 276.

- Turn the ignition switch to START (III). If the headlights do not dim, check the condition of the fuses. If the fuses are OK, there is probably something wrong with the electrical circuit for the ignition switch or starter motor. You will need a qualified technician to determine the problem. (See **Towing** on page 291.)

If the headlights dim noticeably or go out when you try to start the engine, either the battery is discharged or the connections are corroded. Check the condition of the battery and terminal connections (see page 230). You can then try jump starting the vehicle from a booster battery (see page 276).

If Your Engine Won't Start, Jump Starting

The Starter Operates Normally

In this case, the starter motor's speed sounds normal, or even faster than normal, when you turn the ignition switch to START (III), but the engine does not run.

- Are you using the proper starting procedure? Refer to **Starting the Engine** on page 169 .
- Do you have fuel? Turn the ignition switch to ON (II) for a minute and watch the fuel gauge. The low fuel level warning light may not be working, so you were not reminded to fill the tank.
- There may be an electrical problem, such as no power to the fuel pump. Check all the fuses (see page 286).

If you find nothing wrong, you will need a qualified technician to find the problem. See **Towing** on page 291.

Jump Starting

If your vehicle's battery has run down, you may be able to start the engine by using a booster battery. Although this seems like a simple procedure, you should take several precautions.

A battery can explode if you do not follow the correct procedure, seriously injuring anyone nearby.

Keep all sparks, open flames, and smoking materials away from the battery.

You cannot start a Honda with an automatic transmission by pushing or pulling it.

To jump start your vehicle, follow these directions closely:

1. Open the hood and check the physical condition of the battery (see page 230). In very cold weather, check the condition of the electrolyte. If it seems slushy or like ice, do not try jump starting until it thaws.

NOTICE

If a battery sits in extreme cold, the electrolyte inside can freeze. Attempting to jump start with a frozen battery can cause it to rupture.

2. Turn off all the electrical accessories: heater, A/C, climate control, stereo system, lights, etc. Put the transmission in Neutral or Park and set the parking brake.

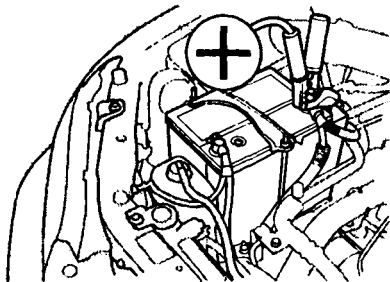

4-cylinder models

3. Connect one jumper cable to the positive (+) terminal on the booster battery. Connect the other end to the positive (+) terminal on your Honda's battery.

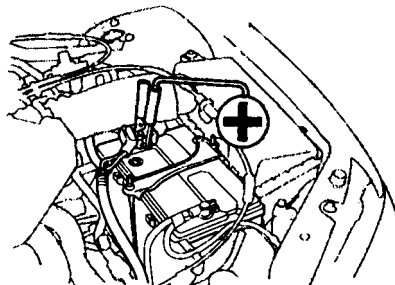

6-cylinder models

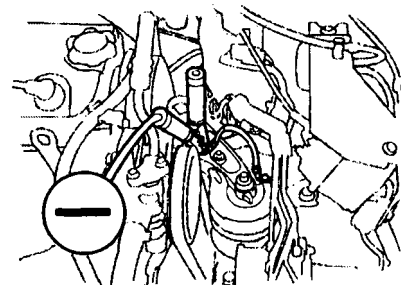

4-cylinder models

4. Connect the second jumper cable to the negative (—) terminal on the booster battery. Connect the other end to the grounding strap as shown. Do not connect this jumper cable to any other part of the engine.

CONTINUED

Jump Starting

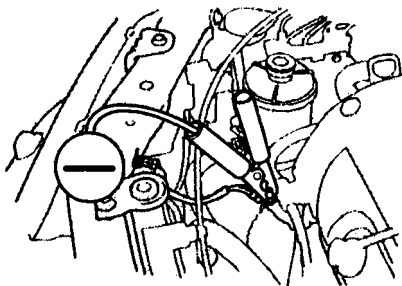

6-cylinder models

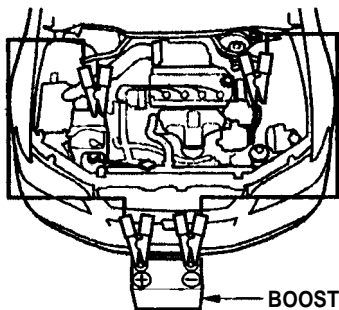

4-cylinder models

BOOSTER
BATTERY

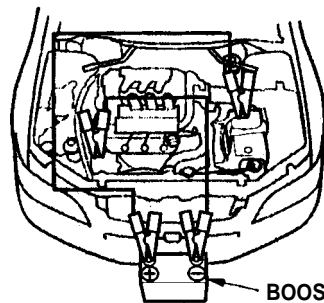

6-cylinder models

BOOSTER
BATTERY

5. If the booster battery is in another vehicle, have an assistant start that vehicle and run it at a fast idle.
6. Start your vehicle. If the starter motor still operates slowly, check the jumper cable connections to make sure they have good metal-to-metal contact.

7. Once your vehicle is running, disconnect the negative cable from your vehicle, then from the booster battery. Disconnect the positive cable from your vehicle, then the booster battery.

The pointer of your vehicle's temperature gauge should stay in the midrange under most conditions. It may go higher if you are driving up a long steep hill on a very hot day. If it climbs to the red mark, you should determine the reason.

NOTICE

Driving with the temperature gauge pointer at the red mark can cause serious damage to your engine.

Your vehicle can overheat for several reasons, such as lack of coolant or a mechanical problem. The only indication may be the temperature gauge climbing to or above the red mark. Or you may see steam or spray coming from under the hood. In either case, you should take immediate action.

Steam and spray from an overheated engine can seriously scald you.

Do not open the hood if steam is coming out.

1. Safely pull to the side of the road. Put the transmission in Neutral or Park and set the parking brake. Turn off the heating and cooling/ climate control system and all other accessories. Turn on the hazard warning indicators.
2. If you see steam and/or spray coming from under the hood, turn off the engine.
3. If you do not see steam or spray, leave the engine running and watch the temperature gauge. If the high heat is due to overloading (climbing a long, steep hill on a hot day with the A/C running, for example), the engine should start to cool down almost immediately. If it does, wait until the temperature gauge comes down to the mid-point then continue driving.

CONTINUED

If Your Engine Overheats

4. If the temperature gauge stays at the red mark, turn off the engine.
5. Wait until you see no more signs of steam or spray, then open the hood.
6. Look for any obvious coolant leaks, such as a split radiator hose. Everything is still extremely hot, so use caution. If you find a leak, it must be repaired before you continue driving (see **Towing** on page 291).
7. If you don't find an obvious leak, check the coolant level in the radiator reserve tank (see page 160). If the level is below the MIN mark, add coolant to halfway between the MIN and MAX marks.
8. If there was no coolant in the reserve tank, you may also have to add coolant to the radiator. Let the engine cool down until the pointer

reaches the middle of the temperature gauge, or lower, before checking the radiator.

Removing the radiator cap while the engine is hot can cause the coolant to spray out, seriously scalding you.

Always let the engine and radiator cool down before removing the radiator cap.

9. Using gloves or a large heavy cloth, turn the radiator cap counterclockwise, without pushing down, to the first stop. This releases any remaining pressure in the cooling system. After the pressure releases, push down on the cap and turn it until it comes off.

10. Start the engine and set the temperature control dial to maximum (climate control to FULL AUTO at 90°F/32°C). Add coolant to the radiator up to the base of the filler neck. If you do not have the proper coolant mixture available, you can add plain water. Remember to have the cooling system drained and refilled with the proper mixture as soon as you can.
11. Put the radiator cap back on tightly. Run the engine and watch the temperature gauge. If it goes back to the red mark, the engine needs repair. (See **Towing** on page 291.)
12. If the temperature stays normal, check the coolant level in the radiator reserve tank. If it has gone down, add coolant to the MAX mark. Put the cap back on tightly.

LOW OIL PRESSURE INDICATOR

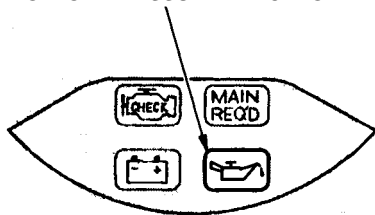

This indicator should light when the ignition switch is ON (II), and go out after the engine starts. It should never come on when the engine is running. If it starts flashing, it indicates that the oil pressure dropped very low for a moment, then recovered. If the indicator stays on with the engine running, it shows that the engine has lost oil pressure and serious engine damage is possible. In either case, you should take immediate action.

NOTICE

Running the engine with low oil pressure can cause serious mechanical damage almost immediately. Turn off the engine as soon as you can safely get the vehicle stopped.

1. Safely pull off the road and shut off the engine. Turn on the hazard warning indicators.
2. Let the vehicle sit for a minute. Open the hood and check the oil level (see page 158). Although oil level and oil pressure are not directly connected, an engine that is very low on oil can lose pressure during cornering and other driving maneuvers.
3. If necessary, add oil to bring the level back to the full mark on the dipstick (see page 206).

4. Start the engine and watch the oil pressure indicator. If the light does not go out within ten seconds, turn off the engine. There is a mechanical problem that needs to be repaired before you can continue driving. (See **Towing** on page 291.)

Charging System Indicator

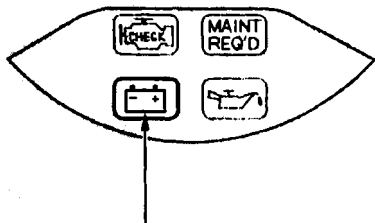

CHARGING SYSTEM INDICATOR

This indicator should come on when the ignition switch is ON (II), and go out after the engine starts. If it comes on brightly when the engine is running, it indicates that the charging system has stopped charging the battery.

Immediately turn off all electrical accessories: radio, heater, A/C, climate control, rear defogger, cruise control, etc. Try not to use other electrically-operated controls such as the power windows. Keep the engine running and take extra care not to stall it. Starting the engine will discharge the battery rapidly.

By eliminating as much of the electrical load as possible, you can drive several miles (kilometers) before the battery is too discharged to keep the engine running. Drive to a service station or garage where you can get technical assistance.

MALFUNCTION INDICATOR LAMP

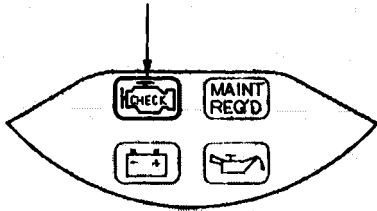

This indicator comes on for a few seconds when you turn the ignition switch ON (II). If it comes on at any other time, it indicates one of the engine's emissions control systems may have a problem. Even though you may feel no difference in your vehicle's performance, it can reduce your fuel economy and cause your vehicle to put out excessive emissions. Continued operation may cause serious damage.

If you have recently refueled your vehicle, the cause of this indicator coming on could be a loose or missing fuel fill cap. Check the cap and tighten it until it clicks. Replace the fuel fill cap if it is missing. Tightening the cap will not make the indicator turn off immediately; it takes three driving trips.

If the indicator remains on past three driving trips, or the fuel cap was not loose or missing, have the vehicle checked by the dealer as soon as possible. Drive moderately until the dealer has inspected the problem. Avoid full-throttle acceleration and driving at high speed.

You should also have the dealer inspect your vehicle if this indicator comes on repeatedly, even though it may turn off as you continue driving.

NOTICE

If you keep driving with the malfunction indicator lamp on, you can damage your vehicle's emissions controls and engine. Those repairs may not be covered by your vehicle's warranties.

Brake System Indicator

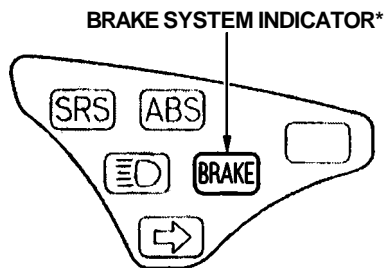

* U.S. indicator shown

The Brake System Indicator light comes on when you turn the ignition ON (II). If the parking brake is not set, it goes off after you start the engine. If the parking brake is set, it goes off when you fully release the parking brake with the engine running.

If it comes on at any other time, it indicates a problem with the vehicle's brake system. In most cases, the problem is a low fluid level in the brake fluid reservoir. Press lightly on the brake pedal to see if it feels normal. If it does, check the brake fluid level the next time you stop at a service station (see page 221). If the fluid level is low, take the vehicle to your dealer and have the brake system inspected for leaks or worn brake pads.

However, if the brake pedal does not feel normal, you should take immediate action. Because of the brake system's dual-circuit design, a problem in one part of the system will still give you braking at two wheels. You will feel the brake pedal go down much farther before the vehicle begins to slow down, and you will have to press harder on the pedal. The distance needed to stop will be much longer.

Slow down by shifting to a lower gear, and pull to the side of the road when it is safe. Because of the longer distance needed to stop, it is hazardous to drive the vehicle. You should have it towed, and repaired as soon as possible. (See **Towing** on page 291.)

If you must drive the vehicle a short distance in this condition, drive slowly and cautiously.

If the electric motor will not close the moonroof, do the following:

1. Check the fuse for the moonroof motor (see page 286). If the fuse is blown, replace it with one of the same or lower rating.
2. Try closing the moonroof. If the new fuse blows immediately or the moonroof motor still does not operate, you can close the moonroof manually.
3. Get the moonroof wrench out of the tool kit in the trunk.

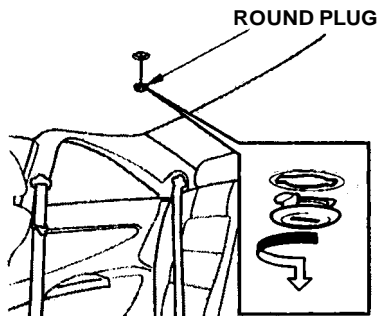

4. Use a screwdriver or coin to remove the round plug in the center of the headliner.

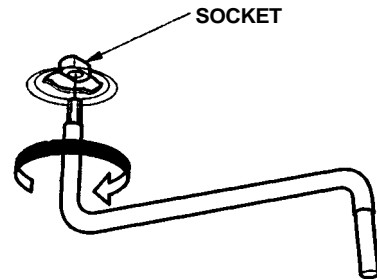

5. Insert the moonroof wrench into the socket behind this plug. Turn the wrench until the moonroof is fully closed.
6. Remove the wrench. Replace the round plug.

Fuses

All the electrical circuits in your vehicle have fuses to protect them from a short circuit or overload. These fuses are located in three fuse boxes.

INTERIOR

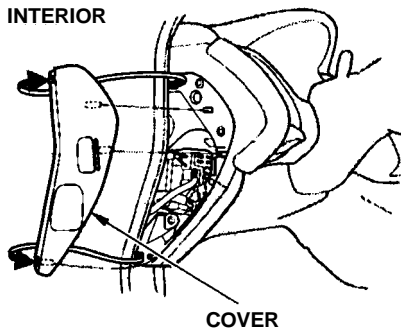

The interior fuse boxes are located on each side of the dashboard. To open an interior fuse box, open the vehicle door. Pull the cover open, then take it out of its hinges by pulling it toward you.

UNDER-HOOD

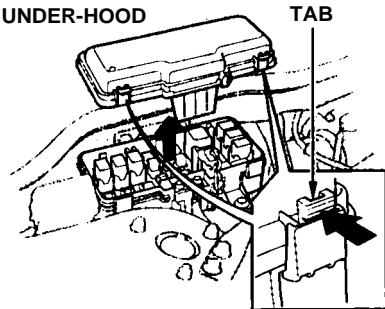

The under-hood fuse box is located in the back of the engine compartment on the passenger's side. To open it, push the tabs as shown.

Checking and Replacing Fuses

If something electrical in your vehicle stops working, the first thing you should check for is a blown fuse. Determine from the chart on pages 289 and 290, or the diagram on the fuse box lid, which fuse or fuses control that component. Check those fuses first, but check all the fuses before deciding that a blown fuse is not the cause. Replace any blown fuses and check the component's operation.

1. Turn the ignition switch to LOCK (0). Make sure the headlights and all other accessories are off.
2. Remove the cover from the fuse box.

FUSE

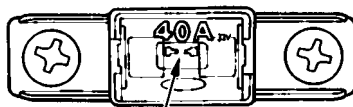

BLOWN

3. Check each of the large fuses in the under-hood fuse box by looking through the top at the wire inside. Removing these fuses requires a Phillips-head screwdriver.

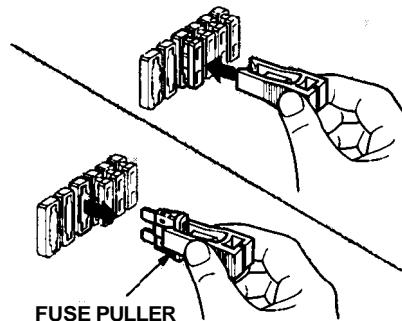

FUSE PULLER

4. Check the smaller fuses in the under-hood fuse box and all the fuses in the interior fuse boxes by pulling out each fuse with the fuse puller provided in the under-hood fuse box.

CONTINUED

BLOWN

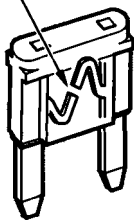

5. Look for a burned wire inside the fuse. If it is burned, replace it with one of the spare fuses of the same rating or lower.

If you cannot drive the vehicle without fixing the problem, and you do not have a spare fuse, take a fuse of the same rating or a lower rating from one of the other circuits. Make sure you can do without that circuit temporarily (such as the accessory power socket or radio).

If you replace the blown fuse with a spare fuse that has a lower rating, it might blow out again. This does not indicate anything wrong. Replace the fuse with one of the correct rating as soon as you can.

NOTICE

Replacing a fuse with one that has a higher rating greatly increases the chances of damaging the electrical system. If you do not have a replacement fuse with the proper rating for the circuit, install one with a lower rating.

6. If the replacement fuse of the same rating blows in a short time, there is probably a serious electrical problem in your vehicle. Leave the blown fuse in that circuit and have your vehicle checked by a qualified mechanic.

On EX and EX-V6 models

If the radio fuse is removed, the audio system will disable itself. The next time you turn on the radio you will see "Code" in the frequency display. Use the Preset buttons to enter the five-digit code (see page 150).

INTERIOR FUSE BOX

Driver's Side

Front ←

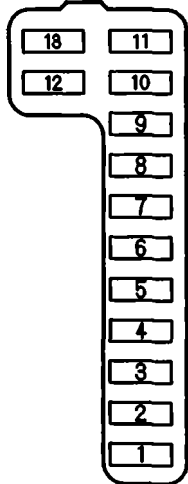

No.	Amps.	Circuits Protected
1	15 A	Fuel Pump
2	10 A	SRS
3	7.5 A	Heater Control, A/C Clutch Relay, Cooling Fan Relay
4	7.5 A	Power Mirror
5	7.5 A	Daytime Running Light*
6	15 A	ECU (ECM/PCM), Cruise Control
7	7.5 A	Washer, Power Window Relay, Moonroof Relay
8	7.5 A	ACC Relay
9	7.5 A	Back-up Lights, Meter Lights
10	7.5 A	Turn Signals
11	15 A	IG Coil
12	30 A	Wiper
13	7.5 A	Starter Signal

* : On Canadian models

Passenger's Side

→ Front

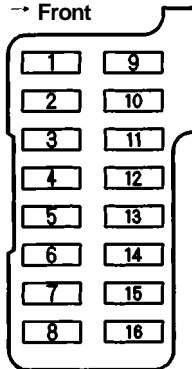

No.	Amps.	Circuits Protected
1	30 A	Moonroof* ¹
2	20 A	Power Seat* ²
3		Not Used
4	20 A	Power Seat* ²
5	—	Not Used
6	10 A	Daytime Running Light* ³
	20 A	LAF Heater* ⁴
7	20 A	Power Window
8	20 A	Passenger's Power Window
9	20 A	Radio, ACC Socket
10	15 A	Small Light, License Light
11	7.5 A	Interior Light, Courtesy Lights
12	20 A	Power Door Locks
13	7.5 A	Clock, Back Up
14	7.5 A	ABS Motor Check* ¹
15	20 A	Driver's Power Window
16	20 A	Power Window

* 1 : EX, EX-V6

* 2 : LX-V6, EX, EX-V6

* 3 : Canadian models

* 4 : U.S. models except LX

CONTINUED

Fuses

UNDER-HOOD FUSE BOX

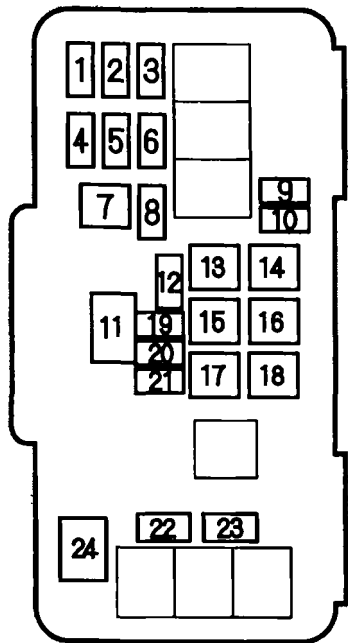

No.	Amps.	Circuits Protected
1	20 A	Left Headlight
2	7.5 A	Dimmer Relay* ¹
3	20 A	Right Headlight
4	20 A	ABS F/S* ²
5	20 A	Stop
6	15 A	ACG
7	30 A	ABS Motor* ²
8	15 A	Hazard
9	20 A	Spare Fuse
10	30 A	Spare Fuse
11	100 A	Battery
12	20 A	Cooling Fan
13	40 A	Back Up, ACC

No.	Amps.	Circuits Protected
14	40 A	Power Window Motor
15	40 A	Power Seat
16	—	Not Used
17	40 A	Heater Motor
18	40 A	Rear Defroster
19	7.5 A	Spare Fuse
20	10 A	Spare Fuse
21	15 A	Spare Fuse
22	20 A	Heated Seat* ¹
23	20 A	Condenser Fan
24	50 A	IG1 Main

* 1 : EX-V6 in Canada

* 2 : EX, EX-V6

If your vehicle needs to be towed, call a professional towing service or, if you belong to one, an organization that provides roadside assistance. Never tow your vehicle behind another vehicle with just a rope or chain. It is very dangerous.

Emergency Towing

There are three popular methods of towing a vehicle:

Flat-bed Equipment—The operator loads your vehicle on the back of a truck. **This is the best way of transporting your Honda.**

Wheel Lift Equipment—The tow truck uses two pivoting arms that go under the tires (front or rear) and lift them off the ground. The other two tires remain on the ground.

Sling-type Equipment—The tow truck uses metal cables with hooks on the ends. These hooks go around parts of the frame or suspension and the cables lift that end of the vehicle off the ground. Your vehicle's suspension and body can be seriously damaged if this method of towing is attempted.

If your Honda cannot be transported by flat-bed, it should be towed with the front wheels off the ground. If due to damage, your vehicle must be towed with the front wheels on the ground, do the following:

5-speed Manual Transmission

- Release the parking brake.
- Shift the transmission to Neutral.

Automatic Transmission:

- Release the parking brake.
- Start the engine.
- Shift to D4, then to N.
- Turn off the engine.

NOTICE

Improper towing preparation will damage the transmission. Follow the above procedure exactly. If you cannot shift the transmission or start the engine (automatic transmission), your vehicle must be transported on a flat-bed.

- It is best to tow the vehicle no farther than 50 miles (80 km), and keep the speed below 35 mph (55 km/h).

NOTICE

Trying to lift or tow your vehicle by the bumpers will cause serious damage. The bumpers are not designed to support the vehicle's weight.

The diagrams in this section give you the dimensions and capacities of your Honda, and the locations of the identification numbers. The explanations of several electronic and mechanical systems on your Honda are for the more technically-oriented owner.

Identification Numbers.....	294	Oxygenated Fuels.....	303
Specifications		Driving in Foreign Countries.....	304
(4-cylinder Models).....	296	Emissions Controls.....	305
Specifications		The Clean Air Act.....	305
(6-cylinder Models).....	298	Crankcase Emissions Control	
Tire Information.....	300	System.....	305
Tire Size Designation.....	300	Evaporative Emissions Control	
Wheel Size Designation.....	300	System.....	305
Tire Speed Ratings.....	300	Exhaust Emissions Controls....	306
DOT Tire Quality Grading.....	301	PGM-FI System.....	306
Treadwear.....	301	Ignition Timing Control	
Traction.....	301	System.....	306
Temperature.....	302	Exhaust Gas Recirculation	
		(EGR) System.....	306
		Three Way Catalytic	
		Converter.....	306
		Replacement Parts.....	306
		Three Way Catalytic Converter...	307

Identification Numbers

Your vehicle has several identifying numbers located in various places.

The Vehicle Identification Number (VIN) is the 17-digit number your Honda dealer uses to register your vehicle for warranty purposes. It is also necessary for licensing and insuring your vehicle. The easiest place to find the VIN is on a plate fastened to the top of the dashboard. You can see it by looking through the windshield on the driver's side. It is also on the Certification label attached to the driver's doorjamb, and is stamped on the engine compartment bulkhead. The VIN is also provided in bar code on the Certification label.

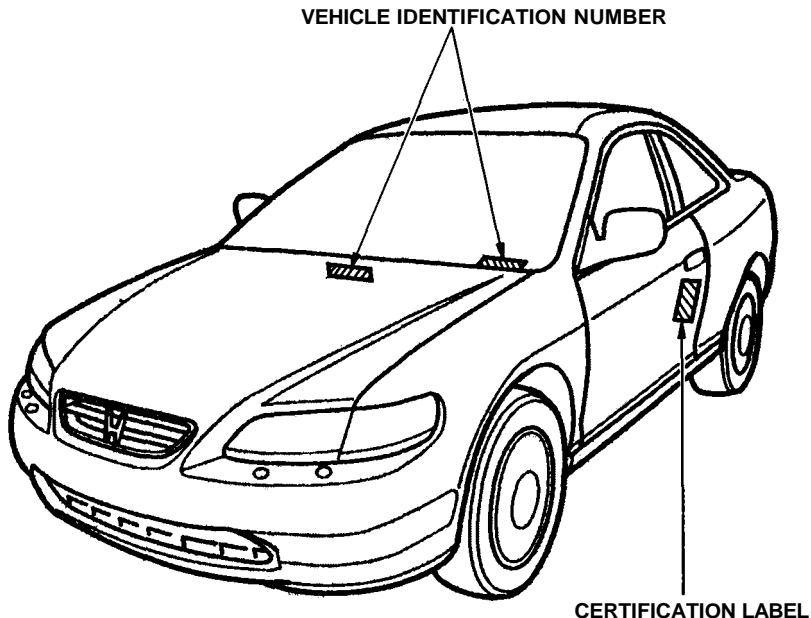

The Engine Number is stamped into the engine block. It is on the front.

The Transmission Number is on a label on top of the transmission.

4-cylinder Models

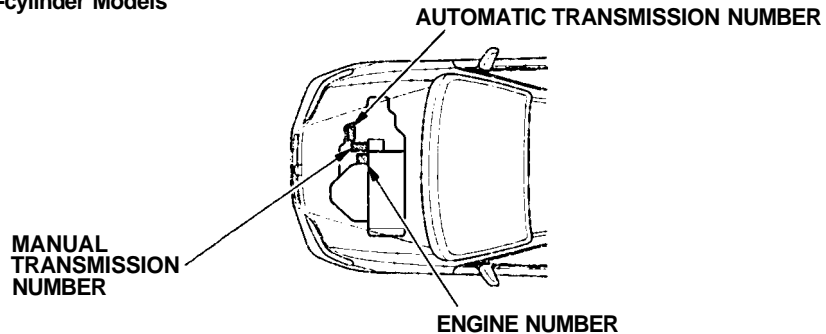

6-cylinder Models

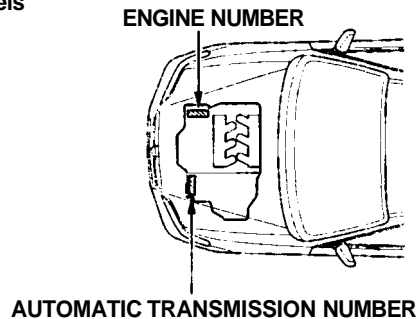

Specifications (4-cylinder Models)

Dimensions

Length	186.8 in (4,745 mm)
Width	70.3 in (1,785 mm)
Height	54.9 in (1,395 mm)
Wheelbase	105.1 in (2,670 mm)
Track	61.2 in (1,555 mm)
Front	
Rear	60.4 in (1,535 mm)

Weights

Gross vehicle weight rating	See the certification label attached to the driver's doorjamb.
-----------------------------	--

Air Conditioning

Refrigerant type	HFC-134a (R-134a)
Charge quantity	24.7–26.5 oz (700–750 g)
Lubricant type	ND-OIL8

Capacities

Fuel tank		Approx. 17.12 US gal (64.8 ℓ , 14.26 Imp gal)
Engine coolant	Change* ¹	
	Manual	1.45 US gal (5.5 ℓ , 1.21 Imp gal)
	Automatic	1.43 US gal (5.4 ℓ , 1.19 Imp gal)
	Total	
	Manual	1.85 US gal (7.0 ℓ , 1.54 Imp gal)
	Automatic	1.82 US gal (6.9 ℓ , 1.52 Imp gal)
Engine oil	Change* ²	
	Including filter	4.5 US qt (4.3 ℓ , 3.8 Imp qt)
	Without filter	4.2 US qt (4.0 ℓ , 3.5 Imp qt)
	Total	5.9 US qt (5.6 ℓ , 4.9 Imp qt)
Manual transmission oil	Change	2.0 US qt (1.9 ℓ , 1.7 Imp qt)
	Total	2.1 US qt (2.0 ℓ , 1.8 Imp qt)
Automatic transmission fluid	Change	2.6 US qt (2.5 ℓ , 2.2 Imp qt)
	Total	6.6 US qt (6.2 ℓ , 5.5 Imp qt)
Windshield washer reservoir	U.S. Vehicles	2.6 US qt (2.5 ℓ , 2.2 Imp qt)
	Canada Vehicles	4.8 US qt (4.5 ℓ , 4.0 Imp qt)

* 1 : Including the coolant in the reserve tank and that remaining in the engine.

Reserve tank capacity:

0.16 US gal (0.6 ℓ , 0.13 Imp gal)

* 2 : Excluding the oil remaining in the engine.

Lights

Headlights	High	12 V – 60 W (HB3)
	Low	12 V – 51 W (HB4)
Front turn signal/side marker lights		12 V – 24/2.2 CP
Front parking lights		12 V – 3 CP
Rear turn signal/taillights		12 V – 32/2 CP
Stop/Taillights		12 V – 32/2 CP
Back-up lights		12 V – 21 W
Rear side marker lights		12 V – 3 CP
License plate lights		12 V – 3 CP
Ceiling light		12 V – 8 W
High-mount brake light		12 V – 21 W
Trunk light		12 V – 5 W
Door courtesy lights		12 V – 3 CP
Vanity mirror light		12 V – 1.8 W
Spotlights		12 V – 4 CP

Battery

Capacity	12 V – 52 AH/5 HR
----------	-------------------

Fuses

Interior	See page 289 or the fuse label attached to the inside of the fuse box door on each side of the dashboard.
Under-hood	See page 290 or the fuse box cover.

Engine

Type	Water cooled 4-stroke SOHC VTEC 4-cylinder gasoline engine
Bore x Stroke	3.39 x 3.82 in (86.0 x 97.0 mm)
Displacement	138 cu-in (2,254 cm ³)
Compression ratio	9.3 : 1
Spark plugs	See spark plug maintenance section page 227 .

Alignment

Toe-in	Front	0.00 in (0.0 mm)
	Rear	0.08 in (2.0 mm)
Camber	Front	0°
	Rear	–0°30'
Caster	Front	2°48'

Tires

Size	Front/Rear	P195/65R15 89H
	Spare	T125/70D15 95M
Pressure	Front/Rear	29 psi (200 kPa , 2.0 kgf/cm ²)
	Spare	60 psi (420 kPa , 4.2 kgf/cm ²)

Specifications (6-cylinder Models)

Dimensions

Length		186.8 in (4,745 mm)
Width		70.3 in (1,785 mm)
Height		55.3 in (1,405 mm)
Wheelbase		105.1 in (2,670 mm)
Track	Front	61.2 in (1,555 mm)
	Rear	60.4 in (1,535 mm)

Weights

Gross vehicle weight rating	See the certification label attached to the driver's doorjamb.
-----------------------------	--

Air Conditioning

Refrigerant type	HFC-134a (R-134a)
Charge quantity	24.7 – 26.5 oz (700 – 750 g)
Lubricant type	ND-OIL8

Capacities

Fuel tank		Approx. 17.12 US gal (64.8 ℓ , 14.26 Imp gal)
Engine coolant	Change* ¹	1.48 US gal (5.6 ℓ , 1.23 Imp gal)
	Total	1.98 US gal (7.5 ℓ , 1.65 Imp gal)
Engine oil	Change* ²	
	Including filter	4.6 US qt (4.4 ℓ , 3.9 Imp qt)
	Without filter	4.2 US qt (4.0 ℓ , 3.5 Imp qt)
	Total	5.3 US qt (5.0 ℓ , 4.4 Imp qt)
Automatic transmission fluid	Change	3.1 US qt (2.9 ℓ , 2.6 Imp qt)
	Total	7.6 US qt (7.2 ℓ , 6.3 Imp qt)
Windshield washer reservoir	U.S. Vehicles	2.6 US qt (2.5 ℓ , 2.2 Imp qt)
	Canada Vehicles	4.8 US qt (4.5 ℓ , 4.0 Imp qt)

* 1 : Including the coolant in the reserve tank and that remaining in the engine.

Reserve tank capacity:

0.16 US gal (0.6 ℓ , 0.13 Imp gal)

* 2 : Excluding the oil remaining in the engine.

Lights

Headlights	High	12 V — 60 W (HB3)
	Low	12 V — 51 W (HB4)
Front turn signal/side marker lights		12 V — 24/2.2 CP
Front parking lights		12 V — 3 CP
Rear turn signal/taillights		12 V — 32/2 CP
Stop/Taillights		12 V — 32/2 CP
Back-up lights		12 V — 21 W
Rear side marker lights		12 V — 3 CP
License plate lights		12 V — 3 CP
Ceiling light		12 V — 8 W
High-mount brake light		12 V — 21 W
Trunk light		12 V — 5 W
Door courtesy lights		12 V — 3 CP
Vanity mirror light		12 V — 1.8 W
Spotlights		12 V — 4 CP

Battery

Capacity	12 V — 55 AH/5 HR
----------	-------------------

Fuses

Interior	See page 289 or the fuse label attached to the inside of the fuse box door on each side of the dashboard.
Under-hood	See page 290 or the fuse box cover.

Engine

Type	Water cooled 4-stroke SOHC VTEC 6-cylinder gasoline engine
Bore x Stroke	3.39 x 3.39 in (86.0 x 86.0 mm)
Displacement	183 cu-in (2,997 cm ³)
Compression ratio	9.4 : 1
Spark plugs	See spark plug maintenance section page 229.

Alignment

Toe-in	Front	0.00 in (0.0 mm)
	Rear	0.08 in (2.0 mm)
Camber	Front	0°
	Rear	-0°30'
Caster	Front	2°48'

Tires

Size	Front/Rear	P205/60R16 91V *1
		P205/65R15 92V *2
	Spare	T135/90D15 100M
Pressure	Front/Rear	32 psi (220 kPa , 2.2 kgf/cm ²) *1
		30 psi (210 kPa , 2.1 kgf/cm ²) *2
	Spare	60 psi (420 kPa , 4.2 kgf/cm ²)

* 1 : EX-V6

* 2 : LX-V6

Tire Information

Tire Size Designation

A tire's sidewall is marked with a tire size designation. You will need this information when selecting replacement tires for your vehicle. The following explains what the letters and numbers in the tire size designation mean.

(Example tire size designation)
P205/60R16 91V

P — Applicable vehicle type (tires marked with the prefix "P" are intended for use on passenger vehicles; however, not all tires have this marking).

205 — Tire width in millimeters.

60 — Aspect ratio. The tire's section height as a percentage of its width.

R — Tire construction code (Radial).

16 — Rim diameter in inches.

91 — Load Index, a numerical code associated with the maximum load the tire can carry.

V — Speed Symbol. See the speed rating chart in this section for additional information.

Wheel Size Designation

Wheels are also marked with important information that you need if you ever have to replace one. The following explains what the letters and numbers in the wheel size designation mean.

(Example wheel size designation)
16 x 6-1/2 JJ

16 — Rim diameter in inches.

6-1/2 — Rim width in inches.

JJ — Rim contour designation.

Tire Speed Ratings

The chart below shows many of the different speed ratings currently being used for passenger vehicle tires. The speed symbol is part of the tire size designation on the sidewall of the tire. This symbol corresponds to that tire's designed maximum safe operating speed.

Speed Symbol or Category	Maximum Speed
Q	99 mph (160 km/h)
S	112 mph (180 km/h)
T	118 mph (190 km/h)
H	130 mph (210 km/h)
V	149 mph (240 km/h)
W	168 mph (270 km/h)
ZR	Over 149 mph (240 km/h)

DOT Tire Quality Grading (U.S. Cars)

The tires on your car meet all U.S. Federal Safety Requirements. All tires are also graded for treadwear, traction, and temperature performance according to Department of Transportation (DOT) standards. The following explains these gradings.

Treadwear

The treadwear grade is a comparative rating based on the wear rate of the tire when tested under controlled conditions on a specified government test course. For example, a tire graded 150 would wear one and one half (1-1/2) times as well on the government course as a tire graded 100. The relative performance of tires depends upon the actual conditions of their use, however, and may depart significantly from the norm due to variations in driving habits, service practices, and differences in road characteristics and climate.

Traction

The traction grades, from highest to lowest, are A, B, and C, and they represent the tire's ability to stop on wet pavement as measured under controlled conditions on specified government test surfaces of asphalt and concrete. A tire marked C may have poor traction performance.

Warning: The traction grade assigned to this tire is based on braking (straight ahead) traction tests and does not include cornering (turning) traction.

CONTINUED

Tire Information

Temperature

The temperature grades are A (the highest), B, and C, representing the tire's resistance to the generation of heat and its ability to dissipate heat when tested under controlled conditions on a specified indoor laboratory test wheel. Sustained high temperature can cause the material of the tire to degenerate and reduce tire life, and excessive temperature can lead to sudden tire failure. The grade C corresponds to a level of performance which all passenger car tires must meet under the Federal Motor Vehicle Safety Standard No. 109. Grades B and A represent higher levels of performance on the laboratory test wheel than the minimum required by law.

Warning: The temperature grade for this tire is established for a tire that is properly inflated and not overloaded. Excessive speed, underinflation, or excessive loading either separately or in combination, can cause heat build-up and possible tire failure.

Some conventional gasolines are being blended with alcohol or an ether compound. These gasolines are collectively referred to as oxygenated fuels. To meet clean air standards, some areas of the United States and Canada use oxygenated fuels to help reduce emissions.

If you use an oxygenated fuel, be sure it is unleaded and meets the minimum octane rating requirement.

Before using an oxygenated fuel, try to confirm the fuel's contents. Some states/provinces require this information to be posted on the pump.

The following are the EPA-approved percentages of oxygenates:

ETHANOL (ethyl or grain alcohol)
You may use gasoline containing up to 10 percent ethanol by volume. Gasoline containing ethanol may be marketed under the name "Gasohol."

MTBE (Methyl Tertiary Butyl Ether)
You may use gasoline containing up to 15 percent MTBE by volume.

METHANOL (methyl or wood alcohol)
You may use gasoline containing up to 5 percent methanol by volume as long as it also contains cosolvents and corrosion inhibitors to protect the fuel system. Gasoline containing more than 5 percent methanol by volume may cause starting and/or performance problems. It may also damage metal, rubber and plastic parts of your fuel system.

If you notice any undesirable operating symptoms, try another service station or switch to another brand of gasoline.

Fuel system damage or performance problems resulting from the use of an oxygenated fuel containing more than the percentages of oxygenates given above are not covered under warranty.

Driving in Foreign Countries

If you are planning to take your Honda outside the U.S. or Canada, contact the tourist bureaus in the areas you will be traveling in to find out about the availability of unleaded gasoline with the proper octane rating.

If unleaded gasoline is not available, be aware that using leaded gasoline in your Honda will affect performance and fuel mileage, and damage its emissions controls. It will no longer comply with U.S. and Canadian emissions regulations, and will be illegal to operate in North America. To bring your vehicle back into compliance will require the replacement of several components, such as the oxygen sensors and the three way catalytic converter. These replacements are not covered under warranty.

The burning of gasoline in your vehicle's engine produces several by-products. Some of these are carbon monoxide (CO), oxides of nitrogen (NOx) and hydrocarbons (HC). Gasoline evaporating from the tank also produces hydrocarbons. Controlling the production of NOx, CO, and HC is important to the environment. Under certain conditions of sunlight and climate, NOx and HC react to form photochemical "smog." Carbon monoxide does not contribute to smog creation, but it is a poisonous gas.

The Clean Air Act

The United States Clean Air Act* sets standards for automobile emissions. It also requires that automobile manufacturers explain to owners how their emissions controls work and what to do to maintain them. This section summarizes how the emissions controls work. Scheduled maintenance is on page [196](#).

* In Canada, Honda vehicles comply with the Canadian Motor Vehicle Safety Standards (CMVSS) for Emissions valid at the time they are manufactured.

Crankcase Emissions Control System

Your vehicle has a Positive Crankcase Ventilation System. This keeps gasses that build up in the engine's crankcase from going into the atmosphere. The Positive Crankcase Ventilation valve routes them from the crankcase back to the intake manifold. They are then drawn into the engine and burned.

Evaporative Emissions Control System

As gasoline evaporates in the fuel tank, an evaporative emissions control canister filled with charcoal adsorbs the vapor. It is stored in this canister while the engine is off. After the engine is started and warmed up, the vapor is drawn into the engine and burned during driving.

Exhaust Emissions Controls

The exhaust emissions controls include four systems: PGM-FI, Ignition Timing Control, Exhaust Gas Recirculation and Three Way Catalytic Converter. These four systems work together to control the engine's combustion and minimize the amount of HC, CO, and NOx that comes out the tailpipe. The exhaust emissions control systems are separate from the crankcase and evaporative emissions control systems.

PGM-FI System

The PGM-FI System uses sequential multiport fuel injection. It has three subsystems: Air Intake, Engine Control, and Fuel Control. The Engine Control Module (ECM)/ Powertrain Control Module (PCM-A/T only) uses various sensors to determine how much air is going into the engine. It then controls how much fuel to inject under all

operating conditions.

Ignition Timing Control System

This system constantly adjusts the ignition timing, reducing the amount of HC, CO and NOx produced.

Exhaust Gas Recirculation (EGR) System

The Exhaust Gas Recirculation (EGR) system takes some of the exhaust gas and routes it back into the intake manifold. Adding exhaust gas to the air/fuel mixture reduces the amount of NOx produced when the fuel is burned.

Three Way Catalytic Converter

The three way catalytic converter is in the exhaust system. Through chemical reactions, it converts HC, CO, and NOx in the engine's exhaust to carbon dioxide (CO₂), dinitrogen (N₂), and water vapor.

Replacement Parts

The emissions control systems are designed and certified to work together in reducing emissions to levels that comply with the Clean Air Act. To make sure the emissions remain low, you should use only new Genuine Honda replacement parts or their equivalent for repairs. Using lower quality parts may increase the emissions from your vehicle.

The emissions control systems are covered by warranties separate from the rest of your vehicle. Read your warranty manual for more information.

The three way catalytic converter contains precious metals that serve as catalysts, promoting chemical reactions to convert the exhaust gasses without affecting the metals. The catalytic converter is referred to as a three-way catalyst, since it acts on HC, CO, and NOx. A replacement unit must be an original Honda part or its equivalent.

The three way catalytic converter must operate at a high temperature for the chemical reactions to take place. It can set on fire any combustible materials that come near it. Park your vehicle away from high grass, dry leaves, or other flammables.

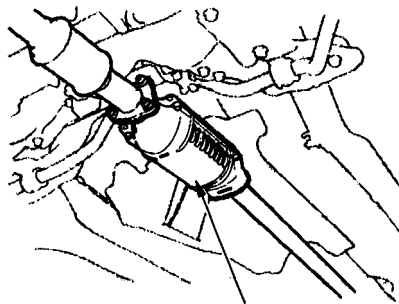

THREE WAY CATALYTIC CONVERTER

A defective three way catalytic converter contributes to air pollution, and can impair your engine's performance. Follow these guidelines to protect your vehicle's three way catalytic converter.

- Keep the engine tuned-up.
- Have your vehicle diagnosed and repaired if it is misfiring, back-firing, stalling, or otherwise not running properly.
- Always use unleaded gasoline. Even a small amount of leaded gasoline can contaminate the catalyst metals, making the three way catalytic converter ineffective.

Customer Relations	
Information.....	310
U.S. Zone Office Map.....	311
Canada Zone Office Map.....	312
Warranty Coverages.....	313
Reporting Safety Defects	
(U.S. Cars).....	314
Authorized Manuals.....	315

Customer Relations Information

Honda dealership personnel are trained professionals. They should be able to answer all your questions. If you encounter a problem that your dealership does not solve to your satisfaction, please discuss it with the dealership's management. The Service Manager or General Manager can help. Almost all problems are solved in this way.

If you are dissatisfied with the decision made by the dealership's management, contact your Honda Customer Relations Zone Office. Refer to the U.S. and Canadian Zone Office maps on the following pages.

When you call or write, please give us this information:

- Vehicle Identification Number (see page 294)
- Name and address of the dealer who services your vehicle
- Date of purchase
- Mileage on your vehicle
- Your name, address, and telephone number
- A detailed description of the problem
- Name of the dealer who sold the vehicle to you

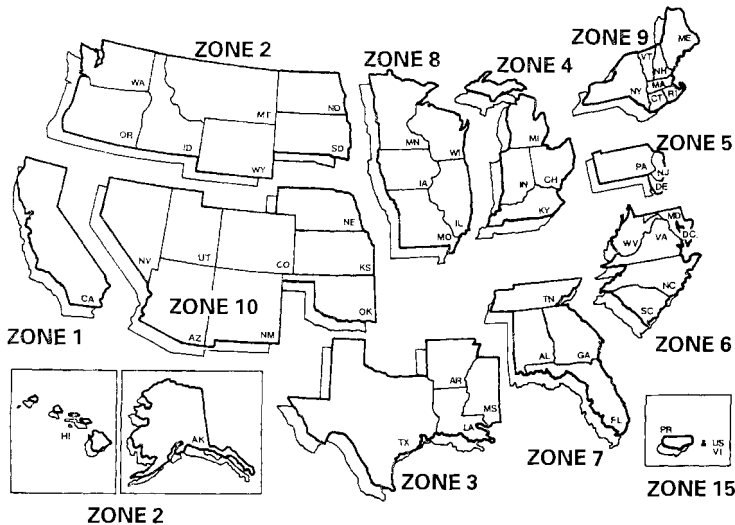

The addresses and telephone numbers are subject to change. If you cannot reach your Zone office, ask your Honda dealer for the current information.

1 Western Zone
P.O. Box 2260

700 Van Ness Avenue
Torrance, California
90509-2260
(310)781-4565

2 Northwestern Zone
P.O. Box 20186

12439 N.E. Airport Way
Portland, Oregon 97230
(503) 256-0943
(also includes Alaska and Hawaii)

3 South Central Zone
4529 Royal Lane

Irving, Texas 75063
(972) 929-5481

4 Central Zone
101 South Stanfield Road

Troy, Ohio 45373
(937) 332-6250

5 Northeastern Zone
P.O. Box 337

Eastgate Industrial Park
115 Gaither Drive
Moorestown, New Jersey 08057
(609) 235-5533
Includes: NYC Metro area and
Fairfield County, CT area

6 Mid-Atlantic Zone

902 Wind River Ln., Suite 200
Gaithersburg, Maryland 20878
(301) 990-2020

7 Southeastern Zone

1500 Morrison Parkway
Alpharetta, Georgia 30201
(770) 442-2045

8 North Central Zone

601 Campus Drive, Suite A-9
Arlington Heights, Illinois 60004
(847) 870-5600

9 New England Zone

555 Old County Road
Windsor Locks, Connecticut 06096
(860) 623-3310
See Zone 5 for:
NYC Metro area and
Fairfield County, CT area

10 West Central Zone

1600 South Abilene Street, Suite D
Aurora, Colorado 80012
(303) 696-3935

15 Puerto Rico and U.S. V.I.

Bella International
P.O. Box 190816
San Juan, PR 00919-0816
(787) 250-4318

Canada Zone Office Map



Western Zone

Honda Canada Inc.
13240 Worster Court
Richmond, B.C.
V6V 2B8
(604) 278-7121

Central Zone

Honda Canada Inc.
715 Milner Avenue
Scarborough, Ontario
M1B 2K8
(416) 299-3400

Quebec Zone

Honda Canada Inc.
1750 rue Eiffel
Boucherville, Quebec
J4B 7W1
(514) 655-6161

Atlantic Zone

Honda Canada Inc.
51 Raddal Avenue
Suite 1
Dartmouth, NS
B3B 1L4
(902) 468-4416

U.S. Owners

Your new Honda is covered by these warranties:

New Vehicle Limited Warranty

covers your new vehicle, except for the battery, emissions control systems and accessories, against defects in materials and workmanship.

Emissions Control Systems Defects Warranty and Emissions

Performance Warranty — these two warranties cover your vehicle's emissions control systems. Time, mileage, and coverage are conditional. Please read the warranty manual for exact information.

Original Equipment Battery Limited Warranty

—this warranty gives up to 100 percent credit toward a replacement battery.

Seat Belt Limited Warranty — a seat belt that fails to function properly is covered for the useful life of the vehicle.

Rust Perforation Limited Warranty

— all exterior body panels are covered for rust-through from the inside for the specified time period with no mileage limit.

Accessory Limited Warranty

— Genuine Honda Accessories are covered under this warranty. Time and mileage limits depend on the type of accessory and other factors. Please read your warranty manual for details.

Replacement Parts Limited

Warranty — covers all Genuine Honda replacement parts against defects in materials and workmanship.

Replacement Battery Limited Warranty — provides prorated coverage for a replacement battery purchased from a Honda dealer.

Replacement Muffler Lifetime Limited Warranty

— provides coverage for as long as the purchaser of the muffler owns the vehicle.

Restrictions and exclusions apply to all these warranties. Please read the 1998 Honda Warranty Information booklet that came with your vehicle for precise information on warranty coverages. Your Honda's original tires are covered by their manufacturer. Tire warranty information is in a separate booklet.

Canadian Owners

Please refer to the 1998 Warranty Manual that came with your vehicle.

Reporting Safety Defects (U.S. Cars)

If you believe that your vehicle has a defect which could cause a crash or could cause injury or death, you should immediately inform the National Highway Traffic Safety Administration (NHTSA) in addition to notifying American Honda Motor Co., Inc.

If NHTSA receives similar complaints, it may open an investigation, and if it finds that a safety defect exists in a group of vehicles, it may order a recall and remedy campaign. However, NHTSA cannot become involved in individual problems between you, your dealer, or American Honda Motor Co., Inc.

To contact NHTSA, you may either call the Auto Safety Hotline toll-free at 1-800-424-9393 (or 366-0123 in Washington D.C. area) or write to: NHTSA, U.S. Department of Transportation, Washington, D.C. 20590. You can also obtain other information about motor vehicle safety from the Hotline.

Purchasing Factory Authorized Manuals (U.S. only)

The following publications covering the operation and servicing of your vehicle can be obtained from Helm Incorporated, either by filling out the attached form or, for credit card holders, calling the toll-free phone number on the form. For manuals prior to the year shown below, contact Helm Incorporated, P.O. Box 07280, Detroit, Michigan 48207, or call 1-800-782-4356.

Publication Form Number	Form Description	Price Each*
61S8000	1998 Honda Accord Service Manual (Base)	\$56.00
61S8001	1998 Honda Accord (V6 Engine) Service Manual Supplement	\$29.00
61S8002	1998 Honda Accord (Coupe) Service Manual Supplement	\$29.00
61S8000EL	1998 Honda Accord Electrical Troubleshooting Manual	\$34.00
61S8030	1998 Honda Accord Body Repair Manual	\$32.00
31S82600	1998 Honda Accord Owner's Manual	\$20.00
HON-R	Order Form for Previous Years- Indicate Year and Model Desired	FREE
* Prices are subject to change without notice and without incurring obligation.		

Valid only for sales within the U.S. Canadian owners should contact their authorized Honda dealer.

ORDER TOLL FREE: 1-800-782-4356

(NOTE: For Credit Card Holder Orders Only)

Monday-Friday 8:00 A.M. — 6:00 P.M. EST

MINIMUM CREDIT CARD PURCHASE \$10.00

OR

By completing this form you can order the materials desired. You can pay by check or money order, or charge to your credit card. Mail to Helm Incorporated at the address shown on the back of the order form.

PUBLICATION NUMBER	VEHICLE MODEL		Qty	Price Each*	Total Price
	Name	Year			
* Prices are subject to change without notice and without incurring obligation.				TOTAL MATERIAL	
				Mich. Purchases Add 6% Sales Tax	
Orders are mailed within 10 days. Please allow adequate time for delivery.				HANDLING CHARGE \$5.00	
				GRAND TOTAL	

A

Accessories and Modifications....	162
Accessories.....	162
Additional Safety Precaution....	163
Modifications.....	163
ACCESSORY (Ignition Key Position).....	70
Accessory Power Socket.....	100
Adding	
Automatic Transmission Fluid.....	219
Brake Fluid.....	221
Clutch Fluid.....	222
Engine Coolant.....	211
Engine Oil.....	206
Manual Transmission Fluid....	220
Power Steering Fluid.....	223
Windshield Washer Fluid.....	218
Additional Information About Your Seat Belts.....	38
Lap/Shoulder Belts.....	38
Seat Belt Maintenance.....	39
Seat Belt System Components...	38

Additional Information About Your SRS.....	40
Additional Safety Precautions...	43
How Your Airbags Work.....	40
How Your SRS Indicator Works.....	42
SRS Components.....	40
Additives, Engine Oil.....	208
Adjustments	
Headlights.....	246
Head Restraints.....	87
Mirrors.....	94
Seats.....	82
Steering Wheel.....	63
Airbag (SRS).....	7, 40
Air Cleaner Element.....	224
Air Conditioning Filter.....	236
Air Conditioning System.....	104, 111
Maintenance.....	235
Usage.....	107, 113
Air Outlets (Vents).....	106, 111
Air Pressure, Tires.....	238
Alcohol in Gasoline.....	303
Antifreeze.....	211
Anti-lock Brakes (ABS) Indicator Light.....	51, 181

Operation.....	180
Anti-theft Steering Column Lock ..	70
Appearance Care.....	259
Audio System.....	119, 131
Automatic Lighting Off Feature....	59
Automatic Speed Control.....	65
Automatic Transmission.....	172
Capacity, Fluid.....	296, 298
Checking Fluid Level.....	219
Shifting.....	173
Shift Lever Position Indicator..	173
Shift Lever Positions.....	173
Shift Lock Release.....	177

B

Battery	
Charging System Indicator.....	50, 282
Jump Starting.....	276
Maintenance.....	230
Specifications.....	297, 299
Before Driving.....	153
Belts, Seat.....	6, 38

CONTINUED

Index

- Beverage Holder..... 97
Body Repair..... 265
Brakes
 Anti-lock System (ABS)..... 180
 Break-in, New Linings 154
 Fluid..... 221
 Light, Burned-out..... 251, 252
 Parking..... 95
 System Indicator..... 50, 284
 Wear Indicators..... 179
Brakes, ABS
 Operation..... 180
 System Indicator..... 51, 181
Braking System..... 179
Break-in, New Vehicle 154
Brightness Control, Instruments... 60
Brights, Headlights..... 58
Bulb Replacement
 Back-up Lights..... 252
 Brake Lights 251, 252
 Ceiling Light..... 256
 Courtesy Light..... 256
 Front Parking Lights..... 250
 Front Side Marker Lights..... 249
 Headlights..... 247
 High-mount Brake Light..... 254
 License Plate Lights..... 255
 Rear Side Marker Lights..... 253
 Specifications..... 297, 299
 Spotlight..... 256
 Trunk Light..... 257
 Turn Signal Lights..... 249
Bulbs, Halogen..... 247
- C**
- Cables, Jump Starting With..... 276
Capacities Chart..... 296, 298
Carbon Monoxide Hazard..... 44
Carrying Cargo..... 164
Cassette Player
 Care..... 148
 Operation..... 124, 145
CAUTION, Explanation of..... ii
CD Changer..... 127, 141
CD Player..... 139
Ceiling Light..... 101
Center Pocket..... 100
Certification Label..... 294
Chains..... 243
Change Oil
 How to..... 208
 When to..... 196
Changing a Flat Tire..... 269
Changing Engine Coolant..... 213
Charging System Indicator 50, 282
Checking
 Automatic Transmission
 Fluid..... 219
 Battery Condition..... 230
 Brake Fluid..... 221
 Clutch Fluid..... 222
 Drive Belts..... 236
 Engine Coolant..... 160
 Engine Oil..... 158
 Fuses..... 287
 Manual Transmission Fluid 220
 Power Steering Fluid..... 223
Checklist, Before Driving..... 168
Child Safety..... 17
Cleaner Element, Air..... 224
Cleaning
 Aluminum Wheels..... 261
 Carpeting..... 262
 Exterior..... 260
 Fabric..... 262
 Interior..... 262
 Leather..... 262

Seat Belts.....	263
Vinyl.....	262
Windows.....	263
Climate Control System.....	111
Clock, Setting the	96
Clutch Fluid.....	222
Coin Box.....	100
CO in the Exhaust.....	305
Cold Weather, Starting in.....	170
Compact Spare.....	268
Console Compartment.....	98
Consumer Information*.....	310
Controls, Instruments and.....	47
Coolant	
Adding.....	211
Checking.....	160
Proper Solution.....	211
Replacing.....	213
Temperature Gauge.....	55
Corrosion Protection.....	264
Courtesy Lights.....	102
Crankcase Emissions Control	
System.....	305
Cruise Control Operation.....	65
Customer Relations Office.....	311

D

DANGER, Explanation of.....	ii
Dashboard.....	48
Daytime Running Lights.....	59
Dead Battery, What to Do.....	276
Defects, Reporting Safety.....	314
Defogger, Rear Window.....	63
Defrosting the Windows.....	109, 117
DEXRON® III Automatic	
Transmission Fluid.....	220
Dimensions.....	296, 298
Dimming the Headlights.....	58
Dipstick	
Automatic Transmission.....	219
Engine Oil.....	158
Directional Signals.....	60
Disabled, Towing Your	
Vehicle If.....	291
Disc Brake Wear Indicators.....	179
Disposal of Used Oil.....	210
Doors	
Locking and Unlocking.....	71
Monitor Light.....	52
Power Door Locks.....	71
DOT Tire Quality Grading.....	301

Downshifting, 5-speed Manual	
Transmission.....	170
Drive Belts.....	236
Driver and Passenger Safety.....	3
Driving.....	167
Economy.....	161
In Bad Weather.....	182
In Foreign Countries.....	304

E

Economy, Fuel.....	161
Emergencies on the Road.....	267
Battery, Jump Starting.....	276
Brake System Indicator.....	284
Changing a Flat Tire.....	269
Charging System Indicator	282
Checking the Fuses.....	286
Low Oil Pressure Indicator.....	281
Malfunction Indicator Lamp....	283
Manually Closing Moonroof ...	285
Overheated Engine.....	279
Emergency Brake.....	95
Emergency Flashers.....	62

CONTINUED

Index

Emissions Controls.....	305
Engine	
Coolant Temperature Gauge	55
Drive Belts.....	236
Malfunction Indicator	
Lamp.....	51, 283
Oil Pressure Indicator.....	50, 281
Oil, What Kind to Use.....	206
Overheating.....	279
Specifications.....	297, 299
Ethanol in Gasoline	303
Evaporative Emissions Controls..	305
Exhaust Fumes.....	44
Expectant Mothers, Use of Seat	
Belts by.....	15
Exterior, Cleaning the.....	260

F

Fabric, Cleaning.....	262
Fan, Interior.....	104, 115
Features, Comfort and	
Convenience.....	103
Filling the Fuel Tank.....	155
Filters	
Air Conditioning.....	224

Oil.....	208
First Gear, Shifting.....	176
5-speed Manual Transmission	
Checking Fluid Level.....	220
5-speed Manual Transmission	
Shifting the.....	170
Flashers, Hazard Warning.....	62
Flat Tire, Changing a.....	269
Fluids	
Automatic Transmission.....	219
Brake.....	221
Clutch.....	222
Manual Transmission.....	220
Power Steering.....	223
Windshield Washer.....	218
FM Stereo Radio	
Reception.....	137
Folding Rear Seat.....	88
Foreign Countries, Driving in.....	304
Four-way Flashers.....	62
Front End, Towing by	
Emergency Wrecker.....	291
Fuel.....	154
Fill Door and Cap.....	155
Gauge.....	55
Octane Requirement.....	154

Oxygenated.....	303
Reserve Indicator.....	53
Tank, Filling the.....	155
Fuses, Checking the.....	286

G

Gas Mileage, Improving.....	161
Gasohol.....	303
Gasoline.....	154
Fuel Reserve Indicator.....	53
Gauge.....	55
Octane Requirement.....	154
Tank, Filling the.....	155
Gas Station Procedures.....	155
Gauges	
Engine Coolant Temperature	55
Fuel.....	55
Gearshift Lever Positions	
Automatic Transmission.....	173
5-speed Manual	
Transmission.....	170
Glass Cleaning.....	263
Glove Box.....	77

H

Halogen Headlight Bulbs.....	247
Hazard Warning Flashers.....	62
Headlights.....	58
Aiming.....	246
Automatic Lighting Off.....	59
Daytime Running Lights.....	59
High Beam Indicator.....	53
High Beams, Turning on.....	58
Low Beams, Turning on	58
Reminder Chime.....	58
Replacing Halogen Bulbs	247
Turning on.....	58
Head Restraints.....	87
Heating and Cooling.....	104
High Altitude, Starting at.....	170
High-Low Beam Switch	58
Homelink Universal Transmitter...	78
Hood, Opening the.....	156
Horn.....	57
Hot Coolant, Warning about.....	211
Hydraulic Clutch.....	222
Hydroplaning.....	183

I

Identification Number, Vehicle....	294
If Your Vehicle Has to be Towed.....	291
Ignition Keys.....	68
Switch.....	70
Timing Control System.....	306
Immobilizer System.....	69
Important Safety Precautions	4
Indicator Lights, Instrument Panel.....	49
Infant Restraint.....	17
Inflation, Proper Tire	238
Inside Mirror.....	94
Inspection, Tire.....	239
Instrument Panel.....	48
Instrument Panel Brightness.....	60
Interior Cleaning.....	262
Interior Lights.....	101
Introduction.....	i

J

Jacking up the Vehicle.....	270
-----------------------------	-----

Jack, Tire.....	269
Jump Starting.....	276

K

Keys.....	68
-----------	----

L

Label, Certification.....	294
Lane Change, Signaling.....	60
Lap/Shoulder Belts.....	13, 38
Leaking of Exhaust into Vehicle ...	44
Lights Bulb Replacement.....	247
Indicator.....	49
Parking.....	58
Turn Signal.....	60
LOCK (Ignition Key Position).....	70
Lockout Prevention.....	72
Locks Anti-theft Steering Column.....	70
Fuel Fill Door.....	155
Glove Box.....	77

CONTINUED

Index

Locks	
Power Door.....	71
Trunk.....	76
Low Coolant Level.....	160
Lower Gear, Downshifting to a....	170
Low Oil Pressure Indicator....	50, 281
Lubricant Specifications	
Chart.....	296, 298
Luggage.....	164

M

Maintenance.....	191
Owner Maintenance Checks....	203
Record.....	201-202
Required Indicator.....	56
Safety.....	192
Schedule.....	194-200
Malfunction Indicator Lamp ..	51, 283
Manual Transmission.....	170
Manual Transmission Fluid	220
Maximum Allowable	
Speeds.....	172, 176
Meters, Gauges.....	54
Methanol in Gasoline.....	303
Mirrors, Adjusting.....	94

Moonroof.....	93
Closing Manually.....	285
Operation.....	93

N

Neutral Gear Position.....	175
New Vehicle Break-in.....	154
Normal Shift Speeds.....	171
NOTICE, Explanation of.....	i
Numbers, Identification.....	294

O

Octane Requirement, Gasoline....	154
Odometer.....	54
Odometer, Trip.....	55
Oil	
Change, How to	208
Change, When to.....	196
Checking Engine.....	158
Pressure Indicator.....	50, 281
Selecting Proper Viscosity	
Chart.....	207
ON (Ignition Key Position).....	70
Opening the Hood.....	156

Operation in Foreign Countries...	304
Outside Mirrors.....	94
Overheating, Engine.....	279
Owner Maintenance Checks.....	203

P

Paint Touch-up.....	261
Panel Brightness Control.....	60
Park Gear Position.....	174
Parking.....	178
Parking Brake.....	95
Parking Lights.....	58
Parking Over Things that Burn...	178
PGM-FI System.....	306
Polishing and Waxing.....	261
Power	
Door Locks.....	71
Mirrors.....	94
Seats.....	84
Steering.....	223
Windows.....	91
Pre-Drive Safety Checklist.....	9
Pregnancy, Using Seat Belts.....	15
Proper Seat Belt Usage.....	13

Protecting Adults.....	10
Additional Safety Precautions....	16
Advice for Pregnant Women.....	15
Protecting Children.....	17
Protecting Infants.....	25
Protecting Larger Children.....	32
Protecting Small Children.....	29
Using Child Seats with Tethers.....	35

R

Radiator Overheating.....	279
Radio/Cassette Sound System	119
Radio/CD Sound System.....	131
Rear End Towing.....	291
Rear Lights, Bulb Replacement...	251
Rear Seat Access.....	86
Rear Seat, Folding.....	88
Rear View Mirror.....	94
Rear Window Defogger.....	63
Reclining the Seat Backs.....	82, 85
Recommended Shift Speeds	171
Reminder Lights.....	49
Remote Audio Controls.....	67
Remote Transmitter.....	73

Replacement Information	
Air Cleaner Element.....	224
Coolant.....	213
Engine Oil and Filter.....	208
Fuses.....	286
Light Bulbs.....	247
Schedule.....	194-200
Spark Plugs.....	226, 228
Timing Belt.....	237
Tires.....	241
Wiper Blades.....	233
Replacing Seat Belts After a Crash.....	39
Reserve Tank, Engine Coolant...	160
Restraint, Child.....	17
Reverse Gear Position.....	174
Rotation, Tire.....	241

S

Safety Belts.....	6, 38
Safety Defects, Reporting*	314
Safety Features.....	5
Airbags.....	7
Door Locks.....	8
Head Restraints.....	8

Seat Belts.....	6
Seats & Seat-Backs.....	8
Safety Labels, Location of.....	45
Safety Messages.....	ii
Seat Belt, Additional Information..	38
Lap/Shoulder Belt.....	38
Seat Belt Maintenance.....	39
Seat Belt System Components...	38
Seat Belts.....	6, 38
Cleaning.....	263
Maintenance.....	39
Reminder Light and Beeper.....	38, 50
System Components.....	38
Tether Attachment Points.....	35
Use During Pregnancy.....	15
Wearing a Lap/Shoulder Belt....	13
Seats, Adjusting the.....	82
Seat Heaters.....	90
Security System.....	151
Serial Number.....	294
Service Intervals.....	196
Service Manual*	315
Service Station Procedures	155

CONTINUED

Setting the Clock.....	96
Shifting	
The Automatic	
Transmission.....	172
The 5-speed Manual	
Transmission.....	170
Shift Lever Position Indicator.....	173
Shift Lock Release.....	177
Side Marker Lights, Bulb	
Replacement in.....	253
Signaling Turns.....	60
Snow Tires.....	243
Solvent-type Cleaners.....	260
Sound System.....	119, 131
Spare Tire	
Inflating.....	268
Specifications.....	297, 299
Spark Plugs, Replacing.....	226, 228
Specifications Charts	296, 298
Speed Control.....	65
Speedometer.....	54
Spotlights.....	101
SRS, Additional Information.....	40
Additional Safety Precautions....	43
How Your Airbags Work.....	40

How Your SRS Indicator	
Works.....	42
SRS Components.....	40
SRS Service.....	42
SRS Indicator.....	42, 51
START (Ignition Key Position)	71
Starting the Engine.....	169
In Cold Weather at High	
Altitude.....	170
With a Dead Battery.....	276
Steam Coming from Engine.....	279
Steering Wheel	
Adjustment.....	63
Anti-theft Column Lock.....	70
Stereo Sound System.....	119, 131
Storing Your Vehicle.....	258
Sunglasses Holder.....	96
Sun Visor.....	99
Supplemental Restraint	
System.....	7, 40
Servicing.....	42
SRS Indicator.....	42, 51
System Components.....	38
Synthetic Oil.....	208

T

Tachometer.....	54
Taillights, Changing Bulbs in.....	251
Taking Care of the Unexpected ..	267
Tape Player	124, 145
Technical Descriptions	
Driving in Foreign Countries...	304
Emissions Control Systems.....	305
Oxygenated Fuels.....	303
Three Way Catalytic	
Converter.....	307
Tire Information.....	300
Temperature Gauge.....	55
Tether Attachment Points.....	35
Theft Protection.....	150
Three Way Catalytic Converter...	307
Time, Setting the.....	96
Timing Belt.....	237
Tire Chains.....	243
Tire, How to Change a Flat.....	269
Tires.....	238
Air Pressure.....	238
Checking Wear.....	239
Compact Spare.....	268
DOT Tire Quality Grading.....	301

Inflation..... 238
 Inspection..... 239
 Maintenance..... 240
 Replacing..... 241
 Rotating..... 241
 Snow..... 243
 Specifications..... 297, 299
 Tire Chains..... 243
 Technical Information..... 300
 Winter Driving..... 242
 Tools, Tire Changing..... 269
 Towing
 A Trailer..... 184
 Emergency Wrecker..... 291
 Transmission
 Checking Fluid Level,
 Automatic..... 219
 Checking Fluid Level,
 Manual..... 220
 Fluid Selection..... 220
 Identification Number..... 294
 Shifting the Automatic..... 173
 Shifting the Manual..... 170
 Treadwear..... 301
 Trip Meter..... 55

Trunk..... 76
 Opening the..... 76
 Open Monitor Light..... 52
 Turn Signals..... 60

U

Underside, Cleaning..... 264
 Unexpected, Taking Care
 of the..... 267
 Uniform Tire Quality Grading..... 301
 Unleaded Gasoline..... 154
 Upholstery Cleaning..... 262
 Used Oil, How to Dispose of..... 210

V

Vanity Mirror..... 99
 Vehicle Capacity Load 165
 Vehicle Dimensions 296, 298
 Vehicle Identification Number..... 294
 Vehicle Storage..... 258
 Ventilation..... 107, 111
 VIN..... 294
 Vinyl Cleaning..... 262
 Viscosity, Oil..... 207

W

Warning Beepers
 Headlights on..... 58
 Key in Ignition..... 71
 Seat Belts..... 38, 50
 WARNING, Explanation of..... ii
 Warning Labels, Location of..... 45
 Warranty Coverages*..... 313
 Washer, Windshield
 Checking the Fluid Level..... 218
 Operation..... 62
 Washing..... 260
 Waxing and Polishing..... 261
 Wheels
 Adjusting the Steering..... 63
 Alignment and Balance..... 240
 Compact Spare..... 268
 Wrench..... 270
 Windows
 Cleaning..... 263
 Operating the Power..... 91
 Rear, Defogger..... 63

CONTINUED

Index

Windshield	
Cleaning.....	61
Defroster.....	109, 117
Wipers, Windshield	
Changing Blades.....	233
Operation.....	61
Worn Tires.....	239
Wrecker, Emergency Towing.....	291

*: U.S. and Canada only

Gasoline:

Unleaded gasoline, pump octane number of 86 or higher.

Fuel tank Capacity:

17.12 US gal (64.8 l, 14.26 Imp gal)

Recommended Engine Oil:

API Service SJ "Energy Conserving" oil, SAE 5W-30 viscosity (see page [207](#)).

Oil change capacity (including filter):

LX, EX

4.5 US qt (4.3 l, 3.8 Imp qt)

LX-V6, EX-V6

4.6 US qt (4.4 l, 3.9 Imp qt)

Automatic Transmission Fluid:

Honda Premium Formula Automatic Transmission Fluid preferred, or a DEXRON® III ATF as a temporary replacement (see page [220](#)).

5-speed Manual Transmission**Fluid:**

Honda Manual Transmission Fluid preferred, or an API service SG, SH or SJ, SAE 10W-30 or 10W-40 motor oil as a temporary replacement (see page [220](#)).

Capacity:

2.0 US qt (1.9 l, 1.7 Imp qt)

Power Steering Fluid:

Genuine Honda Power Steering Fluid preferred, or another brand of power steering fluid as a temporary replacement. Do not use ATF (see page [223](#)).

Brake Fluid:

Genuine Honda DOT 3 Brake Fluid preferred, or a DOT 3 or DOT 4 brake fluid as a temporary replacement (see page [221](#)).

Tire Pressure (measured cold):

LX, EX

Front/Rear:

29 psi (200 kPa, 2.0 kgf/cm²)

LX-V6

Front/Rear:

30 psi (210 kPa, 2.1 kgf/cm²)

EX-V6

Front/Rear:

32 psi (220 kPa, 2.2 kgf/cm²)

Spare Tire:

60 psi (420 kPa, 4.2 kgf/cm²)

