

1999 Civic Sedan Online Reference Owner's Manual

Use these links (and links throughout this manual) to navigate through this reference.

For a printed owner's manual, click on authorized manuals or go to www.helminc.com.

If you have a Civic GX refer to [Civic GX Owner's Manual Supplement](#) for additional information.

Contents

Owner's Identification Form

Introduction	i
A Few Words About Safety	ii
Your Car at a Glance	2
Driver and Passenger Safety	5
Proper use and care of your car's seat belts, and Supplemental Restraint System.	
Instruments and Controls	51
Instrument panel indicator and gauge, and how to use dashboard and steering column controls.	
Comfort and Convenience Features	89
How to operate the climate control system, the audio system, and other convenience features.	
Before Driving	141
What gasoline to use, how to break-in your new car, and how to load luggage and other cargo.	
Driving	155
The proper way to start the engine, shift the transmission, and park, plus towing a trailer.	
Maintenance	173
The Maintenance Schedule shows you when you need to take your car to the dealer.	
Appearance Care	231
Tips on cleaning and protecting your car. Things to look for if your car ever needs body repairs.	
Taking Care of the Unexpected	237
This section covers several problems motorists sometimes experience, and how to handle them.	
Technical Information	261
ID numbers, dimensions, capacities, and technical information.	
Warranty and Customer Relations (U.S. and Canada)	275
A summary of the warranties covering your new Honda, and how to contact us.	
Authorized Manuals (U.S. only)	281
How to order manuals and other technical literature.	
Index	I

Service Information Summary

A summary of information you need when you pull up to the fuel pump.

Congratulations ! Your selection of a 1999 Honda Civic was a wise investment. It will give you years of driving pleasure.

One of the best ways to enhance the enjoyment of your new Honda is to read this manual. In it, you will learn how to operate its driving controls and convenience items. Afterwards, keep this owner's manual in your car so you can refer to it at any time.

Several warranties protect your new Honda. Read the warranty booklet thoroughly so you understand the coverages and are aware of your rights and responsibilities.

Maintaining your car according to the schedules given in this manual helps to keep your driving trouble-free while it preserves your investment. When your car needs maintenance, keep in mind that your Honda dealer's staff is specially trained in servicing the many systems unique to your Honda. Your Honda dealer is dedicated to your satisfaction and will be pleased to answer any questions and concerns.

As you read this manual, you will find information that is preceded by a **NOTICE** symbol. This information is intended to help you avoid damage to your Honda, other property, or the environment.

A Few Words About Safety

Your safety, and the safety of others, is very important. And operating this vehicle safely is an important responsibility.

To help you make informed decisions about safety, we have provided operating procedures and other information on labels and in this manual. This information alerts you to potential hazards that could hurt you or others.

Of course, it is not practical or possible to warn you about all the hazards associated with operating or maintaining your vehicle. You must use your own good judgement.

You will find this important safety information in a variety of forms, including:

- **Safety Labels** — on the vehicle.
- **Safety Messages** — preceded by a safety alert symbol  and one of three signal words: **DANGER**, **WARNING**, or **CAUTION**.

These signal words mean:

You **WILL** be **KILLED** or **SERIOUSLY HURT** if you don't follow instructions.

You **CAN** be **KILLED** or **SERIOUSLY HURT** if you don't follow instructions.

You **CAN** be **HURT** if you don't follow instructions.

- **Safety Headings** — such as Important Safety Reminders or Important Safety Precautions.
- **Safety Section** — such as Driver and Passenger Safety.
- **Instructions** — how to use this vehicle correctly and safely.

This entire book is filled with important safety information — please read it carefully.

Your Car at a Glance

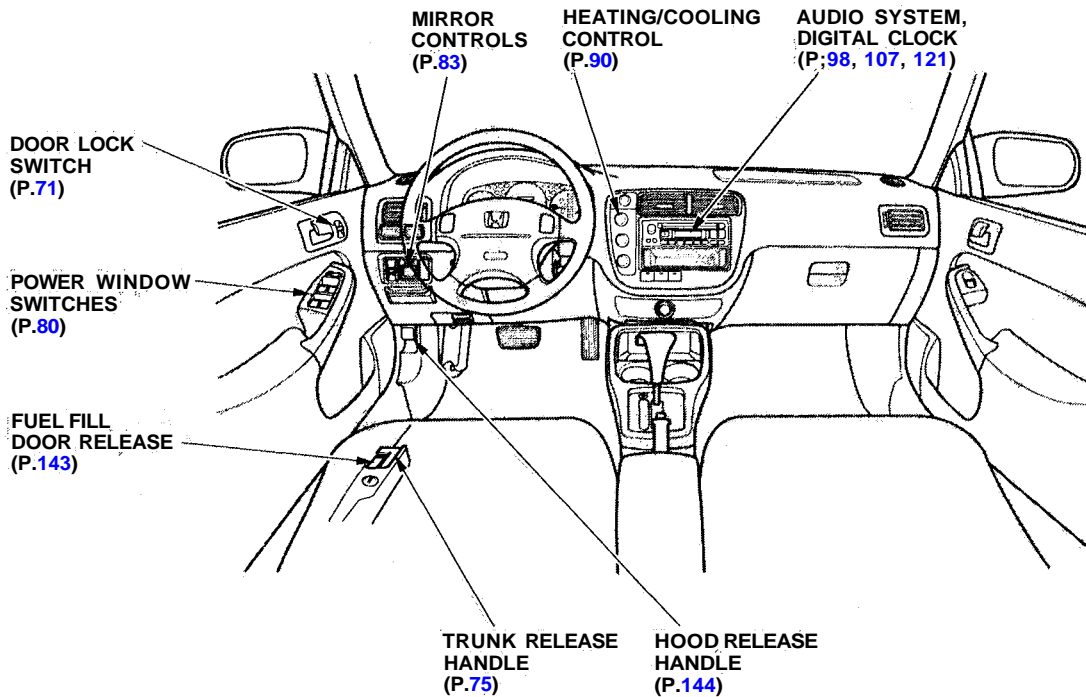

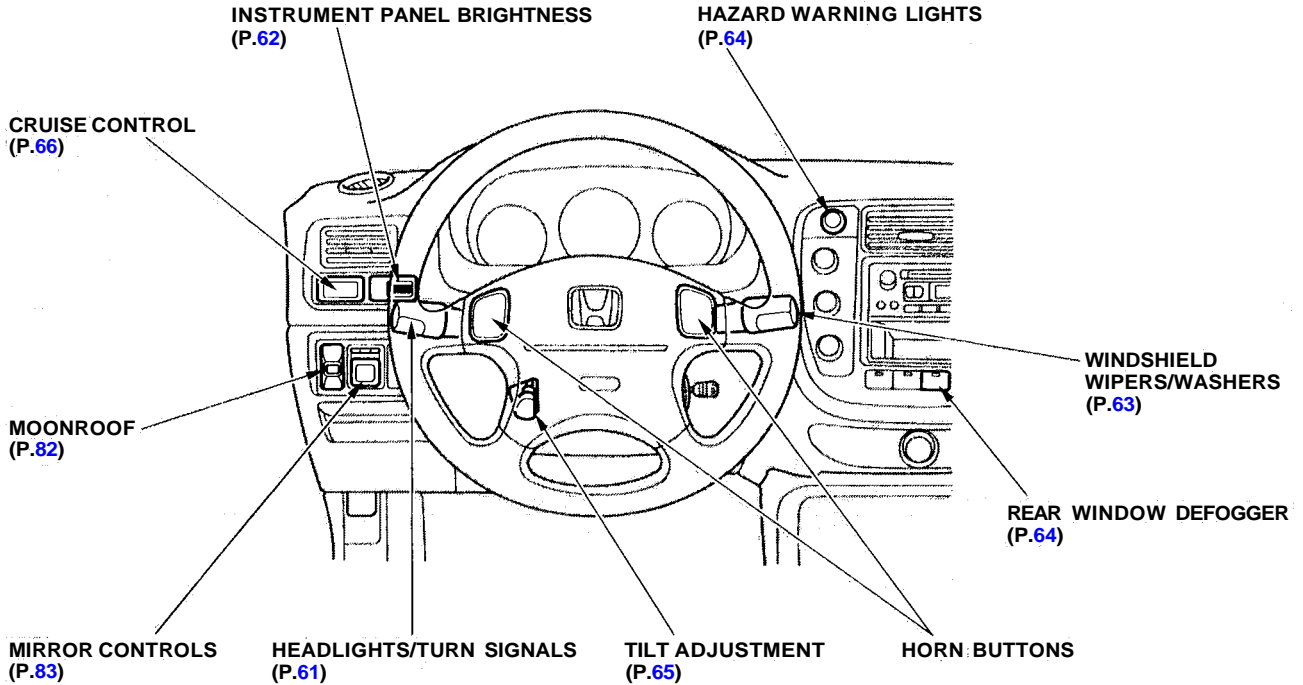

This section gives you important information about how to protect yourself and your passengers. It shows you how to use seat belts properly. It explains your Supplemental Restraint System. And it tells you how to properly restrain infants and children in your car.

Important Safety Precautions	6
Your Car's Safety Features.....	7
Seat Belts.....	8

Airbags.....	9
Seats & Seat-Backs.....	10
Head Restraints.....	10
Door Locks.....	11
Pre-Drive Safety Checklist.....	11
Protecting Adults.....	12
1. Close and Lock the Doors.....	12
2. Adjust the Front Seats.....	12
3. Adjust the Seat-Backs.....	13
4. Adjust the Head Restraints....	14
5. Fasten and Position the Seat Belts.....	15
6. Adjust the Steering Wheel....	18
7. Maintain a Proper Sitting Position.....	18
Advice for Pregnant Women.....	19
Additional Safety Precautions....	19
Protecting Children.....	21
All Children Must Be Restrained.....	21
Children Should Sit in the Back Seat.....	22
The Passenger's Airbag Poses Serious Risks to Children.....	22
If You Must Drive with Several Children.....	24

If a Child Requires Close Attention.....	24
Additional Safety Precautions....	24
General Guidelines for Using Child Seats.....	25
Protecting Infants.....	29
Protecting Small Children.....	33
Protecting Larger Children.....	37
Using Child Seats with Tethers.....	40
Additional Information About Your Seat Belts.....	42
Seat Belt System Components...	42
Lap/Shoulder Belt.....	42
Lap Belt.....	43
Seat Belt Maintenance.....	44
Additional Information About Your SRS.....	45
SRS Components.....	45
How Your Airbags Work.....	45
How the SRS Indicator Light Works.....	47
SRS Service.....	47
Additional Safety Precautions....	48
Carbon Monoxide Hazard.....	49
Safety Labels.....	50

Important Safety Precautions

You'll find many safety recommendations throughout this section, and throughout this manual. The recommendations on this page are the ones we consider to be the most important.

Always Wear Your Seat Belt

A seat belt is your best protection in all types of collisions. Airbags supplement seat belts, but airbags are designed to inflate only in a moderate to severe frontal collision. So even though your car is equipped with airbags, make sure you and your passengers always wear your seat belts, and wear them properly. (See page [15](#).)

Restrain All Children

Children are safest when they are properly restrained in the back seat, not the front seat. A child who is too small for a seat belt must be properly restrained in a child safety seat. (See page [21](#).)

Be Aware of Airbag Hazards

While airbags save lives, they can cause serious or fatal injuries to occupants who sit too close to them, or are not properly restrained. Infants, young children, and short adults are at the greatest risk. Be sure to follow all instructions and warnings in this manual. (See page [7](#).)

Don't Drink and Drive

Alcohol and driving don't mix. Even one drink can reduce your ability to respond to changing conditions, and your reaction time gets worse with every additional drink. So don't drink and drive, and don't let your friends drink and drive, either.

Control Your Speed

Excessive speed is a major factor in crash injuries and deaths. Generally, the higher the speed the greater the risk, but serious accidents can also occur at lower speeds. Never drive faster than is safe for current conditions, regardless of the maximum speed posted.

Keep Your Car in Safe Condition

Having a tire blowout or a mechanical failure can be extremely hazardous. To reduce the possibility of such problems, check your tire pressures and condition frequently, and perform all regularly scheduled maintenance. (See page [178](#).)

Your Car's Safety Features

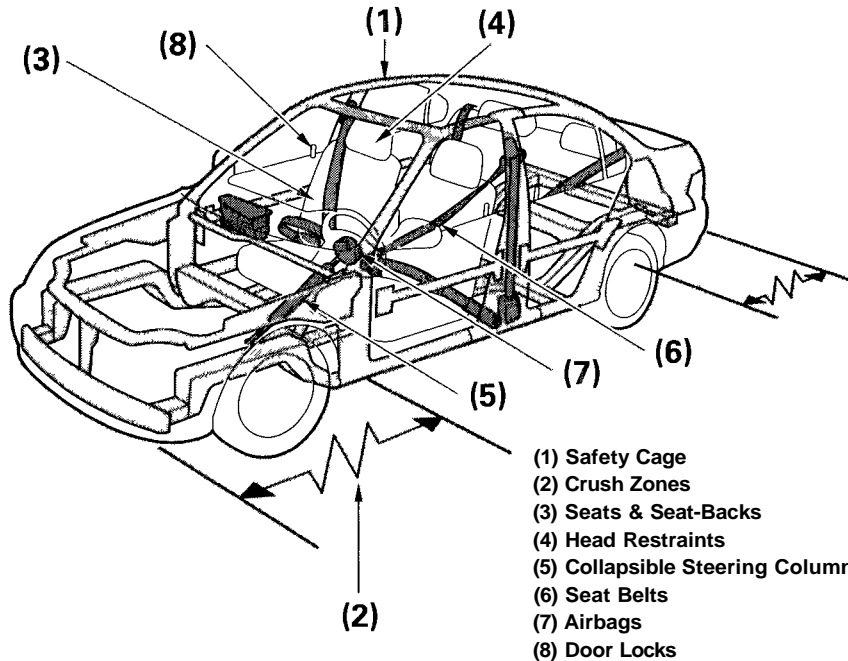

Your car is equipped with many features that work together to protect you and your passengers during a crash.

Some safety features do not require any action on your part. These include a strong steel framework that forms a safety cage around the passenger compartment; front and rear crush zones that are designed to crumple and absorb energy during a crash; and a collapsible steering column.

These safety features are designed to reduce the severity of injuries in a crash. However, you and your passengers can't take full advantage of these safety features unless you remain sitting in a proper position and ***always wear your seat belts properly***. In fact, some safety features can contribute to injuries if they are not used properly.

Your Car's Safety Features

Seat Belts

For your safety, and the safety of your passengers, your car is equipped with seat belts in all seating positions.



Your seat belt system also includes a light on the instrument panel to remind you and your passengers to fasten your seat belts.

Why Wear Seat Belts

Seat belts are the single most effective safety device for adults and larger children. (Infants and smaller children must be properly restrained in child seats.)

Not wearing a seat belt properly increases the chance of serious injury or death in a crash, even though your car has airbags.

In addition, most states and all Canadian provinces require you to wear seat belts.

Not wearing a seat belt properly increases the chance of serious injury or death in a crash, even if you have airbags.

Be sure you and your passengers always wear seat belts and wear them properly.

When properly worn, seat belts:

- Keep you connected to the vehicle so you can take advantage of the car's built-in safety features.
- Help protect you in almost every type of crash, including side and rear impacts and rollovers. (Your airbag can only be helpful in a moderate to severe frontal

collision.)

- Help keep you from being thrown against the inside of the vehicle and against other occupants.
- Keep you from being thrown out of the vehicle.
- Help keep you in a good position should the airbags ever deploy. A good position reduces the risk of injury from an inflating airbag, and allows you to get the best advantage from the airbag.

Of course, seat belts cannot completely protect you in every crash. But in most cases, seat belts can reduce your risk of serious injury.

What you should do: Always wear your seat belt, and make sure you wear it properly.

Airbags

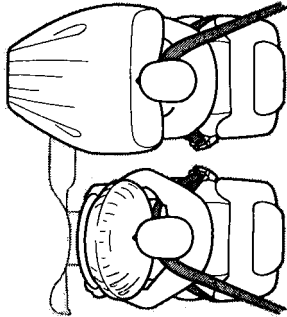

Your car has a Supplemental Restraint System (SRS) with frontal airbags to help protect the driver and a front seat passenger.

SRS This system also includes an indicator light on the instrument panel to alert you to a possible problem with the system.

The most important things you need to know about your airbags are:

- ***Airbags do not replace seat belts.*** The seat belts are the occupants' primary protection in all types of collisions. The airbags supplement the seat belts by providing extra protection for the head and chest of each front seat occupant in a moderate to severe frontal collision.
- ***Airbags offer no protection in side impacts, rear impacts, rollovers, or minor collisions.*** Airbags are designed to deploy only during a moderate to severe frontal collision.
- ***Airbags can pose serious hazards.*** To do their job, airbags must inflate with tremendous force and speed. So while airbags save lives,

they can cause serious injuries to adults and larger children who are not wearing seat belts, are not wearing them properly, are sitting too close to the airbag, or are not sitting in a proper position. Infants and small children are at an even greater risk of injury or death.

What you should do: Always wear your seat belt properly, and sit upright and as far back as possible from the steering wheel or dashboard.

Your Car's Safety Features

Seats & Seat-Backs

Your car's seats are designed to keep you in a comfortable, upright position so you can take full advantage of the protection offered by seat belts and the energy absorbing materials in the seats.

How you adjust your seats and seat-backs can also affect your safety. For example, sitting too close to the steering wheel or dashboard increases the risk of you or your passenger being injured by striking the inside of the car, or by an inflating airbag.

Reclining a seat-back too far reduces the seat belt's effectiveness and increases the chance that the seat's occupant will slide under the seat belt in a crash and be seriously injured.

What you should do: Move the front seats as far back as possible, and keep adjustable seat-backs in an upright position whenever the car is moving.

Head Restraints

Head restraints can help protect you from whiplash and other injuries. For maximum protection, the back of your head should rest against the center of the head restraint.

Door Locks

Keeping your doors locked reduces the chance of being thrown out of the car during a crash. It also helps prevent occupants from accidentally opening a door and falling out, and outsiders from unexpectedly opening your doors.

Pre-Drive Safety Checklist

To make sure you and your passengers get the maximum protection from your car's safety features, check the following each time before you drive away:

- All adults, and children who have outgrown child safety seats, are wearing their seat belts and wearing them properly (see page [15](#)).
- Any infant or small child is properly restrained in a child seat in the back seat (see page [21](#)).
- Front seat occupants are sitting upright and as far back as possible from the steering wheel and dashboard (see page [12](#)).
- Seat-backs are upright (see page [13](#)).

- Head restraints are properly adjusted (see page [15](#)).
- All doors are closed and locked (see page [12](#)).
- All cargo is properly stored or secured (see page [151](#)).

The rest of this section gives more detailed information about how you can maximize your safety.

Remember, however, that no safety system can prevent all injuries or deaths that can occur in severe crashes, even when seat belts are properly worn and the airbags deploy.

Protecting Adults

Introduction

The following pages provide instructions on how to properly protect the driver and other adult occupants.

These instructions also apply to children who have outgrown child seats and are large enough to wear lap/shoulder belts. (See page 37 for important additional guidelines on how to properly protect larger children.)

1. Close and Lock the Doors

After everyone has entered the car, be sure the doors are closed and locked.

For safety, locking the doors reduces the chance that a passenger, especially a child, will open a door while the car is moving and accidentally fall out. It also reduces the chance of someone being thrown out of the car during a crash.

For security, locked doors can prevent an outsider from unexpectedly opening a door when you come to a stop.

See page 70 for how to lock the doors.

2. Adjust the Front Seats

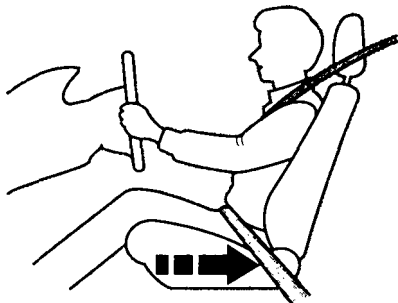

Any driver who sits too close to the steering wheel is at risk of being seriously injured or killed by striking the steering wheel, or from being struck by an inflating airbag during a crash.

To reduce the chance of injury, wear your seat belt properly, sit upright with your back against the seat, and move the seat as far back as possible from the steering wheel while still maintaining full control of the car. Also make sure your front seat passenger moves the seat as far to the rear as possible.

Sitting too close to an airbag can result in serious injury or death if the airbags inflate.

Always sit as far back from the airbags as possible.

Most shorter drivers can get far enough away from the steering wheel and still reach the pedals. However, if you are concerned about sitting too close, we recommend that you investigate whether some type of adaptive equipment may help.

Once your seat is adjusted correctly, rock it back and forth to make sure the seat is locked in position.

See page [76](#) for how to adjust the front seats.

3. Adjust the Seat-Backs

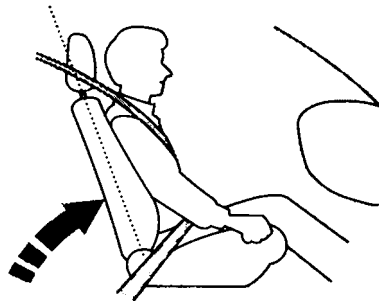

Adjust the driver's seat-back to a comfortable, upright position, leaving ample space between your chest and the airbag cover in the center of the steering wheel. If you sit too close to the steering wheel, you could be injured if the front airbag inflates.

A front passenger should also adjust the seat-back to an upright position, but as far from the dashboard as

possible. A passenger who sits too close to the dashboard could be injured if the front airbag inflates.

Reclining a seat-back so that the shoulder part of the belt no longer rests against the occupant's chest reduces the protective capability of the belt. It also increases the chance of sliding under the belt in a crash and being seriously injured. The farther a seat-back is reclined, the greater the risk of injury.

Reclining the seat-back too far can result in serious injury or death in a crash.

Adjust the seat-back to an upright position and sit well back in the seat.

See page [78](#) for how to adjust seat-backs.

4. Adjust the Head Restraints

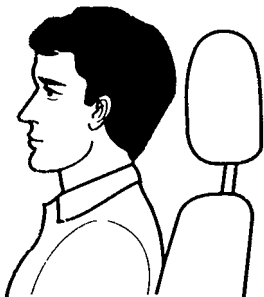

Before driving, make sure everyone with an adjustable head restraint has properly positioned the head restraint. The restraint should be positioned so the back of the occupant's head rests against the center of the restraint. A taller person should adjust the restraint as high as possible.

Improperly positioning head restraints reduces their effectiveness and you can be seriously injured in a crash.

Make sure head restraints are in place and positioned properly before driving.

Properly adjusted head restraints will help protect occupants from whiplash and other crash injuries.

See page [78](#) for how to adjust the head restraints.

5. Fasten and Position the Seat Belts

Using a Lap/Shoulder Belt

Insert the latch plate into the buckle, then tug on the belt to make sure the belt is securely latched. Also check that the belt is not twisted, because a twisted belt can cause serious injuries in a crash.

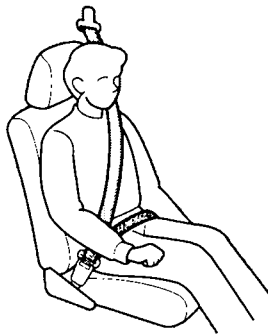

Position the lap part of the belt as low as possible across your hips, then pull up on the shoulder part of the belt so the lap part fits snugly. This lets your strong pelvic bones take the force of a crash and reduces the chance of internal injuries.

If necessary, pull up on the belt again to remove any slack from the shoulder part, then check that the belt rests across the center of your chest and over your shoulder. This spreads the forces of a crash over the strongest bones in your upper body.

Improperly positioning the seat belts can cause serious injury or death in a crash.

Make sure all seat belts are properly positioned before driving.

CONTINUED

Protecting Adults

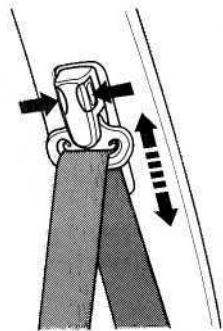

If the seat belt touches or crosses your neck, or if it crosses your arm instead of your shoulder, you need to adjust the seat belt anchor height.

To adjust the height of a front seat belt anchor, squeeze the two release buttons and slide the anchor up or down as needed (it has four positions).

Never place the shoulder portion of a lap/shoulder belt under your arm or behind your back. This could cause very serious injuries in a crash.

Using the Lap Belt

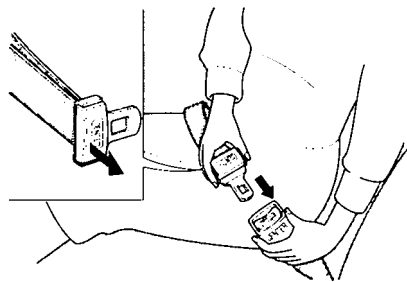

Insert the latch plate into the buckle marked **CENTER**.

If the belt is too short, hold the latch plate at a right angle and pull on the plate to extend the belt. Then insert the latch plate into the buckle, and tug on the belt to make sure the belt is securely latched.

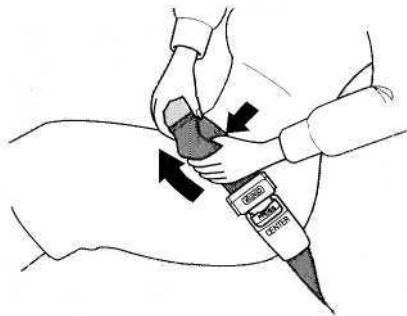

Position the belt as low as possible across your hips. This lets your strong pelvic bones take the force of a crash and reduces the chance of internal injuries.

Pull on the loose end of the belt for a snug but comfortable fit.

If a Seat Belt Doesn't Work Properly

If a seat belt does not seem to work as it should, it may not protect the occupant in a crash. ***No one should sit in a seat with an inoperative seat belt.*** Anyone using a seat belt that is not working properly can be seriously injured or killed. Have your Honda dealer check the belt as soon as possible.

See page [42](#) for additional information about your seat belt system and how to take care of your belts.

6. Adjust the Steering Wheel

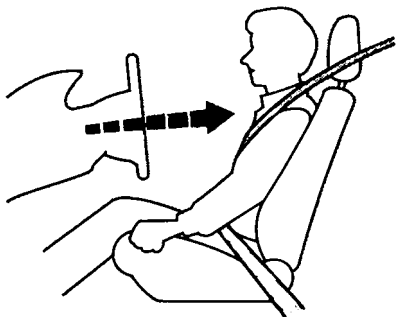

Adjust the steering wheel, if needed, so that the wheel points toward your chest, not toward your face.

Pointing the steering wheel toward your face decreases the protective capability of the driver's airbag.

See page [65](#) for how to adjust the steering wheel.

7. Maintain a Proper Sitting Position

After all occupants have adjusted their seats and put on seat belts, it is very important that they continue to sit upright, well back in their seats, with their feet on the floor, until the car is parked and the engine is off.

Sitting improperly can increase the chance of injury during a crash. For example, if an occupant slouches, lies down, turns sideways, sits forward, leans forward or sideways, or puts one or both feet up, the chance of injury during a crash is greatly increased.

In addition, an occupant who is out of position in the front seat can be seriously or fatally injured by striking interior parts of the car, or by being struck by an inflating airbag.

Sitting improperly or out of position can result in serious injury or death in a crash.

Always sit upright, well back in the seat, with your feet on the floor.

Remember, to get the best protection from your car's airbags and other safety features, you must sit properly and wear your seat belt properly.

Advice for Pregnant Women



Because protecting the mother is the best way to protect her unborn child, a pregnant woman should always wear a seat belt whenever she drives or rides in a vehicle.

We recommend that pregnant women use a lap/shoulder belt whenever possible. Remember to keep the lap portion of the belt as low as possible across your hips.

Pregnant women should also sit upright and as far back as possible from the steering wheel or dashboard. This will reduce the risk of injuries to both the mother and her unborn child that can be caused by a crash or an inflating airbag.

Each time you have a check-up, ask your doctor if it's okay for you to drive.

Additional Safety Precautions

- **Two people should never use the same seat belt.** If they do, they could be very seriously injured in a crash.
- **Do not put any accessories on seat belts.** Devices intended to improve occupant comfort or reposition the shoulder part of a seat belt, can severely compromise the protective capability of seat belts and increase the chance of serious injury in a crash.

CONTINUED

Protecting Adults

- ***Do not place hard or sharp objects between yourself and an airbag.*** Carrying hard or sharp objects on your lap, or driving with a pipe or other sharp object in your mouth, can result in injuries if your airbags inflate.
- ***Keep your hands and arms away from the airbag covers.*** If your hands or arms are close to the SRS covers in the center of the steering wheel and on top of the dashboard, they could be injured if the airbags inflate.

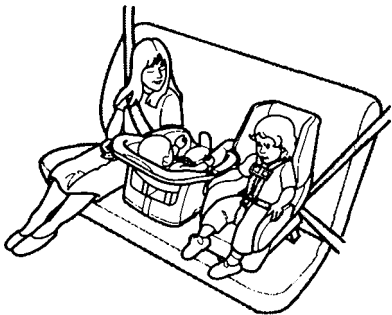

Children depend on adults to protect them. However, despite their best intentions, many parents and other adults may not know how to *properly* protect young passengers.

So if you have children, or if you ever need to drive with a grandchild or other children in your car, be sure to read this section.

Children who are unrestrained or improperly restrained can be seriously injured or killed in a crash.

Any child too small for a seat belt should be properly restrained in a child seat. A larger child should be properly restrained with a seat belt.

All Children Must Be Restrained

Each year, many children are injured or killed in vehicle crashes because they are either unrestrained or not properly restrained. In fact, vehicle accidents are the number one cause of death of children ages 12 and under.

To reduce the number of child deaths and injuries, every state and Canadian province requires that infants and children be restrained whenever they ride in a vehicle.

Any child who is too small to wear a seat belt should be properly restrained in a child seat. (See page [25.](#))

A larger child should always be restrained with a seat belt. (See page [37.](#))

Children Should Sit in the Back Seat

According to accident statistics, children of all ages and sizes are safer when they are restrained in the back seat, not the front seat. The National Highway Traffic Safety Administration and Transport Canada recommend that all children ages 12 and under be properly restrained in the back seat. In the back seat, children are less likely to be injured by striking hard interior parts during a collision or hard braking. Also, children cannot be injured by an inflating airbag when they ride in the back.

The Passenger's Airbag Poses Serious Risks to Children

Airbags have been designed to help protect adults in a moderate to severe frontal collision. To do this, the passenger's airbag is quite large, and it inflates with tremendous speed.

Infants

Never put a rear-facing child seat in the front seat of a vehicle equipped with a passenger's airbag. If the airbag inflates, it can hit the back of the child seat with enough force to kill or very seriously injure an infant.

Small Children

Placing a forward-facing child seat in the front seat of a vehicle equipped with a passenger's airbag can be hazardous. If the vehicle seat is too far forward, or the child's head is thrown forward during a collision, an inflating airbag can strike the child with enough force to kill or very seriously injure a small child.

Larger Children

Children who have outgrown child seats are also at risk of being injured or killed by an inflating passenger's airbag. Whenever possible, larger children should sit in the back seat, properly restrained with a seat belt. (See page 37 for important information about protecting larger children.)

U.S. Models

To remind you of the passenger's airbag hazards, and that children must be properly restrained in the back seat, your car has warning labels on the dashboard and on the driver's and front passenger's visors. Please read and follow the instructions on these labels.



Canadian Models

To remind you of the airbag hazards, your car has warning labels on the driver's and front passenger's visors. Please read and follow the instructions on these labels.

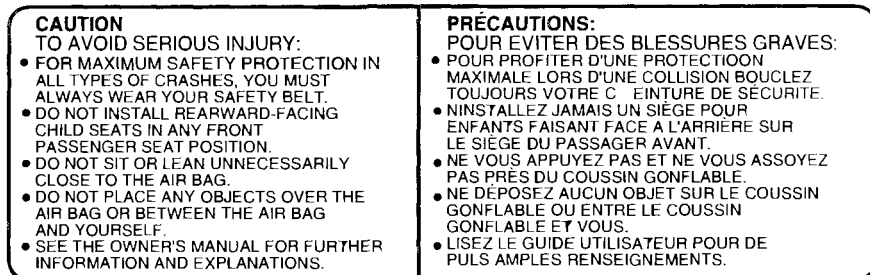

If You Must Drive with Several Children

Your car has three seating positions in the back seat where children can be properly restrained.

If you ever have to carry more than three children in your car:

- Place the largest child in the front seat, provided the child is large enough to wear a seat belt properly (see page 37).
- Move the vehicle seat as far to the rear as possible (see page 12).
- Have the child sit upright and well back in the seat (see page 18).
- Make sure the seat belt is properly positioned and secured (see page 15).

If a Child Requires Close Attention

Many parents say they prefer to put an infant or small child in the front passenger seat so they can watch the child, or because the child requires attention.

Placing a child in the front seat exposes the child to hazards from the airbag, and paying close attention to a child distracts the driver from the important tasks of driving, placing both of you at risk.

If a child requires physical attention or frequent visual contact, we strongly recommend that another adult ride with the child in the back seat. The back seat is far safer for a child than the front.

Additional Safety Precautions

- **Use childproof door locks to prevent children from opening the doors.** Using this feature will prevent children from opening the doors and accidentally falling out (see page 75).

Use the main power window switch to prevent children from opening the rear windows. Using this feature will prevent children from playing with the windows, which could expose them to hazards or distract the driver (see page 80).

- **Do not leave children alone in your vehicle.** Leaving children without adult supervision is illegal in most states and provinces, and can be very hazardous. For example, infants and small children left in a vehicle on a hot day can die from heatstroke. And children left alone with the key in the ignition can accidentally set the vehicle in motion, possibly injuring themselves or others.

General Guidelines for Using Child Seats

The following pages give general guidelines for selecting and installing child seats for infants and small children.

Selecting a Child Seat

To provide proper protection, a child seat should meet three requirements:

- 1. The child seat should meet safety standards.** The child seat should meet Federal Motor Vehicle Safety Standard 213 (FMVSS 213) or Canadian Motor Vehicle Safety Standard 213 (CMVSS 213). Look for the manufacturer's statement of compliance on the box and seat.
- 2. The child seat should be of the proper type and size to fit the child.**

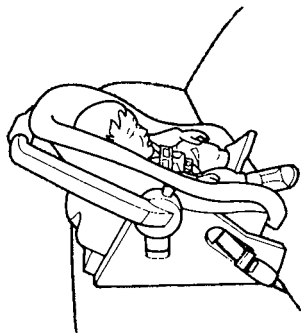

Infants: Children up to about one year old should be restrained in a rear-facing, reclining child seat. Only a rear-facing seat provides the proper support to protect an infant's head, neck, and back. See page 29 for additional information on protecting infants.

CONTINUED

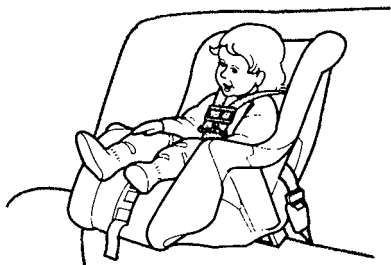

Small Children: A child who is too large for a rear-facing child seat, and who can sit up without support, should be restrained in a forward-facing child seat. See page 33 for additional information on protecting small children.

3. *The child seat should fit the vehicle seating position (or positions) where it will be used.*

Due to variations in the design of child seats, vehicle seats, and seat belts, all child seats will not fit all vehicle seating positions.

However, Honda is confident that one or more child seat models can fit and be properly installed in all recommended seating positions in your car.

Before purchasing a child seat, we recommend that parents test the child seat in the specific vehicle seating position (or positions) where they intend to use the seat. If a previously purchased child seat does not fit, you may need to buy a different one that will fit.

Placing a Child Seat

This page briefly summarizes Honda's recommendations on where to place rear-facing and forward-facing child seats in your car.

Airbags Pose Serious Risks to Children

The passenger's airbag inflates with enough force to kill or seriously injure an infant in a rear-facing child seat.

A small child in a forward-facing child seat is also at risk. If the vehicle seat is too far forward, or the child's head is thrown forward during a collision, an inflating airbag can kill or seriously injure the child.

If a small child must ride in the front, follow the instructions provided.

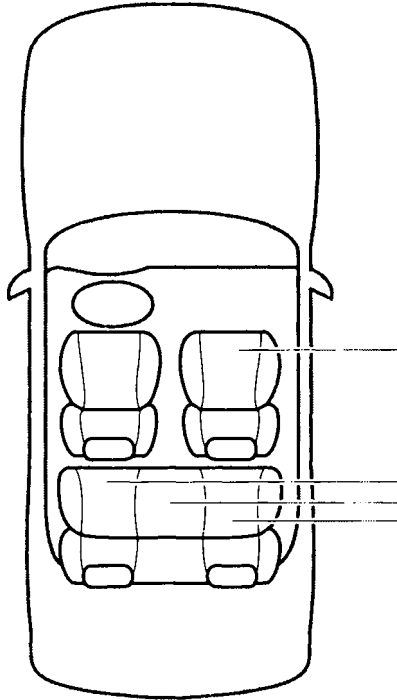

Front Passenger's Seat

Infants: Never in the front seat, due to the passenger's airbag hazard.

Small children: Not recommended, due to the passenger's airbag hazard. If a small child must ride in front, move the vehicle seat to the rear-most position and secure a front-facing child seat with the seat belt, (see page 34).

Back Seats

Infants: Recommended positions. Secure a rear-facing child seat with the seat belt. (see page 30).

Small children: Recommended positions. Secure a front-facing child seat with the seat belt. (see page 34).

CONTINUED

Installing a Child Seat

After selecting a proper child seat, and a good position to install the seat, there are three main steps in installing the seat:

1. Secure the child seat to the car with a seat belt.

All child seats must be secured to the car with the lap belt or the lap part of a lap/shoulder belt. A child whose seat is not properly secured to the car can be endangered in a crash. See pages 30 and 34 for instructions on how to secure child seats in this car.

2. Make sure the child seat is firmly secured.

After installing a child seat, push and pull the seat forward and from side to side to verify that it is secure.

To provide security during normal driving maneuvers as well as during a collision, we recommend that parents secure a child seat as firmly as possible.

However, a child seat does not need to be "rock solid." In some vehicles or seating positions, it may be difficult to install a child seat so that it does not move at all. Some side-to-side or back-and-forth movement can be expected and should not reduce the child seat's effectiveness.

If the child seat is not secure, try installing it in a different seating position, or use a different style of child seat that can be firmly secured in the desired seating position.

3. Secure the child in the child seat.

Make sure the child is properly strapped in the child seat according to the child seat maker's instructions. A child who is not properly secured in a child seat can be thrown out of the seat in a crash and seriously injured.

Storing a Child Seat

When you are not using a child seat, either remove it and store it in a safe place, or make sure it is properly secured. An unsecured child seat can be thrown around the car during a crash or sudden stop and injure someone.

Protecting Infants

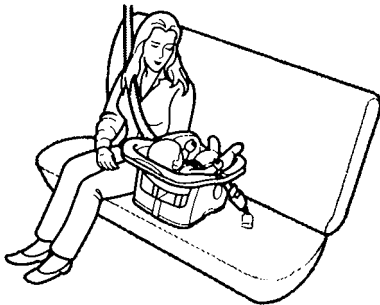

Child Seat Type

Only a rear-facing child seat provides proper support for a baby's head, neck, and back. Infants up to about one year of age must be restrained in a rear-facing child seat.

Two types of seats may be used: a seat designed exclusively for infants, or a convertible seat used in the rear-facing, reclining mode.

Placing a rear-facing child seat in the front seat can result in serious injury or death if the airbags inflate.

Always place a rear-facing child seat in the back seat, not the front.

We recommend that an infant be restrained in a rear-facing child seat until the infant reaches the seat maker's weight or height limit and is able to sit up without support.

Rear-Facing Child Seat Placement

In this car, a rear-facing child seat can be placed in any seating position in the back seat, but not in the front seat.

Never put a rear-facing child seat in the front seat.

If the passenger's airbag inflates, it can hit the back of the child seat with enough force to kill or seriously injure an infant. If an infant must be closely watched, we recommend that another adult sit in the back seat with the baby.

Do not put a rear-facing child seat in a forward-facing position.

If placed facing forward, an infant could be very seriously injured during a frontal collision.

CONTINUED

Installing a Rear-Facing Child Seat with a Lap/Shoulder Belt

The lap/shoulder belts in the outer back seats have a locking mechanism that must be activated to secure a child seat.

The following pages provide instructions on how to secure a rear-facing child seat with this type of seat belt.

See page 32 for how to secure a rear-facing child seat in the center back seat with the lap belt.

For tips on installing a rear-facing child seat with either type of seat belt, see page 32.

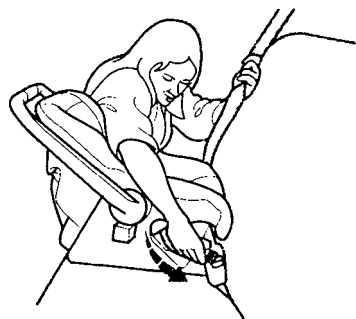

1. With the child seat in the desired back seating position, route the belt through the child seat according to the seat maker's instructions, then insert the latch plate into the buckle.

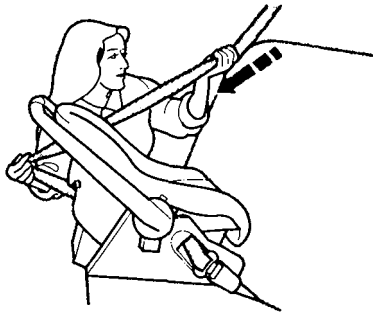

2. To activate the lockable retractor, slowly pull the shoulder part of the belt all the way out until it stops, then let the belt feed back into the retractor (you might hear a clicking noise as the belt retracts).
3. After the belt has retracted, tug on it. If the belt is locked, you will not be able to pull it out. If you can pull the belt out, it is not locked and you will need to repeat these steps.

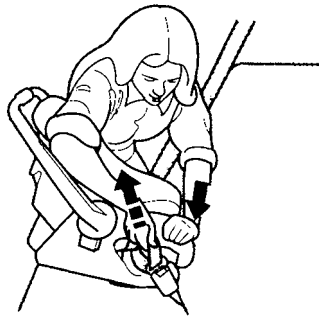

4. After confirming that the belt is locked, grab the shoulder part of the belt near the buckle and pull up to remove any slack from the lap part of the belt. Remember, if the lap part of the belt is not tight, the child seat will not be secure. To remove slack, it may help to put weight on the child seat, or push on the back of the seat, while pulling up on the belt.

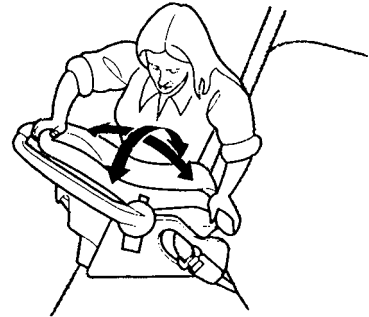

5. Push and pull the child seat forward and from side to side to verify that it is secure enough to stay upright during normal driving maneuvers. If the child seat is not secure, unlatch the belt, allow it to retract fully, then repeat these steps.

To deactivate the locking mechanism and remove a child seat, unlatch the buckle, unroute the seat belt, and let the belt fully retract.

CONTINUED

Installing a Rear-Facing Child Seat with the Lap Belt

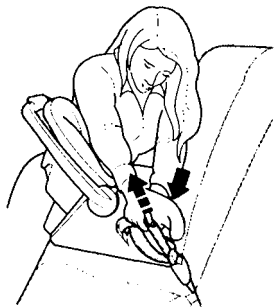

To install a rear-facing child seat in the center back seat with the lap belt, follow instruction number 1 on page 30 for routing and latching the seat belt. Then pull hard on the loose end of the belt to remove any slack (it may help to put weight on the child seat while pulling on the belt). Finally, follow instruction number 5 on page 31 to verify that the child seat is secure.

Rear-Facing Child Seat Installation Tips

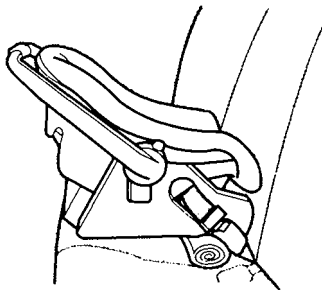

For proper protection, an infant must ride in a reclined, or semi-reclined position. To determine the proper reclining angle, check with the baby's doctor or follow the seat maker's recommendations.

To achieve the desired reclining angle, it may help to put a rolled up towel under the toe of the child seat, as shown.

When properly installed, a rear-facing child seat may prevent the driver or a front-seat passenger from moving the seat as far back as recommended (see page 12). Or it may prevent them from locking the seat-back in the desired upright position (see page 13).

In either case, we recommend that you place the child seat directly behind the front passenger seat, move the front seat as far forward as needed, and leave it unoccupied. Or you may wish to get a smaller child seat that allows you to safely carry a front passenger.

Additional Precautions for Infants

- **Never hold an infant on your lap.**

If you are not wearing a seat belt in a crash, you could be thrown forward into the dashboard and crush the infant.

If you are wearing a seat belt, the infant can be torn from your arms. For example, if your car crashes into a parked vehicle at 30 mph (48 km/h), a 20-lb (9 kg) infant will become a 600-lb (275 kg) force, and you will not be able to hold on.

- **Never put a seat belt over yourself and an infant.** During a crash, the belt could press deep into the infant and cause very serious injuries.

Protecting Small Children

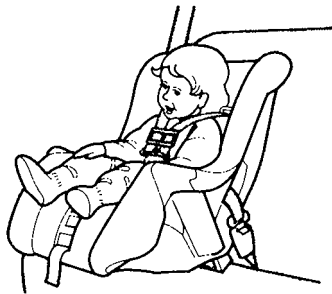

Child Seat Type

A child who can sit up without support, and who fits within the child seat maker's weight and height limits, should be restrained in a forward-facing, upright child seat.

Of the different seats available, we recommend those that have a five-point harness system as shown.

We also recommend that a small child stay in the child seat as long as possible, until the child reaches the weight or height limit for the seat.

Child Seat Placement

In this car, the best place to install a forward-facing child seat is in one of the seating positions in the back seat.

Placing a forward-facing child seat in the front seat of a car equipped with a passenger airbag can be hazardous.

If the car seat is too far forward, or the child's head is thrown forward during a collision, an inflating passenger's airbag can strike the child with enough force to cause very serious or fatal injuries. If a small child must be closely watched, we recommend that another adult sit in the back seat with the child.

CONTINUED

Improperly placing a forward-facing child seat in the front seat can result in serious injury or death if the airbags inflate.

If you must place a forward-facing child seat in front, move the vehicle seat as far back as possible and properly restrain the child.

If it is necessary to put a forward-facing child seat in the front, move the vehicle seat as far to the rear as possible, be sure the child seat is firmly secured to the car, and the child is properly strapped in the seat.

Installing a Child Seat with a Lap/Shoulder Belt

The lap/shoulder belts in the outer back and front passenger seating positions have a locking mechanism that must be activated to secure a child seat.

The following pages provide instructions on how to secure a forward-facing child seat with this type of seat belt.

See page [36](#) for how to secure a forward-facing child seat in the center back seat with the lap belt.

For tips on installing a forward-facing child seat with either type of seat belt, see page [33](#).

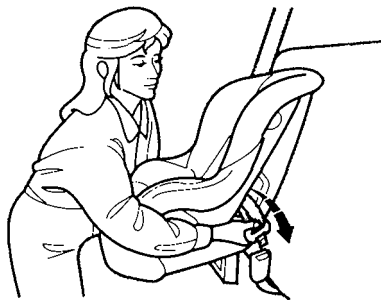

1. With the child seat in the desired seating position, route the belt through the child seat according to the seat maker's instructions, then insert the latch plate into the buckle.

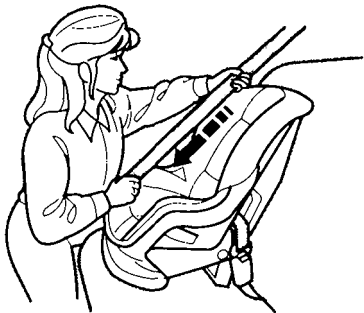

2. To activate the lockable retractor, slowly pull the shoulder part of the belt all the way out until it stops, then let the belt feed back into the retractor (you might hear a clicking noise as the belt retracts),
3. After the belt has retracted, tug on it. If the belt is locked, you will not be able to pull it out. If you can pull the belt out, it is not locked and you will need to repeat these steps.



4. After confirming that the belt is locked, grab the shoulder part of the belt near the buckle and pull up to remove any slack from the lap part of the belt. Remember, if the lap part of the belt is not tight, the child seat will not be secure. It may help to put weight on the child seat, or push on the back of the seat, while pulling up on the belt.

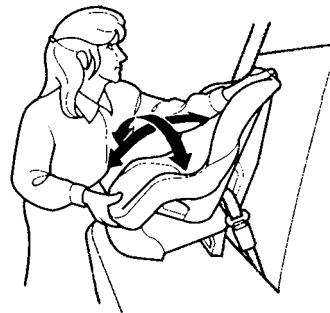

5. Push and pull the child seat forward and from side to side to verify that it is secure enough to stay upright during normal driving maneuvers. If the child seat is not secure, unlatch the belt, allow it to retract fully, then repeat these steps.

CONTINUED

To deactivate the locking mechanism in order to remove a child seat, unlatch the buckle, unrout the seat belt, and let the belt fully retract.

Installing a Child Seat with the Lap Belt



To install a forward-facing child seat in the center back seat with the lap belt, follow instruction number 1 on page 34 for routing and latching the seat belt. Then pull hard on the loose end of the belt to remove any slack; it may help to put weight on the child seat while pulling on the belt. Finally, follow instruction number 5 on page 35 to verify that the child seat is secure.

Additional Precautions for Small Children

- ***Never hold a small child on your lap.*** If you are not wearing a seat belt in a crash, you could be thrown forward into the dashboard and crush the child.

If you are wearing a seat belt, the child can be torn from your arms during a crash. For example, if your car crashes into a parked vehicle at 30 mph (48 km/h), a 30-lb (14 kg) child will become a 900-lb (410 kg) force, and you will not be able to hold on.

- ***Never put a seat belt over yourself and a child.*** During a crash, the belt could press deep into the child and cause very serious injuries.

Protecting Larger Children

When a child reaches the recommended weight or height limit for a forward-facing child seat, the child should sit in one of the outer back seats and wear a lap/shoulder belt. The lap/shoulder belt provides better protection than the lap belt.

If a child is too short for the shoulder part of the belt to properly fit, we recommend that the child use a booster seat until they are tall enough to use the seat belt without a booster.

The following pages give instructions on how to check proper seat belt fit, what kind of booster seat to use if one is needed, and important precautions for children who must sit in the front seat.

Allowing a larger child to sit improperly in the front seat can result in injury or death if the airbags inflate.

If a larger child must sit in front, make sure the child moves the seat as far back as possible and wears the seat belt properly.

Checking Seat Belt Fit

To determine if a lap/shoulder belt properly fits a child, have the child put on the seat belt. Follow the instructions on page 15. Then check how the belt fits.

CONTINUED

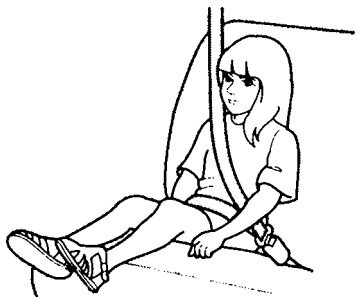

If the shoulder part of the belt rests over the child's collarbone and against the center of the chest, as shown, the child is large enough to wear the seat belt.

However, if the belt touches or crosses the child's neck, the child needs to use a booster seat.

Do not let a child wear a seat belt across the neck. This could result in serious neck injuries during a crash.

Do not let a child put the shoulder part of a seat belt behind the back or under the arm. This could cause very serious injuries during a crash. It also increases the chance that the child will slide under the belt in a crash and be injured.

Do not put any accessories on a seat belt. Devices intended to improve occupant comfort or reposition the shoulder part of a seat belt, severely compromise the protective capability of seat belts and increase the chance of serious injury in a crash.

Two children should never use the same seat belt. If they do, they could be very seriously injured in a crash.

Using a Booster Seat



If a child needs a booster seat, we recommend choosing a style that allows the child to use the lap/shoulder belt directly, without a shield, as shown.

Whichever style you select, follow the booster seat maker's instructions.

A child may continue using a booster seat until the tops of the ears are even with the top of the seat-back. A child of this height should be tall enough to use the lap/shoulder belt without a booster.

When Can a Larger Child Sit in Front

The National Highway Traffic Safety Administration and Transport Canada recommend that all children ages 12 and under be properly restrained in the back seat.

The back seat is the safest place for a child of any age or size.

In addition, the passenger's airbag poses serious risks to children. If the seat is too far forward, or the child's head is thrown forward during a collision, or the child is unrestrained or out of position, an inflating airbag can kill or seriously injure the child.

Of course, children vary widely. And while age may be one indicator of when a child can safely ride in the front, there are other important factors you should consider.

CONTINUED

Protecting Children

Physical Size

Physically, a child must be large enough for the lap/shoulder belt to properly fit over the hips, chest, and shoulder (see page 15). If the seat belt does not fit properly, the child should not sit in the front.

Maturity

To safely ride in front, a child must be able to follow the rules, including sitting properly and wearing the seat belt properly throughout a ride.

If you decide that a child can safely ride up front, be sure to:

- Carefully read the owner's manual and make sure you understand all seat belt instructions and all safety information.
- Move the vehicle seat to the rear-most position.
- Have the child sit up straight, back against the seat, and feet on or near the floor.
- Check that the child's seat belt is properly positioned and secured.
- Supervise the child. Even mature children sometimes need to be reminded to fasten the seat belts or sit properly.

Using Child Seats with Tethers

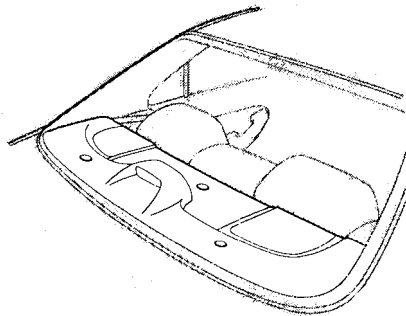

Your car has three attachment points on the rear shelf for securing a tether-style child seat to the car.

Since a tether can provide additional security, we recommend using a tether whenever one is required or available. (Tethers are required in Canada. U.S. owners may check with the child seat maker to determine whether a tether is available for a particular child seat.)

To attach the tether to the car:

1. Using the illustration on page 40, locate the attachment point you want to use.
2. Remove the plug with a small flat-tipped screwdriver or a fingernail file.
3. Install the anchor plate and mounting hardware. The hardware is available for purchase from your Honda dealer (part number 82410-SE3-C01). For Canadian models, the hardware is supplied with the car.

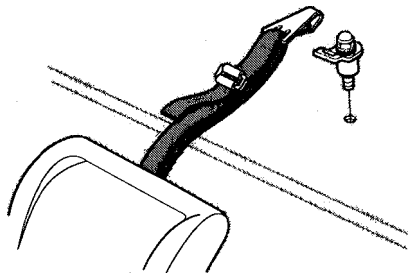

When installing tether hardware, make sure the toothed washer is on the bottom of the bolt. Tighten the bolt to:

16 lbf·ft (22 N·m, 2.2 kgf·m)

If a torque wrench was not used, see your Honda dealer as soon as possible to verify proper installation.

To attach a tether to a child seat, follow the child seat maker's instructions.

If you are not sure how to install the tether, or you need mounting hardware, contact your Honda dealer.

Additional Information About Your Seat Belts

Seat Belt System Components

Your seat belt system includes lap/shoulder belts in the front seats and the outer back seats, and a lap belt in the center back seat.



The system also includes a light on the instrument panel to remind you and your passengers to fasten your belts. If the driver's seat belt is not fastened before the ignition is turned ON (II), the light will come on and a beeper will also sound. The beeper will stop after a few seconds, but the light will stay on until the driver's seat belt is fastened.

Lap/Shoulder Belt

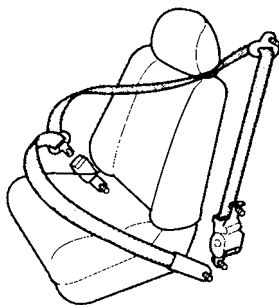

This seat belt has a single belt that goes over your shoulder, across your chest and across your hips.

To fasten the belt, insert the latch plate into the buckle, then tug on the belt to make sure the buckle is latched.

To unlock the belt, push the red PRESS button on the buckle.

Guide the belt across your body to the door pillar. After exiting the car, be sure the belt is out of the way and

will not get closed in the door.

All lap/shoulder belts have an emergency locking retractor. In normal driving, the retractor lets you move freely in your seat while it keeps some tension on the belt. During a collision or sudden stop, the retractor automatically locks the belt to help restrain your body.

The lap/shoulder belts in all seating positions except the driver's have an additional locking mechanism that must be activated to secure a child seat. (See pages 30 and 34 for instructions on how to secure child seats with this type of seat belt.)

If the shoulder part of the belt is pulled all the way out, the locking mechanism will activate. The belt will retract, but it will not allow a passenger to move freely.

To deactivate the locking mechanism, unlatch the buckle and let the seat belt fully retract. To refasten the belt, pull it out only as far as needed.

See page 15 for instructions on how to wear the lap/shoulder belt properly.

Lap Belt

The lap belt has one manually-adjusted belt that fits across the hips.

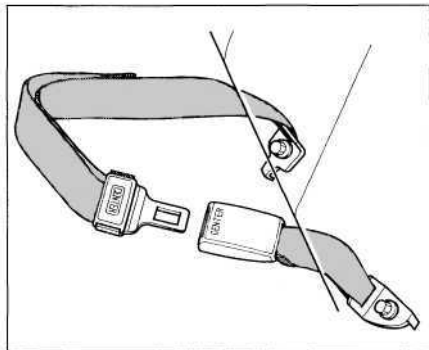

To fasten the belt, insert the latch plate into the buckle marked **CENTER**, then tug on the belt to make sure the buckle is latched.

To unlock the belt, push the red **PRESS** button.

See page 16 for how to lengthen the lap belt, and how to properly position the belt.

Additional Information About Your Seat Belts

Seat Belt Maintenance

For safety, you should check the condition of your seat belts regularly.

Pull each belt out fully and look for frays, cuts, burns, and wear. Check that the latches work smoothly and that the lap/shoulder belts retract easily. Any belt not in good condition or not working properly will not provide good protection and should be replaced as soon as possible.

U.S. Models

Honda provides a lifetime warranty on seat belts. Honda will repair or replace any seat belt component that fails to function properly during normal use. Please see your *Honda Warranty Information* booklet for details.

Not checking or maintaining seat belts can result in serious injury or death if the seat belts do not work properly when needed.

Check your seat belts regularly and have any problem corrected as soon as possible.

If a seat belt is worn during a crash, you should have your dealer inspect the belt, and replace it if necessary. A belt that has been worn during a crash may not provide the same level of protection in a subsequent crash. The dealer should also inspect the anchors for damage and replace them if needed.

For information on how to clean your seat belts, see page [234](#).

SRS Components

Your Supplemental Restraint System (SRS) includes:

- Two front airbags. The driver's airbag is stored in the center of the steering wheel; the front passenger's airbag is stored in the dashboard. Both are marked "SRS AIRBAG."
- Sensors that can detect a moderate to severe frontal collision.
- A sophisticated electronic system that continually monitors the sensors, control unit, the airbag activators, and all related wiring when the ignition is ON (II).

- An indicator light on the instrument panel that alerts you to a possible problem with the system (see page 47).
- Emergency backup power in case your car's electrical system is disconnected in a crash.

How Your Airbags Work

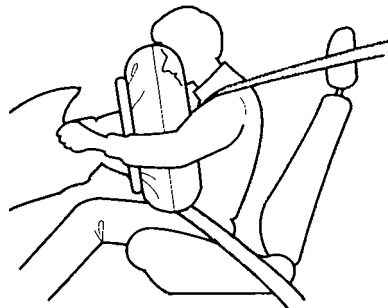

If you ever have a moderate to severe frontal collision, the sensors will detect rapid deceleration and signal the control unit to instantly inflate the airbags.

During a crash, your seat belt helps restrain your lower body and torso. Your airbag provides a cushion to help restrain and protect your head and chest.

CONTINUED

Additional Information About Your SRS

Since both airbags use the same sensors, both airbags normally inflate at the same time. However, it is possible for only one airbag to inflate.

This can occur when the severity of a collision is at the margin, or threshold, that determines whether or not the airbags will deploy. In such cases, the seat belt will provide sufficient protection, and the supplemental protection offered by the airbag would be minimal.

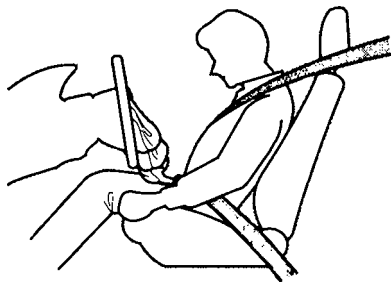

After inflating, the airbags immediately deflate, so they won't interfere with the driver's visibility, or the ability to steer or operate other controls.

The total time for inflation and deflation is approximately one-tenth of a second, so fast that most occupants are not aware that the airbags deployed until they see them lying in their laps.

After a crash, you may see what looks like smoke. This is actually powder from the airbag's surface. Although the powder is not harmful, people with respiratory problems may experience some temporary discomfort. If this occurs, get out of the car as soon as it is safe to do so.

U.S. Owners

For additional information on how your airbags work, see the booklet titled *SRS: What You Need to Know About Airbags* that came with your owner's manual.

Canadian Owners

For additional information on how your airbags work, ask your dealer for a copy of the booklet titled *SRS: What You Need to Know About Airbags*.

How the SRS Indicator Light Works

SRS The purpose of the SRS light is to alert you to a potential problem with your Supplemental Restraint System.

When you turn the ignition ON (II), this indicator will light up briefly then go out. This tells you that the system is working properly.

However, if the light comes on at any other time, you should have the system checked by your dealer. For example:

- If the SRS indicator light does not come on after you turn the ignition ON (II).
- If the light stays on after the engine starts.

- If the light comes on or flashes on and off while you drive.

If you see any of these indications, your airbags may not deploy when you need them. See your Honda dealer as soon as possible.

Ignoring the SRS indicator light can result in serious injury or death if the airbags do not inflate when needed.

Have your vehicle checked by a dealer as soon as possible if the SRS light alerts you to a potential problem.

SRS Service

Your Supplemental Restraint System is virtually maintenance-free, and there are no parts you can safely service. However, you must have your car serviced if:

- **Your airbags ever inflate.** The airbags and the control unit must be replaced. Do not try to remove or replace the airbags yourself. This must be done by a Honda dealer or a knowledgeable body shop.
- **The SRS indicator light alerts you to a problem.** Take your car to an authorized Honda dealer as soon as possible. If you ignore this indication, the airbags might not inflate when you need them.

Additional Information About Your SRS

Additional Safety Precautions

- Do not attempt to deactivate your airbags. Together, airbags and seat belts provide the best protection in a moderate to severe frontal collision.
- Do not tamper with SRS components or wiring for any reason. Tampering could cause the airbags to deploy, possibly causing very serious injury.

See page [150](#) for further information and precautions relating to your SRS.

Your car's exhaust contains carbon monoxide gas. You should have no problem with carbon monoxide entering the car in normal driving if you maintain your car properly. Have the exhaust system inspected for leaks whenever:

- The car is raised for an oil change.
- You notice a change in the sound of the exhaust.
- The car was in an accident that may have damaged the underside.

Carbon monoxide gas is toxic. Breathing it can cause unconsciousness and even kill you.

Avoid any enclosed areas or activities that expose you to carbon monoxide.

High levels of carbon monoxide can collect rapidly in enclosed areas, such as a garage. Do not run the engine with the garage door closed. Even with the door open, run the engine only long enough to move the vehicle out of the garage.

With the trunk lid open, air flow can pull exhaust gas into your car's interior and create a hazardous condition. If you must drive with the trunk lid open, open all the windows and set the climate control system as shown below.

If you must sit in your parked car, even in an unconfined area, with the engine running, adjust the heating and cooling system as follows:

1. Select the Fresh Air mode.
2. Select the  mode.
3. Turn the fan on high speed.
4. Set the temperature control to a comfortable setting.

Safety Labels

These labels are in the locations shown. They warn you of potential hazards that could cause serious injury. Read these labels carefully.

If a label comes off or becomes hard to read, contact your Honda dealer for a replacement.

HOOD

⚠ WARNING

The airbag inflator is explosive and, if accidentally deployed, can seriously hurt you. Follow Service Manual instructions carefully.

⚠ ATTENTION

Le gonfleur SRS est explosible, et s'il se déploie accidentellement, il risque de provoquer des blessures graves ou de tuer. Suivre attentivement les instructions du manuel d'entretien.

RADIATOR CAP



DASH BOARD

U.S. models only

⚠ WARNING

**Children Can Be KILLED or INJURED
by Passenger Air Bag**

The back seat is the safest place for children 12 and under.
Make sure all children use seat belts or child seats.

SUN VISOR

U.S. models

⚠ WARNING



DEATH or SERIOUS INJURY can occur

- Children 12 and under can be killed by the air bag
- The BACK SEAT is the SAFEST place for children
- NEVER put a rear-facing child seat in the front
- Sit as far back as possible from the air bag
- ALWAYS use SEAT BELTS and CHILD RESTRAINTS

Canadian models

CAUTION TO AVOID SERIOUS INJURY:
• FOR MAXIMUM SAFETY PROTECTION IN ALL TYPES OF CRASHES, YOU MUST ALWAYS WEAR YOUR SAFETY BELT
• DO NOT INSTALL REARWARD-FACING CHILD SEATS IN ANY FRONT PASSENGER SEAT POSITION
• DO NOT SIT OR LEAN UNNECESSARILY CLOSE TO THE AIR BAG
• DO NOT PLACE ANY OBJECTS OVER THE AIR BAG OR BETWEEN THE AIR BAG AND YOURSELF
• SEE THE OWNER'S MANUAL FOR FURTHER INFORMATION AND EXPLANATIONS.

PRECAUTIONS: POUR ÉVITER DES BLESSURES GRAVES:
• POUR PROFITER D'UNE PROTECTION MAXIMALE EN CAS DE COLLISION, TOUJOURS VOTRE CEINTURE DE SÉCURITÉ
• N'INSTALLEZ JAMAIS UN SIÈGE POUR ENFANTS FAISANT FACE À L'ARRIÈRE SUR LE SIÈGE DU PASSAGER AVANT
• NE VOUS APPUYEZ PAS ET NE VOUS ASSOYEZ PAS PRES DU COUSSIN GONFLABLE
• NE DÉPOSEZ AUCUN OBJET SUR LE COUSSIN GONFLABLE OU ENTRE LE COUSSIN GONFLABLE ET VOUS
• LISEZ LE GUIDE D'UTILISATION POUR DE PLUS AMPLES RENSEIGNEMENTS

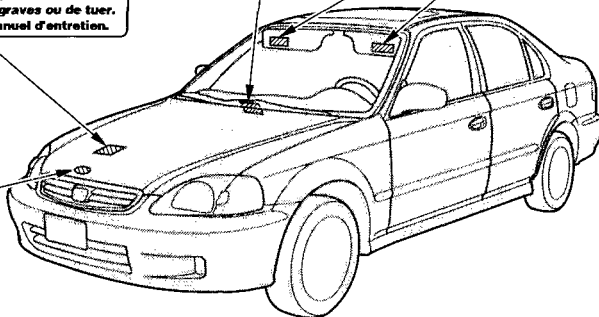

This section gives information about the controls and displays that contribute to the daily operation of your Honda. All the essential controls are within easy reach.

Control Locations.....	52	Ignition Switch.....	69
Indicator Lights.....	53	Door Locks.....	70
Gauges.....	57	Power Door Locks.....	71
Speedometer.....	57	Remote Transmitter.....	72
Tachometer.....	57	Childproof Door Locks.....	75
Odometer.....	57	Trunk.....	75
Trip Meter.....	57	Seat Adjustments.....	76
Fuel Gauge.....	58	Front Seat Adjustments.....	76
Temperature Gauge.....	58	Driver's Seat Height	
Maintenance Required		Adjustment.....	77
Indicator.....	59	Head Restraints.....	78
Controls Near the Steering		Folding Rear Seat.....	79
Wheel.....	60	Power Windows.....	80
Headlights.....	61	Moonroof.....	82
Daytime Running Lights.....	61	Mirrors.....	82
Instrument Panel Brightness.....	62	Adjusting the Power Mirrors.....	83
Turn Signals.....	62	Parking Brake.....	84
Windshield Wipers.....	63	Glove Box.....	85
Windshield Washers.....	63	Beverage Holder.....	85
Hazard Warning.....	64	Accessory Power Socket.....	86
Rear Window Defogger.....	64	Ashtrays.....	86
Steering Wheel Adjustment.....	65	Interior Light.....	87
Steering Wheel Controls	66		
Cruise Control.....	66		
Keys and Locks.....	69		
Keys.....	69		

Control Locations

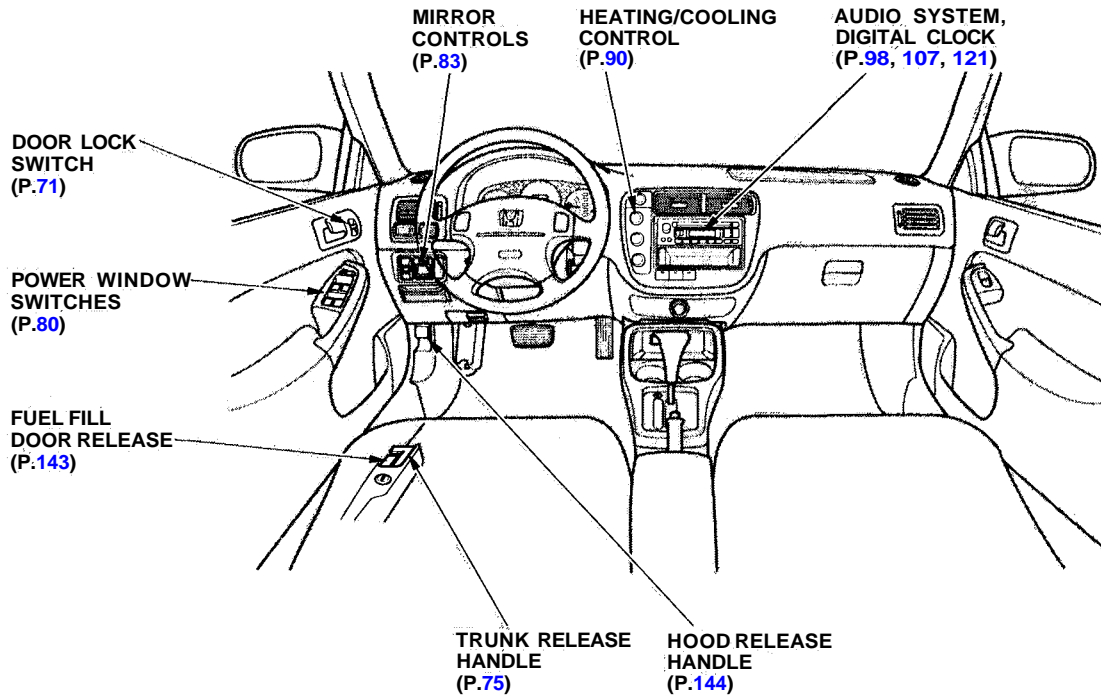

The instrument panel has many indicators to give you important information about your car.

* The U.S. instrument panel is shown. Differences for the Canadian model are noted in the text.

EX and U.S. LX

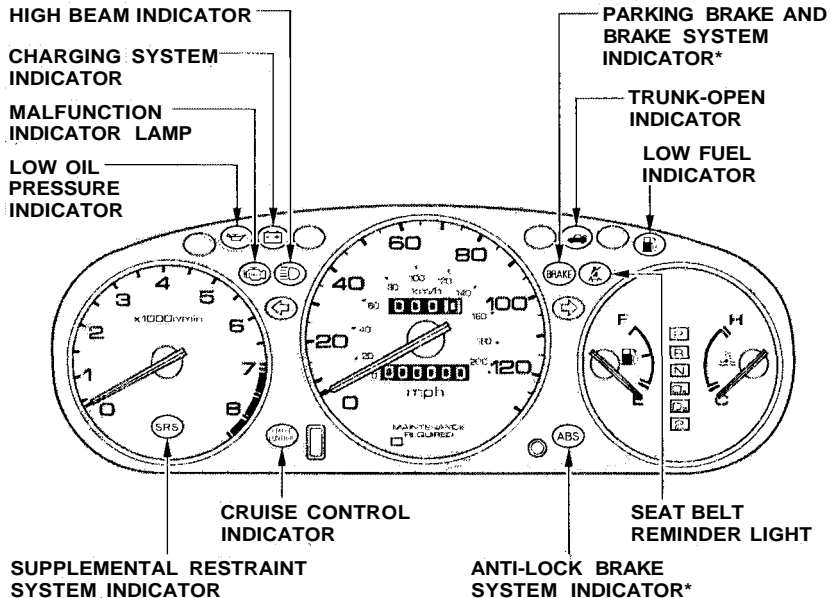

CONTINUED

Indicator Lights

U.S. DX, Value Package, and Canadian LX

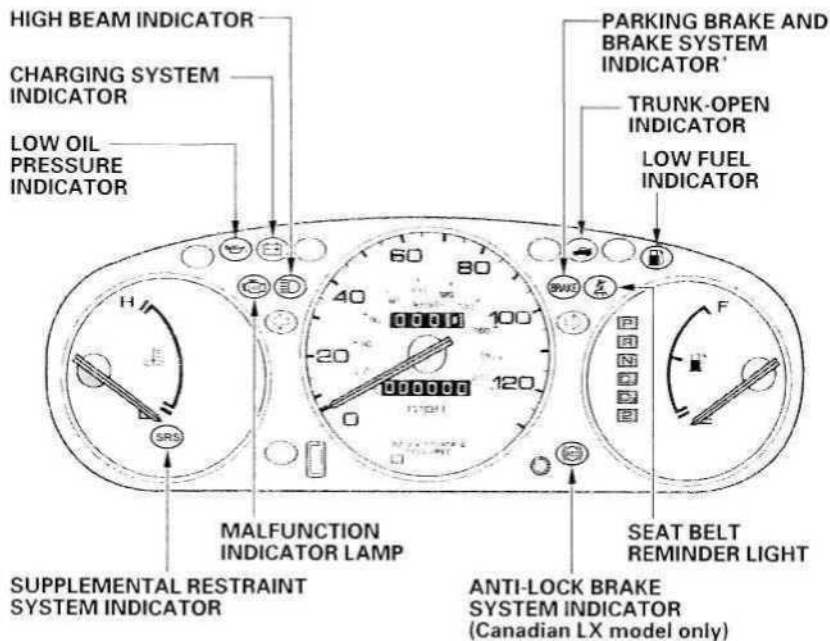

Seat Belt Reminder Light

This indicator lights when you turn the ignition switch ON (II). It is a reminder to you and your passengers to protect yourselves by fastening the seat belts. A beeper also sounds if you have not fastened your seat belt.

If you do not fasten your seat belt, the beeper will stop after a few seconds but the light stays on until you do. Both the light and the beeper stay off if you fasten your seat belt before turning on the ignition.

* Differences in the indicators for Canadian models are noted in the text.

Supplemental Restraint System Indicator

This indicator lights when you turn the ignition switch ON (II). If it comes on at any other time, it indicates a problem in the supplemental restraint system. For complete information, see page [47](#).

Charging System Indicator

If this light comes on when the engine is running, the battery is not being charged. For complete information, see page [250](#).

Low Oil Pressure Indicator

The engine can be severely damaged if this light flashes or stays on when the engine is running. For complete information, see page [249](#).

U.S.	Canada	Parking Brake and Brake System Indicator
		

This light has two functions:

1. It lights as a reminder that you have not released the parking brake. Driving with the parking brake applied can damage the brakes and tires.
2. If it remains lit after you release the parking brake while the engine is running, or comes on while driving, it can indicate a problem in the brake system. For complete information, see page [252](#).

U.S.	Canada	Anti-lock Brake System (ABS) Indicator
		

Only on models equipped with ABS (see page [167](#))

This light normally comes on for a few seconds when you turn the ignition switch ON (II), and when the ignition switch is turned to START (III). If this light comes on at any other time, there is a problem in the ABS. If this happens, take the car to your dealer to have it checked. With the light on, your car still has normal braking ability but no anti-lock.

Indicator Lights



Malfunction Indicator Lamp

See page [251](#).



Turn Signal and Hazard Warning Indicators

The left or right turn signal light blinks when you signal a lane change or turn. If the light does not blink or blinks rapidly, it usually means one of the turn signal bulbs is burned out (see page [222](#)). Replace the bulb as soon as possible, since other drivers cannot see that you are signalling.

When you turn on the Hazard Warning switch, both turn signal lights blink. All turn signals on the outside of the car should flash.



High Beam Indicator

This light comes on with the high beam headlights. See page [61](#) for information on the headlight controls.

On Canadian models, this indicator comes on with reduced brightness when the Daytime Running Lights (DRL) are on (see page [61](#)).



Cruise Control Indicator

Only on models equipped with Cruise Control System

This lights when you set the cruise control. See page [66](#) for information on operating the cruise control.



Trunk-open Indicator

This light comes on if the trunk lid is not closed tightly.



Low Fuel Indicator

This light comes on as a reminder that you must refuel soon.



Washer Level Indicator

Canadian models only
This light comes on when the washer fluid level is low. Add washer fluid when you see this light come on (see page [196](#)).

EX and U.S. LX

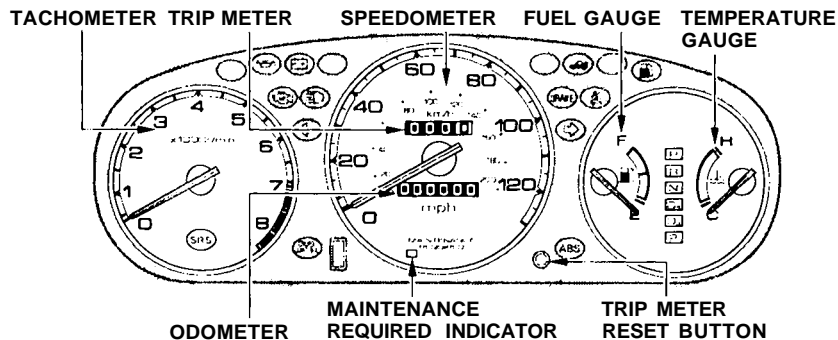
**Speedometer***U.S. Models*

This shows your speed in miles per hour (mph). The smaller inner numbers are the speed in kilometers per hour (km/h).

Canadian Models

This shows your speed in kilometers per hour (km/h). The smaller inner numbers are the speed in miles per hour (mph).

Tachometer

On LX and EX models in U.S., and EX model in Canada

The tachometer shows the engine speed in revolutions per minute (rpm). To protect the engine from damage, never drive with the tachometer needle in the red zone.

Odometer

The odometer shows the total distance your car has been driven. It measures miles in U.S. models and kilometers in Canadian models. It is illegal under U.S. federal law and Canadian provincial regulations to disconnect, reset, or alter the odometer with the intent to change the number of miles or kilometers indicated.

Trip Meter

This meter shows the number of miles (U.S.) or kilometers (Canada) driven since you last reset it. To reset it, push the trip meter reset button.

Gauges

U.S. DX, Value Package, and Canadian LX

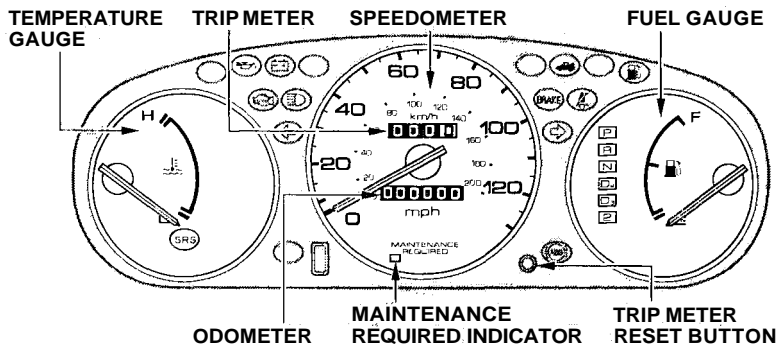

Fuel Gauge

This shows how much fuel you have. It is most accurate when the car is on level ground. It may show slightly more or less than the actual amount when you are driving on curvy or hilly roads.

The gauge stays at the same fuel level reading after you turn off the ignition. When you add fuel, the gauge slowly changes to the new reading after you turn the ignition switch back ON (II).

Temperature Gauge

This shows the temperature of the engine's coolant. During normal operation, the pointer should rise from the bottom white mark to about the middle of the gauge. In severe driving conditions, such as very hot weather or a long period of uphill driving, the pointer may rise to the upper blue zone. If it reaches the red (Hot) mark, pull safely to the side of the road. Turn to page [247](#) for instructions and precautions on checking the engine's cooling system.

Maintenance Required Indicator

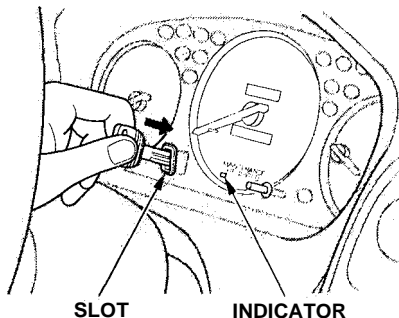

U.S. Models

This indicator reminds you that it is nearing 7,500 miles (12,000 km) since the last scheduled maintenance. Refer to the Maintenance Schedules for Normal and Severe Driving Conditions on pages [178](#) – [182](#).

When the distance driven since the last scheduled maintenance nears 7,500 miles (12,000 km), the indicator will turn yellow. If you exceed 7,500 miles (12,000 km), the indicator will turn red.

Your dealer will reset the indicator when he performs the scheduled maintenance. If someone else performs the maintenance, reset the indicator by inserting your key in the slot beside the indicator.

Controls Near the Steering Wheel

The two levers on the steering column contain controls for driving features you use most often. The left lever controls the turn signals, headlights, and high beams. The right lever controls the windshield washers and wipers.

The rear window defogger switch is on the dashboard to the right of the center air vents.

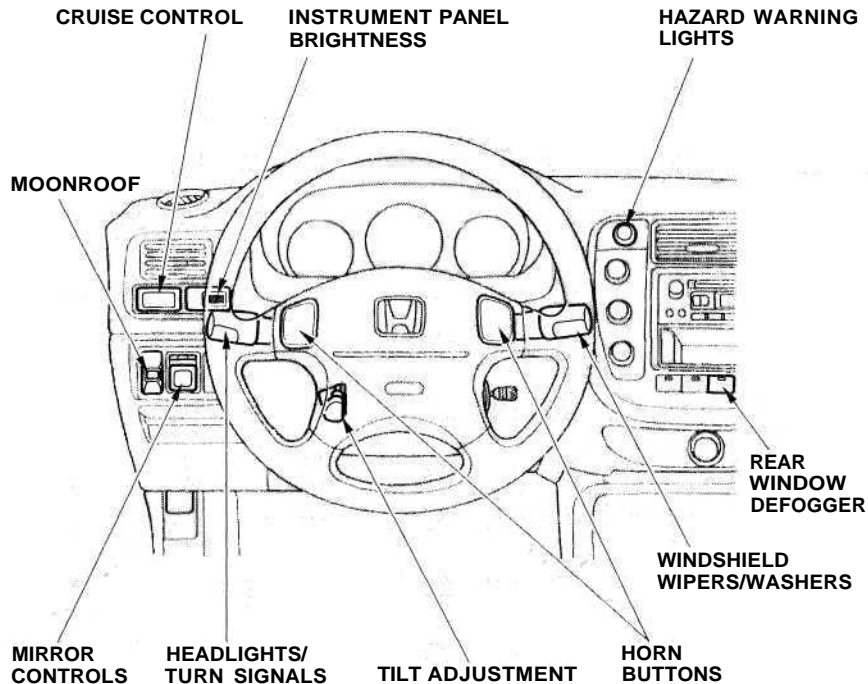

The controls under the left air vent are for the moonroof, mirrors, cruise control and instrument panel brightness.

The tilt adjustment lever on the underside of the steering column allows you to tilt the steering wheel.

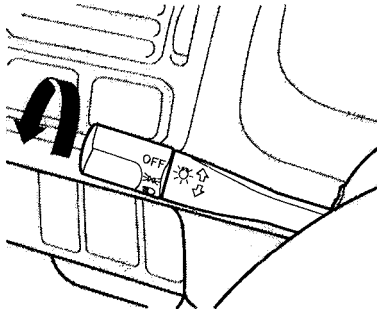

Headlights



The rotating switch on the left lever controls the lights. Turning this switch to the "  " position turns on the parking lights, taillights, instrument panel lights, side-marker lights, and rear license plate lights. Turning the switch to the "  " position turns on the headlights.

If you leave the lights on with the ignition switch in ACCESSORY (I) or LOCK (0), you will hear a reminder beeper when you open the driver's door.

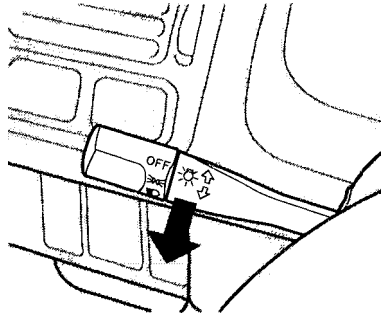

To change between low beams and high beams, pull the turn signal lever until you hear a click, then let go. The blue high beam indicator will light (see page [56](#)).

To flash the high beams, pull the turn signal lever back lightly, then release it. The high beams will come on and go off.

The high beams will stay on for as long as you hold the lever back, no matter what position the headlight switch is in.

Daytime Running Lights (Canadian Models)

With the headlight switch off, the high beam headlights come on with reduced brightness when you turn the ignition switch to ON (II) and release the parking brake. They remain on until you turn the ignition off, even if you set the parking brake.

The headlights revert to normal operation when you turn them on with the switch.

Controls Near the Steering Wheel

Instrument Panel Brightness

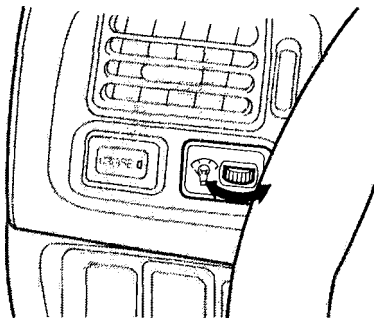

The dial on the dashboard to the left of the instrument panel controls the brightness of the instrument panel lights. Turn the dial to adjust the brightness.

Turn Signals

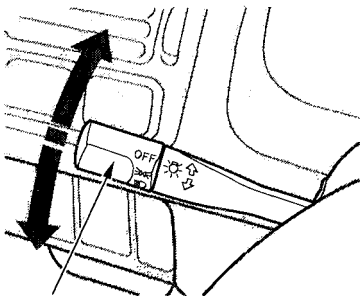

TURN SIGNAL LEVER

Signal a turn or lane change with this lever. Push down on the lever to signal a left turn, and up to signal a right turn. If you push it up or down all the way, the turn signal continues to blink even when you release the lever. It shuts off automatically as you complete the turn.

To signal a lane change, push lightly on the turn signal lever in the proper direction and hold it. The lever will return to the center position as soon as you release it.

Windshield Wipers

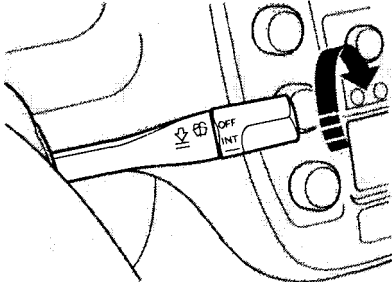

The right lever controls the windshield wipers and washers. The rotary switch at the end of the lever has three positions:

- INT: intermittent
- : low speed
- — : high speed

In intermittent, the wipers operate every few seconds. In low speed and high speed, the wipers run continuously.

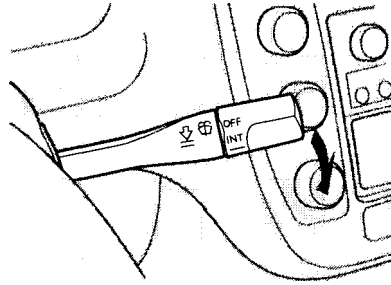

To operate the wipers in mist mode, push the control lever down. The wipers run at high speed until you release the lever. This gives you a quick way to clear the windshield.

Windshield Washers

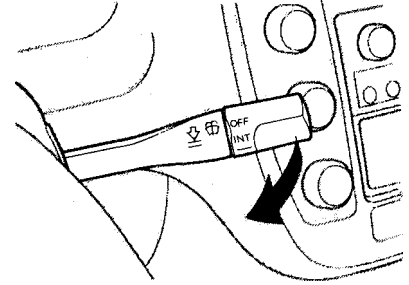

To clean the windshield, pull back on the wiper control lever. The washers spray until you release the lever.

The wipers run at low speed while you're pulling the lever, then complete one more sweep of the windshield after you release it.

Controls Near the Steering Wheel

Hazard Warning

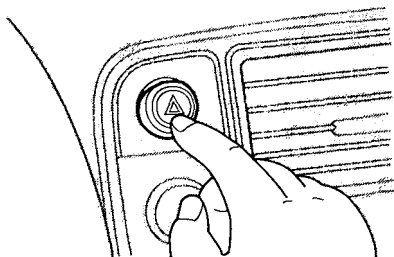

Push the red button to the left of the center vents to turn on the hazard warning lights (four-way flashers). This causes all four outside turn signals and both indicators in the instrument panel to flash. Use the hazard warning panel lights if you need to park in a dangerous area near heavy traffic, or if your car is disabled.

Rear Window Defogger

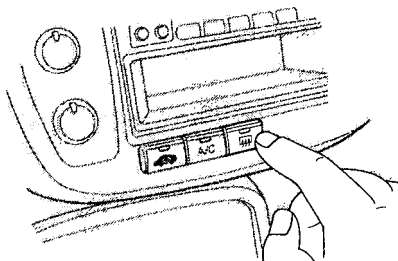

The rear window defogger will clear fog, frost, and thin ice from the window. Push the defogger button to turn it on and off. The light in the button lights to show the defogger is on. If you do not turn it off, the defogger will shut itself off after about 25 minutes. It also shuts off when you turn off the ignition. You have to turn it on again when you restart the car.

Make sure the rear window is clear and you have good visibility before starting to drive.

The defogger wires on the inside of the rear window can be accidentally damaged. When cleaning the glass, always wipe side to side.

Steering Wheel Adjustment

See page 18 for important safety information about how to properly position the steering wheel

Make any steering wheel adjustment before you start driving.

Adjusting the steering wheel position while driving may cause you to lose control of the car and be seriously injured in a crash.

Adjust the steering wheel only when the car is stopped.

To adjust the steering wheel upward or downward:

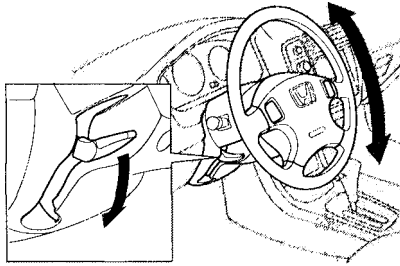

1. Push the lever under the steering column all the way down.
2. Move the steering wheel to the desired position, making sure the wheel points toward your chest, not toward your face. Make sure you can see the instrument panel gauges and the indicator lights.

3. Push the lever up to lock the steering wheel in that position.
4. Make sure you have securely locked the steering wheel in place by trying to move it up and down.

Steering Wheel Controls

Cruise Control

On LX and EX models in the U.S., and EX model in Canada

Cruise control allows you to maintain a set speed above 25 mph (40 km/h) without keeping your foot on the accelerator pedal. It should be used for cruising on straight, open highways. It is not recommended for conditions such as city driving, winding roads, slippery roads, heavy rain, or bad weather. You should have full control of the car under those conditions.

Improper use of the cruise control can lead to a crash.

Use the cruise control only when traveling on open highways in good weather.

NOTICE

The cruise control, as it operates, moves the accelerator pedal. You can damage your car's accelerator mechanism by resting your foot under the pedal and blocking the movement.

Using the Cruise Control

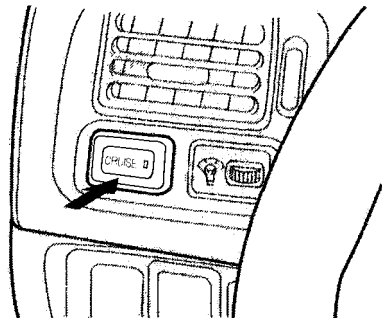

1. Push in the Cruise Control Master Switch to the left of the steering column. The indicator in the switch will light.
2. Accelerate to the desired cruising speed above 25 mph (40 km/h).

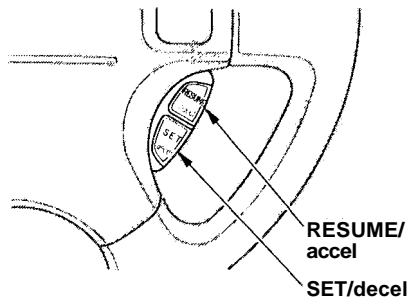

3. Press the SET/decel button on the steering wheel. The CRUISE CONTROL light on the instrument panel comes on. This shows the system is now activated.

The cruise control may not hold the set speed when you are going up and down hills. If your speed increases going down a hill, use the brakes to slow down to the desired speed. This will cancel the

cruise control. To resume the set speed press the RESUME/accel button. The CRUISE CONTROL light on the instrument panel comes on.

Changing the Set Speed

You can increase the set cruising speed in any of these ways:

- Press and hold the RESUME/accel button. The car will accelerate. When you reach the desired cruising speed, release the button.
- Push on the accelerator pedal. Accelerate to the desired cruising speed and press the SET/decel button.
- To increase your speed in very small amounts, tap the RESUME/accel button repeatedly. Each time you do this, your car will go about 1 mph (1.6 km/h) faster.

You can decrease the set cruising speed in any of these ways:

- Press and hold the SET/decel button. The car will decelerate. Release the button when you reach the desired speed.
- To slow down in very small amounts, tap the SET/decel button repeatedly. Each time you do this, your car will go about 1 mph (1.6 km/h) slower.
- Tap the brake or clutch pedal lightly with your foot. The CRUISE CONTROL light on the instrument panel will go out. When the car slows to the desired speed, press the SET/decel button. The car will then maintain the desired speed.

CONTINUED

Steering Wheel Controls

Even with the cruise control turned on, you can still use the accelerator pedal to speed up for passing. After completing the pass, take your foot off the accelerator pedal. The car will return to the set cruising speed.

Resting your foot on the brake or clutch pedal will cause the cruise control to cancel.

Cancelling the Cruise Control

You can cancel the cruise control in any of these ways:

- Tap the brake or clutch pedal.
- Press the SET/decel and RESUME/accel buttons at the same time.
- Press the Cruise Control Master Switch.

When you tap the brake or clutch pedal, or press the SET and RESUME buttons at the same time, the CRUISE CONTROL light on the instrument panel will go out and the car will begin to slow down. You can use the accelerator pedal in the normal way.

The system remembers the previously-set cruising speed. To return to that speed, accelerate to above 25 mph (40 km/h) and press

the RESUME/accel button until the CRUISE CONTROL light comes on. The car will accelerate to the same cruising speed as before.

Pressing the Cruise Control Master Switch turns the system completely off and erases the previous cruising speed from memory. To use the system again, refer to ***Using the Cruise Control.***

Keys

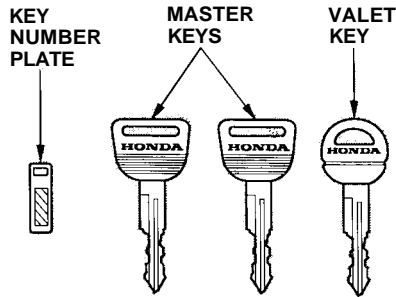

Your car comes with two master keys and a valet key. The master key fits all the locks on your car:

- Ignition
- Doors
- Trunk
- Trunk release handle
- Rear seat trunk access

The valet key works only in the ignition and the door locks. You can keep the trunk, trunk release handle and rear seat trunk access locked when you leave your car and the valet key at a parking facility. (See Trunk, page 75.)

You should have received a key number plate with your set of keys. You will need this key number if you ever have to get a lost key replaced. Keep the plate stored in a safe place. When replacing keys, use only Honda-approved key blanks.

Remote Transmitter

Standard on the EX and Value Package models in the U.S.
Optional on the LX model in the U.S. and EX model in Canada

Your car also comes with two remote transmitters; see page 72 for an explanation of the operation.

Ignition Switch

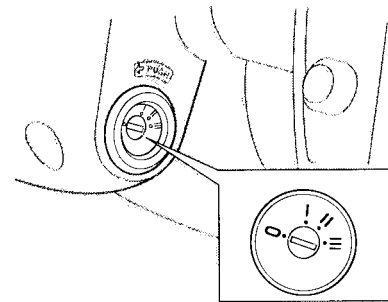

The ignition switch is on the right side of the steering column. It has four positions:

- LOCK (0)
- ACCESSORY (I)
- ON (II)
- START (III)

CONTINUED

LOCK (0) — You can insert or remove the key only in this position. To switch from ACCESSORY to LOCK, you must push the key in slightly as you turn it. If your car has an automatic transmission, the shift lever must also be in Park. The anti-theft lock will lock the steering column when you remove the key. If the front wheels are turned, the anti-theft lock may sometimes make it difficult to turn the key from LOCK to ACCESSORY. Firmly turn the steering wheel to the left or to the right as you turn the key.

Removing the key from the ignition switch while driving locks the steering. This can cause you to lose control.

Remove the key from the ignition switch only when parked.

ACCESSORY (I) — In this position, you can operate the audio system and the accessory power socket.

ON (II) — This is the normal key position when driving. All features and accessories on the car are usable. Several of the lights on the instrument panel come on as a test when you turn the ignition switch from ACCESSORY to ON.

START (III) — Use this position only to start the engine. The switch returns to ON (II) when you let go of the key.

You will hear a reminder beeper if you leave the key in the ignition switch in the LOCK (0) or ACCESSORY (I) position and open the driver's door. Remove the key to turn off the beeper.

Door Locks

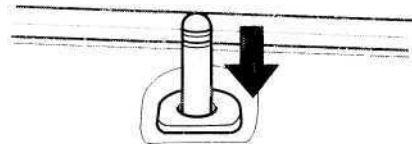

Each door has a lock tab on the top. Push the tab down to lock the door and pull it up to unlock.

To lock any passenger's door when getting out of the car, push the lock tab down and close the door. To lock the driver's door, pull the outside door handle and push the lock tab down. Release the handle, then close the door.

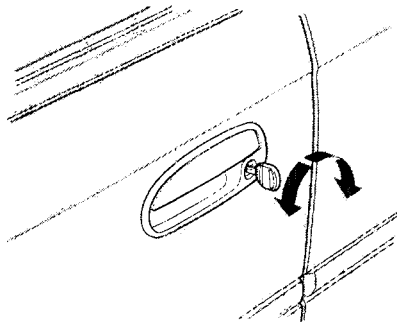

The front doors can be locked and unlocked from the outside with the key.

Power Door Locks

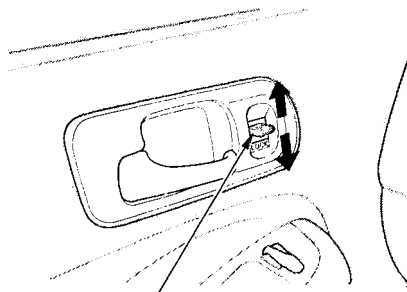

MASTER DOOR LOCK SWITCH

On Value Package, LX, and EX models in the U.S., and EX model in Canada
The master door lock switch allows control of all door locks from the driver's door. Push the switch down to lock all doors, and up to unlock them.

All doors lock when you push down the lock tab on the driver's door, or lock the driver's door from the outside with the key. Only the driver's door unlocks when you use the key or lock tab. To unlock the passengers' doors, use the master door lock switch or the lock tab on each door.

Remote Transmitter

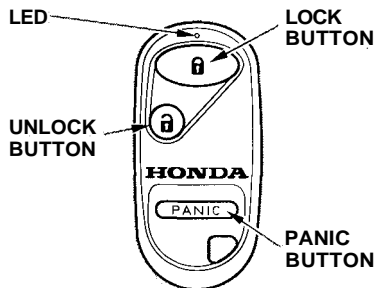

Standard on the Value Package and EX models in the U.S. Optional on the LX model in the U.S. and EX model in Canada

You can lock and unlock your car with the remote transmitter. When you push the LOCK button, all doors lock. The parking lights, side marker lights, and taillights flash once.

When you push the UNLOCK button once, only the driver's door unlocks.

The passenger's door unlocks when you push the button a second time. The parking lights, side marker lights, and taillights flash twice.

The interior light (if the interior light switch is in the center position) will come on when you press the UNLOCK button. If you do not open any door, the light will go out in about 30 seconds and the doors will automatically relock. If you relock the doors with the remote transmitter before 30 seconds have elapsed, the light will go off immediately.

You cannot lock or unlock the doors with the remote transmitter if any door is not fully closed or the key is in the ignition switch.

Panic Mode

Panic mode allows you to remotely activate your car's horn and exterior lights. When activated, the horn will sound, and the exterior lights will flash, for about 30 seconds. To activate panic mode, press and hold the PANIC button for about one second.

To cancel PANIC mode before 30 seconds, press any button on the remote transmitter. You can also turn the ignition switch to ACCESSORY (I) or ON (II).

Panic mode will not activate if the key is in the ignition switch.

Replacing the Battery

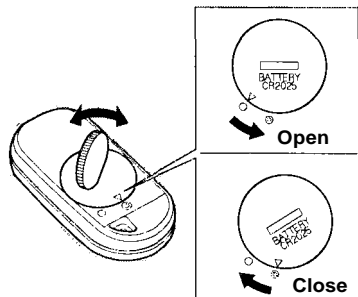

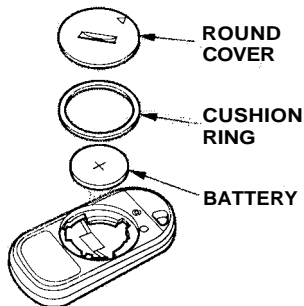

When the remote transmitter's battery begins to get weak, it may take several pushes on the button to lock or unlock the doors, and the LED will get dim. Replace the battery as soon as possible.

Battery type: CR2025



To replace the battery, remove the round cover on the back of the transmitter by turning it counterclockwise with a coin.

Remove the old battery and note the polarity. Make sure the polarity of the new battery is the same (+ side facing up), then insert it in the transmitter.

Reinstall the cushion ring. Align the  mark on the cover with the  mark on the transmitter, then set the cover in place and turn it clockwise.

After the battery is changed, the transmitter must be synchronized with the main unit. With the doors and trunk lid closed, press either the LOCK or UNLOCK button six times.

CONTINUED

Transmitter Care

Avoid severe shock to the transmitter, such as dropping or throwing it. Also, protect it from extreme hot or cold temperatures.

Clean the transmitter case with a soft cloth. Do not use strong cleaners or solvents that could harm the case. Immersing the transmitter in any liquid will harm the transmitter and cause it to not function properly.

If you lose a transmitter, you will need to have the replacement programmed to your car's system by your Honda dealer. Any other transmitters you have will also need to be reprogrammed.

As required by the FCC:

This device complies with Part 15 of the FCC rules. Operation is subject to the following two conditions: (1) This device may not cause harmful interference, and (2) this device must accept any interference received, including interference that may cause undesired operation.

This device complies with DOC standards in Canada.

Changes or modifications not expressly approved by the party responsible for compliance could void the user's authority to operate the equipment.

Childproof Door Locks

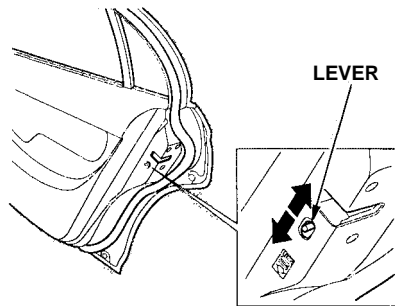

The childproof door locks are designed to prevent children seated in the rear from accidentally opening the rear doors. Each rear door has a lock lever near the edge. With the lever in the LOCK position, the door cannot be opened from the inside regardless of the position of the lock tab. To open the door, pull the lock tab up and use the outside door handle.

Trunk



You can open the trunk in two ways:

- Pull the trunk release handle to the left of the driver's seat.
- Use the master key to open the trunk lock. The valet key does not work in this lock.

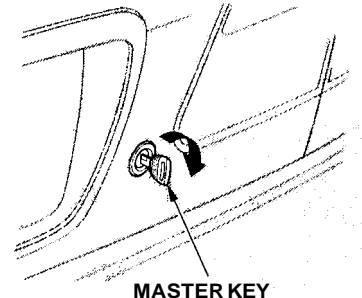

To close the trunk, press down on the trunk lid.

See page [151](#) for cargo loading and weight limit information. Keep the trunk lid closed at all times while driving to avoid damaging the lid, and to prevent exhaust gas from getting into the interior. See **Carbon Monoxide Hazard** on page [49](#).

CONTINUED

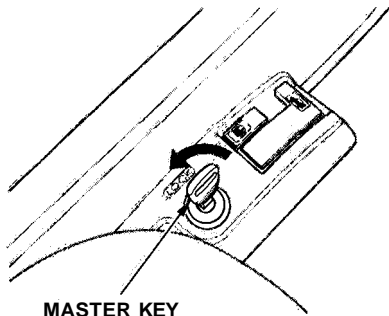

To protect items in the trunk when you need to give the key to someone else, lock the trunk release handle with the master key and give the other person the valet key.

Front Seat Adjustments

See pages 12 — 13 for important safety information and warnings about how to properly position seats and seat-backs. Adjust the seat before you start driving.

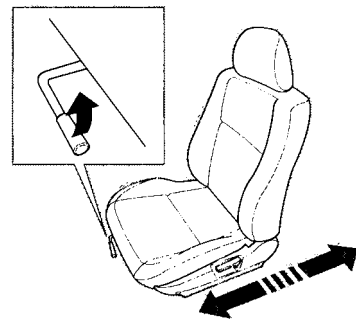

To adjust the seat forward and backward, pull up on the lever under the seat cushion's front edge. Move the seat to the desired position and release the lever. Try to move the seat to make sure it is locked in position.

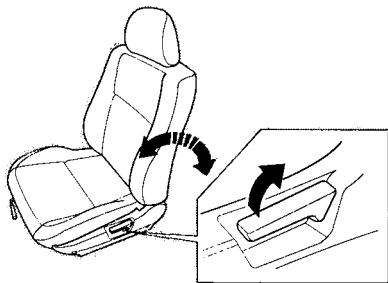

To change the angle of the seat-back, pull up on the lever on the outside of the seat bottom. Move the seat-back to the desired position and release the lever. Let the seat-back latch in the new position.

Driver's Seat Height Adjustment

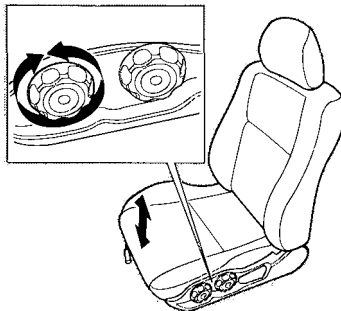

On LX and EX models in the U.S., and EX model in Canada

The height of your driver's seat is adjustable. Turn the front dial on the outside of the seat cushion to raise the front of the seat bottom and turn the rear dial to raise the rear.

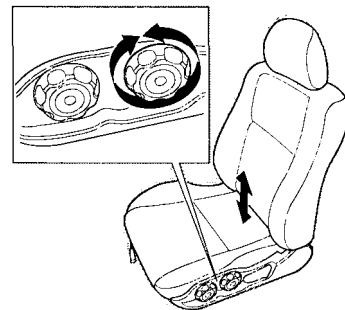

Make all adjustments before you start driving.

Seat Adjustments

Head Restraints

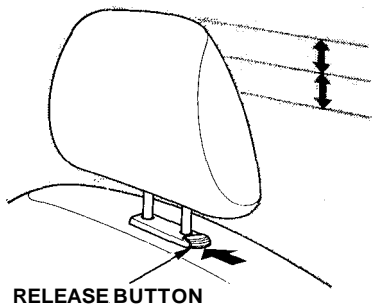

See page 14 for important safety information and a warning about how to properly position the head restraints.

The front head restraints help protect you and your passenger from whiplash and other injuries. They are most effective when you adjust them so the back of the occupant's head rests against the center of the restraint. A taller person should adjust the restraint as high as possible.

The front head restraints adjust for height. You need both hands to adjust the restraint. Do not attempt to adjust it while driving. To raise it, pull upward. To lower the restraint, push the release button sideways and push the restraint down.

To remove a head restraint for cleaning or repair, pull it up as far as it will go. Push the release button and pull the restraint out of the seat-back.

The back of the rear seat folds down to give you direct access to the trunk. Each side folds down separately. With only half the seat folded, you can still carry a passenger in the back seat.

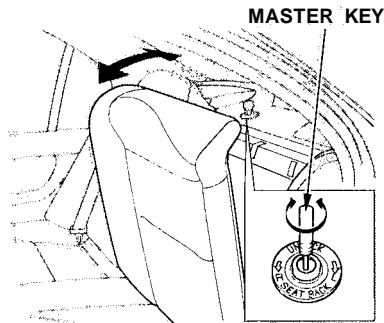

To fold down either side of the seat-back from inside the car, insert the master key in the lock on the rear shelf. To fold down the driver's side, turn the key clockwise, pull down the top of the seat-back, then release the key. To fold down the passenger's side, turn the key counterclockwise and perform the same procedure.

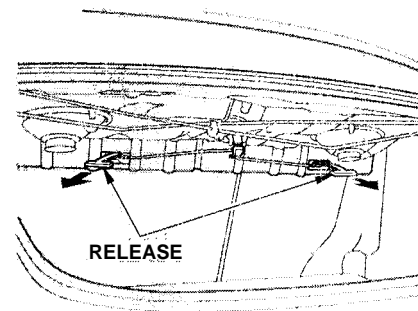

To release the seat-back from inside the trunk, pull the release under the rear shelf. Push the seat-back down, then let go of the release.

To lock the seat-back upright, push it firmly against the rear shell. Make sure it is latched in place by pulling on the top of the seat.

CONTINUED

Folding Rear Seat, Power Windows

Make sure all items in the trunk, or items extending through the opening into the back seat are secured. Loose items can fly forward and cause injury if you have to brake hard. See **Carrying Cargo** on page 151.

Never drive with the seat-back folded down and the trunk lid open. See **Carbon Monoxide Hazard** on page 49.

Power Windows

DRIVER'S WINDOW SWITCH

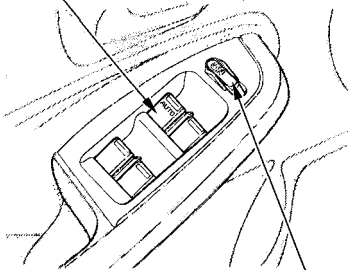

MAIN SWITCH

On LX and EX models in the U.S., and EX model in Canada

Your car's windows are electrically-powered. Turn the ignition switch to ON (II) to raise or lower any window.

Each door has a switch that controls its window. To open the window, push the switch down and hold it. Release the switch when you want the window to stop. Close the window by pulling back on the

switch and holding it.

The driver's door armrest has a master power window control panel. To open any of the passengers' windows, push down on the appropriate switch and hold it down until the window reaches the desired position. To close the window, pull back on the window switch. Release the switch when the window gets to the position you want.

Closing a power window on a child's hands or fingers can cause serious injury.

Make sure your children are away from the windows before closing them.

The master control panel also contains these extra features:

AUTO — To open the driver's window fully, push the window switch firmly down and release it. The window automatically goes all the way down. To stop the window from going all the way down, pull back on the window switch briefly.

To open the driver's window only partially, push the window switch down lightly and hold it. The window will stop as soon as you release the switch.

The AUTO function only works to lower the driver's window. To raise the window, you must pull back on the window switch and hold it until the window reaches the desired position.

The MAIN switch controls power to the passengers' windows. With this switch off, the passengers' windows cannot be raised or lowered. The MAIN switch does not affect the driver's window. Keep the MAIN switch off when you have children in the car so they do not injure themselves by operating the windows unintentionally.

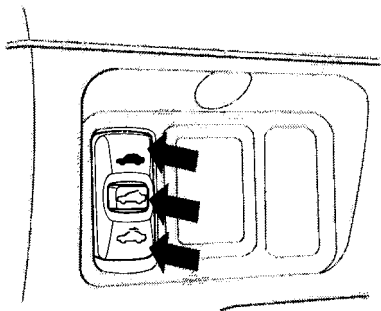

Moonroof, Mirrors

Moonroof



On U.S. EX model

Use the switches on the dashboard under the left vent to operate the moonroof. The ignition must be ON (II).

To lift the rear of the moonroof for ventilation, push the  button. To slide the moonroof back, push the  switch. Hold it until the moonroof reaches the desired position, then release the switch.

To close the moonroof, press and hold the  switch.

Closing the moonroof on someone's hands or fingers can cause serious injury.

Make sure passengers are clear of the moonroof before closing it.

NOTICE

If you try to open the moonroof in below-freezing temperatures, or when it is covered with snow or ice, you can damage the moonroof panel or motor.

Mirrors

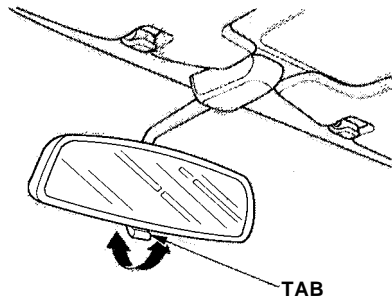

Keep the inside and outside mirrors clean and adjusted for best visibility. Be sure to adjust the mirrors before you start driving.

The inside mirror has day and night positions. The night position reduces glare from headlights behind you. Flip the tab on the bottom edge of the mirror to select the day or night position.

Adjusting the Power Mirrors

SELECTOR SWITCH

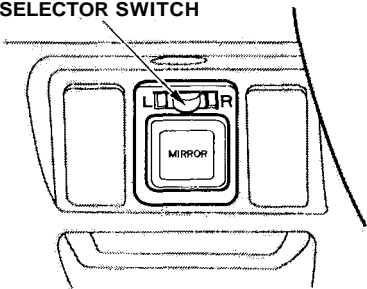

On LX and EX models in the U.S., and EX model in Canada
Adjust the outside mirrors with the adjustment switch on the left side of the dashboard:

1. Turn the ignition switch ON (II).
2. Move the selector switch to L (driver's side) or R (passenger's side).

ADJUSTMENT SWITCH

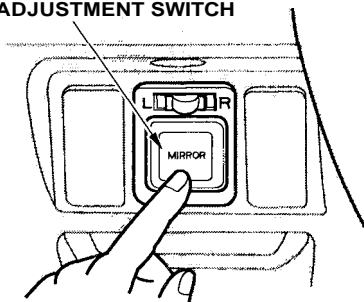

3. Push the appropriate edge of the adjustment switch to move the mirror right, left, up or down.
4. When you finish, move the selector switch to the center (off) position. This turns off the adjustment switch so you can't move a mirror out of position by accidentally bumping the switch.

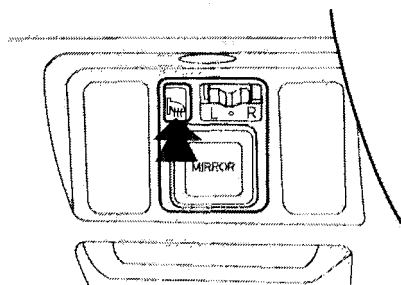

On Canadian EX model
The outside mirrors are heated to remove fog and frost. With the ignition switch ON (II), turn on the heaters by pressing the button. The light in the button comes on as a reminder. Press the button again to turn the heaters off.

Parking Brake

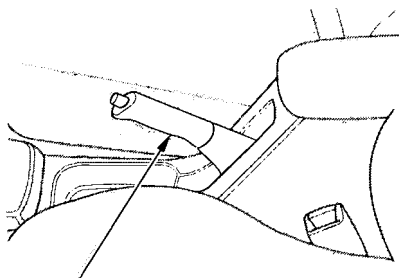

PARKING BRAKE LEVER

To apply the parking brake, pull the lever up fully. To release it, pull up slightly, push the button, and lower the lever. The parking brake light on the instrument panel should go out when the parking brake is fully released (see page [55](#)).

NOTICE

Driving the car with the parking brake applied can damage the rear brakes and axles.

Glove Box

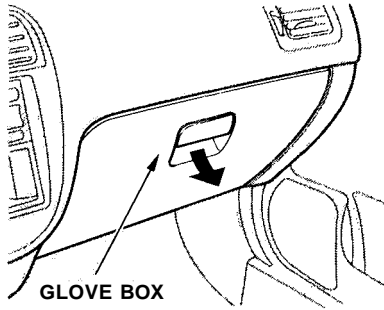

Open the glove box by pulling the handle. Close it with a firm push.

An open glove box can cause serious injury to your passenger in a crash, even if the passenger is wearing the seat belt.

Always keep the glove box closed while driving.

Beverage Holder

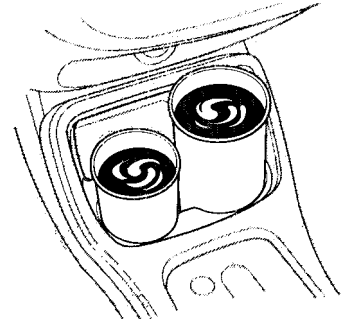

Be careful when you are using the beverage holder. A spilled liquid that is very hot can scald you or your passengers. Spilled liquids can also damage the upholstery, carpeting, and electrical components in the interior.

Accessory Power Socket, Ashtrays

Accessory Power Socket

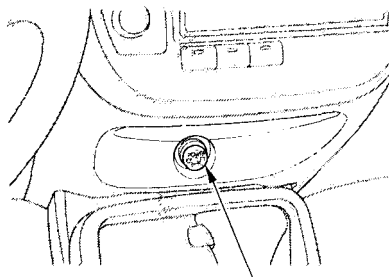

ACCESSORY POWER SOCKET

To use the accessory power socket, pull down the cover. The ignition switch must be in ACCESSORY (I) or ON (II).

This socket is intended to supply power for 12 volt DC accessories that are rated 120 watts or less (10 amps).

It will not power an automotive type cigarette lighter element.

Ashtrays (Optional)

Front and rear ashtrays are available as options. The front ashtray fits in the beverage holder. The rear ashtray fits in the rear of the center armrest.

Open the rear ashtray by swinging the upper edge down. To remove the ashtray for emptying, open the ashtray and then lift it up and out.

NOTICE

Use the ashtray only for cigarettes, cigars, and other smoking materials. To prevent a possible fire and damage to your car, don't put paper or other things that can burn in the ashtray.

(U.S.: EX)

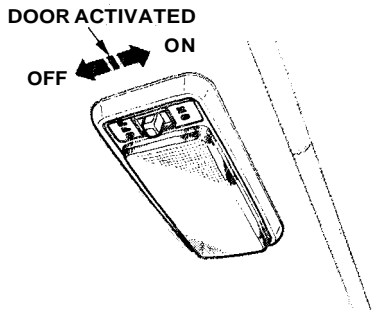

The interior light has a three-position switch. In the OFF position, the light does not come on. In the center position, the interior light comes on when you open any door. In the ON position, the interior light stays on continuously.

(U.S.: DX, Value Package, and LX,
Canada: LX, EX)

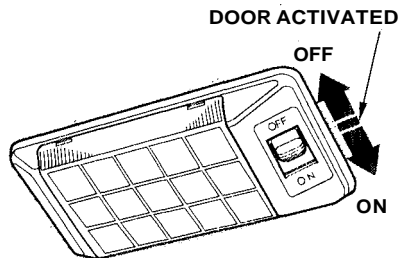

On vehicles with remote transmitter
The interior light (with the switch in the center position) also comes on when you unlock the door with the remote transmitter (see page 72).

(U.S.: EX)

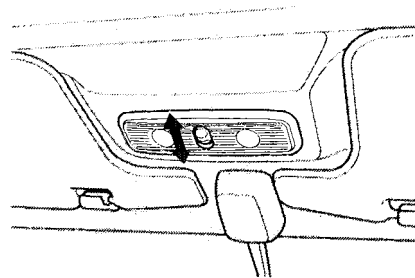

Turn on the spotlight by pushing the button next to each light. Push the button again to turn it off. You can use the spotlights at all times.

The heating and air conditioning* systems in your Honda provide a comfortable driving environment in all weather conditions.

The standard audio system has many features. This section describes those features and how to use them. (If you selected an optional audio system, refer to the operating instructions that came with it.)

* Air conditioning is standard on the Value Package, LX, and EX models in the U.S. It is optional on other models.

Heating and Cooling.....	90	CD Changer Error	
What Each Control Does.....	90	Indications.....	120
How to Use the System.....	92	Audio System (U.S. Value	
To Turn Everything Off	97	Package and EX)	121
Audio System (U.S. DX and LX,		Operating the Radio.....	122
and Canadian LX).....	98	Adjusting the Sound.....	125
Operating the Radio.....	98	Digital Clock.....	126
Adjusting the Sound.....	100	Radio Frequencies.....	127
Digital Clock.....	101	Radio Reception.....	127
Operating the Optional Cassette		Operating the CD Player.....	129
Player.....	102	Operating the CD Changer.....	131
Tape Search Functions.....	102	Protecting Compact Discs.....	132
Operating the Optional		CD Player Error Indications.....	133
CD Player/Changer.....	104	CD Changer Error	
CD Changer Error		Indications.....	134
Indications.....	106	Operating the Cassette	
Audio System (Canadian EX)	107	Player.....	135
Operating the Radio.....	108	Tape Search Functions.....	136
Adjusting the Sound.....	111	Caring for the Cassette	
Digital Clock.....	112	Player.....	138
Operating the Cassette		Theft Protection.....	139
Player.....	113		
Tape Search Functions.....	114		
Operating the Optional			
CD Changer.....	117		

Heating and Cooling

Proper use of the Heating and Cooling system can make the interior dry and comfortable, and keep the windows clear for best visibility.

If your car does not have air conditioning, it can be installed at any time. Your dealer will install a Genuine Honda air conditioning system that meets Honda's high quality standards and is designed to exactly fit your car. Please contact your dealer for more information.

What Each Control Does

Fan Control Dial

Turning this dial clockwise increases the fan's speed, which increases air flow.

Temperature Control Dial

Turning this dial clockwise increases the temperature of the air flow.

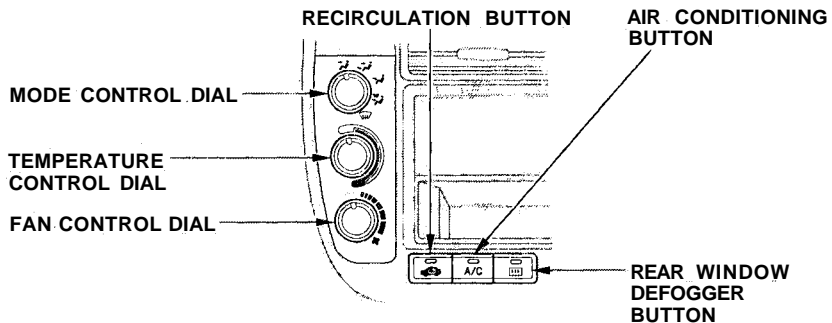

Air Conditioning (A/C) Button

This button turns the air conditioning ON and OFF. The indicator in the button lights when the A/C is on.

Rear Window Defogger Button

This button turns the rear window defogger on and off (see page 64).

Recirculation Button

This button controls the source of the air going into the system. When the indicator in this button is lit, air from the car's interior is sent through the system again (Recirculation mode). When the indicator is off, air is brought in from outside the car (Fresh Air mode).

Mode Control Dial

Use the MODE control dial to select the vents the air flows from. Some air will flow from the dashboard vents in all modes.

 Air flows from the center and corner vents in the dashboard.

 Air flow is divided between the vents in the dashboard and the floor vents.

 Air flows from the floor vents.

 Air flow is divided between the floor vents and the defroster vents at the base of the windshield.

 Air flows from the defroster vents at the base of the windshield.

When you select , the system automatically switches to Fresh Air mode and turns on the A/C.

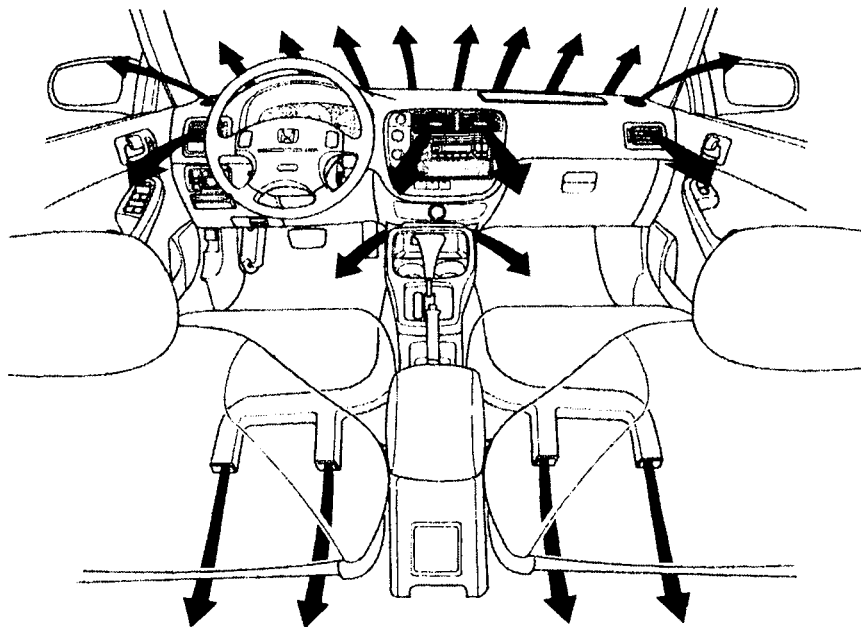

Heating and Cooling

Vent Controls

CENTER VENT

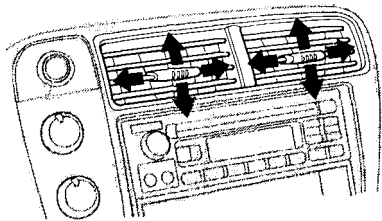

You can adjust the direction of the air coming from the dashboard vents by moving the tab in the center of each vent up-and-down and side-to-side.

SIDE VENT

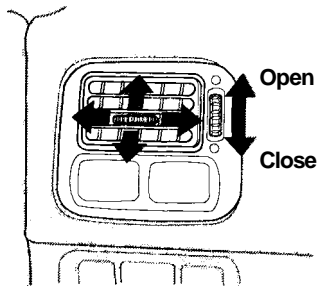

The vents in the corners of the dashboard can be opened and closed with the dials next to them.

How to Use the System

This section covers how to set up the system controls for ventilation, heating, cooling, dehumidifying, and defrosting.

The engine must be running for the heater and air conditioning to generate hot and cold air. The heater uses engine coolant to warm the air. If the engine is cold, it will be several minutes before you feel warm air coming from the system. The air conditioning does not rely on engine temperature.

It is best to leave the system in Fresh Air mode under almost all conditions. Keeping the system in Recirculation mode, particularly with the A/C off, can cause the windows to fog up. Switch to Recirculation mode when you are driving through smoky or dusty conditions, then switch back to Fresh Air mode when the condition clears.

The outside air intakes for the heating and cooling system are at the base of the windshield. Keep these clear of leaves and other debris.

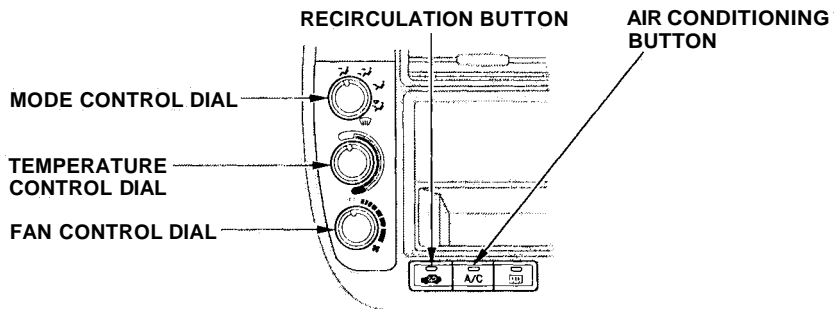

Ventilation

The flow-through ventilation system draws in outside air, circulates it through the interior, then exhausts it through vents near the rear window.

1. Turn the temperature control dial all the way to the left. Make sure the A/C is off.
2. Select  and Fresh Air mode.
3. Set the fan to the desired speed.

CONTINUED

Heating and Cooling

To Cool with A/C

1. Turn on the A/C by pressing the button. The light in the button should come on when a fan speed is selected.
2. Make sure the temperature control dial is all the way to the left.
3. Select .
4. If the outside air is humid, select Recirculation mode. If the outside air is dry, select Fresh Air mode.
5. Set the fan to the desired speed.

If the interior is very warm from being parked in the sun, you can cool it down more rapidly by setting up the controls this way:

1. Start the engine.
2. Turn on the A/C by pressing the button. Make sure the temperature control dial is all the way counterclockwise.
3. Set the fan to maximum speed.
4. Open the windows partially. Select  and Fresh Air mode.

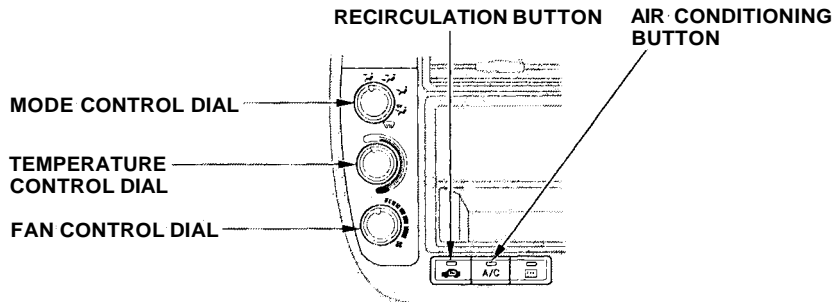

When the interior has cooled down to a more comfortable temperature, close the windows and set the controls as described for normal cooling.

Air conditioning places an extra load on the engine. Watch the engine coolant temperature gauge (see page 58) when driving in stop-and-go traffic or climbing a long, steep hill. If it moves near the red zone, turn off the A/C until the gauge reads normally.

To Heat

To warm the interior:

1. Start the engine.
2. Select  and Fresh Air mode.
3. Set the fan to the desired speed.
4. Adjust the warmth of the air with the temperature control dial.

To Heat and Dehumidify with Air Conditioning



Air conditioning, as it cools, removes moisture from the air. When used in combination with the heater, it makes the interior warm and dry.

1. Switch the fan on.
2. Turn on the air conditioning.
3. Select  and Fresh Air mode.
4. Adjust the temperature control dial so the mixture of heated and cooled air feels comfortable.

This setting is suitable for all driving conditions whenever the outside temperature is above 32°F (0°C).

To Defog and Defrost



To remove fog from the inside of the windows:

1. Switch the fan on.
2. Select  .
When you select  , the system automatically switches to Fresh Air mode and turns on the A/C.
3. Adjust the temperature control dial so the air flow from the defroster vents feels warm.
4. Turn on the rear window defogger to help clear the rear window.
When you switch to another mode from  , the A/C stays on.
Press the A/C button to turn it off.

CONTINUED

Heating and Cooling

To remove exterior frost or ice from the windshield and side windows after the car has been sitting out in cold weather:

1. Start the engine.
2. Select  .
When you select  , the system automatically switches to Fresh Air mode and turns on the A/C.
3. Switch the fan and temperature controls to maximum.

To rapidly remove exterior frost or ice from the windshield (on very cold days), first select the Recirculation mode. Once the windshield is clear, select the Fresh Air mode to avoid fogging the windows.

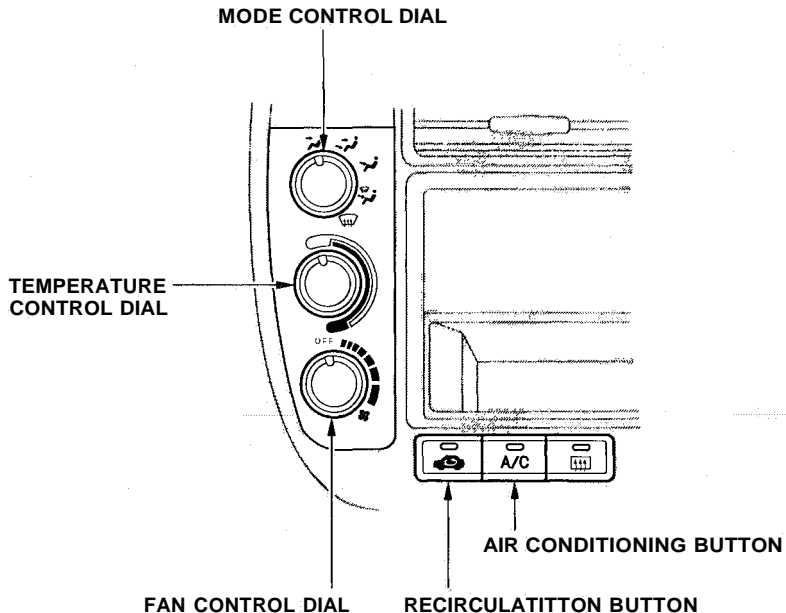

These settings direct all the air flow to the defroster vents at the base of the windshield and the side window defroster vents. The air flow will get warmer and clear the windows faster as the engine warms up. You can close the side vents with the dial beside each vent. This will send more warm air to the windshield defroster vents.

For safety, make sure you have a clear view through all the windows before driving away.

To Turn Everything Off

To shut off the system temporarily, turn the fan speed and temperature control dials all the way to the left.

You should shut the system completely off only for the first few minutes of driving in cold weather, until the engine coolant warms up enough to operate the heater. Keep the fan on at all other times so stale air does not build up in the interior.

AM/FM Stereo Audio System

For DX and LX models in the U.S., and LX model in Canada

Your Honda's audio system provides clear reception on both AM and FM bands, while the preset buttons allow you to easily select your favorite stations.

Operating the Radio

The ignition switch must be in ACCESSORY (I) or ON (II) to operate the audio system. Turn the system on by pressing the PWR/VOL knob or the AM/FM button. Adjust the volume by turning the knob.

The band and frequency that the radio was last tuned to is displayed. To change bands, press the AM/FM button. On the FM band, ST will be displayed if the station is broadcasting in stereo. Stereo reproduction on AM is not available.

You can use any of three methods to find radio stations on the selected band: TUNE, SEEK, or the Preset buttons.

TUNE — Use the TUNE/SEEK switch to tune the radio to a desired frequency. Press the right side (^) to tune to a higher frequency, or the

left side (v) to tune to a lower frequency. The frequency numbers will start to change rapidly. Release the bar when the display reaches the desired frequency. To change the frequency in small increments, press and release the TUNE/SEEK switch quickly.

SEEK — The SEEK function searches the band for a station with a strong signal. To activate it, press the TUNE/SEEK switch until you hear a beep, then release it. Depending on which side of the switch you press, the system scans upward or downward from the current frequency. It stops when it finds a station with a strong signal.

Preset — You can store the frequencies of your favorite radio stations in the six preset buttons. Each button will store one frequency on the AM band, and two on the FM band.

To store a frequency:

1. Select the desired band, AM or FM. FM1 and FM2 let you store two frequencies with each Preset button.
2. Use the TUNE or SEEK function to tune the radio to a desired station.
3. Pick the Preset button you want for that station. Press the button and hold it until you hear a beep.
4. Repeat steps 1 to 3 to store a total of six stations on AM and twelve on FM.

Once a station's frequency is stored, simply press and release the proper Preset button to tune to it. The preset frequencies will be lost if your car's battery goes dead, is disconnected, or the radio fuse is removed.

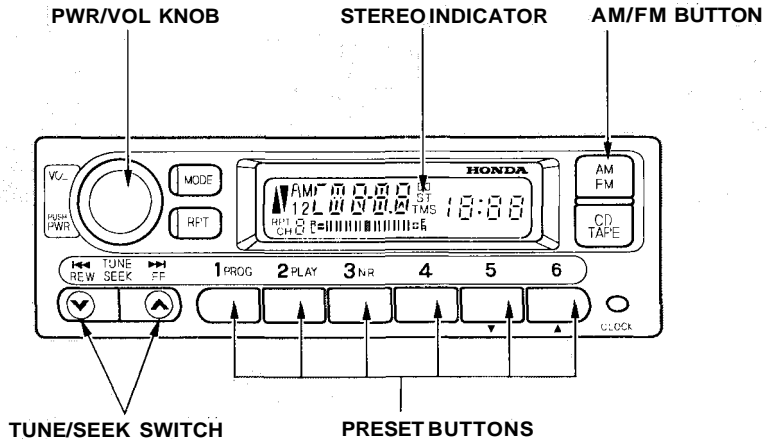

Audio System

Adjusting the Sound

Bass, Treble, Balance, and Fader are each adjustable. You select which of these you want to adjust by pressing the MODE button. The mode changes from BAS to TRE to FAD to BAL, and then back to VOL each time you press the button. Each mode is shown in the display as it changes.

Balance/Fader — These two modes adjust the strength of the sound coming from each speaker. BAL adjusts the side-to-side strength, while FAD adjusts the front-to-back strength.

Select BAL or FAD by pressing the MODE button. Adjust the Balance or Fader to your liking by turning the PWR/VOL knob. The indicator bars on the display show you the range.

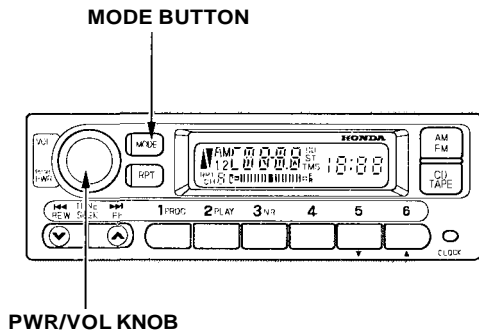

Treble/Bass — Use these modes to adjust the tone to your liking. Select TRE or BAS by pressing the MODE button. Adjust the desired mode by turning the PWR/VOL knob. The indicator bars on the display show you the range.

As you adjust a mode, you will hear a beep whenever the indicator bar reaches the center, far left, and far right of its range. The system will automatically return the display to normal mode about seven seconds after you stop adjusting a mode with the PWR/VOL knob.

Radio Frequencies and Reception

For information, See page [127](#).

Digital Clock

The audio system also displays the time. The ignition switch must be in ACCESSORY (I) or ON (II).

To set the time, press the **CLOCK** button. The hour numbers will begin blinking. Press the Preset 5 button to get the numbers to count down, or the Preset 6 button to get the hours to count up.

Press the **CLOCK** button again, and the minutes numbers will begin blinking. Use the Preset 5 or Preset 6 button to change the minutes to the correct value.

After you have set the clock, press the **CLOCK** button again to return to the normal display. If you do not, the system will automatically return to the normal display about seven seconds after you stop pressing the Preset buttons.

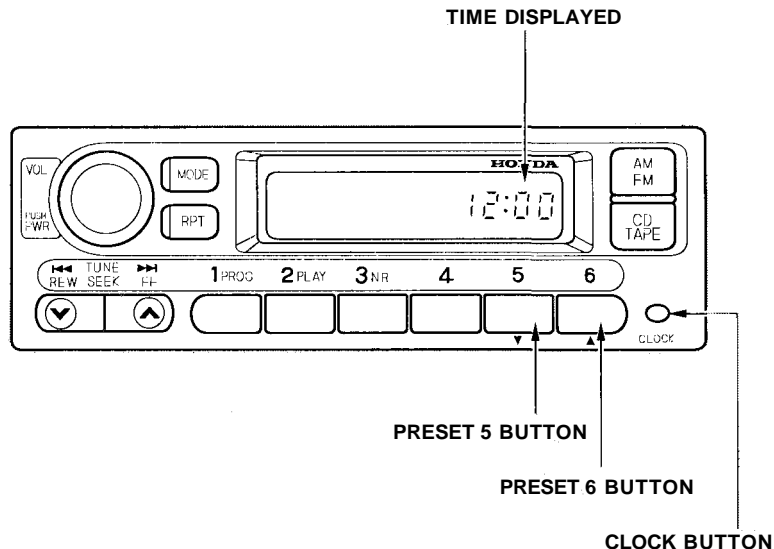

Operating the Optional Cassette Player

The cassette system features Dolby B* noise reduction, automatic sensing of chromium-dioxide (CrO₂) tape, and autoreverse for continuous play.

* Dolby noise reduction manufactured under license from Dolby Laboratories Licensing Corporation. "DOLBY" and the double-D symbol  are trademarks of Dolby Laboratories Licensing Corporation.

Make sure the tape opening on the cassette is facing to the right, then insert the cassette most of the way into the slot. The system will pull it in the rest of the way, and begin to play.

The tape direction indicator will light to show you which side of the cassette is playing. The ▲ indicates the side you inserted facing upward is now playing. If you want to play

the other side, press the PROG button.

Dolby B noise reduction turns on when you insert a cassette. If the tape was not recorded with Dolby B noise reduction, turn it off by pressing the NR button.

When the system reaches the end of the tape, it will automatically reverse direction and play the other side. If you want to remove the cassette from the drive, press the EJECT button.

If you turn the system off while a tape is playing, either with the PWR/VOL knob or by turning off the ignition, the cassette will remain in the drive. When you turn the system back on, the tape will begin playing where it left off.

To switch to the radio or optional CD changer while listening to a tape,

press the AM/FM or CD/TAPE button. To change back to the cassette player, press the CD/TAPE button.

Tape Search Functions

With a cassette playing, you can use the FF, REW, TMS, or REPEAT function to find a desired program.

FF/REW — Fast Forward and Rewind move the tape rapidly. Press and release the REW side of the TUNE/SEEK switch to rewind the tape, or the FF side to fast forward. Press the PLAY button to take the system out of rewind or fast forward. If the system reaches the end of the tape while in fast forward or rewind, it automatically stops that function, reverses direction, and begins to play.

TMS — The Tape Music Search function allows you to find the beginning of a song or passage. To activate TMS, press FF or REW until you hear a beep. You will see TMS displayed. When the system reaches the beginning of the next song or passage (FF), or the beginning of the song just played (REW), it goes back to PLAY mode.

REPEAT — The Repeat function continuously replays the current song or passage. Press the RPT button to activate it; you will see RPT displayed as a reminder. When the system reaches the end of the song or passage currently playing, it will automatically go into rewind. When it senses the beginning of the same song or passage, the system returns to PLAY mode. It will continue to repeat this same program until you deactivate REPEAT by pressing the button again.

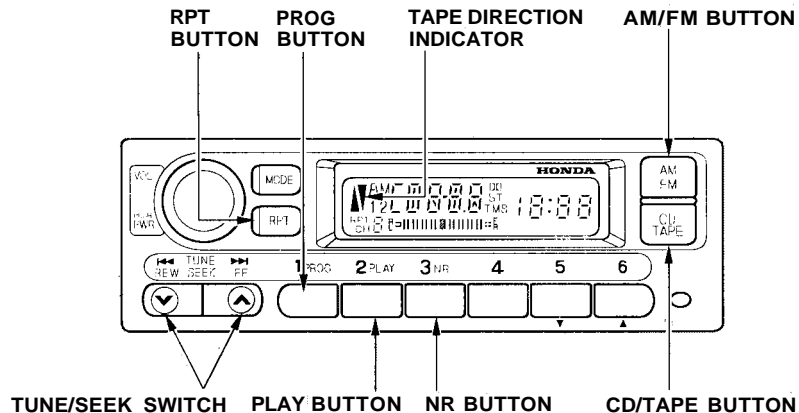

The TMS and REPEAT functions use silent periods on the tape to find the end of a song or passage. These features may not work to your satisfaction if there is almost no gap between selections, a high noise level between selections, or a silent period in the middle of a selection.

Caring for Cassettes

Damaged cassettes can jam inside the drive or cause other problems. See page 138 for information on cassette care and protection.

Audio System

Operating the Optional CD Player/Changer

A Compact Disc changer is available through your dealer. It holds up to six discs, providing several hours of continuous entertainment. You operate the CD changer with the same controls used for the radio.

Your dealer also has an accessory in-dash single CD player available that is operated by the radio controls. To operate this unit, use the instructions (except for those relating to multiple discs) in this section.

To operate the CD player or changer, the ignition must be in ACCESSORY (I) or ON (II).

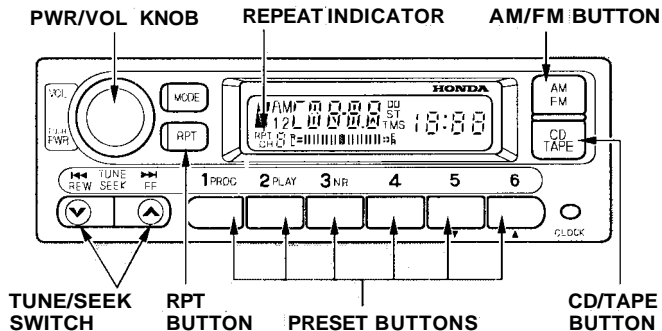

CD Player

Insert the disc into the CD slot. Push the disc in halfway, the drive will pull it in the rest of the way. Push the CD/TAPE button and the disc will start to play.

You will see the track number being played in the display.

You can also play 3-inch (8-cm) discs without using an adapter ring. In all cases, play only standard round discs. Odd-shaped CDs may jam in the drive or cause other problems.

When the system reaches the end of the disc, it will return to the beginning and play that disc again.

Press the EJECT button to remove the disc from the player.

If you eject the disc, but do not remove it from the slot, the system will automatically reload the disc after 15 seconds and put the CD player in pause mode. To begin playing the disc, press the CD button.

CD Changer

Using the instructions that came with the changer, load the desired CDs in the magazine, and load the magazine in the changer. Play only standard round discs. Odd-shaped CDs may jam in the drive or cause other problems.

Press the CD/TAPE button. You will see "CD" in the display. The system will start to play the first track of the first disc. When that disc ends, the next disc in the magazine is loaded and played. After the last disc finishes, the system returns to disc 1.

To select a different disc, press the appropriate preset button (1 – 6). If you select an empty slot in the magazine, the changer will, after finding that slot empty, try to load the CD in the next slot. This continues until it finds a CD to load and play.

CD Player and Changer

You can use the TUNE/SEEK switch to select tracks within a disc. If you press and release the TUNE/SEEK switch, the system will move to the beginning of a track. Press the ►► side to move to the beginning of the next track, and the ◀◀ side to move to the beginning of the current track.

If you push and hold the TUNE/SEEK switch, you will hear a beep and the system will continue to move across tracks. Release the switch when you think it has reached the desired place on the disc.

REPEAT — When you activate the Repeat feature by pressing the RPT button, the system continuously replays the current track. You will see RPT in the display as a reminder. Press the RPT button again to turn it off.

To take the system out of CD mode, press the AM/FM button or insert a cassette in the player. If a tape is already in the cassette player, press the CD/TAPE button. When you return to CD mode, play will continue at the same point that it left off.

If you turn the system off while a CD is playing, either with the PWR/VOL knob or the ignition switch, play will continue at the same point when you turn it back on.

Audio System

CD Changer Error Indications

If you see an error indication in the display while operating the CD changer, find the cause in the chart to the right. If you cannot clear the error indication, take the car to your Honda dealer.

Indication	Cause	Solution
CD0000	No CD in the CD magazine	Insert CD.
CD - - -	No CD magazine in the CD changer	Insert CD magazine.
CD - - H	High temperature	Will disappear when the temperature returns to normal.
CD E E E E	Misconnection or disconnection of CD changer	See your Honda dealer.
CD E - 1	Disc-changer malfunction	Consult your Honda dealer.
CD E - 2	Disc is in changer mechanism	Press the magazine eject button, and insert an empty magazine.
CD E - 3 CD E - 4 CD E - 5	Disc-changer malfunction	If the code disappears within a few seconds, unit is OK. If it does not, consult your Honda dealer.
CD E - 6	Disc-changer malfunction	Press the magazine eject button and pull out the magazine, check for error indication. Insert the magazine again. If the magazine cannot be pulled out, consult your Honda dealer.
CD E - 7	CD magazine ejection impossible	Press the magazine eject button. If the magazine does not eject, consult your Honda dealer.

AM/FM/Cassette Stereo Audio System

On Canadian EX model only

Your Honda's audio system provides clear reception on both AM and FM bands, while the preset buttons allow you to easily select your favorite stations.

The cassette system features Dolby B* noise reduction, automatic sensing of chromium-dioxide (CrO₂) tape, and autoreverse for continuous play.

* Dolby noise reduction manufactured under license from Dolby Laboratories Licensing Corporation. "DOLBY" and the double-D symbol  are trademarks of Dolby Laboratories Licensing Corporation.

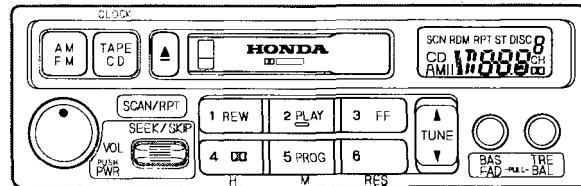

Audio System

Operating the Radio

The ignition switch must be in ACCESSORY (I) or ON (II) to operate the audio system. Turn the system on by pushing the PWR/VOL knob.

Adjust the volume by turning the PWR/VOL knob.

The band and frequency that the radio was last tuned to is displayed. To change bands, press the AM/FM button. On the FM band, ST will be displayed if the station is broadcasting in stereo. Stereo reproduction on AM is not available.

You can use any of four methods to find radio stations on the selected band: TUNE, SEEK, SCAN or the Preset buttons.

TUNE — Use the TUNE bar to tune the radio to a desired frequency. Press the upper part (▲) to tune to a higher frequency, or the lower part (▼) to tune to a lower frequency. The frequency numbers will start to change rapidly. Release the bar when the display reaches the desired frequency. To change the frequency in small increments, press and release the TUNE bar quickly.

SEEK — The SEEK function searches the band for a station with a strong signal. To activate it, push the SEEK switch up or down, then release it. Depending on which way you push the switch, the system scans upward or downward from the current frequency. It stops when it finds a station with a strong signal.

SCAN - The SCAN function samples all the stations with strong signals on the selected band. To activate it, press the SCAN button, then release it. The system will scan up the band for a station with a strong signal. When it finds one, it will stop and play that station for approximately five seconds. If you do nothing, the system will then scan for the next strong station and play that for five seconds. When it plays a station that you want to continue listening to, press the SCAN button again.

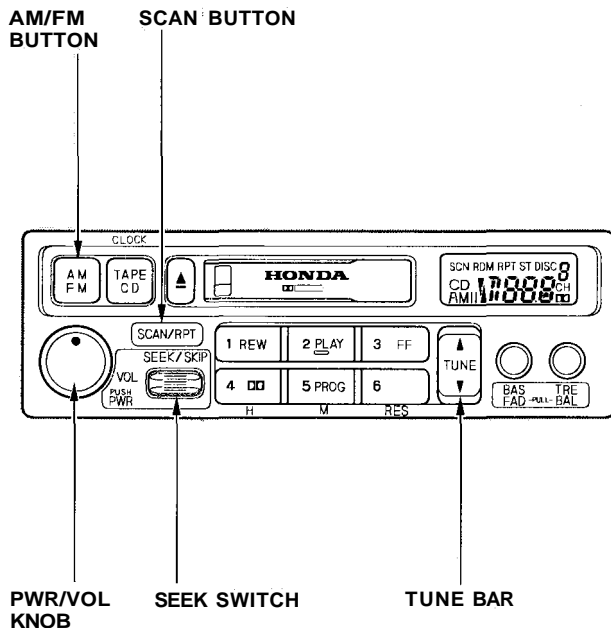

CONTINUED

Audio System

Preset — You can store the frequencies of your favorite radio stations in the six preset buttons. Each button will store one frequency on the AM band, and two on the FM band.

To store a frequency:

1. Select the desired band, AM or FM. FM1 and FM2 let you store two frequencies with each Preset button.
2. Use the TUNE or SEEK function to tune the radio to a desired station.
3. Pick the Preset button you want for that station. Press the button and hold it until you hear a beep.
4. Repeat steps 1 to 3 to store a total of six stations on AM and twelve on FM.

AM/FM BUTTON

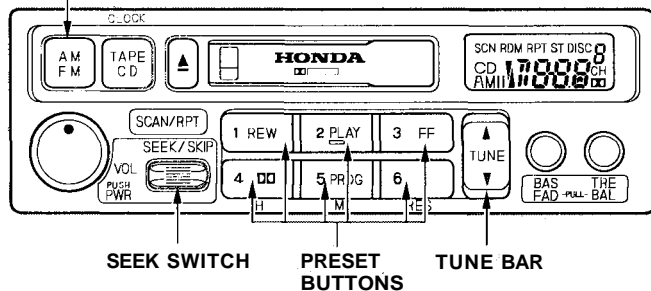

Once a station's frequency is stored, simply press and release the proper preset button to tune to it. The preset frequencies will be lost if your car's battery goes dead, is disconnected, or the radio fuse is removed.

Adjusting the Sound

Balance/Fader — These two controls adjust the strength of the sound coming from each speaker. The Balance control adjusts the side-to-side strength, while the Fader control adjusts the front-to-back strength.

To adjust the fader, push on the BASS/FADER control knob to get it to pop out. Pull it out slightly farther, and adjust the front-to-back sound to your liking. Push the knob back in when you are done so you cannot change the setting by accidentally bumping it.

To adjust the balance, push on the TREBLE/BALANCE control knob to get it to pop out. Pull it out slightly farther, and adjust the side-to-side sound to your liking. Push the knob back in when you are done so you cannot change the setting by accidentally bumping it.

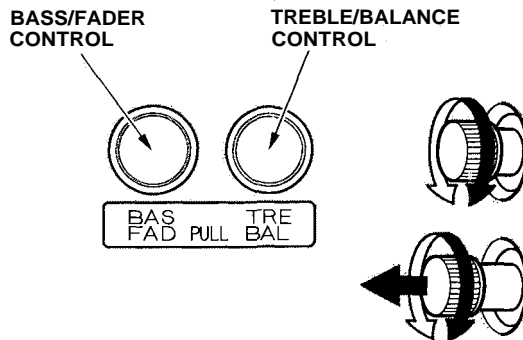

Treble/Bass — Use these controls to adjust the tone to your liking.

To adjust the Treble level, push on the TREBLE/BALANCE control knob to get it to pop out. Without pulling it out farther, turn the knob to adjust the treble level. Push the knob back in when you are done so you cannot change the setting by accidentally bumping it.

To adjust the Bass level, push on the BASS/FADER control knob to get it to pop out. Without pulling it out farther, turn the knob to adjust the bass level. Push the knob back in when you are done so you cannot change the setting by accidentally bumping it.

Audio System

Radio Frequencies and Reception

For information, See page 127.

Audio System Lighting

You can use the instrument panel brightness control dial to adjust the illumination of the audio system (see page 62). The audio system illuminates when the parking lights are on, even if the radio is turned off.

Digital Clock

The display of your audio system usually shows the time when the ignition switch is in ACCESSORY (I) or ON (II). It shows operation mode of radio, cassette player, or optional CD changer when you operate them, and goes back to the time display after five seconds.

If an error occurs while operating the optional CD changer, the display will keep showing the error code and will not switch to the time display until the error is corrected (see page 120).

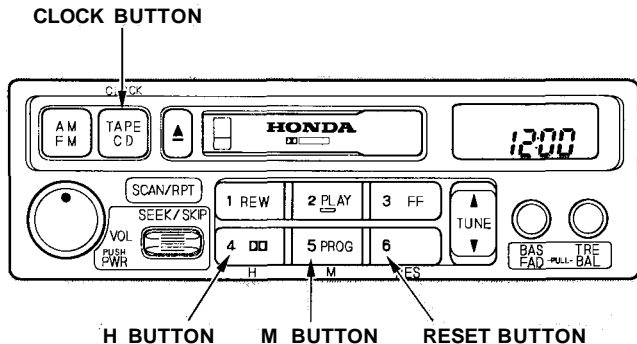

To set the time, press the CLOCK (TAPE/CD) button for more than two seconds. To set the hours, press the H (Preset 4) button. The hour numbers will begin blinking. Keep pressing the button until the numbers advance to the desired time.

To set the minutes, press the M (Preset 5) button. The minutes numbers will begin blinking. Keep

pressing the button until the numbers advance to the desired time.

You can use the RESET (Preset 6) button to quickly set the time to the nearest hour. If the displayed time is before the half hour, pressing RESET sets the clock back to the previous hour. If the displayed time is after the half hour, pressing RESET sets the clock forward to the beginning of the next hour. For example:

- 1:06 would RESET to 1:00
- 1:52 would RESET to 2:00

The blinking stops and the time is set when you press any keys other than the time setting keys (Preset 4, 5 and 6).

Operating the Cassette Player

Turn the audio system ON. Make sure the tape opening on the cassette is facing to the right, then insert the cassette most of the way into the slot. The system will pull it in the rest of the way, and begin to play.

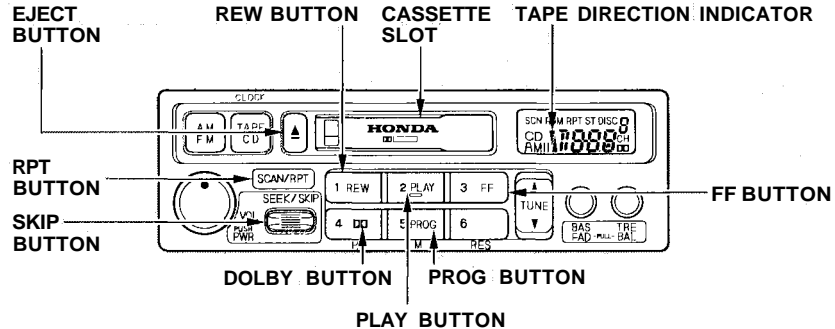

The tape direction indicator will light to show you which side of the cassette is playing. The ▲ indicates the side you inserted facing upward is now playing. If you want to play the other side, press the PROG button.

Dolby B noise reduction turns on when you insert a cassette. If the tape was not recorded with Dolby B noise reduction, turn it off by pressing the DD button.

CONTINUED

When the system reaches the end of the tape, it will automatically reverse direction and play the other side. If you want to remove the cassette from the drive, press the EJECT button.

Tape Search Functions

With a cassette playing, you can use the FF, REW, SKIP, or REPEAT function to find a desired program.

FF/REW — Fast Forward and Re-wind move the tape rapidly. To re-wind the tape, push the REW button. You will see REW in the display. To fast forward the tape, push the FF button. You will see FF displayed. Press the PLAY button to take the system out of rewind or fast forward. If the system reaches the end of the tape while in fast forward or rewind, it automatically stops that function, reverses direction, and begins to play.

SKIP — The Skip Function allows you to find the beginning of a song or passage. To find the beginning of the song or passage currently playing, push the SKIP switch down. You will see REW flashing in the display as the tape rewinds. To find the beginning of the next song, push the SKIP switch up. You will see FF flashing in the display as the tape fast forwards. When the system finds the beginning of a song or passage, it goes back to PLAY mode.

REPEAT — The Repeat function continuously replays the current song or passage. Press the RPT button to activate it; you will see RPT displayed as a reminder. When the system reaches the end of the song or passage currently playing, it will automatically go into rewind. When it senses the beginning of the same song or passage, the system returns to PLAY mode. It will continue to repeat this same program until you deactivate REPEAT by pressing the button again.

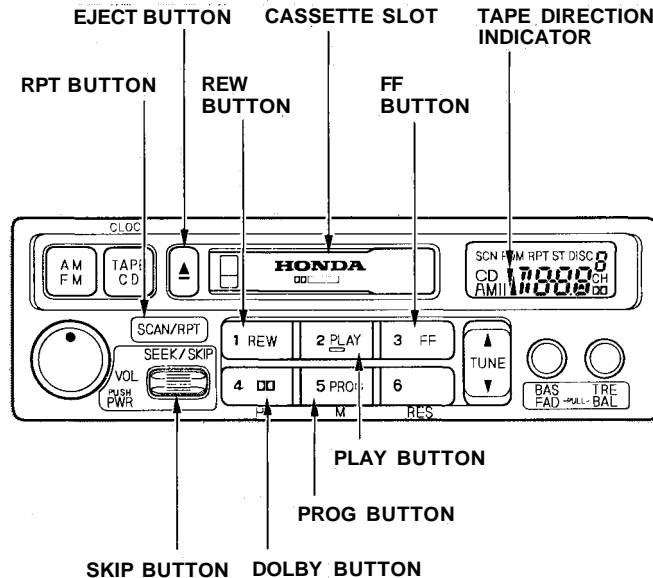

CONTINUED

Audio System

The SKIP and REPEAT functions use silent periods on the tape to find the end of a song or passage. These features may not work to your satisfaction if there is almost no gap between selections, a high noise level between selections, or a silent period in the middle of selection.

Caring for Cassettes

Damaged cassettes can jam inside the drive or cause other problems. See page 138 for information on cassette care and protection.

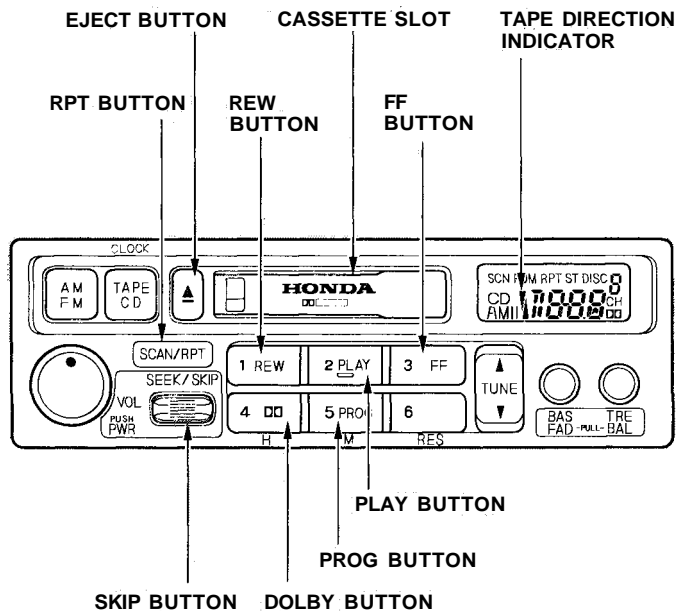

Operating the Optional CD Player/Changer

A Compact Disc changer is available from your dealer. It holds up to six discs, providing several hours of continuous entertainment. You operate the CD changer with the same controls used for the radio and cassette player.

Your dealer also has an accessory in-dash single CD player available that is operated by the radio controls. To operate this unit, use the instructions (except for those relating to multiple discs) in this section.

Using the instructions that came with the changer, load the desired CDs in the magazine, and load the magazine in the changer. Play only standard round discs. Odd-shaped CDs may jam in the drive or cause other problems.

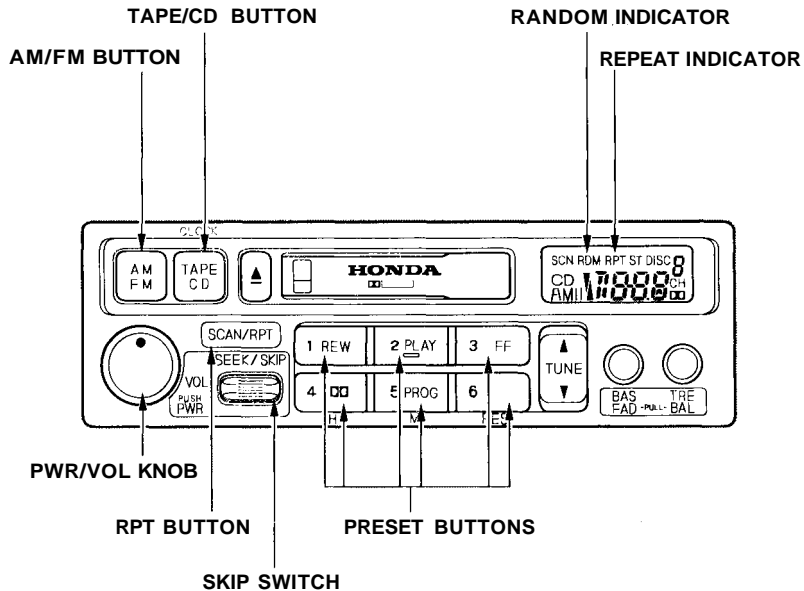

CONTINUED

Audio System

To operate the CD changer or player, the ignition must be in ACCESSORY (I) or ON (II) and the audio system must be on.

Press the CD button until "CD" appears in the display. The system will start to play the first track of the first disc in the magazine.

When that disc ends, the next disc in the magazine is loaded and played. After the last disc finishes, the system returns to disc 1.

To select a different disc, press the appropriate preset button (1 — 6). If you select an empty slot in the magazine, the changer will, after finding that slot empty, try to load the CD in the next slot. This continues until it finds a CD to load and play.

You can use the SKIP switch to select tracks within a disc. If you push and release the SKIP switch, the system will move to the beginning of a track. Push the switch up to move to the beginning of the next track, and push the switch down to move to the beginning of the current track.

If you push and hold the SKIP switch, you will hear a beep and the system will continue to move across tracks. Release the switch when you think it has reached the desired place on the disc.

REPEAT — When you activate the Repeat feature by pressing the RPT button, the system continuously replays the current track. You will see RPT in the display as a reminder. Press the RPT button again to turn it off.

RANDOM PLAY — This feature, when activated, plays the tracks on a CD in random order, rather than in the order they are recorded on the CD. To activate Random Play, press and hold the RPT button until you see RDM in the display. The system will then select and play tracks randomly on the current disc. When all tracks on that disc have been played, the next disc is loaded and played randomly. This continues until you deactivate Random Play by pressing RPT again.

If the system is in Repeat mode, you must turn it off by pressing RPT before you can select Random Play. Then press the button again until you see RDM displayed.

To take the system out of CD mode, press the AM/FM button or insert a cassette in the player. If a tape is already in the cassette player, press the TAPE button. When you return to CD mode, play will continue at the same disc and track.

If you turn the system off while a CD is playing, either with the PWR/VOL knob or the ignition switch, play will continue at the same disc and track when you turn it back on.

Protecting Compact Discs

For information on how to handle and protect compact discs, see page [132](#).

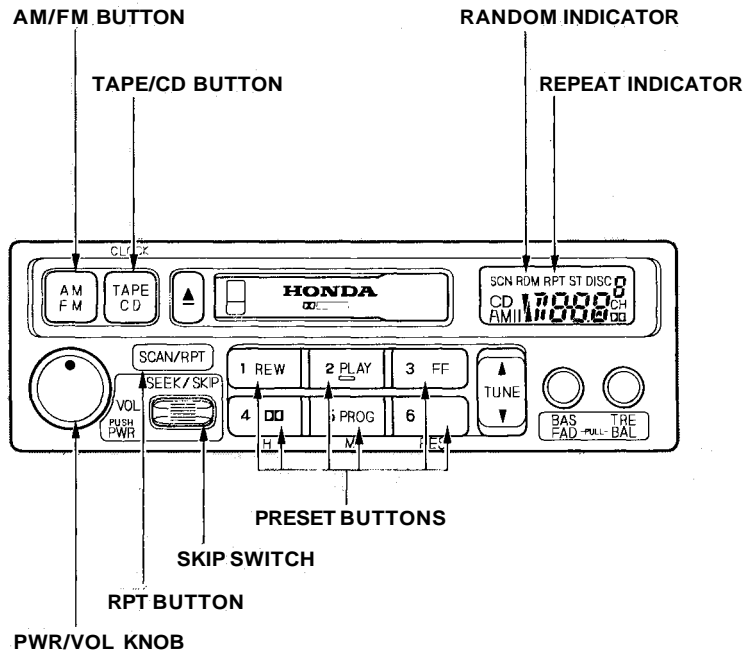

CD Changer Error Indications

If you see an error indication in the display while operating the CD changer, find the cause in the chart to the right. If you cannot clear the error indication, take the car to your Honda dealer.

Indication	Cause	Solution
E01	Disc-changer malfunction.	If the code disappears within a few seconds, unit is OK. Press the magazine eject button and pull out the magazine, check for error indication. Insert the magazine again. If the code does not disappear or the magazine cannot be pulled out, consult your Honda dealer.
	CD magazine ejection impossible.	Press the magazine eject button. If the magazine does not eject, consult your Honda dealer.
E02	Disc is in changer mechanism.	Press the magazine eject button, and insert an empty magazine.
---H	High temperature.	Will disappear when the temperature returns to normal.
EEE	Misconnection or disconnection of CD changer.	See your Honda dealer.
---	No CD magazine in the CD changer.	Insert CD magazine.
000	No CD in magazine.	Insert CD in magazine.

AM/FM/CD Audio System

On U.S. Value Package and EX models
Your Honda's audio system provides clear reception on both AM and FM bands, while the preset buttons allow you to easily select your favorite stations.

The anti-theft feature will disable the system if it is disconnected from the car's battery. To get the system working again, you must enter a code number (see page [139](#)).

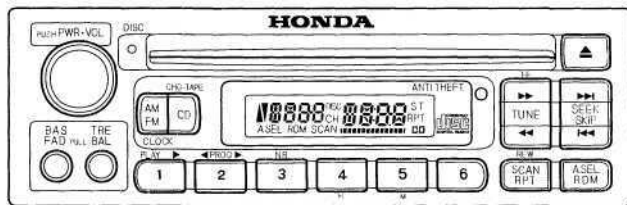

Audio System

Operating the Radio

The ignition switch must be in ACCESSORY (I) or ON (II) to operate the audio system. Turn the system on by pushing the PWR/VOL knob. Adjust the volume by turning the same knob.

The band and frequency that the radio was last tuned to is displayed. To change bands, press the AM/FM button. On the FM band, ST will be displayed if the station is broadcasting in stereo. Stereo reproduction on AM is not available.

You can use any of four methods to find radio stations on the selected band: TUNE, SEEK, SCAN or the Preset buttons.

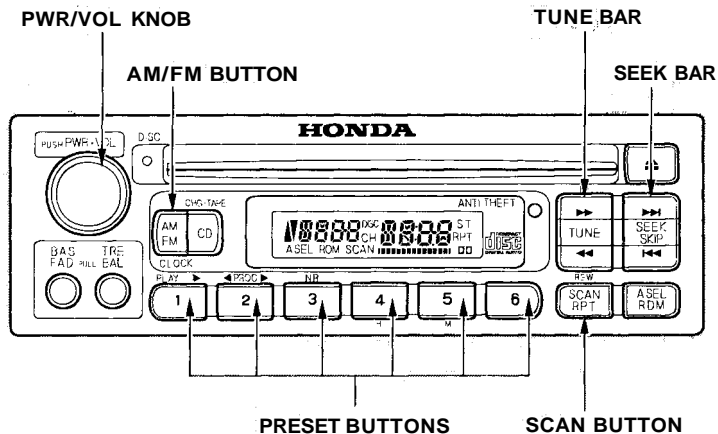

TUNE — Use the TUNE bar to tune the radio to a desired frequency. Press the ►► side of the bar to tune to a higher frequency, and the ◀◀ side to tune to a lower frequency. The frequency numbers will start to change rapidly. Release the bar when the display reaches the desired frequency. To change the frequency in small increments, press and release the TUNE bar quickly.

SEEK — The SEEK function searches the band for a station with a strong signal. To activate it, press the SEEK bar on either the ◀◀ or ►► side, then release it. Depending on which side you press, the system scans upward or downward from the current frequency. It stops when it finds a station with a strong signal.

SCAN — The SCAN function samples all the stations with strong signals on the selected band. To activate it, press the SCAN button, then release it. The system will scan up the band for a station with a strong signal. When the system is in the SCAN mode, SCAN shows in the display. When it finds one, it will stop and play that station for approximately five seconds. If you do nothing, the system will then scan for the next strong station and play that for five seconds. When it plays a station that you want to continue listening to, press the SCAN button again.

Preset — You can store the frequencies of your favorite radio stations in the six preset buttons. Each button will store one frequency on the AM band, and two on the FM band.

To store a frequency:

1. Select the desired band, AM or FM. FM1 and FM2 let you store two frequencies with each Preset button.
2. Use the TUNE or SEEK function to tune the radio to a desired station.
3. Pick the Preset button you want for that station. Press the button and hold it until you hear a beep.
4. Repeat steps 1 to 3 to store a total of six stations on AM and twelve on FM.

Once a station's frequency is stored, simply press and release the proper preset button to tune to it. The preset frequencies will be lost if your car's battery goes dead, is disconnected, or the radio fuse is removed.

CONTINUED

AUTO SELECT — If you are traveling far from home and can no longer receive the stations you preset, you can use the Auto Select feature to find stations in the local area.

To activate Auto Select, press the A. SEL button. A. SEL will flash in the display, and the system will go into scan mode for several seconds. It automatically scans both bands, looking for stations with strong signals; It stores the frequencies of six AM stations and twelve FM stations in the preset buttons. You can then use the preset buttons to select those stations.

If you are in a remote area, Auto Select may not find six strong AM stations or twelve strong FM stations. If this happens, you will see a "0" displayed when you press any preset button that does not have a station stored.

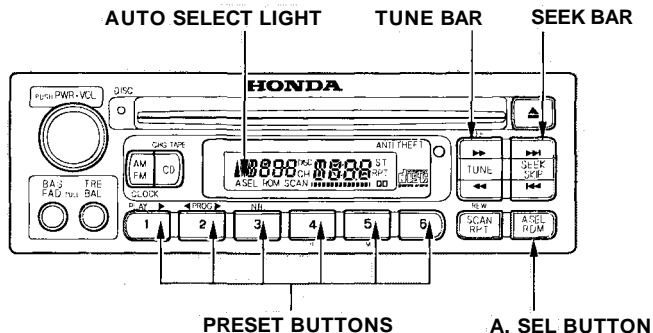

If you do not like the stations Auto Select has stored, you can store other frequencies in the preset buttons. Use the TUNE, SEEK, or SCAN function to find the desired frequencies, then store them in the selected preset buttons as described previously.

Auto Select does not erase the frequencies that you preset previously. When you return home, turn off Auto Select by pressing the A. SEL button. The preset buttons will then select the frequencies you originally set.

Adjusting the Sound

Balance/Fader — These two controls adjust the strength of the sound coming from each speaker. The Balance control adjusts the side-to-side strength, while the Fader control adjusts the front-to-back strength.

To adjust the fader, push on the BASS/FADER control knob to get it to pop out. Pull it out slightly farther, and adjust the front-to-back sound to your liking. Push the knob back in when you are done so you cannot change the setting by accidentally bumping it.

To adjust the balance, push on the TREBLE/BALANCE control knob to get it to pop out. Pull it out slightly farther, and adjust the side-to-side sound to your liking. Push the knob back in when you are done so you cannot change the setting by accidentally bumping it.

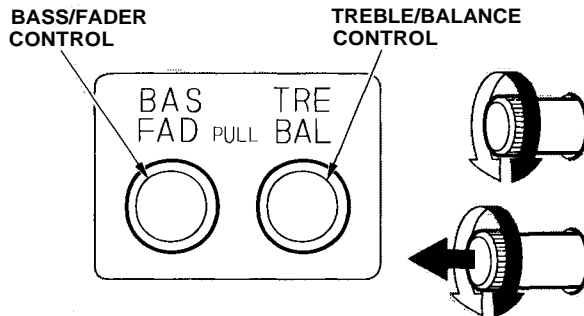

Treble/Bass — Use these controls to adjust the tone to your liking.

To adjust the Treble level, push on the TREBLE/BALANCE control knob to get it to pop out. Without pulling it out farther, turn the knob to adjust the treble level. Push the knob back in when you are done so you cannot change the setting by accidentally bumping it.

To adjust the Bass level, push on the BASS/FADER control knob to get it to pop out. Without pulling it out farther, turn the knob to adjust the bass level. Push the knob back in when you are done so you cannot change the setting by accidentally bumping it.

Audio System

Audio System Lighting

You can use the instrument panel brightness control dial to adjust the illumination of the audio system (see page 62). The audio system illuminates when the parking lights are on, even if the radio is turned off.

Digital Clock

The display of your audio system usually shows the time when the ignition switch is in ACCESSORY (I) or ON (II). It shows operation mode of radio, CD player, or optional CD changer/cassette player when you operate them, and goes back to the time display after five seconds. The display also goes back to the time display two seconds after you turn the volume knob to adjust the volume.

If an error occurs while operating the CD player or optional CD changer, the display will show the error code and will not switch to the time display until the error is

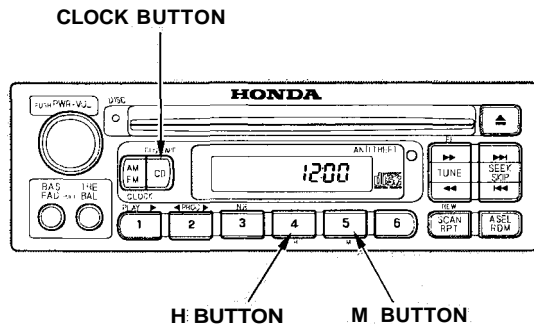

corrected (see page 133 and 134).

To set the time, press the CLOCK (AM/FM) button for more than two seconds until you hear a beep. The time display will begin blinking. To set the hour, press and hold the H (Preset 4) button until the hour advances to the desired time.

To set the minutes, press and hold the M (Preset 5) button until the numbers advance to the desired time.

When you are finished, press the CLOCK button again. The time display will stop blinking and the time is now set.

Radio Frequencies

Your Honda's radio can receive the complete AM and FM bands. Those bands cover these frequencies:

AM band:

530 to 1,710 kilohertz

FM band:

87.7 to 107.9 megahertz

Radio stations on the AM band are assigned frequencies at least ten kilohertz apart (530, 540, 550). Stations on the FM band are assigned frequencies at least 0.2 megahertz apart (87.9, 88.1, 88.3).

Stations must use these exact frequencies. It is fairly common for stations to round-off the frequency in their advertising, so your radio could display a frequency of 100.9 even though the announcer may identify the station as "FM101."

Radio Reception

How well your Honda's radio receives stations is dependent on many factors, such as the distance from the station's transmitter, nearby large objects, and atmospheric conditions.

A radio station's signal gets weaker as you get farther away from its transmitter. If you are listening to an AM station, you will notice the sound volume becoming weaker, and the station drifting in and out. If you are listening to an FM station, you will see the stereo indicator flickering off and on as the signal weakens. Eventually, the stereo indicator will go off and the sound will fade completely as you get out of range of the station's signal.

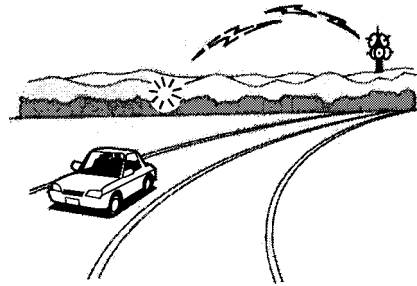

Driving very near the transmitter of a station that is broadcasting on a frequency close to the frequency of the station you are listening to can also affect your radio's reception. You may temporarily hear both stations, or hear only the station you are close to.

CONTINUED

Audio System

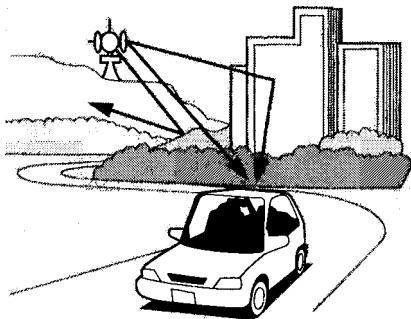

Radio signals, especially on the FM band, are deflected by large objects such as buildings and hills. Your radio then receives both the direct signal from the station's transmitter, and the deflected signal. This causes the sound to distort or flutter. This is a main cause of poor radio reception in city driving.

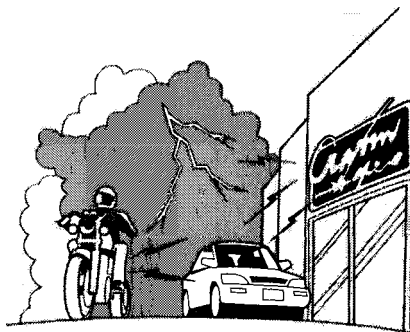

Radio reception can be affected by atmospheric conditions such as thunderstorms, high humidity, and even sunspots. You may be able to receive a distant radio station one day and not receive it the next day because of a change in conditions.

Electrical interference from passing vehicles and stationary sources can cause temporary reception problems.

*As required by the FCC:
Changes or modifications not expressly approved by the party responsible for compliance could void the user's authority to operate the equipment.*

Operating the CD Player

You operate the CD player with the same controls used for the radio.

With the ignition switch in ACCESSORY (I) or ON (II), insert the disc into the CD slot. Push the disc in halfway, the drive will pull it in the rest of the way and begin to play. The number of the track that is playing is shown in the display.

You can also play 3-inch (8-cm) discs without using an adapter ring. Play only standard round discs. Odd-shaped CDs may jam in drive or cause other problems.

When the system reaches the end of the disc, it will return to the beginning and play that disc again.

You can switch to the radio while a CD is playing by pressing the AM/FM button. Press the CD button to return to playing the CD. The CD will begin playing where it left off.

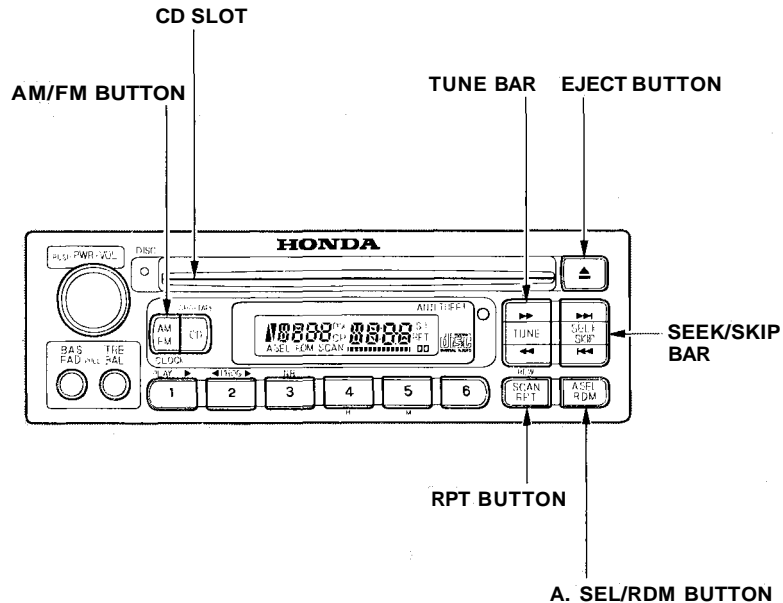

CONTINUED



Audio System



If you turn the system off while a CD is playing, either with the PWR/VOL knob or by turning off the ignition, the disc will stay in the drive. When you turn the system back on, the CD will begin playing where it left off.

Press the eject button to remove the disc from the drive.

If you eject the disc, but do not remove it from the slot, the system will automatically reload the disc after 15 seconds and put the CD player in pause mode. To begin playing the disc, press the CD button.

You can use the TUNE and SEEK/SKIP bars while a disc is playing to select passages and change tracks.

To move rapidly within a track, press and hold the TUNE bar. Press the  side to move forward. You will see CUE in the display. Press the  side to move backward. You will see REW displayed. Release the bar when the system reaches the point you want.

Each time you press the  side of the SEEK/SKIP bar, the system skips forward to the beginning of the next track. Press the  side to skip backward to the beginning of the current track. Press it again to skip to the beginning of the previous track.

REPEAT — To activate the Repeat feature, press and release the RPT button. You will see RPT in the display. The system continuously

replays the current track. Press the RPT button again to turn it off.

RANDOM PLAY — This feature, when activated, plays the tracks on the CD in random order, rather than in the order they are recorded on the CD. To activate Random Play, press and release the A. SEL/RDM button. You will see RDM in the display. The system will then select and play tracks randomly. This continues until you deactivate Random Play by pressing A. SEL/RDM again.

If the system is in Repeat mode, you must turn it off by pressing RPT button before selecting Random Play.

Operating the CD Changer (Optional)

A Compact Disc changer is available for your vehicle. It holds up to six discs, providing several hours of continuous entertainment. You operate this CD changer with the same controls used for the in-dash CD player.

Load the desired CD's in the magazine and load the magazine in the changer according to the instructions that came with the unit. Play only standard round discs. Odd-shaped CDs may jam in the drive or cause other problems.

To select the CD changer, press the CD button. The disc and track numbers will be displayed.

To select a different disc, press the appropriate preset button (1 — 6). If you select an empty slot in the magazine, the changer will, after finding that slot empty, try to load the CD in the next slot. This continues until it finds a CD to load and play.

If you load a CD in the in-dash player while the changer is playing a CD, the system will stop the changer and begin playing the in-dash CD. To select the changer again, press the CD button. Play will begin where it left off. Use the CD button to switch between the player and the changer.

If you eject the in-dash CD while it is playing, the system will automatically switch to the CD changer and begin play where it left off. If there are no CDs in the changer, the display will flash. You will have to select another mode (AM or FM) with the button.

When you switch back to CD mode, the system selects the same unit (in-dash or changer) that was playing when you switched out of CD mode.

To use the SKIP, REPEAT, and RANDOM functions, refer to the in-dash player operating instructions.

Protecting Compact Discs

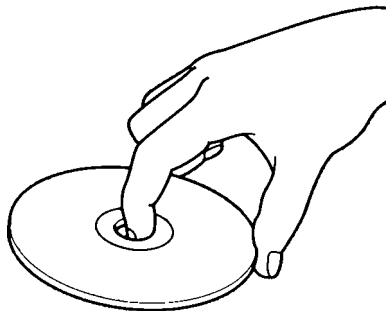

Handle a CD by its edges; never touch either surface. Contamination from fingerprints, liquids, felt-tip pens, and labels can cause the CD to not play properly, or possibly jam in the drive.

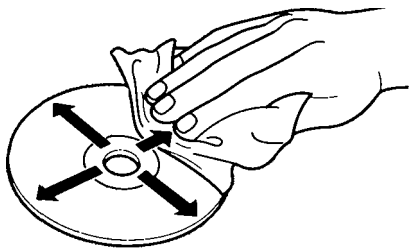

When a CD is not being played, store it in its case to protect it from dust and other contamination. To prevent warpage, keep CDs out of direct sunlight and extreme heat.

To clean a disc, use a clean soft cloth. Wipe across the disc from the center to the outside edge.

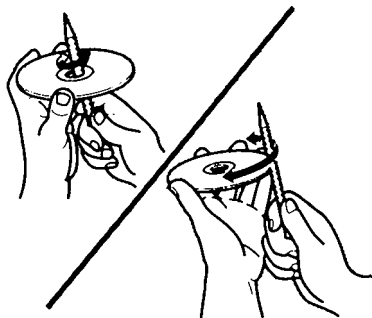

A new CD may be rough on the inner and outer edges. The small plastic pieces causing this roughness can flake off and fall on the recording surface of the disc, causing skipping or other problems. Remove these pieces by rubbing the inner and outer edges with the side of a pencil or pen.

Never try to insert foreign objects in the CD player or the magazine.

CD Player Error Indications

If you see an error indication in the display while operating the CD player, find the cause in the chart to the right. If you cannot clear the error indication, take the car to your Honda dealer.

Indication	Cause	Solution
CD E-00	System Error FOCUS Error	Press the EJECT button and pull out the disc. Check if the disc is inserted correctly in the CD player. Make sure the disc is not scratched or damaged.
CD E-01	Mechanical Error	Press the EJECT button and pull out the disc. Check the disc for damage or deformation. If the CD cannot be pulled out or the error indication does not disappear after the disc is ejected, see your Honda dealer. Do not try to force the disc out of the player.
CD E-02	Communication Error LSI Error	Consult your Honda dealer.

CD Changer Error Indications

If you see an error indication in the display while operating the CD changer, find the cause in the chart to the right. If you cannot clear the error indication, take the car to your Honda dealer.

Indication	Cause	Solution
CD 0 ^{DISC} E-00	System Error FOCUS Error	Press the magazine eject button and pull out the magazine, check for error indication. Insert the magazine again. If the code does not disappear or the magazine cannot be pulled out, consult your Honda dealer.
CD 0 ^{DISC} E-01	Mechanical Error	Press the magazine eject button and pull out the magazine, check for error indication. Insert the magazine again. If the code does not disappear or the magazine cannot be pulled out, consult your Honda dealer.
CD 0 ^{DISC} E-02	Communication Error LSI Error	See your Honda dealer.
CD 0 ^{DISC} ...-H	High temperature.	Will disappear when the temperature returns to normal.
CD 0 ^{DISC} ...- -	No CD magazine in the CD changer.	Insert CD magazine.
	No CD in the CD magazine	Insert CD.

Operating the Cassette Player (Optional)

The cassette system features Dolby B* noise reduction, automatic sensing of chromium-dioxide (CrO₂) tape, and autoreverse for continuous play.

Make sure the tape opening on the cassette is facing to the right, then insert the cassette most of the way into the slot. The system will pull it in the rest of the way, and begin to play.

* Dolby noise reduction manufactured under license from Dolby Laboratories Licensing Corporation. "DOLBY" and the double-D symbol  are trademarks of Dolby Laboratories Licensing Corporation.

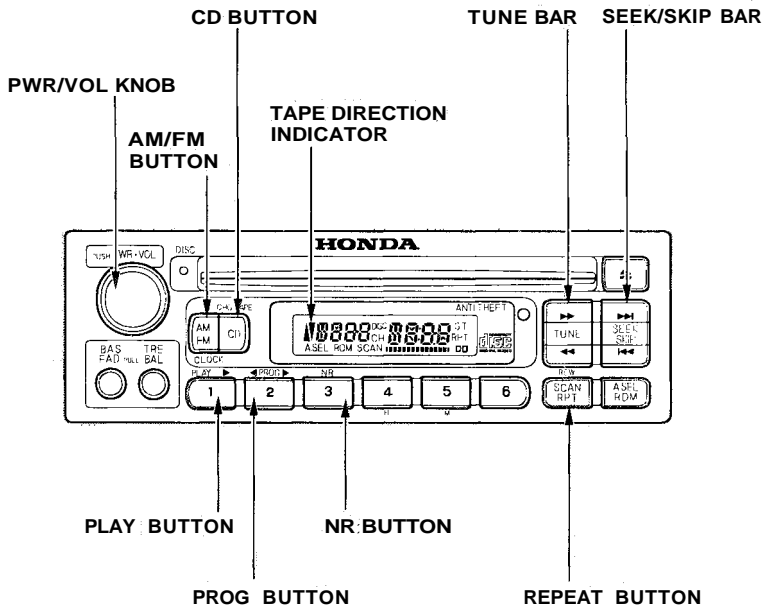

CONTINUED

Audio System

The tape direction indicator will light to show you which side of the cassette is playing. The ▲ indicates the side you inserted facing upward is now playing. If you want to play the other side, press the PROG button.

Dolby B noise reduction turns on when you insert a cassette. If the tape was not recorded with Dolby B noise reduction, turn it off by pressing the NR button.

This feature remains turned off until you turn it on by pressing the button again.

When the system reaches the end of the tape, it will automatically reverse direction and play the other side. If you want to remove the cassette from the drive, press the EJECT button on the cassette player.

If you turn the system off while a tape is playing, either with the PWR/VOL knob or by turning off the ignition, the cassette will remain in the drive. When you turn the system back on, the cassette player will be in pause mode. To begin playing, press the PLAY button.

To switch to the radio or CD player while a tape is playing, press the AM/FM, or CD button. To change back to the cassette player, push the CD button.

Tape Search Functions

With a cassette playing, you can use the FF, REW, SKIP, or REPEAT function to find a desired program.

FF/REW — Fast Forward and Rewind move the tape rapidly. Press and release the ►► side of the TUNE bar to fast forward the tape, or the ◀◀ side to rewind. You will see FF or REW flashing in the display. To stop fast forward or rewind, press either side of the TUNE bar or the PLAY button. If the system reaches the end of the tape while in fast forward or rewind, it automatically stops that function, reverses direction, and begins to play.

SKIP — The skip function allows you to find the beginning of a song or passage. To activate SKIP, press the SEEK/SKIP bar. Press the ►► side to advance to the beginning of the next song or passage, or the ◀◀ side to return to the beginning of the current song or passage. FF or REW will flash in the display as the tape moves. When the system reaches the beginning of the next song or passage (FF), or the beginning of the current one (REW), it goes back to PLAY mode.

REPEAT — The Repeat function continuously replays the current song or passage. Press the REPEAT button to activate it; you will see RPT displayed as a reminder. When the system reaches the end of the song or passage currently playing, it will automatically go into rewind. When it senses the beginning of the same song or passage, the system returns to PLAY mode. It will continue to repeat this same program until you deactivate REPEAT by pressing the button again.

The SKIP and REPEAT functions use silent periods on the tape to find the end of a song or passage. These features may not work to your satisfaction if there is almost no gap between selections, a high noise level between selections, or a silent period in the middle of selection.

Caring for the Cassette Player

The cassette player picks up dirt and oxides from the tape. This contamination builds up over time and causes the sound quality to degrade. To prevent this, you should clean the player after every 30 hours of use. Your dealer has a cleaning kit available.

If you do not clean the cassette player regularly, it may eventually become impossible to remove the contamination with a normal cleaning kit.

Use 100-minute or shorter cassettes. Cassettes longer than that use thinner tape that may break or jam the drive.

Look at the cassette before you insert it. If the tape is loose, tighten it by turning a hub with a pencil or your finger.

If the label is peeling off, remove it from the cassette or it could cause the cassette to jam in the player. Never try to insert a warped or damaged cassette in the player.

When they are not in use, store cassettes in their cases to protect them from dust and moisture. Never place cassettes where they will be exposed to direct sunlight, high heat, or high humidity. If a cassette is exposed to extreme heat or cold, let it reach a moderate temperature before inserting it in the player.

Never try to insert foreign objects into the cassette player.

If you see the error indication “*TAPER*” (except U.S. Value Package and EX)/ “*TAPE Err*” (U.S. Value Package and EX) on the display, press the EJECT button and remove the cassette from the unit. Make sure the tape is not damaged. If the cassette will not eject or the error indication stays on after the cassette ejects, take the vehicle to your Honda dealer.

Except U.S. Value Package and EX
If a problem develops in the connection between the cassette player and the radio, you will see “*TEEE*” in the display. Take the vehicle to your Honda dealer.

Theft Protection

On U.S. Value Package and EX models

Your car's audio system will disable itself if it is disconnected from electrical power for any reason. To make it work again, the user must enter a specific five-digit code in the Preset buttons. Because there are hundreds of number combinations possible from five digits, making the system work without knowing the exact code is nearly impossible.

You should have received a card that lists your audio system's code number and serial number. It is best to store this card in a safe place at home. In addition, you should write the audio system's serial number in this Owner's Manual. If you should happen to lose the card, you must obtain the code number from your Honda dealer. To do this, you will need the system's serial number.

If your car's battery is disconnected or goes dead, the audio system will disable itself. If this happens, you will see "LOCK" in the frequency display the next time you turn on the system. Use the Preset buttons to enter the five-digit code. If it is entered correctly, the radio will start playing.

If you make a mistake entering the code, do not start over or try to correct your mistake. Complete the five-digit sequence, then enter the correct code. You have ten tries to enter the correct code. If you are unsuccessful in ten attempts, you must then leave the system on for one hour before trying again.

You will have to store your favorite stations in the Preset buttons after the system begins working. Your original settings were lost when power was disconnected.

Before you begin driving your Honda, you should know what gasoline to use, and how to check the levels of important fluids. You also need to know how to properly store luggage or packages. The information in this section will help you. If you plan to add any accessories to your car, please read the information in this section first.

Break-in Period.....	142
Gasoline.....	142
Service Station Procedures.....	143
Filling the Fuel Tank.....	143
Opening the Hood.....	144
Oil Check.....	146
Engine Coolant Check.....	147
Fuel Economy.....	148
Vehicle Condition.....	148
Driving Habits.....	148
Accessories and Modifications....	149
Carrying Cargo.....	151

Break-in Period, Gasoline

Break-in Period

Help assure your car's future reliability and performance by paying extra attention to how you drive during the first 600 miles (1,000 km). During this period:

- Avoid full-throttle starts and rapid acceleration.
- Avoid hard braking. New brakes need to be broken-in by moderate use for the first 200 miles (300 km).

You should follow these same recommendations with an overhauled or exchanged engine, or when the brakes are relined.

Gasoline

Your Honda is designed to operate on unleaded gasoline with a pump octane number of 86 or higher. Use of a lower octane gasoline can cause a persistent, heavy metallic rapping noise in the engine that can lead to mechanical damage.

We recommend gasolines containing detergent additives that help prevent fuel system and engine deposits.

Using gasoline containing lead will damage your car's emissions controls. This contributes to air pollution.

In Canada, some gasolines contain an octane-enhancing additive called MMT. If you use such gasolines, your emission control system performance may deteriorate and the Malfunction Indicator Lamp on your instrument panel may turn on. If this happens, contact your authorized Honda dealer for service.

Filling the Fuel Tank

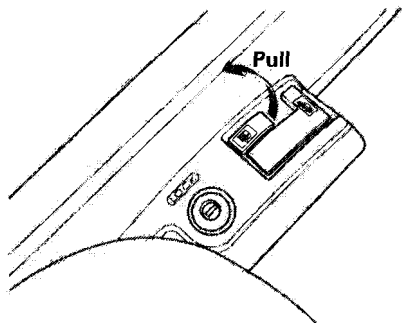

1. Because the fuel fill cap is on the driver's side of the car, park with that side closest to the service station pumps.
2. Open the fuel fill door by pulling on the handle to the left of the driver's seat.

Gasoline is highly flammable and explosive. You can be burned or seriously injured when handling fuel.

- Stop the engine and keep heat, sparks, and flame away. Handle fuel only outdoors.
- Wipe up spills immediately.

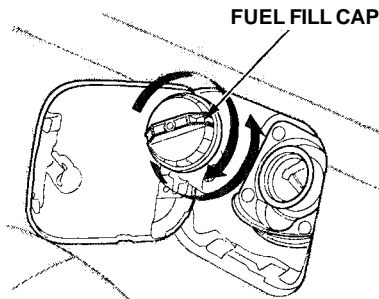

You may hear a hissing sound as pressure inside the tank escapes.

4. Stop filling the tank after the fuel pump automatically clicks off. Do not try to "top off" the tank, leave some room for the fuel to expand with temperature changes.

Your car has an on-board refueling vapor recovery system to help keep fuel vapors from going into the atmosphere. If the fuel pump keeps clicking off even though the tank is not full, there may be a problem with this system. Consult your dealer.

CONTINUED

5. Screw the fuel fill cap back on, tighten it until it clicks at least three times. If you do not properly tighten the cap, the Malfunction Indicator Lamp may come on (see page 251).
6. Push the fuel fill door closed until it latches.

Opening the Hood

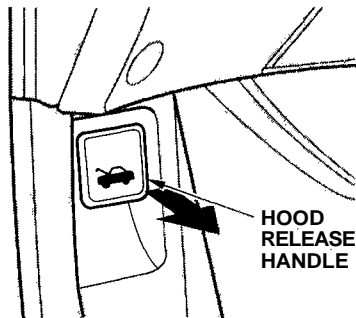

1. Shift to Park or Neutral and set the parking brake. Pull the hood release handle located under the lower left corner of the dashboard. The hood will pop up slightly.

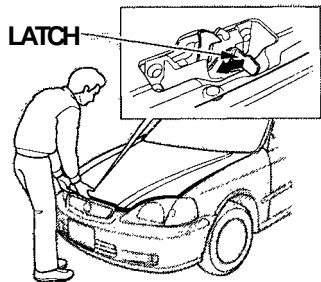

2. Standing in front of the car, put your fingers under the front edge of the hood to the right of center. Slide your hand to the left until you feel the hood latch handle. Push this handle up until it releases the hood. Lift the hood.

If you can open the hood without lifting the hood latch handle, or the hood latch handle moves stiffly or does not spring back as before, the mechanism should be cleaned and lubricated (see page 202).

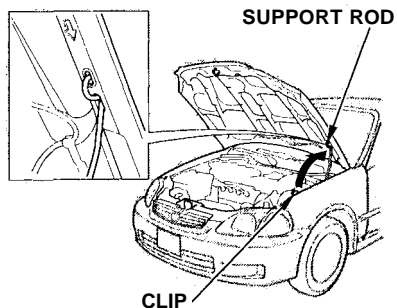

3. Pull the support rod out of its clip and insert the end into the hole on the left side of the hood.

To close the hood, lift it up slightly to remove the support rod from the hole. Put the support rod back into its holding clip. Lower the hood to about a foot (30 cm) above the fender, then let it drop.

After closing the hood, make sure it is securely latched.

CONTINUED

Service Station Procedures

Oil Check

DIPSTICK

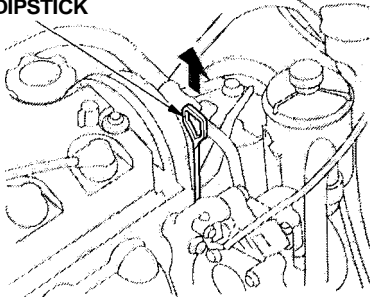

Check the engine oil level every time you fill the car with fuel. Wait a few minutes after turning the engine off before you check the oil.

1. Remove the dipstick (orange handle).

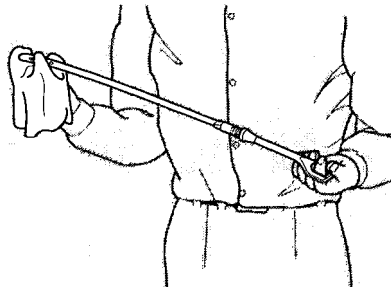

2. Wipe the dipstick with a clean cloth or paper towel.

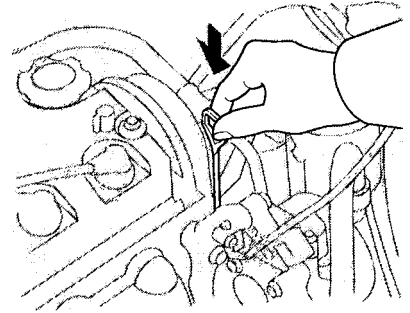

3. Insert it all the way back in its tube.



4. Remove the dipstick again and check the level. It should be between the upper and lower marks.

If it is near or below the lower mark, see **Adding Oil** on page [187](#).

Engine Coolant Check

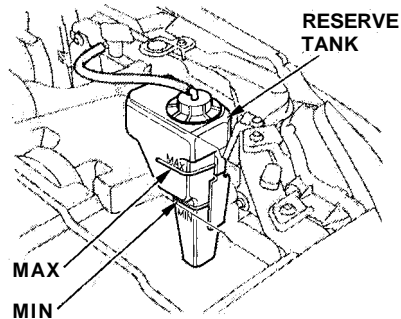

Look at the coolant level in the radiator reserve tank. Make sure it is between the MAX and MIN lines. If it is below the MIN line, see **Adding Engine Coolant** on page [191](#) for information on adding the proper coolant.

Refer to **Owner Maintenance Checks** on page [185](#) for information on checking other items in your Honda.

Fuel Economy

The condition of your car and your driving habits are the two most important things that affect the fuel mileage you get.

Vehicle Condition

Always maintain your car according to the maintenance schedule. This will keep it in top operating condition.

An important part of that maintenance is the **Owner Maintenance Checks** (see page 185). For example, an underinflated tire causes more "rolling resistance," which uses fuel. It also wears out faster, so check the tire pressure at least monthly.

In winter, the build-up of snow on your car's underside adds weight and rolling resistance. Frequent cleaning helps your fuel mileage and reduces the chance of corrosion.

Driving Habits

You can improve fuel economy by driving moderately. Rapid acceleration, abrupt cornering, and hard braking use more fuel.

Always drive in the highest gear that allows the engine to run and accelerate smoothly.

Depending on traffic conditions, try to maintain a constant speed. Every time you slow down and speed up, your car uses extra fuel. Use the cruise control, when appropriate, to increase fuel economy.

A cold engine uses more fuel than a warm engine. It is not necessary to "warm-up" a cold engine by letting it idle for a long time. You can drive away in about a minute, no matter how cold it is outside. The engine will warm up faster, and you get better fuel economy. To cut down on the number of "cold starts," try to combine several short trips into one.

The air conditioning puts an extra load on the engine which makes it use more fuel. Turn off the A/C to cut down on air conditioning use. Use the flow-through ventilation when the outside air temperature is moderate.

Modifying your car, or installing some non-Honda accessories, can make your car unsafe. Before you make any modifications or add any accessories, be sure to read the following information.

Accessories

Your dealer has Genuine Honda accessories that allow you to personalize your car. These accessories have been designed and approved for your car, and are covered by warranty.

Non-Honda accessories are usually designed for universal applications. Although aftermarket accessories may fit on your car, they may not meet factory specifications, and could adversely affect your car's handling and stability. (See "Modifications" on the page [150](#) for additional information.)

Improper accessories or modifications can affect your car's handling, stability and performance, and cause a crash in which you can be hurt or killed.

Follow all instructions in this owner's manual regarding accessories and modifications.

When properly installed, cellular phones, alarms, two-way radios, and low-powered audio systems should not interfere with your car's computer-controlled systems, such as the SRS and anti-lock brake system.

However, if electronic accessories are improperly installed, or exceed your car's electrical system capacity, they can interfere with the operation

of your car, or even cause the airbags to deploy.

Before installing any accessory:

- Make sure the accessory does not obscure any lights, or interfere with proper car operation or performance.
- Be sure electronic accessories do not overload electrical circuits (see page [254](#)).
- Have the installer contact your Honda dealer for assistance before installing any electronic accessory.

If possible, have your dealer inspect the final installation.

Accessories and Modifications

Modifications

Do not remove any original equipment or modify your car in any way that would alter its design or operation. This could make your car unsafe and illegal to drive.

For example, do not make any modifications that would change the ride height of your car, or install wheels and tires with a different overall diameter.

Such modifications can adversely affect handling, and interfere with the operation of the car's anti-lock brakes and other systems.

In addition, any modifications that decrease ground clearance increase the chance of undercarriage parts striking a curb, speed bump, or other raised object, which could cause your airbags to deploy.

Do not modify your steering wheel or any other part of your Supplemental Restraint System. Modifications could make the system ineffective.

Additional Safety Precaution

Do not attach or place objects on the airbag covers. Any object attached to or placed on the covers marked "SRS AIRBAG," in the center of the steering wheel and on top of the dashboard, could interfere with the proper operation of the airbags. Or, if the airbags inflate, the objects could be propelled inside the car and hurt someone.

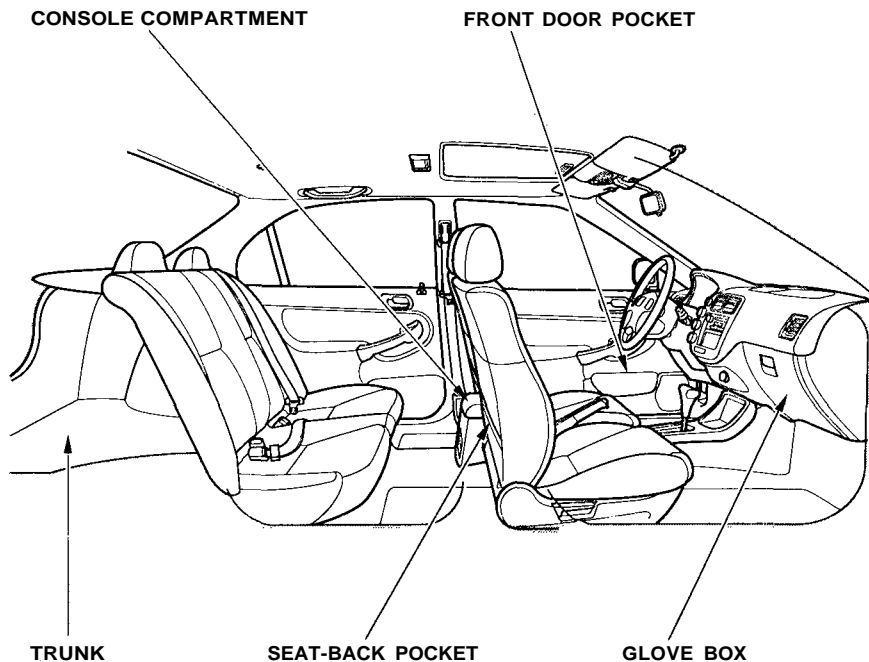

Your car has several convenient storage areas so you can stow cargo safely.

The glove box, and the pockets in the front doors and seat-backs, are designed for small, lightweight items. The trunk is intended for larger, heavier items. In addition, the back seat can be folded down to allow you to carry more cargo or longer items.

However, carrying too much cargo, or improperly storing it, can affect your car's handling, stability and operation and make it unsafe. Before carrying any type of cargo, be sure to read the following pages.

Carrying Cargo

Load Limit

The maximum load for your car is 8501bs(395kg).

This figure includes the total weight of all occupants, cargo, and accessories.

To figure out how much cargo you can carry:

- Add up the weight of all occupants.
- Subtract the total from 850 lbs (395kg).

The final number is the total weight of cargo you can carry.

Overloading or improper loading can affect handling and stability and cause a crash in which you can be hurt or killed.

Follow all load limits and other loading guidelines in this manual.

Carrying Items in the Passenger Compartment

- Store or secure all items that could be thrown around and hurt someone during a crash.
- Do not put any items on top of the rear shelf. They can block your view and be thrown around the car during a crash.
- Be sure items placed on the floor behind the front seats cannot roll under the seats and interfere with the driver's ability to operate the pedals, or with the proper operation of the seats.
- Keep the glove box closed while driving. If the lid is open, a passenger could injure their knees during a crash or sudden stop.

Carrying Cargo in the Trunk or on a Roof Rack

- Distribute cargo evenly on the floor of the trunk, placing the heaviest items on the bottom and as far forward as possible.
 - If you fold down the back seat, tie down items that could be thrown about the car during a crash or sudden stop.
 - If you carry large items that prevent you from closing the hatch, exhaust gas can enter the passenger area. To avoid the possibility of carbon monoxide poisoning, follow the instructions on page 49.
- If you can carry any items on a roof rack, be sure the total weight of the rack and the items does not exceed the maximum allowable weight. Please contact your Honda dealer for further information.

This section gives you tips on starting the engine under various conditions, and how to operate the 5-speed manual and automatic transmissions. It also includes important information on parking your car, and the braking system.

Preparing to Drive.....	156
Starting the Engine.....	157
Starting in Cold Weather at High Altitude.....	157
5-speed Manual Transmission.....	158
Recommended Shift Points.....	158
Engine Speed Limiter.....	159
Automatic Transmission.....	160
Shift Lever Position Indicator..	160
Shift Lever Positions.....	161
Engine Speed Limiter.....	163
Shift Lock Release.....	164
Parking.....	165
Parking Tips.....	165
The Braking System.....	166
Brake Wear Indicators.....	166
Brake System Design.....	167
Anti-lock Brakes.....	167
Important Safety Reminders.....	168
ABS Indicator.....	168
Driving in Bad Weather.....	170
Towing a Trailer.....	171

Preparing to Drive

You should do the following checks and adjustments every day before you drive your car.

1. Make sure all windows, mirrors, and outside lights are clean and unobstructed. Remove frost, snow, or ice.
2. Check that the hood and trunk are fully closed.
3. Visually check the tires. If a tire looks low, use a gauge to check its pressure.
4. Check that any items you may be carrying with you inside are stored properly or fastened down securely.
5. Check the adjustment of the seat (see page 76).
6. Check the adjustment of the inside and outside mirrors (see page 82).
7. Check the adjustment of the steering wheel (see page 65).
8. Make sure the doors are securely closed and locked.
9. Fasten your seat belt. Check that your passengers have fastened their seat belts (see page 15).
10. Turn the ignition switch ON (II). Check the indicator lights in the instrument panel.
11. Start the engine (see page 157).
12. Check the gauges and indicator lights in the instrument panel (see page 53).

1. Apply the parking brake.
2. In cold weather, turn off all electrical accessories to reduce the drain on the battery.
3. *Manual Transmission:*
Push the clutch pedal down all the way. START (III) does not function unless the clutch pedal is depressed.

Automatic Transmission:
Make sure the shift lever is in Park. Press on the brake pedal.
4. Without touching the accelerator pedal, turn the ignition key to the START (III) position. If the engine does not start right away, do not hold the key in START (III) for more than 15 seconds at a time. Pause for at least 10 seconds before trying again.

5. If the engine does not start within 15 seconds, or starts but stalls right away, repeat step 4 with the accelerator pedal pressed half-way down. If the engine starts, release pressure on the accelerator pedal so the engine does not race.
6. If the engine still does not start, press the accelerator pedal all the way down and hold it there while starting in order to clear flooding. As before, keep the ignition key in the START (III) position for no more than 15 seconds. Return to step 5 if the engine does not start. If it starts, lift your foot off the accelerator pedal so the engine does not race.

Starting in Cold Weather at High Altitude (Above 8,000 feet/ 2,400 meters)

An engine is harder to start in cold weather. The thinner air found at high altitude above 8,000 feet (2,400

meters) adds to the problem. Use the following procedure:

1. Turn off all electrical accessories to reduce the drain on the battery.
2. Push the accelerator pedal half-way to the floor and hold it there while starting the engine. Do not hold the ignition key in START (III) for more than 15 seconds. When the engine starts, release the accelerator pedal gradually as the engine speeds up and smooths out.
3. If the engine fails to start in step 2, push the accelerator pedal to the floor and hold it there while you try to start the engine for no more than 15 seconds. If the engine does not start, return to step 2.

5-speed Manual Transmission

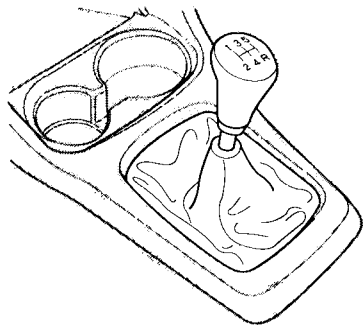

The manual transmission is synchronized in all forward gears for smooth operation. It has a lockout so you cannot shift directly from Fifth to Reverse. When shifting up or down, make sure you push the clutch pedal down all the way, shift to the next gear, and let the pedal up gradually. When you are not shifting, do not rest your foot on the clutch pedal. This can cause your clutch to wear out faster.

Come to a full stop before you shift into Reverse. You can damage the transmission by trying to shift into Reverse with the car moving. Push down the clutch pedal, and pause for a few seconds before shifting into Reverse, or shift into one of the forward gears for a moment. This stops the gears so they won't "grind."

When slowing down, you can get extra braking from the engine by shifting to a lower gear. This extra braking can help you maintain a safe speed and prevent your brakes from overheating while going down a steep hill. Before downshifting, make sure engine speed will not go into the tachometer's red zone in the lower gear.

Rapid slowing or speeding-up can cause loss of control on slippery surfaces. If you crash, you can be injured.

Use extra care when driving on slippery surfaces.

Recommended Shift Points

Drive in the highest gear that lets the engine run and accelerate smoothly. This will give you the best fuel economy and effective emissions control. The following shift points are recommended:

Shift up	Normal acceleration
1st to 2nd	15 mph (24 km/h)
2nd to 3rd	27 mph (43 km/h)
3rd to 4th	39 mph (63 km/h)
4th to 5th	53 mph (85 km/h)

Shift up	Cruise from acceleration
1st to 2nd	9 mph (14 km/h)
2nd to 3rd	20 mph (32 km/h)
3rd to 4th	33 mph (53 km/h)
4th to 5th	48 mph (77 km/h)

Engine Speed Limiter

If you exceed the maximum speed for the gear you are in, the engine speed will enter into the tachometer's red zone. If this occurs, you may feel the engine cut in and out. This is caused by a limiter in the engine's computer controls. The engine will run normally when you reduce the RPM below the red zone.

Before downshifting, make sure the engine will not go into the tachometer's red zone in the lower gear.

Automatic Transmission

Your Honda's transmission has four forward speeds, and is electronically controlled for smoother shifting. It also has a "lock-up" torque converter for better fuel economy. You may feel what seems like another shift when the converter locks.

Shift Lever Position Indicator

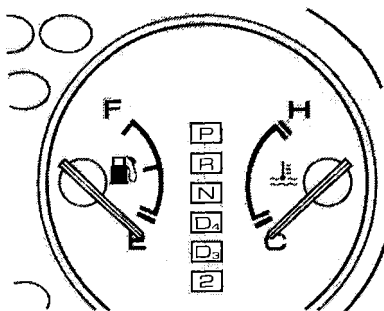

This indicator on the instrument panel shows which position the shift lever is in.

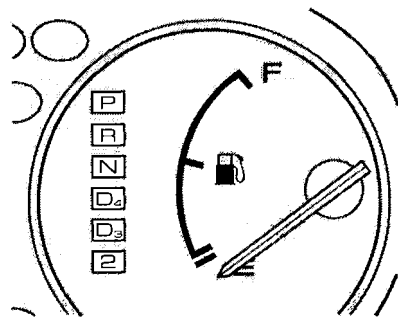

The "D4" indicator comes on for a few seconds when you turn the ignition switch ON (II). If it flashes while driving (in any shift position), it indicates a possible problem in the transmission. Avoid rapid acceleration and have the transmission checked by an authorized Honda dealer as soon as possible.

Shift Lever Positions

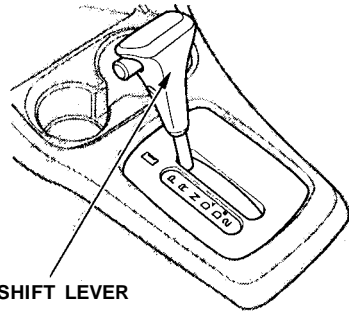

To shift from:	Do this:
P to R	Press the brake pedal and press the release button.
R to P N to R D3 to 2	Press the release button.
2 to D3 D3 to D4 D4 to N D4 to D3 N to D4 R to N	Move the lever.

The shift lever has six positions. It must be in Park or Neutral to start the engine. When you are stopped in D4, D3, 2, N or R, press firmly on the brake pedal, and keep your foot off the accelerator pedal.

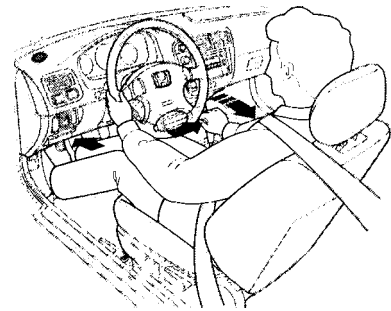

Park (P) — This position mechanically locks the transmission. Use Park whenever you are turning off or starting the engine. To shift out of Park, you must press on the brake pedal and have your foot off the accelerator pedal. Press the release button on the side of the shift lever to move it.

CONTINUED

Automatic Transmission

If you have done all of the above and still cannot move the lever out of Park, see Shift Lock Release on page 164.

You must also press the release button to shift into Park. To avoid transmission damage, come to a complete stop before shifting into Park. The shift lever must be in Park before you can remove the key from the ignition switch.

Reverse (R) — To shift to Reverse from Park, see the explanation under Park. To shift to Reverse from Neutral, come to a complete stop and then shift. Press the release button before shifting into Reverse from Neutral.

Neutral (N) — Use Neutral if you need to restart a stalled engine, or if it is necessary to stop briefly with the engine idling. Shift to Park position if you need to leave the car for any reason. Press on the brake pedal when you are moving the shift lever from Neutral to another gear.

Drive (D4) — Use this position for your normal driving. The transmission automatically selects a suitable gear for your speed and acceleration. You may notice the transmission shifting up at higher speeds when the engine is cold. This helps the engine warm up faster.

Drive (D3) — This position is similar to D4, except only the first three gears are selected. Use D3 to provide engine braking when going down a steep hill. D3 can also keep the transmission from cycling between third and fourth gears in stop-and-go driving.

For faster acceleration when in D3 or D4, you can get the transmission to automatically downshift by pushing the accelerator pedal to the floor. The transmission will shift down one or two gears, depending on your speed.

Second (2) — To shift to Second, press the release button on the side of the shift lever. This position locks the transmission in second gear. It does not downshift to first gear when you come to a stop. Second gives you more power when climbing, and increased engine braking when going down steep hills. Use second gear when starting out on a slippery surface or in deep snow. It will help reduce wheelspin.

Engine Speed Limiter

If you exceed the maximum speed for the gear you are in, the engine speed will enter into the tachometer's red zone. If this occurs, you may feel the engine cut in and out. This is caused by a limiter in the engine's computer controls. The engine will run normally when you reduce the RPM below the red zone.

Automatic Transmission

Shift Lock Release

This allows you to move the shift lever out of Park if the normal method of pushing on the brake pedal and pressing the release button does not work.

1. Set the Parking brake.
2. Remove the key from the ignition switch.
3. Put a cloth on the edge of the shift lock release slot cover next to the shift lever.

Use a small flat-tipped screwdriver or small metal plate (neither are included in the tool kit) to remove the cover. Carefully pry off the edge of the cover.

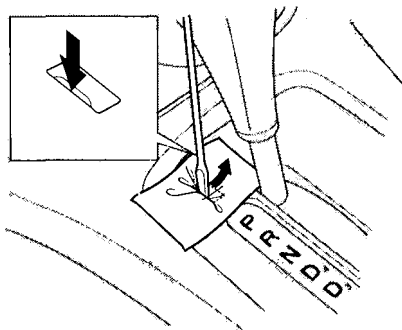

4. Insert the key in the Shift Lock Release slot.
5. Push down on the key while you press the release button on the shift lever and move the shift lever out of Park to Neutral.

RELEASE BUTTON

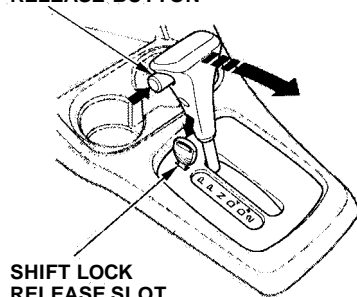

SHIFT LOCK
RELEASE SLOT

6. Remove the key from the shift lock release slot, then reinstall the cover.
Depress the brake pedal and restart the engine.

If you need to use the Shift Lock Release, it means your car is developing a problem. Have the car checked by your Honda dealer.

Always use the parking brake when you park your car. The indicator on the instrument panel shows that the parking brake is not fully released; it does not indicate that the parking brake is firmly set. Make sure the parking brake is set firmly or your car may roll if it is parked on an incline.

If your car has an automatic transmission, set the parking brake before you put the transmission in Park. This keeps the car from moving and putting pressure on the parking mechanism in the transmission — making it easier to move the shift lever out of Park when you want to drive away.

If the car is facing uphill, turn the front wheels away from the curb. If you have a manual transmission, put it in first gear.

If the car is facing downhill, turn the front wheels toward the curb. If you have a manual transmission, put it in reverse gear.

Make sure the parking brake is fully released before driving away. Driving with the parking brake partially set can overheat or damage the rear brakes.

Parking Tips

- Make sure the moonroof and the windows are closed.
- Turn off the lights.
- Place any packages, valuables, etc., in the trunk or take them with you.
- Lock the doors with the key or the remote transmitter.
- Never park over dry leaves, tall grass, or other flammable materials. The three way catalytic converter gets very hot, and could cause these materials to catch on fire.

The Braking System

All Civics are equipped with front disc brakes. The brakes on the rear wheels are drum. A power assist helps reduce the effort needed on the brake pedal.

Put your foot on the brake pedal only when you intend to brake. Resting your foot on the pedal keeps the brakes applied lightly, causing them to build up heat. Heat build-up can reduce how well your brakes work. It also keeps your brake lights on all the time, confusing drivers behind you.

Constant application of the brakes when going down a long hill builds up heat and reduces their effectiveness. Use the engine to assist the brakes by downshifting to a lower gear and taking your foot off the accelerator pedal.

Check your brakes after driving through deep water. Apply the brakes moderately to see if they feel normal. If not, apply them gently and frequently until they do. Since a longer distance is needed to stop with wet brakes, be extra cautious and alert in your driving.

Brake Wear Indicators

The front disc brakes on all models have audible brake wear indicators. When the brake pads need replacing, you will hear a distinctive metallic "screeching" sound when you apply the brakes. If you do not have the brake pads replaced, they will begin screeching all the time.

Your brakes may sometimes squeal or squeak when you apply them lightly. Do not confuse this with the brake wear indicators. They make a very audible "screeching."

Brake System Design

The hydraulic system that operates the brakes has two separate circuits. Each circuit works diagonally across the vehicle (the left-front brake is connected with the right-rear brake, etc.). If one circuit should develop a problem, you will still have braking at two wheels.

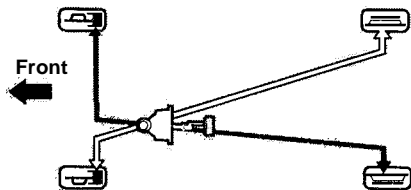

Anti-lock Brakes

The U.S. EX model has an Anti-lock Brake System (ABS) as standard equipment. It is optional on all Canadian models.

ABS helps to prevent the wheels from locking up and skidding during hard braking, allowing you to retain steering control.

When the front tires skid, you lose steering control; the car continues straight ahead even though you turn the steering wheel. The ABS helps to prevent lock-up and helps you retain steering control by pumping the brakes rapidly; much faster than a person can do it.

You should never pump the brake pedal, this defeats the purpose of the ABS. Let the ABS work for you by always keeping firm, steady pressure on the brake pedal as you steer away from the hazard. This is sometimes referred to as *"stomp and steer."*

You will feel a pulsation in the brake pedal when the ABS activates, and you may hear some noise. This is normal, it is the ABS rapidly pumping the brakes.

Activation varies with the amount of traction your tires have. On dry pavement, you will need to press on the brake pedal very hard before you activate the ABS. However, you may feel the ABS activate immediately if you are trying to stop on snow or ice.

CONTINUED

The Braking System

Important Safety Reminders

ABS does not reduce the time or distance it takes to stop the car, it only helps with steering control during braking. You should always maintain a safe following distance from other vehicles.

ABS will not prevent a skid that results from changing direction abruptly, such as trying to take a corner too fast or making a sudden lane change. Always drive at a safe, prudent speed for the road and weather conditions.

ABS cannot prevent a loss of stability. Always steer moderately when you are braking hard. Severe or sharp steering wheel movement can still cause your car to veer into oncoming traffic or off the road.

A vehicle with ABS may require a longer distance to stop on loose or uneven surfaces, such as gravel or snow, than a vehicle without anti-lock. Slow down and allow a greater distance between vehicles under those conditions.

ABS Indicator

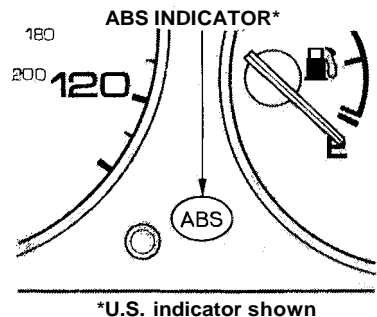

The ABS is self-checking. It also checks itself whenever you use the brakes.

If anything goes wrong, the ABS indicator on the instrument panel comes on (see page 55). This means the anti-lock function of the braking system has shut down. The brakes still work like a conventional system without anti-lock, providing normal stopping ability. You should have the dealer inspect your car as soon as possible if this light stays on after you start the engine, or comes on while driving.

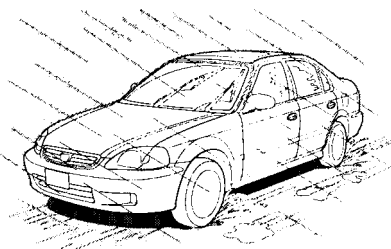

Rain, fog, and snow conditions require a different driving technique because of reduced traction and visibility. Keep your car well-maintained and exercise greater caution when you need to drive in bad weather. The cruise control should not be used in these conditions.

Driving Technique — Always drive slower than you would in dry weather. It takes your car longer to react, even in conditions that may seem just barely damp. Apply smooth, even pressure to all the controls. Abrupt steering wheel movements or sudden, hard application of the brakes can cause loss of control in wet weather. Be extra cautious for the first few miles (kilometers) of driving while you adjust to the change in driving conditions. This is especially true in snow. A person can forget some snow-driving techniques during the summer months. Practice is needed to relearn those skills.

Exercise extra caution when driving in rain after a long dry spell. After months of dry weather, the first rains bring oil to the surface of the roadway, making it slippery.

Visibility — Being able to see clearly in all directions and being visible to other drivers are important in all weather conditions. This is more difficult in bad weather. To be seen more clearly during daylight hours, turn on your headlights.

Inspect your windshield wipers and washers frequently. Keep the windshield washer reservoir full of the proper fluid. Have the windshield wiper blades replaced if they start to streak the windshield or leave parts unwiped. Use the defrosters and air conditioning to keep the windows from fogging up on the inside (see page [95](#)).

Traction — Check your tires frequently for wear and proper pressure. Both are important in preventing "hydroplaning" (loss of traction on a wet surface). In the winter, mount snow tires on all four wheels for the best handling.

Watch road conditions carefully, they can change from moment to moment. Wet leaves can be as slippery as ice. "Clear" roads can have patches of ice. Driving conditions can be very hazardous when the outside temperature is near freezing. The road surface can become covered with areas of water puddles mixed with areas of ice, so your traction can change without warning.

Be careful when downshifting. If traction is low, you can lock up the drive wheels for a moment and cause a skid.

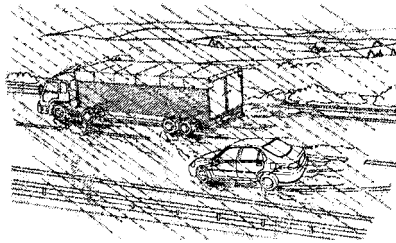

Be very cautious when passing, or being passed by other vehicles. The spray from large vehicles reduces your visibility, and the wind buffeting can cause you to lose control.

Towing a Trailer

Your vehicle is not designed to tow a trailer. Attempting to do so can void your warranties.

This section explains why it is important to keep your car well maintained and to follow basic maintenance safety precautions.

This section also includes Maintenance Schedules for normal driving and severe driving conditions, a Maintenance Record, and instructions for simple maintenance tasks you may want to take care of yourself.

If you have the skills and tools to perform more complex maintenance tasks on your Honda, you may want to purchase the Service Manual. See page 281 for information on how to obtain a copy, or see your Honda dealer.

Maintenance Safety.....	174	Hood Latch.....	202
Important Safety Precautions..	175	Spark Plugs.....	203
Maintenance Schedule.....	176	Replacement.....	203
Maintenance Record.....	183	Specifications.....	204
Owner Maintenance Checks.....	185	Battery.....	205
Fluid Locations.....	186	Wiper Blades.....	207
Engine Oil.....	187	Air Conditioning System.....	209
Adding Oil.....	187	Drive Belts.....	210
Recommended Oil.....	187	Timing Belt.....	210
Synthetic Oil.....	188	Tires.....	211
Additives.....	188	Inflation.....	211
Changing the Oil and Filter.....	189	Recommended Tire Pressures	
Cooling System.....	191	for Normal Driving.....	212
Adding Engine Coolant.....	191	Inspection.....	213
Replacing Engine Coolant.....	193	Maintenance.....	213
Windshield Washers.....	196	Tire Rotation.....	214
Transmission Fluid.....	197	Replacing Tires and Wheels ...	215
Automatic		Wheels and Tires.....	216
Transmission.....	197	Winter Driving.....	216
5-speed Manual		Snow Tires.....	216
Transmission.....	198	Tire Chains.....	217
Brake and Clutch Fluid.....	198	Lights.....	218
Brake System.....	199	Replacing Bulbs.....	220
Clutch System.....	199	Storing Your Car.....	229
Power Steering.....	200		
Air Cleaner Element.....	201		

Maintenance Safety

Regularly maintaining your car is the best way to protect your investment. Proper maintenance is essential to your safety and the safety of your passengers. It will also reward you with more economical, trouble-free driving and help reduce air pollution.

Improperly maintaining this car or failing to correct a problem before driving can cause a crash in which you can be seriously hurt or killed.

Always follow the inspection and maintenance recommendations and schedules in this owner's manual.

This section includes instructions for simple maintenance tasks, such as checking and adding oil. Any service items not detailed in this section should be performed by a Honda technician or other qualified mechanic.

Some of the most important safety precautions are given here. However, we cannot warn you of every conceivable hazard that can arise in performing maintenance. Only you can decide whether or not you should perform a given task.

Failure to properly follow maintenance instructions and precautions can cause you to be seriously hurt or killed.

Always follow the procedures and precautions in this owner's manual.

Important Safety Precautions

Before you begin any maintenance, make sure your car is parked on level ground and that the parking brake is set. Also, be sure the engine is off. This will help to eliminate several potential hazards:

- **Carbon monoxide poisoning from engine exhaust.** Be sure there is adequate ventilation whenever you operate the engine.
- **Burns from hot parts.** Let the engine and exhaust system cool before touching any parts.
- **Injury from moving parts.** Do not run the engine unless instructed to do so.

Read the instructions before you begin, and make sure you have the tools and skills required.

To reduce the possibility of fire or explosion, be careful when working around gasoline or batteries. Use a commercially available degreaser or parts cleaner, not gasoline, to clean parts. Keep cigarettes, sparks, and flames away from the battery and all fuel-related parts.

You should wear eye protection and protective clothing when working near the battery or when using compressed air.

Maintenance Schedule

The Maintenance Schedule specifies how often you should have your car serviced and what things need attention. It is essential that you have your car serviced as scheduled to retain its high level of safety, dependability, and emissions control performance.

The services and time or distance intervals shown in the maintenance schedule assume you will use your car as normal transportation for passengers and their possessions. You should also follow these recommendations:

- Avoid exceeding your car's load limit. This puts excess stress on the engine, brakes, and many other parts of your car. The load limit is shown on the label on the driver's doorjamb.
- Operate your car on reasonable roads within the legal speed limit.
- Drive your car regularly over a distance of several miles (kilometers).
- Always use unleaded gasoline with the proper octane rating (see page [142](#)).

Which Schedule to Follow:

Service your car according to the time and mileage periods on one of the Maintenance Schedules on the following pages. Select the schedule for "Severe Conditions" if most of your driving is done under one or more of the conditions listed on that page. Otherwise, follow the schedule for "Normal Conditions."

Your authorized Honda dealer knows your car best and can provide competent, efficient service. However, service at a dealer is not mandatory to keep your warranties in effect. Maintenance may be done by any qualified service facility or person who is skilled in this type of automotive service. Keep all the receipts as proof of completion, and have the person who does the work fill out the Maintenance Record. Check your warranty booklet for more information.

We recommend the use of Genuine Honda parts and fluids whenever you have maintenance done. These are manufactured to the same high-quality standards as the original components, so you can be confident of their performance and durability.

U.S. Vehicles:

Maintenance, replacement or repair of emissions control devices and systems may be done by any automotive repair establishment or individual using parts that are "certified" to EPA standards.

According to state and federal regulations, failure to perform maintenance on the items marked with # will not void your emissions warranties. However, Honda recommends that all maintenance services be performed at the recommended time or mileage period to ensure long-term reliability.

Maintenance Schedule (Normal Conditions)

Service at the indicated distance or time – whichever comes first.	miles x 1,000	15	30	45	60	75	90	105	120
	km x 1,000	24	48	72	96	120	144	168	192
	months	12	24	36	48	60	72	84	96
Replace engine oil	Replace every 7,500 miles (12,000 km) or 12 months								
Replace engine oil filter	•	•	•	•	•	•	•	•	•
Check engine oil and coolant	Check oil and coolant at each fuel stop								
Replace air cleaner element		•		•		•		•	
Inspect valve clearance	At 30,000 miles (48,000 km) only								
Replace spark plugs		•		•		•		•	
Replace timing belt and inspect water pump								•	
Inspect and adjust drive belts		•		•		•		•	
Inspect idle speed								•	
Replace engine coolant				•		•		•	
Replace transmission fluid							•		
Inspect front and rear brakes	•	•	•	•	•	•	•	•	•
Replace brake fluid			•			•		•	
Check parking brake adjustment	•	•	•	•	•	•	•	•	•
Rotate tires (Check tire inflation and condition at least once per month)	Rotate tires every 7,500 miles (12,000 km)								
Visually inspect the following items:									
Tie rod ends, steering gear box, and boots									
Suspension components									
Driveshaft boots									
Brake hoses and lines (including ABS)	•	•	•	•	•	•	•	•	•
All fluid levels and condition of fluids									
Cooling system hoses and connections									
* Exhaust system									
* Fuel lines and connections									

U.S. Owners

Follow the Normal Conditions Maintenance Schedule if the severe driving conditions specified in the Severe Conditions Maintenance Schedule do not apply.

NOTE: If you only *OCCASIONALLY* drive under a "severe" condition, you should follow the Normal Conditions Maintenance Schedule.

Canadian Owners

Follow the Maintenance Schedule for Severe Conditions.

Maintenance Schedule for Normal Conditions (listed by distance/time)

Service at the indicated distance or time, whichever comes first. Do the items in **A, B, C** as required for each distance/time interval. Follow this schedule if the severe driving conditions described in the Severe Conditions Schedule on the next page do not apply.

Canadian owners: Follow the schedule for Severe Conditions.

7,500 mi/12,000 km	Do items in A.
15,000 mi/24,000 km/1 yr	Do items in A, B.
22,500 mi/36,000 km	Do items in A.
30,000 mi/48,000 km/2 yrs	<input type="checkbox"/> Check valve clearance, cold engine. Do items in A, B, C.
37,500 mi/60,000 km	Do items in A.
45,000 mi/72,000 km/3 yrs	<input type="checkbox"/> Replace coolant. <input type="checkbox"/> Replace brake fluid (including ABS). Do items in A, B.
52,500 mi/84,000 km	Do items in A.
60,000 mi/96,000 km/4 yrs	Do items in A, B, C.
67,500 mi/108,000 km	Do items in A.
75,000 mi/120,000 km/5 yrs	<input type="checkbox"/> Replace coolant. Do items in A, B.
82,500 mi/132,000 km	Do items in A.
90,000 mi/144,000 km/6 yrs	<input type="checkbox"/> Replace brake fluid (including ABS). <input type="checkbox"/> Replace transmission fluid. Do items in A, B, C.
97,500 mi/156,000 km	Do items in A.
105,000 mi/168,000 km/7 yrs	<input type="checkbox"/> Replace timing belt, inspect water pump.* <input type="checkbox"/> Replace coolant. <input type="checkbox"/> Check idle speed. Do items in A, B.
112,500 mi/181,000 km	Do items in A.
120,000 mi/193,000 km/8 yrs	Do items in A, B, C.

A	<input type="checkbox"/> Replace engine oil. <input type="checkbox"/> Rotate tires (follow pattern on page 214).
B	<input type="checkbox"/> Replace engine oil filter. <input type="checkbox"/> Inspect front and rear brakes. <input type="checkbox"/> Check parking brake adjustment. <input type="checkbox"/> Inspect tie rod ends, steering gearbox and boots. <input type="checkbox"/> Inspect suspension components. <input type="checkbox"/> Inspect driveshaft boots. <input type="checkbox"/> Inspect brake hoses and lines (including ABS). <input type="checkbox"/> Check all fluid levels, condition of fluids, and check for leaks. <input type="checkbox"/> Inspect cooling system hoses and connections. <input type="checkbox"/> Inspect exhaust system. <input type="checkbox"/> Inspect fuel lines and connections.
C	<input type="checkbox"/> Replace air cleaner element. <input type="checkbox"/> Replace spark plugs. <input type="checkbox"/> Inspect and adjust drive belts.

: See information on maintenance and emissions warranty, last column, [page 177](#).

* : See Timing Belt on [page 210](#) to determine need for replacement.

Maintenance Schedule (Severe Conditions)

Service at the indicated distance or time - whichever comes first.	miles x 1,000	15	30	45	60	75	90	105	120
	km x 1,000	24	48	72	96	120	144	168	192
	months	12	24	36	48	60	72	84	96
Replace engine oil and oil filter	Replace every 3,750 miles (6,000 km) or 6 months								
Check engine oil and coolant	Check oil and coolant at each fuel stop								
Replace air cleaner element	•	•	•	•	•	•	•	•	•
Use normal schedule except in dusty conditions									
Inspect valve clearance	At 30,000 miles (48,000 km) only								
Replace spark plugs		•		•		•		•	•
Replace timing belt* and inspect water pump								•	
Inspect and adjust drive belts		•		•		•		•	•
Inspect idle speed								•	
Replace engine coolant			•		•		•	•	
Replace transmission fluid		•		•		•		•	•
Inspect front and rear brakes	Inspect every 7,500 miles (12,000 km) or 6 months								
Replace brake fluid			•				•		
Check parking brake adjustment	•	•	•	•	•	•	•	•	•
Lubricate all hinges, locks and latches	•	•	•	•	•	•	•	•	•
Rotate tires (Check tire inflation and condition at least once per month)	Rotate tires every 7,500 miles (12,000 km)								
Visually inspect the following items:									
Tie rod ends, steering gear box, and boots	Every 7,500 miles (12,000 km) or 6 months								
Suspension components									
Driveshaft boots									
Brake hoses and lines (including ABS)									
All fluid levels and condition of fluids									
Cooling system hoses and connections	•	•	•	•	•	•	•	•	•
*Exhaust system/Fuel lines and connections									
Lights and controls/Vehicle underbody									

*: Refer to page 210 for replacement information under special driving conditions.

U.S. Owners

Follow the Severe Conditions Maintenance Schedule if you drive your vehicle **MAINLY** under one or more of the following conditions:

- Driving less than 5 miles (8 km) per trip or, in freezing temperatures, driving less than 10 miles (16 km) per trip.
- Driving in hot [over 90°F (32° C)] conditions.
- Extensive idling or long periods of stop-and-go driving.
- Driving with a roof-top carrier, or driving in mountainous conditions.
- Driving on muddy, dusty, or de-iced roads.

Canadian Owners

Follow the Maintenance Schedule for Severe Conditions.

Maintenance Schedule for Severe Conditions (listed by distance/time)

Use this schedule if your vehicle is MAINLY driven in any of the following Severe Conditions, or normally driven in Canada; otherwise use the Normal Schedule. Service at the indicated distance or time, whichever comes first. Do the items in **A, B, C** as required for each distance/time.

3,750 mi/6,000 km/6 mos	<input type="checkbox"/> Replace engine oil and filter.
7,500 mi/12,000 km/-	Do items in A.
11,250 mi/18,000 km/-	<input type="checkbox"/> Replace engine oil and filter.
15,000 mi/24,000 km/1 yr	Do items in A, B.
18,750 mi/30,000 km/-	<input type="checkbox"/> Replace engine oil and filter.
22,500 mi/36,000 km/1½ yrs	Do items in A.
26,250 mi/42,000 km/-	<input type="checkbox"/> Replace engine oil and filter.
30,000 mi/48,000 km/2 yrs	<input type="checkbox"/> Check valve clearance, cold engine. Do items in A, B, C.
33,750 mi/54,000 km/-	<input type="checkbox"/> Replace engine oil and filter.
37,500 mi/60,000 km/2½ yrs	Do items in A.
41,250 mi/66,000 km/-	<input type="checkbox"/> Replace engine oil and filter.
45,000 mi/72,000 km/3 yrs	<input type="checkbox"/> Replace coolant. <input type="checkbox"/> Replace brake fluid. Do items in A, B.
48,750 mi/78,000 km/-	<input type="checkbox"/> Replace engine oil and filter.
52,500 mi/84,000 km/3½ yrs	Do items in A.
56,250 mi/90,000 km/-	<input type="checkbox"/> Replace engine oil and filter.
60,000 mi/96,000 km/4 yrs	Do items in A, B, C. <input type="checkbox"/> Replace timing belt ^{†‡} and inspect the water pump.
63,750 mi/102,000 km/-	<input type="checkbox"/> Replace engine oil and filter.
67,500 mi/108,000 km/4½ yrs	Do items in A.
71,250 mi/114,000 km/-	<input type="checkbox"/> Replace engine oil and filter.
75,000 mi/120,000 km/5 yrs	<input type="checkbox"/> Replace coolant. Do items in A, B.
78,750 mi/126,000 km/-	<input type="checkbox"/> Replace engine oil and filter.

Severe Conditions:

- Driving less than 5 mi (8 km) per trip, in freezing temperatures, less than 10 mi (16 km) per trip.
- Driving in extremely hot weather (over 90°F/32°C).
- Extensive idling or long periods of stop-and-go driving.
- Driving with a roof-top carrier, or driving in mountains.
- Driving on muddy, dusty, or de-iced roads.

- A**
- Replace engine oil and filter.
 - Inspect front and rear brakes.
 - Rotate tires (follow pattern on page 214).
 - Inspect tie rod ends, steering gearbox and boots.
 - Inspect suspension components.
 - Inspect driveshaft boots.
- B**
- Replace air cleaner element.
 - Check parking brake adjustment.
 - Lubricate all hinges, locks and latches.

CONTINUED

Maintenance Schedule for Severe Conditions (listed by distance/time)

82,500 mi/132,000 km/5½ yrs	Do items in A.
86,250 mi/138,000 km/-	<input type="checkbox"/> Replace engine oil and filter.
90,000 mi/144,000 km/6 yrs	<input type="checkbox"/> Replace brake fluid. Do items in A, B, C.
93,750 mi/150,000 km/-	<input type="checkbox"/> Replace engine oil and filter.
97,500 mi/156,000 km/6½ yrs	Do items in A.
101,250 mi/162,000 km/-	<input type="checkbox"/> Replace engine oil and filter.
105,000 mi/168,000 km/7 yrs	<input type="checkbox"/> Replace timing belt, inspect water pump.* <input type="checkbox"/> Replace coolant. <input type="checkbox"/> Check idle speed. Do items in A, B.
108,750 mi/175,000 km/-	<input type="checkbox"/> Replace engine oil and filter.
112,500 mi/181,000 km/7½ yrs	Do items in A.
116,250 mi/187,000 km/-	<input type="checkbox"/> Replace engine oil and filter.
120,000 mi/193,000 km/8 yrs	Do items in A, B, C. <input type="checkbox"/> Replace timing belt* and inspect the water pump.

<input type="checkbox"/> Inspect brake hoses and lines.
<input type="checkbox"/> Check all fluid levels, condition of fluids, and check for leaks.
<input type="checkbox"/> Inspect cooling system hoses and connections.
<input type="checkbox"/> * Inspect exhaust system.
<input type="checkbox"/> * Inspect fuel lines and connections.
<input type="checkbox"/> Check all lights.
<input type="checkbox"/> Inspect the underbody.
C <input type="checkbox"/> Replace spark plugs.
<input type="checkbox"/> Inspect and adjust drive belts.
<input type="checkbox"/> Replace transmission fluid.

: See information on maintenance and emissions warranty, last column, page 177.

* : See Timing Belt on page 210 to determine need for replacement.

Required Maintenance Record (for Normal and Severe Schedules)

You or the servicing dealer can record all completed maintenance here, whether you follow the schedule for normal conditions (page 178) or severe conditions (page 180). Keep the receipts for all work done on your vehicle.

3,750 mi 6,000 km (or 6 mo)	Signature or dealer stamp	mi/km
		Date
7,500 mi 12,000 km		mi/km
		Date
11,250 mi 18,000 km		mi/km
		Date
15,000 mi 24,000 km (or 1 year)		mi/km
		Date
18,750 mi 30,000 km		mi/km
		Date
22,500 mi 36,000 km (or 1½ years)		mi/km
		Date
26,250 mi 42,000 km		mi/km
		Date
30,000 mi 48,000 km (or 2 years)		mi/km
		Date

33,750 mi 54,000 km	Signature or dealer stamp	mi/km
		Date
37,500 mi 60,000 km (or 2½ years)		mi/km
		Date
41,250 mi 66,000 km		mi/km
		Date
45,000 mi 72,000 km (or 3 years)		mi/km
		Date
48,750 mi 78,000 km		mi/km
		Date
52,500 mi 84,000 km (or 3½ years)		mi/km
		Date
56,250 mi 90,000 km		mi/km
		Date
60,000 mi 96,000 km (or 4 years)		mi/km
		Date

CONTINUED

Required Maintenance Record (for Normal and Severe Schedules)

63,750 mi 102,000 km	Signature or dealer stamp	mi/km
		Date
67,500 mi 108,000 km (or 4½ years)		mi/km
		Date
71,250 mi 114,000 km		mi/km
		Date
75,000 mi 120,000 km (or 5 years)		mi/km
		Date
78,750 mi 126,000 km		mi/km
		Date
82,500 mi 132,000 km (or 5½ years)		mi/km
		Date
86,250 mi 138,000 km		mi/km
		Date
90,000 mi 144,000 km (or 6 years)		mi/km
		Date

93,750 mi 150,000 km	Signature or dealer stamp	mi/km
		Date
97,500 mi 156,000 km (or 6½ years)		mi/km
		Date
101,250 mi 162,000 km		mi/km
		Date
105,000 mi 168,000 km (or 7 years)		mi/km
		Date
108,750 mi 174,000 km		mi/km
		Date
112,500 mi 180,000 km (or 7½ years)		mi/km
		Date
116,250 mi 186,000 km		mi/km
		Date
120,000 mi 192,000 km (or 8 years)		mi/km
		Date

You should check the following items at the specified intervals. If you are unsure of how to perform any check, turn to the page given.

- Engine oil level — Check every time you fill the fuel tank. See page [146](#).
- Engine coolant level — Check the radiator reserve tank every time you fill the fuel tank. See page [147](#).
- Windshield washer fluid — Check the level in the reservoir monthly. If weather conditions cause you to use the washers frequently, check the reservoir each time you stop for fuel. See page [196](#).
- Automatic transmission — Check the fluid level monthly. See page [197](#).
- Brakes — Check the fluid level monthly. See page [198](#).
- Tires — Check the tire pressure monthly. Examine the tread for wear and foreign objects. See page [211](#).
- Lights — Check the operation of the headlights, parking lights, taillights, high-mount brake light, turn signals, brake lights, and license plate lights monthly. See page [218](#).

Fluid Locations

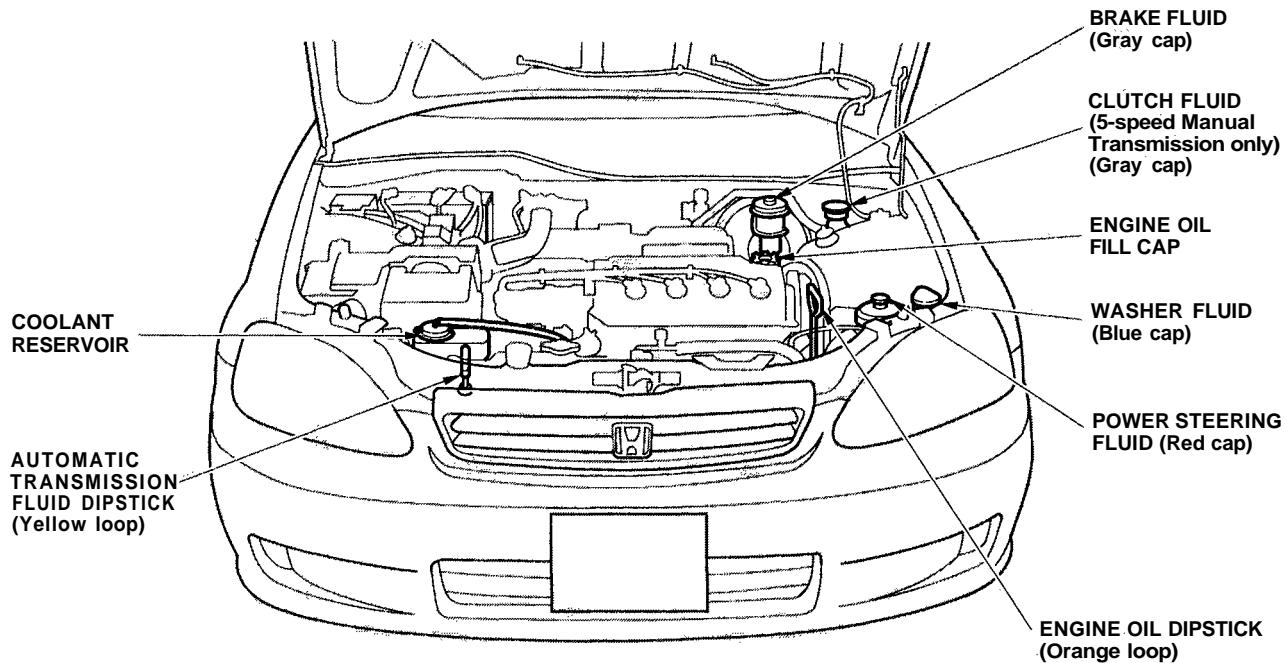

Adding Oil

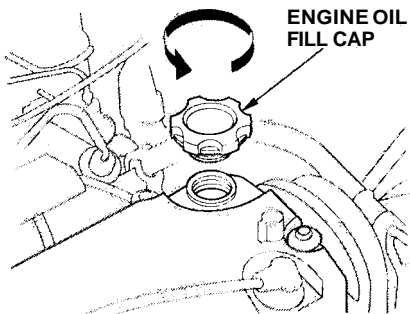

To add oil, unscrew and remove the engine oil fill cap on top of the valve cover. Pour in the oil, and replace the engine oil fill cap. Tighten it securely. Wait a few minutes and recheck the oil level. Do not fill above the upper mark; you could damage the engine.

Recommended Oil

Oil is a major contributor to your engine's performance and longevity. Always use a premium-grade detergent oil.

You can determine an oil's SAE viscosity and Service Classification from the API Service label on the oil container.

A fuel-efficient oil is recommended for your Honda. This is shown on the API Service label by the words "Energy Conserving." This oil is formulated to help your engine use less fuel.

The API Service label also tells you the service classification of the oil. Always use an oil that is labeled "API Service SJ." This service rating may include other classifications, such as CD. These additional classifications are not a problem, as long as the label also carries the SJ classification.

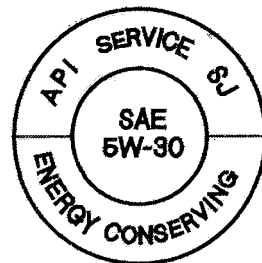

API SERVICE LABEL

CONTINUED

Engine Oil

The oil container may also display the API Certification seal. Make sure it says "For Gasoline Engines."



API CERTIFICATION MARK

The SAE numbers tell you the oil's viscosity or weight. Select the oil for your car according to this chart.

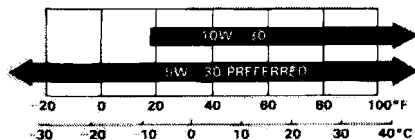

Ambient Temperature

An oil with a viscosity of 5W-30 is preferred for improved fuel economy and year-round protection in your Honda. You may use a 10W-30 oil if the temperature in your area never goes below 20°F (— 7°C).

Synthetic Oil

You may use a synthetic motor oil if it meets the same requirements given for conventional motor oil; energy conserving, a service classification of SJ, and the proper weight as shown on the chart. When using synthetic oil, you must follow the oil and filter change intervals given in the maintenance schedule.

Additives

Your Honda does not need any oil additives. Purchasing additives for the engine or transmission will not increase your car's performance or longevity. It only increases the cost of operating your car.

Changing the Oil and Filter

Always change the oil and filter according to the time and distance (miles/kilometers) recommendations in the maintenance schedule. The oil and filter collect contaminants that can damage your engine if they are not removed regularly.

Changing the oil and filter requires special tools and access from underneath the car. The car should be raised on a service station-type hydraulic lift for this service. Unless you have the knowledge and proper equipment, you should have this maintenance done by a skilled mechanic.

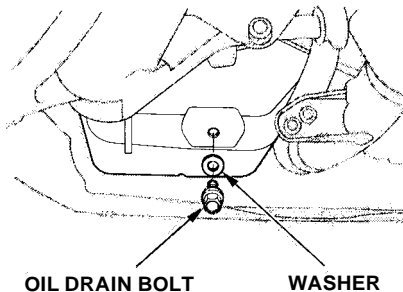

1. Run the engine until it reaches normal operating temperature, then shut it off.
2. Open the hood and remove the engine oil fill cap. Remove the oil drain bolt and washer from the bottom of the engine. Drain the oil into an appropriate container.

OIL FILTER

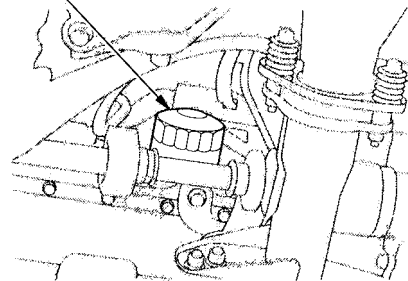

3. Remove the oil filter and let the remaining oil drain. A special wrench (available from your Honda dealer) is required to remove the filter.
4. Install a new oil filter according to instructions that come with it.

CONTINUED

Engine Oil

5. Put a new washer on the drain bolt, then reinstall the drain bolt.

Tighten it to:

(U.S.: DX, Value Package, and LX,
Canada: LX, EX)

33 lbf·ft (44 N·m, 4.5 kgf·m)

(U.S.: EX)

29 lbf·ft (39 N·m, 4.0 kgf·m)

6. Refill the engine with the recommended oil.

Engine oil change capacity
(including filter):

(U.S.: DX, Value Package, and LX,
Canada: LX, EX)

3.8 US qt (3.6 ℓ , 3.2 Imp qt)

(U.S.: EX)

3.5 US qt (3.3 ℓ , 2.9 Imp qt)

7. Replace the engine oil fill cap.

Start the engine. The oil pressure indicator light should go out within five seconds. If it does not, turn off the engine and reinspect your work.

8. Let the engine run for several minutes and check the drain bolt and oil filter for leaks.

9. Turn off the engine, let it sit for several minutes, then check the oil level. If necessary, add oil to bring the level to the upper mark on the dipstick.

NOTICE

Improper disposal of engine oil can be harmful to the environment. If you change your own oil, please dispose of the used oil properly. Put it in a sealed container and take it to a recycling center. Do not discard it in a trash bin or dump it on the ground.

Adding Engine Coolant

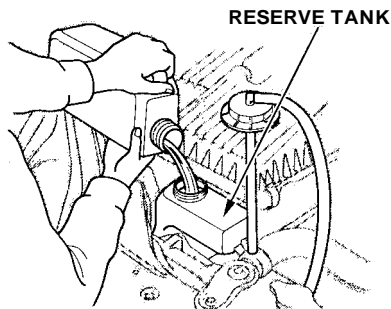

If the coolant level in the reserve tank is at or below the MIN line, add coolant to bring it up to the MAX line. Inspect the cooling system for leaks. This coolant should always be a mixture of 50 percent antifreeze and 50 percent water. Never add straight antifreeze or plain water.

Always use Genuine Honda antifreeze/coolant. If it is not available, you may use another major-brand non-silicate coolant as a temporary replacement. Make sure it is a high-quality coolant recommended for aluminum engines. However, continued use of any non-Honda coolant can result in corrosion, causing the cooling system to malfunction or fail. Have the cooling system flushed and refilled with Honda antifreeze/coolant as soon as possible.

If the reserve tank is completely empty, you should also check the coolant level in the radiator.

Removing the radiator cap while the engine is hot can cause the coolant to spray out, seriously scalding you.

Always let the engine and radiator cool down before removing the radiator cap.

1. Make sure the engine and radiator are cool.

CONTINUED

Cooling System

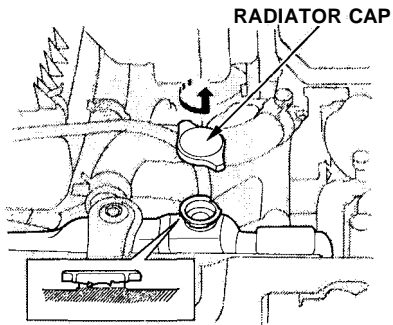

2. Turn the radiator cap counter-clockwise, without pressing down on it, until it stops. This relieves any pressure remaining in the cooling system.
3. Remove the radiator cap by pushing down and turning counterclockwise.

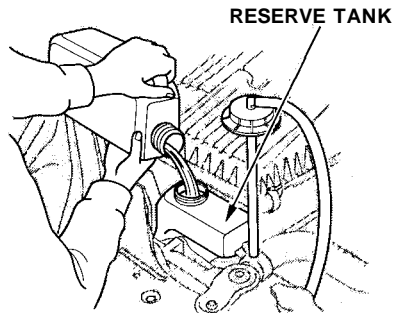

4. The coolant level should be up to the base of the filler neck. Add coolant if it is low.
5. Put the radiator cap back on. Tighten it fully.
6. Pour coolant into the reserve tank. Fill it to halfway between the MAX and MIN marks. Put the cap back on the reserve tank.

Do not add any rust inhibitors or other additives to your car's cooling system. They may not be compatible with the coolant or engine components.

Replacing Engine Coolant

The cooling system should be completely drained and refilled with new coolant according to the time and distance recommendations in the maintenance schedule. Only use Genuine Honda antifreeze/coolant.

Draining the coolant requires access to the underside of the car. Unless you have the tools and knowledge, you should have this maintenance done by a skilled mechanic.

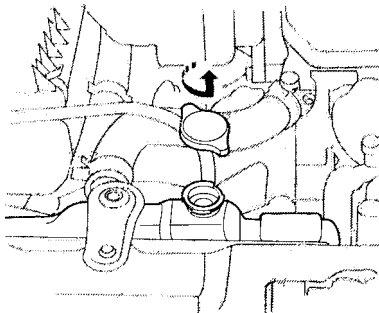

1. Turn the ignition ON (II). Turn the temperature control dial to maximum heat. Turn off the ignition and remove the key. Open the hood. Make sure the engine and radiator are cool to the touch.
2. Remove the radiator cap.

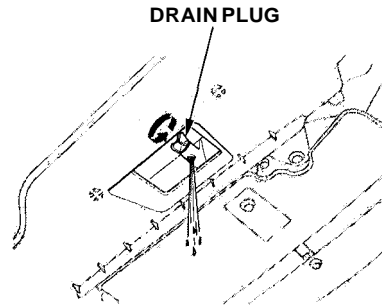

3. Loosen the drain plug on the bottom of the radiator. The coolant will come out through the hole in the splash cover.

CONTINUED

Cooling System

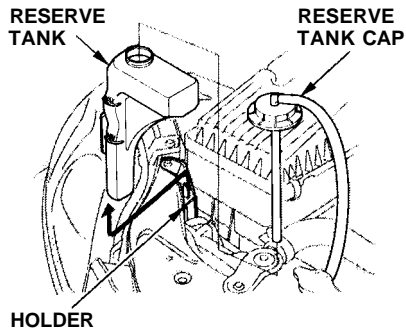

4. Remove the reserve tank from its holder by pulling it straight up. Drain the coolant, then put the tank back in its holder.

5. When the coolant stops draining, tighten the drain plug in the bottom of the radiator.

6. Mix the recommended antifreeze with an equal amount of purified or distilled water in a clean container. The cooling system capacity is:

With 5-speed manual transmission:
0.82 US gal (3.1 ℓ , 0.68 Imp gal)

With automatic transmission:
(U.S. DX, Value Package, and LX,
Canada: LX, EX)
0.79 US gal (3.0 ℓ , 0.66 Imp gal)

(U.S.: EX)
0.85 US gal (3.2 ℓ , 0.70 Imp gal)

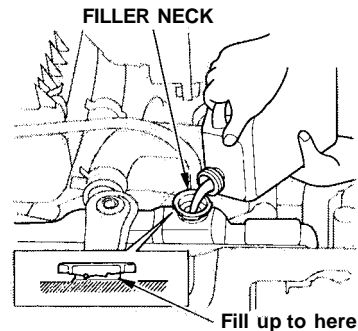

7. Pour coolant into the radiator up to the base of the filler neck. Start the engine and let it run for about 30 seconds. Then turn off the engine.

8. Fill the reserve tank to the MAX mark. Install the reserve tank cap.
9. Check the level in the radiator, add coolant if needed.
10. Install the radiator cap, and tighten it to the first stop.

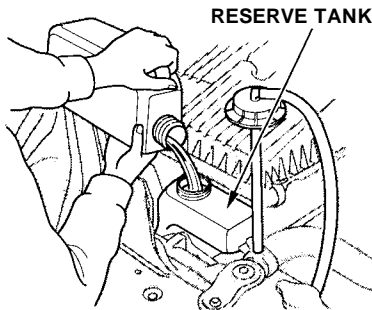

11. Start the engine and let it run until the cooling fan comes on two times. Then stop the engine.
12. Remove the radiator cap. Fill the radiator with coolant up to the base of the filler neck.

13. Start the engine and hold it at 1,500 rpm until the cooling fan comes on. Turn off the engine. Check the coolant level in the radiator and add coolant if needed.
14. Install the radiator cap, and tighten it fully.
15. If necessary, fill the reserve tank to the MAX mark. Install the reserve tank cap.

Windshield Washers

Check the level in the windshield washer reservoir at least monthly during normal usage. In bad weather, when you use the washers often, check the level every time you stop for fuel.

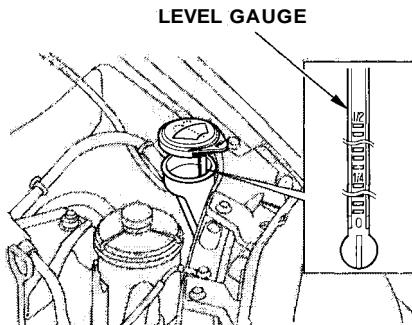

The windshield washer reservoir is located behind the driver's side headlight. Check the reservoir's fluid level by removing the cap and looking at the level gauge attached to the cap.

Fill the reservoir with a good-quality windshield washer fluid. This increases the cleaning capability and prevents freezing in cold weather.

When you refill the reservoir, clean the edges of the windshield wiper blades with windshield washer fluid on a clean cloth. This will help to condition the blade edges.

NOTICE

Do not use engine antifreeze or a vinegar/water solution in the windshield washer reservoir.

Antifreeze can damage your car's paint, while a vinegar/water solution can damage the windshield washer pump.

Use only commercially-available windshield washer fluid.

Automatic Transmission

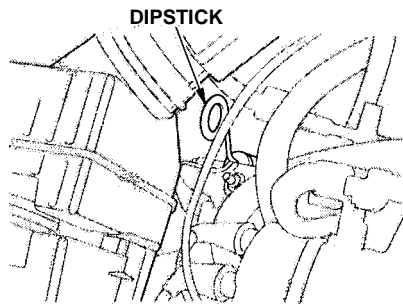

Check the fluid level with the engine at normal operating temperature.

1. Park the car on level ground. Shut off the engine.
2. Remove the dipstick (yellow loop) from the transmission and wipe it with a clean cloth.

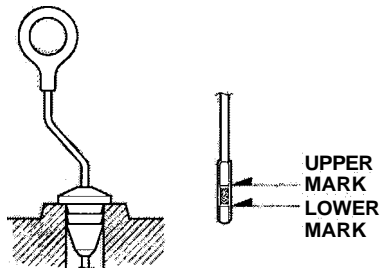

3. Insert the dipstick all the way into the transmission securely as shown in the illustration.
4. Remove the dipstick and check the fluid level. It should be between the upper and lower marks.

5. If the level is below the lower mark, add fluid into the filler hole to bring it to the upper mark. Always use Honda Premium Formula Automatic Transmission Fluid (ATF). If it is not available, you may use a DEXRON® III automatic transmission fluid as a temporary replacement. However, continued use can affect shift quality. Have the transmission drained and refilled with Honda ATF as soon as it is convenient.

6. Insert the dipstick all the way back into the transmission securely as shown in the illustration.

The transmission should be drained and refilled with new fluid according to the time and distance recommendations in the maintenance schedule.

Transmission Fluid, Brake and Clutch Fluid

5-speed Manual Transmission

FILLER BOLT

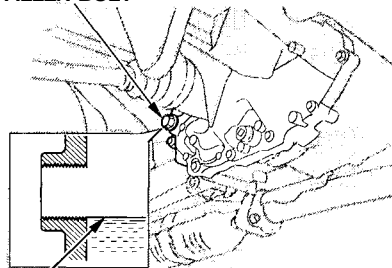

Correct level

Check the fluid level with the transmission at normal operating temperature and the car sitting on level ground. Remove the transmission filler bolt and carefully feel inside the bolt hole with your finger. The fluid level should be up to the edge of the bolt hole. If it is not, add Genuine Honda Manual Transmission Fluid (MTF) until it starts to run out of the hole. Reinstall the filler bolt and tighten it securely.

If Honda MTF is not available, you may use an API service SG, SH or SJ grade motor oil with a viscosity of SAE 10W-30 or 10W-40 as a temporary replacement. An SG grade is preferred, but an SH or SJ grade may be used if SG is not available. However, motor oil does not contain the proper additives and continued use can cause stiffer shifting. Replace as soon as convenient.

The transmission should be drained and refilled with new fluid according to the time and distance recommendations in the maintenance schedule.

Brake and Clutch Fluid

Check the fluid level in the reservoirs monthly. There are up to two reservoirs, depending on the model. They are:

- Brake fluid reservoir (all models)
- Clutch fluid reservoir (manual transmission only)

The brake fluid should be replaced according to the time and distance recommendations in the maintenance schedule.

Always use Genuine Honda DOT 3 brake fluid. If it is not available, you should use only DOT 3 or DOT 4 fluid, from a sealed container, as a temporary replacement. However, the use of any non-Honda brake fluid can cause corrosion and decrease the life of the system. Have the brake system flushed and refilled with Honda DOT 3 brake fluid as soon as possible.

Brake fluid marked DOT 5 is not compatible with your car's braking system and can cause extensive damage.

Brake System

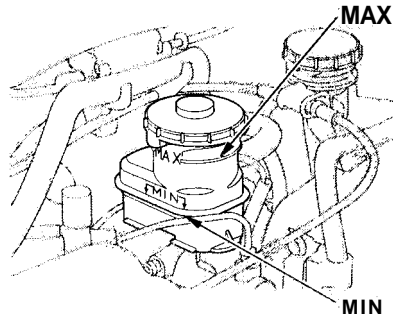

The fluid level should be between the MIN and MAX marks on the side of the reservoir. If the level is at or below the MIN mark, your brake system needs attention. Have the brake system inspected for leaks or worn brake pads.

Clutch System

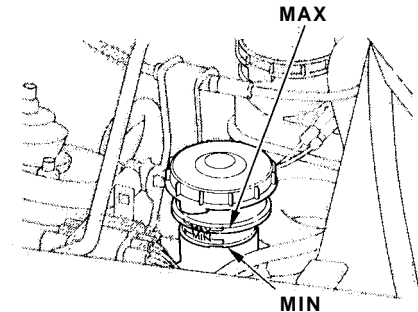

The fluid should be between the MIN and MAX marks on the side of the reservoir. If it is not, add brake fluid to bring it up to that level. Use the same fluid specified for the brake system.

Low fluid level can indicate a leak in the clutch system. Have this system inspected as soon as possible.

Power Steering

Check the level when the engine is cold. Look at the side of the reservoir. The fluid should be between the UPPER LEVEL and LOWER LEVEL. If it is below the LOWER LEVEL, add power steering fluid to the UPPER LEVEL.

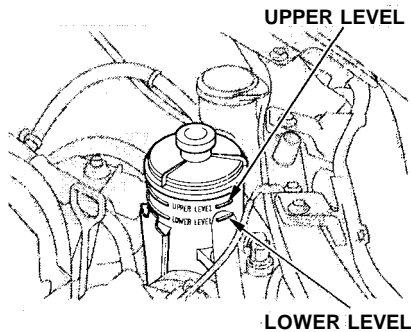

Always use Genuine Honda Power Steering Fluid. If it is not available, you may use another power steering fluid as an emergency replacement. However, continued use can cause increased wear and poor steering in cold weather. Have the power steering system flushed and refilled with Honda PSF as soon as possible.

A low power steering fluid level can indicate a leak in the system. Check the fluid level frequently and have the system inspected as soon as possible.

NOTICE

Turning the steering wheel to full left or right lock and holding it there can damage the power steering pump.

The air cleaner element should be replaced according to the time and distance recommendations in the maintenance schedule.

Replacement

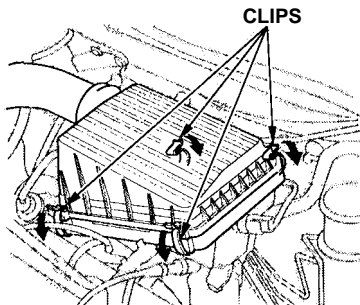

On DX, Value Package, and LX models in the U.S., and all models in Canada
The air cleaner element is inside the air cleaner housing in the engine compartment.

To replace it:

1. Unsnap the four clips and remove the air cleaner housing cover.
2. Remove the old air cleaner element.

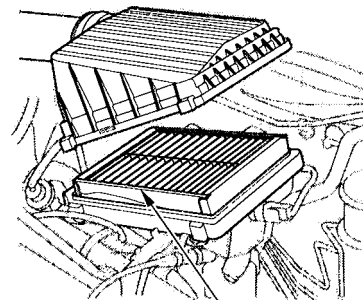

3. Carefully clean the inside of the air cleaner housing with a damp rag.
4. Place the new air cleaner element in the air cleaner housing.
5. Reinstall the air cleaner housing cover, snap the four clips back into place.

Air Cleaner Element, Hood Latch

Replacement

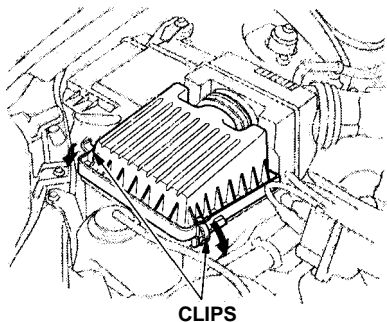

On EX model in the U.S.
The air cleaner element is inside the air cleaner housing on the passenger's side of the engine compartment. To replace it:

1. Unsnap the two clips and remove the air cleaner housing cover.
2. Remove the old air cleaner element.

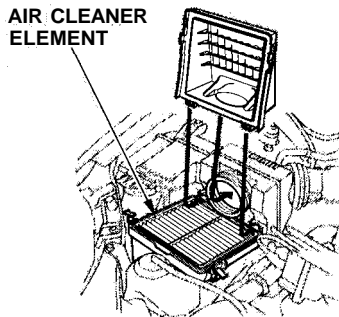

3. Carefully clean the inside of the air cleaner housing with a damp rag.
4. Place the new air cleaner element in the air cleaner housing.
5. Align the tabs and reinstall the air cleaner housing cover, snap the two clips back into place.

Hood Latch

PIVOTS

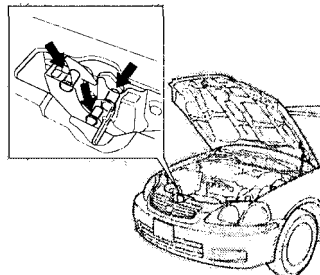

Clean the hood latch assembly with a mild cleaner, then lubricate it with a multipurpose grease. Lubricate all the moving parts, including the pivot. Follow the time and distance recommendations in the Maintenance Schedule. If you are not sure how to clean and grease the latch, contact your Honda dealer.

The spark plugs in your car should be replaced according to the time and distance recommendations in the maintenance schedule.

Replacement

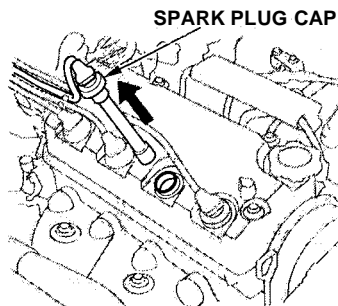

1. Clean up any dirt and oil around the spark plug caps.
2. Remove the spark plug cap by pulling it straight out.
3. Remove the spark plug with a five-eighths inch (16 mm) spark plug socket.

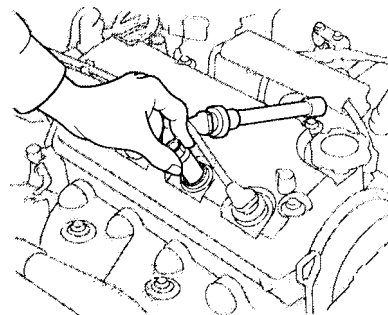

4. Put the new spark plug into the socket; then screw it into the hole. Screw it in by hand so you do not crossthead it.

CONTINUED

Spark Plugs

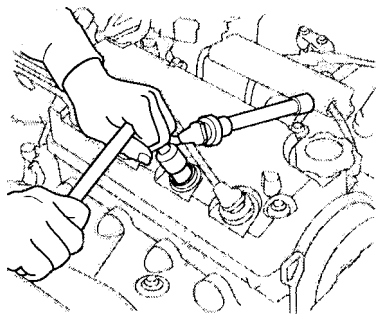

5. Torque the spark plug. (If you do not have a torque wrench, tighten the spark plug two-thirds of a turn after it contacts the cylinder head.)

Tightening torque:

13 lbf·ft (18N·m, 1.8 kgf·m)

NOTICE

Tighten the spark plugs carefully. A spark plug that is too loose can overheat and damage the engine. Overtightening can cause damage to the threads in the cylinder head.

6. Install the spark plug cap.
7. Repeat this procedure for the other three spark plugs.

Specifications:

NGK: ZFR5F-11
DENSO: KJ16CR-L11

Spark Plug Gap:
0.04 in (1.1 mm)⁺⁰_{-0.1 mm}

Check the condition of your car's battery monthly. You should check the color of the test indicator window, and for corrosion on the terminals.

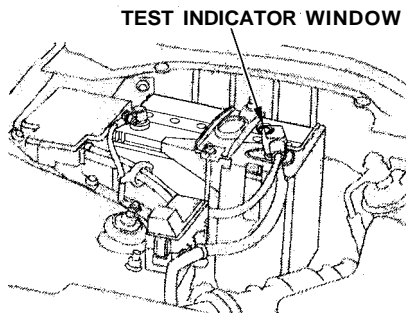

Check the battery condition by looking at the test indicator window on the battery. The label on the battery explains the test indicator's colors.

Check the battery terminals for corrosion (a white or yellowish powder). To remove it, cover the terminals with a solution of baking soda and water. It will bubble up and turn brown. When this stops, wash it off with plain water. Dry off the battery with a cloth or paper towel. Coat the terminals with grease to help prevent future corrosion.

CONTINUED

Battery

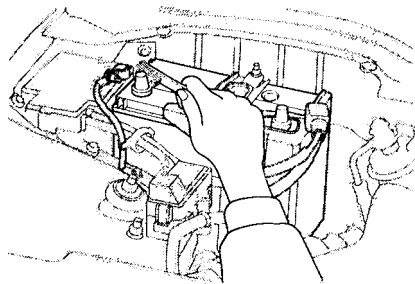

If the terminals are severely corroded, clean them with baking soda and water. Then use a wrench to loosen and remove the cables from the terminals. Always disconnect the negative (—) cable first and reconnect it last. Clean the battery terminals with a terminal cleaning tool or wire brush. Reconnect and tighten the cables, then coat the terminals with grease.

If you need to connect the battery to a charger, disconnect both cables to prevent damage to the car's electrical system.

The battery gives off explosive hydrogen gas during normal operation.

A spark or flame can cause the battery to explode with enough force to kill or seriously hurt you.

Wear protective clothing and a face shield, or have a skilled mechanic do the battery maintenance.

On U.S. Value Package and EX models
If your car's battery is disconnected or goes dead, the audio system will disable itself. The next time you turn on the radio you will see "CODE" in the frequency display. Use the Preset buttons to enter the five-digit code (see page 139).

NOTICE

Charging the battery with the cables connected can seriously damage your car's electronic controls. Detach the battery cables before connecting the battery to a charger.

Check the condition of the wiper blades at least every six months. Look for signs of cracking in the rubber, or areas that are getting hard. Replace the blades if you find these signs, or they leave streaks and unwiped areas when used.

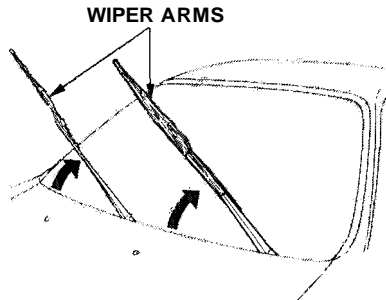

To replace the blade:

1. Raise the wiper arm off the windshield.

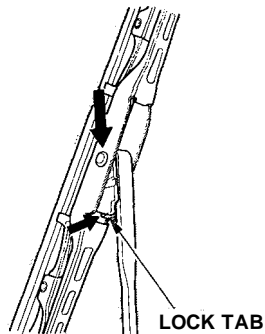

2. Disconnect the blade assembly from the wiper arm by pushing in the lock tab. Hold it in while you push the blade assembly toward the base of the arm.

CONTINUED

Wiper Blades

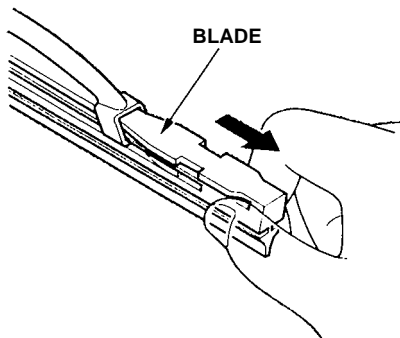

3. Remove the blade from its holder by grasping the tabbed end of the blade. Pull firmly until the tabs come out of the holder.

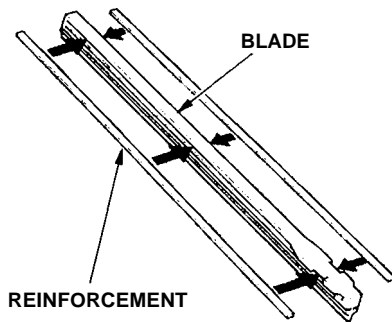

4. Examine the new wiper blades. If they have no plastic or metal reinforcement along the back edge, remove the metal reinforcement strips from the old wiper blade and install them in the slots along the edge of the new blade.

5. Slide the new wiper blade into the holder until the tabs lock.
6. Slide the wiper blade assembly onto the wiper arm. Make sure it locks in place.
7. Lower the wiper arm down against the windshield.

Optional for U.S. DX, and Canadian LX, EX models

Your car's air conditioning is a sealed system. Any major maintenance, such as recharging, should be done by a qualified mechanic. You can do a couple of things to make sure the air conditioning works efficiently.

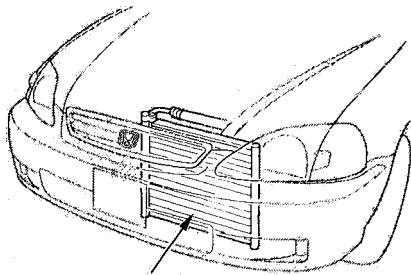

**AIR CONDITIONING
CONDENSER**

Periodically check the engine's radiator and air conditioning condenser for leaves, insects, and dirt stuck to the front surface. These block the air flow and reduce cooling efficiency. Use a light spray from a hose or a soft brush to remove them.

NOTICE

The condenser and radiator fins bend easily. Only use a low-pressure spray or soft-bristle brush to clean them.

Run the air conditioning at least once a week during the cold weather months. Run it for at least ten minutes while you are driving at a steady speed with the engine at normal operating temperature. This circulates the lubricating oil contained in the refrigerant.

If the air conditioning does not get as cold as before, have your dealer check the system. Recharge the system with Refrigerant HFC-134a (R-134a). (See Specifications on page 265.)

NOTICE

Whenever you have the air conditioning system serviced, make sure the service facility uses a refrigerant recycling system. This system captures the refrigerant for reuse. Releasing refrigerant into the atmosphere can damage the environment.

Drive Belts, Timing Belt

Drive Belts

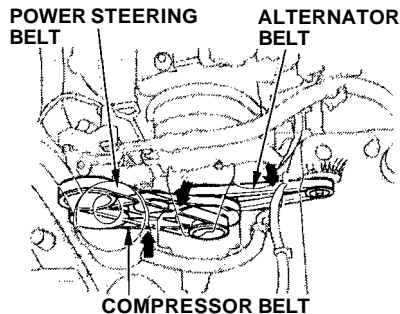

Check the condition of the two or three drive belts. Examine the edges of each belt for cracks or fraying. Check the tension of each belt by pushing on it with your thumb midway between the pulleys.

The belts should have the following "play" or deflection.

Alternator belt:

0.31 — 0.41 in (8.0 — 10.5 mm)

Power steering belt:

0.41 — 0.55 in (10.5 — 14.0 mm)

On vehicles with Air Conditioning System

Compressor belt:

0.30 — 0.37 in (7.5 — 9.5 mm)

If you see signs of wear or looseness, have your dealer adjust or replace the belts.

Timing Belt

The timing belt should normally be replaced at the intervals shown in the maintenance schedule.

Replace this belt at 60,000 miles (U.S.) or 100,000 km (Canada) if you regularly drive your car in one or more of these conditions:

- In very high temperatures (over 110°F, 43°C).
- In very low temperatures (under -20°F, -29°C).

To safely operate your car, your tires must be the proper type and size, in good condition with adequate tread, and correctly inflated. The following pages give more detailed information on how and when to check air pressure, how to inspect your tires for damage and wear, and what to do when your tires need to be replaced.

Using tires that are excessively worn or improperly inflated can cause a crash in which you can be seriously hurt or killed.

Follow all instructions in this owner's manual regarding tire inflation and maintenance.

Inflation

Keeping the tires properly inflated provides the best combination of handling, tread life and riding comfort. Underinflated tires wear unevenly, adversely affect handling and fuel economy, and are more likely to fail from being overheated. Overinflated tires can make your car ride more harshly, are more prone to damage from road hazards, and wear unevenly.

We recommend that you visually check your tires every day. If you think a tire might be low, check it immediately with a tire gauge.

Use a gauge to measure the air pressure at least once a month. Even tires that are in good condition may lose one to two psi (10 to 20 kPa, 0.1 to 0.2 kgf/cm²) per month. Remember to check the spare tire at the same time you check all the other tires.

Check the pressure in the tires when they are cold. This means the car has been parked for at least three hours. If you have to drive the car before checking the tire pressure, the tires can still be considered "cold" if you drive less than 1 mile (1.6km).

CONTINUED

If you check the pressure when the tires are hot (the car has been driven several miles), you will see readings 4 to 6 psi (30 to 40 kPa, 0.3 to 0.4 kgf/cm²) higher than the cold reading. This is normal. Do not let air out to match the specified cold pressure. The tire will be underinflated.

You should get your own tire pressure gauge and use it whenever you check your tire pressures. This will make it easier for you to tell if a pressure loss is due to a tire problem and not due to a variation between gauges.

Recommended Tire Pressures for Normal Driving

The following chart shows the recommended cold tire pressures for most normal driving conditions and speeds. Tire pressures for high speed driving are shown on page [267](#).

Tire Size	Cold Tire Pressure for Normal Driving
P185/65R14 85S	Front: 30 psi (210 kPa , 2.1 kgf/cm ²) Rear: 29 psi (200 kPa , 2.0 kgf/cm ²)

The compact spare tire pressure is:
60 psi (420 kPa , 4.2 kgf/cm²)

These pressures are also given on the tire information label on the driver's doorjamb.

Tubeless tires have some ability to self-seal if they are punctured. However, because leakage is often very slow, you should look closely for punctures if a tire starts losing pressure.

Inspection

Every time you check inflation, you should also examine the tires for damage, foreign objects, and wear.

You should look for:

- Bumps or bulges in the tread or side of the tire. Replace the tire if you find either of these conditions.
- Cuts, splits, or cracks in the side of the tire. Replace the tire if you can see fabric or cord.
- Excessive tread wear.

INDICATOR LOCATION MARKS

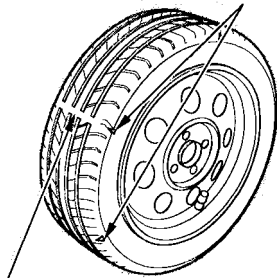

TREAD WEAR INDICATOR

Your car's tires have wear indicators molded into the tread. When the tread wears down to that point, you will see a 1/2 inch (12.7 mm) wide band running across the tread. This shows there is less than 1/16 inch (1.6 mm) of tread left on the tire. A tire that is this worn gives very little traction on wet roads. You should replace the tire if you can see the tread wear indicator in three or more places around the tire.

Maintenance

In addition to proper inflation, correct wheel alignment helps to decrease tire wear. If you find a tire is worn unevenly, have your dealer check the wheel alignment.

The tires were properly balanced by the factory. They may need to be rebalanced at some time before they are worn out. Have your dealer check the tires if you feel a consistent vibration while driving. A tire should always be rebalanced if it is removed from the wheel for repair.

CONTINUED

Tires

Make sure the installer balances the wheels when you have new tires installed. This increases riding comfort and tire life. Your car's original tires were dynamic or "spin" balanced at the factory. For best results, have the installer perform a dynamic balance.

Tire Rotation

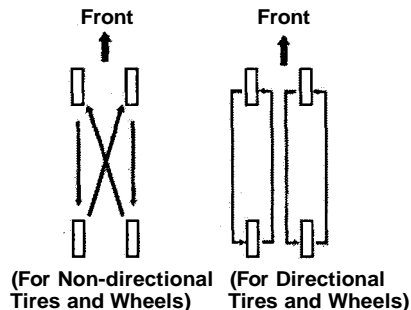

To help increase tire life and distribute wear more evenly, you should have the tires rotated every 7,500 miles (12,000 km). Move the tires to the positions shown in the chart each time they are rotated.

When shopping for replacement tires, you may find that some tires are "directional." This means they are designed to rotate only in one direction. If you use directional tires, they should be rotated only front-to-back.

Replacing Tires and Wheels

The tires that came with your car were selected to match the performance capabilities of the car while providing the best combination of handling, ride comfort, and long life. You should replace them with radial tires of the same size, load range, speed rating, and maximum cold tire pressure rating (as shown on the tire's sidewall). Mixing radial and bias-ply tires on your car can reduce its braking ability, traction, and steering accuracy.

Installing improper tires on your car can affect handling and stability. This can cause a crash in which you can be seriously hurt or killed.

Always use the size and type of tires recommended in this owner's manual.

It is best to replace all four tires at the same time. If that is not possible or necessary, then replace the two front tires or the two rear tires as a pair. Replacing just one tire can seriously affect your car's handling.

The ABS works by comparing the speed of the wheels. When replacing tires, use the same size originally supplied with the car. Tire size and construction can affect wheel speed and may cause the system to work inconsistently.

If you ever need to replace a wheel, make sure the wheel's specifications match those of the original wheel that came on your car. Replacement wheels are available at your Honda dealer.

Tires

Wheels and Tires

Wheels:
14x5J

Tires:
P185/65R1485S

See *Tire Information* on page [266](#) for additional information about tire and wheel size designations. See page [267](#) for information about DOT Tire Quality Grading.

Winter Driving

Tires that are marked "M + S" or "All Season" on the sidewall have an all-weather tread design. They should be suitable for most winter driving conditions. Tires without these markings are designed for optimum traction in dry conditions. They may not provide adequate performance in winter driving. For the best performance in snowy or icy conditions, you should install snow tires or tire chains. They may be required by local laws under certain conditions.

Snow Tires

If you mount snow tires on your Honda, make sure they are radial tires of the same size and load range as the original tires. Mount snow tires on all four wheels to balance your car's handling in all weather conditions. Keep in mind the traction provided by snow tires on dry roads may not be as high as your car's original equipment tires. You should drive cautiously even when the roads are clear. Check with the tire dealer for maximum speed recommendations.

Tire Chains

Mount snow chains on your vehicle when warranted by driving conditions or required by local laws. Make sure the chains are the correct size for your tires. Install them only on the front tires. If metal chains are used, they must be SAE class "S." Cable type traction devices can also be used.

When installing chains, follow the manufacturer's instructions and mount them as tightly as you can. Drive slowly with chains installed. If you hear the chains contacting the body or chassis, stop and investigate. Make sure the chains are installed tightly, and that they are not contacting the brake lines or suspension. Remove the chains as soon as you begin driving on cleared roads.

NOTICE

Chains of the wrong size or that are improperly installed can damage your car's brake lines, suspension, body, and wheels. Stop driving if you hear the chains hitting any part of the car.

Lights

Check the operation of your car's exterior lights at least once a month. A burned out bulb can create an unsafe condition by reducing your car's visibility and the ability to signal your intentions to other drivers.

HEADLIGHT

TURN SIGNAL/
SIDE MARKER/
PARKING LIGHTS

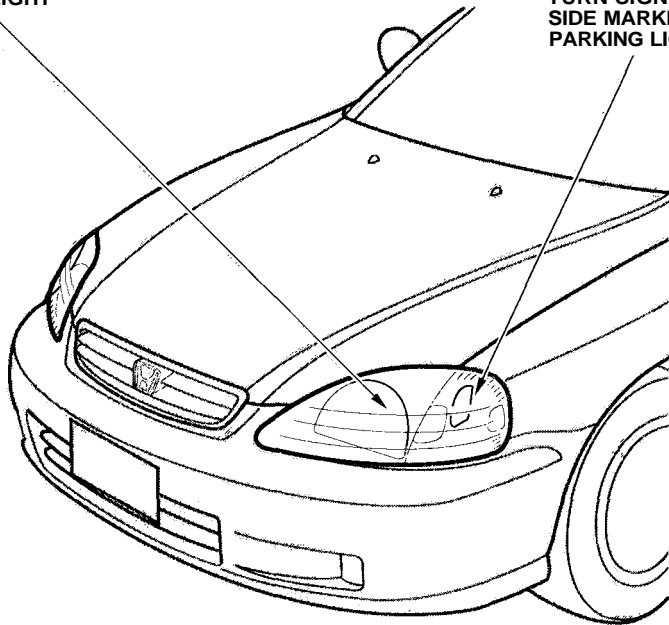

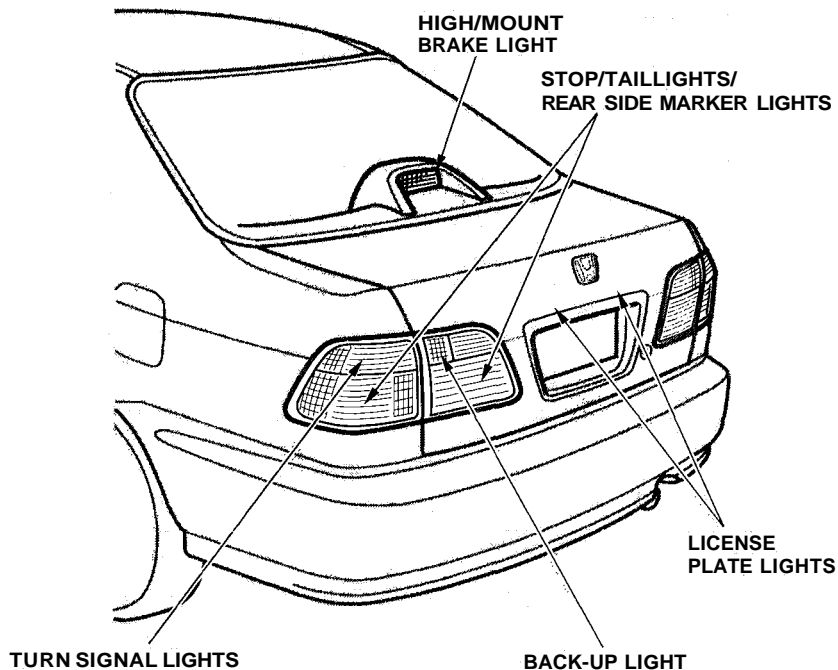

Check the following:

- Headlights (low and high beam)
- Parking lights
- Taillights
- Brake lights
- High-mount brake light
- Turn signals
- Back-up lights
- Hazard light function
- License plate light
- Side marker lights
- Daytime running lights (Canadian models)

If you find any bulbs are burned out, replace them as soon as possible. Refer to the chart on page [265](#) to determine what type of replacement bulb is needed.

Lights

Replacing a Headlight Bulb

Your car has halogen headlight bulbs, one on each side. When replacing a bulb, handle it by its steel base and protect the glass from contact with your skin or hard objects. If you touch the glass, clean it with denatured alcohol and a clean cloth.

NOTICE

Halogen headlight bulbs get very hot when lit. Oil, perspiration, or a scratch on the glass can cause the bulb to overheat and shatter.

HOLDER

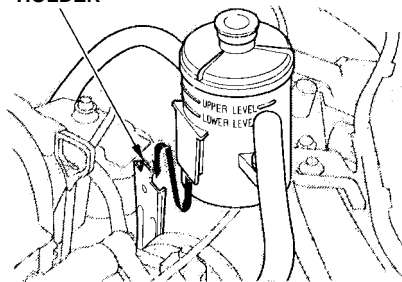

1. Open the hood.
If you need to change the headlight bulb on the driver's side, remove the power steering reservoir tank by pulling it out of its holder.

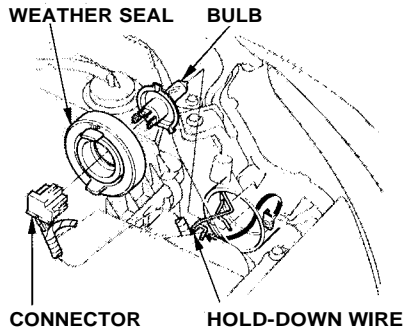

2. Remove the electrical connector from the bulb by squeezing the connector on both sides to unlock the tab. Pull the connector straight off.

3. Remove the rubber weather seal by pulling on the tab.

4. Unclip the end of the hold-down wire from its slot. Pivot it out of the way and remove the bulb.

5. Insert the new bulb into the hole, making sure the tabs are in their slots. Pivot the hold-down wire back in place and clip the end into the slot.

6. Install the rubber seal over the back of the headlight assembly. Make sure it is right side up; it is marked "TOP."

7. Push the electrical connector onto the tabs of the new bulb. Make sure it locks in place. Turn on the headlights to test the new bulb.

8. (Driver's side)
Reinstall the power steering reservoir.

Replacing the Front Side Marker/ Turn Signal and Parking Light Bulb

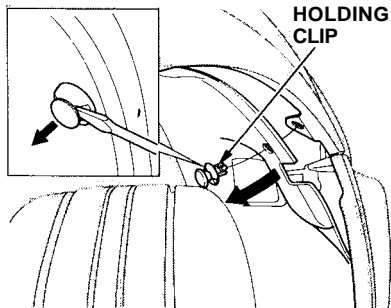

1. If you are changing the bulb on the driver's side, start the engine, turn the steering wheel all the way to the right, and turn off the engine. If you are changing the bulb on the passenger's side, turn the steering wheel to the left.

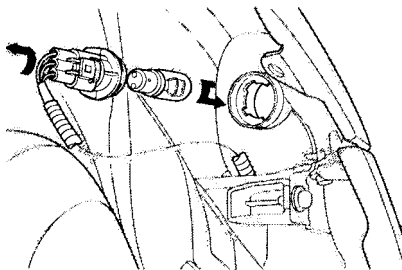

2. Use a flat-tipped screwdriver to remove the holding clip from the inner fender.
3. Pull the inner fender cover back.
4. Remove the socket from the headlight assembly by turning it one-quarter turn counterclockwise.

5. Remove the burned out bulb from the socket by pushing it in and turning counterclockwise until it unlocks.
6. Install the new bulb in the socket. Turn it clockwise to lock it in place.
7. Insert the socket back into the headlight assembly. Turn it clockwise to lock it in place.
8. Test the lights to make sure the new bulb is working.
9. Put the inner fender cover in place. Install the holding clip and tighten it securely.

Replacing Rear Bulbs (in Fenders)

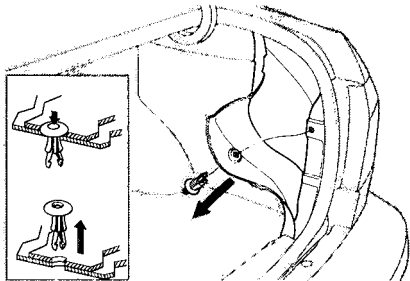

1. Open the trunk.

Undo the fastener on the side of the trunk lining by pushing on the center of the fastener's head until it pops in. Pull the lining back.

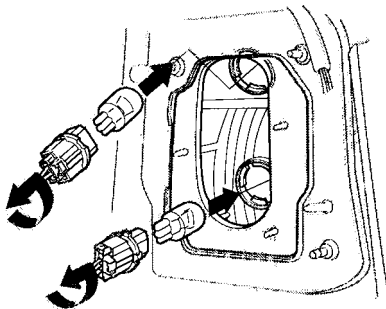

2. Determine which of the two bulbs is burned out: stop/taillight/side marker light or turn signal.
3. Remove the socket by turning it one-quarter turn counterclockwise.

4. Pull the bulb straight out of its socket.
Push the new bulb straight into the socket until it bottoms.
5. Reinstall the socket into the light assembly by turning it clockwise until it locks.
6. Test the lights to make sure the new bulb is working.
7. Reinstall the trunk lining.

CONTINUED

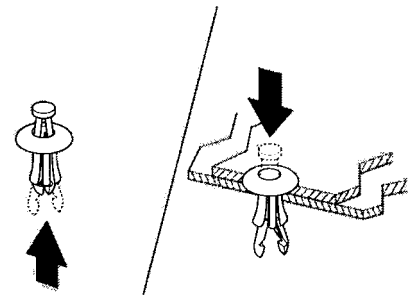

8. Reset the fastener by pushing on the pointed end until it pops back almost flush with the fingers on the housing.

9. Put the fastener in the hole on the side of the trunk lining and push on the center until it locks (the center is flush with the head).

Replacing Rear Bulbs (in Trunk Lid)

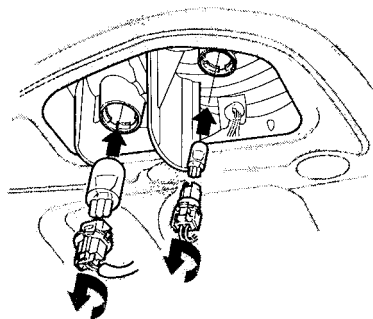

1. Open the trunk.
2. Determine which of the two bulbs is burned out: taillight or back-up light.
3. Remove the socket by turning it one-quarter turn counterclockwise.

4. Pull the bulb straight out of its socket.
Push the new bulb straight into the socket until it bottoms.
5. Insert the socket back into the light assembly. Turn it clockwise to lock it in place.
6. Test the lights to make sure the new bulb is working.

Replacing a High-mount Brake Light Bulb

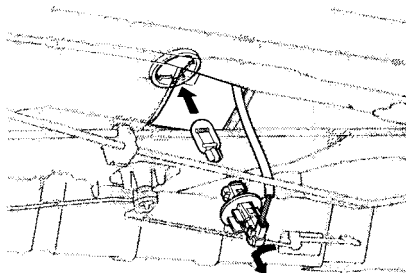

1. Open the trunk and remove the socket from the light assembly by turning it one-quarter turn counter-clockwise.
2. Pull the bulb straight out of its socket.
Push the new bulb straight into the socket until it bottoms.

3. Reinstall the socket. Turn it clockwise until it locks. Make sure the new bulb is working.

Replacing a Rear License Bulb

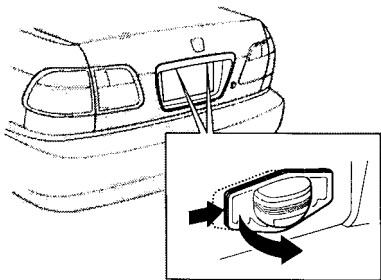

1. Remove the license light assembly by carefully prying on the edge of the lens with a flat-tip screwdriver and pulling the assembly out.
2. Pull the lens from the bulb holder by pulling the lens while squeezing the tabs on both sides of the holder.
3. Pull the bulb straight out of its socket. Push the new bulb in until

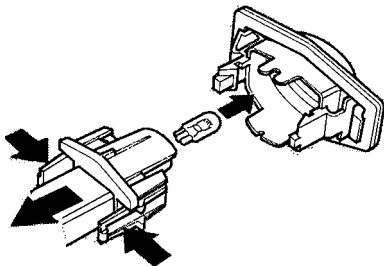

- it bottoms in the socket.
4. Turn on the parking lights and check that the new bulb is working.
 5. Put the lens back on the bulb holder and push it until it latches. Put the light assembly back into the hole. Push it until it snaps into place.

Replacing an Interior Light Bulb (U.S.: EX)

INTERIOR LIGHT

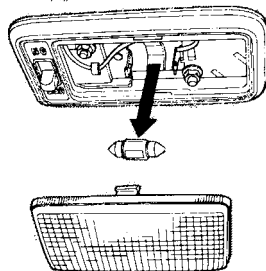

1. Remove the lens by carefully prying on the edge of the lens in the middle with a fingernail file or a small flat-tip screwdriver. Do not pry on the edge of the housing around the lens.

(U.S.: DX, Value Package, and LX,
Canada: LX, EX)

INTERIOR LIGHT

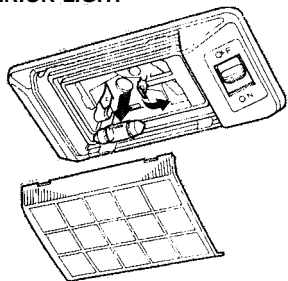

2. Remove the bulb by pulling it straight out of its metal tabs.
3. Push the new bulb into the metal tabs. Snap the lens back in place.

(EX)

SPOTLIGHT

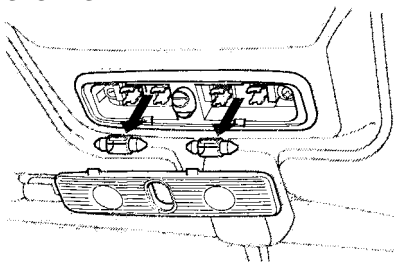

Replacing the Trunk Light Bulb

The trunk light is available on LX and EX models in the U.S., and all models in Canada

TRUNK LIGHT

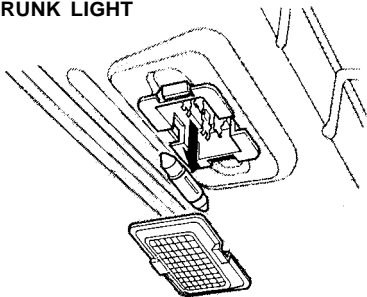

1. Remove the lens by carefully prying on the edge of the lens in the middle with a fingernail file or a small flat-tip screwdriver. Do not pry on the edge of the housing around the lens.

CONTINUED

Lights

2. Remove the bulb by pulling it straight out of its metal tabs.
3. Push the new bulb into the metal tabs. Snap the lens back in place.

If you need to park your car for an extended period (more than one month), there are several things you should do to prepare it for storage. Proper preparation helps prevent deterioration and makes it easier to get your car back on the road. If possible, store your car indoors.

- Fill the fuel tank.
- Change the engine oil and filter (see page [189](#)).
- Wash and dry the exterior completely.
- Clean the interior. Make sure the carpeting, floor mats, etc. are completely dry.
- Leave the parking brake off. Put the transmission in Reverse (5-speed manual) or Park (automatic).

- Block the rear wheels.
- If the car is to be stored for a longer period, it should be supported on jackstands so the tires are off the ground.
- Leave one window open slightly (if the car is being stored indoors).
- Disconnect the battery.
- Support the front wiper blade arms with a folded towel or rag so they do not touch the windshield.
- To minimize sticking, apply a silicone spray lubricant to all door and trunk seals. Also, apply a body wax to the painted surfaces that mate with the door and trunk seals.

- Cover the car with a "breathable" car cover, one made from a porous material such as cotton. Nonporous materials, such as plastic sheeting, trap moisture, which can damage the paint.
- If possible, run the engine for a while periodically (preferably once a month).

If you store your car for 12 months or longer, have your Honda dealer perform the inspections called for in the 24 months/30,000 miles (48,000 km) maintenance schedule as soon as you take it out of storage (see page [178](#)). The replacements called for in the maintenance schedule are not needed unless the car has actually reached that time or mileage.

Regular cleaning and polishing of your Honda helps to keep it "new" looking. This section gives you hints on how to clean your car and preserve its appearance: the paint, brightwork, wheels and interior. Also included are several things you can do to help prevent corrosion.

Exterior Care.....	232
Washing.....	232
Waxing.....	233
Paint Touch-up.....	233
Interior Care.....	234
Carpeting.....	234
Fabric.....	234
Vinyl.....	234
Seat Belts.....	234
Windows.....	235
Air Fresheners.....	235
Corrosion Protection.....	235
Body Repairs.....	236

Exterior Care

Washing

Frequent washing helps preserve your car's beauty. Dirt and grit can scratch the paint, while tree sap and bird droppings can permanently ruin the finish.

Wash your car in a shady area, not in direct sunlight. If the car is parked in the sun, move it into the shade and let the exterior cool down before you start.

Only use the solvents and cleaners recommended in this Owner's Manual.

NOTICE

Chemical solvents and strong cleaners can damage the paint, metal, and plastic on your car.

- Rinse the car thoroughly with cool water to remove loose dirt.
- Fill a bucket with cool water. Mix in a mild detergent, such as dishwashing liquid or a product made especially for car washing.
- Wash the car using the water and detergent solution and a soft-bristle brush, sponge, or soft cloth. Start at the top and work your way down. Rinse frequently.
- Check the body for road tar, tree sap, etc. Remove these stains with tar remover or turpentine. Rinse it off immediately so it does not harm the finish. Remember to re-wax these areas, even if the rest of the car does not need waxing.
- When you have washed and rinsed the whole exterior, dry it with a chamois or soft towel. Letting it air-dry will cause dulling and water spots.

As you dry the car, inspect it for chips and scratches that could allow corrosion to start. Repair them with touch-up paint (see page [233](#)).

Waxing

Always wash and dry the whole car before waxing it. You should wax your car, including the metal trim, whenever water sits on the surface in large patches. It should form into beads or droplets after waxing.

You should use a quality liquid or paste wax. Apply it according to the instructions on the container. In general, there are two types of products:

Waxes — A wax coats the finish and protects it from damage by exposure to sunlight, air pollution, etc. You should use a wax on your Honda when it is new.

Polishes — Polishes and cleaner/waxes can restore the shine to paint that has oxidized and lost some of its shine. They normally contain mild abrasives and solvents that remove the top layer of the finish. You should use a polish on your Honda if the finish does not have its original shine after using a wax.

Cleaning tar, insects, etc. with removers also takes off the wax. Remember to re-wax those areas, even if the rest of the car does not need waxing.

Paint Touch-up

Your dealer has touch-up paint to match your car's color. The color code is printed on a sticker on the driver's doorjamb. Take this code to your dealer so you are sure to get the correct color.

Inspect your car frequently for chips or scratches in the paint. Repair them right away to prevent corrosion of the metal underneath. Use the touch-up paint only on small chips and scratches. More extensive paint damage should be repaired by a professional.

Carpeting

Vacuum the carpeting frequently to remove dirt. Ground-in dirt will make the carpet wear out faster.

Periodically shampoo the carpet to keep it looking new. Use one of the foam-type carpet cleaners on the market. Follow the instructions that come with the cleaner, applying it with a sponge or soft brush. Keep the carpeting as dry as possible by not adding water to the foam.

Fabric

Vacuum dirt and dust out of the material frequently. For general cleaning, use a solution of mild soap and lukewarm water, letting it air dry. To clean off stubborn spots, use a commercially-available fabric cleaner. Test it on a hidden area of the fabric first, to make sure it does not bleach or stain the fabric. Follow the instructions that come with the cleaner.

Vinyl

Remove dirt and dust with a vacuum cleaner. Wipe the vinyl with a soft cloth dampened in a solution of mild soap and water. Use the same solution with a soft-bristle brush on more difficult spots. You can also use commercially-available spray or foam-type vinyl cleaners.

Seat Belts

If your seat belts get dirty, you can use a soft brush with a mixture of mild soap and warm water to clean them. Do not use bleach, dye, or cleaning solvents. They can weaken the belt material. Let the belts air-dry before you use the car.

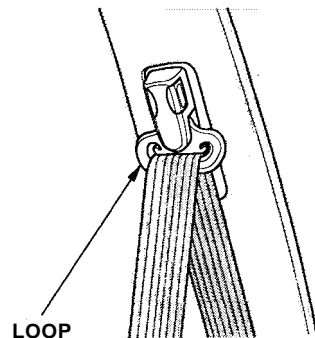

Dirt build-up in the loops of the seat belt anchors can cause the belts to retract slowly. Wipe the insides of the loops with a clean cloth dampened in mild soap and warm water or isopropyl alcohol.

Windows

Clean the windows, inside and out, with a commercially-available glass cleaner. You can also use a mixture of one part white vinegar to ten parts water. This will remove the haze that builds up on the inside of the windows. Use a soft cloth or paper towels to clean all glass and clear plastic surfaces.

NOTICE

The rear window defogger and antenna wires are bonded to the inside of the glass. Wiping vigorously up-and-down can dislodge and break these wires. When cleaning the rear window, use gentle pressure and wipe side-to-side.

Air Fresheners

If you want to use an air freshener/deodorizer in the interior of your car, it is best to use a solid type. Some liquid air fresheners contain chemicals that may cause parts of the interior trim and fabric to crack or discolor.

If you use a liquid air freshener, make sure you fasten it securely so it does not spill as you drive.

Corrosion Protection

Two factors normally contribute to causing corrosion in your car:

1. Moisture trapped in body cavities. Dirt and road salt that collects in hollows on the underside of the car stays damp, promoting corrosion in that area.
2. Removal of paint and protective coatings from the exterior and underside of the car.

Many corrosion-preventive measures are built into your Honda. You can help keep your car from corroding by performing some simple periodic maintenance:

- Repair chips and scratches in the paint as soon as you discover them.

CONTINUED

- Inspect and clean out the drain holes in the bottom of the doors and body.
- Check the floor coverings for dampness. Carpeting and floor mats may remain damp for a long time, especially in winter. This dampness can eventually cause the floor panels to corrode.
- Use a high-pressure spray to clean the underside of your car. This is especially important in areas that use road salt in winter. It is also a good idea in humid climates and areas subject to salt air. Cars equipped with ABS have a sensor and wiring at each wheel. Be careful not to damage them.
- Have the corrosion-preventive coatings on the underside of your car inspected and repaired periodically.

Body Repairs

Body repairs can affect your car's resistance to corrosion. If your car needs repairs after a collision, pay close attention to the parts used in the repair and the quality of the work.

Make sure the repair facility uses Genuine Honda replacement body parts. Some companies make sheet metal pieces that seem to duplicate the original Honda body parts, but are actually inferior in fit, finish, and corrosion resistance. Once installed, they do not give the same high-quality appearance.

When reporting your collision to the insurance company, tell them you want Genuine Honda parts used in the repair. Although most insurers recognize the quality of original parts, some may try to specify that the repairs be done with other available parts. You should investigate this before any repairs are begun.

Take your car to your authorized Honda dealer for inspection after the repairs are completed. Your dealer can make sure that quality materials were used, and that corrosion-preventive coatings were applied to all repaired and replaced parts.

This section covers the more-common problems that motorists experience with their vehicles. It gives you information about how to safely evaluate the problem and what to do to correct it. If the problem has stranded you on the side of the road, you may be able to get going again. If not, you will also find instructions on getting your car towed.

Compact Spare Tire.....	238
Changing a Flat Tire	239
If Your Engine Won't Start.....	244
Nothing Happens or the Starter Motor Operates Very Slowly.....	244
The Starter Operates Normally.....	245
Jump Starting.....	245
If Your Engine Overheats.....	247
Low Oil Pressure Indicator.....	249
Charging System Indicator.....	250
Malfunction Indicator Lamp	251
Brake System Indicator.....	252
Closing the Moonroof.....	253
Fuses.....	254
Checking and Replacing.....	255
Emergency Towing.....	259

Compact Spare Tire

Your car has a compact spare tire that takes up less space. Use this spare tire as a temporary replacement only. Get your regular tire repaired or replaced and put back on your car as soon as you can.

Check the inflation pressure of the compact spare tire every time you check the other tires. It should be inflated to:
60 psi (420 kPa , 4.2 kgf/cm²)

Follow these precautions whenever you are using the compact spare tire:

- Do not exceed 50 mph (80 km/h) under any circumstances.
- This tire gives a harsher ride and less traction on some road surfaces than the regular tire. Use greater caution while driving on this tire.
- Do not mount snow chains on the compact spare.
- The wheel of the folding spare tire is designed especially to fit your car. Do not use your spare tire on another car unless it is the same make and model.

INDICATOR LOCATION MARK

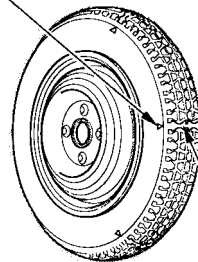

TREAD WEAR INDICATOR BAR

The compact spare tire has a shorter tread life than a regular tire. Replace it when you can see the tread wear indicator bars. The replacement should be the same size and design tire, mounted on the same wheel. The compact spare tire is not designed to be mounted on a regular wheel, and the compact wheel is not designed for mounting a regular tire.

If you have a flat tire while driving, stop in a safe place to change it. Stopping in traffic or on the shoulder of a busy road is dangerous. Drive slowly along the shoulder until you get to an exit or an area to stop that is far away from the traffic lanes.

The car can easily roll off the jack, seriously injuring anyone underneath.

Follow the directions for changing a tire exactly, and never get under the car when it is supported only by the jack.

1. Park the car on firm, level and non-slippery ground away from traffic. Turn on the hazard warning lights and turn the ignition switch to LOCK (0).
2. Put the transmission in Park (automatic) or Reverse (manual). Apply the parking brake. Have all of the passengers get out of the car while you change the tire.

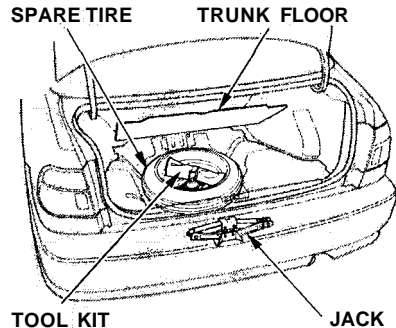

3. Open the trunk. Raise the trunk floor by lifting up on the back edge.
4. Take the tool kit out of the trunk.
5. Unscrew the wing bolt and take the spare tire out of its well.

CONTINUED

Changing a Flat Tire

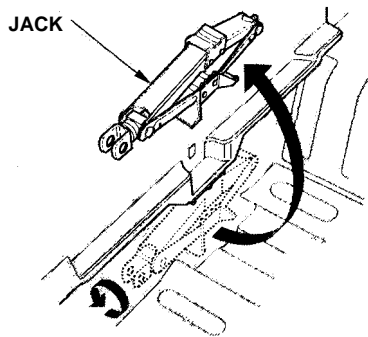

6. Turn the jack's end bracket counterclockwise to loosen it, then remove the jack.

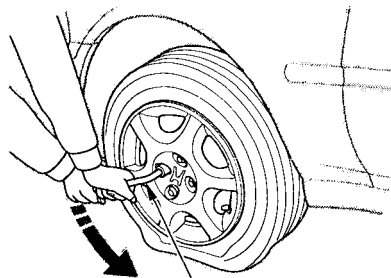

7. Loosen the four wheel nuts 1/2 turn with the wheel wrench.

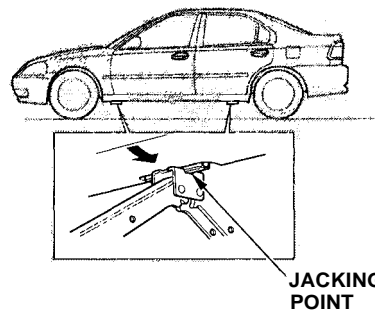

8. Locate the jacking point nearest the tire you need to change. It is pointed to by an arrow molded into the underside of the body. Place the jack under the jacking point. Turn the end bracket clockwise until the top of the jack contacts the jacking point. Make sure the jacking point tab is resting in the jack notch.

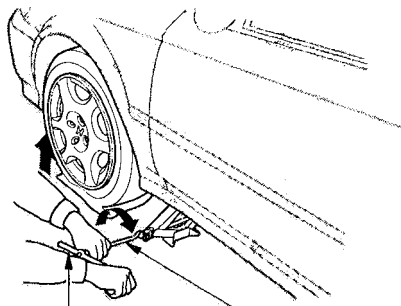

WHEEL WRENCH

EXTENSION

9. Use the extension and wheel wrench as shown to raise the vehicle until the flat tire is off the ground.

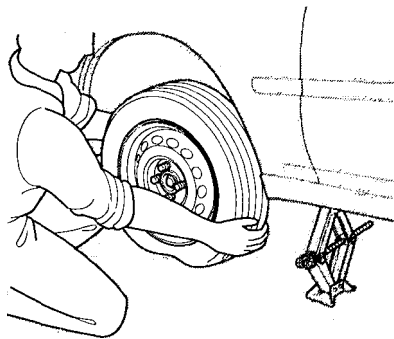

10. Remove the wheel nuts and flat tire. Temporarily place the flat tire on the ground with the outside surface of the wheel facing up. You could scratch the wheel if you put it face down.

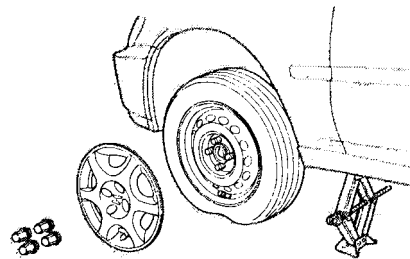

Do not attempt to forcibly pry the wheel cover off with a screwdriver or other tool. The wheel cover cannot be removed without first removing the wheel nuts.

CONTINUED

Changing a Flat Tire

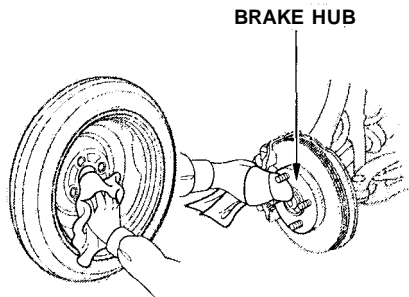

11. Before mounting the spare tire, wipe any dirt off the mounting surface of the wheel and hub with a clean cloth. Wipe the hub carefully, it may be hot from driving.

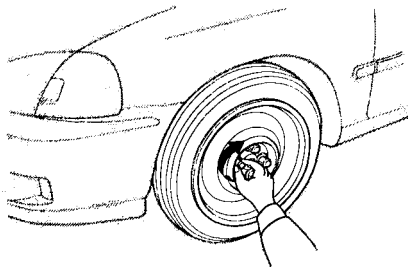

12. Put on the spare tire. Put the wheel nuts back on finger-tight, then tighten them in a crisscross pattern with the wheel wrench until the wheel is firmly against the hub. Do not try to tighten them fully.

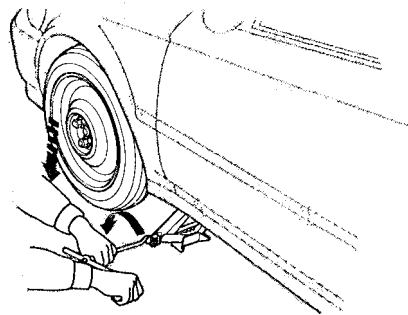

13. Lower the car to the ground and remove the jack.

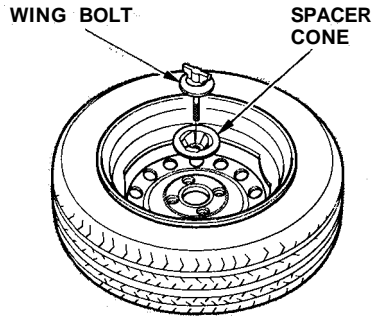
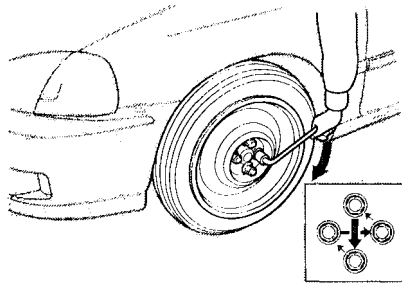

14. Tighten the wheel nuts securely in the same crisscross pattern. Have the wheel nut torque checked at the nearest automotive service facility.
Tighten the wheel nuts to:
80 lbf·ft (108 N·m, 11 kgf·m)

15. Remove the wheel cover or center cap. Place the flat tire face down in the spare tire well.
16. Remove the spacer cone from the wing bolt, turn it over, and put it back on the bolt.
17. Secure the flat tire by screwing the wing bolt back into its hole.

18. Store the jack in the trunk with the end bracket on the left side. Turn the jack's end bracket to lock it in place. Store the tool kit.

Loose items can fly around the interior in a crash and could seriously injure the occupants.

Store the wheel, jack and tools securely before driving.

19. Store the wheel cover in the trunk. Make sure it does not get scratched or damaged.
20. Lower the trunk floor, then close the trunk lid.

If Your Engine Won't Start

Diagnosing why your engine won't start falls into two areas, depending on what you hear when you turn the key to START (III):

- You hear nothing, or almost nothing. The engine's starter motor does not operate at all, or operates very slowly.
- You can hear the starter motor operating normally, or the starter motor sounds like it is spinning faster than normal, but the engine does not start up and run.

Nothing Happens or the Starter Motor Operates Very Slowly

When you turn the ignition switch to START (III), you do not hear the normal noise of the engine trying to start. You may hear a clicking sound or series of clicks, or nothing at all. Check these things:

- Check the transmission interlock. If you have a manual transmission, the clutch pedal must be pushed all the way to the floor or the starter will not operate. With an automatic transmission, it must be in Park or Neutral.
- Turn the ignition switch to ON (II). Turn on the headlights and check their brightness. If the headlights are very dim or don't light at all, the battery is discharged. See **Jump Starting** on page [245](#).

- Turn the ignition switch to START (III). If the headlights do not dim, check the condition of the fuses. If the fuses are OK, there is probably something wrong with the electrical circuit for the ignition switch or starter motor. You will need a qualified technician to determine the problem. (See **Emergency Towing** on page [259](#).)

If the headlights dim noticeably or go out when you try to start the engine, either the battery is discharged or the connections are corroded. Check the condition of the battery and terminal connections (see page [205](#)). You can then try jump starting the car from a booster battery (see page [245](#)).

The Starter Operates Normally

In this case, the starter motor's speed sounds normal, or even faster than normal, when you turn the ignition switch to START (III), but the engine does not run.

- Are you using the proper starting procedure? Refer to **Starting the Engine** on page 157.
- Do you have fuel? Turn the ignition switch to ON (II) for a minute and watch the fuel gauge. The low fuel level warning light may not be working, so you were not reminded to fill the tank.
- There may be an electrical problem, such as no power to the fuel pump. Check all the fuses (see page 255).

If you find nothing wrong, you will need a qualified technician to find the problem. (See **Emergency Towing** on page 259.)

Jump Starting

If your car's battery has run down, you may be able to start the engine by using a booster battery. Although this seems like a simple procedure, you should take several precautions.

A battery can explode if you do not follow the correct procedure, seriously injuring anyone nearby.

Keep all sparks, open flames, and smoking materials away from the battery.

You cannot start a Honda with an automatic transmission by pushing or pulling it.

To jump start your car, follow these directions closely:

1. Open the hood and check the physical condition of the battery (see page 205). In very cold weather, check the condition of the electrolyte. If it seems slushy or like ice, do not try jump starting until it thaws.

NOTICE

If a battery sits in extreme cold, the electrolyte inside can freeze. Attempting to jump start with a frozen battery can cause it to rupture.

2. Turn off all the electrical accessories: heater, A/C, stereo system, lights, etc. Put the transmission in Neutral or Park and set the parking brake.

CONTINUED

Jump Starting

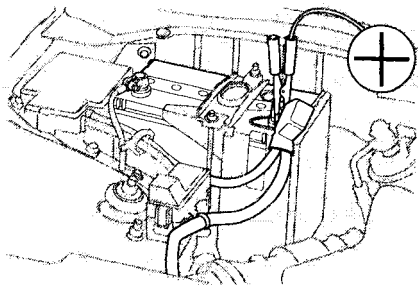

3. Connect one jumper cable to the positive (+) terminal on the booster battery. Connect the other end to the positive (+) terminal on your Honda's battery.

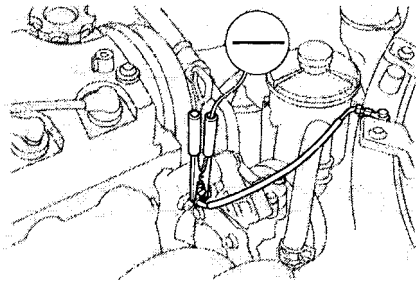

4. Connect the second jumper cable to the negative (-) terminal on the booster battery. Connect the other end to the grounding strap as shown. Do not connect this jumper cable to any other part of the engine.
5. If the booster battery is in another vehicle, have an assistant start that vehicle and run it at a fast idle.

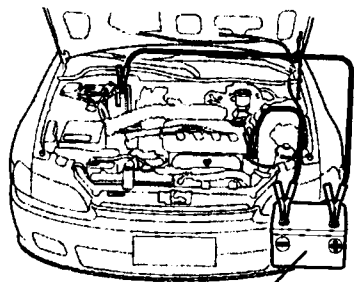

BOOSTER BATTERY

6. Start your car. If the starter motor still operates slowly, check the jumper cable connections to make sure they have good metal-to-metal contact.
7. Once your car is running, disconnect the negative cable from your car, then from the booster battery. Disconnect the positive cable from your car, then the booster battery.

The pointer of your car's temperature gauge should stay in the mid-range under most conditions. It may go higher if you are driving up a long steep hill on a very hot day. If it climbs to the red mark, you should determine the reason.

NOTICE

Driving with the temperature gauge pointer at the red mark can cause serious damage to your engine.

Your car can overheat for several reasons, such as lack of coolant or a mechanical problem. The only indication may be the temperature gauge climbing to or above the red mark. Or you may see steam or spray coming from under the hood. In either case, you should take immediate action.

Steam and spray from an overheated engine can seriously scald you.

Do not open the hood if steam is coming out.

1. Safely pull to the side of the road. Put the transmission in Neutral or Park and set the parking brake. Turn off the heating and cooling system and all other accessories. Turn on the hazard warning indicators.
2. If you see steam and/or spray coming from under the hood, turn off the engine.
3. If you do not see steam or spray, leave the engine running and watch the temperature gauge. If the high heat is due to overloading (climbing a long, steep hill on a hot day with the A/C running, for example), the engine should start to cool down almost immediately. If it does, wait until the temperature gauge comes down to the mid-point then continue driving.

CONTINUED

If Your Engine Overheats

4. If the temperature gauge stays at the red mark, turn off the engine.
5. Wait until you see no more signs of steam or spray, then open the hood.
6. Look for any obvious coolant leaks, such as a split radiator hose. Everything is still extremely hot, so use caution. If you find a leak, it must be repaired before you continue driving. (See **Emergency Towing** on page 259.)
7. If you don't find an obvious leak, check the coolant level in the radiator reserve tank (see page 147). If the level is below the MIN mark, add coolant to halfway between the MIN and MAX marks.
8. If there was no coolant in the reserve tank, you may also have to add coolant to the radiator. Let the engine cool down until the pointer

reaches the middle of the temperature gauge, or lower, before checking the radiator.

Removing the radiator cap while the engine is hot can cause the coolant to spray out, seriously scalding you.

Always let the engine and radiator cool down before removing the radiator cap.

9. Using gloves or a large heavy cloth, turn the radiator cap counterclockwise, without pushing down, to the first stop. This releases any remaining pressure in the cooling system. After the pressure releases, push down on the cap and turn it until it comes off.

10. Start the engine and set the temperature control dial to maximum. Add coolant to the radiator up to the base of the filler neck. If you do not have the proper coolant mixture available, you can add plain water. Remember to have the cooling system drained and refilled with the proper mixture as soon as you can.

11. Put the radiator cap back on tightly. Run the engine and watch the temperature gauge. If it goes back to the red mark, the engine needs repair. (See **Emergency Towing** on page 259.)

12. If the temperature stays normal, check the coolant level in the radiator reserve tank. If it has gone down, add coolant to the MAX mark. Put the cap back on tightly.

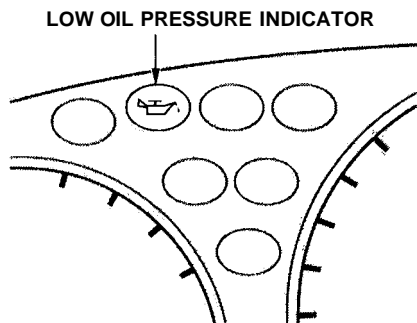

This indicator should light when the ignition switch is ON (II), and go out after the engine starts. It should never come on when the engine is running. If it starts flashing, it indicates that the oil pressure dropped very low for a moment, then recovered. If the indicator stays on with the engine running, it shows that the engine has lost oil pressure and serious engine damage is possible. In either case, you should take immediate action.

NOTICE

Running the engine with low oil pressure can cause serious mechanical damage almost immediately. Turn off the engine as soon as you can safely get the car stopped.

1. Safely pull off the road and shut off the engine. Turn on the hazard warning indicators.
2. Let the car sit for a minute. Open the hood and check the oil level (see page 146). Although oil level and oil pressure are not directly connected, an engine that is very low on oil can lose pressure during cornering and other driving maneuvers.
3. If necessary, add oil to bring the level back to the full mark on the dipstick (see page 187).

4. Start the engine and watch the oil pressure indicator. If the light does not go out within ten seconds, turn off the engine. There is a mechanical problem that needs to be repaired before you can continue driving. (See **Emergency Towing** on page 259.)

Charging System Indicator

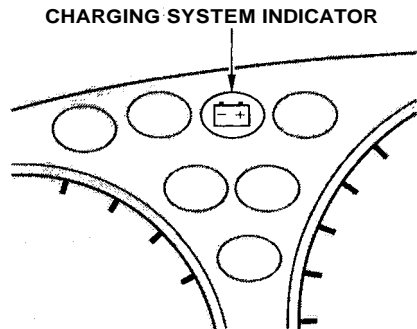

This indicator should come on when the ignition switch is ON (II), and go out after the engine starts. If it comes on brightly when the engine is running, it indicates that the charging system has stopped charging the battery.

Immediately turn off all electrical accessories: radio, heater, A/C, rear defogger, cruise control, etc. Try not to use other electrically-operated controls such as the power windows. Keep the engine running and take extra care not to stall it. Starting the engine will discharge the battery rapidly.

By eliminating as much of the electrical load as possible, you can drive several miles (kilometers) before the battery is too discharged to keep the engine running. Drive to a service station or garage where you can get technical assistance.

MALFUNCTION INDICATOR LAMP

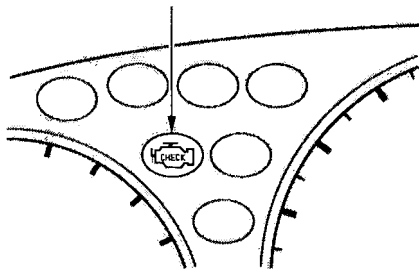

This indicator comes on for a few seconds when you turn the ignition switch ON (II). If it comes on at any other time, it indicates one of the engine's emissions control systems may have a problem. Even though you may feel no difference in your car's performance, it can reduce your fuel economy and cause your car to put out excessive emissions. Continued operation may cause serious damage.

If you have recently refueled your car, the cause of this indicator coming on could be a loose or missing fuel fill cap. Check the cap and tighten it until it clicks at least three times. Replace the fuel fill cap if it is missing. Tightening the cap will not make the indicator turn off immediately; it takes three driving trips.

If the indicator remains on past three driving trips, or the fuel cap was not loose or missing, have the car checked by the dealer as soon as possible. Drive moderately until the dealer has inspected the problem. Avoid full-throttle acceleration and driving at high speed.

You should also have the dealer inspect your car if this indicator comes on repeatedly, even though it may turn off as you continue driving.

NOTICE

If you keep driving with the malfunction indicator lamp on, you can damage your car's emissions controls and engine. Those repairs may not be covered by your car's warranties.

Brake System Indicator

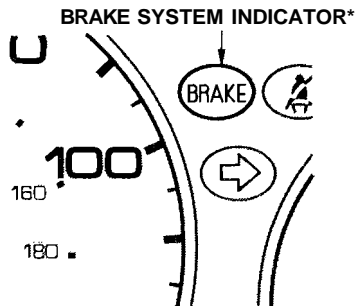

*U.S. indicator shown

The Brake System indicator light should normally come on only when the parking brake is not fully released.

If it comes on at any other time, it indicates a problem with the car's brake system. In most cases, the problem is a low fluid level in the brake fluid reservoir. Press lightly on the brake pedal to see if it feels normal. If it does, check the brake fluid level the next time you stop at a

service station (see page 198). If the fluid level is low, take the car to your dealer and have the brake system inspected for leaks or worn brake pads.

However, if the brake pedal does not feel normal, you should take immediate action. Because of the brake system's dual-circuit design, a problem in one part of the system will still give you braking at two wheels. You will feel the brake pedal go down much farther before the car begins to slow down, and you will have to press harder on the pedal. The distance needed to stop will be much longer.

Slow down by shifting to a lower gear, and pull to the side of the road when it is safe. Because of the longer distance needed to stop, it is hazardous to drive the car. You should have it towed, and repaired as soon as possible. (See **Emergency**

Towing on page 259.)

If you must drive the car a short distance in this condition, drive slowly and cautiously.

If the electric motor will not close the moonroof, do the following:

1. Check the fuse for the moonroof motor (see page 255). If the fuse is blown, replace it with one of the same or lower rating.
2. Try closing the moonroof. If the new fuse blows immediately or the moonroof motor still does not operate, you can close the moonroof manually.
3. Get the moonroof wrench out of the tool kit in the trunk.

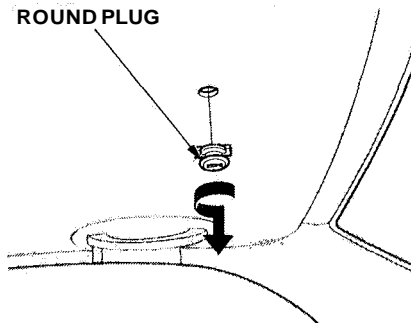

4. Use a screwdriver or coin to remove the round plug in the center of the headliner.

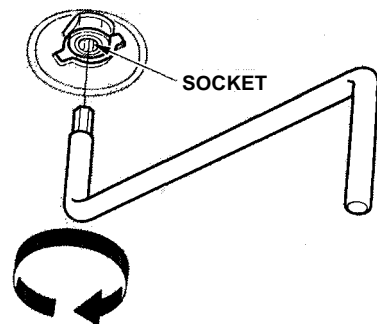

5. Insert the moonroof wrench into the socket behind this plug. Turn the wrench until the moonroof is fully closed.
6. Remove the wrench. Replace the round plug.

Fuses

All the electrical circuits in your car have fuses to protect them from a short circuit or overload. These fuses are located in three fuse boxes.

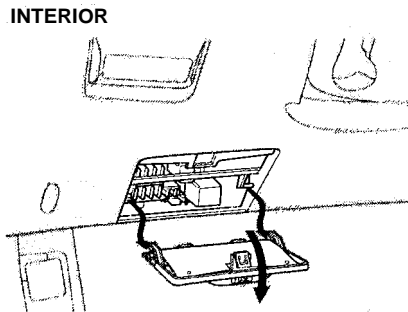

The interior fuse box is underneath the dashboard on the driver's side. Remove the fuse box lid by swinging the lid down and pulling it straight out of its hinges.

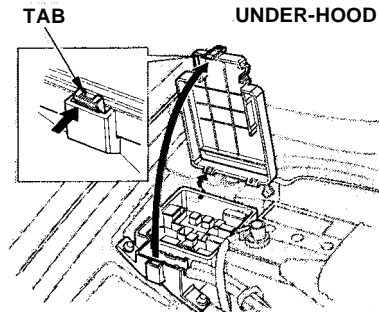

The under-hood fuse box is located in the engine compartment next to the battery. To open it, push the tab as shown.

ABS FUSE BOX

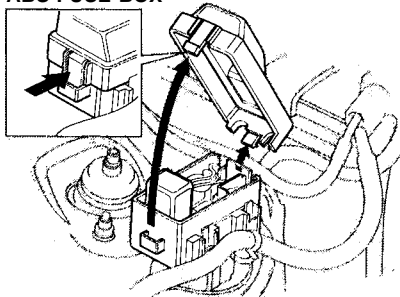

Vehicles equipped with ABS have a third fuse box for the ABS. It is in the engine compartment on the passenger's side.

Checking and Replacing Fuses

If something electrical in your car stops working, the first thing you should check for is a blown fuse. Determine from the chart on pages [257](#) and [258](#), or the diagram on the fuse box lid, which fuse or fuses control that component. Check those fuses first, but check all the fuses before deciding that a blown fuse is not the cause. Replace any blown fuses and check the component's operation.

1. Turn the ignition switch to LOCK (0). Make sure the headlights and all other accessories are off.
2. Remove the cover from the fuse box.

FUSE

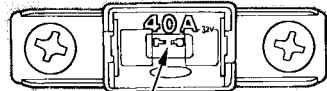

BLOWN

3. Check each of the large fuses in the under-hood fuse box by looking through the top at the wire inside. Removing these fuses requires a Phillips-head screwdriver.

CONTINUED

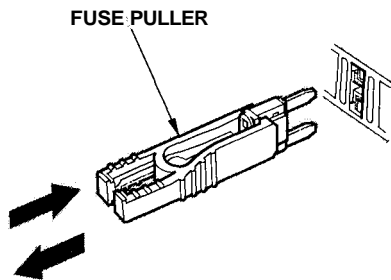

4. Check the smaller fuses in the under-hood fuse box and all the fuses in the interior fuse box by pulling out each fuse with the fuse puller provided in the interior fuse box.

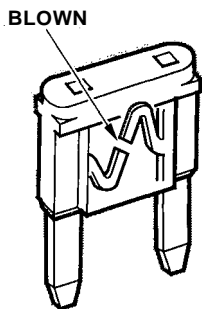

5. Look for a burned wire inside the fuse. If it is burned, replace it with one of the spare fuses of the same rating or lower.

If you cannot drive the car without fixing the problem, and you do not have a spare fuse, take a fuse of the same rating or a lower rating from one of the other circuits. Make sure you can do without that circuit temporarily (such as the cigarette lighter or radio).

If you replace the blown fuse with a spare fuse that has a lower rating, it might blow out again. This does not indicate anything wrong. Replace the fuse with one of the correct rating as soon as you can.

NOTICE

Replacing a fuse with one that has a higher rating greatly increases the chances of damaging the electrical system. If you do not have a replacement fuse with the proper rating for the circuit, install one with a lower rating.

6. If the replacement fuse of the same rating blows in a short time, there is probably a serious electrical problem in your car. Leave the blown fuse in that circuit and have your car checked by a qualified mechanic.

INTERIOR FUSE BOX

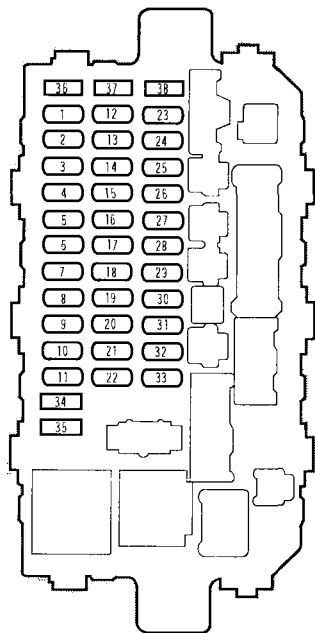

No.	Amps.	Circuits Protected
1	—	Not Used
2	—	Not Used
3	—	Not Used
4	10 A	Right Headlight High Beam
5	10 A	Left Headlight High Beam
6	—	Not Used
7	20 A	Rear Left Power Window
8	20 A	Rear Right Power Window
9	15 A	Ignition Coil
10	20 A	Front Right Power Window
11	20 A	Front Left Power Window
12	7.5 A	Turn Signal Lights
13	15 A	Fuel Pump (SRS Unit)
14	7.5 A	Cruise Control, Keyless
15	7.5 A	Alternator, SP Sensor
16	7.5 A	Rear Defroster Relay
17	7.5 A	Heater, Air Conditioning Relay
18	7.5 A	Daytime Running Light Relay*
19	7.5 A	Back-up Lights
20	10 A	Daytime Running Light*

No.	Amps.	Circuits Protected
21	10 A	Right Headlight Low Beam
22	10 A	Left Headlight Low Beam
23	10 A	SRS
24	7.5 A	Power Window Relay, Moonroof Relay
25	7.5 A	Meter
26	20 A	Front Wiper, Front Washer
27	10 A	Accessory Socket
28	10 A	Radio, Clock
29	—	Not Used
30	7.5 A	Instrument Lights
31	7.5 A	Starter Signal
32	7.5 A	License Plate Lights, Taillights
33	7.5 A	Inter Lock Unit
34	20 A	Spare Fuse
35	7.5 A	Spare Fuse
36	—	Not Used
37	10 A	Spare Fuse
38	15 A	Spare Fuse

* : On Canadian models

CONTINUED

Fuses

UNDER-HOOD FUSE BOX

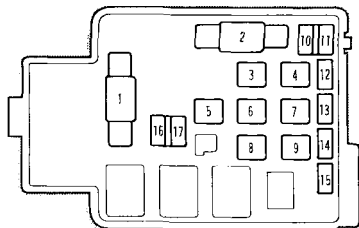

No.	Amps.	Circuits Protected
1	80 A	Battery
2	40 A	Ignition 1
3	—	Not Used
4	40 A	Power Window
5	30 A	Headlight, Small Light
6	—	Not Used
7	30 A	Rear Defroster
8	40 A	Option

No.	Amps.	Circuits Protected
9	40 A	Heater Motor
10	7.5 A	Interior Light
11	15 A	FI E/M (ECM/PCM)
12	7.5 A	Back Up, Radio
13	20 A	Door Lock Unit, Moonroof
14	20 A	Magnetic Clutch (A/C), Condenser Fan (A/C)
15	20 A	Cooling Fan
16	15 A	Horn, Stop Light
17	10 A	Hazard

ABS FUSE BOX

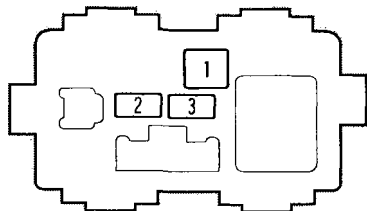

No.	Amps.	Circuits Protected
1	40 A	ABS Pump Motor
2	20 A	ABS + B
3	7.5 A	Motor Check

If your car needs to be towed, call a professional towing service or, if you belong to one, an organization that provides roadside assistance. Never tow your car behind another vehicle with just a rope or chain. It is very dangerous.

There are three popular types of professional towing equipment.

Flat-bed Equipment—The operator loads your car on the back of a truck. **This is the best way to transport your Honda.**

Wheel-Lift Equipment—The tow truck uses two pivoting arms that go under the tires (front or rear) and lift them off the ground. The other two tires remain on the ground. **This is an acceptable way to tow your Honda.**

Sling-type Equipment—The tow truck uses metal cables with hooks on the ends. These hooks go around parts of the frame or suspension and the cables lift that end of the car off the ground. Your car's suspension and body can be seriously damaged. **This method of towing is unacceptable.**

If your Honda cannot be transported by flat-bed, it should be towed by wheel-lift equipment with the front wheels off the ground. If due to damage, your car must be towed with the front wheels on the ground, do the following.

5-speed Manual Transmission

- Release the parking brake.
- Shift the transmission to Neutral.

Automatic Transmission

- Release the parking brake.
- Start the engine.
- Shift to D₄, then to N.
- Turn off the engine.

NOTICE

Improper towing preparation will damage the transmission. Follow the above procedure exactly. If you cannot shift the transmission or start the engine (automatic transmission), your car must be transported with the front wheels off the ground.

With the front wheels on the ground, it is best to tow the vehicle no farther than 50 miles (80 km), and keep the speed below 35 mph (55 km/h).

Emergency Towing

If you decide to tow your car with all four wheels on the ground, make sure you use a properly-designed and attached tow bar. Prepare the car for towing as described above, and leave the ignition switch in Accessory (I) so the steering wheel does not lock. Make sure the radio and any items plugged into the accessory power socket are turned off so they do not run down the battery.

NOTICE

The steering system can be damaged if the steering wheel is locked. Leave the ignition switch in Accessory (I), and make sure the steering wheel turns freely before you begin towing.

NOTICE

Trying to lift or tow your car by the bumpers will cause serious damage. The bumpers are not designed to support the car's weight.

The diagrams in this section give you the dimensions and capacities of your Honda, and the locations of the identification numbers. The explanations of several electronic and mechanical systems on your Honda are for the more technically-oriented owner.

Identification Numbers.....	262	Oxygenated Fuels.....	269
Specifications.....	264	Driving in Foreign Countries.....	270
Tire Information.....	266	Emissions Controls.....	271
Tire Size Designation.....	266	The Clean Air Act.....	271
Wheel Size Designation.....	266	Crankcase Emissions Control System.....	271
Tire Speed Ratings.....	266	Evaporative Emissions Control System.....	271
Tire Pressure Adjustment For High Speed Driving.....	267	Onboard Refueling Vapor Recovery.....	271
DOT Tire Quality Grading.....	267	Exhaust Emissions Controls....	272
Treadwear.....	267	PGM-FI System.....	272
Traction.....	268	Ignition Timing Control System.....	272
Temperature.....	268	Three Way Catalytic Converter.....	272
		Replacement Parts.....	272
		Three Way Catalytic Converter...	273

Identification Numbers

Your car has several identifying numbers located in various places.

The Vehicle Identification Number (VIN) is the 17-digit number your Honda dealer uses to register your car for warranty purposes. It is also necessary for licensing and insuring your car. The easiest place to find the VIN is on a plate fastened to the top of the dashboard. You can see it by looking through the windshield on the driver's side. It is also on the Certification label attached to the driver's doorjamb, and is stamped on the engine compartment bulkhead. The VIN is also provided in bar code on the Certification label.

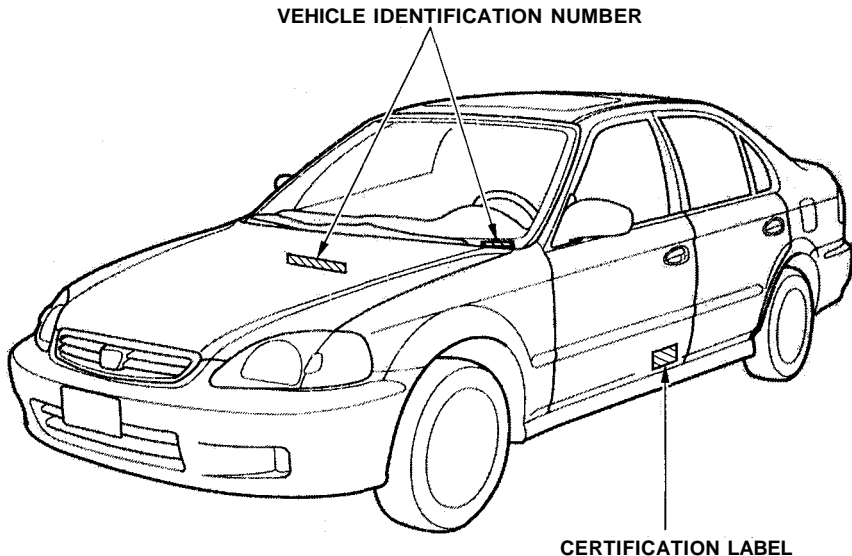

The Engine Number is stamped into the engine block.

The Transmission Number is on a label on top of the transmission.

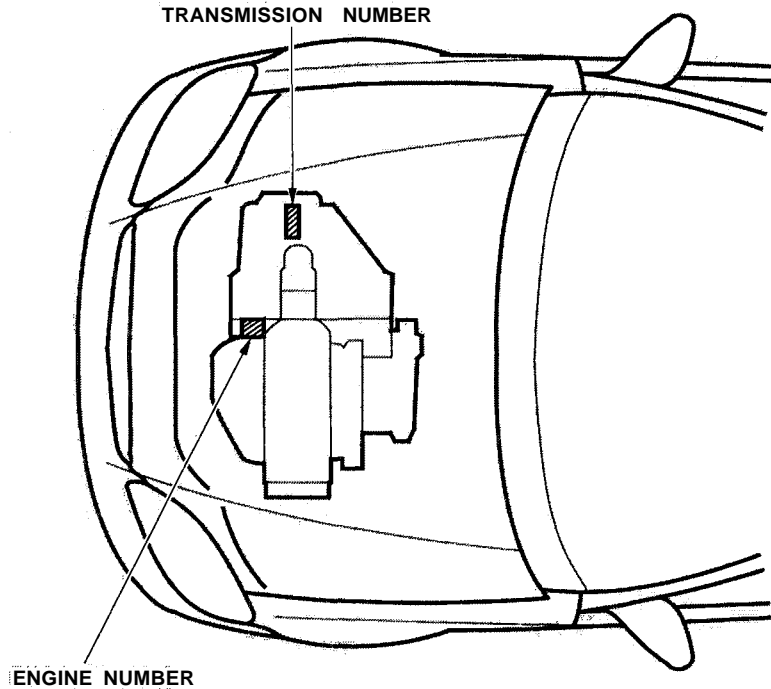

Specifications

Dimensions

Length	175.2 in (4,450 mm)
Width	66.9 in (1,700 mm)
Height	54.7 in (1,390 mm)
Wheelbase	103.1 in (2,620 mm)
Track	58.1 in (1,475 mm)
Front	58.1 in (1,475 mm)
Rear	58.1 in (1,475 mm)

Weights

Gross vehicle weight rating	See the certification label attached to the driver's doorjamb.
-----------------------------	--

Engine

Type	Water cooled 4-stroke SOHC* ¹ , SOHC VTEC* ² 4-cylinder gasoline engine
Bore x Stroke	2.95 x 3.54 in (75.0 x 90.0 mm)
Displacement	97.0 cu-in (1,590 cm ³)
Compression ratio	9.4 : 1 * ¹ 9.6 : 1 * ²
Spark plugs	See spark plug maintenance section page 204.

* 1 : U.S.: DX, Value Package, and LX, Canada: LX, EX

* 2 : U.S.: EX

Capacities

Fuel tank		Approx. 11.9 US gal (45 ℓ , 9.9 Imp gal)
Engine coolant	Change* ¹	
	Manual	0.82 US gal (3.1 ℓ , 0.68 Imp gal)
	Automatic	0.79 US gal (3.0 ℓ , 0.66 Imp gal)* ²
		0.85 US gal (3.2 ℓ , 0.70 Imp gal)* ³
Total	Manual	1.11 US gal (4.2 ℓ , 0.92 Imp gal)
	Automatic	1.08 US gal (4.1 ℓ , 0.90 Imp gal)* ²
		1.14 US gal (4.3 ℓ , 0.95 Imp gal)* ³
Engine oil	Change* ⁴	
	Including filter	3.8 US qt (3.6 ℓ , 3.2 Imp qt)* ³ 3.5 US qt (3.3 ℓ , 2.9 Imp qt)* ²
	Without filter	3.5 US qt (3.3 ℓ , 2.9 Imp qt)* ³ 3.2 US qt (3.0 ℓ , 2.6 Imp qt)* ²
	Total	4.5 US qt (4.3 ℓ , 3.8 Imp qt)* ² 3.9 US qt (3.7 ℓ , 3.3 Imp qt)* ³
Manual transmission fluid	Change	1.9 US qt (1.8 ℓ , 1.6 Imp qt)
	Total	2.0 US qt (1.9 ℓ , 1.7 Imp qt)
Automatic transmission fluid	Change	2.9 US qt (2.7 ℓ , 2.4 Imp qt)
	Total	6.2 US qt (5.9 ℓ , 5.2 Imp qt)
Windshield washer reservoir	U.S. Cars	2.6 US qt (2.5 ℓ , 2.2 Imp qt)
	Canada Cars	4.8 US qt (4.5 ℓ , 4.0 Imp qt)

* 1 : Including the coolant in the reserve tank and that remaining in the engine.

Reserve tank capacity: 0.11 US gal (0.4 ℓ , 0.09 Imp gal)

* 2 : U.S.: DX, Value Package, and LX, Canada: LX, EX

* 3 : U.S.: EX

* 4 : Excluding the oil remaining in the engine.

Air Conditioning

Refrigerant type	HFC-134a (R-134a)
Charge quantity	21.2 – 22.9 oz (600 – 650 g)
Lubricant type	SP-10

Lights

Headlights (HI/LO)	12 V – 60/55 W (HB2)
Front turn signal/side marker/ parking lights	12 V – 43/3 CP (SAE 3496) (12 V – 27/8 W)
Rear turn signal lights	12 V – 21 W
Stop/Taillights/Rear side marker lights	12 V – 21/5 W
Back-up lights	12 V – 21 W
High-mount brake light	12 V – 21 W
License plate lights	12 V – 5 W
Interior light	12 V – 5 W * ¹ 12 V – 8 W * ²
Spotlight	12 V – 5 W
Trunk light	12 V – 3.4 W

* 1 : Without moonroof

* 2 : With moonroof

Battery

Capacity	12 V – 36 AH/5 HR
	12 V – 38 AH/5 HR
	12 V – 47 AH/20 HR

Fuses

Interior	See page 257 or the fuse label attached to the inside of the fuse box door under the dashboard.
Under-hood	See page 258 or the fuse box cover.

Alignment

Toe-in	Front	0.04 in (1.0 mm)
	Rear	0.08 in (2.0 mm)
Camber	Front	0°
	Rear	–1°
Caster	Front	1°40'

Tires

Size	Front/Rear	P185/65R14 85S	
	Spare	T105/80D13 82M * ¹ T105/70D14 83M * ² T125/70D14 93M * ³	
	Pressure	Front	30 psi (210 kPa , 2.1 kgf/cm ²)
		Rear	29 psi (200 kPa , 2.0 kgf/cm ²)
	Spare	60 psi (420 kPa , 4.2 kgf/cm ²)	

* 1 : U.S.: DX, Value Package, and LX, Canada: LX without ABS

* 2 : Canada: EX without ABS

* 3 : U.S.: EX, Canada: LX with ABS, EX with ABS

Tire Information

Tire Size Designation

A tire's sidewall is marked with a tire size designation. You will need this information when selecting replacement tires for your vehicle. The following explains what the letters and numbers in the tire size designation mean.

(Example tire size designation)
P185/65R14 85S

P — Applicable vehicle type (tires marked with the prefix "P" are intended for use on passenger cars; however, not all tires have this marking).

185 — Tire width in millimeters.

65 — Aspect ratio. The tire's section height as a percentage of its width.

R — Tire construction code (Radial).

14 — Rim diameter in inches.

85 — Load Index, a numerical code associated with the maximum load the tire can carry.

S — Speed Symbol. See the speed rating chart in this section for additional information.

Wheel Size Designation

Wheels are also marked with important information that you need if you ever have to replace one. The following explains what the letters and numbers in the wheel size designation mean.

(Example wheel size designation)
14x5 J

14 — Rim diameter in inches.

5 — Rim width in inches.

J — Rim contour designation.

Tire Speed Ratings

The chart below shows many of the different speed ratings currently being used for passenger vehicle tires. The speed symbol is part of the tire size designation on the sidewall of the tire. This symbol corresponds to that tire's designed maximum safe operating speed.

Speed Rating Symbol	Maximum Speed
Q	99 mph (160 km/h)
S	112 mph (180 km/h)
T	118 mph (190 km/h)
H	130 mph (210 km/h)
V	149 mph (240 km/h)
W	168 mph (270 km/h)
ZR	Over 149 mph (240 km/h)

Tire Pressure Adjustment For High Speed Driving

Honda strongly recommends that you not drive faster than posted speed limits and conditions allow. If you decide it is safe to drive at high speeds, be sure to adjust the cold tire pressures as shown below. If you do not adjust the tire pressure, excessive heat can build up and cause sudden tire failure.

Tire Size	Cold Tire Pressure for Speeds over 100 mph (160 km/h)
P185/65R14 85S	Front: 36 psi (250 kPa , 2.5 kgf/cm ²) Rear: 35 psi (240 kPa , 2.4 kgf/cm ²)

Be sure to readjust the pressure for normal driving speeds. You should wait until the tires are cold before adjusting the tire pressure (see page 211).

DOT Tire Quality Grading (U.S. Vehicles)

The tires on your car meet all U.S. Federal Safety Requirements. All tires are also graded for treadwear, traction, and temperature performance according to Department of Transportation (DOT) standards. The following explains these gradings.

Treadwear

The treadwear grade is a comparative rating based on the wear rate of the tire when tested under controlled conditions on a specified government test course. For example, a tire graded 150 would wear one and one half (1-1/2) times as well on the government course as a tire graded 100. The relative performance of tires depends upon the actual conditions of their use, however, and may depart significantly from the norm due to variations in driving habits, service practices, and differences in road characteristics and climate.

CONTINUED

Tire Information

Traction

The traction grades, from highest to lowest, are A, B, and C, and they represent the tire's ability to stop on wet pavement as measured under controlled conditions on specified government test surfaces of asphalt and concrete. A tire marked C may have poor traction performance.

Warning: The traction grade assigned to this tire is based on braking (straight ahead) traction tests and does not include cornering (turning) traction.

Temperature

The temperature grades are A (the highest), B, and C, representing the tire's resistance to the generation of heat and its ability to dissipate heat when tested under controlled conditions on a specified indoor laboratory test wheel. Sustained high temperature can cause the material of the tire to degenerate and reduce tire life, and excessive temperature can lead to sudden tire failure. The grade C corresponds to a level of performance which all passenger car tires must meet under the Federal Motor Vehicle Safety Standard No. 109. Grades B and A represent higher levels of performance on the laboratory test wheel than the minimum required by law.

Warning: The temperature grade for this tire is established for a tire that is properly inflated and not overloaded. Excessive speed, underinflation, or excessive loading either separately or in combination, can cause heat build-up and possible tire failure.

Some conventional gasolines are being blended with alcohol or an ether compound. These gasolines are collectively referred to as oxygenated fuels. To meet clean air standards, some areas of the United States and Canada use oxygenated fuels to help reduce emissions.

If you use an oxygenated fuel, be sure it is unleaded and meets the minimum octane rating requirement.

Before using an oxygenated fuel, try to confirm the fuel's contents. Some states/provinces require this information to be posted on the pump.

The following are the U.S. EPA and Canada CGSB approved percentages of oxygenates:

ETHANOL (ethyl or grain alcohol)
You may use gasoline containing up to 10 percent ethanol by volume. Gasoline containing ethanol may be marketed under the name "Gasohol."

MTBE (Methyl Tertiary Butyl Ether)
You may use gasoline containing up to 15 percent MTBE by volume.

METHANOL (methyl or wood alcohol)
You may use gasoline containing up to 5 percent methanol by volume as long as it also contains cosolvents and corrosion inhibitors to protect the fuel system. Gasoline containing more than 5 percent methanol by volume may cause starting and/or performance problems. It may also damage metal, rubber and plastic parts of your fuel system.

If you notice any undesirable operating symptoms, try another service station or switch to another brand of gasoline.

Fuel system damage or performance problems resulting from the use of an oxygenated fuel containing more than the percentages of oxygenates given above are not covered under warranty.

Driving in Foreign Countries

If you are planning to take your Honda outside the U.S. or Canada, contact the tourist bureaus in the areas you will be traveling in to find out about the availability of unleaded gasoline with the proper octane rating.

If unleaded gasoline is not available, be aware that using leaded gasoline in your Honda will affect performance and fuel mileage, and damage its emissions controls. It will no longer comply with U.S. and Canadian emissions regulations, and will be illegal to operate in North America. To bring your car back into compliance will require the replacement of several components, such as the oxygen sensors and the three way catalytic converter. These replacements are not covered under warranty.

The burning of gasoline in your car's engine produces several byproducts. Some of these are carbon monoxide (CO), oxides of nitrogen (NOx) and hydrocarbons (HC). Gasoline evaporating from the tank also produces hydrocarbons. Controlling the production of NOx, CO, and HC is important to the environment. Under certain conditions of sunlight and climate, NOx and HC react to form photochemical "smog." Carbon monoxide does not contribute to smog creation, but it is a poisonous gas.

The Clean Air Act

The United States Clean Air Act* sets standards for automobile emissions. It also requires that automobile manufacturers explain to owners how their emissions controls work and what to do to maintain them. This section summarizes how the emissions controls work. Scheduled maintenance is on page [178](#).

* In Canada, Honda vehicles comply with the Canadian Motor Vehicle Safety Standards (CMVSS) for Emissions valid at the time they are manufactured.

Crankcase Emissions Control System

Your car has a Positive Crankcase Ventilation System. This keeps gasses that build up in the engine's crankcase from going into the atmosphere. The Positive Crankcase Ventilation valve routes them from

the crankcase back to the intake manifold. They are then drawn into the engine and burned.

Evaporative Emissions Control System

As gasoline evaporates in the fuel tank, an evaporative emissions control canister filled with charcoal adsorbs the vapor. It is stored in this canister while the engine is off. After the engine is started and warmed up, the vapor is drawn into the engine and burned during driving.

Onboard Refueling Vapor Recovery

The Onboard Refueling Vapor Recovery (ORVR) system captures the fuel vapors during refueling. The vapors are adsorbed in a canister filled with activated carbon. While driving, the fuel vapors are drawn into the engine and burned off.

Exhaust Emissions Controls

The exhaust emissions controls include three systems: PGM-FI, Ignition Timing Control and Three Way Catalytic Converter. These three systems work together to control the engine's combustion and minimize the amount of HC, CO, and NOx that comes out the tailpipe. The exhaust emissions control systems are separate from the crankcase and evaporative emissions control systems.

PGM-FI System

The PGM-FI System uses sequential multiport fuel injection. It has three subsystems: Air Intake, Engine Control, and Fuel Control. The Engine Control Module (ECM) or the Powertrain Control Module (PCM) uses various sensors to determine how much air is going into the engine. It then controls how much fuel to inject under all operating conditions.

Ignition Timing Control System

This system constantly adjusts the ignition timing, reducing the amount of HC, CO and NOx produced.

Three Way Catalytic Converter

The three way catalytic converter is in the exhaust system. Through chemical reactions, it converts HC, CO, and NOx in the engine's exhaust to carbon dioxide (CO₂), dinitrogen (N₂), and water vapor.

Replacement Parts

The emissions control systems are designed and certified to work together in reducing emissions to levels that comply with the Clean Air Act. To make sure the emissions remain low, you should use only new Genuine Acura replacement parts or their equivalent for repairs. Using lower quality parts may increase the emissions from your car.

The emissions control systems are covered by warranties separate from the rest of your car. Read your warranty manual for more information.

The three way catalytic converter contains precious metals that serve as catalysts, promoting chemical reactions to convert the exhaust gasses without affecting the metals. The catalytic converter is referred to as a three-way catalyst, since it acts on HC, CO, and NOx. A replacement unit must be an original Honda part or its equivalent.

The three way catalytic converter must operate at a high temperature for the chemical reactions to take place. It can set on fire any combustible materials that come near it. Park your car away from high grass, dry leaves, or other flammables.

(U.S.: EX)

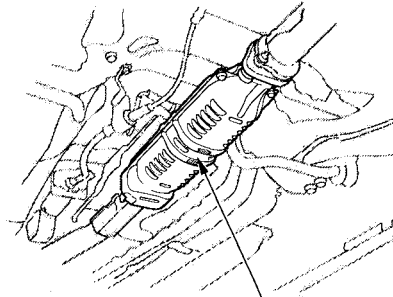

THREE WAY CATALYTIC CONVERTER

A defective three way catalytic converter contributes to air pollution, and can impair your engine's performance. Follow these guidelines to protect your car's three way catalytic converter.

- Always use unleaded gasoline. Even a small amount of leaded gasoline can contaminate the catalyst metals, making the three way catalytic converter ineffective.

(U.S.: DX, Value Package, and LX,
Canada: LX, EX)

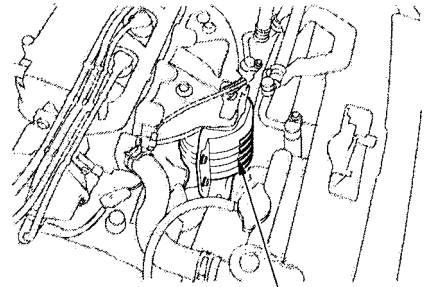

THREE WAY CATALYTIC CONVERTER

- Keep the engine tuned-up.
- Have your car diagnosed and repaired if it is misfiring, back-firing, stalling, or otherwise not running properly.

Customer Relations	
Information.....	276
U.S. Zone Office Map.....	277
Canada Zone Office Map.....	278
Warranty Coverages.....	279
Reporting Safety Defects	
(U.S. Vehicles).....	280
Authorized Manuals.....	281

Customer Relations Information

Honda dealership personnel are trained professionals. They should be able to answer all your questions. If you encounter a problem that your dealership does not solve to your satisfaction, please discuss it with the dealership's management. The Service Manager or General Manager can help. Almost all problems are solved in this way.

If you are dissatisfied with the decision made by the dealership's management, contact your Honda Customer Relations Zone Office. Refer to the U.S. and Canadian Zone Office maps on the following pages.

When you call or write, please give us this information:

- Vehicle Identification Number (see page [262](#))
- Name and address of the dealer who services your car
- Date of purchase
- Mileage on your car
- Your name, address, and telephone number
- A detailed description of the problem
- Name of the dealer who sold the car to you

U.S. Owners

Your new Honda is covered by these warranties:

New Car Limited Warranty — covers your new vehicle, except for the battery, emissions control systems and accessories, against defects in materials and workmanship.

Emissions Control Systems Defects Warranty and Emissions Performance Warranty — these two warranties cover your vehicle's emissions control systems. Time, mileage, and coverage are conditional. Please read the warranty manual for exact information.

Original Equipment Battery Limited Warranty — this warranty gives up to 100 percent credit toward a replacement battery.

Seat Belt Limited Warranty — a seat belt that fails to function properly is covered for the useful life of the vehicle.

Rust Perforation Limited Warranty — all exterior body panels are covered for rust-through from the inside for the specified time period with no mileage limit.

Accessory Limited Warranty — Genuine Honda Accessories are covered under this warranty. Time and mileage limits depend on the type of accessory and other factors. Please read your warranty manual for details.

Replacement Parts Limited Warranty — covers all Genuine Honda replacement parts against defects in materials and workmanship.

Replacement Battery Limited Warranty — provides prorated coverage for a replacement battery purchased from a Honda dealer.

Replacement Muffler Lifetime Limited Warranty — provides coverage for as long as the purchaser of the muffler owns the car. Restrictions and exclusions apply to all these warranties. Please read the 1999 Honda Warranty Information booklet that came with your car for precise information on warranty coverages. Your Honda's original tires are covered by their manufacturer. Tire warranty information is in a separate booklet.

Canadian Owners

Please refer to the 1999 Warranty Manual that came with your car.

Reporting Safety Defects (U.S. Vehicles)

If you believe that your vehicle has a defect which could cause a crash or could cause injury or death, you should immediately inform the National Highway Traffic Safety Administration (NHTSA) in addition to notifying American Honda Motor Co., Inc.

If NHTSA receives similar complaints, it may open an investigation, and if it finds that a safety defect exists in a group of vehicles, it may order a recall and remedy campaign. However, NHTSA cannot become involved in individual problems between you, your dealer, or American Honda Motor Co., Inc.

To contact NHTSA, you may either call the Auto Safety Hotline toll-free at 1-800424-9393 (or 366-0123 in Washington D.C. area) or write to: NHTSA, U.S. Department of Transportation, Washington, D.C. 20590. You can also obtain other information about motor vehicle safety from the Hotline.

A

Accessories and Modifications....	149
Accessories.....	149
Additional Safety Precaution....	150
Modifications.....	150
ACCESSORY (Ignition Key Position).....	70
Accessory Power Socket.....	86
Adding	
Automatic Transmission Fluid.....	197
Brake Fluid.....	198
Clutch Fluid.....	199
Engine Coolant.....	191
Engine Oil.....	187
Manual Transmission Fluid	198
Power Steering Fluid.....	200
Windshield Washer Fluid.....	196
Additional Information About Your Seat Belts.....	42
Lap Belt.....	43
Lap/Shoulder Belt.....	42
Seat Belt Maintenance.....	45
Seat Belt System Components...	42

Additional Information About Your SRS.....	45
Additional Safety Precautions....	48
How Your Airbags Work.....	45
How Your SRS Indicator Works.....	47
SRS Components.....	45
Additives, Engine Oil.....	188
Adjustments	
Head Restraints.....	78
Mirrors.....	83
Seats.....	76
Steering Wheel.....	65
Airbag (SRS).....	9
Air Cleaner Element.....	201
Air Conditioning.....	90
Maintenance.....	209
Usage.....	90
Air Outlets (Vents).....	92
Air Pressure, Tires.....	211
High Speed Driving.....	267
Normal Driving.....	212
Alcohol in Gasoline.....	269
Antifreeze.....	191
Anti-lock Brakes (ABS) Indicator Light.....	55, 168

Operation.....	167
Anti-theft Steering Column Lock.....	70
Appearance Care.....	231
Ashtrays (Optional).....	86
Audio System.....	98, 107, 121
Automatic Speed Control.....	66
Automatic Transmission.....	160
Capacity, Fluid.....	264
Checking Fluid Level.....	197
Shifting.....	161
Shift Lever Position Indicator..	160
Shift Lever Positions.....	161
Shift Lock Release.....	164

B

Battery	
Charging System Indicator.....	55, 250
Jump Starting.....	245
Maintenance.....	205
Specifications.....	265

CONTINUED

Index

Before Driving..... 141
Belts, Seat..... 8
Beverage Holder..... 85
Body Repairs..... 236
Brakes
 Anti-lock System (ABS)..... 167
 Break-in, New Linings 142
 Fluid..... 198
 Light, Burned-out..... 223
 Parking..... 83
 System Indicator..... 55
 Wear Indicators..... 166
Brakes, ABS
 Operation..... 167
 System Indicator..... 55,168
Braking System..... 166
Break-in, New Car..... 142
Brightness Control, Instruments... 62
Brights, Headlights..... 61
Bulb Replacement
 Back-up Lights..... 224
 Brake Lights..... 223
 Front Parking Lights..... 222
 Front Side Marker Lights..... 222
 Headlights..... 220
 High-mount Brake Light..... 225

Interior Light..... 226
License Plate Lights..... 226
Rear Side Marker Lights..... 223
Specifications..... 265
Trunk Light..... 227
Turn Signal Lights..... 222
Bulbs, Halogen..... 220

C

Cables, Jump Starting With..... 246
Capacities Chart..... 264
Carbon Monoxide Hazard..... 49
Carrying Cargo..... 151
Cassette Player
 Care 139
 Operation..... 102, 113, 135
CAUTION, Explanation of..... ii
CD Changer..... 104, 117, 131
CD Player..... 104,129
Certification Label..... 262
Chains..... 217
Change Oil
 How to..... 189
 When to..... 178
Changing a Flat Tire..... 239

Changing Engine Coolant..... 193
Charging System Indicator 55, 250
Checking
 Automatic Transmission
 Fluid..... 197
 Battery Condition..... 205
 Brake Fluid..... 198
 Clutch Fluid..... 199
 Drive Belts..... 210
 Engine Coolant..... 147
 Engine Oil..... 146
 Fuses..... 255
 Manual Transmission Fluid 198
 Power Steering Fluid..... 200
Checklist, Before Driving..... 156
Childproof Door Locks..... 75
Cleaner, Air..... 201
Cleaning
 Exterior..... 232
 Interior..... 234
 Seat Belts..... 234
 Vinyl..... 234
 Windows..... 235
Clock, Setting the..... 101, 112, 126
Clutch Fluid..... 199
CO in the Exhaust..... 271

Cold Weather, Starting in.....	157
Compact Spare.....	238
Consumer Information*.....	276
Controls, Instruments and.....	51
Coolant	
Adding.....	191
Checking.....	147
Proper Solution.....	191
Replacing.....	193
Temperature Gauge.....	58
Corrosion Protection.....	235
Crankcase Emissions Control	
System.....	271
Cruise Control Operation.....	66
Customer Relations Office.....	276

D

DANGER, Explanation of.....	ii
Dashboard.....	52
Daytime Running Lights.....	61
Dead Battery, What to Do.....	245
Defects, Reporting Safety.....	280
Defog and Defrost.....	95
Defogger, Rear Window.....	64
Defrosting the Windows.....	95

DEXRON® III Automatic	
Transmission Fluid.....	197
Dimensions.....	264
Dimming the Headlights.....	61
Dipstick	
Automatic Transmission.....	197
Engine Oil.....	146
Directional Signals.....	62
Disabled, Towing Your Car If.....	259
Disc Brake Wear Indicators.....	166
Disposal of Used Oil.....	190
Doors	
Locking and Unlocking.....	70
Power Door Locks.....	71
DOT Tire Quality Grading.....	267
Downshifting, 5-speed Manual	
Transmission.....	158
Driver and Passenger Safety.....	5
Drive Belts.....	210
Driving.....	155
Economy.....	148
In Bad Weather.....	170
In Foreign Countries.....	270

E

Economy, Fuel.....	148
Emergencies on the Road.....	237
Battery, Jump Starting.....	245
Brake System Indicator.....	252
Changing a Flat Tire.....	239
Charging System Indicator.....	250
Checking the Fuses.....	255
Low Oil Pressure Indicator.....	249
Malfunction Indicator Lamp....	251
Manually Closing Moonroof....	253
Overheated Engine.....	247
Emergency Brake.....	83
Emergency Flashers.....	64
Emergency Towing.....	259
Emissions Controls.....	271
Engine	
Coolant Temperature Gauge	58
Malfunction Indicator	
Lamp.....	56, 251
Oil Pressure Indicator.....	55, 249
Oil, What Kind to Use.....	187
Overheating.....	247
Specifications.....	264

CONTINUED

Index

Ethanol in Gasoline	269
Evaporative Emissions Controls..	271
Exhaust Fumes.....	49
Expectant Mothers, Use of Seat Belts by.....	19
Exterior, Cleaning the.....	232

F

Fabric, Cleaning.....	234
Fan, Interior.....	90
Features, Comfort and Convenience.....	89
Filling the Fuel Tank.....	143
Filters	
Air.....	201
Oil.....	189
5-speed Manual Transmission	
Checking Fluid Level.....	198
Shifting the.....	158
Flashers, Hazard Warning.....	64
Flat Tire, Changing a.....	239
Fluids	
Automatic Transmission.....	197
Brake.....	198
Clutch.....	199

Manual Transmission.....	198
Power Steering.....	200
Windshield Washer.....	196
FM Stereo Radio	
Reception.....	127
Folding Rear Seat.....	79
Foreign Countries, Driving in.....	270
Four-way Flashers.....	64
Front End, Towing by	
Emergency Wrecker.....	259
Fuel.....	142
Fill Door and Cap.....	143
Gauge.....	58
Octane Requirement.....	142
Oxygenated.....	269
Reserve Indicator.....	56
Tank, Filling the.....	143
Fuses, Checking the.....	255

G

Gas Mileage, Improving.....	148
Gasohol.....	259
Gasoline.....	142
Fuel Reserve Indicator.....	56
Gauge.....	58

Octane Requirement.....	142
Tank, Filling the.....	143
Gas Station Procedures.....	143
Gauges	
Engine Coolant Temperature	58
Fuel.....	58
Gearshift Lever Positions	
Automatic Transmission.....	161
5-speed Manual Transmission.....	158
Glass Cleaning.....	235
Glove Box.....	84

H

Halogen Headlight Bulbs.....	220
Hazard Warning Flashers.....	64
Headlights	
Daytime Running Lights.....	61
High Beam Indicator.....	56
High Beams, Turning on.....	61
Low Beams, Turning on.....	61
Reminder Beeper.....	61
Replacing Halogen Bulbs	220
Turning on.....	61
Head Restraints.....	78

Heating and Cooling..... 90
 High Altitude, Starting at..... 157
 High-Low Beam Switch.....61
 High-mount Brake Light..... 225
 Hood, Opening the 144
 Horn..... 60
 Hot Coolant, Warning about..... 191
 Hydraulic Clutch..... 199
 Hydroplaning..... 171

I

Identification Number, Vehicle.... 262
 If Your Car Has to be Towed..... 259
 Ignition
 Keys.....69
 Switch..... 69
 Timing Control System..... 272
 Important Safety Precautions 6
 Indicator Lights, Instrument
 Panel..... 53
 Infant Restraint..... 29
 Inflation, Proper Tire 211
 High Speed Driving..... 267
 Normal Driving..... 212
 Inside Mirror..... 82

Inspection, Tire..... 213
 Instrument Panel..... 52
 Instrument Panel Brightness..... 62
 Interior Cleaning..... 234
 Interior Light..... 87
 Introduction..... i

J

Jacking up the Car..... 240
 Jack, Tire..... 239
 Jump Starting..... 245

K

Keys..... 69

L

Label, Certification..... 261
 Lane Change, Signaling..... 62
 Lap Belt..... 43
 Lap/Shoulder Belts..... 42
 Leaking of Exhaust into Car..... 49
 Lights
 Bulb Replacement..... 220

Indicator..... 53
 Parking..... 61
 Turn Signal..... 62
 LOCK (Ignition Key Position)..... 70
 Locks
 Anti-theft Steering Column..... 70
 Fuel Fill Door..... 143
 Power Door..... 71
 Trunk..... 75
 Low Coolant Level..... 147
 Low Fuel Indicator..... 56
 Lower Gear, Downshifting to a.... 158
 Low Oil Pressure Indicator.... 55, 249
 Lubricant Specifications Chart.... 264
 Luggage..... 151

M

Maintenance..... 173
 Owner Maintenance Checks.... 185
 Record..... 183-184
 Required Indicator..... 59
 Safety..... 174
 Schedule..... 178-182

CONTINUED

Index

Malfunction Indicator Lamp.. 56, 251
Manual Transmission..... 158
Manual Transmission Fluid 198
Meters, Gauges..... 57
Methanol in Gasoline..... 269
Mirrors, Adjusting..... 82
Moonroof..... 82
 Closing Manually..... 253
 Operation..... 82

N

Neutral Gear Position..... 162
New Vehicle Break-in 142
Normal Shift Speeds..... 158
NOTICE, Explanation of..... i
Numbers, Identification..... 262

O

Octane Requirement, Gasoline.... 142
Odometer..... 57
Odometer, Trip..... 57
Oil
 Change, How to..... 189
 Change, When to..... 178

Checking Engine..... 146
Pressure Indicator..... 55, 249
Selecting Proper Viscosity
 Chart..... 188
ON (Ignition Key Position)..... 70
Onboard Refueling Vapor
 Recovery 271
Opening the Hood..... 144
Opening the Trunk..... 75
Operation in Foreign Countries... 270
Outside Mirrors..... 82
Overheating, Engine..... 247

P

Panel Brightness Control..... 62
Park Gear Position..... 161
Parking..... 165
Parking Brake..... 83
Parking Lights..... 61
Parking Over Things that Burn... 273
PGM-FI System..... 272
Polishing and Waxing..... 233
Power
 Door Locks..... 71
 Mirrors..... 82
 Steering..... 200

Windows..... 80
Pre-Drive Safety Checklist..... 11
Pregnancy, Using Seat Belts..... 19
Protecting Adults..... 12
 Additional Safety Precautions.... 19
 Advice for Pregnant Women..... 19
Protecting Children..... 21
 Protecting Infants..... 29
 Protecting Larger Children..... 37
 Protecting Small Children..... 33
 Using Child Seats with
 Tethers..... 40

R

Radiator Overheating..... 247
Radio/CD/Cassette
 Sound System 98,107,121
Rear End Towing..... 259
Rear Lights, Bulb Replacement... 223
Rear Seat, Folding..... 79
Rear View Mirror..... 82
Rear Window Defogger..... 64
Reclining the Seat Backs..... 77
Recommended Shift Speeds 158
Reminder Lights..... 53

Remote Transmitter..... 72

Replacement Information

 Air Cleaner Element..... 201

 Coolant..... 193

 Engine Oil and Filter..... 189

 Fuses..... 255

 Light Bulbs..... 220

 Schedule..... 176

 Spark Plugs..... 203

 Timing Belt..... 210

 Tires..... 215

 Wiper Blades..... 207

Replacing Seat Belts After a

 Crash..... 45

Reserve Tank, Engine Coolant... 147

Restraint, Child..... 21

Reverse Gear Position..... 162

Rotation, Tire..... 214

S

Safety Belts..... 8

Safety Defects, Reporting* 280

Safety Features..... 7

 Airbags..... 9

 Door Locks..... 11

Head Restraints..... 10

Seat Belts..... 8

 Seats & Seat-Backs..... 10

Safety Labels, Location of..... 50

Safety Messages..... ii

Seat Belt, Additional Information.. 42

 Lap Belt..... 43

 Lap/Shoulder Belt..... 42

 Seat Belt Maintenance..... 45

 Seat Belt System Components.. 42

Seat Belts..... 8

 Cleaning..... 234

 Maintenance..... 45

 Reminder Light and Beeper..... 54

 System Components..... 42

 Tether Attachment Points..... 40

 Use During Pregnancy..... 19

Seats, Adjusting the..... 76

Serial Number..... 262

Service Intervals..... 178

Service Manual* 281

Service Station Procedures 143

Setting the Clock.....101, 112, 126

Shifting

 The Automatic Transmission .. 160

The 5-speed Manual

 Transmission..... 158

Shift Lever Position Indicator..... 160

Shift Lock Release..... 164

Side Marker Lights, Bulb

 Replacement in..... 222

Signaling Turns..... 62

Snow Tires..... 216

Solvent-type Cleaners..... 232

Sound System..... 98, 107, 121

Spare Tire

 Inflating..... 238

 Specifications..... 265

Spark Plugs, Replacing..... 203

Specifications Charts..... 264

Speed Control..... 66

Speedometer..... 57

CONTINUED

Index

SRS, Additional Information.....	45
Additional Safety Precautions....	48
How Your Airbags Work.....	45
How Your SRS Indicator Works.....	47
SRS Components.....	45
SRS Service.....	47
SRS Indicator.....	47, 55
START (Ignition Key Position).....	70
Starting the Engine.....	157
In Cold Weather at High Altitude.....	157
With a Dead Battery	245
Steam Coming from Engine.....	247
Steering Wheel Adjustment.....	65
Anti-theft Column Lock.....	70
Stereo Sound System.....	98, 107, 121
Storing Your Car.....	229
Supplemental Restraint System.....	45
Servicing.....	47
SRS Indicator.....	47, 55
System Components.....	45
Synthetic Oil.....	188

T

Tachometer.....	57
Taillights, Changing Bulbs in.....	223
Taking Care of the Unexpected ..	237
Tape Player.....	102, 113, 135
Technical Descriptions	
Driving in Foreign Countries... ..	270
Emissions Control Systems.....	271
Oxygenated Fuels.....	269
Three Way Catalytic Converter.....	273
Tire Information.....	266
Temperature Gauge.....	58
Tether Attachment Points.....	40
Three Way Catalytic Converter... ..	273
Time, Setting the.....	101, 112, 126
Timing Belt.....	210
Tire Chains.....	217
Tire, How to Change a Flat.....	239
Tires.....	211
Air Pressure.....	211
Checking Wear.....	213
Compact Spare.....	238
DOT Tire Quality Grading.....	267
Inflation.....	211

Inspection.....	213
Maintenance.....	213
Replacing.....	215
Rotating.....	214
Snow.....	216
Specifications.....	265
Technical Information.....	266
Technical Information.....	261
Tools, Tire Changing.....	239
Towing	
A Trailer.....	171
Emergency Wrecker.....	259
Transmission	
Checking Fluid Level, Automatic.....	197
Checking Fluid Level, Manual.....	198
Fluid Selection.....	197, 198
Identification Number.....	262
Shifting the Automatic.....	160
Shifting the Manual.....	158
Treadwear.....	267
Trip Meter.....	57
Trunk.....	75
Opening.....	75
Open Monitor Light	56

Turn Signals..... 62

U

Underside, Cleaning..... 235

Unexpected, Taking Care
of the.....237

Uniform Tire Quality Grading..... 267

Unleaded Gasoline..... 142

Upholstery Cleaning..... 234

Used Oil, How to Dispose of..... 190

V

Vehicle Capacity Load 151

Vehicle Dimensions..... 264

Vehicle Identification Number..... 262

Vehicle Storage..... 229

Ventilation..... 92

VIN..... 262

Vinyl Cleaning..... 234

Viscosity, Oil..... 188

W

Warning Bleepers

Headlights on..... 61

Key in Ignition..... 70

Seat Belts..... 54

WARNING, Explanation of..... ii

Warning Labels, Location of..... 50

Warranty Coverages* 279

Washer, Windshield

Checking the Fluid Level..... 196

Operation..... 63

Washing..... 232

Waxing and Polishing..... 233

Wheels

Adjusting the Steering..... 65

Alignment and Balance..... 213

Compact Spare..... 238

Wrench..... 240

Windows

Cleaning..... 235

Operating the Power..... 80

Rear, Defogger..... 64

Windshield

Cleaning..... 63

Defroster..... 95

Wipers, Windshield

Changing Blades..... 207

Operation..... 63

Worn Tires..... 213

Wrecker, Emergency Towing..... 259

* : U.S. and Canada only

Service Information Summary

Gasoline:

Unleaded gasoline, pump octane number of 86 or higher.

Fuel Tank Capacity:

11.9 US gal (45 l , 9.9 Imp gal)

Recommended Engine Oil:

API Service SJ "Energy Conserving" oil, SAE 5W-30 viscosity (see page [151](#)).

Oil change capacity (including filter):

- U.S. DX, Value Package, and LX,
Canada LX, EX
3.8 US qt (3.6 l , 3.2 Imp qt)
- U.S. EX
3.5 US qt (3.3 l , 2.9 Imp qt)

Automatic Transmission Fluid:

Honda Premium Formula Automatic Transmission Fluid preferred, or a DEXRON® III ATF as a temporary replacement (see page [197](#)).

5-speed Manual Transmission Fluid:

Honda Manual Transmission Fluid preferred, or an API service SG, SH or SJ, SAE 10W-30 or 10W-40 motor oil as a temporary replacement (see page [198](#)).

Capacity (including differential):

1.9 US qt (1.8 l , 1.6 Imp qt)

Power Steering Fluid:

Genuine Honda Power Steering Fluid preferred, or another brand of power steering fluid as a temporary replacement. Do not use ATF (see page [200](#)).

Brake Fluid:

Genuine Honda DOTS Brake Fluid preferred, or a DOT 3 or DOT 4 brake fluid as a temporary replacement (see page [199](#)).

Tire Pressure (measured cold):

Front:

30psi(210kPa,2.1 kgf/cm²)

Rear:

29 psi (200 kPa , 2.0 kgf/cm²)