

Congratulations! Your selection of a 2008 Honda Odyssey was a wise investment. It will give you years of driving pleasure.

One of the best ways to enhance the enjoyment of your new vehicle is to read this manual. In it, you will learn how to operate its driving controls and convenience items. Afterwards, keep this owner's manual in your vehicle so you can refer to it at any time.

Several warranties protect your new vehicle. Read the warranty booklet thoroughly so you understand the coverages and are aware of your rights and responsibilities.

Maintaining your vehicle according to the schedules given in this manual helps to keep your driving trouble-free while it preserves your investment. When your vehicle needs maintenance, keep in mind that your dealer's staff is specially trained in servicing the many systems unique to your vehicle. Your dealer is dedicated to your satisfaction and will be pleased to answer any questions and concerns.

As you read this manual, you will find information that is preceded by a **NOTICE** symbol. This information is intended to help you avoid damage to your vehicle, other property, or the environment.

Introduction

California Proposition 65 Warning

WARNING: This product contains or emits chemicals known to the State of California to cause cancer and birth defects or other reproductive harm.

Event Data Recorders

This vehicle is equipped with one or more devices commonly referred to as event data recorders. These devices record front seat belt use, front passenger seat occupancy, airbag deployment data, and the failure of any airbag system component. This data belongs to the vehicle owner and may not be accessed by anyone else except as legally required or with the permission of the vehicle owner.

Service Diagnostic Recorders

This vehicle is equipped with service-related devices that record information about powertrain performance. The data can be used to verify emissions law requirements and/or help technicians diagnose and solve service problems. It may also be combined with data from other sources for research purposes, but it remains confidential.

Your safety, and the safety of others, is very important. And operating this vehicle safely is an important responsibility.

To help you make informed decisions about safety, we have provided operating procedures and other information on labels and in this manual. This information alerts you to potential hazards that could hurt you or others.

Of course, it is not practical or possible to warn you about all the hazards associated with operating or maintaining your vehicle. You must use your own good judgement.

You will find this important safety information in a variety of forms, including:

- **Safety Labels** - on the vehicle.
- **Safety Messages** - preceded by a safety alert symbol  and one of three signal words: **DANGER**, **WARNING**, or **CAUTION**. These signal words mean:

 **DANGER**

You **WILL** be **KILLED** or **SERIOUSLY HURT** if you don't follow instructions.

 **WARNING**

You **CAN** be **KILLED** or **SERIOUSLY HURT** if you don't follow instructions.

 **CAUTION**

You **CAN** be **HURT** if you don't follow instructions.

- **Safety Headings** - such as Important Safety Reminders or Important Safety Precautions.
- **Safety Section** - such as Driver and Passenger Safety.
- **Instructions** - how to use this vehicle correctly and safely.

This entire book is filled with important safety information - please read it carefully.

Owner's Identification Form

Introduction	i
A Few Words About Safety	iii
Your Vehicle at a Glance (main controls)	3
Driver and Passenger Safety (seat belts, SRS, and child protection)	5
Instruments and Controls (indicators, gauges, dashboard, and steering column)	63
Features (climate control, audio, steering wheel, rear entertainment, security, cruise control and HomeLink).....	209
Before Driving (fuel, vehicle break-in, and cargo loading)	359
Driving (engine and transmission operation)	375
Maintenance (minder, fluid checking, minor services, and vehicle storage).....	405
Taking Care of the Unexpected (flat tire, dead battery, overheating, and fuses)	453
Technical Information (vehicle specifications, tires, and emissions controls)	483
Warranty and Customer Relations (U. S. and Canada only) (warranty and contact information)	501
Authorized Manuals (U. S. only) (how to order)	505
Index	I

Service Information Summary (fluid capacities and tire pressures)

Overview of Contents

Contents

A convenient reference to the sections in this manual.

Your Vehicle at a Glance

A quick reference to the main controls in your vehicle.

Driver and Passenger Safety

Important information about the proper use and care of your vehicle's seat belts, an overview of the supplemental restraint system, and valuable information on how to protect children with child restraints.

Instruments and Controls

Explains the purpose of each instrument panel indicator and gauge, and how to use the controls on the dashboard and steering column.

Features

How to operate the heating and cooling system/climate control system, the audio system, rear entertainment and other

convenience features.

Before Driving

What gasoline to use, how to break-in your new vehicle, and how to load luggage and other cargo.

Driving

The proper way to start the engine, shift the transmission, and park; plus what you need to know if you're planning to tow a trailer.

Maintenance

The maintenance minder shows you when you need to take your vehicle to the dealer for maintenance service. There is also a list of things to check and instructions on how to check them.

Taking Care of the Unexpected

This section covers several problems motorists sometimes experience, and details how to handle them.

Technical Information

ID numbers, dimensions, capacities, and technical information.

Warranty and Customer Relations

(U.S. and Canada only)

A summary of the warranties covering your new vehicle, and how to contact us for any reason. Refer to your warranty manual for detailed information.

Authorized Manuals

(U.S. only)

How to order manuals and other technical literature.

Index

Service Information Summary

A summary of the information you need when you pull up to the fuel pump.

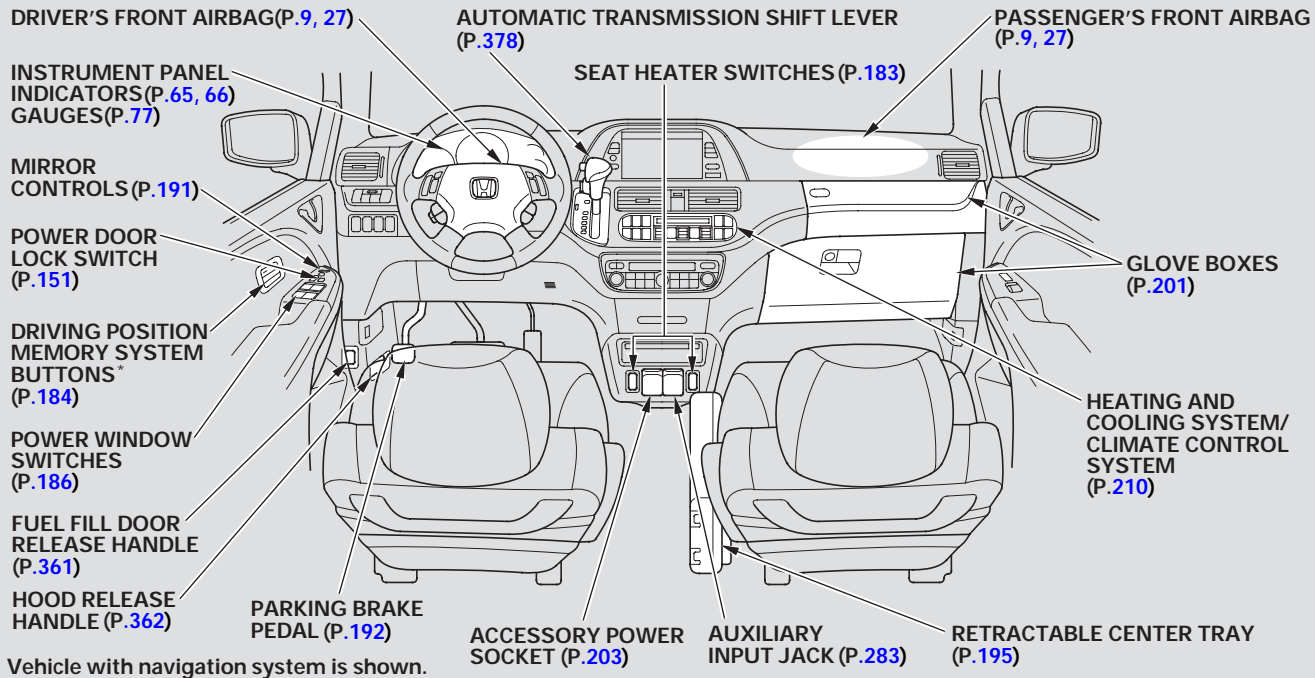

* : If equipped

Your Vehicle at a Glance

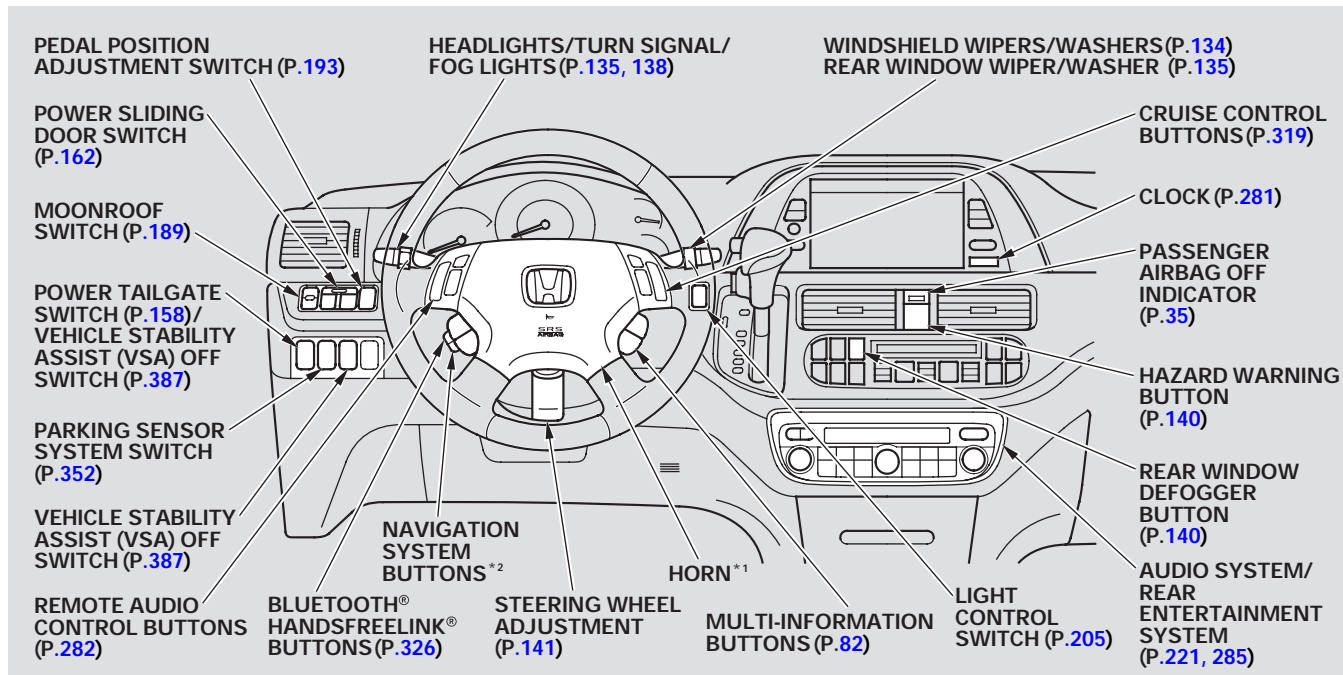

* 1: To use the horn, press the center pad of the steering wheel.

* 2: Only on vehicles equipped with navigation system. Refer to the navigation system manual.

This section gives you important information about how to protect yourself and your passengers. It shows you how to use seat belts. It explains how your airbags work. And it tells you how to properly restrain infants and children in your vehicle.

Important Safety Precautions	6
Your Vehicle's Safety Features.....	7
Seat Belts.....	8
Airbags.....	9
Protecting Adults and Teens.....	11
1. Close and Lock the Doors	11
2. Adjust the Front Seats	12
3. Adjust the Seat-Backs	13
4. Adjust the Head Restraints	14
5. Fasten and Position the Seat Belts	15
6. Maintain a Proper Sitting Position	18
Advice for Pregnant Women.....	19
Additional Safety Precautions....	19

Additional Information About Your Seat Belts.....	21
Seat Belt System Components...	21
Lap/Shoulder Belt.....	22
Automatic Seat Belt Tensioners.....	23
Seat Belt Maintenance.....	24
Additional Information About Your Airbags.....	25
Airbag System Components.....	25
How Your Front Airbags Work.....	27
How Your Side Airbags Work....	31
How Your Side Curtain Airbags Work.....	33
How the SRS Indicator Works...	34
How the Side Airbag Off Indicator Works.....	35
How the Passenger Airbag Off Indicator Works.....	35
Airbag Service.....	36
Additional Safety Precautions....	37
Protecting Children - General Guidelines.....	38
All Children Must Be Restrained	38

All Children Should Sit in a Back Seat.....	39
The Passenger's Front Airbag Can Pose Serious Risks	39
If You Must Drive with Several Children	41
If a Child Requires Close Attention.....	41
Additional Safety Precautions....	41
Protecting Infants and Small Children	43
Protecting Infants.....	43
Protecting Small Children	44
Selecting a Child Seat.....	46
Installing a Child Seat	47
With LATCH.....	48
With a Lap/Shoulder Belt	51
With a Tether.....	53
Protecting Larger Children.....	56
Checking Seat Belt Fit.....	56
Using a Booster Seat.....	57
When Can a Larger Child Sit in Front.....	58
Additional Safety Precautions....	59
Carbon Monoxide Hazard	60
Safety Labels	61

Important Safety Precautions

You'll find many safety recommendations throughout this section, and throughout this manual. The recommendations on this page are the ones we consider to be the most important.

Always Wear Your Seat Belt

A seat belt is your best protection in all types of collisions. Airbags are designed to supplement seat belts, not replace them. So even though your vehicle is equipped with airbags, make sure you and your passengers always wear your seat belts, and wear them properly (see page 15).

Restrain All Children

Children age 12 and under should ride properly restrained in a back seat, not the front seat. Infants and small children should be restrained in a child seat. Larger children should use a booster seat and a lap/shoulder belt until they can use the belt properly without a booster seat (see pages 38 - 59).

Be Aware of Airbag Hazards

While airbags can save lives, they can cause serious or fatal injuries to occupants who sit too close to them, or are not properly restrained. Infants, young children, and short adults are at the greatest risk. Be sure to follow all instructions and warnings in this manual.

Don't Drink and Drive

Alcohol and driving don't mix. Even one drink can reduce your ability to respond to changing conditions, and your reaction time gets worse with

every additional drink. So don't drink and drive, and don't let your friends drink and drive, either.

Control Your Speed

Excessive speed is a major factor in crash injuries and deaths. Generally, the higher the speed, the greater the risk, but serious injuries can also occur at lower speeds. Never drive faster than is safe for current conditions, regardless of the maximum speed posted.

Keep Your Vehicle in Safe Condition

Having a tire blowout or a mechanical failure can be extremely hazardous. To reduce the possibility of such problems, check your tire pressures and condition frequently, and perform all regularly scheduled maintenance (see page 407).

Your Vehicle's Safety Features

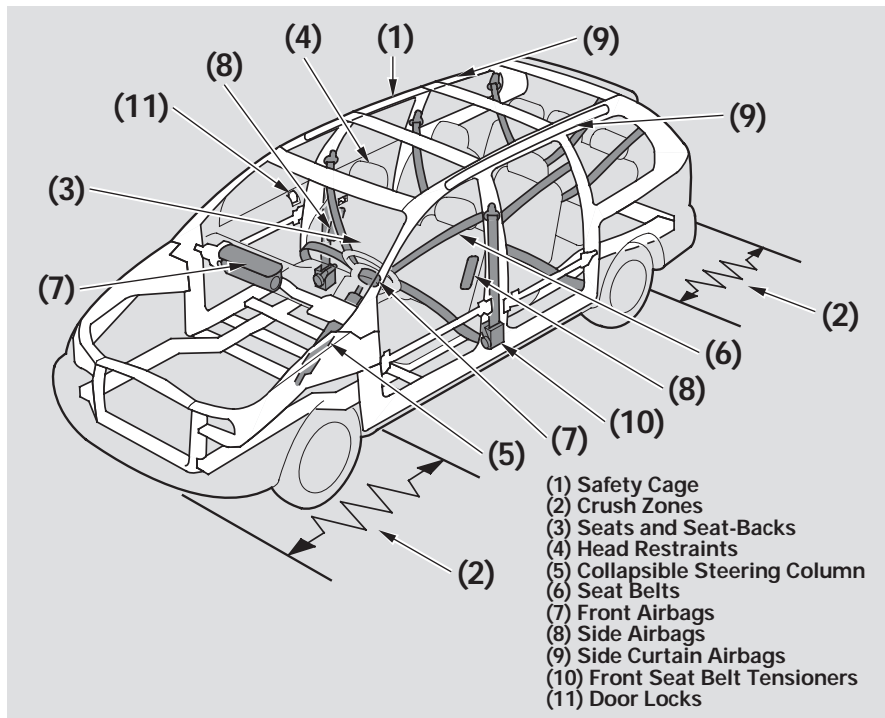

Your vehicle is equipped with many features that work together to protect you and your passengers during a crash.

Some features do not require any action on your part. These include a strong steel framework that forms a safety cage around the passenger compartment, front and rear crush zones, a collapsible steering column, and tensioners that tighten the front seat belts in a crash.

However, you and your passengers can't take full advantage of these features unless you remain sitting in a proper position and ***always wear your seat belts***. In fact, some safety features can contribute to injuries if they are not used properly.

The following pages explain how you can take an active role in protecting yourself and your passengers.

Your Vehicle's Safety Features

Seat Belts

Your vehicle is equipped with seat belts in all seating positions.

Your seat belt system also includes an indicator on the instrument panel and a beeper to remind you and your passengers to fasten your seat belts.

Why Wear Seat Belts

Seat belts are the single most effective safety device for adults and larger children. (Infants and smaller children must be properly restrained in child seats.)

Not wearing a seat belt properly increases the chance of serious injury or death in a crash, even though your vehicle has airbags.

In addition, most states and all Canadian provinces require you to wear seat belts.

WARNING

Not wearing a seat belt properly increases the chance of serious injury or death in a crash, even though your vehicle has airbags.

Be sure you and your passengers always wear seat belts and wear them properly.

When properly worn, seat belts:

- Keep you connected to the vehicle so you can take advantage of the vehicle's built-in safety features.
- Help protect you in almost every type of crash, including frontal, side, and rear impacts and rollovers.

- Help keep you from being thrown against the inside of the vehicle and against other occupants.
- Keep you from being thrown out of the vehicle.
- Help keep you in a good position should the airbags ever deploy. A good position reduces the risk of injury from an inflating airbag and allows you to get the best advantage from the airbag.

Of course, seat belts cannot completely protect you in every crash. But in most cases, seat belts can reduce your risk of serious injury.

What you should do: Always wear your seat belt, and make sure you wear it properly.

Your Vehicle's Safety Features

Airbags

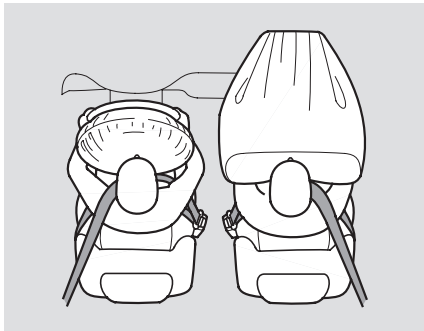

Your vehicle has a supplemental restraint system (SRS) with front airbags to help protect the heads and chests of the driver and a front seat passenger during a moderate to severe frontal collision (see page [27](#) for more information on how your front airbags work).

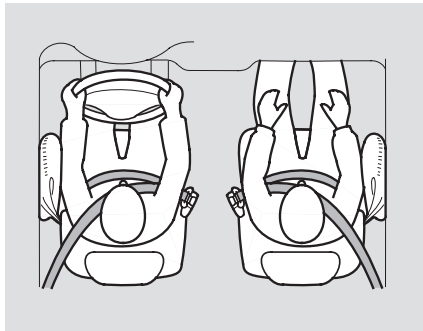

Your vehicle also has side airbags to help protect the upper torso of the driver or a front seat passenger during a moderate to severe side impact (see page [31](#) for more information on how your side airbags work).



In addition, your vehicle has side curtain airbags to help protect the heads of the driver, front passenger, and passengers in the outer rear seating positions during a moderate to severe side impact or rollover (see page [33](#) for more information on how your side curtain airbags work).

CONTINUED

Your Vehicle's Safety Features

The most important things you need to know about your airbags are:

- ***Airbags do not replace seat belts.*** They are designed to supplement the seat belts.
- ***Airbags offer no protection in rear impacts, or minor frontal or side collisions.***
- ***Airbags can pose serious hazards.*** To do their job, airbags must inflate with tremendous force. So while airbags help save lives, they can cause minor injuries or more serious or even fatal injuries if occupants are not properly restrained or sitting properly.

What you should do: Always wear your seat belt properly, and sit upright and as far back from the steering wheel as possible while allowing full control of the vehicle. A front passenger should move their seat as far back from the dashboard as possible.

The rest of this section gives more detailed information about how you can maximize your safety.

Remember, however, that no safety system can prevent all injuries or deaths that can occur in a severe crash, even when seat belts are properly worn and the airbags deploy.

Introduction

The following pages provide instructions on how to properly protect the driver, adult passengers, and teenage children who are large enough and mature enough to drive or ride in the front.

See pages 38 - 59 for important guidelines on how to properly protect infants, small children, and larger children who ride in your vehicle.

1. Close and Lock the Doors

After everyone has entered the vehicle, be sure the doors and the tailgate are closed and locked.



Your vehicle has a door and tailgate open indicator on the instrument panel to indicate when any door or the tailgate is not tightly closed.

On Touring models



The door and tailgate open indicator appears on the multi-information display to indicate when a specific door or the tailgate is not tightly closed.

CONTINUED

Protecting Adults and Teens

When one or more doors are not tightly closed, the “DOOR OPEN” message will come on.

When the tailgate is not tightly closed, the “TAILGATE OPEN” message will come on.

When both tailgate and one or more doors are not tightly closed, the “DOOR & TAILGATE OPEN” message will come on.

Locking the doors and the tailgate reduces the chance of someone being thrown out of the vehicle during a crash, and it helps prevent passengers from accidentally opening a door or the tailgate and falling out.

Locking the doors and the tailgate also helps prevent an outsider from unexpectedly opening a door or the tailgate when you come to a stop.

See page [151](#) for how to lock the doors and the tailgate, and page [75](#) for how the door and tailgate monitor indicator works.

Except Touring models

This vehicle has auto door locking/unlocking features. See page [152](#) for how to set them.

On Touring models

This vehicle has auto door locking/unlocking features. See pages [123](#) and [125](#) for how to set them.

2. Adjust the Front Seats

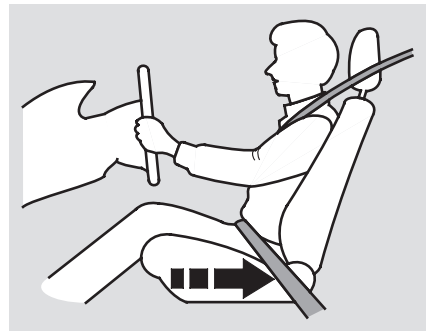

Adjust the driver's seat as far to the rear as possible while allowing you to maintain full control of the vehicle. Have a front passenger adjust their seat as far to the rear as possible.

If you sit too close to the steering wheel or dashboard, you can be seriously injured by an inflating front airbag, or by striking the steering wheel or dashboard.

The National Highway Traffic Safety Administration and Transport Canada recommend that drivers allow at least 10 inches (25 cm) between the center of the steering wheel and the chest. In addition to adjusting the seat, you can adjust the steering wheel up and down, and in and out (see page [141](#)).

If you cannot get far enough away from the steering wheel and still reach the controls, we recommend that you extend the adjustable driver's foot pedals (Touring models only, see page [193](#)), or investigate whether some type of adaptive equipment may help.

⚠ WARNING

Sitting too close to a front airbag can result in serious injury or death if the front airbags inflate.

Always sit as far back from the front airbags as possible.

After you adjust a manual seat, rock it back and forth to make sure the seat is locked in position.

See pages [168](#) and [169](#) for how to adjust the front seats.

3. Adjust the Seat-Backs

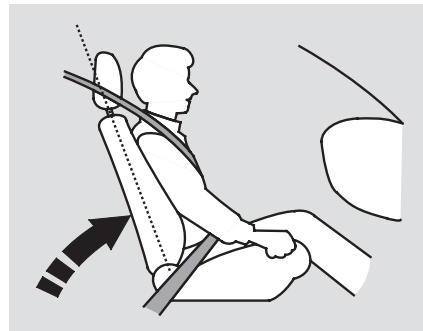

Adjust the driver's seat-back to a comfortable, upright position, leaving ample space between your chest and the airbag cover in the center of the steering wheel.

Passengers with adjustable seat-backs should also adjust their seat-back to a comfortable, upright position.

CONTINUED

Protecting Adults and Teens

⚠ WARNING

Reclining the seat-back too far can result in serious injury or death in a crash.

Adjust the seat-back to an upright position, and sit well back in the seat.

Reclining a seat-back so that the shoulder part of the belt no longer rests against the occupant's chest reduces the protective capability of the belt. It also increases the chance of sliding under the belt in a crash and being seriously injured. The farther a seat-back is reclined, the greater the risk of injury.

See pages [168](#) and [170](#) for how to adjust the seat-backs.

4. Adjust the Head Restraints

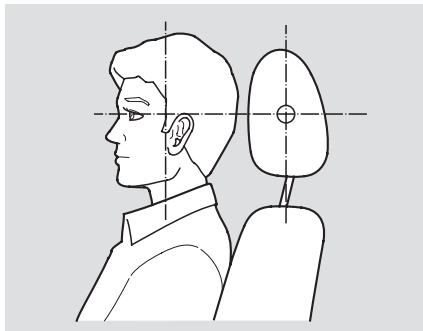

Adjust the driver's head restraint so the center of the back of your head rests against the center of the restraint.

Have passengers adjust their head restraints properly as well. Taller persons should adjust their restraint as high as possible.

⚠ WARNING

Improperly positioning head restraints reduces their effectiveness and you can be seriously injured in a crash.

Make sure head restraints are in place and positioned properly before driving.

Properly adjusted head restraints will help protect occupants from whiplash and other crash injuries.

See page [171](#) for how to adjust the head restraints and how the driver's and front passenger's active head restraints work.

5. Fasten and Position the Seat Belts

Insert the latch plate into the buckle, then tug on the belt to make sure the belt is securely latched. Check that the belt is not twisted, because a twisted belt can cause serious injuries in a crash.

The center seating position of the third row has a detachable seat belt that can be unlatched and retracted into the ceiling to allow the seat to be folded down. See page 16 for how to unlatch and relatch the seat belt.

Except U.S. LX and Canadian DX models

The plus-one seat that can be installed in the center seating position of the second row also has a detachable seat belt.



Position the lap part of the belt as low as possible across your hips, then pull up on the shoulder part of the belt so the lap part fits snugly. This lets your strong pelvic bones take the force of a crash and reduces the chance of internal injuries.

If necessary, pull up on the belt again to remove any slack, then check that the belt rests across the center of your chest and over your shoulder.

This spreads the forces of a crash over the strongest bones in your upper body.

⚠ WARNING

Improperly positioning the seat belts can cause serious injury or death in a crash.

Make sure all seat belts are properly positioned before driving.

If the seat belt touches or crosses your neck, or if it crosses your arm instead of your shoulder, you need to adjust the seat belt anchor height.

CONTINUED

Protecting Adults and Teens

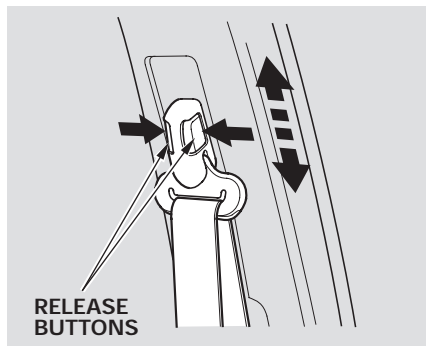

The front seats and second row seats have adjustable seat belt anchors. To adjust the height of an anchor, squeeze the two release buttons, and slide the anchor up or down as needed (it has four positions).

Never place the shoulder portion of a lap/shoulder belt under your arm or behind your back. This could cause very serious injuries in a crash.

If a seat belt does not seem to work as it should, it may not protect the occupant in a crash.

No one should sit in a seat with an inoperative seat belt. Using a seat belt that is not working properly can result in serious injury or death. Have your dealer check the belt as soon as possible.

See page 21 for additional information about your seat belts and how to take care of them.

Using the Lap/Shoulder Belt in the Center Position of the Third Row

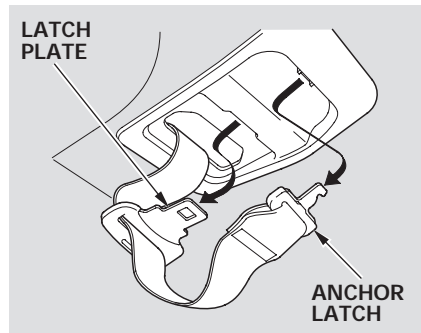

Except U.S. LX and Canadian DX models

The plus-one seat that can be installed in the center seating position of the second row also has a detachable seat belt.

Pull out the anchor latch and the latch plate from the holding slots in the ceiling, and pull out the seat belt to extend it.

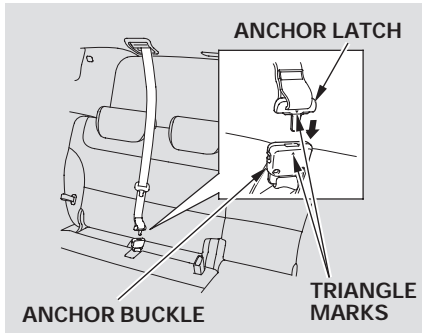

Insert the hook at the end of the anchor latch into the anchor buckle by lining up the triangle marks on the anchor latch in and buckle. Make sure the belt is not twisted. Push the anchor latch until it locks. Then follow the procedure for fastening and positioning an ordinary seat belt (see page 15).

⚠ WARNING

Using the seat belt with the detachable anchor unlatched increases the chance of serious injury or death in a crash.

Before using the seat belt, make sure the detachable anchor is correctly latched.

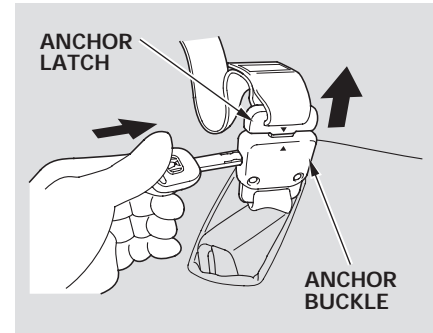

To unlatch the detachable anchor latch, insert your ignition key into the slot on the side of the anchor buckle. Line up the triangle marks on the plate and buckle when reattaching the belt and buckle.

Protecting Adults and Teens

6. Maintain a Proper Sitting Position

After all occupants have adjusted their seats and head restraints, and put on their seat belts, it is very important that they continue to sit upright, well back in their seats, with their feet on the floor, until the vehicle is parked and the engine is off.

Sitting improperly can increase the chance of injury during a crash. For example, if an occupant slouches, lies down, turns sideways, sits forward, leans forward or sideways, or puts one or both feet up, the chance of injury during a crash is greatly increased.

In addition, an occupant who is out of position in the front seat can be seriously or fatally injured in a crash by striking interior parts of the vehicle or being struck by an inflating front airbag.

WARNING

Sitting improperly or out of position can result in serious injury or death in a crash.

Always sit upright, well back in the seat, with your feet on the floor.

Advice for Pregnant Women



If you are pregnant, the best way to protect yourself and your unborn child when driving or riding in a vehicle is to always wear a seat belt, and keep the lap part of the belt as low as possible across the hips.

When driving, remember to sit upright and adjust the seat as far back as possible while allowing full control of the vehicle. When riding as a front passenger, adjust the seat as far back as possible.

This will reduce the risk of injuries to both you and your unborn child that can be caused by a crash or an inflating front airbag.

Each time you have a checkup, ask your doctor if it's okay for you to drive.

Additional Safety Precautions

- ***Never let passengers ride in the cargo area or on top of a folded-down back seat.*** If they do, they could be very seriously injured in a crash.
- ***Passengers should not stand up or change seats while the vehicle is moving.*** A passenger who is not wearing a seat belt during a crash or emergency stop can be thrown against the inside of the vehicle, against other occupants, or out of the vehicle.
- ***Two people should never use the same seat belt.*** If they do, they could be very seriously injured in a crash.

CONTINUED

Protecting Adults and Teens

- **Do not put any accessories on seat belts.** Devices intended to improve occupant comfort or reposition the shoulder part of a seat belt can reduce the protective capability of the belt and increase the chance of serious injury in a crash.
 - **Do not place hard or sharp objects between yourself and a front airbag.** Carrying hard or sharp objects on your lap, or driving with a pipe or other sharp object in your mouth, can result in injuries if your front airbag inflates.
 - **Keep your hands and arms away from the airbag covers.** If your hands or arms are close to an airbag cover, they could be injured if the airbag inflates.
- **Do not attach or place objects on the front airbag covers.** Objects on the covers marked “SRS AIRBAG” could interfere with the proper operation of the airbags or be propelled inside the vehicle and hurt someone if the airbags inflate.
 - **Do not attach hard objects on or near a door.** If a side airbag or a side curtain airbag inflates, a cup holder or other hard object attached on or near the door could be propelled inside the vehicle and hurt someone.

Additional Information About Your Seat Belts

Seat Belt System Components

Your seat belt system includes lap/shoulder belts in all seating positions. The front seat belts are also equipped with automatic seat belt tensioners.

This system uses the same sensors as the front airbags to monitor whether the front seat belts are latched or unlatched, and how much weight is on the front passenger's seat (see pages [30](#) and [31](#)).



The seat belt system includes an indicator on the instrument panel and a beeper to remind you and your passengers to fasten your seat belts.

This system monitors the front seat belts. If you turn the ignition switch to the ON (II) position before your seat belt is fastened, the beeper will sound and the indicator will flash. If your seat belt is not fastened before the beeper stops, the indicator will stop flashing but remain on.

If a front passenger does not fasten their seat belt, the indicator will come on about 6 seconds after the ignition switch is turned to the ON (II) position.

If either the driver or a front passenger does not fasten their seat belt while driving, the beeper will sound and the indicator will flash again at regular intervals.

On Touring model

You will also see a “FASTEN SEAT BELT” or “FASTEN PASSENGER SEAT BELT” message on the multi-information display (see page [88](#)).

When no one is sitting in the front passenger's seat, or a child or small adult is riding there, the indicator should not come on and the beeper should not sound.

CONTINUED

Additional Information About Your Seat Belts

If the indicator comes on or the beeper sounds when the driver's seat belt is latched and there is no front seat passenger and no items on the front seat, something may be interfering with the monitoring system. Look for and remove:

- Any items under the front passenger's seat.
- Any object(s) hanging on the seat or in the seat-back pocket.
- Any objects, such as a folded-down second row seat, that is touching the rear of the seat-back.

If no obstructions are found, have your vehicle checked by a dealer.

Lap/Shoulder Belt

The lap/shoulder belt goes over your shoulder, across your chest, and across your hips.

To fasten the belt, insert the latch plate into the buckle, then tug on the belt to make sure the buckle is latched (see page 15 for how to properly position the belt).

To unlock the belt, press the red PRESS button on the buckle. Guide the belt across your body so that it retracts completely. After exiting the vehicle, be sure the belt is out of the way and will not get closed in the door.

All seat belts have an emergency locking retractor. In normal driving, the retractor lets you move freely in your seat while it keeps some tension on the belt. During a collision or sudden stop, the retractor automatically locks the belt to help restrain your body.

The seat belts in all positions except the driver's have a lockable retractor that must be activated to secure a child seat (see page 52).

Additional Information About Your Seat Belts

If the shoulder part of the belt is pulled all the way out, the lockable retractor will activate. The belt will retract, but it will not allow the passenger to move freely.

To deactivate the lockable retractor, unlatch the buckle and let the seat belt fully retract. To refasten the seat belt, pull it out only as far as needed.

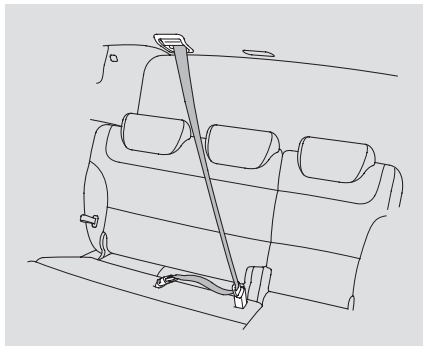

The lap/shoulder belt in the center seating position on the third seat and the second row plus-one seat (depending on models) is equipped with a detachable seat belt that has two parts: a small latch plate and an anchor buckle.

The detachable seat belt should normally be latched whenever the seat-backs are in an upright position. For more information about the detachable seat belt, see page [15](#).

Automatic Seat Belt Tensioners



For added protection, the front seat belts are equipped with automatic seat belt tensioners. When activated, the tensioners immediately tighten the belts to help hold the driver and a front passenger in position.

CONTINUED

Additional Information About Your Seat Belts

The tensioners are designed to activate in any collision severe enough to cause the front airbags to deploy, or if a sensor detects your vehicle is about to roll over (see page [33](#)).

If a side airbag or side curtain airbag deploys during a side impact, the tensioner on that side of the vehicle will also deploy.

The tensioners can also be activated during a collision in which the front airbags *do not deploy*. In this case, the airbags would not be needed, but the additional restraint could be helpful.

When the tensioners are activated, the seat belts will remain tight until they are unbuckled.

Seat Belt Maintenance

For safety, you should check the condition of your seat belts regularly.

Pull each belt out fully, and look for frays, cuts, burns, and wear. Check that the latches work smoothly and the belts retract easily. If a belt does not retract easily, cleaning the belt may correct the problem (see page [436](#)). Any belt that is not in good condition or working properly will not provide good protection and should be replaced as soon as possible.

Honda provides a limited warranty on seat belts. See your *Honda Warranty Information* booklet for details.

If a seat belt is worn during a crash, it must be replaced by the dealer. A belt that has been worn during a crash may not provide the same level of protection in a subsequent crash.

The dealer should also inspect the anchors for damage and replace them if needed. If the automatic seat belt tensioners activate during a crash, they must be replaced.

WARNING

Not checking or maintaining seat belts can result in serious injury or death if the seat belts do not work properly when needed.

Check your seat belts regularly and have any problem corrected as soon as possible.

Additional Information About Your Airbags

Airbag System Components

- (1) Driver's Front Airbag
- (2) Passenger's Front Airbag
- (3) Control Unit
- (4) Front Seat Belt Tensioners
- (5) Side Airbags
- (6) Side Curtain Airbags
- (7) Driver's Seat Position Sensor
- (8) Front Passenger's Weight Sensors
- (9) Front Impact Sensors
- (10) Passenger Airbag Off Indicator
- (11) Side Impact Sensors
- (12) Occupant Position Detection System (OPDS) Sensors
- (13) Front Passenger's Weight Sensors/OPDS Sensors Control Unit
- (14) Rear Safing Sensor
- (15) Supplemental Restraint System (SRS) Indicator

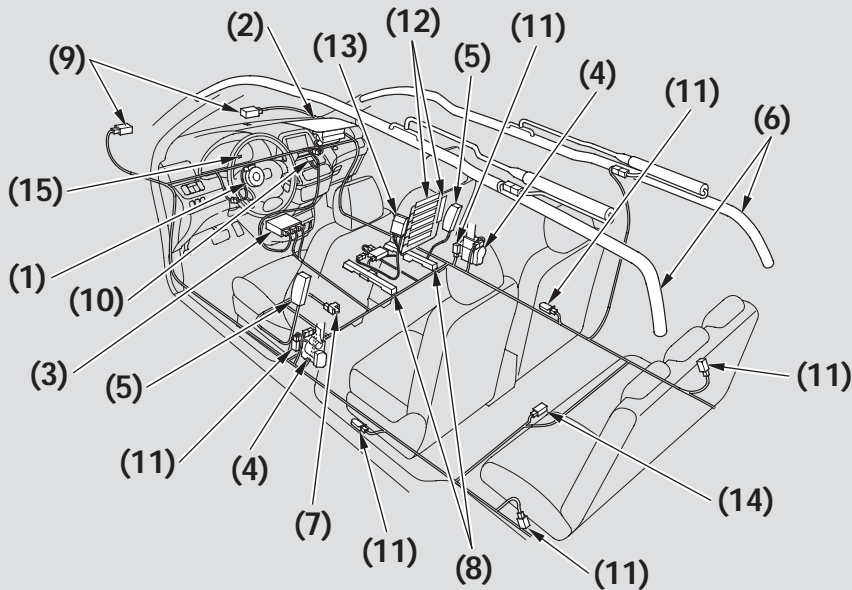

CONTINUED

Additional Information About Your Airbags

Your airbag system includes:

- Two SRS (supplemental restraint system) front airbags. The driver's airbag is stored in the center of the steering wheel; the front passenger's airbag is stored in the dashboard. Both are marked "SRS AIRBAG" (see page 27).
- Two side airbags, one for the driver and one for a front passenger. The airbags are stored in the outer edges of the seat-backs. Both are marked "SIDE AIRBAG" (see page 31).
- Two side curtain airbags, one for each side of the vehicle. The airbags are stored in the ceiling, above the side windows. The front and rear pillars are marked "SIDE CURTAIN AIRBAG" (see page 33).
- Automatic front seat belt tensioners (see page 23).
- Sensors that can detect a moderate to severe front impact, side impact, or if your vehicle is about to rollover.
- Sensors that can detect whether a child is in the passenger's side airbag path and signal the control unit to turn the airbag off (see page 32).
- Sensors that can detect whether the driver's seat belt and the front passenger's seat belt are latched or unlatched (see page 21).
- A driver's seat position sensor that monitors the distance of the seat from the front airbag. If the seat is too far forward, the airbag will inflate with less force (see page 30).
- Weight sensors that monitor the weight on the front passenger's seat. If the weight is about 65 lbs (29 kg) or less (the weight of an infant or small child), the passenger's front airbag will be turned off (see page 30).

Additional Information About Your Airbags

- A rollover sensor that can detect if your vehicle is about to roll over and signal the control unit to deploy both side curtain airbags and front seat belt tensioners (see page 33).
- A sophisticated electronic system that continually monitors and records information about the sensors, the control unit, the airbag activators, the seat belt tensioners, and driver and front passenger seat belt use when the ignition switch is in the ON (II) position.
- An indicator on the instrument panel that alerts you to a possible problem with your airbags, sensors, or seat belt tensioners (see page 34).
- An indicator on the instrument panel that alerts you that the passenger's side airbag has been turned off (see page 35).
- An indicator on the dashboard that alerts you that the passenger's front airbag has been turned off (see page 35).
- Emergency backup power in case your vehicle's electrical system is disconnected in a crash.

How Your Front Airbags Work

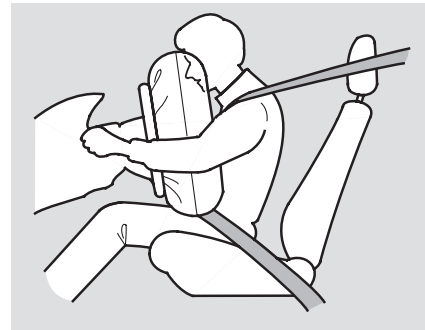

If you ever have a moderate to severe frontal collision, sensors will detect the vehicle's rapid deceleration.

If the rate of deceleration is high enough, the control unit will instantly inflate the driver's and front passenger's airbags, at the time and with the force needed.

CONTINUED

Additional Information About Your Airbags

During a frontal crash, your seat belt restrains your lower body and torso, and the airbag helps protect your head and chest.

Although both airbags normally inflate within a split second of each other, it is possible for only one airbag to deploy.

This can happen if the severity of a collision is at the margin, or threshold, that determines whether or not the airbags will deploy. In such cases, the seat belt will provide sufficient protection, and the supplemental protection offered by the airbag would be minimal.

Only the driver's airbag can deploy if there is no passenger in the front seat, or if the advanced airbag system has turned the passenger's airbag off (see page [35](#)).

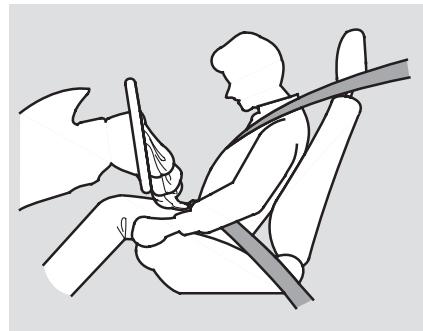

After inflating, the front airbags will immediately deflate, so they won't interfere with the driver's visibility, or the ability to steer or operate other controls.

Additional Information About Your Airbags

The total time for inflation and deflation is one-tenth of a second, so fast that most occupants are not aware that the airbags deployed until they see them lying in their laps.

After a crash, you may see what looks like smoke. This is actually powder from the airbag's surface. Although the powder is not harmful, people with respiratory problems may experience some temporary discomfort. If this occurs, get out of the vehicle as soon as it is safe to do so.

Dual-Stage Airbags

Your front airbags are dual-stage airbags. This means they have two inflation stages that can be ignited sequentially or simultaneously, depending on crash severity.

In a ***more severe*** crash, both stages will ignite simultaneously to provide the quickest and greatest protection.

In a ***less severe*** crash, one stage will ignite first, then the second stage will ignite a split second later. This provides longer airbag inflation time with a little less force.

Dual-Threshold Airbags

Your front airbags are also dual-threshold airbags. Airbags with this feature have two deployment thresholds that depend on whether sensors detect the occupant is wearing a seat belt or not.

If the occupant's belt is ***not latched***, the airbag will deploy at a slightly lower threshold, because the occupant would need extra protection.

If the occupant's belt is ***latched***, the airbag will inflate at a slightly higher threshold, when the airbag would be needed to supplement the protection provided by the seat belt.

CONTINUED

Additional Information About Your Airbags

Advanced Airbags

Your front airbags are also advanced airbags. The main purpose of this feature is to help prevent airbag-caused injuries to short drivers and children who ride in front.

For both advanced airbags to work properly:

- Occupants must sit upright and wear their seat belts properly.
- Do not spill any liquids on or under the seats, cover the sensors, or put any cargo or metal objects under the front seats.
- Second-row passengers should not put their feet under the front seats.

Failure to follow these instructions could damage the sensors or prevent them from working properly.

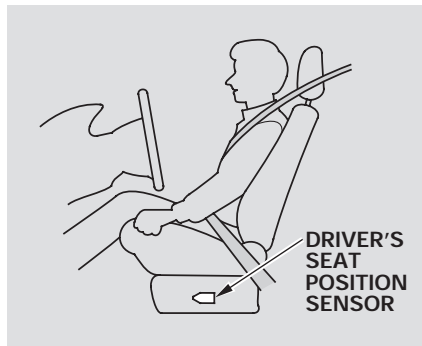

The driver's advanced front airbag system includes a seat position sensor under the seat. If the seat is too far forward, the airbag will inflate with less force, regardless of the severity of the impact.

If there is a problem with the sensor, the SRS indicator will come on, and the airbag will inflate in the normal manner regardless of the driver's seating position.

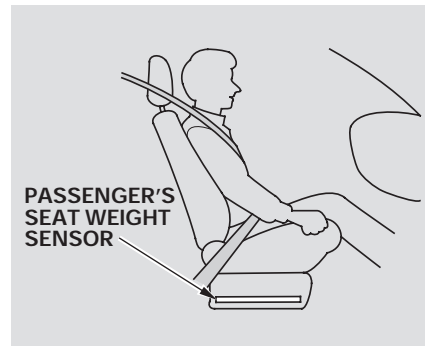

The passenger's advanced front airbag system has weight sensors under the seat. Although Honda does not encourage carrying an infant or small child in front, if the sensors detect the weight of an infant or small child (up to about 65 lbs or 29 kg), the system will automatically turn the passenger's front airbag off.

Additional Information About Your Airbags

Be aware that objects placed on the passenger's seat can also cause the airbag to be turned off.

When the airbag is turned off, a "passenger airbag off" indicator in the center of the dashboard comes on (see page 35).

If the weight sensors detect there is no passenger in the front seat, the airbag will be off. However, the passenger airbag off indicator will not come on.

To ensure that the passenger's advanced front airbag system will work properly, **do not do anything that would increase or decrease the weight on the front passenger's seat.** This includes:

- A second row passenger pushing or pulling on the back of the front passenger's seat.

- Moving the front seat forcibly back against cargo on the seat, the floor behind it, or a folded second row seat.
- Hanging heavy items on the front passenger seat, or placing heavy items in the seat-back pocket.

Also, make sure the floor mat behind the front passenger's seat is properly positioned on the floor (see page 436). If it is not, the mat may interfere with the proper operation of the front passenger's seat and its sensors.

How Your Side Airbags Work

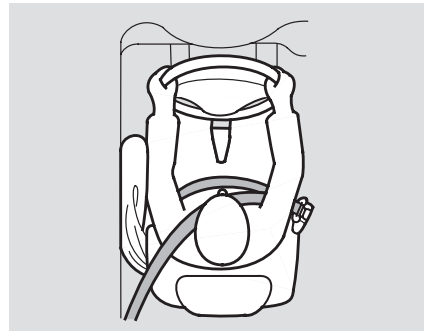

If you ever have a moderate to severe side impact, sensors will detect rapid acceleration and signal the control unit to instantly inflate either the driver's or the passenger's side airbag and activate the seat belt tensioner on the affected side.

CONTINUED

Additional Information About Your Airbags

Only one airbag will deploy during a side impact. If the impact is on the passenger's side, the passenger's side airbag will deploy even if there is no passenger.

To get the best protection from the side airbags, front seat occupants should wear their seat belts and sit upright and well back in their seats.

Side Airbag Cutoff System

Your vehicle has a side airbag cutoff system designed primarily to protect a child riding in the front passenger's seat.

Although Honda does not encourage children to ride in front, if the position sensors detect a child has leaned into the side airbag's deployment path, the airbag will shut off.

The side airbag may also shut off if a short adult leans sideways, or a larger adult slouches and leans sideways into the airbag's deployment path.

Objects placed on the front passenger seat can also cause the side airbag to be shut off.

If the side airbag off indicator comes on (see page 35), have the passenger sit upright. Once the passenger is out of the airbag's deployment path, the system will turn the airbag back on, and the indicator will go out.

There will be some delay between the moment the passenger moves into or out of the airbag deployment path and when the indicator comes on or goes off.

A front seat passenger should not use a cushion or other object as a backrest. It may prevent the cutoff system from working properly.

Additional Information About Your Airbags

How Your Side Curtain Airbags Work

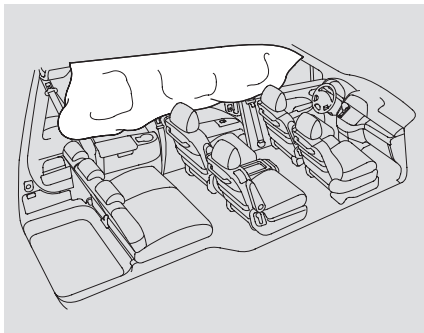

In a Side Impact

In a moderate to severe side impact, sensors will detect rapid acceleration and signal the control unit to instantly inflate the side curtain airbag and activate the seat belt tensioner on the driver's or the passenger's side of the vehicle.

If the impact is on the passenger's side, the passenger's side curtain airbag will inflate even if there are no occupants on that side of the vehicle.

In a Rollover

If the rollover sensor detects your vehicle is about to roll over, it signals the control unit, which immediately deploys both side curtain airbags and activates both front seat belt tensioners.

The airbag on the passenger's side will deploy, and the seat belt tensioner will activate, even if there are no passengers on that side of the vehicle.

To get the best protection from the side curtain airbags, occupants should wear their seat belts and sit upright and well back in their seats.

Additional Information About Your Airbags



How the SRS Indicator Works

The SRS indicator alerts you to a potential problem with your airbags or seat belt tensioners.

When you turn the ignition switch to the ON (II) position, this indicator comes on for several seconds then goes off. This tells you the system is working properly.

If the indicator comes on at any other time, or does not come on at all, you should have the system checked by your dealer. For example:

- If the SRS indicator does not come on after you turn the ignition switch to the ON (II) position.
- If the indicator stays on after the engine starts.
- If the indicator comes on or flashes on and off while you drive.

On Touring models

You will also see a “CHECK AIRBAG SYSTEM” message on the multi-information display (see page 88).

If you see any of these indications, the airbags and seat belt tensioners may not work properly when you need them.

⚠ WARNING

Ignoring the SRS indicator can result in serious injury or death if the airbag systems or tensioners do not work properly.

Have your vehicle checked by a dealer as soon as possible if the SRS indicator alerts you to a possible problem.

Additional Information About Your Airbags

U.S.



Canada



How the Side Airbag Off Indicator Works

This indicator alerts you that the passenger's side airbag has been automatically shut off. It does **not** mean there is a problem with your side airbags.

When you turn the ignition switch to the ON (II) position, the indicator should come on for several seconds and then go off (see page 68). If it doesn't come on, stays on, or comes on while driving without a passenger in the front seat, have the system checked.

On Touring models

You will also see a "PASSENGER SIDE AIRBAG OFF" message on the multi-information display (see page 89).

How the Passenger Airbag Off Indicator Works

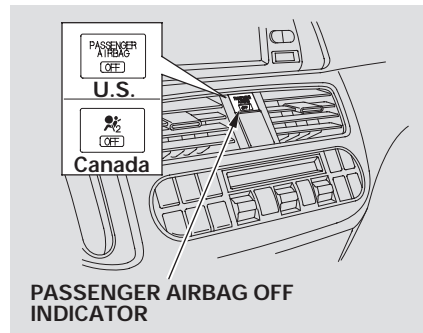

This indicator alerts you that the passenger's front airbag has been shut off because weight sensors detect about 65 lbs (29 kg) or less (the weight of an infant or small child) on the front passenger's seat. It does **not mean** there is a problem with the airbag.

Be aware that objects placed on the front seat can cause the indicator to come on.

If no weight is detected on the front seat, the airbag will be automatically shut off. However, the indicator will not come on.

The passenger airbag off indicator may come on and off repeatedly if the total weight on the seat is near the airbag cutoff threshold.

If an adult or teenage passenger is riding in front, move the seat as far to the rear as possible, and have the passenger sit upright and wear the seat belt properly.

CONTINUED

Additional Information About Your Airbags

If the indicator comes on with no front seat passenger and no objects on the seat, or with an adult riding there, something may be interfering with the weight sensors. Look for and remove:

- Any items under the front passenger's seat.
- Any object(s) hanging on the seat or in the seat-back pocket.
- Any object(s) touching the rear of the seat-back.

If no obstructions are found, have your vehicle checked by a dealer as soon as possible.

Airbag Service

Your airbag systems are virtually maintenance free, and there are no parts you can safely service. However, you must have your vehicle serviced if:

- **An airbag ever inflates.** Any airbag that has deployed must be replaced along with the control unit and other related parts. Any seat belt tensioner that activates must also be replaced.

Do not try to remove or replace any airbag by yourself. This must be done by an authorized dealer or a knowledgeable body shop.

- **The SRS indicator alerts you to a problem.** Take your vehicle to an authorized dealer as soon as possible. If you ignore this indication, your airbags may not operate properly.
- **If your vehicle has a moderate to severe impact.** Even if your airbags do not inflate, your dealer should inspect the driver's seat position sensor, the front passenger's weight sensors, the front seat belt tensioners, and all seat belts worn during a crash to make sure they are operating properly.

Additional Information About Your Airbags

Additional Safety Precautions

- **Do not attempt to deactivate your airbags.** Together, airbags and seat belts provide the best protection.
- **Do not tamper with airbag components or wiring for any reason.** Tampering could cause the airbags to deploy, possibly causing very serious injury.
- **Do not expose the front passenger's seat-back to liquid.** If water or another liquid soaks into the seat-back, it can prevent the side airbag cutoff system from working properly.
- **Do not cover or replace front seat-back covers without consulting your dealer.** Improperly replacing or covering front seat-back covers can prevent your side airbags from inflating during a side impact.
- **Do not remove or modify a front seat without consulting your dealer.** This could make the driver's seat position sensor or the front passenger's weight sensors ineffective. If it is necessary to remove or modify a front seat to accommodate a person with disabilities, first contact Honda Automobile Customer Service at (800) 999-1009.

Protecting Children - General Guidelines



Children depend on adults to protect them. However, despite their best intentions, many adults do not know how to properly protect child passengers.

If you have children, or ever need to drive with a child in your vehicle, be sure to read this section. It begins with important general guidelines, then presents special information for infants, small children, and larger children.

All Children Must Be Restrained

Each year, many children are injured or killed in vehicle crashes because they are either unrestrained or not properly restrained. In fact, vehicle accidents are the number one cause of the death of children ages 12 and under.

To reduce the number of child deaths and injuries, every state and Canadian province requires that infants and children be properly restrained when they ride in a vehicle.

Infants and small children must be restrained in an approved child seat that is properly secured to the vehicle (see pages 43 - 59).

⚠ WARNING

Children who are unrestrained or improperly restrained can be seriously injured or killed in a crash.

Any child too small for a seat belt should be properly restrained in a child seat. A larger child should be properly restrained with a seat belt and use a booster seat if necessary.

Larger children must be restrained with a lap/shoulder belt and ride on a booster seat until the seat belt fits them properly (see pages 56 - 59).

Protecting Children - General Guidelines

All Children Should Sit in a Back Seat

According to accident statistics, children of all ages and sizes are safer when they are restrained in a back seat. The National Highway Traffic Safety Administration and Transport Canada recommend that all children aged 12 and under be properly restrained in a back seat. Some states have laws restricting where children may ride.

Children who ride in back are less likely to be injured by striking interior vehicle parts during a collision or hard braking. Also, children cannot be injured by an inflating front airbag when they ride in the back.

The Passenger's Front Airbag Can Pose Serious Risks

Front airbags have been designed to help protect adults in a moderate to severe frontal collision. To do this, the passenger's front airbag is quite large, and it can inflate with enough force to cause very serious injuries.

Even though your vehicle has an advanced front airbag system that automatically turns the passenger's front airbag off (see page 35), please follow these guidelines:

Infants

Never put a rear-facing child seat in the front seat of a vehicle equipped with a passenger's front airbag. If the airbag inflates, it can hit the back of the child seat with enough force to kill or very seriously injure an infant.

Small Children

Placing a forward-facing child seat in the front seat of a vehicle equipped with a passenger's front airbag can be hazardous. If the vehicle seat is too far forward, or the child's head is thrown forward during a collision, an inflating front airbag can strike the child with enough force to kill or very seriously injure a small child.

Larger Children

Children who have outgrown child seats are also at risk of being injured or killed by an inflating passenger's front airbag. Whenever possible, larger children should sit in the back seat, on a booster seat if needed, and be properly restrained with a seat belt. (See page 56 for important information about protecting larger children.)

CONTINUED

Protecting Children - General Guidelines

To remind you of the passenger's front airbag hazards, and that children must be properly restrained in a back seat, your vehicle has warning labels on the dashboard (U.S. models) and on the front visors. Please read and follow the instructions on these labels.

U.S. Models

SUN VISORS



Canadian Models

SUN VISORS

CAUTION

TO AVOID SERIOUS INJURY:

- FOR MAXIMUM SAFETY PROTECTION IN ALL TYPES OF CRASHES, YOU MUST ALWAYS WEAR YOUR SAFETY BELT.
- DO NOT INSTALL REARWARD-FACING CHILD SEATS IN ANY FRONT PASSENGER SEAT POSITION.
- DO NOT SIT OR LEAN UNNECESSARILY CLOSE TO THE AIR BAG.
- DO NOT PLACE ANY OBJECTS OVER THE AIR BAG OR BETWEEN THE AIR BAG AND YOURSELF.
- SEE THE OWNER'S MANUAL FOR FURTHER INFORMATION AND EXPLANATIONS.

DASHBOARD

This Vehicle is Equipped with
Advanced Air Bags

Even with Advanced Air Bags

Children can be killed or seriously injured by the air bag.
The back seat is the safest place for children.
Never put a rear-facing child seat in the front.
Always use seat belts and child restraints.
See owner's manual for more information about air bags.

To be removed by owner only.

Protecting Children - General Guidelines

If You Must Drive with Several Children

Your vehicle has two rows of back seats where children can be properly restrained. If you ever have to carry a group of children, and a child must ride in front:

- Place the largest child in the front seat, provided the child is large enough to wear the lap/shoulder belt properly (see page 56).
- Move the vehicle seat as far to the rear as possible (see page 168).
- Have the child sit upright and well back in the seat (see page 18).
- Make sure the seat belt is properly positioned and secured (see page 15).

If a Child Requires Close Attention

Many parents say they prefer to put an infant or a small child in the front passenger seat so they can watch the child, or because the child requires attention.

Placing a child in the front seat exposes the child to hazards in a frontal collision, and paying close attention to a child distracts the driver from the important tasks of driving, placing both of you at risk.

If a child requires close physical attention or frequent visual contact, we strongly recommend that another adult ride with the child in a back seat. The back seat is far safer for a child than the front.

Additional Safety Precautions

- **Never hold an infant or child on your lap.** If you are not wearing a seat belt in a crash, you could be thrown forward and crush the child against the dashboard or a seat-back. If you are wearing a seat belt, the child can be torn from your arms and be seriously hurt or killed.
- **Never put a seat belt over yourself and a child.** During a crash, the belt could press deep into the child and cause serious or fatal injuries.
- **Never let two children use the same seat belt.** If they do, they could be very seriously injured in a crash.

Protecting Children - General Guidelines

- ***Make sure any unused seat belt that a child can reach is buckled, the lockable retractor is activated, and the belt is fully retracted and locked.*** If a child wraps a loose seat belt around their neck, they can be seriously or fatally injured. (See pages [51](#) and [52](#) for how to activate and deactivate the lockable retractor.)
- ***Use childproof door locks to prevent children from opening the doors.*** This can prevent children from accidentally falling out (see page [157](#)).

- ***Use the power sliding door main switch to prevent children from operating the sliding doors.*** This will prevent unintended use of the doors.
- ***Do not leave children alone in a vehicle.*** Leaving children without adult supervision is illegal in most states and Canadian provinces, and can be very hazardous.

For example, infants and small children left in a vehicle on a hot day can die from heatstroke. A child left alone with the key in the ignition switch can accidentally set the vehicle in motion, possibly injuring themselves or others.

- ***Lock all doors and the tailgate when your vehicle is not in use.*** Children who play in vehicles can accidentally get trapped inside. Teach your children not to play in or around vehicles.
- ***Keep vehicle keys and remote transmitters out of the reach of children.*** Even very young children learn how to unlock vehicle doors, turn on the ignition switch, and open the tailgate, which can lead to accidental injury or death.

Protecting Infants and Small Children

Protecting Infants

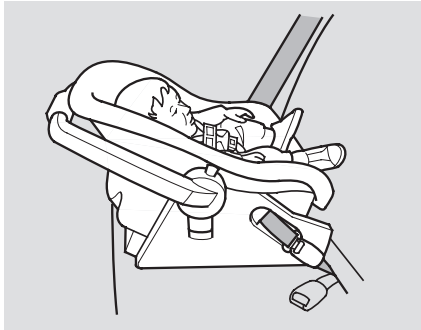

Child Seat Type

An infant must be properly restrained in a rear-facing, reclining child seat until the child reaches the seat maker's weight or height limit for the seat, and the child is at least one year old.

Only a rear-facing child seat provides proper support for a baby's head, neck, and back.

Two types of seats may be used: a seat designed exclusively for infants, or a convertible seat used in the rear-facing, reclining mode.

Do not put a rear-facing child seat in a forward-facing position. If placed facing forward, an infant could be very seriously injured during a frontal collision.

Rear-facing Child Seat Placement

A rear-facing child seat can be placed in any seating position in the second or third row, but not in the front.

Never put a rear-facing child seat in the front seat.

If the passenger's front airbag inflates, it can hit the back of the child seat with enough force to kill or seriously injure an infant.

When properly installed in the second row, a rear-facing child seat may prevent the driver or a front passenger from moving their seat as far back as recommended, or from locking their seat-back in the desired position.

It could also interfere with proper operation of the passenger's advanced front airbag system.

CONTINUED

Protecting Infants and Small Children

In any of these situations, we strongly recommend that you install the child seat directly behind the front passenger's seat, move the seat as far forward as needed, and leave it unoccupied. Or, you may wish to get a smaller rear-facing child seat.

⚠ WARNING

Placing a rear-facing child seat in the front seat can result in serious injury or death during a collision.

Always place a rear-facing child seat in the back seat, not the front.

Protecting Small Children



Child Seat Type

A child who is at least one year old, and who fits within the child seat maker's weight and height limits, should be restrained in a forward-facing, upright child seat.

Of the different seats available, we recommend those that have a five-point harness system as shown.

We also recommend that a small child use the child seat until the child reaches the weight or height limit for the seat.

Child Seat Placement

We strongly recommend placing a forward-facing child seat in a back seat, not the front.

Placing a forward-facing child seat in the front seat of a vehicle equipped with a passenger's airbag can be hazardous. If the vehicle seat is too far forward, or the child's head is thrown forward during a collision, an inflating airbag can strike the child with enough force to cause very serious or fatal injuries.

Even with advanced front airbags that automatically turn the passenger's front airbag off (see page 35), a back seat is the safest place for a small child.

If it is necessary to put a forward-facing child seat in the front, move the vehicle seat as far to the rear as possible, and be sure the child seat is firmly secured to the vehicle and the child is properly strapped in the seat.

⚠ WARNING

Placing a forward-facing child seat in the front seat can result in serious injury or death if the front airbag inflates.

If you must place a forward-facing child seat in front, move the vehicle seat as far back as possible, and properly restrain the child.

Selecting a Child Seat

When buying a child seat, you need to choose either a conventional child seat, or one designed for use with the lower anchors and tethers for children (LATCH) system.

Conventional child seats must be secured to a vehicle with a seat belt, whereas LATCH-compatible seats are secured by attaching the seat to hardware built into the rear seating positions.

Since LATCH-compatible child seats are easier to install and reduce the possibility of improper installation, we recommend selecting this style.

In seating positions and vehicles not equipped with LATCH, a LATCH-compatible child seat can be installed using a seat belt.

Whatever type of seat you choose, to provide proper protection, a child seat should meet three requirements:

- 1. The child seat should meet U.S. or Canadian Motor Vehicle Safety Standard 213.*** Look for FMVSS 213 or CMVSS 213 on the box.
- 2. The child seat should be of the proper type and size to fit the child.*** Rear-facing for infants, forward-facing for small children.
- 3. The child seat should fit the vehicle seating position (or positions) where it will be used.***

Before purchasing a conventional child seat, or using a previously purchased one, we recommend that you test the seat in the specific vehicle seating position or positions where the seat will be used.

After selecting a proper child seat and a good place to install the seat, there are three main steps in installing the seat:

1. Properly secure the child seat to the vehicle. All child seats must be secured to the vehicle with the lap part of a lap/shoulder belt or with the LATCH (lower anchors and tethers for children) system. A child whose seat is not properly secured to the vehicle can be endangered in a crash.

2. Make sure the child seat is firmly secured. After installing a child seat, push and pull the seat forward and from side-to-side to verify that it is secure.

A child seat secured with a seat belt should be installed as firmly as possible. However, it does not need to be “rock solid.” Some side-to-side movement can be expected and should not reduce the child seat’s effectiveness.

If the child seat is not secure, try installing it in a different seating position, or use a different style of child seat that can be firmly secured.

3. Secure the child in the child seat.

Make sure the child is properly strapped in the child seat according to the child seat maker’s instructions. A child who is not properly secured in a child seat can be seriously injured in a crash.

The following pages provide guidelines on how to properly install a child seat. A forward-facing child seat is used in all examples, but the instructions are the same for rear-facing child seats.

Installing a Child Seat

Installing a Child Seat with LATCH

Your vehicle is equipped with LATCH (lower anchors and tethers for children) in the two second row seats and the center seating position of the third row.

The lower anchors are located between the seat-back and seat bottom, and are to be used only with a child seat designed for use with LATCH.

The location of each lower anchor is indicated by a small button above the anchor point.

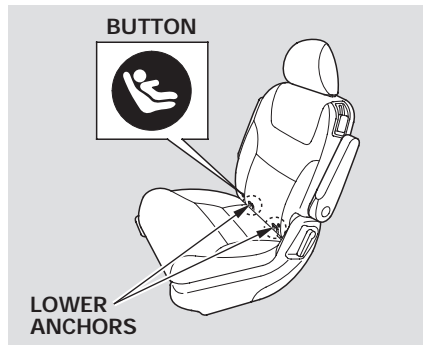

To install a LATCH-compatible child seat in a second row seat:

1. Move the seat belt buckle or tongue away from the lower anchors.
2. Make sure there are no objects near the anchors that could prevent a secure connection between the child seat and the anchors.

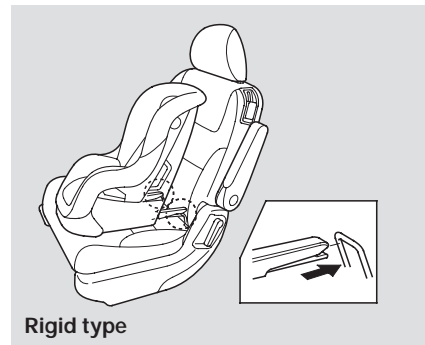

3. Place the child seat on the vehicle seat, then attach the seat to the lower anchors according to the child seat maker's instructions.

Some LATCH-compatible seats have a rigid-type connector as shown above.

Installing a Child Seat

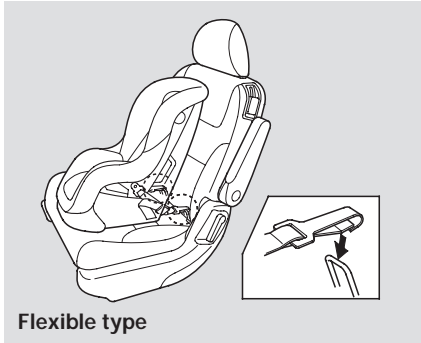

Other LATCH-compatible seats have a flexible-type connector as shown above.

4. Whatever type you have, follow the child seat maker's instructions for adjusting or tightening the fit.

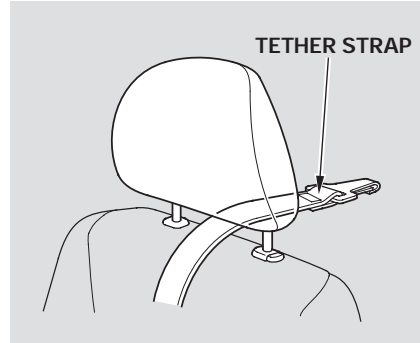

5. Lift the head restraint (see page 171), then route the tether strap through the legs of the head restraint, over the seat-back and through the grab rail.

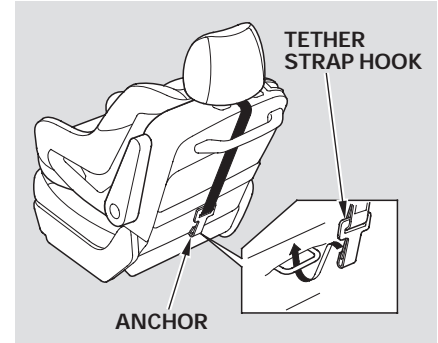

6. Attach the tether strap hook to the anchor, making sure the strap is not twisted, then tighten the strap according to the seat maker's instructions.
7. Push and pull the child seat forward and from side-to-side to verify that it is secure.

Installing a Child Seat

To install a LATCH-compatible child seat in the center seating position of the third row:

1. Unlatch the detachable seat belt anchor latch and retract the seat belt all the way into the ceiling. Place the latch plate and anchor latch in their holding slots (see page [16](#)).

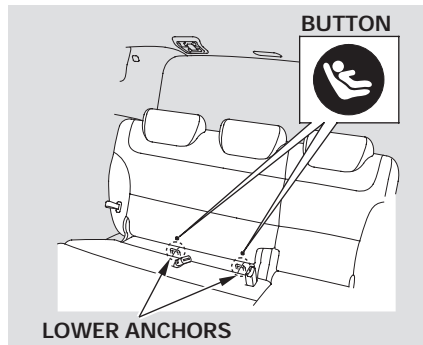

The location of each lower anchor is indicated by a small button above the anchor point.

2. Follow steps 1 through 4 of the second row installation on pages [48](#) and [49](#).

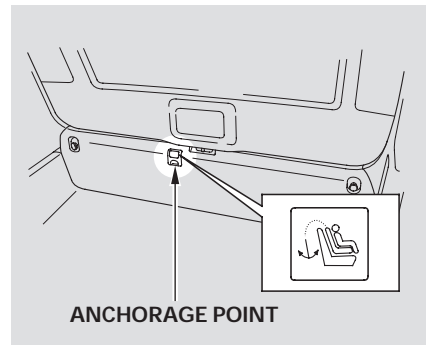

The center seating position of the third row has an anchorage point on the tailgate sill.

3. Slide the anchor cover to open it.

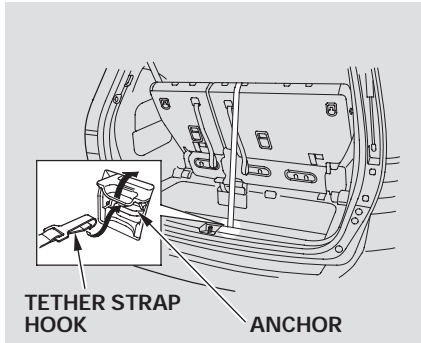

- Remove the head restraint (see page 171). Make sure the removed head restraint is secured in the cargo area. Reinstall the head restraint when the child seat is removed.
- Follow steps 6 and 7 on page 49.

Installing a Child Seat with a Lap/Shoulder Belt

When not using the LATCH system, all child seats must be secured to the vehicle with the lap part of a lap/shoulder belt.

In addition, the lap/shoulder belts in all seating positions except the driver's have a lockable retractor that must be activated to secure a child seat.

If you intend to install a child seat in the center seating position of the third row, make sure the detachable seat belt is properly installed (see page 16).



- With the child seat in the desired seating position, route the belt through the child seat according to the seat maker's instructions, then insert the latch plate into the buckle.

CONTINUED

Installing a Child Seat

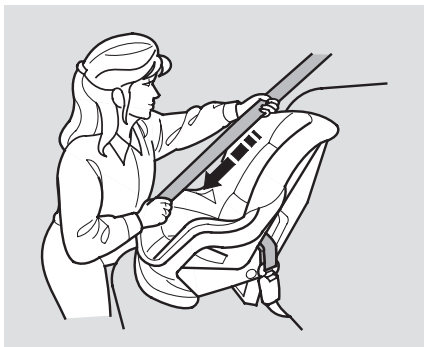

2. To activate the lockable retractor, slowly pull the shoulder part of the belt all the way out until it stops, then let the belt feed back into the retractor.
3. After the belt has retracted, tug on it. If the belt is locked, you will not be able to pull it out. If you can pull the belt out, it is not locked, and you will need to repeat these steps.



4. After confirming that the belt is locked, grab the shoulder part of the belt near the buckle, and pull up to remove any slack from the lap part of the belt. Remember, if the lap part of the belt is not tight, the child seat will not be secure.

To remove slack, it may help to put weight on the child seat, or push on the back of the seat while pulling up on the belt.



5. Push and pull the child seat forward and from side-to-side to verify that it is secure enough to stay upright during normal driving maneuvers. If the child seat is not secure, unlatch the belt, allow it to retract fully, then repeat these steps.

To deactivate the lockable retractor and remove a child seat, unlatch the buckle, unrout the seat belt, and let the belt fully retract.

Installing a Child Seat with a Tether

A child seat with a tether can be installed in any seating position in the second or third row seats.

Since a tether can provide additional security to the lap/shoulder belt installation, we recommend using a tether whenever one is required or available.

Second Row Installation

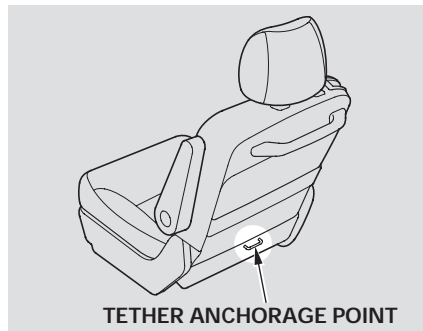

Each second row bucket seat has a tether anchorage point at the bottom of the seat-back.

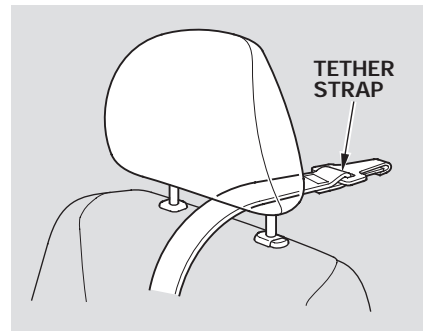

1. After properly securing the child seat (see page 51), lift the head restraint, then route the tether strap over the seat-back and through the head restraint legs.

CONTINUED

Installing a Child Seat

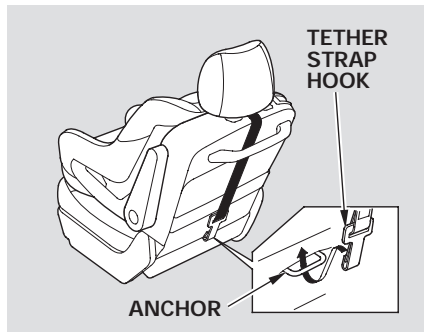

2. Attach the tether strap hook to the anchor, making sure the strap is not twisted.
3. Tighten the strap according to the seat maker's instructions.

Third Row Installation

Outside seating position

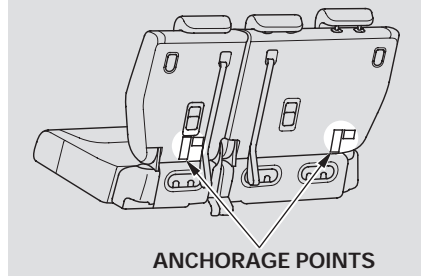

Each outside seating position of the third row has an anchorage point on the seat-back.

Center seating position

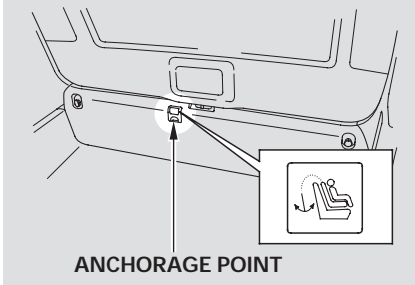

The center seating position of the third row has an anchorage point on the tailgate sill.

Installing a Child Seat

1. Remove the head restraint (see page 171). Make sure the removed head restraint is secured in the cargo area. Reinstall the head restraint when the child seat is removed.

2. (Outside seating position)
To use the anchor, pull up the anchor cover.

(Center seating position)
Slide the anchor cover to open it.

3. After properly securing the child seat (see page 51), route the tether strap over the top of the seat-back.

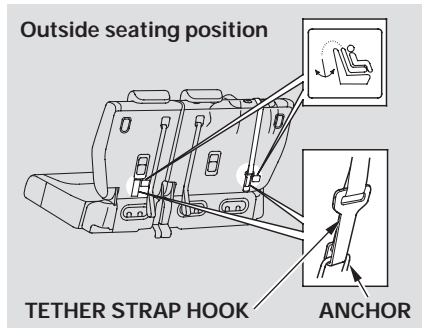

4. Attach the tether strap hook to the anchor, making sure the tether strap is not twisted.

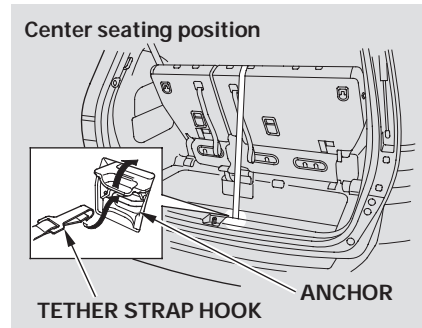

5. Tighten the strap according to the seat maker's instructions.

Protecting Larger Children

When a child reaches the recommended weight or height limit for a forward-facing child seat, the child should sit in a back seat on a booster seat and wear a lap/shoulder belt.

The following pages give instructions on how to check proper seat belt fit, what kind of booster seat to use if one is needed, and important precautions for a child who must sit in front.

⚠ WARNING

Allowing a child age 12 or under to sit in front can result in injury or death if the passenger's front airbag inflates.

If a child must ride in front, move the vehicle seat as far back as possible, use a booster seat if needed, have the child sit up properly and wear the seat belt properly.

Checking Seat Belt Fit



To determine if a lap/shoulder belt properly fits a child, have the child put on the seat belt, then ask yourself:

1. Does the child sit all the way back against the seat?
2. Do the child's knees bend comfortably over the edge of the seat?

3. Does the shoulder belt cross between the child's neck and arm?
4. Is the lap part of the belt as low as possible, touching the child's thighs?
5. Will the child be able to stay seated like this for the whole trip?

If you answer yes to all these questions, the child is ready to wear the lap/shoulder belt correctly. If you answer no to any question, the child needs to ride on a booster seat.

Using a Booster Seat



A child who has outgrown a forward-facing child seat should ride in a back seat and use a booster seat until the lap/shoulder belt fits them properly without the booster.

Some states and Canadian provinces also require children to use a booster seat until they reach a given age or weight (e.g., 6 years or 60 lbs). Be sure to check current laws in the states or provinces where you intend

to drive.

Booster seats can be high-back or low-back. Whichever style you select, make sure the booster seat meets federal safety standards (see page 46) and that you follow the booster seat maker's instructions.

If a child who uses a booster seat must ride in front, move the vehicle seat as far back as possible and be sure the child is wearing the seat belt properly.

A child may continue using a booster seat until the tops of their ears are even with the top of the vehicle's or booster's seat-back. A child of this height should be tall enough to use the lap/shoulder belt without a booster seat.

Protecting Larger Children

When Can a Larger Child Sit in Front

The National Highway Traffic Safety Administration and Transport Canada recommend that all children aged 12 and under be properly restrained in a back seat.

If the passenger's front airbag inflates in a moderate to severe frontal collision, the airbag can cause serious injuries to a child who is unrestrained, improperly restrained, sitting too close to the airbag, or out of position.

A side airbag also poses risks. If any part of a larger child's body is in the path of a deploying side airbag, the child could receive possibly serious injuries.

Of course, children vary widely. And while age may be one indicator of when a child can safely ride in front, there are other important factors you should consider.

Physical Size

Physically, a child must be large enough for the lap/shoulder belt to properly fit (see pages [15](#) and [56](#)). If the seat belt does not fit properly, with or without the child sitting on a booster seat, the child should not sit in front.

Maturity

To safely ride in front, a child must be able to follow the rules, including sitting properly, and wearing the seat belt properly throughout a ride.

If you decide that a child can safely ride up front, be sure to:

- Carefully read the owner's manual, and make sure you understand all seat belt instructions and all safety information.
- Move the vehicle seat to the rear-most position.
- Have the child sit up straight, back against the seat, and feet on or near the floor.
- Check that the child's seat belt is properly and securely positioned.
- Supervise the child. Even mature children sometimes need to be reminded to fasten the seat belts or sit properly.

Additional Safety Precautions

- **Do not let a child wear a seat belt across the neck.** This could result in serious neck injuries during a crash.
- **Do not let a child put the shoulder part of a seat belt behind the back or under the arm.** This could cause very serious injuries during a crash. It also increases the chance that the child will slide under the belt in a crash and be injured.
- **Two children should never use the same seat belt.** If they do, they could be very seriously injured in a crash.
- **Do not put any accessories on a seat belt.** Devices intended to improve a child's comfort or reposition the shoulder part of a seat belt can make the belt less effective and increase the chance of serious injury in a crash.

Carbon Monoxide Hazard

Your vehicle's exhaust contains carbon monoxide gas. Carbon monoxide should not enter the vehicle in normal driving if you maintain your vehicle properly and follow the information on this page.

Have the exhaust system inspected for leaks whenever:

- The vehicle is raised for an oil change.
- You notice a change in the sound of the exhaust.
- The vehicle was in an accident that may have damaged the underside.

WARNING

Carbon monoxide gas is toxic. Breathing it can cause unconsciousness and even kill you.

Avoid any enclosed areas or activities that expose you to carbon monoxide.

High levels of carbon monoxide can collect rapidly in enclosed areas, such as a garage. Do not run the engine with the garage door closed. Even with the door open, run the engine only long enough to move the vehicle out of the garage.

With the tailgate open, air flow can pull exhaust gas into your vehicle's interior and create a hazardous condition. If you must drive with the tailgate open, open all the windows and set the heating and cooling system/climate control system as shown below.

If you must sit in your parked vehicle with the engine running, even in an unconfined area, adjust the heating and cooling system/climate control system as follows:

1. Select the fresh air mode.
2. Select the  mode.
3. Set the fan speed to high.
4. Set the temperature control to a comfortable setting.

These labels are in the locations shown. They warn you of potential hazards that could cause serious injury or death. Read these labels carefully.

If a label comes off or becomes hard to read (except for the U.S. dashboard label which may be removed by the owner), contact your dealer for a replacement.

SUN VISORS

U.S. models



AIRBAG WARNING

FLIP VISOR OVER

WARNING

EVEN WITH ADVANCED AIR BAGS



- Children can be killed or seriously injured by the air bag
- The back seat is the safest place for children
- Never put a rear-facing child seat in the front
- Always use seat belts and child restraints
- See owner's manual for more information about air bags

Canadian models

CAUTION:

- TO AVOID SERIOUS INJURY, IN ALL TYPES OF CRASHES YOU MUST ALWAYS WEAR YOUR SAFETY BELT
- DO NOT INSTALL REARWARD-FACING CHILD SEAT IN REAR FRONT PASSENGER SEAT POSITION
- DO NOT PUT OR PLACE UNNECESSARILY CLOSE TO THE AIR BAGS
- DO NOT PLACE ANY OBJECTS OVER THE AIR BAG OR BETWEEN THE AIR BAG AND YOU PASSENGER
- SEE THE OWNER'S MANUAL FOR FURTHER INFORMATION AND EXPLANATIONS

PRECAUTIONS:

- POUR ÉVITER DES BLESSURES GRAVES, EN TOUTES LES SITUATIONS DE COLLISION, MAXIMALE, LORS D'UNE COLLISION, NOUVEZ TOUJOURS PORTER VOTRE CEINTURE DE SÉCURITÉ
- N'INSTALLEZ JAMAIS UN SIÈGE POUR ENFANT À L'ARRIÈRE D'UN VÉHICULE
- NE PAS METTRE D'OBJETS SUR LE SIÈGE DU PASSAGER AVANT
- NE VOUS APPROCHÉZ PAS ET NE VOUS ASSOYEZ PAS PRÈS DU COUSSIN GONFLABLE
- NE VOUS APPROCHÉZ PAS ET NE VOUS ASSOYEZ PAS PRÈS DU COUSSIN GONFLABLE
- NE VOUS APPROCHÉZ PAS ET NE VOUS ASSOYEZ PAS PRÈS DU COUSSIN GONFLABLE
- LÉSEZ LE GUIDE D'UTILISATION POUR DE PLUS AMPLES RENSEIGNEMENTS

DASHBOARD

U.S. models only

This Vehicle is Equipped with
Advanced Air Bags

Even with Advanced Air Bags

Children can be killed or seriously injured by the air bag.
The back seat is the safest place for children.
Never put a rear-facing child seat in the front.
Always use seat belts and child restraints.
See owner's manual for more information about air bags.

To be removed by owner only.

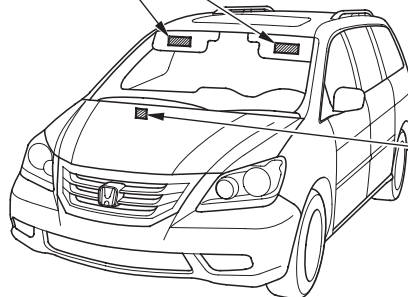

CONTINUED

Safety Labels

HOOD

U.S. models

SUPPLEMENTAL RESTRAINT SYSTEM (SRS)

This vehicle is equipped with front airbags, side airbags in the front seats, front seatbelt tensioners, and side curtain airbags. All SRS electrical wiring and connectors are colored yellow. Tampering with, disconnecting or using test equipment on the SRS wiring can make the system inoperative or cause accidental deployment.

▲ WARNING

Accidental deployment can seriously hurt or kill you. Follow Service Manual instructions carefully.

Canadian models

SUPPLEMENTAL RESTRAINT SYSTEM (SRS)

This vehicle is equipped with front airbags, side airbags in the front seats, front seatbelt tensioners, and side curtain airbags.

All SRS electrical wiring and connectors are colored yellow. Tampering with, disconnecting or using test equipment on the SRS wiring can make the system inoperative or cause accidental deployment.

▲ WARNING

Accidental deployment can seriously hurt or kill you. Follow Service Manual instructions carefully.

SYSTÈME DE RETENUE SUPPLÉMENTAIRE (SRS)

Ce véhicule est équipé de coussins gonflables frontaux, coussins gonflables latéraux, coussins gonflables latéraux de type rideau, ainsi que de pré-tensionneurs de ceinture de sécurité avant. Tous les fils électriques et les connecteurs du système SRS sont jaunes. Toute modification ou débranchement des fils du système SRS ou encore l'utilisation d'appareils d'essai sur ses circuits pourrait rendre le système inopérable ou entraîner un déploiement accidentel.

▲ ATTENTION

Un déploiement accidentel peut entraîner des blessures graves ou la mort. Suivre les instructions du manuel de réparation attentivement.

DOORJAMB

U.S. models

SIDE AIRBAG

- This car is equipped with side airbags in the front seats and side curtain airbags.
- Do not lean against the door.
- See owner's manual for more information.

Canadian models

SIDE AIRBAG

- This car is equipped with side airbags in the front seats and side curtain airbags.
- Do not lean against the door.
- See owner's manual for more information.

COUSSIN GONFLABLE LATÉRAL

- Cette automobile est équipée de coussins gonflables latéraux dans les sièges avant ainsi que de coussins gonflables latéraux de type rideau.
- Ne vous appuyez pas sur la porte.
- Consultez le Manuel du propriétaire pour en savoir plus.

RADIATOR CAP

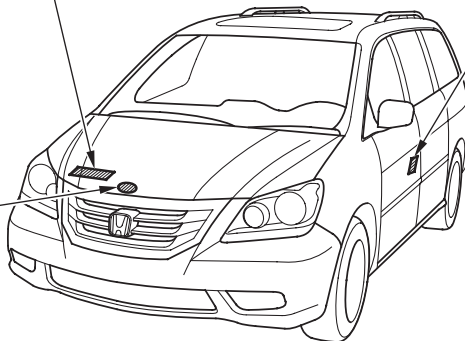

This section gives information about the controls and displays that contribute to the daily operation of your vehicle. All the essential controls are within easy reach.

Control Locations	64	Windshield Wipers and Washers.....	134	Seat Heaters	183
Instrument Panel	65	Rear Window Wiper and Washer.....	135	Driving Position Memory System.....	184
Instrument Panel Indicators.....	67	Turn Signal and Headlights	135	Power Windows	186
Gauges	77	Instrument Panel Brightness	139	Moonroof	189
Multi-Information Display	81	Hazard Warning Button.....	140	Mirrors.....	190
Controls Near the Steering Wheel.....	133	Rear Window Defogger	140	Parking Brake	192
		Steering Wheel Adjustment.....	141	Adjustable Driver's Foot Pedals ..	193
		Keys and Locks.....	142	Interior Convenience Items.....	194
		Immobilizer System.....	143	Retractable Center Tray	195
		Ignition Switch	144	Beverage Holders.....	195
		Remote Transmitter	145	Integrated Sunshade	197
		Opening or Closing the Power Sliding Doors.....	148	Sunglasses Holder	197
		Opening or Closing the Power Tailgate	148	Conversation Mirror	198
		Door Locks	151	Sun Visor	198
		Power Door Locks.....	151	Vanity Mirror	199
		Auto Door Locking/Unlocking	152	Rear Compartment.....	199
		Childproof Door Locks	157	Second Row Console	199
		Tailgate	157	In-Floor Storage Area.....	200
		Power Tailgate	158	Glove Boxes	201
		Sliding Doors.....	161	Center Pocket	202
		Seats	167	Coin Pocket	202
				Accessory Power Sockets.....	203
				AC Power Outlet.....	203
				Interior Lights	205

Control Locations

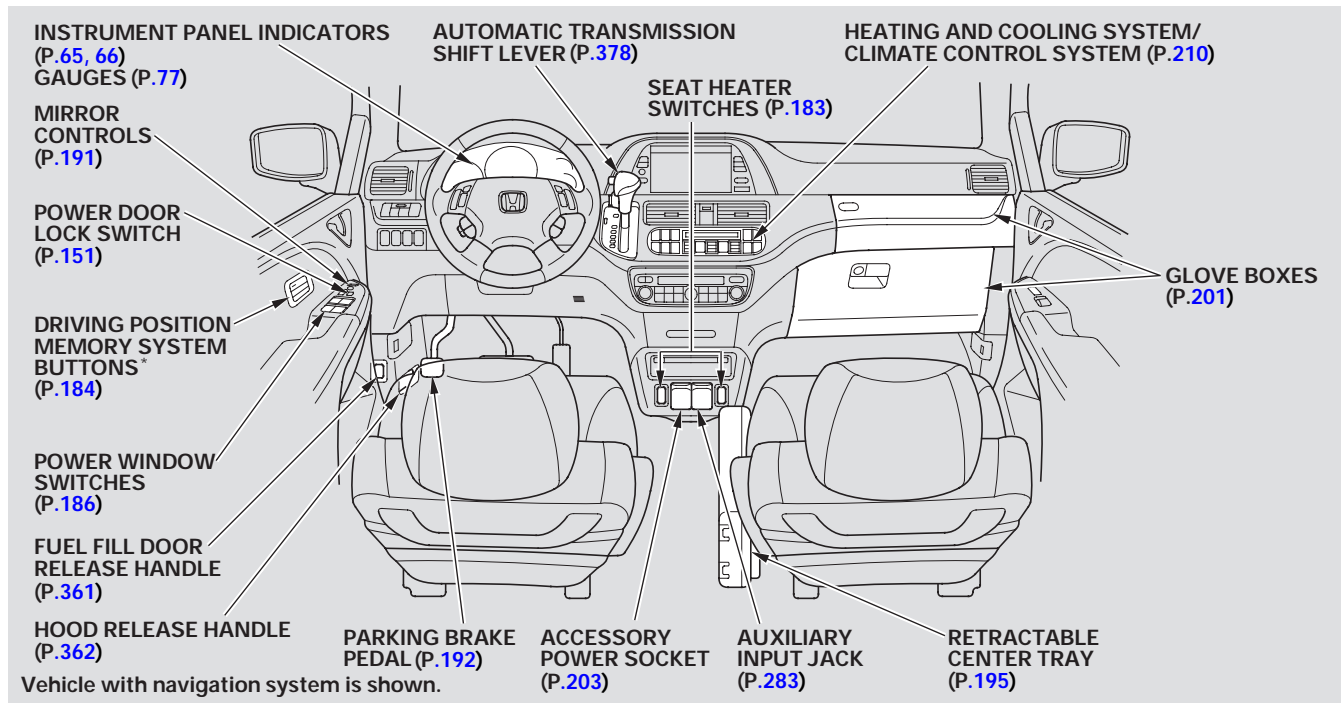

* : If equipped

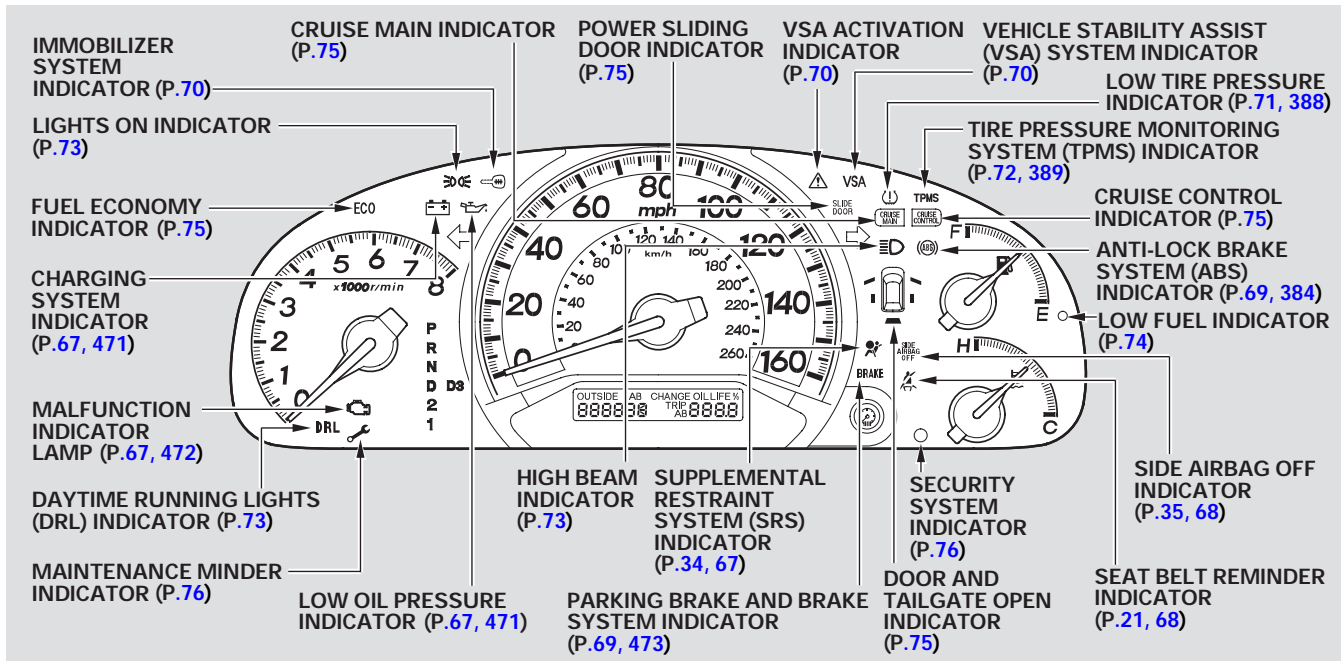
LX, EX, EX-L and Canadian DX models

The U.S. instrument panel is shown. Differences for the Canadian models are noted in the text.

Instrument Panel

Touring models

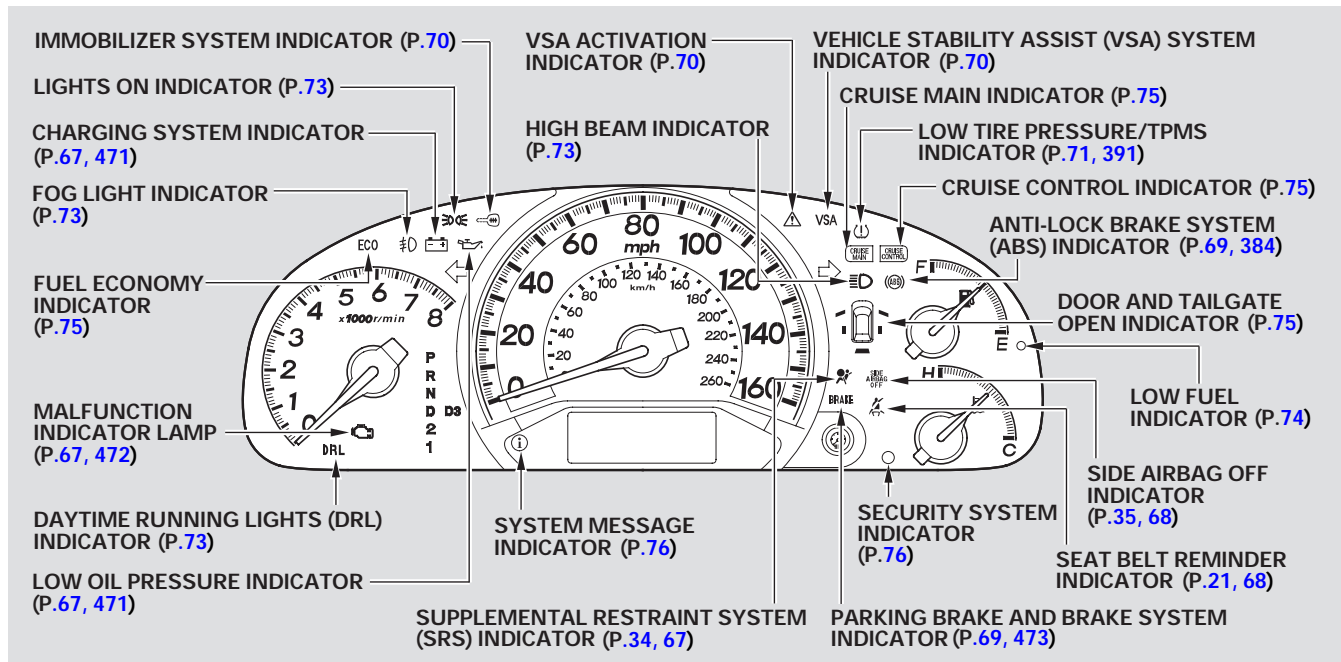

* The U.S. instrument panel is shown. Differences for the Canadian models are noted in the text.

The instrument panel has many indicators to give you important information about your vehicle.



Malfunction Indicator Lamp

For more information, see page [472](#).

On Touring models

You will also see a “CHECK EMISSION SYSTEM” message on the multi-information display (see page [88](#)).



Charging System Indicator

If this indicator comes on when the engine is running, the battery is not being charged. For more information, see page [471](#) .

On Touring models

You will also see a “CHECK CHARGING SYSTEM” message on the multi-information display (see page [88](#)).



Low Oil Pressure Indicator

The engine can be severely damaged if this indicator flashes or stays on when the engine is running. For more information, see page [471](#) .

On Touring models

You will also see a “CHECK ENGINE OIL LEVEL” message on the multi-information display (see page [88](#)).



Supplemental Restraint System (SRS) Indicator

This indicator comes on for several seconds when you turn the ignition switch to the ON (II) position. If it comes on at any other time, it indicates a potential problem with your front airbags. This indicator will also alert you to a potential problem with your side airbags, passenger’s side airbag automatic cutoff system, side curtain airbags, automatic seat belt tensioners, driver’s seat position sensor, or the front passenger’s weight sensors. For more information, see page [34](#) .

On Touring models

You will also see a “CHECK AIRBAG SYSTEM” message on the multi-information display (see page [88](#)).

Instrument Panel Indicators



Seat Belt Reminder Indicator

This indicator comes on when you turn the ignition switch to the ON (II) position. It reminds you and your passengers to fasten your seat belts. A beeper also sounds if you have not fastened your seat belt.

If you turn the ignition switch to the ON (II) position before fastening your seat belts, the beeper sounds, and the indicator flashes. If you do not fasten your seat belts before the beeper stops, the indicator stops flashing but remains on.

If your front passenger does not fasten their seat belt, the indicator comes on about 6 seconds after the ignition switch is turned to the ON (II) position.

If either of you do not fasten your seat belt while driving, the beeper will sound and the indicator will flash again at regular intervals. For more information, see page [21](#).

On Touring models

You will also see a “FASTEN SEAT BELT” or “FASTEN PASSENGER SEAT BELT” message on the multi-information display (see page [88](#)).



U.S.

Canada



Side Airbag Off Indicator

This indicator comes on for several seconds when you turn the ignition switch to the ON (II) position. If it comes on at any other time, it indicates that the passenger’s side airbag has automatically shut off. For more information, see page [35](#).

On Touring models

You will also see a “PASSENGER SIDE AIRBAG OFF” message on the multi-information display (see page [89](#)).



Anti-lock Brake System (ABS) Indicator

This indicator normally comes on for a few seconds when you turn the ignition switch to the ON (II) position, and when the ignition switch is turned to the START (III) position. If it comes on at any other time, there is a problem with the ABS. If this happens, have your vehicle checked at a dealer. With this indicator on, your vehicle still has normal braking ability but no anti-lock function. For more information, see page [384](#) .

On Touring models

You will also see a “CHECK ABS SYSTEM” message on the multi-information display (see page [89](#)).

U.S.

Canada



Parking Brake and Brake System Indicator

This indicator has two functions:

1. It comes on when you turn the ignition switch to the ON (II) position. It is a reminder to check the parking brake. A beeper sounds if you drive with the parking brake not fully released. Driving with the parking brake not fully released can damage the brakes and tires.

On Touring models

You will also see a “RELEASE PARKING BRAKE” message on the multi-information display (see page [88](#)).

2. If it remains on after you have fully released the parking brake while the engine is running, or if it comes on while driving, there could be a problem with the brake system. For more information, see page [473](#) .

On Touring models

You will also see a “BRAKE FLUID LOW” or “CHECK BRAKE SYSTEM” message on the multi-information display (see page [88](#)).

CONTINUED

Instrument Panel Indicators



Immobilizer System Indicator

This indicator comes on for a few seconds when you turn the ignition switch to the ON (II) position. It will go off if you have inserted a properly-coded ignition key. If it is not a properly-coded key, the indicator will blink and the engine will not start (see page [143](#)).

This indicator also blinks several times when you turn the ignition switch from the ON (II) position to the ACCESSORY (I) or LOCK (0) position.



Vehicle Stability Assist (VSA) System Indicator

This indicator normally comes on for a few seconds when you turn the ignition switch to the ON (II) position.

If it comes on and stays on at any other time, or if it does not come on when you turn the ignition switch to the ON (II) position, there is a problem with the VSA system. Take your vehicle to a dealer to have it checked. Without VSA, your vehicle still has normal driving ability, but will not have VSA traction and stability enhancement. See page [386](#) for more information on the VSA system.

On Touring models

You will also see a “CHECK VSA SYSTEM” message on the multi-information display (see page [89](#)).



VSA Activation Indicator

This indicator has three functions:

1. It comes on as a reminder that you have turned off the vehicle stability assist (VSA) system.
2. It flashes when VSA is active (see page [386](#)).
3. It comes on along with the VSA system indicator if there is a problem with the VSA system.

On Touring models

You will also see a “CHECK VSA SYSTEM” message on the multi-information display (see page [89](#)).

This indicator normally comes on for a few seconds when you turn the ignition switch to the ON (II) position. See page [386](#) for more information.

**Low Tire Pressure Indicator**

On LX, EX, EX-L and Canadian DX models

This indicator normally comes on for a few seconds when you turn the ignition switch to the ON (II) position.

If it comes on while driving, it indicates that one or more of your vehicle's tires are significantly low on pressure.

If this happens, pull to the side of the road when it is safe, check which tire has lost the pressure, and determine the cause. If it is because of a flat tire, replace the flat tire with the compact spare (see page [457](#)), and have the flat tire repaired as soon as possible. If two or more tires are underinflated, call a professional towing service (see page [480](#)). For more information, see page [388](#).

**Low Tire Pressure/TPMS Indicator**

On Touring models

This indicator normally comes on for a few seconds when you turn the ignition switch to the ON (II) position.

This indicator has two functions:

1. If it comes on while driving, it indicates that one or more of your vehicle's tires are significantly low on pressure.

You will also see a "CHECK TIRE PRESSURE" message on the multi-information display (see page [88](#)).

Check the tire pressure monitor on the multi-information display and determine the cause (see page [393](#)).

If this happens, pull to the side of the road when it is safe, check which tire has lost pressure on the multi-information display, and determine the cause. If it is because of a flat tire, have the flat tire repaired as soon as possible. If two or more tires are underinflated, call a professional towing service. For more information, see page [480](#).

U.S. model (If equipped)

Your vehicle has Michelin PAX tires. Repair or replacement of PAX tires must be done by a Honda dealer or an authorized Michelin PAX system dealer. For more information, see page [449](#).

CONTINUED

Instrument Panel Indicators

2. If this indicator begins to flash, there is a problem with the tire pressure monitoring system (TPMS). You will also see a “CHECK TPMS SYSTEM” message on the multi-information display. The indicator continues to flash for a while (approximately 1 minute), then stays on. If this happens, have your dealer check the system as soon as possible. For more information, see page [395](#).

TPMS

Tire Pressure Monitoring System (TPMS) Indicator

On LX, EX, EX-L and Canadian DX models

This indicator normally comes on for a few seconds when you turn the ignition switch to the ON (II) position.

If this indicator comes on and stays on at any other time, or if it does not come on when you turn the ignition switch to the ON (II) position, there is a problem with the TPMS. With this indicator on, the low tire pressure indicator will not come on when a tire loses pressure. Take the vehicle to your dealer to have the system checked.





Turn Signal and Hazard Warning Indicators

The left or right turn signal indicator blinks when you signal a lane change or turn. If an indicator does not blink or blinks rapidly, it usually means one of the turn signal bulbs is burned out (see pages [430](#) and [433](#)). Replace the bulb as soon as possible, since other drivers cannot see that you are signaling.

When you press the hazard warning button, both turn signal indicators and all turn signals on the outside of the vehicle flash.



Lights On Indicator

This indicator reminds you that the exterior lights are on. It comes on when the light switch is in either the  or  position. If you turn the ignition switch to the ACCESSORY (I) or the LOCK (0) position without turning off the light switch, this indicator will remain on. A reminder chime will also sound when you open the driver's door and remove the key from the ignition switch.

On Touring models, this indicator also comes on when the light switch is in AUTO and the lights turn on automatically.

Daytime Running Lights Indicator

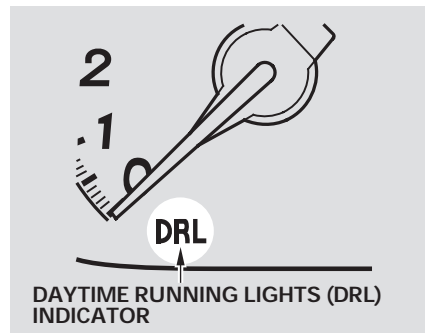

If this indicator comes on when the ignition switch is turned to the ON (II) position and the parking brake is released, it means there is a problem in the high beam headlight's circuit. Have your vehicle checked by your dealer.

On Touring model

If you see a "CHECK DRL SYSTEM" message on the multi-information display, there is a problem in the high beam headlight's circuit. Take your vehicle to a dealer to have it checked (see page [89](#)).



High Beam Indicator

This indicator comes on with the high beam headlights. For more information, see page [136](#) .

This indicator also comes on with reduced brightness when the daytime running lights (DRL) are on (see page [138](#)).



Fog Light Indicator

On Touring models

This indicator comes on when you turn on the fog lights. See page [138](#) for information on fog light operation.

Instrument Panel Indicators

Washer Level Indicator

On Canadian models

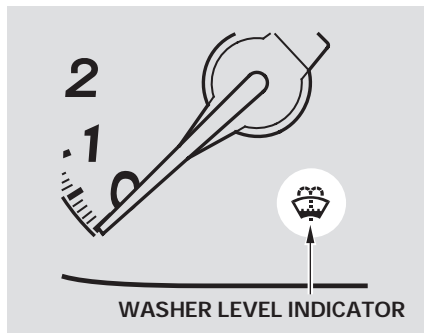

This indicator comes on when the washer fluid level is low. Add washer fluid when you see this indicator comes on (see page [424](#)).

On Canadian Touring models

You will also see a “WASHER FLUID LOW” message on the multi-information display (see page [89](#)).

Low Fuel Indicator

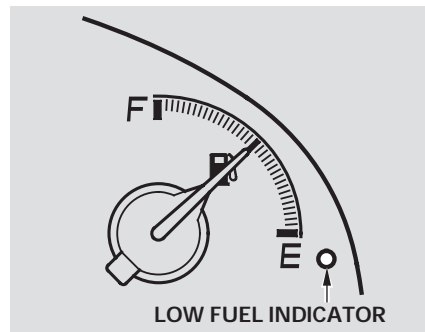

This indicator is in the fuel gauge. It comes on as a reminder that you must refuel soon. When the indicator comes on, there is about 1.08 US gal (4.1 ℓ) of fuel remaining in the tank before the reading reaches E. There is a small reserve of fuel remaining in the tank when the reading does reach E.

On Touring models

You will also see a “FUEL LOW” message on the multi-information display (see page [89](#)).

U.S.

Canada

SLIDE
DOOR**Power Sliding
Door Indicator***On EX and EX-L models*

This indicator comes on for a few seconds when you turn the ignition switch to the ON (II) position. If it comes on at any other time, there is a problem in the power sliding door system. With this indicator on, move the main switch on the dashboard to the OFF position, and have the system checked by your dealer as soon as possible. You can still open or close each sliding door manually. For more information on the power sliding doors, see page 161.

On Touring models

You will also see a “CHECK LEFT SLIDING DOOR” or “CHECK RIGHT SLIDING DOOR” message on the multi-information display (see page 89).

CRUISE
MAIN**Cruise Main Indicator**

This indicator comes on when you turn on the cruise control system by pressing the CRUISE button on the steering wheel (see page 319).

CRUISE
CONTROL**Cruise Control Indicator**

This indicator comes on when you set the cruise control. See page 319 for information on operating the cruise control.

ECO

Fuel Economy Indicator*On EX-L and Touring models*

While the engine is operating in its most economical range, this indicator may come on and stay on. It goes off when your vehicle uses extra fuel.

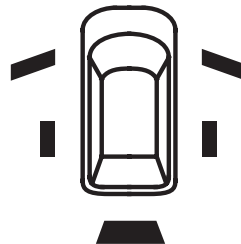
Door and Tailgate Open Indicator

The appropriate light comes on in this indicator if the tailgate or any door is not closed tightly. All the lights in the indicator come on for a few seconds when you turn the ignition switch to the ON (II) position.

On Touring models

The door and tailgate open indicator also appears on the multi-information display.

Instrument Panel Indicators



Maintenance Minder Indicator

On LX, EX, EX-L and Canadian DX models

This indicator comes on for a few seconds when you turn the ignition switch to the ON (II) position. It reminds you that it is time to take your vehicle in for scheduled maintenance. The maintenance main items and sub items will be displayed in the information display. See page [407](#) for more information on the maintenance minder.

This indicator goes off when your dealer resets it after completing the required maintenance service.



System Message Indicator

On Touring models

This indicator comes on when there is a system message on the multi-information display. Press the INFO button on the steering wheel (see page [82](#)) to see the message (see page [87](#)).

Most of the time, this indicator comes on along with other indicators in the instrument panel such as the seat belt reminder indicator, SRS indicator, VSA system indicator, etc.

Security System Indicator

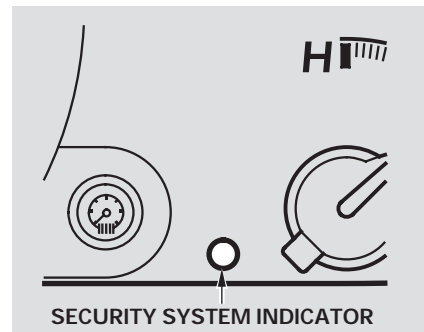

This indicator comes on when the security system is set. For more information, see page [318](#).

LX, EX, EX-L and Canadian DX models

TACHOMETER SPEEDOMETER

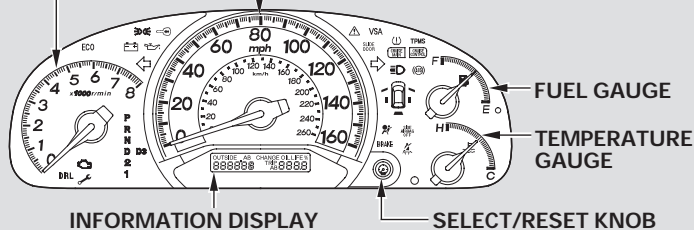

Touring models

TACHOMETER SPEEDOMETER

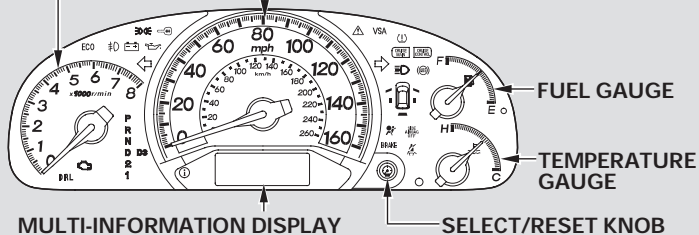

Temperature Gauge

This shows the temperature of the engine's coolant. During normal operation, the pointer should rise to about the middle of the gauge. In severe driving conditions, the pointer may rise to the upper zone. If it reaches the red (hot) mark, pull safely to the side of the road. For instructions and precautions on checking the engine's cooling system, see page 469.

Fuel Gauge

This shows how much fuel you have. It may show slightly more or less than the actual amount. The needle returns to the bottom after you turn off the ignition.

NOTICE

Avoid driving with an extremely low fuel level. Running out of fuel could cause the engine to misfire, damaging the catalytic converter.

Gauges

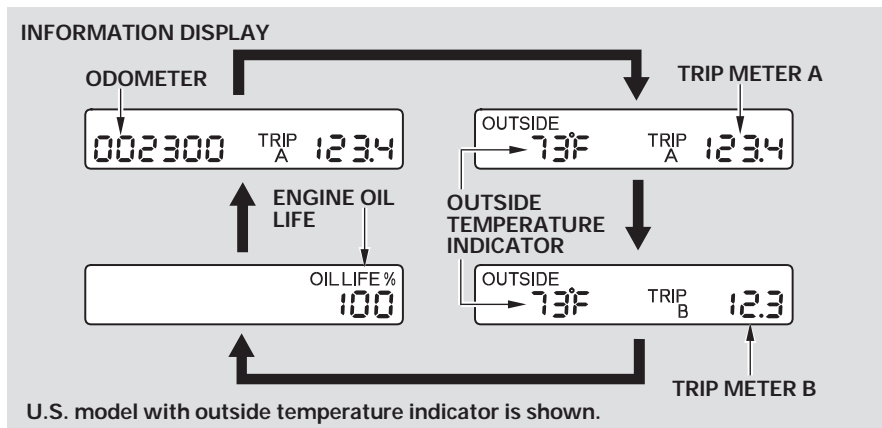

Information Display

On LX, EX, EX-L and Canadian DX models

The information display shows the odometer, trip meter, engine oil life, outside temperature (if equipped), and maintenance item code(s).

To switch the display, press and release the select/reset knob repeatedly. When you turn the ignition switch to the ON (II) position, what you last selected is displayed.

On Touring models

For information about the multi-information display, see page [81](#).

Odometer

The odometer shows the total distance your vehicle has been driven. It measures miles in U.S. models and kilometers in Canadian models. It is illegal under U.S. federal law and Canadian provincial regulations to disconnect, reset, or alter the odometer with the intent to change the number of miles or kilometers indicated.

Trip Meter

This meter shows the number of miles (U.S.) or kilometers (Canada) driven since you last reset it. There are two trip meters: Trip A and Trip B. Switch between these displays by pressing the select/reset knob repeatedly. Each trip meter works independently, so you can keep track of two different distances. To reset a trip meter, display it, and then press and hold the select/reset knob until the number resets to "0.0".

Outside Temperature Indicator*On EX and EX-L models*

This indicator displays the outside temperature in Fahrenheit (U.S. models) or Centigrade (Canadian models). To see the outside temperature, press and release the select/reset knob until the temperature is displayed.

The temperature sensor is in the front bumper. The temperature reading can be affected by heat reflection from the road surface, engine heat, and the exhaust from surrounding traffic. This can cause an incorrect temperature reading when your vehicle speed is under 19 mph (30 km/h). When you start your trip, the sensor is not fully acclimatized, therefore it may take several minutes until the proper temperature is displayed.

In certain weather conditions, temperature readings near freezing (32°F, 0°C) could mean that ice is forming on the road surface.

If the outside temperature is incorrectly displayed, you can adjust it up to $\pm 5^{\circ}\text{F}$ in U.S. models ($\pm 3^{\circ}\text{C}$ in Canadian models) warmer or cooler.

NOTE: The temperature must be stabilized before doing this procedure.

To adjust the outside temperature indicator, press and hold the select/reset knob for 10 seconds. The following sequence will appear for 1 second each: 0, 1, 2, 3, 4, 5, - 5, - 4, - 3, - 2, - 1, 0 (U.S.) or 0, 1, 2, 3, - 3, - 2, - 1, 0 (Canada).

When the temperature reaches the desired value, release the select/reset knob. You should see the new outside temperature displayed.

CONTINUED

Gauges

Maintenance Minder

The information display in the instrument panel shows you the engine oil life and maintenance service items when the ignition switch is in the ON (II) position. This information helps to keep you aware of the periodic maintenance your vehicle needs for continued trouble-free driving. Refer to page [407](#) for more information.

Check Fuel Cap Message

Your vehicle's onboard diagnostic system will detect a loose or missing fuel fill cap as an evaporative system leak. The first time a leak is detected a "CHECK FUEL CAP" message appears on the information display.

Turn the engine off, and confirm the fuel fill cap is installed. If it is, loosen it, then retighten it until it clicks at least once. The message should go off after several days of normal driving once you tighten or replace the fuel fill cap. To scroll to another display, press the select/reset knob.

The "CHECK FUEL CAP" message will appear each time you restart the engine until the system turns the message off.

If the system still detects a leak in your vehicle's evaporative emissions system, the malfunction indicator lamp (MIL) comes on. If the fuel fill cap was not already tightened, turn the engine off, and check or retighten the fuel fill cap until it clicks at least once. The MIL should go off after several days of normal driving once the cap is tightened or replaced. If the MIL does not go off, have your vehicle inspected by a dealer. For more information, see page [472](#).

On Touring models only

The multi-information display in the instrument panel displays various information and messages when the ignition switch is in the ON (II) position. Some of the messages help you operate your vehicle more comfortably.

Others help to keep you aware of the periodic maintenance your vehicle needs for continued trouble-free driving.

You can also customize some vehicle control settings to your liking with the multi-information display and the two buttons on the steering wheel (see page [101](#)).

Normal Display Messages

When you unlock and open the driver's door with the remote transmitter, the display shows "Welcome DRIVER 1" or "Welcome DRIVER 2" depending on which remote transmitter you use. The driver's "ID" is detected by the transmitter. For more information about driver's "ID", see page [149](#).



If you use the key to unlock the driver's door, the display only shows "Welcome." This means the system cannot recognize either "DRIVER 1" or "DRIVER 2." In this case, you cannot use the customized settings on the multi-information display (see page [101](#)).

When you turn the ignition switch to the ACCESSORY (I) position, the display shows "Goodbye."

CONTINUED

Multi-Information Display

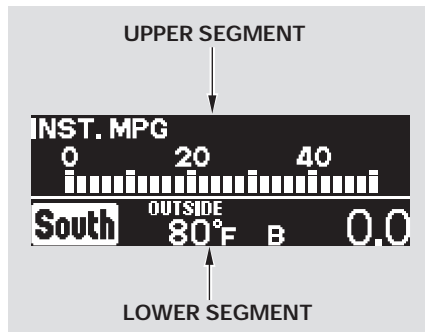

The multi-information display consists of two segments; an upper segment and a lower segment.

In normal display mode, the upper segment displays the trip computer. The lower segment displays the odometer, Trip A/B, outside temperature, compass, and engine oil life and maintenance message.

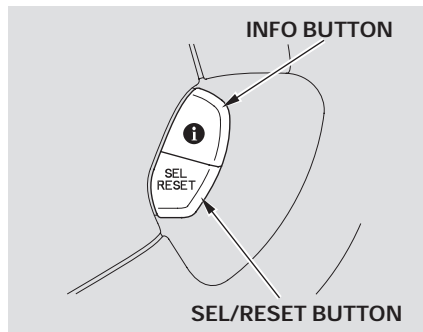

To change the display, press the INFO button on the steering wheel repeatedly until the desired information appears (see page [84](#)).

Messages in the trip computer include:

- **INST. MPG** (U.S. models)/ **INST.L/100 km** (Canadian models): Your vehicle's current fuel mileage.

When you turn off the engine, INST. MPG or INST. L/100 km is also reset.

- **RANGE**: The estimated distance you can travel on the fuel remaining in the tank. This distance is estimated from the fuel economy you received over the last several miles, so it will vary with changes in speed, traffic, etc.

When the battery is disconnected, or you refuel, RANGE is also reset.

- **ELAPSED TIME:** The time traveled since you last reset the trip computer. When you turn the ignition switch to the ON (II) position, ELAPSED TIME is reset.

You can customize the ELAPSED TIME reset condition on the multi-information display (see page [114](#)).

- **AVERAGE SPEED:** The average speed you are traveling.

When you reset Trip A, AVERAGE SPEED is also reset.

- **AVERAGE FUEL A/B:** This shows your vehicle's average fuel economy in mpg (U.S. models) or $\ell/100$ km (Canadian models) since you last reset Trip A or Trip B. When you select Trip B in the lower segment by pressing the SEL/RESET button on the steering wheel, or the select/reset knob on the instrument panel, AVERAGE FUEL B appears on the upper segment.

You can customize the Trip A and AVERAGE FUEL A reset condition on the multi-information display (see page [112](#)).

The average fuel mileage will be reset when you reset the trip meter, or if the vehicle's battery goes dead or is disconnected.

CONTINUED

Multi-Information Display

If you press the INFO button while AVERAGE FUEL is displayed, you will see the tire pressure monitor in both segments. This monitor is a part of the tire pressure monitoring system (TPMS). See page 393 for more information.

Pressing the INFO button again brings the display back to the initial display of the trip computer “INST. MPG” (U.S. models) or “INST. L/100 km” (Canadian models).

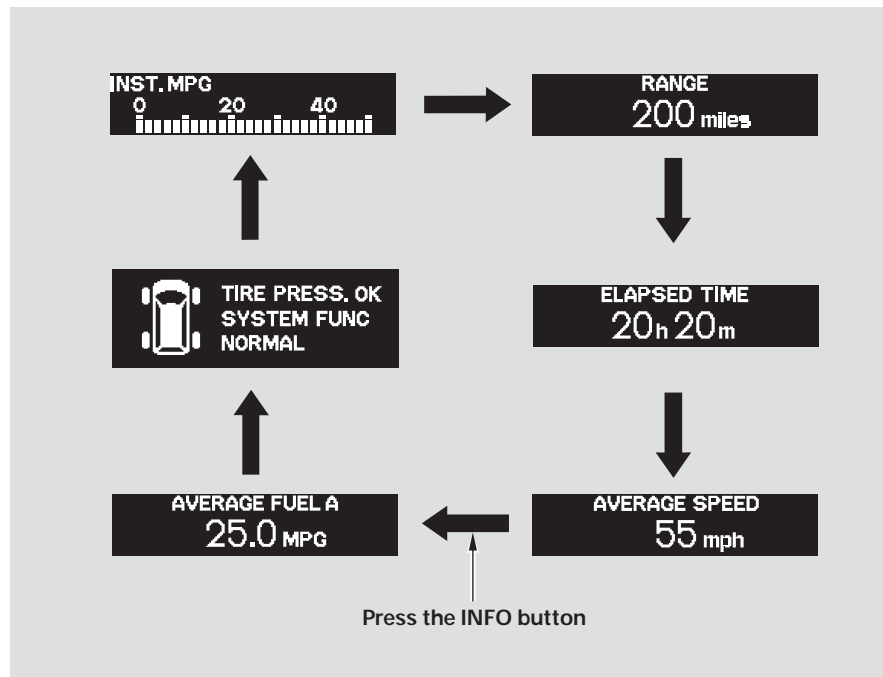

Multi-Information Display

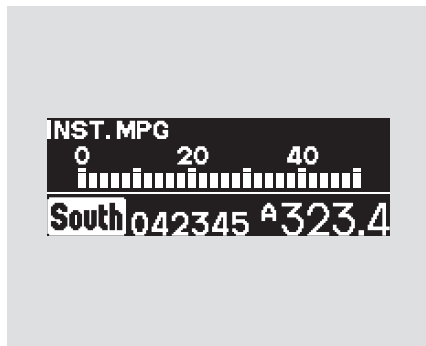

In the lower segment, each time you press the SEL/RESET button on the steering wheel, the display changes from “Trip A/Odometer” to “Trip A/ Outside Temperature” to “Trip B/ Outside Temperature” to “Engine Oil Life”, and then back to the “Trip A/Odometer” as shown in the next column.

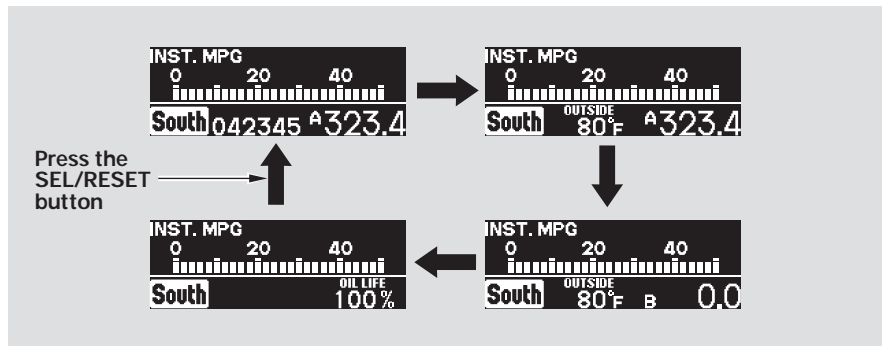

You can also change the display by pushing the select/reset in the instrument panel.

When you turn the ignition switch to the ON (II) position, what you last selected is displayed.

Odometer

The odometer shows the total distance your vehicle has been driven. It measures miles in U.S. models and kilometers in Canadian models. It is illegal under U.S. federal law and Canadian provincial regulations to disconnect, reset, or alter the odometer with the intent to change the number of miles or kilometers indicated.

Multi-Information Display

Trip Meter

While a trip meter is displayed, you can change the display between “Trip A” and “Trip B” by pressing the SEL/RESET button on the steering wheel, or the select/reset knob in the instrument panel.

To reset a trip meter, display it, then press and hold the SEL/RESET button until the number resets to “0.0”.

When you reset Trip A, AVERAGE FUEL A is reset at the same time. When you reset Trip B, AVERAGE FUEL B is reset.

You can customize the Trip A and AVERAGE FUEL A reset condition on the multi-information display (see page [112](#)).

Compass

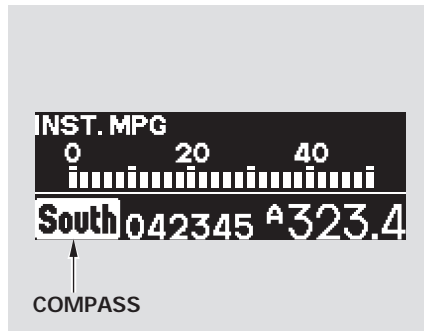

In the left corner of the lower segment, a compass indicates which direction your vehicle is pointed.

Maintenance Minder

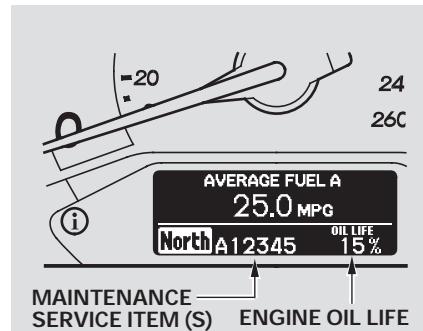

The multi-information display in the instrument panel shows you the engine oil life and maintenance service items when the ignition switch is in the ON (II) position. This information helps to keep you aware of the periodic maintenance your vehicle needs for continued trouble-free driving. Refer to page [407](#) for more information.

Outside Temperature Display

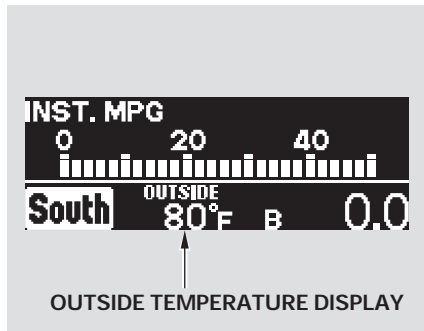

This shows the outside temperature in Fahrenheit (U.S. models), or in Centigrade (Canadian models).

The temperature sensor is in the front bumper. The temperature reading can be affected by heat reflection from the road surface, engine heat, and the exhaust from surrounding traffic. This can cause an incorrect temperature reading when your vehicle speed is under 19 mph (30 km/h). When you start your trip, the sensor is not fully acclimatized, therefore it may take several minutes until the proper temperature is displayed.

In certain weather conditions, temperature readings near freezing (32°F, 0°C) could mean that ice is forming on the road surface.

You can adjust the outside temperature on the multi-information display (see page [110](#)).









System Messages







If there is a problem with your vehicle, for example, the engine oil level is low or a door is not fully closed, the multi-information display will show you the problem. It does this by interrupting the current display with one or more messages.





Here is a list of messages shown on the multi-information display:

CONTINUED

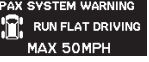





Multi-Information Display





 WARNING: APPROACHING OBJECT		See page 94, 353
 DOOR & TAILGATE OPEN		See page 11, 91
 FASTEN SEAT BELT		See page 21, 91
 FASTEN PASSENGER SEAT BELT		
 RELEASE PARKING BRAKE	U.S.	See page 91, 473
 RELEASE PARKING BRAKE	Canada	
 BRAKE FLUID LOW	U.S.	See page 93, 473
 BRAKE FLUID LOW	Canada	

 CHECK BRAKE SYSTEM	U.S.	See page 97, 473
 CHECK BRAKE SYSTEM	Canada	
 CHECK TPMS SYSTEM		See page 95, 392
 CHECK TIRE PRESSURE		See page 94, 391
 PAX SYSTEM WARNING RUN FLAT LIMIT STOP DRIVING		See page 100, 454
 PAX SYSTEM WARNING RUN FLAT RANGE NEAR LIMIT CHECK TIRE SOON		
 PAX SYSTEM WARNING RUN FLAT DRIVING MAX 50MPH		



 CHECK ENGINE OIL LEVEL		See page 96, 471
 CHECK CHARGING SYSTEM		See page 96, 471
 CHECK EMISSION SYSTEM		See page 97, 472
 CHECK TRANSMIS- SION		See page 97
 CHECK AIRBAG SYSTEM		See page 34, 98

Multi-Information Display

 CHECK ABS SYSTEM	U.S.	See page 98, 384
 CHECK VSA SYSTEM	U.S.	See page 96, 386
 PASSENGER SIDE AIRBAG OFF	U.S.	See page 35, 94
 PASSENGER SIDE AIRBAG OFF	Canada	
 CHECK DRL SYSTEM	U.S.	See page 99, 138
 CHECK POWER TAILGATE	U.S.	See page 99, 160
 CHECK POWER TAILGATE	Canada	

 CHECK LEFT SLIDING DOOR	U.S.	See page 99, 166
 CHECK LEFT SLIDING DOOR	Canada	
 CHECK PARKING SENSOR SYSTEM		See page 98, 354
 FUEL LOW		See page 93
TIGHTEN FUEL CAP		See page 92
 WASHER FLUID LOW		See page 93

* : Canadian model only

 SERVICE DUE SOON A12345		See page 95, 409
 REMOVE KEY		See page 92

CONTINUED

Multi-Information Display

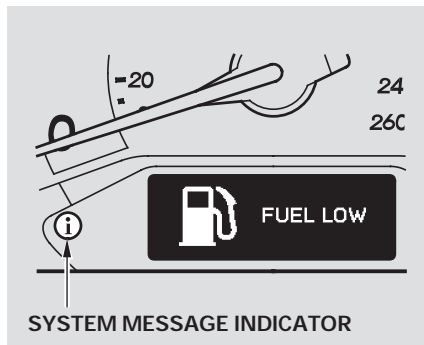

The system message(s) triggers the appropriate indicator(s) on the instrument panel, including the system message indicator, to come on. The system message indicator does not go off until the problem(s) is corrected.

You will also hear a beep when the system message comes on for the first time.

Most of the messages are displayed for about 5 seconds, and then the normal display returns. If there are several system messages to be shown, the display switches these messages every 5 seconds.

To cancel the message(s) before 5 seconds elapsed, press the INFO button on the steering wheel.

Even if you press the INFO button, some messages stay on or come on again at regular intervals until the problem is corrected:

- FASTEN SEAT BELT
- FASTEN PASSENGER SEAT BELT
- RELEASE PARKING BRAKE
- WARNING: APPROACHING OBJECT
- PAX SYSTEM WARNING
(Models with PAX system)

You can see the message(s) again by pressing the INFO button repeatedly if the system message indicator remains lit on the instrument panel.

Fasten Seat Belt

In addition to the seat belt reminder indicator on the instrument panel, the multi-information display interrupts the current display and shows “FASTEN SEAT BELT” or “FASTEN PASSENGER SEAT BELT” if you or your front passenger do not fasten your seat belts while driving. This message remains displayed if you ignore it and do not wear your seat belts while the vehicle is moving.

Door and Tailgate Open

If the tailgate or any door(s) is not closed tightly, the display reminds you to close the tailgate or the door(s) before you start driving. This display continues until you close the door(s) or the tailgate. Pressing the INFO button on the steering wheel momentarily changes the display to the normal display, but it will come back after 5 seconds.

Release Parking Brake

If you start driving without releasing the parking brake, the multi-information display interrupts the current display and shows “RELEASE PARKING BRAKE.” This message continues, and a chime sounds, until you release the parking brake, or the vehicle speed slows down to less than 0.5 mph (0.8 km/h).

CONTINUED

Multi-Information Display

Remove Key

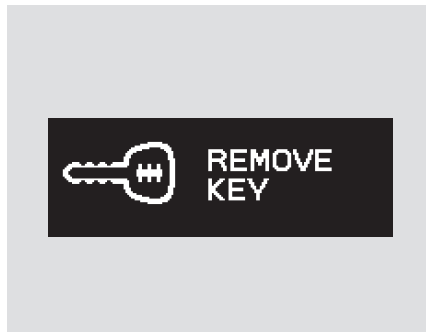

If you leave the key in the ignition switch in the LOCK (0) or ACCESSORY (I) position and open the driver's door, you will see "REMOVE KEY" on the display and hear a reminder beeper.

Tighten Fuel Cap



Your vehicle's on board diagnostic system will detect a loose or missing fuel fill cap as an evaporative system leak. The first time a leak is detected a "TIGHTEN FUEL CAP" message appears on the multi-information display. Turn the engine off, and confirm the fuel fill cap is installed. If it is, loosen it, then retighten it until it clicks at least once. The message should go off after several days of normal driving once you tighten or

replace the fuel fill cap. To scroll to another message, press the INFO button. The "TIGHTEN FUEL CAP" message will appear each time you restart the engine until the system turns the message off.

If the system still detects a leak in your vehicle's evaporative emissions system, the malfunction indicator lamp (MIL) comes on. If the fuel fill cap was not already tightened, turn the engine off, and check or retighten the fuel fill cap until it clicks at least once. The MIL should go off after several days of normal driving once the cap is tightened or replaced. If the MIL does not go off, have your vehicle inspected by a dealer. For more information, see page [472](#) .

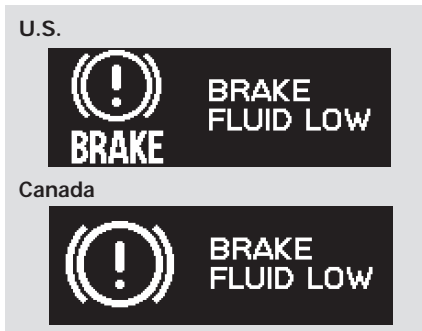
Brake Fluid Low

If the brake fluid level is at or below the MIN mark on the side of the brake fluid reservoir in the engine compartment, you will see "BRAKE FLUID LOW." If you see this message, have the brake system checked by your dealer (see page [473](#)).

Fuel Low

If the level of the fuel in the tank gets low, you will see "FUEL LOW" on the multi-information display, and you must refuel soon. The low fuel indicator on the instrument panel will also come on.

Washer Fluid Low

On Canadian model only
If the fluid level in the windshield washer reservoir gets low, you will see "WASHER FLUID LOW" on the multi-information display.

CONTINUED

Multi-Information Display

Passenger Side Airbag Off



If the passenger's side airbag has automatically shut off, you will see "PASSENGER SIDE AIRBAG OFF" on the multi-information display. See page [35](#) for more information.

Check Tire Pressure



If one or more of your vehicle tires are low on pressure, you will see a "CHECK TIRE PRESSURE" message on the display. See page [391](#) for more information on the tire pressure monitoring system (TPMS).

Warning: Approaching Object



This message, and the indicator to the left of the message, is part of the parking sensor system. If you are approaching too close to an object, you will see "WARNING: APPROACHING OBJECT" on the display and hear a beeper. See page [353](#) for more information.

Maintenance Messages

When the engine oil life reaches 15%, the display shows “SERVICE DUE SOON” and the code for the maintenance items to be performed.

When the engine oil life reaches 5%, the display shows “SERVICE DUE NOW” along with the same maintenance items.

Have your dealer do the indicated maintenance as soon as you see this message, and have them reset the display after completing the service.

If you do not perform the indicated maintenance or do not reset the display, the message changes to “SERVICE PAST DUE” when the engine oil life becomes 0%.

These messages appear on the multi-information display each time you turn the ignition switch to the ON (II) position.

For details on engine oil life and maintenance messages, refer to page [409](#).

Also refer to page [406](#) for important maintenance safety precautions.

Check TPMS System

If there is a problem in the tire pressure monitoring system (TPMS), you will see “CHECK TPMS SYSTEM” on the multi-information display. If you see this message, the TPMS is not monitoring tire pressures. Have the TPMS checked by your dealer as soon as possible (see page [395](#)).

CONTINUED

Multi-Information Display

Check VSA System



If there is a problem with the vehicle stability assist (VSA) system, you will see “CHECK VSA SYSTEM” on the multi-information display. If you see this message, have the VSA system checked by your dealer (see page [386](#)).

Check Engine Oil Level



If the engine oil is very low or has lost pressure, you will see “CHECK ENGINE OIL LEVEL” on the multi-information display. You will also see the low oil pressure indicator in the instrument panel flashing or staying on. If you see this message, you should take immediate action since serious engine damage is possible. Follow the procedure on page [471](#) .

Check Charging System

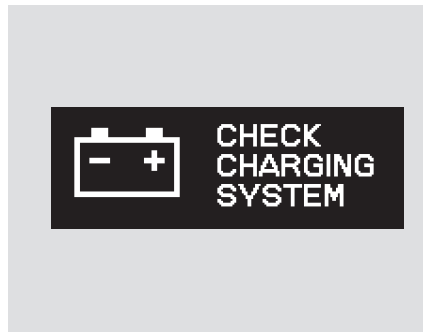

If you see “CHECK CHARGING SYSTEM” on the multi-information display, it means the battery is not being charged. See page [471](#) for more information.

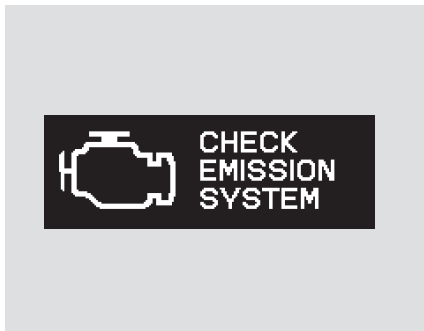
Check Emission System

If you see “CHECK EMISSION SYSTEM” on the multi-information display, it means one of the engine’s emission systems may have a problem. Have your vehicle checked by your dealer (see page [472](#)).

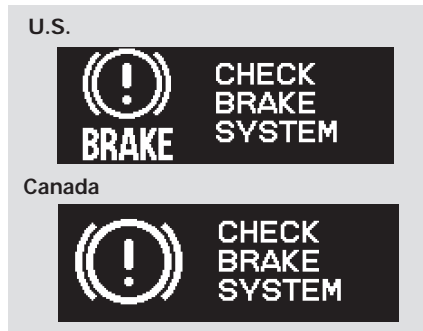
Check Brake System

If there is a problem with the brake system, you will see “CHECK BRAKE SYSTEM” on the multi-information display. The parking brake and brake system indicator in the instrument panel will also come on. See page [473](#) for more information.

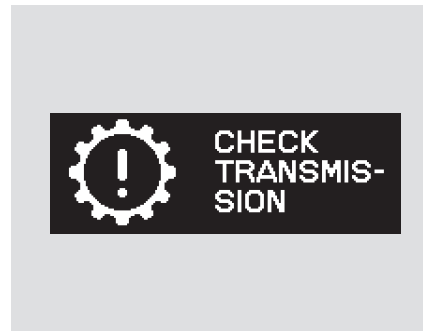
Check Transmission

If there is a problem with the automatic transmission, you will see “CHECK TRANSMISSION” on the multi-information display. Avoid rapid acceleration, and have the transmission checked by a dealer as soon as possible.

CONTINUED

Multi-Information Display

Check ABS System



If there is a problem in the anti-lock brake system (ABS), you will see “CHECK ABS SYSTEM” on the multi-information display. If you see this message, have your vehicle checked by a dealer (see page [384](#)).

Check Airbag System



If there is a problem with your front airbags, side airbags, passenger’s side airbag automatic cutoff system, automatic seat belt tensioners, side curtain airbags, driver’s seat position sensor, or the front passenger’s weight sensors, you will see “CHECK AIRBAG SYSTEM” on the multi-information display. Take your vehicle to a dealer as soon as possible (see page [34](#)).

Check Parking Sensor System

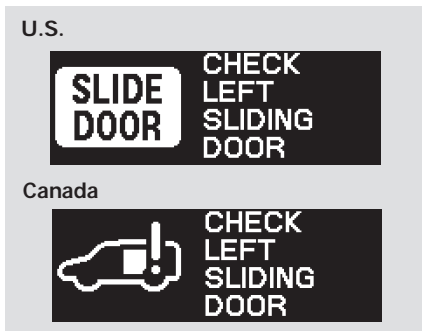

If there is a problem with the parking sensor system, the multi-information display shows a “CHECK PARKING SENSOR SYSTEM” message. See page [354](#) for more information.

Check Left/Right Sliding Door

If there is a problem with either power sliding door, the multi-information display shows “CHECK LEFT SLIDING DOOR” or “CHECK RIGHT SLIDING DOOR.” See page [166](#) for more information.

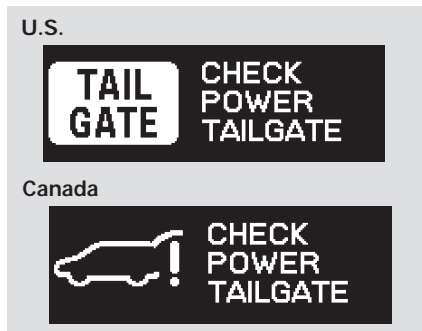
Check Power Tailgate

If there is a problem with the power tailgate, the display shows “CHECK POWER TAILGATE.” See page [158](#) for more information.

Check DRL System

If you see a “CHECK DRL SYSTEM” message on the multi-information display, there is a problem in the high beam headlight’s circuit. Take your vehicle to a dealer to have it checked.

CONTINUED

Multi-Information Display

PAX Warning Messages

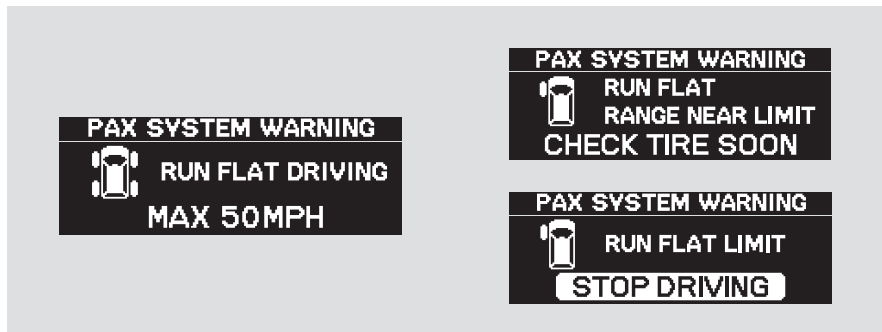

U.S. models (If equipped)
Your vehicle is equipped with the Michelin PAX system. The PAX system uses the multi-information display to show you one of three messages while you are driving with a flat tire.

For more information, see page [454](#) .

Customized Settings

With the ignition switch in the ON (II) position, press and hold the INFO button for more than 3 seconds. "CUSTOMIZE ENTRY" appears on the multi-information display.

You can customize some vehicle control settings for "DRIVER 1" and "DRIVER 2" separately.

To have the driver's ID detected, make sure you use your transmitter to unlock the driver's door.

If you use the key to unlock the driver's door, the system cannot recognize either "DRIVER 1" or "DRIVER 2." In this case, when you try to enter the customizing mode, "DRIVER UNKNOWN CUSTOMIZE IMPOSSIBLE" will be displayed, and you cannot customize the settings.

You cannot customize the settings under these conditions:

- If you turn the ignition switch to the ACCESSORY (I) or the LOCK (0) position.
- If you move the shift lever out of Park.

You can cancel each custom setting (Driver 1, Driver 2). Press and hold the LOCK and SLIDING DOOR button (passenger's side) at the same time until the LED in the remote transmitter will blink twice. At this time, the custom setting is changed to the default setting. To activate each custom setting (Driver 1, Driver 2), repeat this procedure. The LED will blink for 1 second to indicate the custom setting has been activated.

The first customizing menu is:

- CHANGE SETTING
- DEFAULT ALL

If you want to change any vehicle control settings, select "CHANGE SETTING," and follow the instructions on page 106 .

If you want the settings as they were when the vehicle left the factory, select "DEFAULT ALL," as described on page 104.

Use the INFO button on the steering wheel to see the settings, and the SEL/RESET button to enter your selections.

Refer to the table on the following pages about the settings you want to customize.

CONTINUED

Multi-Information Display

Group Setup	Menu Item	Description	Setting Option	Page
METER SETUP (P. 107)	LANGUAGE SELECTION	Changes the language used in the display.	ENGLISH*	108
			FRENCH	
			SPANISH	
	ADJUST OUTSIDE TEMP. DISPLAY	Changes the outside temperature reading above or below its current reading.	- 5F° ~ ±0°F* ~ 5F° (U.S.)	110
			- 3C° ~ ±0°C* ~ 3C° (Canada)	
	TRIP A RESET WITH REFUEL	Causes trip meter A and the average fuel economy to reset when you refuel.	ON	112
			OFF*	
ELAPSED TIME RESET	Resets the elapsed time of your current trip.	IGN RESET*	114	
		TRIP A RESET		
		TRIP B RESET		
POSITION SETUP (P. 116)	MEMORY POSITION LINK	Changes the driver's seat to a stored setting.	ON*	116
			OFF	
LIGHTING SETUP (P. 118)	INTERIOR LIGHT DIMMING TIME	Changes how long (in seconds) the interior lights stay on after you close the doors.	15 sec	118
			30 sec*	
			60 sec	
	HEADLIGHT AUTO OFF TIMER	Changes how long (in seconds) the exterior lights stay on after you close the driver's door.	0 sec	120
			15 sec*	
			30 sec	
			60 sec	

* : Default setting

Group Setup	Menu Item	Description	Setting Option	Page
DOOR · WINDOW SETUP (P. 122)	AUTO DOOR LOCK	Changes when the doors automatically lock.	SHIFT FROM P	123
			WITH VEHICLE SPEED*	
			OFF	
	AUTO DOOR UNLOCK	Changes when the doors automatically unlock.	DRIVER'S DOOR WITH SHIFT TO P*	125
			ALL DOORS WITH SHIFT TO P	
			DRIVER'S DOOR WITH IGN OFF	
			ALL DOORS WITH IGN OFF	
			OFF	
	KEYLESS LOCK ACKNOWLEDGEMENT	The exterior lights flash each time you press the LOCK or UNLOCK button. A beeper will also sound when you press the LOCK button twice.	ON*	127
			OFF	
SECURITY RELOCK TIMER	Changes how long it takes (in seconds) for the doors to relock and the security system to set after you unlock and do not open the door.	30 sec*	129	
		60 sec		
		90 sec		
WIPER SETUP (P. 131)	FRONT WIPER ACTION	Changes the wiper operation between two settings when the wiper switch is in the INT position.	WITH VEH SPD*	131
			INTERMITTENT	
DEFAULT ALL		Changes all the customized settings as they were when the vehicle left the factory.	OK	104
			CANCEL	

* : Default setting

Multi-Information Display

DEFAULT ALL

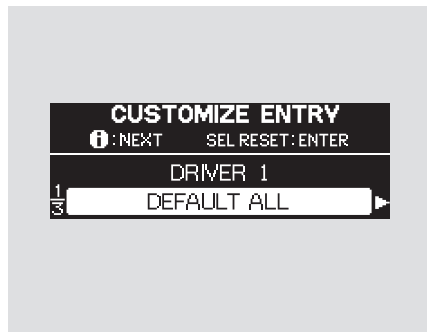

To enter the customizing mode, press and hold the INFO button for more than 3 seconds. Then select "DEFAULT ALL" by pressing the INFO button.

Press the SEL/RESET button to enter "DEFAULT ALL."

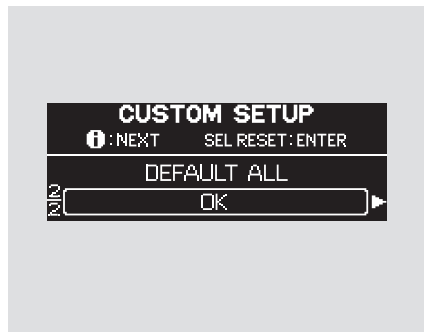

To set the default settings, select "OK" by pressing the INFO button, then press the SEL/RESET button.

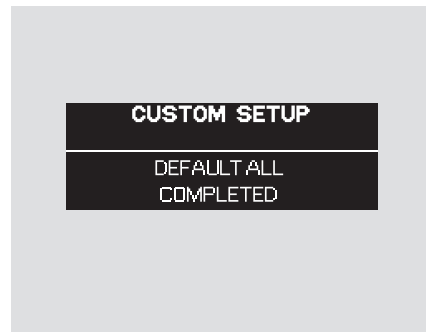

When "DEFAULT ALL" is completed successfully, you will see the above display for several seconds, and the display will return to "CUSTOMIZE ENTRY."

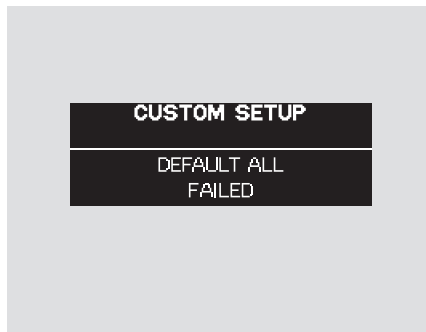

If “DEFAULT ALL” is not completed successfully, you will see the above display for several seconds, then the display goes back to the normal message mode. Repeat the procedure to select “DEFAULT ALL.”

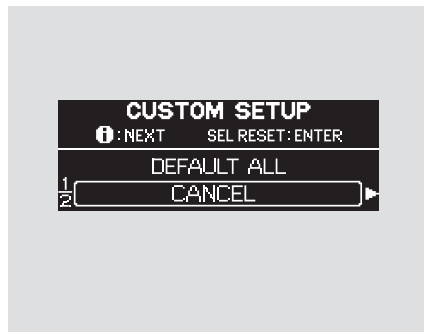

If you want to cancel “DEFAULT ALL,” select “CANCEL,” then press the SEL/RESET button. The display goes back to “CUSTOMIZE ENTRY.”

Multi-Information Display

Change Setting

You can customize some of the vehicle control settings to your preference. Here are the settings you can customize:

- METER SETUP (see page 107)
- POSITION SETUP (see page 116)
- LIGHTING SETUP (see page 118)
- DOOR · WINDOW SETUP (see page 122)
- WIPER SETUP (see page 131)

While the multi-information display is showing “CHANGE SETTING,” press the SEL/RESET button. The display will change to the initial display of CUSTOMIZE GROUP. Then, each time you press the INFO button, the display changes as shown in the next column.

Press the INFO button until you see the setup you want to customize, and press the SEL/RESET button to enter your selection.

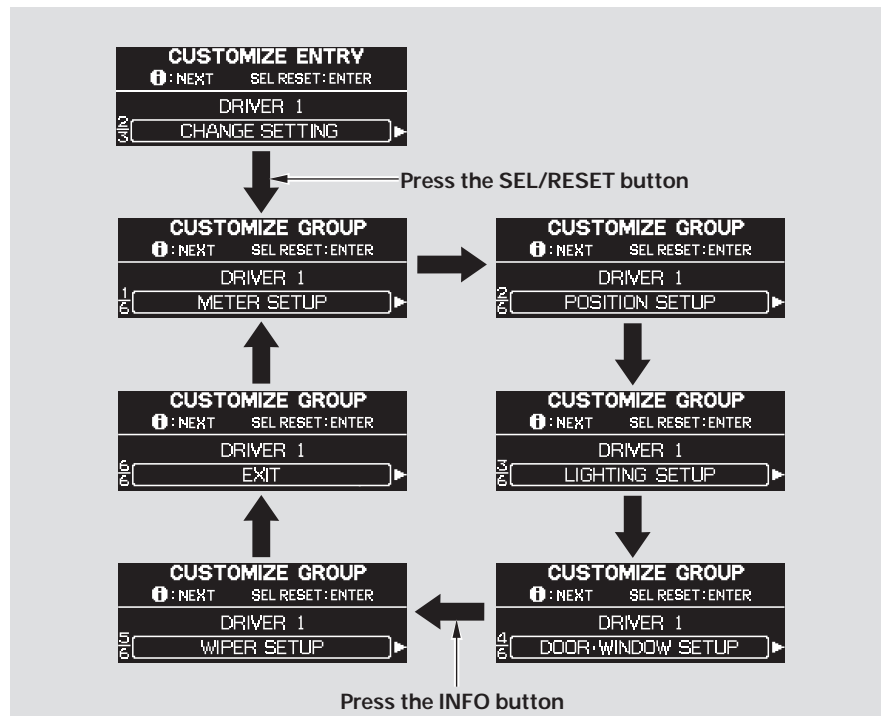

Meter Setup

There are four custom settings items in the Meter Setup:

- LANGUAGE SELECTION (see page 108)
- ADJUST OUTSIDE TEMP. DISPLAY (see page 110)
- TRIP A RESET WITH REFUEL (see page 112)
- ELAPSED TIME RESET (see page 114)

While “METER SETUP” is displayed, press the SEL/RESET button on the steering wheel. Then, press the INFO button repeatedly. Each time you press the INFO button, the display changes as shown.

To customize a setting, press the INFO button repeatedly until you see the setting, and press the SEL/RESET button. Then, follow the procedures described on the following pages.

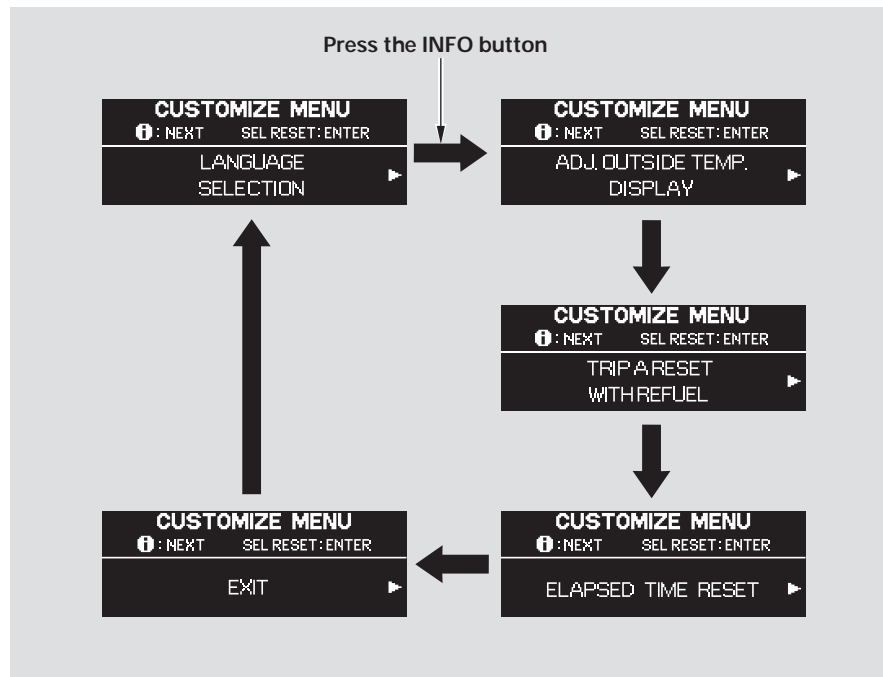

CONTINUED

Multi-Information Display

Language Selection

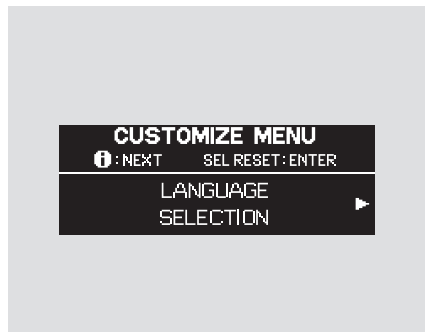

While the multi-information display is showing "METER SETUP," press the SEL/RESET button on the steering wheel. The display changes to "LANGUAGE SELECTION." Press the SEL/RESET button again to enter the language selection mode.

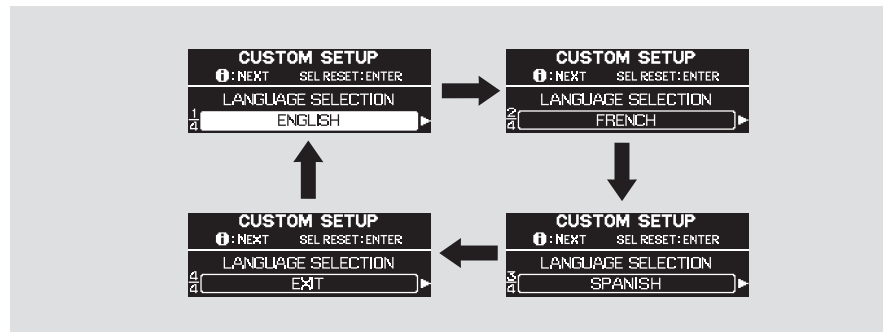

There are three selectable languages, English, French, and Spanish. Each time you press the INFO button, the display changes as shown.

Select the language you want by pressing the INFO button, and press the SEL/RESET button to enter your selection.



When language selection is successfully completed, the display changes to the screen shown above for several seconds, then goes back to "CUSTOMIZE MENU."

All messages on the multi-information display will be shown in the language you selected.



If you fail to select a language properly, you will see the above display for several seconds, then the display goes back to "CUSTOMIZE MENU." Repeat the setup.

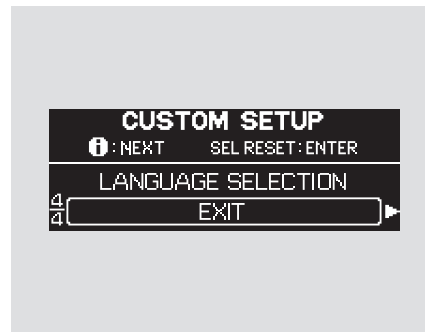

To exit "LANGUAGE SELECTION," press the INFO button repeatedly until you see "EXIT," then press the SEL/RESET button. The display goes back to "CUSTOMIZE MENU."

CONTINUED

Multi-Information Display

Adjust Outside Temp. Display

If you find that the temperature reading is always a few degrees below or above the actual temperature, adjust it as described on the following columns.

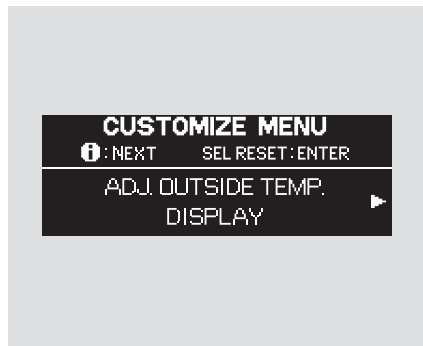

While the multi-information display shows "METER SETUP," press the SEL/RESET button on the steering wheel. The display changes to the "CUSTOMIZE MENU." Press the INFO button once, and you will see "ADJ. OUTSIDE TEMP. DISPLAY" as shown above.

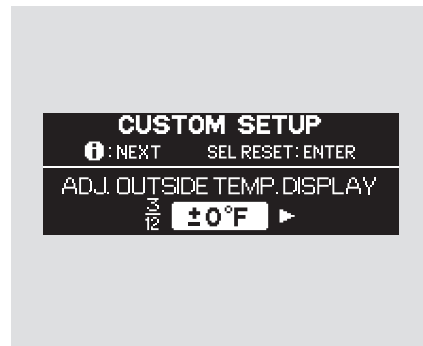

Press the SEL/RESET button. The display changes as shown above. The highlighted number is the current adjustment above or below the outside temperature. Press the INFO button repeatedly until the appropriate number appears, then press the SEL/RESET button to enter your selection.

CUSTOM SETUP

ADJ. OUTSIDE TEMP. DISPLAY
+2°F

When your selection is successfully entered, you will see the above display for several seconds, and then the display changes back to "CUSTOMIZE MENU."

CUSTOM SETUP

ADJ. OUTSIDE TEMP. DISPLAY
"ERROR"

If you fail to enter the desired adjustment properly, you will see the above display for several seconds, then the display goes back to "CUSTOMIZE MENU." Repeat the adjustment.

CUSTOM SETUP

ⓘ : NEXT SEL RESET : ENTER

ADJ. OUTSIDE TEMP. DISPLAY
12
12 EXIT ▶

To exit "ADJ. OUTSIDE TEMP. DISPLAY," press the INFO button until you see "EXIT," and press the SEL/RESET button. The display goes back to "CUSTOMIZE MENU."

CONTINUED

Multi-Information Display

Trip A Reset with Refuel

To cause “Trip meter A” and “Average Fuel Economy” to reset every time you refuel your vehicle, adjust it as described on the following pages.



While the multi-information display shows “METER SETUP” of the “CUSTOMIZE GROUP,” press the SEL/RESET button on the steering wheel. The display changes to “CUSTOMIZE MENU.” Press the INFO button repeatedly until you see “TRIP A RESET WITH REFUEL.” in the lower segment as shown above.

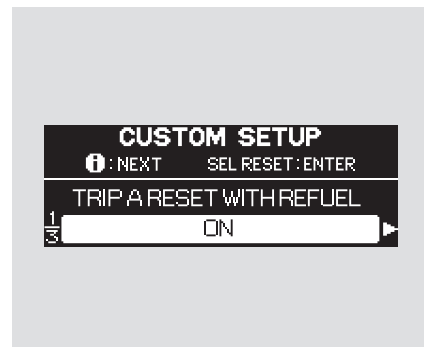

Press the SEL/RESET button. The display changes as shown above. The lower segment changes between “ON” and “OFF” each time you press the INFO button. Enter your selection by pressing the SEL/RESET button.

CUSTOM SETUP

TRIP A RESET WITH REFUEL
ON

When your selection is successfully entered, you will see the above display for several seconds, and then the display goes back to "CUSTOMIZE MENU."

CUSTOM SETUP

TRIP A RESET WITH REFUEL
"ERROR"

If you fail to enter your selection, you will see the above display for several seconds, then the display goes back to "CUSTOMIZE MENU." Repeat the setup.

CUSTOM SETUP

INFO: NEXT SEL RESET: ENTER

TRIP A RESET WITH REFUEL
EXIT

To exit "TRIP A RESET WITH REFUEL," press the INFO button until you see "EXIT," and press the SEL/RESET button. The display goes back to "CUSTOMIZE MENU."

CONTINUED

Multi-Information Display

Elapsed Time Reset

There are three possible settings:

IGN RESET: The elapsed time resets each time the ignition switch is turned to the ON (II) position.

TRIP A RESET: The elapsed time resets each time the TRIP A is reset.

TRIP B RESET: The elapsed time resets each time the TRIP B is reset.

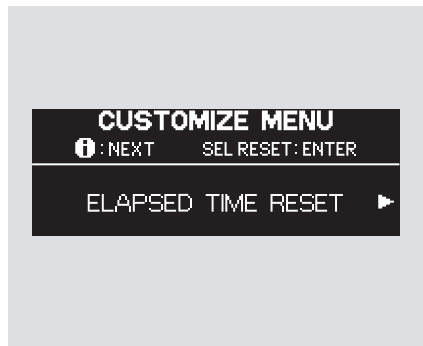

While the multi-information display shows "METER SETUP" of the "CUSTOMIZE GROUP," press the SEL/RESET button on the steering wheel. The display changes to "CUSTOMIZE MENU." Press the INFO button repeatedly until you see "ELAPSED TIME RESET" in the lower segment as shown above.

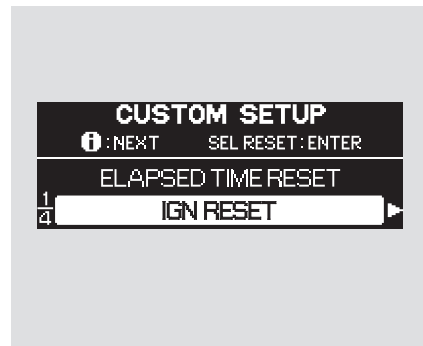

Press the SEL/RESET button. The display changes as shown above.

Press the INFO button repeatedly until the desired condition appears, then press the SEL/RESET button to enter your selection.

CUSTOM SETUP

ELAPSED TIME RESET
TRIP A RESET

When your selection is entered, you will see the above display for several seconds, and the display goes back to "CUSTOMIZE MENU."

CUSTOM SETUP

ELAPSED TIME RESET
"ERROR"

If you fail to enter your selection, you will see the above display for several seconds, and the display goes back to "CUSTOMIZE MENU." Repeat the setup.

CUSTOM SETUP

i : NEXT SEL RESET : ENTER

ELAPSED TIME RESET
4/4 [EXIT] ▶

To exit "ELAPSED TIME RESET," press the INFO button until you see "EXIT," then press the SEL/RESET button.

Multi-Information Display

Position Setup

If “MEMORY POSITION LINK” is “ON,” the driver’s seat and outside mirrors move to the positions stored in the memory when you open the driver’s door, using the remote transmitter.

Refer to page [184](#) for setting the seat position memory. Also refer to page [149](#) for remote transmitter use.

Memory Position Setup

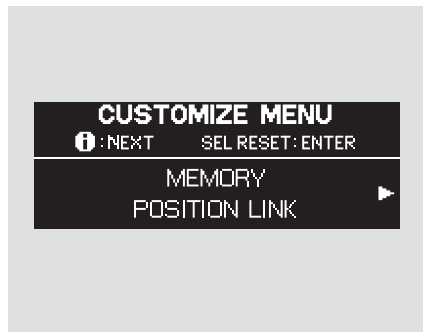

While the multi-information display shows “POSITION SETUP,” press the SEL/RESET button on the steering wheel. The display changes to “MEMORY POSITION LINK” as shown above.

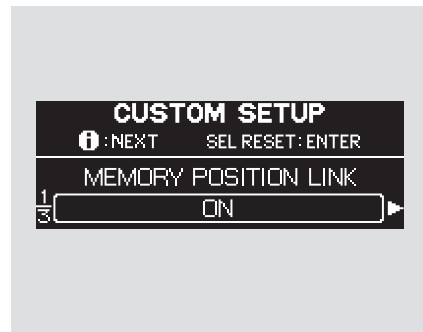

Press the SEL/RESET button. The display changes as shown above.

Select “ON” or “OFF” by pressing the INFO button, and enter your selection by pressing the SEL/RESET button.

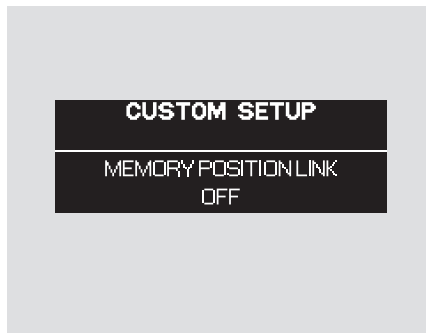

When your selection is entered, you will see the above display for several seconds, then the display goes back to "CUSTOMIZE MENU."

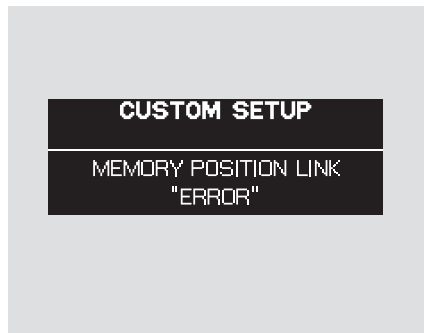

If you fail to enter your selection, you will see the above display for several seconds, and the display goes back to "CUSTOMIZE MENU." Repeat the setup.

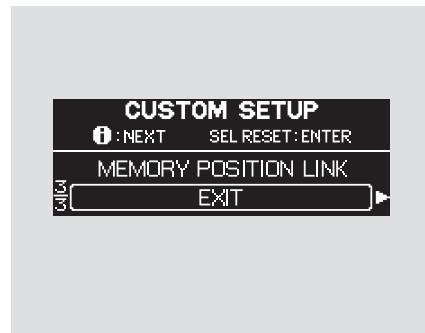

To exit "MEMORY POSITION LINK," press the INFO button until you see "EXIT," then press the SEL/RESET button.

Multi-Information Display

Lighting Setup

There are two custom settings in the Lighting Setup:

- INTERIOR LIGHT DIMMING TIME (see next column)
- HEADLIGHT AUTO OFF TIMER (see page 120)

While the “LIGHTING SETUP” is displayed, press the SEL/RESET button on the steering wheel. Each time you press the INFO button, the display changes between “INTERIOR LIGHT DIMMING TIME” and “HEADLIGHT AUTO OFF TIMER.” To make your selection, press the SEL/RESET button.

Interior Light Dimming Time

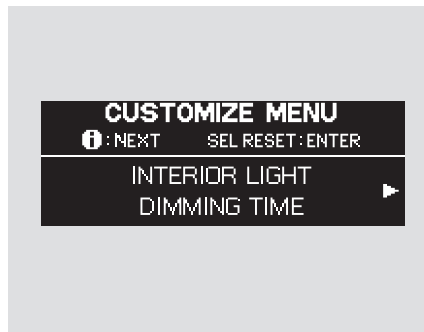

The interior lights fade out when you close all doors. You can change the time that the interior lights fade out.

While the multi-information display shows “LIGHTING SETUP,” press the SEL/RESET button on the steering wheel. The display changes to “INTERIOR LIGHT DIMMING TIME” as shown above.



Press the SEL/RESET button. The display changes as shown above.

Each time you press the INFO button, the highlighted number changes from “15 sec.” to “30 sec.,” and then to “60 sec.” To make your selection, press the SEL/RESET button.

CUSTOM SETUP

INTERIOR LIGHT DIMMING TIME
15 sec

When your selection is entered, you will see the above display for several seconds, and then the display goes back to "CUSTOMIZE MENU."

CUSTOM SETUP

INTERIOR LIGHT DIMMING TIME
"ERROR"

If you fail to enter your selection, you will see the above display for several seconds, and the display goes back to "CUSTOMIZE MENU." Repeat the setup.

CUSTOM SETUP

i : NEXT SEL RESET : ENTER

INTERIOR LIGHT DIMMING TIME
 $\frac{\Delta}{4}$ **EXIT** ▶

To exit "INTERIOR LIGHT DIMMING TIME," press the INFO button until you see "EXIT," then press the SEL/RESET button.

Multi-Information Display

Headlight Auto Off Timer

The headlights, parking lights, taillights, and license plate light turn off after the selected time when you remove the key from the ignition switch and close the driver's door.

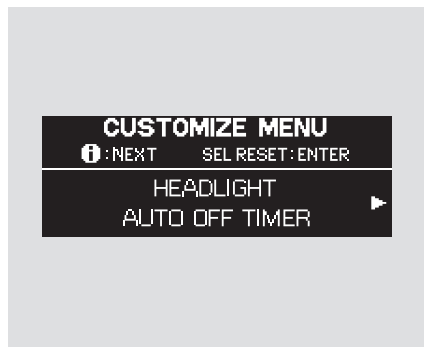

While the multi-information display shows "LIGHTING SETUP," press the SEL/RESET button on the steering wheel. Then press the INFO button to display "HEADLIGHT AUTO OFF TIMER" as shown above.



Press the SEL/RESET button. The display changes as shown above.

Each time you press the INFO button, the highlighted number changes from "0 sec," to "15 sec," to "30 sec," and then to "60 sec." Press the INFO button repeatedly until the desired time appears, then press the SEL/RESET button to enter your selection.

CUSTOM SETUP

HEADLIGHT AUTO OFF TIMER

0 Sec

When your selection is entered, you will see the above display for several seconds, and then the display goes back to "CUSTOMIZE MENU."

CUSTOM SETUP

HEADLIGHT AUTO OFF TIMER

"ERROR"

If you fail to enter your selection, you will see the above display for several seconds, and the display goes back "CUSTOMIZE MENU." Repeat the setup.

CUSTOM SETUP

i : NEXT

SEL RESET : ENTER

HEADLIGHT AUTO OFF TIMER

INFO

EXIT



To exit "HEADLIGHT AUTO OFF TIMER," press the INFO button until you see "EXIT," then press the SEL/RESET button.

Multi-Information Display

Door · Window Setup

There are three custom settings in the Door · Window Setup:

- AUTO DOOR LOCK (see page 123)
- AUTO DOOR UNLOCK (see page 125)
- KEYLESS LOCK ACKNOWLEDGEMENT (see page 127)
- SECURITY RELOCK TIMER (see page 129)

While the multi-information display shows “DOOR · WINDOW SETUP,” press the SEL/RESET button on the steering wheel. Each time you press the INFO button, the display changes as shown in the next column.

To customize a setting, press the INFO button repeatedly until you see the setting you want to customize, and press the SEL/RESET button. Then follow the procedures described on the following pages.

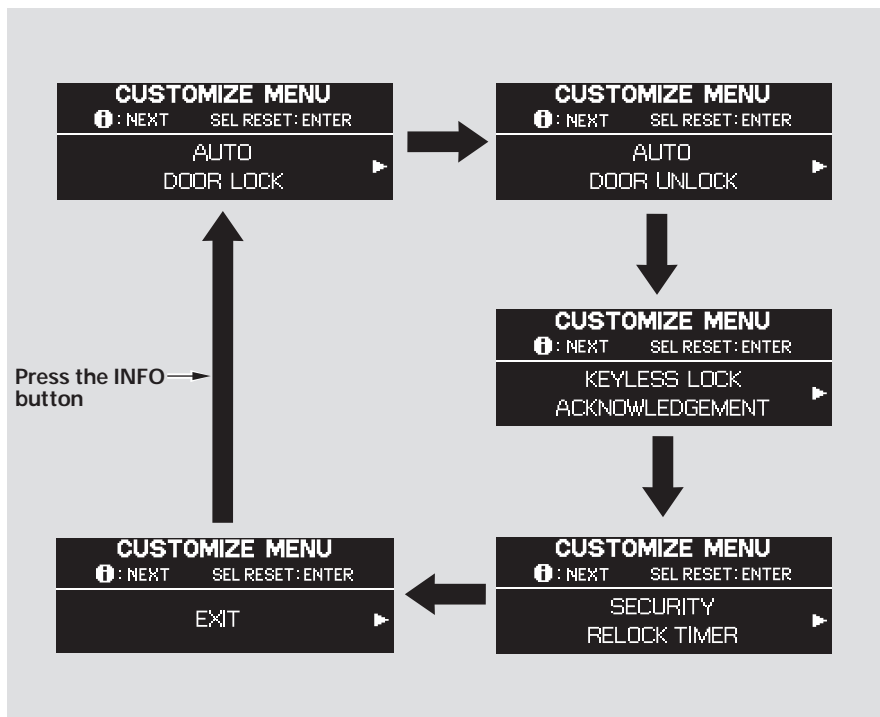

Auto Door Lock

There are three settings you can choose from:

OFF -

The auto door lock is deactivated all the time.

VEHICLE SPEED - The doors lock when the vehicle speed reaches 9 mph (15 km/h).

SHIFT FROM P -

The doors lock whenever you move the shift lever out of Park.



While the multi-information display shows “DOOR · WINDOW SETUP” press the SEL/RESET button on the steering wheel. The display changes to “AUTO DOOR LOCK” as shown above.



Press the SEL/RESET button. The display changes as shown above.

Press the INFO button repeatedly until the desired condition appears, then press the SEL/RESET button to enter your selection.

CONTINUED

Multi-Information Display

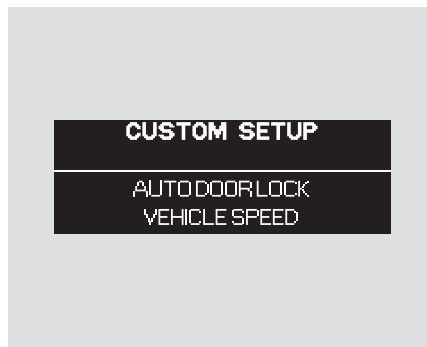

When your selection is entered, you will see the above display for several seconds, and then the display goes back to "CUSTOMIZE MENU."

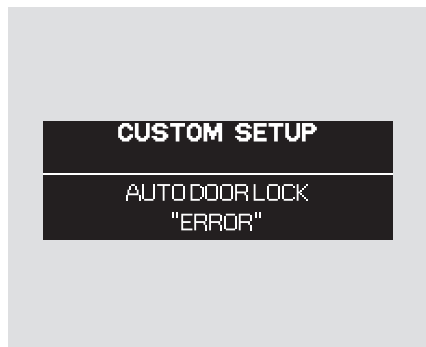

If you fail to enter your selection, you will see the above display for several seconds, and the display goes back to "CUSTOMIZE MENU." Repeat the setup.

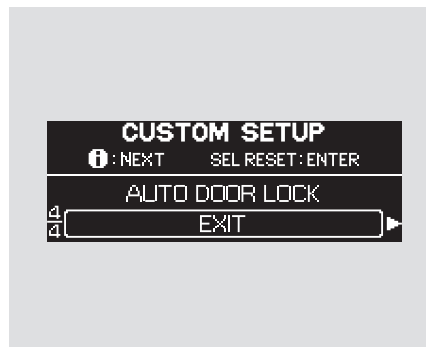

To exit "AUTO DOOR LOCK," press the INFO button until you see "EXIT," then press the SEL/RESET button.

Auto Door Unlock

There are three settings you can choose from:

SHIFT TO P - The driver's door or all the doors unlock when you move the shift lever to Park.

IGN OFF - The driver's door or all the doors unlock when you turn the ignition switch to the LOCK (0) position.

OFF - The auto door unlock is deactivated all the time.

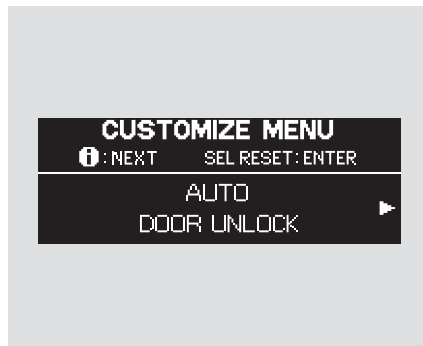

While the multi-information display shows “DOOR WINDOW SETUP,” press the SEL/RESET button on the steering wheel. Then press the INFO button once. The display changes to “AUTO DOOR UNLOCK” as shown above.

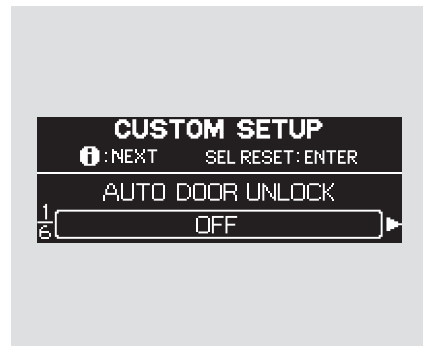

Press the SEL/RESET button. The display changes as shown above.

Press the INFO button repeatedly until the desired condition appears, and press the SEL/RESET button to enter your selection.

CONTINUED

Multi-Information Display



When your selection is entered, you will see the above display for several seconds, and then the display goes back to "CUSTOMIZE MENU."



If you fail to enter your selection, you will see the above display for several seconds, and the display goes back to "CUSTOMIZE MENU." Repeat the setup.

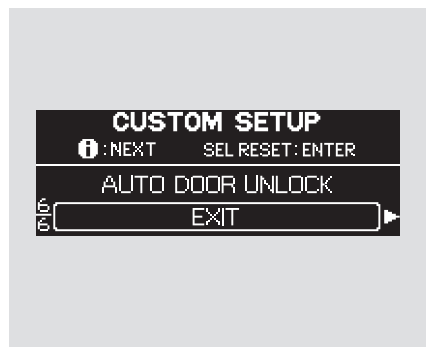

To exit "AUTO DOOR UNLOCK," press the INFO button until you see "EXIT," then press the SEL./RESET button.

Keyless Lock Acknowledgement

When you press the UNLOCK button on the remote transmitter to unlock the doors and the tailgate, the exterior lights blink twice to verify that the doors and the tailgate are unlocked and the security system is turned off.

When you push the LOCK button on the remote transmitter, some exterior lights flash, and a beeper sounds when you push the LOCK button again within 5 seconds to verify that the doors and the tailgate are locked and the security system has set (see page 318). You can customize the exterior lights not to flash and the beeper not to sound.

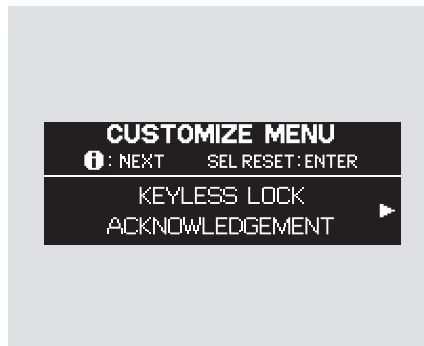

While the multi-information display shows “DOOR·WINDOW SETUP,” press the SEL/RESET button on the steering wheel. Then press the INFO button repeatedly until you see “KEYLESS LOCK ACKNOWLEDGEMENT” as shown above.

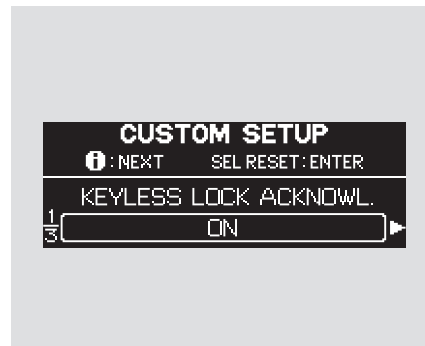

Press the SEL/RESET button. The display changes as shown above.

Each time you press the INFO button, the display changes to “ON,” to “OFF,” then to “EXIT.”

Select “ON” or “OFF” by pressing the INFO button, and enter your selection by pressing the SEL/RESET button.

CONTINUED

Multi-Information Display

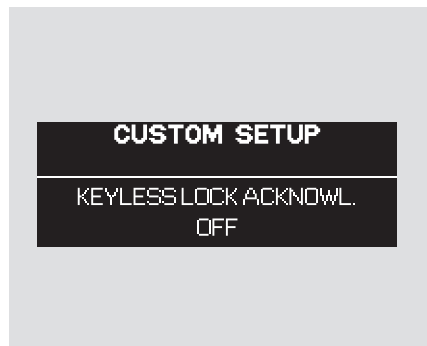

When your selection is entered, you will see the above display for several seconds, and then the display changes to "CUSTOMIZE MENU."

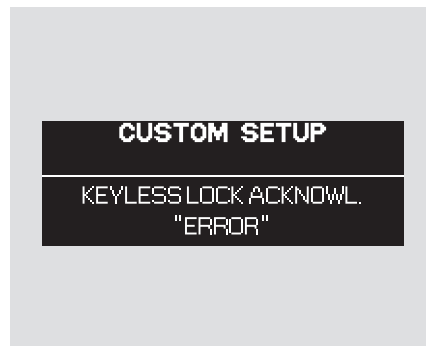

If you fail to enter your selection, you will see the above display for several seconds, and the display goes back to "CUSTOMIZE MENU." Repeat the setup.

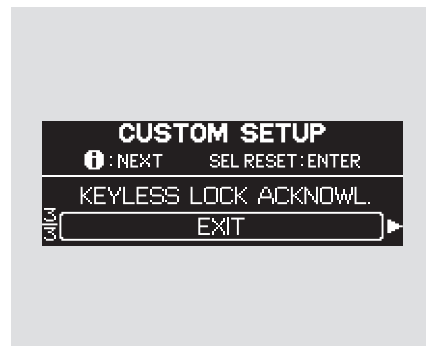

To exit "KEYLESS LOCK ACKNOWLEDEMENT," press the INFO button until you see "EXIT," then press the SEL/RESET button.

Security Relock Timer

If you unlock the doors and the tailgate with the remote transmitter, but do not open any of the doors or the tailgate within 30 seconds, the doors and the tailgate automatically relock and the security system sets.

You can change this relock time from 30 seconds to 60 or 90 seconds.

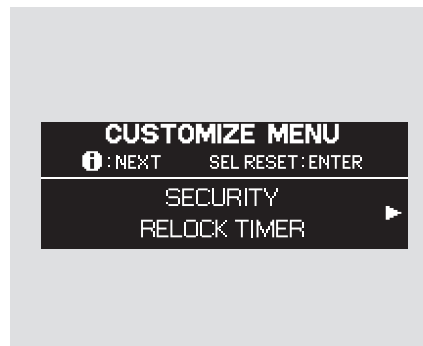

While the multi-information display shows "DOOR WINDOW SETUP," press the SEL/RESET button on the steering wheel. Then press the INFO button repeatedly until you see "SECURITY RELOCK TIMER" as shown above.



Press the SEL/RESET button, then press the INFO button.

Select the desired relock time by pressing the INFO button, and enter your selection by pressing the SEL/RESET button.

CONTINUED

Multi-Information Display

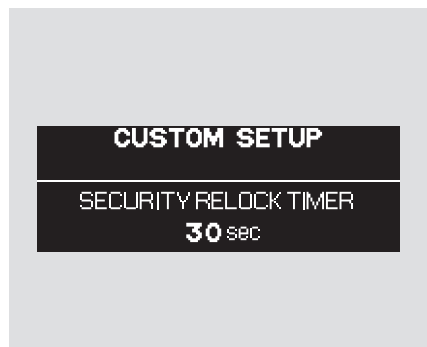

When your selection is entered, you will see the above display for several seconds, and then the display goes back to "CUSTOMIZE MENU."

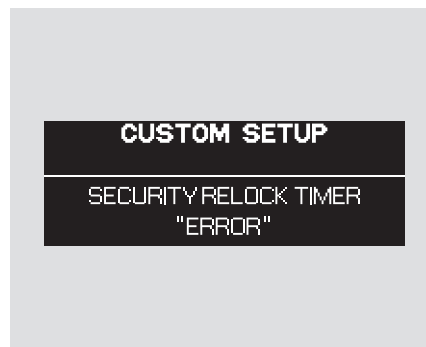

If you fail to enter your selection, you will see the above display for several seconds, and the display goes back to "CUSTOMIZE MENU." Repeat the setup.

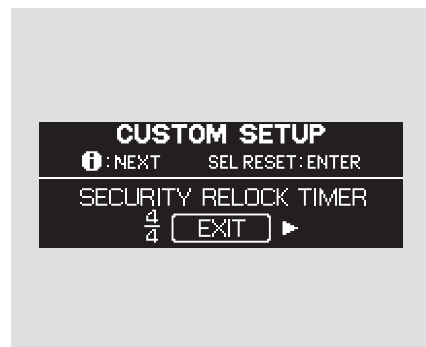

To exit "SECURITY RELOCK TIMER," press the INFO button until you see "EXIT," then press the SEL/RESET button.

Wiper Setup

You can select from these two settings when the wiper switch is in the INT (intermittent) position:

WITH VEH SPD - The intermittent operation varies according to vehicle speed.

INTERMITTENT - The intermittent operation varies according to the selection you make on the wiper lever's intermittent control ring.

Front Wiper Action

With “WIPER SETUP” shown on the multi-information display, press the SEL/RESET button on the steering wheel. The display changes to “FRONT WIPER ACTION” as shown above.

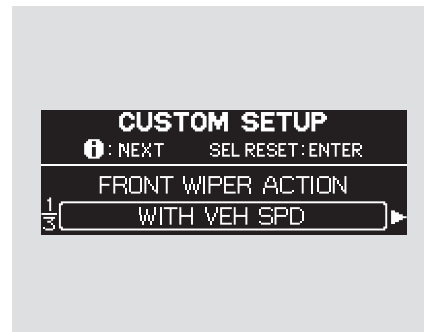

Press the SEL/RESET button. The display changes as shown above.

Press the INFO button to select “WITH VEH SPD” or “INTERMITTENT,” and enter your selection by pressing the SEL/RESET button.

CONTINUED

Multi-Information Display

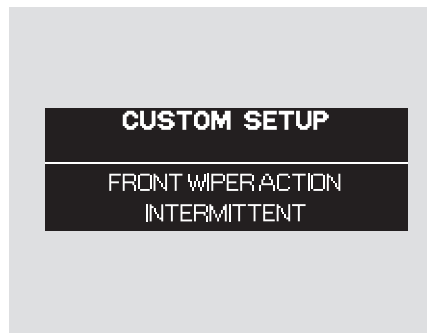

When your selection is entered, you will see the above display for several seconds, and then the display goes back to "CUSTOMIZE MENU."



If you fail to enter your selection, you will see the above display for several seconds, and the display goes back to "CUSTOMIZE MENU." Repeat the setup.

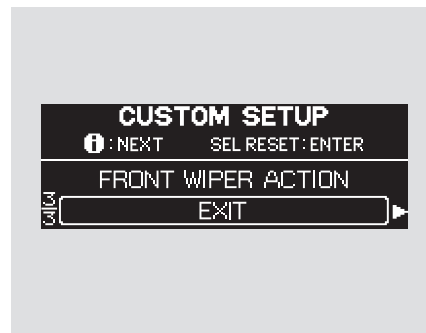

To exit "FRONT WIPER ACTION," press the INFO button until you see "EXIT," then press the SEL/RESET button.

Controls Near the Steering Wheel

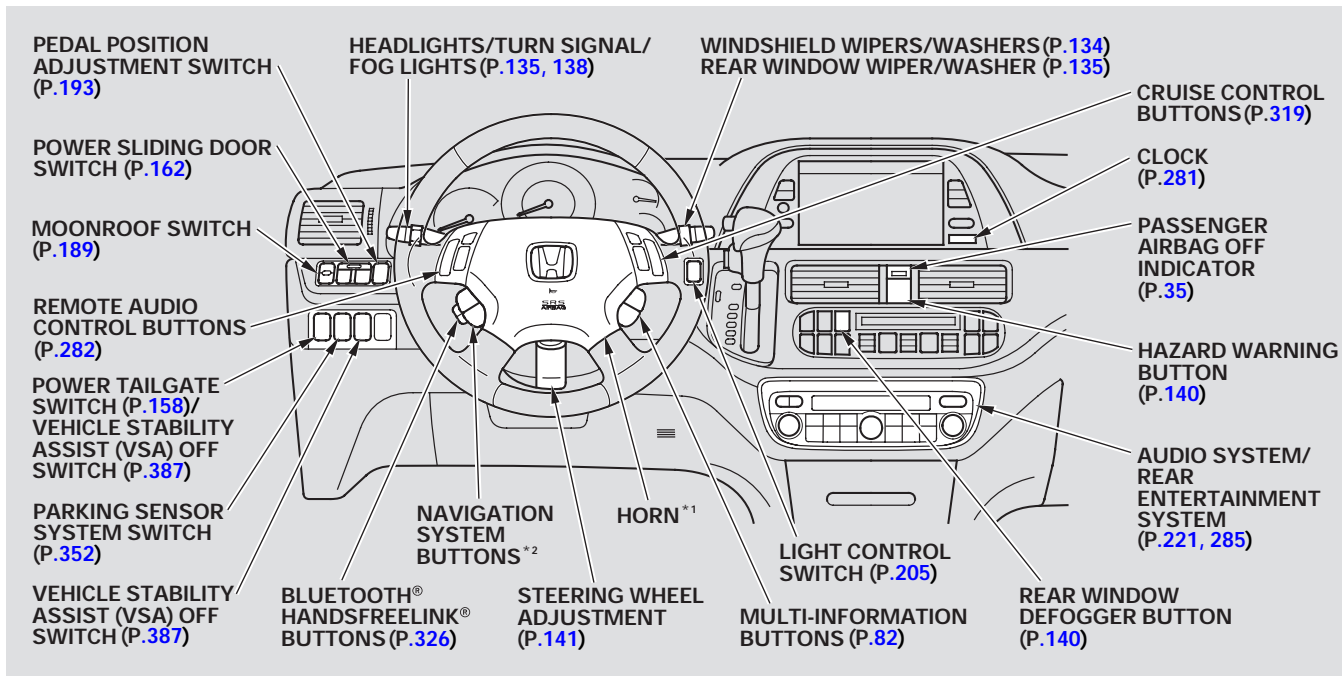

* 1: To use the horn, press the center pad of the steering wheel.

* 2: Only on vehicles equipped with navigation system. Refer to the navigation system manual.

Windshield Wipers and Washers

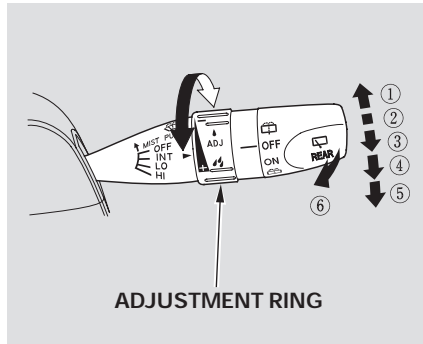

1. MIST
2. OFF
3. INT - Intermittent
4. LO - Low speed
5. HI - High speed
6. Windshield washers

Push the right lever up or down to select a position.

MIST - The wipers run at high speed until you release the lever.

OFF - The wipers are not activated.

INT - The length of the wipe interval is varied automatically according to vehicle's speed.

Vary the delay by turning the adjustment ring. If you turn it to the shortest delay ( position), the wipers change to low speed operation when the vehicle speed exceeds 12 mph (20 km/h).

LO - The wipers run at low speed.

HI - The wipers run at high speed.

Windshield Washer - Pull the wiper control lever toward you, and hold it. The washers spray until you release the lever. The wipers run at low speed, then complete one more sweep after you release the lever.

On Touring models

You can customize some windshield wiper settings. See page [131](#) for more information.

Windshield Wipers and Washers, Turn Signal and Headlights

Rear Window Wiper and Washer

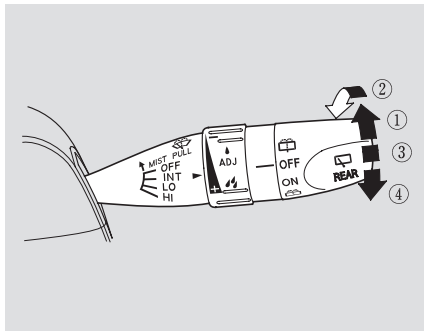

1. To turn on the rear window wiper, rotate the switch clockwise to ON. It operates intermittently.
2. Hold past ON to turn the window wiper on and the window washer on.
3. OFF
4. Rotate the switch counterclockwise to spray the window washer.

When you shift the transmission to the reverse position with the front windshield wipers activated, the rear window wiper operates automatically.

When the wiper control lever is positioned as follows:

INT - The rear window wiper operates intermittently.

LO or HI - The rear window wiper operates continuously.

Turn Signal and Headlights

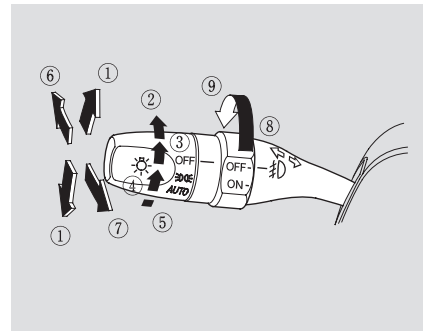



1. Turn signal
2. Off
3. Parking and indicator lights
4. AUTO (Touring models only)
5. Headlights on
6. High beams
7. Flash high beams
8. Fog lights off (Touring models only)
9. Fog lights on (Touring models only)

Turn Signal, Headlights

Turn Signal - Push down on the lever to signal a left turn and up to signal a right turn. To signal a lane change, push lightly on the lever, and hold it. The lever will return to center when you release it or complete a turn.

Headlights - The rotating switch on the left lever controls the lights. Turning this switch to the “ ” position turns on the parking lights, taillights, instrument panel lights, side-marker lights, and rear license plate lights.

Turning the switch to the “ ” position turns on the headlights.

When the light switch is in the “ ” or “ ” position, the lights on indicator comes on as a reminder. This indicator stays on if you leave the light switch on and turn the ignition switch to the ACCESSORY (I) or the LOCK (0) position.

If you leave the lights on with the key removed from the ignition switch, you will hear a reminder chime when you open the driver's door.

High Beams - To switch from low beams to high beams, push the left lever forward until you hear a click. The high beam indicator will come on (see page [73](#)). Pull it back to return to low beams. To flash the high beams, pull the lever back lightly, then release it. The high beams will stay on as long as you hold the lever back.

On Touring models

AUTO - The automatic lighting feature turns on the headlights, all other exterior lights, and the instrument panel lights when it senses low ambient light.

To turn on the automatic lighting, turn the light switch to AUTO at any time. The lights will come on automatically when the outside light level becomes low (at dusk, for example). The lights on indicator comes on as a reminder. The lights and indicator turn off automatically when the system senses high ambient light.

The lights turn off automatically when you turn the ignition switch to the LOCK (0) position. To turn them on again, either turn the ignition switch to the ON (II) position, or turn the light switch to position.

Even with the automatic lighting feature turned on, we recommend that you turn on the lights manually when driving at night or in a dense fog, or when you enter dark areas such as long tunnels or parking facilities.

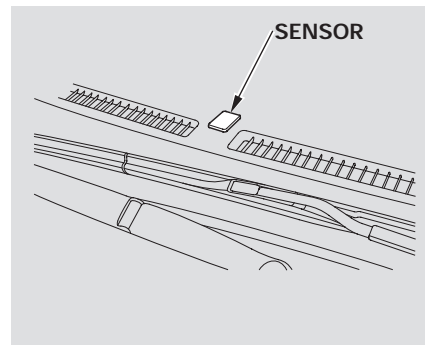

The automatic lighting feature is controlled by a sensor located on top of the dashboard. Do not cover this sensor or spill liquids on it.

Headlights

Fog Lights

On Touring models

Turn the fog lights on and off by turning the switch next to the headlight switch.

You can use the fog lights only when the headlights are on low beam. They will go off when the headlights are turned off.

Daytime Running Lights



With the headlight switch off, the high beam headlights and the high beam indicator come on with reduced brightness when you turn the ignition switch to the ON (II) position and release the parking brake. They remain on until you turn the ignition switch off, even if you set the parking brake.

The headlights revert to normal operation when you turn them on with the switch.

Automatic Lighting Off Feature

On EX, EX-L and Touring models only

This turns off the headlights, parking lights, taillights, side marker lights, license plate lights, and instrument panel lights within 15* seconds of removing the key from the ignition switch and closing the driver's door.

This feature activates if you leave the headlight switch in the  or  position, remove the key, then open and close the driver's door. If you remove the key from the ignition switch with the headlight switch on, but do not open the door and get out, the lights turn off after 10 minutes.

The lights turn on again when you unlock or open the driver's door. If you unlock the door, but do not open it within 15* seconds, the lights go off. With the driver's door open, you will hear a lights-on reminder chime.

* On the Touring models, this time is changeable. See page [118](#) for how to select and set the time.

Instrument Panel Brightness

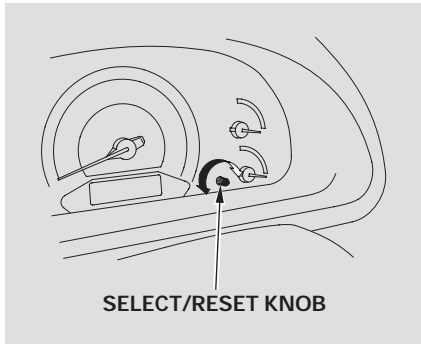

The select/reset knob on the instrument panel controls the brightness of the instrument panel lights. Turn the knob to adjust the brightness.

Separate adjustments can be made when the headlights are on and off.

You will hear a beep when maximum or minimum brightness is reached. You will also hear a beep when the maximum level is canceled by turning the knob a click to the left.

Touring model is shown

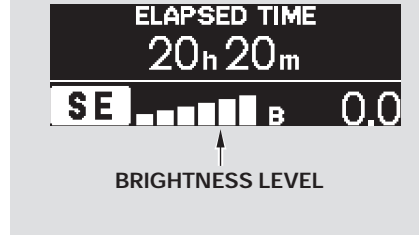

The level of brightness is shown on the multi-information display (Touring models) or on the information display (LX, EX, EX-L and Canadian DX models) while you adjust it. It goes out 5 seconds after you finish adjusting.

To reduce glare at night, the instrument panel illumination dims when you turn the light switch to ☀ or ☾. Turning the select/reset knob to the right until you hear a beep will cancel the reduced brightness.

Hazard Warning Button, Rear Window Defogger

Hazard Warning Button

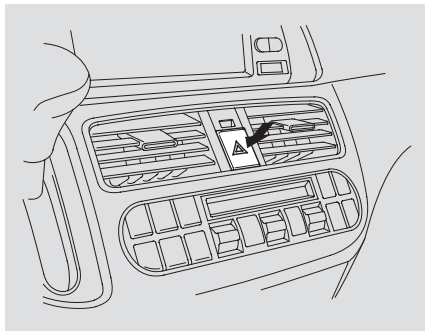

Push the button between the center vents to turn on the hazard warning lights (four-way flashers). This causes all outside turn signals and both indicators in the instrument panel to flash. Use the hazard warning lights if you need to park in a dangerous area near heavy traffic, or if your vehicle is disabled.

Rear Window Defogger

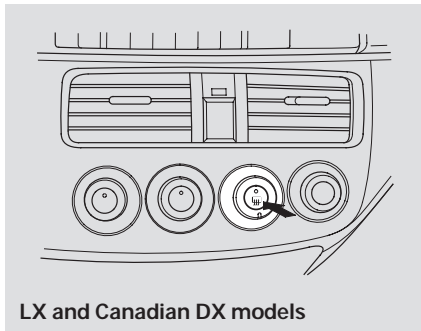

LX and Canadian DX models

The rear window defogger will clear fog, frost, and thin ice from the window. Push the defogger button to turn it on and off. The indicator in the button comes on to show the defogger is on. It shuts off when you turn off the ignition. You have to turn the defogger on again when you restart the vehicle.

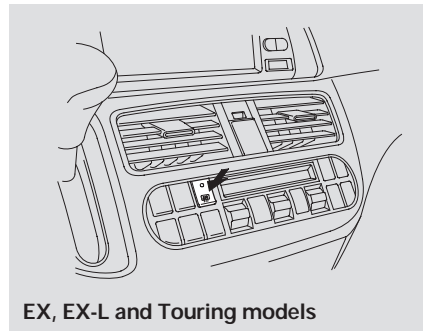

EX, EX-L and Touring models

Make sure the rear window is clear and you have good visibility before starting to drive.

The defogger wires on the inside of the rear window can be accidentally damaged. When cleaning the glass, always wipe side-to-side.

Steering Wheel Adjustment

Make any steering wheel adjustment before you start driving.

⚠ WARNING

Adjusting the steering wheel position while driving may cause you to lose control of the vehicle and be seriously injured in a crash.

Adjust the steering wheel only when the vehicle is stopped.

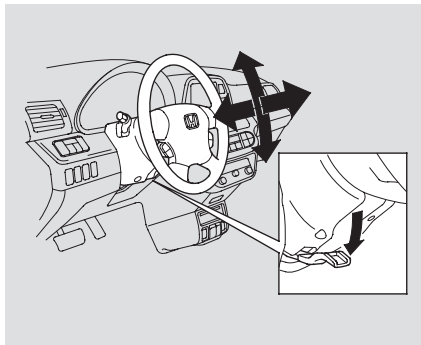

1. Push the lever under the steering column all the way down.
2. Move the steering wheel so it points toward your chest, not toward your face. Make sure you can see the instrument panel gauges and indicators.

3. Push the lever up to lock the steering wheel in position.
4. Make sure you have securely locked the steering wheel in place by trying to move it up, down, in, and out.

Keys and Locks

EX, EX-L and Touring models

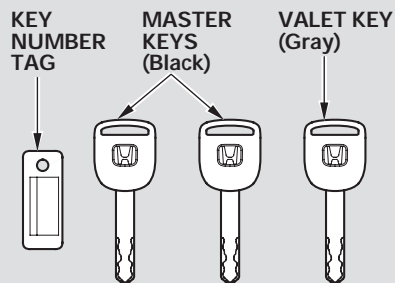

The master key fits all the locks on your vehicle. The valet key works only in the ignition and the door locks. You can keep the glove box locked when you leave your vehicle and the valet key at a parking facility.

LX and Canadian DX models

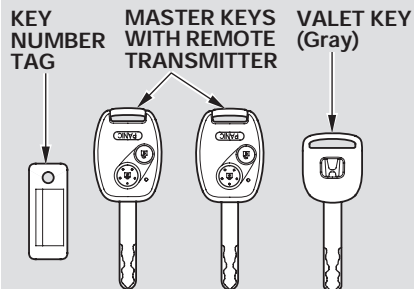

You should have received a key number tag with your keys. You will need this key number if you ever have to get a lost key replaced. Use only Honda-approved key blanks.

These keys contain electronic circuits that are activated by the immobilizer system. They will not work to start the engine if the circuits are damaged.

- Protect the keys from direct sunlight, high temperature, and high humidity.
- Do not drop the keys or set heavy objects on them.
- Keep the keys away from liquids. If they get wet, dry them immediately with a soft cloth.

The keys without a remote transmitter do not contain batteries. Do not try to take them apart.

The immobilizer system protects your vehicle from theft. If an improperly-coded key (or other device) is used, the engine will not start.

When you turn the ignition switch to the ON (II) position, the immobilizer system indicator should come on for a few seconds, then go off. If the indicator starts to blink, it means the system does not recognize the coding of the key. Turn the ignition switch to the LOCK (0) position, remove the key, reinsert it, and turn the ignition switch to the ON (II) position again.

This indicator also blinks several times when you turn the ignition switch from the ON (II) position to the ACCESSORY (I) or LOCK (0) position.

The system may not recognize your key's coding if another immobilizer key or other metal object (i.e. key fob) is near the ignition switch when you insert the key.

If the system repeatedly does not recognize the coding of your key, contact your dealer.

Do not attempt to alter this system or add other devices to it. Electrical problems could result that may make your vehicle undrivable.

If you have lost your key and you cannot start the engine, contact your dealer.

NOTICE

Always take the ignition key with you whenever you leave the vehicle alone.

As required by the FCC:

This device complies with Part 15 of the FCC rules. Operation is subject to the following two conditions: (1) This device may not cause harmful interference, and (2) this device must accept any interference received, including interference that may cause undesired operation.

Changes or modifications not expressly approved by the party responsible for compliance could void the user's authority to operate the equipment.

This device complies with Industry Canada Standard RSS-210. Operation is subject to the following two conditions: (1) this device may not cause interference, and (2) this device must accept any interference that may cause undesired operation of the device.

Ignition Switch

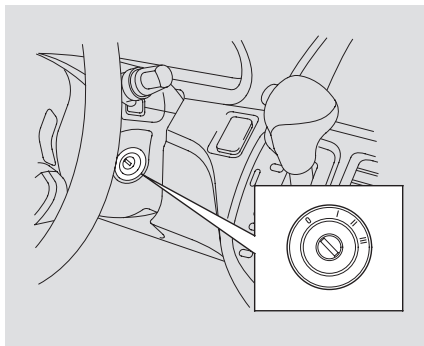

The ignition switch has four positions: LOCK (0), ACCESSORY (I), ON (II), and START (III).

LOCK (0) - You can insert or remove the key only in this position. To turn the key to the LOCK (0) position, the shift lever must be in Park, and you must push the key in slightly.

If the front wheels are turned, the anti-theft lock may make it difficult to turn the key. Firmly turn the steering wheel to the left or right as you turn the key.

ACCESSORY (I) - You can operate the audio system and the accessory power sockets in this position.

ON (II) - This is the normal key position when driving. Several of the indicators on the instrument panel come on as a test when you turn the ignition switch from the ACCESSORY (I) to the ON (II) position.

START (III) - Use this position only to start the engine. The switch returns to the ON (II) position when you let go of the key.

You will hear a reminder beeper if you leave the key in the ignition switch in the LOCK (0) or the ACCESSORY (I) position and open the driver's door. Remove the key to turn off the beeper.

On Touring models

You will also see a "REMOVE KEY" message on the multi-information display (see page [89](#)).

The shift lever must be in Park before you can remove the key from the ignition switch.

On LX and Canadian DX models

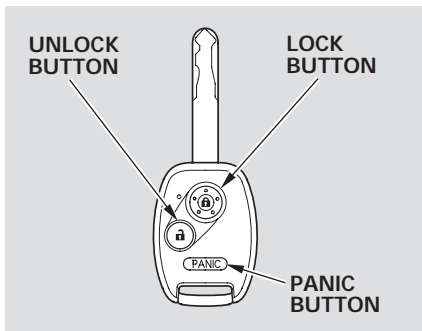

LOCK - Press this button once to lock all doors and the tailgate. Some exterior lights will flash once. When you push **LOCK** twice within 5 seconds, you will hear a beep to verify that the security system has set. You cannot lock the doors and the tailgate if any door or the tailgate is not fully closed or the key is in the ignition switch.

UNLOCK - Press this button once to unlock the driver's door. Press it twice to unlock the other doors and the tailgate. Some exterior lights will flash twice each time you press the button. If you do not open any door or the tailgate within 30 seconds, they will automatically relock.

When you press the **UNLOCK** button, the front and rear individual map lights, depending on their switch positions, will come on (see page 205). If you do not open any door, the lights stay on for about 30 seconds, then go out. If you relock the doors and the tailgate with the remote transmitter before 30 seconds have elapsed, the lights will go off immediately.

PANIC - Press and hold this button for about 1 second to attract attention; the horn will sound, and the exterior lights will flash for about 30 seconds. To cancel panic mode, press any other button on the remote transmitter, or turn the ignition switch to the ON (II) position. Panic mode does not work when the key is in the ignition switch.

Remote Transmitter

Replacing the Transmitter Battery

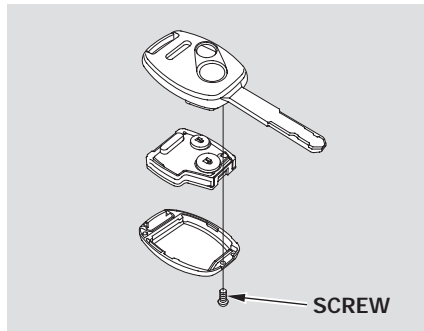

If it takes several pushes on the button to lock or unlock the doors and the tailgate, replace the battery as soon as possible.

Battery type: CR1616

To replace the battery:

1. Remove the screw at the base of the transmitter with a small Phillips-head screwdriver.

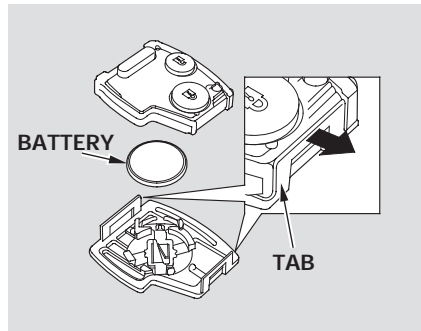

2. Separate the transmitter by prying its middle seam with your fingernail.
3. Inside the transmitter, separate the inner cover from the keypad by releasing the two tabs on the cover.

4. Remove the old battery from the back of the inner cover, and note the polarity. Make sure the polarity of the new battery is the same (+ side facing down), then insert it into the back of the cover.

An improperly disposed of battery can hurt the environment. Always confirm local regulations for battery disposal.

On EX, EX-L and Touring models

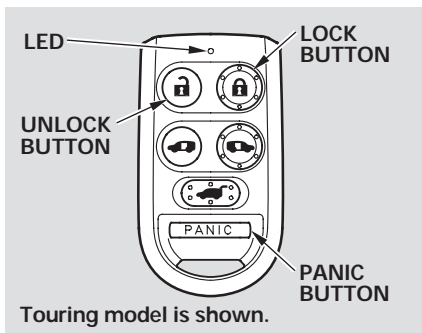

LOCK - Press this button once to lock all doors and the tailgate. Some exterior lights will flash once. When you push LOCK twice within 5 seconds, you will hear a beep to verify that the security system has set. You cannot lock the doors and the tailgate if any door or the tailgate is not fully closed or the key is in the ignition switch.

UNLOCK - Press this button once to unlock the driver's door. Press it twice to unlock the other doors and the tailgate. Some exterior lights will flash twice each time you press the button.

If you do not open any doors or the tailgate within 30 seconds, they will automatically relock and the security system sets.

On Touring models, you can change this setting (see page 129).

If you press the LOCK button and the PASSENGER'S SIDE SLIDING DOOR button at the same time for about 1 second, the LED in the remote transmitter will blink twice, and all doors and the tailgate will unlock simultaneously when you press the UNLOCK button. To cancel this feature, press the LOCK button and the PASSENGER'S SIDE SLIDING DOOR button at the same

time. The LED will blink once.

When you press the UNLOCK button, the front and rear individual map lights, depending on their switch positions, will come on (see page 205). If you do not open any door, the lights stay on for about 30 seconds, then go out. If you relock the doors and the tailgate with the remote transmitter before 30 seconds have elapsed, the lights will go off immediately.

PANIC - Press and hold this button for about 1 second to attract attention; the horn will sound, and the exterior lights will flash for about 30 seconds. To cancel panic mode, press any other button on the remote transmitter, or turn the ignition switch to the ON (II) position. Panic mode does not work when the key is in the ignition switch.

Remote Transmitter

Opening or Closing the Power Sliding Doors

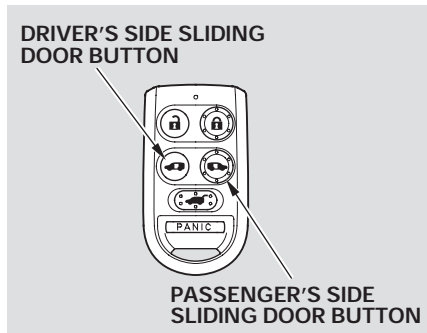

You can open or close each sliding door with the remote transmitter when the doors are unlocked. Push and hold the right button to open or close the passenger's side door, and the left button to open or close the driver's side door.

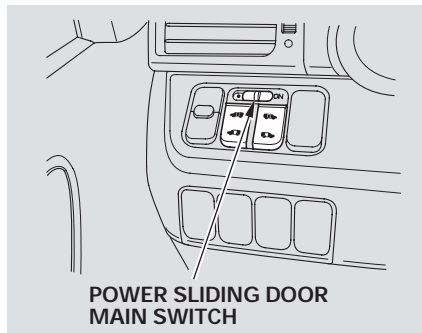

If the power sliding door MAIN switch on the dashboard is in the OFF position, you cannot open or close the sliding doors with the remote transmitter.

Opening or Closing the Power Tailgate

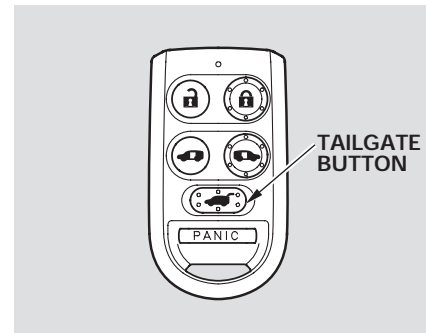

On Touring models only
You can open or close the power tailgate with the remote transmitter when the doors are unlocked. Press and hold the TAILGATE button to open or close the power tailgate. When the tailgate begins to move, you will hear a beep, and some front and rear lights will flash.

Recalling a Memorized Seat Position

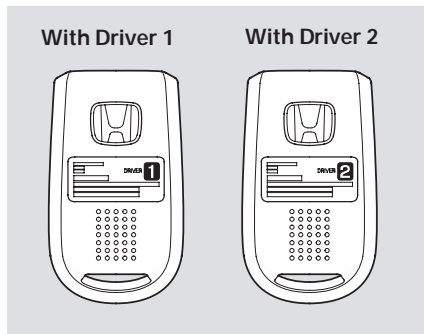

On Touring models only

Each remote transmitter activates the driver's seat position memory system (see page 184) and customized vehicle control settings (see page 101). When you open the driver's door after unlocking it with the remote transmitter, the driver's seat and outside mirrors move to the positions stored in memory. You will hear two beeps when the movement

is completed.

The driving position memory activation (Driver 1, Driver 2) is shown on the back of each transmitter. Make sure you store your seat and outside mirror positions in the memory that is activated by the transmitter you normally carry.

You can turn off this system activation with the remote transmitter. Press and hold the LOCK and UNLOCK buttons at the same time. The LED in the remote transmitter will blink twice. Then release the buttons, and press the LOCK or UNLOCK button.

To turn the keyless memory settings back on, repeat this procedure. The LED will come on for 1 second to indicate the feature has been turned on.

Remote Transmitter Care

- Avoid dropping or throwing the transmitter.
- Protect the transmitter from extreme temperature.
- Do not immerse the transmitter in any liquid.
- If you lose a transmitter, the replacement needs to be reprogrammed by your dealer.

Remote Transmitter

Replacing the Transmitter Battery

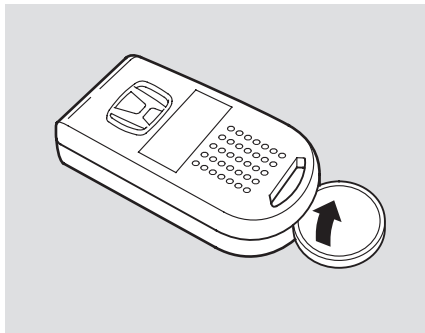

If it takes several pushes on the button to lock or unlock the doors and the tailgate, replace the battery as soon as possible.

Battery type: CR2025

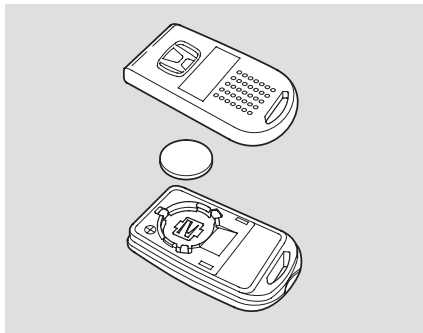

To replace the battery, separate the halves by carefully prying on the edge with a coin. Remove the old battery, and insert a new battery with the + side facing up. Snap the two halves of the transmitter case back together.

An improperly disposed of battery can hurt the environment. Always confirm local regulations for battery disposal.

As required by the FCC:

This device complies with Part 15 of the FCC rules. Operation is subject to the following two conditions: (1) This device may not cause harmful interference, and (2) this device must accept any interference received, including interference that may cause undesired operation.

Changes or modifications not expressly approved by the party responsible for compliance could void the user's authority to operate the equipment.

This device complies with Industry Canada Standard RSS-210.

Operation is subject to the following two conditions: (1) this device may not cause interference, and (2) this device must accept any interference that may cause undesired operation of the device.

Power Door Locks

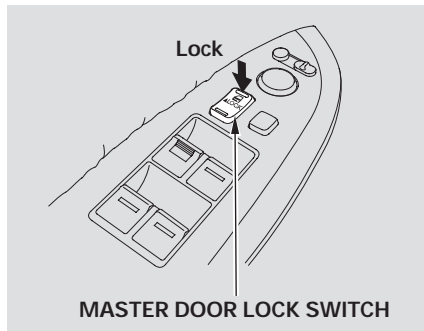

To lock the doors and the tailgate, press the front of the master door lock switch on either front door, press the lock tab on the driver's door, or use the outside lock on the driver's door.

Pressing the rear of the master door lock switch will unlock all doors and the tailgate.

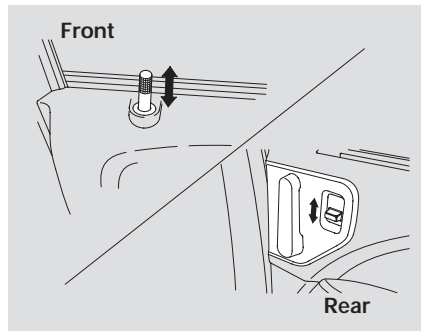

The lock tab on any door locks and unlocks that door.

All doors and the tailgate can be locked from the outside by using the key in the driver's door lock. To unlock only the driver's door, insert the key, turn the key, and release it. The remaining doors and the tailgate unlock when you turn the key a second time within a few seconds.

Lockout Prevention

With the driver's door open and the key in the ignition, both master door lock switches are disabled. They are not disabled if the driver's door is closed. Pushing the front of the master door lock switch on the open passenger's door will lock all doors and the tailgate.

Door Locks

Auto Door Locking/Unlocking

On LX, EX, EX-L and Canadian DX models

Your vehicle has customizable settings for the doors and tailgate to automatically lock and unlock. There are default settings for each of these features. You can turn off or change the settings for these features as described on the following pages.

When you customize the setting, make sure your vehicle is parked safely, the engine is off, and apply the parking brake. Make all settings before you start driving.

On Touring models

To change the "AUTO DOOR LOCK" setting, see page [123](#).

To change the "AUTO DOOR UNLOCK" setting, see page [125](#).

Auto Door Locking

On LX, EX, EX-L and Canadian DX models

The auto door locking feature has three possible settings:

- The auto door locking is deactivated all the time.
- The doors and the tailgate lock whenever you move the shift lever out of the Park (P) position.
- The doors and the tailgate lock when the vehicle speed reaches 9 mph (15 km/h). This is the default setting.

To turn off the Auto Door Lock modes:

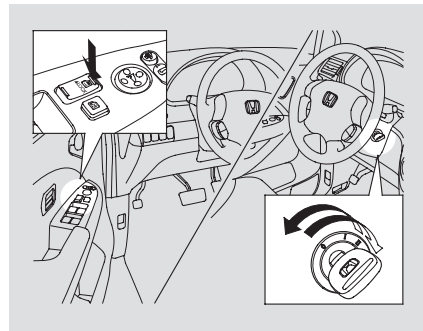

1. Make sure the shift lever is in the Park (P) position.
2. Turn the ignition switch to the ON (II) position, and open the driver's door.

3. Push and hold the front of the master door lock switch on the driver's door until you hear a click (after about 5 seconds).
4. Release the switch, and within 5 seconds, turn the ignition switch to the LOCK (0) position.

To program the Park Lock mode:
Locks all doors and tailgate when the shift lever is moved out of the Park (P) position.

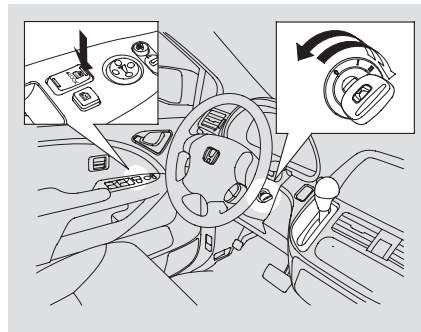

1. Make sure the shift lever is in the Park (P) position.
2. Turn the ignition switch to the ON (I) position, and make sure to close the driver's door.

3. Push and hold the front of the master door lock switch on the driver's door. You will hear a click. Keep holding the switch until you hear another click (after about 5 seconds).
4. Release the switch, and within 5 seconds, turn the ignition switch to the LOCK (0) position.

Door Locks

To program the Drive Lock mode:

Locks all doors and tailgate when the vehicle's speed reaches about 9 mph (15 km/h).

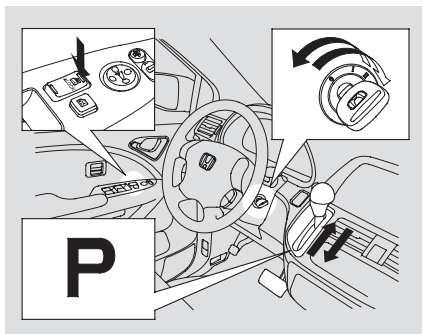

1. Make sure the shift lever is in the Park (P) position.
2. Turn the ignition switch to the ON (I) position, and make sure to close the driver's door.

3. Push and hold the brake pedal, and move the shift lever out of the Park (P) position.
4. Push and hold the front of the master door lock switch on the driver's door. You will hear a click. Keep holding the switch until you hear another click (after about 5 seconds).
5. Release the switch and, within 5 seconds, turn the ignition switch to the ACCESSORY (I) position. Move the shift lever to the Park (P) position.
6. Turn the ignition switch to the LOCK (0) position.

Auto Door Unlocking

On LX, EX, EX-L and Canadian DX models

The auto door unlocking feature has five possible settings:

- The auto door unlocking is deactivated all the time.
- The driver's door unlocks when you move the shift lever to the Park (P) position. This is the default setting.
- All doors and tailgate unlock when you move the shift lever to the Park (P) position.
- The driver's door unlocks whenever you turn the ignition switch to the ACCESSORY (I) position.
- All doors and tailgate unlock whenever you turn the ignition switch to the ACCESSORY (I) position.

To turn off the Auto Door Unlock modes:

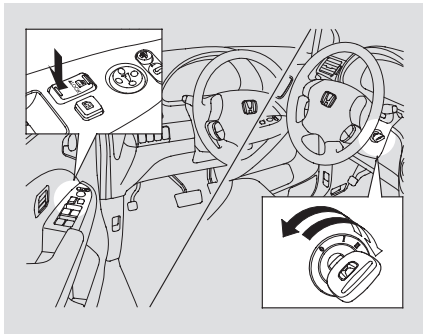

1. Make sure the shift lever is in the Park (P) position.
2. Turn the ignition switch to the ON (II) position, and open the driver's door.

3. Push and hold the rear of the master door lock switch on the driver's door. You will hear a click, and after about 5 seconds, you will hear another click.
4. Release the switch, and within 5 seconds, turn the ignition switch to the LOCK (0) position.

To program the Park Unlock mode:
Unlocks the driver's door or all doors and tailgate when the shift lever is moved into the Park (P) position.

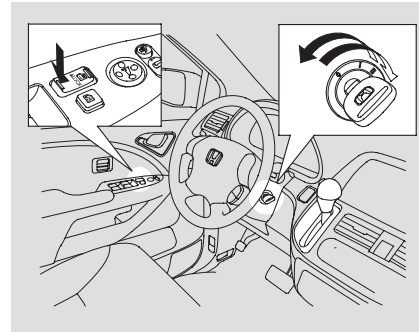

1. Make sure the shift lever is in the Park (P) position.
2. Turn the ignition switch to the ON (II) position, and make sure to close the driver's door.

CONTINUED

Door Locks

3. Push and hold the rear of the master door lock switch on the driver's door. You will hear a click. Continue to hold down the switch:

- Until you hear another click (after about 5 seconds) to activate *driver's door unlock feature*.
- Or, until you hear two more clicks (after about 10 seconds) to activate *all doors and tailgate unlock feature*.

4. Release the switch, and within 5 seconds, turn the ignition switch to the LOCK (0) position.

To program the Ignition Switch Unlock mode:

Unlocks the driver's door or all doors and tailgate when the ignition switch is moved out of the ON (II) position.

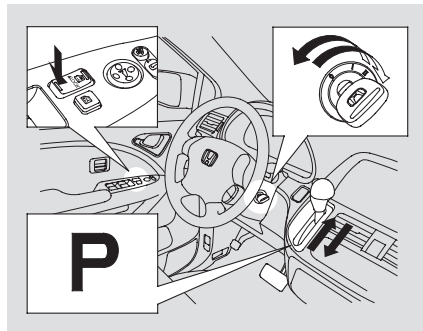

1. Make sure the shift lever is in the Park (P) position.
2. Turn the ignition switch to the ON (II) position, and make sure to close the driver's door.

3. Push and hold the brake pedal, and move the shift lever out of P.

4. Push and hold the rear of the master door lock switch on the driver's door. You will hear a click. Continue to hold the switch:

- Until you hear another click (after about 5 seconds) to activate the driver's door unlock feature.
- Or, until you hear two more clicks (after about 10 seconds) to activate all doors and tailgate unlock feature.

5. Release the switch and, within 5 seconds, turn the ignition switch to the ACCESSORY (I) position. Move the shift lever to the Park (P) position.

6. Turn the ignition switch to the LOCK (0) position.

Childproof Door Locks

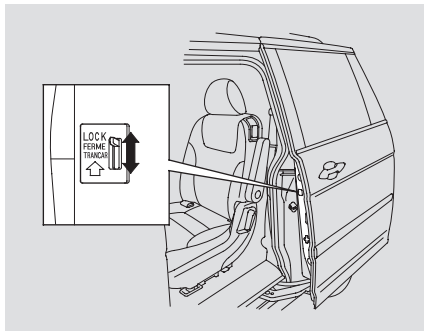

The childproof door locks are designed to prevent children seated in the rear from accidentally opening the rear sliding doors. Each door has a lock lever near the edge. With the lever in the LOCK position, the door cannot be opened from the inside regardless of the position of the lock tab. To open the door, pull the lock tab up and use the outside door handle.

On EX, EX-L and Touring models
With the childproof door locks on, automatic operation with the inside door handle is disabled.

Tailgate

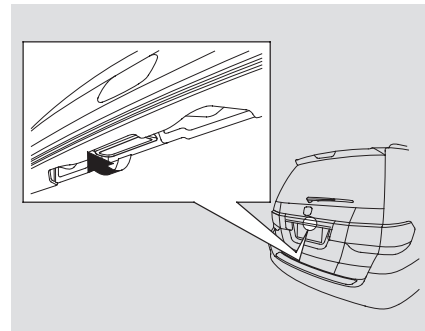

To open the tailgate, pull the handle, then lift up. To close the tailgate, use the inner handle to pull it down, then press down on the back edge.

Keep the tailgate closed at all times while driving to avoid damaging the tailgate and to prevent exhaust gas from getting into the interior. See **Carbon Monoxide Hazard** on page 60.

Tailgate

Power Tailgate

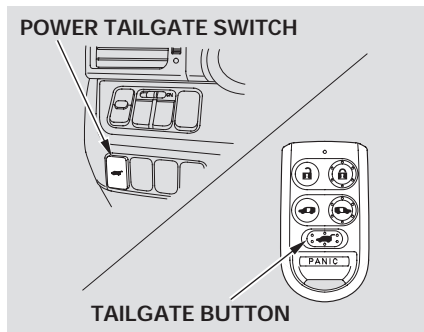

On Touring models only
The tailgate can be opened and closed with the remote transmitter or the switch on the dashboard when both front doors are unlocked.

Press and hold the tailgate button on the remote transmitter or the dashboard switch for about 1 second to open or close the tailgate. Each time you press the button on the remote transmitter or the dashboard switch, you will hear a beep, and some front and rear lights will flash.

If you push the same button or switch again while the tailgate is opening or closing, you will hear three beeps, and the tailgate will stop moving, reverse direction, and stop at the fully opened or closed position.

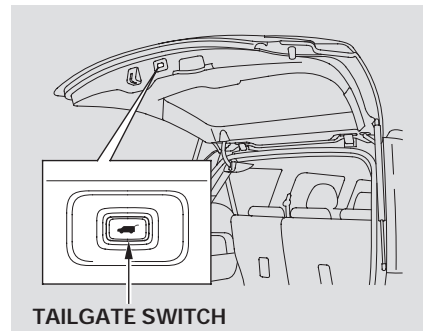

The tailgate can also be closed by pressing the button on the tailgate. If you press the button again while the tailgate is closing, you will hear three beeps, and the tailgate will stop moving, reverse direction, and stop at the fully opened position.

To open or close the tailgate manually, see page [160](#).

Auto-Reverse

The power tailgate has an auto-reverse feature. If it meets resistance while opening or closing, it will beep three times and reverse direction. However, the tailgate may not reverse immediately. Always make sure passengers and objects are clear of the tailgate before opening or closing it.

⚠ WARNING

Closing a power tailgate while anyone is in the path of the tailgate can cause serious injury.

Make sure everyone is clear before closing the power tailgate.

Also check that passengers, especially children, do not have their hands on the edge of the tailgate or on the tailgate sill. The auto reverse feature stops working when the tailgate is about to latch so the motor can pull the tailgate shut.

If your vehicle's battery is disconnected, goes dead, or the fuse is removed while the tailgate is fully open, the power tailgate needs to be reset. After connecting the battery or installing the fuse, close the tailgate fully by hand.

The power tailgate may not open or close under the these conditions:

- The vehicle is parked on a steep hill.
- When the vehicle is swayed in a strong wind.

- When the tailgate or the roof is covered with snow or ice.

Do not install any accessories on the tailgate. It may cause the tailgate not to function properly. If there is snow or ice on the tailgate, make sure to remove it before you operate the tailgate.

If you pull the tailgate release handle while the tailgate is opening or closing, it will stop moving. You need to open or close it the rest of the way manually.

The tailgate has sensors on both sides. Be careful not to damage them. If the sensors are damaged, the power tailgate does not function properly.

CONTINUED

Tailgate

If you try to drive off with the tailgate not closed completely, a beeper sounds and a “DOOR & TAILGATE OPEN” message is shown on the multi-information display.

Keep the tailgate closed at all times while driving to avoid damaging the tailgate and to prevent exhaust gas from getting into the interior. See **Carbon Monoxide Hazard** on page 60 .

If there is a problem in the power tailgate system, you will see a “CHECK POWER TAILGATE” message on the multi-information display. Have the system checked by your dealer.

With this message shown on the multi-information display, you can still open or close the tailgate manually.

Unlocking the Tailgate

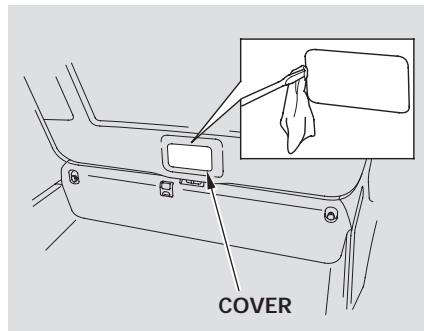

If the power door lock system cannot unlock the tailgate, unlock it manually.

Use a small flat-tipped screwdriver to remove the cover on the back of the tailgate.

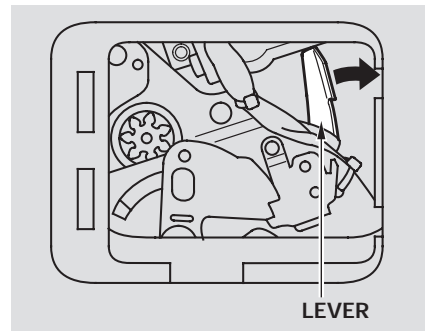

On Touring models
Push the release lever to the right as shown.

If you need to unlock the tailgate manually, it means there is a problem with the tailgate. Have the vehicle checked by your dealer.

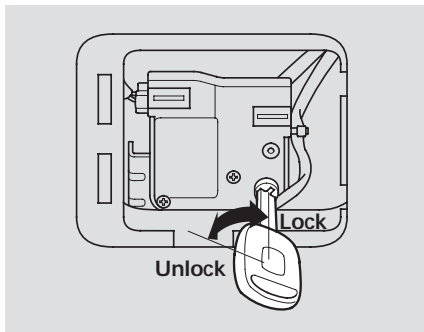

On LX, EX, EX-L and Canadian DX models

Use the key to unlock the tailgate as shown, then pull the outer handle to open the tailgate.

If you need to unlock the tailgate manually, it means there is a problem with the tailgate. Have the vehicle checked by your dealer.

Opening and Closing Manual Sliding Doors

On LX and Canadian DX models

To open, pull the inside or outside door handle, and slide the door back. It will latch in the fully open position. When opening from the inside, the childproof door lock must be unlocked.

To close, pull either handle, and slide the door closed. Make sure the door is closed and latched securely before driving, and all passengers are clear of the sliding doors before closing them.

When opening a sliding door, it stops about halfway if the window is open more than 3 in (8 cm). If the vehicle is facing downhill, the sliding door will slam shut when you release the door handle. Always close the window fully before opening the sliding door.

Power Sliding Doors

On EX, EX-L and Touring models

The doors are electrically powered and can be operated with the remote transmitter, the door handles, or the dashboard switches. To operate the doors:

- The shift lever must be in Park or neutral. To operate the doors with the shift lever in neutral, the ignition switch must be in the ON (II) position with the brake pedal pressed or the parking brake applied.
- The MAIN switch must be in the ON position.
- The doors must be unlocked.

CONTINUED

Sliding Doors

When the shift lever is in Park:

If you shift out of Park while a door is closing, you will hear a beep until the door closes.

When you shift out of Park while a door is opening, you will hear a continuous tone and the door will stop moving if you release the brake pedal or the parking brake. Stop the vehicle and close the door.

When the shift lever is in neutral and the ignition switch is in the ON (II) position:

If you shift out of neutral or release the brake pedal or the parking brake while a door is closing, you will hear a beep until the door closes.

If you shift out of neutral or release the brake pedal or the parking brake while a door is opening, you will hear a continuous tone and the door will stop moving. Stop the vehicle and close the door.

Door Handles

To open the door with the inside door handle, pull the handle backward. Push it forward to close the door. If you pull backward or push forward on the door handle while a door is opening or closing, the door stops moving. Pull backward or push forward to open or close the door fully.

To open or close the door with the outside door handle, pull the door handle. If you pull the door handle while a door is opening or closing, the door stops moving. If you pull the door handle again, the door will open fully.

Dashboard Switches

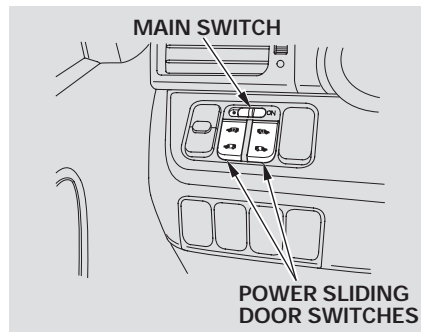

The dashboard switches to the left of the steering column allow you to open or close the power sliding doors.

The MAIN switch on the dashboard controls power to the sliding doors.

To open a power sliding door, push and release the bottom of the appropriate switch. If you forget to unlock the door, you will hear three beeps. Unlock the door, and try again.

To close a sliding door, push and release the top of the switch.

To stop a door, push either the top or bottom of the switch. The door will stop and you will hear three beeps. Push the switch again to resume movement.

When the MAIN switch is in the OFF position, you have to operate the doors manually.

Remote Transmitter

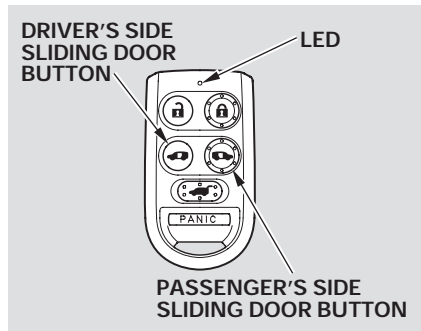

To open and close a power sliding door, press and hold the appropriate button for at least 1 second. If you forget to unlock the door, you will hear three beeps. Unlock the door, and try again.

To stop movement, push the appropriate door button; you will hear three beeps. Push and hold the same button again for at least 1 second and the door will reverse direction.

Auto-Reverse

Each power sliding door has an auto-reverse feature. If a door meets resistance while closing, it will beep three times and reverse direction. However, the door may not reverse immediately and may cause some bruising or discomfort. Always make sure passengers and objects are clear of the doors before closing them.

If a rear window is open more than 3 in (8 cm), the power sliding door is designed to stop about halfway to avoid accidents. If this happens, close the door with the door handles, the dashboard switch, or the remote transmitter. Close the window and open the sliding door. Make sure the window is fully closed before you operate the power sliding door.

Sliding Doors

Manually Opening/Closing the Power Sliding Door

You can manually open or close the sliding doors. The MAIN switch must be in the OFF position. To open a door, pull the inside or outside door handle, and slide the door back. It will latch in the fully open position. To close, pull either handle and slide the door forward. When the door is almost closed, the auto-closer will pull the door shut.

Important Sliding Door Precautions

On EX, EX-L and Touring models

Before operating the sliding doors, check that passengers, especially children, do not have their hands on the edge of the sliding door or on the door pillar. The auto-reverse motor stops working when the door is about to latch so the auto-closer can pull the door shut.

If there is an obstacle in the door sill, the power sliding door may not open or close properly. When removing the obstacle from the door sill, make sure to turn off the main switch on the dashboard.

When replacing a flat tire, make sure to turn off the power sliding door main switch on the dashboard.

On all models

Do not allow anyone to step on the lower arm of the sliding door while the door is open. This could damage the sliding door mechanism.

When you drive with children in your vehicle, use the childproof door locks (see page [157](#)). This will prevent children from opening the doors accidentally.

Do not put any item in the door pocket that sticks out from the pocket. It can prevent the doors from opening or closing properly, and damage the vehicle body.

⚠ WARNING

Closing a sliding door while any part of a passenger is in the door's path can cause serious injury.

Make sure all passengers are clear of the doorway before closing a sliding door.

Refueling

When you release the fuel fill door, the driver's side sliding door automatically locks so it cannot open and interfere with the fuel door. If a passenger attempts to unlock the door by cycling the lock knob several times, the door can be opened.

If a passenger needs to get out while you are refueling, instruct that person to exit on the passenger's side.

When you close the fuel fill door, the driver's side sliding door unlocks if it was unlocked when you opened the fuel fill door.

On EX, EX-L and Touring models

If you open the fuel fill door while the driver's side sliding door is opening, the sliding door stops. If this happens, the door must be operated manually.

Parking on a Hill

When parking facing downhill, make sure the doors are latched in the fully open position, and then hold the door open for your passengers. Do not pull the inside or outside door handle, or the door will slam shut.

On EX, EX-L and Touring models

Make sure the main switch on the dashboard is in the ON position.

When parking facing downhill on a steep grade, the power sliding doors may not open or close as they do normally.

If you leave the vehicle on a steep downhill with a power sliding door half open and the engine off, the magnetic lock will turn off after 30 minutes and the sliding door will automatically open or close. In this case you will hear a continuous tone.

If your vehicle is facing downhill, do not turn the main switch to OFF while the door is opening because the door may slam shut.

Sliding Doors

Pinch Sensor

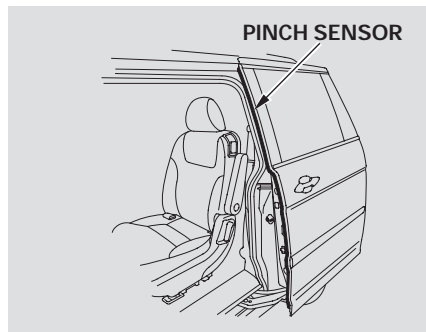

On EX, EX-L and Touring models
Each sliding door has a pinch sensor on the front edge. Do not damage this sensor, or the power sliding door may not operate properly.

Power Sliding Door Indicator

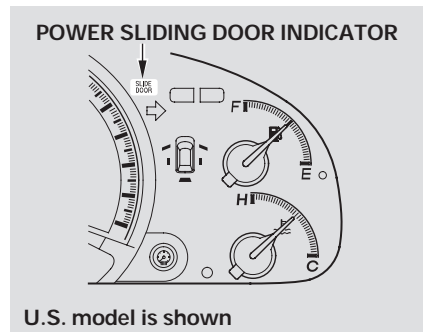

On EX and EX-L models
If the power sliding door indicator comes on and stays on, there is a problem in the system. Turn the MAIN switch to OFF, and have the system inspected by a dealer.

On Touring models

If there is a problem in the power sliding door system, you will see a “CHECK LEFT SLIDING DOOR” or “CHECK RIGHT SLIDING DOOR” message on the multi-information display (see page 89). If this message stays on, turn the MAIN switch to OFF, and have the system inspected by your dealer.

If the battery is disconnected or goes dead, close the sliding door completely by hand. If it still does not operate properly after the battery is reconnected, have your vehicle checked by a dealer.

Passenger Seating ***Convertible Second Row Bucket Seats***

There are bucket seats with armrests for two front passengers, bucket seats with armrests for two passengers in the second row, and a bench seat for three passengers in the third row.

For greater cargo capacity, the seats in the second row can be removed, and the bench seat in the third row can be folded into the floor.

Except U.S. LX and Canadian DX models

Your vehicle has a second row plus-one seat that can be installed between the second row bucket seats when needed. The plus-one seat can also be used as a second row center console.

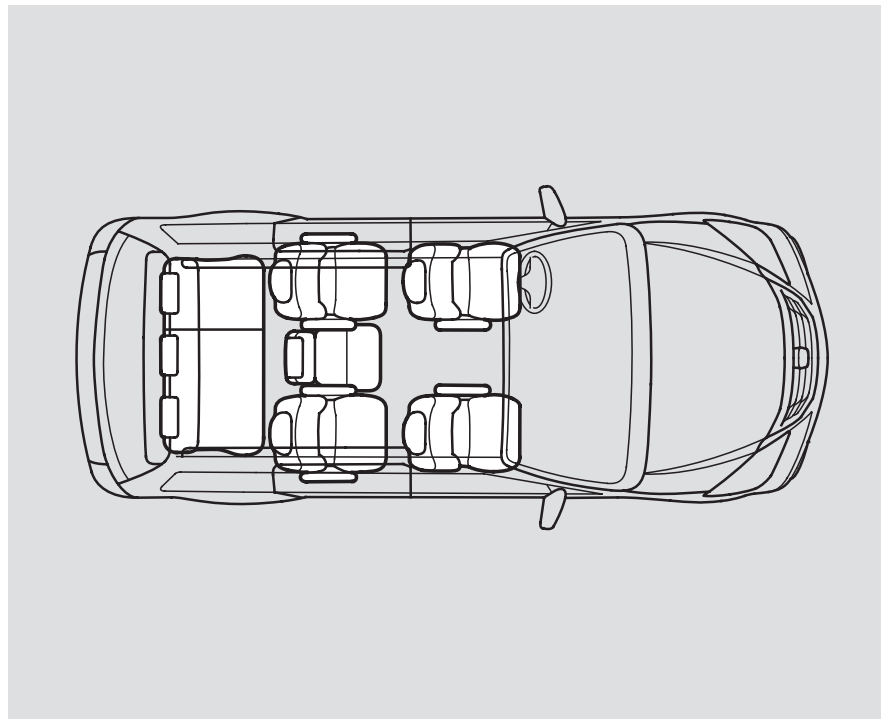

Seats

Seat Adjustments

See pages 12 - 13 for important safety information and warnings about how to properly position the seats and seat-backs.

The EX-L and Touring models have a power adjustable driver's seat and front passenger's seat. The EX model has a power adjustable driver's seat and manual front passenger's seat. LX and DX models have manual driver's seat and front passenger's seat adjustments.

The seats in the second and third rows adjust manually.

Make all seat adjustments before you start driving.

Manual Seat Adjustments

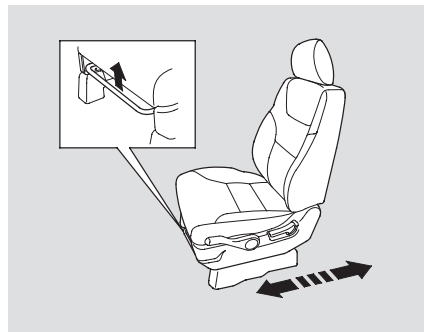

To adjust the seat forward and backward, pull up on the bar under the seat cushion's front edge. Move the seat to the desired position, and release the bar. Try to move the seat to make sure it is locked in position.

To adjust the bucket seats in the second row, pull up the bar on the front of the seat bottom. The third row seats do not adjust forward and backward.

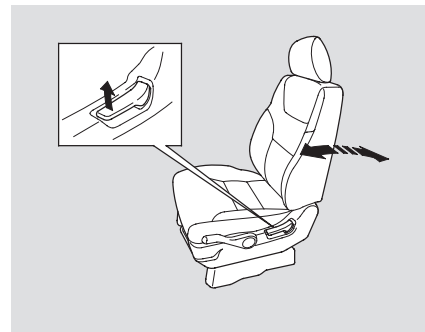

To change the seat-back angle of the front seat, pull up the lever on the outside of the seat bottom.

To change the seat-back angle of the bucket seats in the second row, pull forward on the lever on the outside of the seat-back.

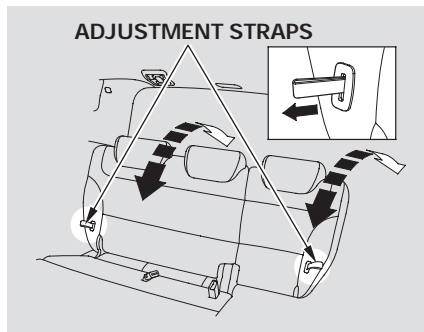

The left and right halves of the third seat-back can be adjusted separately. To adjust the angle, pull the adjustment strap on the outside of each seat-back, move the seat-back to the desired position, and release the adjustment strap. Let the seat-back latch in the new position.

Driver's Seat Manual Height Adjustment

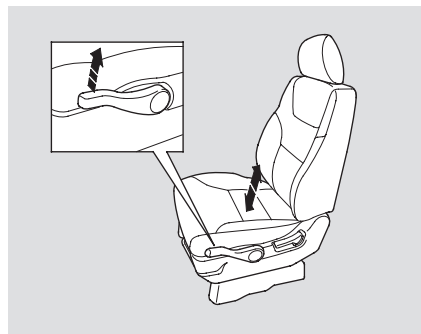

On LX and Canadian DX models
The height of your driver's seat is adjustable. Pull up the lever on the outside of the seat cushion to raise the seat bottom or push the lever down to lower the seat cushion.

Make all adjustments before you start driving.

Power Seat Adjustments

On EX, EX-L and Touring models
See pages 12 - 13 for important safety information and warnings about how to properly position the seats and seat-backs.

The controls for the adjustable driver's power seat are on the outside edge of the seat bottom. You can adjust the power seat with the ignition switch in any position. Make all seat adjustments before you start driving.

On EX-L and Touring models
The passenger's seat has two switches. One moves the seat forward and backward, and the other adjusts the seat-back angle.

CONTINUED

Seats

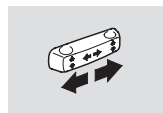
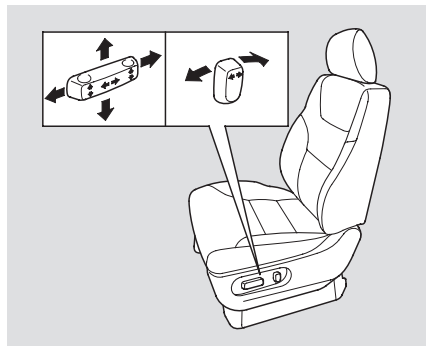

Moves the seat forward and backward.

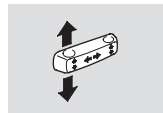

Moves the front of the seat up or down. (Driver's seat only)

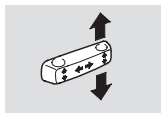

Raises or lowers the seat. (Driver's seat only)

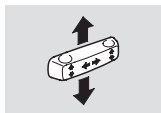

Moves the whole seat up and forward, or down and backward. The front of the seat also tilts up or down at the same time. (Driver's seat only)

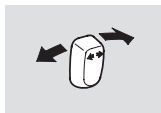

Adjusts the seat-back angle forward or backward.

Driver's Lumbar Support



On EX, EX-L and Touring models
To change the lumbar support, move the lever on the right side of the seat-back forward or backward. Keep moving the lever forward or backward until you find a suitable position.

Armrests

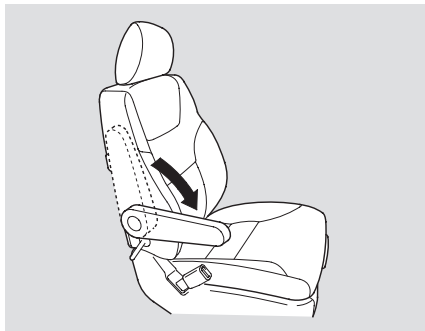

An armrest is located on each of the front seats and on each side of the second row seats (depending on models). Pivot it down to use it. When you remove the bucket seats in the second row, pivot the armrests up out of the way.

On EX-L and Touring models
The angle of the armrest on each front seat is adjustable. Pivot the armrest down, and pull it up to the

desired angle.

Head Restraints

See page 14 for important safety information and a warning about improperly positioning head restraints.

Your vehicle is equipped with head restraints in all seating positions to help protect you and your passengers from whiplash and other injuries.

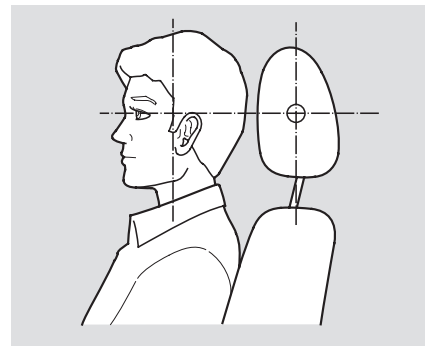

They are most effective when you adjust them so the center of the back of the occupant's head rests against the center of the restraint.

CONTINUED

Seats

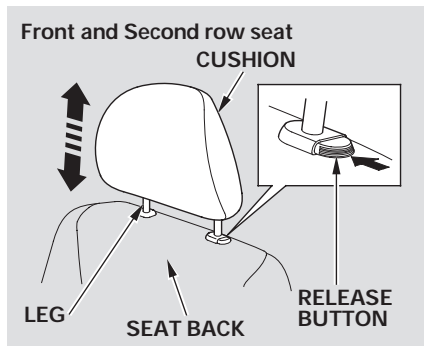

Adjusting the Head Restraint

The front and rear head restraints adjust for height. You need both hands to adjust the restraint. Do not attempt to adjust it while driving. To raise it, pull upward. To lower the restraint, push the release button and push the restraint down.

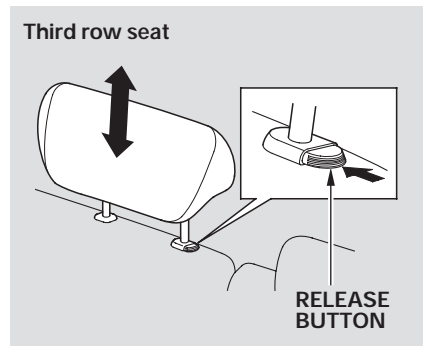

Removing the Head Restraint

To remove a head restraint for cleaning or repair, pull it up as far as it will go. Push the release button, then pull the restraint out of the seat-back.

When reinstalling a head restraint, put the legs back in place. Then adjust it to the appropriate height while pressing the release button.

Make sure the removed head restraints are securely stored.

⚠ WARNING

Failure to reinstall the head restraints can result in severe injury during a crash.

Always replace the head restraints before driving.

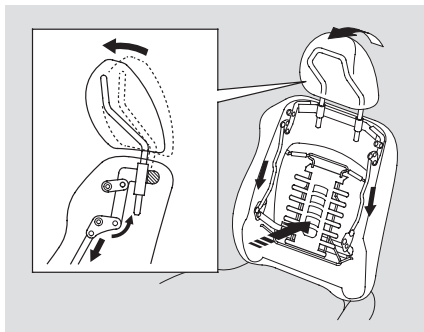
Active Head Restraints

The driver's and front passenger's seats have active head restraints. If the vehicle is struck severely from the rear, the occupant properly secured with the seat belt will be pushed against the seat-back and the head restraint will automatically move forward.

This reduces the distance between the restraint and the occupant's head. It also helps protect the occupants against whiplash and injuries to the neck and upper spine.

After a collision, the activated restraint should return to its normal position.

If the restraints do not return to their normal position, or in the event of a severe collision, have the vehicle inspected by a Honda dealer.

For a head restraint system to work properly:

- Do not hang any items on the head restraints, or from the restraint legs.
- Do not place any object between an occupant and the seat-back.
- Install each restraint in its proper location.
- Only use genuine Honda replacement head restraints.

Seats

Third Row Seat Access

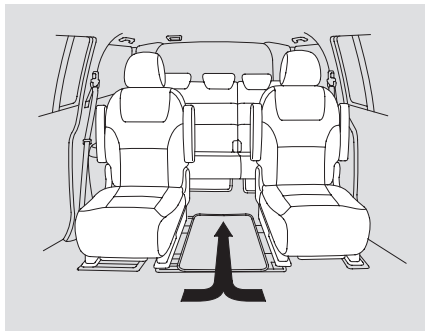

To get into or out of the third row seat, walk between the second row seats.

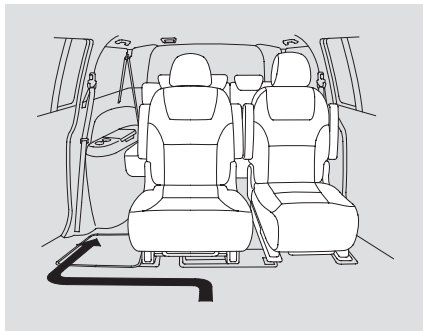

When the seat on the passenger's side is moved to the center, walk through the passenger's side to get into or out of the third row seat.

You need to remove the plus-one seat (see page [178](#)) before you can make this seat arrangement.

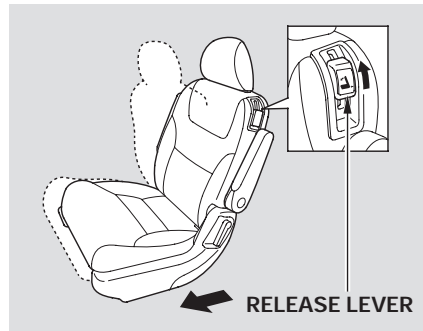

To get into or out of the third row seat, pull up the release lever on the shoulder of each second row bucket seat. The seat-back will tilt forward and the whole seat will slide forward.

Moving the Second Row Bucket Seat

The second row bucket seat on the passenger's side can be moved to the center to provide access to the third row seat.

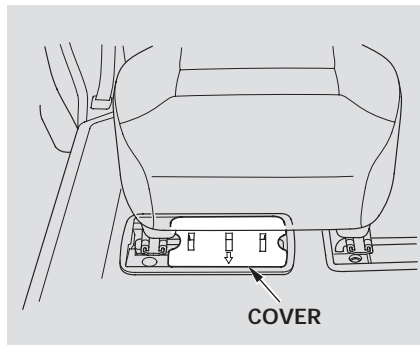

1. Remove the passenger's side second row bucket seat (see page [177](#)), then remove the cover.

If you have already set the floor mat under the passenger's side bucket seat, make sure you remove it before moving the bucket seat.

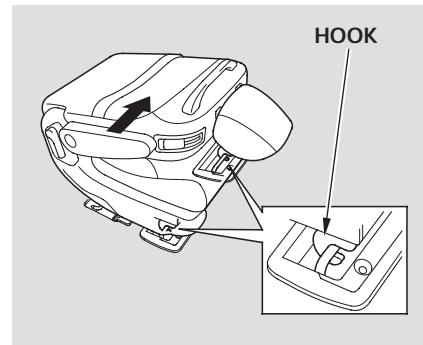

2. Hook the front of the seat to the floor, then slide the seat toward the center of the vehicle.
3. Push the back of the seat down over the floor hooks. Make sure the seat is securely locked in place.

CONTINUED

Seats

To return the seat to the outside position, remove the seat, reinstall the cover, then reinstall the seat.

Make sure the seats are securely locked in place before driving. A seat that is not locked in place could fly around and cause injury in a sudden stop or crash.

Seats and Floor Mats

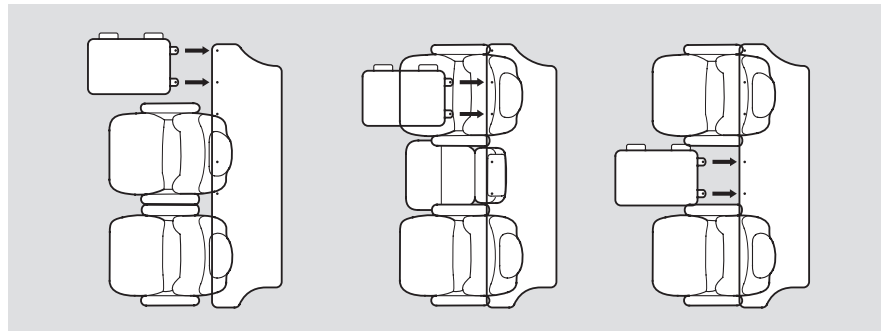

When the plus-one seat is in the center position, store the floor mat under the passenger's side bucket seat as shown above.

When the passenger's side bucket seat is in the outside position, and the plus-one seat is not used, install the floor mat and the cover over the floor anchors.

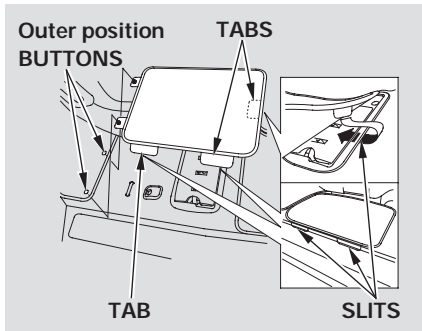

To install the floor mat in an outer position or the center position, insert the tabs into the slits on the floor, then snap the two buttons in place. Refer to the illustrations above.

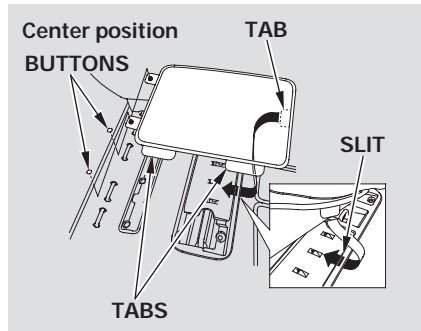

Removing the Bucket Seats in the Second Row

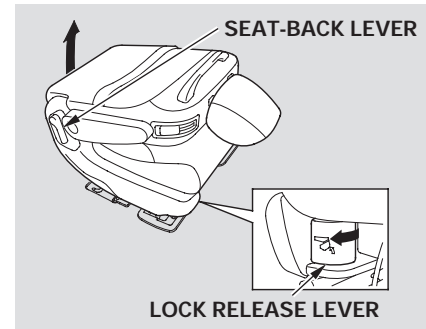

Both seats can be removed to give more cargo capacity. Do not remove the seats while driving.

To remove a second row seat:
1. Pull up the seat-back angle adjustment lever, and fold the seat-back forward.

CONTINUED

Seats

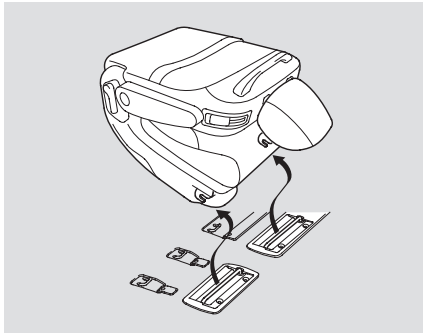

2. Unlock the seat from the floor by pulling the lock release lever under the seat cushion's front edge and lifting the rear of the seat.
3. Unhook the front of the seat from the floor by pulling it back slightly, then pivoting it upward.

To reinstall the seat, hook the front of the seat to the floor, then push the rear of the seat-back until it locks in place. Make sure the seat is securely latched before driving.

Removing the Second Row Plus-One Seat

Except U.S. LX and Canadian DX models

Your vehicle has a plus-one seat for the second row center position.

You can remove the plus-one seat when it is not used. Do not remove the seat while driving.

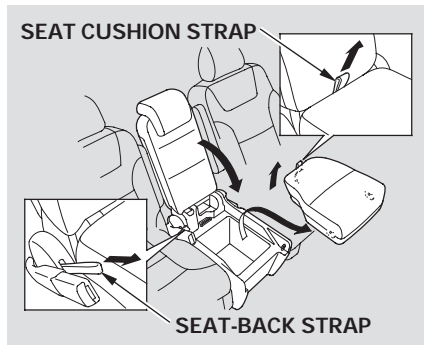

To remove the plus-one seat:

1. Lower the head restraints fully.
2. Remove the seat cushion by pulling the seat cushion strap.
3. Fold the seat-back forward by pulling the seat-back strap.

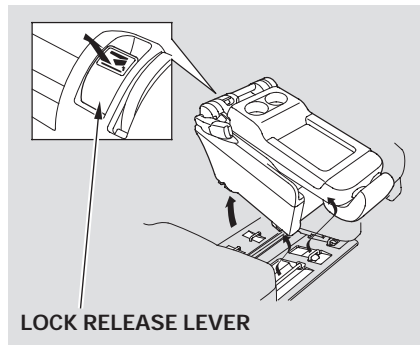

4. Unlock the seat from the floor by pulling the lock release lever and lifting the rear of the seat.

5. Unhook the front of the seat from the floor by pulling it back slightly, then pivoting it upward.

Seats



To install the plus-one seat:

Hook the front of the seat to the floor, then push down the back until it locks. Make sure both the front and back of the seat are securely latched. Pull up the seat-back, and adjust the seat-back angle to the desired position while pulling the seat-back strap on the outside of the seat bottom.

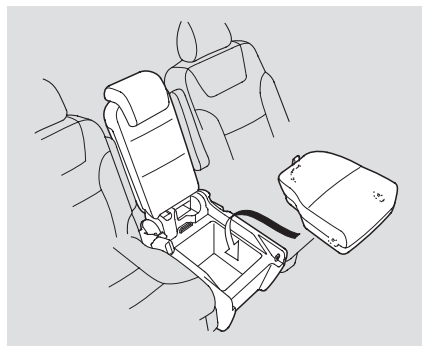

Install the seat cushion on the seat bottom plate. To install the cushion, hook the front of the cushion first, then push down the rear until the cushion is securely positioned.

To use the plus-one seat as a center console, remove its seat cushion by pulling up the seat cushion strap. Then pivot the seat-back forward until it is flat. Store the seat cushion in the floor storage area.

Make sure the seats are securely locked in place before driving. A seat that is not locked in place could fly around and cause injury in a sudden stop or crash.

Folding the One-Motion Third Row “Magic Seat”

To create more cargo space, you can fold the one-motion third row “Magic Seat” into the floor recess.

1. Unlatch the center seat detachable seat belt anchor, and let the belt retract all the way into the ceiling. Place the latch plate and anchor latch into their holding slots. Make sure both seat belts on the outer seats are out of the way.
2. Lower the head restraints fully.

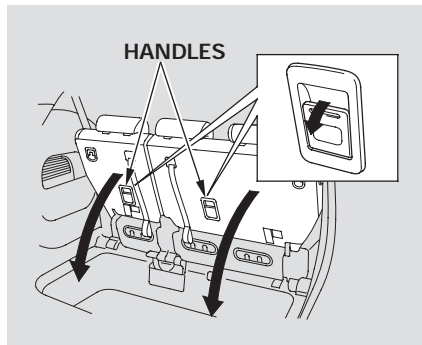

3. Pull the handle on each seat-back to unlock the front legs of the third row seat.
4. Pivot the seat into the cargo area floor recess.

Make sure all items in the cargo area are secured. Loose items can fly forward and cause injury if you have to brake hard. See **Carrying Cargo** on page [370](#).

CONTINUED

Seats



To return the seat to the upright position:

1. Pull the seat out of the recess by pulling on the handle. Pivot the seat forward all the way. The front legs of the third row seat will automatically latch.

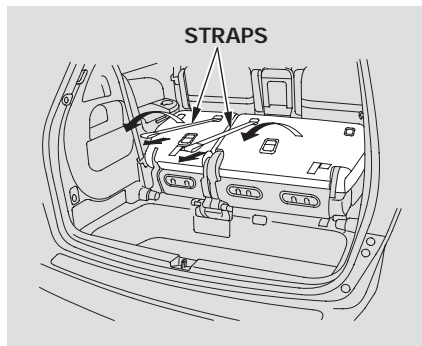

2. Pull the seat-back upright with the strap. Make sure the seat is securely locked into position before driving.

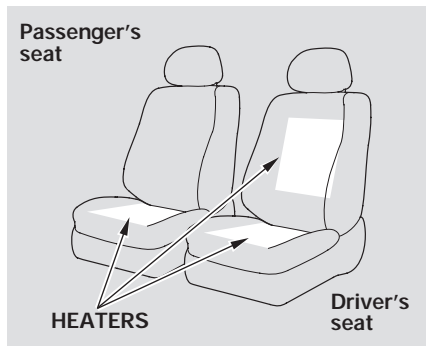

On EX-L and Touring models
Both front seats are equipped with seat heaters. The passenger seat only has heaters in the seat bottom because of the side airbag system. The ignition switch must be in the ON (II) position to use them. The seat heater switches are located on the dashboard above the center pocket. Push the top of the switch, HI, to rapidly heat up the seat. After the seat reaches a comfortable temperature, select LO by pushing

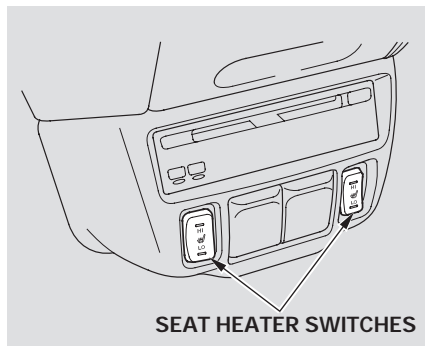

the bottom of the switch. This will keep the seat warm.

In the HI setting, the heater turns off when the seat gets warm, and turns back on after the seat's temperature drops.

In LO, the heater does not cycle with temperature change.

Follow these precautions when using the seat heaters:

- Use the HI setting only to heat the seats quickly, because it draws large amounts of current from the battery.
- If the engine is left idling for an extended period, do not use the seat heaters, even on the LO setting. It can weaken the battery, causing hard starting.

Driving Position Memory System

On Touring model only

Your vehicle has a memory feature for the driver's seat and outside mirror positions.

Two seat and outside mirror positions can be stored in separate memories. You select a memorized position by pushing the appropriate button or using the appropriate remote transmitter (Driver 1 or Driver 2).

This setting can be linked or unlinked with the remote transmitter. For more information, see page [149](#).

You can change the "MEMORY POSITION LINK" setting on the multi-information display (see page [116](#)).

Storing a Driving Position in Memory

Store a driver's seat position only when the vehicle is parked.

1. Turn the ignition switch to the ON (II) position. You cannot add a new seat position in memory unless the ignition switch is in the ON (II) position. You can recall a memorized position with the ignition switch in any position.
2. Adjust the seat to a comfortable position (see page [170](#)).
3. Adjust the outside mirrors for best visibility (see page [191](#)).

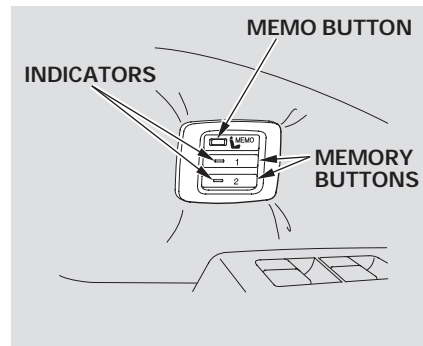

4. Press and release the MEMO button on the driver's door. You will hear a beep. Then, both indicators in the memory buttons will start to blink. Press and hold one of the memory buttons (1 or 2) within 5 seconds after you press the MEMO button. When the system completes storing a new driving position, you hear two beeps. The indicator in the stored memory button will come on.

Doing any of the following after pressing the MEMO button will cancel the storing procedure.

- Not pressing a memory button within 5 seconds.
- Pressing the MEMO button again within 5 seconds.
- Readjusting the seat position.
- Readjusting the outside mirror position.

Each memory button stores only one driving position. Storing a new position erases the previous setting stored in that button's memory. If you want to add a new position while retaining the current one, use the other memory button.

All stored driving positions will be lost if your vehicle's battery goes dead or is disconnected.

Selecting a Memorized Position

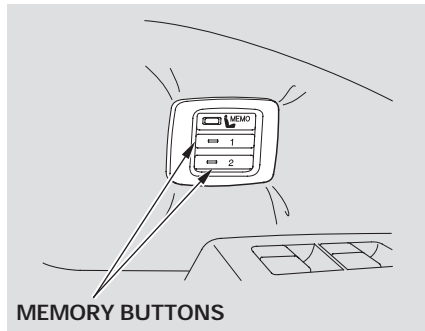

To select a memorized position, do this:

1. Make sure the shift lever is in the Park (P) position.
2. Press the desired memory button (1 or 2) until you hear a beep.

The system will move the seat and outside mirrors to the memorized positions. The indicator in the

selected memory button will flash during movement. When the adjustments are complete, you will hear two beeps, and the indicator will remain on.

To stop the system's automatic adjustment, do any of these actions:

- Press any button on the driver's door: MEMO, memory button 1 or 2.
- Push any of the adjustment switches for the seat.
- Shift out of Park.
- Adjust the outside mirrors.

If desired, you can use the adjustment switches to change the positions of the seat or outside mirrors after they are in their memorized positions. If you change the memorized position, the indicator in the memory button will go out. To keep this driving position for later use, you must store it in the driving position memory.

Power Windows

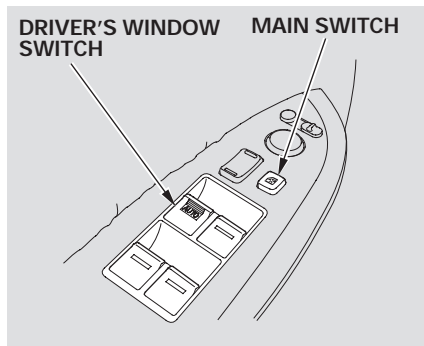

Turn the ignition switch to the ON (II) position to raise or lower any window. To open the window, push the switch down to the first detent and hold it. Release the switch when you want the window to stop. Pull back on the switch and hold it to close the window.

The windows will operate for up to 10 minutes after you turn off the ignition switch. Opening either front door cancels this function.

⚠ WARNING

Closing a power window on someone's hands or fingers can cause serious injury.

Make sure your passengers are away from the windows before closing them.

AUTO - To open/close the driver's window, push the window switch firmly down or up to the second detent, and release it. The window will automatically go up or down all the way. To stop the window, pull/push on the window switch briefly.

If the MAIN switch is OFF, the passenger windows cannot be raised or lowered. Keep the MAIN switch off when you have children in the vehicle so they do not injure themselves by operating the windows unintentionally.

AUTO REVERSE - If the driver's window senses any obstacle while it is closing automatically, it will reverse direction, and then stop. To close the window, remove the obstacle, then use the window switch again.

Auto reverse stops sensing when the window is almost closed. You should always check that all passengers and objects are away from the window before closing it.

NOTE: Only on the driver's window, the auto reverse function is disabled when you continuously pull up the switch.

If your vehicle's battery is disconnected or goes dead, or the driver's window fuse is removed, the AUTO function may be disabled. If the AUTO function is disabled, the power window system will need to be reset after reconnecting the battery or installing the fuse.

1. Start the engine. Push down and hold the driver's window switch until the window is fully open.
2. Pull and hold the driver's window switch to close the window completely, then hold the switch for about 2 seconds.

If the power windows do not operate properly after resetting, have your vehicle checked by your dealer.

Opening the Windows with the Remote Transmitter

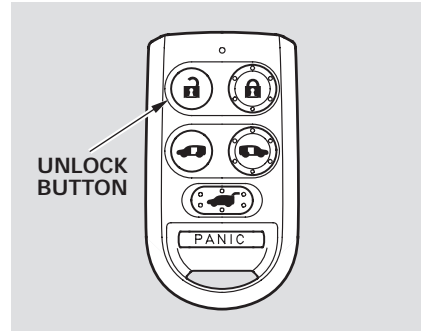

On EX, EX-L and Touring models
You can open all of the windows from the outside with the remote transmitter.

1. Press the UNLOCK button once to unlock the driver's door.

2. Press the UNLOCK button a second time, and hold it. The passenger's doors unlock, and all four windows start to open. To stop the windows, release the button.
3. To open the windows further, press the button again and hold it. If the windows stop before the desired position, repeat steps 1 and 2.

You cannot close the windows with the remote transmitter.

Power Windows

Opening/Closing the Windows with the Key

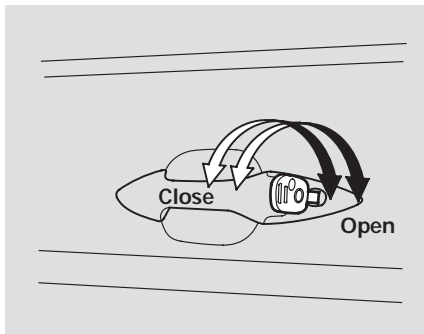

On EX, EX-L and Touring models

You can open and close the windows with the key in the driver's door lock.

To open:

1. Insert the key in the driver's door lock.
2. Turn the key clockwise, then release it.

3. Turn the key clockwise again, and hold it. All four windows start to open. To stop the windows, release the key.
4. To open the windows further, turn and hold the key again (within 10 seconds of step 2).

To close:

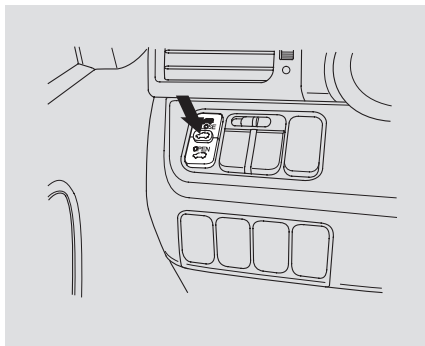

1. Insert the key in the driver's door lock.
2. Turn the key counterclockwise, then release it.
3. Turn the key counterclockwise again, and hold it. All four windows start to close. To stop the windows, release the key.
4. To close the windows further, turn and hold the key again (within 10 seconds of step 2).

If the windows stop before the desired position, repeat steps 2 and 3.



On EX-L and Touring models

The moonroof can be tilted up in the back for ventilation, or it can be slid back into the roof. Use the switch under the left dashboard vent to operate the moonroof. You must turn the ignition switch to the ON (II) position for the moonroof to operate.

To tilt up the back of the moonroof, press and hold the center button (). To close the moonroof, press and hold the top of the switch (). To open the moonroof, press and hold the bottom of the switch ().

⚠ WARNING

Opening or closing the moonroof on someone's hands or fingers can cause serious injury.

Make sure all hands and fingers are clear of the moonroof before opening or closing it.

NOTICE

If you try to open the moonroof in below-freezing temperatures, or when it is covered with snow or ice, you can damage the moonroof panel or its motor.

The moonroof has a key-off delay. You can still open and close the moonroof for up to 10 minutes after you turn off the ignition. The key-off delay cancels as soon as you open either front door. You must then turn the ignition to the ON (II) position for the moonroof to operate.

Mirrors

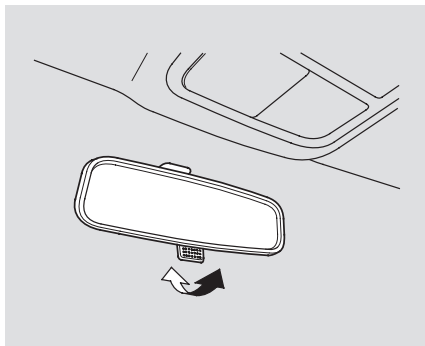

Keep the inside and outside mirrors clean and adjusted for best visibility. Be sure to adjust the mirrors before you start driving.

On LX, EX and Canadian DX models

The inside mirror has day and night positions. The night position reduces glare from headlights behind you. Flip the tab on the bottom edge of the mirror to select the day or night position.

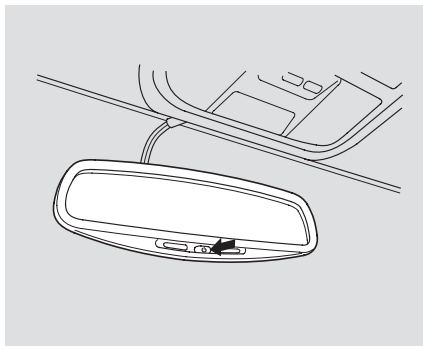

On EX-L and Touring models

The inside mirror can automatically darken to reduce glare. To turn on this feature, press the button on the bottom of the mirror. The AUTO indicator comes on as a reminder. When it is on, the mirror darkens when it senses the headlights of a vehicle behind you, then returns to normal visibility when the lights are gone. Press the button again to turn off this feature.

On U.S. EX-L without navigation system and Canadian EX-L models

When you shift to reverse with the ignition switch in the ON (II) position, the rear view is shown on the left side of the inside mirror. For more information, see page [357](#).

Adjusting the Power Mirrors

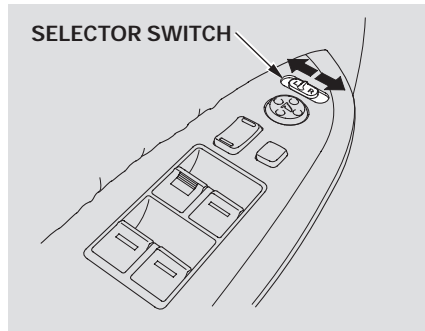

1. Turn the ignition switch to the ON (II) position.
2. Move the selector switch to L (driver's side) or R (passenger's side).

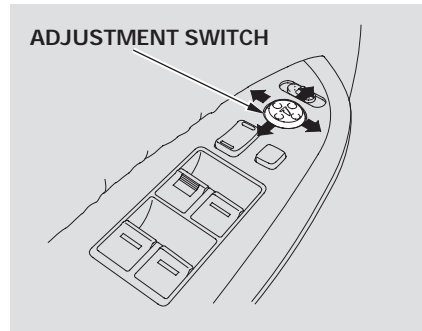

3. Push the appropriate edge of the adjustment switch to move the mirror right, left, up, or down.

When you finish, move the selector switch to the center (off) position. This turns the adjustment switch off to keep your settings.

Reverse Tilt Door Mirror

Both outside door mirrors have a reverse tilt feature. When in reverse, the selected mirror will tilt down slightly to improve your view as you parallel park. Shifting out of reverse will return the mirrors to their original position.

- To tilt the driver's mirror, place the selector switch in the left position.
- To tilt the passenger's mirror, place the switch in the right position.
- To turn the feature off, place the switch in the center position.

Mirrors, Parking Brake

Heated Mirrors

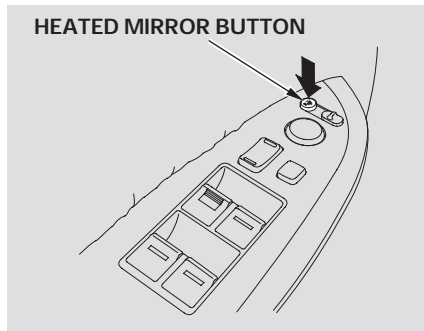

Except U.S. LX model
The outside mirrors are heated to remove fog and frost. With the ignition switch in the ON (II) position, turn on the heaters by pressing the button. The indicator in the button comes on as a reminder. Press the button again to turn the heaters off.

Parking Brake

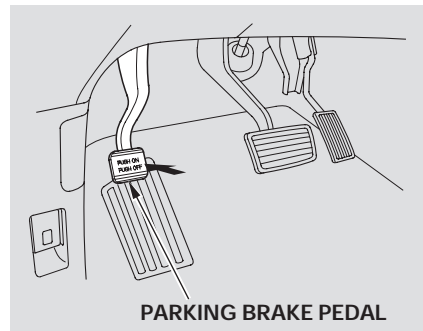

To apply the parking brake, push the pedal down with your foot. To release it, push on the pedal again. The parking brake indicator on the instrument panel should go out when the parking brake is fully released (see page [69](#)).

NOTICE

Driving the vehicle with the parking brake applied can damage the rear brakes and axles. A beeper will sound if the vehicle is driven with the parking brake on.

On Touring models
You will also see a "RELEASE PARKING BRAKE" message on the multi-information display (see page [88](#)).

Adjustable Driver's Foot Pedals

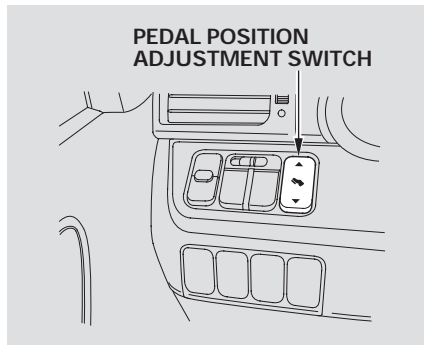

On Touring models only

You can adjust the position of the brake pedal and accelerator pedal when the shift lever is in the Park position. Push the top of the adjustment switch to move the pedals forward, and the bottom to move them backward.

To adjust the pedals:

1. Push and hold the top of the adjustment switch until pedals are closest to you.
2. Adjust your seat and the steering wheel so you can operate the controls and steering wheel easily.
3. Push and hold the bottom of the adjustment switch until pedals are in the position you can press them fully and comfortably.

Do not adjust the pedals with your foot on or under either pedal.

Make all adjustments before you start driving.

Interior Convenience Items

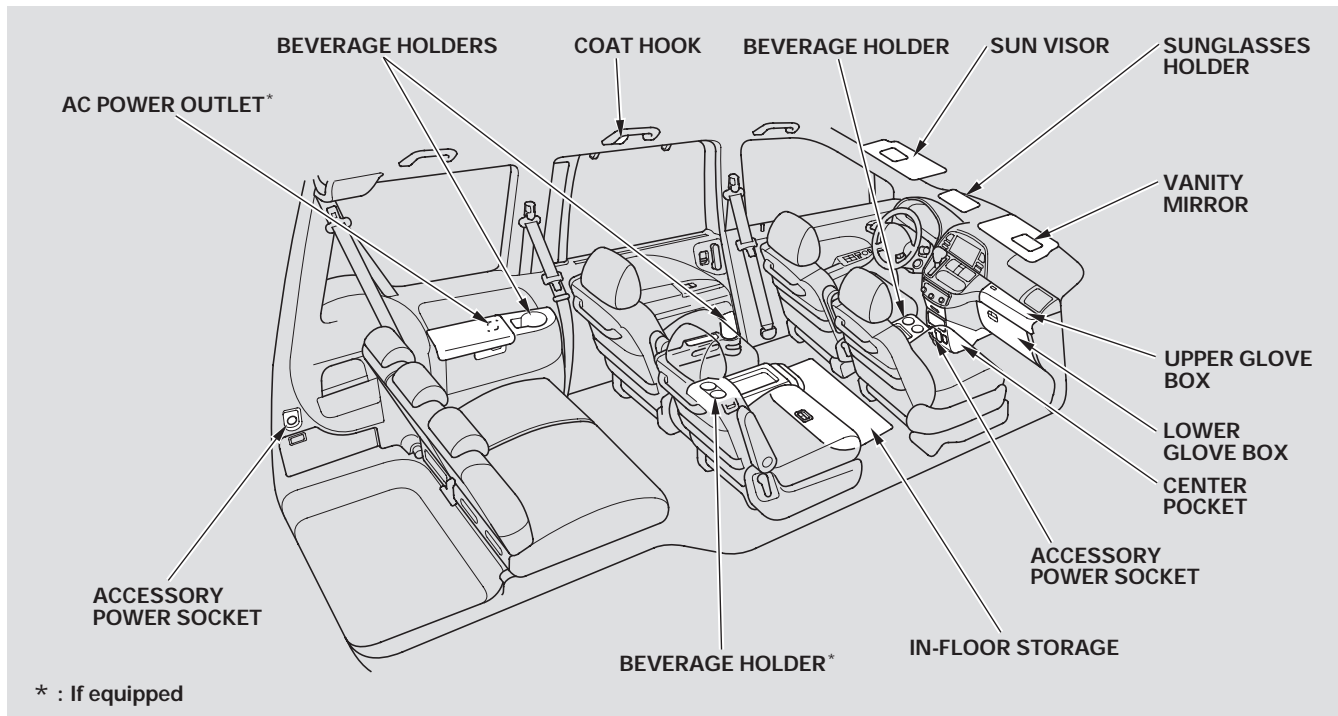

Retractable Center Tray

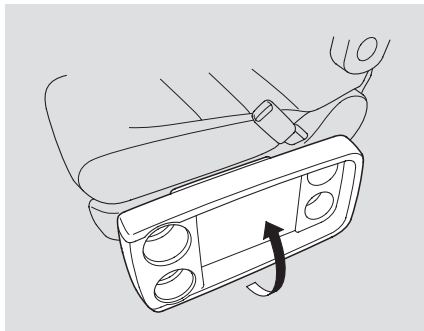

To use the retractable center tray, pull up the outside edge of the tray until it latches. To store it, pull the lever and lower the tray.

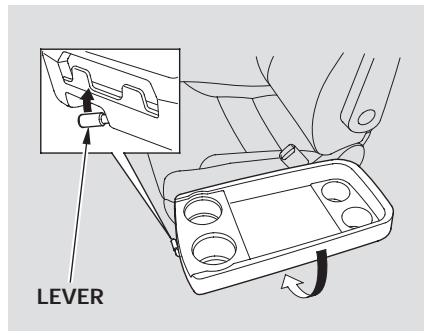

Sitting on or getting under the tray, or putting heavy objects on the tray, may damage or deform it.

Do not keep items on the tray while driving. They may fall down or fly around when you go around corners or brake hard.

Beverage Holders

Be careful when you are using the beverage holders. A spilled liquid that is very hot can scald you or your passengers. Spilled liquids can damage the upholstery, carpeting, and electrical components in the interior.

CONTINUED

Interior Convenience Items

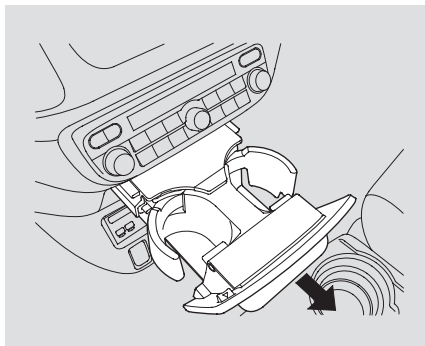

To use the front beverage holder, pull the handle.

Additional beverage holders for the front seat passengers are in the retractable center tray.

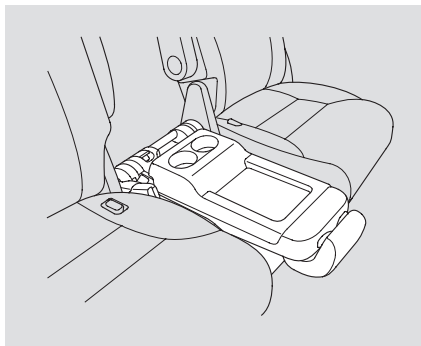

Except U.S. LX and Canadian DX models

The plus-one seat has a beverage holder on the back of the seat-back.

To use the beverage holder, remove the seat cushion, and fold the seat-back by pulling the seat-back strap (see page [179](#)).

The beverage holders for the third row seat passengers are in the armrests on the rear side panels.

Interior Convenience Items

Integrated Sunshades

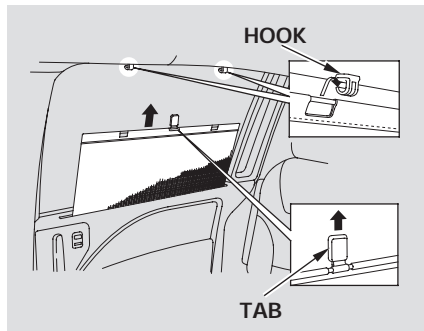

On EX, EX-L and Touring models
Each rear sliding door has an integrated sunshade. To use a sunshade, hold the tab on the top and pull the sunshade all the way up. Insert the holes on the sunshade into the hooks on the window frame. To store the shade, unhook it, and let it retract all the way down.

The sunshades are intended for use only when the windows are fully closed. If a window is opened, the shade can be blown off its hooks. As the shade automatically retracts, it could hit and hurt anyone sitting too close to the window.

Sunglasses Holder

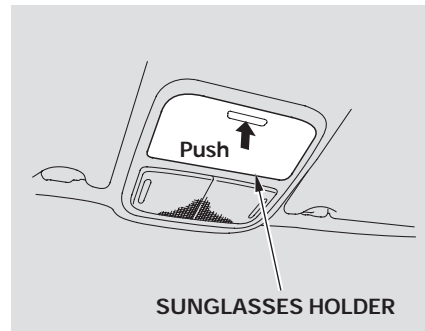

To open the sunglasses holder, push then release the raised detent. It will unlatch and swing down. To close it, push it until it latches. Make sure the holder is closed while you are driving.

CONTINUED

Interior Convenience Items

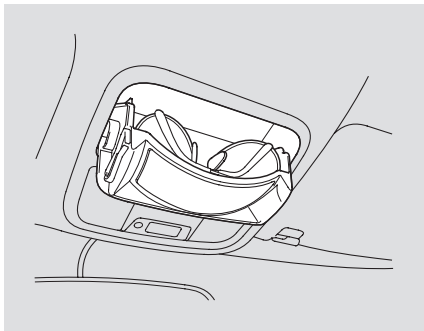

Some larger styles of sunglasses may not fit in the holder.

You may also store small items in this holder. Make sure they are small enough to let the holder close and latch, and that they are not heavy enough to cause the holder to pop open while driving.

Conversation Mirror

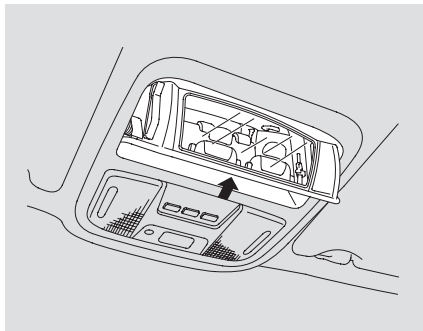

If equipped

The sunglasses holder uses a convex mirror for its bottom panel. You can see all the vehicle passengers in this mirror. To use the mirror, open the sunglasses holder fully, push it to the first detent, and release it.

To switch back to the sunglasses holder, close the conversation mirror and then open the sunglasses holder.

Sun Visor

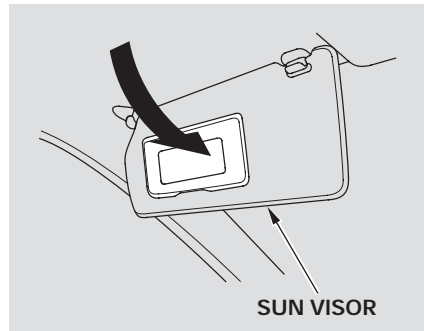

To use the sun visor, pull it down. When using the sun visor for the side window, remove the support rod from the clip, and swing it out.

Make sure you put the sun visor back in place when you are getting into or out of the vehicle.

Vanity Mirror

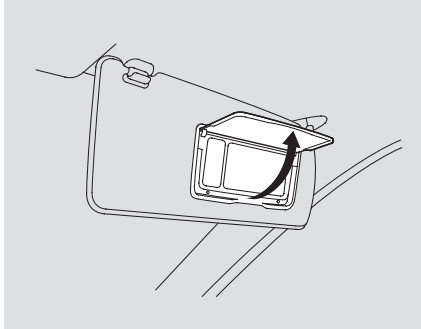

Pull up the vanity mirror cover to use the mirror. The lights come on when you open the cover. Make sure you close the cover when you are not using the vanity mirror.

The vanity mirror light will not come on if the sun visor is slid outward.

Rear Compartment

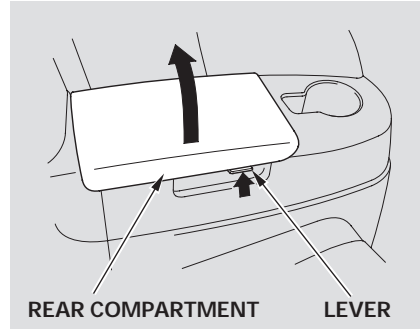

To open the compartment, pull the lever and lift the lid. To close, lower the lid and push it down until it latches.

Second Row Console

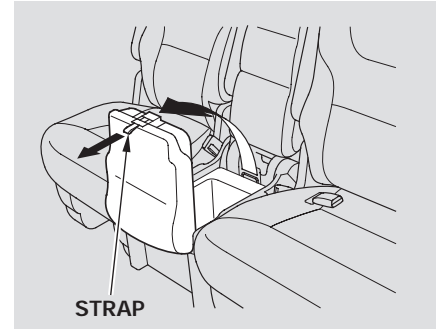

Except U.S. LX and Canadian DX models

You can store items under the seat cushion of the plus-one seat. Pull the strap to raise the seat cushion, store items, then reinstall the cushion or remove the cushion and fold the seat-back down to use the seat as a tray.

Interior Convenience Items

In-Floor Storage Area

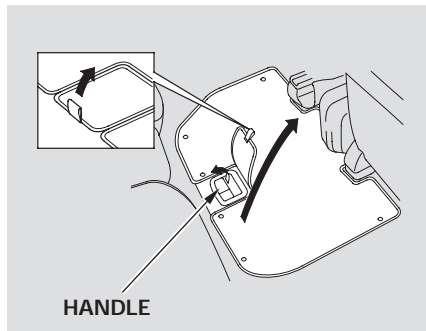

There is a large storage area under the floor between the front seats and the second row bucket seats.

To place or remove large items from the storage area, pull off the carpet near the second row seat, and pull the handle to open the large lid.

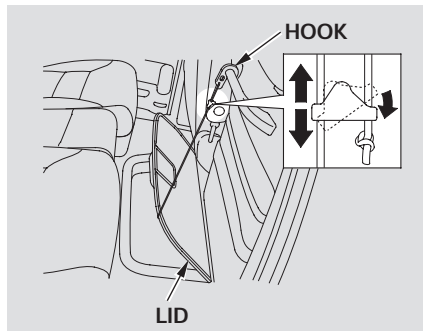

If equipped

To keep the lid open, attach the hook to the grab rail on the back of the front seat-back.

You can adjust the length of the hook strap. Pull down the upper edge of the stopper, and slide it up or down.

You can store items in the floor storage area up to 22 lbs (10 kg). Do not exceed this weight limit, or you may damage the floor storage area.

The inside of the storage area can get very hot. Do not store any items that should be kept cool, or items that can be easily damaged, warped, or deformed by heat.

Dust, sand, etc., can accumulate in the floor storage area. If you spill liquid on the floor around the floor storage area, it can get inside the storage area, and the moisture can be trapped inside. Always keep the inside of the storage area dry and clean.

To prevent items from being thrown about the vehicle and possibly hurting someone in an accident or sudden stop, be sure the storage area lids are securely closed before driving away.

Interior Convenience Items

Glove Boxes

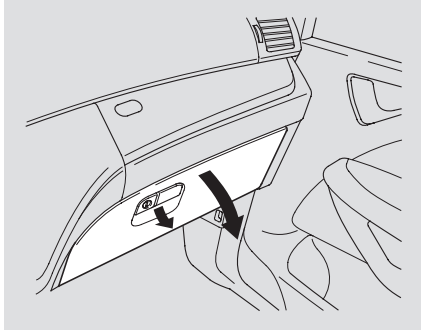

Open the lower glove box by pulling the bottom of the handle. Close it with a firm push. Lock or unlock the glove box with the master key.

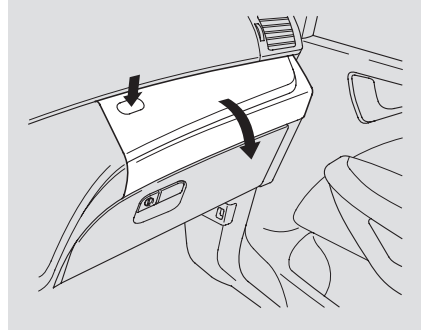

Open the upper glove box by pressing the button. The lid will swing open. Close it with a firm push.

Keep the glove boxes closed while driving. If either are open, a passenger could be injured during a crash or sudden stop.

⚠ WARNING

An open glove box can cause serious injury to your passenger in a crash, even if the passenger is wearing the seat belt.

Always keep the glove boxes closed while driving.

Interior Convenience Items

Center Pocket

Without rear entertainment system

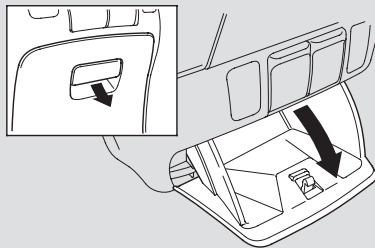

Open the center pocket by pulling the handle. Close it with a firm push.

With rear entertainment system

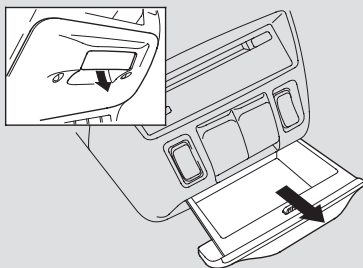

Coin Pocket

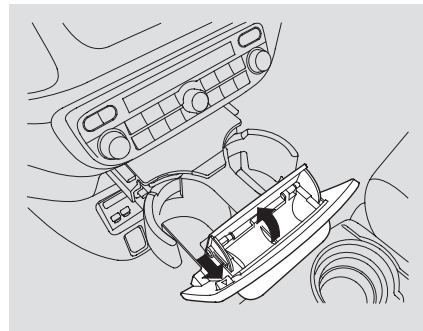

A coin holder is located in front of the beverage holder. To use the coin holder, pull the handle, then push the button. The lid will swing open. To close the lid, push it down until it latches.

Make sure to close the lid before you close the beverage holder.

Accessory Power Sockets

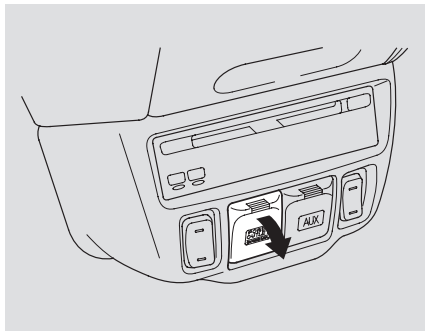

There are two accessory power sockets in your vehicle. One accessory power socket is above the center pocket and another is on the cargo area sidewall on the driver's side.

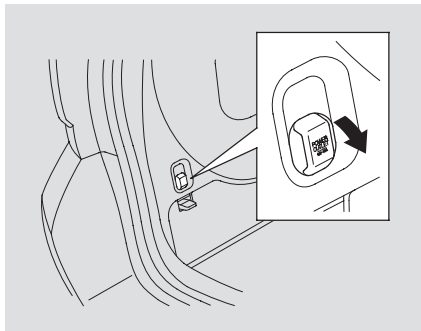

Each socket is intended to supply power for 12 volt DC accessories that are rated 120 watts or less (10 amps).

None of the sockets will power an automotive type cigarette lighter element.

AC Power Outlet

If equipped

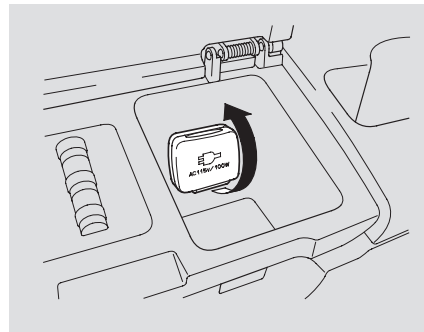

There is a 115 volt AC power outlet in the rear compartment on the driver's side. To use the AC power outlet, open the rear compartment lid and open the outlet cover. Insert the plug into the receptacle slightly, turn it 90° clockwise, then push in the plug all the way.

Always run the engine when you use the AC power outlet.

Interior Convenience Items

The maximum capacity for this power outlet is 115 volt AC at 100 watts or less. If you use an appliance which requires more than 100 watts, it automatically stops supplying the power. If this happens, turn the ignition switch off and turn it on again.

NOTE: The AC power outlet is not designed for electric appliances which require high initial peak wattage such as cathode-ray tube type televisions, refrigerators, electric pumps, etc. It is also not suitable for devices that process precise data such as medical equipment or measuring instruments. Any appliances that require an extremely stable power supply such as microcomputer-controlled electric blankets, touch sensor lamps, etc., should not be connected to this outlet.

Light Control Switch

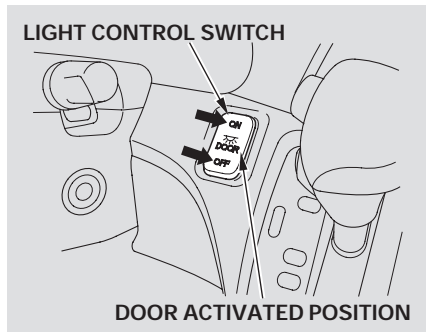

The light control switch controls the interior lights: the individual map lights in the front, the individual map lights above the second and third row passengers. This switch has three positions: OFF, door activated, and ON.

When the switch is in the OFF position:

- None of the lights come on when a door is opened.
- The individual map lights in the front can be turned on and off by pressing the lenses.
- The individual map lights in the second and third rows cannot be turned on.

When the switch is in the door activated position:

- The individual map lights in the front come on when any door is opened. When the doors are closed, each light can be turned on and off by pressing the lenses.
- The individual map lights in the second and third rows come on when any door is opened. When the doors are closed, each light can be turned on and off by pushing on the lens.

CONTINUED

Interior Lights

When the switch is in the ON position:

- All the individual map lights come on and stay on as long as the switch remains in the ON position.

After all doors are closed tightly, the light(s) dims slightly, then fades out in about 30 seconds.

With the light control switch in the door activated position, all the individual map lights come on when you unlock the door with the remote transmitter (see page [147](#)).

With any door left open, the lights stay on about 3 minutes, then go out.

On Touring models

You can change the “INTERIOR LIGHT DIMMING TIME” setting on the multi-information display (see page [118](#)).

Individual Map Lights

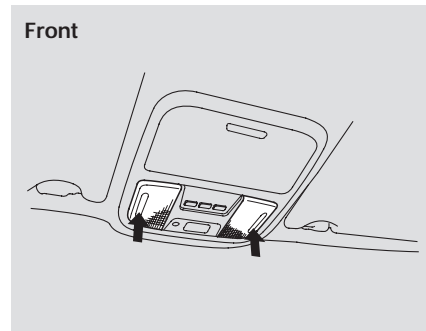

Turn on the front and rear individual map lights by pushing the lens of each light. Push the lens again to turn it off. You can also operate these lights with the light control switch (see page [205](#)).

Rear

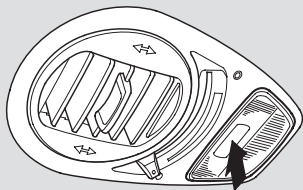

Cargo Area Light

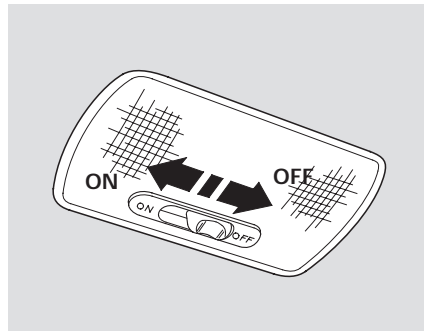

The cargo area light has a three-position switch. In the OFF position, the light does not come on. In the center position, it comes on when you open the tailgate. In the ON position, it stays on continuously.

Ignition Switch Light

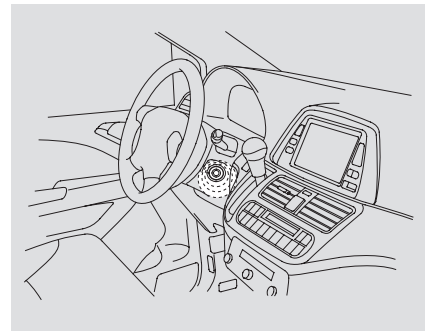

The ignition switch light comes on when you open the driver's door, and stays on several seconds after you close the door.

Interior Lights

Courtesy Lights

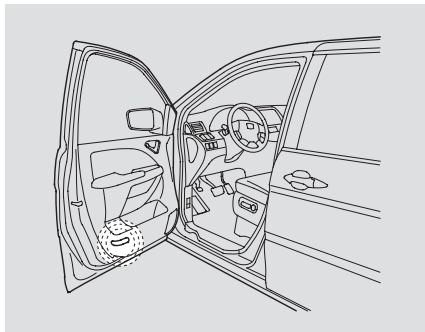

The courtesy lights in the front doors come on when you open any door.

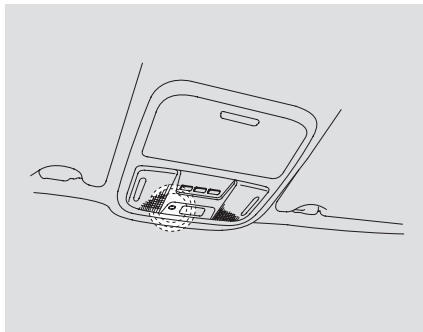

The courtesy light between the map lights come on when you turn the parking lights on. To adjust its brightness, turn the select/reset knob on the instrument panel.

The heating and air conditioning system in your vehicle provides a comfortable driving environment in all weather conditions.

The standard audio system has many features. This section describes those features and how to use them. (If you have an optional audio system, refer to the operating instructions that came with it.)

Your vehicle has an anti-theft audio system that requires a code number to enable it.

The security system helps to discourage vandalism and theft of your vehicle.

On vehicles with navigation system
The climate control system and the audio system have a voice control feature. Refer to the navigation system manual for more information.

Vents, Heating, and A/C	210	Auxiliary Input Jack.....	283
Using Automatic Climate Control	215	Radio Theft Protection.....	284
Using the Rear A/C Unit.....	216	Rear Entertainment System.....	285
Climate Control Sensors.....	220	Security System	318
Audio System	221	Cruise Control.....	319
<i>LX and Canadian DX models</i>		HomeLink® Universal	
Playing the AM/FM Radio.....	222	Transceiver.....	322
Playing a Disc.....	226	Bluetooth® HandsFreeLink®.....	325
Disc Player Error Messages	233	Parking Sensor System.....	352
<i>EX and EX-L models without navigation system</i>		Reaview Camera and Monitor	356
Playing the AM/FM Radio.....	234		
Playing the XM® Satellite Radio ..	238		
Playing Discs.....	244		
Disc Changer Error Messages	251		
<i>Models with navigation system</i>			
Playing the AM/FM Radio.....	252		
Playing the XM® Satellite Radio ..	257		
Playing Discs.....	263		
Disc Changer Error Messages	271		
Protecting Your Discs.....	272		
AM/FM Radio Reception.....	275		
Playing a Tape.....	277		
Setting the Clock	281		
Remote Audio Controls.....	282		

Vents, Heating, and A/C

LX and Canadian DX models

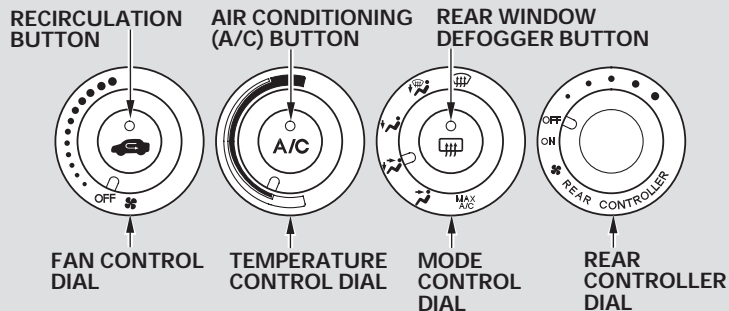

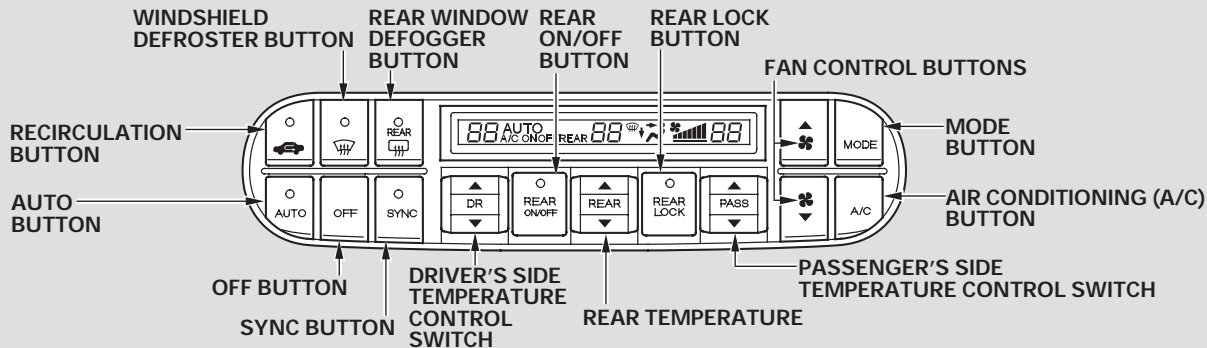

EX, EX-L and Touring models



Fan Control*On LX and Canadian DX models*

Turn the dial clockwise to increase the fan speed and airflow. Turn the dial counterclockwise to decrease it.

On EX, EX-L and Touring models

Press the  button to increase the fan speed and airflow. Press the  button to decrease it.

Temperature Control*On LX and Canadian DX models*

Turning this dial clockwise increases the temperature of the airflow.

On EX, EX-L and Touring models



Your vehicle has four temperature control buttons, two for the driver, and two for the front passenger.

On EX, EX-L and Touring models

When the rear passenger's zone is turned on using the REAR button on the front control panel, a second row passenger also can adjust the

temperature, fan speed and air flow.

On EX, EX-L and Touring models

The rear passenger compartment temperature can also be set separately. Press the top () of the appropriate temperature control button to increase the temperature of airflow. Press the bottom () of the button to decrease it. Each set temperature is shown in the display.

When you set the temperature to its lower limit or its upper limit, it will be displayed as "Lo" or "Hi".

SYNC Button*On EX, EX-L and Touring models*

When you press this button, the indicator in the button comes on, and the passenger's side temperature and the rear passenger compartment is synchronized to the driver's side set temperature. Changing the passenger's side temperature or the temperature of the rear passenger

compartment makes the indicator to go off, and takes the system out of SYNC mode.

Air Conditioning (A/C) Button

This button turns the air conditioning on and off. On LX and Canadian DX models, the indicator in the button is on when the A/C is on. On EX, EX-L, and Touring models, you will see A/C ON or A/C OFF in the display.

Recirculation Button

When the indicator in the button is on, air from the vehicle's interior is sent throughout the system again. When the indicator is off, air is brought in from the outside of the vehicle (fresh air mode).

CONTINUED

Vents, Heating, and A/C

The outside air intakes for the heating and cooling system are at the base of the windshield. Keep this area clear of leaves and other debris.



Rear Window Defogger Button  ^{REAR}
This button turns the rear window defogger on and off (see page [140](#)).

Mode Control

Use the mode control dial or button to select the vents the air flows from. Some air will flow from the dashboard vents in all modes.

 Air flows from the center and corner vents in the dashboard.

 Airflow is divided between the vents in the dashboard and the floor vents.

 Air flows from the floor vents. When you select , the system automatically switches to fresh air mode.



 Airflow is divided between the floor vents and defroster vents at the base of the windshield.

 Air flows from the defroster vents at the base of the windshield.

When you select , the system automatically switches to fresh air mode and turns on the A/C. The passenger's temperature cannot be set separately from the driver's.

On LX and Canadian DX models

 The system automatically turns on the A/C and switches to recirculation mode. Air flows from the center and side vents in the dashboard. In this mode, you cannot turn off the A/C and also cannot switch to fresh air mode.

When you switch to  from , the A/C stays on, and you can turn it on and off manually.

When you switch to another mode, the A/C returns to its original setting, either on or off, as displayed by the A/C indicator.

REAR/REAR LOCK Button

On EX, EX-L and Touring models
When you want to change the temperature of the rear passenger compartment, press the REAR button. The indicator in the button comes on, and you can change the temperature using the rear temperature control button. When you press the REAR LOCK button, the indicator in the button comes on, the rear A/C passenger control panel is disabled, and you cannot change any settings from it. See page [219](#) for how to operate the rear passenger control panel.

Ventilation

The flow-through ventilation system draws in outside air, circulates it through the interior, then exhausts it through vents near the rear side panels.

1. Set the temperature control dial or button to the lower limit.
2. Make sure the A/C is off.
3. Select  and fresh air mode.
4. Set the fan to the desired speed.

Using the Heater

The heater uses engine coolant to warm the air. If the engine is cold, it will be several minutes before you feel warm air coming from the system.

1. Select   and fresh air mode.
2. Set the fan to the desired speed.
3. Adjust the warmth of the air with the temperature control dial or buttons.

Using the A/C

Air conditioning places an extra load on the engine. Watch the engine coolant temperature gauge (see page [77](#)). If it moves near the red mark, turn off the A/C until the gauge reads normally.

1. Press the A/C button. The indicator in the button comes on (LX and Canadian DX models) or “A/C ON” is shown in the display (EX, EX-L and Touring models) when a fan speed is selected.
2. Make sure the temperature is set to the lower limit.
3. Select .
4. If the outside air is humid, select recirculation mode. If the outside air is dry, select fresh air mode.
5. Set the fan to the desired speed.

CONTINUED

Vents, Heating, and A/C

If the interior is very warm, you can cool it down more rapidly by partially opening the windows, turning on the air conditioning, and setting the fan to maximum speed in fresh air mode.

Dehumidify the Interior



Air conditioning, as it cools, removes moisture from the air. When used in combination with the heater, it makes the interior warm and dry.

1. Switch the fan on.
2. Turn on the air conditioning.
3. Select  and fresh air mode.
4. Adjust the temperature to your preference.

This setting is suitable for all driving conditions whenever the outside temperature is above 32°F (0°C).

To Defog and Defrost

To remove fog from the inside of the windows:

1. Set the fan to high.
2. Select . The system automatically switches to the fresh air mode and turns on the A/C. The indicator in the A/C button will not come on (LX and Canadian DX models), or the A/C ON indicator will not come on (EX, EX-L, and Touring models), if the A/C was off to start with.
3. Adjust the temperature so the airflow feels warm.
4. Select  to help clear the rear window.

When you switch to another mode from , the A/C turns off. But if it was on to start with, it stays on.

To Remove Exterior Frost or Ice From the Windows

1. Select . The system automatically switches to fresh air mode and turns on the A/C.

The indicator in the A/C button will not come on (LX and Canadian DX models), or the A/C ON indicator will not come on (EX, EX-L, and Touring models), if the A/C was off to start with.

2. Select .
3. Set the fan and temperature controls to maximum level.

To clear the windows faster, you can close the dashboard corner vents by rotating the wheel next to each vent. This sends more warm air to the windshield defroster vents. Once the windshield is clear, select fresh air mode to avoid fogging the windows. For your safety, make sure you have a clear view through all the windows before driving.

Using Automatic Climate Control

On EX, EX-L and Touring models

The automatic climate control system adjusts the fan speed and airflow levels to maintain the interior temperature you select.

1. Press the Auto button. The indicator in the button comes on.
2. Set the desired temperature with the temperature control button. You will see AUTO in the system's display. You can set the driver's side temperature and passenger's side temperature and the temperature of the rear passenger compartment separately. The system automatically selects the proper mix of conditioned and/or heated air that will, as quickly as possible, raise or lower the interior temperature to your preference.

If you set the temperature to its lower or its upper limit, the system runs at full cooling or heating only. It does not regulate the interior temperature.

When you press a fan control button, the fan is taken out of AUTO mode.

On models with navigation system

In AUTO mode, the vehicle's interior temperature is independently regulated for the driver and passenger. If the driver's side of the vehicle is getting too much sun, the system will adjust to a lower temperature.

In AUTO mode, the rear passenger compartment temperature is also regulated independently.

Semi-automatic Operation

On EX, EX-L and Touring models

You can manually select various functions of the climate control system when it is in fully automatic mode. All other features remain automatically controlled. Making any manual selection causes the word AUTO in the display to go out.

To Turn Everything Off

On LX and Canadian DX models

Turn the fan speed and temperature control dials all the way to the left, and turn the rear controller dial to the OFF position.

On EX, EX-L and Touring models

Press the OFF button and the REAR button (indicator is off).

- Keep the system completely off for short periods only.
- To keep stale air and mustiness from collecting, you should have the fan running at all times.

Vents, Heating, and A/C

Voice Control System

On models with navigation system

The climate control system for your vehicle can also be operated by voice control. See the navigation section in your quick start guide for an overview of this system, and the navigation system manual for complete details.

Using the Rear A/C Unit

On LX and Canadian DX models

You can adjust the airflow of the rear A/C unit with the rear controller dial on the front control panel. The rear passengers can also adjust the direction and the amount of airflow on the rear control panel.

On EX, EX-L, and Touring models

You can adjust the temperature of the rear A/C unit with the REAR button and the rear temperature control switch on the front control panel.

The rear passengers can also adjust the fan speed, temperature, and airflow of the rear A/C unit with the rear control panel.

Rear Controller Dial

(On front control panel)

On LX and Canadian DX models

OFF - With the dial in this position, no air flows to the rear vents. The rear control panel cannot be used by a second row passenger to adjust the rear A/C. Turning the dial clockwise changes the fan speed to the rear passengers.

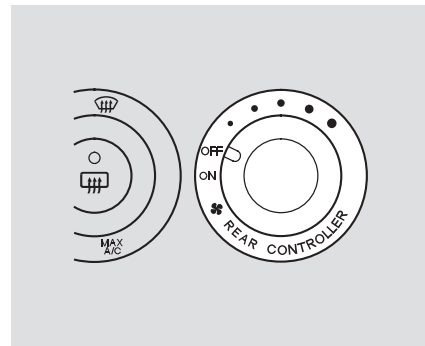

ON - With the dial in this position, the rear control panel can be used by a second row passenger to adjust the rear fan speed, airflow, and temperature.

REAR A/C Controls (On front control panel)

EX, EX-L and Touring models

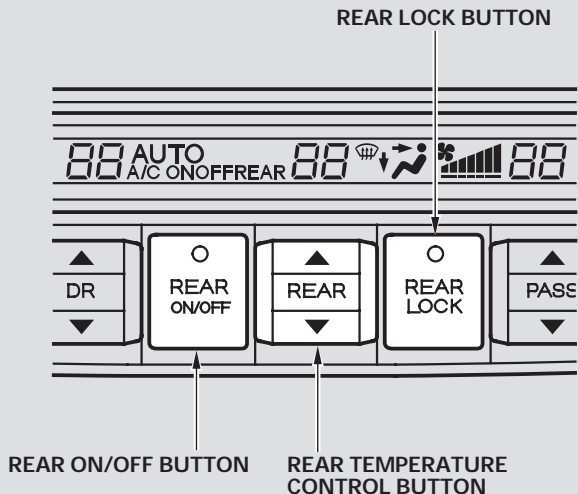

On EX, EX-L and Touring models

REAR Button - When the indicator in this button is off, no air flows to the rear vents. The rear control panel cannot be used by a second row passenger to adjust the rear A/C. When the indicator in this button is on, the rear temperature can be adjusted with the REAR button in the center of the front control panel. In addition, the rear control panel can be used by a second row passenger to adjust the rear fan speed, airflow, and temperature.

REAR LOCK Button - When the indicator in this button is on, the rear control panel is disabled, and the rear A/C can only be controlled by the front control panel.

Vents, Heating, and A/C

Rear Control Panel

LX and Canadian DX models

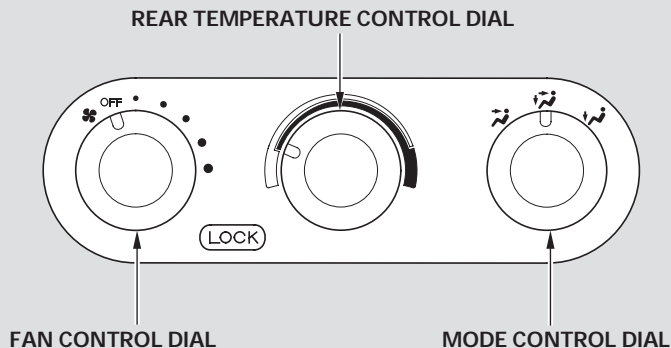

On LX and Canadian DX models

The rear control panel can only be used when the rear controller dial on the front control panel is in the ON position.

Turn the fan control dial clockwise to increase fan speed and airflow.

Select the vents the air flows from with the mode control dial.

When  is selected, air flows from the rear ceiling vents.

When  is selected, air flows from the rear floor vents.

When  is selected, airflow is divided between the rear floor vents and rear ceiling vents.

Turn the rear temperature control dial clockwise to increase the temperature of the airflow.



EX, EX-L and Touring models

TEMPERATURE
CONTROL BUTTONFAN CONTROL
BUTTON*On EX, EX-L and Touring models*

The rear control panel can only be used when the indicator in the REAR LOCK button on the front control panel is off.

Press the top () of the temperature control button to increase the temperature of airflow, and the bottom () of the button to decrease it. The temperature you adjust is shown in the system display.

Press the top () of the fan control button to increase the fan speed and airflow. Press the bottom () of the button to decrease it. The level of the fan speed is shown in the display.

Each time you press the mode button, the mode display changes from , to , then to .

When  is selected, air flows from the rear ceiling vents.

When  is selected, air flows from the rear floor vents.

When  is selected, airflow is divided between the rear floor vents and rear ceiling vents.

Pressing the AUTO button puts the system in automatic operation mode. The rear system automatically adjusts the fan speed and airflow levels to maintain the selected temperature of the rear passenger compartment.

Pressing the OFF button shuts off the rear climate control system.

Vents, Heating, and A/C, Climate Control Sensors

Rear Ceiling Vents

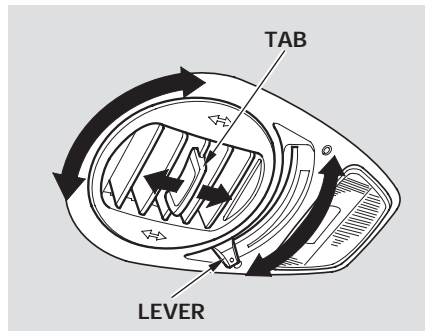

The direction and quantity of airflow from each rear ceiling vent is adjustable.

To adjust the direction of air coming from a rear ceiling vent, move the tab in the center of each vent back-and-forth, and rotate the vent with the tab. The lever next to each vent can be opened and closed to regulate the amount of airflow.

Sunlight and Temperature Sensors

On EX, EX-L and Touring models

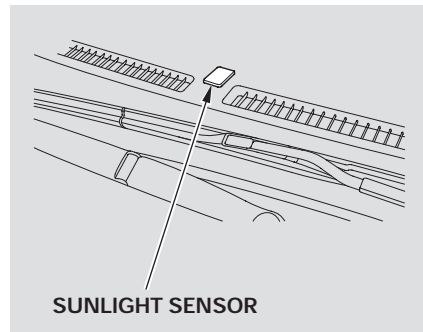

The climate control system has three sensors. A sunlight sensor is in the top of the dashboard, and a temperature sensor is next to the steering column. There is also a rear sensor on the rear sidewall near the exhaust vent. Do not cover the sensors or spill any liquid on them.

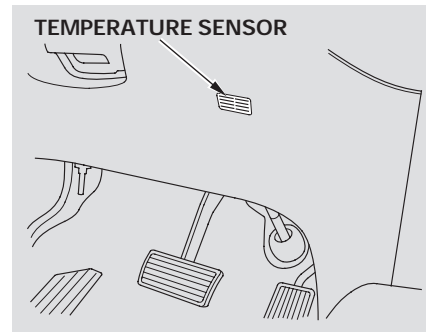

An audio system is standard on all models. Read the appropriate pages (as shown below) to use your vehicle's audio system.

On LX and Canadian DX models, see pages [222](#) through [233](#).

For vehicles without navigation system, see pages [234](#) through [251](#).

For vehicles with navigation system, see pages [252](#) through [271](#).

For vehicles with rear entertainment system, see pages [285](#) through [317](#).

LX and Canadian DX models

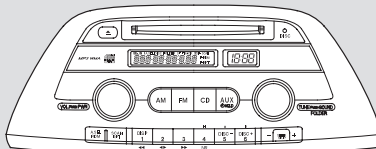

EX and EX-L models

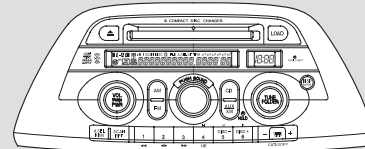

EX-L model with Rear Entertainment System

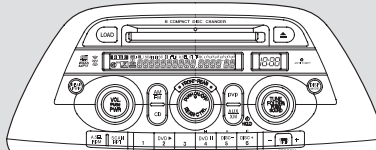

U.S. EX-L and Touring models with Rear Entertainment System with Navigation System

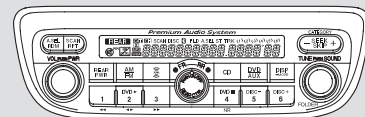

CONTINUED

Playing the AM/FM Radio (LX and Canadian DX models)

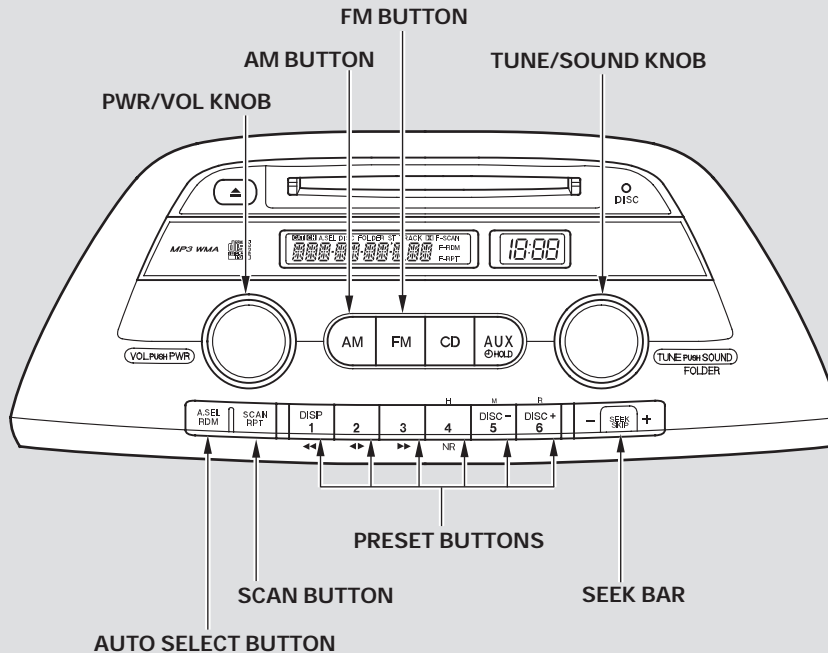

Playing the AM/FM Radio (LX and Canadian DX models)

To Play the AM/FM Radio

The ignition switch must be in the ACCESSORY (I) or ON (II) position. Turn the system on by pushing the PWR/VOL knob. Adjust the volume by turning the same knob.

The band and frequency that the radio was last tuned to are displayed. To change bands, press the AM or FM button. On the FM band, ST will be displayed if the station is broadcasting in stereo. Stereo reproduction in AM is not available.

On the AM band, AM noise reduction turns on automatically.

To Select a Station

You can use any of five methods to find radio stations on the selected band: tune, seek, scan, the preset buttons, and auto select.

TUNE - Use the TUNE knob to tune the radio to a desired frequency. Turn the knob right to tune to a higher frequency, or left to tune to a lower frequency.

SEEK - The SEEK function searches up and down from the current frequency to find a station with a strong signal. To activate it press the + or - side of the bar, then release it.

SCAN - The scan function samples all stations with strong signals on the selected band. To activate it, press the SCAN button, then release it. You will see SCAN in the display. The system will scan for a station with a strong signal. When it finds one, it will stop and play that station for about 10 seconds.

If you do nothing, the system will scan for the next strong station and play it for 10 seconds. When it plays a station that you want to listen to, press the SCAN button again.

CONTINUED

Playing the AM/FM Radio (LX and Canadian DX models)

Preset - Each preset button can store one frequency on AM and two frequencies on FM.

1. Select the desired band, AM or FM. FM1 and FM2 let you store two frequencies with each preset button.
2. Use the tune, seek, or scan function to tune the radio to a desired station.
3. Pick a preset button, and hold it until you hear a beep.
4. Repeat steps 1 through 3 to store a total of six stations on AM and twelve stations on FM.

AUTO SELECT - If you are traveling far from home and can no longer receive your preset stations, you can use the auto select feature to find stations in the local area.

Press the A. SEL button. "A. SEL" appears in the display, and the system goes into scan mode for several seconds. It stores the frequencies of six AM and twelve FM stations in the preset buttons.

You will see a "0" displayed after pressing a preset button if auto select cannot find a strong station for that preset button.

If you do not like the stations auto select has stored, you can store other frequencies on the preset buttons as previously described.

To turn off auto select, press the A. SEL (auto select) button. This restores the presets you originally set.

For information on AM/FM radio frequencies and reception, see page [275](#).

Playing the AM/FM Radio (LX and Canadian DX models)

Adjusting the Sound

Press the SOUND (TUNE) knob repeatedly to display the bass, treble, balance, and fader settings.

Each mode is shown in the display as it changes. Turn the SOUND (TUNE) knob to adjust the setting to your liking. When the level reaches the center, you will see “C” in the display. The system will automatically return the display to the selected audio mode about 5 seconds after you stop adjusting a mode.

Treble/Bass - Use the TRE/BAS modes to adjust the tone to your liking.

Balance/Fader - These two modes adjust the strength of the sound coming from each speaker. BAL adjusts the side-to-side strength, while FAD adjusts the front-to-back strength.

Audio System Lighting

You can use the instrument panel brightness control knob to adjust the illumination of the audio system (see page [139](#)). The audio system illuminates when the parking lights are on, even if the system is turned off.

Playing a Disc (LX and Canadian DX models)

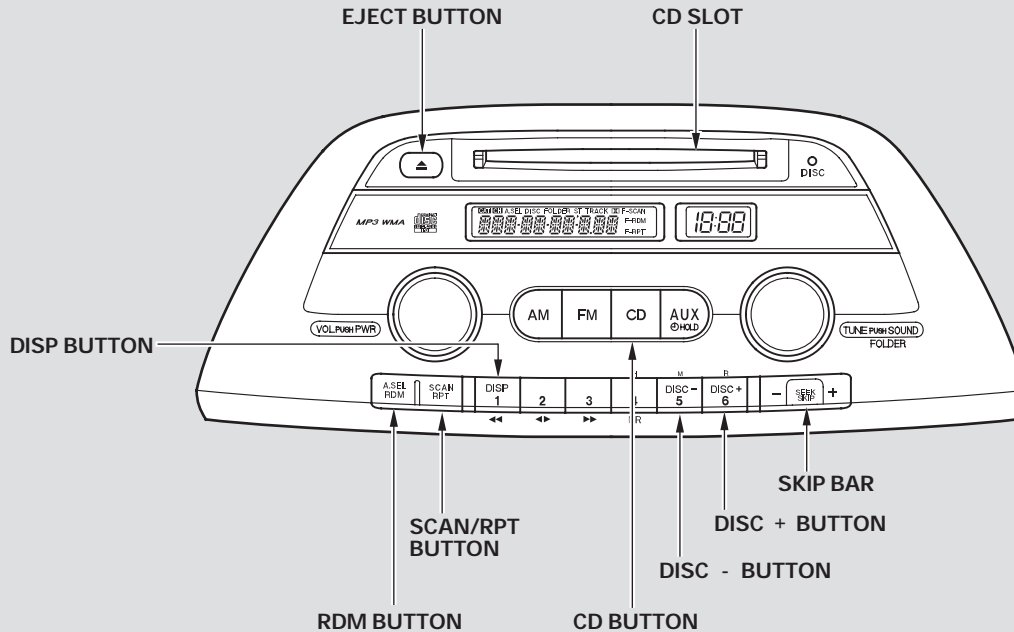

Playing a Disc (LX and Canadian DX models)

To Play a Disc

To load or play discs, the ignition switch must be in the ACCESSORY (I) or ON (II) position.

You operate the disc player with the same controls used for the radio. To select the disc player, press the CD button. You will see "CD" in the display.

NOTICE

Do not use discs with adhesive labels. The label can curl up and cause the disc to jam in the unit.

This audio system can also play CD-Rs and CD-RWs compressed in MP3 or WMA formats. When playing a disc in MP3, you will see "MP3" in the display. In WMA format, "WMA" will appear in the display. You can select up to 99 folders, or up to 255 tracks/files.

NOTE:

If a file on an MP3 or WMA disc is protected by digital rights management (DRM), the audio unit displays UNSUPPORTED FORMAT, and then skips to the next file.

Video CDs and DVD discs do not work in this unit.

The specifications for compatible MP3 files are:

- Sampling frequency:
32/44.1/48 kHz (MPEG1)
24/22.05/16 kHz (MPEG2)
- Bit rate:
32/40/48/56/64/80/96/112/128/
160/192/224/256/320 kbps
(MPEG1)
8/16/24/32/40/48/56/64/80/96/
112/128/160 kbps (MPEG2)
- Compatible with variable bit rate and multi-session
- Maximum layers
(including ROOT): 8 layers

CONTINUED

Playing a Disc (LX and Canadian DX models)

The specifications for compatible WMA files are:

- Sampling frequency:
32/44.1/48 kHz
- Bit rate:
48/64/80/96/128/160/192 kbps
- Compatible with variable bit rate and multi-session
- Maximum layers
(including ROOT): 8 layers

To Load a Disc

Insert a disc about halfway into the disc slot. The drive will pull the disc in the rest of the way to play it. You operate the disc player with the same controls used for the radio.

The number of the current track is shown in the display. When playing a disc in MP3 or WMA, the numbers of the current folder and file are shown. The system will continuously play a disc until you change modes.

You cannot load and play 3-inch (8-cm) discs in this system.

For information on how to handle and protect compact discs, see page [272](#).

Text Data Display Function

Each time you press the DISP (preset 1) button, the display shows you the text data on a disc, if the disc was recorded with text data.

You can see the album, artist, and track name in the display. If a disc is recorded in MP3 or WMA, you can see the folder and file name, and the album, artist, and track tag.

With the folder name, you will see the FOLDER indicator in the display. The TRACK indicator is shown with the file or track name.

When you press and release the DISP button while a disc without text data is playing, you will see “NO INFO” on the display.

The display shows up to about 16 characters of selected text data (the folder name, file name, etc.).

Playing a Disc (LX and Canadian DX models)

If the text data has more than 16 characters, you will see the first 15 characters and the > indicator in the display. Press and hold the DISP button until the next 16 characters are shown. You can see up to about 31 characters of the text data.

If you press and hold the DISP button again, the display shows the first 16 characters again.

If any letter is not available, it is replaced with “.” (dot) in the display. When the disc has no text data, you will see “NO INFO” on the display.

You will also see some text data under these conditions:

- When a new folder, file, or track is selected.
- When you change the audio mode to play a disc with text data or in MP3 or WMA.

- When you insert a disc, and the system begins to play.

When playing a CD-DA with text data, the album and track name are shown in the display. With a disc in MP3 or WMA, the display shows the folder and file name.

When you turn on the audio system next time, the system keeps your selection with the DISP button.

To Change or Select Tracks/Files

You can use the SKIP bar while a disc is playing to select passages and change tracks (files in MP3/WMA mode).

SKIP - Each time you press and release the + SKIP bar, the player skips forward to the beginning of the next track (file in MP3 or WMA mode). Press and release the - to skip backward to the beginning of the current track. Press it again to skip to the beginning of the previous track.

To move rapidly within a track, press and hold the ►► or ◀◀ SKIP bar.

CONTINUED

Playing a Disc (LX and Canadian DX models)

In MP3 or WMA mode

FOLDER SELECTION - To select a different folder, turn the TUNE knob to move to the beginning of the next folder. Turn the knob to the right until it clicks once to skip to the next folder, and to the left to move to the beginning of the current folder. Turn it again to skip to the beginning of the previous folder. Turning the TUNE knob more than two clicks skips several folders.

SCAN (TRACK/FILE SCAN) -

The scan function samples all tracks (files in MP3 or WMA) on the disc in the order they are recorded on the disc. To activate scan, press and hold the SCAN/RPT button. You will see SCAN in the display. You will get a 10 second sampling of each track/file on the disc. Press and hold the SCAN/RPT button for about 2 seconds to get out of scan mode and play the last track/file sampled.

In MP3 or WMA mode

F-SCAN (FOLDER SCAN) - This feature, when activated, samples the first file of each folder on the disc. To activate folder scan, press and hold the SCAN/RPT button to select SCAN, then press and release the button again to select folder scan. You will see F-SCAN in the display.

The system plays the first file in the first folder for about 10 seconds. If you do nothing, the system will then play the first files in the remaining folders for 10 seconds each. After playing the first file of the last folder, the system plays normally.

Each time you press and release the SCAN/RPT button, the mode changes from file scan to folder scan, then to normal playing.

Playing a Disc (LX and Canadian DX models)

REPEAT (TRACK/FILE REPEAT) - To continuously replay a track (file in MP3 or WMA mode), press and release the SCAN/RPT button. You will see RPT in the display. Press and hold the SCAN/RPT button for 2 seconds to turn it off.

In MP3 or WMA mode
FOLDER-REPEAT - This feature, when activated, replays all files on the selected folder in the order they are compressed. To activate folder repeat, press the SCAN/RPT button twice. You will see F-RPT in the display. The system continuously replays the current folder. Press the SCAN/RPT button again to turn it off.

Each time you press and release the SCAN/RPT button, the mode changes from file repeat to folder repeat, then to normal playing.

RANDOM (Random within a disc) - This feature plays the tracks (the files in MP3 or WMA mode) within a disc in random order. To activate random play, press and release the RDM button. In MP3 or WMA mode, press the RDM button twice to select RDM (within a disc random play). You will see RDM in the display. Press the RDM button again to turn it off.

CONTINUED

Playing a Disc (LX and Canadian DX models)

In MP3 or WMA mode

FOLDER-RANDOM - This feature, when activated, plays all files on the selected folder in random order. To activate folder random, press the RDM button. You will see F-RDM in the display. The system will then select and play files randomly. This continues until you deactivate folder random by pressing and holding the RDM button for 2 seconds.

Each time you press and release the RDM button, the mode changes from folder random play to random play (within a disc random play), then to normal playing.

To Stop Playing a Disc

Press the eject button (▲) to remove the disc. If you eject the disc, but do not remove it from the slot, the system will automatically reload the disc after 10 seconds and put it in pause mode. To begin playing, press the CD button.

Press the AM or FM button to switch to the radio while a disc is playing. Press the CD button to play the disc.

If you turn the system off while a disc is playing, either with the PWR/VOL knob or by turning off the ignition switch, the disc will stay in the drive. When you turn the system back on, the disc will begin playing where it left off.

Protecting Compact Discs

For information on how to handle and protect compact discs, see page [272](#).

Disc Player Error Messages (LX and Canadian DX models)

The chart on the right explains the error messages you may see in the display while playing a disc.

If you see an error message in the display while playing a disc, press the eject button. After ejecting the disc, check it for damage or deformation. If there is no damage, insert the disc again. For the additional information on damaged discs, see page [273](#).

The audio system will try to play the disc. If there is still a problem, the error message will reappear. Press the eject button, and pull out the disc. Insert a different disc. If the new disc plays, there is a problem with the first disc. If the error message cycle repeats and you cannot clear it, take your vehicle to a dealer.

Error Message	Cause	Solution
UNSUPPORTED FORMAT	Track/File format not supported	Current track will skipped. The next supported track or file plays automatically.
BAD DISC CHECK MANUAL PUSH EJECT	Mechanical Error	Press the eject button and pull out the disc. Check the disc for serious damage, signs of deformation, excessive scratches, and/or dirt (see page 273). Insert the disc again. If the code does not disappear, or the disc cannot be removed, consult your dealer. Do not try to force the disc out of the player.
BAD DISC CHECK MANUAL	Servo Error	

The ejected disc will not be reloaded automatically.

Playing the AM/FM Radio (EX and EX-L models without navigation system)

EX and EX-L models
EX-L model is shown.

EX-L model with Rear Entertainment System

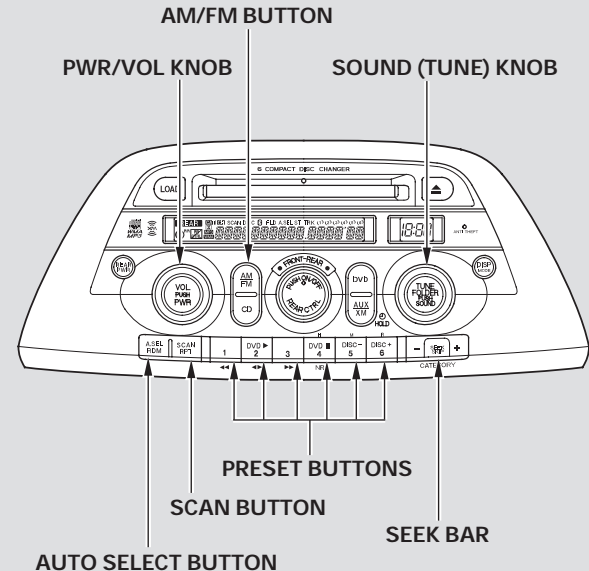
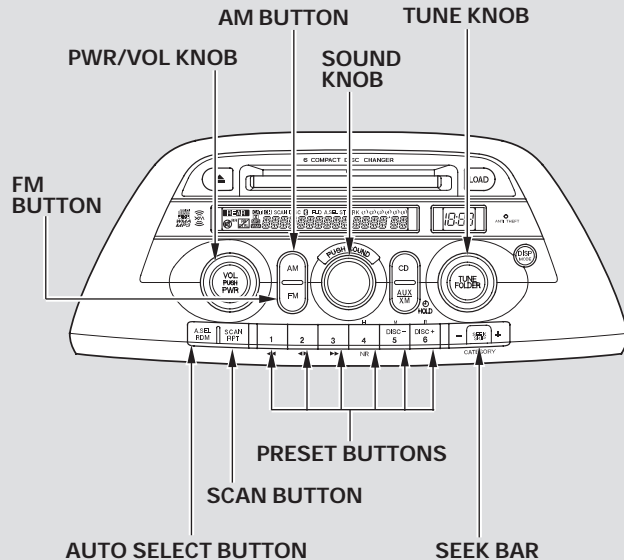

Playing the AM/FM Radio (EX and EX-L models without navigation system)

To Play the AM/FM Radio

The ignition switch must be in the ACCESSORY (I) or ON (II) position. Turn the system on by pushing the PWR/VOL knob. Adjust the volume by turning the same knob.

The band and frequency that the radio was last tuned to is displayed. To change bands, press the AM or FM button, or AM/FM button. On the FM band, ST will be displayed if the station is broadcasting in stereo. Stereo reproduction in AM is not available.

On the AM band, AM noise reduction turns on automatically.

To Select a Station

You can use any of five methods to find radio stations on the selected band: tune, seek, scan, the preset buttons, and auto select.

TUNE - Use the TUNE knob to tune the radio to a desired frequency. Turn the knob right to tune to a higher frequency, or left to tune to a lower frequency.

SEEK - The SEEK function searches up and down from the current frequency to find a station with a strong signal. To activate it press the + or - side of the bar, then release it.

SCAN - The SCAN function samples all stations with strong signals on the selected band. To activate it, press the SCAN button, then release it. You will see SCAN in the display. The system will scan for a station with a strong signal. When it finds one, it will stop and play that station for about 5 seconds.

If you do nothing, the system will then scan for the next strong station and play it for 5 seconds. When it plays a station you want to listen to, press the SCAN button again.

CONTINUED

Playing the AM/FM Radio (EX and EX-L models without navigation system)

Preset - Each preset button can store one frequency on AM and two frequencies on FM.

1. Select the desired band, AM or FM. FM1 and FM2 let you store two frequencies with each preset button.
2. Use the tune, seek, or scan function to tune the radio to a desired station.
3. Pick a preset button, and hold it until you hear a beep.
4. Repeat steps 1 through 3 to store a total of six stations on AM and twelve stations on FM.

AUTO SELECT - If you are traveling far from home and can no longer receive your preset stations, you can use the auto select feature to find stations in the local area.

Press the A. SEL button. "A. SEL" appears in the display, and the system goes into scan mode for several seconds. It stores the frequencies of six AM and twelve FM stations in the preset buttons.

You will see a "0" displayed after pressing a preset button if auto select cannot find a strong station for that preset button.

If you do not like the stations auto select has stored, you can store other frequencies on the preset buttons as previously described.

To turn off auto select, press the A. SEL (auto select) button. This restores the presets you originally set.

For information on AM/FM radio frequencies and reception, see page [275](#).

Playing the AM/FM Radio (EX and EX-L models without navigation system)

Adjusting the Sound

Press the SOUND (TUNE) knob repeatedly to display the bass, treble, balance, and fader settings.

Each mode is shown in the display as it changes. Turn the SOUND (TUNE) knob to adjust the setting to your liking. When the level reaches the center, you will see “C” in the display. The system will automatically return the display to the selected audio mode about 5 seconds after you stop adjusting a mode.

Treble/Bass - Use the TRE/BAS modes to adjust the tone to your liking.

Balance/Fader - These two modes adjust the strength of the sound coming from each speaker. BAL adjusts the side-to-side strength, while FAD adjusts the front-to-back strength.

Audio System Lighting

You can use the instrument panel brightness control knob to adjust the illumination of the audio system (see page 139). The audio system illuminates when the parking lights are on, even if the system is turned off.

Playing the XM[®] Satellite Radio (U.S. EX and all EX-L models without navigation system)

U.S. EX and EX-L models
U.S. model is shown.

EX-L model with Rear Entertainment System

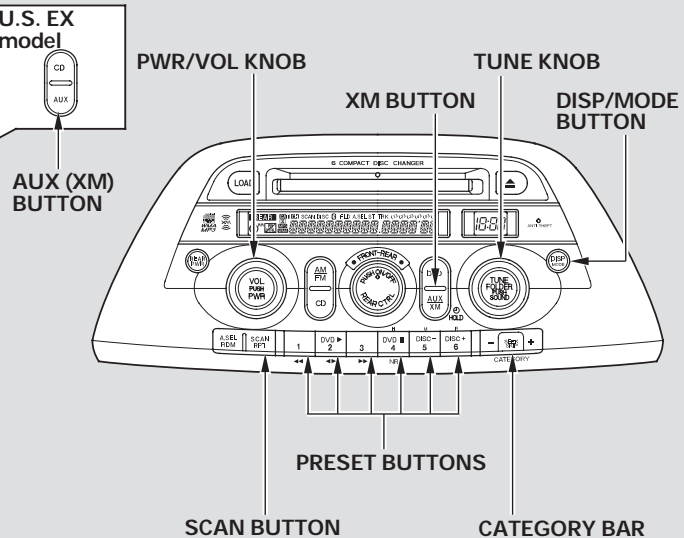
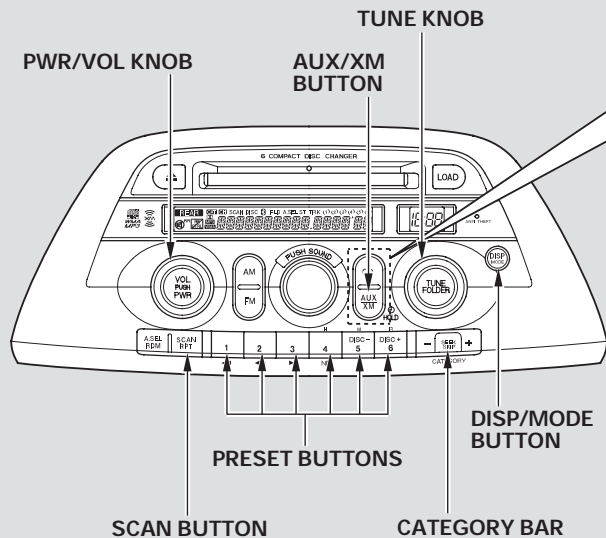

Playing the XM[®] Satellite Radio (U.S. EX and all EX-L models without navigation system)

Your vehicle is capable of receiving XM[®] Satellite Radio anywhere in the United States, and Canada, except Hawaii and Alaska. XM[®] is a registered trademark of XM Satellite Radio, Inc.

XM satellite radio receives signals from two satellites to produce clear, high-quality digital reception. It offers many channels in several categories. Along with a large selection of different types of music, XM satellite radio allows you to view channel and category selections in the display.

U.S. EX models

Though it is not equipped with an XM satellite radio system, your vehicle is "XM Ready." If you purchase an XM radio receiver, you can connect it to your vehicle's audio system to receive XM broadcasts.

Operating the XM Radio

To listen to XM radio, turn the ignition switch to the ACCESSORY (I) or the ON (II) position. Push the PWR/VOL knob to turn on the audio system, and press the AUX/XM button. Adjust the volume by turning the PWR/VOL knob. The last channel you listened to will show in the display.

MODE - To switch between channel mode and category mode, press and hold the DISP/MODE button until the mode changes.

In channel mode, you can select all of the available channels. In category mode, such as Jazz, Rock, Classical, etc., you can select all of the channels within that category.

Each time you press and release the DISP/MODE button, the display changes in the following sequence: channel name, channel number, category, artist name, and music title.

On the audio display, you will see the selected CHANNEL (number), CATEGORY, NAME (artist name), and TITLE (music title).

You may experience periods when XM Radio does not transmit the artist's name and song title information. If this happens, there is nothing wrong with your system.

CONTINUED

Playing the XM[®] Satellite Radio (U.S. EX and all EX-L models without navigation system)

On models with a rear entertainment system, you cannot listen to XM Radio and a disc at the same time. For example, when XM Radio is playing on the front speakers, you cannot listen to a disc on the rear speakers, or vice versa.

TUNE - Turn the tune knob left or right to select channels. In the category mode, you can only select channels within that category.

CATEGORY - Press either side of the bar (- or +) to select another category.

SCAN - The SCAN function gives you a sampling of all channels while in the channel mode. In the category mode, only the stations within that category are scanned. To activate scan, press the SCAN button. The system plays each channel in numerical order for a few seconds, then selects the next channel. When you hear a channel you want to continue listening to, press the button again.

Preset - You can store up to 12 preset channels using the six preset buttons. Each button stores one channel from the XM1 band and one channel from the XM2 band.

To store a channel:

1. Press the AUX/XM button. Either XM1 or XM2 will show in the display.
2. Use the selector knob, or the CATEGORY bar or SCAN button to tune to a desired channel.

In category mode, only channels within that category can be selected. In channel mode, all channels can be selected.

3. Pick the preset button you want for that channel. Press and hold the button until you hear a beep.

Playing the XM[®] Satellite Radio (U.S. EX and all EX-L models without navigation system)

- Repeat steps 2 and 3 to store the first six channels.
- Press the XM button again. The other XM band will show. Store the next six channels using steps 2 and 3.

Once a channel is stored, simply press and release the proper preset button to tune to it.

XM Radio Display Messages

“LOADING” - XM is loading the audio or program information.

“OFF AIR” - The channel currently selected is no longer broadcasting.

“UPDATING” - The encryption code is being updated. Wait until the encryption code is fully updated. Channels 0 and 1 should still work normally.

“NO SIGNAL” - The signal is currently too weak. Move the vehicle to an area away from tall buildings, and with an unobstructed view of the southern horizon.

“ - - - - ” - The selected channel number does not exist or is not part of your subscription.

“NO INFO” - The selected channel has no artist or title information at this time.

“CHECK ANTENNA” - There is a problem with the XM antenna. Please consult your dealer.

CONTINUED

Playing the XM® Satellite Radio (U.S. EX and all EX-L models without navigation system)

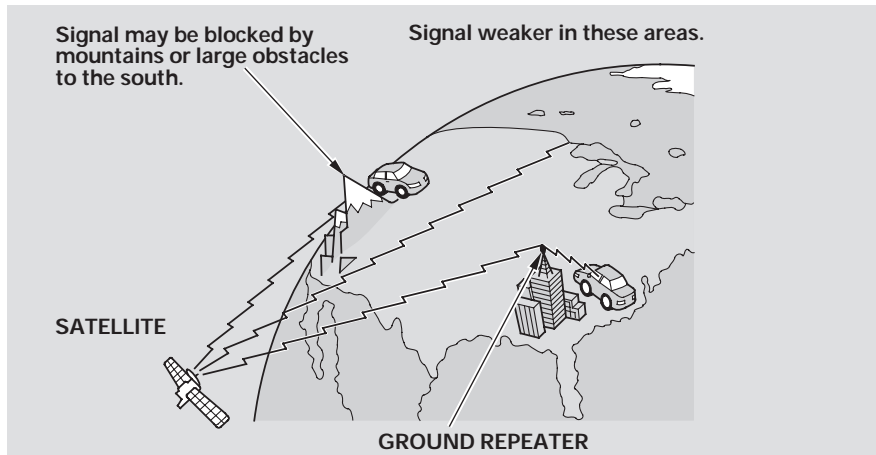

The XM satellites are in orbit over the equator; therefore, objects south of the vehicle may cause satellite reception interruptions. To help compensate for this, ground-based repeaters are placed in major metropolitan areas.

Satellite signals are more likely to be blocked by tall buildings and mountains the farther north you travel from the equator.

Depending on where you drive, you may experience reception problems. Interference can be caused by any of these conditions:

- Driving on the north side of an east/west mountain road.
- Driving on the north side of a large commercial truck on an east/west road.
- Driving in tunnels.
- Driving on a road beside a vertical wall, steep cliff, or hill to the south of you.
- Driving on the lower level of a multi-tiered road.
- Driving on a single lane road alongside dense trees taller than 50 ft. (15 m) to the south of you.

Playing the XM[®] Satellite Radio (U.S. EX and all EX-L models without navigation system)

There may be other geographic situations that could affect XM radio reception.

*As required by the FCC:
Changes or modifications not expressly approved by the party responsible for compliance could void the user's authority to operate the equipment.*

Receiving Satellite Radio Service

If your XM Radio service has expired or you purchased your vehicle from a previous owner, you can listen to a sampling of the broadcasts available on XM satellite radio. With the ignition switch in the ACCESSORY (I) or the ON (II) position, push the PWR/VOL knob to turn on the audio system and press the AUX/XM button. A variety of music types and styles will play.

If you decide to purchase XM satellite radio service, contact XM Radio at www.xmradio.com, or at 1-800-852-9696. In Canada, contact XM Canada at www.xmradio.ca, or at 1-877-438-9677. You will need to give them your radio I.D. number and your credit card number. To get your radio I.D. number, turn the TUNE knob until "0" appears in the display. Your I.D. will appear in the display.

After you've registered with XM Radio, keep your audio system in the Satellite Radio mode while you wait for activation. This should take about 30 minutes.

While waiting for activation, make sure your vehicle remains in an open area with good reception. Once your audio system is activated, "CATEGORY" or "CH" will appear in the display, and you'll be able to listen to XM Radio broadcasts. XM Radio will continue to send an activation signal to your vehicle for at least 12 hours from the activation request. If the service has not been activated after 36 hours, contact XM Radio.

Playing Discs (EX and EX-L models without navigation system)

EX and EX-L models

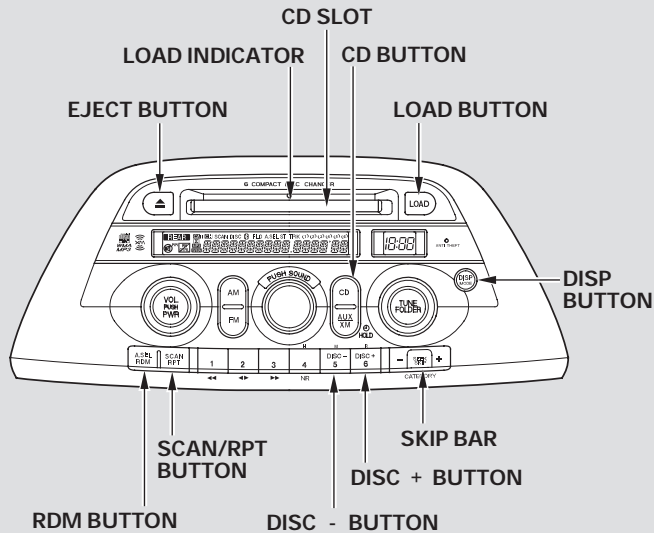

EX-L model with Rear Entertainment System

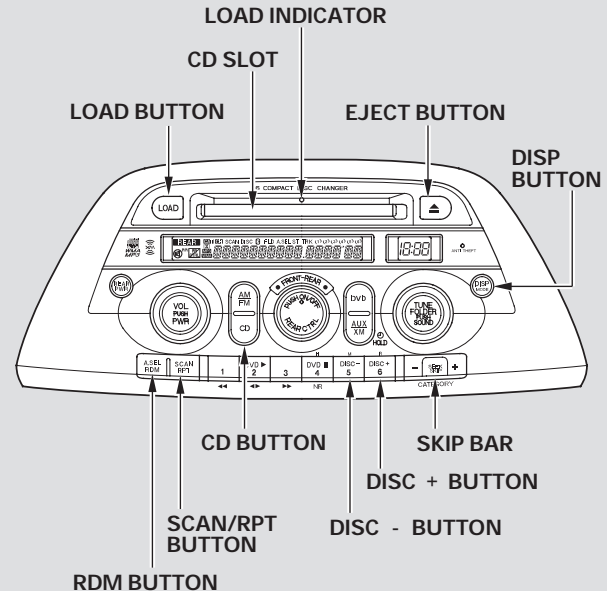

Playing Discs (EX and EX-L models without navigation system)

Operating the CD Changer

Your vehicle's audio system has an in-dash disc changer that holds up to six discs. You operate this disc changer with the same controls used for the radio. To operate the disc changer, the ignition switch must be in the ACCESSORY (I) or ON (II) position.

NOTICE

Do not use discs with adhesive labels. The label can curl up and cause the disc to jam in the unit.

This audio system can also play CD-Rs and CD-RWs compressed in MP3 or WMA formats. When playing a disc in MP3, you will see "MP3" in the display. In WMA format, "WMA" will appear in the display. You can select up to 99 folders, or up to 255 tracks/files.

NOTE:

If a file on an MP3 or WMA disc is protected by digital rights management (DRM), the audio unit displays UNSUPPORTED FORMAT, and then skips to the next file.

Video CDs and DVD discs do not work in this unit.

The specifications of the compatible MP3 file are:

- Sampling frequency:
32/44.1/48 kHz (MPEG1)
24/22.05/16 kHz (MPEG2)
- Bit rate:
32/40/48/56/64/80/96/112/128/
160/192/224/256/320 kbps
(MPEG1)
8/16/24/32/40/48/56/64/80/96/
112/128/160 kbps (MPEG2)
- Compatible with variable bit rate and multi-session
- Maximum layers
(including ROOT): 8 layers

The specifications of the compatible WMA file are:

- Sampling frequency:
32/44.1/48 kHz
- Bit rate:
48/64/80/96/128/160/192 kbps
- Compatible with variable bit rate and multi-session
- Maximum layers
(including ROOT): 8 layers

Loading CDs in the Changer

To load multiple discs in one operation:

1. Press and hold the LOAD button beside the CD slot until you see "LOAD" in the display, then release the button.
2. On the upper right side of the display, the disc number for an empty position will begin blinking, and the green CD load indicator will come on.

CONTINUED

Playing Discs (EX and EX-L models without navigation system)

3. Insert the disc into the CD slot. Insert it only about halfway; the drive will pull it in the rest of the way. You will see "BUSY" in the display. The CD loaded indicator turns red and blinks as the disc is loaded.
4. When "LOAD" appears again in the display, insert the next disc into the CD slot.
5. Repeat this until all six positions are loaded. The system will then begin playing the last disc loaded.

If you are not loading discs into all six positions, press the LOAD button again after the last disc has loaded. The system will begin playing the last disc loaded.

If you stop loading discs before all six positions are filled, the system will wait for 10 seconds, stop the load operation, and begin playing the last disc loaded.

To load a single disc:

1. Press and release the LOAD button.
2. When the disc number for an empty position starts to blink and the green CD load indicator comes on, you will see LOAD in the display. Insert the disc into the CD slot. Insert it only about halfway, the drive will pull it in the rest of the way.
3. The system will load the disc and begin playing it.

If you press the LOAD button while a disc is playing, the system will stop playing that disc and start the loading sequence. It will then play the disc just loaded.

You can also load a disc into an empty position while a disc is playing by pressing the appropriate preset button. Select an empty position (the disc number indicator is off), and press the preset button for that position (1 to 6). The system will stop playing the current disc and start the loading sequence. It will then play the disc just loaded.

You cannot load and play 3-inch (8-cm) discs in this system.

Playing Discs (EX and EX-L models without navigation system)

Text Data Display Function

Each time you press the DISP button, the display shows you the text data on a disc, if the disc was recorded with text data.

You can see the album, artist, and track name in the display. If a disc is recorded in MP3 or WMA, you can see the folder and file name, and the album, artist, and track tag.

With the folder name, you will see the FOLDER indicator in the display. The TRACK indicator is shown with the file or track name.

When you press and release the DISP button while a disc without text data is playing, you will see "NO INFO" on the display.

The display shows up to about 16 characters of selected text data (the folder name, file name, etc.).

If the text data has more than 16 characters, you will see the first 15 characters and the > indicator in the display. Press and hold the DISP button until the next 16 characters are shown. You can see up to about 31 characters of the text data. If you press and hold the DISP button again, the display shows the first 16 characters again.

If any letter is not available, it is replaced with "." (dot) in the display. When the disc has no text data, you will see "NO INFO" on the display.

You will also see some text data under these conditions:

- When a new folder, file, or track is selected.
- When you change the audio mode to play a disc with text data or in MP3 or WMA.
- When you insert a disc, and the system begins to play.

When playing a CD-DA with text data, the album and track name are shown in the display. With a disc in MP3 or WMA, the display shows the folder and file name.

When you turn on the audio system next time, the system keeps your selection with the DISP button.

To Change or Select Tracks/Files

You can use the SKIP bar while a disc is playing to select passages and change tracks (files in MP3/WMA mode).

SKIP - Each time you press and release the + SKIP bar, the player skips forward to the beginning of the next track (file in MP3 or WMA mode). Press and release the - to skip backward to the beginning of the current track. Press it again to skip to the beginning of the previous track.

To move rapidly within a track, press and hold the ►► or ◄◄ SKIP bar.

Playing Discs (EX and EX-L models without navigation system)

In MP3 or WMA mode

FOLDER SELECTION - To select a different folder, turn the TUNE knob to move to the beginning of the next folder. Turn the knob to the right until it clicks once to skip to the next folder, and to the left to move to the beginning of the current folder. Turn it again to skip to the beginning of the previous folder. Turning the TUNE knob more than two clicks skips several folders.

SCAN (TRACK/FILE SCAN) - The scan function samples all tracks (files in MP3 or WMA) on the disc in the order they are recorded on the disc. To activate scan, press and hold the SCAN/RPT button. You will see SCAN in the display. You will get a 10 second sampling of each track/file on the disc. Press and hold the SCAN/RPT button for about 2 seconds to get out of scan mode and play the last track/file sampled.

In MP3 or WMA mode

F-SCAN (FOLDER SCAN) - This feature, when activated, samples the first file of each folder on the disc. To activate folder scan, press and hold the SCAN/RPT button to select SCAN, then press and release the button again to select folder scan. You will see F-SCAN in the display.

The system plays the first file in the first folder for about 10 seconds. If you do nothing, the system will then play the first files in the remaining folders for 10 seconds each. After playing the first file of the last folder, the system plays normally.

Press and hold the SCAN/RPT button for 2 seconds to get out of scan mode and play the last file sampled.

DISC SCAN - This feature, when activated, samples the first track (file in MP3 or WMA) in each disc. To activate the DISC SCAN feature, press and hold the SCAN/RPT button to select SCAN, then press and release the button twice to select disc scan. You will see D-SCAN in the display. The system will then play the first track/file in the disc for about 10 seconds. If you do nothing, the system will then play the first track/file in the remaining discs for 10 seconds each. After playing the first track/file of the last disc, the system plays normally.

Each time you press and release the SCAN/RPT button, the mode changes from scan, to folder scan, to disc scan, then to normal playing.

Playing Discs (EX and EX-L models without navigation system)

REPEAT (TRACK/FILE REPEAT) - To continuously replay a track (file in MP3 or WMA mode), press and release the SCAN/RPT button. You will see RPT in the display. Press and hold the SCAN/RPT button for 2 seconds to turn it off.

In MP3 or WMA mode

FOLDER-REPEAT - This feature, when activated, replays all files on the selected folder in the order they are compressed. To activate folder repeat, press the SCAN/RPT button twice. You will see F-RPT in the display. The system continuously replays the current folder. Press and hold the SCAN/RPT button for 2 seconds to turn it off.

DISC REPEAT - To activate the DISC REPEAT feature, press the SCAN/RPT button three times. You will see "D-RPT" in the display as a reminder. The system continuously replays the current disc. Press the SCAN/RPT button again to turn it off.

Each time you press and release the SCAN/RPT button, the mode changes from file repeat, to folder repeat, to disc repeat, then to normal playing.

RANDOM (Random within a disc) - This feature plays the tracks (the files in MP3 or WMA mode) within a disc in random order. To activate random play, press and release the RDM button. In MP3 or WMA mode, press the RDM button twice to select RDM (within a disc random play). You will see RDM in the display. Press the RDM button again to turn it off.

In MP3 or WMA mode

FOLDER-RANDOM - This feature, when activated, plays all files on the selected folder in random order. To activate folder random, press the RDM button. You will see F-RDM in the display. The system will then select and play files randomly. This continues until you deactivate folder random by pressing and holding the RDM button for 2 seconds.

Each time you press and release the RDM button, the mode changes from folder random play to random play (within a disc random play), then to normal playing.

Playing Discs (EX and EX-L models without navigation system)

Removing Discs from the In-dash Disc Changer

To remove the disc that is currently playing, press the eject button. You will see "EJECT" in the display. When you remove the disc from the slot, the system automatically begins the load sequence so you can load another disc in that position. If you do not load another disc after 15 seconds, the system selects the previous mode (AM, FM, or XM).

If you do not remove the disc from the slot, the system will reload the disc after 10 seconds, and select the previous mode (AM, FM, or XM). To begin playing the disc, press the CD button.

To remove a different disc from the changer, first select it with the appropriate preset button. When that disc begins playing, press the eject button.

If you press the eject button while listening to the radio, or with the audio system turned off, the disc that was last selected is ejected. After that disc is ejected, pressing the eject button again will eject the next disc in numerical order. By doing this six times, you can remove all the CDs from the changer.

In any mode, if you press the eject button and hold it until you hear a beep, the system will eject all of the discs in the changer.

You can also eject discs when the ignition switch is off. The disc that was last selected is ejected first. You can eject up to six discs, one at a time.

Protecting Compact Discs

For information on how to handle and protect compact discs, see page [272](#).

Disc Changer Error Messages (EX and EX-L models without navigation system)

The chart on the right explains the error messages you may see in the display while playing a disc.

If you see an error message in the display while playing a disc, press the eject button. After ejecting the disc, check it for damage or deformation. If there is no damage, insert the disc again.

For the additional information on damaged discs, see page [273](#).

The audio system will try to play the disc. If there is still a problem, the error message will reappear. Press the eject button, and pull out the disc. Insert a different disc. If the new disc plays, there is a problem with the first disc. If the error message cycle repeats and you cannot clear it, take your vehicle to a dealer.

Error Message	Cause	Solution
HEAT ERROR	High temperature	Will disappear when the temperature returns to normal.
UNSUPPORTED FORMAT	Track/File format not supported	Current track will be skipped. The next supported track or file plays automatically.
BAD DISC PLEASE CHECK OWNER'S MANUAL PUSH EJECT	Mechanical Error	Press the EJECT button and pull out the disc(s). Check the disc for serious damage, signs of deformation, excessive scratches, and/or dirt (see page 273). Insert the disc again. If the code does not disappear, or the disc(s) cannot be removed, consult your dealer. Do not try to force the disc out of the player.
BAD DISC PLEASE CHECK OWNER'S MANUAL	Servo Error	

Playing the AM/FM Radio (Models with navigation system)

Voice Control System

The audio system for your vehicle can also be operated by voice control. See the navigation section in your quick start guide for an overview of this system, and the navigation system manual for complete details.

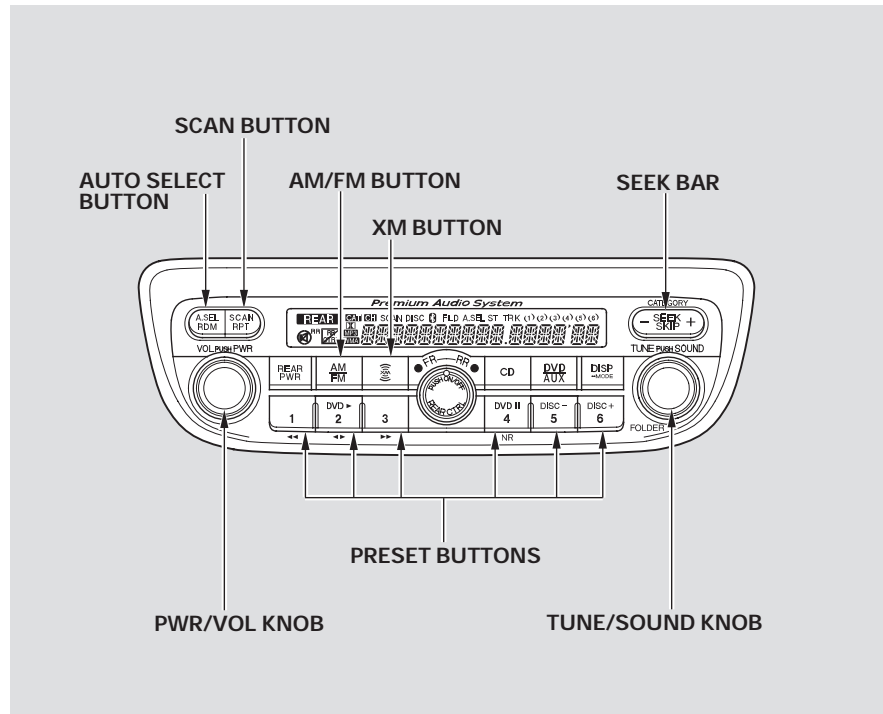

Playing the AM/FM Radio (Models with navigation system)

To Play the AM/FM Radio

The ignition switch must be in the ACCESSORY (I) or ON (II) position. Turn the system on by pushing the PWR/VOL knob. Adjust the volume by turning the same knob.

You can also operate the audio system using the control icons on the audio screen.

The band and frequency that the radio was last tuned to is displayed. To change bands, press the AM/FM button. On the FM band, ST will be displayed if the station is broadcasting in stereo. Stereo reproduction in AM is not available.

To Select a Station

You can use any of five methods to find radio stations on the selected band: tune, seek, scan, the preset buttons, and auto select.

TUNE - Use the TUNE knob to tune the radio to a desired frequency. Turn the knob right to tune to a higher frequency, or left to tune to a lower frequency.

SEEK - The SEEK function searches up and down from the current frequency to find a station with a strong signal. To activate it press the + or - side of the bar, then release it.

SCAN - The scan function samples all stations with strong signals on the selected band. To activate it, press the SCAN button, then release it. You will see SCAN in the display. The system will scan for a station with a strong signal. When it finds one, it will stop and play that station for about 10 seconds.

If you do nothing, the system will scan for the next strong station and play it for 10 seconds. When it plays a station that you want to listen to, press the SCAN button again.

Preset - Each preset button can store one frequency on AM and two frequencies on FM.

1. Select the desired band, AM or FM. FM1 and FM2 let you store two frequencies with each preset button (icon).
2. Use the tune, seek, or scan function to tune the radio to a desired station.
3. Pick a preset button (icon), and hold it until you hear a beep.
4. Repeat steps 1 through 3 to store a total of six stations on AM and twelve stations on FM.

CONTINUED

Playing the AM/FM Radio (Models with navigation system)

AUTO SELECT - If you are traveling far from home and can no longer receive your preset stations, you can use the auto select feature to find stations in the local area.

Press the A. SEL button. "A. SEL" appears in the display, and the system goes into scan mode for several seconds. It stores the frequencies of six AM and twelve FM stations in the preset buttons.

You will see a "0" displayed after pressing a preset button if auto select cannot find a strong station for that preset button.

If you do not like the stations auto select has stored, you can store other frequencies on the preset buttons (icons) as previously described.

To turn off auto select, press the A.SEL button or touch the AUTO SELECT icon. This restores the presets you originally set.

For information on AM/FM radio frequencies and reception, see page [275](#).

Adjusting the Sound

Press the SOUND (TUNE) knob repeatedly to display the bass, treble, balance, and fader settings.

Each mode is shown in the display as it changes. Turn the SOUND (TUNE) knob to adjust the setting to your liking. When the level reaches the center, you will see "C" in the display. The system will automatically return the display to the selected audio mode about 5 seconds after you stop adjusting a mode.

Treble/Bass - Use the TRE/BAS modes to adjust the tone to your liking.

Balance/Fader - These two modes adjust the strength of the sound coming from each speaker. BAL adjusts the side-to-side strength, while FAD adjusts the front-to-back strength.

Playing the AM/FM Radio (Models with navigation system)

Operating the Radio on the Navigation System Screen

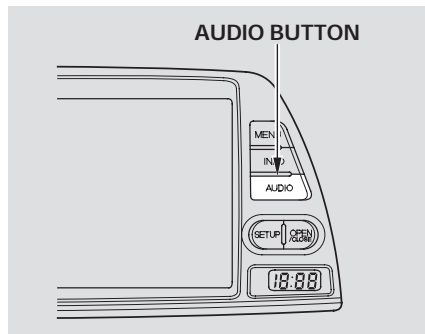

On models with navigation system
In addition to the knobs and buttons on the radio control panel, you can operate some of the radio controls on the navigation system screen.

While you are listening to the radio, you can change to another band by pressing the AUDIO button next to the navigation system screen, and then touching the desired band icon (FM1, FM2, or AM).

AUTO SELECT, SCAN, and SEEK are adjustable from the navigation screen. For an explanation of these functions, see pages [253](#) and [254](#).

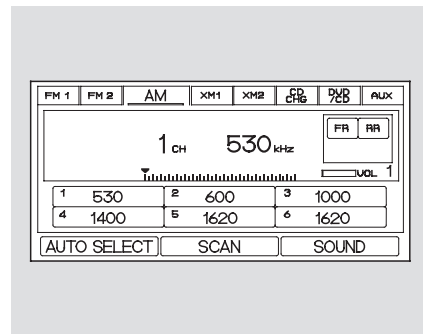

AUTO SELECT - Touch the AUTO SELECT icon to activate the auto select function. You will see AUTO SEL in the upper display.

SCAN - Touch the SCAN icon to activate the scan function. You will see SCAN on the display. Touch the icon again to deactivate it.

CONTINUED

Playing the AM/FM Radio (Models with navigation system)

Adjusting the Sound

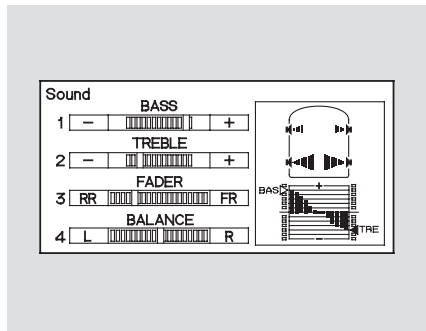

You can also adjust the sound from the navigation screen.

To adjust the sound, push the AUDIO button, then enter the sound grid by touching the SOUND icon on the display.

Treble/Bass - To adjust the treble and bass, touch + or - on each side of the treble or bass adjustment bar. The adjustment bar shows you the current setting.

Left/Right Balance and Front/Rear Fader - These modes adjust the strength of the sound coming from each speaker. Left/Right balance adjusts the side-to-side strength, while Front/Rear fader adjust the front-to-back strength. To adjust the left/right balance, touch the “L” or “R” icon.

To adjust the front/rear fader, touch the “FR” or “RR” icon.

To see the audio display when you are finished adjusting the sound, wait 5 seconds.

Audio System Lighting

You can use the instrument panel brightness control knob to adjust the illumination of the audio system (see page 139). The audio system illuminates when the parking lights are on, even if the system is turned off.

Playing the XM[®] Satellite Radio (Models with navigation system)

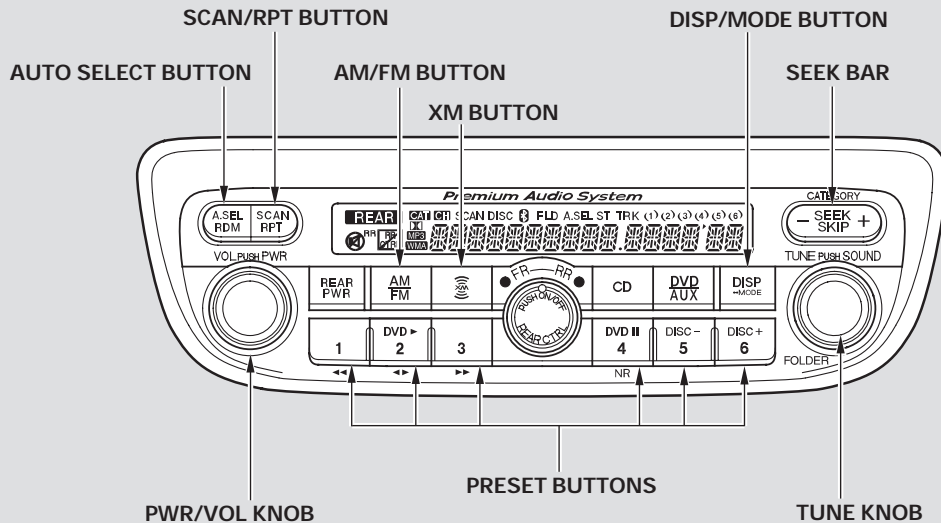

CONTINUED

Playing the XM[®] Satellite Radio (Models with navigation system)

Your vehicle is capable of receiving XM[®] Satellite Radio anywhere in the United States, and Canada, except Hawaii and Alaska. XM[®] is a registered trademark of XM Satellite Radio, Inc.

XM radio receives signals from two satellites to produce clear, high-quality digital reception. It offers many channels in several categories. Along with a large selection of different types of music, XM radio allows you to view channel and category selections in the display. The navigation system screen also shows all XM information when the AUDIO button is pressed.

Operating the XM Radio

To listen to XM radio, turn the ignition switch to the ACCESSORY (I) or the ON (II) position. Push the PWR/VOL knob to turn on the audio system, and press the «XM» button. Adjust the volume by turning the PWR/VOL knob. The last channel you listened to will show in the display.

You can also change to the XM radio while you are listening to an FM station, AM station, CD, etc. by touching the XM1 or XM2 icon on the audio display (navigation system screen).

MODE - To switch between channel mode and category mode, press and hold the DISP/MODE button until the mode changes. In channel mode, you can select all of the available channels. In category mode, such as Jazz, Rock, Classical, etc., you can select all of the channels within that category.

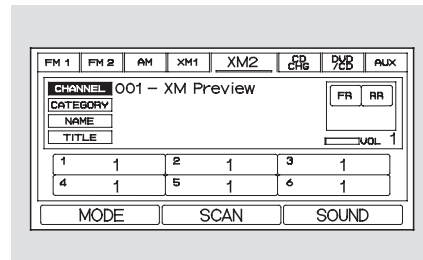

Each time you press and release the DISP/MODE button, the display changes in the following sequence: channel name, channel number, category, artist name, and music title.

On the audio display, you will see the selected CHANNEL (number), CATEGORY, NAME (artist name), and TITLE (music title).

You may experience periods when XM Radio does not transmit the artist's name and song title information. If this happens, there is nothing wrong with your system.

Playing the XM® Satellite Radio (Models with navigation system)

On models with a rear entertainment system and a navigation system, you cannot listen to XM Radio and a disc at the same time. For example, when XM Radio is playing on the front speakers, you cannot listen to a disc on the rear speakers, or vice versa.

TUNE - Turn the tune knob left or right to select channels. In the category mode, you can only select channels within that category.

CATEGORY - Press either side of the bar (- or +) to select another category.

SCAN - The scan function gives you a sampling of all channels while in the channel mode. In the category mode, only the channels within that category are scanned. To activate scan, press the SCAN/RPT button or touch the SCAN icon on the audio display. The system plays each channel in numerical order for a few

seconds, then selects the next channel. When you hear a channel you want to continue listening to, press the button or touch the icon again.

Preset - You can store up to 12 preset channels using the six preset buttons or preset icons on the audio display. Each button stores one channel from the XM1 band and one channel from the XM2 band.

To store a channel:

1. Press the «XM» button. Either XM1 or XM2 will show in the display.
2. Use the TUNE knob, the CATEGORY bar, or the SCAN button to tune to a desired channel. You can also touch the SCAN icon on the audio display.

In category mode, only channels within that category can be selected. In channel mode, all channels can be selected.

3. Pick the preset button (icon) you want for that channel. Press and hold the button (icon) until you hear a beep.
4. Repeat steps 2 and 3 to store the first six channels.
5. Press the «XM» button again or touch the other XM icon (XM1 or XM2) on the audio display. Store the next six channels using steps 2 and 3.

Once a channel is stored, press and release the proper preset button (icon) to tune to it.

Playing the XM[®] Satellite Radio (Models with navigation system)

XM Radio Display Messages

“LOADING” - XM is loading the audio or program information.

“OFF AIR” - The channel currently selected is no longer broadcasting.

“UPDATING” - The encryption code is being updated. Wait until the encryption code is fully updated. Channels 0 and 1 should still work normally.

“NO SIGNAL” - The signal is currently too weak. Move the vehicle to an area away from tall buildings, and with an unobstructed view of the southern horizon.

“ - - - - ” - The selected channel number does not exist, or is not part of your subscription, or this channel has no artist or title information at this time.

“NO INFO” - This channel has no artist or title information at this time.

“CHECK ANTENNA” - There is a problem with the XM antenna. Please consult your dealer.

Playing the XM[®] Satellite Radio (Models with navigation system)

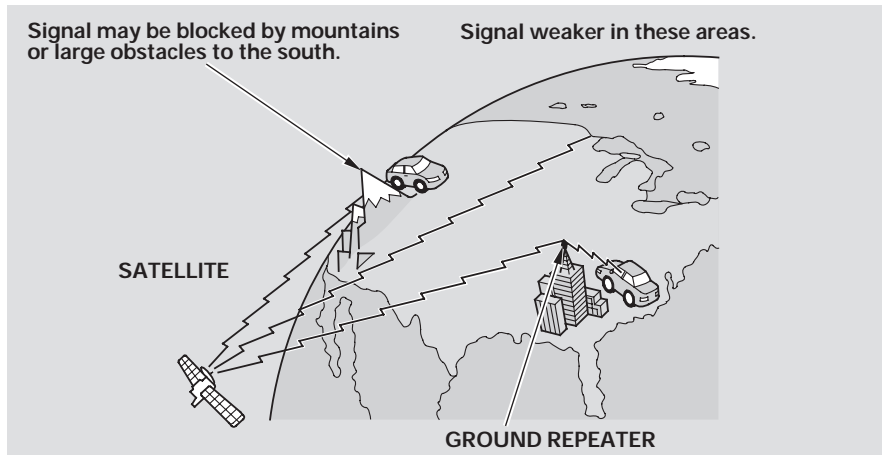

The XM satellites are in orbit over the equator; therefore, objects south of the vehicle may cause satellite reception interruptions. To help compensate for this, ground-based repeaters are placed in major metropolitan areas. Satellite signals are more likely to be blocked by tall buildings and

mountains the farther north you travel from the equator.

Depending on where you drive, you may experience reception problems. Interference can be caused by any of these conditions:

- Driving on the north side of an east/west mountain road.
- Driving on the north side of a large commercial truck on an east/west road.
- Driving in tunnels.
- Driving on a road beside a vertical wall, steep cliff, or hill to the south of you.
- Driving on the lower level of a multi-tiered road.
- Driving on a single lane road alongside dense trees taller than 50 ft. (15 m) to the south of you.

CONTINUED

Playing the XM[®] Satellite Radio (Models with navigation system)

There may also be other geographic situations or structures that could affect satellite radio reception.

As required by the FCC:

Changes or modifications not expressly approved by the party responsible for compliance could void the user's authority to operate the equipment.

Receiving Satellite Radio Service

If your XM Radio service has expired or you purchased your vehicle from a previous owner, you can listen to a sampling of the broadcasts available on XM satellite radio. With the ignition switch in the ACCESSORY (I) or the ON (II) position, push the PWR/VOL knob to turn on the audio system and press the XM RADIO button. A variety of music types and styles will play.

If you decide to purchase XM satellite radio service, contact XM Radio at www.xmradio.com, or at 1-800-852-9696. In Canada, contact XM Canada at www.xmradio.ca, or at 1-877-438-9677. You will need to give them your radio I.D. number and your credit card number. To get your radio I.D. number, turn the TUNE knob until "0" appears in the display. Your I.D. will appear in the display.

After you've registered with XM Radio, keep your audio system in the satellite radio mode while you wait for activation. This should take about 30 minutes.

While waiting for activation, make sure your vehicle remains in an open area with good reception. Once your audio system is activated, "category" or "CH" will appear in the display, and you'll be able to listen to XM radio broadcasts. XM Radio will continue to send an activation signal to your vehicle for at least 12 hours from the activation request. If the service has not been activated after 36 hours, contact XM Radio.

Playing Discs (Models with navigation system)

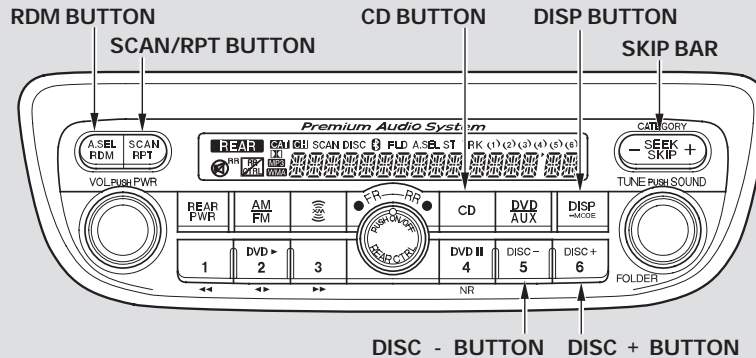
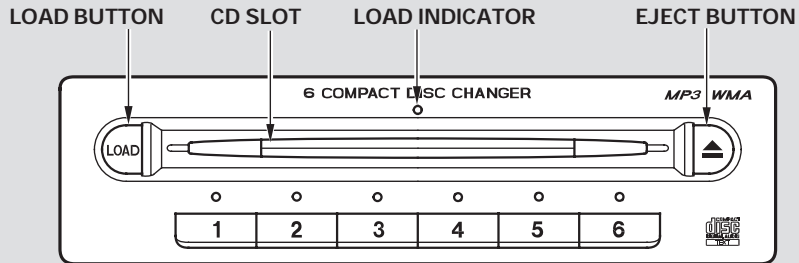

CONTINUED

Playing Discs (Models with navigation system)

Operating the CD Changer

Your vehicle's audio system has an in-dash disc changer that holds up to six discs. You operate this disc changer with the same controls used for the radio. To operate the disc changer, the ignition switch must be in the ACCESSORY (I) or ON (II) position.

NOTICE

Do not use discs with adhesive labels. The label can curl up and cause the disc to jam in the unit.

This audio system can also play CD-Rs and CD-RWs compressed in MP3 or WMA formats. When playing a disc in MP3, you will see "MP3" in the display. In WMA format, "WMA" will appear in the display. You can select up to 99 folders, or up to 255 tracks/files.

NOTE:

If a file on an MP3 or WMA disc is protected by digital rights management (DRM), the audio unit displays UNSUPPORTED FORMAT, and then skips to the next file.

Video CDs and DVD discs do not work in this unit.

The specifications of the compatible MP3 file are:

- Sampling frequency:
32/44.1/48 kHz (MPEG1)
24/22.05/16 kHz (MPEG2)
- Bit rate:
32/40/48/56/64/80/96/112/128/
160/192/224/256/320 kbps
(MPEG1)
8/16/24/32/40/48/56/64/80/96/
112/128/160 kbps (MPEG2)
- Compatible with variable bit rate and multi-session
- Maximum layers
(including ROOT): 8 layers

The specifications of the compatible WMA file are:

- Sampling frequency:
32/44.1/48 kHz
- Bit rate:
48/64/80/96/128/160/192 kbps
- Compatible with variable bit rate and multi-session
- Maximum layers
(including ROOT): 8 layers

Playing Discs (Models with navigation system)

The CD changer is behind the navigation system screen. To use the CD changer, press the OPEN button beside the screen. The screen folds back, and the CD changer appears.

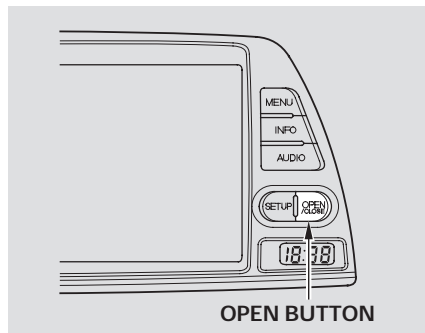

To return the screen to the upright position, press the OPEN button again. Do not use the folded screen as a tray. If you put a cup, for example, on the screen, the liquid inside the cup may spill on the screen when you go over a bump.

Loading Discs in the In-dash Disc Changer

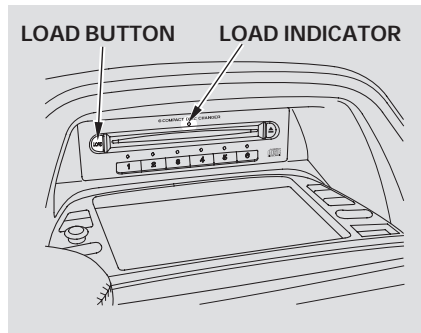

To load multiple discs in one operation:

1. Press and hold the LOAD button beside the CD slot until you see "LOAD" in the display, then release the button.

2. The indicators above the disc buttons of the empty positions will blink, and the green load indicator above the CD slot comes on.
3. Insert a disc into the CD slot. Insert it only about halfway; the drive will pull it in the rest of the way. You will see "BUSY" in the display. The CD load indicator turns red and blinks as the disc is loaded.
4. When "LOAD" appears again in the display, insert the next disc into the CD slot.
5. Repeat this until all six positions are loaded. The system will then begin playing the first disc loaded.

If you stop loading discs before all six positions are filled, the system will wait for 10 seconds, then stop the load operation and begin playing the last disc loaded. *CONTINUED*

Playing Discs (Models with navigation system)

To load a single disc:

1. Press and release the LOAD button.
2. The indicators above the Disc buttons of the empty positions will blink, and the green CD load indicator comes on. When you see "LOAD" in the display, insert the disc into the CD slot. Insert it only about halfway; the drive will pull it in the rest of the way.
3. The system will load the disc and begin playing it.

If you press the LOAD button while a disc is playing, the system will stop playing that disc and start the loading sequence. It will then play the disc just loaded.

You can also load a disc into an empty position while a disc is playing by pressing the appropriate disc button. Select an empty disc button (the indicator above the button is off), and press the button. The system will stop playing the current disc and start the loading sequence. It will then play the disc just loaded.

You cannot load and play 3-inch (8-cm) discs in this system.

Text Data Display Function

Each time you press the DISP button, the display shows you the text data on a disc, if the disc was recorded with text data.

You can see the album, artist, and track name in the display. If a disc is recorded in MP3 or WMA, you can see the folder and file name, and the album, artist, and track tag.

With the folder name, you will see the FOLDER indicator in the display. The TRACK indicator is shown with the file or track name.

When you press and release the DISP button while a disc without text data is playing, you will see "NO INFO" on the display.

The display shows up to about 16 characters of selected text data (the folder name, file name, etc.).

Playing Discs (Models with navigation system)

If the text data has more than 16 characters, you will see the first 15 characters and the > indicator in the display. Press and hold the DISP button until the next 16 characters are shown. You can see up to about 31 characters of the text data.

If you press and hold the DISP button again, the display shows the first 16 characters again.

If any letter is not available, it is replaced with “.” (dot) in the display. When the disc has no text data, you will see “NO INFO” on the display.

You will also see some text data under these conditions:

- When a new folder, file, or track is selected.
- When you change the audio mode to play a disc with text data or in MP3 or WMA.

- When you insert a disc, and the system begins to play.

When playing a CD-DA with text data, the album and track name are shown in the display. With a disc in MP3 or WMA, the display shows the folder and file name.

When you turn on the audio system next time, the system keeps your selection with the DISP button.

To Change or Select Tracks/Files

You can use the SKIP bar while a disc is playing to select passages and change tracks (files in MP3/WMA mode).

SKIP - Each time you press and release the + SKIP bar, the player skips forward to the beginning of the next track (file in MP3 or WMA mode). Press and release the - to skip backward to the beginning of the current track. Press it again to skip to the beginning of the previous track.

To move rapidly within a track, press and hold the ►►| or |◄◄ SKIP bar.

Playing Discs (Models with navigation system)

In MP3 or WMA mode

FOLDER SELECTION - To select a different folder, turn the TUNE knob to move to the beginning of the next folder. Turn the knob to the right until it clicks once to skip to the next folder, and to the left to move to the beginning of the current folder. Turn it again to skip to the beginning of the previous folder. Turning the TUNE knob more than two clicks skips several folders.

SCAN (TRACK/FILE SCAN) - The scan function samples all tracks (files in MP3 or WMA) on the disc in the order they are recorded on the disc. To activate scan, press and hold the SCAN/RPT button. You will see SCAN in the display. You will get a 10 second sampling of each track/file on the disc. Press and hold the SCAN/RPT button for about 2 seconds to get out of scan mode and play the last track/file sampled.

In MP3 or WMA mode

F-SCAN (FOLDER SCAN) - This feature, when activated, samples the first file of each folder on the disc. To activate folder scan, press and hold the SCAN/RPT button to select SCAN, then press and release the button again to select folder scan. You will see F-SCAN in the display.

The system plays the first file in the first folder for about 10 seconds. If you do nothing, the system will then play the first files in the remaining folders for 10 seconds each. After playing the first file of the last folder, the system plays normally.

Press and hold the SCAN/RPT button for 2 seconds to get out of scan mode and play the last file sampled.

DISC SCAN - This feature, when activated, samples the first track (file in MP3 or WMA) in each disc. To activate the DISC SCAN feature, press and hold the SCAN/RPT button to select SCAN, then press and release the button twice to select disc scan. You will see D-SCAN in the display. The system will then play the first track/file in the disc for about 10 seconds. If you do nothing, the system will then play the first track/file in the remaining discs for 10 seconds each. After playing the first track/file of the last disc, the system plays normally.

Each time you press and release the SCAN/RPT button, the mode changes from scan, to folder scan, to disc scan, then to normal playing.

Playing Discs (Models with navigation system)

REPEAT (TRACK/FILE REPEAT) - To continuously replay a track (file in MP3 or WMA mode), press and release the SCAN/RPT button. You will see RPT in the display. Press and hold the SCAN/RPT button for 2 seconds to turn it off.

In MP3 or WMA mode

FOLDER-REPEAT - This feature, when activated, replays all files on the selected folder in the order they are compressed. To activate folder repeat, press the SCAN/RPT button twice. You will see F-RPT in the display. The system continuously replays the current folder. Press and hold the SCAN/RPT button for 2 seconds to turn it off.

DISC REPEAT - To activate the DISC REPEAT feature, press the SCAN/RPT button three times. You will see "D-RPT" in the display as a reminder. The system continuously replays the current disc. Press the SCAN/RPT button again to turn it off.

Each time you press and release the SCAN/RPT button, the mode changes from file repeat, to folder repeat, to disc repeat, then to normal playing.

RANDOM (Random within a disc) - This feature plays the tracks (the files in MP3 or WMA mode) within a disc in random order. To activate random play, press and release the RDM button. In MP3 or WMA mode, press the RDM button twice to select RDM (within a disc random play). You will see RDM in the display. Press the RDM button again to turn it off.

In MP3 or WMA mode

FOLDER-RANDOM - This feature, when activated, plays all files on the selected folder in random order. To activate folder random, press the RDM button. You will see F-RDM in the display. The system will then select and play files randomly. This continues until you deactivate folder random by pressing and holding the RDM button for 2 seconds.

Each time you press and release the RDM button, the mode changes from folder random play to random play (within a disc random play), then to normal playing.

Playing Discs (Models with navigation system)

Removing Discs from the In-dash Disc Changer

To remove the disc that is currently playing, press the eject button. You will see “EJECT” in the display. When you remove the disc from the slot, the system automatically begins the load sequence so you can load another disc in that position. If you do not load another disc after 15 seconds, the system selects the previous mode (AM, FM, or XM).

If you do not remove the disc from the slot, the system will reload the disc after 10 seconds, and select the previous mode (AM, FM, or XM). To begin playing the disc, press the CD button.

To remove a different disc from the changer, first select it with the appropriate preset button. When that disc begins playing, press the eject button.

If you press the eject button while listening to the radio, or with the audio system turned off, the disc that was last selected is ejected. After that disc is ejected, pressing the eject button again will eject the next disc in numerical order. By doing this six times, you can remove all the CDs from the changer.

In any mode, if you press the eject button and hold it until you hear a beep, the system will eject all of the discs in the changer.

You can also eject discs when the ignition switch is off. The disc that was last selected is ejected first. You can eject up to six discs, one at a time.

Protecting Compact Discs

For information on how to handle and protect compact discs, see page [272](#).

Disc Changer Error Messages (Models with navigation system)

The chart on the right explains the error messages you may see in the display while playing a disc.

If you see an error message in the display while playing a disc, press the eject button. After ejecting the disc, check it for damage or deformation. If there is no damage, insert the disc again.

For the additional information on damaged discs, see page [273](#).

The audio system will try to play the disc. If there is still a problem, the error message will reappear. Press the eject button, and pull out the disc. Insert a different disc. If the new disc plays, there is a problem with the first disc. If the error message cycle repeats and you cannot clear it, take your vehicle to a dealer.

Error Message	Cause	Solution
HEAT ERROR	High temperature	Will disappear when the temperature returns to normal.
UNSUPPORTED FORMAT	Track/File format not supported	Current track will be skipped. The next supported track or file plays automatically.
BAD DISC PLEASE CHECK OWNER'S MANUAL PUSH EJECT	Mechanical Error	Press the EJECT button and pull out the disc(s). Check the disc for serious damage, signs of deformation, excessive scratches, and/or dirt (see page 273). Insert the disc again. If the code does not disappear, or the disc(s) cannot be removed, consult your dealer. Do not try to force the disc out of the player.
BAD DISC PLEASE CHECK OWNER'S MANUAL	Servo Error	

Protecting Your Discs

General Information

- When using CD-R discs, use only high quality discs labeled for audio use.
- When recording a CD-R, the recording must be closed for it to be used.
- CD-RW discs will not work in this unit.
- Play only standard round discs. Odd-shaped CDs may jam in the drive or cause other problems.
- Handle your discs properly to prevent damage and skipping.

Protecting Discs

When a disc is not being played, store it in its case to protect it from dust and other contamination. To prevent warpage, keep discs out of direct sunlight and extreme heat.

To clean a disc, use a clean soft cloth. Wipe across the disc from the center to the outside edge.

A new disc may be rough on the inner and outer edges. The small plastic pieces causing this roughness can flake off and fall on the recording surface of the disc, causing skipping or other problems. Remove these pieces by rubbing the inner and outer edges with the side of a pencil or pen.

Never try to insert foreign objects in the disc player or the disc changer.

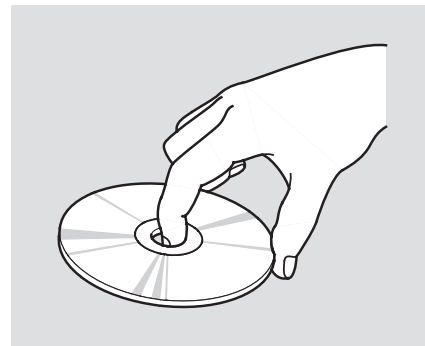

Handle a disc by its edges; never touch either surface. Do not place stabilizer rings or labels on the disc. These, along with contamination from fingerprints, liquids, and felt-tip pens, can cause the disc to not play properly, or possibly jam in the drive.

Additional Information on Recommended Discs

The in-dash disc player/changer has a sophisticated and delicate mechanism. If you insert a damaged disc as indicated in this section, it may become stuck inside and damage the audio unit.

Examples of these discs are shown to the right:

1. Bubbled, wrinkled, labelled, and excessively thick discs

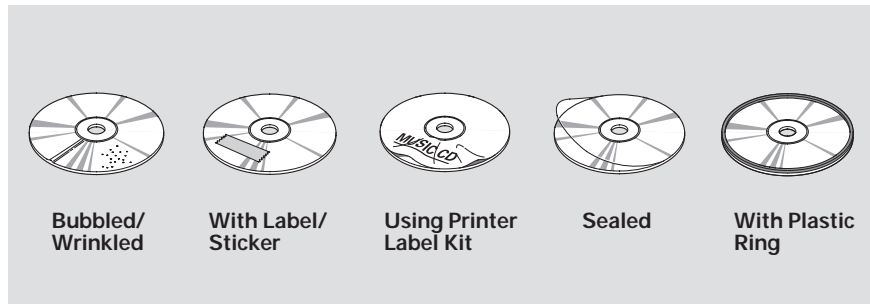
Bubbled/
WrinkledWith Label/
StickerUsing Printer
Label Kit

Sealed

With Plastic
Ring

2. Damaged discs

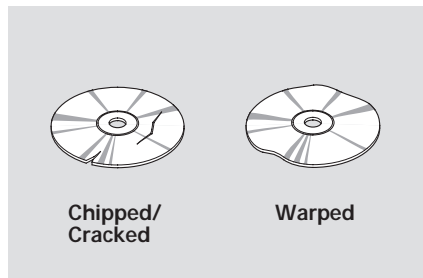
Chipped/
Cracked

Warped

3. Poor quality discs

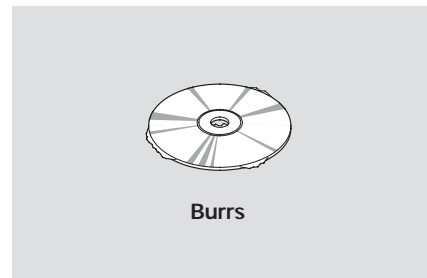

Burr

CONTINUED

Protecting Your Discs

4. Small, irregular shaped discs

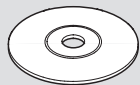

3-inch (8-cm) CD

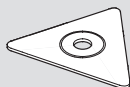

Triangle Shape

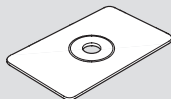

Can Shape

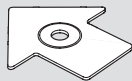

Arrow Shape

5. Discs with scratches, dirty discs

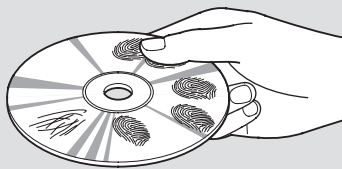

Fingerprints, scratches, etc.

- CD-R or CD-RW may not play due to the recording conditions.
- Scratches and fingerprints on the discs may cause the sound to skip.

- Recommended discs are printed with the following logo.



- Audio unit may not play the following formats.



- This audio unit cannot play a Dual-disc®.

Radio Frequencies

The radio can receive the complete AM and FM bands.

Those bands cover these frequencies:

AM band: 530 to 1,710 kHz

FM band: 87.7 to 107.9 MHz

Radio stations on the AM band are assigned frequencies at least 10 kHz apart (530, 540, 550). Stations on the FM band are assigned frequencies at least 0.2 MHz apart (87.9, 88.1, 88.3).

Stations must use these exact frequencies. It is fairly common for stations to round-off the frequency in their advertising, so your radio could display a frequency of 100.9 even though the announcer may identify the station as "FM101."

Radio Reception

How well the radio receives stations is dependent on many factors, such as the distance from the station's transmitter, nearby large objects, and atmospheric conditions.

A radio station's signal gets weaker as you get farther away from its transmitter. If you are listening to an AM station, you will notice the sound volume becoming weaker, and the station drifting in and out. If you are listening to an FM station, you will see the stereo indicator flickering off and on as the signal weakens. Eventually, the stereo indicator will go off and the sound will fade completely as you get out of range of the station's signal.

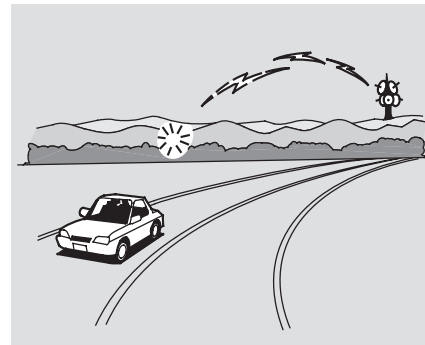

Driving very near the transmitter of a station that is broadcasting on a frequency close to the frequency of the station you are listening to can also affect your radio's reception. You may temporarily hear both stations, or hear only the station you are close to.

CONTINUED

AM/FM Radio Reception

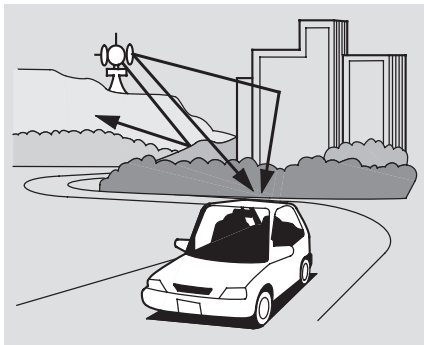

Radio signals, especially on the FM band, are deflected by large objects such as buildings and hills. Your radio then receives both the direct signal from the station's transmitter, and the deflected signal. This causes the sound to distort or flutter. This is a main cause of poor radio reception in city driving.



Radio reception can be affected by atmospheric conditions such as thunderstorms, high humidity, and even sunspots. You may be able to receive a distant radio station one day and not receive it the next day because of a change in conditions.

Electrical interference from passing vehicles and stationary sources (such as garages or parking structures) can cause temporary reception problems.

*As required by the FCC:
Changes or modifications not expressly
approved by the party responsible for
compliance could void the user's
authority to operate the equipment.*

Playing a Tape (Optional)

LX and Canadian DX models

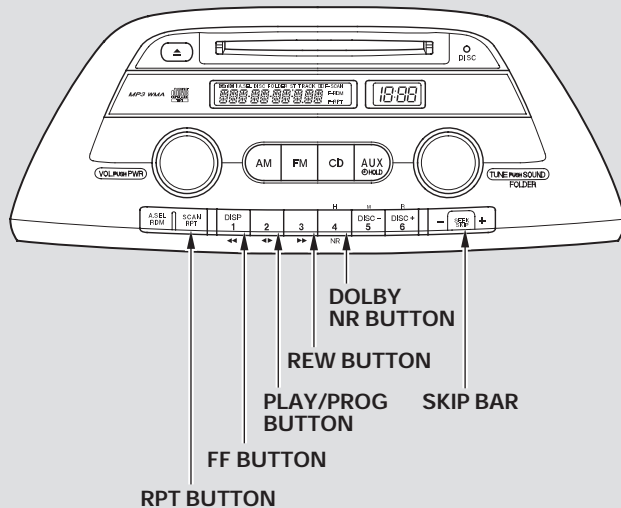

EX and EX-L models without Rear Entertainment System

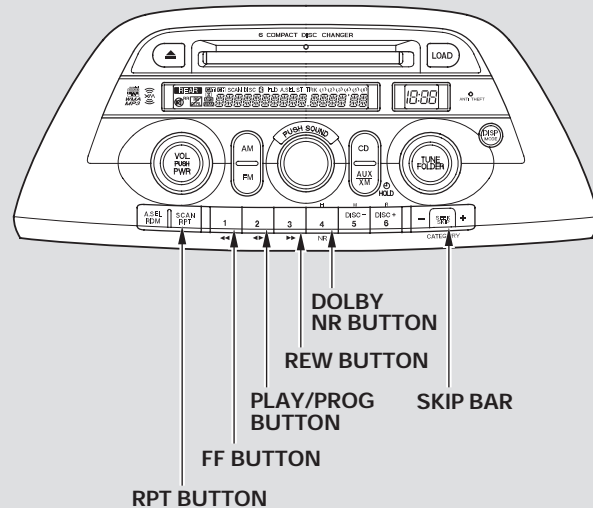

U.S. EX-L model is shown.

CONTINUED

Playing a Tape (Optional)

EX-L model with Rear Entertainment System without Navigation System

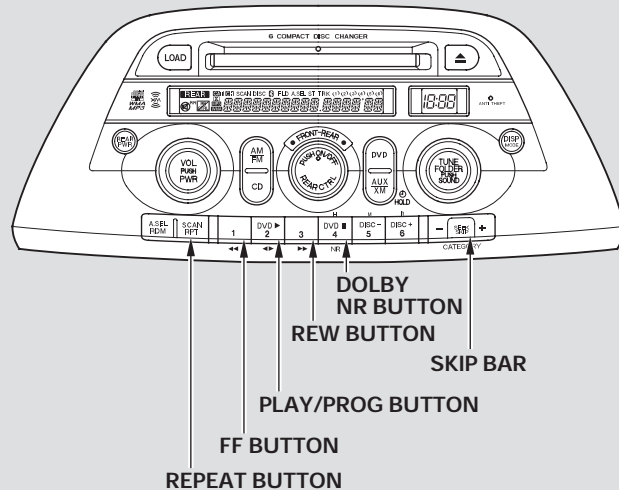

EX-L and Touring models with Rear Entertainment System and Navigation System

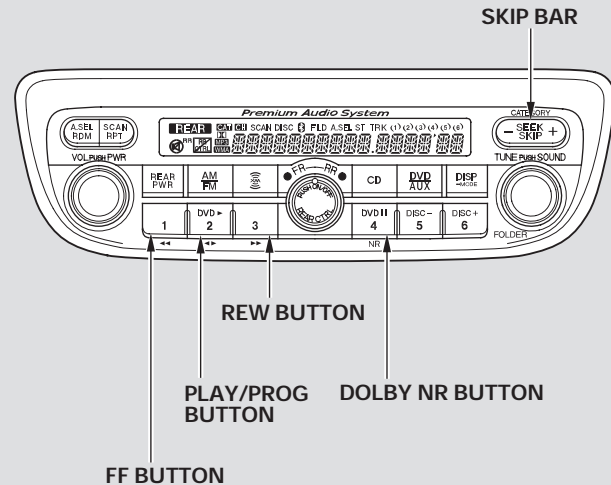



To Play a Tape

Optional on some models

The ignition switch must be in the ACCESSORY (I) or the ON (II) position. Make sure the open side of the tape is facing right, then insert the tape most of the way into the slot. The system will pull the tape in the rest of the way and begin to play it.

The tape direction indicator will come on to show you which side of the tape is playing. The  indicates the side you inserted upward is now playing. If you want to play the other side, press the PLAY/PROG button. When the player reaches the end of the tape, it will automatically reverse direction and play the other side.

Dolby* noise reduction turns on when you insert a tape. The  indicator will come on in the display. If the tape was not recorded in Dolby, turn it off by pressing the NR button. Dolby remains off until you press the NR button again.

* Dolby noise reduction is manufactured under license from Dolby Laboratories Licensing Corporation. "DOLBY" and the double-D symbol  are trademarks of Dolby Laboratories Licensing Corporation.

To Stop Playing a Tape

To remove the tape, press the EJECT button. If you want to turn the player off, press the PWR/VOL knob or turn off the ignition. The tape will remain in the drive. When you turn the system back on, the tape will begin playing where it left off.

To switch to the radio or CD player while a tape is playing, press the AM or FM button or AM/FM button, or CD button. To change back to the tape player, press the AUX button.

Tape Search Functions

FF/REW - To rewind the tape, push the REW button. You will see REW in the display. To fast forward the tape, push the FF button. You will see FF displayed. Press the FF, REW, or PLAY/PROG button to take the system out of rewind or fast forward.

CONTINUED

Playing a Tape (Optional)

SKIP - Press the - side of the SKIP bar to find the beginning of the current song or passage. Press the + side of the SKIP bar to find the beginning of a song or passage. When the system reaches the beginning of a song or passage, it begins to play it.

REPEAT - Press the RPT button to continuously play a song or passage. You will see RPT displayed. The track will repeat until you press the RPT button again.

NOTE: The skip and repeat functions use silent periods on the tape to find the end of a song or passage. These features may not work if there is almost no gap between selections, a high noise level, or a silent period in the middle of a selection.

Caring for the Tape and Player

The tape player picks up dirt and oxides from the tape. This contamination builds up over time and causes the sound quality to degrade. To prevent this, you should clean the player after every 30 hours of use.

If you do not clean the tape player regularly, it may eventually become impossible to remove the contamination with a normal cleaning kit. Your dealer has a cleaning kit available.

Use 100-minute or shorter tapes. Tapes longer than that may break or jam in the drive.

If the tape is loose, tighten it by turning the hub with a pencil or your finger. If the label is peeling off, remove it or it could cause the tape to jam in the player. Never try to insert a warped or damaged tape in the player.

Store tapes in their cases to protect them from dust and moisture. Never place tapes where they will be exposed to direct sunlight, high heat, or high humidity. If a tape is exposed to extreme heat or cold, let it reach a moderate temperature before inserting it into the player.

Never try to insert foreign objects into the tape player.

LX and Canadian DX models

CLOCK BUTTON

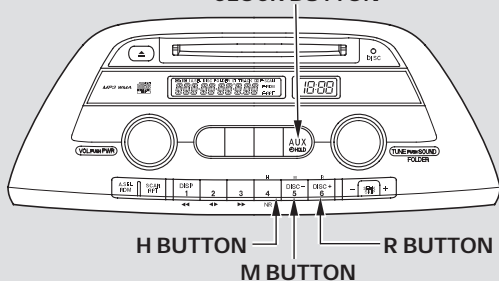

EX and EX-L models

CLOCK BUTTON

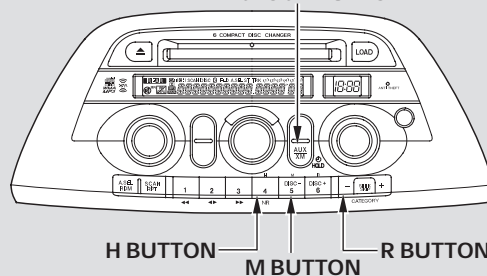

U.S. EX-L model is shown.

On models without navigation system
If your vehicle's battery is disconnected or goes dead, you may need to set the clock.

Press and hold the CLOCK button until the clock flashes. Change the hours by pressing the H button until the numbers advance to the desired time. Change the minutes by pressing the M button until the numbers advance to the desired time.

When you are finished, press the CLOCK button again.

You can quickly set the time to the nearest hour. If the displayed time is before the half hour, pressing and holding the CLOCK button, then pressing the R (RESET) button sets the clock back to the previous hour. If the displayed time is after the half hour, the clock sets forward to the beginning of the next hour.

For example: 1:06 will reset to 1:00
1:52 will reset to 2:00

On models with navigation system
Refer to the navigation system manual for how to adjust the time.

Remote Audio Controls

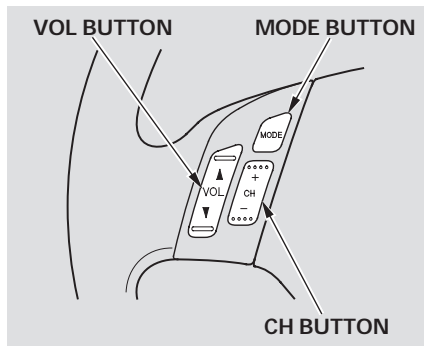

On EX, EX-L and Touring models

Three controls for the audio system are mounted in the steering wheel hub. They let you control basic functions without removing your hand from the steering wheel.

The VOL button adjusts the volume up () or down (). Press the top or bottom of the button and hold it until the desired volume is reached, then release it.

The MODE button changes the mode. Pressing the button repeatedly selects FM1, FM2, AM, CD (if a CD is loaded), or a tape (if equipped). On models with satellite radio system, you can also select XM1 and XM2.

If you are listening to the radio, use the CH button to change stations. Each time you press the top (+) of the button, the system goes to the next preset station on the band you are listening to. Press the bottom (-) to go back to the previous station.

If you are playing a disc, the system skips to the beginning of the next track (file in MP3 or WMA format) each time you press the top (+) of the CH button. Press the bottom (-) to return to the beginning of the current track/file. Press it twice to return to the previous track/file.

You will see the track/file number and the elapsed time. If the disc has text data or is compressed in MP3 or WMA, you can also see any other information (track title, file name, folder name, etc.).

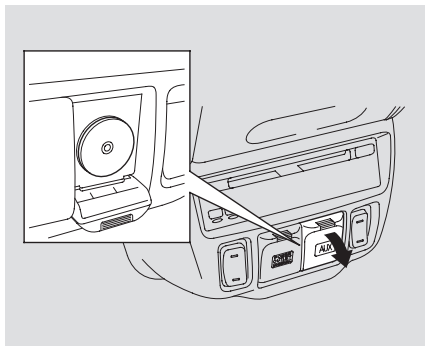

The auxiliary input jack is on the dashboard next to the accessory power socket. The system will accept auxiliary input from standard audio accessories.

When a compatible audio unit is connected to the jack, press the AUX button to select it.

Radio Theft Protection

On EX, EX-L and Touring models

Your vehicle's audio system may disable itself if it is disconnected from electrical power for any reason. To make it work again, you must enter a specific five-digit code with the preset buttons. Because there are hundreds of number combinations possible from the five digits, making the system work without knowing the exact code is nearly impossible.

You should have received a card that lists your audio system code number and serial number. It is best to store this card in a safe place at home. In addition, you should write the audio system's serial number in this owner's manual.

If you lose the card, you must obtain the code number from your dealer. To do this, you will need the audio system's serial number.

If your vehicle's battery is disconnected or goes dead, or the radio fuse is removed, the audio system will disable itself. If this happens, you will see CODE in the frequency display the next time you turn on the system. Use the preset buttons to enter the five-digit code. The code is on the radio code card included in your owner's manual kit. When it is entered correctly, the radio will start playing.

If you make a mistake entering the code, do not start over; complete the five-digit sequence, then enter the correct code. You have 10 tries to enter the correct code. If you are unsuccessful in 10 attempts, you must then leave the system on for 1 hour before trying again.

Rear Entertainment System

Models with Navigation System

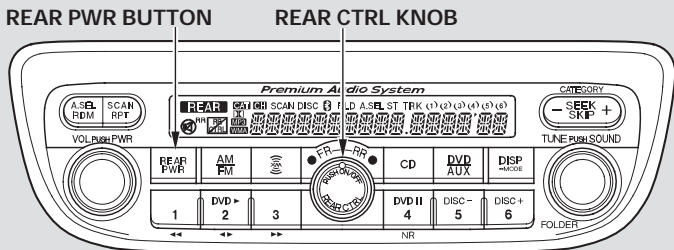

Overhead Screen Unit

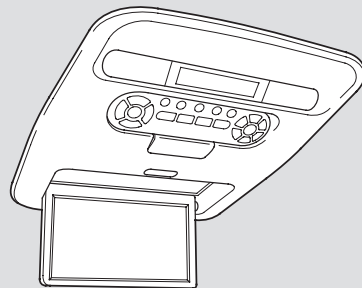

Models without Navigation System

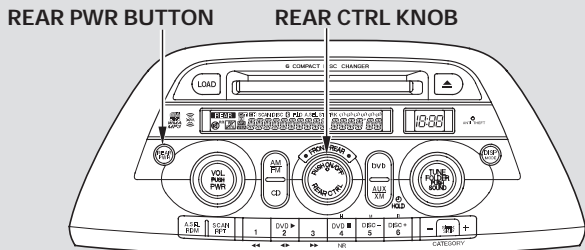

DVD Player

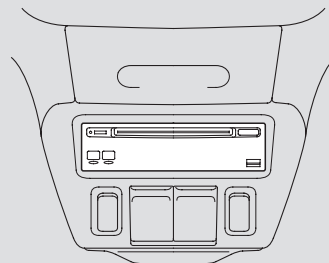

CONTINUED

Rear Entertainment System

Available on EX-L and Touring models

Your vehicle is equipped with a rear entertainment system that includes a DVD player for the enjoyment of the rear passengers.

With this system, the rear passengers can enjoy a different entertainment source (AM/FM radio, XM radio, CD changer, DVD player or AUX) than the front seat occupants. The audio is broadcast through the supplied wireless headphones.

The ignition switch must be in the ACCESSORY (I) or the ON (II) position to operate the rear entertainment system.

To Turn On the System

Press the REAR PWR button. To turn on the rear controls (ceiling panel/remote control), press the RR CTRL knob. The system's icon shows in the upper display. Your passengers can then operate the rear system with the control panel in the ceiling. The rear control panel can be used as a remote control when it is detached from the ceiling unit. Press the RR CTRL knob again to turn the rear controls off. You will see the Rear Controls Off icon in the upper display.

The rear system selects the source it was last set to. If that source has been removed (the DVD has been ejected from the player, for example), you will see "DVD EJECT" in the display. You should select another source or insert a DVD.

Rear Speakers

When you turn on the system, the rear speakers are automatically turned off if the rear system selects a different entertainment source than the front system. You will see the Rear Speakers Off icon in the upper display. The sound for the rear system is sent to the wireless headphones.

If you want to turn the rear speakers on again, press and hold the REAR PWR button until the Rear Speakers Off icon goes off.

NOTE: The rear speakers are connected to the front system, so they will always play the source that the front system is set to.

To Select Rear Entertainment from the Front Control Panel

To operate the rear entertainment system from the front panel, turn the RR CTRL knob counterclockwise. The amber RR LED comes on to show that the control panel is enabled.

To play the radio, the buttons for the front entertainment system have the same functions.

If CDs are loaded in the CD changer, select CD. If a CD is loaded in the lower player, select DVD/AUX.

Operating the DVD Player from the Front Control Panel

The DVD player in your rear entertainment system can play DVD video discs and CDs.

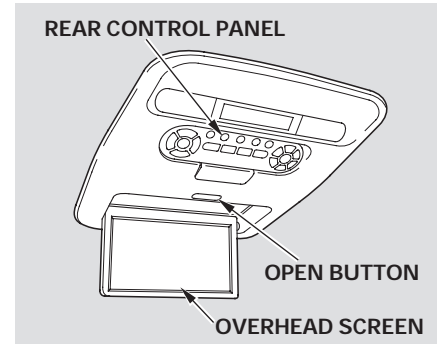

Open the overhead screen by pushing the OPEN button. The screen will swing down part-way. Pivot the screen the rest of the way. If you pivot the screen too far forward, past the second detent, the display will turn off. Pivot the screen back to the second or first detent to turn the display back on. To close the screen, pivot it up until it latches.

CONTINUED

Rear Entertainment System

Models with Navigation System

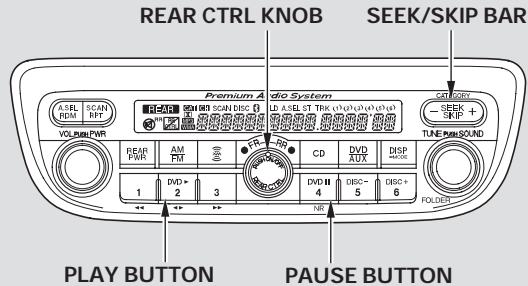

Models without Navigation System

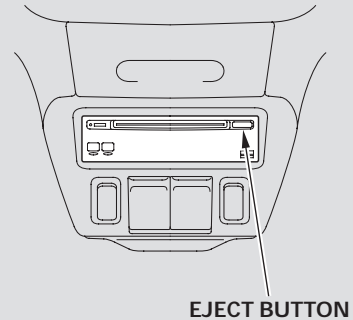
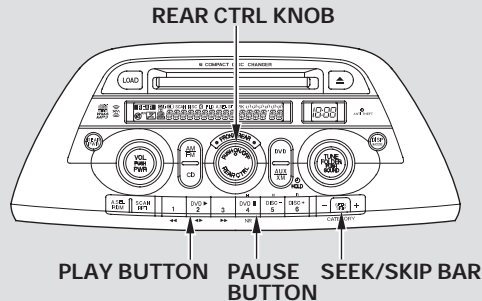

Turn the Rear CTRL knob clockwise. The amber Rear LED comes on to show that the control panel is now enabled.

Insert a DVD into the DVD/CD player below the front panel.

Push the DVD in halfway, the drive will pull it in the rest of the way.

PLAY - Press the PLAY button if the DVD does not start playing automatically.

PAUSE - Press the PAUSE button to pause the DVD. Press the button again or press PLAY to resume. Pause works only with the DVD player.

SEEK/SKIP - Press and hold the + side to move forward; you will see "CUE" in the display. Press and hold the - side to move backward; you will see "REV" in the display. Release the bar when the system reaches the point you want.

Each time you press and release the + side of the SEEK/SKIP bar, the system skips forward to the beginning of the next track or chapter. Press and release the - side of the bar to skip backward to the beginning of the current track or chapter. Press it again to skip to the beginning of the previous track or chapter.

EJECT - Press the eject button to remove the DVD from the drive.

To Return to Front Audio Controls







To return front panel control to the front audio system, turn the REAR CTRL knob counterclockwise.

Rear Entertainment System

Using the Rear Control Panel



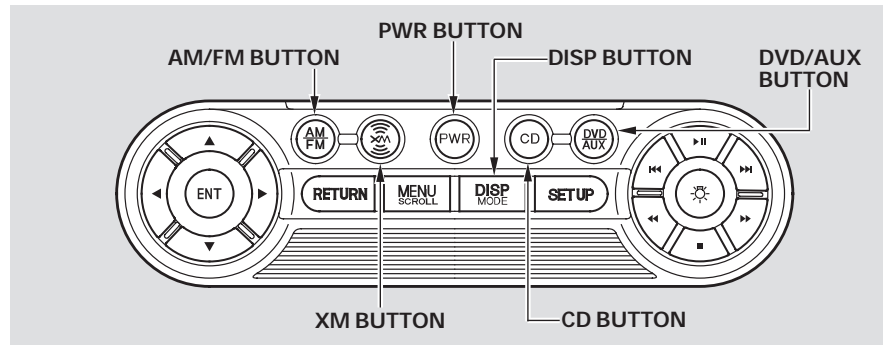

To turn on the rear entertainment system from the rear control panel, press the PWR button. Use the AM/FM button, XM button, CD button, DVD/AUX button to select the entertainment source. The selected source will be shown in the display. Make sure the rear control operation has not been disabled with the REAR CTRL knob on the front panel.

To Play the Radio from the Rear Control Panel

Use the  and  buttons to select a station from the preset buttons. Press the  button to tune the radio to a higher frequency, or press the  button to tune to a lower frequency. Pressing the  or  button causes the system to search up or down the band for a station with a strong signal. You will see SEEK in the display.



To Play the XM Radio from the Rear Control Panel

Use the  and  buttons to select a station from the preset buttons. Press the  button to search up the channels in the channel mode. The system will search up the channels within the category when the radio is in the category mode. Press the  button to search down the channels in the channel mode. The system will search down the channels within the category

when the radio is in the category mode.

Press the ►► or ◀◀ button to select another category.

Pressing and holding the DISP button for more than 5 seconds will change the search mode between Channel Search and Category Search. Each time you press and release the DISP button, the display above the rear control panel changes in the following sequence: Channel Number, Category Name, Music Name, Artist Name, Channel Name, and back to Channel Number.

To Play a CD from the Rear Control Panel

If CDs are loaded in the CD changer, select them by pressing the CD button. If a CD is loaded in the DVD player, press the DVD/AUX button. Press the ►► button to skip to the beginning of the next track. Press the ◀◀ button to return to the beginning of the current track.

To move rapidly within a track, press and hold the ►► or ◀◀ button. The system will continue to move through the track. Press the ►► button to move forward, or the ◀◀ button to move backward.

Release the button when the system reaches the point you want.

If CDs are loaded in the CD changer and the overhead screen is not open, pressing the or button changes the discs.

To Play the Optional Tape Player from the Rear Control Panel

To rewind the tape, push the ◀◀ button. You will see REW in the display. To fast forward the tape, push the ►► button. You will see FF displayed.

Press the ►► button to find the beginning of the current song or passage. Press the ◀◀ button to find the beginning of the next song or passage.

Press the ►|| button to change the tape direction.

Rear Entertainment System

To Play a DVD from the Rear Control Panel

The video screen is for use by rear seat passengers only. The driver and front seat passenger should not try to view the screen while driving.

Open the overhead screen by pushing the OPEN button. The screen will swing down part-way. Pivot the screen the rest of the way. If you pivot the screen too far forward, past the second detent, the display will turn off. Pivot the screen back to the second or first detent to turn the display back on. To close the screen, pivot it up until it latches.

Press the **▶||** button when you want to pause the DVD. Press this button again to go back to PLAY.

Press the **▶▶** button to skip to the beginning of the next chapter. Press the **◀◀** button to return to the beginning of the current chapter.

REAR CONTROL PANEL

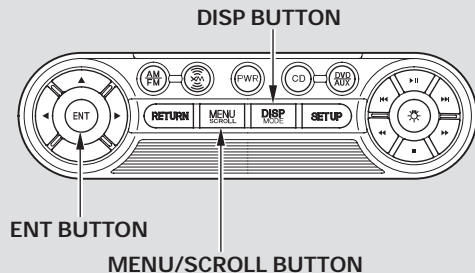
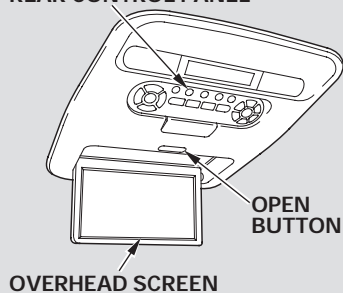

Press the **◀◀** button again quickly to go to the previous chapter.

To move rapidly within a chapter, press and hold the **▶▶** or **◀◀** button. The system will continue to move through the chapter. Press the **▶▶** button to move forward, or the **◀◀** button to move backward. Release the button when the system reaches the point you want.

To select the menu on the DVD, press the MENU/SCROLL button. Use the **▲**, **▼**, **▶**, and **◀** buttons to move to the desired menu selection, then press the ENT button to enter your selection.

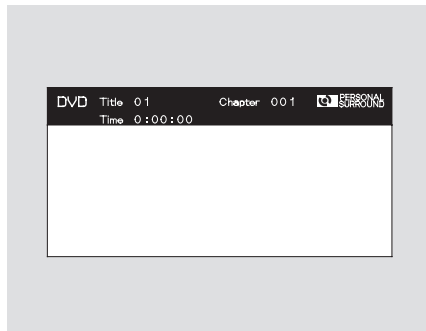
DISP Button

When you press the DISP button while a DVD is playing, the title, chapter, elapsed time, and personal surround logo are displayed (STATUS 1).

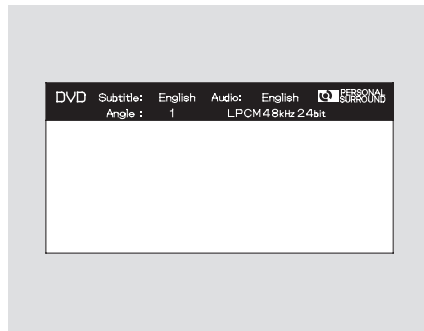

When you press the DISP button again, the subtitle, audio, angle, sound characteristics, and personal surround logo are displayed (STATUS 2).

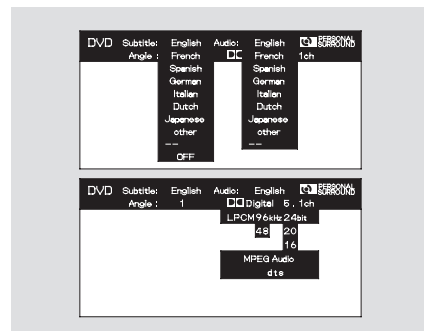

To go back to play, press the DISP button.

Rear Entertainment System

MENU Button

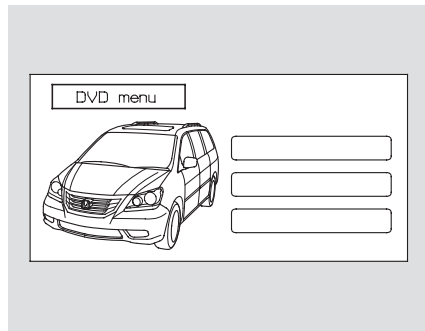

When you press the MENU button while a DVD is playing, the DVD's main menu is displayed. To go back to play, press the RETURN button.

System Messages

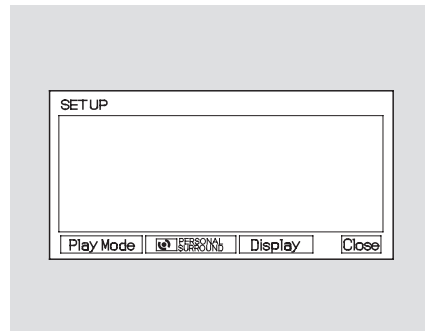

When you press the SETUP button while a DVD is playing, the DVD's setup menu is displayed at the bottom of the screen. You can then change various settings of play mode, personal surround, and display. To go back to play without changing any setting, press the RETURN or SETUP button, or select "Close" by pressing the ► or ◀ button, then press the ENT button.

Play Mode

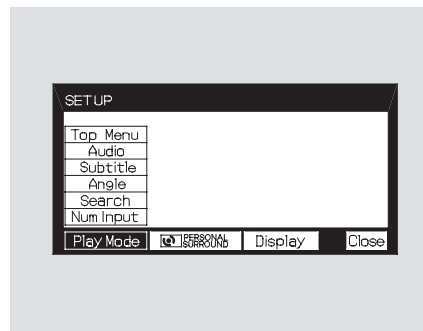

When you select "Play Mode" by pressing the ► or ◀ button, the play mode setup menu is displayed above the "Play Mode" icon.

Top Menu

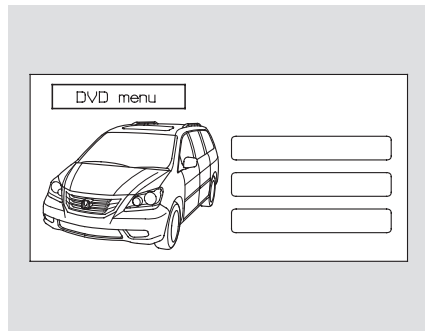

When you select “TOP MENU” using the **UP** or **DOWN** button, the DVD’s title menu is displayed. This menu is also displayed when you press the **MENU** button while a DVD is not playing.

To go back to play, press the return button.

Audio

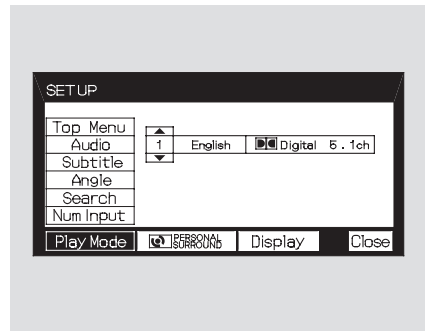

When you select “Audio” from the play mode setup menu by pressing the **UP** or **DOWN** button, you will see a submenu of the dubbed language.

Select the desired language by pressing the **UP** or **DOWN** button. The sound characteristics (Dolby Digital, LPCM, MPEG Audio, dts) recorded with the selected language are also displayed next to the language.

The selectable languages vary from DVD to DVD, and this feature may not be available on some DVDs.

Press the **RETURN** or **ENT** button to go back to the play mode setup menu.

CONTINUED

Rear Entertainment System

Subtitle

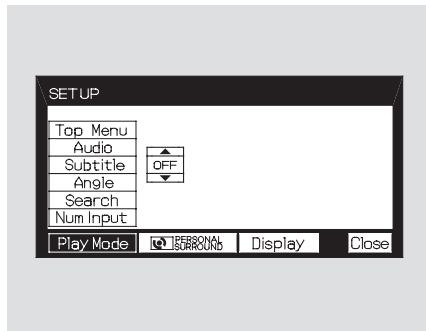

To turn the subtitle on and off, select "Subtitle" from the setup menu by pressing the **Left** or **Right** button. You will see submenu "OFF" or "ON." Select "OFF" or "ON" by pressing the **Up** or **Down** button.

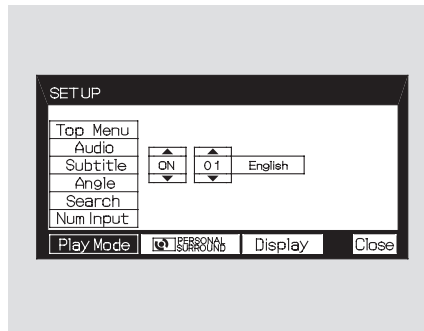

If more than one subtitle language is available, you will see the language currently selected when you select "ON" in the previous step. Select the desired subtitle language by pressing the **Left** or **Right** button. Press the RETURN or ENT button to go back to the play mode setup menu.

Angle

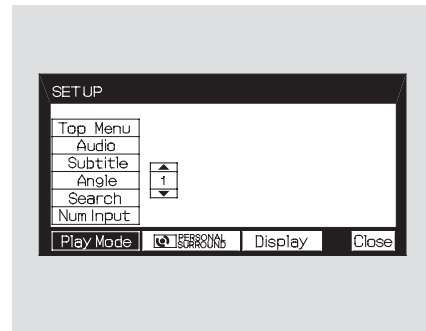

On some DVDs, the scenes are recorded by more than one camera, giving different viewpoints of the same scene. To change the angle, select "Angle" from the setup menu. You will see a submenu if there are different angles available. Select the number on the submenu by pressing the **Left** or **Right** button. Press the RETURN or ENT button to go back to the play mode setup menu.

Search

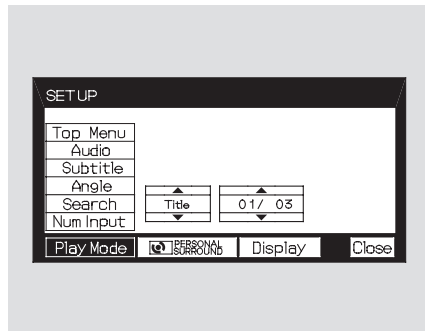

When you select “Search” from the play mode setup menu, you will see the submenu shown above. In the left submenu, you can select between “Title” and “Chapter.” The right submenu displays the current title or chapter number and the total number of titles or chapters.

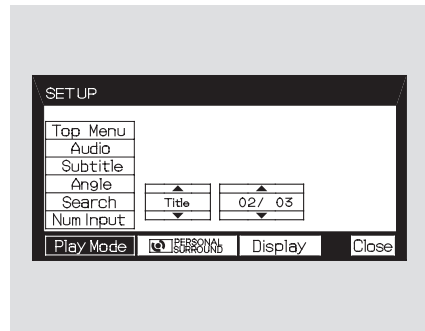

To do a title search, select “Title” by pressing the or button. Change the number on the right submenu by pressing the or button, and press the ENT button to begin the title search. If you press the RETURN button, the display returns to the play mode setup menu without doing the search.

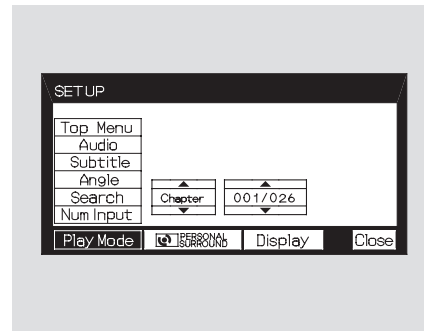

To do a chapter search, select “Chapter” by pressing the or button. Change the number on the right submenu by pressing the or button, and press the ENT button to begin the chapter search. If you press the RETURN button, the display returns to the play mode setup menu without doing the search.

CONTINUED

Rear Entertainment System

Num Input

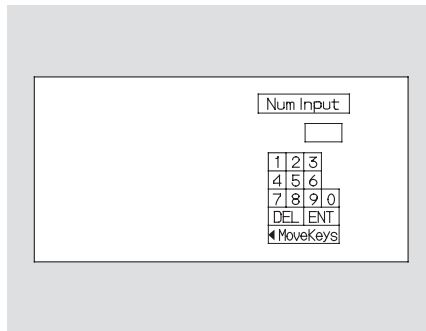

A numerical command can be issued to a DVD by inputting a two digit number, and a button number can be selected on the screen.

Select the "Num Input" from the play mode setup menu. The screen will change as shown above. If you select the "Move Key" using the \blacktriangledown , \blacktriangle , \blacktriangleright , or \blacktriangleleft button, and press the ENT button, the Num Input display on the screen will

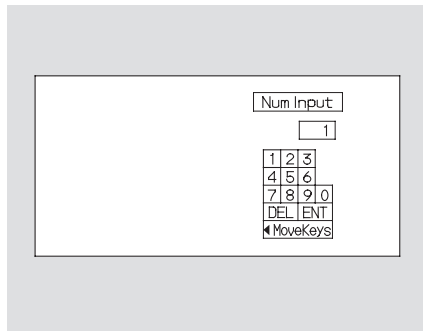

change from the left side to right side or right to left.

Select the first digit number using the \blacktriangledown , \blacktriangle , \blacktriangleright , or \blacktriangleleft button, and enter it by pressing the ENT button. If you want to change the number, select "DEL," and press the ENT button, then select and enter the new number.

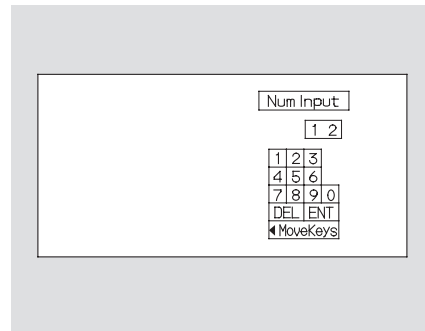

Select and enter the second digit number the same way. The cursor will automatically move to the "ENT" icon when you press the ENT button. Press the ENT button to enter the number command. To go back to the DVD screen, press the RETURN button.

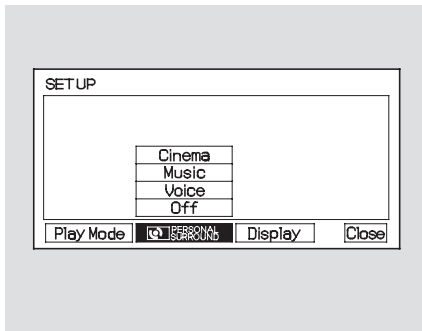
Personal Surround

When you select “PERSONAL SURROUND” by pressing the **▶** or **◀** button, the personal surround setup menu is displayed above the “PERSONAL SURROUND” icon.

Selecting one of the sound effects, Cinema, Music, or Voice, from the personal surround menu allows you to change the sound in your headphones to match the disc you are playing.

Select “Cinema,” “Music,” or “Voice” by pressing the **▶** or **◀** button, and enter your selection by pressing the ENT button. The “PERSONAL SURROUND” logo is displayed in the upper right corner of the screen.

If you select “Off,” the logo disappears, and there will be no special sound effect.

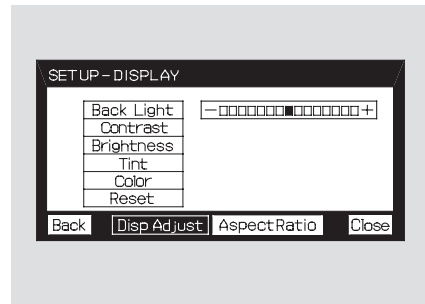
Display

To adjust the display, select “Display” by pressing the **▶** or **◀** button, and enter your selection by pressing the ENT button. The display changes as shown above.

You can adjust these display settings:

- Back Light
- Contrast
- Brightness
- Tint
- Color

CONTINUED

Rear Entertainment System

Back Light
 Contrast
 Brightness
 Tint
 Color

Select the quality you want to adjust by pressing the or button, and then pressing the ENT button. The adjustment bar is displayed next to the selected item. Adjust the setting by pressing the or button. When you are finished with your adjustment, press the ENT button.

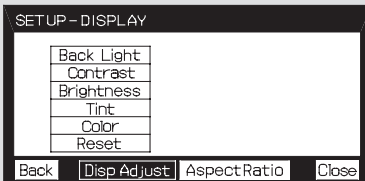

If you want to set the display to the default setting, select “Reset” by pressing the or button, and then pressing the ENT button.

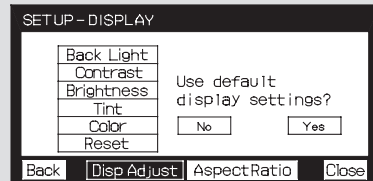

The display changes as shown above.

Select “Yes,” and press the ENT button. You will see the message “Default display settings applied” on the display for 5 seconds.

Screen Mode

You can set the screen mode to these settings:

- Normal
- Wide
- Zoom
- Full

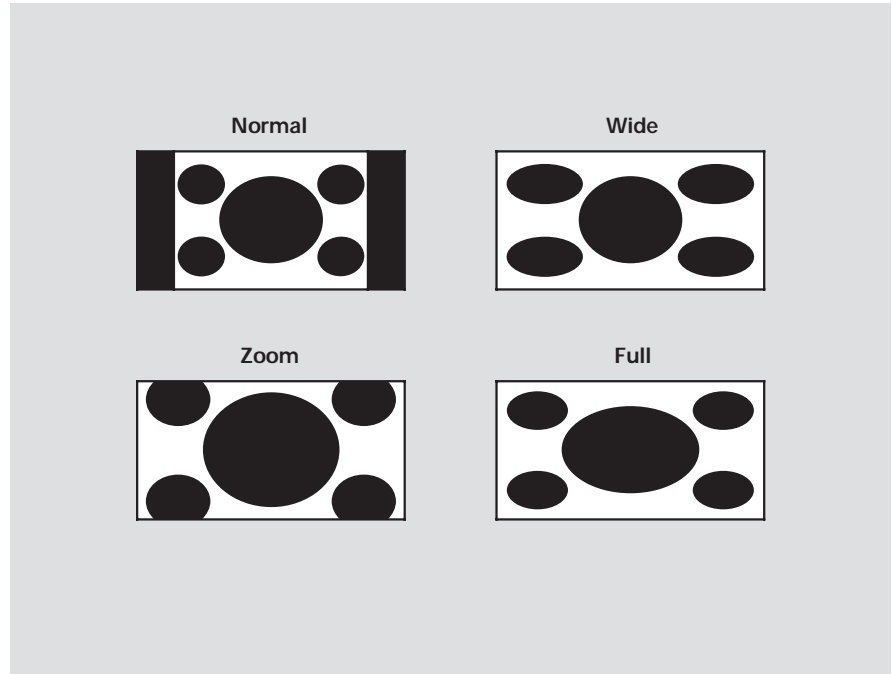

CONTINUED

Rear Entertainment System

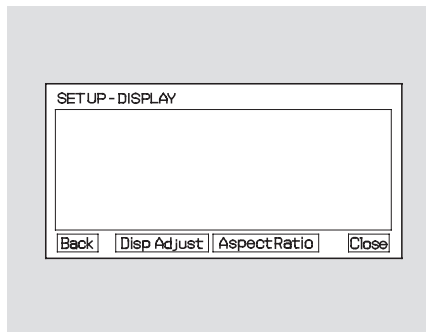

Select the “Aspect Ratio” by pressing the **▶** or **◀** button, then press the ENT button.

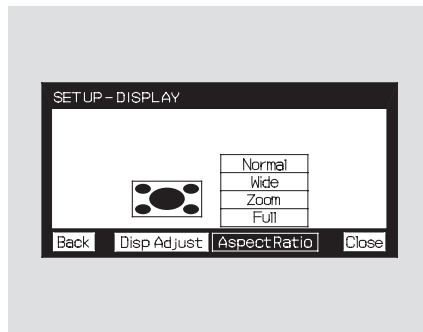

The selectable setting menu is displayed, and the current setting is highlighted in blue.

Select the desired setting by pressing the **▶** or **◀** button, then press the ENT button.

The selected setting will be highlighted in blue for one second, and the screen returns to the play mode in the selected setting.

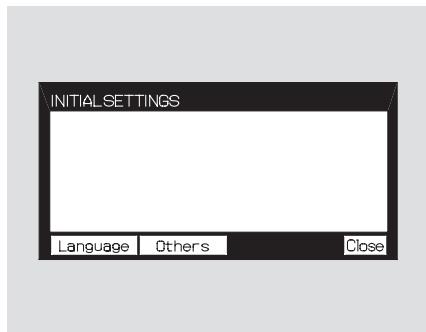
INITIAL SETTINGS Menu

When you press the **SETUP** button on the rear control panel when a DVD is not playing, the “INITIAL SETTINGS” menu is displayed.

There are two selectable menus: “Language” and “Others.”

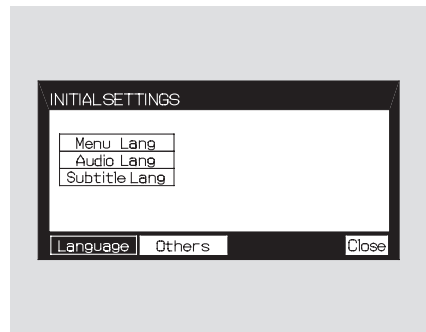
INITIAL SETTINGS (Language)

When you select “Language” with the **▶** or **◀** button, the menu shown above appears.

To return to the stop or prestop screen, select “Close” using the **▶** or **◀** button, and then press the **ENT**, or the **SETUP** button.

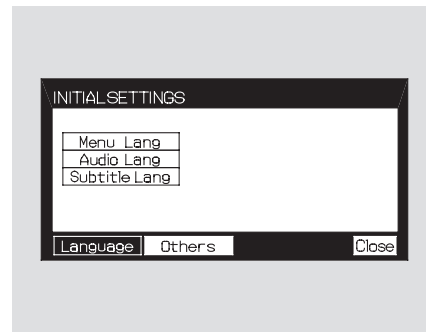
Menu Language

To select the language used in the DISC menus, select “Menu Lang” by pressing the **▶** or **◀** button. You will see the submenu next to “Menu Lang.”

CONTINUED

Rear Entertainment System

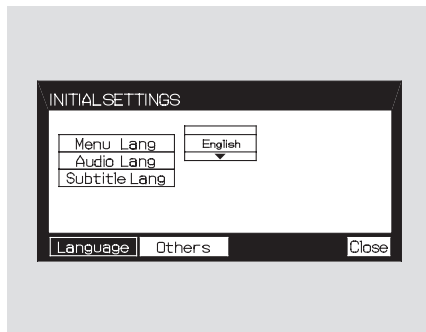

Select the desired language by pressing the **ENT** button, and then pressing the **ENT** button.

The selectable languages are, English, French, Spanish, German, Italian, Dutch, and Japanese.

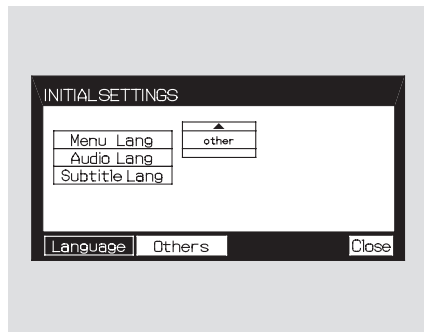

If you want another language than those listed, you need to enter the code number of the desired language. Select "other," and press the **ENT** button. The display changes as shown in the next column.

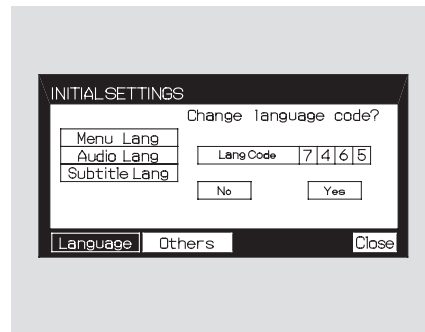

If you select "No," and press the **ENT** button, the display returns to the initial screen of the "Language" menu.

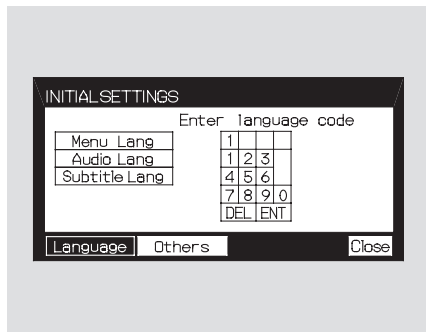

If you select “Yes,” the display changes to the language code input mode. Select the first number digit using the ▼, ▲, ►, or ◀ button, and press the ENT button to enter it. Repeat this until all four digits are filled. When the fourth digit is entered, the cursor automatically moves to “ENT” on the display. Press the ENT button on the control panel to enter the new language code.

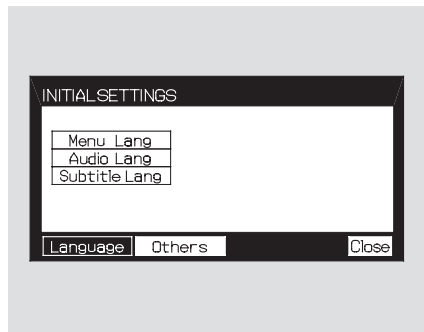

If you made a mistake entering a number digit, select “DEL” on the display with the ▼, ▲, ►, or ◀ button, and press the ENT button on the control panel. Then select and enter the correct number digit as described. The display returns to the initial “Language” menu screen.

Audio Language

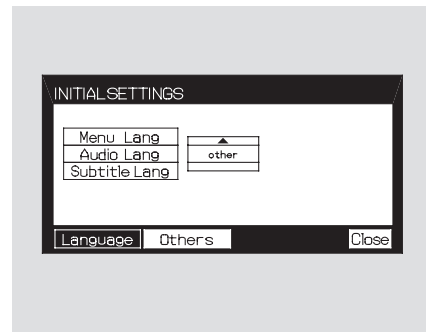

You can select the dubbed language before playing DVDs. Select “Audio Language” by pressing the or button. You will see the submenu next to “Audio Language.”



Follow the same instructions you used to set the menu language.

CONTINUED

Rear Entertainment System

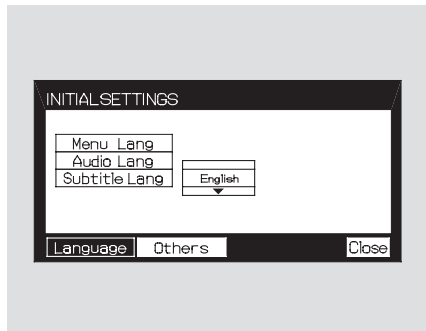
Subtitle Language



You can select the subtitle language before playing DVDs. Select "Subtitle Language" by pressing the  or  button. You will see the submenu next to the "Subtitle Language."

Follow the same instructions you used to set the menu language.

INITIAL SETTINGS (Others)

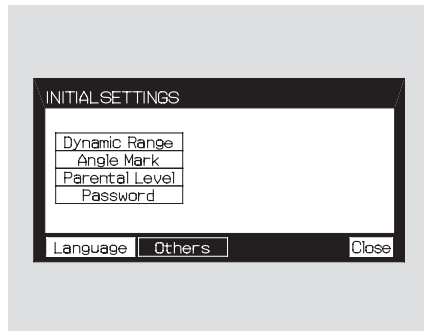

When you select "Others" at the bottom of the "INITIAL SETTINGS" screen, the above menu appears on the screen.

Dynamic Range

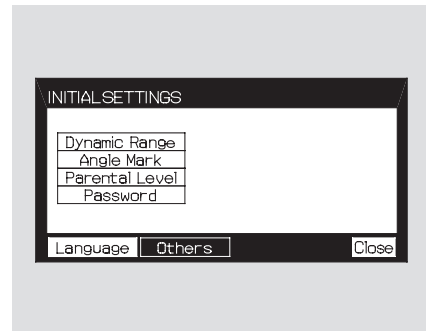

"Dynamic Range" reduces the differences between the loud and quiet sound levels throughout the disc. When this is on, the louder sounds are lowered, and quieter sounds are increased.

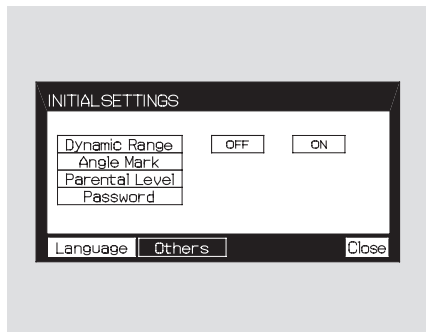

When you select the “Dynamic Range” by pressing the **▶** or **◀** button, you will see the submenu next to the “Dynamic Range” as shown above.

To turn “Dynamic Range” on or off, select “ON” or “OFF” by pressing the **▶** or **◀** button, and then press the ENT button.

Angle Mark

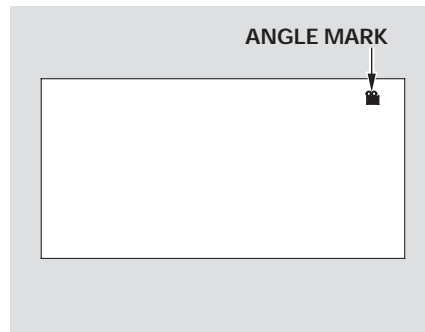

When you switch to another angle while playing a DVD, the angle mark is displayed in the upper right corner of the screen.

You can set the system to display or not display this angle mark.

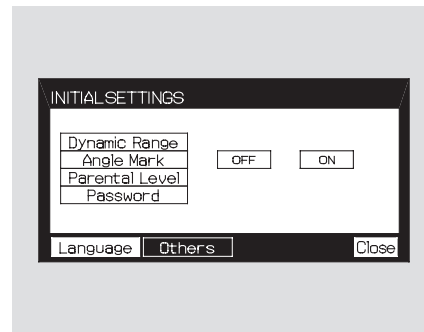

Select “Angle Mark” by pressing the **▶** or **◀** button. The above submenu appears. If you want the angle mark to be displayed, select “ON” with the **▶** or **◀** button, and then press the ENT button. The display returns to the “Others” menu.

CONTINUED

Rear Entertainment System

Parental Control Level

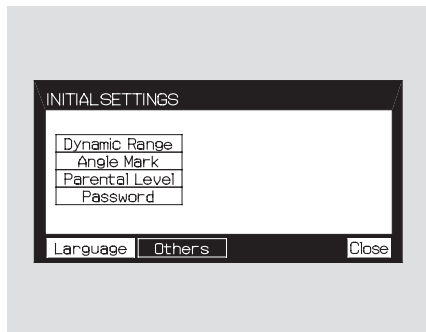

You can place an auditory restriction by changing the parental control level. The higher the level number, the lower the restriction.

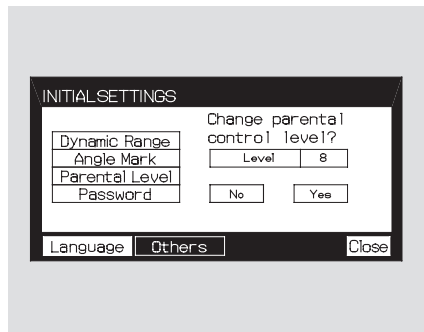

Select "Parental Level" by pressing the **or** button. You will see the submenu shown above. If you select "No," and press the ENT button, the display returns to the "Others" menu.

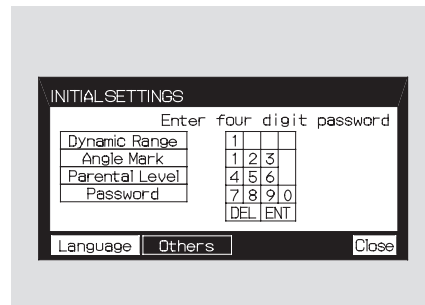

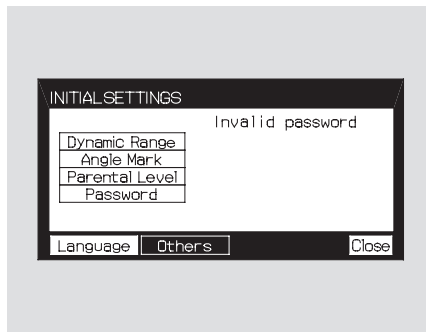

When you select and enter "Yes," the display changes as shown above. To change the level, you need to enter your four digit password. Select the number for the first digit by pressing the **▼**, **▲**, **▶**, or **◀** button, and enter it by pressing the ENT button. Repeat this until all four digits are filled. When you enter the fourth number, the cursor automatically moves to "ENT" on the display. Press the ENT button on the control panel.

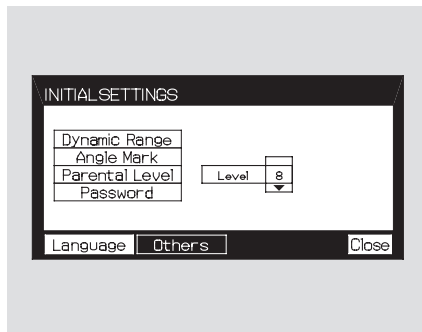

If the system does not recognize the password you entered, you will see the above display. Repeat the parental control level steps until you enter the correct password.



If you enter the password correctly, you can then change the parental control level.

Once you correctly enter the password, press the  or  button to change the level, and then press the ENT button to enter your selection.

Changing the Password

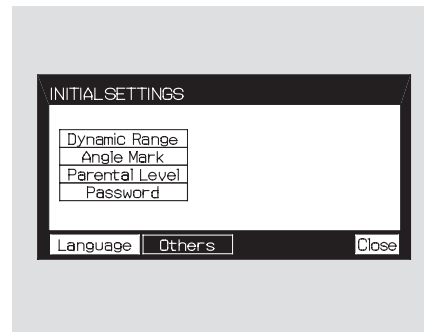

The password was set to “1111” when the vehicle left the factory.

CONTINUED

Rear Entertainment System

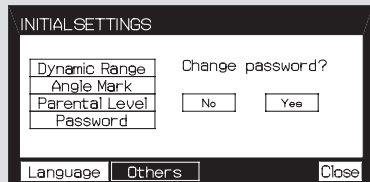

To change the password, select "Password." You will see the above menu displayed. Select "Yes" by pressing the **▶** or **◀** button, then press the ENT button.

If you select "No," and press the ENT button, the display returns to the "Others" menu.

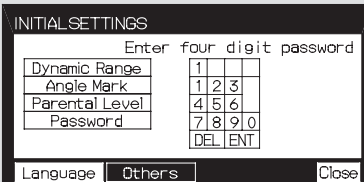

Select the first digit by pressing the **▼**, **▲**, **▶**, or **◀** button, and enter it by pressing the ENT button. Repeat this until all four digits are entered. When you enter the fourth number, the cursor automatically moves to "ENT" on the display. Press the ENT button on the control panel.

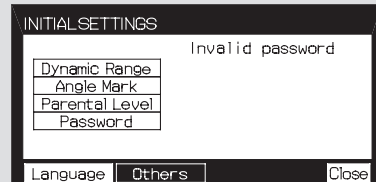

If the system does not recognize the password you entered, you will see the above display. Repeat the password setting steps until you enter the correct password.

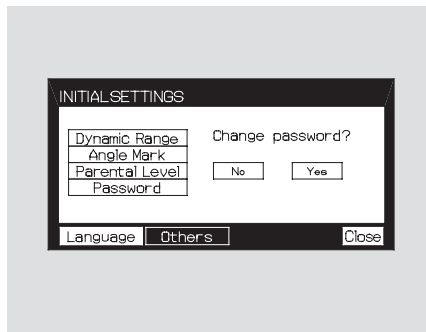

If you forget the password, select "Password," and press the button 10 times.

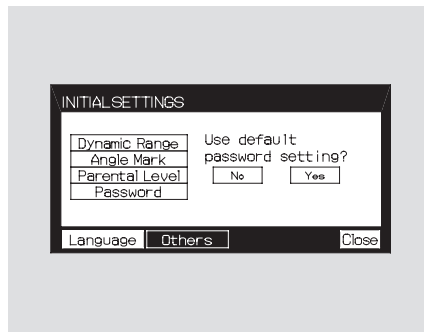

The display changes as shown above. If you want to use the default password (1111), select "Yes," and press the ENT button.

The message "Default password setting applied" is displayed for 5 seconds.

Rear Entertainment System

Remote Control

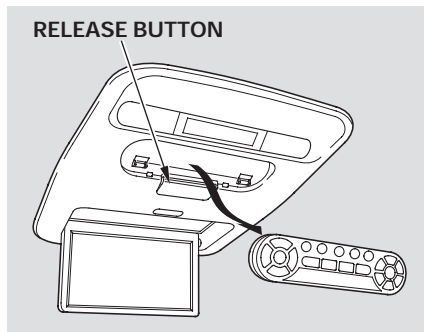

The rear control panel can be detached from the ceiling unit and used as a remote control. To remove it from the ceiling unit, press the release button. The control panel will swing down partway. Pivot it down further past the detent until it detaches from the hinge. To reinstall it, reverse the procedure.

Replacing the Remote Control Batteries

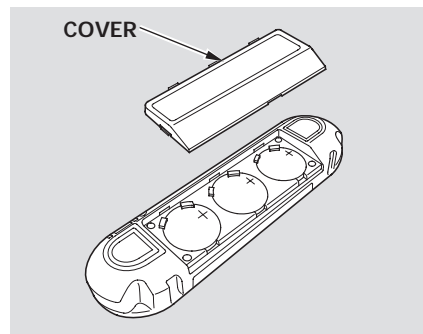

If it takes several pushes on the button to operate the rear entertainment system, have your dealer replace the batteries as soon as possible.

Battery type: BR3032

An improperly disposed of battery can hurt the environment. Always confirm local regulations for battery disposal.

As required by the FCC: This device complies with Part 15 of the FCC rules. Operation is subject to the following two conditions: (1) This device may not cause harmful interference, and (2) this device must accept any interference received, including interference that may cause undesired operation.

Changes or modifications not expressly approved by the party responsible for compliance could void the user's authority to operate the equipment.

This device complies with Industry Canada Standard RSS-210. Operation is subject to the following two conditions: (1) this device may not cause interference, and (2) this device must accept any interference that may cause undesired operation of the device.

Playable DVDs



There are various types of DVDs available. Some of them are not compatible with your system.

The DVD player in your rear entertainment system can play DVDs and CDs bearing the above marks on their packages or jackets.

Those packages or jackets should also bear the designation of “1” or “ALL”. DVD-ROMs cannot be played in this system.

Protecting DVDs

The tips on how to handle and protect DVDs are basically the same as those for compact discs. Refer to “Protecting Your CDs” on page [272](#).

Rear Entertainment System

DVD Player Error Messages

The chart on the right explains the error messages you may see in the display while playing a disc.

If you see an error message in the display while playing a disc, press the eject button. After ejecting the disc, check it for damage or deformation. If there is no damage, insert the disc again.

For the additional information on damaged discs, see page [273](#).

The audio system will try to play the disc. If there is still a problem, the error message will reappear. Press the eject button, and pull out the disc.

Insert a different disc. If the new disc plays, there is a problem with the first disc. If the error message cycle repeats and you cannot clear it, take your vehicle to a dealer.

Message	Solution
ERROR F0	Eject the disc and reinsert it.
ERROR F2	
Invalid region code	Use a disc with the regional designation of "1" or "All".
Invalid disc	The disc is not playable in this unit. Eject the disc, and insert a disc compatible with this system.
Parental control active. Change level to view.	Reinsert the disc, and increase the parental control level (see pages 308 and 309).

Wireless Headphones

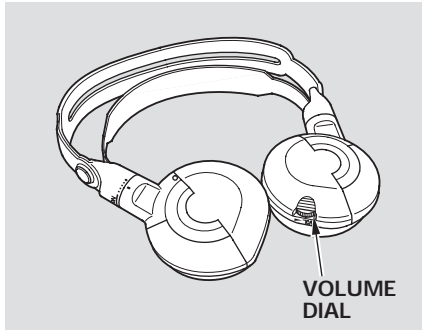

Some state and local government agencies prohibit the use of headphones by the driver of a motor vehicle. Always obey applicable laws and regulations.

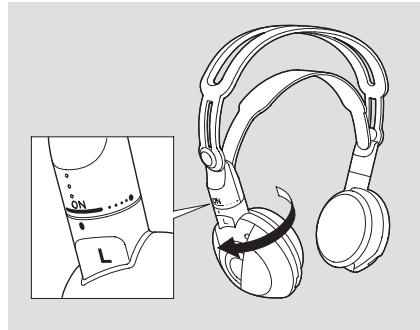

The audio for the rear entertainment system is sent to the wireless headphones that come with the system. When using the headphones, make sure you wear them correctly: L (left) and R (right) are marked on the sides of the frame. Wearing the headphones backwards may affect audio reception, limiting the sound quality and range.

To use the headphones, pivot the earpieces outward. This turns them on. To adjust the volume, turn the dial on the bottom of the right earpiece. When you remove the headphones, the earpieces automatically pivot inward, and the headphones turn off. When not in use, store the headphones in the pocket of either front seat.

Rear Entertainment System

Replacing Batteries

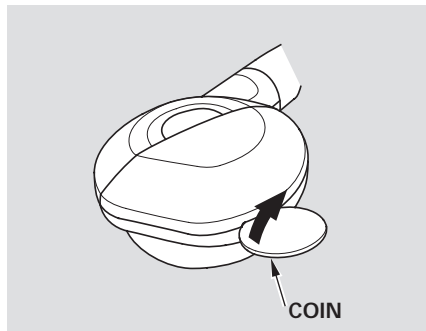

Each headphone uses one AAA battery. The battery is under the cover on the left earpiece. To remove the cover, insert a coin in the slot and twist it slightly to pry the cover away from the earpiece. Pull the cover outward, and pivot it out of the way.

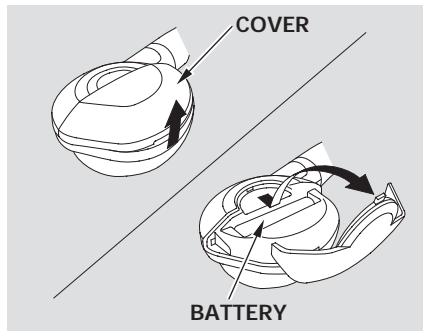

Remove the battery. Install the new battery in the earpiece as shown in the diagram next to the battery slot. Slide the cover back into place on the earpiece, then press down on the back edge to lock it in place.

An improperly disposed of battery can hurt the environment. Always confirm local regulations for battery disposal.

Auxiliary Input Jacks

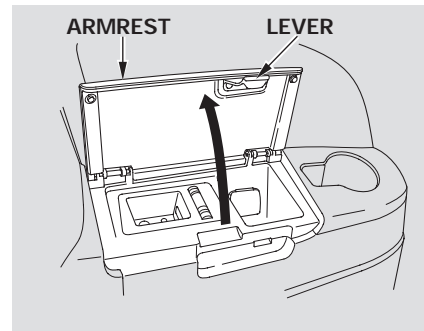

Auxiliary input jacks and headphone connectors for the rear entertainment system are under the third row seat armrest on the driver's side. To access these connectors, open the cover by pulling up on the lever.

AUXILIARY INPUT JACKS

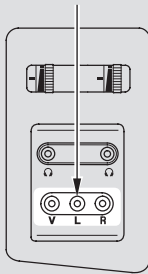

The system will accept auxiliary inputs from standard video games and video equipment. Some video game power supplies may cause poor picture quality.

V = Video jack
L = Left audio jack
R = Right audio jack

VOLUME DIALS

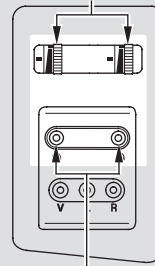

HEADPHONE CONNECTORS

There are two headphone connectors for the third row seat passengers. Each connector has its own volume control.

Security System

The security system helps to protect your vehicle and valuables from theft. The horn sounds and a combination of headlights, parking lights, side marker lights, and taillights flashes if someone attempts to break into your vehicle or remove the radio. This alarm continues for 2 minutes, then the system resets. To reset an alarming system before the 2 minutes have elapsed, unlock the driver's door with the key or the remote transmitter.

The security system automatically sets 15 seconds after you lock the doors, hood, and the tailgate. For the system to activate, you must lock the doors and the tailgate from the outside with the key, driver's lock tab, door lock master switch, or remote transmitter. The security system indicator on the instrument panel starts blinking immediately to show you the system is setting itself.

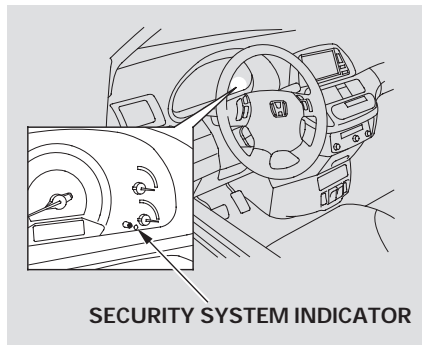

Once the security system is set, opening any door, the tailgate, or the hood without using the key or the remote transmitter, will cause it to alarm. It also alarms if the radio is removed from the dashboard or the wiring is cut.

The alarm will also be activated if the passenger inside the locked vehicle turns the ignition switch on.

The security system will not set if the hood, tailgate, or any door is not fully closed. Before you leave the vehicle, make sure the doors, tailgate, and hood are securely closed.

NOTE: To see if the system is set after you exit the vehicle, press the LOCK button on the remote transmitter within 5 seconds. If the system is set, the horn will beep once.

Do not attempt to alter this system or add other devices to it.

Cruise control allows you to maintain a set speed above 25 mph (40 km/h) without keeping your foot on the accelerator pedal. It should be used for cruising on straight, open highways. It is not recommended for city driving, winding roads, slippery roads, heavy rain, or bad weather.

⚠ WARNING

Improper use of the cruise control can lead to a crash.

Use the cruise control only when traveling on open highways in good weather.

Using Cruise Control

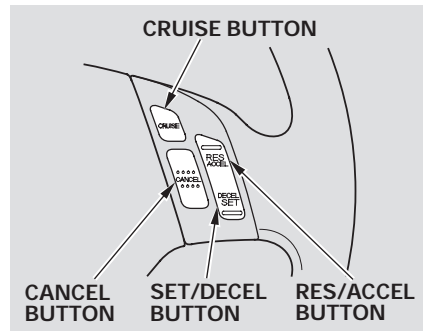

1. Push the **CRUISE** button on the steering wheel. The **CRUISE MAIN** indicator on the instrument panel comes on.
2. Accelerate to the desired cruising speed above 25 mph (40 km/h).

3. Press and release the **SET/DECEL** button on the steering wheel. The **CRUISE CONTROL** indicator on the instrument panel comes on to show the system is now activated.

Cruise control may not hold the set speed when you are going up and down hills. If your vehicle speed increases going down a hill, use the brakes to slow down. This will cancel the cruise control. To resume the set speed, press the **RES/ACCEL** button. The **CRUISE CONTROL** indicator on the instrument panel will come back on.

When climbing a steep hill, the automatic transmission may downshift to hold the set speed.

Cruise Control

Changing the Set Speed

You can increase the set speed in any of these ways:

- Press and hold the RES/ACCEL button. When you reach the desired speed, release the button.
- Push on the accelerator pedal. Accelerate to the desired cruising speed, then press the SET/DECEL button.
- To increase the speed in very small amounts, tap the RES/ACCEL button. Each time you do this, your vehicle will speed up about 1 mph (1.6 km/h).

You can decrease the set speed in any of these ways:

- Press and hold the SET/DECEL button. Release the button when you reach the desired speed.
- To slow down in very small amounts, tap the SET/DECEL button. Each time you do this, your vehicle will slow down about 1 mph (1.6 km/h).
- Tap the brake pedal lightly with your foot. The CRUISE CONTROL indicator on the instrument panel will go out. When the vehicle slows to the desired speed, press the SET/DECEL button.

Even with cruise control turned on, you can still use the accelerator pedal to speed up for passing. After completing the pass, take your foot off the accelerator pedal. The vehicle will return to the set speed.

Resting your foot on the brake pedal causes cruise control to cancel.

Cancelling Cruise Control

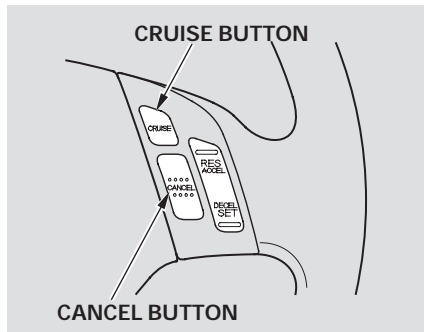

You can cancel cruise control in any of these ways:

- Tap the brake pedal.
- Push the CANCEL button on the steering wheel.
- Push the CRUISE button on the steering wheel.

The cruise control will be canceled when the vehicle speed reaches about 25 mph (40 km/h) or less.

Resuming the Set Speed

When you push the CANCEL button or tap the brake pedal, the system remembers the previously set speed. To return to that speed, accelerate to above 25 mph (40 km/h), then press and release the RES/ACCEL button. The CRUISE CONTROL indicator comes on. The vehicle accelerates to the same speed as before.

Pressing the CRUISE button turns the system completely off and erases the previous set speed.

HomeLink® Universal Transceiver

On EX, EX-L and Touring models

The HomeLink® Universal Transceiver built into your vehicle can be programmed to operate up to three remote controlled devices around your home, such as garage doors, lighting, or home security systems.

General Information

Before programming your HomeLink to operate a garage door opener, confirm that the opener has an external entrapment protection system, such as an “electronic eye,” or other safety and reverse stop features.

If your garage door was manufactured before April 1, 1982, you may not be able to program HomeLink to operate it. These units do not have safety features that cause the motor to stop and reverse it if an obstacle is detected during closing, increasing the risk of injury.

Do not use HomeLink with any garage door opener that lacks safety stop and reverse features.

Units manufactured between April 1, 1982 and January 1, 1993 may be equipped with safety stop and reverse features. If your unit does not have an external entrapment protection system, an easy test to confirm the function and performance of the safety stop and reverse feature is to lay a 2 × 4 under the closing door. The door should stop and reverse upon contacting the piece of wood. As an additional safety feature, garage door openers manufactured after January 1, 1993 are required to have external entrapment protection systems, such as an electronic eye, which detect an object obstructing the door.

Important Safety Precautions

Refer to the safety information that

came with your garage door opener to test that the safety features are functioning properly. If you do not have this information, contact the manufacturer of the equipment. Before programming HomeLink to a garage door or gate opener, make sure that people and objects are out of the way of the device to prevent potential injury or damage. When programming a garage door opener, park just outside the garage.

Training HomeLink

Before you begin - If you just received your vehicle and have not trained any of the buttons in HomeLink before, you should erase any previously learned codes before training the first button. To do this, press and hold the two outside buttons on the HomeLink transceiver for about 20 seconds, until the red indicator flashes. Release the buttons, then proceed to step 1.

If you are training the second or third buttons, go directly to step 1.

Training a Button

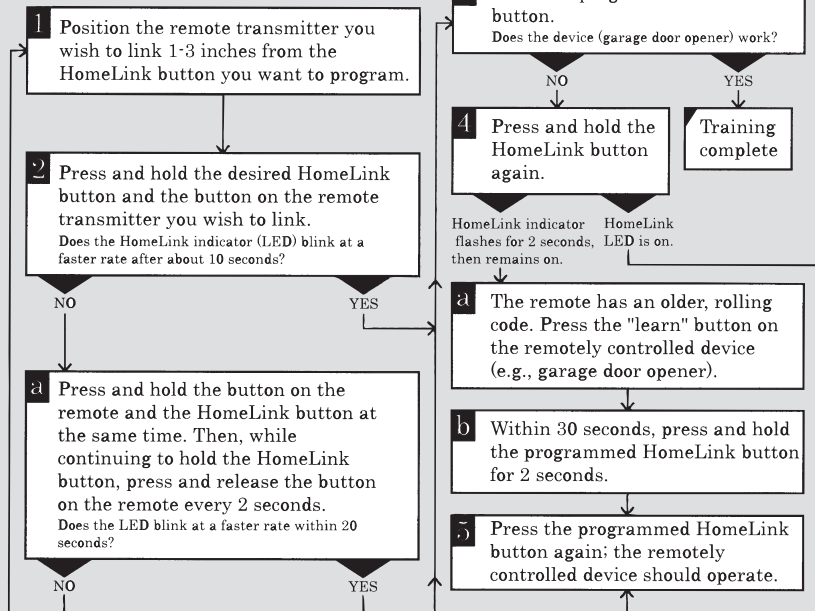

Retraining a Button

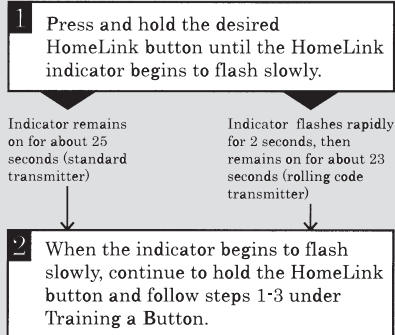

Erasing Codes

To erase codes stored in all buttons, press and hold the two outer buttons until the HomeLink indicator begins to flash (about 10 to 20 seconds), then release the buttons. You should erase all three codes before selling the vehicle.

If you have any problems programming HomeLink, see the owner's manual included with the device you are trying to program, or call HomeLink at 1-800-355-3515 or go online to www.homeLink.com.

HomeLink® Universal Transceiver

HomeLink® is a registered trademark of Johnson Controls, Inc.

As required by the FCC:

This device complies with Part 15 of the FCC rules. Operation is subject to the following two conditions: (1) This device may not cause harmful interference, and (2) this device must accept any interference received, including interference that may cause undesired operation.

Changes or modifications not expressly approved by the party responsible for compliance could void the user's authority to operate the equipment.

This device complies with Industry Canada Standard RSS-210.

Operation is subject to the following two conditions: (1) this device may not cause interference, and (2) this device must accept any interference that may cause undesired operation of the device.

Touring models only

Your vehicle is equipped with the Bluetooth® HandsFreeLink® (HFL). HFL uses Bluetooth® technology to link your cellphone to your vehicle. With HFL, you can place and receive calls through your vehicle's audio system, without the distraction of handling your cellphone. To use this feature, you need a Bluetooth-compatible cellphone with the Hands Free Profile. For more information, and a list of compatible cellphones, visit handsfreelink.honda.com, or call (888) 528-7876. In Canada, visit www.honda.ca, or call (888) 9-HONDA-9. The HFL is available in both English and French (Canadian models only). To change the language, see page [349](#).

Here are the main features of the HFL. Instructions for using the HFL begin on page [328](#).

Voice Control

HFL recognizes simple voice commands, such as phone numbers and names. It uses these commands to automatically dial, receive, and store numbers. For more information on voice control, see Using Voice Control on page [328](#).

Bluetooth Wireless® Technology

Bluetooth® is a registered trademark of Bluetooth SIG, Inc. Bluetooth is the wireless technology that links your phone to the HFL. The HFL uses a Class 2 Bluetooth, which means the maximum range between your phone and vehicle is 30 feet (10 meters). To use the HFL, your phone must have approved Bluetooth capability along with the Hands Free Profile. This type of phone is available through many phone makers and cellular carriers. You can also find an approved phone by visiting handsfreelink.honda.com, or by calling

the Hands Free Link® consumer support at (888) 528-7876. In Canada, visit www.honda.ca, or call (888) 9-HONDA-9.

The Bluetooth® word mark and logos are registered trademarks owned by Bluetooth SIG, Inc. and any use of such marks by Honda Motor Co., Ltd. is under license. Other trademarks and trade names are those of their respective owners.

Incoming/Outgoing Calls

With a linked phone, the HFL allows you to send and receive calls in your vehicle without holding the phone.

Bluetooth® HandsFreeLink®

Phonebook

The HFL can store up to 50 names and phone numbers in its phonebook. With a linked phone, you can then automatically dial any name or number in the phonebook.

Your vehicle's HFL system has the cellular phonebook import function. This allows you to import your cellular phonebook to the HFL. Using the navigation system, you can make a call directly and store a desired number in the HFL from the list shown on the navigation display. For more information on how to import the phonebook or to make a call, see page [335](#).

You can also store the desired number to the HFL directly from your cellular phone using the receive contact function in the HFL.

Microphone

The HFL microphone is on the ceiling, between the front map lights and the HomeLink buttons. On models with navigation system, the microphone is shared with the navigation system.

Audio System

When the HFL is in use, the sound comes through the vehicle's front audio system speakers. If the audio system is in use while operating either of the HFL buttons or making a call, the HFL overrides the audio system. To change the volume level, use the audio system volume knob, or the steering wheel volume controls.

HFL Buttons

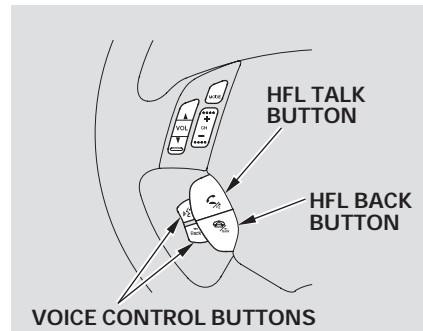

To operate the HFL, use the HFL Talk and Back buttons on the left side of the steering wheel.

The HFL buttons are used as follows:

HFL Talk: This button is used before you give a command, to answer incoming calls, and to confirm system information. Press and release the button, then wait for a beep before giving a command.

HFL Back: This button is used to end a call, go back to the previous voice control command, and to cancel an operation.

Information Display

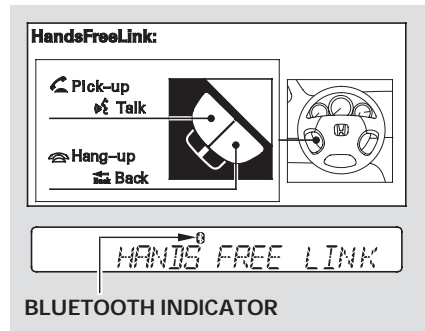

When you are operating the HFL, dialing or receiving calls with the audio system in use, you will see the above screen on the navigation display.

You will also see “HANDS FREE LINK” on the audio display.

“” indicator will be displayed on the audio display if your phone is linked to the Bluetooth® compatible cell phone.

Bluetooth® HandsFreeLink®

How to Use the HFL

The HFL is operated by the HFL Talk and Back buttons on the left side of the steering wheel. The next few pages provide instructions for all basic features of the HFL.

NOTE: All phones may not operate identically, and some may cause inconsistent operation of the HFL.

Using Voice Control

Here are some guidelines for using voice control:

- To enter a command, press and release the Talk button. Then, after the beep, say your command in a clear, natural tone.
- Close the windows and the moonroof.
- Lower the A/C fan speed during voice recognition operation.
- Adjust the airflow from both the dashboard and side vents so they do not blow against the microphone on the ceiling.
- After pressing the Talk button, wait for the beep, then give a voice command.

- Give a voice command in a clear natural speaking voice without pausing between words or numbers. If the system cannot recognize your command because of the background noise, speak louder.
- If the microphone picks up voices other than yours, the system may not interpret your voice commands correctly.
- If the HFL does not recognize a command, its response is, "Pardon." If it doesn't recognize the command a second time, its response is, "Please repeat." If it doesn't recognize the command a third time, it plays the Help prompt.

- To hear a list of available options at any time, press the Talk button, wait for the beep, and say, “Hands free help.”
 - Many commands can be spoken together. For example, you can say, “Dial 123-456-7891.”
 - To enter a string of numbers in a Call or Dial command, you can say them all at once, or you can separate them in blocks of 3, 4, 7, 10, and 11.
 - To skip a voice prompt, press the Talk button while the HFL is speaking. The HFL will then begin listening for your next command.
- To go back one step in a command process, say, “Go back,” or press the Back button.
If nothing is said while the HFL is listening for a command, the HFL will time out and stop its voice recognition. The next time you press the Talk button, the HFL begins listening from the point at which it timed out.
 - To end a command sequence at any time, press and hold the Back button, or press and release the Talk button, wait for the beep, and say, “Cancel.” The next time you press the Talk button, the HFL begins from its main menu.
- When you finish a command sequence, the HFL goes back to its main menu. For example, when you store the name, “Eric,” the HFL response is, “Eric has been stored.” The next time you press the Talk button, you will be at the main menu.

Bluetooth® HandsFreeLink®

Setting Up the System

The voice of the HFL can be set to male or female (U.S. models only). Also, the incoming notification can be set to a ring tone, a prompt, or no notification.

To set up the system, do this:

1. Press and release the Talk button. After the beep, say "System." The HFL response is, "System options are setup and clear."
2. Press and release the Talk button. After the beep, say "Setup." The HFL response is "Would you like male or female prompts?"

3. Press and release the Talk button. After the beep, say "Male" or "Female," depending on the system voice you want. The HFL response is, "Male (Female) prompts have been selected. Would you like an audible notification of an incoming call?"
4. Press and release the Talk button. If you say "Yes" after the beep, the HFL response is, "Would you like the notification to be a ring tone or prompt?" If you say "No" after the beep, the HFL returns to its main menu. Saying "No" will result in no ring tone or prompt playback during an incoming call. The audio system will still mute, and a message will be displayed.

5. Press and release the Talk button. After the beep, say "Ring tone" or "Prompt." The HFL response is "A ring tone will be used" or "An incoming call prompt will be used." If you choose "Ring tone," you will hear a ring tone through the audio speakers to announce an incoming call. If you choose "Prompt," you will hear this message to announce an incoming call: "You have an incoming call."
6. The HFL response continues "A security option is available to lock the HFL system. Each time the vehicle is turned on, a passcode would be required to use this system. Would you like this security option turned on?" If you say "Yes," you can set your passcode. Refer to the setting procedure in the next column.

Setting Your Passcode

The HFL will accept a numeric, four-digit passcode that you can use for security purposes.

To set your passcode, do this:

1. Follow the system setup procedure as described previously.
2. Press and release the Talk button. After the beep, say “Yes.”
3. The HFL response is “What is the four-digit number you would like to set as your passcode?”
4. Press and release the Talk button. After the beep, say the four-digit passcode you want to use. For example, say “1, 2, 3, 4.” The HFL response is “1, 2, 3, 4. Is this correct?”

5. Press and release the Talk button. After the beep, say “Yes.” The HFL response is “Security is on. Each time the vehicle is turned on, the passcode will be required to use the system. The system setup is complete. Returning to the main menu.”

6. Press and release the Talk button. If you say “No.” after the beep, the HFL response is “Security will not be used. The system setup is complete.”

To enter your passcode, do this:

Once a passcode is set, you can lock the HFL so it only operates after the passcode is entered.

1. The HFL will prompt you for your passcode each time the ignition switch is turned to the ON (II) position and you press the Talk button. You will only be asked for the passcode once per ignition

cycle. If the passcode is set, its response is “The system is locked. What is the four-digit passcode?”

2. Press and release the Talk button. After the beep, say your four-digit passcode. For example, say “1, 2, 3, 4.”
3. If the passcode is correct, the HFL response is “Main menu.” If the passcode is not correct, the HFL response is “1, 2, 3, 4 is incorrect. Please try again.” Go back to the step 2.

If you forget your passcode and you cannot activate the HFL, consult your dealer to cancel the passcode.

Bluetooth® HandsFreeLink®

Pairing Your Phone

Your Bluetooth® compatible phone with Hands Free Profile must be paired to the HFL before you can make and receive hands-free calls. To confirm that your phone is Bluetooth® compatible, visit handsfreelink.honda.com, or call (888) 528-7876. In Canada, call (888) 9-HONDA-9. Your phone retailer should also be able to confirm that your phone is Bluetooth® compatible.

NOTE:

- HFL does not allow you to pair your phone if the vehicle is moving.
- For pairing, your phone must be in its Discovery mode.
- Up to six phones can be paired to the HFL.
- The following procedure works for most phones. If you cannot pair your phone to the HFL with this procedure, refer to your phone's operating manual, visit

handsfreelink.honda.com, call the Hands Free Link® consumer support at (888) 528-7876, or call your phone retailer. In Canada, call (888) 9-HONDA-9.

- During the pairing process, turn off any previously paired phones before pairing a new phone.
1. With your phone on and the ignition in the ACCESSORY (I) or ON (II) position, press and release the Talk button. After the beep, say "Phone setup." The HFL response is "Phone setup options are status, pair, edit, delete, and list."
 2. Press and release the Talk button. After the beep, say "Pair." The HFL response is "The pairing process requires operation of your mobile phone. For safety, only perform this function while the vehicle is stopped. State a four-digit code for pairing. Note this

code. It will be requested by the phone."

3. Press and release the Talk button. After the beep, say the four-digit code you want to use. For example, say "1, 2, 3, 4." The HFL response is, "1, 2, 3, 4. Is this correct?"
4. Press and release the Talk button. After the beep, say "Yes." The HFL response is "HFL is now searching for a Bluetooth phone. Make sure the phone you are trying to pair is in discovery mode."

NOTE: Steps 5 and 6 show a common way to get your phone into its Discovery mode. If these steps do not work on your phone, refer to the phone's operating manual.

5. Follow the prompts on your phone to get it into its Discovery mode. The phone will search for the HFL. When it comes up, select HandsFreeLink from the list of options displayed on your phone.
6. When asked by the phone, enter the four-digit code from step 3 into your phone. The HFL response is "A new phone has been found. What would you like to name this phone?"
7. Press and release the Talk button. After the beep, say the name you want to use. For example, say "Eric's phone." The HFL response is "Eric's phone has been successfully paired. Returning to the main menu."
8. If you want to pair another phone, repeat steps 1 through 7.

To rename a paired phone, do this:

1. Press and release the Talk button. After the beep, say "Phone setup." The HFL response is "Phone setup options are status, pair, edit, delete, and list."
2. Press and release the Talk button. After the beep, say "Edit." The HFL response is "Which phone would you like to edit?"
3. Press and release the Talk button. After the beep, say the name of the phone you want to rename. For example, say "Eric's phone." The HFL response is "What is the new name for Eric's phone?"
4. Press and release the Talk button. After the beep, say the new name of the phone. For example, say "Lisa's phone." The HFL response is, "The name has been changed. Returning to the main menu."

To delete a paired phone, do this:

1. Press and release the Talk button. After the beep, say "Phone setup." The HFL response is, "Phone setup options are status, pair, edit, delete, and list."
2. Press and release the Talk button. After the beep, say "Delete." The HFL response is, "Which phone would you like to delete?"
3. Press and release the Talk button. After the beep, say the name of the phone you want to delete. For example say "Eric's phone." The HFL response is "Would you like to delete Eric's phone?"

CONTINUED

Bluetooth® HandsFreeLink®

4. Press and release the Talk button. After the beep, say “Yes.” The HFL response is “Preparing to delete Eric’s phone. Say OK to continue, otherwise, say Go back, or Cancel.”
5. Press and release the Talk button. If you say “OK” after the beep, the HFL response is “The phone has been deleted. Returning to the main menu.” If you say “Go back,” or “Cancel,” the phone will not be deleted.

To list all paired phones, do this:

1. Press and release the Talk button. After the beep, say “Phone setup.” The HFL response is, “Phone setup options are status, pair, edit, delete, and list.”
2. Press and release the Talk button. After the beep, say “List.” The HFL responds by listing the name of each paired phone. When all

phones paired to the system have been read, the HFL response is “The entire list has been read. Returning to the main menu.”

To find out the status of the phone being used, do this:

1. Press and release the Talk button. After the beep, say “Phone setup.” The HFL response is “Phone setup options are status, pair, edit, delete, and list.”
2. Press and release the Talk button. After the beep, say “Status.” An example of the HFL response is, “Eric’s phone is linked. Battery strength is three bars. Signal strength is five bars, and the phone is roaming. Returning to the main menu.”

To change from the currently linked phone to another paired phone, do this:

1. Press and release the Talk button. After the beep, say “Next phone.” The HFL response is “Searching for the next phone.” The HFL then disconnects the linked phone and searches for another paired phone. If no other phones are found, the first phone remains linked.

Making a Call

You can make calls using any phone number, or by using a name in the HFL phonebook. You can also redial the last number called. During a call, the HFL allows you to talk up to 30 minutes after you remove the key from the ignition switch. Continuing a call without running the engine may discharge and weaken the vehicle's battery.

To make a call using a phone number, do this:

1. With your phone on and the ignition in the ACCESSORY (I) or ON (II) position, press and release the Talk button. After the beep, say "Call" or "Dial." The HFL response is, "What name or number would you like to call/dial?"
2. Press and release the Talk button. After the beep, say the number you want to call. For example, say "123 456 7891." The HFL response is "123 456 7891. Say call, dial, or continue to add numbers."
3. Press and release the Talk button. After the beep, say "Call" or "Dial." The HFL response is "Calling" or "Dialing." Once connected, you will hear the person you called through the audio speakers. To change the volume, use the audio system volume knob, or the steering wheel volume controls.
4. To end the call, press the Back button.

You can also make a call directly from the list shown on the navigation display.

For more information on how to make a call, see page [338](#).

Bluetooth® HandsFreeLink®

To make a call using a name in the HFL phonebook, do this:

1. With your phone on and the ignition in the ACCESSORY (I) or ON (II) position, press and release the Talk button. After the beep, say “Call” or “Dial.” The HFL response is, “What name or number would you like to call/dial?”
2. Press and release the Talk button. After the beep, say the name you want to call. For example, say “Eric.” The HFL response is “Would you like to call Eric?”
3. Press and release the Talk button. After the beep, say “Yes.” The HFL response is “Calling” or “Dialing.” Once connected, you will hear the person you called through the audio speakers. To change the volume, use the audio system volume knob, or the steering wheel volume controls.

4. To end the call, press the Back button.

To redial the last number called by the phone, press and release the Talk button. After the beep, say “Redial.” The HFL response is, “Redialing.” Once connected, you will hear the person you called through the audio speakers. To change the volume, use the audio system volume knob, or the steering wheel volume controls.

Sending Numbers or Names During a Call

The HFL allows you to send numbers or names during a call. This is useful when you call a menu-driven phone system. You can also program account numbers into the HFL phonebook for easy retrieval during menu-driven calls.

To send a number during a call, do this:

1. Press and release the Talk button. After the beep, say “Send.” The HFL response is, “What name or number would you like to send?”
2. Press and release the Talk button. After the beep, say the number you want to send. For example, say “1, 2, 3.” The HFL response is “1, 2, 3. Say send, or continue to add numbers.”

NOTE: To send a pound (#), say “pound.” To send a star (*), say “star.”

3. Press and release the Talk button. After the beep, say “Send.” The dial tones will be sent, and the call will continue.

To send a name during a call, do this:

1. Press and release the Talk button. After the beep, say “Send.” The HFL response is, “What name or number would you like to send?”
2. Press and release the Talk button. After the beep, say the name you want to send. For example, say “Account number.” The HFL response is “Would you like to send account number?”
3. Press and release the Talk button. After the beep, say “Yes.” The dial tones will be sent, and the call will continue.

Receiving a Call

If you receive a call when you are not on the phone, the HFL interrupts the audio system (if it is on), and plays the incoming call notification, if activated. To answer the call, press the Talk button and begin speaking. If you don't want to answer the call, press the Back button.

If your phone has Call Waiting, and you receive a call when you are on the phone, press and release the Talk button to answer it. When you do this, the original call is placed on hold. To return to the original call, press the Talk button again. If you don't want to answer the new call, disregard it, and continue with your original call. If you want to hang up the original call and answer the new call, press the Back button.

Transferring a Call

During a call, you can transfer it from the HFL to your phone, or from your phone to the HFL.

To transfer a call from the HFL to your phone, do this:

Press and release the Talk button. After the beep, say “Transfer.” The audio switches from the HFL to the phone.

To transfer a call from your phone to the HFL, do this:

Press and release the Talk button. After the beep, say “Transfer.” The audio switches from your phone to the HFL.

Bluetooth® HandsFreeLink®

Muting a Call

During a call, you can mute or unmute your voice to the person you are talking to.

To mute your voice, do this:

1. Press and release the Talk button. After the beep, say “Mute.” The HFL response is, “Mute is active.”

To unmute your voice, do this:

2. Press and release the Talk button. After the beep, say “Mute.” The HFL response is, “Mute is canceled.”

Setting up the Phonebook

The HFL phonebook can store up to 50 names with their associated numbers. These can be any types of numbers. For example, you can store a phone number and use it to make a call, or you can store an account number and use it during a call to a menu-driven phone system.

To add a name, do this:

1. Press and release the Talk button. After the beep, say “Phonebook.” The HFL response is “Phonebook options are store, edit, delete, receive contact, and list.”
2. Press and release the Talk button. After the beep, say “Store.” The HFL response is, “What name would you like to store?”

3. Press and release the Talk button. After the beep, say the name you would like to store. For example, say “Eric” or say “account number.” The HFL response is “What is the number for Eric,” or “What is the number for account number?”
4. Press and release the Talk button. After the beep, say the number. For example, say “123 456 7891.” The HFL response is “123 456 7891. Say enter, or continue to add numbers.”
5. Press and release the Talk button. After the beep, say “Enter.” The HFL response is “Eric (or account number) has been stored. Returning to the main menu.”

To edit the number of a name, do this:

1. Press and release the Talk button. After the beep, say "Phonebook." The HFL response is "Phonebook options are store, edit, delete, receive contact, and list."
2. Press and release the Talk button. After the beep, say "Edit." The HFL response is, "What name would you like to edit?"
3. Press and release the Talk button. After the beep, say the name you would like to edit. For example, say "Eric." The HFL response is "What is the new number for Eric?"
4. Press and release the Talk button. After the beep, say the new number for Eric. For example, say "987 654 3219." The HFL response is, "987 654 3219." Say "Enter." or continue to add numbers.

5. Press and release the Talk button. After the beep, say "Enter." The HFL response is "The number has been changed. Returning to the main menu."

To delete a name, do this:

1. Press and release the Talk button. After the beep, say "Phonebook." The HFL response is, "The Phonebook options are store, edit, delete, receive contact, and list."
2. Press and release the Talk button. After the beep, say "Delete." The HFL response is, "What name would you like to delete?"
3. Press and release the Talk button. After the beep, say the name you would like to delete. For example, say "Eric." The HFL response is "Would you like to delete Eric?"

4. Press and release the Talk button. After the beep, say "Yes." The HFL response is, "The name has been deleted. Returning to the main menu."

To list all names in the phonebook, do this:

1. Press and release the Talk button. After the beep, say "Phonebook." The HFL response is "Phonebook options are store, edit, delete, receive contact, and list."
2. Press and release the Talk button. After the beep, say "List." The HFL responds by listing the names in the phonebook in the order which they were stored. When the end of the list is reached, the HFL response is, "The entire list has been read. Returning to the main menu."

CONTINUED

Bluetooth® HandsFreeLink®

To call a name from the phonebook list, do this:

1. Press and release the Talk button. After the beep, say “Phonebook.” The HFL response is “Phonebook options are store, edit, delete, receive contact, and list.”
2. Press and release the Talk button. After the beep, say “List.” The HFL responds by listing the names in the phonebook. When it says the name you want to call, for example, Eric, press the Talk button, and then say “Call.” The HFL response is, “Would you like to call Eric?”
3. Press and release the Talk button. After the beep, say “Yes.” The HFL response is “Calling.” Once connected, you will hear the person you called through the audio speakers. To change the volume, use the audio system volume knob, or the steering

wheel volume controls.

Storing a Phone Number Directly from Your Phone

You can store the desired number to the HFL phonebook directly from your cellular phone.

NOTE: Your phone may not have this capability. Visit handsfreelink.honda.com, or call the Hands Free Link® consumer support at (888) 528-7876. In Canada, call (888) 9-HONDA-9. You can see your phone’s owner’s manual for information.

To store a phone number from your phone:

1. With your phone on and the ignition switch in the ACCESSORY (I) or ON (II) position, press and release the Talk button. After the beep, say “Phonebook.” The HFL response is, “Phonebook options are store, edit, delete, receive contact and

list.”

2. Press and release the Talk button. After the beep, say “Receive contact.” The HFL response is, “The receive process requires operation of your mobile phone. For safety, only perform this function while the vehicle is stopped. HFL is now waiting to receive a contact from a Bluetooth device.”
3. Select a desired number from the list on your phone, and transmit/send (individual steps will vary for each type of phone, refer to your phone’s owner’s manual) via Bluetooth. The HFL response is “One phone number has been received for this contact. What name would you like to store for the mobile number? To discard this number, say ‘Discard.’ ”

4. Press and release the Talk button. After the beep, say the name you would like to store. For example, say "Neil at work." The HFL response is, "Neil at work will be stored. Is this correct?"
5. Press and release the Talk button. After the beep, say either "Yes" or "No." The HFL response is, "Neil at work has been stored. If more than one number was received for the contact entry, the HFL asks for the name of the next number. If only one number is received, or all numbers have been stored, the HFL response is, "Would you like HFL to receive another contact?"
6. If you want to continue to store any other numbers, press and release the Talk button. After the beep, say "Yes." The HFL response is, "HFL is now waiting to receive a contact from a Bluetooth device."
7. Select a desired number from the list on your phone, and transmit/send (individual steps will vary for each type of phone, refer to your phone's owner's manual) via Bluetooth. The HFL response is "One phone number has been received for this contact. What name would you like to store for the mobile number? To discard this number, say 'Discard.' "
8. Press and release the Talk button. After the beep, say the name you would like to store. For example, say "Susan at work." The HFL response is, "Susan at work will be stored. Is this correct?"
9. Press and release the Talk button. After the beep, say either "Yes" or "No." The HFL response is "Susan at work has been stored. Would you like HFL to receive another contact?"
10. If you do not want to continue to store any other numbers, press and release the Talk button. After the beep, say "No." The HFL response is "Returning to the main menu."

Bluetooth® HandsFreeLink®

Cellular Phonebook Options

The cellular phonebook option allows you to store up to 1,000 names and 10,000 phone numbers in the phonebook of Bluetooth® HandsFreeLink® from your cellular phonebook. The maximum names and numbers to be stored varies on the data size. With the HFL, you can then automatically dial any name or number in the phonebook.

NOTE: Your phone may not have this capability. Visit handsfreelink.honda.com, or call the Hands Free Link® consumer support at (888) 528-7876. In Canada, call (888) 9-HONDA-9. You can see your phone's owner's manual for information.

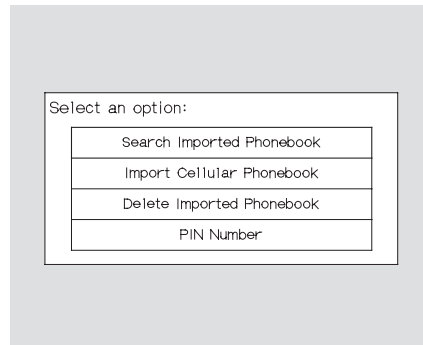

To use the cellular phonebook with the HFL, say or select "Cellular Phonebook" from the Information screen. The navigation display will change as shown above.

If any phonebook is not stored and your phone is not linked to the HFL, Cellular Phonebook is grayed out.

PIN Number. This option allows you to add, change, or remove a PIN number for any phonebook that has been imported.

Import Cellular Phonebook: This option allows you to store the phonebook of your cellular phone in the HFL. When you link your phone to the HFL and select this option, the system will start importing and loading the phonebook.

Search Imported Phonebook: This option allows you to search the phone numbers stored in the HFL. When you enter a keyword for a person's name, such as the first name or last name, the system will find the number you want and let you make calls.

Delete Imported Phonebook: This option allows you to delete the stored phonebook from the HFL. When you link your phone to the HFL and select this option, the system will automatically delete the phonebook of the linked phone from the HFL (see page [346](#)).

To import the cellular phonebook
You can import the phonebook of your cellular phone into the HFL. Link your phone to the HFL, and select "Import Cellular Phonebook" from the "Select an option" screen. When the message "The import was successful." is displayed, touch the screen to select "OK."

Example

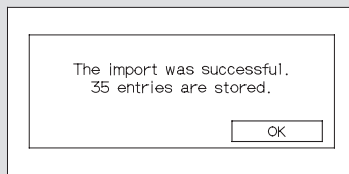

NOTE:

- HFL does not allow you to pair your phone if the vehicle is moving.
- Up to six phones can be paired to the HFL.

For information on linking to the HFL, see page [332](#).

CONTINUED

To search the imported phonebook

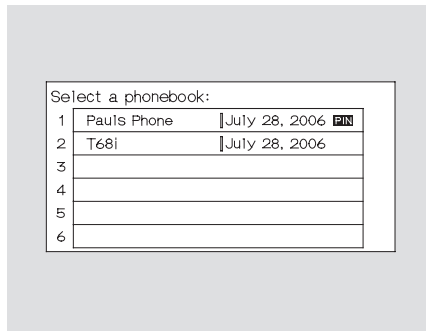

You can search the stored number by entering keywords.

Select “Search Imported Phonebook” from the “Select an option” screen. The display will change as shown above.

Select a phonebook from the displayed list. If the phonebook you select has a PIN icon, you will need the 4-digit PIN number to access the phonebook. The following screen will appear.

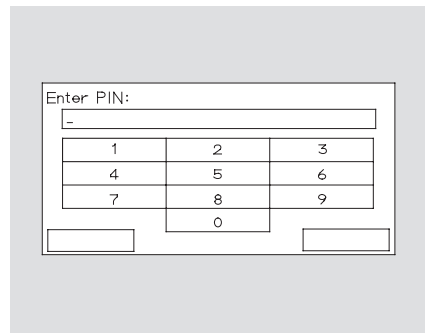

Enter the PIN number. You cannot access a PIN protected phonebook if you do not use the correct PIN number.

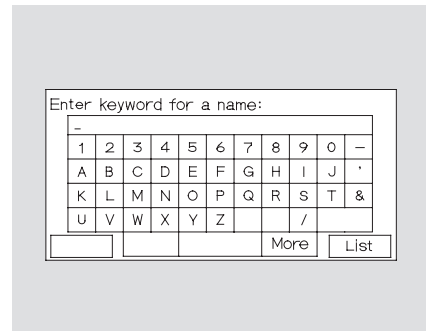

Enter the keyword for a person's name, such as the first name or last name, using the joystick. If the system does not find an exact match, say or select “LIST” when you finish entering the keyword.

The system will display a list of person's names, with the closest match to the name you entered at the top of the list.

Select the number (1 - 6) of the desired person from the list.

Up to three category icons are displayed in the right side of the list. These category icons indicate how many numbers are stored for the person. If a name has more than three category icons, “ . . . ” is displayed.

The following category icons will appear:

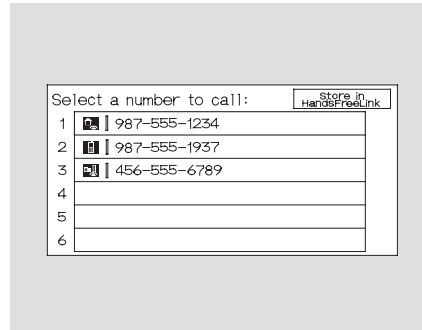
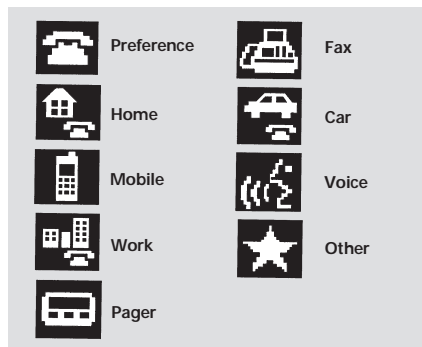

After selecting a person, the system will display a list of the person's phone numbers.

Select the desired number from the list to make a call.

To store an imported phonebook number

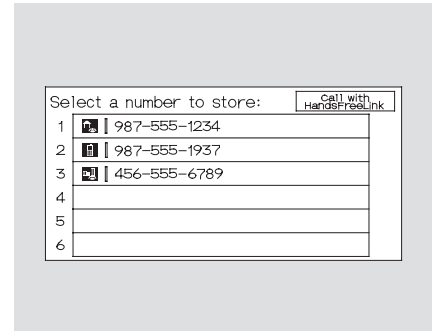

Say or select “STORE IN HandsFreeLink” from the “Select a number to call” screen. The screen shown above will appear.

Select the desired number from the list to store it in the HFL.

CONTINUED

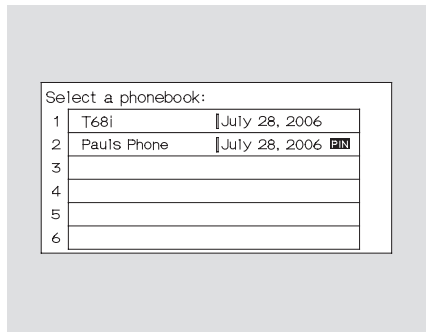
To delete the imported phonebook

You can delete the stored phonebook from the HFL. Link your phone to the HFL and select “Delete Imported Phonebook” from the “Select an option” screen. The display will change as shown above.

Select a phonebook from the displayed list. If the phonebook you select has a PIN icon, you will need the 4-digit PIN number to access the phonebook. The following screen will appear.

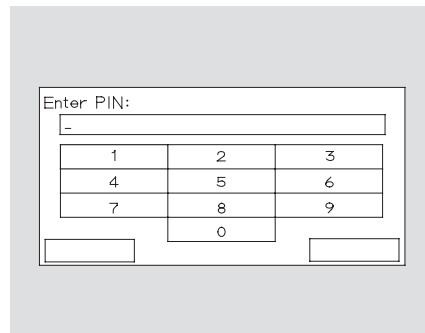

Enter the PIN number to access the phonebook. You cannot access a PIN protected phonebook if you do not use the correct PIN number.

After you enter the correct PIN number, or if the phonebook you select is not PIN protected, the following screen appears.

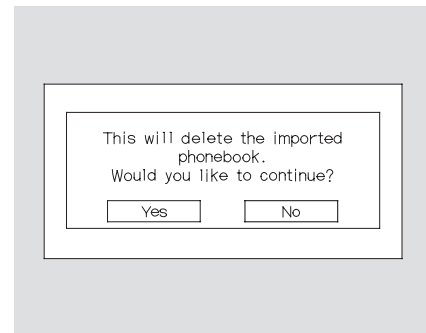

Say or select “Yes”, and the message “The imported phonebook has been deleted.” will appear. Select “OK” to complete the deletion.

To add, change, or remove a PIN number from any phonebook

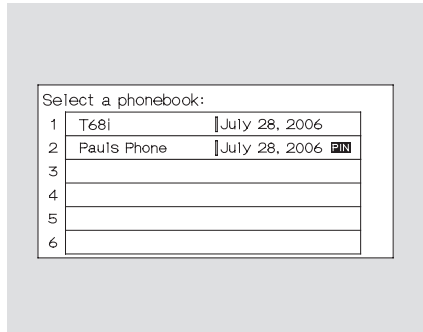

You can add, change or remove a PIN number from any phonebook. Select “PIN Number” from the “Select an Option” screen. The display will change as shown above.

To add a PIN number

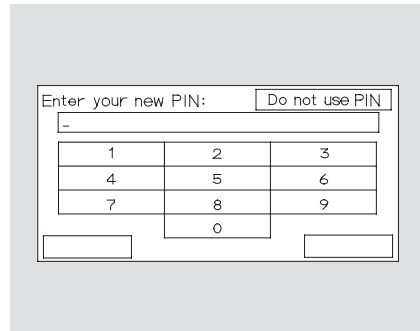

1. Select the phonebook you wish to add the PIN number to. The phonebook you select cannot already have a PIN icon. The display will change as shown above.

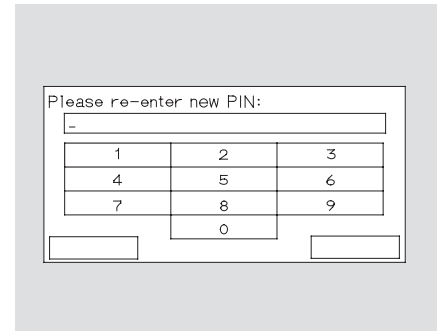

2. Enter the 4-digit PIN number. You will be asked to re-enter the PIN to verify.

CONTINUED

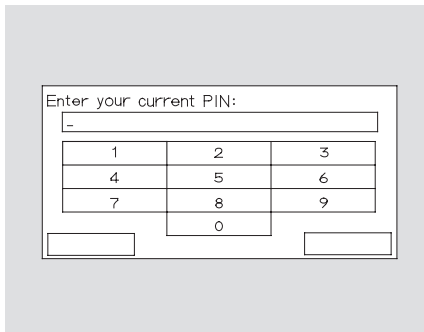
To change a PIN number

1. Select the phonebook you wish to change the PIN number for. The display will change as shown above.

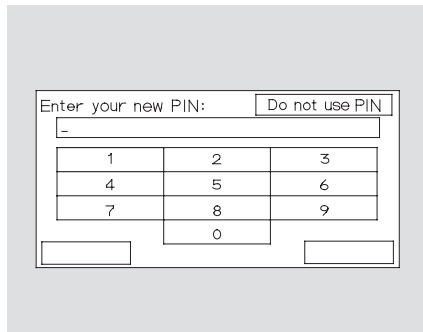

2. Enter your current PIN number.

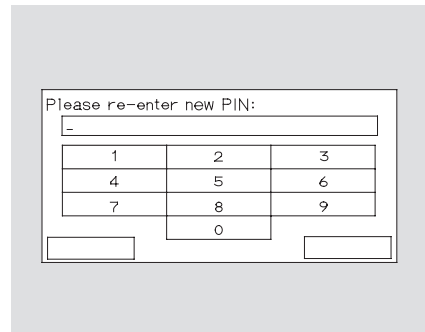

3. Enter your new 4-digit PIN number. You will be asked to re-enter the PIN to verify.

Clearing the System

This operation clears the HFL of your passcode, your paired phones, all names in the HFL phonebook, and all imported phonebooks. Clearing is recommended before you sell your vehicle.

To clear the system, do this:

1. Press and release the Talk button. After the beep, say "System." The HFL response is, "System options are setup and clear."
2. Press and release the Talk button. After the beep, say "Clear." The HFL response is, "This process will clear all paired phones, clear all entries in the phonebook, and clear the passcode. Is this what you would like to do?"

3. Press and release the Talk button. After the beep, say "Yes." The HFL response is "Preparing to clear all paired phones, all phonebook entries, and the passcode. This may take up to 2 minutes to complete." Press and release the Talk button. After the beep, say "OK" to proceed, or say "Go back" or "Cancel."
4. If you said "OK," after a short period of time, the HFL response is, "System has been cleared. Returning to the main menu."

Changing Language

Canadian models only

To change from English to French, do this:

1. Press and release the Talk button. After the beep, say "Change language." The HFL response is "English or French?"
2. Press and release the Talk button. After the beep, say "French." The HFL response is "Vous avez selectionne Français. Les noms enregistres en mode Anglais ne seront pas accessible en mode Français. Voulez-vous continuer? You have selected French. Name tags that were stored while in English mode will not be accessible in French mode. Would you like to continue? "

CONTINUED

Bluetooth® HandsFreeLink®

3. Press and release the Talk button. After the beep, say “Oui” or “Yes.” If there are no paired phones without French name tags, the HFL response is “Venillez attendre que le systeme change de langue. Please wait while the language is changed.” “La langue a ete changee. Retour au menu principal.”

NOTE: If there are paired phones without French name tags, the following prompts will continue.

If there are paired phones without French name tags, the HFL response is “Pour que le système identifie les téléphones qui ont été jumelés dans une autre langue, les noms des téléphones doivent être ré-enregistrés.”

4. The HFL response is, for example, “Quel est le nom Français pour < Paul’s phone > ?” Press and release the Talk button. After the beep, say “Téléphone de Paul.” The HFL response is, “Quel est le nom Français pour < Pat’s phone > ?” Press and release the Talk button. Say “Téléphone de Pat.” After all paired phones missing a French name tag are re-recorded, the HFL will prompt, “Retour au menu principal.”

To change from French to English, do this:

1. Press and release the Talk button. After the beep, say “Changer Langue.” The HFL response is, “Anglais ou Français?”
2. Press and release the Talk button. After the beep, say “English.” The HFL response is, “You have selected English. Name tags that were stored while in French mode will not be accessible in English mode. Would you like to continue?”, then the system repeats the response in English.

3. Press and release the Talk button. After the beep, say “Yes” or “Oui.” If there are no paired phones without English name tags, the HFL response is “Please wait while the language is changed. Veuillez attendre que le système change de langue.” “The language has been changed. Returning to the main menu.”
4. The HFL says, for example, “What is the English name for < Téléphone de Paul > ?” Press and release the Talk button. After the beep, say “Paul’s phone.” The HFL response is “What is the English name for < Téléphone de Pat > ?” Press and release the Talk button. After the beep, say “Pat’s phone.” After all paired phones missing an English name tag are re-recorded, the HFL will say “Returning to the main menu.”

NOTE: If there are paired phones without English name tags, the following prompts will continue.

If there are paired phones without English name tags, the HFL response is “The language has been changed. For the system to identify phones that were paired while in another language, the phone names need to be re-recorded.”

*As required by the FCC:
This device complies with Part 15 of the FCC rules. Operation is subject to the following two conditions: (1) This device may not cause harmful interference, and (2) this device must accept any interference received, including interference that may cause undesired operation.*

Changes or modifications not expressly approved by the party responsible for compliance could void the user’s authority to operate the equipment.

*This device complies with Industry Canada Standard RSS-210.
Operation is subject to the following two conditions: (1) this device may not cause interference, and (2) this device must accept any interference that may cause undesired operation of the device.*

Parking Sensor System

On Touring models

Your vehicle has a parking sensor system. The system lets you know the approximate distance between your vehicle and most obstacles while you are parking. When the system is on and your vehicle is nearing an obstacle, you will hear a beeper and see system messages on the multi-information display.

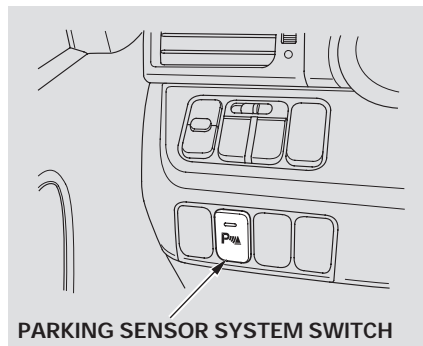

To activate the system, push the switch on the dashboard with the ignition in the ON (II) position. The indicator in the switch comes on when the system is on. To turn the system off, push the switch again.

All obstacles may not always be sensed. Even when the system is on, you should look for obstacles near your vehicle to make sure it is safe to park.

The system has two front corner sensors, two rear corner sensors, and a rear center sensor.

The rear center sensors work when the shift lever is in reverse (R), and the vehicle speed is less than 5 mph (8 km/h).

The corner sensors work only when the shift lever is in any position other than P and the vehicle speed is less than 5 mph (8 km/h).

Multi-Information Display Messages and Beeper Operation

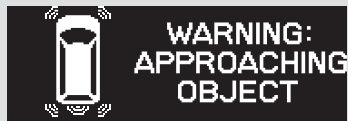





When you turn the system on, all indicators will appear on the multi-information display, and a beeper sounds once.

When the system senses an obstacle, the appropriate indicator comes on, and a beeper sounds as shown in the following tables.

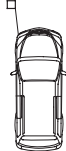
Corner Sensor Operation







Example shown: Obstacle is at the left front of the vehicle

Distance	About 16-20 in (40-50 cm) 	About 12-16 in (30-40 cm) 	About 12 in (30 cm) or less 
Indicator	Upper left indicator stays on 	Upper left indicator stays on 	Upper left indicator stays on 
Beeper	Short beeps	Very short beeps	Continuous beep

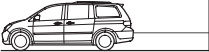
CONTINUED

Parking Sensor System

Rear Center Sensor Operation

Distance	About 40-70 in (1-1.8 m) 	About 24-40 in (0.6-1 m) 	About 24 in (0.6 m) or less 
Indicator	Bottom indicator stays on 	Bottom indicator stays on 	Bottom indicator stays on 
Beeper	Short beeps	Very short beeps	Continuous beeps



If the system develops a problem, you will see a “CHECK PARKING SENSOR SYSTEM” message on the multi-information display, and a beeper sounds continuously. Very often, a sensor covered with mud, ice, snow, etc. is the cause of this message. Check the sensors first. If the message stays on or the beeper does not stop, have the system checked by your dealer.

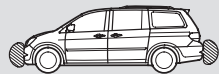
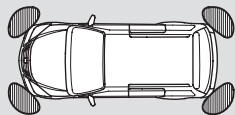

Within about 20 in (50 cm)

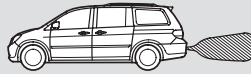
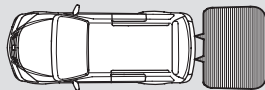

Within about 70 in (1.8 m)

The range of the corner sensors and the rear center sensor are limited. Each corner sensor is capable of sensing an obstacle only when your vehicle is 20 in (50 cm) or closer. The rear center sensor senses an obstacle that is behind your vehicle 70 in (1.8 m) or closer.

Do not put any accessories on or around the sensors.

The system may not function properly under these conditions:

- The sensors are covered with snow, ice, mud, etc.
- When the vehicle is on a rough road, on grass, or on a hill.
- After the vehicle has been sitting out in hot or cold weather.

- When the system is affected by some electrical equipment or devices generating an ultrasonic wave.
- When operating the vehicle in bad weather.

The system may not sense thin or low objects, or sonic-absorptive materials such as snow, cotton, or sponge.

The system cannot sense objects directly under the bumper.

Canadian Owners:

This device complies with Industry Canada Standard RSS-210. Operation is subject to the following two conditions: (1) this device may not cause interference, and (2) this device must accept any interference that may cause undesired operation of the device.

Rearview Camera and Monitor

On EX-L and Touring models

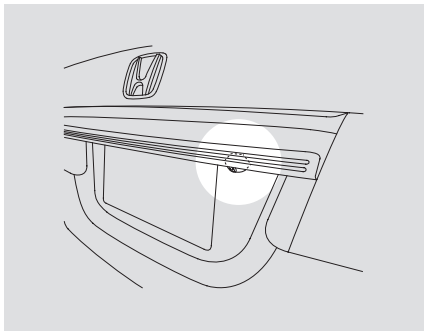

Whenever you shift to reverse (R) with the ignition switch in the ON (II) position, the rear view is shown on the navigation system screen. On vehicle without navigation system, the rear view is shown on the left side of the inside mirror.

For the best picture, always keep the rearview camera clean, and do not cover the camera lens. To avoid scratching the lens when you clean it, use a moist, soft cloth.

Since the rearview camera display area is limited, you should always back up slowly and carefully, and look behind you for obstacles.

On U.S. EX-L with navigation system and Touring models

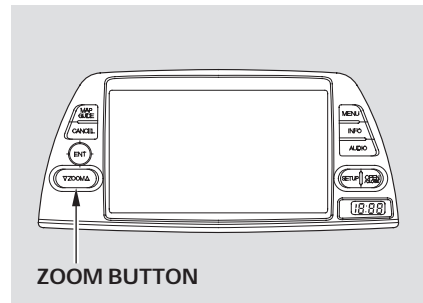

When in reverse, the touch screen and navigation system “hard” buttons are locked out, except the “ZOOM” button. Touching the “ ” or “ ” button allows you to adjust the brightness of the rearview camera image.

NOTICE

The camera brightness cannot be adjusted by voice control.

On U.S. EX-L without navigation system and Canadian EX-L models

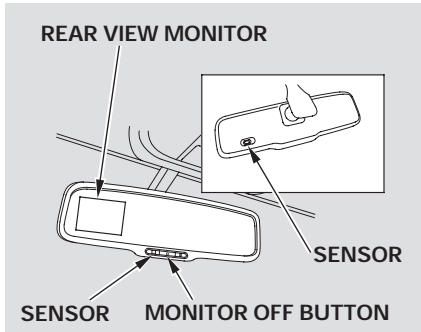

You can turn the monitor on and off by pressing the monitor off button when the shift lever is in reverse. The monitor turns on everytime you shift to reverse, even if you turned it off the last time.

Monitor brightness is adjusted automatically by sensors. If you use the monitor continuously at high temperature, the monitor will gradually dim.

The inside mirror will be hot when you use the monitor for an extended period of time.

If a bright light (such as sunlight) is shining on the inside mirror, the image may be difficult to see.

[Main Menu](#)

[Table Of Contents](#)

Before you begin driving your vehicle, you should know what gasoline to use and how to check the levels of important fluids. You also need to know how to properly store luggage or packages. The information in this section will help you. If you plan to add any accessories to your vehicle, please read the information in this section first.

Break-in period.....	360
Fuel Recommendation	360
Service Station Procedures	361
Refueling.....	361
Opening and Closing the Hood.....	362
Oil Check.....	363
Engine Coolant Check	364
Fuel Economy	365
Accessories and Modifications	368
Carrying Cargo	370

Break-in Period, Fuel Recommendation

Break-in Period

Help assure your vehicle's future reliability and performance by paying extra attention to how you drive during the first 600 miles (1,000 km). During this period:

- Avoid full-throttle starts and rapid acceleration.
- Avoid hard braking for the first 200 miles (300 km).
- Do not change the oil until the scheduled maintenance time.
- Do not tow a trailer.

You should also follow these recommendations with an overhauled or exchanged engine, or when the brakes are replaced.

Fuel Recommendation

Your vehicle is designed to operate on unleaded gasoline with a pump octane number of 87 or higher. Use of a lower octane gasoline can cause a persistent, heavy, metallic rapping noise that can lead to engine damage.

We recommend using quality gasolines containing detergent additives that help prevent fuel system and engine deposits.

In addition, in order to maintain good performance, fuel economy, and emissions control, we strongly recommend, in areas where it is available, the use of gasoline that does NOT contain manganese-based fuel additives such as MMT.

Use of gasoline with these additives may adversely affect performance, and cause the Malfunction Indicator Lamp on your instrument panel to come on. If this happens, contact your dealer for service.

Some gasoline today is blended with oxygenates such as ethanol or MTBE. Your vehicle is designed to operate on oxygenated gasoline containing up to 10% ethanol by volume and up to 15% MTBE by volume. Do not use gasoline containing methanol.

If you notice any undesirable operating symptoms, try another service station or switch to another brand of gasoline.

For further important fuel-related information, please refer to your **Quick Start Guide**.

Refueling

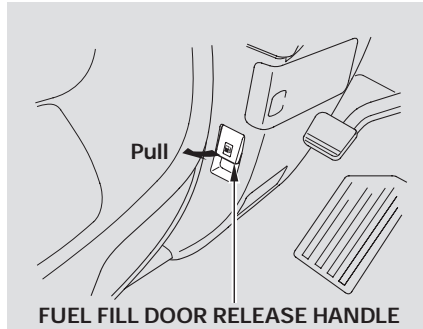

1. Park with the driver's side closest to the service station pump.
2. Open the fuel fill door by pulling on the handle under the lower left corner of the dashboard.

Before refueling, make sure the rear sliding door on the driver's side is closed.

⚠ WARNING

Gasoline is highly flammable and explosive. You can be burned or seriously injured when handling fuel.

- Stop the engine, and keep heat, sparks, and flame away.
- Handle fuel only outdoors.
- Wipe up spills immediately.

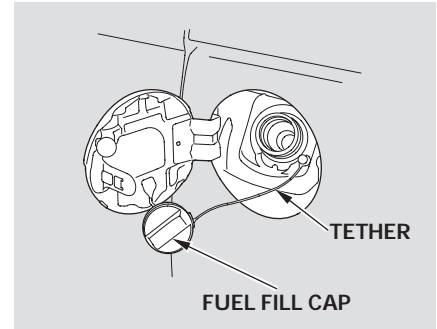

3. Remove the fuel fill cap slowly. You may hear a hissing sound as pressure inside the tank escapes. The fuel fill cap is attached to the fuel filler with a tether. Insert the attachment on the fuel fill cap into the slit on the fuel fill door.

CONTINUED

Service Station Procedures

4. Stop filling the tank after the fuel nozzle automatically clicks off. Do not try to “top off” the tank. Leave some room for the fuel to expand with temperature changes.

If the fuel nozzle keeps clicking off even though the tank is not full, there may be a problem with your vehicle’s fuel vapor recovery system. The system helps keep fuel vapor from going into the atmosphere. Try filling at another pump. If this does not fix the problem, consult your dealer.

5. Screw the fuel fill cap back on until it clicks at least once.

On LX, EX, EX-L and Canadian DX models

If you do not properly tighten the cap, you will see a “CHECK FUEL CAP” message on the information display (see page 80).

On Touring models

If you do not properly tighten the cap, you will see a “TIGHTEN FUEL CAP” message on the multi-information display (see page 92).

6. Push the fuel fill door closed until it latches.

Opening and Closing the Hood

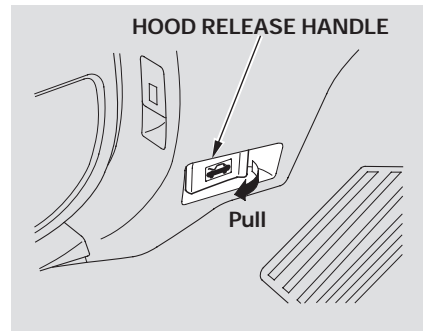

1. Park the vehicle, and set the parking brake. Pull the hood release handle located under the lower left corner of the dashboard. The hood will pop up slightly.

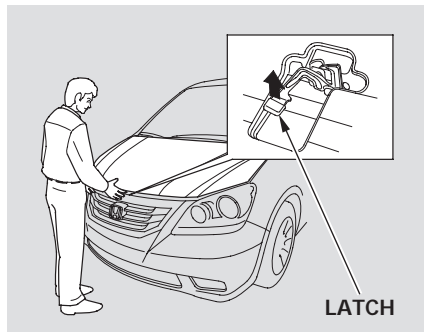

- Put your fingers under the front edge of the hood. The hood latch handle is above the "H" logo. Pull this handle until it releases the hood, then lift the hood.

If the hood latch handle moves stiffly, or you can open the hood without lifting the handle, the mechanism should be cleaned and lubricated.

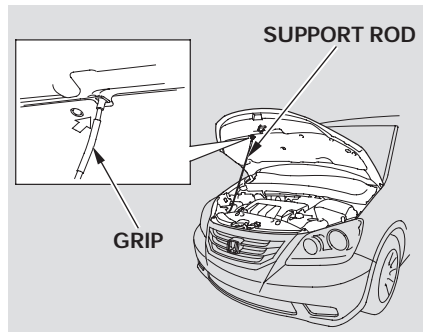

- Holding the grip, pull the support rod out of its clip. Insert the end into the designated hole in the hood.

To close the hood, lift it up slightly to remove the support rod from the hole. Put the support rod back into its holding clip. Lower the hood to about a foot (30 cm) above the fender, then let it drop. Make sure it is securely latched.

Oil Check

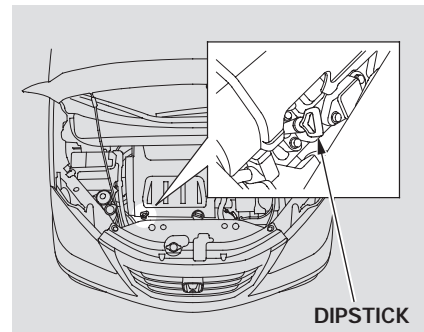

Park the vehicle on a level surface. Wait a few minutes after turning the engine off before you check the oil.

- Remove the dipstick (orange loop).
- Wipe off the dipstick with a clean cloth or paper towel.
- Insert the dipstick all the way back into its hole.

CONTINUED

Service Station Procedures

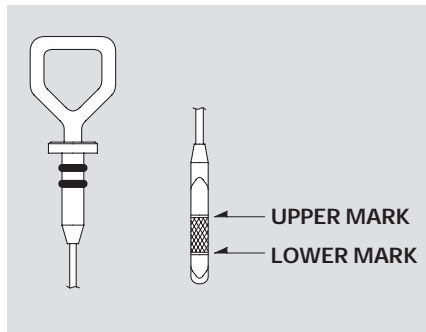

4. Remove the dipstick again, and check the level. It should be between the upper and lower marks.

If it is near or below the lower mark, see **Adding Engine Oil** on page [418](#).

Engine Coolant Check

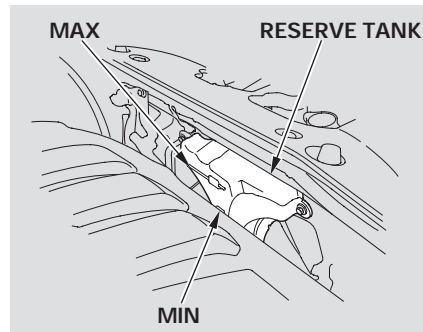

Look at the coolant level in the radiator reserve tank. Make sure it is between the MAX and MIN lines. If it is below the MIN line, see **Adding Engine Coolant** on page [422](#) for information on adding the proper coolant.

Refer to **Owner's Maintenance Checks** on page [415](#) for information about checking other items on your vehicle.

Actual Mileage and EPA Fuel Economy Estimates Comparison.

Fuel economy is not a fixed number. It varies based on driving conditions, driving habits and vehicle condition. Therefore, it is not possible for one set of estimates to predict fuel economy precisely for all drivers in all environments.

The EPA fuel economy estimates shown in the example to the right are a useful tool for comparison when buying a vehicle. EPA estimates include:

City MPG - Represents urban driving in a vehicle in light traffic. A range of miles per gallon achieved is also provided.

Highway MPG - Represents a mixture of rural and interstate driving, in a warmed-up vehicle, typical of longer trips in free-flowing traffic. A range of miles per gallon

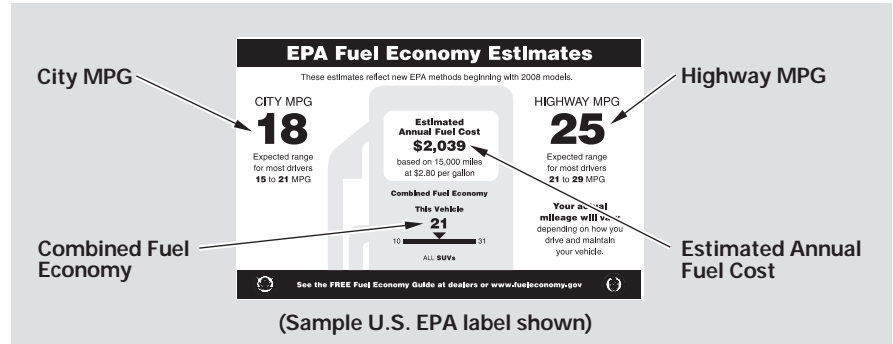

achieved is also provided.

Combined Fuel Economy - Represents a combination of city and highway driving. The scale represents the range of combined fuel economy for other vehicles in the class.

Estimated Annual Fuel Cost - Provides an estimated annual fuel cost, based on 15,000 miles (20,000 km) per year multiplied by the cost per gallon (based on EPA fuel cost data) divided by the combined fuel economy.

For more information on fuel economy ratings and factors that affect fuel economy, visit www.fueleconomy.gov (Canada: Visit www.vehicles.gc.ca)

Fuel Economy

Fuel Economy Factors

The following factors can lower your vehicle's fuel economy:

- Aggressive driving (hard acceleration and braking)
- Excessive idling, accelerating and braking in stop-and-go traffic
- Cold engine operation (engines are more efficient when warmed up)
- Driving with a heavy load or the air conditioner running
- Improperly inflated tires

Improving Fuel Economy

Vehicle Maintenance

A properly maintained vehicle maximizes fuel economy. Poor maintenance can significantly reduce fuel economy. Always maintain your vehicle according to the maintenance messages displayed on the multi-information display (see **Owner's Maintenance Checks** on page [415](#)). For example:

- **Use the recommended viscosity motor oil, displaying the API Certification Seal (see page [418](#)).**
- **Maintain proper tire inflation**
 - An under-inflated tire increases "rolling resistance," which reduces fuel economy.
- **Avoid carrying excess weight in your vehicle** - It puts a heavier load on the engine, increasing fuel consumption.
- **Keep your vehicle clean** - In particular, a build-up of snow or mud on your vehicle's underside adds weight and rolling resistance. Frequent cleaning helps your fuel economy.

Drive Efficiently

- **Drive moderately** - Rapid acceleration, abrupt cornering, and hard braking increase fuel consumption.

- **Observe the speed limit** - Aerodynamic drag has a big effect on fuel mileage at speeds above 45 mph (75 km/h). Reduce your speed and you reduce the drag. Trailers, car top carriers, roof racks and bike racks are also big contributors to increased drag.
- **Always drive in the highest gear possible** - If your vehicle has a manual transmission, you can boost your fuel economy by up shifting as early as possible.
- **Avoid excessive idling** - Idling results in 0 miles per gallon.

- **Minimize the use of the air conditioning system** - The A/C puts an extra load on the engine which makes it use more fuel. Use the fresh-air ventilation when possible.
- **Plan and combine trips** - Combine several short trips into one. A warmed-up engine is more fuel efficient than a cold one.

Calculating Fuel Economy

Measuring Techniques

Direct calculation is the recommended source of information about your actual fuel economy. Using frequency of fill-ups or taking fuel gauge readings are NOT accurate measures of fuel economy. Fuel economy may improve over the first several thousand miles.

Checking Your Fuel Economy

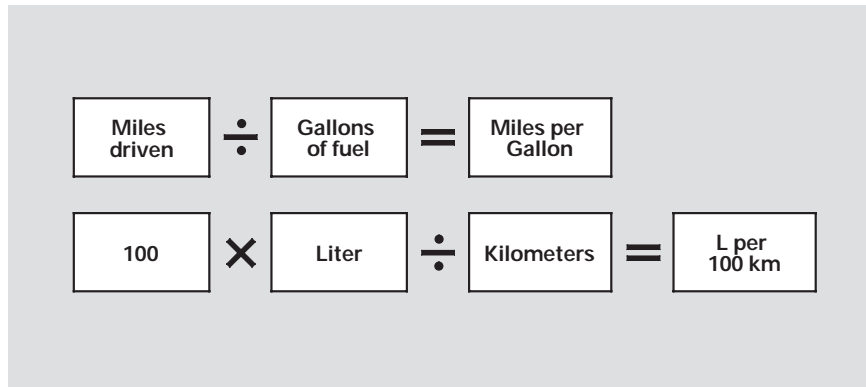

- 1) Fill the fuel tank until the nozzle automatically clicks off.
- 2) Reset trip counter to zero.
- 3) Record the total gallons (liters) needed to refill.
- 4) Follow one of the simple calculations above.

Accessories and Modifications

Modifying your vehicle, or installing some non-Honda accessories, can make it unsafe. Before you make any modifications or add any accessories, be sure to read the following information.

Accessories

Your dealer has Honda accessories that allow you to personalize your vehicle. These accessories have been designed and approved for your vehicle, and are covered by warranty.

Although non-Honda accessories may fit on your vehicle, they may not meet factory specifications, and could adversely affect your vehicle's handling and stability.

WARNING

Improper accessories or modifications can affect your vehicle's handling, stability, and performance, and cause a crash in which you can be hurt or killed.

Follow all instructions in this owner's manual regarding accessories and modifications.

When properly installed, cellular phones, alarms, two-way radios, and low-powered audio systems should not interfere with your vehicle's computer controlled systems, such as your airbags, anti-lock brakes, and tire pressure monitoring system.

Before installing any accessory:

- Make sure the accessory does not obscure any lights, or interfere with proper vehicle operation or performance.
- Be sure electronic accessories do not overload electrical circuits (see page 474) or interfere with the proper operation of your vehicle.
- Before installing any electronic accessory, have the installer contact your dealer for assistance. If possible, have your dealer inspect the final installation.
- Do not install accessories on the side pillars or across the rear windows. Accessories installed in these areas may interfere with proper operation of the side curtain airbags.

Modifying Your Vehicle

Removing parts from your vehicle, or replacing components with non-Honda components could seriously affect your vehicle's handling, stability, and reliability.

Here are some examples:

- Lowering the vehicle with a non-Honda suspension kit that significantly reduces ground clearance can allow the undercarriage to hit speed bumps or other raised objects, which could cause the airbags to deploy.

- Raising your vehicle with a non-Honda suspension kit can affect the handling and stability.
- Non-Honda wheels, because they are a universal design, can cause excessive stress on suspension components and will not be compatible with the tire pressure monitoring system (TPMS).

- Larger or smaller wheels and tires can interfere with the operation of your vehicle's anti-lock brakes and other systems.
- Modifying your steering wheel or any other part of your vehicle's safety systems could make the systems ineffective.

If you plan to modify your vehicle, consult your dealer.

Carrying Cargo

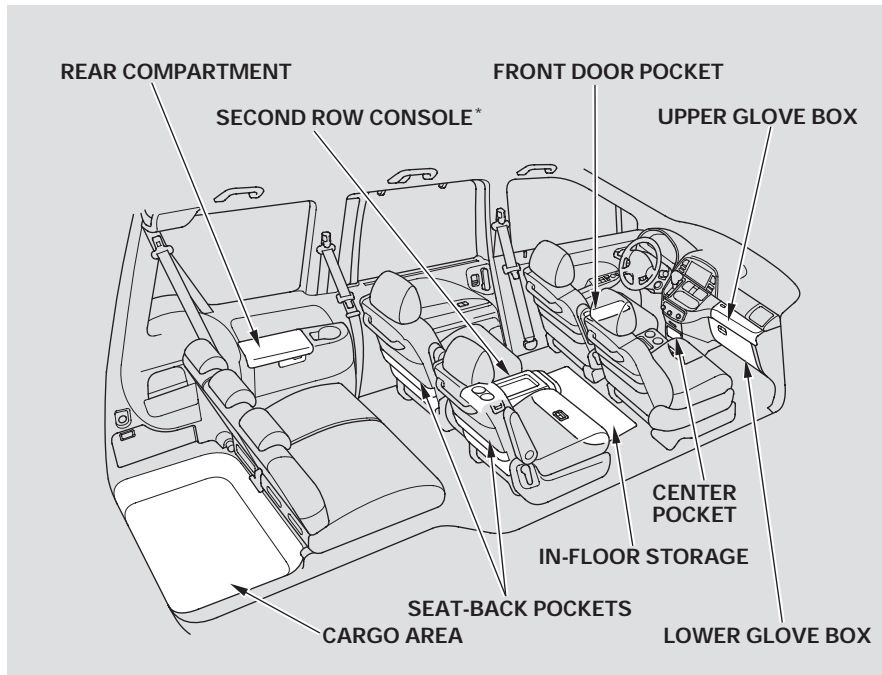

* : If equipped

Your vehicle has several convenient storage areas:

- Glove box (upper and lower)
- In-floor storage
- Front door and seat-back pockets
- Rear cargo area, including the second row seats when removed, and the third row seat when folded flat
- Second row console *
- Center pocket
- Rear compartment
- Roof-rack (if installed)

However, carrying too much cargo, or improperly storing it, can affect your vehicle's handling, stability, stopping distance, and tires, and make it unsafe. Before carrying any type of cargo, be sure to read the following pages.

Load Limits

The maximum load for your vehicle is:

U.S. LX and Canadian DX models:

1,349 lbs (612 kg)

Canadian LX and EX models:

1,388 lbs (630 kg)

EX-L and Touring models:

1,322 lbs (600 kg)

See Tire And Loading Information label attached to the driver's doorjamb.

Label Example

TIRE AND LOADING INFORMATION			
SEATING CAPACITY TOTAL X FRONT X SECOND X THIRD X			
The combined weight of occupants and cargo should never exceed XXXkg or XXXlbs			
TIRE	SIZE	COLD TIRE PRESSURE	
FRONT	XXXX/XXXX XXXX	XXXKPA . XXPSI	SEE OWNER'S MANUAL FOR ADDITIONAL INFORMATION
REAR	XXXX/XXXX XXXX	XXXKPA . XXPSI	
SPARE	XXXX/XXXX XXXX	XXXKPA . XXPSI	

This figure includes the total weight of all occupants, cargo, and accessories, and the tongue load if you are towing a trailer.

⚠ WARNING

Overloading or improper loading can affect handling and stability and cause a crash in which you can be hurt or killed.

Follow all load limits and other loading guidelines in this manual.

Steps for Determining Correct Load Limit -









- (1) Locate the statement "The combined weight of occupants and cargo should never exceed XXX kg or XXX lbs." on your vehicle's placard.
- (2) Determine the combined weight of the driver and passengers that will be riding in your vehicle.
- (3) Subtract the combined weight of the driver and passengers from XXX kg or XXX lbs.

- (4) The resulting figure equals the available amount of cargo and luggage load capacity. For example, if the "XXX" amount equals 1,400 lbs. and there will be five 150 lb. passengers in your vehicle, the amount of available cargo and luggage load capacity is 650 lbs.
(1,400 - 750 (5 × 150) = 650 lbs.)

- (5) Determine the combined weight of luggage and cargo being loaded on the vehicle. That weight may not safely exceed the available cargo and luggage load capacity calculated in Step 4.
- (6) If your vehicle will be towing a trailer, load from your trailer will be transferred to your vehicle. Consult this manual to determine how this reduces the available cargo and luggage load capacity of your vehicle.

CONTINUED

Carrying Cargo

Example 1	 Max Load (1,322 lbs)	\geq  Passenger Weight (150 lbs x 2 = 300 lbs)	+  Cargo Weight (1,022 lbs)
Example 2	 Max Load (1,322 lbs)	\geq  Passenger Weight (150 lbs x 4 = 600 lbs)	+  Cargo Weight (722 lbs)
Example 3	 Max Load (1,322 lbs)	\geq  Passenger Weight (150 lbs x 5 = 750 lbs)	+  Cargo Weight (572 lbs)

In addition, the total weight of the vehicle, all occupants, accessories, cargo, and trailer tongue load must not exceed the Gross Vehicle Weight Rating (GVWR) or the Gross Axle Weight Rating (GAWR). Both are on a label on the driver's doorjamb.

Max load on EX-L and Touring models is used in the Examples.

Carrying Items in the Passenger Compartment

- Store or secure all items that could be thrown around and hurt someone during a crash.
- Be sure items placed on the floor behind the front seats cannot roll under the seats and interfere with the pedals, the seat operation, or the proper operation of the sensors under the seats.
- Keep the glove boxes closed while driving. If either are open, a passenger could be injured during a crash or sudden stop.

If you remove or fold the rear seats down, tie down items that could be thrown about the vehicle during a crash or sudden stop. Also, keep all cargo below the bottom of the windows. If it is higher than the windows, it could interfere with the proper operation of the side curtain airbags.

Carrying Cargo in the Cargo Area or on a Roof Rack

- Distribute cargo evenly on the floor of the cargo area, placing the heaviest items on the bottom and as far forward as possible. Tie down items that could be thrown about the vehicle during a crash or sudden stop.
- If you carry large items that prevent you from closing the tailgate, exhaust gas can enter the passenger area. To avoid the possibility of **carbon monoxide poisoning**, follow the instructions on page [60](#) .

Carrying Cargo

- If you place items near the rear windows, be sure they are below the bottom of the windows. If cargo is higher, it could interfere with proper operation of the side curtain airbags.
- If you carry any items on a roof rack, be sure the total weight of the rack and the items does not exceed 150 lb (68 kg).

If you use an accessory roof rack, the roof rack weight limit may be lower. Refer to the information that came with your roof rack.

Grocery Bag Hooks



The grocery bag hooks on the back of the third row seats are designed to hold plastic grocery bags containing lightweight items. Heavy objects may damage the hooks.

This section gives you tips on starting the engine under various conditions, and how to operate the automatic transmission. It also includes important information on parking your vehicle, the braking system, the vehicle stability assist system, the tire pressure monitoring system, and facts you need if you are planning to tow a trailer.

Preparing to Drive	376
Starting the Engine.....	377
Automatic Transmission.....	378
Parking.....	382
Braking System.....	383
Anti-lock Brakes (ABS)	384
Vehicle Stability Assist (VSA) System.....	386
Tire Pressure Monitoring System (TPMS)	388
Towing a Trailer	396
Towing Your Vehicle	403

Preparing to Drive

You should do the following checks and adjustments before you drive your vehicle.

1. Make sure all windows, mirrors, and outside lights are clean and unobstructed. Remove frost, snow, or ice.
2. Check that the hood is fully closed.
3. Visually check the tires. If a tire looks low, use a gauge to check its pressure (see page [443](#)).
4. Check that any items you may be carrying are stored properly or fastened down securely.
5. Check the seat adjustment (see page [169](#)).
6. Check the adjustment of the inside and outside mirrors (see page [190](#)).
7. Check the steering wheel adjustment (see page [141](#)).
8. Make sure the doors and the tailgate are securely closed and locked.
9. Fasten your seat belt. Check that your passengers have fastened their seat belts (see page [15](#)).
10. When you start the engine, check the gauges and indicators in the instrument panel, and the messages in the information display or multi-information display (depending on models) (see pages [65](#) , [66](#) , [77](#) , and [87](#)).

1. Apply the parking brake.
2. In cold weather, turn off all electrical accessories to reduce the drain on the battery.
3. Make sure the shift lever is in Park. Press on the brake pedal.
4. Without touching the accelerator pedal, turn the ignition key to the START (III) position. Do not hold the key in the START (III) position for more than 15 seconds at a time. If the engine does not start right away, pause for at least 10 seconds before trying again.

NOTICE

*The immobilizer system protects your vehicle from theft. If an improperly-coded key (or other device) is used, the engine's fuel system is disabled. See **Immobilizer System** on page [143](#).*

5. If the engine does not start within 15 seconds, or starts but stalls right away, repeat step 4 with the accelerator pedal pressed halfway down. If the engine starts, release pressure on the accelerator pedal so the engine does not race.

6. If the engine fails to start, press the accelerator pedal all the way down, and hold it there while starting to clear flooding. If the engine still does not start, return to step 5.

NOTICE

The engine is harder to start in cold weather. Also, the thinner air found at altitudes above 8,000 feet (2,400 meters) adds to this problem.

Automatic Transmission

Shift Lever Position Indicators

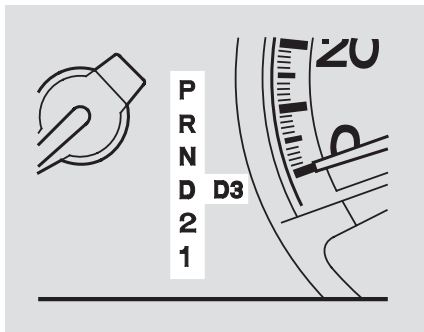

These indicators on the instrument panel show which position the shift lever is in.

The “D” indicator comes on for a few seconds when you turn the ignition switch to the ON (II) position. If it flashes while driving (in any shift position), it indicates a possible problem in the transmission.

If the malfunction indicator lamp comes on along with the “D” indicator, there is a problem in the automatic transmission control system. Avoid rapid acceleration, and have the transmission checked by your dealer as soon as possible.

On Touring models

When the “D” indicator warns of a possible problem with the transmission, you will see a “CHECK TRANSMISSION” message on the multi-information display (see page [88](#)).

Shifting

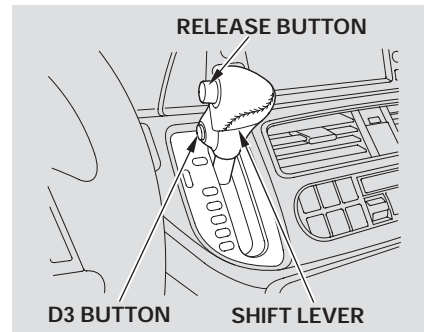

To shift from any position, press firmly on the brake pedal and press the release button on the side of the shift lever. You cannot shift out of Park when the ignition switch is in the LOCK (0) or ACCESSORY (I) position.

To shift from:	Do this:
P to R	Press the brake pedal, and press the release button.
R to P N to R D ₃ to 2 2 to 1	Press the release button.
1 to 2 2 to D D to N N to D R to N	Move the lever.
D ₃ to D D to D ₃	Press the D ₃ button.

Park (P) - This position mechanically locks the transmission. Use Park whenever you are turning off or starting the engine. To shift out of Park, you must press on the brake pedal and have your foot off the accelerator pedal. Press the release button on the side of the shift lever to move it.

If you have done all of the above and still cannot move the lever out of Park, see **Shift Lock Release** on page [381](#).

To avoid transmission damage, come to a complete stop before shifting into Park. You must also press the release button to shift into Park. The shift lever must be in Park before you can remove the key from the ignition switch.

Reverse (R) - Press the brake pedal and press the release button on the side of the shift lever to shift from Park to reverse. To shift from reverse to neutral, come to a complete stop and then shift. Press the release button before shifting into reverse from neutral.

Neutral (N) - Use neutral if you need to restart a stalled engine, or if it is necessary to stop briefly with the engine idling. Shift to the Park position if you need to leave your vehicle for any reason. Press on the brake pedal when you are moving the shift lever from neutral to another gear.

CONTINUED

Automatic Transmission

Drive (D) - Use this position for normal driving. The transmission automatically selects a suitable gear for your speed and acceleration.

Drive (D3) - To use D3, press the D3 button when the shift lever is in the “D” position. This position is similar to D, except only the first three gears are selected instead of all five. Use D3 when towing a trailer in hilly terrain, or to provide engine braking when going down a steep hill. D3 can also keep the transmission from cycling between third and fourth gears in stop-and-go driving.

Second (2) - This position locks the transmission in second gear. It does not downshift to first gear when you come to a stop.

Use second gear:

- For more power when climbing.
- To increase engine braking when going down steep hills.
- For starting out on a slippery surface or in deep snow.
- When driving downhill with a trailer.

First (1) - To shift from second to first, press the release button on the side of the shift lever. This position locks the transmission in first gear. By upshifting and downshifting through 1, 2, D3, and D, you can operate the transmission much like a manual transmission without a clutch pedal.

Engine Speed Limiter

If you exceed the maximum speed for the gear you are in, the engine speed will enter into the tachometer's red zone. If this occurs, you may feel the engine cut in and out. This is caused by a limiter in the engine's computer controls. The engine will run normally when you reduce the rpm below the red zone.

Shift Lock Release

This allows you to move the shift lever out of Park if the normal method of pushing on the brake pedal and pressing the release button does not work.

1. Set the parking brake.
2. Remove the key from the ignition switch.
3. Put a cloth on the notch of the shift lock release slot cover. Using a small flat-tipped screwdriver or a metal fingernail file, carefully pry on the notch of the cover to remove it.

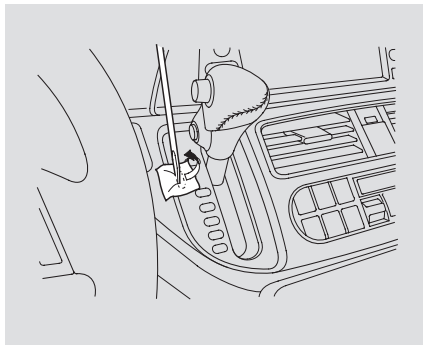

4. Insert the key in the shift lock release slot.
5. Push down on the key while you press the release button on the shift lever and move the shift lever out of Park to neutral.

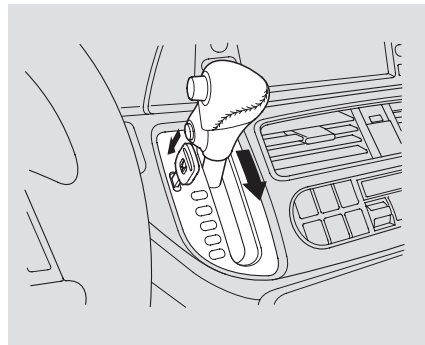

6. Remove the key from the shift lock release slot, then reinstall the cover. Make sure the notch on the cover is on the left side. Press the brake pedal, and restart the engine.

If you need to use the shift lock release, it means your vehicle is developing a problem. Have it checked by your dealer.

Parking

Always use the parking brake when you park your vehicle. Make sure the parking brake is set firmly, or your vehicle may roll if it is parked on an incline.

Set the parking brake before you put the transmission in Park. This keeps the vehicle from moving and putting pressure on the parking mechanism in the transmission.

Parking Tips

- Make sure the moonroof (if equipped) and the windows are closed.
 - Turn off the lights.
 - Place any packages, valuables, etc. in the cargo area or take them with you.
 - Lock the doors and the tailgate.
 - Check the indicator on the instrument panel to verify that the security system is set.
 - Never park over dry leaves, tall grass, or other flammable materials. The hot three way catalytic converter could cause these materials to catch on fire.
- If the vehicle is facing uphill, turn the front wheels away from the curb.
 - If the vehicle is facing downhill, turn the front wheels toward the curb.
 - Make sure the parking brake is fully released before driving away. Driving with the parking brake partially set can overheat or damage the rear brakes.

Your vehicle is equipped with disc brakes at all four wheels. A power assist helps reduce the effort needed on the brake pedal. The anti-lock brake system (ABS) helps you retain steering control when braking very hard.

Resting your foot on the pedal keeps the brakes applied lightly, builds up heat, and reduces their effectiveness and reduces brake pad life. In addition, fuel economy can be reduced. It also keeps your brake lights on all the time, confusing drivers behind you.

Constant application of the brakes when going down a long hill builds up heat and reduces their effectiveness. Use the engine to assist the brakes by taking your foot off the accelerator and downshifting to a lower gear.

Check your brakes after driving through deep water. Apply the brakes moderately to see if they feel normal. If not, apply them gently and frequently until they do. Be extra cautious and alert in your driving.

Braking System Design

The hydraulic system that operates the brakes has two separate circuits. Each circuit works diagonally across the vehicle (the left-front brake is connected with the right-rear brake, etc.). If one circuit should develop a problem, you will still have braking at two wheels.

Brake Pad Wear Indicators

All four brakes have audible brake wear indicators.

If the brake pads need replacing, you will hear a distinctive, metallic screeching sound when you apply the brake pedal. If you do not have the brake pads replaced, they will screech all the time. It is normal for the brakes to occasionally squeal or squeak when you apply them.

Anti-lock Brakes (ABS)

The anti-lock brake system (ABS) helps prevent the wheels from locking up, and helps you retain steering control by pumping the brakes rapidly, much faster than a person can do it.

The electronic brake distribution (EBD) system, which is part of the ABS, also balances the front-to-rear braking distribution according to vehicle loading.

You should never pump the brake pedal. Let the ABS work for you by always keeping firm, steady pressure on the brake pedal. This is sometimes referred to as “stomp and steer.”

You will feel a pulsation in the brake pedal when the ABS activates, and you may hear some noise. This is normal: it is the ABS rapidly pumping the brakes. On dry pavement, you will need to press on the brake pedal very hard before the ABS activates. However, you may feel the ABS activate immediately if you are trying to stop on snow or ice.



ABS Indicator

If this indicator comes on, the anti-lock function of the braking system has shut down. The brakes still work like a conventional system, but without anti-lock. You should have your dealer inspect your vehicle as soon as possible.

On Touring models

You will also see a “CHECK ABS SYSTEM” message on the multi-information display (see page [89](#)).

If the ABS indicator and the brake system indicator come on together, and the parking brake is fully released, the EBD system may also be shut down.

On Touring models

If this happens, you will also see “CHECK ABS SYSTEM” and “CHECK BRAKE SYSTEM” messages on the multi-information display.

Test your brakes as instructed on page 473 . If the brakes feel normal, drive slowly and have your vehicle repaired by your dealer as soon as possible. Avoid sudden hard braking which could cause the rear wheels to lock up and possibly lead to a loss of control.

The VSA indicator will come on along with the ABS indicator.

Important Safety Reminders
ABS does not reduce the time or distance it takes to stop the vehicle. It only helps with the steering control during braking.

ABS will not prevent a skid that results from changing direction abruptly, such as trying to take a corner too fast or making a sudden lane change. Always drive at a safe speed for the road and weather conditions.

ABS cannot prevent a loss of stability. Always steer moderately when you are braking hard. Severe or sharp steering wheel movement can still cause your vehicle to veer into oncoming traffic or off the road.

A vehicle with ABS may require a longer distance to stop on loose or uneven surfaces, such as gravel or snow, than a vehicle without anti-lock.

Vehicle Stability Assist (VSA) System

The vehicle stability assist (VSA) system helps to stabilize the vehicle during cornering if the vehicle turns more or less than desired. It also assists you in maintaining traction while accelerating on loose or slippery road surfaces. It does this by regulating the engine's output and by selectively applying the brakes.

When VSA activates, you may notice that the engine does not respond to the accelerator in the same way it does at other times. There may also be some noise from the VSA hydraulic system. You will also see the VSA activation indicator blink.

The VSA system cannot enhance the vehicle's driving stability in all situations and does not control your vehicle's entire braking system. It is still your responsibility to drive and corner at reasonable speeds and to leave a sufficient margin of safety.



VSA Activation Indicator

When VSA activates, you will see the VSA activation indicator blink (see [page 70](#)).



VSA System Indicator

If the VSA system indicator comes on while driving, pull to the side of the road when it is safe, and turn off the engine. Reset the system by restarting the engine. If the VSA system indicator stays on or comes back on while driving, have the VSA system inspected by your dealer. If the indicator does not come on when the ignition switch is turned to the ON (II) position, there may be a problem with the VSA system. Have your dealer inspect your vehicle as soon as possible.

On Touring models only

You will also see a "CHECK VSA SYSTEM" message on the multi-information display if there is a problem with the VSA system.

Without VSA, your vehicle still has normal braking and cornering ability, but it does not have VSA traction and stability enhancement.

The VSA system automatically turns on every time you start the engine, even if you turned it off the last time you drove the vehicle.

Except Touring models

- If the low tire pressure indicator or TPMS indicator comes on, see [page 388](#) .

Touring model

- If the low tire pressure/TPMS indicator comes on, see [page 391](#) . Or, if the multi-information display shows a "CHECK TPMS SYSTEM" message with the indicator flashing, see [page 88](#) .

In this case, you cannot turn off the VSA using the OFF switch again.

Vehicle Stability Assist (VSA) System

VSA Off Switch

In certain unusual conditions when your vehicle gets stuck in shallow mud or fresh snow, it may be easier to free it with the VSA temporarily switched off. When the VSA system is off, the traction control system is also off. You should only attempt to free your vehicle with the VSA off if you are not able to free it when the VSA is on.

Immediately after freeing your vehicle, be sure to switch the VSA on again. We do not recommend driving your vehicle with the VSA and traction control systems switched off.

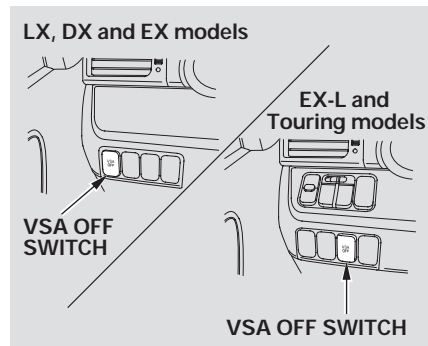

This switch is under the left vent. Press it to turn the VSA system on and off.

When VSA is off, the VSA activation indicator comes on as a reminder.

VSA is turned on every time you start the engine, even if you turned it off the last time you drove the vehicle.

VSA and Tire Sizes

Driving with varying tire or wheel sizes may cause the VSA to malfunction. When replacing tires, make sure they are of the same size and type as your original tires (see page [447](#)).

If you install winter tires, make sure they are the same size as those that were originally supplied with your vehicle. Exercise the same caution during winter driving as you would if your vehicle was not equipped with VSA.

Tire Pressure Monitoring System (TPMS) - Except Touring models

On LX, EX, EX-L and Canadian DX models

Your vehicle is equipped with a tire pressure monitoring system (TPMS) that turns on every time you start the engine and monitors the pressure in your tires while driving.

Each tire has its own pressure sensor (not including the spare tire). If the air pressure of a tire becomes significantly low while driving, the sensor in that tire immediately sends a signal that causes the low tire pressure indicator to come on.



Low Tire Pressure Indicator

When the low tire pressure indicator is on, one or more of your tires is significantly underinflated. You should stop and check your tires as soon as possible, and inflate them to the proper pressure as indicated on the vehicle's tire information placard.

If you think you can safely drive a short distance to a service station, proceed slowly, and inflate the tire to the recommended pressure shown on the driver's doorjamb.

If the tire is flat, or if the tire pressure is too low to continue driving, replace the tire with the compact spare tire (see page [457](#)).

If you cannot make the low tire pressure indicator go out after inflating the tires to the specified values, have your dealer check the system as soon as possible.

Driving on a significantly under-inflated tire causes the tire to overheat and can lead to tire failure. Under-inflation also reduces fuel efficiency and tire tread life, and may affect the vehicle's handling and stopping ability.

Because tire pressure varies by temperature and other conditions, the low tire pressure indicator may come on unexpectedly.

Tire Pressure Monitoring System (TPMS) - Except Touring models

For example, if you check and fill your tires in a warm area, then drive in extremely cold weather, the tire pressure will be lower than measured and could be underinflated and cause the low tire pressure indicator to come on. Or, if you check and adjust your tire pressure in cooler conditions, and drive into extremely hot conditions, the tire may become overinflated. However, the low tire pressure indicator will not come on if the tires are overinflated.

Refer to page [442](#) for tire inflation guidelines.

Although your tire pressure is monitored, you must manually check the tire pressures monthly.

Each tire, including the spare, should be checked monthly when cold, and set to the recommended inflation pressure as specified on the tire

information label and in the owner's manual (see page [443](#)).

TPMS

Tire Pressure Monitoring System (TPMS) Indicator

This indicator comes on and stays on if there is a problem with the tire pressure monitoring system.

If this happens, the system will shut off and no longer monitor tire pressures. Have the system checked by your dealer as soon as possible.

If the low tire pressure indicator or TPMS indicator comes on, the VSA system automatically turns on even if the VSA system is turned off by pressing the VSA OFF switch (see page [391](#)). If this happens, you cannot turn the VSA system off by pressing the VSA OFF switch again.

When you restart the vehicle with the compact spare tire, the TPMS indicator may also come on and stay on after driving several miles (kilometers).

Tire Pressure Monitoring System (TPMS) - Except Touring models

Changing a Tire with TPMS

If you have a flat tire, the low tire pressure indicator will come on. Replace the flat tire with the compact spare tire (see page 457).

Each wheel (except the compact spare tire wheel) is equipped with a tire pressure sensor mounted inside the tire behind the valve stem. You must use TPMS specific wheels. It is recommended that you always have your tires serviced by your dealer or qualified technician.

After you replace the flat tire with the compact spare tire, the low tire pressure indicator stays on. This is normal; the system is not monitoring the spare tire pressure. Manually check the spare tire pressure to be sure it is correct. After several miles (kilometers) driving with the compact spare tire, the TPMS indicator comes on and the low tire pressure indicator goes off.

The low tire pressure indicator or the TPMS indicator will go off, after several miles (kilometers) driving, when you replace the spare tire with the specified regular tire equipped with the tire pressure monitor sensor.

Never use a puncture-repairing agent in a flat tire. If used, you will have to replace the tire pressure sensor. Have the flat tire repaired by your dealer as soon as possible.

As required by the FCC:

This device complies with Part 15 of the FCC rules. Operation is subject to the following two conditions: (1) This device may not cause harmful interference, and (2) this device must accept any interference received, including interference that may cause undesired operation.

Changes or modifications not expressly approved by the party responsible for compliance could void the user's authority to operate the equipment.

This device complies with Industry Canada Standard RSS-210.

Operation is subject to the following two conditions: (1) this device may not cause interference, and (2) this device must accept any interference that may cause undesired operation of the device.

Tire Pressure Monitoring System (TPMS) - Touring models

Your vehicle is equipped with a tire pressure monitoring system (TPMS) that turns on every time you start the engine and monitors the pressure in your tires while driving.

Each tire has its own pressure sensor. If the air pressure of a tire becomes significantly low, the sensor in that tire immediately sends a signal that causes the low tire pressure/TPMS indicator in the instrumental panel and the appropriate tire position indicator on the tire pressure monitor on the multi-information display (see page [393](#)) to come on.



Low Tire Pressure/ TPMS Indicator

When the low tire pressure/TPMS indicator is on, one or more of your tires is significantly underinflated. The multi-information display also shows a “CHECK TIRE PRESSURE” message (see page [393](#)). You should stop and check your tires as soon as possible, and inflate them to the proper pressure as indicated on the vehicle’s tire information placard.

Driving on a significantly underinflated tire causes the tire to overheat and can lead to tire failure. Under-inflation also reduces fuel efficiency and tire tread life, and may affect the vehicle’s handling and stopping ability.

Because tire pressure varies by temperature and other conditions, the low tire pressure/TPMS indicator may come on unexpectedly.

For example, if you check and fill your tires in a warm area, then drive in extremely cold weather, the tire pressure will be lower than measured and could be underinflated and cause the low tire pressure/TPMS indicator to come on. Or, if you check and adjust your tire pressure in cooler conditions, and drive into extremely hot conditions, the tire may become overinflated. However, the low tire pressure/TPMS indicator will not come on if the tires are overinflated.

Refer to page [442](#) for tire inflation guidelines.

If there is a problem with the TPMS, this indicator begins to flash. It stops flashing after approximately 1 minute, then stays on. You will also see a “CHECK TPMS SYSTEM” message on the multi-information display (see page [395](#)).

CONTINUED

Tire Pressure Monitoring System (TPMS) - Touring models

Although your tire pressure is monitored, you must manually check the tire pressures monthly.

Each tire, including the spare, should be checked monthly when the vehicle is cold, and set to the recommended inflation pressure as specified on the vehicle placard and in the owner's manual (see page [443](#)).

If you think you can safely drive a short distance to a service station, proceed slowly to the station, then inflate the tire to the recommended pressure.

If the tire is flat, or if the tire pressure is too low to continue driving, replace the tire with the compact spare tire (see page [457](#)).

Changing a Tire with TPMS

If you have a flat tire, the low tire pressure/TPMS and tire monitor indicators will come on. Replace the indicated flat tire with the compact spare tire (see page [458](#)).

After the flat tire is replaced with the spare tire, the low tire pressure/TPMS indicator stays on while driving. After several miles (kilometers) driving, this indicator begins to flash, then stays on again. You will also see a "CHECK TPMS SYSTEM" message on the multi-information display. This is normal; the system cannot monitor the spare tire pressure. Manually check the spare tire pressure to be sure it is correct.

This indicator and the warning message on the multi-information display will go off, after several miles (kilometers) driving, when the spare tire is replaced with the specified

regular tire equipped with the tire pressure monitor sensor.

Never use a puncture-repairing agent in a flat tire. If used, you will have to replace the tire pressure sensor. Have the flat tire repaired by your dealer as soon as possible.

Each wheel is equipped with a tire pressure sensor mounted inside the tire behind the valve stem. You must use TPMS specific wheels. It is recommended that you always have your tires serviced by your dealer or a qualified technician.

Tire Pressure Monitoring System (TPMS) - Touring models

Tire Pressure Monitor

On Touring models



To display the tire pressure monitor, press the INFO button until it appears on the multi-information display.

When all tire pressures are normal, the tire pressure monitor will show a "TIRE PRESS. OK SYSTEM FUNC NORMAL" message.

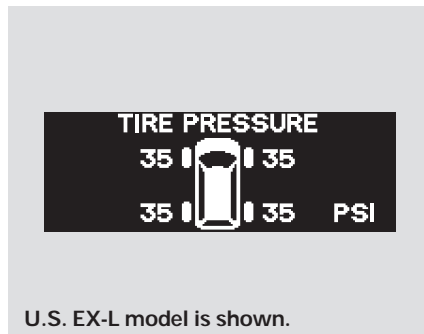

U.S. EX-L model is shown.

When the TPMS is functioning normally, you can see the tire pressure readings of each tire in psi (U.S. models) or kPa (Canadian models) by pressing the SEL/RESET button while the multi-information display shows the tire pressure monitor.



When any of the tires have low pressure, the low tire pressure/TPMS indicator on the instrument panel comes on, and the multi-information display also interrupts the current display and shows a "CHECK TIRE PRESSURE" message. You can see one or more of the low pressure tire positions highlighted in the display along with this message.

Tire Pressure Monitoring System (TPMS) - Touring models

It is possible that the pressures shown on the multi-information display and the pressures you manually measure are slightly different.

If the difference is significant or you cannot make the low tire pressure/TPMS indicator and message on the multi-information display go out after inflating the tires to the specified values, have your dealer check the system as soon as possible.

Pax System Warning

On U.S. models with the Michelin PAX system



If a flat tire is causing the low tire pressure indicator to come on, you will see the above message on the multi-information display.

Because your vehicle is equipped with the Michelin PAX system, you can continue to drive up to about 125 miles (200 km). If you have a flat tire, take your vehicle to the nearest Honda dealer or authorized Michelin PAX system dealer.

Changing a Tire with TPMS

The tires on your vehicles are PAX tires, and you cannot replace or repair a flat tire. Replacement or repair of tires must be performed by a Honda dealer or an authorized Michelin PAX system dealer.

For more information on the Michelin PAX system, refer to page [454](#).

Tire Pressure Monitoring System (TPMS) - Touring models

Check TPMS System Message

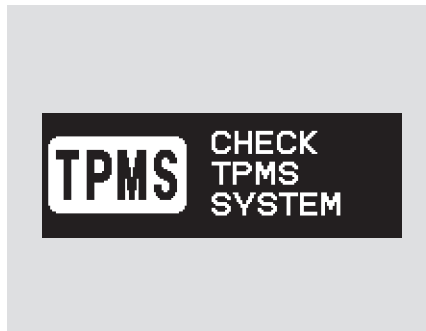

If there is a problem with the TPMS, the multi-information display shows a “CHECK TPMS SYSTEM” message.

Also, the low tire pressure/TPMS indicator begins to flash, then stays on (see page [71](#)).

If you see this message, the system may not be able to detect or signal low tire pressure as intended. Also, the tire pressure readings will not be displayed. Have your vehicle checked by a dealer as soon as possible.

If the low tire pressure/TPMS indicator comes on, or the multi-information display shows a “CHECK TPMS SYSTEM” message, the VSA system automatically turns on even when the VSA system is turned off by pressing the VSA OFF switch (see page [387](#)). If this happens, you cannot turn the VSA system off by pressing the VSA OFF switch again.

When you restart the vehicle with the compact spare tire, the TPMS system message will also be displayed on the multi-information display after several miles (kilometers) driving.

As required by the FCC:

This device complies with Part 15 of the FCC rules. Operation is subject to the following two conditions: (1) This device may not cause harmful interference, and (2) this device must accept any interference received, including interference that may cause undesired operation.

Changes or modifications not expressly approved by the party responsible for compliance could void the user’s authority to operate the equipment.

This device complies with Industry Canada Standard RSS-210.

Operation is subject to the following two conditions: (1) this device may not cause interference, and (2) this device must accept any interference that may cause undesired operation of the device.

Towing a Trailer

Your vehicle has been designed primarily to carry passengers and their cargo. You can also use it to tow a trailer if you carefully observe the load limits, use the proper equipment, and follow the guidelines in this section.

⚠ WARNING

Exceeding any load limit or improperly loading your vehicle and trailer can cause a crash in which you can be seriously hurt or killed.

Check the loading of your vehicle and trailer carefully before starting to drive.

Load Limits

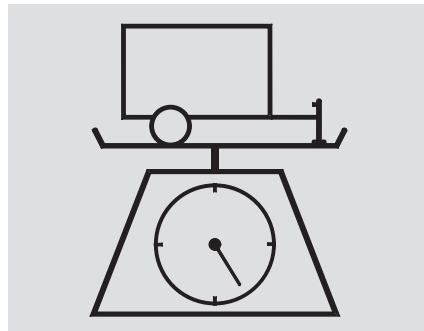

Total Trailer Weight: The maximum allowable weight of the trailer and everything in or on it depends on several factors. See page [397](#) for the driving limits for your towing situation. Towing a load that is too heavy can seriously affect your vehicle's handling and performance. It can also damage the engine and drivetrain.

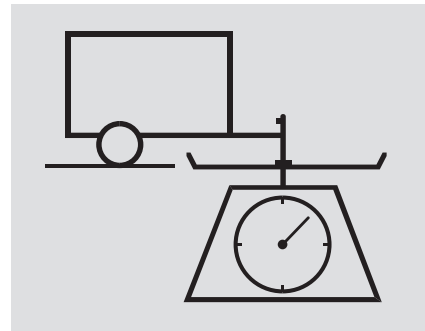

Tongue Load: The weight that the tongue of a fully-loaded trailer puts on the hitch should be approximately 10% of the total trailer weight. Too much tongue load reduces front-tire traction and steering control. Too little tongue load can make the trailer unstable and cause it to sway.

Maximum Total Trailer Weight

Number of Occupants ^{*1}	Equipped with transmission cooler and power steering fluid cooler ^{*2}
1	3,500 lbs (1,580 kg)
2	3,350 lbs (1,520 kg)
3	3,200 lbs (1,450 kg)
4	3,050 lbs (1,380 kg)
5	2,900 lbs (1,310 kg)
6	2,750 lbs (1,250 kg)
7 ^{*3}	2,600 lbs (1,180 kg) ^{*3} 1,550 lbs (700 kg) ^{*4}
8 ^{*4}	650 lbs (290 kg)

* 1: Including driver. Based on 150 lbs (70 kg) per occupant.

* 2: See page 399 for information about fluid coolers.

* 3: U.S. LX and Canadian DX models

* 4: EX, EX-L, Touring and Canadian LX models

To achieve a proper tongue load, start by loading 60% of the load toward the front of the trailer and 40% toward the rear, then re-adjust the load as needed.

Gross Vehicle Weight Rating (GVWR):

The maximum allowable weight of the vehicle, all occupants, all cargo, and the tongue load is 6,019 lbs (2,730 kg).

Gross Axle Weight Rating (GAWR):

The maximum allowable weight of the vehicle, all occupants, all cargo, and the tongue load must not exceed 2,910 lbs (1,320 kg) on the front axle, and 3,197 lbs (1,450 kg) on the rear axle.

Gross Combined Weight Rating (GCWR):

The maximum allowable weight of the fully loaded vehicle and trailer is 8,410 lbs (3,815 kg).

Towing a Trailer

Checking Loads

The best way to confirm that all loads are within limits is to check them at a public scale. For public scales in your area, check your local phone book, or contact your trailer dealer or rental agency for assistance.

If you cannot get to a public scale, you can estimate the total trailer weight by adding the weight of your trailer (as quoted by the manufacturer) with everything in or on the trailer.

If you normally pull the same load each time you tow a trailer, you can use a suitable scale or a special tongue load gauge to check the tongue load the first time you set up a towing combination (a fully loaded vehicle and trailer), then recheck the tongue load whenever the conditions change.

Towing Equipment and Accessories

Towing generally requires a variety of supplemental equipment, depending on the size of your trailer, how much load you are towing, and where you tow. To ensure the best quality, we recommend that you purchase Honda equipment whenever possible.

Discuss your needs with your trailer sales or rental agency, and follow the guidelines in this section. Also make sure that all equipment is properly installed and meets federal, state, province, and local regulations.

Hitches

Any hitch used on your vehicle must be properly bolted to the underbody, using the six threaded holes provided. A hitch and the required fluid coolers designed especially for your Odyssey can be obtained from your Honda dealer.

Weight Distributing Hitch

If the total trailer weight is more than 1,850 lbs (840 kg), you must also use a weight distributing hitch. This device transfers weight from the vehicle's rear wheels to the front wheels, and to the trailer's wheels. Carefully follow the hitch maker's instructions for proper installation and adjustment.

Safety Chains

Always use safety chains when you tow a trailer. Make sure the chains are secured to the trailer and hitch, and that they cross under the tongue and can catch the trailer if it becomes unhitched. Leave enough slack to allow the trailer to turn corners easily, but do not let the chains drag on the ground.

Sway Control

If the total trailer weight exceeds 2,000 lbs (900 kg), you should install a sway control device to minimize swaying that can occur in crosswinds and in normal and emergency driving maneuvers. Your trailer maker can tell you what kind of sway control you need and how to install it.

Transmission Fluid Cooler and Power Steering Fluid Cooler

To help prevent overheating, a transmission fluid cooler and a power steering fluid cooler are required for trailer towing. These coolers are available only from your Honda dealer.

Towing a Trailer

Trailer Brakes

Honda recommends that any trailer having a total weight of 1,000 lbs (450 kg) or more be equipped with its own electric or surge-type brakes.

If you choose electric brakes, be sure they are electronically actuated. Do not attempt to tap into your vehicle's hydraulic system. No matter how successful it may seem, any attempt to attach trailer brakes to your vehicle's hydraulic system will lower braking effectiveness and create a potential hazard.

See your trailer dealer or rental agency for more information on installing electric brakes.

Trailer Lights

Trailer lights and equipment must comply with federal, state, province, and local regulations. Check the requirements for the areas where you plan to tow, and use only equipment designed for your vehicle.

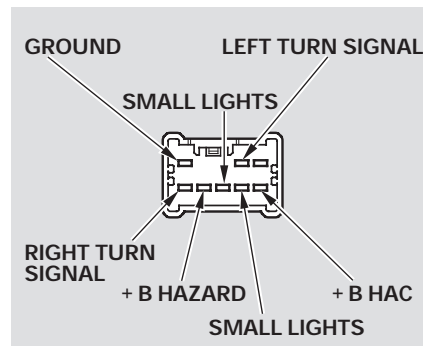

Your vehicle has a trailer lighting connector behind the right side panel in the cargo area. Refer to the drawing above for the purpose of each pin.

Since lighting and wiring vary by trailer type and brand, you should have a qualified technician install a suitable connector between the vehicle and the trailer. Improper equipment or installation can cause damage to your vehicle's electrical system and affect your vehicle warranty.

Spare Tires

When towing a trailer, we recommend that you carry a full-size spare wheel and tire for your vehicle and trailer. If you use the compact spare tire that came with your vehicle, it could adversely affect vehicle handling. See page 447 for proper tire size, page 463 for how to store a full size wheel and tire, and page 458 for information on changing a flat tire.

Remember to unhitch the trailer before changing a flat. Ask your trailer sales or rental agency where and how to store the trailer's spare tire.

If equipped

Because of the Michelin PAX system, you must not change a flat tire, or use a compact spare tire on your vehicle.

Additional Towing Equipment

Many states and Canadian provinces require special outside mirrors when towing a trailer. Even if they don't, you should install special mirrors if you cannot clearly see behind you, or if the trailer creates a blind spot.

Ask your trailer sales or rental agency if any other items are recommended or required for your towing situation.

Break-In Period

Avoid towing a trailer during your vehicle's first 600 miles (1,000 km) (see page 360).

Towing a Trailer

Pre-Tow Checklist

When preparing to tow, and before driving away, be sure to check the following:

- The vehicle has been properly serviced, and the suspension, cooling system, and lights are in good operating condition.
- The trailer has been properly serviced and is in good condition.
- All weights and loads are within limits.
- The hitch, safety chains, and any other attachments are secure.

- All items in or on the trailer are properly secured and cannot shift while you drive.
- Your vehicle tires and spare are properly inflated, and the trailer tires and spare are inflated as recommended by the trailer maker.
- The lights and brakes on your vehicle and the trailer are working properly.
- You may want to fill the fuel tank with premium fuel. Premium fuel provides improved performance.

Driving Safely With a Trailer

The added weight, length, and height of a trailer will affect your vehicle's handling and performance, so driving with a trailer requires some special driving skills and techniques.

For your safety and the safety of others, take time to practice driving maneuvers before heading for the open road, and follow the guidelines below.

Towing Speeds and Gears

Drive slower than normal in all driving situations, and obey posted speed limits for vehicles with trailers. Use the D position when towing a trailer on level roads. Do not exceed 55 mph (88 km/h). At higher speeds, the trailer may sway or affect vehicle handling.

Towing a Trailer, Towing Your Vehicle

Making Turns and Braking

Make turns more slowly and wider than normal. The trailer tracks a smaller arc than your vehicle, and it can hit or run over something the vehicle misses. Allow more time and distance for braking. Do not brake or turn suddenly as this could cause the trailer to jackknife or turn over.

Driving on Hills

When climbing hills, closely watch your temperature gauge. If it nears the red mark, turn the air conditioning off, reduce speed and, if necessary, pull to the side of the road to let the engine cool.

If the automatic transmission shifts frequently while going up a hill, shift to D3.

If you must stop when facing uphill, use the foot brake or parking brake. Do not try to hold the vehicle in place by pressing on the accelerator, as this can cause the automatic transmission to overheat.

When driving down hills, reduce your speed, and shift down to second gear. Do not “ride” the brakes, and remember, it will take longer to slow down and stop when towing a trailer.

Handling Crosswinds and Buffeting

Crosswinds and air turbulence caused by passing trucks can disrupt your steering and cause the trailer to sway. When being passed by a large vehicle, keep a constant speed, and steer straight ahead. Do not try to make quick steering or braking corrections.

Backing Up

Always drive slowly and have someone guide you when backing up. Grip the *bottom* of the steering wheel; then turn the wheel to the left to get the trailer to move to the left, and turn the wheel right to move the trailer to the right.

Parking

Follow all normal precautions when parking, including putting the transmission in Park and firmly setting the parking brake. Also, place wheel chocks at each of the trailer’s tires.

Towing Your Vehicle

Your vehicle is not designed to be towed behind a motor home. If your vehicle needs to be towed in an emergency, see page [480](#).

[Main Menu](#)

[Table Of Contents](#)

This section explains why it is important to keep your vehicle well maintained and how to follow basic maintenance safety precautions.

This section also includes instructions on how to read the maintenance minder messages on the information display or multi-information display (depending on models), and instructions for simple maintenance tasks you may want to take care of yourself.

If you have the skills and tools to perform more complex maintenance tasks on your vehicle, you may want to purchase the service manual. See page 505 for information on how to obtain a copy, or see your dealer.

Maintenance Safety.....	406
Maintenance Minder.....	407
Fluid Locations.....	417
Adding Engine Oil	418
Changing the Engine Oil and Filter	420
Engine Coolant.....	422
Windshield Washers	424
Automatic Transmission Fluid.....	425
Brake Fluid.....	427
Power Steering Fluid.....	428
Timing Belt.....	428
Lights	429
Cleaning the Seat Belts.....	436
Floor Mats	436
Dust and Pollen Filter	436
Wiper Blades	437
Wheels	442
Tires	442
Checking the Battery.....	450
Vehicle Storage.....	451

Maintenance Safety

All service items not detailed in this section should be performed by a certified technician or other qualified mechanic.

Important Safety Precautions

To eliminate potential hazards, read the instructions before you begin, and make sure you have the tools and skills required.

- Make sure your vehicle is parked on level ground, the parking brake is set, and the engine is off.
- To clean parts, use a commercially available degreaser or parts cleaner, not gasoline.
- To reduce the possibility of fire or explosion, keep cigarettes, sparks, and flames away from the battery and all fuel-related parts.
- Wear eye protection and protective clothing when working with the battery or compressed air.

WARNING

Improperly maintaining this vehicle, or failing to correct a problem before driving can cause a crash in which you can be seriously hurt or killed.

Always follow the inspection and maintenance recommendations and schedules in this owner's manual.

Potential Vehicle Hazards

- **Carbon Monoxide poison from engine exhaust.** Be sure there is adequate ventilation whenever you operate the engine.
- **Burns from hot parts.** Let the engine and exhaust system cool down before touching any parts.

- **Injury from moving parts.** Do not run the engine unless instructed to do so.

WARNING

Failure to properly follow maintenance instructions and precautions can cause you to be seriously hurt or killed.

Always follow the procedures and precautions in this owner's manual.

Some of the most important safety precautions are given here. However, we cannot warn you of every conceivable hazard that can arise in performing maintenance. Only you can decide whether or not you should perform a given task.

Your vehicle displays engine oil life and maintenance service items on the information display (LX, EX, EX-L and Canadian DX models), or on the multi-information display (Touring models), to show you when you should have your dealer perform engine oil replacement and indicated maintenance service.

Based on the engine operating conditions and accumulated engine revolutions, the onboard computer in your vehicle calculates the remaining engine oil life and displays it as a percentage.

Engine Oil Life Indicator

On LX, EX, EX-L and Canadian DX models

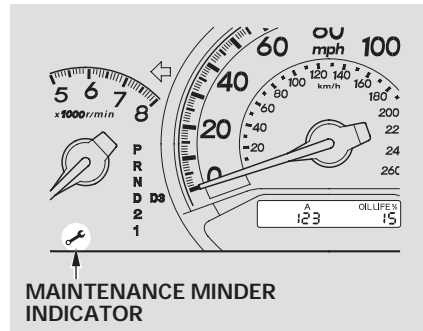

To see the current engine oil life, turn the ignition switch to the ON (II) position, and push and release the select/reset knob on the instrument panel repeatedly, until the engine oil life is displayed.

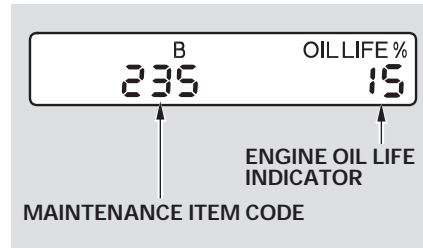

If the oil life is 15 percent or less, you will see the oil life indicator for every time you turn the ignition switch to the ON (II) position. This indicator stays on until you cancel it by pressing the select/reset knob. The maintenance minder indicator will also come on, and the maintenance item code(s) for other scheduled maintenance items needing service will be displayed next to the engine oil life indicator.

CONTINUED

Maintenance Minder

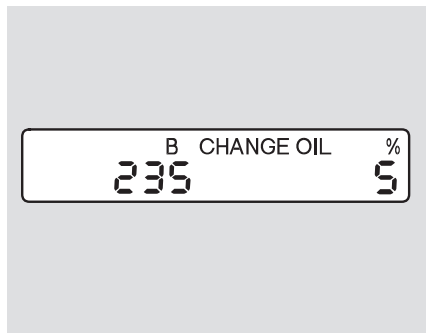

When the remaining engine oil life is less than 5 percent, you will see a "CHANGE OIL" message on the information display, along with the same maintenance item code(s), every time you turn the ignition switch to the ON (II) position.

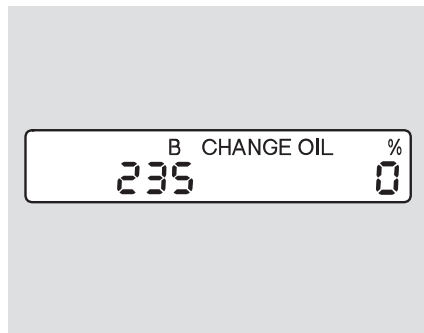

When the remaining engine oil life is 0 percent, you will see the above display. In this display, the remaining oil life indicator will be blinking. This display comes on and stays on every time you turn the ignition switch to the ON (II) position. When you see this message, have the indicated maintenance performed by your dealer as soon as possible.

You can change the display to the odometer, the trip meter, or the outside temperature by pushing the select/reset knob on the instrument panel.

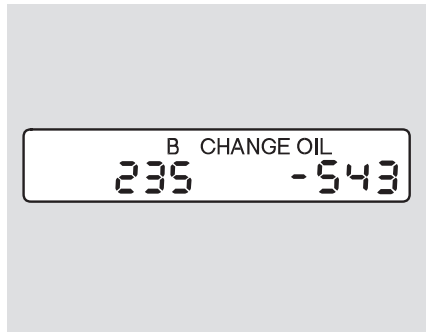

If you still do not perform the indicated maintenance, you will see a negative mileage, for example “ - 543,” blinking in the display. This negative mileage means that you should have performed the indicated maintenance 543 miles ago. Immediately have the indicated maintenance done by your dealer.

On Touring models

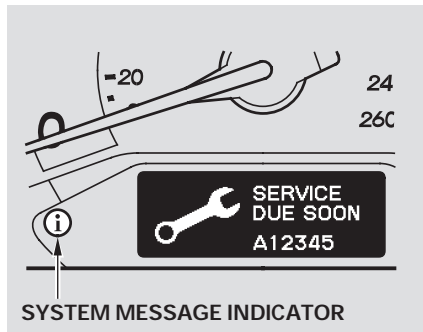

To see the current engine oil life, turn the ignition switch to the ON (II) position, then push and release the SEL/RESET button on the steering wheel repeatedly, until the engine oil life is displayed.

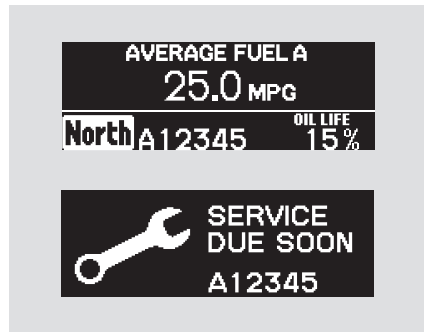

When the remaining engine oil life is 15 percent or less, the display shows a “SERVICE DUE SOON” message along with the maintenance item code(s) for other scheduled maintenance items needing service.

When you turn the ignition switch to the ON (II) position, the system message indicator will also come on.

CONTINUED

Maintenance Minder

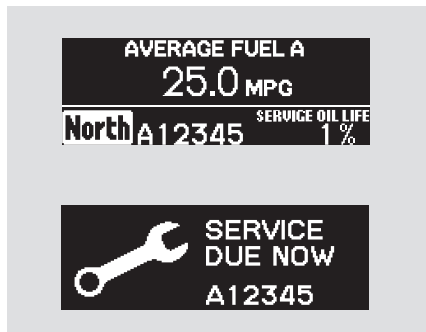

When the remaining engine oil life is less than 5 percent, you will see the above display. The display then changes to "SERVICE DUE NOW." Have the indicated maintenance done as soon as possible.

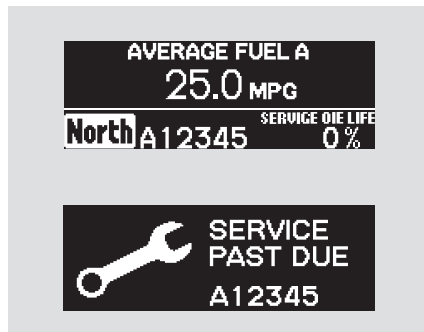

When the remaining engine oil life is less than 0 percent and you have not done the required maintenance, you will see the above display for several seconds. In this display, "0" will be blinking.

The display then changes to "SERVICE PAST DUE."

These messages will come on every time you turn the ignition switch to the ON (II) position.

Immediately have the service performed, and make sure to reset the display as described on page 413.

You can change the display to the odometer, the trip meter, or the outside temperature by pushing the SEL/RESET button on the steering wheel.

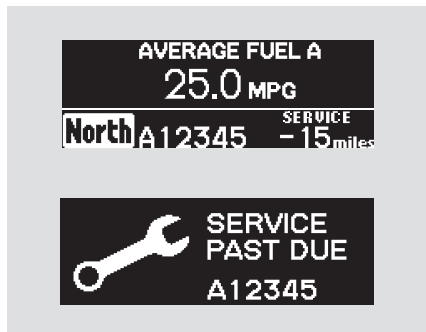

If you still do not get the indicated maintenance done, you will see a negative mileage, for example “ - 15” blinking. This negative mileage display means you should have done the indicated maintenance 15 miles ago. Immediately have the indicated maintenance done by your dealer.

Maintenance Main Items and Sub Items

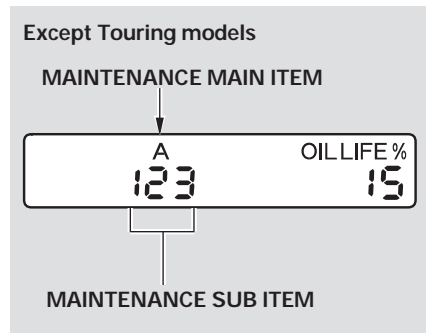

All the maintenance items displayed on the information display or the multi-information display are in code.

For an explanation of the maintenance codes, see page [416](#) .

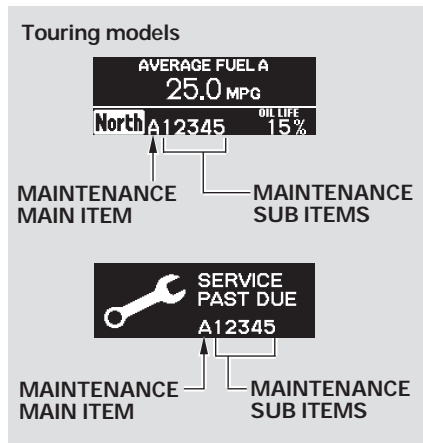

Maintenance Minder

Resetting the Engine Oil Life Indicator

On LX, EX, EX-L and Canadian DX models

Your dealer will reset the display after completing the required maintenance service. You will see "OIL LIFE 100 %" on the information display the next time you turn the ignition switch to the ON (II) position.

If maintenance service is done by someone other than your dealer, reset the maintenance minder as follows:

1. Turn the ignition switch to the ON (II) position.
2. Press the select/reset knob until the engine oil life indicator is displayed.

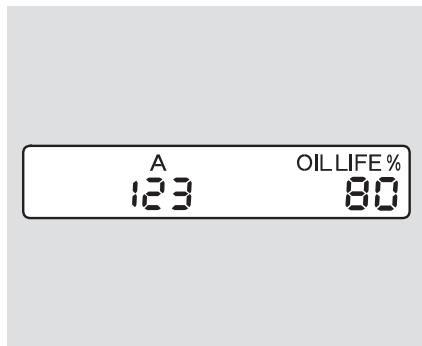

3. Press the select/reset knob for about 10 seconds. The engine oil life indicator and the maintenance item code(s) will blink.

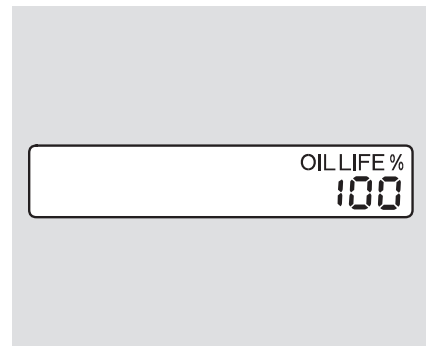

4. Press the select/reset knob for more than 5 seconds. The maintenance items code(s) will disappear, and the engine oil life indicator will reset to "100."

On Touring models

1. Turn the ignition switch to the ON (II) position.
2. Press the SEL/RESET button on the steering wheel until you see the engine oil life display.



3. Press the SEL/RESET button on the steering wheel for about 10 seconds. The display will change to the “CUSTOM SETUP” mode.
4. Press the SEL/RESET button on the steering wheel. The maintenance item code(s) will disappear, and the engine oil life will reset to “100.”



5. If you want to cancel resetting, press the INFO button on the steering wheel. The display changes as shown. Press the SEL/RESET button. This cancels the resetting procedure, and the screen returns to the normal display mode.

CONTINUED

Maintenance Minder

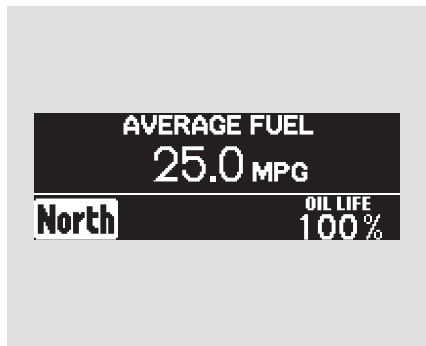

6. When you select “RESET” and press the SEL/RESET button, the multi-information display resets as shown above.

Important Maintenance Precautions

If you have the required service done but do not reset the display, or reset the display without doing the service, the system will not show the proper maintenance intervals. This can lead to serious mechanical problems because you will no longer have an accurate record of when maintenance is needed.

Your authorized Honda dealer knows your vehicle best and can provide competent, efficient service.

However, service at a dealer is not mandatory to keep your warranties in effect. Maintenance may be done by any qualified service facility or person who is skilled in this type of automotive service. Make sure to have the service facility or person reset the display as previously described. Keep all receipts as proof of completion, and have the person who does the work fill out your Honda Service History or Canadian Maintenance Log. Check your warranty booklet for more information.

We recommend the use of Honda parts and fluids whenever you have maintenance done. These are manufactured to the same high-quality standards as the original components, so you can be confident of their performance and durability.

U.S. Vehicles:

Maintenance, replacement, or repair of emissions control devices and systems may be done by any automotive repair establishment or individual using parts that are “certified” to EPA standards.

According to state and federal regulations, failure to perform maintenance on the items marked with # will not void your emissions warranties. However, all maintenance services should be performed in accordance with the intervals indicated by the odometer/trip meter display or the multi-information display.

Owner's Maintenance Checks

You should check the following items at the specified intervals. If you are unsure of how to perform any check, turn to the appropriate page listed.

- Engine oil level - Check every time you fill the fuel tank. See page [363](#) .
- Engine coolant level - Check the radiator reserve tank every time you fill the fuel tank. See page [364](#) .
- Automatic transmission - Check the fluid level monthly. See page [425](#) .
- Brakes - Check the fluid level monthly. See page [427](#) .
- Tires - Check the tire pressure monthly. Examine the tread for wear and foreign objects. See page [442](#) .

- Lights - Check the operation of the headlights, parking lights, taillights, high-mount brake light, and license plate lights monthly. See page [429](#) .

Maintenance Minder

Symbol	Maintenance Main Items
A	<ul style="list-style-type: none"> ● Replace engine oil*¹
B	<ul style="list-style-type: none"> ● Replace engine oil*¹ and oil filter ● Inspect front and rear brakes ● Check parking brake adjustment ● Inspect these items: <ul style="list-style-type: none"> ● Tie rod ends, steering gear box, and boots ● Suspension components ● Driveshaft boots ● Brake hoses and lines (including ABS) ● All fluid levels and condition of fluids ● Exhaust system*[#] ● Fuel lines and connections*[#]

* 1 : If the message "SERVICE DUE NOW" does not appear more than 12 months after the display is reset, change the engine oil every year.

: See information on maintenance and emissions warranty on page 415.

NOTE: ● Independent of the maintenance messages in the information display, replace the brake fluid every 3 years.
 ● Inspect idle speed every 160,000 miles (256,000 km).
 ● Adjust the valves during services A, B, 1, 2, or 3 only if they are noisy.

Symbol	Maintenance Sub Items
1	<ul style="list-style-type: none"> ● Rotate tires
2	<ul style="list-style-type: none"> ● Replace air cleaner element If you drive in dusty conditions, replace every 15,000 miles (24,000 km). ● Replace dust and pollen filter If you drive primarily in urban areas that have high concentrations of soot in the air from industry and from diesel-powered vehicles, replace every 15,000 miles (24,000 km). ● Inspect drive belt
3	<ul style="list-style-type: none"> ● Replace transmission fluid
4	<ul style="list-style-type: none"> ● Replace spark plugs ● Replace timing belt and inspect water pump If you drive regularly in very high temperatures (over 110°F, 43°C), in very low temperatures (under - 20°F, - 29°C), replace every 60,000 miles (U.S.)/100,000 km (Canada). ● Inspect valve clearance
5	<ul style="list-style-type: none"> ● Replace engine coolant

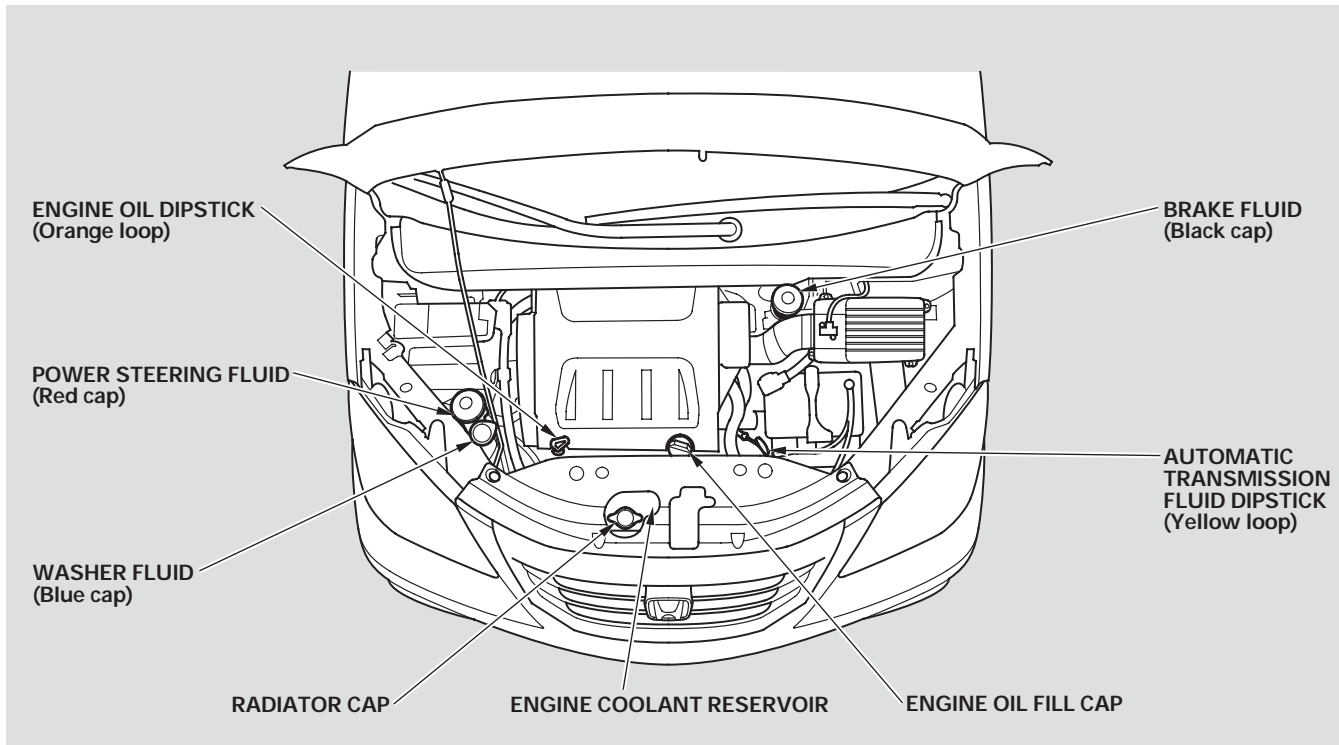

Adding Engine Oil

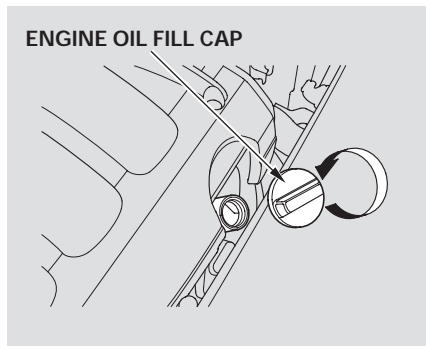

Unscrew and remove the engine oil fill cap on top of the valve cover. Pour in the oil slowly and carefully so you do not spill. Clean up any spills immediately. Spilled oil could damage components in the engine compartment.

Reinstall the engine oil fill cap, and tighten it securely. Wait a few minutes, and recheck the oil level on the engine oil dipstick. Do not fill above the upper mark; you could damage the engine.

Recommended Engine Oil



Oil is a major contributor to your engine's performance and longevity. Always use a premium-grade 5W-20 detergent oil displaying the API Certification Seal. This seal indicates the oil is energy conserving, and that it meets the American Petroleum Institute's latest requirements.

Honda Motor Oil is the preferred 5W-20 lubricant for your vehicle. It is highly recommended that you use Honda Motor Oil in your vehicle for optimum engine protection. Make sure the API Certification Seal says "For Gasoline Engines."

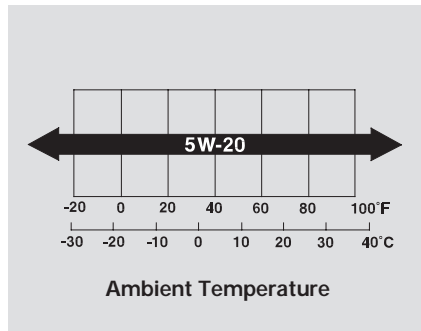

The oil viscosity or weight is provided on the container's label. 5W-20 oil is formulated for year-round protection of your vehicle to improve cold weather starting and fuel economy.

Synthetic Oil

You may use a synthetic motor oil if it meets the same requirements given for a conventional motor oil: it displays the API Certification Seal, and it is the proper weight. You must follow the oil and filter change intervals shown on the odometer/trip meter display or on the multi-information display.

Engine Oil Additives

Your vehicle's engine does not require any oil additives. Additives may adversely affect engine or transmission performance and durability.

Changing the Engine Oil and Filter

Always change the oil and filter according to the maintenance messages shown on the odometer/trip meter display or on the multi-information display. The oil and filter collect contaminants that can damage your engine if they are not removed regularly.

Changing the oil and filter requires special tools and access from underneath the vehicle. The vehicle should be raised on a service station-type hydraulic lift for this service. Unless you have the knowledge and proper equipment, you should have this maintenance done by a skilled technician.

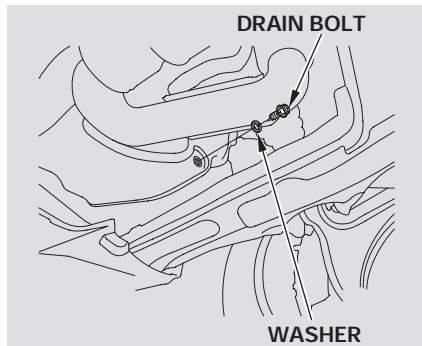

1. Run the engine until it reaches normal operating temperature, then shut it off.
2. Open the hood, and remove the engine oil fill cap. Remove the oil drain bolt and washer from the bottom of the engine. Drain the oil into an appropriate container.

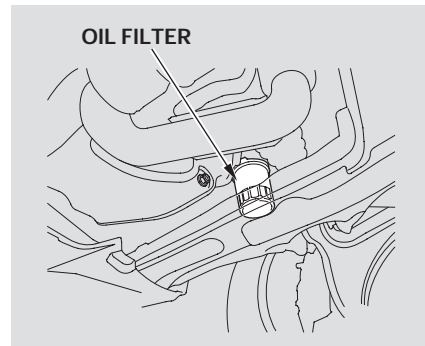

3. Remove the oil filter, and let the remaining oil drain. A special wrench (available from your dealer) is required.

Make sure the oil filter gasket is not stuck to the engine block. If it is, remove it before installing a new oil filter.

Changing the Engine Oil and Filter

4. Install a new oil filter according to the instructions that come with it.
5. Put a new washer on the drain bolt, then reinstall the drain bolt. Tighten the drain bolt to:
29 lbf·ft (39 N·m , 4.0 kgf·m)
6. Refill the engine with the recommended oil.

Engine oil change capacity (including filter):
4.5 US qt (4.3 ℓ)
7. Replace the engine oil fill cap. Start the engine. The oil pressure indicator should go out within 5 seconds. If it does not, turn off the engine, and check your work.
8. Let the engine run for several minutes, then check the drain bolt and oil filter for leaks.
9. Turn off the engine and let it sit for several minutes, then check the oil level on the dipstick. If necessary, add more oil.

NOTICE

Improper disposal of engine oil can be harmful to the environment. If you change your own oil, please dispose of the used oil properly. Put it in a sealed container, and take it to a recycling center. Do not discard it in a trash bin or dump it on the ground.

Engine Coolant

Adding Engine Coolant

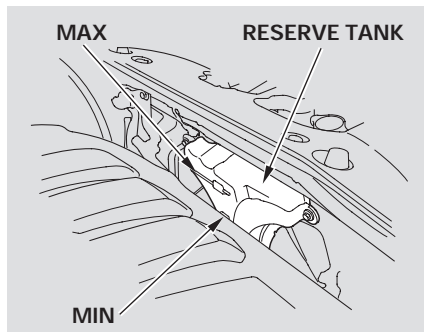

If the coolant level in the reserve tank is at or below the MIN line, add coolant to bring it up to the MAX line. Inspect the cooling system for leaks.

Always use Honda Long-life Antifreeze/Coolant Type 2. This coolant is pre-mixed with 50 percent antifreeze and 50 percent water. Never add straight antifreeze or plain water.

If Honda antifreeze/coolant is not available, you may use another major-brand non-silicate coolant as a temporary replacement. Make sure it is a high-quality coolant recommended for aluminum engines. Continued use of any non-Honda coolant can result in corrosion, causing the cooling system to malfunction or fail. Have the cooling system flushed and refilled with Honda antifreeze/coolant as soon as possible.

If the reserve tank is completely empty, you should also check the coolant level in the radiator.

⚠ WARNING

Removing the radiator cap while the engine is hot can cause the coolant to spray out, seriously scalding you.

Always let the engine and radiator cool down before removing the radiator cap.

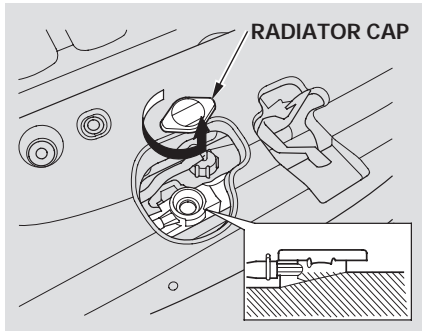

1. When the radiator and engine are cool, relieve any pressure in the cooling system by turning the radiator cap counterclockwise, without pressing down.
2. Remove the radiator cap by pushing down and turning counterclockwise.

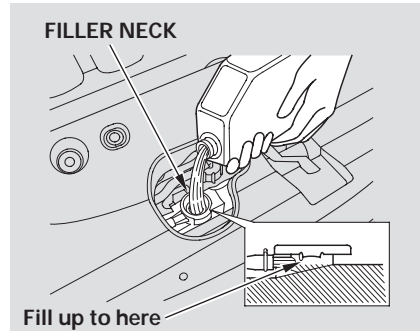

3. The coolant level should be up to the base of the filler neck. Add coolant if it is low.

Pour the coolant slowly and carefully so you do not spill. Clean up any spill immediately; it could damage components in the engine compartment.

4. Put the radiator cap back on, and tighten it fully.
5. Pour coolant into the reserve tank. Fill it to halfway between the MAX and MIN marks. Put the cap back on the reserve tank.

Do not add any rust inhibitors or other additives to your vehicle's cooling system. They may not be compatible with the coolant or engine components.

Windshield Washers

Check the fluid level in the windshield washer reservoir at least monthly during normal use. This reservoir supplies the windshield and rear window washers.

Check the fluid level by removing the cap and looking at the level gauge attached to the cap.

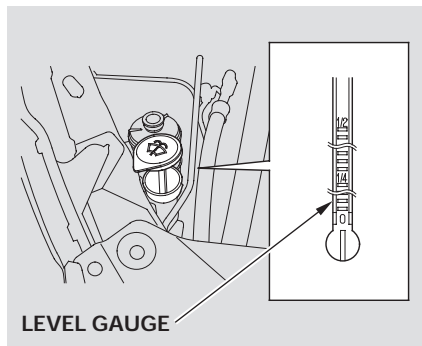

On Canadian models: The low washer level indicator comes on when the level is low (see page 74).

On Canadian Touring model: You will also see a “WASHER FLUID LOW” message on the multi-information display (see page 89).

Fill the reservoir with a good-quality windshield washer fluid. This increases the cleaning capability and prevents freezing in cold weather.

When you refill the reservoir, clean the edges of the windshield wiper blades with windshield washer fluid on a clean cloth. This will help to condition the blade edges.

NOTICE

Do not use engine antifreeze or a vinegar/water solution in the windshield washer reservoir. Antifreeze can damage your vehicle’s paint, while a vinegar/water solution can damage the windshield washer pump. Use only commercially-available windshield washer fluid.

Automatic Transmission Fluid

Check the fluid level with the engine at normal operating temperature.

1. Park the vehicle on level ground. Start the engine, let it run until the radiator fan comes on, then shut off the engine. For accurate results, wait about 60 seconds (but no longer than 90 seconds) before doing step 2.

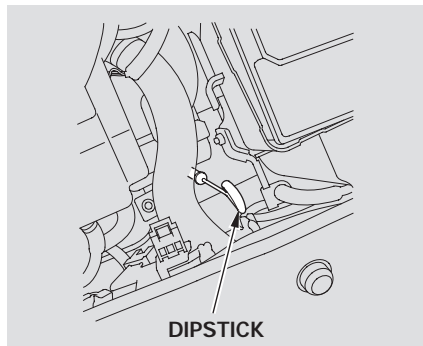

2. Remove the dipstick (yellow loop) from the transmission, and wipe it with a clean cloth.

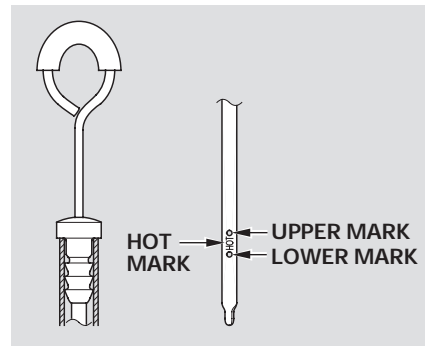

3. Insert the dipstick all the way into the transmission securely as shown in the illustration.
4. Remove the dipstick, and check the fluid level. It should be between the upper and lower marks.

CONTINUED

Automatic Transmission Fluid

5. If the level is below the lower mark, add fluid into the dipstick tube to bring it to the level between the upper and lower marks on the dipstick.

Pour the fluid slowly and carefully so you do not spill any. Clean up any spill immediately; it could damage components in the engine compartment.

Always use Honda ATF-Z1 (automatic transmission fluid).

NOTICE

Use only Honda Genuine ATF-Z1 (Automatic Transmission Fluid). Do not mix with other transmission fluids. Using transmission fluid other than Honda Genuine ATF-Z1 may cause deterioration in transmission operation and durability, and could result in damage to the transmission. Damage resulting from the use of transmission fluid other than Honda Genuine ATF-Z1 is not covered by the Honda new vehicle warranty.

6. Insert the dipstick all the way back into the transmission securely as shown in the illustration.

Make sure the rubber cap on the dipstick fits in the dipstick guide and that you push the dipstick in all the way.

The transmission should be drained and refilled with new fluid when this service is indicated on a maintenance message on the information display or on the multi-information display (depending on models).

If you are not sure how to add fluid, contact your dealer.

Check the brake fluid level in the reservoirs monthly.

Replace the brake fluid every 3 years, independent of mileage.

Always use Honda Heavy Duty Brake Fluid DOT 3. If it is not available, you should use only DOT 3 or DOT 4 fluid, from a sealed container, as a temporary replacement.

Using any non-Honda brake fluid can cause corrosion and decrease the life of the system. Have the brake system flushed and refilled with Honda Heavy Duty Brake Fluid DOT 3 as soon as possible.

Brake fluid marked DOT 5 is not compatible with your vehicle's braking system and can cause extensive damage.

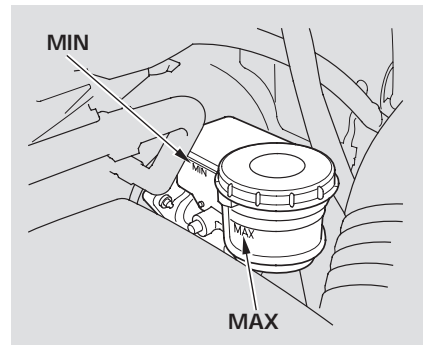

The fluid level should be between the MIN and MAX marks on the side of the reservoir. If the level is at or below the MIN mark, your brake system needs attention. Have the brake system inspected for leaks or worn brake pads.

Power Steering Fluid, Timing Belt

Power Steering Fluid

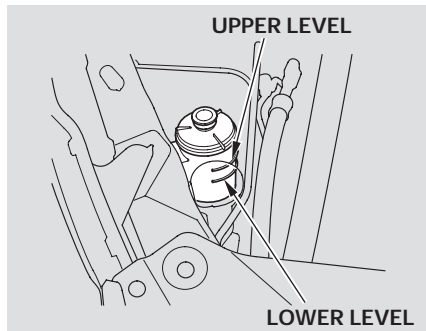

Check the level on the side of the reservoir when the engine is cold. The fluid should be between the UPPER LEVEL and LOWER LEVEL. If not, add power steering fluid to the UPPER LEVEL mark.

Pour the fluid slowly and carefully so you do not spill. Clean up any spill immediately; it could damage components in the engine compartment.

Always use Honda Power Steering Fluid. You may use another power steering fluid as an emergency replacement, but have the power steering system flushed and refilled with Honda PSF as soon as possible.

A low power steering fluid level can indicate a leak in the system. Check the fluid level frequently, and have the system inspected as soon as possible.

If you are not sure how to add fluid, contact your dealer.

NOTICE

Turning the steering wheel to full left or right lock and holding it there can damage the power steering pump.

Timing Belt

The timing belt should be replaced at the intervals shown in the maintenance minder schedule.

Replace the belt at 60,000 miles (100,000 km) if you regularly drive your vehicle in one or more of these conditions:

- In very high temperatures (over 110°F, 43°C).
- In very low temperatures (under - 20°F, - 29°C).

Headlight Aiming

The headlights were properly aimed when your vehicle was new. If you regularly carry heavy items in the cargo area or pull a trailer, readjustment may be required. Adjustments should be done by your dealer or other qualified technician.

Replacing a Headlight Bulb

Your vehicle has halogen headlight bulbs, two on each side. When replacing a bulb, handle it by its base and protect the glass from contact with your skin or hard objects. If you touch the glass, clean it with denatured alcohol and a clean cloth.

NOTICE

Halogen headlight bulbs get very hot when lit. Oil, perspiration, or a scratch on the glass can cause the bulb to overheat and shatter.

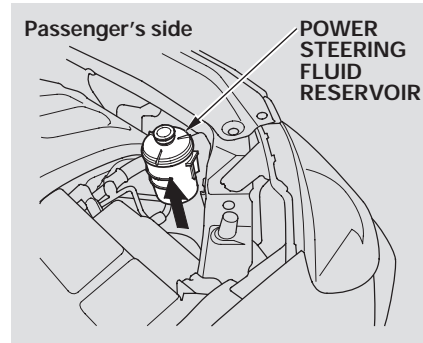

The high beam headlight bulb and the low beam headlight bulb are replaced the same way.

1. Open the hood. To change the high beam headlight bulb on the passenger's side, remove the power steering fluid reservoir from its holder by pulling it straight up.

CONTINUED

Lights

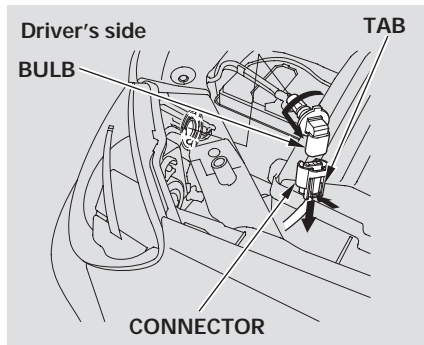

2. Remove the electrical connector from the bulb by pushing on the tab and pulling the connector down.
3. Remove the bulb by turning it one-quarter turn counterclockwise.
4. Insert the new bulb into the hole, and turn it one-quarter turn clockwise to lock it in place.

5. Push the electrical connector back onto the bulb. Make sure it is on all the way.
6. Turn on the headlights to test the new bulb.
7. If you replaced the high beam headlight bulb on the passenger's side, reinstall the power steering fluid reservoir.

Replacing a Front Turn Signal Bulb

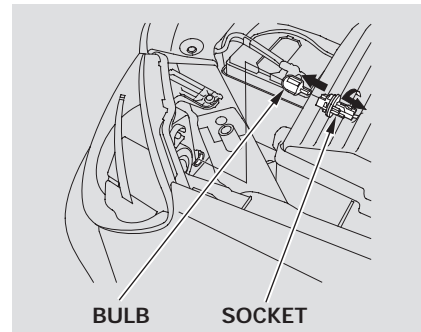

1. Open the hood. Remove the socket from the headlight assembly by turning it one-quarter turn counterclockwise.
2. Pull the burned out bulb straight out of its socket. Push the new bulb straight into the socket until it bottoms.

3. Insert the socket back into the headlight assembly. Turn it clockwise to lock it in place.
4. Turn on the lights to make sure the new bulb is working.

Replacing a Front Parking/Side Marker Bulb

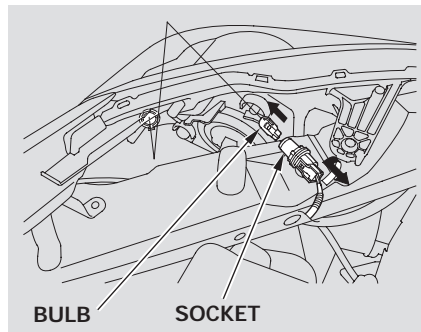

1. Open the hood. Remove the socket from the headlight assembly by turning it one-quarter turn counterclockwise.
2. Pull the bulb straight out of its socket. Push the new bulb straight into the socket until it bottoms.

3. Insert the socket back into the headlight assembly. Turn it clockwise to lock it in place.
4. Turn on the lights to make sure the new bulb is working.

Lights

Replacing a Fog Light Bulb

Touring models only

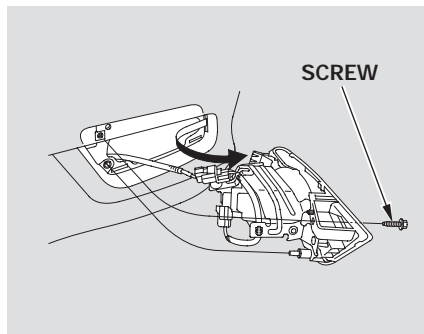

1. Use a Phillips-head screwdriver to remove the screw.
2. Remove the fog light assembly from the bumper by pulling its inner edge first, then the whole assembly out of the bumper.

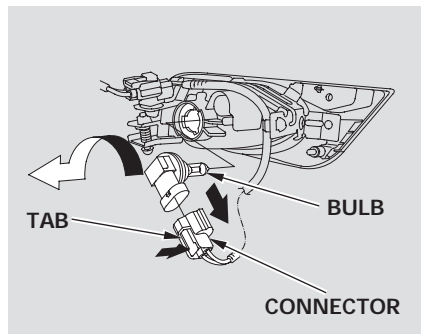

3. Remove the electrical connector from the bulb by pushing on the tab and pulling the connector down.
4. Remove the bulb from the fog light assembly by turning it one-quarter turn counterclockwise.

5. Insert the new bulb into the assembly and turn it one-quarter turn clockwise to lock it in place.
6. Push the electrical connector onto the new bulb.
7. Turn on the fog lights to test the new bulb.
8. Reinstall the fog light assembly, then tighten the screw.

NOTICE

Halogen bulbs get very hot when lit. Oil, perspiration, or a scratch on the glass can cause the bulb to overheat and shatter.

Replacing Rear Bulbs (in Rear Pillar)

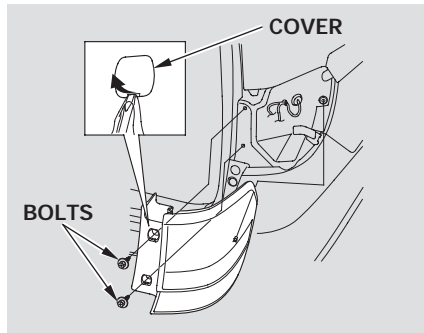

1. Open the tailgate.
2. Remove the two bolt covers on the rear pillar by prying on the bottom edge with a flat-tip screwdriver. Remove the bolts with a Phillips-head screwdriver, and remove the light assembly from the rear pillar.

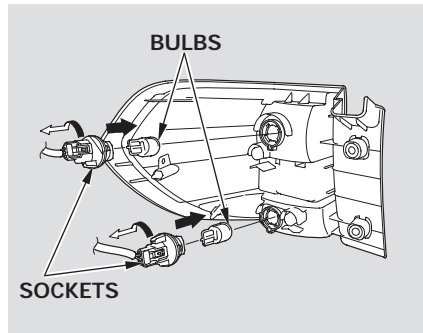

3. Determine which of the two bulbs is burned out: turn signal or brake/taillight.
4. Remove the socket by turning it one-quarter turn counterclockwise.
5. Remove the bulb by pulling it straight out of its socket. Push the new bulb straight into the socket until it bottoms.

6. Test the lights to make sure the new bulb is working.
7. Put the socket back into the light assembly, and turn it clockwise to lock it in place.
8. Install the rear light assembly in the rear pillar. Tighten the two bolts. Snap the bolt covers into position.

Lights

Replacing Rear Bulbs (in Tailgate)

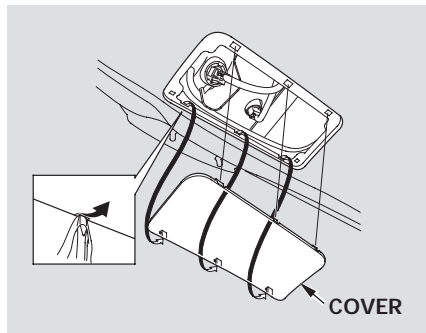

1. Open the tailgate. Place a cloth on the edge of the light assembly cover. Remove the cover by carefully prying in the notch on its middle edge with a flat-tip screwdriver.
2. Determine which of the two bulbs is burned out: taillight or back-up light.

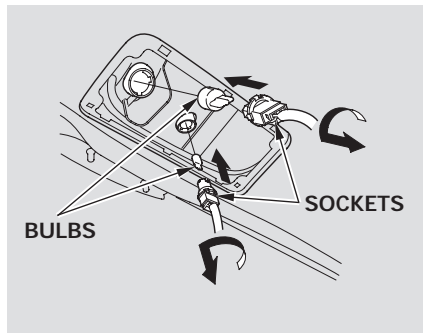

3. Remove the socket by turning it one-quarter turn counterclockwise.
4. Pull the bulb straight out of its socket. Push the new bulb straight into the socket until it bottoms.
5. Turn on the lights to make sure the new bulb is working.
6. Reinstall the socket into the light assembly by turning it clockwise until it locks.
7. Reinstall the light assembly cover.

Replacing a High-mount Brake Light Bulb

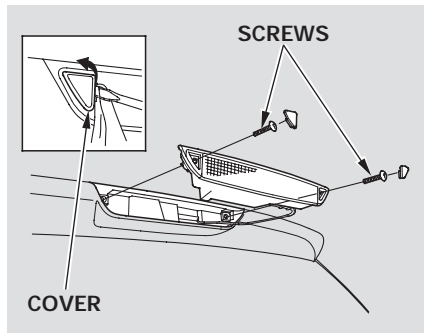

1. Remove the two screw covers on the light assembly by prying on the side edge with a flat-tip screwdriver.
2. Remove the screws with a Phillips-head screwdriver, then remove the light assembly from the tailgate.

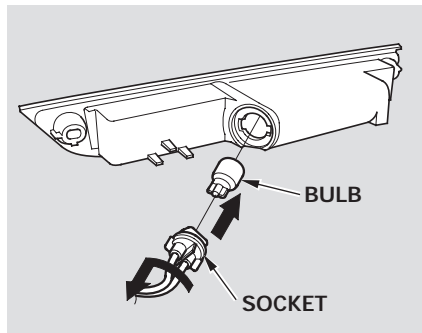

3. Remove the socket from the light assembly by turning it one-quarter turn counterclockwise.
4. Pull the bulb straight out of its socket. Push the new bulb straight into the socket until it bottoms.

5. Press the brake pedal to make sure the new bulb is working.
6. Put the socket back into the light assembly, and turn it clockwise to lock it in place.
7. Reinstall the high-mount brake light assembly into the tailgate. Tighten the two screws and reinstall the covers.

Cleaning the Seat Belts, Floor Mats, Dust and Pollen Filter

Cleaning the Seat Belts

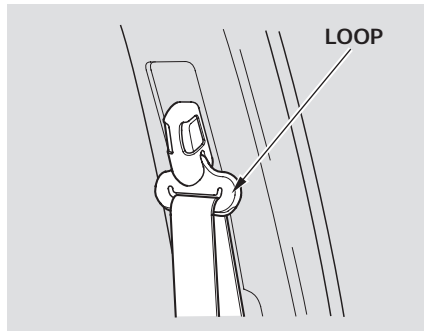

If your seat belts get dirty, use a soft brush with a mixture of mild soap and warm water to clean them. Do not use bleach, dye, or cleaning solvents. Let the belts air dry before you use the vehicle.

Dirt build-up in the loops of the seat belt anchors can cause the belts to retract slowly. Wipe the insides of the loops with a clean cloth dampened in mild soap and warm water or isopropyl alcohol.

Floor Mats

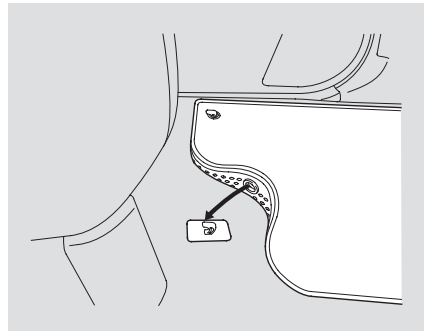

The driver's floor mat that came with your vehicle hooks over the floor mat anchors. This keeps the floor mat from sliding forward and possibly interfering with the pedals.

If you remove the driver's floor mat, make sure to re-anchor it when you put it back in your vehicle.

If you use a non-Honda floor mat, make sure it fits properly and that it can be used with the floor mat anchors. Do not put additional floor mats on top of the anchored mat.

Dust and Pollen Filter

On EX, EX-L and Touring models

This filter removes the dust and pollen that is brought in from the outside through the climate control system.

Have your dealer replace the filter when this service is indicated by a maintenance message on the odometer/trip meter display or on the multi-information display. It should be replaced every 15,000 miles (24,000 km) if you drive primarily in urban areas that have high concentrations of soot in the air, or if the flow from the climate control system becomes less than usual.

Check the condition of the wiper blades at least every 6 months. Replace them if you find signs of cracking in the rubber, and areas that are getting hard or if they leave streaks and unwiped areas when used.

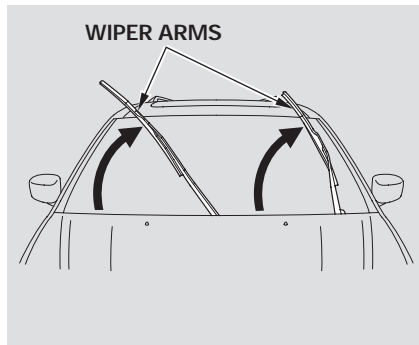

To replace a front wiper blade:

1. Raise the wiper arm off the windshield. Raise the driver's side first, then the passenger's side.

NOTICE

Do not open the hood when the wiper arms are raised, or you will damage the hood and the arms.

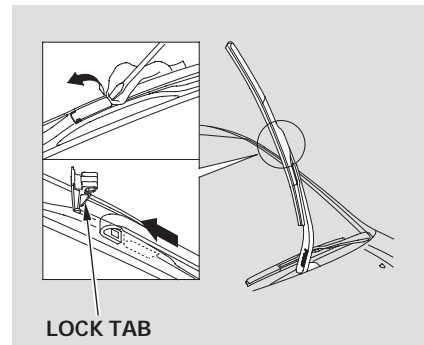

2. Disconnect the blade assembly from the wiper arm:
 - Put a cloth on the edge of the lock tab, then push up on the lock tab carefully with a flat-tip screwdriver.

CONTINUED

Wiper Blades

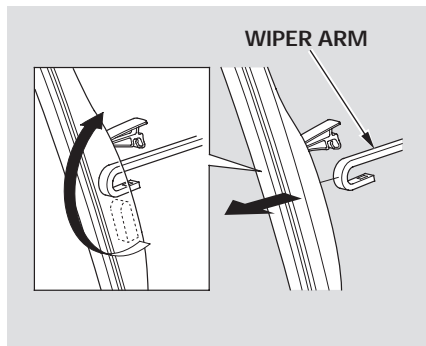

- Pivot the blade assembly toward the wiper arm until it releases from the wiper arm.

When replacing a wiper blade, make sure not to drop the wiper blade or wiper arm down on the windshield.

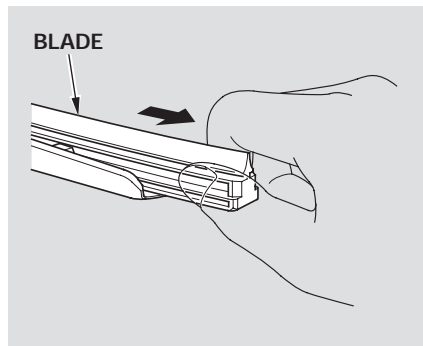

3. Remove the blade from its holder by grabbing the tabbed end of the blade. Pull firmly until the tabs come out of the holder.

4. Examine the new wiper blades. If they have no plastic or metal reinforcement along the back edge, remove the metal reinforcement strips from the old wiper blade, and install them in the slots along the edge of the new blade.

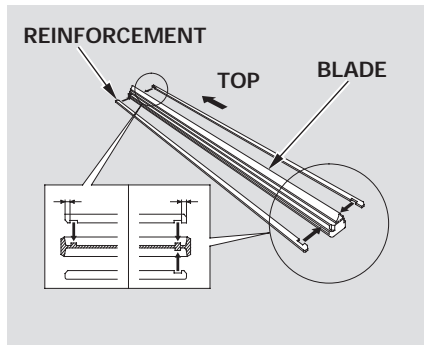

Make sure the three rubber tabs inside the blade fit to each notch of the reinforcement, as shown.

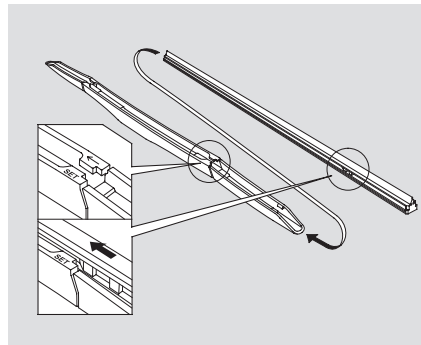

5. Place the top of the wiper blade on the end of the blade assembly, and slide the blade onto the assembly in the direction pointed to by the arrow.
Make sure the tab on the blade assembly fits in the indent of the wiper blade and the blade is completely installed.

6. Slide the wiper blade assembly onto the wiper arm. Push down the lock tab. Make sure the wiper blade assembly locks in place.
7. Lower the wiper arm down against the windshield, the passenger's side first, then the driver's side.

CONTINUED

Wiper Blades

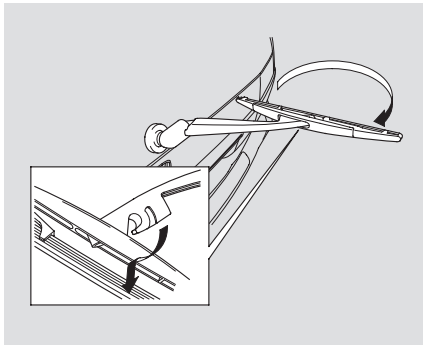

To replace a rear wiper blade:

1. Disconnect the blade assembly from the wiper arm by pivoting the blade assembly upward.

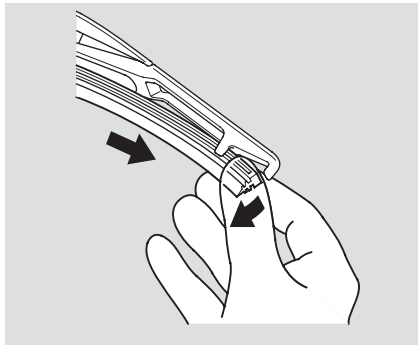

2. Pull one end of the blade out from the holder. Slide the blade out of the holder.

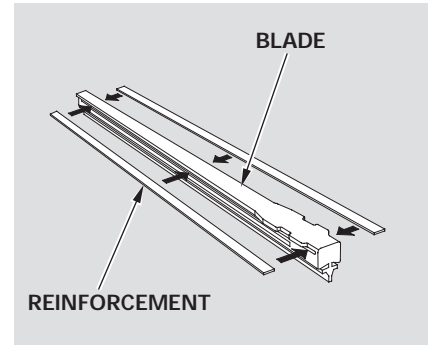

3. Examine the new wiper blades. If they have no plastic or metal reinforcement along the back edge, remove the metal reinforcement strips from the old wiper blade, and install them in the slots along the edge of the new blade.

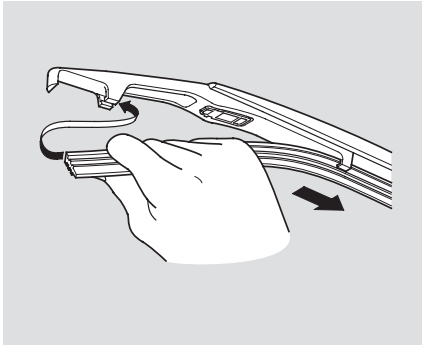

4. Slide the new blade into the wiper arm. Make sure it is engaged in the slot along its full length.

Insert both ends of the blade into the holder. Make sure they are secure.

5. Install the wiper blade assembly onto the wiper arm. Make sure it locks in place.
6. Lower the wiper arm against the windshield.

Wheels, Tires

Wheels

Clean the wheels as you would the rest of the exterior. Wash them with the same solution, and rinse them thoroughly.

If equipped

Aluminum alloy wheels have a protective clear-coat that keeps the aluminum from corroding and tarnishing. Cleaning the wheels with harsh chemicals (including some commercial wheel cleaners) or a stiff brush can damage the clear-coat. To clean the wheels, use a mild detergent and a soft brush or sponge.

Tires

To safely operate your vehicle, your tires must be the proper type and size, in good condition with adequate tread, and correctly inflated.

The following pages give more detailed information on how to take care of your tires and what to do when they need to be replaced.

WARNING

Using tires that are excessively worn or improperly inflated can cause a crash in which you can be seriously hurt or killed.

Follow all instructions in this owner's manual regarding tire inflation and maintenance.

Inflation Guidelines

Keeping the tires properly inflated provides the best combination of handling, tread life, and riding comfort.

- Underinflated tires wear unevenly, adversely affect handling and fuel economy, and are more likely to fail from being overheated.
- Overinflated tires can make your vehicle ride more harshly, are more prone to damage from road hazards, and wear unevenly.

The tire pressure monitoring system (TPMS) will warn you when a tire pressure is low. See page [388](#) for information on the TPMS.

Even though your vehicle is equipped with TPMS, we recommend that you visually check your tires every day. If you think a tire might be low, check it immediately with a tire gauge.

Use a gauge to measure the air pressure in each tire at least once a month. Even tires that are in good condition may lose 1 to 2 psi (10 to 20 kPa, 0.1 to 0.2 kgf/cm²) per month. Remember to check the spare tire at the same time.

Check the air pressures when the tires are cold. This means the vehicle has been parked for at least 3 hours, or driven less than 1 mile (1.6 km). Add or release air, if needed, to match the recommended cold tire pressures.

If you check air pressures when the tires are hot [driven for several miles (kilometers)], you will see readings 4 to 6 psi (30 to 40 kPa, 0.3 to 0.4 kgf/cm²) higher than the cold readings. This is normal. Do not let air out to match the recommended cold air pressure. The tire will be underinflated.

You should use your own tire pressure gauge whenever you check your tire pressures. This will make it easier for you to tell if a pressure loss is due to a tire problem and not due to a variation between gauges.

While tubeless tires have some ability to self-seal if they are punctured, you should look closely for punctures if a tire starts losing pressure.

Recommended Tire Pressures

The following chart shows the recommended cold tire pressures for most normal and high-speed driving conditions.

LX, EX and Canadian DX models

Tire Size	Cold Tire Pressure for Normal Driving
235/65R16 103T	Front: 33 psi (230 kPa , 2.3 kgf/cm ²) Rear: 35 psi (240 kPa , 2.4 kgf/cm ²)

EX-L models

Tire Size	Cold Tire Pressure for Normal Driving
235/65R16 103T	Front: 35 psi (240 kPa , 2.4 kgf/cm ²) Rear: 35 psi (240 kPa , 2.4 kgf/cm ²)

CONTINUED

Tires

Touring model without the Michelin PAX system

Tire Size	Cold Tire Pressure for Normal Driving
235/60R17 102T	Front: 33 psi (230 kPa , 2.3 kgf/cm ²) Rear: 35 psi (240 kPa , 2.4 kgf/cm ²)

The compact spare tire pressure is: 60 psi (420 kPa , 4.2 kgf/cm²)

U.S. Touring model with the Michelin PAX system

Tire Size	Cold Tire Pressure for Normal Driving
235-710R460A 104T	Front: 33 psi (230 kPa , 2.3 kgf/cm ²) Rear: 35 psi (240 kPa , 2.4 kgf/cm ²)

For convenience, the recommended tire sizes and cold tire pressures are on a label on the driver's doorjamb. For additional information about your tires, see page [490](#) .

Tire Inspection

Every time you check inflation, you should also examine the tires for damage, foreign objects, and wear.

You should look for:

- Bumps or bulges in the tread or side of the tire. Replace the tire if you find either of these conditions.
- Cuts, splits, or cracks in the side of the tire. Replace the tire if you can see fabric or cord.
- Excessive tread wear.

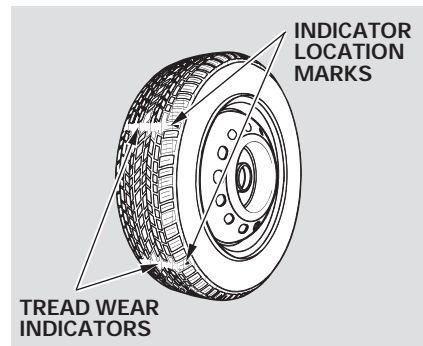

Your tires have wear indicators molded into the tread. When the tread wears down, you will see a 1/2 inch (12.7 mm) wide band across the tread. This shows there is less than 1/16 inch (1.6 mm) of tread left on the tire.

A tire this worn gives very little traction on wet roads. You should replace the tire if you can see three or more tread wear indicators.

Tire Service Life

The service life of your tires is dependent on many factors, including, but not limited to, driving habits, road conditions, vehicle loading, inflation pressure, maintenance history, speed, and environmental conditions (even when the tires are not in use).

In addition to your regular inspections and inflation pressure maintenance, it is recommended that you have annual inspections performed once the tires reach five years old. It is also recommended that all tires, including the spare, be removed from service after 10 years from the date of manufacture, regardless of their condition or state of wear.

The last four digits of the TIN (tire identification number) are found on the sidewall of the tire and indicate the date of manufacture (See **Tire Labeling** on page 490).

Tire Maintenance

In addition to proper inflation, correct wheel alignment helps to decrease tire wear. If you find a tire is worn unevenly, have your dealer check the wheel alignment.

Have your dealer check the tires if you feel a consistent vibration while driving. A tire should always be rebalanced if it is removed from the wheel. When you have new tires installed, make sure they are balanced. This increases riding comfort and tire life. For best results, have the installer perform a dynamic balance.

NOTICE

*If equipped
Improper wheel weights can damage your vehicle's aluminum wheels. Use only genuine Honda wheel weights for balancing.*

Tire Rotation

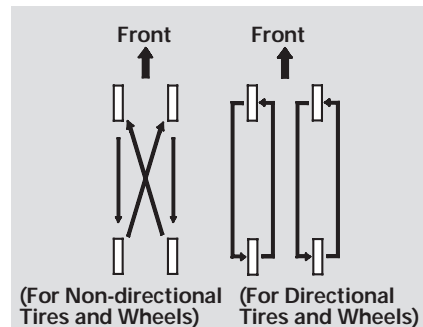

To help increase tire life and distribute wear more evenly, rotate the tires according to the maintenance messages displayed on the information display or multi-information display (depending on models). Move the tires to the positions shown in the diagram each time they are rotated. If you purchase directional tires, rotate only front-to-back.

Tires

Replacing Tires and Wheels

Replace your tires with radial tires of the same size, load range, speed rating, and maximum cold tire pressure rating (as shown on the tire's sidewall).

Mixing radial and bias-ply tires on your vehicle can reduce braking ability, traction, and steering accuracy. Using tires of a different size or construction can cause the ABS and vehicle stability assist system (VSA) to work inconsistently.

The ABS and VSA system work by comparing the speed of each wheel. When replacing tires, use the same size originally supplied with the vehicle. Tire size and construction can affect wheel speed and may cause the system to activate.

Vehicles without the Michelin PAX system

Your vehicle is not designed for Michelin PAX system wheels or tires. Use only the wheels and tires designated in this owner's manual. Never mix conventional wheels or tires with PAX system wheels or tires.

It is best to replace all four tires at the same time. If that is not possible or necessary, replace the two front tires or two rear tires as a pair. Replacing just one tire can seriously affect your vehicle's handling.

If you ever replace a wheel, make sure that the wheel's specifications match those of the original wheels.

Also be sure you use only TPMS specific wheels. If you do not, the tire pressure monitoring system will not work.

Replacement wheels are available at your dealer.

WARNING

Installing improper tires on your vehicle can affect handling and stability. This can cause a crash in which you can be seriously hurt or killed.

Always use the size and type of tires recommended in this owner's manual.

Wheel and Tire Specifications**Wheels:***All models except Touring models*

16 x 7J (TPMS)

*Touring models without the Michelin**PAX system*

17 x 7J (TPMS)

*On models with the Michelin PAX**system*

225 x 460A (TPMS&PAX)

Tires:*All models except Touring models*

235/65R16 103T

*Touring models without the Michelin**PAX system*

235/60R17 102T

*On models with the Michelin PAX**system*

235-710R460A 104T (PAX)

See page [488](#) for information about DOT Tire Quality Grading, and page [490](#) for tire size and labeling information.

Winter Driving

Tires marked “M + S” or “All Season” on the sidewall have an all-weather tread design suitable for most winter driving conditions.

For the best performance in snowy or icy conditions, you should install snow tires or tire chains. They may be required by local laws under certain conditions.

Snow Tires

If you mount snow tires on your vehicle, make sure they are radial tires of the same size and load range as the original tires. Mount snow tires on all four wheels. The traction provided by snow tires on dry roads may be lower than your original tires. Check with the tire dealer for maximum speed recommendations.

There are no snow tires compatible with the PAX system.

Tire Chains

Mount tire chains on your tires when required by driving conditions or local laws. Install them only on the front tires.

Because your vehicle has limited tire clearance, Honda strongly recommends using the chains listed below.

All except Touring models

Link-type: SCC Quick Grip QG1142

Cable-type: SCC SC Cable SC1042

On Touring models

Link-type: SCC Quick Grip QG1138

Cable-type: SCC SC Cable SC1038

On models with Michelin PAX system

Link-type: Laclede # 1142

Cable-type: SCC SC Cable SC1042

CONTINUED

Tires

Tire chains cannot be used with a flat front tire. If a front tire goes flat when a tire chain is installed on it, remove the chain, and follow the precautions described under Michelin PAX System (see page [454](#)).

The previously listed chains are the only ones that have been approved by Honda for use on your vehicle. Since Honda cannot test all chains, you must be personally responsible for proper selection, installation, and use of tire chains.

These chains are available at many auto supply stores. For a complete list of stores, visit the SCC website at www.scc-chain.com. When installing chains, follow the manufacturer's instructions, and mount them as tightly as you can. Drive slowly with chains installed.

When installing cables, follow the manufacturer's instructions, and mount them as tight as you can. Make sure they are not contacting the brake lines or suspension. Drive slowly with them installed. If you hear them coming into contact with the body or chassis, stop and investigate. Remove them as soon as you begin driving on cleared roads.

WARNING

Using the wrong chains, or not properly installing chains, can damage the brake lines and cause a crash in which you can be seriously injured or killed.

Follow all instructions in this owner's manual regarding the selection and use of tire chains.

NOTICE

Traction devices that are the wrong size or improperly installed can damage your vehicle's brake lines, suspension, body, and wheels. Stop driving if they are hitting any part of the vehicle.

Michelin® PAX System™*If equipped*

Your vehicle is equipped with the Michelin PAX system which, together with the tire pressure monitoring system (TPMS), enables you to continue driving even if one or more of your tires loses its pressure.

The tires and wheels on your vehicle are specially designed for the PAX system, and the PAX system is specifically designed and fine-tuned for your vehicle.

Because of these reasons, use only the wheels and tires designated in this owner's manual. Never mix PAX system wheels or tires with conventional wheels or tires.

There are no snow tires compatible with the PAX system, and not all tire chains are suitable for use on the PAX system tires.

If you mount snow chains on your tires, use the chains recommended by Honda (see page [447](#)).

Do not replace the PAX system tires and wheels with conventional tires and wheels. Doing so would disable the PAX system and the tire pressure monitoring system (TPMS), and may void your new vehicle warranty.

Important Precautions

- Never use a tire repair agent in a PAX system tire, and never repair a PAX system tire by yourself. Repair or replacement must be done by a Honda dealer or an authorized Michelin PAX system dealer.
- If you must continue driving with a flat tire, follow all the procedures and precautions described on page [458](#).

Checking the Battery

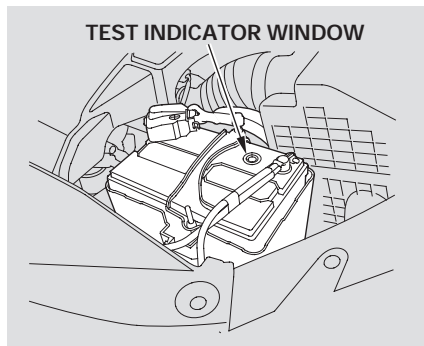

Check the condition of the battery monthly by looking at the test indicator window. The label on the battery explains the test indicator's colors.

Check the terminals for corrosion (a white or yellowish powder). To remove it, cover the terminals with a solution of baking soda and water. It will bubble up and turn brown. When this stops, wash it off with plain water. Dry off the battery with a cloth or paper towel. Coat the terminals with grease to help prevent future corrosion.

If additional battery maintenance is needed, see your dealer or a qualified technician.

WARNING: Battery posts, terminals, and related accessories contain lead and lead compounds. **Wash your hands after handling.**

If you need to connect the battery to a charger, disconnect both cables to prevent damaging your vehicle's electrical system. Always disconnect the negative (-) cable first, and reconnect it last.

⚠ WARNING

The battery gives off explosive hydrogen gas during normal operation.

A spark or flame can cause the battery to explode with enough force to kill or seriously hurt you.

Wear protective clothing and a face shield, or have a skilled technician do the battery maintenance.

If you need to park your vehicle for an extended period (more than 1 month), there are several things you should do to prepare it for storage. Proper preparation helps prevent deterioration and makes it easier to get your vehicle back on the road. If possible, store your vehicle indoors.

- Fill the fuel tank.
- Wash and dry the exterior completely.
- Clean the interior. Make sure the carpeting, floor mats, etc., are completely dry.
- Leave the parking brake off. Put the transmission in Park.

- Block the rear wheels.
- If the vehicle is to be stored for a longer period, it should be supported on jackstands so the tires are off the ground.
- Leave one window open slightly (if the vehicle is being stored indoors).
- Disconnect the battery.
- Support the front and rear wiper blade arms with a folded towel or rag so they do not touch the windshield.
- To minimize sticking, apply a silicone spray lubricant to all door and tailgate seals. Also, apply a vehicle body wax to the painted surfaces that mate with the door and tailgate seals.

- Cover the vehicle with a “breathable” cover, one made from a porous material such as cotton. Non-porous materials, such as plastic sheeting, trap moisture, which can damage the paint.
- If possible, periodically run the engine until it reaches full operating temperature (the cooling fans cycle twice). Preferably, do this once a month.

[Main Menu](#)

[Table Of Contents](#)

This section covers the more common problems that motorists experience with their vehicles. It gives you information about how to safely evaluate the problem and what to do to correct it. If the problem has stranded you on the side of the road, you may be able to get going again. If not, you will also find instructions on getting your vehicle towed.

Driving with a Flat Tire	454
Michelin® PAX System™	454
Compact Spare Tire.....	457
Changing a Flat Tire	458
If the Engine Won't Start.....	465
Jump Starting	467
If the Engine Overheats	469
Low Oil Pressure Indicator	471
Charging System Indicator.....	471
Malfunction Indicator Lamp	472
Readiness Codes.....	472
Brake System Indicator	473
Fuses	474
Fuse Locations.....	477
Emergency Towing	480

Driving With a Flat Tire

Michelin® PAX System™

If equipped

Your vehicle is equipped with the Michelin PAX system. Since each Michelin PAX system tire has an inner support ring that allows it to continue running without air, it may be difficult to immediately judge from its appearance if a tire is punctured. Your vehicle is also equipped with a tire pressure monitoring system (TPMS), and this system may be your first detection of a flat tire.



The TPMS monitors the air pressure of all four tires whenever the ignition switch is in the ON (II) position. It will immediately sense if a tire starts to lose its pressure, and give you warning with the low tire pressure/TPMS indicator in the instrument panel and a “CHECK TIRE PRESSURE” message on the multi-information display. If the indicator and the warning message do not come on again after you inflate the tire to its correct air pressure (see

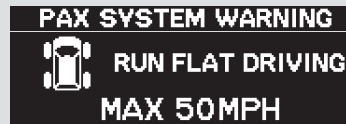

page 444), it was probably a natural loss of the air pressure and you can continue driving as before.

If the indicator and the message come on again, you probably have a flat tire. In this case, you will see a “PAX SYSTEM WARNING” message on the multi-information display.

With the PAX system tires, you can drive up to about 125 miles (200 km) even if one or more of your tires are punctured. This allows you to drive to the nearest Honda dealer or authorized Michelin PAX system dealer to have the tire(s) repaired.

If you get a flat tire, never try to repair it yourself, and never replace a flat tire with a compact spare tire.

Follow the instructions shown on the multi-information display, and drive very carefully.

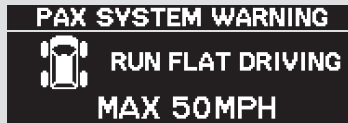

The above message shows that you are driving your vehicle on a flat tire, and should observe the "RUN FLAT DRIVING" speed limit of 50 mph (80 km/h). Drive to your nearest Honda dealer or authorized Michelin PAX system dealer, or call the PAX help hotline at 1-877-PAXTIRE (1-877-729-8473).

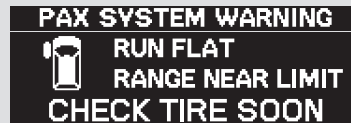

If the display changes to the above message, it means that "RUN FLAT DRIVING" is nearing the limit, and you have to stop driving soon. Take your vehicle to the nearest Honda dealer or authorized Michelin PAX system dealer as soon as possible.

CONTINUED

Driving With a Flat Tire



If you see the above message on the multi-information display, you have reached the limit of run flat driving, and you should stop driving immediately. Be aware that if you continue to drive, the noise and vibration level from the tire will increase significantly, and the tire may no longer be repairable.

Call a professional towing service who can transport your vehicle on flat-bed equipment. Never tow your

vehicle behind another vehicle with a rope or chain. Flat-bed equipment is the best way to transport your vehicle. Your vehicle can also be towed by wheel-lift equipment with the wheels off the ground (see page 480).

Important Safety Precautions

Although your vehicle is capable of run flat driving, you should always observe the following:

- Do not drive faster than 50 mph (80 km/h).
- Drive carefully. Your vehicle may handle differently from when the tires are properly inflated, especially when cornering.
- In its run flat mode, a PAX system tire is somewhat noisier than when it is fully inflated, this is normal.

- Stop driving immediately when you see a “RUN FLAT LIMIT STOP DRIVING” message on the multi-information display. Continuous driving after this message will make it impossible to repair the tire.

If you cannot find a Honda dealer or an authorized Michelin PAX system dealer where you are driving, call the PAX help hotline at 1-877-PAXTIRE (1-877-729-8473).

Models without Michelin PAX System

Use the compact spare tire as a temporary replacement only. Get your regular tire repaired or replaced, and put it back on your vehicle as soon as you can.

Check the inflation pressure of the compact spare tire every time you check the other tires. It should be inflated to:

60 psi (420 kPa , 4.2 kgf/cm²)

Follow these precautions:

- Never exceed 50 mph (80 km/h).
- This tire gives a harsher ride and less traction on some road surfaces. Use greater caution while driving.
- Do not mount snow chains on the compact spare tire.

- Do not use your compact spare tire on another vehicle unless it is the same make and model.

Except Touring models

- The low tire pressure indicator comes on and stays on after you replace the flat tire with the compact spare tire. After several miles (kilometers) driving with the compact spare tire, the TPMS indicator comes on and the low tire pressure indicator goes off.

Touring models

- After the flat tire is replaced with the spare tire, the low tire pressure/TPMS indicator stays on. After several miles (kilometers) driving with the spare, this indicator begins to flash, then stays on again. You will also see a "CHECK TPMS SYSTEM" message on the multi-information display (see page 395).

INDICATOR LOCATION MARK

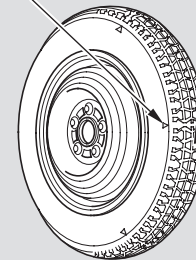

TREAD WEAR INDICATOR BAR

Replace the tire when you can see the tread wear indicator bars. The replacement should be the same size and design tire, mounted on the same wheel. The spare tire is not designed to be mounted on a regular wheel, and the spare wheel is not designed for mounting a regular tire.

Changing a Flat Tire

Models without Michelin PAX System

If you have a flat tire while driving, stop in a safe place to change it. Drive slowly along the shoulder until you get to an exit or an area that is far away from the traffic lanes.

⚠ WARNING

The vehicle can easily roll off the jack, seriously injuring anyone underneath.

Follow the directions for changing a tire exactly, and never get under the vehicle when it is supported only by the jack.

1. Park the vehicle on firm, level, and non-slippery ground. Put the transmission in Park. Apply the parking brake. If you are towing a trailer, unhitch it.
2. Turn on the hazard warning lights, and turn the ignition switch to the LOCK (0) position. Have all passengers get out of the vehicle while you change the tire.

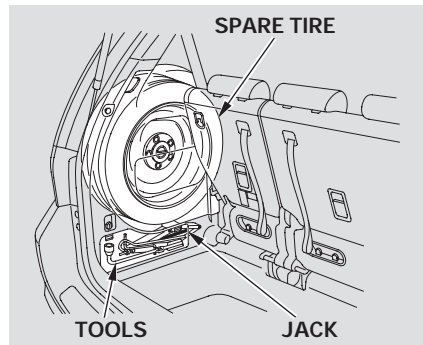

3. Open the tailgate. The jack is behind a cover in the cargo area on the driver's side, and tools are on the back of the cover. Remove the cover by pushing the tabs down and pulling the cover out.

Changing a Flat Tire

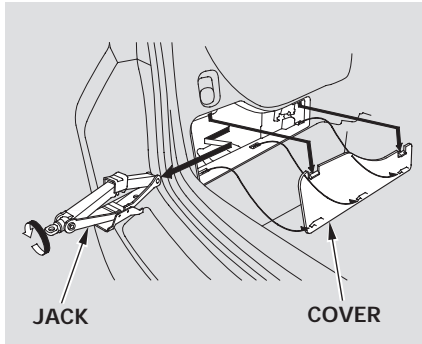

4. Loosen the jack from its holder by turning the end counterclockwise.

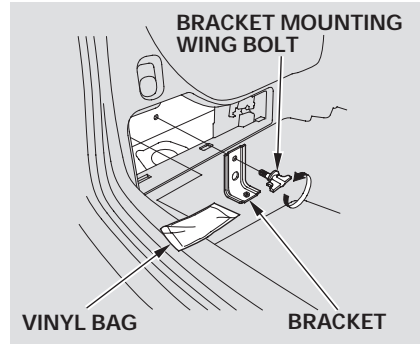

5. Remove the bracket from the jack storage area by unscrewing the bracket mounting wing bolt. Remove the vinyl storage bag.

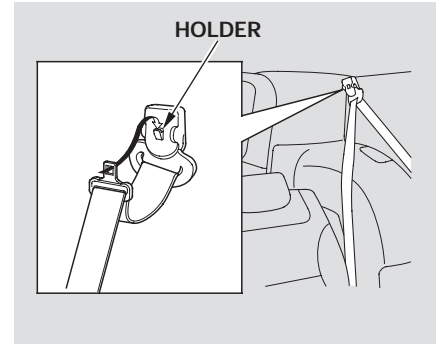

6. Move the seat belt out of the way by hanging the latch plate on the holder.
7. Fold down the third row seat (see page [181](#)).

CONTINUED

Changing a Flat Tire

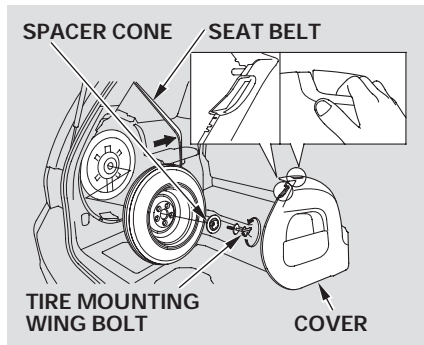

The spare tire is stored behind spare tire cover on the sidewall of the cargo area on the driver's side.

8. Remove the cover by holding the two handles on the spare tire cover and pulling the cover out.
9. Unscrew the tire mounting wing bolt, and take the spare tire out of its holder.

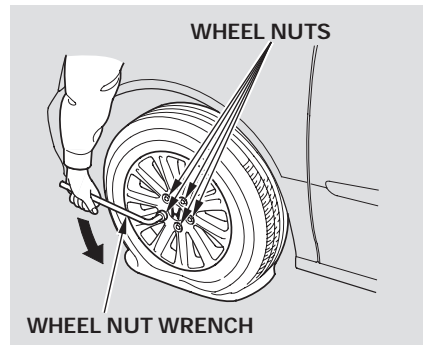

10. If you are changing a rear tire, close the sliding door.

On EX, EX-L and Touring models
Make sure you also turn off the sliding door main switch.

11. Loosen each wheel nut 1/2 turn with the wheel nut wrench.

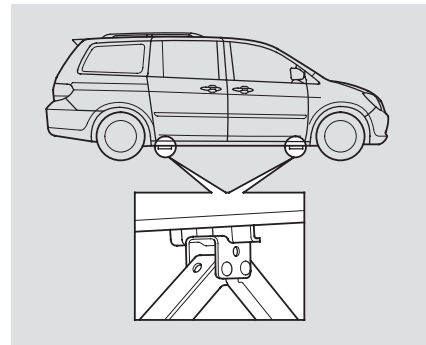

12. Place the jack under the jacking point nearest the tire you need to change. Turn the end bracket clockwise until the top of the jack contacts the jacking point. Make sure the jacking point tab is resting in the jack notch.

Changing a Flat Tire

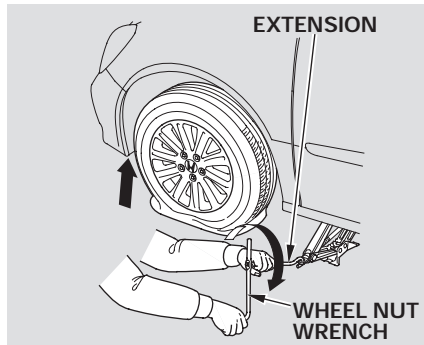

13. Use the extension and the wheel nut wrench as shown to raise the vehicle until the flat tire is off the ground.

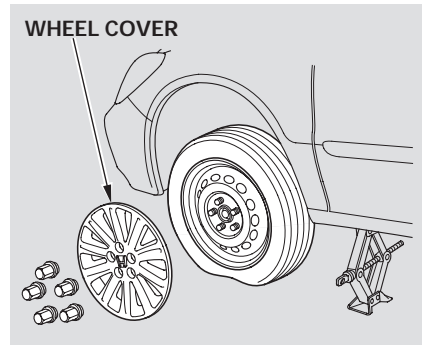

14. Remove the wheel nuts, then remove the flat tire. Handle the wheel nuts carefully; they may be hot from driving. Place the flat tire on the ground with the outside surface facing up.

On LX and Canadian DX models
Do not attempt to forcibly pry the wheel cover off with a screwdriver or other tool. The wheel cover cannot be removed without first removing the wheel nuts.

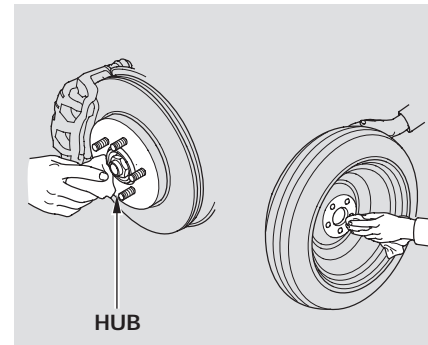

15. Before mounting the spare tire, wipe any dirt off the mounting surface of the wheel and hub with a clean cloth. Wipe the hub carefully; it may be hot from driving.

CONTINUED

Changing a Flat Tire

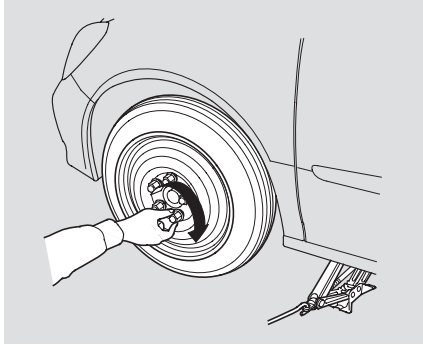

16. Put on the spare tire. Put the wheel nuts back on finger-tight, then tighten them in a crisscross pattern with the wheel nut wrench until the wheel is firmly against the hub. Do not try to tighten the wheel nuts fully.

17. Lower the vehicle to the ground, and remove the jack.

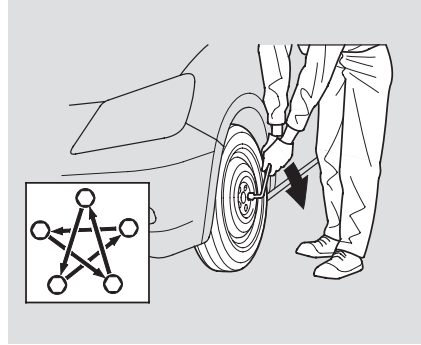

18. Tighten the wheel nuts securely in a crisscross pattern. Have the wheel nut torque checked at the nearest automotive service facility. Tighten the wheel nuts to:

94 lbf·ft (127 N·m , 13 kgf·m)

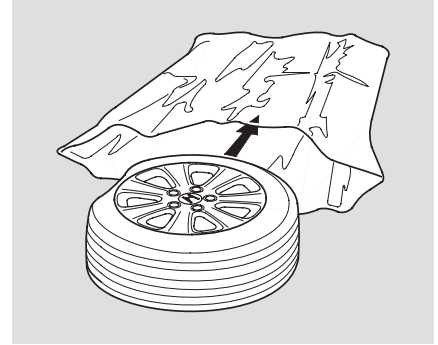

19. Put the flat tire in the supplied vinyl storage bag.

Changing a Flat Tire

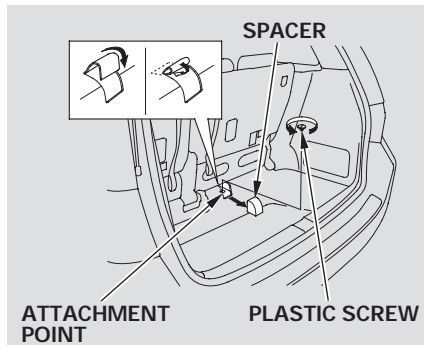

20. Return the third row seat to an upright position.
21. You will find a U-shaped carpet piece behind the seat bottom of the third row seat. Pull up the U-shaped carpet piece, fold it, and tack the end under the carpet. Remove the spacer, and unfasten the plastic screw with a coin.

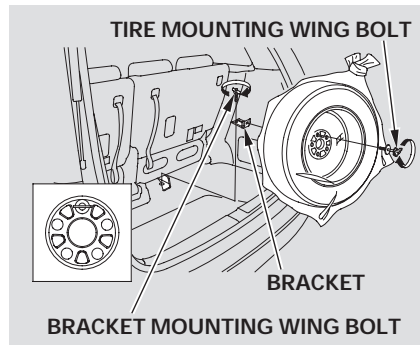

22. Install the bracket and the bracket mounting wing bolt on the attachment point as shown, and tighten the bolt. Make sure the bracket is securely tightened.

23. Install the flat tire on the bracket with the inside of the wheel facing toward you. Install the tire mounting wing bolt to the bracket through one of the five wheel nut holes as shown. Poke a hole in the vinyl bag as needed. Secure the flat tire by tightening the tire mounting wing bolt.
24. Store the jack in its holder. To store the jack, align the locator stud in the jack base with the hole in the jack holder. Turn the jack's end bracket clockwise to lock it in place. Store the tools in the holders on the back of the jack storage cover.

CONTINUED

Changing a Flat Tire

25. Store the spacer and the plastic screw in a noticeable place.

Make sure to reinstall the plastic screw after the flat tire is repaired and installed on the vehicle.

26. *On LX and Canadian DX models*

Store the wheel cover in the spare tire storage area.

27. Install the spare tire storage cover.

⚠ WARNING

Loose items can fly around the interior in a crash and could seriously injure the occupants.

Store the wheel, jack, and tools securely before driving.

Storing a Flat Tire on the Folded Third Row Seat

You can store the flat tire on the top of the folded third row seat.

1. Pull up the U-shaped carpet piece, fold it, and tack the end under the carpet.
2. Remove the spacer, and unfasten the plastic screw with a coin.
3. *On EX, EX-L and Touring models*
Remove the center cap before storing the flat tire.

Store the spacer, plastic screw and center cap in a noticeable place.

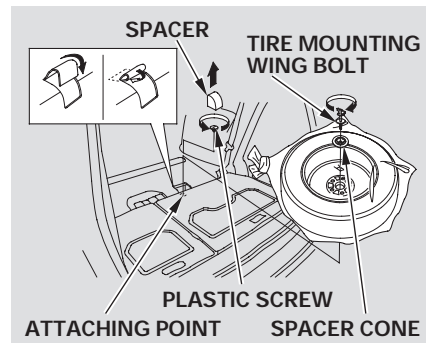

4. Place the flat tire face down on the attachment point. Put the spacer cone on the flat tire as shown. Poke holes in the vinyl bag. Secure the flat tire into the attachment point by tightening the tire mounting wing bolt through the center cap hole of the flat tire wheel.
5. Follow step 22 through 26 on pages [463](#) and [464](#).

Diagnosing why the engine won't start falls into two areas, depending on what you hear when you turn the ignition switch to the START (III) position:

- You hear nothing, or almost nothing. The engine's starter motor does not operate at all, or operates very slowly.
- You can hear the starter motor operating normally, or the starter motor sounds like it is spinning faster than normal, but the engine does not start up and run.

Nothing Happens or the Starter Motor Operates Very Slowly

When you turn the ignition switch to the START (III) position, you do not hear the normal noise of the engine trying to start. You may hear a clicking sound, a series of clicks, or nothing at all.

Check these things:

- Check the transmission interlock. The transmission must be in Park or neutral or the starter will not operate.
- Turn the ignition switch to the ON (II) position. Turn on the headlights, and check their brightness. If the headlights are very dim or do not come on at all, the battery is discharged. See **Jump Starting** on page [467](#).

- Turn the ignition switch to the START (III) position. If the headlights do not dim, check the condition of the fuses. If the fuses are OK, there is probably something wrong with the electrical circuit for the ignition switch or starter motor. You will need a qualified technician to determine the problem. See **Emergency Towing** on page [480](#).

If the headlights dim noticeably or go out when you try to start the engine, either the battery is discharged or the connections are corroded. Check the condition of the battery and terminal connections (see page [450](#)). You can then try jump starting the vehicle from a booster battery (see page [467](#)).

If the Engine Won't Start

The Starter Operates Normally

In this case, the starter motor's speed sounds normal, or even faster than normal, when you turn the ignition switch to the START (III) position, but the engine does not run.

- Are you using the proper starting procedure? Refer to **Starting the Engine** on page [377](#).

- Are you using a properly coded key? An improperly coded key will cause the immobilizer system indicator in the instrument panel to blink rapidly (see page [143](#)).
- Do you have fuel? Check the fuel gauge; the low fuel indicator may not be working.
- There may be an electrical problem, such as no power to the fuel pump. Check all the fuses (see page [475](#)).

If you find nothing wrong, you will need a qualified technician to find the problem. See **Emergency Towing** on page [480](#).

Although this seems like a simple procedure, you should take several precautions.

⚠ WARNING

A battery can explode if you do not follow the correct procedure, seriously injuring anyone nearby.

Keep all sparks, open flames, and smoking materials away from the battery.

You cannot start your vehicle by pushing or pulling it.

To Jump Start Your Vehicle:

1. Open the hood, and check the physical condition of the battery. In very cold weather, check the condition of the electrolyte. If it seems slushy or frozen, do not try jump starting until it thaws.

NOTICE

If a battery sits in extreme cold, the electrolyte inside can freeze. Attempting to jump start with a frozen battery can cause it to rupture.

2. Turn off all the electrical accessories: heater, A/C, climate control, audio system, lights, etc. Put the transmission in neutral or Park, and set the parking brake.

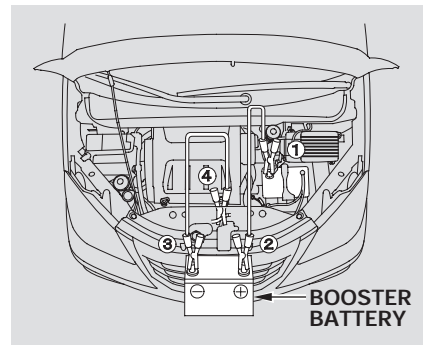

The numbers in the illustration show you the order to connect the jumper cables.

CONTINUED

Jump Starting

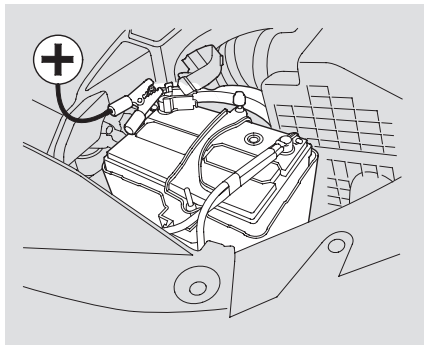

3. Connect one jumper cable to the positive (+) terminal on your vehicle's battery. Connect the other end to the positive (+) terminal on the booster battery.

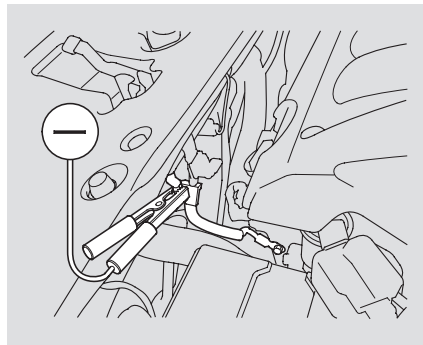

4. Connect the second jumper cable to the negative (-) terminal on the booster battery. Connect the other end to the grounding strap as shown. Do not connect this jumper cable to any other part of the engine.

5. If the booster battery is in another vehicle, have an assistant start that vehicle and run it at a fast idle.
6. Start the vehicle. If the starter motor still operates slowly, check that the jumper cables have good metal-to-metal contact.
7. Once the vehicle is running, disconnect the negative cable from your vehicle, then from the booster battery. Disconnect the positive cable from your vehicle, and then from the booster battery.

Keep the ends of the jumper cables away from each other and any metal on the vehicle until everything is disconnected. Otherwise, you may cause an electrical short.

The pointer of the vehicle's temperature gauge should stay in the midrange. If it climbs to the red mark, you should determine the reason (hot day, driving up a steep hill, etc.).

If your vehicle overheats, you should take immediate action. The only indication may be the temperature gauge climbing to or above the red mark. Or you may see steam or spray coming from under the hood.

NOTICE

Driving with the temperature gauge pointer at the red mark can cause serious damage to the engine.

⚠ WARNING

Steam and spray from an overheated engine can seriously scald you.

Do not open the hood if steam is coming out.

1. Safely pull to the side of the road. Put the transmission in Park, and set the parking brake. Turn off all accessories, and turn on the hazard warning indicators.
2. If you see steam and/or spray coming from under the hood, turn off the engine. Wait until you see no more signs of steam or spray, then open the hood.
3. If you do not see steam or spray, leave the engine running and watch the temperature gauge. If the high heat is due to overloading, the engine should start to cool down almost immediately. If it does, wait until the temperature gauge comes down to the midpoint, then continue driving.
4. If the temperature gauge stays at the red mark, turn off the engine.
5. Look for any obvious coolant leaks, such as a split radiator hose. Everything is still extremely hot, so use caution. If you find a leak, it must be repaired before you continue driving (see **Emergency Towing** on page 480).

CONTINUED

If the Engine Overheats

6. If you do not find an obvious leak, check the coolant level in the radiator reserve tank. Add coolant if the level is below the MIN mark.
 7. If there was no coolant in the reserve tank, you may need to add coolant to the radiator. Let the engine cool down until the pointer reaches the middle of the temperature gauge, or lower, before checking the radiator.
- ⚠ WARNING**
- Removing the radiator cap while the engine is hot can cause the coolant to spray out, seriously scalding you.
- Always let the engine and radiator cool down before removing the radiator cap.
8. Using gloves or a large heavy cloth, turn the radiator cap counterclockwise, without pushing down, to the first stop. After the pressure releases, push down on the cap, and turn it until it comes off.
 9. Start the engine, and set the temperature control dial to maximum heat (climate control to AUTO at “  ”). Add coolant to the radiator up to the base of the filler neck. If you do not have the proper coolant mixture available, you can add plain water. Remember to have the cooling system drained and refilled with the proper mixture as soon as you can.
 10. Put the radiator cap back on tightly. Run the engine, and check the temperature gauge. If it goes back to the red mark, the engine needs repair (see **Emergency Towing** on page 480).
 11. If the temperature stays normal, check the coolant level in the radiator reserve tank. If it has gone down, add coolant to the MAX mark. Put the cap back on tightly.

Low Oil Pressure Indicator, Charging System Indicator



Low Oil Pressure Indicator

This indicator should never come on when the engine is running. If it starts flashing or stays on, the oil pressure has dropped very low or lost pressure. Serious engine damage is possible, and you should take immediate action.

NOTICE

Running the engine with low oil pressure can cause serious mechanical damage almost immediately. Turn off the engine as soon as you can safely get the vehicle stopped.

On Touring models

You will also see a “CHECK ENGINE OIL LEVEL” message on the multi-information display (see page 88).

1. Safely pull off the road, and shut off the engine. Turn on the hazard warning indicators.
2. Let the vehicle sit for a minute. Open the hood, and check the oil level (see page 363). An engine very low on oil can lose pressure during cornering and other driving maneuvers.
3. If necessary, add oil to bring the level back to the full mark on the dipstick (see page 418).
4. Start the engine, and watch the oil pressure indicator. If it does not go out within 10 seconds, turn off the engine. There is a mechanical problem that needs to be repaired before you can continue driving (see **Emergency Towing** on page 480).



Charging System Indicator

If the charging system indicator comes on brightly when the engine is running, the battery is not being charged.

On Touring models

You will also see a “CHECK CHARGING SYSTEM” message on the multi-information display (see page 88).

Immediately turn off all electrical accessories. Try not to use other electrically operated controls such as the power windows. Keep the engine running; starting the engine will discharge the battery rapidly.

Go to a service station or garage where you can get technical assistance.

Malfunction Indicator Lamp, Readiness Codes



Malfunction Indicator Lamp

If this indicator comes on while driving, it means one of the engine's emissions control systems may have a problem. Even though you may feel no difference in your vehicle's performance, continued operation may cause serious damage.

If the indicator comes on repeatedly, even though it may turn off as you continue driving, have your vehicle checked by your dealer as soon as possible.

NOTICE

If you keep driving with the malfunction indicator lamp on, you can damage your vehicle's emissions controls and engine. Those repairs may not be covered by your vehicle's warranties.

The indicator may also come on with the "D" indicator.

On Touring models



You will also see a "CHECK EMISSION SYSTEM" message on the multi-information display (see page 88).

Readiness Codes

Your vehicle has certain "readiness codes" that are part of the on-board diagnostics for the emissions systems. In some states, part of the emissions testing is to make sure these codes are set. If they are not set, the test cannot be completed.

If your vehicle's battery has been disconnected or gone dead, these codes are erased. It can take several days of driving under various conditions to set the codes again.

To check if they are set, turn the ignition switch to the ON (II) position without starting the engine. The malfunction indicator lamp will come on for 20 seconds. If it then goes off, the readiness codes are set. If it blinks 5 times, the readiness codes are not set. If possible, do not take your vehicle for a state emissions test until the readiness codes are set. Refer to **Emissions Testing** for more information (see page 498).

U.S.  Canada  The brake system indicator normally comes on when you turn the ignition switch to the ON (II) position, and as a reminder to check the parking brake. It will stay on if you do not fully release the parking brake.

If the brake system indicator comes on while driving, the brake fluid level is probably low. Press lightly on the brake pedal to see if it feels normal. If it does, check the brake fluid level the next time you stop at a service station (see page [427](#)).

On Touring models

You will also see a “BRAKE FLUID LOW” message on the multi-information display (see page [88](#)).

If the fluid level is low, take your vehicle to a dealer, and have the brake system inspected for leaks or worn brake pads.

However, if the brake pedal does not feel normal, you should take immediate action. A problem in one part of the system’s dual circuit design will still give you braking at two wheels. You will feel the brake pedal go down much farther before the vehicle begins to slow down, and you will have to press harder on the pedal.

On Touring models

You will also see a “CHECK BRAKE SYSTEM” message on the multi-information display (see page [88](#)).

Slow down by shifting to a lower gear, and pull to the side of the road when it is safe. Because of the long distance needed to stop, it is hazardous to drive the vehicle. You should have it towed and repaired as soon as possible (see **Emergency Towing** on page [480](#)).

If you must drive the vehicle a short distance in this condition, drive slowly and carefully.

If the ABS indicator and the VSA indicator come on with the brake system indicator, have the vehicle inspected by your dealer immediately.

Fuses

DRIVER'S SIDE INTERIOR FUSE BOX

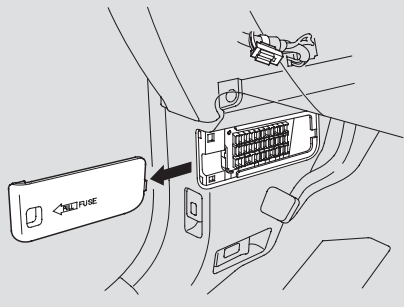

The vehicle's fuses are contained in four fuse boxes (three, if the vehicle does not have a rear entertainment system). The interior fuse boxes are located under the dashboard on the driver's and passenger's side.

PASSENGER'S SIDE INTERIOR FUSE BOX

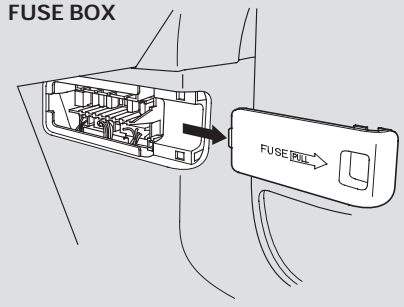

To open the passenger's fuse box, pull the right edge of the cover.

The primary under-hood fuse box is on the passenger's side. To open it, push the tabs as shown.

The secondary under-hood fuse box is behind the primary fuse box.

PRIMARY UNDER-HOOD FUSE BOX

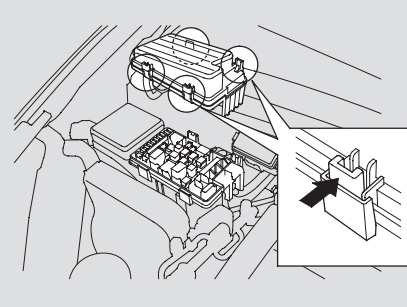

SECONDARY UNDER-HOOD FUSE BOX

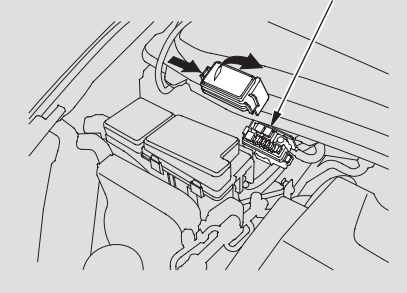

Checking and Replacing Fuses

If something electrical in your vehicle stops working, the first thing you should check for is a blown fuse. Determine from the chart on pages 477 through 479, or the diagram on the fuse box lid, which fuse or fuses control that device. The diagram for the interior driver's side fuse box is on the kick panel below the fuse box. Check those fuses first, but check all the fuses before deciding that a blown fuse is the cause. Replace any blown fuses, and check if the device works.

1. Turn the ignition switch to the LOCK (0) position. Make sure the headlights and all other accessories are off.
2. Remove the cover from the fuse box.

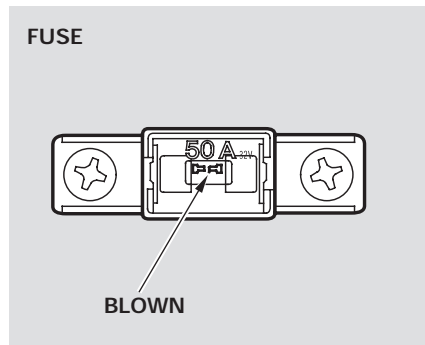

3. Check each of the large fuses in the primary under-hood fuse box by looking through the top at the wire inside. Removing these fuses requires a Phillips-head screwdriver.

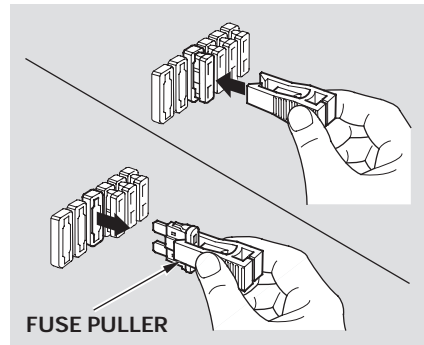

4. Check the smaller fuses in the under-hood fuse box and all the fuses in the interior fuse boxes by pulling out each fuse with the fuse puller provided in the primary under-hood fuse box.

CONTINUED

Fuses

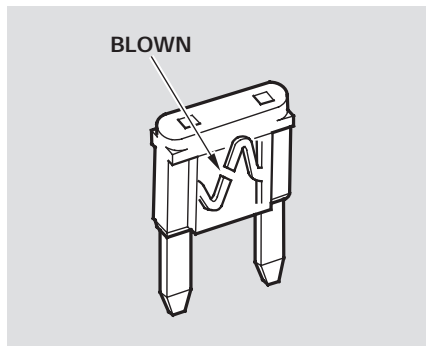

5. Look for a blown wire inside the fuse. If it is blown, replace the fuse with one of the spare fuses of the same rating or lower.

If you cannot drive the vehicle without fixing the problem, and you do not have a spare fuse, take a fuse of the same rating or a lower rating from one of the other circuits. Make sure you can do without that circuit temporarily (such as the accessory power socket or radio).

If you replace the blown fuse with a spare fuse that has a lower rating, it might blow out again. This does not indicate anything wrong. Replace the fuse with one of the correct rating as soon as you can.

NOTICE

Replacing a fuse with one that has a higher rating greatly increases the chances of damaging the electrical system. If you do not have a replacement fuse with the proper rating for the circuit, install one with a lower rating.

6. If the replacement fuse of the same rating blows in a short time, there is probably a serious electrical problem with your vehicle. Leave the blown fuse in that circuit, and have your vehicle checked by a qualified technician.

If the driver's power window fuse is removed, the AUTO function of the driver's window will be disabled. You should reset the AUTO feature, (see page [187](#)).

On EX, EX-L and Touring models
If the radio fuse is removed, the audio system will disable itself. The next time you turn on the radio you will see "CODE" in the frequency display. Use the preset buttons to enter the five-digit code (see page [284](#)).

PRIMARY UNDER-HOOD FUSE BOX

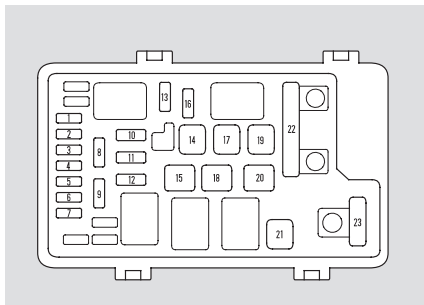

SECONDARY UNDER-HOOD FUSE BOX

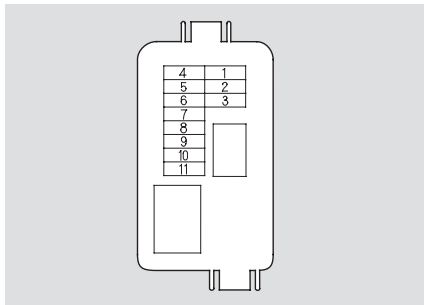

No.	Amps.	Circuits Protected
1	10 A	Left Headlight Low
2	30 A	Rear Defroster Coil
3	10 A	Left Headlight High
4	15 A	Small Lights
5	10 A	Right Headlight High
6	10 A	Right Headlight Low
7	7.5 A	Back Up
8	15 A	FI ECU (PCM)
9	30 A	Condenser Fan
10	-	Not used
11	30 A	Cooling Fan
12	7.5 A	MG Clutch

No.	Amps.	Circuits Protected
1	-	Not Used
2	40 A	Left Power Sliding Door*
3	40 A	Right Power Sliding Door*
4	40 A	Power Tailgate*
5	20 A	Premium
6	20 A	AC Inverter

No.	Amps.	Circuits Protected
13	20 A	Horn, Stop
14	30 A	Rear Defroster
15	40 A	Back Up, ACC
16	15 A	Hazard
17	30 A	VSA Motor
18	30 A	VSA
19	30 A	Option 1
20	40 A	Option 2
21	40 A	Heater Motor
22	70 A	Passenger's Fuse Box
	120 A	Battery
23	50 A	IG1 Main
	50 A	Power Window Main
	40 A*	

No.	Amps.	Circuits Protected
7	20 A	Fog Light*
8	10 A	ACM
9	20 A	AS power Seat Slide*
10	20 A	AS power Seat Recline*
11	7.5 A	Rear Entertainment System*

* : For some types

CONTINUED

Fuse Locations

INTERIOR FUSE BOX

Driver's Side

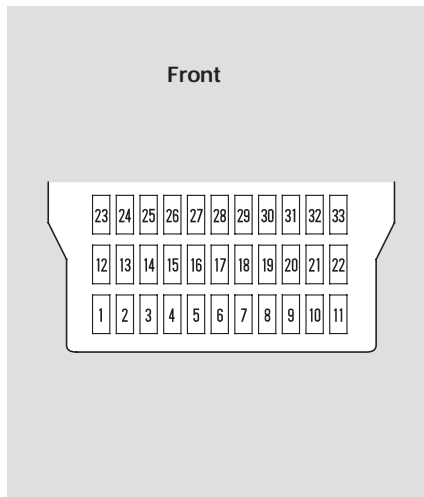

No.	Amps.	Circuits Protected
1	7.5 A	TPMS
2	15 A	IG Coil
3	10 A	Daytime Running Light
4	15 A	LAF
5	10 A	Radio
6	7.5 A	Interior Lights
7	7.5 A	Back Up
8	-	Not Used
9	15 A	Front Accessory Socket
10	7.5 A	OPDS
11	30 A	IG Wiper
12	15 A	Rear Accessory Socket
13	20 A	Left Power Sliding Door Closer*
14	20 A	Driver Power Seat Slide*
15	20 A	Pedal Position Adjustment*
16	20 A	Dr Power Seat Recline*
17	20 A	Power Tailgate Closer*

No.	Amps.	Circuits Protected
18	15 A	IG ACC
19	15 A	IG Fuel Pump
20	10 A	IG Washer
21	7.5 A	IG Meter
22	10 A	IG SRS
23	7.5 A	IGP
24	20 A	Left Rear Power Window
25	20 A	Right Rear Power Window
26	20 A	Passenger's Power Window
27	20 A	Driver's Power Window
28	20 A	Moonroof*
29	-	Not Used
30	10 A	IG HAC
31	15 A	IG SOL
32	10 A	ACC
33	7.5 A	HAC OP

* : For some types

INTERIOR FUSE BOX UPPER AREA

Driver's Side

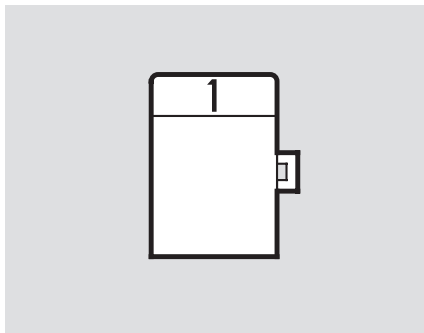

No.	Amps.	Circuits Protected
1	7.5 A	STS

INTERIOR FUSE BOX

Passenger's Side

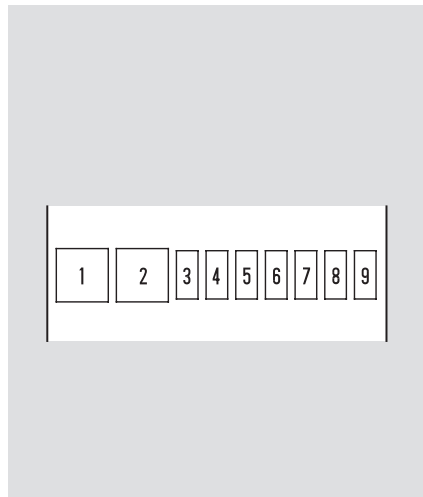

No.	Amps.	Circuits Protected
1	30 A	Rear Blower
2	-	Not Used
3	15 A	DBW
4	20 A	Door Lock
5	-	Not Used
6	15 A	Heated Seat*
7	7.5 A	Instrument Panel
8	20 A	Right Power Sliding Door Closer*
9	-	Not Used

* : For some types

Emergency Towing

If your vehicle needs to be towed, call a professional towing service or organization. Never tow your vehicle with just a rope or chain. It is very dangerous.

There are two ways to tow your vehicle:

Flat-bed Equipment - The operator loads your vehicle on the back of a truck. **This is the best way to transport your vehicle.**

Wheel-lift Equipment - The tow truck uses two pivoting arms that go under the tires and lift them off the ground. The flat tire side (front or rear) should be lifted by the wheel-lift equipment. The other two tires remain on the ground. **This is an acceptable way to tow your vehicle.**

If, due to damage, your vehicle must be towed with the front wheels on the ground, do this:

- Start the engine.
- Press on the brake pedal. Move the shift lever through all its positions.
- Shift to D position for 5 seconds, then to N.
- Turn off the engine.
- Release the parking brake.
- Leave the ignition switch in the ACCESSORY (I) position so the steering wheel does not lock.

NOTICE

Improper towing preparation will damage the transmission. Follow the above procedure exactly. If you cannot shift the transmission or start the engine, your vehicle must be transported with the front wheels off the ground.

With the front wheels on the ground, it is best to tow the vehicle no farther than 50 miles (80 km), and keep the speed below 35 mph (55 km/h).

NOTICE

The steering system can be damaged if the steering wheel is locked. Leave the ignition switch in the ACCESSORY (I) position, and make sure the steering wheel turns freely before you begin towing.

NOTICE

Trying to lift or tow your vehicle by the bumpers will cause serious damage. The bumpers are not designed to support the vehicle's weight.

[Main Menu](#)

[Table Of Contents](#)

The diagrams in this section give you the dimensions and capacities of your vehicle and the locations of the identification numbers. It also includes information you should know about your vehicle's tires and emissions control systems.

Identification Numbers.....	484	Exhaust Gas Recirculation (EGR) System.....	496
Specifications	486	Three Way Catalytic Converter.....	496
DOT Tire Quality Grading (U.S. Vehicles)	488	Replacement Parts.....	496
Uniform Tire Quality Grading	488	Three Way Catalytic Converter...	497
Treadwear	488	Emissions Testing	498
Traction.....	488	Testing of Readiness Codes.....	498
Temperature	489		
Tire Labeling.....	490		
Tire Pressure Monitoring System (TPMS) - Required Federal Explanation.....	492		
Emissions Controls.....	495		
The Clean Air Act.....	495		
Crankcase Emissions Control System.....	495		
Evaporative Emissions Control System.....	495		
Onboard Refueling Vapor Recovery	495		
Exhaust Emissions Controls	496		
PGM-FI System	496		
Ignition Timing Control System.....	496		

Identification Numbers

Your vehicle has several identifying numbers in various places.

The vehicle identification number (VIN) is the 17-digit number your dealer uses to register your vehicle for warranty purposes. It is also necessary for licensing and insuring your vehicle. The easiest place to find the VIN is on a plate fastened to the top of the dashboard. You can see it by looking through the windshield on the driver's side. It is also on the certification label attached to the driver's doorjamb, and is stamped on the engine compartment bulkhead. The VIN is also provided in bar code on the certification label.

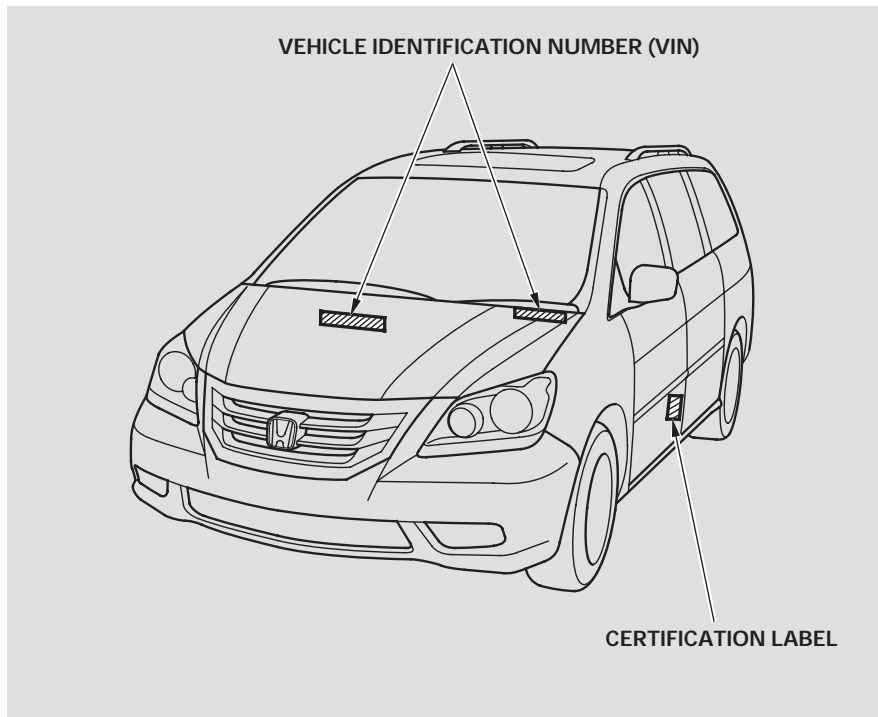

The engine number is stamped into the engine block. It is on the front.

The transmission number is on a label on the side of the transmission.

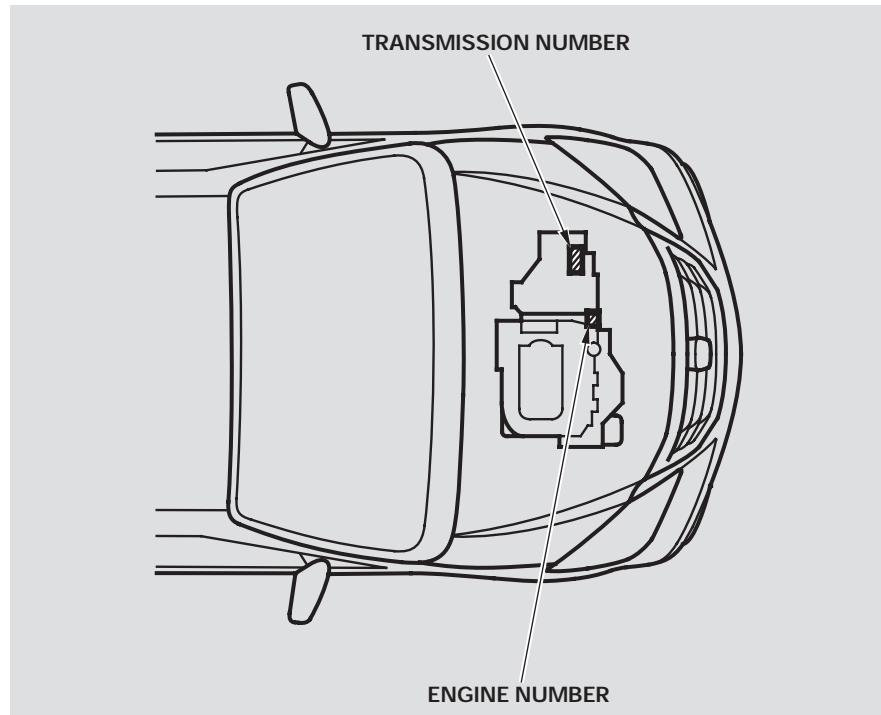

Specifications

Dimensions

Length	202.0 in (5,132 mm)
Width	77.1 in (1,958 mm)
Height	68.8 in (1,748 mm) ^{*1} 70.0 in (1,778 mm) ^{*2}
Wheelbase	118.1 in (3,000 mm)
Track	Front 66.7 in (1,694 mm) Rear 66.8 in (1,697 mm)

* 1 : LX and Canadian DX models

* 2 : EX, EX-L and Touring models

Weights

Gross vehicle weight rating	See the tire information label attached to the driver's doorjamb.
Gross combined weight rating (GCWR)	8,410 lbs (3,815 kg)

Engine

Type	Water cooled 4-stroke SOHC VTEC ^{*1} or i-VTEC · VCM ^{*2} , 6-cylinder (V6), gasoline engine
Bore x Stroke	3.50 x 3.66 in (89.0 x 93.0 mm)
Displacement	212 cu-in (3,471 cm ³)
Compression ratio	10.0 : 1 ^{*1} 10.5 : 1 ^{*2}
Spark plugs	NGK: IZFR5K11 ^{*1} DENSO: SKJ16DR-M11 ^{*1} NGK: ILZKR7B11 ^{*2} DENSO: SXU22HCR11 ^{*2}

* 1 : LX, EX and Canadian DX models

* 2 : EX-L and Touring models

Air Conditioning

Refrigerant type	HFC-134a (R-134a)
Charge quantity	24.7 - 26.5 oz (700 - 750 g)
Lubricant type	ND-OIL8

Capacities

Fuel tank	Approx. 21 US gal (80 ℓ)
Engine coolant	Change ^{*1} Total 1.85 US gal (7.0 ℓ) 2.56 US gal (9.7 ℓ)
Engine oil	Change ^{*2} Including filter 4.5 US qt (4.3 ℓ) Without filter 4.2 US qt (4.0 ℓ) Total 5.3 US qt (5.0 ℓ)
Automatic transmission fluid	Change 3.3 US qt (3.1 ℓ) Total 8.0 US qt (7.6 ℓ)
Windshield washer reservoir	U.S. Vehicles 2.6 US qt (2.5 ℓ) Canada Vehicles 4.8 US qt (4.5 ℓ)

* 1 : Including the coolant in the reserve tank and that remaining in the engine

Reserve tank capacity:

0.190 US gal (0.72 ℓ)

* 2 : Excluding the oil remaining in the engine

Lights

Headlights	High	12 V - 60 W (HB3)
	Low	12 V - 51 W (HB4)
Fog lights		12 V - 55 W (H11)
Front turn signal lights		12 V - 21 W (Amber)
Front parking/side marker lights		12 V - 3 CP
Rear turn signal lights		12 V - 21 W (Amber)
Stop/Taillights		12 V - 21/5 W
Taillights		12 V - 2 CP
Back-up lights		12 V - 21 W
License plate lights		12 V - 5 W
High-mount brake light		12 V - 16 W
Individual map lights	Front	12 V - 8 W
	Rear	12 V - 5 W
Vanity mirror lights		12 V - 2 W
Cargo area light		12 V - 8 W
Door courtesy light		12 V - 3.8 W (2 CP)

Battery

Capacity		12 V - 60 AH/5 HR
		12 V - 72 AH/20 HR

Fuses

Interior	Driver's side	See page 478 and 479 or the fuse label attached to the dashboard.
	Passenger's side	See page 479 or the fuse label attached to the inside of the fuse box door under the dashboard.
Under-hood		See page 477 or the fuse box cover.

Alignment

Toe-in	Front	0.00 in (0.0 mm)
	Rear	0.08 in (2.0 mm)
Camber	Front	0°
	Rear	- 0°30'
Caster	Front	2°32'

Tires

Size	Front/Rear	235/65R16 103T * ¹ 235/60R17 102T * ²
	Spare	235-710R460A 104T * ³ T135/80D17 103M* ¹
Pressure	Front	33 psi (230 kPa, 2.3 kgf/cm ²)
		35 psi (240 kPa, 2.4 kgf/cm ²) * ⁴
	Rear	35 psi (240 kPa, 2.4 kgf/cm ²)
		60 psi (420 kPa, 4.2 kgf/cm ²) * ¹

* 1 : Except U.S.Touring models (With PAX)

* 2 : Touring models (Without PAX)

* 3 : U.S. Touring models (With PAX)

* 4 : EX-L models

Seating Capacities

Total		8/7 *
Front		2
Rear	Second row	3/2 *
	Third row	3

* : U.S. LX and Canadian DX models

DOT Tire Quality Grading (U.S. Vehicles)

The tires on your car meet all U.S. Federal Safety Requirements. All tires are also graded for treadwear, traction, and temperature performance according to Department of Transportation (DOT) standards. The following explains these gradings.

Uniform Tire Quality Grading

Quality grades can be found where applicable on the tire sidewall between tread shoulder and maximum section width. For example:

Treadwear 200

Traction AA

Temperature A

All passenger car tires must conform to Federal Safety Requirements in addition to these grades.

Treadwear

The treadwear grade is a comparative rating based on the wear rate of the tire when tested under controlled conditions on a specified government test course. For example, a tire graded 150 would wear one and one-half (1 1/2) times as well on the government course as a tire graded 100. The relative performance of tires depends upon the actual conditions of their use, however, and may depart significantly from the norm due to variations in driving habits, service practices and differences in road characteristics and climate.

Traction

The traction grades, from highest to lowest, are AA, A, B, and C. Those grades represent the tire's ability to stop on wet pavement as measured under controlled conditions on specified government test surfaces of asphalt and concrete. A tire marked C may have poor traction performance.

Warning: The traction grade assigned to this tire is based on straight-ahead braking traction tests, and does not include acceleration, cornering, hydroplaning, or peak traction characteristics.

DOT Tire Quality Grading (U.S. Vehicles)

Temperature

The temperature grades are A (the highest), B, and C, representing the tire's resistance to the generation of heat and its ability to dissipate heat when tested under controlled conditions on a specified indoor laboratory test wheel. Sustained high temperature can cause the material of the tire to degenerate and reduce tire life, and excessive temperature can lead to sudden tire failure. The grade C corresponds to a level of performance which all passenger car tires must meet under the Federal Motor Vehicle Safety Standard No. 109. Grades B and A represent higher levels of performance on the laboratory test wheel than the minimum required by law.

Warning: The temperature grade for this tire is established for a tire that is properly inflated and not overloaded. Excessive speed, underinflation, or excessive loading, either separately or in combination, can cause heat buildup and possible tire failure.

Tire Labeling

The tires that came on your vehicle have a number of markings. Those you should be aware of are described below.

TIRE LABELING EXAMPLE

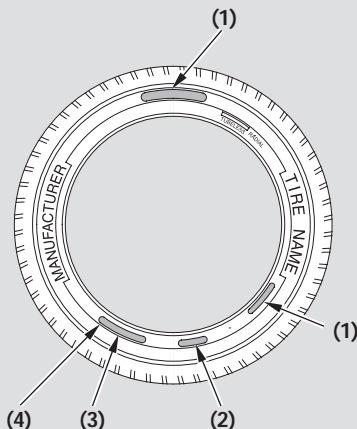

- (1) Tire Size
- (2) Tire Identification Number (TIN)
- (3) Maximum Tire Pressure
- (4) Maximum Tire Load

Tire Size

Whenever tires are replaced, they should be replaced with tires of the same size. Following is an example of tire size with an explanation of what each component means.

235/60R17 102T

- 235 - Tire width in millimeters.
- 60 - Aspect ratio (the tire's section height as a percentage of its width).
- R - Tire construction code (R indicates radial).
- 17 - Rim diameter in inches.

102 - Load index (a numerical code associated with the maximum load the tire can carry).

T - Speed symbol (an alphabetical code indicating the maximum speed rating).

Tire Identification Number (TIN)

The tire identification number (TIN) is a group of numbers and letters that look like the following example. TIN is located on the sidewall of the tire.

DOT B97R FW6X 2202

DOT - This indicates that the tire meets all requirements of the U.S. Department of Transportation.

B97R - Manufacturer's identification mark.

Tire Labeling (PAX System Tires)

FX6X - Tire type code.

2202 - Date of manufacture.

Year

Week

Maximum Tire Pressure

Max Press - The maximum air pressure the tire can hold.

Maximum Tire Load

Max Load - The maximum load the tire can carry at maximum air pressure.

PAX System™ Tire Labeling

If equipped

The PAX system tires have different markings from conventional tire markings. Following is an example of PAX system tire size with an explanation of what each component means.

235-710R460A 104T

235 - Tire width in millimeters.

710 - Outside diameter of the tire in millimeters.

R - Tire construction code (R indicates radial)

460 - Nominal diameter at the rim seat in millimeters.

A - Symmetric

104 - Load index (a numerical code associated with the maximum load the tire can carry).

T - Speed symbol (an alphabetical code indicating the maximum speed rating).

Tire Pressure Monitoring System (TPMS) - Required Federal Explanation

All models

Each tire, including the spare (if provided), should be checked monthly when cold and inflated to the inflation pressure recommended by the vehicle manufacturer on the vehicle placard or tire inflation pressure label.

(If your vehicle has tires of a different size than the size indicated on the vehicle placard or tire inflation pressure label, you should determine the proper tire inflation pressure for those tires.)

As an added safety feature, your vehicle has been equipped with a tire pressure monitoring system (TPMS) that illuminates a low tire pressure telltale



when one or more of your tires is significantly under-inflated.

Accordingly, when the low tire pressure telltale illuminates, you should stop and check your tires as soon as possible, and inflate them to the proper pressure.

Driving on a significantly under-inflated tire causes the tire to overheat and can lead to tire failure. Under-inflation also reduces fuel efficiency and tire tread life, and may affect the vehicle's handling and stopping ability.

Please note that the TPMS is not a substitute for proper tire maintenance, and it is the driver's responsibility to maintain correct tire pressure, even if under-inflation has not reached the level to trigger illumination of the TPMS low tire pressure telltale.

Tire Pressure Monitoring System (TPMS) - Required Federal Explanation

Except Touring models

Your vehicle has also been equipped with a TPMS malfunction indicator to indicate when the system is not operating properly. The TPMS malfunction indicator is provided by a separate telltale, which displays the symbol "TPMS" when illuminated.

When the malfunction indicator is illuminated,

TPMS

the system may not be able to detect or signal low tire pressure as intended.

TPMS malfunctions may occur for a variety of reasons, including the installation of replacement or alternate tires or wheels on the vehicle that prevent the TPMS from functioning properly.

Always check the TPMS malfunction telltale after replacing one or more tires or wheels on your vehicle to ensure that the replacement or alternate tires and wheels allow the TPMS to continue to function properly.

Tire Pressure Monitoring System (TPMS) - Required Federal Explanation

Touring model

Your vehicle has also been equipped with a TPMS malfunction indicator to indicate when the system is not operating properly. The TPMS malfunction indicator is combined with the low tire pressure telltale.

When the system detects a malfunction, the telltale will flash for approximately one minute and then remain continuously illuminated. This sequence will continue upon subsequent vehicle start-ups as long as the malfunction exists.

When the malfunction indicator is illuminated, the system may not be able to detect or signal low tire pressure as intended.

TPMS malfunctions may occur for a variety of reasons, including the installation of replacement or alternate tires or wheels on the vehicle that prevent the TPMS from functioning properly.

Always check the TPMS malfunction telltale after replacing one or more tires or wheels on your vehicle to ensure that the replacement or alternate tires and wheels allow the TPMS to continue to function properly.

The burning of gasoline in your vehicle's engine produces several by-products. Some of these are carbon monoxide (CO), oxides of nitrogen (NOx), and hydrocarbons (HC). Gasoline evaporating from the tank also produces hydrocarbons. Controlling the production of NOx, CO, and HC is important to the environment. Under certain conditions of sunlight and climate, NOx and HC react to form photochemical "smog." Carbon monoxide does not contribute to smog creation, but it is a poisonous gas.

The Clean Air Act

The United States Clean Air Act* sets standards for automobile emissions. It also requires that automobile manufacturers explain to owners how their emissions controls work and what to do to maintain them. This section summarizes how the emissions controls work. Scheduled maintenance is on page [416](#).

* In Canada, Honda vehicles comply with the Canadian emission requirements, as specified in an agreement with Environment Canada, at the time they are manufactured.

Crankcase Emissions Control System

Your vehicle has a positive crankcase ventilation system. This keeps gasses that build up in the engine's crankcase from going into the atmosphere. The positive

crankcase ventilation valve routes them from the crankcase back to the intake manifold. They are then drawn into the engine and burned.

Evaporative Emissions Control System

As gasoline evaporates in the fuel tank, an evaporative emissions control canister filled with charcoal adsorbs the vapor. It is stored in this canister while the engine is off. After the engine is started and warmed up, the vapor is drawn into the engine and burned during driving.

Onboard Refueling Vapor Recovery

The onboard refueling vapor recovery (ORVR) system captures the fuel vapors during refueling. The vapors are adsorbed in a canister filled with activated carbon. While driving, the fuel vapors are drawn into the engine and burned off.

Emissions Controls

Exhaust Emissions Controls

The exhaust emissions controls include four systems: PGM-FI, ignition timing control, exhaust gas recirculation, and three way catalytic converter. These four systems work together to control the engine's combustion and minimize the amount of HC, CO, and NOx that come out the tailpipe. The exhaust emissions control systems are separate from the crankcase and evaporative emissions control systems.

PGM-FI System

The PGM-FI system uses sequential multiport fuel injection. It has three subsystems: air intake, engine control, and fuel control. The powertrain control module (PCM) uses various sensors to determine how much air is going into the engine. It then controls how much fuel to inject under all operating conditions.

Ignition Timing Control System

This system constantly adjusts the ignition timing, reducing the amount of HC, CO, and NOx produced.

Exhaust Gas Recirculation (EGR) System

The exhaust gas recirculation (EGR) system takes some of the exhaust gas and routes it back into the intake manifold. Adding exhaust gas to the air/fuel mixture reduces the amount of NOx produced when the fuel is burned.

Three Way Catalytic Converter

The three way catalytic converter is in the exhaust system. Through chemical reactions, it converts HC, CO, and NOx in the engine's exhaust to carbon dioxide (CO₂), nitrogen (N₂), and water vapor.

Replacement Parts

The emissions control systems are designed and certified to work together in reducing emissions to levels that comply with the Clean Air Act. To make sure the emissions remain low, you should use only new Honda replacement parts or their equivalent for repairs. Using lower quality parts may increase the emissions from your vehicle.

The emissions control systems are covered by warranties separate from the rest of your vehicle. Read your warranty manual for more information.

Three Way Catalytic Converter

The three way catalytic converters contain precious metals that serve as catalysts, promoting chemical reactions to convert the exhaust gasses without affecting the metals. The catalytic converters are referred to as three-way catalysts, since they act on HC, CO, and NOx. Replacement units must be original Honda parts or their equivalent.

The three way catalytic converter must operate at a high temperature for the chemical reactions to take place. It can set on fire any combustible materials that come near it. Park your vehicle away from high grass, dry leaves, or other flammables.

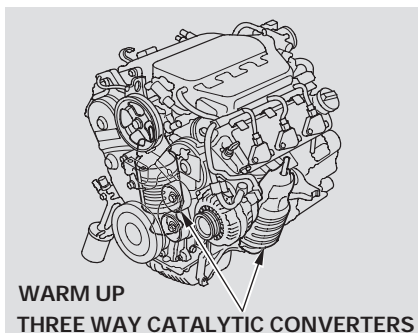
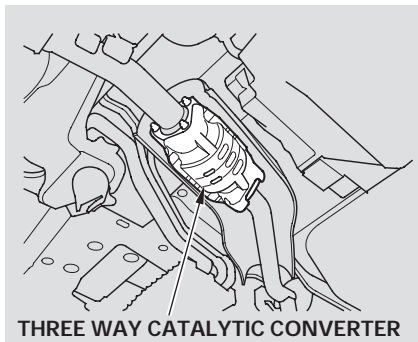

A defective three way catalytic converter contributes to air pollution, and can impair your engine's performance. Follow these guidelines to protect your vehicle's three way catalytic converter.

- Always use unleaded gasoline. Even a small amount of leaded gasoline can contaminate the catalyst metals, making the three way catalytic converter ineffective.
- Keep the engine well maintained.
- Have your vehicle diagnosed and repaired if it is misfiring, back-firing, stalling, or otherwise not running properly.

Emissions Testing

Testing of Readiness Codes

If you take your vehicle for an emissions test shortly after the battery has been disconnected or gone dead, it may not pass the test. This is because of certain “readiness codes” that must be set in the on-board diagnostics for the emissions systems. These codes are erased when the battery is disconnected, and set again only after several days of driving under a variety of conditions.

If the testing facility determines that the readiness codes are not set, you will be requested to return at a later date to complete the test. If you must get the vehicle retested within the next two or three days, you can condition the vehicle for retesting by doing the following.

1. Make sure the gas tank is nearly, but not completely, full (around 3/4).
2. Make sure the vehicle has been parked with the engine off for 6 hours or more.
3. Make sure the ambient temperature is between 40° and 95° F (4° and 35° C).

4. Without touching the accelerator pedal, start the engine, and let it idle for 20 seconds.
5. Keep the vehicle in Park. Increase the engine speed to 2,000 rpm, and hold it there until the temperature gauge rises to at least 1/4 of the scale (about 3 minutes).
6. Without touching the accelerator pedal, let the engine idle for 20 seconds.

7. Select a nearby lightly traveled major highway where you can maintain a speed of 50 to 60 mph for at least 20 minutes. Drive on the highway in D (A/T). Do not use the cruise control. When traffic allows, drive for 90 seconds without moving the accelerator pedal. (Vehicle speed may vary slightly; this is okay.) If you cannot do this for a continuous 90 seconds because of traffic conditions, drive for at least 30 seconds, then repeat it two more times (for a total of 90 seconds).

8. Then drive in city/suburban traffic for at least 10 minutes. When traffic conditions allow, let the vehicle coast for several seconds without using the accelerator pedal or the brake pedal.

9. Make sure the vehicle has been parked with the engine off for 30 minutes.

If the testing facility determines the readiness codes are still not set, see your dealer.

[Main Menu](#)

[Table Of Contents](#)

Warranty and Customer Relations

Customer Service Information.....	502
Warranty Coverages	503
Reporting Safety Defects (U.S. Vehicles)	504
Authorized Manuals	505

Customer Service Information

Honda dealership personnel are trained professionals. They should be able to answer all your questions. If you encounter a problem that your dealership does not solve to your satisfaction, please discuss it with the dealership's management. The service manager or general manager can help. Almost all problems are solved in this way.

If you are dissatisfied with the decision made by the dealership's management, contact your Honda Customer Service Office.

U.S. Owners:

American Honda Motor Co., Inc.
Automobile Customer Service
Mail Stop 500-2N-7A
1919 Torrance Boulevard
Torrance, California 90501-2746

Tel: (800) 999-1009

Canadian Owners:

Customer Relations
Honda Canada Inc.
715 Milner Avenue
Toronto, ON
M1B 2K8

Tel: 1-888-9-HONDA-9
Fax: Toll-free 1-877-939-0909
Toronto (416) 287-4776

In Puerto Rico and the U.S. Virgin Islands:

Vortex Motor Corp.
Bella International
P.O. Box 190816
San Juan, PR 00919-0816

Tel: (787) 620-7546

When you call or write, please give us this information:

- Vehicle Identification Number (see page [484](#))
- Name and address of the dealer who services your vehicle
- Date of purchase
- Mileage on your vehicle
- Your name, address, and telephone number
- A detailed description of the problem
- Name of the dealer who sold the vehicle to you

U.S. Owners

Your new vehicle is covered by these warranties:

New Vehicle Limited Warranty - covers your new vehicle, except for the battery, emissions control systems, and accessories, against defects in materials and workmanship.

Emissions Control Systems Defects Warranty and Emissions Performance Warranty - these two warranties cover your vehicle's emissions control systems. Time, mileage, and coverage are conditional. Please read your warranty booklet for exact information.

Original Equipment Battery Limited Warranty - this warranty gives up to 100% credit toward a replacement battery.

Seat Belt Limited Warranty - a seat belt that fails to function properly is covered by a limited warranty. Please read your warranty booklet for details.

Rust Perforation Limited Warranty - all exterior body panels are covered for rust-through from the inside for the specified time period with no mileage limit.

Accessory Limited Warranty - Honda accessories are covered under this warranty. Time and mileage limits depend on the type of accessory and other factors. Please read your warranty booklet for details.

Replacement Parts Limited Warranty - covers all Honda replacement parts against defects in materials and workmanship.

Replacement Battery Limited Warranty - provides prorated coverage for a replacement battery purchased from your dealer.

Replacement Muffler Lifetime Limited Warranty - provides coverage for as long as the purchaser of the muffler owns the vehicle.

Restrictions and exclusions apply to all these warranties. Please read the 2008 Honda warranty information booklet that came with your vehicle for precise information on warranty coverages. Your vehicle's original tires are covered by their manufacturer. Tire warranty information is in a separate booklet.

Canadian Owners

Please refer to the 2008 warranty manual that came with your vehicle.

Reporting Safety Defects (U.S. Vehicles)

If you believe that your vehicle has a defect which could cause a crash or could cause injury or death, you should immediately inform the National Highway Traffic Safety Administration (NHTSA) in addition to notifying American Honda Motor Co., Inc.

If NHTSA receives similar complaints, it may open an investigation, and if it finds that a safety defect exists in a group of vehicles, it may order a recall and remedy campaign. However, NHTSA cannot become involved in individual problems between you, your dealer, or American Honda Motor Co., Inc.

To contact NHTSA, you may call the Vehicle Safety Hotline toll-free at 1-888-327-4236 (TTY: 1-800-424-9153); go to <http://www.safercar.gov>; or write to: Administrator, NHTSA, 1200 New Jersey Avenue, SE., Washington, DC 20590. You can also obtain other information about motor vehicle safety from <http://www.safercar.gov>.

Purchasing Factory Authorized Manuals (U.S. only)

The publications shown below can be purchased from Helm Incorporated. You can order by phone or online:

- Call Helm Inc. at 1-800-782-4356 (credit card orders only)
- Go online at www.helminc.com

If you are interested in other years or models, contact Helm Inc. at 1-800-782-4356.

Publication Form Number	Form Description
61SHJ03	2007-08 Honda Odyssey Service Manual
61SHJ02EL	2005-08 Honda Odyssey Electrical Troubleshooting Manual
61SHJ40	2005 Model Series Honda Odyssey Body Repair Manual
31SHJ630	2008 Honda Odyssey Owner's Manual
31SHJ810	2008 Honda Odyssey Navigation System Manual
31SHJM30	2008 Honda Odyssey Honda Service History
31SHJQ30	2008 Honda Odyssey Quick Start Guide
HON-R	Order Form for Previous Years-Indicate Year and Model Desired

Service Manual:

Covers maintenance and recommended procedures for repair to engine and chassis components. It is written for the journeyman mechanic, but it is simple enough for most mechanically inclined owners to understand.

Electrical Troubleshooting Manual:

Complements the Service Manual by providing in-depth troubleshooting information for each electrical circuit in your vehicle.

Body Repair Manual:

Describes the procedures involved in the replacement of damaged body parts.

Main Menu

A

Accessories.....	368
ACCESSORY (Ignition Key Position)	144
Accessory Power Socket	203
AC Power Outlet.....	203
Additives, Engine Oil.....	419
Advanced Airbag System.....	30
Airbag (SRS)	9, 25
Air Conditioning System.....	210
Rear A/C Control	216
Air Outlets (Vents).....	213, 220
Air Pressure, Tires	443
Antifreeze	424
Anti-lock Brakes (ABS) Indicator.....	69, 384
Operation.....	384
Anti-theft, Audio System.....	284
Anti-theft Steering Column Lock.....	144
Armrests.....	171
Audio Controls, Remote.....	282
Audio System	221
Automatic Seat Belt Tensioners....	23
Automatic Lighting Off Feature..	138

Automatic Speed Control.....	319
Automatic Transmission.....	378
Capacity, Fluid	486
Checking Fluid Level	425
Shifting.....	378
Shift Lever Position Indicators.....	378
Shift Lever Positions	379
Shift Lock Release.....	381
Auxiliary Input Jack.....	283

B

Battery Charging System Indicator.....	67, 471
Jump Starting	467
Maintenance.....	450
Specifications	487
Before Driving	359
Belts, Seat	8, 21
Beverage Holders.....	195
Bluetooth® HandsFreeLink®	325
Booster Seats	57
Brakes Anti-lock System (ABS).....	384

Break-in, New Linings	360
Bulb Replacement	433, 435
Fluid	427
Pad Wear Indicators.....	383
Parking.....	192
System Indicator	69, 473
Braking System.....	383
Break-in, New Vehicle	360
Brightness Control, Instruments	139
Brights, Headlights	136
Bulb Replacement Back-up Lights	434
Brake Lights.....	433
Front Parking Lights.....	431
Front Side Marker Lights.....	431
Front Turn Signal Light.....	430
Headlights	429
Rear Bulbs	433, 434
Rear Turn Signal Light	433
Specifications	487
Bulbs, Halogen.....	429

CONTINUED

Index

C

Cancel Button.....	321
Capacities Chart.....	486
Carbon Monoxide Hazard.....	60
Cargo Area Light.....	207
Cargo, How to Carry.....	370
CAUTION, Explanation of.....	ii
CD Care.....	272
CD Changer.....	244, 263
CD Changer Error	
Messages.....	251, 271
CD Player.....	226
Center Pocket.....	202
Center Tray.....	195
Certification Label.....	484
Chains, Tires.....	447
Changing Oil	
How to.....	420
When to.....	407
Changing a Flat Tire.....	458
Charging System Indicator ...	67, 471
Checklist, Before Driving.....	376
Childproof Door Locks.....	157
Child Safety.....	38
Booster Seats.....	57

Child Seats.....	46
Important Safety Reminders.....	41
Infants.....	43
Larger Children.....	47
LATCH.....	48
Risks with Airbags.....	39
Small Children.....	44
Tethers.....	53
Where Should A Child Sit?.....	39
Child Seats.....	43
LATCH Anchorage System.....	48
Tether Anchorage Points.....	54
Cleaning	
Seat Belts.....	436
Climate Control System.....	215
Clock.....	281
Code, Audio System.....	284
CO in the Exhaust.....	495
Cold Weather, Starting in.....	377
Compact Spare Tire.....	457
Consumer Information.....	502
Controls, Instruments and.....	63
Conversation Mirror.....	198
Coolant	
Adding.....	422
Checking.....	364

Proper Solution.....	422
Temperature Gauge.....	77
Crankcase Emissions Control	
System.....	495
Cruise Control Indicator.....	75
Cruise Control Operation.....	319
Cup Holders.....	195
Customer Service Office.....	502

D

DANGER, Explanation of.....	ii
Dashboard.....	3, 64
Daytime Running Lights.....	138
Daytime Running Lights	
Indicator.....	73
Dead Battery.....	467
Defects, Reporting Safety.....	504
Defogger, Rear Window.....	140
Defrosting the Windows.....	214
Dimensions.....	486
Dimming the Headlights.....	136
Dipstick	
Automatic Transmission.....	425
Engine Oil.....	363
Directional Signals.....	136

Disc Brake Pad Wear Indicators	383
Disposal of Used Oil	421
Doors	
Auto Door Locking/ unlocking	152
Locking and Unlocking	151
Lockout Prevention	151
Manual Sliding Doors	161
Open monitor	75, 91
Power Door Locks	151
Power Sliding Doors	161
DOT Tire Quality Grading	488
Driver and Passenger Safety	5
Driving	375
Economy	365
Driving Position Memory System	184
Dust and Pollen Filter	436
DVD Error Message	314
DVD Player	285

E

Economy, Fuel	365
---------------------	-----

Emergencies	453
Battery, Jump Starting	467
Brake System Indicator	473
Changing a Flat Tire	458
Charging System Indicator	471
Checking the Fuses	475
Driving with a Flat Tire	449
Hazard Warning Flashers	140
Jump Starting	467
Low Oil Pressure Indicator	471
Malfunction Indicator Lamp	472
Overheated Engine	469
Towing	480
Emergency Brake	192
Emergency Flashers	140
Emergency Towing	480
Emissions Controls	495
Emissions Testing, State	498
Engine	
Coolant Temperature Gauge	77
Engine Speed Limiter	380
If It Won't Start	465
Malfunction Indicator Lamp	67, 472
Oil Pressure Indicator	67, 471
Oil, What Kind to Use	418

Overheating	469
Specifications	486
Starting	377
Evaporative Emissions Controls ..	495
Exhaust Fumes	60
Exhaust Gas Recirculation System	496
Expectant Mothers, Use of Seat Belts by	19

F

Fan, Interior	211
Features, Comfort and Convenience	209
Filling the Fuel Tank	361
Filters	
Dust and Pollen Filter	436
Oil	420
Flashers, Hazard Warning	140
Flat Tire, Changing a	458
Floor Mats	176, 436
Floor Storage Area	200

CONTINUED

Important Safety Precautions	6
Indicators	65, 66
ABS (Anti-lock Brake)	69, 384
Brake (Parking and Brake System)	69, 473
Charging System	67, 471
Cruise Control	75
DRL (Daytime Running Lights)	73
Indicators	
Fog Light	73
Fuel Economy	75
High Beam	73
Key (Immobilizer System)	70
Lights On	73
Low Fuel	74
Low Oil Pressure	67, 471
Low Tire Pressure.....	71, 388, 391
Maintenance Minder.....	76
Side Airbag Off	35, 68
SRS	34, 67
System Message	76
TPMS	72, 389, 392
Turn Signal and Hazard Warning	72

Vehicle Stability Assist (VSA) System.....	70
VSA Activation.....	70
Washer Level.....	74
Individual Map Lights.....	206
Infant Restraint.....	43
Infant Seats.....	45
LATCH Anchorage System	48
Lower Anchors	48
Tether Anchorage Points	54
Inflation, Proper Tire	443
In-Floor Storage Area.....	200
Inside Mirror	190
Inspection, Tire	444
Instrument Panel	4, 133
Instrument Panel Brightness.....	139
Integrated Sunshade	197
Interior Lights	205
Introduction.....	i

J

Jacking up the Vehicle	460
Jack, Tire	459
Jump Starting	467

K

Keys.....	142
-----------	-----

L

Label, Certification.....	484
Lane Change, Signaling	136
Lap/Shoulder Belts	15, 22
LATCH Anchorage System.....	48
Light Control Switch.....	205
Lights	
Bulb Replacement	429
Indicator	73
Interior	205
Parking.....	135
Turn Signal.....	136
Load Limits.....	371, 396
LOCK (Ignition Key Position)	144

CONTINUED

Index

- Locks
- Anti-theft Steering Column 144
 - Fuel Fill Door 361
 - Glove Box 201
 - Lockout Prevention 151
 - Power Door 151
 - Sliding Doors 161
 - Tailgate 157
- Low Coolant Level 364
- Low Fuel Indicator 74
- Low Oil Pressure Indicator 67, 471
- Lower Anchors 48, 50
- Lower Glove Box 201
- Lubricant Specifications Chart 486
- Luggage, Storing (Cargo) 370
- M**
- Maintenance 405
- Minder 407-416
 - Minder Indicator 76
 - Owner Maintenance Checks 415
 - Safety 406
- Malfunction Indicator Lamp .. 67, 472
- Manual Sliding Doors 161
- Meters, Gauges 77
- Michelin PAX System 454
- Mirrors, Adjusting 190
- Modifications 369
- Modifying Your Vehicle 368
- Moonroof 189
- Moving the Second Row Bucket
Seat 175
- Multi-Information Display 81
- N**
- Neutral Gear Position 379
- New Vehicle Break-in 360
- NOTICE, Explanation of i
- Numbers, Identification 484
- O**
- Octane Requirement, Gasoline 360
- Odometer 78, 85
- Odometer, Trip 78, 86
- Oil
- Change, How to 420
 - Change, When to 407
 - Checking Engine 363
 - Pressure Indicator 67, 471
- Selecting Proper Viscosity
Chart 419
- ON (Ignition Key Position) 144
- Onboard Refueling Vapor
Recovery 495
- Outside Mirrors 191
- Overheating, Engine 469
- Owner Maintenance Checks 415
- Oxygenated Fuels 360
- P**
- Panel Brightness Control 139
- Park Gear Position 379
- Parking 382
- Parking Brake 192
- Parking Brake and Brake
System Indicator 69, 473
- Parking Lights 136
- Parking Sensor System 352
- Parking Over Things that Burn... 382
- Passenger Airbag Off Indicator 35
- PAX System 454
- PGM-FI System 496
- Power Door Locks 151

Power Sliding Doors	
Indicator.....	75
Operation.....	161
Switches.....	162
Power Socket Locations.....	194
Power Tailgate.....	158
Power Windows.....	186
Pregnancy, Using Seat Belts.....	19
Protecting Adults and Teens.....	11
Additional Safety Precautions....	19
Advice for Pregnant Women.....	19
Protecting Children.....	38
Protecting Infants.....	43
Protecting Larger Children.....	56
Protecting Small Children.....	44
Using Child Seats with	
Tethers.....	53
Using LATCH.....	48

R

Radiator Overheating.....	469
Radio/CD Sound System.....	221
Readiness Codes.....	472
Rear Audio Control Panel.....	290
Rear A/C Unit.....	216

Rear Entertainment System.....	285
Rear Lights, Bulb	
Replacement.....	433, 434
Rearview Camera and Monitor....	356
Rear View Mirror.....	190
Rear Window Defogger.....	140
Rear Window Wiper and	
Washer.....	135
Reclining the Seat Backs.....	168, 170
Reclining the Second Row Seats..	168
Reclining the Third Row Seat.....	169
Reminder Indicators.....	65, 66
Remote Audio Controls.....	282
Remote Control (RES).....	312
Remote Transmitter.....	145
Removing the Second Row	
Seats.....	177
Replacement Information	
Engine Oil and Filter.....	420
Fuses.....	474
Light Bulbs.....	429
Timing Belt.....	428
Tires.....	446
Wiper Blades.....	437
Replacing Seat Belts After a	
Crash.....	24

Reserve Tank,	
Engine Coolant.....	364, 422
Retractable Center Tray.....	195
Reverse Gear Position.....	379
Roof Rack.....	373
Rotation, Tire.....	445

S

Safety Belts.....	8, 21
Safety Defects, Reporting.....	504
Safety Features.....	7
Airbags.....	9
Seat Belts.....	8
Safety Labels, Location of.....	61
Safety Messages.....	ii

CONTINUED

Index

- | | | | | | |
|---------------------------------|---------------|--------------------------------------|--------|-----------------------------------|--------------|
| Seat Belts..... | 8, 21 | Third Row Seat Access..... | 174 | Speedometer | 77 |
| Additional Information..... | 21 | Security System | 318 | SRS, Additional Information..... | 25 |
| Automatic Seat Belt | | Sensors | | Additional Safety Precautions.... | 37 |
| Tensioners..... | 23 | Front Passenger's Weight | | Airbag Service..... | 36 |
| Cleaning..... | 436 | Sensors..... | 30 | How the SRS Indicator Works... 34 | |
| Lap/Shoulder Belt..... | 22 | Driver's Seat Position Sensor.... | 30 | How Your Airbags | |
| Maintenance..... | 24 | Serial Number | 484 | Work | 27, 31, 33 |
| Reminder Indicator and | | Service Intervals | 407 | SRS Components | 25 |
| Beeper..... | 21, 68 | Service Manual | 505 | SRS Indicator..... | 34, 67 |
| Replacement..... | 24 | Service Station Procedure | 361 | START (Ignition Key Position) ... | 144 |
| System Components..... | 21 | Setting the Clock | 281 | Starting the Engine..... | 377 |
| Use During Pregnancy..... | 19 | Shift Lever Position Indicators | 378 | In Cold Weather at High | |
| Wearing a Lap/Shoulder Belt.... | 15 | Shift Lock Release..... | 381 | Altitude | 377 |
| Seat Heaters | 183 | Side Airbags | 9, 31 | With a Dead Battery | 467 |
| Seats | 167 | Off Indicator..... | 35, 68 | State Emissions Testing | 498 |
| Adjustments..... | 168, 169, 170 | Side Marker Lights, Bulb | | Steam Coming from Engine..... | 469 |
| Drivers Lumbar Support..... | 170 | Replacement..... | 431 | Steering Wheel | |
| Folding the Third Row Seat | 181 | Signaling Turns..... | 136 | Adjustment | 141 |
| Head Restraints | 171 | Sliding Doors..... | 161 | Anti-theft Column Lock | 144 |
| Manual Height Adjustment..... | 169 | Snow Tires..... | 447 | Buttons..... | 82, 282, 319 |
| Passenger Seating | 167 | Sound System..... | 221 | Stereo Sound System | 221 |
| Reclining the Third Row Seat .. | 169 | Spare Tire | | Storing Your Vehicle..... | 451 |
| Removing the Second Row | | Inflating..... | 457 | Second Row Plus-One Seat..... | 178 |
| Seats | 177 | Specifications | 487 | Sunglasses Holder | 197 |
| Removing the Second Row | | Specifications Charts..... | 486 | Sun Visor..... | 198 |
| Plus-One Seat | 178 | Speed Control..... | 319 | | |

Supplemental Restraint System	
Servicing	36
SRS Indicator.....	34, 67
System Components.....	25
Synthetic Oil.....	419

T

Tachometer	77
Tailgate	157
Opening the.....	157, 158
Open Monitor Indicator	75, 91
Taillights, Changing Bulbs... ..	433, 434
Taking Care of the Unexpected ..	453
Technical Descriptions	
Emissions Control Systems.....	495
Three Way Catalytic Converter.....	496, 497
Temperature Gauge	77
Temperature, Inside Sensor.....	220
Tensioners, Seat Belts	23
Tether Anchorage Points	54
Theft Protection.....	284
Three Way Catalytic Converter... ..	497
Tilt and Telescoping the Steering Wheel	141

Time, Setting the	281
Timing Belt.....	428
Tire Chains	447
Tire, How to Change a Flat	458
Tires	442
Air Pressure	442
Balancing.....	445
Checking Wear	444
Compact Spare	457
DOT Tire Quality Grading.....	488
Inflation.....	442
Inspection	444
Labeling	490
Replacing.....	446
Rotating.....	445
Service Life.....	445
Snow	447
Specifications	487
Tire Chains	447
Tire Pressure Monitoring System (TPMS).....	388, 391
Tools, Tire Changing	458
Towing	
A Trailer.....	396
Emergency Wrecker.....	480
Equipment and Accessories.....	398

Weight Limit	396
Trailer Loading.....	396
Trailer Towing Tips.....	402
Transmission	
Checking Fluid Level.....	425
Fluid Selection.....	426
Identification Number.....	485
Shifting the Automatic.....	378
Treadwear	488
Trip Meter	78, 86
Turn Signals	136

U

Unexpected, Taking Care of the	453
Uniform Tire Quality Grading	488
Unleaded Gasoline.....	360
Upper Glove Box.....	201
Used Oil, How to Dispose of	421

V

Vanity Mirror	199
---------------------	-----

CONTINUED

Main Menu

Main Menu

Main Menu

Service Information Summary

Gasoline:

Unleaded gasoline, pump octane number of 87 or higher.

Fuel Tank Capacity:

21 US gal (80 ℓ)

Recommended Engine Oil:

API Premium grade 5W-20 detergent oil (see page [418](#)).

Oil change capacity (including filter):

4.5 US qt (4.3 ℓ)

Automatic Transmission Fluid:

Honda ATF-Z1 (Automatic Transmission Fluid) (see page [426](#)).

Power Steering Fluid:

Honda Power Steering Fluid preferred, or another brand of power steering fluid as a temporary replacement. Do not use ATF (see page [428](#)).

Brake Fluid:

Honda Heavy Duty Brake Fluid DOT 3 preferred, or a DOT 3 or DOT 4 brake fluid as a temporary replacement (see page [427](#)).

Tire Pressure (measured cold):

LX, EX, Touring models and Canadian DX models:

Front:

33 psi (230 kPa , 2.3 kgf/cm²)

Rear:

35 psi (240 kPa , 2.4 kgf/cm²)

EX-L models:

Front:

35 psi (240 kPa , 2.4 kgf/cm²)

Rear:

35 psi (240 kPa , 2.4 kgf/cm²)

All models except U.S. Touring models with PAX system

Compact Spare Tire:

60 psi (420 kPa , 4.2 kgf/cm²)

Owner's Identification

OWNER _____

ADDRESS _____

STREET

CITY

STATE/PROVINCE

ZIP CODE/
POSTAL CODE

V. I. N. _____

DELIVERY DATE _____

(Date sold to original retail purchaser)

DEALER NAME _____ DEALER NO. _____

ADDRESS _____

STREET

CITY

STATE/PROVINCE

ZIP CODE/
POSTAL CODE

OWNER'S SIGNATURE _____

DEALER'S SIGNATURE _____

This owner's manual should be considered a permanent part of the vehicle and should remain with the vehicle when it is sold.

This owner's manual covers all models of the Odyssey. You may find descriptions of equipment and features that are not on your particular model.

The information and specifications included in this publication were in effect at the time of approval for printing. Honda Motor Co., Ltd. reserves the right, however, to discontinue or change specifications or design at any time without notice and without incurring any obligation whatsoever.

**POUR CLIENTS CANADIEN
AVIS IMPORTANT: Si vous avez
besoin d'un Manuel du Conducteur
en français, veuillez demander à
votre concessionnaire de
commander le numéro de pièce
33SHJC30**