

2011 CR-Z Online Reference Owner's Manual

This owner's manual should be considered a permanent part of the vehicle and should remain with the vehicle when it is sold.

This owner's manual covers all models of the CR-Z. You may find descriptions of equipment and features that are not on your particular model.

Images throughout this owner's manual (including the front cover) represent features and equipment that are available on some, but not all, models. Your particular model may not have some of these features.

The information and specifications included in this publication were in effect at the time of approval for printing. Honda Motor Co., Ltd. reserves the right, however, to discontinue or change specifications or design at any time without notice and without incurring any obligation.

➤ Safe Driving [P. 29](#)

For Safe Driving [P. 30](#)

Seat Belts [P. 34](#)

Airbags [P. 41](#)

➤ Instrument Panel [P. 67](#)

Indicators [P. 68](#)

Gauges and Multi-Information Display [P. 81](#)

➤ Controls [P. 97](#)

Setting the Clock [P. 98](#)

Locking and Unlocking the Doors [P. 99](#)

Operating the Switches Around the Steering Wheel [P. 109](#)

Interior Lights/Interior Convenience Items [P. 123](#)

➤ Features [P. 135](#)

Audio System [P. 136](#)

Audio without Navigation System [P. 141](#)

General Information on the Audio System [P. 170](#)

➤ Driving [P. 191](#)

Before Driving [P. 192](#)

Towing a Trailer [P. 196](#)

Refueling [P. 231](#)

Fuel Economy [P. 234](#)

➤ Maintenance [P. 237](#)

Before Performing Maintenance [P. 238](#) Maintenance Minder™ [P. 241](#)

Checking and Maintaining Wiper Blades [P. 266](#)

Climate Control System Maintenance [P. 280](#)

➤ Handling the Unexpected [P. 285](#)

Tools [P. 286](#)

If a Tire Goes Flat [P. 287](#)

Overheating [P. 297](#)

Indicator, Coming On/Blinking [P. 299](#)

➤ Information [P. 311](#)

Specifications [P. 312](#)

Identification Numbers [P. 314](#)

Emissions Testing [P. 317](#)

Authorized Manuals [P. 319](#)

Contents

Quick Reference Guide [P. 2](#)

Safe Driving [P. 29](#)

Instrument Panel [P. 67](#)

Controls [P. 97](#)

Features [P. 135](#)

Driving [P. 191](#)

Maintenance [P. 237](#)

Handling the Unexpected [P. 285](#)

Information [P. 311](#)

Index [P. 323](#)

Child Safety [P. 56](#)

Exhaust Gas Hazard [P. 64](#)

Safety Labels [P. 65](#)

Opening and Closing the Hatch [P. 104](#)
Adjusting the Mirror [P. 118](#)
Climate Control System [P. 131](#)

Security System [P. 105](#)
Adjusting the Seats [P. 119](#)

Opening and Closing the Windows [P. 107](#)

Audio with Navigation System [P. 151](#)
Bluetooth® HandsFreeLink® [P. 173](#)

Audio Error Messages [P. 167](#)

Audio Remote Controls [P. 169](#)

When Driving [P. 197](#)
Accessories and Modifications [P. 235](#)

Braking [P. 219](#)

Parking Your Vehicle [P. 223](#)

Maintenance Under the Hood [P. 245](#)
Checking and Maintaining Tires [P. 269](#)
Cleaning [P. 281](#)

Replacing Light Bulbs [P. 258](#)
12 Volt Battery [P. 278](#)

Remote Transmitter Care [P. 279](#)

Engine Does Not Start [P. 293](#)
Fuses [P. 304](#)

Jump Starting [P. 294](#)
Emergency Towing [P. 308](#)

Shift Lever Does Not Move [P. 296](#)
When You Cannot Open the Hatch [P. 310](#)

Devices that Emit Radio Waves [P. 315](#)
Customer Service Information [P. 320](#)

Reporting Safety Defects (U.S. Vehicles) [P. 316](#)
Warranty Coverages [P. 321](#)

Visual Index

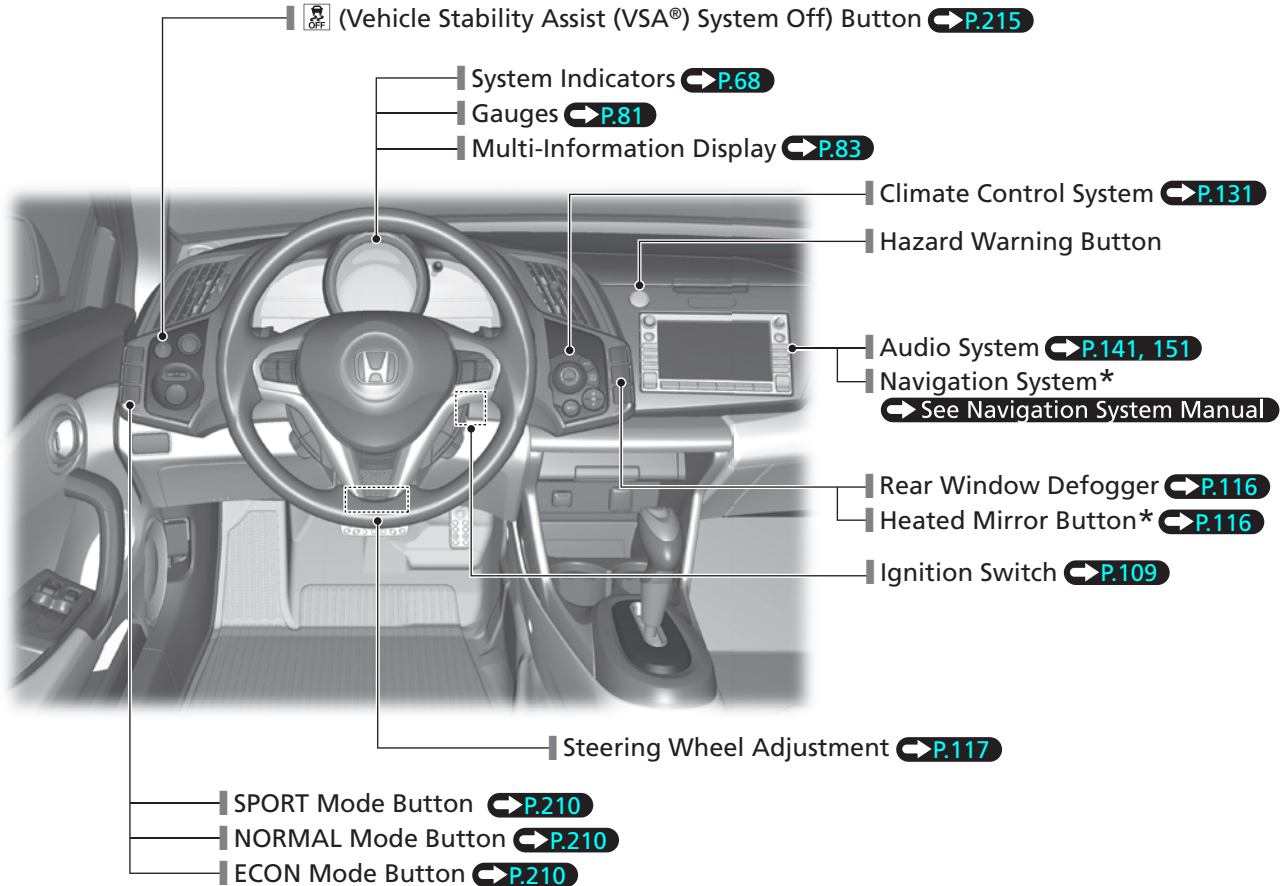

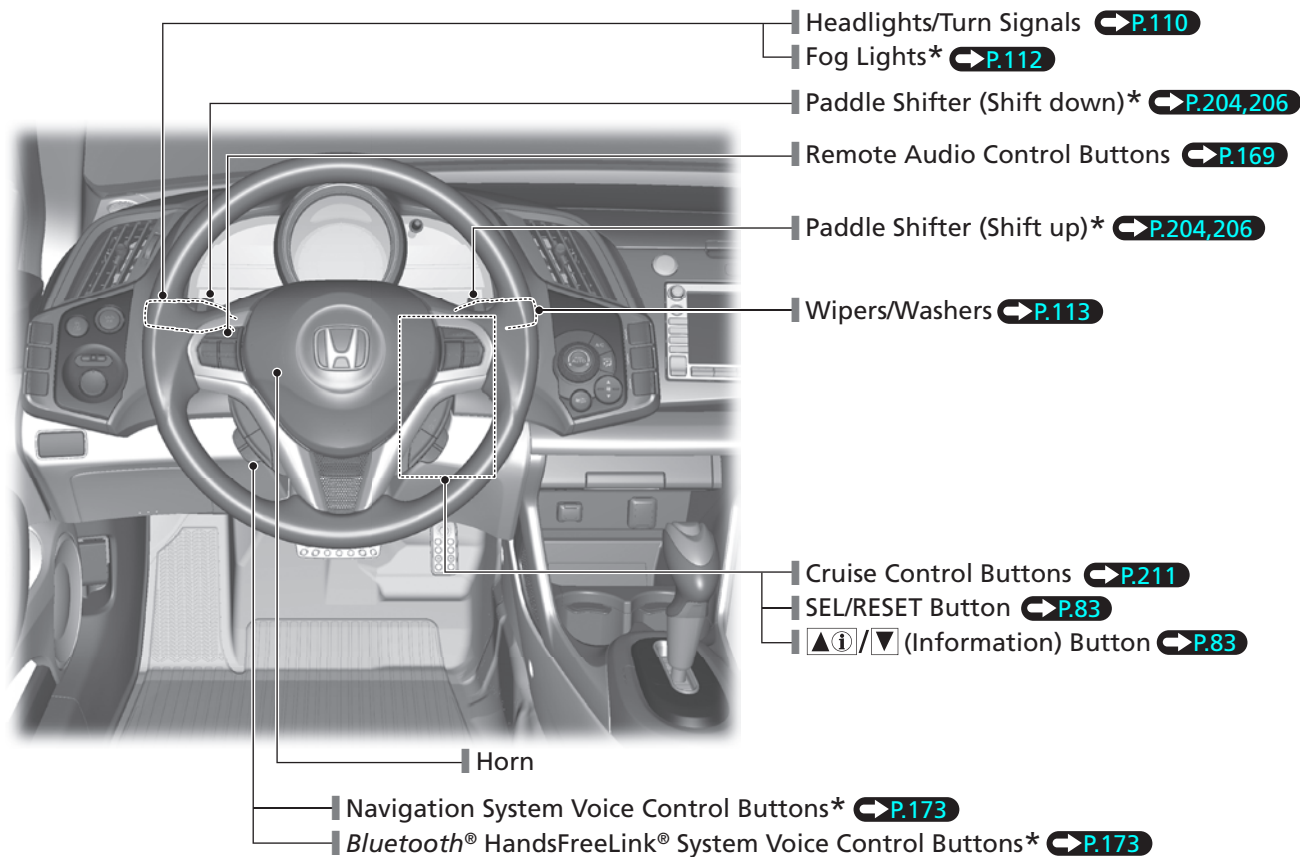

Visual Index

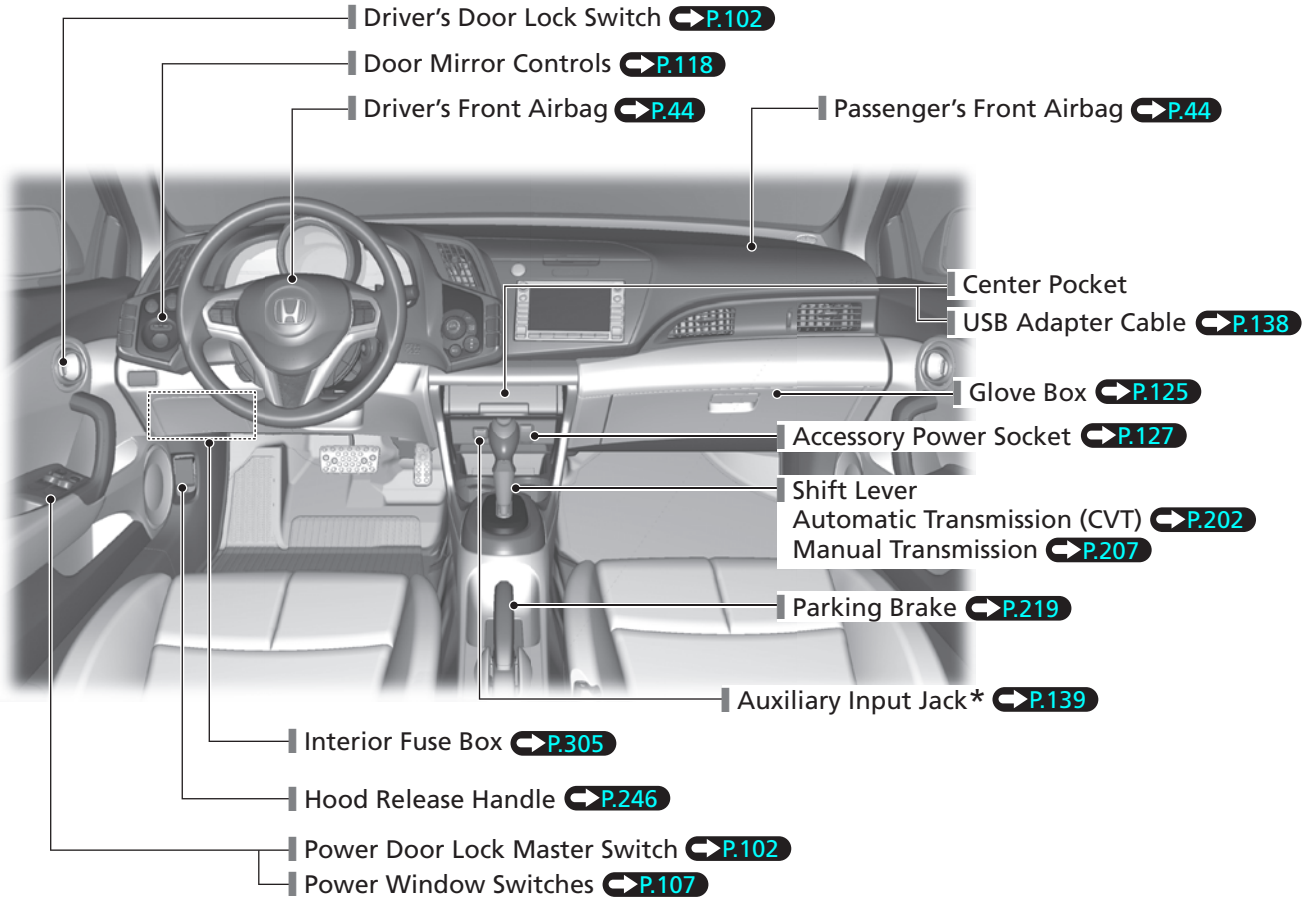

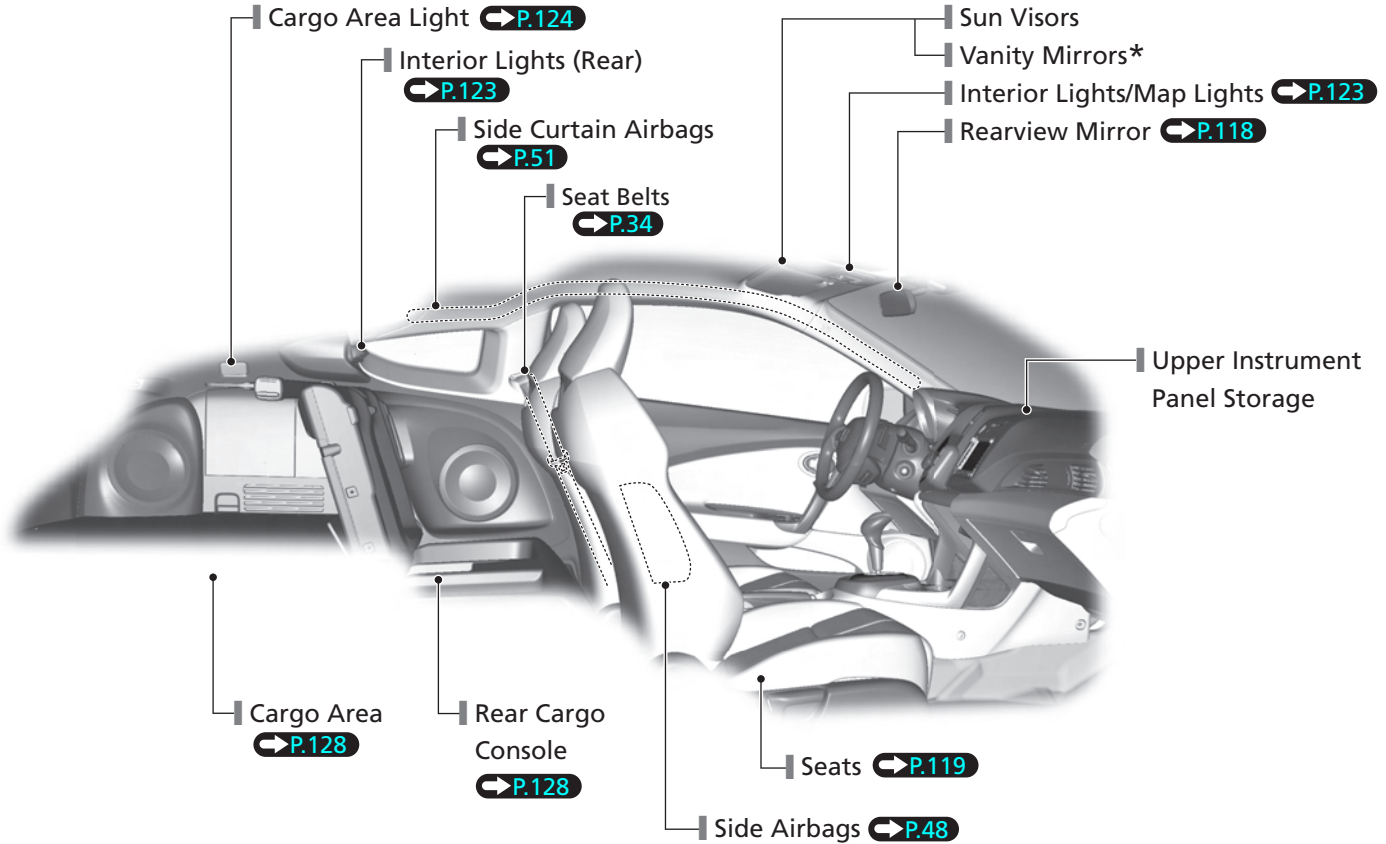

Visual Index

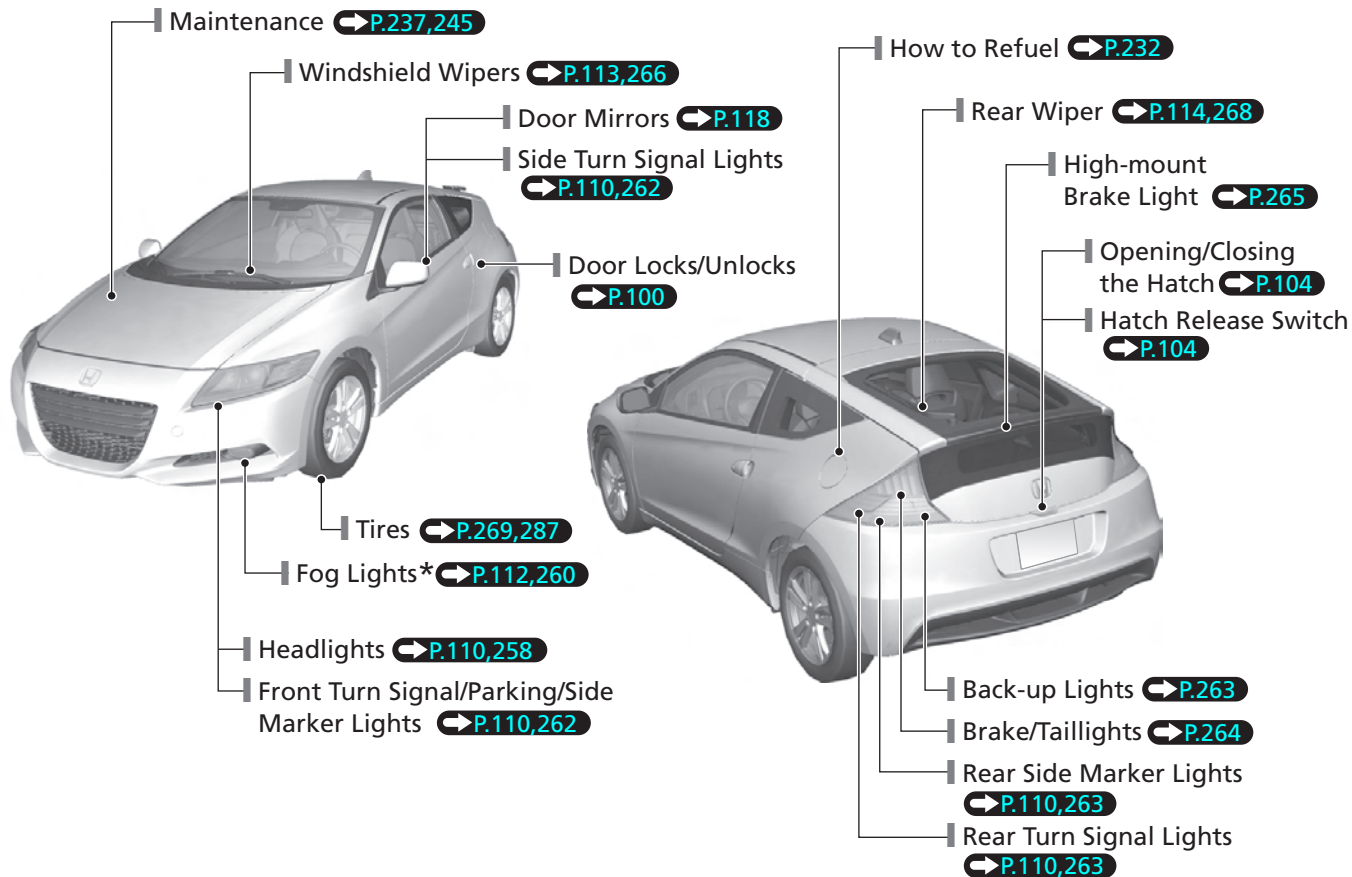

3-Mode Drive System

There are three driving modes for your vehicle: SPORT, NORMAL, and ECON. Each mode offers a different level of driving performance. The mode buttons are located on the control panel. NORMAL mode, which is most suitable for all-purpose driving, is the default setting for your vehicle.



The indicator of the selected mode comes on.

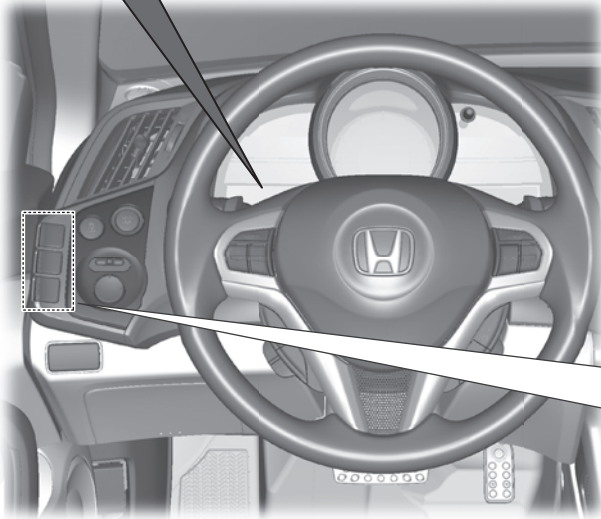

SPORT Mode

Increases engine performance and handling. Suitable for driving at hills or curves in a mountain, or driving in a suburb.

NORMAL Mode

Balances driving performance and fuel economy. Best for most driving situations.

ECON Mode

Maximizes fuel economy. Provides longer auto idle stop operating time when the climate control system is in use.

Eco Assist System

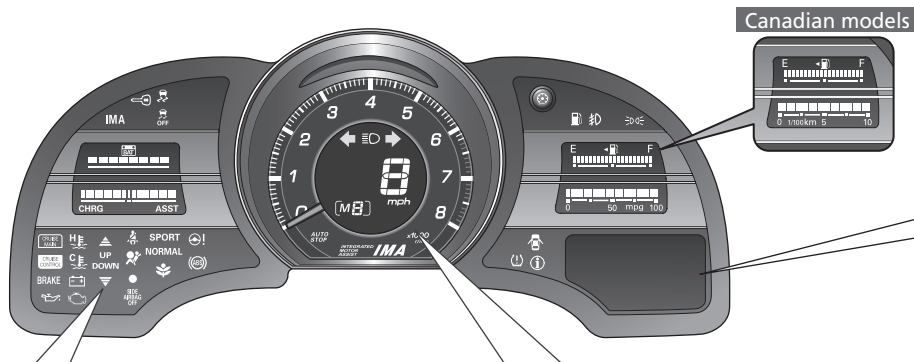

The Shift Up/Down Indicators*

➔ P.208

- These indicators alert you when it is appropriate to shift to attain better fuel economy.



UP

DOWN



Displays when shifting up is recommended.

Displays when shifting down is recommended.

The indicators do not come on in SPORT mode.

Ambient Meter

- Changes color to reflect your driving style.
- Colors
 - Green: Saving fuel consumption
 - Blue green: Slow acceleration/deceleration
 - Blue: Aggressive acceleration/deceleration
- Changes to a constant red when SPORT mode is selected.

The ambient meter color changes in accordance with:

Automatic transmission (CVT) model

Your brake or accelerator pedal operation.

Manual transmission model

Your brake or accelerator pedal operation, and shift changes based on the shift up indicator.

Drive Cycle Score/Lifetime Points

- Comes on when the ignition switch is in LOCK **0**.

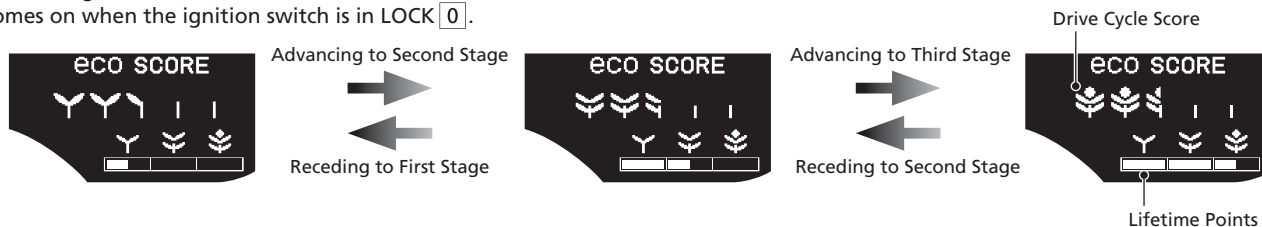

Real Time Score (represents your current trip) [↔ P.85](#)

- Each time you turn the ignition switch to ON **II**, the Eco Guide screen starts without any leaves on the plants. Leaves accumulate or diminish based on your driving style during the current trip.

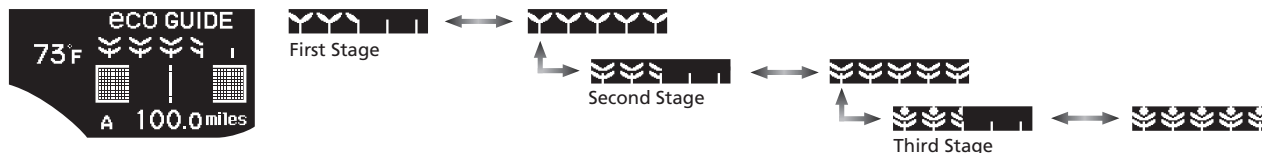

Eco Guide Feedback with Eco Drive Bar [↔ P.86](#)

- Keep the bar from extending too much to the left or right side. The shorter the bar is while driving, the higher the fuel economy becomes.

The bar extends to the right when you press the accelerator pedal.

Slow, steady acceleration/
Maximizes fuel economy



Moderate acceleration



Aggressive/Inconsistent acceleration



The bar extends to the left when you press the brake pedal.

Slow deceleration/
Maximizes fuel economy



Moderate deceleration



Aggressive deceleration



The Honda IMA System

The main power source for the Honda IMA system is the gasoline engine. The electric motor assists the engine to improve fuel economy, based on current operating conditions.

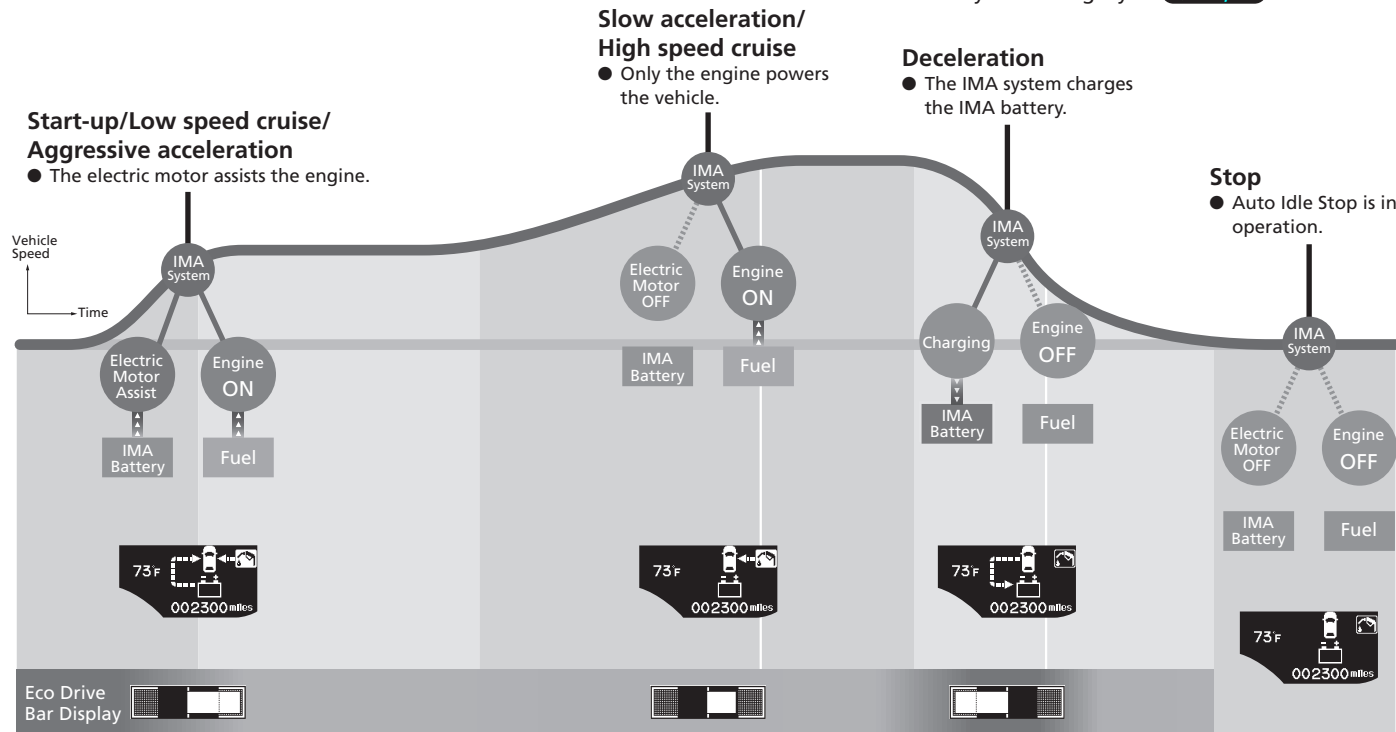





Tips to Improve Fuel Economy

To help your vehicle's fuel economy:

- Avoid aggressive acceleration/braking
- Monitor the ambient meter and the Eco drive bar displayed on the multi-information display. It reflects your driving style. [P.8,86](#)

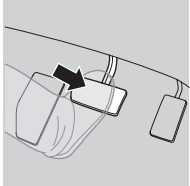
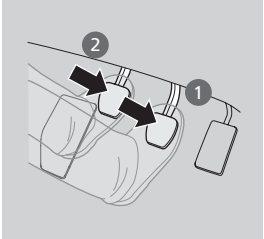
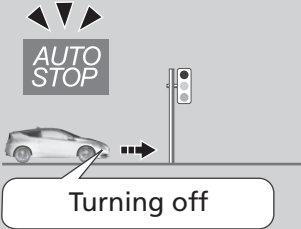
Auto Idle Stop Function

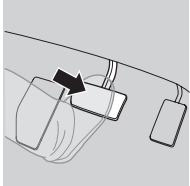
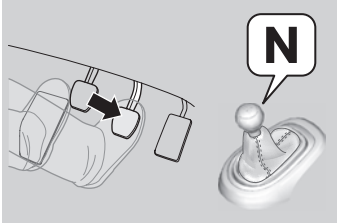
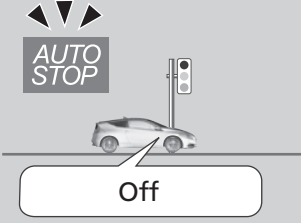
To improve fuel economy, the engine stops and then restarts as detailed below. When Auto Idle Stop is on, the AUTO STOP indicator blinks. [➡ P.76](#)

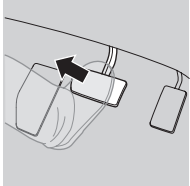
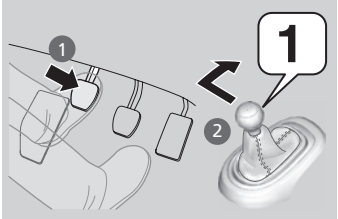
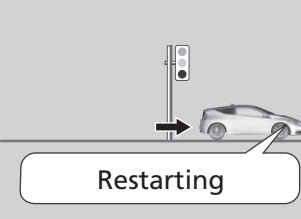
At	Automatic transmission (CVT)	Manual transmission	Engine status
Deceleration 	<p>Depress the brake pedal. The vehicle speed goes below 6 mph (10 km/h).</p> 	<ol style="list-style-type: none"> 1. Depress the brake pedal. The vehicle speed goes below 19 mph (30 km/h). 2. Fully depress the clutch pedal. 	
Stop 	<p>Continue to depress the brake pedal.</p> 	<ul style="list-style-type: none"> • Continue to depress the brake pedal. • Move the shift lever to N. • Release the clutch pedal. 	
Start-up 	<p>Release the brake pedal.</p> 	<ol style="list-style-type: none"> 1. Fully depress the clutch pedal again. 2. Move the shift lever to 1. 3. Depress the accelerator pedal to resume driving. 	

To Keep the IMA Battery in Good Condition

Drive your vehicle at least once a month for more than 30 minutes.

Parking your vehicle for an extended period can cause the IMA battery to weaken or decrease the IMA battery life.

Safety Precautions

Do not cover the air intake.



If the air intake is obstructed during vehicle operation, the IMA battery can become too hot. To protect the battery, the system may start limiting IMA battery output power and cause the IMA system and 12 volt battery charging system indicators to come on.

IMA System Indicator → **P.73**

12 Volt Battery Charging System Indicator → **P.69**

Do not touch the Honda IMA System

A high voltage current runs through Honda IMA System. Consult your authorized dealer when maintenance or repair is needed.

Do not spill any liquids on or around the IMA battery, as they can damage the IMA battery. If you accidentally spill liquids on or around the battery, ensure that the spill is completely wiped up as soon as possible. The IMA system indicator may come on.

If a crash occurs

- Be careful of electric shock hazard.
 - ▶ If a crash severely damaged your vehicle, there is a possibility of electrical shock. Do not touch the IMA system components or its wiring (orange).
- Avoid contact with IMA battery fluid.
 - ▶ The battery fluid may leak as a result of a crash. Avoid any skin or eye contact with the fluid. The battery fluid is corrosive. If you accidentally touched it, flush your eyes or skin with a large quantity of water for at least five minutes, and seek medical attention immediately.
- Use a fire extinguisher for an electrical fire.
 - ▶ Attempting to extinguish an electrical fire with a small quantity of water can be dangerous.

When the vehicle is disposed

- The IMA battery is a Nickel hydride battery. Honda collects and recycles used IMA batteries – consult with your dealer for proper battery disposal in the event your vehicle is not repairable.

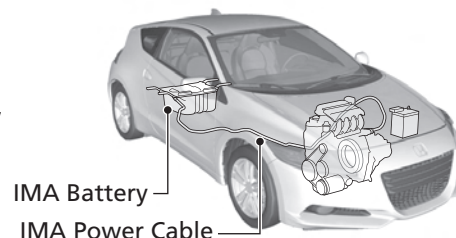

Safe Driving [↔ P.29](#)

Airbags [↔ P.41](#)

- Your vehicle is fitted with airbags to help protect you and your passenger during a moderate to severe collision.

Child Safety [↔ P.56](#)

- Your vehicle is not recommended for child passengers. If you decide to disregard our recommendations and transport a child passenger, the child should be properly restrained. Never put a rear-facing child seat in the passenger's seat.

Exhaust Gas Hazard [↔ P.64](#)

- Your vehicle emits dangerous exhaust gases that contain carbon monoxide. Do not run the engine in confined spaces where carbon monoxide gas can accumulate.

Seat Belts [↔ P.34](#)

- Fasten your seat belt and sit with a correct driving posture.
- Check that your passenger is wearing their seat belt correctly.

Before Driving Checklist [↔ P.192](#)

- Before driving, check the seat positions, steering wheel and mirror adjustments.

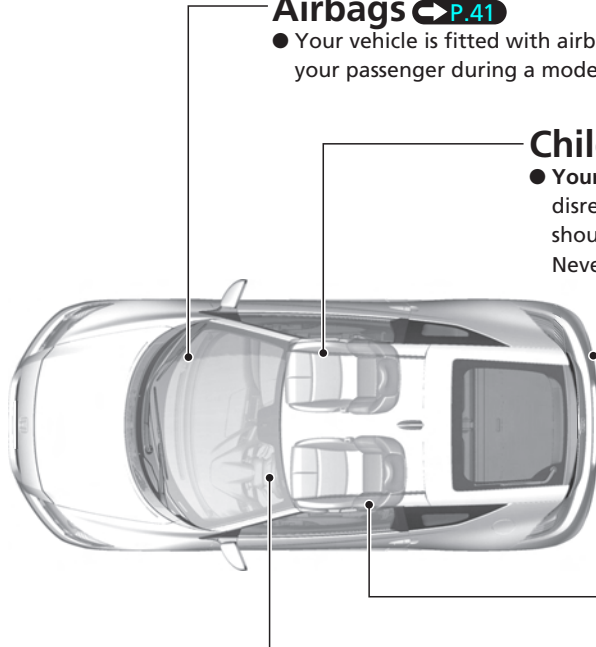



Fasten your lap belt as low as possible.











Instrument Panel ↔ P.67

Gauges ↔ P.81

Lights Reminders

-  Lights On Indicator
-  High Beam Indicator
-  Fog Light Indicator*



System Indicators

-  Malfunction Indicator Lamp
-  Low Oil Pressure Indicator
-  12 Volt Battery Charging System Indicator
-  Anti-lock Brake System (ABS) Indicator
-  Vehicle Stability Assist (VSA®) System Indicator
-  VSA® OFF Indicator
-  Turn Signal and Hazard Warning Indicators
-  Electric Power Steering (EPS) Indicator
-  IMA System Indicator
-  Auto Idle Stop Indicator

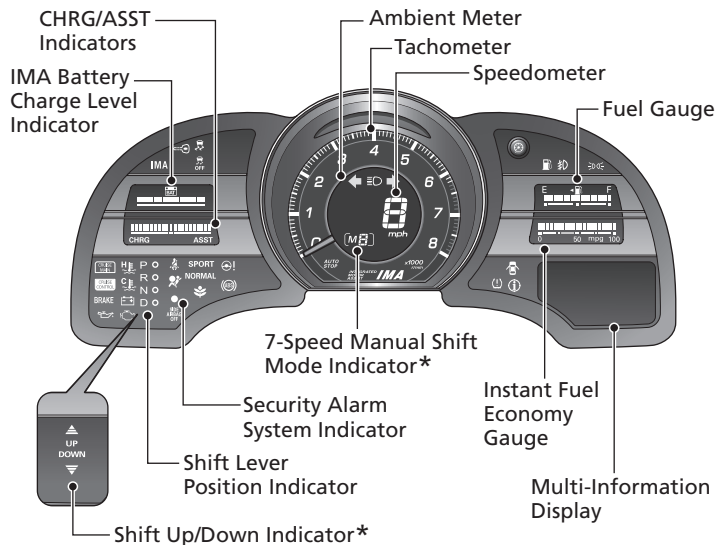

Multi-Information Display ↔ P.83



System Indicators













-  High Temperature Indicator
-  Low Temperature Indicator
-  Low Fuel Indicator

System Indicators

-  SPORT SPORT Mode Indicator
-  NORMAL NORMAL Mode Indicator
-  ECON Mode Indicator

System Indicators ↔ P.68

System Indicators

-  Seat Belt Reminder Indicator
-  Immobilizer System Indicator
- BRAKE**
 -  U.S. Parking Brake and Brake System Indicator
 -  Canada
-  Supplemental Restraint System Indicator
-  U.S. SIDE AIRBAG OFF Side Airbag Off Indicator
-  Canada
- U.S. models only**
 -  Low Tire Pressure/TPMS Indicator
-  Door/Hatch Open Indicator
-  CRUISE MAIN Cruise Main Indicator
-  CRUISE CONTROL Cruise Control Indicator
-  System Message Indicator

Controls P.97

Turn Signals P.110

Turn Signal Control Lever

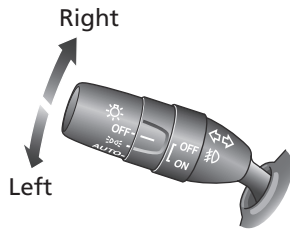

Lights P.110

Light Control Switches

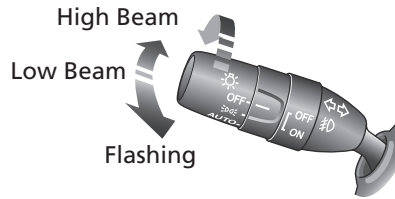

Wipers and Washers P.113

Wiper/Washer Control Lever

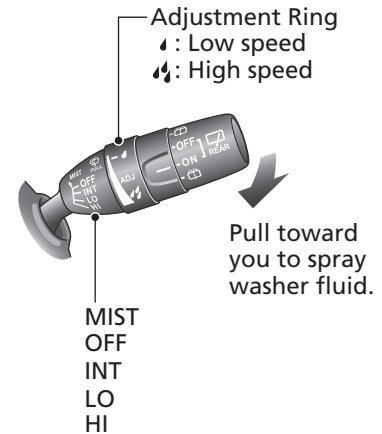

Steering Wheel [P.117](#)

- Reposition the steering wheel by pulling the steering wheel adjustment lever toward you.

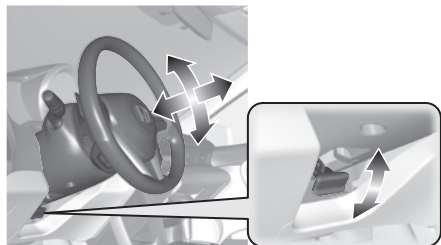

Hatch [P.104](#)

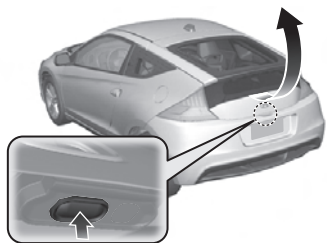

- With the doors unlocked, press the hatch release switch on the hatch to open it.

Door Mirrors [P.118](#)

- With the ignition switch in ON , move the selector switch to L or R.
- Push the appropriate edge of the adjustment switch to adjust the mirror.

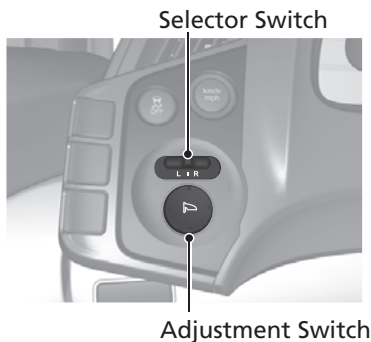

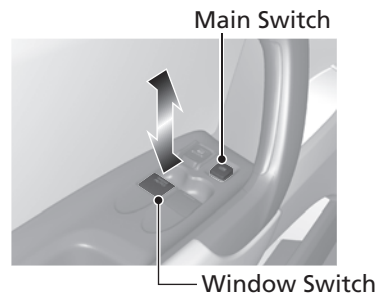

Power Windows [P.107](#)

- With the ignition switch in ON , open and close the power windows.
- If the main switch is in the OFF position, the passenger's window can be opened and closed with its own switch.
- If the main switch is in the ON position, the passenger's window switch is disabled.



Climate Control System P.131

- Press the AUTO button to activate the automatic climate control system.
- Press the  button to turn the system on or off.
- Press the  button to defrost the windshield.

On models with navigation system

The climate control system is voice operable. See the navigation system manual for complete details.

MODE Control Button

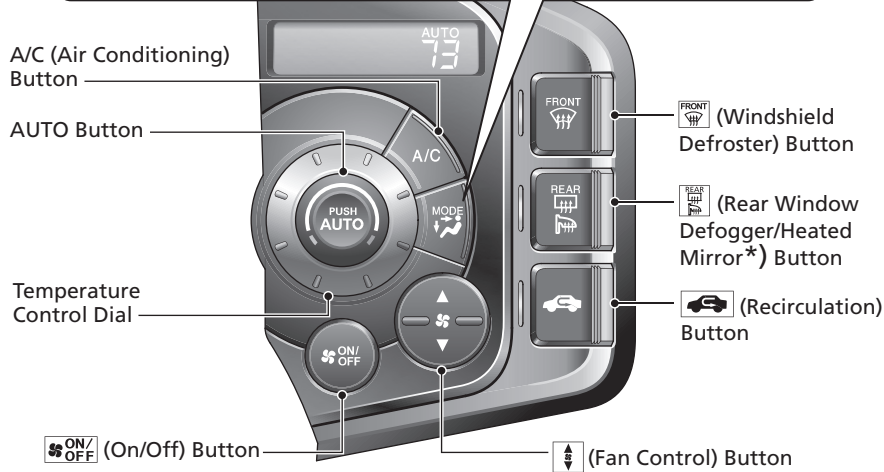
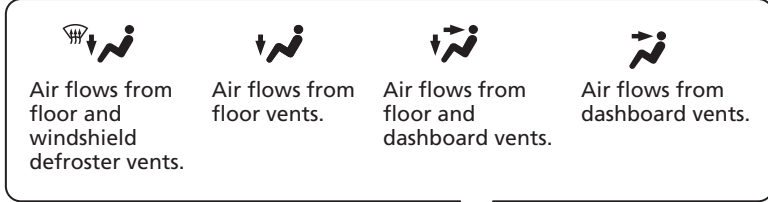

Features [↔ P.135](#)

Clock [↔ P.98](#)

Models without navigation system

- 1 Press the FM/AM button until you hear a beep. The displayed time begins flashing.
- 2 Press the **1** (Hour) or **2** (Minute) button to set the time. Press the **3** (Reset) button to set the time to the nearest hour.
- 3 Press the FM/AM button again to set the time.

Models with navigation system

The navigation system receives signals from GPS satellites, updating the clock automatically.

On models without navigation system [↔ P.141](#)

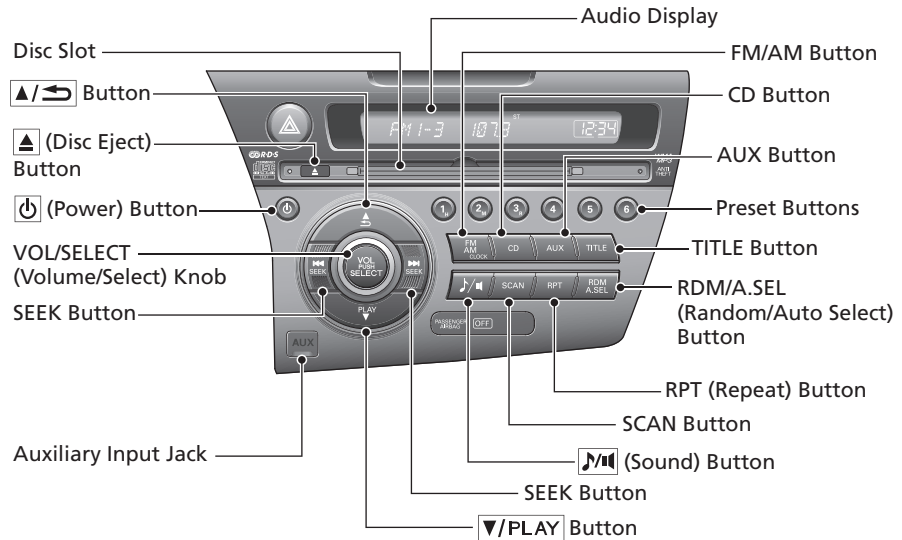

On models with navigation system [↔ P.151](#)
 For navigation system operation [↔ See Navigation System Manual](#)

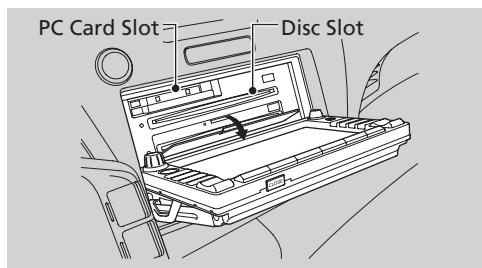
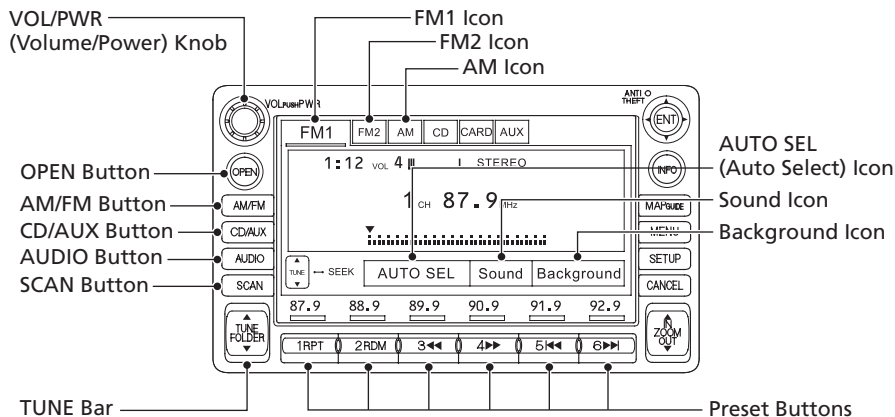

● **Audio Remote Controls** [↔ P.169](#)

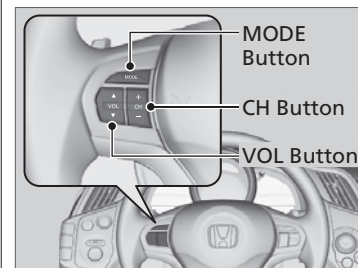

- **VOL (volume) Button**
 Press ▲/▼ to adjust the volume up/down.
- **MODE Button**
 Press and release to change the audio mode: FM1/FM2/AM/DISC/PC Card/AUX.
- **CH (channel) Button**
 Radio: Press and release to change the preset station.
 Press and hold to select the next or previous strong station.
 Disc/PC Card/USB device:
 Press and release to skip to the beginning of the next song or return to the beginning of the current song.
 Press and hold to change a folder.

Driving [P.191](#)

Manual Transmission [P.207](#)

Automatic Transmission (CVT) [P.202](#)

- Shift to **P** and depress the brake pedal when starting the engine.

Shifting

P **Park**
Turn off or start the engine.
Transmission is locked.

R **Reverse**

N **Neutral**
Transmission is not locked.

D **Drive**
Normal driving.
7-speed mode can be used.
L mode is available.

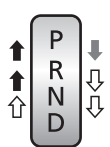
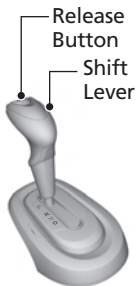

↓ Depress the brake pedal and press the release button to move out of **P**.

↑ ↓ Move the shift lever without pressing the release button.

↑ Press the release button to move the shift lever.

7-Speed Manual Shift Mode [P.204](#)

- Allows you to manually shift the transmission up or down without removing your hands from the steering wheel.

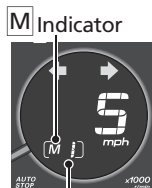

Shift Indicator

Shift Down **-**
Paddle Shifter

Shift Up **+**
Paddle Shifter

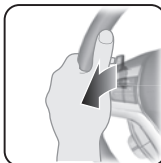

SPORT Mode

- Pulling a paddle shifter changes the mode from automatic transmission (CVT) to 7-speed manual shift mode. The **M** indicator and the selected speed number are displayed in the shift indicator.

NORMAL Mode/ECON Mode

- Pulling a paddle shifter temporarily changes the mode from automatic transmission (CVT) to 7-speed manual shift mode. The selected speed number is displayed in the shift indicator.

L (Low) Mode [P.206](#)

- Use Low to get more power when climbing steep hills.
- Pull the **+** and **-** paddle shifters at the same time until the shift indicator display changes to "L".

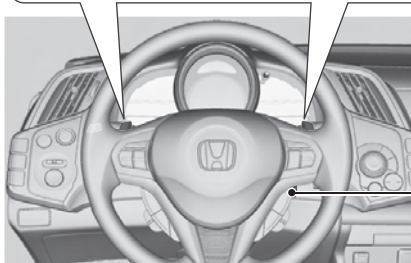

Ignition Switch



VSA® Off Button [↔ P.215](#)

- The vehicle stability assist (VSA®) system helps stabilize the vehicle during sharp cornering, and helps maintain traction while accelerating on loose or slippery road surfaces.
- VSA® comes on automatically every time you start the engine.
- To turn VSA® on or off, press and hold the  button until you hear a beep.

Cruise Control [↔ P.211](#)

- Cruise control allows you to maintain a set speed without keeping your foot on the accelerator pedal.
- To use cruise control, press the CRUISE button, then press the DECEL/SET button when the vehicle speed is above 25 mph (40 km/h).

Tire Pressure Monitoring System (TPMS) [↔ P.216](#)

U.S. models only

- TPMS monitors tire pressure.
- TPMS is turned on automatically every time you start the engine.

Refueling [↔ P.231](#)

Fuel recommendation: Unleaded gasoline with a pump octane number 87 or higher

Fuel tank capacity: 10.6 US gal (40 L)

- 1 Press and release the center of the rear edge of the fuel fill door. You hear a click. The door pops open slightly.
- 2 Turn the fuel fill cap slowly to remove the cap.
- 3 Place the cap in the holder on the fuel fill door.
- 4 After refueling, screw the cap back on until it clicks at least once.

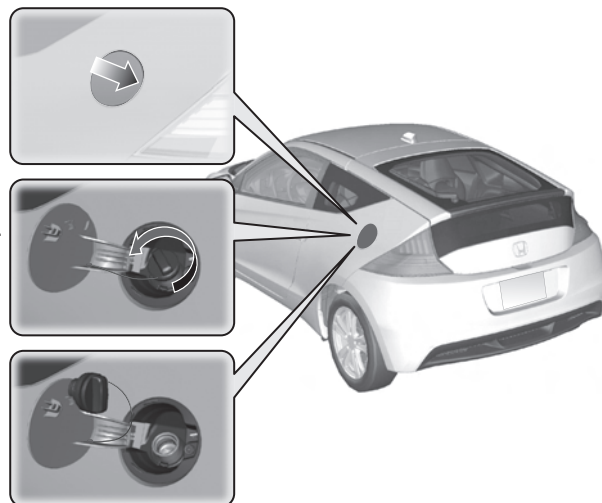

Maintenance [↔ P.237](#)

Under the Hood [↔ P.245](#)

- Check engine oil, engine coolant, and window washer fluid. Add when necessary.
- Check transmission fluid (CVT).
- Check brake fluid and clutch fluid.
- Check the 12 volt battery regularly.

- 1 Pull the hood release handle under the corner of the dashboard.

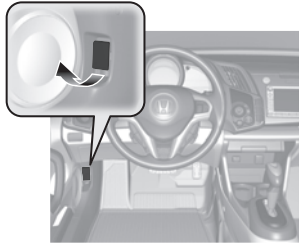

- 2 Locate the hood latch handle, pull the handle up, and lift up the hood.

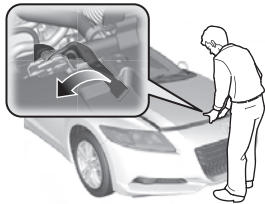

- 3 When finished, close the hood and make sure it is firmly locked in place.

Wiper Blades [↔ P.266](#)

- Replace blades if they leave streaks across the windshield.

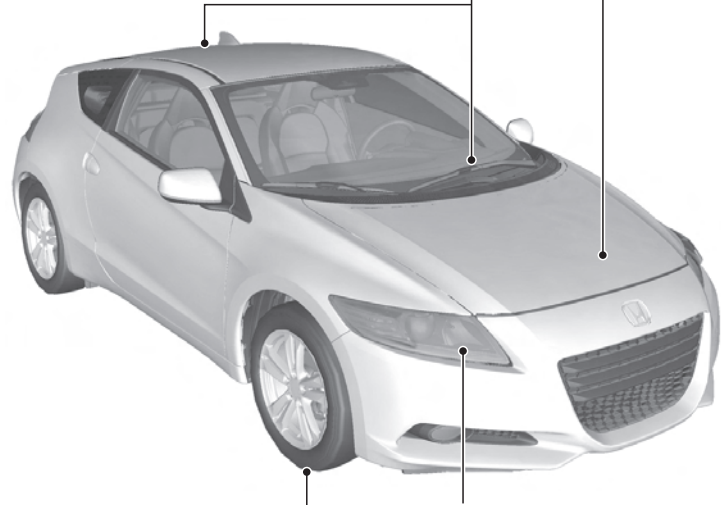

Tires [↔ P.269](#)

- Inspect tires and wheels regularly.
- Check tire pressure regularly.
- Install snow tires for winter driving.

Lights [↔ P.258](#)

- Inspect all lights regularly.

Handling the Unexpected ↔ P.285

Flat Tire ↔ P.287

- Park in a safe location and replace the flat tire with the compact spare tire located under the cargo area.



Engine Won't Start ↔ P.293

- If the 12 volt battery is dead, jump start it using a booster battery.

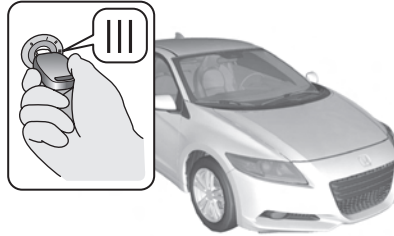

Overheating ↔ P.297

- Park in a safe location. If there is no steam coming out, open the hood, and let the engine cool down.



Indicators Come On ↔ P.299

- Identify the indicator and consult the owner's manual.



Blown Fuse ↔ P.304

- Check for a blown fuse if an electrical device does not operate.

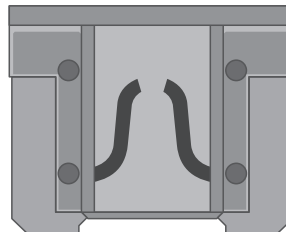

Emergency Towing ↔ P.308

- Call a professional towing service if you need to tow your vehicle.

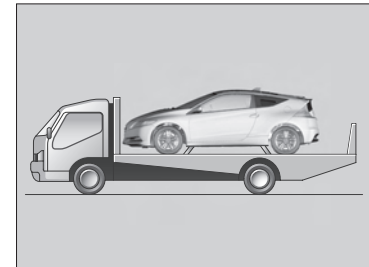

What to Do If

Q The ignition switch does not turn from **0** to **I**. Why?

A

- The steering wheel may be locked.
- Try to turn the steering wheel left and right while turning the ignition key.

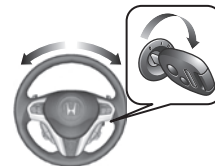

Q The ignition switch does not turn from **I** to **0** and I cannot remove the key. Why?

A The shift lever should be moved to **P** on the automatic transmission (CVT) model.

Q Why does the brake pedal pulsate slightly when applying the brakes?

A This can occur when the ABS activates, and does not indicate a problem. Apply firm, steady pressure on the brake pedal. Never pump the brake pedal.

Q Why do the doors lock after I unlocked the doors using a remote transmitter?

A If you do not open the doors within 30 seconds, the doors relock automatically.

Q Why does the beeper sound when I open the driver's door?

A The beeper sounds when:

- The key is left in the ignition switch.
- The exterior lights are left on.
- The auto idle stop is in operation.

Q Why does the beeper sound when I start driving?

A The beeper sounds when:

- The driver and/or passenger are not wearing their seat belts.
- The parking brake lever is not fully released.

Q Why does a screeching sound occur when I apply the brake pedal?

A The brake pads may need to be replaced. Have your vehicle inspected by a dealer.

California Proposition 65 Warning

WARNING: This product contains or emits chemicals known to the state of California to cause cancer and birth defects or other reproductive harm.

Event Data Recorders

This vehicle is equipped with one or more devices commonly referred to as event data recorders. These devices record front seat belt use, front passenger seat occupancy, airbag deployment data, and the failure of any airbag system component. This data belongs to the vehicle owner and may not be accessed by anyone else except as legally required or with the permission of the vehicle owner.

Service Diagnostic Recorders

This vehicle is equipped with service-related devices that record information about powertrain performance. The data can be used to verify emissions law requirements and/or help technicians diagnose and solve service problems. It may also be combined with data from other sources for research purposes, but it remains confidential.

California Perchlorate Contamination Prevention Act

The airbags, seat belt tensioners, and CR type batteries in this vehicle may contain perchlorate materials - special handling may apply. See www.dtsc.ca.gov/hazardouswaste/perchlorate/

As you read this manual, you will find information that is preceded by a **NOTICE** symbol. This information is intended to help you avoid damage to your vehicle, other property, or the environment.

A Few Words About Safety

Your safety, and the safety of others, is very important. And operating this vehicle safely is an important responsibility.

To help you make informed decisions about safety, we have provided operating procedures and other information on labels and in this manual. This information alerts you to potential hazards that could hurt you or others.

Of course, it is not practical or possible to warn you about all the hazards associated with operating or maintaining your vehicle. You must use your own good judgement.

You will find this important safety information in a variety of forms, including:

- **Safety Labels** - on the vehicle.
- **Safety Messages** - preceded by a safety alert symbol  and one of three signal words: **DANGER**, **WARNING**, or **CAUTION**.

These signal words mean:

 **DANGER**

You **WILL** be **KILLED** or **SERIOUSLY HURT** if you don't follow instructions.

 **WARNING**

You **CAN** be **KILLED** or **SERIOUSLY HURT** if you don't follow instructions.

 **CAUTION**

You **CAN** be **HURT** if you don't follow instructions.

- **Safety Headings** - such as Important Safety Precautions.
- **Safety Section** - such as Safe Driving.
- **Instructions** - how to use this vehicle correctly and safely.

This entire book is filled with important safety information - please read it carefully.

Safe Driving

You can find many safety recommendations throughout this chapter, and throughout this manual.

- For Safe Driving** 30
 - Important Safety Precautions..... 30
 - Your Vehicle’s Safety Features 32
- Seat Belts**
 - About Your Seat Belts 34
 - Fastening a Seat Belt 37
 - Seat Belt Inspection 40

- Airbags**
 - Airbag System Components 41
 - Types of Airbags..... 44
 - Front Airbags (SRS)..... 44
 - Side Airbags..... 48
 - Side Curtain Airbags..... 51
 - Airbag System Indicators 52
 - Airbag Care..... 55

- Child Safety**
 - Protecting Child Passengers..... 56
 - Safety of Infants and Small Children 58
 - Protecting Larger Children..... 62
- Exhaust Gas Hazard**
 - Carbon Monoxide Gas 64
- Safety Labels** 65

The following pages explain your vehicle's safety features and how to use them properly. The safety precautions below are ones that we consider to be among the most important.

Important Safety Precautions

■ Don't Drink and Drive

Alcohol and driving don't mix. Even one drink can reduce your ability to respond to changing conditions, and your reaction time gets worse with every additional drink. So don't drink and drive, and don't let your friends drink and drive, either.

■ Pay Appropriate Attention to the Task of Driving Safely

Engaging in cell phone conversation or other activities that keep you from paying close attention to the road, other vehicles, and pedestrians could lead to a crash. Remember, situations can change quickly, and only you can decide when it is safe to divert some attention away from driving.

■ Control Your Speed

Excessive speed is a major factor in crash injuries and deaths. Generally, the higher the speed, the greater the risk, but serious injuries can also occur at lower speeds. Never drive faster than is safe for current conditions, regardless of the maximum speed posted.

■ Keep Your Vehicle in Safe Condition

Having a tire blowout or a mechanical failure can be extremely hazardous. To reduce the possibility of such problems, check your tires' pressure and condition frequently, and perform all regularly scheduled maintenance.

☒ Important Safety Precautions

Some states, provinces and territories prohibit the use of cell phones (other than hands-free devices) by the driver while driving.

■ Always Wear Your Seat Belt

A seat belt is your best protection in all types of collisions. Airbags are designed to supplement seat belts, not replace them. So even though your vehicle is equipped with airbags, make sure you and your passenger always wear your seat belts, and wear them properly.

■ Your Vehicle is Not Recommended for Child Passengers

The National Highway Traffic Safety Administration and Transport Canada recommend that all children age 12 and under be properly restrained in a back seat. Since this vehicle does not have a back seat, we strongly recommend that you do not carry any child who is not large enough and mature enough to ride in front.

■ Be Aware of Airbag Hazards

While airbags can save lives, they can cause serious or fatal injuries to occupants who sit too close to them, or are not properly restrained. Infants, young children, and short adults are at the greatest risk. Be sure to follow all instructions and warnings in this manual.

» Important Safety Precautions

Never carry an infant in a rear-facing child seat in this vehicle.

If an older child must ride in this vehicle, follow all child safety instructions and warnings in this manual.

» **Child Safety** [P.56](#)

Your Vehicle's Safety Features

Your vehicle is equipped with many features that work together to help protect you and your passenger during a crash.

Some features do not require any action on your part. These include a strong steel framework that forms a safety cage around the passenger compartment, front and rear crush zones, a collapsible steering column, and tensioners that tighten the seat belts in a crash.

However, you and your passenger cannot take full advantage of these features unless you remain sitting in the correct position and always wear your seat belts. In fact, some safety features can contribute to injuries if they are not used properly.

The following checklist will help you take an active role in protecting yourself and your passenger.

■ Safety Checklist

For the safety of you and your passenger, make a habit of checking these items each time before you drive.

- After everyone has entered the vehicle, be sure both doors and the hatch are closed and locked. Locking the doors and the hatch helps prevent an occupant from being ejected and an outsider from unexpectedly opening a door or the hatch.
 - ☒ **Locking/Unlocking Doors from Inside** [P.102](#)
- Adjust your seat to a position suitable for driving. Be sure the seats are adjusted as far to the rear as possible while allowing the driver to control the vehicle. Sitting too close to a front airbag can result in serious or fatal injury in a crash.
 - ☒ **Adjusting the Seats** [P.119](#)
- Always wear your seat belt, and make sure you wear it properly. Confirm that any passenger is properly belted as well.
 - ☒ **Fastening the Seat Belts** [P.37](#)
- If you choose to ignore our warnings and carry a child in this vehicle, make every effort to protect them by properly using a seat belt or a child seat according to the child's age, height, and weight.
 - ☒ **Child Safety** [P.56](#)

☒ Safety Checklist

If the door/hatch open indicator is on, a door and/or the hatch is not completely closed. Close both doors and the hatch tightly until the indicator goes off.

☒ **Door/Hatch Open Indicator** [P.72](#)

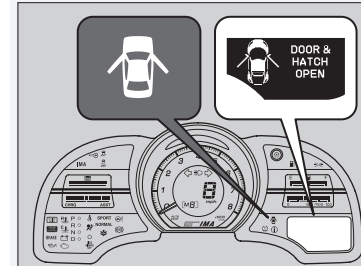

About Your Seat Belts

Seat belts are the single most effective safety device because they keep you connected to the vehicle so that you can take advantage of many built-in safety features. They also help keep you from being thrown against the inside of the vehicle, against a passenger, or out of the vehicle. When worn properly, seat belts also keep your body properly positioned in a crash so that you can take full advantage of the additional protection provided by the airbags.

In addition, seat belts help protect you in almost every type of crash, including:

- frontal impacts
- side impacts
- rear impacts
- rollovers

■ Lap/Shoulder Seat Belts

Both seating positions are equipped with lap/shoulder seat belts with emergency locking retractors. In normal driving the retractor lets you move freely while keeping some tension on the belt. During a collision or sudden stop the retractor locks to restrain your body. The passenger's seat belt has a lockable retractor that must be properly activated when using a forward-facing child seat, should you choose to disregard our recommendations and install one.

- **Installing a Child Seat using the Lockable Retractor Seat Belt** [P.60](#)

⌘ About Your Seat Belts

⚠ WARNING

Not wearing a seat belt properly increases the chance of serious injury or death in a crash, even though your vehicle has airbags.

Be sure you and your passenger always wear seat belts and wear them properly.

Seat belts cannot completely protect you in every crash. But in most cases, seat belts can reduce your risk of serious injury.

Most states and all Canadian provinces and territories require you to wear seat belts.

■ Proper Use of Seat Belts

Follow these guidelines for proper use:

- All occupants should sit upright, well back in the seat, and remain in that position for the duration of the trip. Slouching or leaning reduces the effectiveness of the belt and can increase the chance of serious injury in a crash.
- Never place the shoulder part of a lap/shoulder seat belt under your arm or behind your back. This could cause very serious injuries in a crash.
- Two people should never use the same seat belt. If they do, they could be very seriously injured in a crash.
- Do not put any accessories on the seat belts. Devices intended to improve comfort or reposition the shoulder part of a seat belt can reduce the protective capability and increase the chance of serious injury in a crash.

■ Seat Belt Reminder

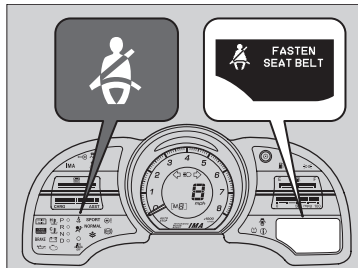

Your vehicle monitors seat belt use. If the ignition switch is turned to ON **II** before the driver's seat belt is fastened, a beeper will sound and the indicator will blink. If the driver does not fasten the belt before the beeper stops, the indicator will remain on.

The beeper will also periodically sound and the indicator will blink while driving until the driver's and passenger's seat belts are fastened.

▣ About Your Seat Belts

If your passenger moves around and extends the seat belt, the lockable retractor may activate. If this happens, release the retractor by unfastening the seat belt and allow the belt to retract completely. Then refasten the belt.

▣ Seat Belt Reminder

The indicator will also come on if a passenger does not fasten their seat belt within 6 seconds after the ignition switch is turned to ON **II**. When no one is sitting in the passenger's seat, or a child or small adult is riding there, the indicator will not come on. This is because the weight sensor in the seat cannot detect their presence.

■ Automatic Seat Belt Tensioners

The driver's and passenger's seats are equipped with automatic seat belt tensioners to enhance safety.

The tensioners automatically tighten the seat belts during a moderate to severe frontal collision, sometimes even if the collision is not severe enough to inflate the front airbags.

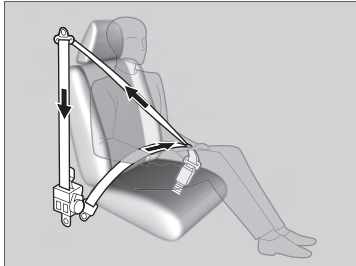

⊗ Automatic Seat Belt Tensioners

The seat belt tensioners can only operate once. If a tensioner is activated, the SRS indicator will come on. Have a dealer replace the tensioner and thoroughly inspect the seat belt system as it may not offer protection in a subsequent crash.

Fastening a Seat Belt

After adjusting your seat to the proper position, and while sitting upright and well back in the seat:

➤ **Adjusting the Seats** P.119

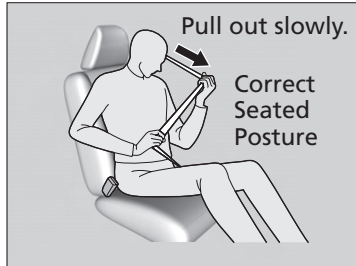

1. Pull the seat belt out slowly.

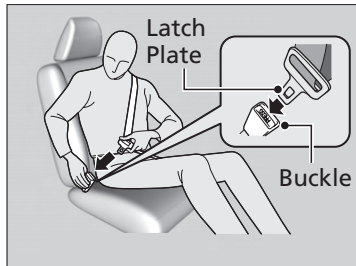

2. Insert the latch plate into the buckle, then tug on the belt to make sure the buckle is secure.

- ▶ Make sure that the belt is not twisted or caught on anything.

⌘ Fastening a Seat Belt

No one should sit in a seat with an inoperative seat belt or one that does not appear to be working correctly. Using a seat belt that is not working properly may not protect the occupant in a crash. Have your dealer check the belt as soon as possible.

Never insert any foreign objects into the buckle or retractor mechanism.



3. Position the lap part of the belt as low as possible across your hips, then pull up on the shoulder part of the belt so the lap part fits snugly. This lets your strong pelvic bones take the force of a crash and reduces the chance of internal injuries.
4. If necessary, pull up on the belt again to remove any slack, then check that the belt rests across the center of your chest and over your shoulder. This spreads the forces of a crash over the strongest bones in your upper body.

Fastening a Seat Belt

⚠ WARNING

Improperly positioning the seat belts can cause serious injury or death in a crash.

Make sure all seat belts are properly positioned before driving.

To release the belt, push the red PRESS button then guide the belt by hand until it has retracted completely.

When exiting the vehicle, be sure the belt is out of the way and will not get closed in the door.

Advice for Pregnant Women

If you are pregnant, the best way to protect yourself and your unborn child when driving or riding in a vehicle is to always wear a seat belt and keep the lap part of the belt as low as possible across the hips.

Wear the shoulder belt across the chest avoiding the abdomen.



Wear the lap part of the belt as low as possible across the hips.

Advice for Pregnant Women

Each time you have a checkup, ask your doctor if it is okay for you to drive.

To reduce the risk of injuries to both you and your unborn child that can be caused by an inflating front airbag:

- When driving, sit upright and adjust the seat as far back as possible while allowing full control of the vehicle.
- When sitting in the passenger's seat, adjust the seat as far back as possible.

Seat Belt Inspection

Regularly check the condition of your seat belts as follows:

- Pull each belt out fully, and look for frays, cuts, burns, and wear.
- Check that the latches work smoothly and the belts retract easily.
 - ▶ If a belt does not retract easily, cleaning the belt may correct the problem. Only use a mild soap and warm water. Do not use bleach or cleaning solvents.

Any belt that is not in good condition or working properly will not provide proper protection and should be replaced as soon as possible.

A belt that has been worn during a crash may not provide the same level of protection in a subsequent crash. Have your seat belts inspected by a dealer after any collision.

⌘ Seat Belt Inspection

⚠ WARNING

Not checking or maintaining seat belts can result in serious injury or death if the seat belts do not work properly when needed.

Check your seat belts regularly and have any problem corrected as soon as possible.

Airbag System Components

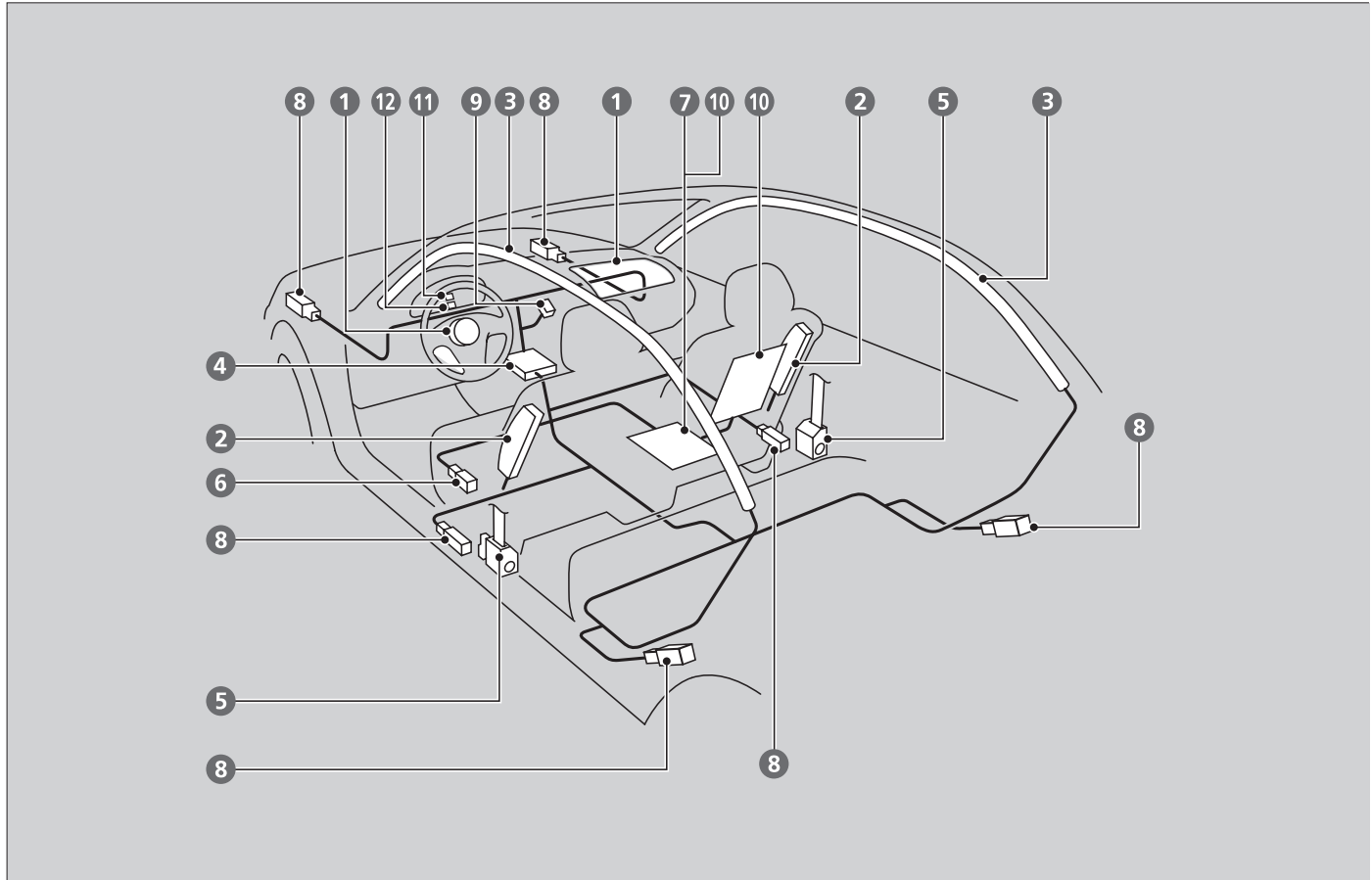

The front, front side, and side curtain airbags are deployed according to the direction and severity of the impact. The airbag system includes:

- 1 Two SRS (Supplemental Restraint System) front airbags. The driver's airbag is stored in the center of the steering wheel; the passenger's airbag is stored in the dashboard. Both are marked "SRS AIRBAG."
- 2 Two side airbags, one for the driver and one for a passenger. The airbags are stored in the outer edges of the seat-backs. Both are marked "SIDE AIRBAG."
- 3 Two side curtain airbags, one for each side of the vehicle. The airbags are stored in the ceiling, above the side windows. The front and rear pillars are marked "SIDE CURTAIN AIRBAG."
- 4 An electronic control unit that continually monitors and records information about the sensors, the airbag activators, the seat belt tensioners, and driver and passenger seat belt use when the ignition switch is in ON **II**. It also includes emergency backup power in case your vehicle's electrical system is disconnected in a crash.
- 5 Automatic seat belt tensioners. The driver's and passenger's seat belts incorporate sensors that detect whether or not they are fastened.
- 6 A driver's seat position sensor that monitors the distance of the seat from the front airbag. If the seat is too far forward, the airbag will inflate with less force.
- 7 Weight sensors in the passenger's seat. The passenger's airbag will be turned off if the weight on the seat is 65 lbs (29 kg) or less (the weight of an infant or small child).
- 8 Impact sensors that can detect a moderate to severe front or side collision.
- 9 An indicator on the dashboard that alerts you that the passenger's front airbag has been turned off.
- 10 Sensors that can detect if a child or small statured adult is in the deployment path of the passenger's side airbag.
- 11 An indicator on the instrument panel that alerts you to a possible problem with your airbag system or seat belt tensioners.
- 12 An indicator on the instrument panel that alerts you that the passenger's side airbag has been turned off.

■ Important Facts About Your Airbags

Airbags can pose serious hazards. To do their job, airbags must inflate with tremendous force. So, while airbags help save lives, they can cause minor injuries, and sometimes even fatal ones if occupants are not wearing their seat belts properly and sitting correctly.

What you should do: Always wear your seat belt properly, and sit upright and as far back from the steering wheel as possible while allowing full control of the vehicle. A passenger should move their seat as far back from the dashboard as possible.

Remember, however, that no safety system can prevent all injuries or deaths that can occur in a severe crash, even when seat belts are properly worn and the airbags deploy.

Do not place hard or sharp objects between yourself and a front airbag.

Carrying hard or sharp objects on your lap, or driving with a pipe or other sharp object in your mouth, can result in injuries if your front airbag inflates.

Do not attach or place objects on the front airbag covers. Objects on the covers marked “SRS AIRBAG” could interfere with the proper operation of the airbags or be propelled inside the vehicle and hurt someone if the airbags inflate.

▣ Important Facts about Your Airbags

Do not attempt to deactivate your airbags. Together, airbags and seat belts provide the best protection.

When driving, keep your hands and arms out of the deployment path of the front airbag by holding each side of the steering wheel. Do not drive with an arm over the airbag cover.

Types of Airbags

Your vehicle is equipped with three types of airbags:

- **Front airbags:** Airbags in front of the driver's and passenger's seats.
- **Side airbags:** Airbags in the driver's and passenger's seat-backs.
- **Side curtain airbags:** Airbags in the ceiling along side the windows on both sides of the vehicle.

Each is discussed in the following pages.

Front Airbags (SRS)

The front SRS airbags inflate in a moderate to severe frontal collision to help protect the head and chest of the driver and/or passenger.

SRS (Supplemental Restraint System) indicates that the airbags are designed to supplement seat belts, not replace them. Seat belts are the occupant's primary restraint system.

Housing Locations

The front airbags are housed in the center of the steering wheel for the driver, and in the dashboard for the passenger. Both airbags are marked SRS AIRBAG.

☒ Type of Airbags

The airbags can inflate whenever the ignition switch is in ON **II**.

☒ Front Airbags (SRS)

Dual-Stage, Multi-Threshold Front Airbags (SRS)

Your vehicle is equipped with dual-stage, multiple-threshold front airbags (SRS).

During a frontal crash severe enough to cause one or both front airbags to deploy, the airbags can inflate at different rates, depending on the severity of the crash, whether or not the seat belts are latched, and other factors.

Front airbags are designed to supplement the seat belts to help reduce the likelihood of head and chest injuries in frontal crashes.

■ Operation

Front airbags are designed to inflate during a moderate-to-severe frontal collision. When the vehicle decelerates suddenly, the sensors send information to the control unit which signals one or both front airbags to inflate.

A frontal collision can be either head-on or angled between two vehicles, or when a vehicle crashes into a stationary object, such as a concrete wall.

■ How the Front Airbags Work

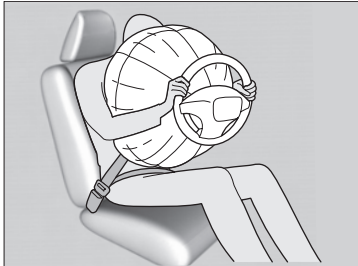

While your seat belt restrains your torso, the front airbag provides supplemental protection for your head and chest.

The front airbags deflate immediately so that they won't interfere with the driver's visibility or the ability to steer or operate other controls.

The total time for inflation and deflation is so fast that most occupants are not aware that the airbags deployed until they see them lying in front of them.

▣ How the Front Airbags Work

After a front airbag inflates in a crash, you may see what looks like smoke. This is actually powder from the airbag's surface. Although the powder is not harmful, people with respiratory problems may experience some temporary discomfort. If this occurs, get out of the vehicle as soon as it is safe to do so.

Although the driver's and passenger's airbags normally inflate within a split second of each other, it is possible for only one airbag to deploy. This can happen if the severity of a collision is at the margin, or threshold, that determines whether or not the airbags will deploy. In such cases, the seat belt will provide sufficient protection, and the supplemental protection offered by the airbag would be minimal.

■ When Front Airbags Should Not Deploy

Minor frontal crashes: Front airbags are designed to supplement seat belts and help save lives, not to prevent minor scrapes, or even broken bones that might occur during a less than moderate-to-severe frontal crash.

Side impacts: Front airbags can provide protection when a sudden deceleration causes a driver or passenger to move towards the front of the vehicle. Side airbags and side curtain airbags have been specifically designed to help reduce the severity of injuries that can occur during a moderate-to-severe side impact which can cause the driver or passenger to move towards the side of the vehicle.

Rear impacts: Head restraints and seat belts are your best protection during a rear impact. Front airbags cannot provide any significant protection and are not designed to deploy in such collisions.

Rollovers: Seat belts, and in vehicles equipped with a rollover sensor, side airbags and side curtain airbags offer the best protection in a rollover. Because front airbags could provide little if any protection, they are not designed to deploy during a rollover.

■ When Front Airbags Deploy with Little or No Visible Damage

Because the airbag system senses sudden deceleration, a strong impact to the vehicle framework or suspension might cause one or more of the airbags to deploy. Examples include running into a curb, the edge of a hole, or other low fixed object that causes a sudden deceleration in the vehicle chassis. Since the impact is underneath the vehicle, damage may not be readily apparent.

■ When Front Airbags May Not Deploy, Even Though Exterior Damage Appears Severe

Since crushable body parts absorb crash energy during an impact, the amount of visible damage does not always indicate proper airbag operation. In fact, some collisions can result in severe damage but no airbag deployment because the airbags would not have been needed or would not have provided protection even if they had deployed.

Advanced Airbags

Your front airbags have advanced features to reduce the likelihood of airbag related injuries to smaller occupants.

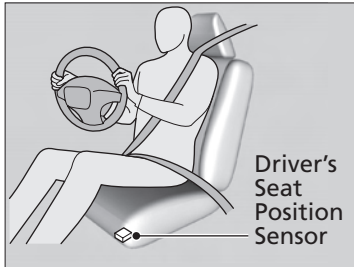

The driver's advanced front airbag system includes a seat position sensor. If the seat is too far forward, the airbag inflates with less force, regardless of the severity of the impact.

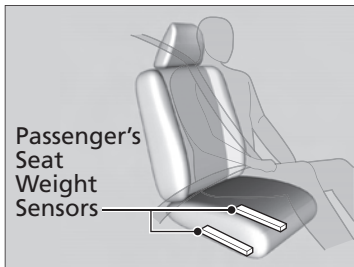

The passenger's advanced front airbag system includes weight sensors. Although Honda recommends against carrying an infant or small child in the passenger seat, if the sensors detect the weight of a child (up to about 65 lbs or 29 kg), the system will automatically turn off the passenger's front airbag.

Advanced Airbags

If there is a problem with the driver's seat position sensor, the SRS indicator will come on and the airbag will inflate with full (normal) force, regardless of the driver's seating position.

For both advanced front airbags to work properly:

- Do not spill any liquid on or under the seats.
- Do not put any object under the passenger's seat.
- Make sure any objects are positioned properly on the rear floor. Improperly positioned objects can interfere with the advanced airbag sensors.
- All occupants should sit upright and wear their seat belts properly.

Side Airbags

The side airbags help protect the upper torso of the driver or a passenger during a moderate to severe side impact.

Housing Locations

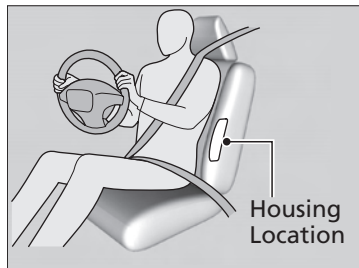

The side airbags are housed in the outside edge of the driver's and passenger's seat-backs. Both are marked SIDE AIRBAG.

Operation

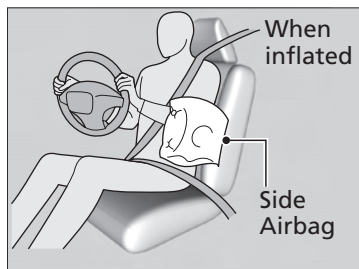

When the sensors detect a moderate-to-severe side impact, the control unit signals the side airbag on the impact side to immediately inflate.

Side Airbags

Do not attach accessories on or near the side airbags. They can interfere with the proper operation of the airbags, or hurt someone if an airbag inflates.

If the impact is on the passenger side, the airbag deploys even if there is no passenger in the passenger seat.

Do not cover or replace the front seat-back covers without consulting a dealer.

Improperly replacing or covering front seat-back covers can prevent your side airbags from properly deploying during a side impact.

■ When a Side Airbag Deploys With Little or No Visible Damage

Because the airbag systems sense sudden acceleration, a strong impact to the side of the vehicle's framework can cause a side airbag to deploy. In such cases, there may be little or no damage, but the side impact sensors detected a severe enough impact to deploy the airbag.

■ When a Side Airbag May Not Deploy, Even Though Visible Damage Appears Severe

It is possible for a side airbag to not deploy during an impact that results in apparently severe damage. This can occur when the point of impact was towards the far front or rear of the vehicle, or when the vehicle's crushable body parts absorbed most of the crash energy. In either case, the side airbag would not have been needed nor provided protection even if it had deployed.

■ Side Airbag Cutoff System

To prevent a passenger from possible injury by an inflating side airbag, the passenger side airbag is automatically turned off when:

- The height sensors detect a child or small statured adult is seated in the passenger seat.
- The position sensors detect that the passenger is leaning into the deployment path of the side airbag.

When the side airbag cutoff system is activated, the side airbag off indicator comes on.

☒ **Side Airbag Off Indicator** P.54

■ Side Airbag Off Indicator

If the side airbag off indicator comes on, have the passenger sit upright. A few seconds after the passenger is sitting properly, the side airbag will automatically be turned on, and the indicator will go off.

If the passenger is a child, the indicator will remain on so long as the child is seated. Since this vehicle does not have a back seat, we recommend that you do not carry any child who is not large enough and mature enough to ride in front.

☒ Side Airbag Cutoff System

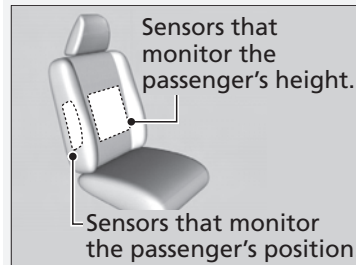

The sensors that monitor the passenger's height and body position may not work if:

- The seat-back is wet
- The passenger is touching a metal or other electrical conductive object
- A seat cushion is on the seat
- The passenger is wearing thick clothing

Side Curtain Airbags

The side curtain airbags help protect the heads of the driver and a passenger during a moderate-to-severe side impact.

Housing Locations

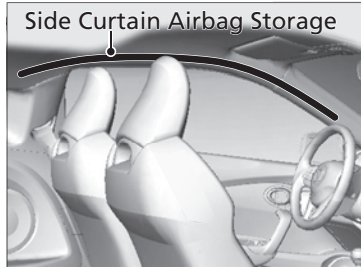

The side curtain airbags are located in the ceiling above the windows on the driver side and the passenger side.

Operation

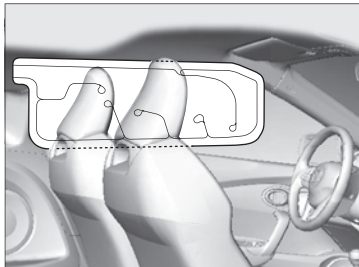

The side curtain airbag is designed to deploy in a moderate-to-severe side impact.

When Side Curtain Airbags Deploy in a Frontal Collision

One or both side curtain airbags may inflate in a moderate-to-severe angled frontal collision.

In this case, the side curtain airbags will deploy slightly after the front airbags.

Side Curtain Airbags

The side curtain airbags are most effective when an occupant is wearing their seat belt properly and sitting upright, well back in their seat.

Do not attach any objects to the side windows or roof pillars as they can interfere with the proper operation of the side curtain airbags.

Airbag System Indicators

If a problem occurs in the airbag system, the SRS indicator will come on and a message appears on the multi-information display.

■ SRS (Supplemental Restraint System) Indicator

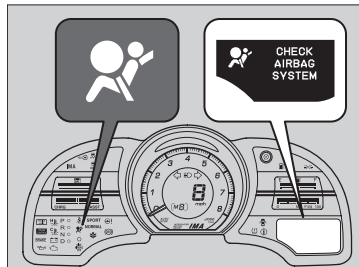

■ When the Ignition Switch Is Turned to ON

The indicator comes on briefly then goes off. This tells you the system is working properly.

If the indicator comes on at any other time, or does not come on at all, have the system checked by a dealer as soon as possible. If you do not, your airbags and seat belt tensioners may not work properly when they are needed.

⌘ SRS (Supplemental Restraint System) Indicator

WARNING

Ignoring the SRS indicator can result in serious injury or death if the airbag systems or tensioners do not work properly.

Have your vehicle checked by a dealer as soon as possible if the SRS indicator alerts you to a possible problem.

Passenger Airbag Off Indicator

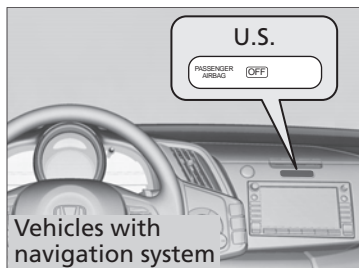
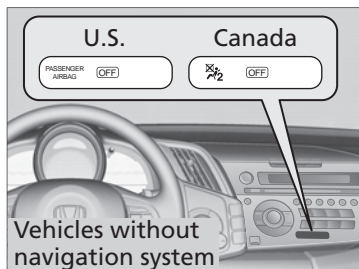

■ When the Passenger Airbag Off Indicator Comes On

The indicator comes on to alert you that the passenger's front airbag has been turned off. This occurs when the passenger's weight sensors detect 65 lbs (29 kg) or less, the weight of an infant or small child, on the seat.

Your vehicle is not recommended for child passengers. Never put a rear-facing child seat in this vehicle.

If you decided to disregard our recommendations and transport a small child, they should be properly restrained.

☑ **Child Safety** P.56

Objects placed on the seat can also cause the indicator to come on.

If the passenger seat is empty, the passenger's front airbag will not deploy and the indicator will not come on.

☒ Passenger Airbag Off Indicator

If the indicator comes on with no passenger and no objects on the passenger's seat, or with an adult riding there, something may be interfering with the weight sensors. Such as:

- An object hanging on the seat.
- An object pressing the rear of the seat-back.
- The seat or seat-back is forced back against cargo on the rear trays or floor behind it.
- An object placed under the passenger's seat.

If none of these conditions exist, have your vehicle checked by a dealer as soon as possible.

The passenger airbag off indicator may come on and off repeatedly if the total weight on the seat is near the airbag cutoff threshold.

■ Side Airbag Off Indicator

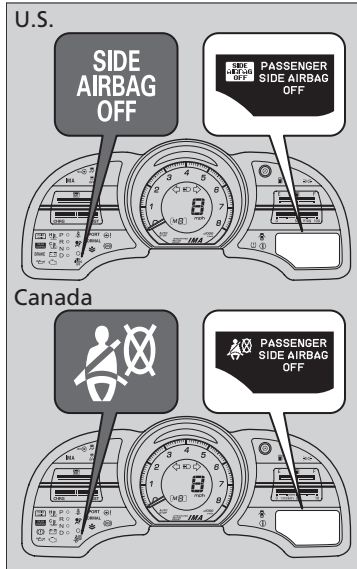

■ When the Side Airbag Off Indicator Comes On

This indicator comes on if the passenger side airbag has been turned off because the passenger is too small to be sitting in the passenger's seat, is slouching or not sitting upright, or has leaned into the airbag's deployment path.

Unless the passenger is a smaller statured adult or a child, the indicator should go off when the passenger returns to a proper upright sitting position.

⌘ Side Airbag Off Indicator

When you turn the ignition switch to ON (II), the indicator should come on briefly and then go out. If it doesn't come on, stays on, or comes on while driving without a passenger in the seat, have the system checked by a dealer as soon as possible.

Airbag Care

You do not need to perform any maintenance to your airbag system. However, you should have your vehicle inspected by a dealer in the following situations:

■ When the Airbags Have Deployed

If an airbag has inflated, the control unit and other related parts must be replaced. Similarly, once an automatic seat belt tensioner has been activated, it must be replaced.

■ When the Vehicle Has Been in a Moderate to Severe Collision

Even if the airbags did not inflate, have your dealer inspect the following: the driver's seat position sensor, the passenger's weight sensors, seat belt tensioners, and each seat belt that was worn during the crash.

■ Do Not Remove or Modify a Seat Without Consulting a Dealer

This would likely disable the driver's seat position sensor or the passenger's weight sensors. If it is necessary to remove or modify a seat to accommodate a person with disabilities, contact a Honda dealer, or for US vehicles, American Honda Automobile Customer Service at 800-999-1009 and for Canadian vehicles, Honda Canada Customer Relations at 866-946-6329.

Protecting Child Passengers

Each year, many children are injured or killed in vehicle crashes because they are either unrestrained or not properly restrained. In fact, vehicle collisions are the number one cause of death of children age 12 and under.

To reduce the number of child deaths and injuries, every state, Canadian province and territory requires that children be properly restrained when they ride in a vehicle.

Since this vehicle does not have a back seat, Honda recommends that you do not carry a child, age 12 or under, as a passenger. This is because:

- An inflating front or side airbag can injure or kill a child sitting in the passenger's seat.
- A child in the passenger's seat is more likely to interfere with the driver's ability to safely control the vehicle.
- Statistics show that children of all sizes and ages are safer when they are properly restrained in a rear seat. Because this vehicle does not have a rear seat, we recommend that you do not carry a child aged 12 or under in this vehicle.

Protecting Child Passengers

WARNING

Children who are unrestrained or improperly restrained can be seriously injured or killed in a crash.

Any child too small for a seat belt should be properly restrained in a child seat. A larger child should be properly restrained with a seat belt, using a booster seat if necessary.

The National Highway Traffic Safety Administration and Transport Canada recommend that all children age 12 and under be properly restrained in a rear seat. Some states or provinces/territories have laws restricting where children may ride.

Never put a rear-facing child seat in this vehicle.

- Any child who is too small to wear a seat belt must be properly restrained in an approved child seat that is properly secured to the vehicle using the lap belt portion of the lap/shoulder belt.
- Never hold a small child on your lap because it is impossible to protect them in the event of a collision.
- Never put a seat belt over yourself and a child. During a crash, the belt would likely press deep into the child and cause serious or fatal injuries.
- Never let two children use the same seat belt. Both children could be very seriously injured in a crash.
- Do not allow children to operate the doors, windows or seat adjustments.
- Do not leave children in the vehicle unattended, especially in hot weather when the inside of the vehicle can get hot enough to kill them. They could also activate vehicle controls causing it to move unexpectedly.

» Protecting Child Passengers

⚠ WARNING

Allowing a child to play with a seat belt or wrap one around their neck can result in serious injury or death.

Instruct children not to play with any seat belt and make sure any unused seat belt a child can reach is buckled, fully retracted, and locked.

To deactivate a lockable retractor, release the buckle and allow the seat belt to wind up all the way.

To remind you of the passenger's front airbag hazards and child safety, your vehicle has warning labels on the dashboard (U.S. models) and on the front visors. Please read and follow the instructions on these labels.

» [Safety Labels P.65](#)

Safety of Infants and Small Children

■ Protecting Infants

An infant must be properly restrained in a rear-facing, reclining child seat until the infant reaches the seat maker's weight or height limit for the seat, and the infant is at least one year old. **Because rear-facing child seats should not be used in this vehicle, you should never carry an infant in this vehicle.**

» Protecting Infants

WARNING

Placing a rear-facing child seat in the passenger's seat can result in serious injury or death during a crash.

Never install a rear-facing child seat in this vehicle.

Rear-facing child seats should never be installed in a forward facing position.

Protecting Smaller Children

Since this vehicle does not have a back seat, Honda recommends that you do not carry a child, age 12 or under, as a passenger.

This is because placing a forward-facing child seat in the passenger's seat can be hazardous, even with advanced front airbags that automatically turn the passenger's front airbag off.

If you choose to ignore our warnings and transport a small child in this vehicle, be sure to move the passenger seat as far to the rear as possible, and follow the instructions and guidelines in the following pages.

Selecting a Forward-facing Child Seat

Important Consideration When Selecting a Child Seat

Make sure the child seat meets the following three requirements to ensure that it provides adequate protection:

- The child seat is the correct type and size for the child.
- The child seat is the correct type for the seating position.
- The child seat is compliant with Federal Motor Vehicle Safety Standard 213 or Canadian Motor Vehicle Safety Standard 213.

Protecting Smaller Children

WARNING

Placing a forward-facing child seat in the passenger's seat can result in serious injury or death if the front airbag inflates.

If you must place a forward-facing child seat in the passenger's seat, move the vehicle seat as far back as possible, and properly restrain the child.

Educate yourself about the laws and regulations regarding child seat use where you are driving, and follow the child seat manufacturer's instructions.

All child seats must be secured to the vehicle with the lap part of a lap/shoulder belt. A child whose seat is not properly secured to the vehicle can be endangered in a crash.

■ Installing a Child Seat

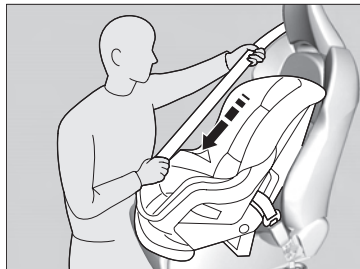
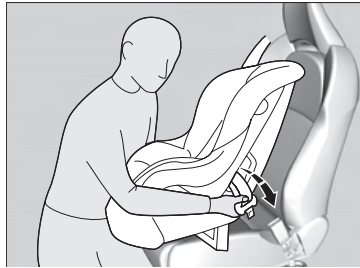

1. Move the passenger seat to the rearmost position.
2. Place the child seat on the passenger seat.
3. Route the seat belt through the child seat according to the seat maker's instructions, and insert the latch plate into the buckle.
 - Insert the latch plate fully until it clicks.
4. Slowly pull the shoulder part of the belt all the way out until it stops. This activates the lockable retractor.
5. Let the seat belt wind up to remove the slack and then try to pull it out to make sure it is locked and does not come out.
 - If you are able to pull the shoulder belt out, the lockable retractor is not activated. Pull the seat belt all the way out, and repeat steps 3 – 5.
6. Grab the shoulder part of the seat belt near the buckle, and pull up to remove any slack from the lap part of the belt.
 - When doing this, place your weight on the child seat and push it into the vehicle seat.

☒ Installing a Child Seat

All child seats must be secured to the vehicle with the lap part of a lap/shoulder belt.

For your child's safety, when using a child seat installed using the vehicle's seat belt system, check that the seat is properly secured to the vehicle.

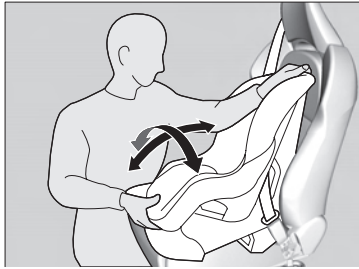

7. Make sure the child seat is firmly secured by rocking it forward and back and side to side; little movement should be felt.

■ Adding Security with a Tether

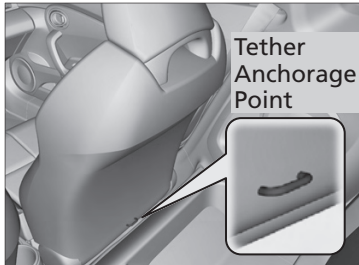

A tether anchorage point is provided behind the passenger seat. A child seat with a tether can be installed, so long as the base of the child seat is secured using a seat belt.

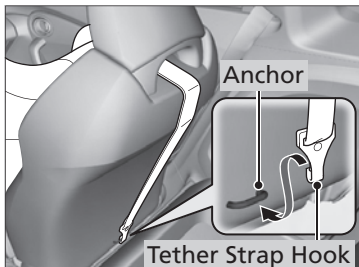

1. Route the tether strap through the head restraint legs. Make sure the strap is not twisted.
2. Secure the tether strap hook onto the anchor.
3. Tighten the tether strap as instructed by the child seat manufacturer.

▣ Installing a Child Seat with a Seat Belt

A child seat that is not properly secured will not adequately protect a child in a crash and may cause injury to the child or another vehicle occupant.

To deactivate a lockable retractor, release the buckle and allow the seat belt to wind up all the way.

▣ Adding Security with a Tether

Since a tether can provide additional security to the lap/shoulder seat belt installation, we recommend using a tether whenever one is available.

Protecting Larger Children

Since this vehicle does not have a back seat, Honda recommends that you do not carry a child age 12 or under as a passenger. This is because children who have outgrown child seats are also at risk of being injured or killed by an inflating passenger's front airbag. If a larger child must ride in this vehicle, the information in the following pages provides guidelines to help you decide when a given child may ride in this vehicle, and how to properly protect the child.

■ Checking Seat Belt Fit

When a child is too big for a child seat, secure the child in the passenger's seat using the lap/shoulder seat belt. Have the child sit upright and all the way back in the seat, then answer the following questions.



■ Checklist

- Do the child's knees bend comfortably over the edge of the seat?
- Does the shoulder belt cross between the child's neck and arm?
- Is the lap part of the seat belt as low as possible, touching the child's thighs?
- Will the child be able to stay seated like this for the whole trip?

If you answer yes to all these questions, the child is ready to wear the lap/shoulder seat belt correctly. If you answer no to any question, the child needs a booster seat.

» Protecting Larger Children

⚠ WARNING

Allowing a child age 12 or under to ride in the vehicle can result in injury or death if the passenger's front airbag inflates.

If a larger child must ride in the vehicle, move the vehicle seat as far back as possible, and use a booster seat if needed. Have the child sit up and wear the seat belt properly.

■ Booster Seats

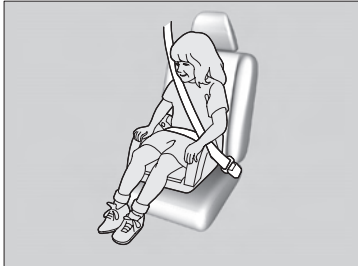

If a lap/shoulder seat belt cannot be used properly, position the child in a booster seat in the passenger's seating position. For the child's safety, check that the child meets the booster seat manufacturer's recommendations.

■ Protecting Larger Children - Final Checks

If you decide that a child can safely ride in this vehicle, be sure that:

- You have read and fully understand the instructions and safety information in this manual.
- The passenger seat is as far back as possible.
- The child is sitting upright and well back in the seat.
- The seat belt is properly positioned.

■ Monitoring a Child Passenger

We strongly recommend that you keep an eye on a child passenger. Even older, more mature children sometimes need to be reminded to fasten their seat belts and sit up properly.

»» Booster Seats

When installing a booster seat, make sure to read the instructions that came with it, and install the seat accordingly.

There are high-and low-type booster seats. Choose a booster seat that allows the child to wear the seat belt correctly.

Some U.S. states and Canadian provinces/territories require children to use a booster seat until they reach a given age or weight (e.g. 6 years or 60 lbs/27 kg). Be sure to check current laws in the state or province/territory where you intend to drive.

Carbon Monoxide Gas

The exhaust gas from this vehicle contains carbon monoxide. As long as you properly maintain your vehicle, carbon monoxide gas will not get into the interior.

■ Have the Exhaust System Inspected for Leaks Whenever

- The exhaust system is making an unusual noise.
- The exhaust system may have been damaged.
- The vehicle is raised for an oil change.

When you operate a vehicle with the hatch open, airflow can pull exhaust gas into the interior and create a hazardous condition. If you must drive with the hatch open, open both windows and set the climate control system as shown below.

1. Select the fresh air mode.
2. Select the  mode.
3. Set the fan speed to high.
4. Set the temperature control to a comfortable setting.

Adjust the climate control system in the same manner if you sit in your parked vehicle with the engine running.

☒ Carbon Monoxide Gas

⚠ WARNING

Carbon monoxide gas is toxic.
Breathing it can cause unconsciousness
and even kill you.

Avoid any enclosed areas or activities
that expose you to carbon monoxide.

An enclosed area such as a garage can quickly fill up with carbon monoxide gas.
Do not run the engine with the garage door closed.
Even when the garage door is open, drive out of the garage immediately after starting the engine.

Safety Labels

These labels are in the locations shown. They warn you of potential hazards that can cause serious injury or death. Read these labels carefully.

If a label comes off or becomes hard to read (except for the U.S. dashboard label which may be removed by the owner), contact your dealer for a replacement.

Sun Visor

U.S. models Canadian models

AIR BAG WARNING
FLIP VISOR OVER

WARNING

EVEN WITH ADVANCED AIR BAGS

- Always use seat belts and always buckle up properly.
- Never get in a vehicle with an inflating air bag.
- Always use seat belts and always buckle up properly.
- Use seat belts correctly for more information about air bags.

CAUTION
TO AVOID SERIOUS INJURY:
• FOR MAXIMUM SAFETY PROTECTION IN ALL TYPES OF CRASHES, YOU MUST ALWAYS WEAR YOUR SAFETY BELT.
• DO NOT INSTALL REARWARD-FACING CHILD SEATS IN ANY FRONT PASSENGER SEAT POSITION.
• DO NOT SIT OR LEAN UNNECESSARILY CLOSE TO THE AIR BAG.
• DO NOT PLACE ANY OBJECTS OVER THE AIR BAG OR BETWEEN THE AIR BAG AND YOURSELF.
• SEE THE OWNER'S MANUAL FOR FURTHER INFORMATION AND EXPLANATIONS.

PRECAUTIONS:
POUR ÉVITER DES BLESSURES GRAVES:
• POUR PROFITER D'UNE PROTECTION MAXIMALE EN CAS D'UNE COLLISION, BOUCLEZ TOUJOURS VOTRE CEINTURE DE SÉCURITÉ.
• N'INSTALLEZ JAMAIS UN SIÈGE POUR ENFANTS FAISANT FACE À L'ARRIÈRE SUR LE SIÈGE DU PASSAGER AVANT.
• NE VOUS APPUYEZ PAS ET NE VOUS ASSOYEZ PAS PRÈS DU COUSSIN GONFLABLE.
• NE DÉPOSEZ AUCUN OBJET SUR LE COUSSIN GONFLABLE ET VOUS.
• LISEZ LE GUIDE UTILISATEUR POUR DE PLUS AMPLES RENSEIGNEMENTS.

Separator

U.S. models Canadian models

WARNING

This vehicle is not equipped with rear seats or seatbelts. Sitting in this area may result in injury or death, and may violate state laws. Only the driver and one front seat passenger may be safely seated in this vehicle.

WARNING

This vehicle is not equipped with rear seats or seatbelts. Sitting in this area may result in injury or death, and may violate state laws. Only the driver and one front seat passenger may be safely seated in this vehicle.

AVERTISSEMENT

Ce véhicule n'est pas équipé de sièges arrière ni de ceinture de sécurité arrière. S'asseoir dans cette zone peut causer des blessures sérieuses ou mortelles et/ou enfreindre des lois provinciales. Seule le conducteur et le passager sur le siège du passager peuvent être assis en toute sécurité dans ce véhicule en toute sécurité.

Cargo Area

U.S. models Canadian models

DANGER

HIGH VOLTAGE
You will be killed or hurt.

Before servicing:

- Remove ignition key and shut off main switch.
- Check voltage at junction board terminal.
- Always wear insulated gloves and use insulated tools.
- Consult repair and follow service manual instructions.

DANGER
HAUTE TENSION

HIGH VOLTAGE
You will be killed or hurt.

Before servicing:

- Remove ignition key and shut off main switch.
- Check voltage at junction board terminal.
- Always wear insulated gloves and use insulated tools.
- Consult repair and follow service manual instructions.

HAUTE TENSION
Vous serez tué ou blessé.

Avant de travailler:

- Retirez la clé de contact et fermez l'interrupteur principal.
- Contrôlez la tension à la borne de jonction du tableau.
- Portez toujours des gants isolants et utilisez des outils isolants.
- Consultez le manuel de réparation et suivez les instructions du Manuel de réparation.

Dashboard

U.S. models only

This Vehicle is Equipped with Advanced Air Bags

Even with Advanced Air Bags, children and pregnant women should not sit in the back seat of this car. For more information, see the Owner's Manual. Do not drink alcohol and drive. Always use seat belts and always buckle up properly. Use seat belts correctly for more information about air bags.

© 2010 HONDA MOTOR CO., LTD.

Radiator Cap

DANGER WARNING
危險 危險

▶ NEVER OPEN WHEN HOT
Hot coolant will scald you!
▶ N'OUVREZ PAS QUAND CHAUD
Le liquide de refroidissement est très chaud.
▶ 高温時、請勿打開

1.1

Doorjamb

U.S. models Canadian models

SIDE AIRBAG

- This car is equipped with side airbags in the front seats and side curtain airbags.
- Do not lean against the door.
- See owner's manual for more information.

SIDE AIRBAG

- This car is equipped with side airbags in the front seats and side curtain airbags.
- Do not lean against the door.
- See owner's manual for more information.

COUSSIN GONFLABLE LATÉRAL

- Cette automobile est équipée de coussins gonflables latéraux dans les sièges avant ainsi que de coussins gonflables latéraux de type rideau.
- N'appuyez pas sur la porte.
- Consultez le Manuel du propriétaire pour en savoir plus.







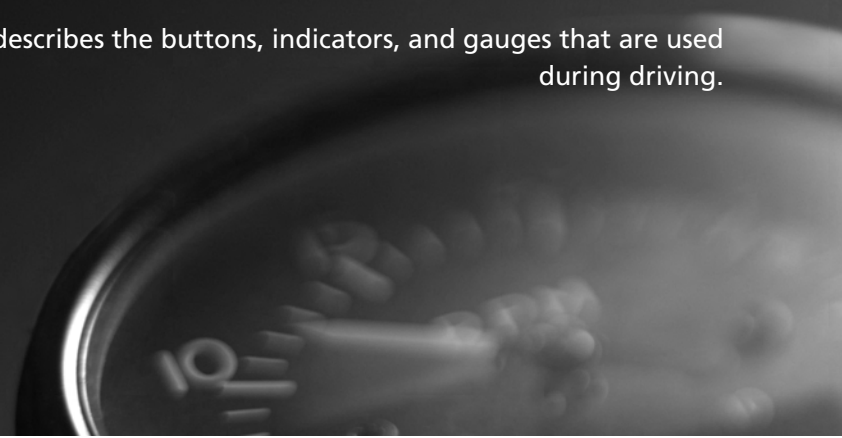







2011 CR-Z







Instrument Panel

This chapter describes the buttons, indicators, and gauges that are used during driving.



















Indicators	68
Multi-Information Display Warning and Information Messages	78
Gauges and Multi-Information Display	
Gauges	81
Multi-Information Display	83











Indicator	Name	On/Blinking	Explanation	Message
<p>U.S. BRAKE</p> <p>Canada </p>	Parking Brake and Brake System Indicator	<ul style="list-style-type: none"> • Comes on briefly when you turn the ignition switch to ON , then goes off (comes on when the parking brake is applied). • Comes on when the brake fluid level is low. • Comes on if there is a problem with the brake system. • The beeper sounds and the indicator comes on if you drive with the parking brake not fully released. 	<ul style="list-style-type: none"> • Comes on while driving - Make sure the parking brake is released. Check the brake fluid level.  What to Do When It Comes On While Driving P.302 • Comes on along with the ABS indicator - Have the vehicle checked by a dealer.  If the Brake System Indicator Comes On P.302 	<p>U.S. Canada</p>      
	Low Oil Pressure Indicator	<ul style="list-style-type: none"> • Comes on when you turn the ignition switch to ON , and goes off when the engine starts. • Comes on when the engine oil pressure is low. 	<ul style="list-style-type: none"> • Comes on during driving - Immediately stop in a safe place.  If the Low Oil Pressure Indicator Comes On P.299 	















Indicator	Name	On/Blinking	Explanation	Message
	Malfunction Indicator Lamp	<ul style="list-style-type: none"> Comes on when you turn the ignition switch to ON II, and goes off either when the engine starts or after several seconds if the engine is not started. If “readiness codes” have not been set, it blinks five times before it goes off. Comes on if there is a problem with the emissions control system. Blinks when a misfire in the engine’s cylinders is detected. 	<ul style="list-style-type: none"> Readiness codes are part of the on board diagnostics for the emissions control systems. <ul style="list-style-type: none"> ☑ Readiness Codes P.317 Comes on during driving - Have the vehicle checked by a dealer immediately. Blinks during driving - Stop in a safe place where there are no flammable objects. Stop the engine for 10 minutes or more, and wait for it to cool down. Then, take the vehicle to a dealer. <ul style="list-style-type: none"> ☑ If the Malfunction Indicator Lamp Comes On or Blinking P.301 	
	12 Volt Battery Charging System Indicator	<ul style="list-style-type: none"> Comes on when you turn the ignition switch to ON II, and goes off when the engine starts. Comes on when the 12 volt battery is not charging. 	<ul style="list-style-type: none"> Comes on during driving - Turn off the climate control system and rear defogger in order to reduce electricity consumption. <ul style="list-style-type: none"> ☑ If the 12 Volt Battery Charging System Indicator Comes On P.300 	
	Transmission Indicator (Shift Position Indicator)*	<ul style="list-style-type: none"> Comes on for a few seconds when you turn the ignition switch to ON II, then goes off. Blinks if the transmission system has a problem. 	<ul style="list-style-type: none"> Blinks during driving - Avoid sudden starts and acceleration and have the vehicle checked by a dealer immediately. 	







*Not available on all models









Indicator	Name	On/Blinking	Explanation	Message
	Seat Belt Reminder Indicator	<ul style="list-style-type: none"> Comes on and the beeper sounds if you are not wearing a seat belt when you turn the ignition switch to ON II. If the passenger is not wearing a seat belt, the indicator comes on about six seconds later. Blinks during driving if either you or your passenger has not fastened a seat belt. The beeper sounds and the indicator blinks at regular intervals. 	<ul style="list-style-type: none"> The beeper stops and the indicator goes off when you and your passenger fasten your seat belts. Stays on after you or your passenger has fastened the seat belt - A detection error may have occurred in the sensor. Have the vehicle checked by a dealer.  Seat Belt Reminder Indicator P.35 	 
	Low Fuel Indicator	<ul style="list-style-type: none"> Comes on when the fuel reserve is running low (approximately 1.8 U.S. gal./6.9 Liter left). Blinks if there is a problem with the fuel gauge. 	<ul style="list-style-type: none"> Comes on - Refuel your vehicle as soon as possible. Blinks - Have the vehicle checked by a dealer. 	
	ABS (Anti-lock Brake System) Indicator	<ul style="list-style-type: none"> Comes on for a few seconds when you turn the ignition switch to ON II, then goes off. If it comes at any other time, there is a problem with the ABS. 	<ul style="list-style-type: none"> Stays on constantly - Have the vehicle checked by a dealer. With this indicator on, your vehicle still has normal braking ability but no anti-lock function.  ABS (Anti-lock Brake System) P.221 	









Indicator	Name	On/Blinking	Explanation	Message
	Supplemental Restraint System Indicator	<ul style="list-style-type: none"> Comes on for a few seconds when you turn the ignition switch to ON II, then goes off. Comes on if a problem with any of the following is detected: <ul style="list-style-type: none"> Supplemental restraint system Side airbag system Side curtain airbag system Seat belt tensioner 	<ul style="list-style-type: none"> Stays on constantly or does not come on at all - Have the vehicle checked by a dealer. 	 <p>CHECK AIRBAG SYSTEM</p>
	VSA® (Vehicle Stability Assist) System Indicator	<ul style="list-style-type: none"> Comes on for a few seconds when you turn the ignition switch to ON II, then goes off. Blinks when VSA® is active. Comes on if there is a problem with the VSA® system. Comes on if there is a problem with the hill start assist system. Comes on if there is a problem with the creep aid system (CVT) or the brake assist system. 	<ul style="list-style-type: none"> Stays on constantly - Have the vehicle checked by a dealer.  VSA® (Vehicle Stability Assist) System P.214 	 <p>CHECK VSA SYSTEM</p>  <p>CHECK HILL START ASSIST SYSTEM</p>
	VSA® (Vehicle Stability Assist) OFF Indicator	<ul style="list-style-type: none"> Comes on for a few seconds when you turn the ignition switch to ON II, then goes off. Comes on when you deactivate VSA®. 	<ul style="list-style-type: none">  VSA® (Vehicle Stability Assist) System P.215 	<p>—</p>







Indicator	Name	On/Blinking	Explanation	Message
	Door/Hatch Open Indicator	<ul style="list-style-type: none"> Comes on for a few seconds if you turn the ignition switch to ON , then goes off. Comes on if the hatch or either door is not completely closed. 	<ul style="list-style-type: none"> Goes off if both doors and the hatch are closed. 	
	EPS (Electric Power Steering System) Indicator	<ul style="list-style-type: none"> Comes on when you turn the ignition switch to ON , and goes off when the engine starts. Comes on if there is a problem with the EPS (Electric Power Steering System). 	<ul style="list-style-type: none"> Stays on constantly or does not come on at all - Have the vehicle checked by a dealer.  If the EPS Indicator Comes On P.302 	
	U.S. models only Low Tire Pressure/TPMS Indicator	<ul style="list-style-type: none"> Comes on briefly when you turn the ignition switch to ON . Comes on if the tire pressure of any of the tires becomes significantly low. Blinks for about one minute, and then stays on if there is a problem with the TPMS, or when a compact spare tire is temporarily installed. 	<ul style="list-style-type: none"> Comes on during driving - Stop in a safe place, check tire pressures, and inflate the tire(s) if necessary. 	
			<ul style="list-style-type: none"> Blinks and remains on - Have the vehicle checked by a dealer. If the vehicle is fitted with a compact spare, get your regular tire repaired or replaced and put back on your vehicle as soon as you can. 	

Indicator	Name	On/Blinking	Explanation	Message
	High Temperature Indicator	<ul style="list-style-type: none"> Comes on briefly when you turn the ignition switch to ON . Blinks when the engine coolant temperature goes up, and stays on if the temperature continues to rise. 	<ul style="list-style-type: none"> Blinks while driving - Drive slowly to prevent overheating. Stays on while driving - Immediately stop in a safe place and allow the engine to cool.  Overheating P.297 	
	IMA System Indicator	<ul style="list-style-type: none"> Comes on briefly when you turn the ignition switch to ON . Comes on if there is a problem with the IMA system. 	<ul style="list-style-type: none"> Remains on or does not come on at all - Avoid high speed driving and have the vehicle checked by a dealer as soon as possible.  If the IMA Indicator Comes ON P.303 	
	System Message Indicator	<ul style="list-style-type: none"> Comes on along with a beep when a problem is detected. A system message on the multi-information display appears at the same time. 	<ul style="list-style-type: none"> While the indicator is on, press the /  (information) button to see the message again. Refer to the Indicators information in this chapter when a system message appears on the multi-information display. Take the appropriate action for the message. The multi-information display does not return to the normal screen unless the warning is canceled, or the /  button is pressed. 	

Indicator	Name	On/Blinking	Explanation	Message
	Low Temperature Indicator	<ul style="list-style-type: none"> Comes on when the engine coolant temperature is low. 	<ul style="list-style-type: none"> If the indicator stays on after the engine has reached normal operating temperature, there may be a problem with the temperature sensors. Have the vehicle inspected by a dealer. 	—
<div style="display: flex; flex-direction: column; align-items: center;"> <div style="text-align: center;">  <p>U.S. SIDE AIRBAG OFF</p> </div> <div style="text-align: center;">  <p>Canada</p> </div> </div>	Side Airbag Off Indicator	<ul style="list-style-type: none"> Comes on for a few seconds when you turn the ignition switch to ON , then goes off. Comes on when the passenger side airbag system is automatically shut off. 	<ul style="list-style-type: none"> It does not mean there is a problem with your side airbags. Comes on when nobody is sitting in the passenger seat - Have the vehicle checked by a dealer. Comes on when someone is sitting in the seat - Have the person sit properly. 	<div style="text-align: center;"> <p>U.S.</p>  </div> <div style="text-align: center; margin-top: 10px;"> <p>Canada</p>  </div>
	High Beam Indicator	<ul style="list-style-type: none"> Comes on when the high beam headlights are on. Comes on with reduced brightness when DRL (daytime running lights) are on. 	—	—

Indicator	Name	On/Blinking	Explanation	Message
	Lights On Indicator	<ul style="list-style-type: none"> Comes on whenever the light switch is on, or in AUTO when the exterior lights are on. 	<ul style="list-style-type: none"> If you remove the key from the ignition switch while the light is on, a chime sounds when the driver's door is opened. 	—
	Fog Light Indicator*	<ul style="list-style-type: none"> Comes on when the fog lights are on. 	—	—
	Turn Signal Indicators	<ul style="list-style-type: none"> The turn signal indicators blink when you operate the turn signal lever. If you press the hazard warning button, both indicators and all turn signals blink at the same time. 	<ul style="list-style-type: none"> Does not blink or blinks rapidly - A turn signal light bulb has blown. Change the bulb immediately.  Replacing Light Bulbs P.262, 263 	—
	Immobilizer System Indicator	<ul style="list-style-type: none"> Comes on briefly when you turn the ignition switch to ON , then goes off. Comes on if the immobilizer system cannot recognize the key information. 	<ul style="list-style-type: none"> Blinks - You cannot start the engine. Turn the ignition switch to LOCK , pull the key out, and then insert the key and turn it to ON  again. Repeatedly blinks - The system may be malfunctioning. Have the vehicle checked by a dealer. Do not attempt to alter this system or add other devices to it. Electrical problems can occur. 	—











Indicator	Name	On/Blinking	Explanation	Message
	Security Alarm System Indicator	<ul style="list-style-type: none"> Blinks when the security alarm system has been set. 	➤ Security Alarm System P.105	—
	Auto Idle Stop Indicator	<ul style="list-style-type: none"> Blinks when Auto Idle Stop is in operation. The engine automatically shuts off. 	➤ Auto Idle Stop P.224, 227	—
	Cruise Main Indicator	<ul style="list-style-type: none"> Comes on when you press the CRUISE button. 	➤ Cruise Control P.211	—
	Cruise Control Indicator	<ul style="list-style-type: none"> Comes on if you have set a speed for cruise control. 	➤ Cruise Control P.211	—
	Shift Up Indicator*	<ul style="list-style-type: none"> Comes on briefly when you turn the ignition switch to ON II. Comes on when shifting up is recommended. 	➤ Shift Up/Down Indicators P.208	—
	Shift Down Indicator*	<ul style="list-style-type: none"> Comes on briefly when you turn the ignition switch to ON II. Comes on when shifting down is recommended. 		
	SPORT Mode Indicator* ¹	<ul style="list-style-type: none"> Comes on briefly when you turn the ignition switch to ON II. Comes on when you press the SPORT mode button. 	➤ 3-Mode Drive System P.210	





Indicator	Name	On/Blinking	Explanation	Message
NORMAL	NORMAL Mode Indicator* ¹	<ul style="list-style-type: none"> Comes on briefly when you turn the ignition switch to ON . Comes on when you press the NORMAL mode button. 	 3-Mode Drive System P.210	
	ECON Mode Indicator* ¹	<ul style="list-style-type: none"> Comes on briefly when you turn the ignition switch to ON . Comes on when you press the ECON mode button. 	 3-Mode Drive System P.210	



*1: The driving mode message on the multi-information display appears for a few seconds when you press the appropriate mode button.

Multi-Information Display Warning and Information Messages

The following messages appear only on the multi-information display. Press the  (information) button to see the message again with the system message indicator on.

Message	Condition	Explanation
	<ul style="list-style-type: none"> Appears when the fuel fill cap is loose or is not installed. 	<ul style="list-style-type: none">  Tighten the Fuel Fill Cap P.301
	<ul style="list-style-type: none"> Appears if there is a problem with the DRL system. 	<ul style="list-style-type: none">  Daytime Running Lights P.112
<p>Canadian models only</p> 	<ul style="list-style-type: none"> Appears when washer fluid gets low. 	<ul style="list-style-type: none"> Refilling washer fluid.  Refilling Window Washer Fluid P.257
	<ul style="list-style-type: none"> Appears when the scheduled maintenance is due soon. Consequently, "SERVICE DUE NOW" and "SERVICE PAST DUE" follow. 	<ul style="list-style-type: none">  Maintenance Minder™ P.241
	<ul style="list-style-type: none"> Appears when you open the driver's door while the ignition key is in ACCESSORY . 	<ul style="list-style-type: none"> Turn the ignition switch to LOCK , then remove the key.

Message	Condition	Explanation
 <p>ACCESSORY (I) POSITION</p>	<ul style="list-style-type: none"> Appears when the ignition key is turned to ACCESSORY I from ON II. (The driver's door is closed.) 	—
 <p>REMOVE KEY</p>	<ul style="list-style-type: none"> Appears when you open the driver's door while the ignition key is in LOCK 0. 	<ul style="list-style-type: none"> Remove the key from the ignition switch.
<p>FULLY DEPRESS CLUTCH PEDAL</p> 	<p>Appears if the clutch pedal is not fully depressed while the auto idle stop is in operation, and the engine is ready to restart.</p>	<ul style="list-style-type: none"> Fully depress the clutch pedal. <ul style="list-style-type: none"> ➤ Auto Idle Stop P.227
<p>SHIFT TO NEUTRAL</p> 	<ul style="list-style-type: none"> Appears when the shift lever is in any forward gear position, and the auto idle stop operating time has continued for a while. 	<ul style="list-style-type: none"> Shift to N. <ul style="list-style-type: none"> ➤ Auto Idle Stop P.227
<p>RESTART ENGINE</p> 	<ul style="list-style-type: none"> Appears while the auto idle stop is in operation, and to allow the engine to restart again for the following reasons: <ul style="list-style-type: none"> The IMA battery charge is low. There is a problem with the system. 	<ul style="list-style-type: none"> Manually start the engine. <ul style="list-style-type: none"> ➤ Starting the Engine P.197

Message	Condition	Explanation
<p>Automatic transmission (CVT) model</p>  <p>Manual transmission model</p> 	<ul style="list-style-type: none"> • Appears while you are customizing the settings for the following reasons: • The shift lever is moved out of P (CVT). • The parking brake is released (manual transmission). 	<p> Customization Procedure P.90</p>

Gauges

Gauges include the speedometer, tachometer, fuel gauge, and IMA battery related indicators.

They are displayed when the ignition switch is in ON .

Speedometer

Displays your driving speed in mph or km/h.

Fuel Gauge

Displays the amount of fuel left in the fuel tank.

Tachometer

Shows the number of engine revolutions per minute.

Speedometer

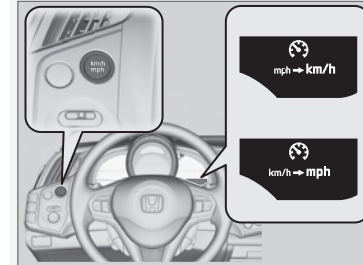

Press and hold the kmh/mpH change button until you hear a beep. The speedometer reading and the displayed measurements on the multi-information display switch between mph and km/h. The display change message appears for a few seconds.

Fuel Gauge

NOTICE

You should refuel when the reading approaches . Running out of fuel can cause the engine to misfire, damaging the catalytic converter.

The actual amount of remaining fuel may differ from the fuel gauge reading.

■ Instant Fuel Economy Gauge

Shows the instant fuel economy as a bar graph in mpg or l/100km.

■ IMA Battery Charge Level Indicator

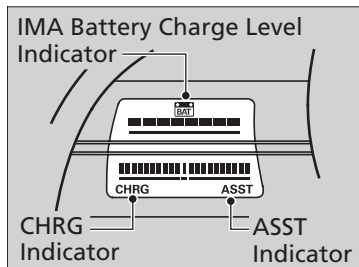

The remaining battery charge level is displayed as a bar graph.

■ Electric Motor Assist Indicator (ASST)

The degree to which the electric motor is assisting the engine is displayed by the ASST indicator bar.

■ Battery Charge in Progress (CHRG)

The degree to which the IMA battery is being charged is displayed by the CHRG indicator bar.

☒ Instant Fuel Economy Gauge

Press and hold the kmh/mpg change button to switch the measurement.

☒ IMA Battery Charge Level Indicator

The IMA battery charge level may decrease rapidly under the following conditions:

- When the 12 volt battery has been replaced.
- When the IMA battery has been disconnected.
- When the IMA battery control system is correcting its reading.

The charge level reading will be corrected automatically while driving.

☒ Electric Motor Assist Indicator (ASST)

If the IMA battery is too hot or too cold, the IMA battery's output power is limited to protect the battery. This disables the IMA assist and auto idle stop, even though the battery is well-charged.

It takes a short time to normalize the IMA battery's output power depending on the weather.

Multi-Information Display

The multi-information display shows the odometer, trip meter, outside temperature, and other fuel economy information. It also displays important messages such as warnings and other helpful information.

Switching the Display

Press the /▼ button or the SEL/RESET button to change the display.

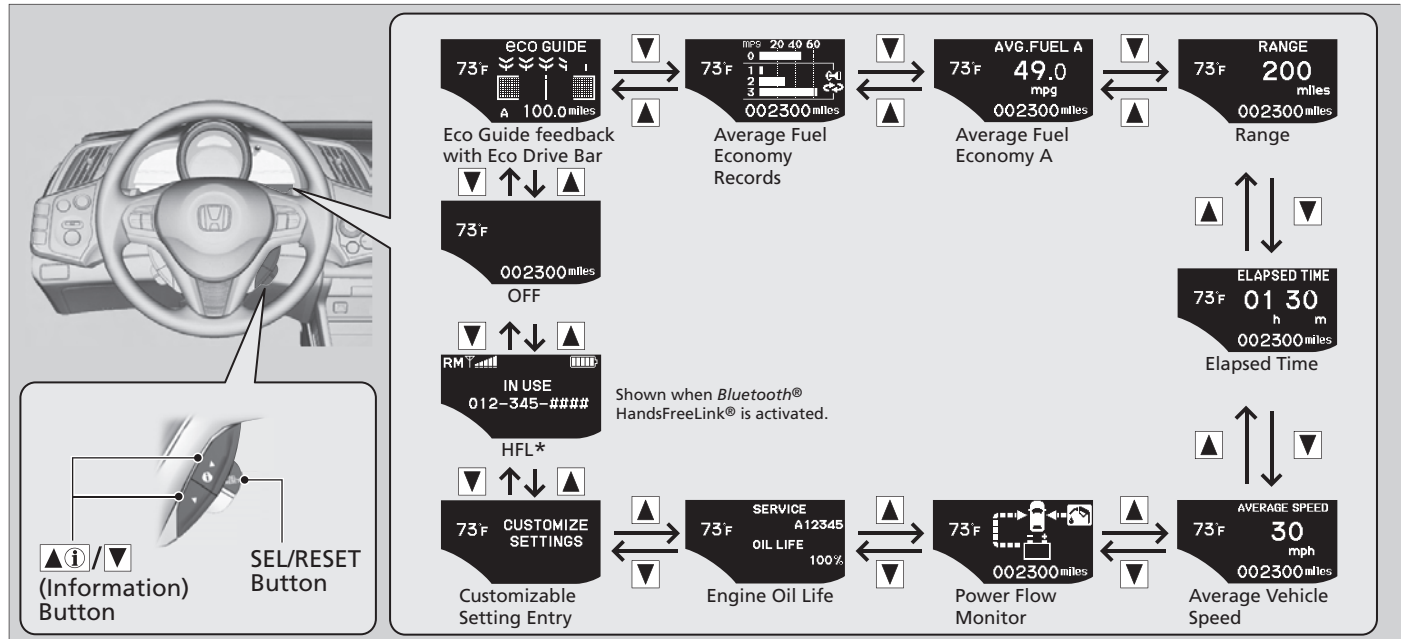

*Not available on all models

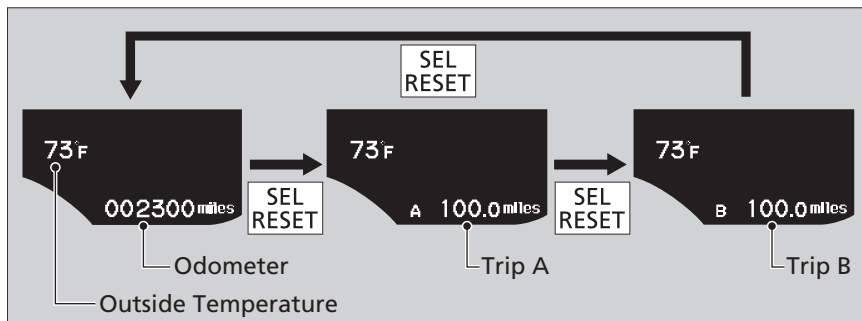

■ Odometer

Shows the total number of miles or kilometers that your vehicle has accumulated.

■ Trip Meter

Shows the total number of miles or kilometers driven since the last reset. Meters A and B can be used to measure 2 separate trips.

■ Resetting a Trip Meter

To reset a trip meter, display it, then press and hold the SEL/RESET button. The trip meter is reset to "0.0".

■ Outside Temperature

Shows the outside temperature in Fahrenheit (U.S.) or Celsius (Canada).

■ Adjusting the Outside Temperature Display

Adjust the temperature reading up to $\pm 5^{\circ}\text{F}$ or $\pm 3^{\circ}\text{C}$ if the temperature reading seems incorrect.

Use the multi-information display's customized features to correct the temperature.

► **Customizing Features** P.90

☒ Trip Meter

Switch between trip meter A and trip meter B by pressing the SEL/RESET button.

☒ Outside Temperature

The temperature sensor is in the front bumper. Road heat and exhaust from another vehicle can affect the temperature reading when your vehicle speed is less than 19 mph (30 km/h).

It may take several minutes for the display to be updated after the temperature reading has stabilized.

Eco Assist Scoring (Real-Time Score)/Eco Guide Feedback

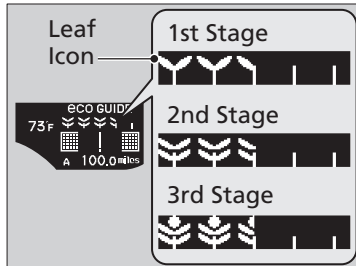

■ Real-Time Score

The Eco assist scoring system is a point system you can use to monitor your driving style and its impact on fuel economy. Points are represented by leaf icons on the multi-information display. Leaves are:

- Accumulated when your driving style is fuel efficient.
- Deducted when your style is not fuel efficient.

■ Reset the System

To clear all leaves and lifetime points, complete the following steps within 30 seconds, and do not run the engine.

1. Automatic transmission (CVT): The shift lever must be in **P**.
Manual transmission: The parking brake must be set.
2. Turn the ignition switch to ON **II**.
3. Make sure the NORMAL mode is selected.
4. Depress the brake pedal twice.
 - ▶ The ambient meter color changes from blue to green.
 - ▶ When the "meter color change" setting on the multi-information display is off, the color stays in blue.
5. Press the ECON mode button.
6. Press the NORMAL mode button.
 - ▶ The ambient meter color turns off.
7. Turn the ignition switch to LOCK **0**.

» Reset the System

If the ECON mode is on in step 2, press the NORMAL mode button. Turn the ignition switch to LOCK **0**, then go to step 1.

■ Eco Guide Feedback with Eco Drive Bar

The bar extends to the right or left of the center line while driving. The more aggressive the acceleration is, the further the bar extends to the right. The more aggressive the deceleration is, the further the bar extends to the left. Keep the bar near the center line for better fuel economy while driving.

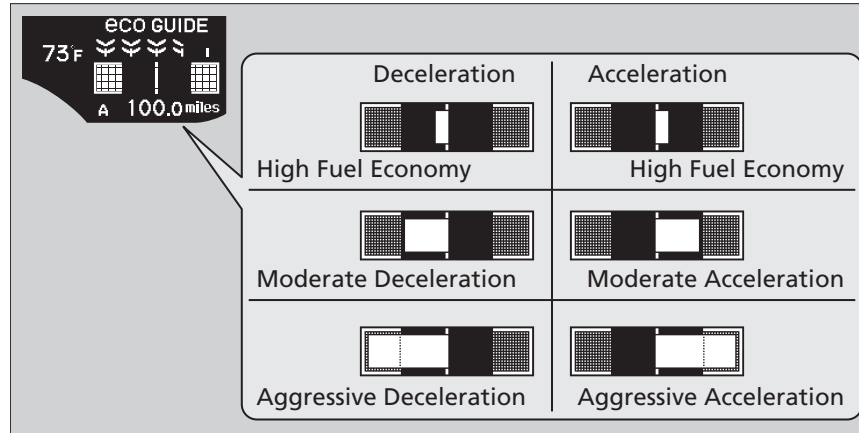

» Eco Guide Feedback with Eco Drive Bar

Automatic Transmission (CVT) model

The ambient meter color changes corresponding to the level of eco drive bar extension.

Average Fuel Economy Records

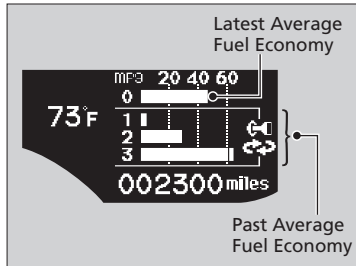

Shows the average fuel economy for the last three driving cycles (1-3), and the current driving cycle (0) in mpg or l/100 km.

Each time you turn the ignition switch to ON **II**, the display is updated, and the oldest record is deleted.

Average Fuel Economy

Shows the estimated average fuel economy of each trip meter in mpg or l/100 km. The display is updated at set intervals. When a trip meter is reset, its average fuel economy is also reset at the same time.

Range

Shows the estimated distance you can travel on the fuel remaining. This distance is estimated from the fuel economy of your trips in the past.

Elapsed Time

The elapsed time display shows the time during one drive cycle.

Average Speed

The display shows the average speed in mph or km/h since the last time Trip A was reset.

⌘ Average Fuel Economy

You can choose to reset either Trip A or average fuel economy A when you refuel.

⌘ **Customized Features P.90**

⌘ Elapsed Time

You can change the elapsed time reset criteria.

⌘ **Customized Features P.90**

■ Power Flow Monitor

Displays engine and electric motor power flow – whether the system is assisting the engine or charging the battery.

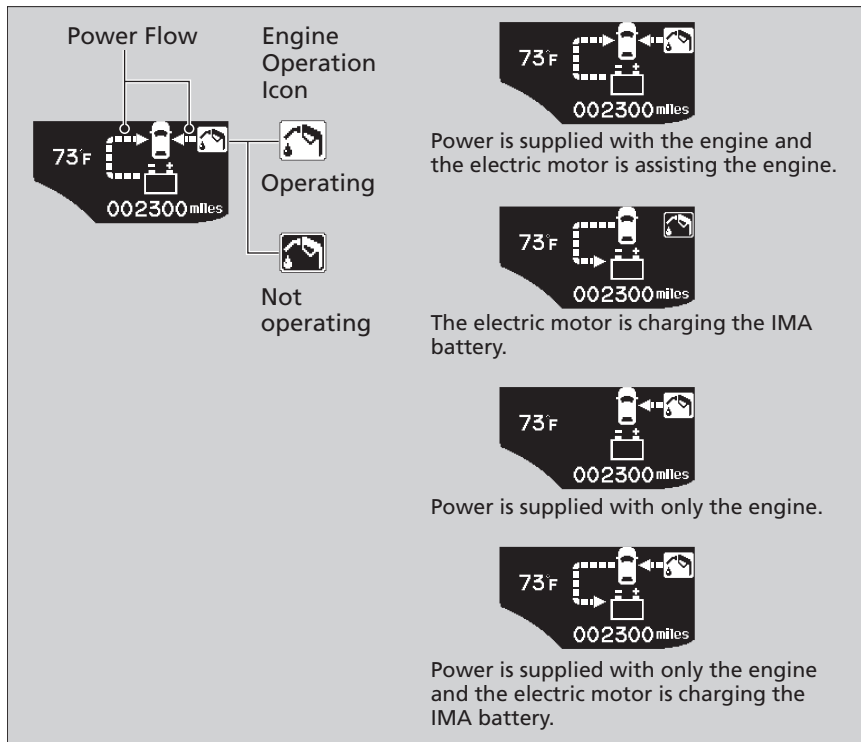

▣ Power Flow Monitor

The displayed power flow may not correspond to the ASST/CHRG indicators directly.

- ▣ **Electric Motor Assist Indicator (ASST)** P.82
- ▣ **Battery Charge in Progress (CHRG)** P.82

■ Engine Oil Life

Shows the remaining oil life and Maintenance Minder™.

📄 Maintenance Minder™ [P.241](#)

■ Bluetooth® HandsFreeLink®*



Shows your paired cell phone's information.

📄 Bluetooth® HandsFreeLink® [P.173](#)

■ Customized Features



Use the multi-information display to customize certain features.

■ How to Customize

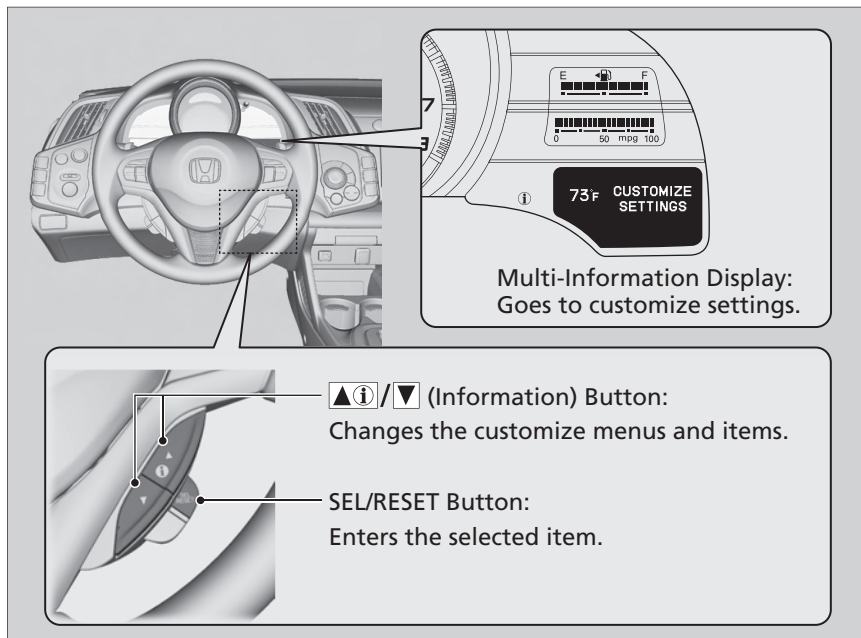
Select the "CUSTOMIZE SETTINGS" screen by pressing the / button while the ignition switch is in ON , the shift lever is in **P** (CVT), and the parking brake is set (manual transmission). The screen switches to "CHG SETTING."



⌘ Customized Features

To select customizing items, press the SEL/RESET button on the "CHG SETTING" screen, then press the / button.

- [List of Customizable Options P.92](#)
- [Example of Customization Settings P.94](#)

When you customize settings:

Automatic transmission (CVT) model
Shift to **P**.

Manual transmission model
Set the parking brake.

■ Customizing Flow

Press the /  button.

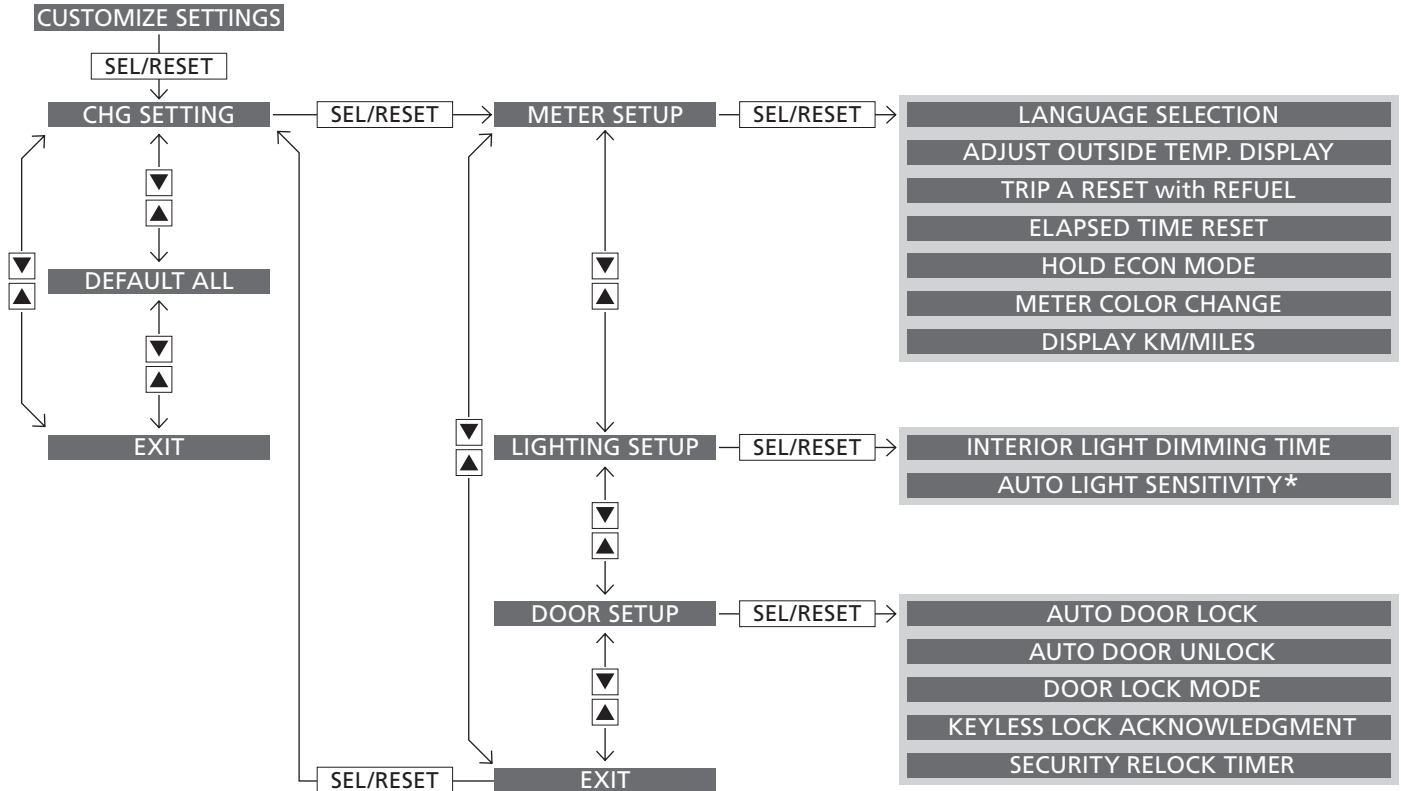

*Not available on all models

■ List of Customizable Options

Setup Group	Customizable Features	Description	Selectable Settings
Meter Setup	Language Selection	Changes the displayed language.	English* ¹ , French, Spanish
	Adjust outside temp. display	Adjusts the temperature reading by a few degrees.	-5°F ~ ±0°F* ¹ ~ +5°F (U.S.) -3°C ~ ±0°C* ¹ ~ +3°C (Canada)
	Trip A Reset with Refuel	Sets Trip A and the average fuel economy to reset when you refuel.	ON, OFF* ¹
	Elapsed Time Reset	Changes the resetting conditions of the elapsed time.	IGN OFF* ¹ , Trip A, Trip B
	Hold ECON Mode	Maintains ECON mode.	ON, OFF* ¹
	Meter Color Change	Turns the ambient meter feature on and off.	ON* ¹ , OFF
	Display Km/Miles	Changes the displayed measurement on the multi-information display.	AUTO* ¹ , KM, MILES
Lighting Setup	Interior Light Dimming Time	Changes the length of time the interior lights stay on after you close the doors.	60 sec, 30 sec* ¹ , 15 sec
	Auto Light Sensitivity* ²	Changes the timing for the headlights to come on.	Max, High, Mid* ¹ , Low, Min

*1: Default Setting

*2: If equipped

Setup Group	Customizable Features	Description	Selectable Settings
Door Setup	Auto Door Lock	Changes the setting for the automatic locking feature.	Shift from P (A/T only), With VEH SPD* ¹ , OFF
	Auto Door Unlock	Changes the setting for when the doors and the hatch unlock automatically.	Shift to P * ² , IGN off* ³ , OFF Driver Door* ¹ , All Doors
	Door Lock Mode	Sets up either the driver's door or both doors and the hatch to unlock on the first push of the remote.	Driver Door* ¹ All Doors
	Key Lock Acknowledgment	LOCK/UNLOCK - The exterior lights flash LOCK (2nd push) - The beeper sounds	ON* ¹ , OFF
	Security Relock Timer	Changes the time it takes for the doors and the hatch to relock and the security system to set after you unlock the vehicle without opening either door or the hatch.	90 sec, 60 sec* ¹ , 30 sec
Default All		Sets/Cancel all the customized settings as default.	Set, Cancel

*1: Default Setting

*2: Default Setting on automatic transmission (CVT) model

*3: Default Setting on manual transmission

■ Example for Customizing Settings

The steps for changing the “Trip A reset with refuel” setting to ON are shown below. The default setting for “Trip A reset with refuel” is OFF.

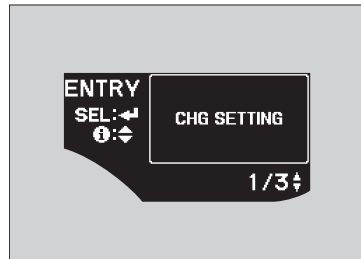

1. Press the button until “CUSTOMIZE SETTINGS” appears on the display, then press the SEL/RESET button to go into the “CHG SETTING” group.

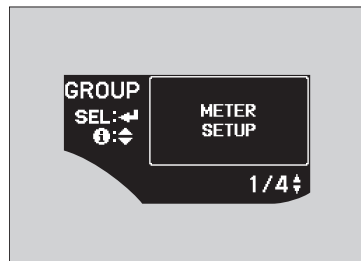

2. Press the SEL/RESET button to go into the “METER SETUP” group.

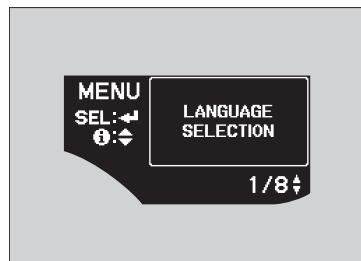

3. Press the SEL/RESET button again.
 - ▶ “LANGUAGE SELECTION” appears first in the display.

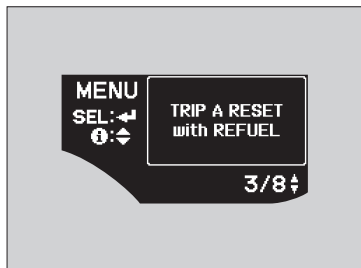

4. Press the /▼ button until "TRIP A RESET with REFUEL" appears on the display, then press the SEL/RESET button.
 - ▶ The display switches to the "Customization setup" screen, where you can select "ON," "OFF," or "EXIT."



5. Press the /▼ button and select "ON", then press the SEL/RESET button.
 - ▶ The "ON" setup screen appears, then the display returns to the "Customization menu" screen.

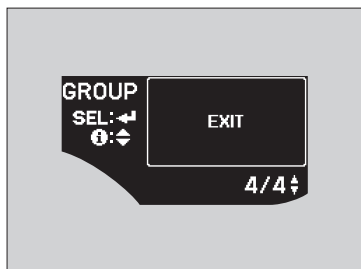

6. Press the /▼ button until "EXIT" appears in the display, then press the SEL/RESET button.
7. Repeat step 6 until you return to the normal screen.

Controls

This chapter explains how to operate the various controls necessary for driving.



Setting the Clock	98
Locking and Unlocking the Doors	
Key Types and Functions	99
Locking/Unlocking the Doors from the Outside	100
Locking/Unlocking the Doors from the Inside	102
Auto Door Lock/Unlock	103
Opening and Closing the Hatch	104
Security System	105
Immobilizer System	105
Security Alarm System	105
Opening and Closing the Windows	107

Operating the Switches Around the Steering Wheel	
Ignition Switch	109
Turn Signals	110
Light Switches	110
Fog Lights*	112
Daytime Running Lights.....	112
Wipers and Washers.....	113
Brightness Control.....	115
Rear Defogger/Heated Door Mirror* Button.....	116
Adjusting the Steering Wheel	117

Adjusting the Mirror	
Interior Rearview Mirror.....	118
Door Mirrors	118
Adjusting the Seats	
Adjusting the Seat Position.....	119
Interior Lights/Interior Convenience Items	
Interior Lights	123
Interior Convenience Items	125
Climate Control System	
Using Automatic Climate Control	131
Automatic Climate Control Sensors	133

*Not available on all models

Clock

Models without navigation system

You can adjust the time in the clock display, using the CLOCK (AM/FM) button.

■ Adjusting the Time

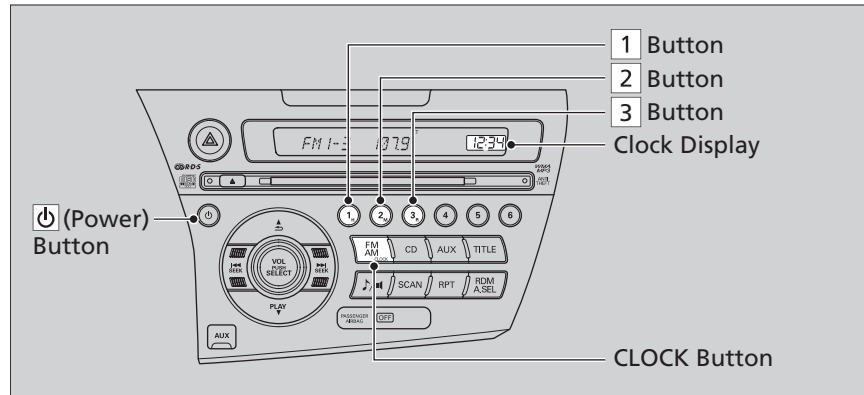

1. Press and hold the CLOCK button until the clock display begins to blink.
2. Press the **1** (Hour) button to change the hours.
3. Press the **2** (Minute) button to change the minutes.
4. Press the CLOCK button to go back to the normal display.

» Clock

To set the time to the nearest hour:
Press and hold the CLOCK button until the clock display begins to blink, then press the **3** (Reset) button.

Depending on the displayed time, the clock sets forward or backward.

Example:

1:06 will reset to 1:00

1:53 will reset to 2:00

Models with navigation system

The clock is automatically updated through the navigation system, so the time does not need to be adjusted.

Key Types and Functions

This vehicle comes with the following keys:

Keys

Key with Remote Transmitter



Use the key to start and stop the engine, and to lock and unlock all the doors and hatch. You can also use the remote transmitter to lock and unlock the doors and hatch.

Key Number Tag



Contains a number that you will need if you purchase a replacement key.

Key Types and Functions

All of the keys have an immobilizer system. The immobilizer system helps to protect against vehicle theft.

Immobilizer System P.105

The keys contain precision electronics. Adhere to the following advice to prevent damage to the electronics:

- Do not leave the keys in direct sunlight, or in locations with high temperature or high humidity.
- Do not drop the keys or set heavy objects on them.
- Keep the keys away from liquids.
- Do not take the keys apart except for replacing the battery.

If the circuit in the keys are damaged, the engine may not start, and the remote transmitter may not work.

If the keys do not work properly, have them inspected by a dealer.

Key Number Tag

Keep the key number tag separate from the key in a safe place outside of your vehicle.

If you wish to purchase an additional key, contact your dealer.

If you lose your key and you cannot start the engine, contact your dealer.

Locking/Unlocking the Doors from the Outside

■ Using the Remote Transmitter

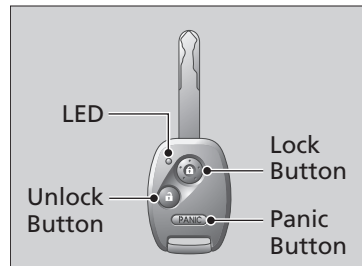

■ Locking the Vehicle

Press the LOCK button.

Once:

- ▶ Some exterior lights will flash, all the doors and hatch will lock, and the security system sets.

Twice (within five seconds after the first push):

- ▶ A beeper sounds and verifies the security system is set.

■ Unlocking the Vehicle

Press the UNLOCK button.

Once:

- ▶ Some exterior lights will flash twice, and the driver's door unlocks.

Twice:

- ▶ The passenger's door and the hatch unlock.

■ Panic Mode

If you press the panic button for approximately one second, the following will occur:

- The horn sounds.
- Some exterior lights flash for about 30 seconds.

■ Canceling Panic Mode

Press any button on the remote transmitter, or turn the ignition switch to ON .

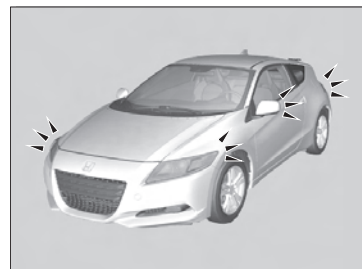

☒ Using the Remote Transmitter

Open the door or the hatch within 30 seconds.

If you do not open a door or the hatch within 30 seconds of unlocking the vehicle with the remote transmitter, the doors and the hatch will automatically relock.

If the light control switch is in the door activated position, the interior lights come on when you press the UNLOCK button.

No doors opened: The lights fade out after 30 seconds.

Doors relocked with the remote: The lights go off immediately.

☒ Interior Lights [P.123](#)

The remote transmitter uses low-power signals, so the operating range may vary depending on the surroundings.

The remote transmitter will not work when the key is in the ignition switch. The remote will not lock the vehicle when a door or the hatch is open.

If the distance at which it works varies, the battery is probably low.

If the LED does not come on when you press a button, the battery is dead.

☒ Replacing the Battery [P.279](#)

■ Locking/Unlocking the Doors Using a Key

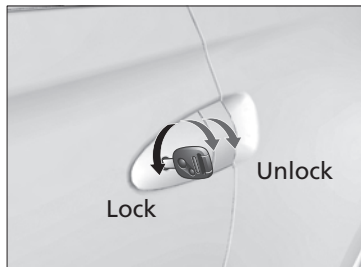

Fully insert the key and turn it.

■ Locking a Door Without Using a Key

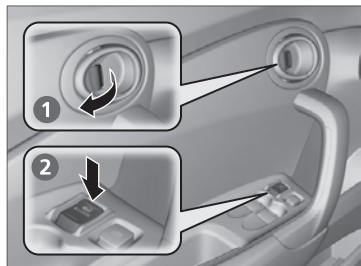

■ Locking the Driver's Door

Pull the lock tab rearward **1** or push the master door lock switch in the lock direction **2**, and close the door.

■ Locking the Passenger's Door

Pull the lock tab rearward and close the door.

■ Lockout Prevention System

The doors and the hatch cannot be locked when the key is in the ignition switch, and either door or the hatch is open.

▣ Locking/Unlocking the Doors Using a Key

When you lock the driver's door with a key, all of the doors and hatch lock at the same time. When unlocking, the driver's door unlocks first. Turn the key a second time within a few seconds to unlock the passenger's door and the hatch.

▣ Locking a Door Without Using a Key

When you lock the driver's door, all of the doors and hatch lock at the same time. Make sure you have the key in your hand before locking the door to prevent it from being locked in the vehicle.

Locking/Unlocking the Doors from the Inside

■ Using the Lock Tab

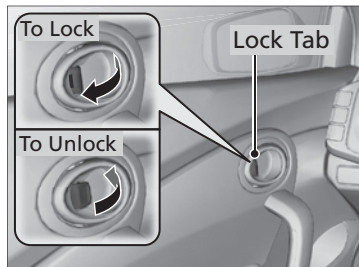

■ Locking a Door

Pull the lock tab.

■ Unlocking a Door

Push the lock tab in.

■ Using the Master Door Lock Switch

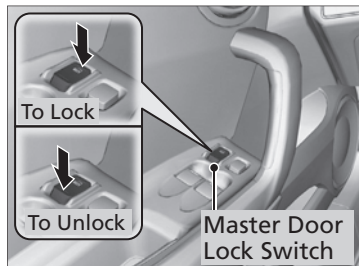

Press the master door lock in as shown to lock or unlock both doors and the hatch.

⊗ Using the Lock Tab

When you lock the door using the lock tab on the driver's door, all of the doors and hatch lock at the same time.

When you unlock the door using the lock tab on the driver's door, only the driver's door will unlock.

⊗ Using the Master Door Lock Switch

When you lock/unlock the driver's door using the master lock switch, all of the doors and hatch lock/unlock at the same time.

Auto Door Lock/Unlock

■ Auto Door Lock

The auto door lock function automatically locks all the doors and hatch when the vehicle reaches about 9 mph (15 km/h).

■ Auto Door Unlock

Automatic transmission (CVT)

When you depress the brake pedal and move the shift lever in **P**, the driver's door automatically unlocks.

Manual transmission

When you depress the brake pedal and turn the ignition switch to LOCK **0**, the driver's door automatically unlocks.

☒ Auto Door Lock/Unlock

The auto door lock/unlock settings can be customized using the multi-information display.

☒ **Customization Procedure** [P.90](#)

Precautions for Opening/Closing the Hatch

■ When Opening the Hatch

- Open the hatch all the way.
 - ▶ If it is not fully opened, the hatch may come down accidentally by its own weight.
- We recommend that you do not drive while the hatch is open.
 - ▶ Exhaust gas may get into the interior.
 - **Carbon Monoxide** P.64

■ When Closing the Hatch

Keep the hatch closed while driving to avoid damaging it, and to prevent exhaust gas from leaking into the vehicle.

Using the Hatch Release Switch

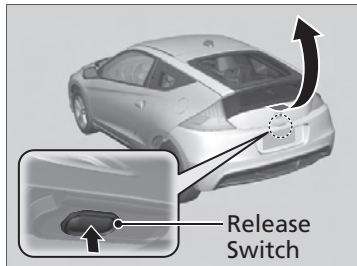

Push the release switch on the hatch after the doors are unlocked.

☒ Using the Hatch Release Switch

When the driver's door is locked, the hatch will lock when it is closed.

Immobilizer System

The immobilizer system prevents a key that has not been pre-registered from starting the engine. Each key contains electronic transmitters that use electronic signals to verify the key.

Pay attention to the following when inserting the key to the ignition switch.

- Do not allow objects that emit strong radio waves near the ignition switch.
- Make sure the key is not covered by or touching a metal object.
- Do not bring a key from another vehicle's immobilizer system near the ignition switch.

Security Alarm System

The security alarm system activates when the doors, hatch, or hood are opened without the key, or remote transmitter. It also activates if you turn the ignition switch to ON  after locking the doors and the hatch with the remote transmitter.

■ When the Security Alarm System Activates

The horn beeps intermittently, and all of the exterior lights flash.

■ To Deactivate the Security Alarm System

Unlock the vehicle using the key, or remote transmitter. The system, along with the horn and flashing lights, are deactivated.

» Immobilizer System

NOTICE

Leaving the ignition key in the vehicle can result in theft or accidental movement of the vehicle. Always take the ignition key with you whenever you leave the vehicle unattended.

Do not alter the system or add other devices to it. Doing so may damage the system and make your vehicle inoperable.

» Security Alarm System

The security alarm continues for a maximum of two minutes until the security alarm system deactivates.

■ Setting the Security Alarm System

The security alarm system automatically sets when the following conditions have been met:

- The ignition switch is in LOCK [0], and the key has been removed from the ignition switch.
- The hood is closed.
- Both doors and the hatch are locked.

■ When the Security Alarm System Sets

The security system indicator in the instrument panel blinks. When the blinking interval changes after about 15 seconds, the security alarm system is set.

■ To Cancel the Security Alarm System

The security alarm system is canceled when the vehicle is unlocked using the key or remote transmitter. The security system indicator goes off at the same time.

⌘ Security Alarm System

Do not set the security alarm system when someone is in the vehicle or a window is open. The system can accidentally activate when unlocking the door with the lock tab or the master door lock switch.

If the 12 volt battery goes dead after you have set the security alarm system, the security alarm may go off once the battery is recharged or replaced. If this occurs, deactivate the security alarm system by unlocking a door using the key or remote transmitter.

Do not attempt to alter this system or add another device to it.

Opening/Closing the Power Windows

The power windows can be opened and closed when the ignition switch is in ON , using the switches on the doors. The driver side switch can be used to open and close both windows.

The main switch on the driver side must be switched off (not pushed in) to open and close the passenger's window from the passenger side.

When the main switch is turned on (pushed in), you can only operate the passenger's window from the driver's seat. Turn the main switch on if a child rides in the passenger's seat.

Opening/Closing the Driver's Window

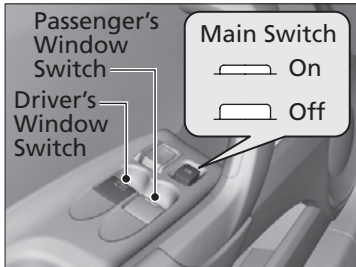

■ Automatic Operation

To open: Push the switch down firmly.

To close: Pull the switch up firmly.

The window opens or closes completely. To stop the window at any time, push or pull the switch briefly.

■ Manual Operation

To open: Push the switch down lightly.

To close: Pull the switch up lightly.

Release the switch when the window reaches the desired position.

Opening/Closing the Power Windows

WARNING

Closing a power window on someone's hands or fingers can cause serious injury.

Make sure your passenger is away from the window before closing it.

The auto-reverse function stops sensing when the window is almost closed to ensure that it fully closes.

The power windows can be operated for up to 10 minutes after you turn the ignition switch off. Opening either door cancels this function.

Auto Reverse

If a power window senses resistance when closing automatically, it will stop closing, and reverse direction.

The driver's window auto reverse function is disabled when you continuously pull up the switch.

■ Opening/Closing the Passenger's Window

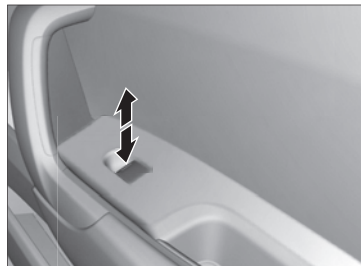

To open: Push the switch down.

To close: Pull the switch up.

Release the switch when the window reaches the desired position.

Ignition Switch

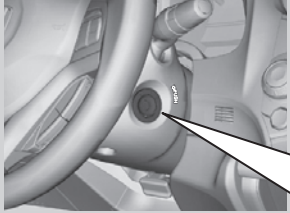

- 0** LOCK: Insert and remove the key in this position.
- I** ACCESSORY: Operate the audio system and other accessories in this position.
- II** ON: This is the position when driving.
- III** START: This position is for starting the engine. The switch returns to ON **II** when you let go of the key.

» Ignition Switch

Manual transmission models

⚠ WARNING

Removing the key from the ignition switch locks the steering. If you do this while the vehicle is in motion, you can lose control of the vehicle.

Only remove the key from the ignition switch when parked.

Automatic transmission (CVT) models

You cannot take the key out unless the shift lever is in **P**.

On all models

If you open the driver's door when the key is in LOCK **0** or ACCESSORY **I**, a warning buzzer will sound to remind you to take the key out. If the key won't turn from LOCK **0** to ACCESSORY **I**, turn the key while moving the steering wheel left and right. The steering wheel will unlock, allowing the key to turn.

Turn Signals

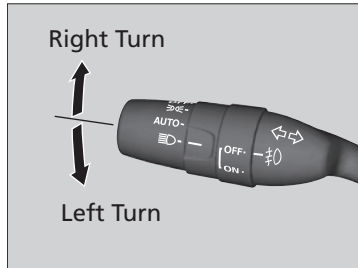

The turn signals can be used when the ignition switch is in ON **II**.

Light Switches

Manual Operation

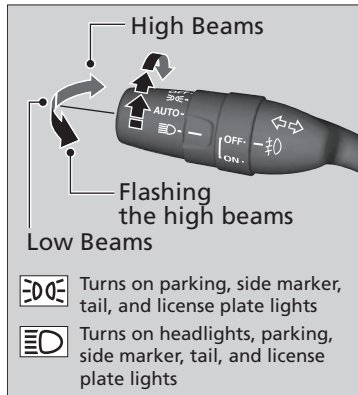

Rotating the light switch turns the lights on and off, regardless of the position of the ignition switch.

■ **Low Beams**
Rotate the light switch to .

■ **High Beams**
Push the lever forward until you hear a click.
Pull the lever back to return to low beams.

■ **Flashing the High Beams**
Pull the lever back and release it.

Light Switches

If you remove the key with the lights on, a lights on reminder chime will sound.

When the lights are on, the lights on indicator in the instrument panel will be on.

➤ **Indicators P.68**

Repeatedly turning the headlights on and off reduces the life of the HID headlight bulbs. If you sense that the level of the headlights is abnormal, have the vehicle inspected by a dealer.

Do not leave the lights on when the engine is off because it will cause the battery to discharge.

Automatic Operation (automatic lighting control)*

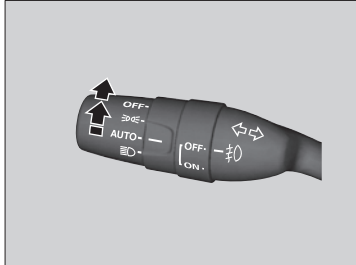

Automatic lighting control can be used when the ignition switch is in ON **II**.

When you turn the light switch to **AUTO**, the headlights and other exterior lights will switch on and off automatically depending on the ambient brightness.

Automatic Operation (automatic lighting control)

We recommend that you turn on the lights manually when driving at night, in a dense fog, or in dark areas such as long tunnels or parking facilities.

The light sensor is in the location shown below. Do not cover this light sensor with anything; otherwise, the automatic lighting system may not work properly.

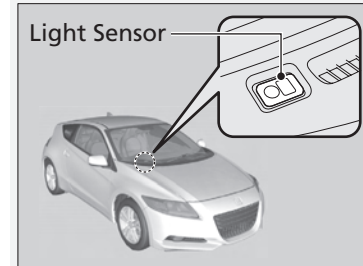

You can change the AUTO light sensitivity using the multi-information display.

➤ **Customization Procedure P.90**

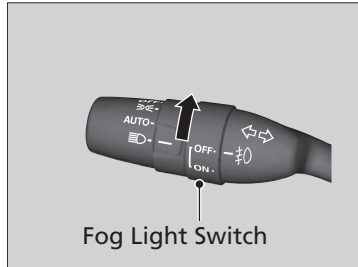

Fog Lights*



When the low beam headlights are on, turn the fog light switch on to use the fog lights.

Daytime Running Lights

The high beam headlights and indicator come on slightly dimmer than normal.

- The ignition switch is in ON .
- The headlight switch is off, or in .
- The parking brake is released.

The lights remain on even if you set the parking brake. Turning off the ignition switch will turn off the daytime running lights.

The high beam headlights return to the original brightness once the headlight switch is turned on.

❖ Fog Lights

When the fog lights are on, the indicator in the instrument panel will be on. They go off when the headlights turn off, or when the daytime running lights are on.

❖ **Indicators** [P.68](#)

❖ Daytime Running Lights

When there is a problem with the daytime running lights system, "CHECK DRL SYSTEM" appears on the multi-information display. Have your vehicle checked at a dealer.

Wipers and Washers

■ Front Wiper/Washer

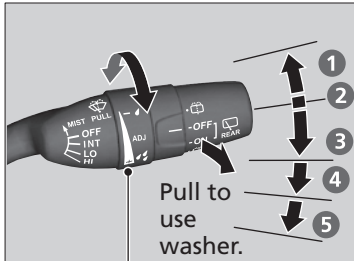

Intermittent Time Adjustment Ring

- 1 MIST
- 2 OFF
- 3 INT: Intermittent
- 4 LO: Low speed wipe
- 5 HI: High speed wipe

The windshield wipers and washers can be used when the ignition switch is in ON **II**.

■ MIST

The wipers run at high speed until you release the lever.

■ Wiper Switch (OFF, INT, LO, HI)

Change the wiper switch setting according to the amount of rain.

■ Adjusting the Delay

Turn the adjustment ring to adjust the wiper delay.



Long delay

Short delay

■ Washer

Sprays while you pull the lever toward you. When you release the lever, the wipers make two or three more sweeps before stopping.

» Wipers and Washers

If the vehicle speeds up while the wipers are operating intermittently, the interval decreases by about four seconds. Also, when the vehicle starts moving, the wipers make a single sweep. In the shortest delay setting (👉), the wipers change to low speed operation when the vehicle speed exceeds 12 mph (20 km/h).

NOTICE

Do not use the wipers when the windshield is dry. The windshield will get scratched, or the rubber blades will get damaged.

Turn the washers off if no washer fluid comes out. The pump may get damaged.

NOTICE

In cold weather, the blades may freeze to the windshield, becoming stuck. Operating the wipers in this condition may damage the wipers. Use the defroster to warm the windshield, then turn the wipers on.

■ Rear Wiper/Washer

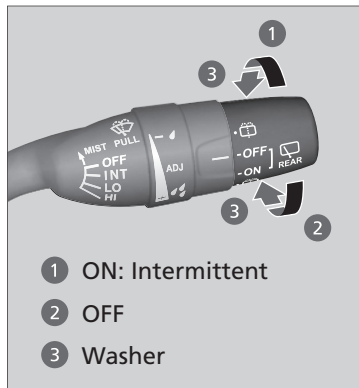

- 1 ON: Intermittent
- 2 OFF
- 3 Washer

The rear wiper and washer can be used when the ignition switch is in ON **II**.

■ Wiper Switch (OFF, ON)

The wiper operates intermittently after completing a few sweeps.

■ Washer ()

Sprays while you rotate the switch to this position.

Hold it to activate the wiper and to spray the washer. Once released, it stops operating after a few more sweeps.

■ Operating in Reverse

When you shift the transmission to **R** with the front wiper activated, the rear wiper operates automatically as follows even if its switch is off.

Front Wiper Position	Rear Wiper Operation
INT (Intermittent)	Intermittent
LO (Low speed wipe) HI (High speed wipe)	Continuous

⌘ Wipers and Washers

If the wiper stops operating due to any obstacle such as the build-up of snow, park the vehicle in a safe place.

Rotate the wiper switch to OFF, and turn the ignition switch to ACCESSORY **I** or LOCK **0**, then remove the obstacle.

The wiper motor is equipped with a breaker that may stop motor operation temporarily to prevent an overload. Wiper operation will return to normal within a few minutes, once the circuit has returned to normal.

Brightness Control

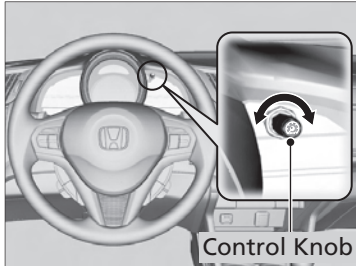

When the parking lights are turned on and the ignition switch is in ON (II), you can use the brightness control knob to adjust instrument panel brightness.

Brighten: Turn the knob to the right.

Dim: Turn the knob to the left.

You will hear a beeper when the brightness reaches minimum or maximum. The multi-information display will return to its original state several seconds after you adjust the brightness.

■ Brightness Level Indicator

The brightness level is shown on the multi-information display while you are adjusting it. As the brightness level increases to the right, the instrument panel gets brighter.

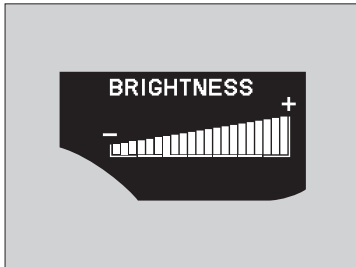

» Brightness Control

The brightness of the instrument panel varies according to whether the headlights are on or off. The instrument panel dims to reduce glare when you turn the light switch to or , or the exterior lights are on with the light switch in AUTO position.

Pressing either / (information) button switches the display.

If you turn the knob to the right until the brightness display is up to max, the beeper sounds. This cancels the reduced instrument panel brightness when the parking lights are on.

The brightness can be set differently for when the exterior lights are on, and when they are off.

Rear Defogger/Heated Door Mirror* Button

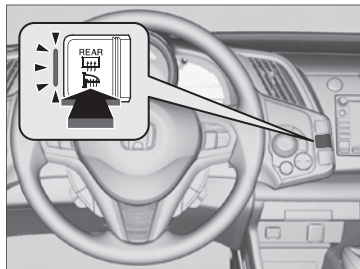

Press the rear defogger and heated door mirror button to defog the rear window and mirrors when the ignition switch is in ON .

The rear defogger and heated door mirrors automatically switch off after 10–30 minutes depending on the outside temperature. However, if the outside temperature is 32°F (0°C) or below, they do not automatically switch off.

⌘ Rear Defogger/Heated Door Mirror Button

NOTICE

When cleaning the inside of the rear window, be careful not to damage the heating wires. It is critical to wipe the window from side to side along the defogger heating wires.

This system consumes a lot of power, so turn it off when the window has been defogged. Also, do not use the system for a long period when the engine is idling. This may weaken the 12 volt battery, making it difficult to start the engine.

Adjusting the Steering Wheel

The steering wheel height and distance from your body can be adjusted so that you can comfortably grip the steering wheel in an appropriate driving posture.

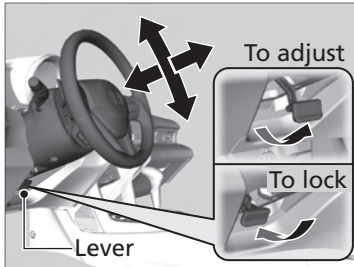

1. Pull the steering wheel adjustment lever up.
 - ▶ The steering wheel adjustment lever is under the steering column.
2. Move the steering wheel up or down, and in or out.
 - ▶ Make sure you can see the instrument panel gauges and indicators.
3. Push the steering wheel adjustment lever down to lock the steering wheel in position.
 - ▶ After adjusting the position, make sure you have securely locked the steering wheel in place by trying to move it up, down, in, and out.

Adjusting the Steering Wheel

WARNING

Adjusting the steering wheel position while driving may cause you to lose control of the vehicle and be seriously injured in a crash.

Adjust the steering wheel only when the vehicle is stopped.

Make any steering wheel adjustments before you start driving.

Interior Rearview Mirror

Adjust the angle of the rearview mirror when you are sitting in the correct driving posture.

■ Rearview Mirror with Day and Night Positions



Flip the tab to switch the position. The night position will help to reduce the glare from headlights behind you when driving after dark.

⊗ Adjusting the Mirror

Keep the inside and outside mirrors clean and adjusted for best visibility. Adjust the mirrors before you start driving.

Door Mirrors

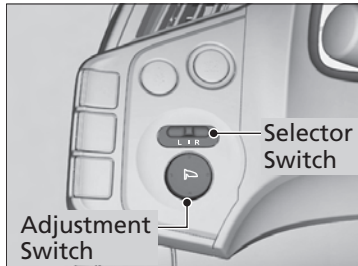

You can adjust the door mirrors when the ignition switch is in ON **II**.

■ Mirror Position Adjustment

L/R selector switch: Select the left or right mirror. After adjusting the mirror, return the switch to the center position.

Mirror position adjustment switch: Press the switch left, right, up, or down to move the mirror.

Adjusting the Seat Position

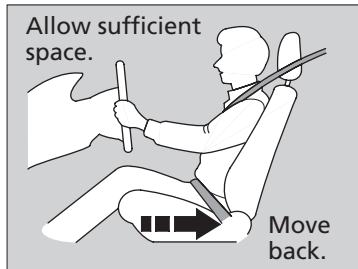

Adjust the driver's seat as far back as possible while allowing you to maintain full control of the vehicle. You should be able to sit upright, well back in the seat and be able to adequately press the pedals without leaning forward, and grip the steering wheel comfortably. The passenger's seat should be adjusted in a similar manner, so that it is as far back from the front airbag in the dashboard as possible.

Height Adjustment

(Driver's seat only)
Pull up or push down the lever to raise or lower the seat.

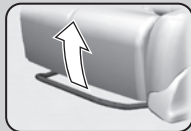
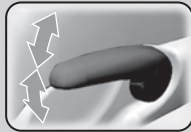

Horizontal Position Adjustment

Pull up on the bar to move the seat, then release the bar.

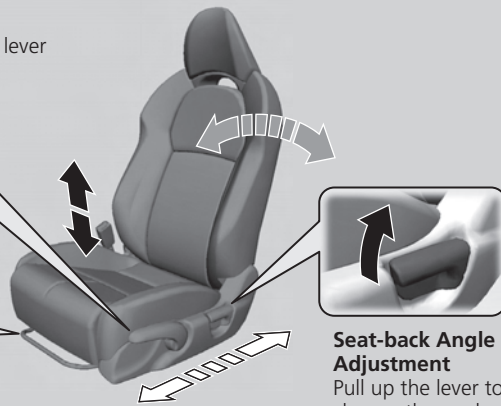

Driver's seat is shown.

Seat-back Angle Adjustment

Pull up the lever to change the angle.

Adjusting the Seats

WARNING

Sitting too close to a front airbag can result in serious injury or death if the front airbags inflate.

Always sit as far back from the front airbags as possible while maintaining control of the vehicle.

The National Highway Traffic Safety Administration and Transport Canada recommend that drivers allow at least 10 inches (25 cm) between the center of the steering wheel and their chest.

Always make seat adjustments before driving.

Once a seat is adjusted correctly, rock it back and forth to make sure it is locked in position.

■ Adjusting the Seat-Backs

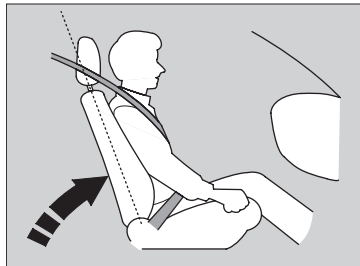

Adjust the driver's seat-back to a comfortable, upright position, leaving ample space between your chest and the airbag cover in the center of the steering wheel.

The passenger should also adjust their seat-back to a comfortable, upright position.

Reclining a seat-back so that the shoulder part of the belt no longer rests against the occupant's chest reduces the protective capability of the belt. It also increases the chance of sliding under the belt in a crash and being seriously injured. The farther a seat-back is reclined, the greater the risk of injury.

⌘ Adjusting the Seat-Backs

⚠ WARNING

Reclining the seat-back too far can result in serious injury or death in a crash.

Adjust the seat-back to an upright position, and sit well back in the seat.

Do not put a cushion, or other object, between the seat-back and your back.

Doing so may interfere with proper seat belt or airbag operation.

If you cannot get far enough away from the steering wheel and still reach the controls, we recommend that you investigate whether some type of adaptive equipment may help.

■ Head Restraints

Your vehicle is equipped with head restraints in both seating positions. However, they are non-adjustable.

Head restraints are effective for protection against whiplash and other rear-impact crash injuries.

■ Removing and Installing the Head Restraint for Cleaning

To remove the head restraint:

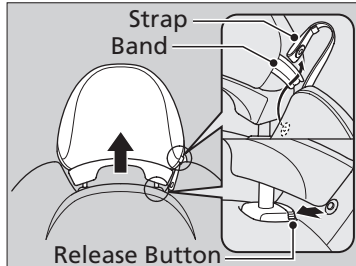

1. Unhook the strap on the outside edge of the seat-back.
2. Pull out the strap throughout the band on the outside under edge of the head restraint.
3. Push the release button, and pull the head restraint upward.

To install the head restraint:

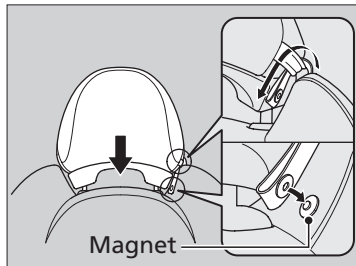

1. Put the legs back in place, then slightly lower it.
 - Do not push it down fully until it locks in place.
2. Insert the strap onto the band, then hook it to the magnet on the outside edge of the seat-back.
3. Push the head restraint down until it locks. Make sure the head restraint locks in place when you reinstall it.

» Head Restraints

⚠ WARNING

Failure to reinstall the head restraints can result in severe injury during a crash.

Always replace the head restraints before driving.

The driver's and passenger's seats have active head restraints.

■ Maintain a Proper Sitting Position

After all occupants have adjusted their seats, and put on their seat belts, it is very important that they continue to sit upright, well back in their seats, with their feet on the floor, until the vehicle is safely parked and the engine is off.

Sitting improperly can increase the chance of injury during a crash. For example, if an occupant slouches, lies down, turns sideways, sits forward, leans forward or sideways, or puts one or both feet up, the chance of injury during a crash is greatly increased.

In addition, an occupant who is out of position in the seat can be seriously or fatally injured in a crash by striking interior parts of the vehicle or being struck by an inflating front airbag.

■ Active Head Restraints

The driver's and passenger's seats have active head restraints. In a rear impact, an occupant properly secured by a seat belt will be pushed against the seat-back and the head restraint will move forward. This reduces the distance between the restraint and the occupant's head. It also helps protect the occupants against the likelihood of whiplash and injuries to the neck and upper spine.

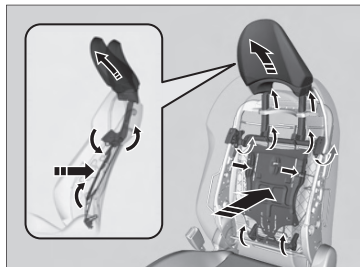

⌘ Maintain a Proper Sitting Position

⚠ WARNING

Sitting improperly or out of position can result in serious injury or death in a crash.

Always sit upright, well back in the seat, with your feet on the floor.

⌘ Active Head Restraints

In order for the active head restraint to operate properly:

- Do not hang any items on the head restraints, or from the restraint legs.
- Do not place any objects between an occupant and the seat-back.

After a collision, the activated restraint should return to its normal position. If the restraints do not return to their normal position, or in the event of a severe collision, have the vehicle inspected by a dealer.

Interior Lights

Interior Light Switch

Front interior lights are located between the sun visors. Rear interior lights are located at the back corner of each rear window.

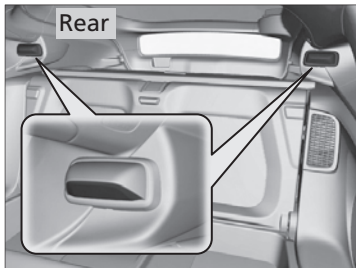
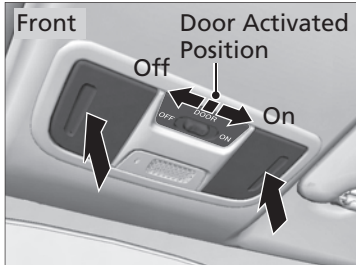

■ ON

The interior lights come on regardless of whether the doors are open or closed.

■ Door Activated

The interior lights come on in the following situations:

- When either of the doors are opened.
- You unlock the driver's door.
- You remove the key from the ignition switch.

■ OFF

The interior lights remain off regardless of whether the doors are open or closed.

Each front interior light can be used as a map light. Each light can be turned on and off by pressing the lenses.

» Interior Lights

In the door activated position, the interior lights fade out and go off about 30 seconds after the doors are closed.

The lights go off after 30 seconds in the following situations:

- When you unlock the driver's door but do not open it.
- When you remove the key from the ignition switch but do not open a door.

The interior lights go off immediately in the following situations:

- When you lock the driver's door.
- When you close the driver's door with the key in the ignition switch.
- When you turn the ignition switch to ON **II**.

If you leave either door open without the key in the ignition switch, the interior lights go off after about 15 minutes.

You can change the interior lights dimming time.

» Customized Features P.90

When the interior light switch is in the door activated position and either door is open, the front interior light will not go off when you press the lens.

■ Cargo Area Light

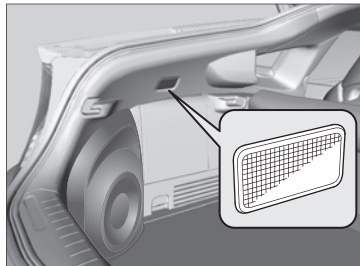

The light on the rear left side of the cargo area comes on when the hatch is opened.

Interior Convenience Items

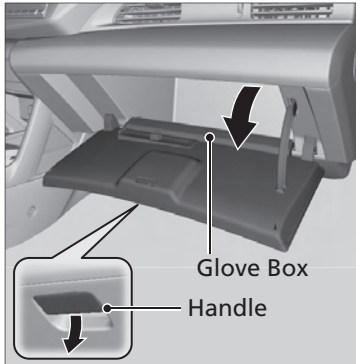

Glove Box

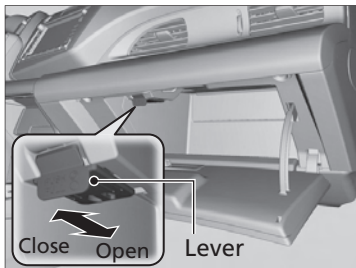

Pull the handle to open the glove box.



You can keep beverage bottles and cans cool with the air conditioning system.

1. Push the lever forward to open the air vent in the glove box.
2. Turn on the climate control system and adjust the temperature to cool.
3. Set the mode control  or .
 - The cool air is diverted through the air vent.

Glove Box

WARNING

An open glove box can cause serious injury to your passenger in a crash, even if the passenger is wearing the seat belt.

Always keep the glove box closed while driving.

The glove box light comes on when the parking lights are on.

Use only resealable containers or keep unopened cans in the glove box.

Spilled liquids can damage the upholstery and electrical components in the glove box and inside the dashboard.

When the heater begins to divert warm air, the airflow into the glove box is shut off.

■ Beverage Holders

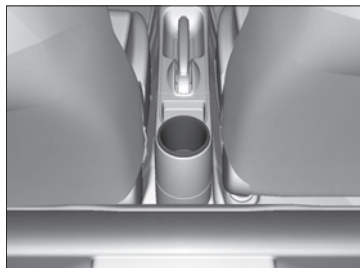
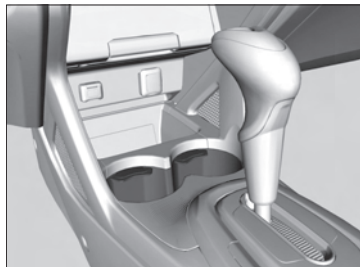

» Beverage Holders

NOTICE

Spilled liquids can damage the upholstery, carpeting, and electrical components in the interior.

Be careful when you are using the beverage holders. Hot liquid can scald you.

■ Accessory Power Socket



There is an accessory power socket in the front console panel. It can be used when the ignition switch is in ACCESSORY **I** or ON **II**.

Open the cover to use it.

☒ Accessory Power Socket

The accessory power socket is designed to supply power for 12 volt DC accessories that are rated 120 watts or less (10 amps).

NOTICE

Do not insert an automotive type cigarette lighter element. This can overheat the power socket.

To prevent 12 volt battery drain, only use the power socket with the engine running.

■ Rear Cargo Console

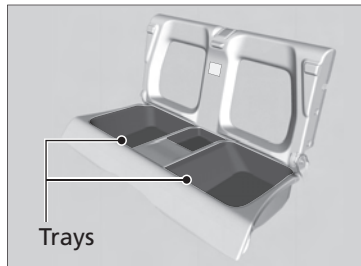

Rear trays to store small items are located on the rear cargo console.

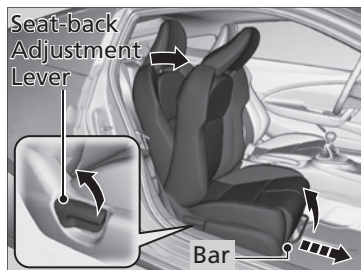

To access the rear cargo console, open the door, slide the seat by pulling up on the bar, then pull up on the seat-back adjustment lever.

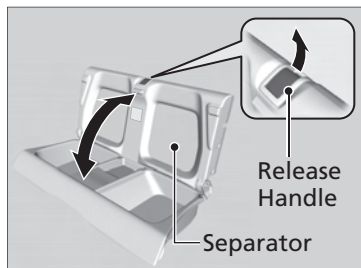

■ Separator

Folding down the separator will create more cargo area.

1. Remove any items from the rear trays.
2. Pull up the release handle on the top of the separator.

⊗ Rear Trays

⚠ WARNING

This vehicle is not equipped with rear seats or seatbelts.

Sitting in this area may result in injury or death, and may violate state laws.

Only the driver and one front seat passenger may be safely seated in this vehicle.

Make sure all items on the rear trays are secured. They could be thrown around and cause injury during a crash.

To return the separator upright, push it backwards until it locks.

Make sure that the folded separator does not press against the passenger seat, as this could cause the weight sensors to work improperly.

⊗ Side Airbag Off Indicator [P.54](#)

Make sure all items in the cargo area are secured. Loose items can fly forward if you have to brake hard.

■ Tonneau Cover

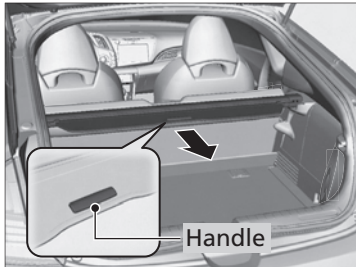

The tonneau cover can be used to conceal your parcels and protect them from direct sunlight.

■ To Extend:

Pull the handle on the center edge, then clip the mounting rods in the hooks on both sides of the hatch opening.

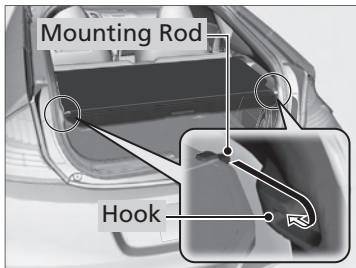

■ To Retract:

Slip the rods out of the hooks, then slowly roll it back until it is completely retracted.

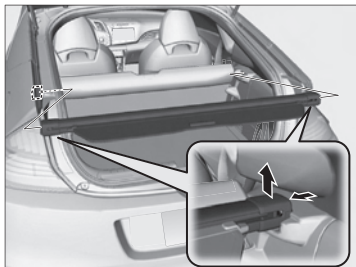

■ To Remove:

Push either end of the housing inward, then lift it out of its position.

» Tonneau Cover

Do not access parcels in the cargo area while driving. This may cause injury if you have to brake hard.

Do not stack objects higher than the top of the seat in the cargo area. They could block your view and be thrown about the vehicle during a sudden stop.

To prevent tonneau cover damage:

- Do not place items on the tonneau cover.
- Do not put weight on the tonneau cover.

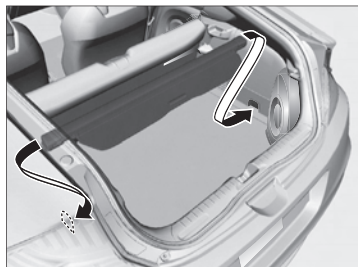

■ **To Store:**

The housing unit can be stored on the cargo area floor to make more space available.

Push one end of the unit into the hole on one side panel, then insert the other end into the hole on the other side.

After storing the unit, rock it up and down to make sure it is securely placed.

Reverse this procedure to install the housing unit in place.

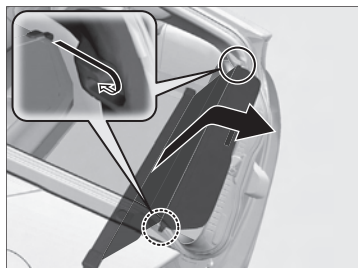

■ **To Separate the Cargo Area into two:**

1. Pull out the tonneau cover from its housing while it is stored on the cargo area floor.
2. Clip the mounting rods in the hooks at both sides of the hatch opening.

Using Automatic Climate Control

The automatic climate control system maintains the interior temperature you select. The system also selects the proper mix of heated or cooled air that will as quickly as possible, raise or lower the interior temperature to your preference.

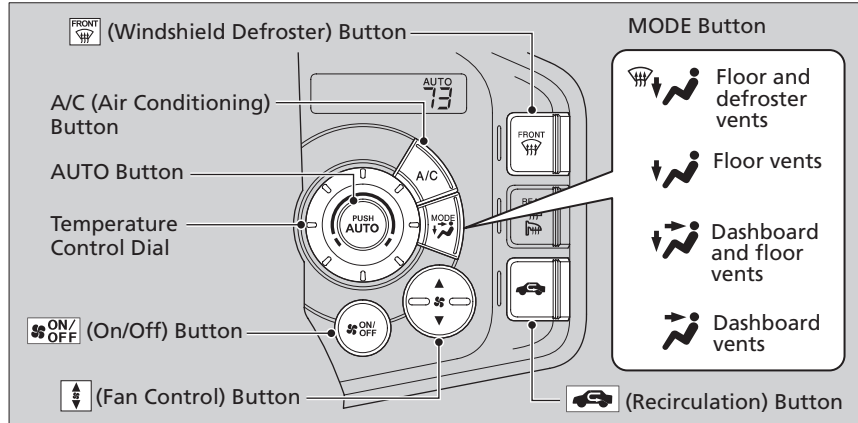

Use the system when the engine is running.

1. Press the AUTO button.
2. Adjust the interior temperature using the temperature control dial.
3. Press the **ON/OFF** button to cancel.

■ Switching Between the Recirculation and Fresh Air Modes

Press the **ON/OFF** button and switch the mode depending on environmental conditions.

Recirculation Mode (indicator on): Recirculates air from the vehicle's interior through the system.

Fresh Air Mode (indicator off): Maintains outside ventilation. Keep the system in fresh air mode in normal situations.

▣ Using Automatic Climate Control

If any buttons are pressed while using the climate control system in AUTO, the function of the button that was pressed will take priority. The AUTO indicator will go off, but functions unrelated to the button that was pressed will be controlled automatically.

During the auto idle stop, the air conditioning system will be turned off.

If the ECON mode is selected, the fan may also be turned off.

To prevent cold air from blowing in from outside, the fan may not start immediately when the AUTO button is pressed.

Once you have set the desired temperature, do not use the temperature control dial more than necessary.

Doing so may delay the time it takes to reach the set temperature.

If the interior is very warm, you can cool it down more rapidly by partially opening the windows, turning the system on AUTO, and setting the temperature to low.

When you set the temperature to the lower or upper limit, Lo or Hi is displayed.

Pressing the **ON/OFF** button switches the climate control system between on and off. The system selects your last selection.

■ Defrosting the Windshield and Windows

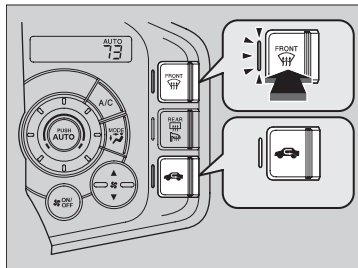

Pressing the  button turns the air conditioning system on and automatically switches the system to fresh air mode.

Press the  button again to turn off, the system returns to the previous settings.

■ To Rapidly Defrost the Windows

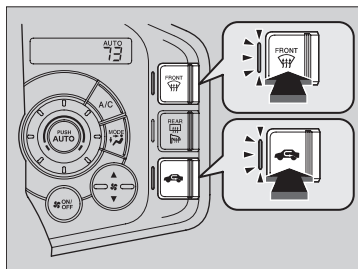

1. Press the  button.
2. Press the  button.

⌘ Defrosting the Windshield and Windows

Do not set the temperature near the upper or lower limit.

When cold air hits the windshield, the outside of the windshield may fog up.

If the side windows fog up, adjust the vents so that the air hits the side windows.

For your safety, make sure you have a clear view through all the windows before driving.

⌘ To Rapidly Defrost or Defog the Windows

After defrosting or defogging the windows, switch over to fresh air mode.

If you keep the system in recirculation mode, the windows may fog up from humidity. This impedes visibility.

On automatic transmission (CVT) model

Pressing the  button restarts the engine automatically during the auto idle stop.

On manual transmission model

To defog during the auto idle stop, restart the engine as follows.

1. Make sure the shift lever is in **N**.
2. Depress the clutch pedal fully.
3. Press the  button.

Automatic Climate Control Sensors

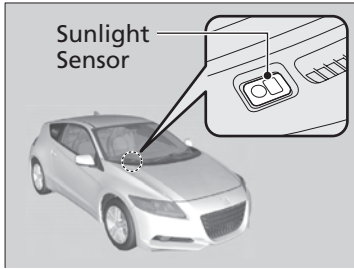

The automatic climate control system is equipped with a sunlight sensor and an interior temperature/humidity sensor. Do not cover or spill any liquid on them.

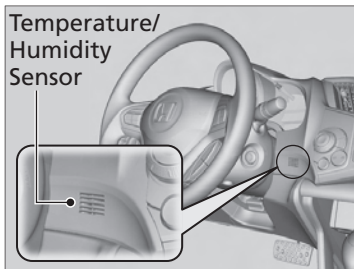

Features

This chapter describes how to operate the audio system and other technology features.

Audio System

About Your Audio System	136
Compatible iPod and USB Flash Memory Devices.....	137
USB Adapter Cable.....	138
Auxiliary Input Jack.....	139
Audio System Theft Protection	140

Audio without Navigation System

Audio System Basic Operation	141
Playing the AM/FM Radio	143
Playing a CD.....	145
Playing an iPod®	147
Playing a USB Flash Memory Device.....	149

Audio with Navigation System

Audio System Basic Operation	151
Playing the AM/FM Radio	154
Playing a Disc	156
Playing a PC Card.....	158
Playing an iPod®	162
Playing a USB Flash Memory Device.....	165

Audio Error Messages

Disc Player.....	167
iPod®/USB Flash Memory Device	168

Audio Remote Controls

General Information on the Audio System

Recommended Discs	170
Recommended USB Flash Memory Devices.....	172
Bluetooth® HandsFreeLink®	173
Using HFL.....	173
HFL Menus.....	175
Phone Setup.....	177
Making a Call.....	179
HFL Phonebook	183
Cellular Phonebook.....	185
System Setup	188

About Your Audio System

The audio system features AM/FM radio. It can also play audio discs, WMA/MP3/AAC files, iPods, and USB flash memory devices.

The audio system is operable from the buttons and switches on the panel, icons on the navigation screen, or the remote controls on the steering wheel.

The radio theft protection feature is activated if the audio system is disconnected from electric power. You need to enter an audio security code that comes with your vehicle to reactivate the disabled system.

» About Your Audio System

Video CDs, DVDs, and 3-inch (8-cm) mini discs are not supported.

iPod is a registered trademark owned by Apple Inc.

Models with navigation system

You can operate the audio system by voice commands. See the navigation system manual for full details.

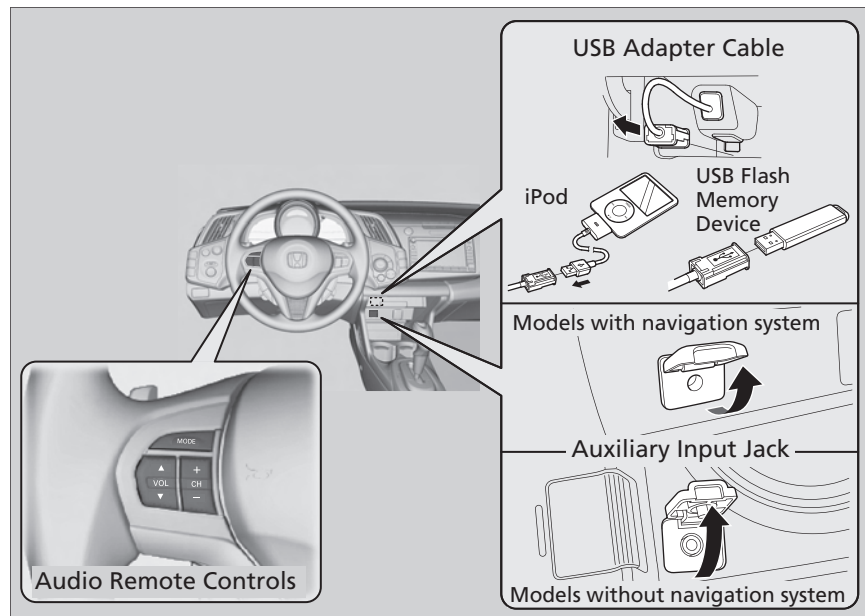

2011 CR-Z

Compatible iPod and USB Flash Memory Devices

■ iPod Model Compatibility

Model	Software
iPod classic (80/160G)	Ver. 1.1.2 or more
iPod classic (120G)	Ver. 2.0.1 or more
iPod with video (iPod 5th generation)	Ver. 1.3.0 or more
iPod nano	Ver. 1.3.1 or more
iPod nano 2nd generation	Ver. 1.1.3 or more
iPod nano 3rd generation	Ver. 1.1.3 or more
iPod nano 4th generation	Ver. 1.0.3 or more
iPod nano 5th generation	Ver. 1.0.1 or more
iPod touch	Ver. 1.1.5 or more
iPod touch 2nd generation	Ver. 2.2.1 or more

■ USB Flash Memory Devices

Use a recommended USB flash memory device of 256 MB or higher.
 Some digital audio players may not be compatible.
 Some USB flash memory devices (e.g., a device with security lockout) may not work.
 Some software files may not allow for audio play or text data display.
 Some versions of MP3, WMA, or AAC formats may be unsupported. If an unsupported file is found, the audio unit displays UNSUPPORTED, and then skips to the next file.

▣ USB Flash Memory Devices

Files on the USB flash memory device are played in their stored order. This order may be different from the order displayed on your PC or device.

USB Adapter Cable

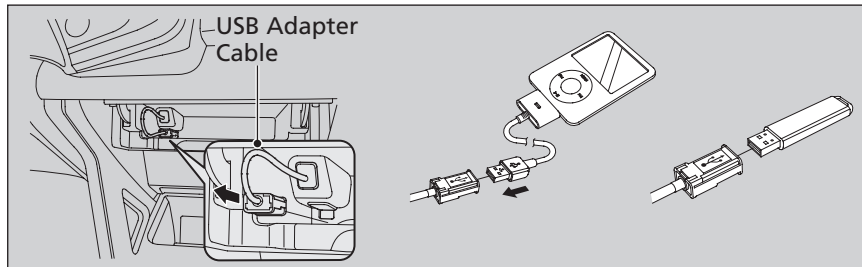

1. Pull up the center pocket lid.
2. Unclip the USB connector and loosen the adapter cable.
3. Install the iPod dock connector or the USB flash memory device to the USB connector.

⌘ USB Adapter Cable

- Do not leave the iPod or USB flash memory device in the vehicle. Direct sunlight and high temperatures may damage it.
- Do not use an extension cable with the USB adapter cable.
- Do not connect your iPod or USB flash memory device using a hub.
- Do not use a device such as a card reader or hard disk drive, as the device or your files may be damaged.
- We recommend backing up your data before using the device in your vehicle.
- Displayed messages may vary depending on the device model and software version.

If the audio system does not recognize your iPod, try reconnecting it a few times or reboot the device.

To reboot, follow the manufacturer's instructions provided with your iPod or visit www.apple.com/ipod.

Auxiliary Input Jack

Use the jack on the front panel to connect standard audio devices.

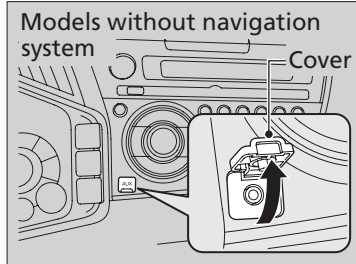

1. Open the AUX cover.
2. Connect a standard audio device to the input jack using a 1/8 inch (3.5 mm) stereo miniplug.
 - ▶ The audio system automatically switches to the AUX mode.

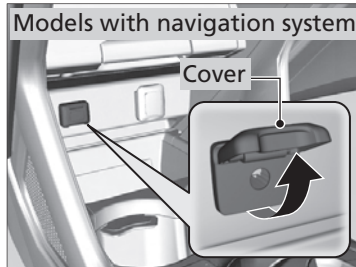

▶▶ Auxiliary Input Jack

To switch the mode, press either FM/AM, or the CD button. You can return to the AUX mode by pressing the AUX button.

Models with navigation system

Press either the AM/FM button or the CD/AUX button, or touch the icon to switch the mode.

You cannot use the auxiliary input jack if you replace the audio system.

Audio System Theft Protection

The audio system is disabled when it is disconnected from the power source, such as when the 12 volt battery is disconnected or goes dead.

■ Entering the Audio Security Code

“ENTER CODE” appears on the display when the power is reconnected.

1. Turn on the audio system.
2. Enter the security code using the preset buttons.

Models with navigation system

Touch the icon to enter the code, then touch the Done icon to set it.

If you enter an incorrect digit, continue to the last digit, then try again. If you do not enter the code correctly after 10 tries, you need to visit a dealer to have the system reset.

⊗ Audio System Theft Protection

Find the audio system's security code and serial number on the radio code card.

Do not store the card in your vehicle. If you lose the radio code card, you must obtain the information from a dealer.

Audio System Basic Operation

To use the audio system function, the ignition switch must be in ACCESSORY **I** or ON **II**.

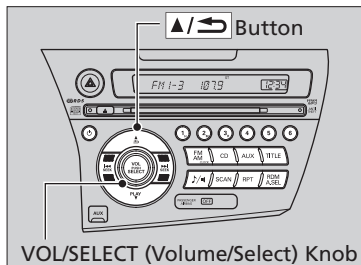

Use the VOL/SELECT knob to access some audio functions.

VOL/SELECT knob: Turns left and right to select the items. Press  to set your selection.

 button: Press to go back to the previous display.

▶▶ Audio System Basic Operation



These indications are used to show how to move the VOL/SELECT knob.

Rotate  to select.

Press  to ENTER.

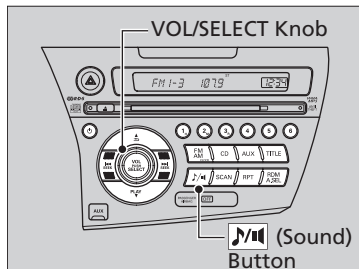
■ Adjusting the Sound



Press the  button, and rotate  to adjust the setting.

Each time you press the  button, a sound mode switches as follows.

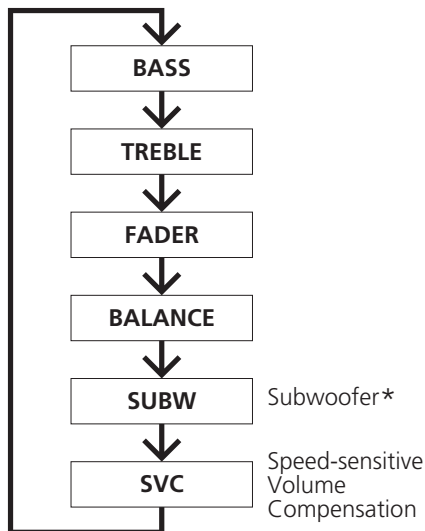

⌘ Adjusting the Sound

When the adjustment level reaches the center, you will see "C" in the display.

The SVC has four modes: OFF, LOW, MID, and HIGH.

SVC adjusts the volume level based on the vehicle speed. The faster you go, the audio volume increases. As you slow down, the audio volume decreases.

Playing the AM/FM Radio

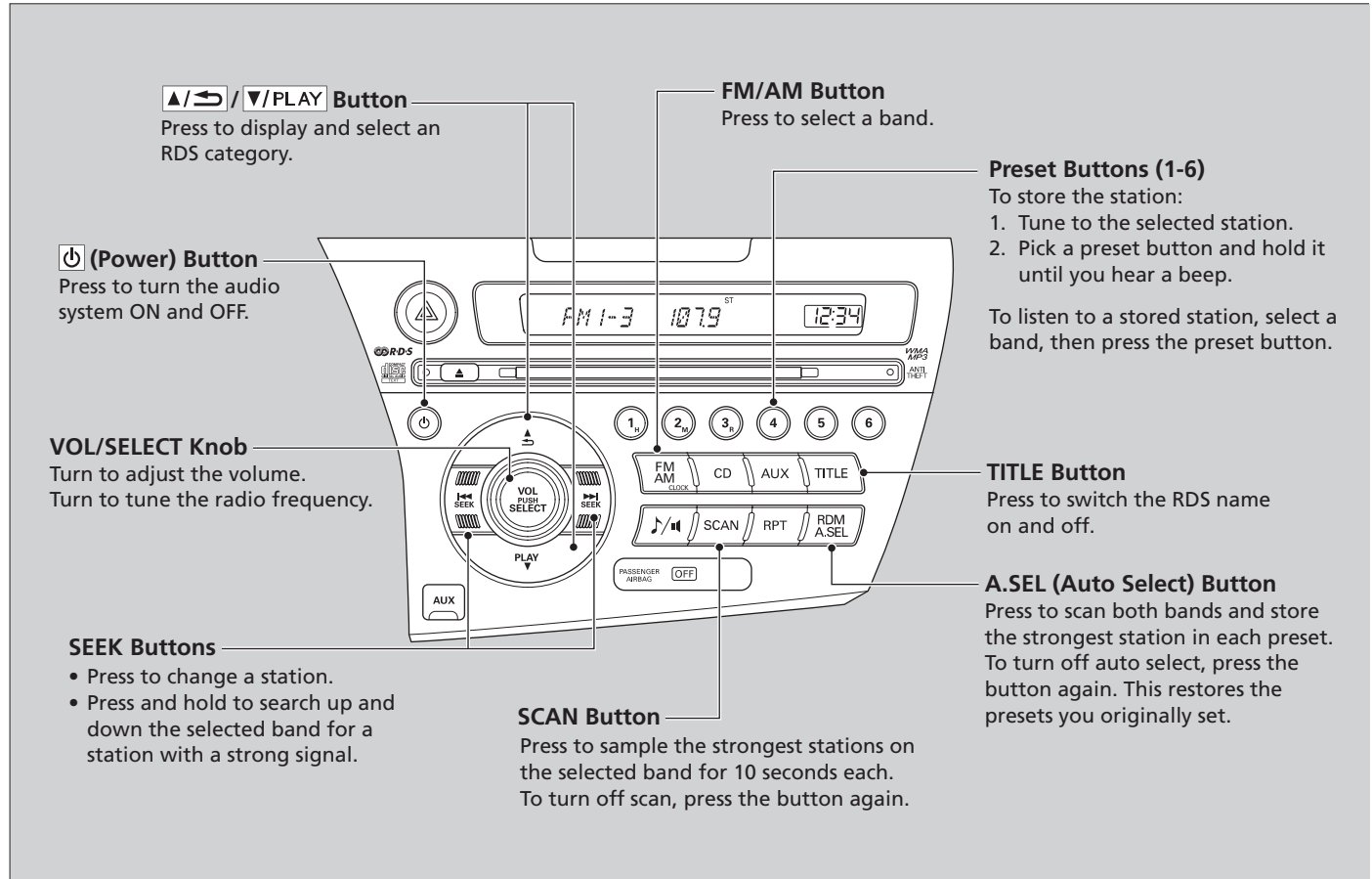

■ Radio Data System (RDS)



Provides text data information related to your selected RDS capable FM station.

■ RDS INFO ON

Press the TITLE button while listening to an RDS capable station. "RDS INFO ON" appears, and the station name is displayed.

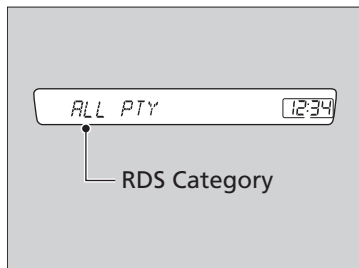
■ To Find an RDS Station from Your Selected Program Category



1. Press the  /  button to display and select an RDS category.
2. Use the SEEK or SCAN function to select an RDS station.

▶▶ Playing the AM/FM Radio

A stereo indicator (ST) comes on the display for stereo FM broadcasts. Stereo reproduction in AM is not available.

Switching the Audio Mode

Press the MODE button on the steering wheel.

▶▶ **Audio Remote Controls** [P.169](#)

You can store six AM stations and twelve FM stations in the preset buttons. FM1 and FM2 let you store six stations each.

A.SEL function scans and stores up to six AM stations and twelve FM stations with a strong signal in the preset buttons.

If you do not like the stations auto select has stored, you can store other frequencies on the preset buttons manually.

▶▶ Radio Data System (RDS)

The display shows up to 31 characters of text data. Press and hold the TITLE button to see additional characters. ▷ indicates that the text data continues.

The display goes back to the previous screen if you press and hold the button again.

Playing a CD

Your audio system supports audio CDs, CD-Rs, and CD-RWs in either MP3 or WMA format. With the disc loaded, press the CD button.

VOL/SELECT (Volume/Select) Knob
Turn to change tracks/files. Turn to select an item, then press the VOL/SELECT knob to set your selection.

▲ (Disc Eject) Button
Press to eject a disc.

⏻ (Power) Button
Press to turn the audio system ON and OFF.

SEEK Buttons
Press **◀** or **▶** to change tracks (files in MP3 or WMA).

SCAN Button
You will get a 10-seconds sampling of each song.

- Press to sample all tracks on the disc (all files in the current folder in MP3 or WMA).
- Press two times to sample the first file in each of the main folders (MP3 or WMA).
- To turn off scan, press and hold the button.

▲/↔ / ▼/PLAY Button
Press the **▲/↔** button to skip to the next folder, and the **▼/PLAY** button to skip to the beginning of the previous folder in MP3 or WMA.

Disc Slot
Insert a CD about halfway into the disc slot.

CD Button
Press to play a CD.

TITLE Button
Press to display the text data on a CD (if it was recorded with text data).

RDM (Random) Button





- Press to play all tracks/files on a disc in random order.
- Press two times to play all files in the current folder (MP3 or WMA) in random order.
- To turn off random, press and hold the button.

RPT (Repeat) Button

- Press to replay a track/file continuously.
- Press two times to replay all files in the current folder.
- To turn off repeat, press and hold the button.

Other controls shown: CD RDS, FM AM LOCK, CD, AUX, TITLE, 1-6, SCAN, RPT, RDM A.SEL, AUX, PASSENGER AIRBAG OFF.

How to Select a File from a Folder with the VOL/SELECT Knob (MP3/WMA)

1. Press  to switch the display to a folder list.
2. Rotate  to select a folder.
 - ▶ Press the **▼/PLAY** button to play the first file on the selected folder.
3. Press  to change the display to a file list of that folder.
4. Rotate  to select a file, then press .

▶▶ Playing a CD

NOTICE

Do not use CDs with adhesive labels. The label can cause the CD to jam in the unit.

WMA files protected by digital rights management (DRM) cannot be played.

The audio system displays UNSUPPORTED, then skips to the next file.

Text data appears on the display under the following circumstances:

- When you select a new folder, file, or track.
- When you change the audio mode to CD.
- When you insert a CD.

The display shows up to 31 characters of text data. Press and hold the TITLE button to see additional characters. ▷ indicates that the text data continues.

The display goes back to the previous screen if you press and hold the button again.

If you eject the CD but do not remove it from the slot, the system reloads the CD automatically after several seconds.



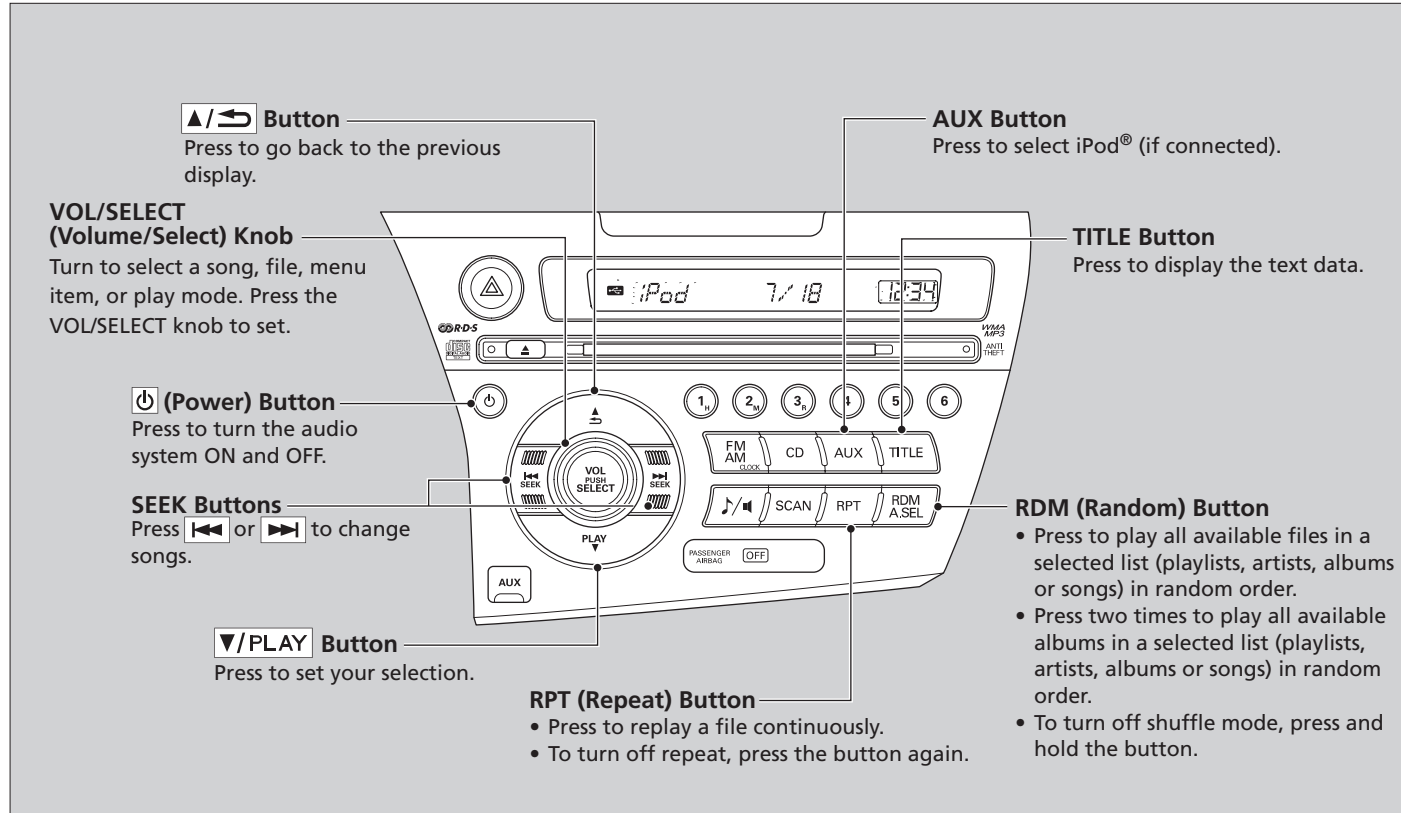

Playing an iPod®

Connect your iPod using your dock connector to the USB adapter cable, then press the AUX button.

🔌 **Connecting an iPod/USB Flash Memory Device** [P.138](#)



■ How to Select a File from iPod Menu

1. Press  to display the iPod menu.
2. Rotate  to select a menu.
3. Press  to display the items on that menu.
4. Rotate  to select an item, then press .

▶▶ Playing an iPod®

Use only compatible iPods with the latest software. This audio system cannot operate an iPod as a mass storage device.

▶ **General Information** [P.137](#)

Available operating functions vary on models or versions. Some functions may not be available on the vehicle's audio system.

If there is a problem, you may see an error message on the audio display.

▶ **iPod® Error Messages** [P.168](#)

Playing a USB Flash Memory Device

Your audio system reads and plays sound files on a USB flash memory device in either MP3, WMA or AAC*¹ format. Connect your USB flash memory device to the USB adapter cable, then press the AUX button.

☒ Connecting an iPod/USB Flash Memory Device P.138

▲/▶ / ▼/PLAY Button
Press the ▲/▶ button to skip to the next folder, and the ▼/PLAY button to skip to the beginning of the previous folder.

VOL/SELECT (Volume/Select) Knob
Turn to select a file, then press the VOL/SELECT knob to play.

(Power) Button
Press to turn the audio system ON and OFF.

SEEK Buttons
Press ◀ or ▶ to change files.

SCAN Button
You will get a 10-second sampling of each file.

- Press to sample all files in the current folder.
- Press two times to sample the first file in each of the main folders.
- To turn off scan, press and hold the button.

AUX Button
Press to select USB flash memory device (if connected).

TITLE Button
Press to display the text data.

RDM (Random) Button







- Press to play all files in random order.
- Press two times to play all files in the current folder in random order.
- To turn off random, press and hold the button.

RPT (Repeat) Button

- Press to replay a file continuously.
- Press two times to replay all files in the current folder.
- To turn off repeat, press and hold the button.

*1: Only AAC format files recorded with iTunes® are playable on this audio unit.

■ How to Select a File form a Folder with the VOL/SELECT Knob

1. Press  to switch the display to a folder list.
2. Rotate  to select a folder.
 - ▶ Press the  button to play the first file on the selected folder.
3. Press  to change the display to a file list of that folder.
 - ▶ Press the  button to go back to the previous display.
4. Rotate  to select a file, then press .

⌘ Playing a USB Flash Memory Device

Use the recommended USB flash memory devices.

⌘ **General Information** [P.137](#)

Files in WMA format protected by digital rights management (DRM) cannot be played.

The audio system displays UNPLAYABLE FILE, and then skips to the next file.

If there is a problem, you may see an error message on the audio display.

⌘ **USB Flash Memory Device Error Messages** [P.168](#)

Audio System Basic Operation

To use the audio system, the ignition switch must be in ACCESSORY **I** or ON **II**.

Operation with the Control Icons

To operate the audio system, press the control buttons on the side of the screen or touch the control icons on the audio screen.

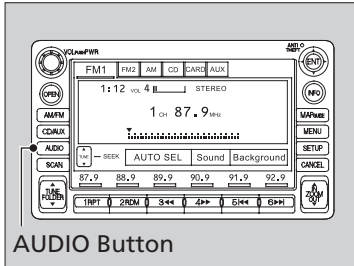

Press the AUDIO button to show the audio screen.

To select any function, touch the appropriate icon on the screen.

How to Access the Disc Slot or PC Card Slot

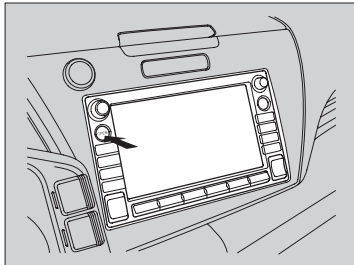

Press the OPEN button.

The screen folds back, and the disc and PC card slots appears.

Audio System Basic Operation

Voice Control System

The audio system is voice operable. See the navigation system manual for details.

Operation with the Control Icons

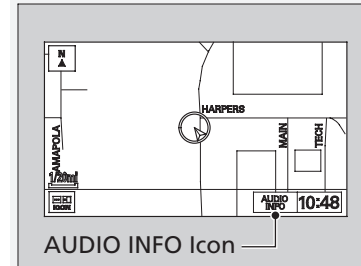

On the navigation screen, touch the AUDIO INFO icon to see the selected audio information. Press any of the audio buttons to display the audio status bar at the bottom of the screen.

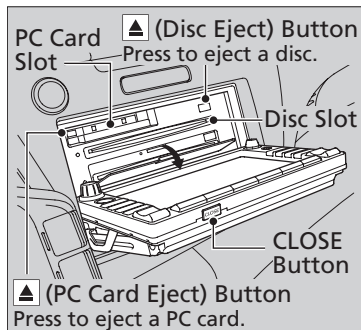

Push the CLOSE button to return the screen to the upright position.

■ Adjusting the Sound

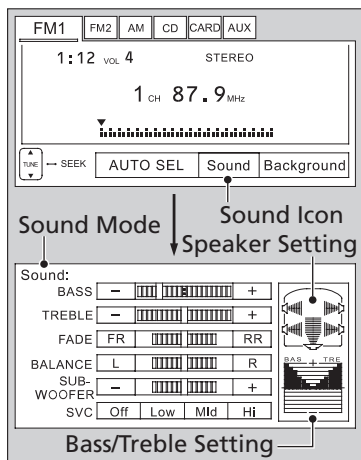

Press the AUDIO button, then touch the Sound icon.

Adjustable Settings:

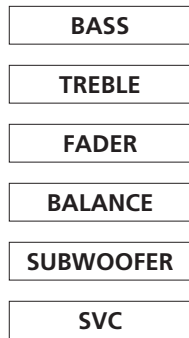

Speed-sensitive Volume Compensation

To adjust each setting, touch any setting icon such as FR or RR on the fader setting.

⌘ Operation with the Control Icons

If you eject the disc but do not remove it from the slot, the system reloads the disc automatically after several seconds.

Do not use the folded down screen as a tray.

⌘ Adjusting the Sound

When the adjustment level reaches the center, you will see "C" in the display.

The SVC has four modes: OFF, LOW, MID, and HIGH.

SVC adjusts the volume level based on the vehicle speed. The faster you go, the audio volume increases. As you slow down, the audio volume decreases. If you feel the sound is too loud, choose low.

The system automatically returns to the selected audio mode several seconds after you stop adjusting a setting.

■ Selecting the Background

There are three backgrounds to choose from when displaying sound levels:

Level: The sound level is shown with the vertical bars.

Spectrum Analysis: The sound level appears as ripples of water.

Off

Each time you touch the Background icon, the screen changes.

■ Operation with the Joystick

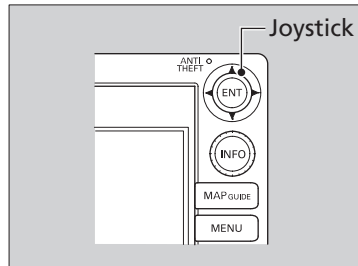

Use the joystick to select an icon on the screen and access some audio functions.

Push left, right, up, or down to select an item.

Press to set your selection.

Playing the AM/FM Radio

VOL/PWR (Volume/Power) Knob

Press to turn the audio system ON and OFF.
Turn to adjust the volume.

AM/FM Button

Press to change the band.

AUDIO Button

Press to display the audio mode on the navigation screen.

SCAN Button

Press to sample the strongest stations on the selected band for 10 seconds each.
To turn off scan, press it again.

FM1/FM2/AM Icon

Touch to select the band.

Navigation Display

Joystick

AUTO SEL (Auto Select) Icon

Touch to scan both bands and store the strongest station in each preset.
To turn off auto select, touch it again. This restores the presets you originally set.

Preset Buttons (1-6)

To store the station:
1. Tune to the selected station.
2. Pick a preset button and hold it until you hear a beep.

To listen to a stored station, select a band, then press the preset button.

TUNE Bar

- Press either side to select a station.
- Press and hold to search for a station with a strong signal up and down the selected band.

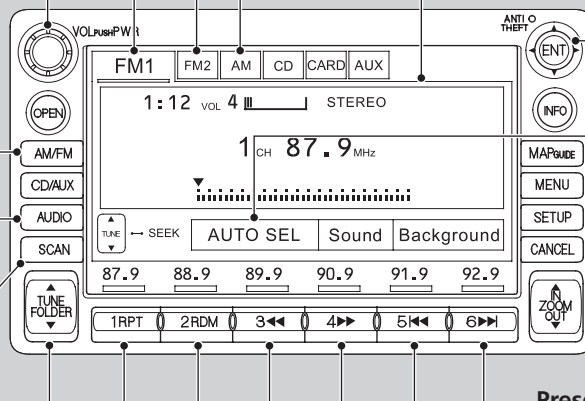

▶▶ Playing the AM/FM Radio

A stereo indicator (STEREO) comes on the display for stereo FM broadcasts.

Stereo reproduction in AM is not available.

Switching the Audio Mode

Press the MODE button on the steering wheel.

▶▶ **Audio Remote Controls** [P.169](#)

You can store six AM stations and twelve FM stations in the preset buttons. FM1 and FM2 let you store six stations each.

AUTO SEL scans and stores up to six AM stations and twelve FM stations with a strong signal in the preset buttons.

If you do not like the stations auto select has stored, you can store other frequencies on the preset buttons manually.

Playing a Disc

Your audio system supports audio CDs, CD-Rs, and CD-RWs in either MP3 or WMA format. With the disc loaded, press the CD/AUX button or touch the CD icon.

VOL/PWR (Volume/Power) Knob
Press to turn the audio system ON and OFF.
Turn to adjust the volume.

CD/AUX Button
Press to play the disc.

AUDIO Button
Press to display the audio mode on the navigation screen.

SCAN Button
You will get a 10-second sampling of each song.

- Press to sample all tracks on the disc (all files in the current folder in MP3 or WMA).
- Press two times to sample the first file in each folder on the disc (MP3 or WMA).
- To turn off scan, press and hold the button.

FOLDER Bar
Press ▲ to skip to the next folder, and ▼ to skip to the beginning of the previous folder in MP3 or WMA.

RPT (Repeat) Button

- Press to replay a track/file continuously.
- Press and hold to replay all files in the current folder (MP3 or WMA).
- To turn off repeat, press the button again.

RDM (Random) Button

- Press to play all tracks/files in random order.
- Press and hold to play all files in the current folder (MP3 or WMA) in random order.
- To turn off random, press the button again.

Navigation Display

Joystick

▶▶ / ◀◀ (Fast Forward/Rewind) Buttons
Press and hold to move rapidly within a track/file.

▶▶ / ◀◀ (Skip) Buttons
Press ▶▶ or ◀◀ to change tracks (files in MP3 or WMA).

CD Icon
Touch to play the disc.

Navigation Display

The navigation display shows the following information:
 - Top: VOL/PWR, FM1, FM2, AM, CD, CARD, AUX, ANTI THEFT (ENT)
 - Center: 1:12 VOL 4, MP3, TRACK 01 Track A, FOLDER 256 AAAA, TIME 02' 35"
 - Bottom: SCAN, FOLDER SCAN, Track List, Sound, Background, TRACK REPEAT, TRACK RANDOM, REW, FF, SKIP -, SKIP +, CANCEL, ZOOM OUT

How to Select a File from a List (MP3/WMA)

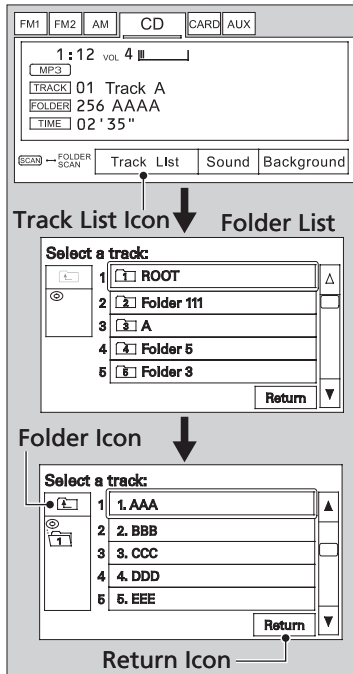

1. Touch the Track List icon to display a folder list.
2. Touch the ▲ or ▼ icon to scroll through the list, and touch an icon to select a folder.
3. Scroll through the list and touch an icon to select a file.
 - ▶ Touch the Return icon to go back to the previous screen.
 - ▶ Touch the folder icon on the upper left to move to the parent folder.

- Any songs not in a folder will automatically be added to the "Root" folder, which is then displayed at the top of the Folder List.
- If the root folder has some additional folders in the lower layer, they will be listed on the screen.
- To exit the list, press the AUDIO button.

▶▶ Playing a Disc

NOTICE

Do not use discs with adhesive labels. The label can curl up and cause the disc to jam in the unit.

WMA files protected by digital rights management (DRM) cannot be played.

The audio system displays FILE ERROR, then skips to the next file.

Playing a PC Card

Your audio system reads and plays audio files on a PC card in either MP3 or WMA format. Insert a PC card into the PC card slot, then press the CD/AUX button, or touch the AUX icon.

➤ **How to Access the Disc Slot or PC Card Slot** P.151

VOL/PWR (Volume/Power) Knob
Press to turn the audio system ON and OFF.
Turn to adjust the volume.

Navigation Display

CD/AUX Button
Press to play the PC card.

AUDIO Button
Press to display the audio mode on the navigation screen.

SCAN Button
You will get a 10-second sampling of each song.
• Press to sample all files.
• Press and hold to sample the first file in each folder/artist/album.
• To turn off scan, press the button again.

FOLDER Bar
Press ▲ to skip to the next folder, and ▼ to skip to the beginning of the previous folder.

RPT (Repeat) Button
• Press to replay a file continuously.
• Press and hold to replay all files in the current folder.
• To turn off repeat, press the button again.

RDM (Random) Button
• Press to play all files in the current folder in random order.
• Press and hold to play all files in each folder/artist/album in random order.
• To turn off random, press the button again.

AUX Icon
Touch to play the PC card.

PLAY MODE Icon
Touch to select any of three modes (folder, artist, album).

Joystick

Fast Forward/Rewind Buttons
Press and hold to move rapidly within a file.

Skip Buttons
Press ►► or ◀◀ to change files.

Navigation Screen Content:
VOL PWR, FM1 FM2 AM CD CARD AUX, ENT, ANTI THEFT, INFO, MAP, MENU, SETUP, CANCEL, ZOOM OUT, TRACK 01 Track A, FOLDER 256 AAAA, TIME 02' 35", SCAN, FOLDER SCAN, Track List, Sound, Background, TRACK REPEAT, TRACK RANDOM, REW, FF, SKIP -, SKIP +, 1RPT, 2RDM, 3◀◀, 4►►, 5◀◀, 6►►

How to Select a Play Mode

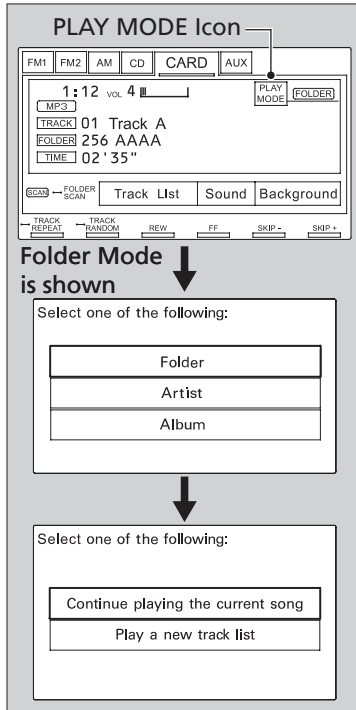

1. Touch the PLAY MODE icon.

There are three play modes:

Folder mode: Plays files in the order they are recorded to the PC card.

Artist mode: Plays files in alphabetical order, by artist and song title.

Album mode: Plays albums (folders) in alphabetical order.

2. Touch the play mode icon.

3. Touch either playing menu.
 - ▶ "Continue playing the current song" goes into the selected play mode after playing the current file.

How to Select a Play Mode

Pressing the CANCEL button goes back to the previous screen. To exit the play mode screen, press the AUDIO button.

WMA format protected by digital rights management (DRM) cannot be played. The audio system skips to the next file.

If there is a problem with the PC card player, see a dealer.

■ How to Select a File from a List

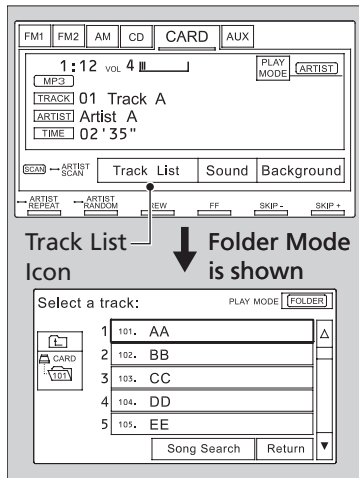

1. Touch the Track List icon.

2. Touch an icon to select a file.
- ▶ Touch the Return icon to go back to the previous screen.
 - ▶ In folder mode, touch the folder icon on the upper left to move to the parent folder.
 - ▶ Touch the ▲ or ▼ icon to scroll through the list.

☒ How to Select a File from a List

In artist mode, artist name list is shown.

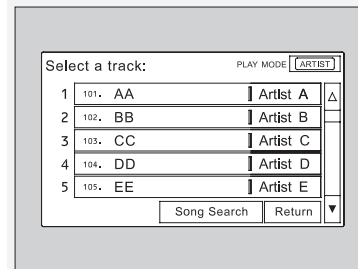

In album mode, album name list is shown.

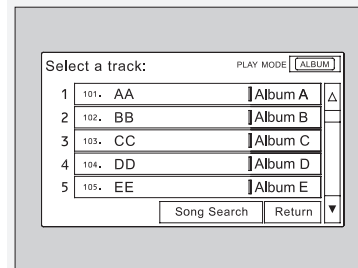

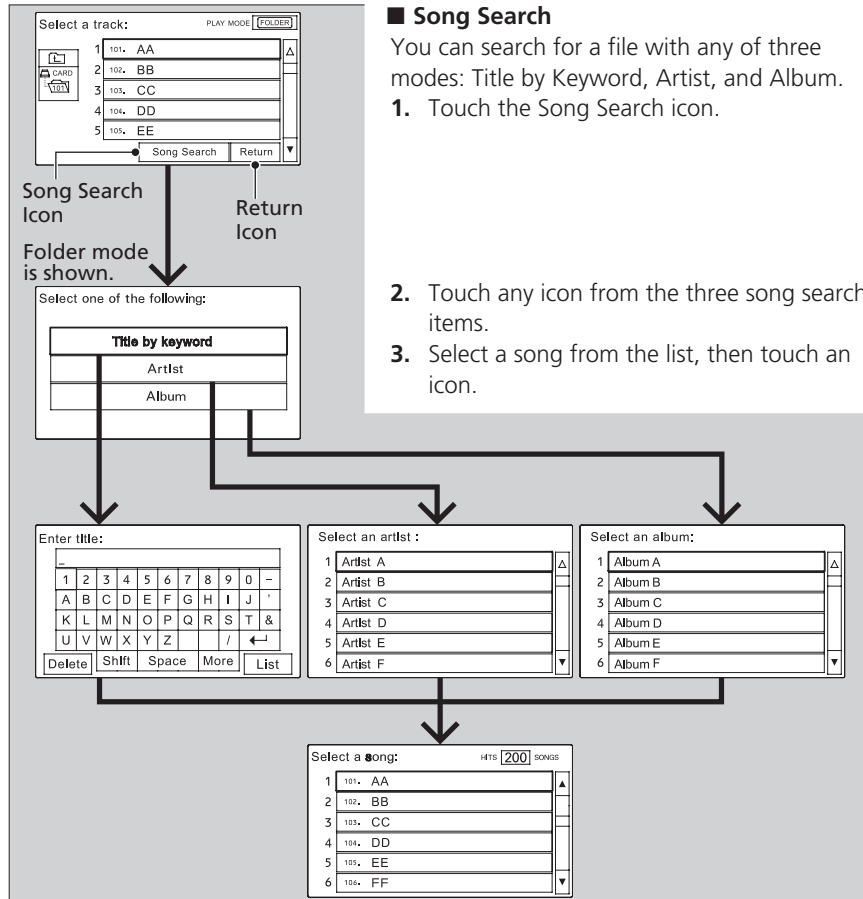

☒ Song Search

- Touch the Return icon to go back to the previous screen.
- In folder mode, touch the folder icon on the upper left to move to the parent folder.
- Touch the ▲ or ▼ icon to scroll through the list.

In Title by Keyword mode, touch the letter icons to enter the title name or any keyword. Touch the List icon to begin the song search.

Delete icon: Touch to cancel the selected letter.
More icon: Touch to show the other character list.

Press the CANCEL button to exit the song search mode.

Playing an iPod®

Connect your iPod using your dock connector to the USB adapter cable, then press the CD/AUX button or touch the USB icon.

▶ [Connecting an iPod/USB Flash Memory Device P.138](#)

VOL/PWR (Volume/Power) Knob

Press to turn the audio system ON and OFF.
Turn to adjust the volume.

CD/AUX Button

Press to play an iPod®.

AUDIO Button

Press to display the audio mode on the navigation screen.
The display shows the current file number and total of playable files.

USB Icon

Touch to play an iPod®.

Joystick

Navigation Display

▶▶ / ◀◀ (Skip) Buttons

Press ▶▶ or ◀◀ to change files.

RPT (Repeat) Button

- Press to replay a file continuously.
- To turn off repeat, press the button again.

RDM (Random) Button

- Press to play all available files in a selected list (playlists, artists, albums or songs) in random order.
- Press and hold to play all available albums in a selected list (playlists, artists, albums or songs) in random order.
- To turn off shuffle mode, press the button again.

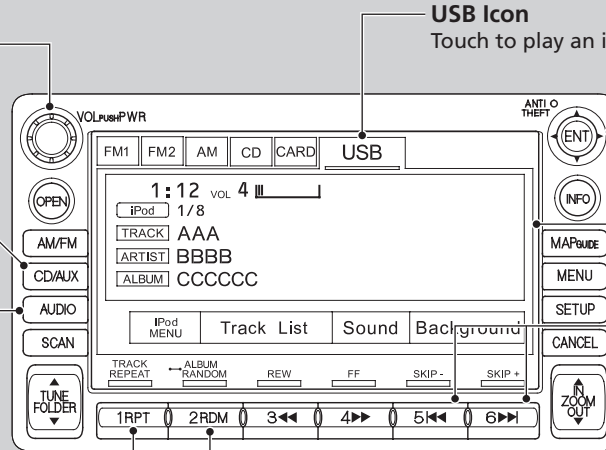

How to Select a File from the iPod Menu

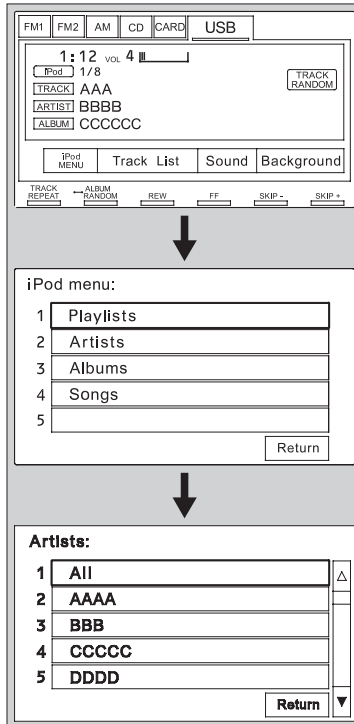

1. Touch the iPod MENU icon.

2. Touch any of the mode icons (playlists, artists, albums, and songs).

3. Touch an item on the displayed list.

- ▶ Touch the Return icon to go back to the previous screen.
- ▶ Touch the ▲ or ▼ icon to scroll through the list.

▶▶ Playing an iPod®

Use only compatible iPods with the latest software. This audio system cannot operate an iPod as a mass storage device.

▶ [General Information P.137](#)

Available operating functions vary on models or versions. Some functions may not be available on the vehicle's audio system.

If there is a problem, you may see an error message on the display.

▶ [iPod® Error Messages P.168](#)

Voice Control System

You can select the AUX mode by using the navigation system voice control buttons, but you cannot operate the play mode functions by voice.

Pressing the CANCEL button goes back to the previous screen. To exit the play mode screen, press the AUDIO button.

■ How to Select a File from a Track List

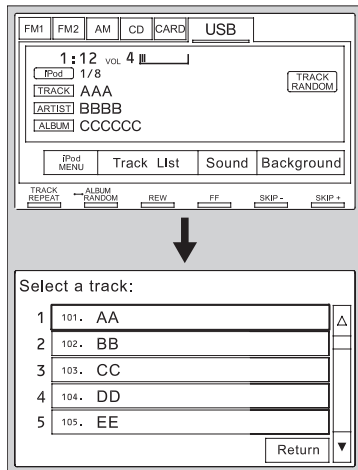

1. Touch the Track List icon.

2. Touch an item on the displayed list.

- ▶ Touch the Return icon to go back to the previous screen.
- ▶ Touch the ▲ or ▼ icon to scroll through the list.

Playing a USB Flash Memory Device

Your audio system reads and plays audio files on a USB flash memory device in either MP3, WMA or AAC*1 format.

Connect your USB flash memory device to the USB adapter cable, then press the CD/AUX button or touch the USB icon.

☒ **Connecting an iPod/USB Flash Memory Device** P.138

VOL/PWR (Volume/Power) Knob
Press to turn the audio system ON and OFF.
Turn to adjust the volume.

CD/AUX Button
Press to play a USB flash memory device.

AUDIO Button
Press to display the audio mode on the navigation screen.

SCAN Button
You will get a 10-second sampling of each song.

- Press to sample all files in the current folder.
- Press to sample first file in the main folder.
- To turn off scan, press the button again.

FOLDER Bar
Press ▲ to skip to the next folder, and ▼ to skip to the beginning of the previous folder.

RPT (Repeat) Button

- Press to replay a file continuously.
- Press and hold to replay all files in the current folder.
- To turn off repeat, press the button again.

RDM (Random) Button

- Press to play all files in random order.
- Press and hold to play all files in the current folder in random order.
- To turn off random, press the button again.

USB Icon
Touch to play a USB flash memory device.

Joystick

Navigation Display

(Skip) Buttons
Press ►► or ◀◀ to change files.

The diagram shows a central navigation display with the following information: '1:12 VOL 4', 'MP3', 'TRACK 01 Track A', 'FOLDER 256 AAAA', and 'TIME 02'35"'. Below the display are buttons for 'FOLDER REPEAT', 'FOLDER RANDOM', 'REW', 'FF', 'SKIP-', and 'SKIP+'. At the bottom of the display are buttons labeled '1RPT', '2RDM', '3◀◀', '4▶▶', '5◀◀', and '6▶▶'. The physical interface includes a 'VOL/PWR' knob, 'OPEN', 'AM/FM', 'CD/AUX', 'AUDIO', 'SCAN', and 'TUNE FOLDER' buttons on the left; a 'USB' icon, 'ENT', 'INFO', 'MAP/POU', 'MENU', 'SETUP', 'CANCEL', and 'ZOOM OUT' buttons on the right; and a joystick at the top right.

*1: Only AAC format files recorded with iTunes® are playable on this audio unit.

■ How to Select a File from a Folder

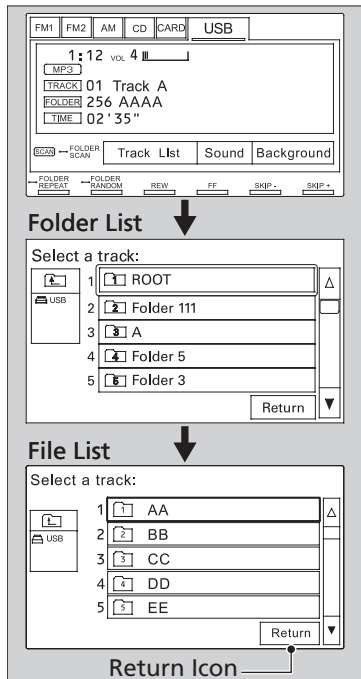

1. Touch the Track List icon.

2. Touch the ▲ or ▼ icon to scroll through the list, and touch an icon to select a folder.

3. Scroll through the list and touch an icon to select a file.

- ▶ Touch the Return icon to go back to the previous screen.
- ▶ Touch the folder icon on the upper left to move to the parent folder.

- If a song is not in a folder, it automatically goes to a “Root” folder, which is at the top of the Folder List.
- If the root folder has additional folders in the lower layer, they will be listed on the screen.
- To exit the list, press the AUDIO button.

▶▶ Playing a USB Flash Memory Device

Use the recommended USB flash memory devices.

▶ General Information P.137

WMA format protected by digital rights management (DRM) cannot be played.

The audio system displays UNPLAYABLE FILE, and then skips to the next file.

Some versions of MP3, WMA or AAC format may not be supported.



The audio system displays UNSUPPORTED, and then skips to the next file.

If there is a problem, you may see an error message on the display.

▶ USB Flash Memory Device Error Messages P.168

Disc Player

If a disc error occurs, you may see the following error messages.

Error Message	Cause	Solution
HEAT ERROR	High temperature	<ul style="list-style-type: none"> • Turn the audio system off and allow the player to cool down until the error message is cleared.
UNSUPPORTED	Track/file format not supported	<ul style="list-style-type: none"> • Current track/file will be skipped. The next supported track/file plays automatically.
BAD DISC PLEASE CHECK OWNERS MANUAL PUSH EJECT	Mechanical error	<ul style="list-style-type: none"> • Press the  (eject) button and remove the disc, and check that the error message is cleared. • Check that the disc is not damaged or deformed, and insert the disc again. ➤ Protecting Discs P.171
MECH ERROR		<ul style="list-style-type: none"> • If the error message reappears, press the  button, and pull out the disc. • Insert a different disc. If the new disc plays, there is a problem with the first disc. • If the error message repeats, or the disc cannot be removed, contact your dealer. Do not try to force the disc out of the player.
CHECK DISC	Disc error	<ul style="list-style-type: none"> • Check that the disc is not damaged or deformed. ➤ Protecting Discs P.171

iPod®/USB Flash Memory Device

If an error occurs while playing an iPod or USB flash memory device, you may see the following error messages.

If you cannot clear the error message, contact your dealer.

Error Message	Solution
USB ERROR	There is a problem with the USB adapter unit.
BAD USB DEVICE PLEASE CHECK OWNERS MANUAL	An incompatible device is connected. Disconnect the device. Then turn the audio system off, and turn it on again. Do not reconnect the device that caused the error.
iPod NO SONG	Appears when the iPod is empty.
UNSUPPORTED VER.	Appears when an unsupported iPod is connected. If it appears when a supported iPod is connected, update the iPod software to the newer version.
CONNECT RETRY	Appears when the system does not acknowledge the iPod. Reconnect the iPod.
UNPLAYABLE FILE	Appears when the files in the USB flash memory device are DRM or an unsupported format. This error message appears for about 3 seconds, then plays the next song.
USB NO SONG	Appears when the USB flash memory device is empty or there are no MP3, WMA, or AAC files in the USB flash memory device.
UNSUPPORTED	Appears when an unsupported device is connected. If it appears when the supported device is connected, reconnect the device.

Allows you to operate the audio system while driving.

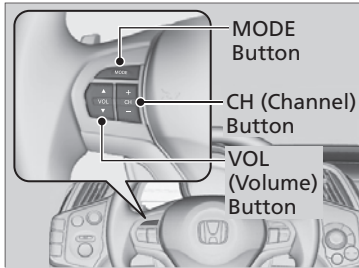

MODE Button

Cycles through the audio modes as follows:

Models without navigation system

FM1 → FM2 → AM → Disc → AUX

Models with navigation system

FM1 → FM2 → AM → Disc → PC Card → AUX

VOL Button

Press ▲ : Increases the volume

Press ▼ : Decreases the volume

CH Button

- When listening to the radio
 - Press + : Selects the next preset radio station.
 - Press - : Selects the previous preset radio station.
- When listening to a disc, PC Card, USB flash memory device or iPod
 - Press + : Skips to the next song.
 - Press - : Goes back to the beginning of the current or previous song.

Audio Remote Controls

When in the AUX mode, the following is operable from the remote controls:

- iPod/USB flash memory device connected to the USB adapter cable

Recommended Discs

- Use only high-quality CD-R or CD-RW discs labeled for audio use.
- Use only CD-R or CD-RW discs on which the recordings are closed.
- Play only standard round shaped discs.

The disc packages or jackets should have one of these marks.



❏ Recommended Discs

A dual-disc cannot play on this audio unit. If recorded under certain conditions, a CD-R or CD-RW may not play either.

■ Protecting Discs

Follow these precautions when handling or storing discs.

- Store a disc in its case when it is not being played.
- When wiping a disc, use a soft clean cloth from the center to the outside edge.
- Handle a disc by its edge. Never touch either surface.
- Never insert foreign objects into the disc player.
- Keep discs out of direct sunlight and extreme heat.
- Do not place stabilizer rings or labels on the disc.
- Avoid fingerprints, liquids, and felt-tip pens on the disc.

» Protecting Discs

NOTICE

Do not insert a damaged disc. It may become stuck inside and damage the audio unit.

Examples:

- Bubbled, wrinkled, labeled, and excessively thick discs

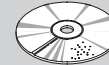

Bubbled/
Wrinkled

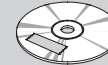

With Label/
Sticker



Using Printer
Label Kit

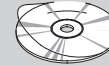

Sealed

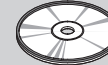

With Plastic Ring

- Damaged discs

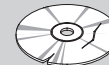

Chipped/
Cracked

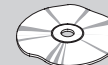

Warped

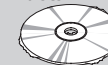

Burrs

- Poor quality discs

- Small discs



3-inch
(8-cm)
CD

The following formats may not be compatible with the audio system:



Recommended USB Flash Memory Devices

Use a recommended USB flash memory device of 256 MB or higher.

Recommended PC Card

Based on PCMCIA 2.1/JEIDA 4.2:

CompactFlash

Flash ATA

SD memory card

Always use the recommended memory card with the appropriate adapter (if an adapter is needed). Some memory cards will not work in this unit.

■ Protecting PC Cards

- Do not leave the PC card in the vehicle. Direct sunlight and high temperatures may damage it.
- Make sure to put a PC card straight into the slot.
- Do not insert anything other than a PC card into the slot.
- Do not close the screen (move it to the upright position) until the PC card is inserted all the way into its slot or is removed.
- We recommend backing up your data before using the device in your vehicle.
- Never insert foreign objects into the PC card slot.

Bluetooth® HandsFreeLink® (HFL) allows you to place and receive phone calls using your vehicle's audio system, without handling your cell phone.

Using HFL

HFL Buttons

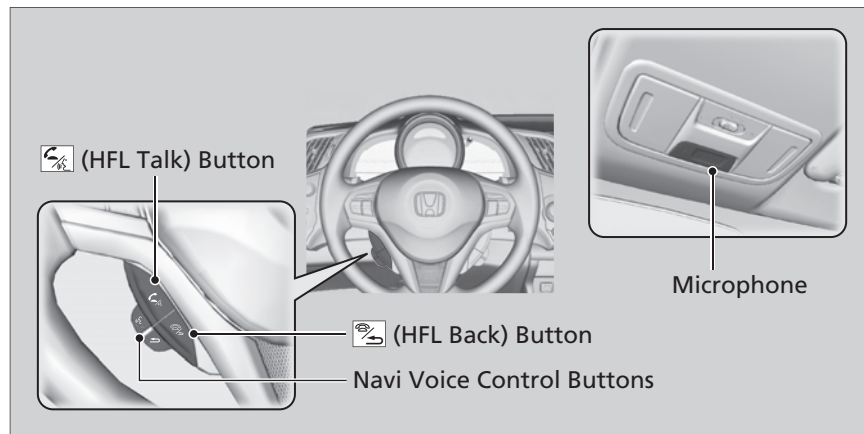

 **Button:** Press to give a command or answer a call.

 **Button:** Press to end a call, go back to the previous command, or cancel a command.

Bluetooth® HandsFreeLink® (HFL)

To use HFL, you need a Bluetooth-compatible cell phone. For a list of compatible phones, pairing procedures, and special feature capabilities:

- U.S.: Visit www.handsfreelink.honda.com, or call (888) 528-7876.
- Canada: Visit www.honda.ca, or call (888) 9-HONDA-9.

Voice Control Tips:

- Adjust or close the vents and all windows, as noise coming from them may interfere with the microphone.
- Press and release the  button before giving a command. Speak clearly and naturally after a beep.
- If the microphone picks up voices other than yours, the command may be misinterpreted.
- A command that consists of several words can be spoken together. For example, say "Call 123-456-7890" at once.
- When HFL is in use, navigation voice commands cannot be recognized.
- To change the volume level, use the audio system's volume knob or the remote audio controls.

■ Help Features

- To hear general HFL information and help, say “Tutorial.”
- Say “Hands-free help” or “Help” any time to get help or hear a list of commands.

■ Multi-Information Display

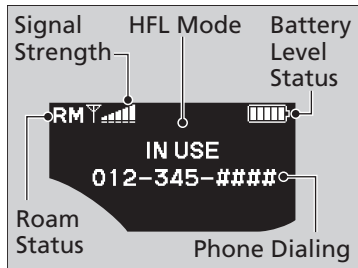

The multi-information display notifies you when there is an incoming call.

☒ Bluetooth® HandsFreeLink® (HFL)

Bluetooth® Wireless Technology
Bluetooth® name and logos are registered trademarks owned by *Bluetooth* SIG, Inc., and any use of such marks by Honda Motors Co., Ltd., is under license. Other trademarks and trade names are those of their respective owners.

☒ Multi-Information Display

The information that appears on the multi-information display varies between phone models.

HFL Menus

The ignition switch must be in ACCESSORY **I** or ON **II** to use HFL.

☒ HFL Menus

To use HFL, you must first pair your *Bluetooth*-compatible cell phone to the system while the vehicle is parked.

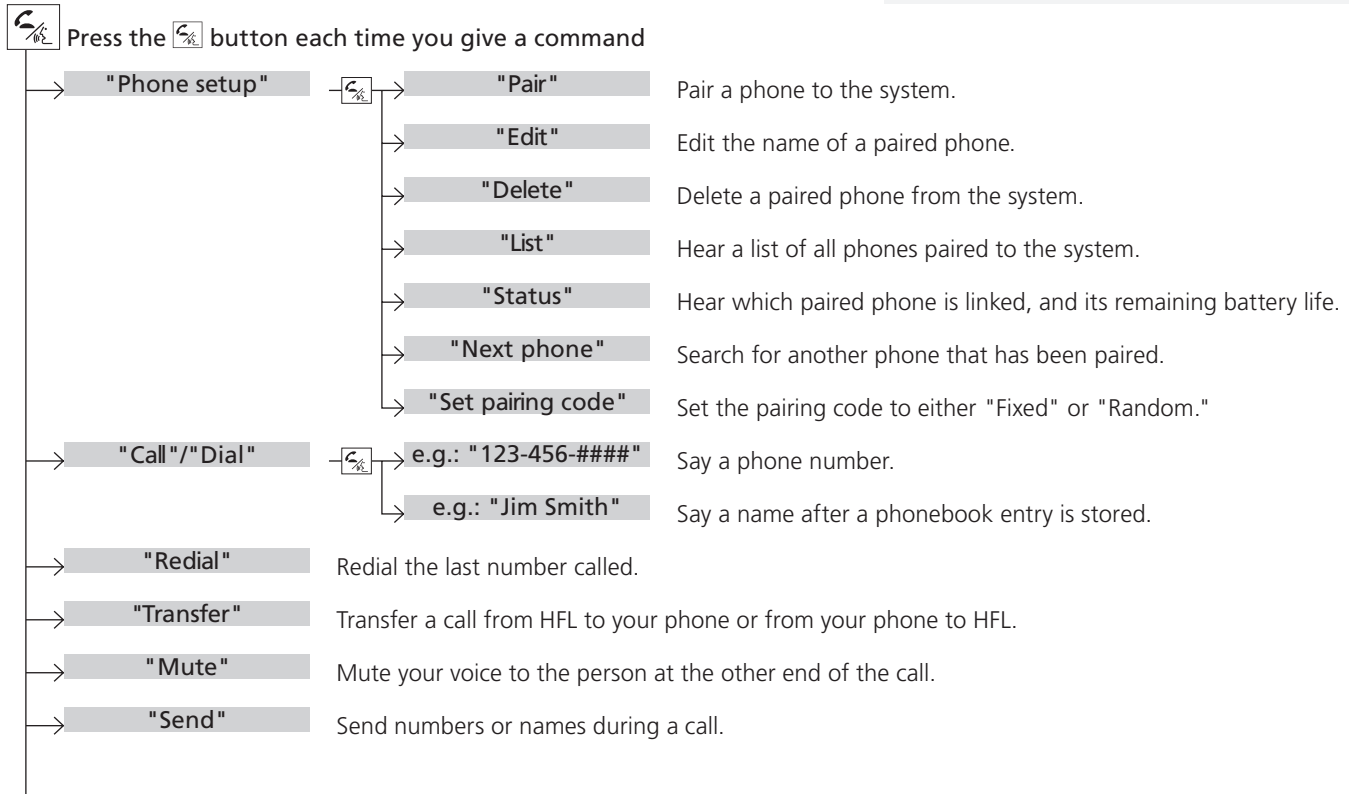

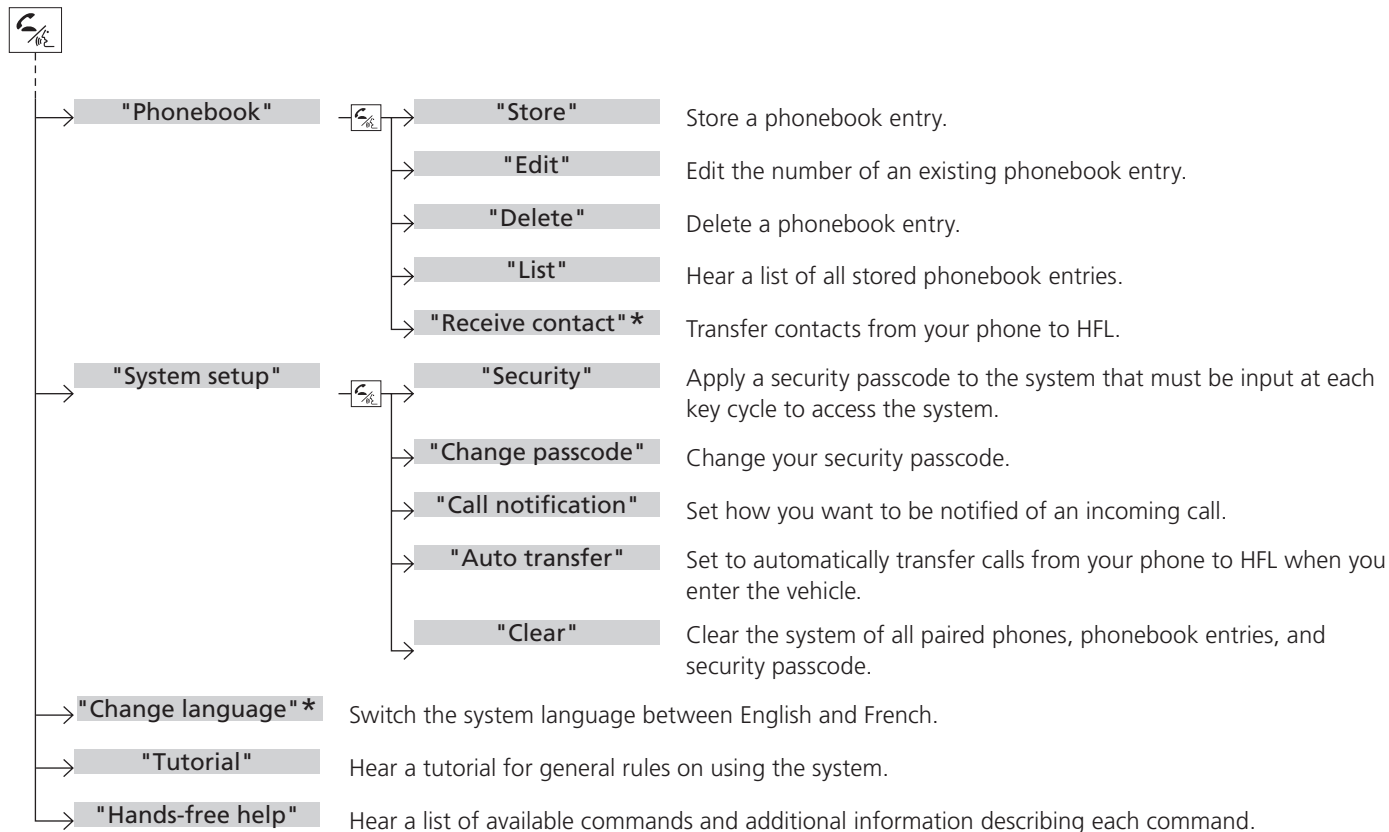

■ Phone Setup

■ To Pair a Cell Phone

1. If no phone has been paired to the system before, HFL gives you information about how to pair the first phone.
If a phone has already been paired: say "Phone Setup" and "Pair" after the HFL prompts.
2. Follow the HFL prompts and put your phone in discovery or search mode.
 - ▶ HFL gives you a four-digit code and begins searching for your phone.
3. When your phone finds a *Bluetooth*® device, select HFL from the options and enter the four-digit code.
4. Follow the HFL prompts and name the newly paired phone.

■ To Rename a Paired Phone

1. Say "Phone Setup."
2. Say "Edit" after the prompts.
3. Follow the HFL prompts and rename the phone.
 - ▶ If there is more than one phone paired to the system, HFL asks you which phone's name you want to change.

■ To Delete a Paired Phone

1. Say "Phone Setup."
2. Say "Delete" after the prompts.
3. Follow the HFL prompts.
 - ▶ HFL asks you which phone you want to delete.

☒ Phone Setup

Press the  button and wait for a beep before giving a command.

Your *Bluetooth*-compatible phone must be paired to HFL before you can make and receive hands-free calls.

Phone Pairing Tips:

- You cannot pair your phone while the vehicle is moving.
- Your phone must be in the discovery or search mode when pairing the phone. Refer to your phone's manual.
- Up to six phones can be paired.
- Your phone's battery may drain faster when it is paired to HFL.
- If your phone is not ready for pairing or not found by the system within three minutes, the system times out and returns to idle.

■ To Hear the Name of All Paired Phones

1. Say "Phone Setup."
2. Say "List" after the prompts.
3. HFL reads out all the paired phones' names.

■ To Hear Which Paired Phone Is Currently Linked

1. Say "Phone Setup."
2. Say "Status" after the prompts.
3. HFL tells you which phone is linked with the system.

■ To Change the Currently Linked Phone

1. Say "Phone Setup."
2. Say "Next Phone" after the prompts.
3. HFL disconnects the current phone, and searches for another paired phone.
4. Once another phone is found, it is connected to the system. HFL informs you which phone is now linked.

■ To Change the Pairing Code Setting

1. Say "Phone Setup."
2. Say "Set Pairing Code" after the prompts.
3. If you want HFL to create a random code each time you pair a phone, say "Random." If you want to create your own four-digit code, say "Fixed."
4. Follow the HFL prompts.

☒ Phone Setup

If no other phones are found or paired when trying to switch to another phone, HFL informs you that the original phone is linked again.

■ Making a Call

You can make calls using any phone number or a name in the HFL phonebook, and redial the last number called.

Models with navigation system

You can make calls using the Cellular Phonebook (if your phone is compatible with this feature), or entering the phone number on the screen.

■ Direct Dialing a Phone Number

1. Say "Call" or "Dial."
2. Say the number you want to dial after the prompts.
3. Say "Call" or "Dial" after the prompts.

■ From the HFL Phonebook

1. Say "Call" or "Dial."
2. Say the name stored in the HFL phonebook after the prompts.
3. Follow the HFL prompts.

■ To Redial the Last Number Called by HFL

Say "Redial."

■ To End a Call

Press the  button.

» Making a Call

Press the  button and wait for a beep before giving a command.

The maximum range between your phone and vehicle is 30 feet (10 meters).

HFL allows you to talk up to 30 minutes after you remove the key from the ignition switch. However, this may weaken the vehicle's 12 volt battery.

Once a call is connected, you can hear the voice of the person you are calling through the audio speakers.

■ From the Cellular Phonebook*

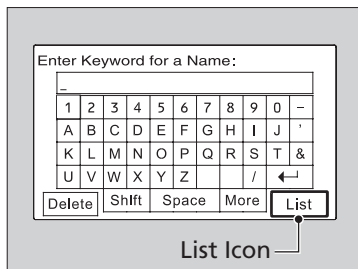
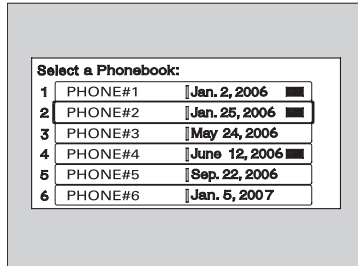
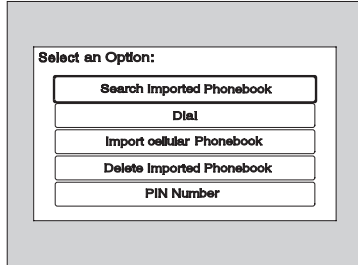

1. Press the INFO button, then select **Cellular Phonebook**.
2. Select **Search Imported Phonebook**.
3. Select a phonebook.
4. Enter the keyword (the first letter) for either the first or last name to search for a specific name in the phonebook, or touch the List icon to list all entries.

☒ Making a Call

You need to enter the PIN first if the phonebook is PIN-protected.

☒ PIN P.187

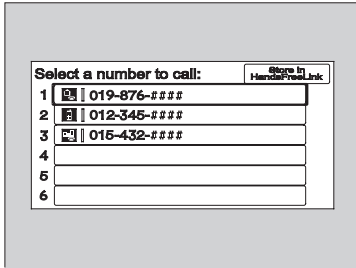

5. Select a person from the search result list, and select the phone number.
 - ▶ If you have stored more than one phone number for that person on your cell phone, select the phone number you want to call from the category icons displayed next to the person's name.

■ Using a Phone Number (Navigation Screen)

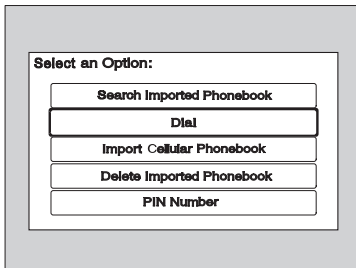

1. Press the INFO button, then select **Cellular Phonebook**.

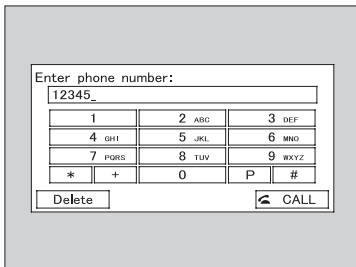

2. Select **Dial**.
3. Enter a phone number.
4. Select **CALL** to make the call.



▣ Making a Call

Once you select the phone number, the system starts dialing it.

If you choose Store In HandsFreeLink, you can add the number to the HFL phonebook. The number stored in HFL can be dialed by a voice tag.

▣ **Store a Number in HFL** P.186

■ Receiving a Call

Press the  button to answer the call, or the  button to hang up. When there is an incoming call, a call notification (if activated) sounds and a message appears on the display.

■ Transferring a Call

You can transfer a call from HFL to your phone, or from your phone to HFL. Press the  button and say “Transfer.”

■ Muting a Call

To mute or unmute your voice during a call, press and release the  button and say “Mute.”

⌘ Receiving a Call

Call Waiting

Press the  button to put the original call on hold to answer the incoming call.

Press the  button again to return to the original call.

Ignore the incoming call if you do not want to answer it.

Press the  button if you want to hang up the original and answer the incoming call.

■ Sending Numbers or Names During a Call

You can send numbers and names during a call. This is useful when calling a menu-driven phone system.

■ To Send a Number or Name During a Call

1. Say "Send."
2. Say the number or name you want to send after the prompts.
3. Follow the HFL prompts.

■ HFL Phonebook

You can store up to 50 names with their associated numbers in HFL. The numbers you store can be account numbers or passwords. These numbers can be sent to a menu-driven call.

■ To Store a Phonebook Entry



1. Say "Phonebook."
2. Say "Store" after the prompts.
3. Say a name you want to list as your phonebook entry.
4. Say the number you want to store for the name entry.
5. Follow the HFL prompts and say "Enter" to store the entry.

■ To Edit the Number Stored for a Name

1. Say "Phonebook."
2. Say "Edit" after the prompts.
3. Say a name you want to edit. When asked, say the new number for that name.
4. Follow the HFL prompts and say "Enter" to store the entry.

» Sending Numbers or Names During a Call

Press the  button before a command.

To send a , say "Pound." To send a , say "Star."

» HFL Phonebook

- Avoid using duplicate name entries.
- Avoid using "home" as a name entry.
- It is easier for HFL to recognize a multisyllabic or longer name. For example, use "Peter" instead of "Pete," or "John Smith" instead of "John."

■ **To Delete a Name**

1. Say "Phonebook."
2. Say "Delete" after the prompts.
3. Say a name you want to delete.
4. Say "Yes," and follow the HFL prompts.

■ **To List All Names in the Phonebook**

1. Say "Phonebook."
2. Say "List" after the prompts.
3. HFL begins reading the names in the order they were stored.
4. When you hear a name you want to call, say "Call."

■ **To Store a Specific Phone Number from Your Cell Phone Directly to the HFL Phonebook***

1. Say "Phonebook."
2. Say "Receive Contact" after the prompts.
3. Follow the HFL prompts, select a number from your cell phone, and send it to HFL.
 - ▶ If it is not the number you want to store, say "Discard."
4. Say the name for that number.
5. Follow the HFL prompts to continue.

■ Cellular Phonebook Option*

The cellular phonebook can store around 1,000 names and 10,000 phone numbers imported from a paired cell phone's phonebook. The amount of names and numbers that can be stored varies by data size.

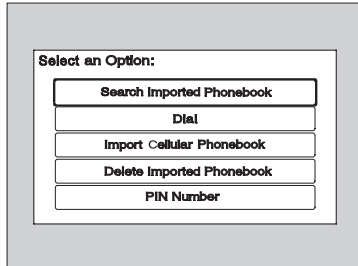

Press the INFO button, and select **Cellular Phonebook**. There are five options.

■ Import Cellular Phonebook

Once you select this option, the system begins importing the phonebook from the paired cell phone. Select OK after the import is completed.

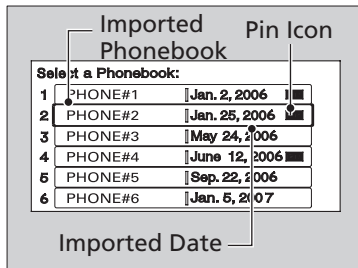

■ Search Imported Phonebook

You can search the phone numbers by the person's name.

1. Select **Search Imported Phonebook**, and a list of imported phonebooks appears.
2. Select a phonebook you want to search.
 - ▶ If the phonebook is PIN-protected, enter the PIN.

▶ PIN P.187

⌘ HFL Phonebook

For a list of cell phones that are compatible with this feature:

- U.S.: Visit www.handsfreelink.honda.com, or call (888) 528-7876.
- Canada: Visit www.honda.ca/, or call (888) 9-HONDA-9.

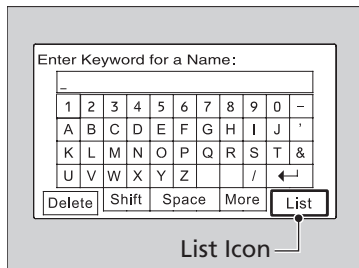

3. Enter the keyword (the first letter) for the first or last name.
 - ▶ Touch the List icon to list all entries.
4. Select the person's name you want to call and then press the  button.

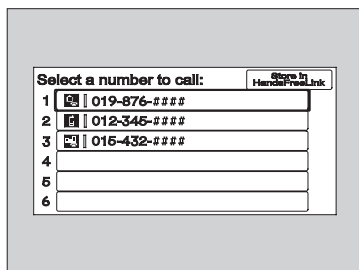

■ STORE IN HandsFreeLink

Numbers in the Cellular Phonebook can be stored in the HFL phonebook with a voice tag.

1. **Select STORE IN HandsFreeLink.**
2. Select a number you want to store in the HFL phonebook.
3. Follow the prompts.

■ Delete Imported Phonebook

1. Select **Delete Imported Phonebook**, and a list of imported phonebooks appears.
2. Select a phonebook you want to delete.
 - ▶ If the phonebook is PIN-protected, enter the PIN.
 - ▶ [PIN P.187](#)
3. After making a selection, the confirmation screen appears. Select **Yes**, then **OK** to complete the deletion.

⊗ Cellular Phonebook Option

When you select a person from the list in the cellular phonebook, you may see up to three category icons. The icons indicate what types of numbers are stored for that name.

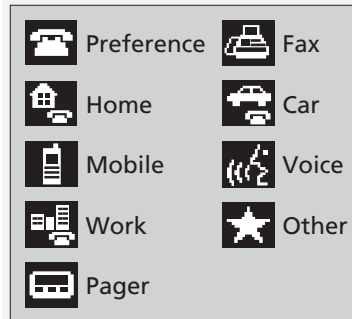

If a name has more than four numbers, "... " appears instead of category icons.

■ PIN Number

Each Cellular Phonebook can be PIN-protected. Select **PIN Number** to set, change, or delete a PIN.

To Set a PIN:

1. Select a phonebook that is not PIN protected. The “Enter your new PIN screen” appears.
2. Enter a four-digit PIN. You will have to re-enter it for confirmation.

To change the PIN to a new PIN

1. Select a phonebook you want to change the PIN for.
2. Enter the current PIN.
3. Enter the new PIN. You will have to re-enter it for confirmation.

To remove the PIN:

1. Select a phonebook you want to remove the PIN for.
2. Enter the current PIN.
3. Select **DO NOT USE PIN**.

■ System Setup

This command group allows you to change or customize HFL basic settings.

■ To Set a Four-digit Passcode to Lock the HFL System for Security

1. Say "System Setup."
2. Say "Security."
3. Follow the HFL prompts and say the four-digit number of your choice.
4. Follow the HFL prompts and confirm the number.

■ To Change the Security Passcode

1. Say "System Setup."
2. Say "Change Passcode" after the prompts.
3. Say the new four-digit passcode after the HFL prompts.
4. Follow the HFL prompts.

■ To Select a Ring Tone or a Prompt as the Incoming Call Notification

1. Say "System Setup."
2. Say "Call Notification" after the prompts.
3. Say "Ring Tone" or "Prompt" after the prompts. For no audible notification, say "Off."

⌘ System Setup

Press the  button before a command.

Once a passcode is set, you are required to enter the passcode with every new key cycle to use HFL. If you forget the code, go to your dealer to have the passcode reset. You can also cancel the passcode by clearing all the data stored in the HFL system.

⌘ To Clear the System [P.189](#)

The default setting of the incoming notification is a prompt.

■ To Activate or Deactivate the Auto Transfer Function

The call on your cell phone can be automatically transferred to HFL when you get into the vehicle and turn on the ignition.

1. Say "System Setup."
2. Say "Auto Transfer" after the prompts. HFL lets you know the current status.
3. Follow the HFL prompts to change the setting.

■ To Clear the System

Paired phones, all stored or imported phonebook data, and any passcodes are erased.

1. Say "System Setup."
2. Say "Clear" after the prompts.
3. Follow the HFL prompts.

■ Change Language*

You can set the system language to French or English.

1. Say "Change Language."
2. Follow the HFL prompts.

If you have not named your paired phone in the selected language, HFL will ask you to name it in that language.

» System Setup

Press the  button before a command.

You can clear the system if you forget the passcode and cannot access HFL.

When HFL asks you for the passcode, say "System Clear."

» Change Language

Quick Language Selection

If you want to change the language, to French for example, say "Français" and follow the prompt.



Driving

This chapter describes driving, refueling, and information on items such as accessories.

Before Driving

Driving Preparation.....	192
Maximum Load Limit.....	194

Towing a Trailer

Towing Your Vehicle	196
---------------------------	-----

When Driving

Starting the Engine.....	197
Precautions While Driving.....	200
Automatic Transmission (CVT)	201
Shifting (Automatic Transmission - CVT).....	202
Shifting (Manual Transmission).....	207
3-Mode Drive System	210
Cruise Control.....	211

VSA® (Vehicle Stability Assist), aka ESC (Electronic Stability Control), System.....	214
TPMS (Tire Pressure Monitoring System) .	216
Tire Pressure Monitoring System (TPMS) - Required Federal Explanation.....	217

Braking

Brake System.....	219
ABS (Anti-lock Brake System).....	221
Brake Assist System	222

Parking Your Vehicle

When Stopped	223
Auto Idle Stop (Automatic Transmission - CVT).....	224

Auto Idle Stop (Manual Transmission).....	227
Parking.....	230

Refueling

Fuel Information.....	231
How to Refuel.....	232

Fuel Economy

Improving Fuel Economy	234
------------------------------	-----

Accessories and Modifications

Accessories.....	235
Modifications	235

Driving Preparation

Check the following items before you start driving.

■ Check Items Before Getting In the Vehicle

- Make sure there is no obstruction on the windows, door mirrors, exterior lights, or other parts of the vehicle.
 - ▶ Remove any frost, snow, or ice.
 - ▶ Remove any snow on the roof, as this can slip down and obstruct your field of vision while driving. When frozen hard, remove ice once it has softened.
 - ▶ When removing ice from around the wheels, be sure not to damage the wheel or wheel components.
- Make sure the hood is securely closed.
 - ▶ If the hood opens while driving, your front view will be blocked.
- Make sure the tires are in good condition.
 - ▶ Check air pressures, and check for damage and excessive wear.
 - ❏ **Checking and Maintaining Tires** P.269
- Make sure there is no person or object behind or around the vehicle.
 - ▶ There are blind spots from the inside.

■ Check Items in the Compartment

- Store or secure all items on board properly.
 - ▶ Carrying too much cargo, or improperly storing it, can affect your vehicle's handling, stability, stopping distance, and tires, and make it unsafe.
 - ❏ **Maximum Load Limit** P.194
- Do not pile items higher than the seat height.
 - ▶ They can block your view and may be thrown forward in the event of sudden braking.

❏ Check Items Before Getting On the Vehicle

NOTICE

If the doors are frozen shut, use warm water around the door edges to melt any ice. Do not try to force them open, as this can damage the rubber trim around the doors. When done, wipe dry to avoid further freezing.

Do not pour warm water into the key cylinder. You will be unable to insert key if the hole freezes.

❏ Check Items in the Compartment

The headlight aim is set by the factory, and typically does not need to be adjusted. However, if you regularly carry heavy items in the cargo area, have the aiming readjusted at your dealer or by a qualified technician.

- Do not place anything in the seat footwells. Make sure to secure the floor mats.
 - ▶ An object or unsecured floor mat can interfere with your brake and accelerator pedal operation while driving.
- If you have any animals on board, do not let them move around in the vehicle.
 - ▶ They may interfere with driving and a crash could occur.
- Securely close and lock both doors and the hatch.
 - ☒ **Locking and Unlocking the Doors from Inside** [P.102](#)
- Adjust your seating position properly.
 - ☒ **Adjusting the Seats** [P.119](#)
- Adjust the mirrors and steering wheel properly for your driving.
 - ▶ Adjust them while sitting in the proper driving position.
 - ☒ **Adjusting the Mirrors** [P.118](#)
 - ☒ **Steering Wheel Adjustments** [P.117](#)
- Be sure items placed on the floor behind the driver's and passenger's seats cannot roll under the seats.
 - ▶ They can interfere with the driver's ability to operate the pedals, the operation of the seats, or the operation of the sensors under the seats.
- Everyone in the vehicle must fasten their seat belt.
 - ☒ **Fastening a Seat Belt** [P.37](#)
- Make sure that the indicators in the instrument panel come on when you start the vehicle, and go off soon after.
 - ▶ Always have a dealer check the vehicle if any of the indicators indicate a problem.
 - ☒ **Indicators** [P.68](#)

Maximum Load Limit

The maximum load for your vehicle is 400 lbs (181 kg).
See Tire and Loading Information label attached to the driver's doorjamb.

Label Example

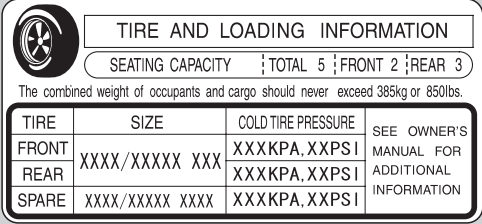

TIRE AND LOADING INFORMATION

SEATING CAPACITY : TOTAL 5 ; FRONT 2 ; REAR 3

The combined weight of occupants and cargo should never exceed 385kg or 850lbs.

TIRE	SIZE	COLD TIRE PRESSURE	SEE OWNER'S MANUAL FOR ADDITIONAL INFORMATION
FRONT	XXXX/XXXX XXX	XXXKPA, XXPSI	
REAR	XXXX/XXXX XXX	XXXKPA, XXPSI	
SPARE	XXXX/XXXX XXX	XXXKPA, XXPSI	

This figure includes the total weight of all occupants, cargo, and accessories, and the tongue load if you are towing a trailer.
Steps for Determining Correct Load Limit -

- (1) Locate the statement "The combined weight of occupants and cargo should never exceed XXX kg or XXX lbs." on your vehicle's placard.
- (2) Determine the combined weight of the driver and passengers that will be riding in your vehicle.
- (3) Subtract the combined weight of the driver and passengers from XXX kg or XXX lbs.
- (4) The resulting figure equals the available amount of cargo and luggage load capacity. For example, if the "XXX" amount equals 1,400 lbs. and there will be five 150 lb. passengers in your vehicle, the amount of available cargo and luggage load capacity is 650 lbs.
(1,400 - 750 (5 x 150) = 650 lbs.)

Maximum Load Limit

⚠ WARNING

Overloading or improper loading can affect handling and stability and cause a crash in which you can be hurt or killed.

Follow all load limits and other loading guidelines in this manual.

Gross Vehicle Weight Rating (GVWR):
The maximum allowable weight of the vehicle, all occupants, all accessories, and all cargo.

➤ **Specifications** [P.312](#)



Gross Axle Weight Rating (GAWR):
The maximum allowable weight of the vehicle axle.



➤ **Specifications** [P.312](#)

- (5) Determine the combined weight of luggage and cargo being loaded on the vehicle. That weight may not safely exceed the available cargo and luggage load capacity calculated in step 4.
- (6) If your vehicle will be towing a trailer, load from your trailer will be transferred to your vehicle. Consult this manual to determine how this reduces the available cargo and luggage load capacity of your vehicle.

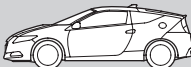
In addition, the total weight of the vehicle, all occupants, accessories, cargo, and trailer tongue load must not exceed the Gross Vehicle Weight Rating (GVWR) or the Gross Axle Weight Rating (GAWR). Both are on a label on the driver's doorjamb.

Load Limits Example

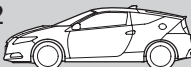
<p>Example 1</p>  <p>Max Load 400 lbs (181 kg)</p>	\geq		$+$	
		<p>Passenger Weight 150 lbs x 1 = 150 lbs (68 kg x 1 = 68 kg)</p>		<p>Cargo Weight 250 lbs (113 kg)</p>

<p>Example 2</p>  <p>Max Load 400 lbs (181 kg)</p>	\geq		$+$	
		<p>Passenger Weight 150 lbs x 2 = 300 lbs (68 kg x 2 = 136 kg)</p>		<p>Cargo Weight 100 lbs (45 kg)</p>

Your vehicle is not designed to tow a trailer. Attempting to do so can void your warranties.

Towing Your Vehicle

Your vehicle is not designed to be towed behind a motor home. If your vehicle needs to be towed in an emergency, refer to the emergency towing information.

➤ **Emergency Towing** [P.308](#)

Starting the Engine

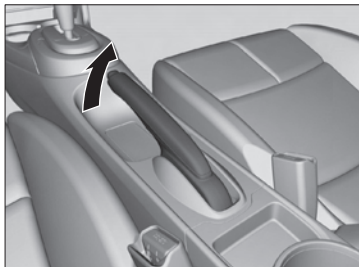

1. Make sure the parking brake is applied.

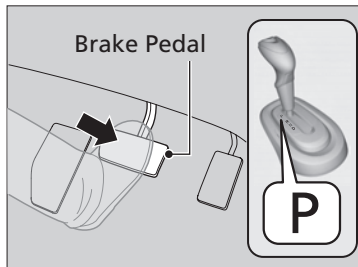

Automatic transmission (CVT) model

2. Check that the shift lever is in **P**, then depress the brake pedal.
 - ▶ Although it is possible to start the vehicle in **N**, it is safer to start it in **P**.

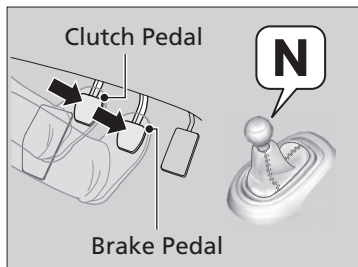

Manual transmission model

2. Check that the shift lever is in **N**. Then depress the brake pedal with your right foot, and the clutch pedal with your left foot.
 - ▶ The clutch pedal must be fully depressed to start the engine.

Starting the Engine

Keep your foot firmly on the brake pedal when starting the engine.

The engine is harder to start in cold weather and in thinner air found at altitudes above 8,000 feet (2,400 meters).

When starting the engine in cold weather, turn off all electrical accessories such as the lights, climate control system, and rear defogger in order to reduce battery drain.

If the exhaust sounds abnormal or if you can smell exhaust gas inside the vehicle, have your vehicle checked by a dealer. There may be a problem with the engine or exhaust system.

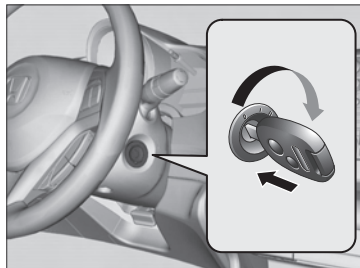

3. Turn the ignition switch to START **III** without depressing the accelerator pedal.

⌘ Starting the Engine

Do not hold the key in START **III** for more than 15 seconds.

- If the engine does not start right away, wait for at least 10 seconds before trying again.
- If the engine starts, but then immediately stops, wait at least 10 seconds before repeating step 3 while gently depressing the accelerator pedal. Release the accelerator pedal once the engine starts.

The immobilizer system protects your vehicle from theft. If an improperly coded key (or other device) is used, the engine's fuel system is disabled.

⌘ **Immobilizer System P.105**

■ Starting to Drive

Automatic transmission (CVT) model

1. Keeping your right foot on the brake pedal, release the parking brake. Check that the brake system indicator has gone off.
⌘ **Parking Brake P.219**
2. Put the shift lever in **D**. Select **R** when reversing.
3. Gradually release the brake pedal and gently depress the accelerator pedal to pull away.

■ Creep Aid System

Automatic transmission (CVT) model

With the shift lever in **D** or **N**, this feature applies brake pressure briefly as you release the brake pedal to prevent the vehicle from moving unexpectedly.

■ Hill Start Assist System

Manual transmission model

Hill start assist feature helps to prevent the vehicle from rolling on inclines as you move your foot from the brake pedal to the accelerator.

Depress the clutch pedal, and shift to **1** when facing uphill, or **R** when facing downhill, then release the brake pedal.

The brakes remain engaged briefly as you release the brake pedal.

» Hill Start Assist System

Hill start assist may not prevent the vehicle from rolling downhill on a very steep or slippery slope, and will not operate on small inclines.

Hill start assist is not a replacement for the parking brake.

Hill start assist will still operate even when VSA® is switched off.

Precautions While Driving

In Rain

Avoid driving in deep water and on flooded roads. This can damage the engine or cause electrical component failure.

Other Precautions

If there is a strong impact with something under the vehicle, stop in a safe location. Check the underside of the vehicle for damage and fuel or brake fluid leaks.

Precautions While Driving

NOTICE

Do not operate the shift lever while pressing the accelerator pedal. You could damage the transmission.

If the ignition switch is turned to ACCESSORY **I** or LOCK **O** while driving, the engine will shut down and all steering and brake power assist functions will stop, making it difficult to control the vehicle.

Do not drive with the shift lever in **N**, as you will lose engine braking (and acceleration) performance.

During the first 600 miles (1,000 km) of operation, avoid sudden acceleration or full throttle operation so as to not damage the engine or powertrain.

Avoid hard braking for the first 200 miles (300 km). You should also follow this when the brakes are replaced.

Automatic Transmission (CVT)

■ Creeping

The following conditions cause the engine to run at high revolutions, and increase creeping:

- Immediately after the engine starts.
- When the climate control system is in use.

Keep the brake pedal firmly depressed.

■ Kickdown

Depressing the accelerator pedal while driving uphill may cause the transmission to drop to a lower ratio, unexpectedly increasing vehicle speed. Depress the accelerator pedal carefully, especially on slippery roads and curves.

Shifting

Automatic transmission (CVT) model

Change the shift position in accordance with your driving need.

■ Names and Functions of Shift Lever Positions



- P Park**
Used when parking or starting the engine.
- R Reverse**
Used when backing up.
- N Neutral**
Used when idling
- D Drive**
Used for:
 - Normal driving
 - Temporarily driving in the 7-speed manual shift mode (when driving in ECON or NORMAL mode)
 - Driving in the 7-speed manual shift mode (when driving in SPORT mode)
 - Driving in L mode

⌘ Shifting

You cannot turn the ignition switch to LOCK **O** and remove the key unless the shift lever is in **P**.

The vehicle may move forward very slightly even in **N** while the engine is cold.

Depress the brake pedal firmly and, when necessary, apply the parking brake.

The engine may cut in and out in **R** or depending on the road condition, even when the engine speed is lower than the tachometer's red zone. This is the engine's computer working to protect the transmission.

Shift Lever Operation

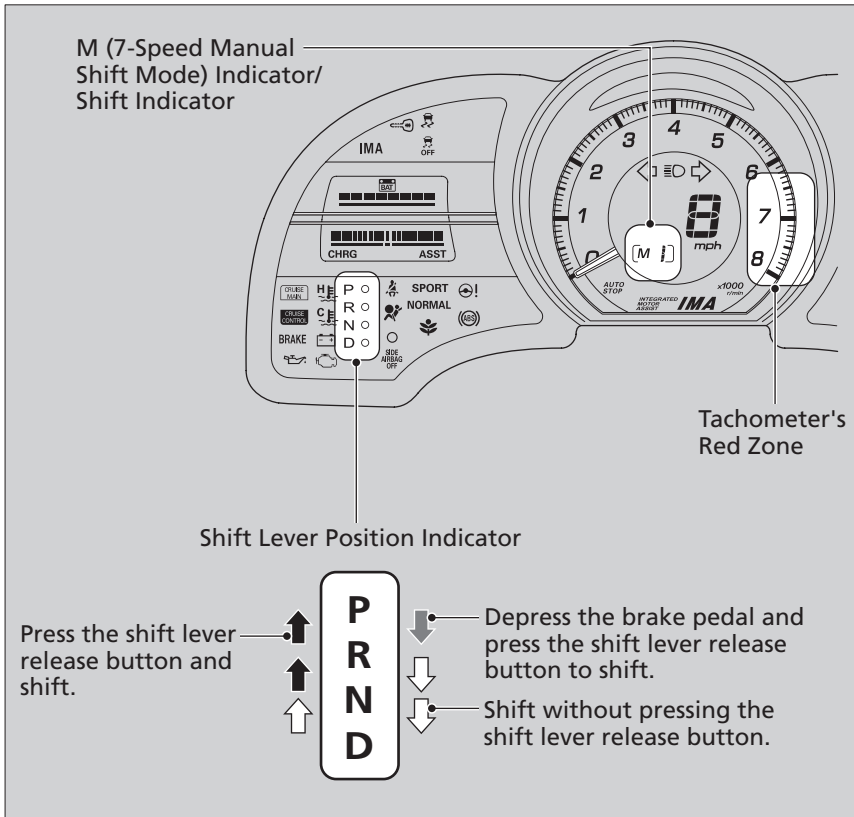

Shift Lever Operation

NOTICE

Before you move the shift lever from **D** to **R** and vice versa, come to a complete stop and keep the brake pedal depressed. Operating the shift lever before the vehicle has come to a complete standstill can damage the transmission.

Use the shift lever position indicator to check the lever position before pulling away.

Whichever position the shift lever is in when driving, a blinking **D** indicator indicates a transmission problem. Avoid sudden acceleration and have the transmission checked by a dealer as soon as possible.

The fuel supply may be cut off if you drive at engine speeds in or over the tachometer red zone (engine speed limit). If this happens, you may experience a slight jolt.

It may not be possible to operate the shift lever if the brake pedal is applied while the shift lever release button is held down. Depress the brake pedal first.

■ 7-Speed Manual Shift Mode

Use the paddle shifters to change between first and seventh speeds without removing your hands from the steering wheel. The transmission switches to the 7-speed manual shift mode when you pull a paddle shifter while driving. This mode is useful when engine braking is needed.

You can cancel this mode by pressing any of the three driving mode buttons, or pulling the  paddle shifter for a few seconds.

■ When the Driving Mode is in ECON or NORMAL

The shift mode goes into the 7-speed manual shift mode temporarily, and the number is displayed in the shift indicator.

The 7-speed manual shift mode is canceled automatically if you drive at constant speed or accelerate, and the number in the shift indicator goes off.

The 7-speed manual shift mode is especially useful when reducing the vehicle speed temporarily before making a turn.

■ When the Driving Mode is in SPORT

The shift mode goes into the 7-speed manual shift mode. The  indicator and the speed number are displayed in the shift indicator. As the vehicle speed slows down, the transmission automatically shifts down accordingly. When the vehicle comes to a stop, it automatically shifts down into first.

If the vehicle speed increases and the engine speed reaches near the tachometer's red zone, the transmission automatically shifts up.

⌘ 7-Speed Manual Shift Mode

To improve fuel economy, the transmission may shift up to a higher speed than the seventh under certain circumstances. In this case, the number in the shift indicator remains as "7."

In the 7-speed manual shift mode, the transmission shifts up or down by operating either paddle shifter under the following conditions:

Shift Up: The engine speed reaches the lowest threshold of the higher speed position.

Shift Down: The engine speed reaches the highest threshold of the lower speed position.

When the engine speed reaches near the tachometer's red zone, the transmission shifts up automatically.

When the engine speed reaches the lowest threshold of the selected speed position, the transmission shifts down automatically.

Operating the paddle shifters on slippery surfaces may cause the tires to lock up. In this case, the 7-speed manual shift mode is canceled and goes back to the normal D driving mode.

7-Speed Manual Shift Mode Operation

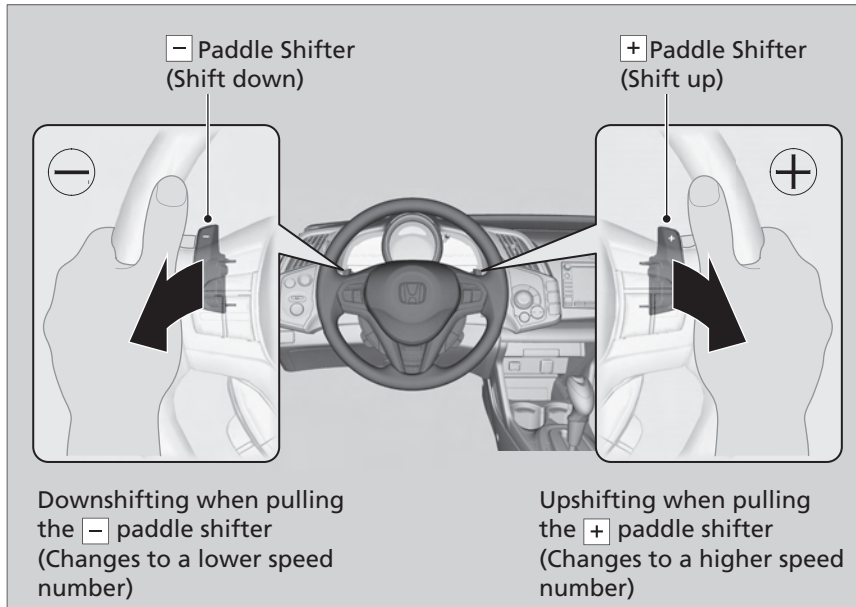

7-Speed Manual Shift Mode Operation

Each paddle shift operation makes a single speed change.

To change continuously, release the paddle shifter before pulling it again for the next speed.

Recommended Shift Points

Use this table as a guideline for efficient fuel economy and effective emission control.

Shift Up	Normal Acceleration
1 to 2	15 mph (24 km/h)
2 to 3	25 mph (40 km/h)
3 to 4	40 mph (64 km/h)
4 to 5	47 mph (76 km/h)
5 to 6	52 mph (84 km/h)
6 to 7	57 mph (92 km/h)

If the position indicator blinks when you try to shift up or down, this means your vehicle speed is not in its allowable shifting range.

Slightly accelerate to shift up and decelerate to shift down while the indicator is blinking.

■ L Mode Operation

Use this mode to get more power when climbing hills.

To switch to the L mode, pull and hold both paddle shifters (**+** and **-**) at the same time with the shift lever in **D**.

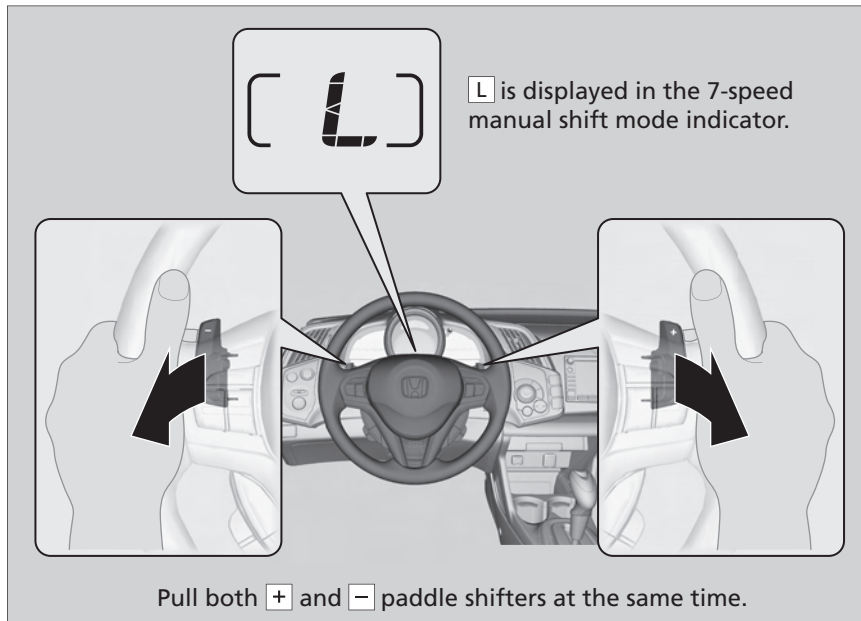

To cancel this mode, pull and hold both paddle shifters again, or press any of the three driving mode buttons. The **L** indicator goes off.

☒ L Mode Operation

Use the L mode to get more engine braking in the 7-speed manual shift mode.

Shifting

Manual transmission model

Shift Lever Operation

Fully depress the clutch pedal to operate the shift lever and change gears, then slowly release the pedal.

Depress the clutch pedal, and pause for a few seconds before shifting into **R**, or shift into one of the forward gears for a moment. This stops the gears so they won't "grind."

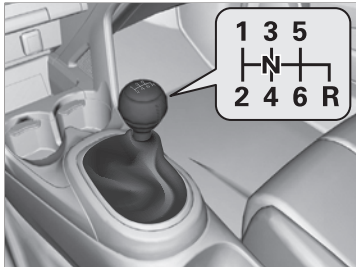

When you are not shifting, do not rest your foot on the clutch pedal. This can cause your clutch to wear out faster.

» Shifting

NOTICE

Do not shift to **R** before the vehicle comes to a complete stop.

Shifting to **R** before stopping can damage the transmission.

Recommended Shift Points

Driving in the highest gear that allows the engine to run and accelerate smoothly helps to optimize fuel economy and emissions control. The following shift points are recommended:

Shift Up	Normal Acceleration
1st to 2nd	15 mph (24 km/h)
2nd to 3rd	25 mph (40 km/h)
3rd to 4th	40 mph (64 km/h)
4th to 5th	47 mph (76 km/h)
5th to 6th	52 mph (84 km/h)

If you exceed the maximum speed for the gear you are in, the engine speed will enter into the tachometer's red zone. When this happens, you may experience a slight jolt.

NOTICE

Before downshifting, make sure the engine will not go into the tachometer's red zone.

Should this occur, it can severely damage your engine.

There is a metallic part on the shift lever. If you leave the vehicle parked outside for a long time on a hot day, be careful before moving the shift lever. Because of heat, the shift lever may be extremely hot. If the outside temperature is low, the shift lever feels cold.

■ Shift Up/Down Indicators

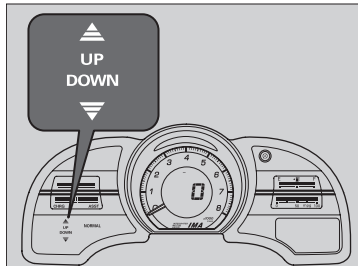

Come on to indicate when a gear change is appropriate to maintain the most fuel efficient driving style.

The shift up indicator: Comes on when shifting up is recommended.

The shift down indicator: Comes on when shifting down is recommended.

- ▶ The indicators do not come on in the SPORT mode.

☒ Shift Up/Down Indicators

This indicator will not prompt you to downshift to increase engine braking. It is up to you to downshift to increase engine braking when driving downhill.

Always shift down at the appropriate vehicle speed.

The shift down indicator does not come on when downshifting from **2** to **1**.

Ambient meter color may change if you do not change gears when a shift indicator illuminates. This can result in a change in fuel economy.

Road and traffic conditions may require you to shift at times other than those indicated.

Reverse Lockout

The manual transmission has a lockout mechanism that stops you from accidentally shifting into **R** from a forward gear while the vehicle is moving at a certain speed.

If you cannot shift to **R** when the vehicle is stopped, do the following:

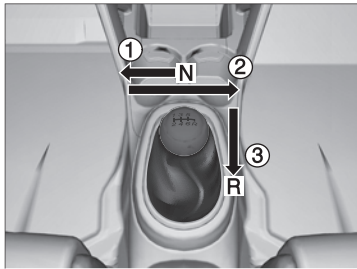

1. Depress the clutch pedal, move the shift lever all the way to the left, and shift to **R**.
2. If you still cannot shift into **R**, apply the parking brake, and turn the ignition switch to ACCESSORY **I** or LOCK **O**.
3. Depress the clutch pedal and shift into **R**.
4. Keep depressing the clutch pedal and start the engine.

Have the vehicle checked by a dealer if you have to go through this procedure repeatedly.

3-Mode Drive System

Driving mode is in NORMAL when you turn the ignition switch to ON .

To change driving modes, press the desired mode button. The corresponding mode indicator comes on in the instrument panel, and the mode icon appears briefly on the multi-information display.

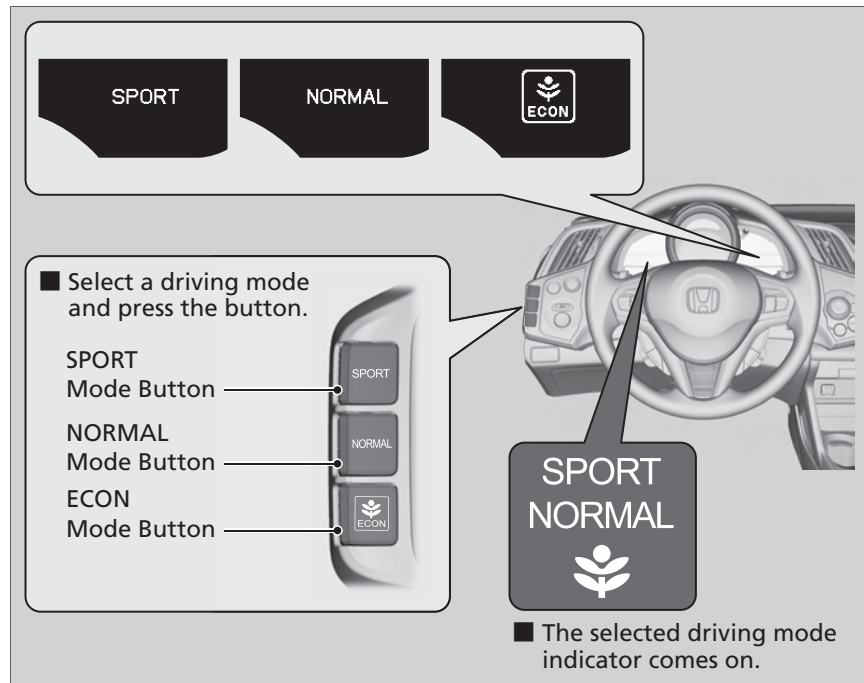

3-Mode Drive System

To keep the system in the ECON mode the next time the ignition switch is turned to ON , change the customized setting on the multi-information display.

Customized Features P.90

The ECON mode helps you improve your fuel economy by changing the engine, transmission, climate control system, cruise control, and IMA system performances.

While in the ECON mode, the climate control system has greater temperature fluctuations.

Cruise Control

Maintains a constant vehicle speed without having to keep your foot on the accelerator. Use cruise control on freeways or open roads where you can travel at a constant speed with little acceleration or deceleration.

When to use

Automatic transmission model

- Vehicle speed for cruise control: Desired speed in a range above roughly 25 mph (40 km/h).

Always keep sufficient distance between you and the vehicle in front of you.



How to use

- Press the CRUISE button on the steering wheel.



CRUISE MAIN is on in the instrument panel. Cruise control is ready to use.

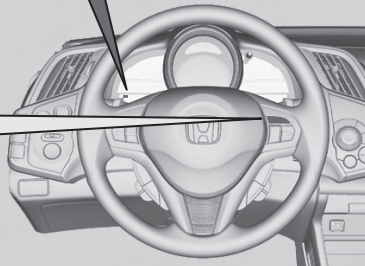

» Cruise Control

⚠ WARNING

Improper use of the cruise control can lead to a crash.

Use the cruise control only when traveling on open highways in good weather.

When the ignition switch is in ACCESSORY **I** or LOCK **0**, cruise control automatically goes off.

It may not be possible to maintain a constant speed when driving uphill or downhill.

When climbing a steep hill with the ECON mode, it may take relatively more time to accelerate to maintain the set speed.

When not using cruise control, turn off cruise control by pressing the CRUISE button.

Manual transmission

While the cruise control system is activated, the shift up or down indicator does not work.

■ To Set the Vehicle Speed

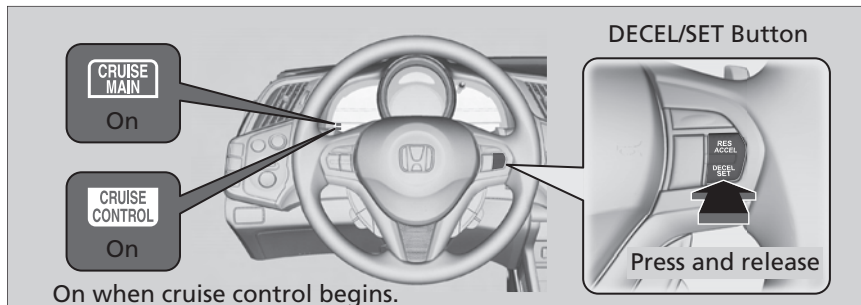

Press the DECEL/SET button when you reach the desired speed using the accelerator pedal.

The moment you release the DECEL/SET button, the set speed is fixed, and cruise control begins. The **CRUISE CONTROL** indicator comes on.

■ To Cancel

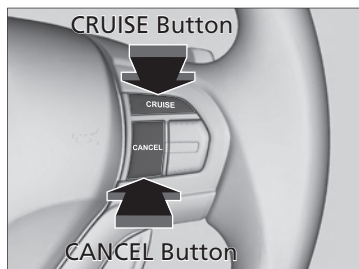

To cancel cruise control, do any of the following:

- Press the CANCEL button.
- Press the CRUISE button.
- Depress the brake pedal.
- Depress the clutch pedal.

The **CRUISE CONTROL** indicator goes off.

☒ To Cancel

Resuming the prior set speed

After cruise control has been canceled, you can still resume the prior set speed by pressing the RES/ACCEL button while driving at a speed of at least 25 mph (40 km/h) or more.

You cannot set or resume in the following situations:

- When vehicle speed is less than 25 mph (40 km/h)
- When the CRUISE button is turned off

At vehicle speeds of 22 mph (35 km/h) or less, cruise control is canceled automatically.

■ To Adjust the Vehicle Speed

Increase or decrease the vehicle speed using the accelerator and brake pedals, and set the vehicle speed with the DECEL/SET button on the steering wheel.

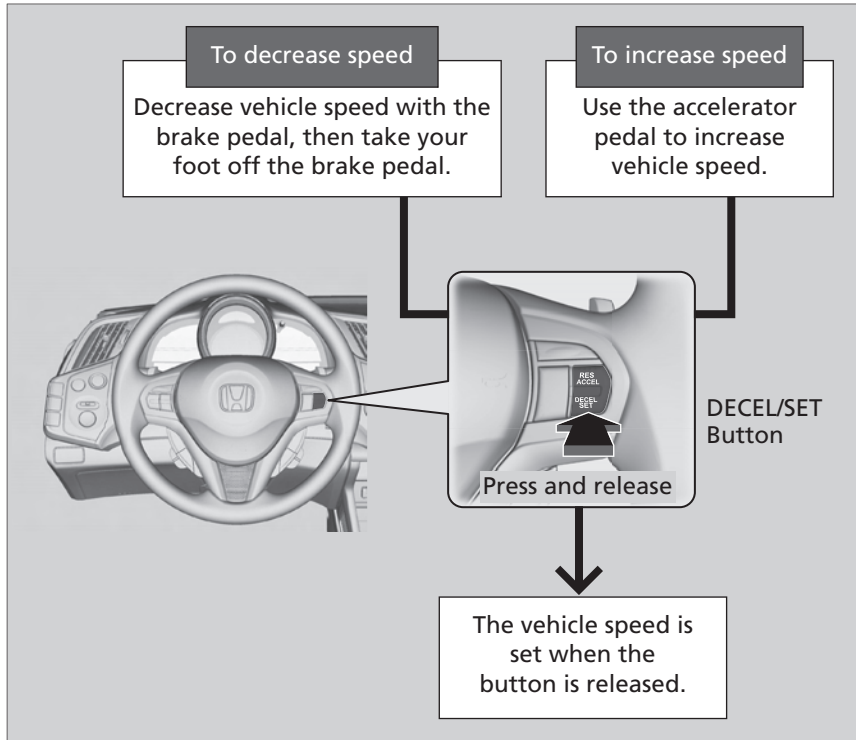

▣ To Adjust the Vehicle Speed

Vehicle speed can be increased or decreased also using the RES/ACCEL or DECEL/SET button on the steering wheel.

RES/ACCEL Button

- Each time you press the button, vehicle speed is increased by about 1 mph (1.6 km/h).
- If you keep it pressed, vehicle speed increases until you release it. This speed is then set.

DECEL/SET Button

- Each time you press it, vehicle speed decreases by about 1 mph (1.6 km/h).
- If you keep it pressed, vehicle speed decreases until you release it. This speed is then set.

VSA® (Vehicle Stability Assist), aka ESC (Electronic Stability Control), System

VSA® helps to stabilize the vehicle during cornering if the vehicle turns more or less than what was intended. It also assists in maintaining traction on slippery surfaces. It does so by regulating engine output and selectively applying the brakes.

VSA® Operation

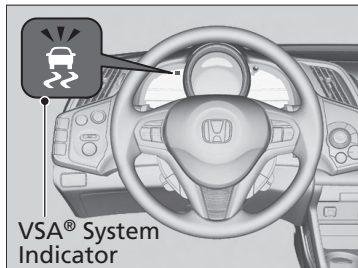

When VSA® activates, you may notice that the engine does not respond to the accelerator. You may also notice some noise from the hydraulic system. You will also see the indicator blink.

⊗ VSA® (Vehicle Stability Assist), aka ESC (Electronic Stability Control), System

The VSA® may not function properly if tire type and size are mixed. Make sure to use the same size and type of tire, and the air pressures as specified.

When the VSA® indicator comes on and stays on while driving, there may be a problem with the system. While this may not interfere with normal driving, have your vehicle checked by a dealer immediately.

VSA® cannot enhance stability in all driving situations and does not control the entire braking system. You still need to drive and corner at speeds appropriate for the conditions and always leave a sufficient margin of safety.

The main function of the VSA® system is generally known as Electronic Stability Control (ESC). The system also includes a traction control function.

■ VSA® On and Off

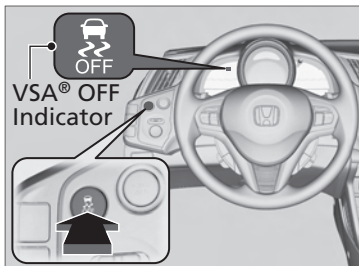

This button is on the driver side control panel. To turn the VSA® system on and off, press and hold it until you hear a beep.

VSA® will stop and the indicator will come on.

To turn it on again, press the  (VSA® off) button until you hear a beep.

VSA® is turned on every time you start the engine, even if you turned it off the last time you drove the vehicle.

▣ VSA® (Vehicle Stability Assist), aka ESC (Electronic Stability Control), System

Without VSA®, your vehicle will have normal braking and cornering ability, but it will not have VSA® traction and stability enhancement.

In certain unusual conditions when your vehicle gets stuck in shallow mud or fresh snow, it may be easier to free it with the VSA® temporarily switched off.

When the VSA® system is off, the traction control system is also off. You should only attempt to free your vehicle with the VSA® off if you are not able to free it when the VSA® is on.

Immediately after freeing your vehicle, be sure to switch VSA® on again. We do not recommend driving your vehicle with the VSA® and traction control systems switched off.

If the low tire pressure/TPMS indicator comes on or blinks, the VSA® system comes on automatically. In this case, you cannot turn the system off by pressing the  button.

You may hear a motor sound coming from the engine compartment while system checks are being performed immediately after starting the engine or while driving. This is normal.

TPMS (Tire Pressure Monitoring System)

U.S. models only

Monitors the tire pressure while you are driving. If your vehicle's tire pressure becomes significantly low, the low tire pressure/TPMS indicator comes on and a message appears on the multi-information display.



"CHECK TIRE PRESSURE" is displayed when a tire has significantly low pressure.

⌘ TPMS (Tire Pressure Monitoring System)

Conditions such as low ambient temperature and altitude change directly affect tire pressure and can trigger the low tire pressure/TPMS indicator to come on.

⌘ If the Low Tire Pressure/TPMS Indicator Comes On or Blinks [P.303](#)

Tire pressure checked and inflated in:

- Warm weather can become under-inflated in colder weather.
- Cool weather can become over-inflated in warmer weather.

The low tire pressure/TPMS indicator will not come on as a result of over inflation.

Tire Pressure Monitoring System (TPMS) - Required Federal Explanation

U.S. models only

Each tire, including the spare (if provided), should be checked monthly when cold and inflated to the inflation pressure recommended by the vehicle manufacturer on the vehicle placard or tire inflation pressure label.

(If your vehicle has tires of a different size than the size indicated on the vehicle placard or tire inflation pressure label, you should determine the proper tire inflation pressure for those tires.)

As an added safety feature, your vehicle has been equipped with a tire pressure monitoring system (TPMS) that illuminates a low tire pressure telltale



when one or more of your tires is significantly under-inflated.

Accordingly, when the low tire pressure telltale illuminates, you should stop and check your tires as soon as possible, and inflate them to the proper pressure.

Driving on a significantly under-inflated tire causes the tire to overheat and can lead to tire failure. Under-inflation also reduces fuel efficiency and tire tread life, and may affect the vehicle's handling and stopping ability.

Please note that the TPMS is not a substitute for proper tire maintenance, and it is the driver's responsibility to maintain correct tire pressure, even if under-inflation has not reached the level to trigger illumination of the TPMS low tire pressure telltale.

Your vehicle has also been equipped with a TPMS malfunction indicator to indicate when the system is not operating properly. The TPMS malfunction indicator is combined with the low tire pressure telltale. When the system detects a malfunction, the telltale will flash for approximately one minute and then remain continuously illuminated. This sequence will continue upon subsequent vehicle start-ups as long as the malfunction exists.

When the malfunction indicator is illuminated, the system may not be able to detect or signal low tire pressure as intended.

TPMS malfunctions may occur for a variety of reasons, including the installation of replacement or alternate tires or wheels on the vehicle that prevent the TPMS from functioning properly.

Always check the TPMS malfunction telltale after replacing one or more tires or wheels on your vehicle to ensure that the replacement or alternate tires and wheels allow the TPMS to continue to function properly.

Brake System

■ Parking Brake

Use the parking brake to keep the vehicle stationary when parking.

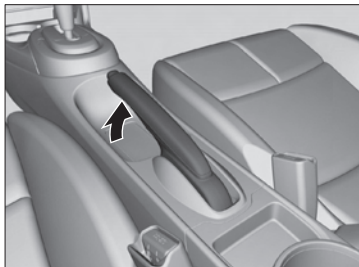

To apply:

Pull the lever fully up without pressing the release button.

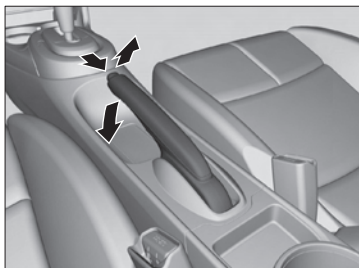

To release:

1. Pull the lever slightly, and press and hold the release button.
2. Lower the lever down all the way, then release the button.

» Parking Brake

NOTICE

Release the parking brake fully before driving. The rear brakes and axle can be damaged if you drive with the parking brake applied.

If you start driving without fully releasing the parking brake, a buzzer sounds as a warning, and "RELEASE PARKING BRAKE" appears on the multi-information display.

Always apply the parking brake when parking.

When the outside temperature is extremely cold, do not apply the parking brake to prevent it from freezing, and do the following:

Automatic transmission model

Put the shift lever in **P**, then place a block or other wheel chock to stop the wheels from turning.

Manual transmission model

Put the shift lever in **R** or **1**, then place a block or other wheel chock to stop the wheels from turning.

■ Foot Brake

Your vehicle is equipped with disc brakes at all four wheels. A power assist helps reduce the effort needed on the brake pedal. The brake assist system increases the stopping force when you depress the brake pedal hard in an emergency situation. The anti-lock brake system (ABS) helps you retain steering control when braking very hard.

✎ **Brake Assist System** [P.222](#)

✎ **ABS (Anti-lock Brake System)** [P.221](#)

✎ Foot Brake

Check the brakes after driving through deep water, or if there is a buildup of road surface water. If necessary, dry the brakes by lightly depressing the pedal several times.

If you hear a continuous metallic friction sound when applying the brakes, the brake pads need to be replaced. Have the vehicle checked by a dealer.

Constantly using the brake pedal while going down a long hill builds up heat, which reduces the brake effectiveness. Apply engine braking by taking your foot off the accelerator pedal and downshifting to a lower gear. With manual transmission use a lower gear for greater engine braking.

Do not rest your foot on the brake pedal while driving, as it will lightly apply the brakes and cause them to lose effectiveness over time and reduce pad life. It will also confuse drivers behind you.

ABS (Anti-lock Brake System)

■ ABS

Helps prevent the wheels from locking up, and helps you retain steering control by pumping the brakes rapidly, much faster than you can do.

The electronic brake distribution (EBD) system, which is part of the ABS, also balances the front-to-rear braking distribution according to vehicle loading.

You should never pump the brake pedal. Let the ABS work for you by always keeping firm, steady pressure on the brake pedal. This is sometimes referred to as “stomp and steer.”

■ ABS Operation

The brake pedal may pulsate slightly when the ABS is working. Keep holding the pedal firmly down. On dry pavement, you will need to press on the brake pedal very hard before the ABS activates. However, you may feel the ABS activate immediately if you are trying to stop on snow or ice.

When the vehicle speed goes under 6 mph (10 km/h), the ABS stops.

» ABS (Anti-lock Brake System)

NOTICE

The ABS may not function correctly if you use an incorrect tire type and size.

When the ABS indicator comes on while driving, there may be a problem with the system. While normal braking is not affected, there is a possibility of the ABS not operating. Have the vehicle checked by a dealer immediately.

The ABS does not reduce the time or distance it takes to stop the vehicle. It only helps with steering control during hard braking.

In the following cases, your vehicle may need more stopping distance than a vehicle without ABS:

- When driving on rough road surfaces, including when driving on uneven surfaces, such as gravel or snow.
- When tire chains are installed.

You may hear a motor sound coming from the engine compartment while system checks are being performed immediately after starting the engine or while driving. This is normal.

Brake Assist System

■ Brake Assist System

Designed to assist the driver by generating greater braking force when you depress the brake pedal hard during emergency braking.

■ Brake Assist System Operation

Press the brake pedal firmly for more powerful braking.

When brake assist operates, the pedal may wiggle slightly and an operating noise may be heard. This is normal. Keep holding the brake pedal firmly down.

When Stopped

1. Always use the parking brake when you park your vehicle.
2. Make sure the parking brake is set firmly, or your vehicle may roll if parked on an incline.

» Parking Your Vehicle

Do not park your vehicle near flammable objects, such as dry grass, oil, or timber. Heat from the exhaust can cause a fire.

» When Stopped

Automatic transmission (CVT) model

NOTICE

The following can damage the transmission:

- Depressing the accelerator and brake pedals simultaneously.
- Holding the vehicle in place when facing uphill by depressing the accelerator pedal.
- Moving the shift lever into **P** before the vehicle stops completely.

Auto Idle Stop (Automatic Transmission - CVT)

To help maximize fuel economy, Auto Idle Stop shuts off the engine when the vehicle comes to a stop, depending on environmental and vehicle operating conditions. The AUTO STOP indicator blinks at this time.

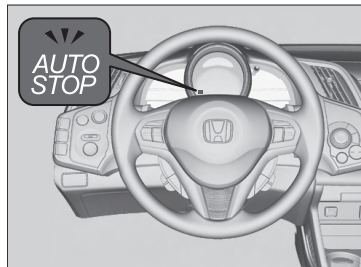

The engine then restarts once the vehicle is about to move again, and the indicator goes off.

If the driver's door is opened while the indicator is blinking, a buzzer sounds to notify you that the auto idle stop function is in operation.

☒ Auto Idle Stop (Automatic Transmission - CVT)

The duration of the Auto Idle Stop operation:

- **Increases** in the ECON mode compared to normal or sport mode with climate control in use.
- **Decreases** if you operate the wipers and climate control simultaneously.

■ Auto Idle Stop Activates When:

The idle stop is done when the vehicle stops with the shift lever in **D** and the brake pedal depressed.

■ Auto Idle Stop Does Not Activate When:

- The low temperature indicator is on.
- The IMA battery charge is low.
- The bars of the ASST/CHRG indicators do not move when accelerating or decelerating.
- The transmission fluid temperature is low.
- The vehicle comes to a stop again before the vehicle speed reaches 9 mph (15 km/h) after the engine starts.
- Stopped on a steep incline.
- The shift lever is in a position other than **D** or **N**.
- Airflow from the climate control system increases.
 - ▶ If you have selected the fan speed manually:
The display shows more than five vertical bars.
- Shift mode is in the L mode.
-  is on (the indicator is on).

■ Auto Idle Stop May Not Activate When:

- The climate control system is in use, and there is a significant difference between the set temperature and the actual interior temperature. (Except when in ECON mode).
- When humidity in the interior is high.
- The vehicle is stopped by braking suddenly.

⌘ Auto Idle Stop Activates When:

The brake pedal is depressed, and the vehicle slows down to a speed below 6 mph (10 km/h).

■ The Engine Automatically Restarts When:

The brake pedal is released.

■ Engine Restarts Even If the Brake Pedal is Depressed When:

- The shift position is changed to **R**.
- Shift mode set in the L mode.
- The accelerator pedal is depressed.
- The pressure to the brake pedal is reduced and the vehicle starts moving while stopped on an incline.
- The IMA battery charge becomes low.
- The low temperature indicator comes on.
- The climate control system is in use, and the difference between the set temperature and actual interior temperature becomes significant.
- The climate control system is being used to dehumidify the interior.
- The pressure on the brake pedal is repeatedly applied and released slightly.
- The  (windshield defogger) button is pressed.

Auto Idle Stop (Manual Transmission)

To help maximize fuel economy, the engine automatically stops when the vehicle comes to a stop, depending on environmental and vehicle operating conditions. The AUTO STOP indicator blinks at this time. The engine then restarts once the vehicle is about to move again when you depress the clutch pedal fully, and the indicator goes off.

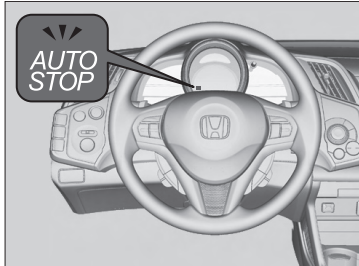

If the driver's door is opened while the indicator is blinking, a buzzer sounds to notify you that the auto idle stop function is in operation.

⌘ Auto Idle Stop (Manual Transmission)

If the Auto Idle Stop operating time lasts long enough to lower the 12 volt battery charge or the IMA battery charge, the engine may not restart automatically.

Manually turn off the engine when you leave your vehicle.

The duration of auto idle stop operation:

- **Increases** in the ECON mode compared to normal or sport mode with climate control in use.
- **Decreases** if you operate the wipers and climate control simultaneously.

■ Auto Idle Stop Activates When:

Stopping with the brake, the clutch pedal is fully depressed, and the shift lever is in **N**.

▶ To restart the engine automatically, depress the clutch pedal.

■ Auto Idle Stop Does Not Activate When:

- The low temperature indicator is on.
- The IMA battery charge is low.
- The bars of the ASST/CHRG indicators do not move when accelerating or decelerating.
- The vehicle comes to a stop again before the vehicle speed reaches 9 mph (15km/h) after the engine starts.
- The shift lever is in **R**.
- Airflow from the climate control system increases.
 - ▶ If you have selected the fan speed manually:
The display shows more than five vertical bars.
-  is on (the indicator is on).

■ Auto Idle Stop May Not Activate When:

- The climate control system is in use, and there is a significant difference between the set temperature and the actual interior temperature. (Except when in ECON mode).
- When humidity in the interior is high.
- The vehicle is stopped by braking suddenly

⊗ Auto Idle Stop Activates When:

The brake pedal is depressed, the vehicle slows down to a speed below 19 mph (30 km/h), and the clutch pedal is fully pressed.

The engine may not stop or restart automatically if you fail to fully depress the clutch pedal. Keeping the proper driving positions makes it easier for you to depress the clutch pedal fully.

▶ **Adjusting the Seats** P.119

■ The Engine Automatically Restarts When:

The clutch pedal is fully depressed, and the shift lever is moved to a position other than **N**.

■ The Engine Automatically Restarts When the Clutch Pedal is Fully Depressed Even If the Shift Lever is in **N** When:

- The low temperature indicator comes on.
- The accelerator pedal is pressed.
- The IMA battery charge becomes low.
- The climate control system is in use, and the difference between the set temperature and actual interior temperature becomes significant.
- The climate control system is being used to dehumidify the interior.

The engine automatically restarts when the pressure on the brake pedal is repeatedly applied and released slightly during a stop. This applies even if the clutch pedal is not fully depressed.

■ When the Auto Idle Stop Indicator Starts Blinking Rapidly

Fully depress the clutch pedal.

- ▶ The engine automatically restarts

▣ When the Auto Idle Stop Indicator Starts Blinking Rapidly

The indicator starts blinking rapidly under the following conditions:

- The  (windshield defogger) button is pressed.
- When the climate control system is in use and moisture builds up inside the vehicle.
- When the climate control system is in use and the difference between the set temperature and the actual temperature inside the vehicle becomes significant.

Parking

Automatic transmission (CVT) model

1. Depress the brake pedal firmly with the shift lever in **D**.
2. Apply the parking brake while holding the brake pedal down.
3. Move the shift lever to **P**.
4. Turn off the engine.

⌘ Parking

Raise the wiper arms when snow is expected.

Fuel Information

■ Fuel Recommendation

Unleaded gasoline, pump octane number 87 or higher

Use of a lower octane gasoline can cause a persistent, heavy metallic knocking noise that can lead to engine damage.

■ Fuel Tank Capacity: 10.6 U.S. gal (40 L)

» Fuel Information

NOTICE

We strongly recommend that you do NOT use gasoline that contains manganese-based fuel additives such as MMT.

Use of gasoline with these additives may adversely affect performance of the emissions control system, breach the emissions warranty, and cause the malfunction indicator lamp to come on. If this happens, have it checked by a dealer.

NOTICE

Use of gasoline that contains these additives presents the following risks:

- Damage to the exhaust system including the catalytic converter
- Damage to the engine and fuel system
- Detrimental effects on the engine and other systems

Some gasoline today is blended with oxygenates such as ethanol. Your vehicle is designed to operate on oxygenated gasoline containing up to 10% ethanol by volume.

For more information, visit www.hondacars.com, www.honda.ca for Canadian customers. For details about the factors affecting fuel economy ratings, see www.fueleconomy.gov (www.vehicles.gc.ca for Canada).

How to Refuel

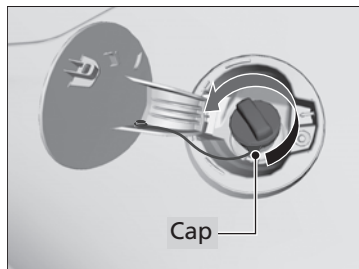
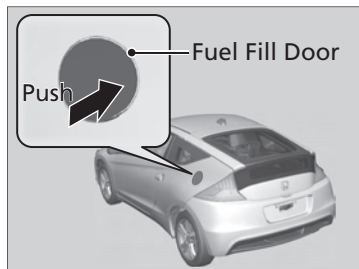

1. Stop your vehicle with the service station pump on the left side of the vehicle in the rear.
2. Turn off the engine.
3. Press the area indicated by the arrow to release the fuel fill door. You will hear a click.
4. Remove the fuel fill cap slowly. If you hear a release of air, wait until this stops, then turn the knob slowly to open the fuel fill cap.

How to Refuel

⚠WARNING

Gasoline is highly flammable and explosive. You can be burned or seriously injured when handling fuel.

- Stop the engine, and keep heat, sparks, and flame away.
- Handle fuel only outdoors.
- Wipe up spills immediately.

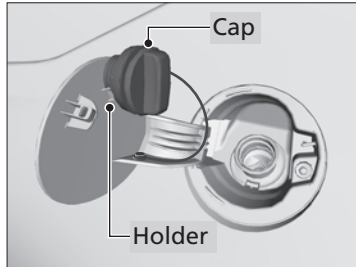

5. Place the fuel fill cap in the holder.
6. Insert the fuel nozzle fully.
 - ▶ When the tank is full, the fuel nozzle will click off automatically. This leaves space in the fuel tank in case the fuel expands with a change in the temperature.
7. After filling, replace the fuel fill cap, tightening it until you hear it click at least once.
 - ▶ Shut the fuel fill door by hand.

» How to Refuel

NOTICE

The fuel nozzle automatically stops to leave space in the fuel tank so that fuel does not overflow as a result of changes in air temperature. If the fuel nozzle keeps turning off when the tank is not full, there may be a problem with the pump's fuel vapor recovery system. Try filling at another pump. If this does not fix the problem, consult a dealer.

Do not continue to add fuel after the nozzle has automatically stopped. Additional fuel can exceed the full tank capacity.

Improving Fuel Economy

Fuel economy is dependent on several conditions, including driving conditions, your driving habits, and the condition of your vehicle, and loading. Depending on these and other conditions, you may or may not achieve the rated fuel economy of this vehicle.

Maintenance and Fuel Economy

You can optimize your fuel economy with proper maintenance of your vehicle. Always maintain your vehicle in accordance with the messages displayed on the multi-information display.

- Use engine oil with the viscosity recommended by the API Certification Seal.
- Maintain the specified tire pressure.
- Do not load the vehicle with excess cargo.
- Keep your vehicle clean. A buildup of snow or mud on your vehicle's underside adds weight and increases wind resistance.

Improving Fuel Economy

Direct calculation is the recommended method to determine actual fuel consumed while driving.

$$\begin{array}{l} \boxed{\text{Miles driven}} \div \boxed{\text{Gallons of fuel}} = \boxed{\text{Miles per Gallon}} \\ \boxed{100} \times \boxed{\text{Liter}} \div \boxed{\text{Kilometers}} = \boxed{\text{L per 100 km}} \end{array}$$

In Canada, posted fuel economy numbers are established following a simulated test. For more information on how this test is performed, please visit <http://oee.nrcan.gc.ca/>

Accessories

When installing accessories, check the following:

- Do not install accessories on the windshield. They can obstruct your view and delay your reaction to driving conditions.
- Do not install accessories on the side pillars or across the side windows. Accessories installed in these areas may interfere with proper operation of the side curtain airbags.
- Be sure electronic accessories do not overload electrical circuits or interfere with proper operation of your vehicle.
 - ▣ Fuse P.304
- Before installing any electronic accessory, have the installer contact a dealer for assistance. If possible, have a dealer inspect the final installation.

Modifications

Do not modify your vehicle or use non-Honda components that can affect its handling, stability, and reliability.

Overall vehicle performance can be affected. Always make sure all equipment is properly installed and maintained, and that it meets federal, state, province, territory, and local regulations.

» Accessories and Modifications

⚠ WARNING

Improper accessories or modifications can affect your vehicle's handling, stability, and performance, and cause a crash in which you can be hurt or killed.

Follow all instructions in this owner's manual regarding accessories and modifications.

Use Honda Genuine accessories to ensure proper operation on your vehicle. Contact your dealer when purchasing and installing parts and accessories.

Maintenance

This chapter discusses basic maintenance.



Before Performing Maintenance

Inspection and Maintenance.....	238
Safety When Performing Maintenance ...	239
Parts and Fluids Used in Maintenance Service	240

Maintenance Minder™

241

Maintenance Under the Hood

Maintenance Items Under the Hood	245
Opening the Hood	246
Recommended Engine Oil	247
Oil Check	248
Adding Engine Oil	249
Changing the Engine Oil and Oil Filter	250

Engine Coolant	252
Transmission Fluid	254
Brake/Clutch Fluid	256
Refilling Window Washer Fluid	257

Replacing Light Bulbs

258

Checking and Maintaining Wiper Blades

Checking Wiper Blades.....	266
Changing the Front Wiper Blade Rubber	266
Changing the Rear Wiper Blade Rubber..	268

Checking and Maintaining Tires

Checking Tires.....	269
Tire and Loading Information Label	270
Tire Labeling.....	270

DOT Tire Quality Grading (U.S. Vehicles) .	272
Wear Indicators	274
Tire Service Life	274
Tire and Wheel Replacement.....	275
Tire Rotation	276
Winter Tires.....	277

12 Volt Battery

278

Remote Transmitter Care

279

Replacing the Battery	279
-----------------------------	-----

Climate Control System Maintenance ...

280

Cleaning

281

Interior Care.....	281
Exterior Care	283

Inspection and Maintenance

For your safety, perform all listed inspections and maintenance to keep your vehicle in good condition. If you become aware of any abnormality (noise, smell, insufficient brake fluid, oil residue on the ground, etc.), have your vehicle inspected by a dealer. (Note, however, that service at a dealer is not mandatory to keep your warranties in effect.) Refer to the separate maintenance booklet for detailed maintenance and inspection information.

Types of Inspection and Maintenance

Daily Inspections

Perform inspections before long distance trips, when washing the vehicle, or when refueling.

Periodic Inspections

- Check the automatic transmission fluid level monthly.
 - **Automatic Transmission Fluid** P.254
- Check the brake fluid level monthly.
 - **Brake/Clutch Fluid** P.256
- Check the tire pressure monthly. Examine the tread for wear and foreign objects.
 - **Checking and Maintaining Tires** P.269
- Check the operation of the headlights, parking lights, taillights, high-mount brake light, and license plate lights monthly.
 - **Replacing Light Bulbs** P.258
- Check the condition of the wiper blades at least every six months.
 - **Checking and Maintaining Wiper Blades** P.266

Inspection and Maintenance

U.S. models only

Maintenance, replacement, or repair of emissions control devices and systems may be done by any automotive repair establishment or individual using parts that are "certified" to EPA standards.

According to state and federal regulations, failure to perform maintenance on the items marked with # will not void your emissions warranties. However, all maintenance services should be performed in accordance with the intervals indicated by the multi-information display.

➤ **Maintenance Service Items** P.243

If you want to perform complex maintenance tasks that require more skills and tools, purchase the service manual.

➤ **Authorized Manuals** P.319

If you want to perform maintenance yourself, make sure that you have the necessary tools and skills first.

After performing maintenance, complete the records in the separate maintenance booklet.

Safety When Performing Maintenance

Some of the most important safety precautions are given here.

However, we cannot warn you of every conceivable hazard that can arise in performing maintenance. Only you can decide whether or not you should perform a given task.

Maintenance Safety

- To reduce the possibility of fire or explosion, keep cigarettes, sparks, and flames away from the battery and all fuel related parts.
- To clean parts, use a commercially available degreaser or parts cleaner, not gasoline.
- Wear eye protection and protective clothing when working with the 12 volt battery or compressed air.
- Engine exhaust gasses contain carbon monoxide, which is poisonous and can kill you.
 - Only operate the engine if there is sufficient ventilation.

Vehicle Safety

- The vehicle must be in a stationary condition.
 - Make sure your vehicle is parked on level ground, the parking brake is set, and the engine is off.
- Be aware that hot parts can burn you.
 - Make sure to let the engine and exhaust system cool thoroughly before touching vehicle parts.
- Be aware that moving parts can injure you.
 - Do not start the engine unless instructed, and keep your hands and limbs away from moving parts.
- Do not touch the IMA battery and wirings (orange).

» Safety When Performing Maintenance

WARNING

Improperly maintaining this vehicle or failing to correct a problem before driving can cause a crash in which you can be seriously hurt or killed.

Always follow the inspection and maintenance recommendations according to the schedules in this owner's manual.

WARNING

Failure to properly follow maintenance instructions and precautions can cause you to be seriously hurt or killed.

Always follow the procedures and precautions in this owner's manual.

Parts and Fluids Used in Maintenance Service

The use of Honda genuine parts and fluids is recommended when maintaining and servicing your vehicle. Honda genuine parts are manufactured according to the same high quality standards used in Honda vehicles.

If the engine oil life is less than 15%, you will see the maintenance minder messages appear on the multi-information display every time you turn the ignition switch to ON **II**. The messages notify you when to change the engine oil, or when to bring your vehicle to a dealer for indicated maintenance services.

■ Displaying the Engine Oil Life

1. Turn the ignition switch to ON **II**.
2. Press the **▲(i)/▼** button repeatedly until the engine oil life appears on the multi-information display.

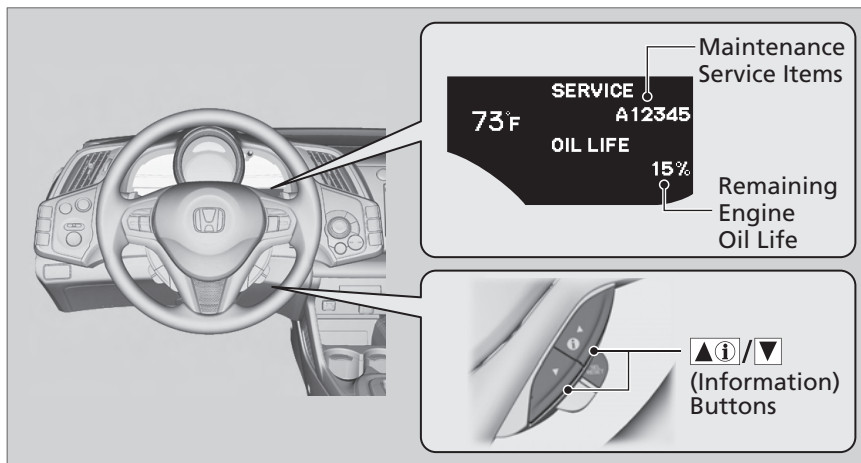







The system message indicator (i) comes on along with the maintenance minder message.

▣ Displaying the Engine Oil Life

Based on the engine operating conditions, the remaining engine oil life is calculated and displayed as a percentage.

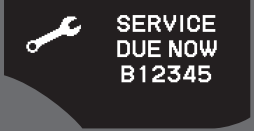
Displayed Engine Oil Life (%)	Calculated Engine Oil Life (%)
100	100 to 91
90	90 to 81
80	80 to 71
70	70 to 61
60	60 to 51
50	50 to 41
40	40 to 31
30	30 to 21
20	20 to 16
15	15 to 11
10	10 to 6
5	5 to 1
0	0

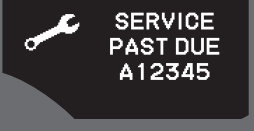
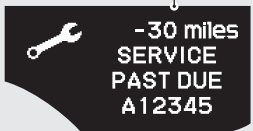
Maintenance Minder Messages on the Multi-Information Display

Maintenance Message	Oil Life Display	Explanation	Information
<p>SERVICE DUE SOON</p> 	<p>15%</p> 	<p>The remaining engine oil life is 15 to 6 percent. Once you switch the display by pressing the /▼ button, this message will go off.</p>	<p>The engine oil is approaching the end of its service life, and the maintenance items should be inspected and serviced soon.</p>
<p>SERVICE DUE NOW</p> 	<p>5%</p> 	<p>The remaining engine oil life is 5 to 1 percent. Press the /▼ button to switch to another display.</p>	<p>The engine oil has almost reached the end of its service life, and the maintenance items should be inspected and serviced as soon as possible.</p>
<p>SERVICE PAST DUE</p> 	<p>Negative Distance</p> <p>U.S.</p>  <p>Canada</p> 	<p>The remaining engine oil life has passed its service life, and a negative distance appears after driving over 10 miles (US models) or 10 km (Canadian models). Press the /▼ button to switch to another display.</p>	<p>The engine oil life has passed. The maintenance items must be inspected and serviced immediately.</p>

Maintenance Service Items

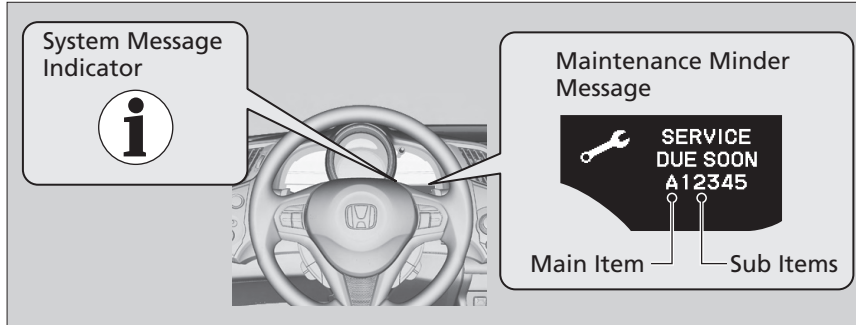

Code	Maintenance Main Items	Code	Maintenance Sub Items
A	<ul style="list-style-type: none"> • Replace engine oil*¹ 	1	<ul style="list-style-type: none"> • Rotate tires
B	<ul style="list-style-type: none"> • Replace engine oil*¹ and oil filter • Inspect front and rear brakes • Check parking brake adjustment • Inspect tie rod ends, steering gear box, and boots • Inspect suspension components • Inspect driveshaft boots • Inspect brake hoses and lines (including ABS/VSA[®]) • Inspect all fluid levels and condition of fluids • Inspect exhaust system[#] • Inspect fuel lines and connections[#] 	2	<ul style="list-style-type: none"> • Replace air cleaner element*² • Replace dust and pollen filter*³ • Inspect drive belt
		3	<ul style="list-style-type: none"> • Replace transmission fluid
		4	<ul style="list-style-type: none"> • Replace spark plugs • Inspect valve clearance
		5	<ul style="list-style-type: none"> • Replace engine coolant

» Maintenance Service Items

- Independent of the maintenance minder messages, replace the brake fluid every 3 years.
- Inspect idle speed every 160,000 miles (256,000 km).
- Adjust the valves during services A, B, 1, 2, or 3 only if they are noisy.

*1: Change the engine oil according to the maintenance minder messages, or annually, whichever comes first.

*2: If you drive in dusty conditions, replace the air cleaner element every 15,000 miles (24,000 km).



*3: If you drive primarily in urban areas that have high concentrations of soot in the air from industry and from diesel-powered vehicles, replace the dust and pollen filter every 15,000 miles (24,000 km).

#: See information on maintenance and emissions warranty.

■ Resetting the Display

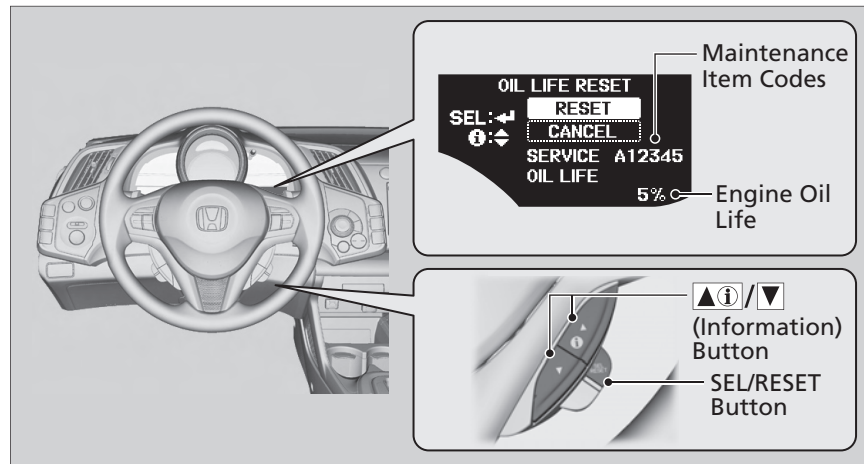
Reset the engine oil life display if you have performed the maintenance service.



1. Turn the ignition switch to ON .
2. Display the engine oil life by repeatedly pressing the  button.
3. Press and hold the SEL/RESET button for 10 seconds or more.
 - ▶ The oil life reset mode is displayed on the multi-information display.
4. Select "RESET" with the , then press the SEL/RESET button.
 - ▶ The service code will disappear and the engine oil life display will return to 100 %.

To cancel the oil life reset mode, select "CANCEL", then press the SEL/RESET button.

» Resetting the Display

NOTICE

Failure to reset the engine oil life after a maintenance service results in the system showing incorrect maintenance intervals, which can lead to serious mechanical problems.

The dealer will reset the engine oil life display after completing the required maintenance service. If someone other than a dealer performs maintenance service, reset the engine oil life display yourself.

Maintenance Items Under the Hood

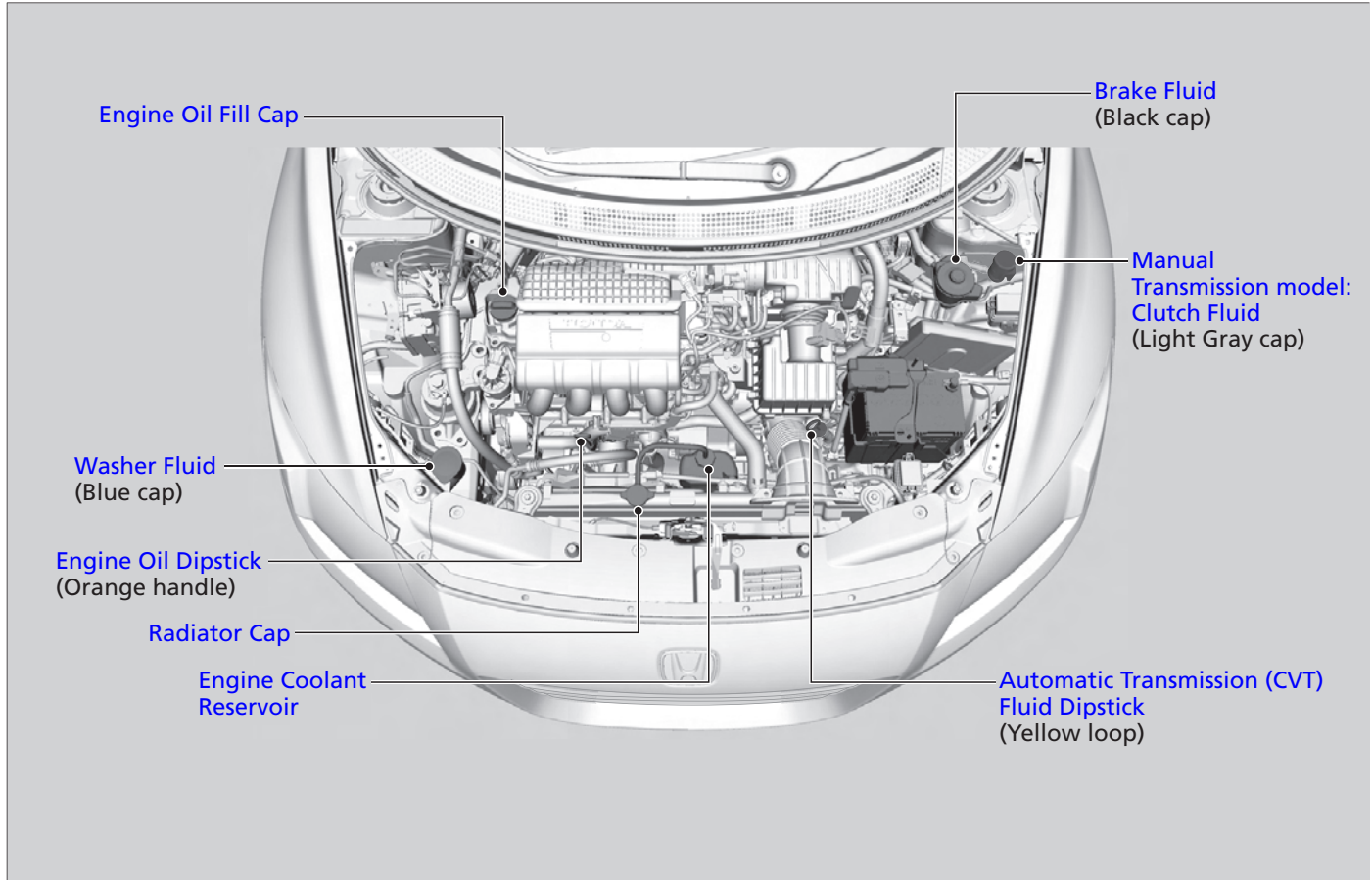

2011 CR-Z

Opening the Hood

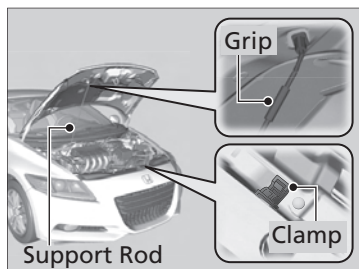
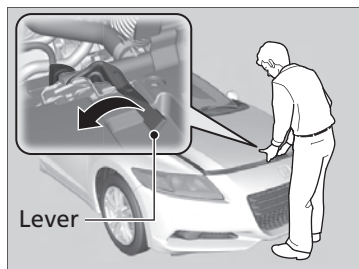
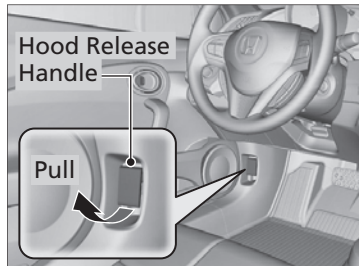

1. Park the vehicle on a level surface, and set the parking brake.
2. Pull the hood release handle under the lower left corner of the dashboard.
 - The hood will pop up slightly.
3. Push up the hood latch lever in the center of the hood to release the lock mechanism, and open the hood.
4. Remove the support rod from the clamp using the grip. Mount the support rod in the hood.

When closing, remove the support rod, and stow it in the clamp, then gently lower the hood. Remove your hand at a height of approximately 12 inches (30 cm) and let the hood close.

Opening the Hood

NOTICE

Do not open the hood when the wiper arms are raised.

The hood will strike the wipers, and may damage either the hood or the wipers.

When closing the hood, check that the hood is securely locked.

If the hood latch lever moves stiffly, or if you can open the hood without lifting the lever, the mechanism should be cleaned and lubricated.

Do not open the hood while the auto idle stop function is activated.

Recommended Engine Oil

Oil is a major contributor to your engine's performance and longevity. If you drive the vehicle with insufficient or deteriorated oil, the engine may fail or be damaged.



This seal indicates the oil is energy conserving and that it meets the American Petroleum Institute's latest requirements.

- **Genuine Honda Motor Oil**
- **Premium-grade 0W-20 detergent oil with an API Certification Seal on the container.**

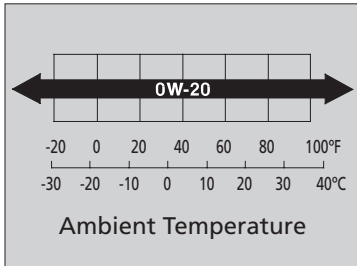

Use a commercial engine oil of suitable viscosity for the ambient temperature as shown below.

■ Synthetic Oil

You may also use synthetic motor oil if it is labeled with the API Certification Seal and is the specified viscosity.

▣ Recommended Engine Oil

Engine Oil Additives

Your vehicle does not require oil additives. In fact, they may adversely affect the engine or transmission performance and durability.

Oil Check

We recommend that you check the engine oil level every time you refuel.

Park the vehicle on level ground.

Wait approximately 3 minutes after turning the engine off before you check the oil.

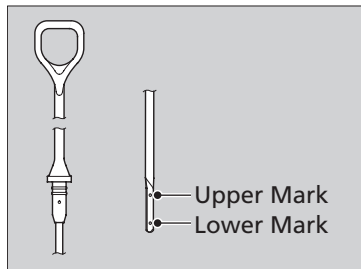
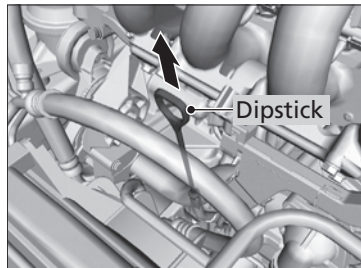

1. Remove the dipstick (orange handle).
2. Wipe the dipstick with a clean cloth or paper towel.
3. Insert the dipstick back all the way into its hole.
4. Remove the dipstick again, and check the level. It should be between the upper and lower marks.

Oil Check

If it is near or below the lower mark, add oil.

Adding Engine Oil

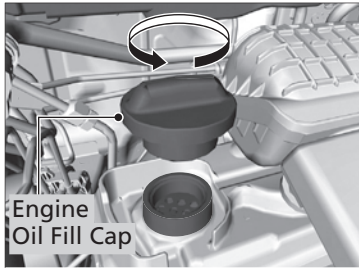

1. Unscrew and remove the engine oil fill cap.
2. Slowly pour in the oil.
3. Reinstall the engine oil fill cap, and tighten it securely.
4. Wait for several minutes and recheck the engine oil dipstick.

⌘ Adding Engine Oil

If any oil spills, wipe it up immediately. Spilled oil may damage the engine compartment components.

NOTICE

Do not fill the engine oil above the upper limit mark. Overfilling the engine oil may result in engine damage.

Changing the Engine Oil and Oil Filter

You must change the engine oil and oil filter regularly in order to maintain the engine's lubrication. The engine may be damaged if they are not changed regularly. Change the oil and filter in accordance with the maintenance message on the multi-information display.

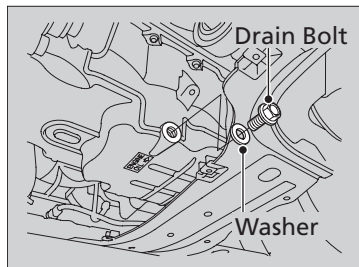
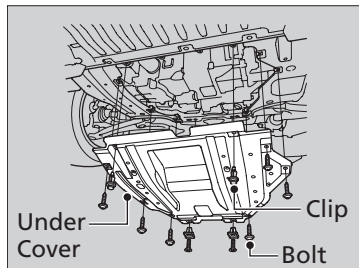

1. Run the engine until it reaches normal operating temperature, and then turn the engine off.
2. Open the hood and remove the engine oil fill cap.
3. Remove the bolts and clips on the undercarriage and remove the cover.
4. Remove the drain bolt and washer from the bottom of the engine, and drain the oil into a suitable container.
5. Remove the oil filter and dispose of the remaining oil.

► Changing the Engine Oil and Oil Filter

NOTICE

You may damage the environment if you do not dispose of the oil in a suitable way. If you are changing the oil by yourself, appropriately dispose of the used oil. Put the oil in a sealed container and take it to a recycling center. Do not throw the oil away into a garbage can or onto the ground.

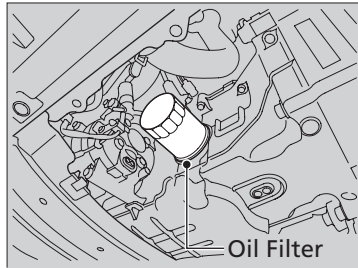

6. Check that the filter gasket is not stuck to the engine contact surface.
 - If it is stuck, you must detach it.
7. Wipe away dirt and dust adhering to the contact surface of the engine block, and install a new oil filter.
8. Put a new washer on the drain bolt, then reinstall the drain bolt.
 - Tightening torque: 29 lbf·ft (39 N·m, 4.0 kgf·m)
9. Pour the recommended engine oil into the engine.
 - Engine oil change capacity (including filter): 3.8 US qt (3.6 L)
10. Reinstall the engine oil fill cap back and start the engine.
11. Run the engine for a few minutes, and then check that there is no leak from the drain bolt or oil filter.
12. Stop the engine, wait for a few minutes, and then check the oil level on the engine oil dipstick.
 - If necessary, add more engine oil.

▣ Changing the Engine Oil and Oil Filter

You will need a special wrench to replace the oil filter. You can buy this wrench from a dealer.

When installing the new oil filter, follow the instruction supplied with the oil filter.

Reinstall the engine oil fill cap. Start the engine. The low oil pressure indicator should go off within five seconds. If it does not, turn off the engine, and check your work.

Engine Coolant

Specified coolant: Honda Long Life Antifreeze/Coolant Type 2

This coolant is premixed with 50% antifreeze and 50% water. Do not add any more antifreeze or water.

We recommend you check the engine coolant level every time you refuel. Check the reserve tank first. If it is completely empty, also check the coolant level in the radiator. Add the engine coolant accordingly.

Reserve Tank

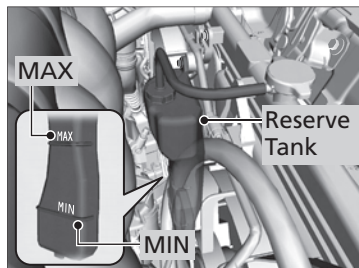

1. Check the amount of coolant in the reserve tank.

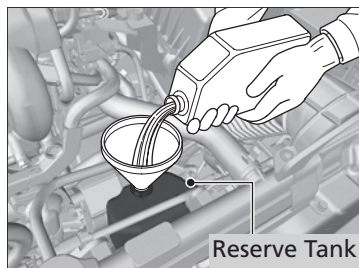

2. If the coolant level is below the MIN mark, add coolant until it reaches the MAX mark.
3. Inspect the cooling system for leaks.

Engine Coolant

If Honda antifreeze/coolant is not available, you may use another major brand non-silicate coolant as a temporary replacement. Check that it is a high quality coolant recommended for aluminum engines. Continued use of any non-Honda coolant can result in corrosion, causing the cooling system to malfunction or fail. Have the cooling system flushed and refilled with Honda antifreeze/coolant as soon as possible.

Do not add rust inhibitors or other additives to your vehicle's cooling system. They may not be compatible with the coolant or with the engine components.

Radiator

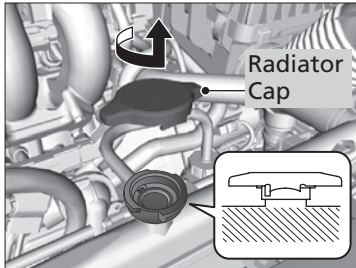

1. Make sure the engine and radiator are cool.
2. Turn the radiator cap counterclockwise and relieve any pressure in the cooling system. Do not press the cap down when turning.
3. Push down and turn the radiator cap counterclockwise to remove it.
4. The coolant level should be up to the base of the filler neck. Add coolant if it is low.
5. Put the radiator cap back on, and tighten it fully.
6. Pour coolant into the reserve tank until it reaches the MAX mark. Put the cap back on the reserve tank.
 - Pour the fluid slowly and carefully so you do not spill any. Clean up any spills immediately; they can damage components in the engine compartment.

» Radiator

⚠ WARNING

Removing the radiator cap while the engine is hot can cause the coolant to spray out, seriously scalding you.

Always let the engine and radiator cool down before removing the radiator cap.

Transmission Fluid

■ Automatic Transmission Fluid

■ Continuously Variable Transmission (CVT)

Specified fluid: Honda CVTF (continuously variable transmission fluid)

Check the fluid level when the engine is at normal operating temperature.

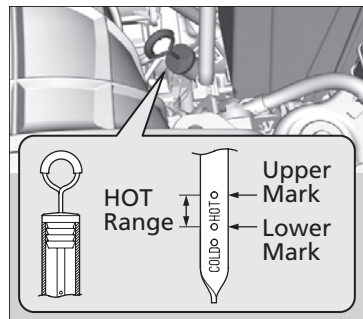

1. Park on level ground, and start the engine.
2. Wait until the radiator fan starts and then turn off the engine.
 - Perform step 3 after waiting for about 60 seconds (less than 90 seconds).
3. Remove the dipstick (yellow loop) from the transmission and wipe it with a clean cloth.
4. Insert the dipstick all the way back into the transmission securely, as shown in the image.
5. Remove the dipstick again and check the fluid level.
 - It should be between the upper and lower marks in the HOT range.
6. If the level is below the lower mark, add fluid into the dipstick hole to bring it to the level between the upper and lower marks, and have your vehicle checked by a dealer immediately.
 - Pour the fluid slowly and carefully so you do not spill any. Clean up any spills immediately; they can damage components in the engine compartment.

Manual Transmission Fluid

Specified fluid: Honda Manual Transmission Fluid (MTF)

Check the fluid level when the engine is at normal operating temperature.

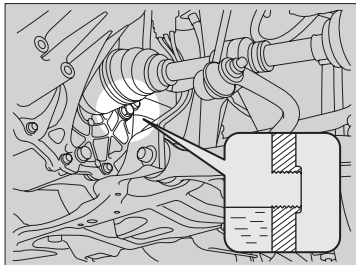
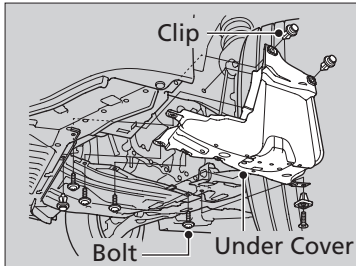

1. Park the vehicle on level ground.
2. Remove the bolts with a wrench and clips with a flat-tip screwdriver, then carefully remove the under cover.
3. Remove the transmission filler bolt and washer.
Carefully feel inside the bolt hole with your fingers.
 - ▶ Check if the fluid level is up to the edge of the bolt hole.
4. If the fluid level is not up to the edge of the bolt hole, add Honda Manual Transmission Fluid (MTF) until it runs out of the hole.
5. Put a new washer on the filler bolt, then reinstall the filler bolt.
 - ▶ Tightening torque: 33 lbf·ft (44 N·m, 4.5 kgf·m)
6. Reinstall the under cover with the bolts and clips.

Manual Transmission Fluid

If Honda MTF is not available, you may use the API certificated SAE 10 W-30 or 10 W-40 viscosity motor oil as a temporary measure. Replace with MTF as soon as possible. Motor oil does not contain the proper additives for the transmission and continued use can cause stiffer shifting.

Brake/Clutch Fluid

Specified fluid: Honda Heavy Duty Brake Fluid DOT 3

Use the same fluid for both the brakes and clutch.

■ Checking the Brake Fluid

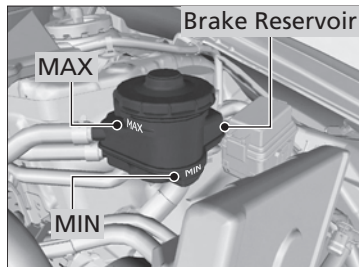

The fluid level should be between the MIN and MAX marks on the side of the reservoir.

■ Checking the Clutch Fluid

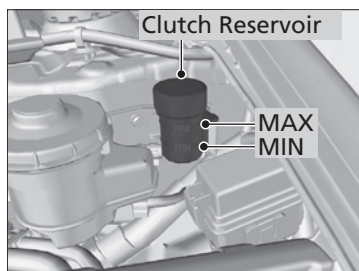

The fluid level should be between the MIN and MAX marks on the side of the reservoir.

⌘ Brake/Clutch Fluid

If the specified brake fluid is not available, you should use only DOT 3 or DOT 4 fluid from a sealed container as a temporary replacement.

Using any non-Honda brake fluid can cause corrosion and decrease the longevity of the system. Have the brake system flushed and refilled with Honda Heavy Duty Brake Fluid DOT 3 as soon as possible.

NOTICE

Brake fluid marked DOT 5 is not compatible with your vehicle's braking system and can cause extensive damage.

If the brake fluid level is at or below the MIN mark, have the system inspected for leaks or worn brake pads by a dealer.

⌘ Checking the Clutch Fluid

If the clutch fluid level is at or below the MIN mark, have the system inspected for leaks or a worn clutch plate by a dealer.

Refilling Window Washer Fluid

Models with washer fluid level gauge*

Check the amount of window washer fluid using the washer fluid level gauge on the cap.

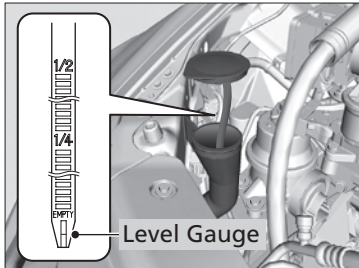

If the level is low, fill the washer reservoir.

Models with washer level sensor*

If the washer fluid is low, a message appears on the multi-information display.

Pour the washer fluid carefully. Do not overflow the reservoir.

» Refilling Window Washer Fluid

NOTICE

Do not use engine antifreeze or a vinegar/water solution in the window washer reservoir. Antifreeze can damage your vehicle's paint. A vinegar/water solution can damage the window washer pump.

*Not available on all models

Headlight Bulbs

When replacing, use the following bulbs.

High beam headlight: 60W (HB3)

**Low beam headlight: 55W (H11 for halogen bulb type)
35W (D4S for high voltage discharge)**

■ High Beam Headlight

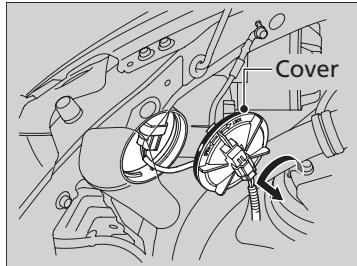

1. Remove the cover.

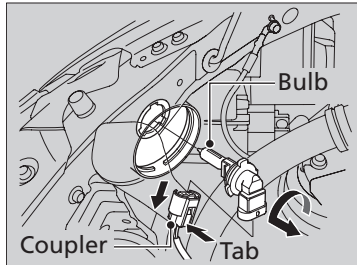

2. Remove the coupler.
 - ▶ It can be removed by pushing the tab.
3. Rotate the old bulb to the left to remove.
4. Insert a new bulb into the headlight assembly and turn it to the right.
5. Insert the coupler into the connector of the bulb.

⌘ Headlight Bulbs

NOTICE

Halogen bulbs get very hot when lit. Oil, perspiration, or a scratch on the glass can cause the bulb to overheat and shatter.

NOTICE

The headlight aim is set by the factory, and typically does not need to be adjusted. However, if you regularly carry heavy items in the cargo area, have the aiming readjusted by a dealer or another qualified technician.

The HB3 and H11 types are halogen bulbs.

When replacing a bulb, handle it by its base, and protect the glass from contact with your skin or hard objects. If you touch the glass, clean it with denatured alcohol and a clean cloth.

The exterior lights' inside lenses (headlights, brake lights, etc.) may fog temporarily after a vehicle wash or while driving in the rain. This does not impact the exterior light function.

However, if you see a large amount of water or ice accumulated inside the lenses, have your vehicle inspected by a dealer.

■ Low Beam Headlights (High Voltage Discharge Type)*

Ask a dealer to inspect and replace low beam headlights.

■ Low Beam Headlights (Halogen Headlights)*

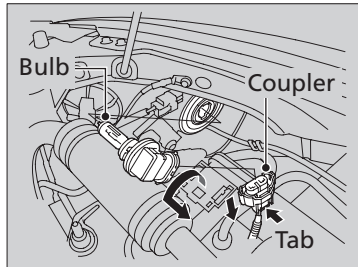

1. Remove the coupler.
 - ▶ It can be removed by pushing the tab.
2. Rotate the old bulb to the left to remove.
3. Insert a new bulb into the headlight assembly and turn it to the right.
4. Insert the coupler into the connector of the bulb.

Fog Light Bulbs*

When replacing, use the following bulbs.

Fog Lights: 55W (H11)

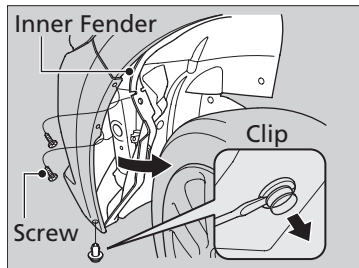

1. Turn the steering wheel all the way to the opposite side from the fog light being replaced.

Passenger side: Turn the steering wheel to the left.

Driver side: Turn the steering wheel to the right.

2. Remove the clip and screws, and pull the inner fender back.

» Fog Light Bulbs

NOTICE

Halogen bulbs get very hot when lit. Oil, perspiration, or a scratch on the glass can cause the bulb to overheat and shatter.

The fog lights are halogen bulbs. When replacing a bulb, handle it by its plastic case, and protect the glass from contact with your skin or hard objects. If you touch the glass, clean it with denatured alcohol and a clean cloth.

When removing the clip, insert a flat-tip screwdriver, and lift and remove the central pin.

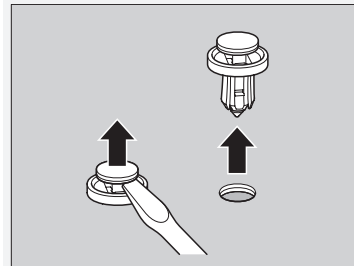

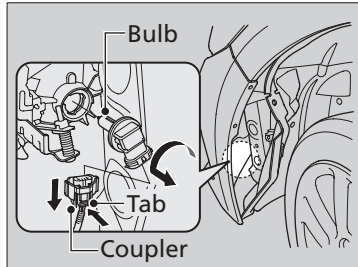

3. Remove the coupler.
 - ▶ It can be removed by pushing the tab.
4. Rotate the old bulb to the left to remove.
5. Insert a new bulb into the light assembly and turn it to the right.
6. Insert the coupler into the connector of the bulb.

☒ Fog Light Bulbs

When mounting the clip, insert while keeping the central pin of the clip raised, and push until the pin is flat.

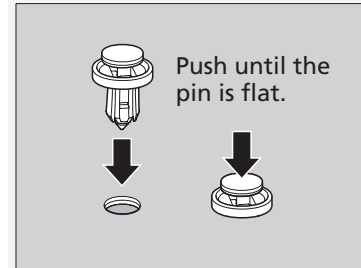

Front Turn Signal/Parking/Side Marker Light Bulbs

When replacing, use the following bulbs.

Front Turn Signal/Parking/Side Marker: 28/8W

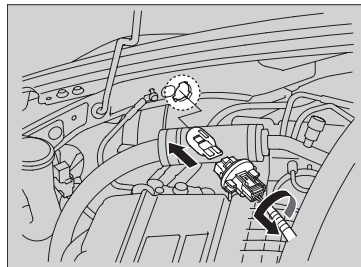

1. Turn the socket to the left and remove it, then remove the old bulb.
2. Insert a new bulb.

Side Turn Signal/Emergency Indicator Light Bulbs

Door mirrors have side turn signal lights. Have an authorized Honda dealer inspect and replace the light bulbs.

Back-Up, Rear Turn Signal and Rear Side Marker Light Bulbs

When replacing, use the following bulbs.

Back-Up: 16W
Rear Turn Signal: 21W (Amber)
Rear Side Marker: 3CP

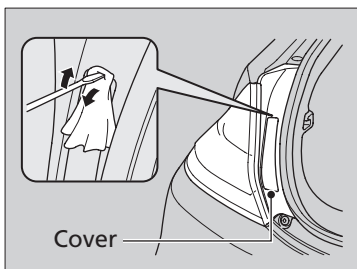

1. Pry on the edge of the cover using a flat-tip screwdriver to remove the cover.
 - ▶ Wrap the flat-tip screwdriver with a cloth to prevent scratches.

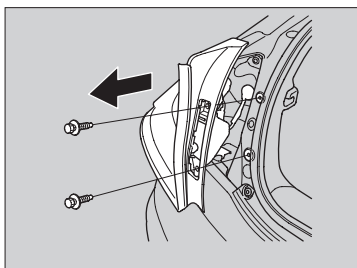

2. Remove the bolts.
3. Pull the light assembly out of the rear pillar.

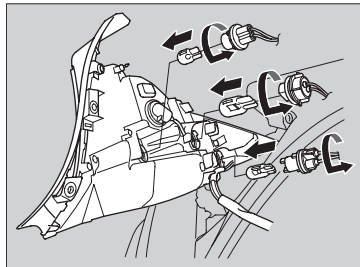

4. Turn the socket to the left and remove it, then remove the old bulb.
5. Insert a new bulb.

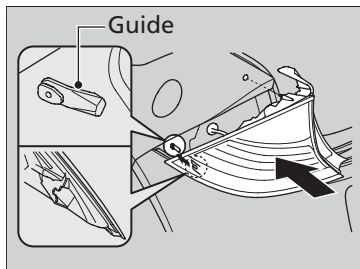

6. Reinstall the light assembly by sliding it on to the guide on the body.

Brake/Taillight Bulbs

Brake/rear taillight bulbs are LED type. Have an authorized Honda dealer inspect and replace the light bulbs.

License Plate Light Bulbs

When replacing, use the following bulbs.

License Plate Light: 5W

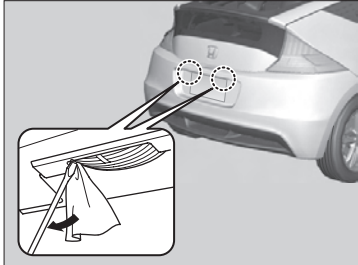

1. Remove the lens by prying on the edge of the lens using a flat-tip screwdriver.
 - ▶ Wrap the flat-tip screwdriver with a cloth to prevent scratches.

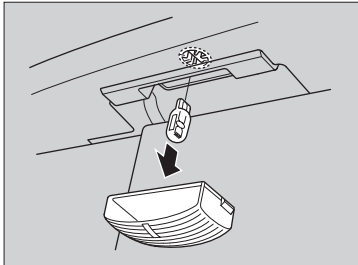

2. Remove the old bulb.
3. Insert a new bulb.

High-Mount Brake Light Bulbs

High-mount brake light bulbs are LED type. Have an authorized Honda dealer inspect and replace the light bulbs.

Checking Wiper Blades

If the wiper blade rubber has deteriorated, it will leaves streaks and the metal wiper arm may scratch the window glass.

Changing the Front Wiper Blade Rubber

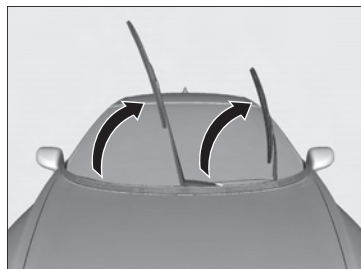

1. Lift the driver side wiper arm first, then the passenger side.

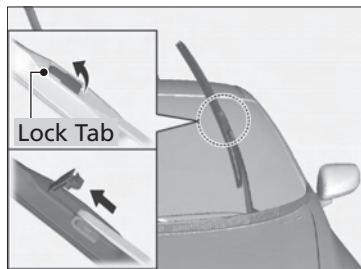

2. Push the lock tab up.
3. Slide the blade from the wiper arm.

» Changing the Front Wiper Blade Rubber

NOTICE

When replacing a wiper blade, make sure not to drop the wiper blade or wiper arm down on the windshield.

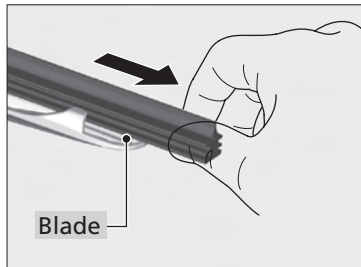

4. Slide the wiper blade out from its holder by pulling the tabbed end out.

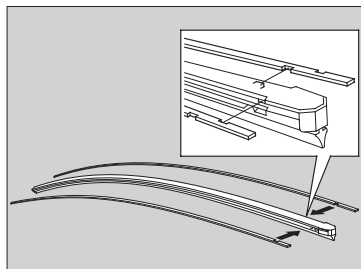

5. Remove the retainer from the rubber blade that has been removed, and mount it to a new rubber blade.
 - Correctly align the rubber protrusion and the retainer groove.

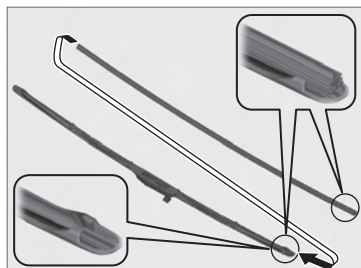

6. Slide the new wiper blade onto the holder from the bottom end.
 - The tab on the blade should fit in the indent of the wiper blade.
7. Slide the wiper blade onto the wiper arm, then push down the lock tab.
8. Lower the passenger side wiper arm first, then the driver side.

Changing the Rear Wiper Blade Rubber

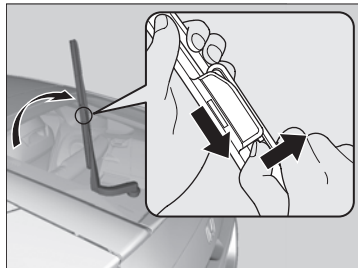

1. Raise the wiper arm off.
2. Slide the wiper blade out from the wiper arm while pushing the lock tab.

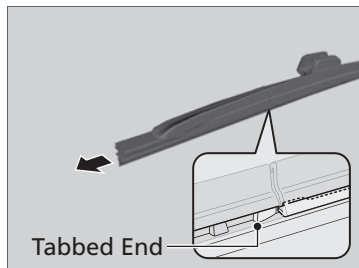

3. Slide the wiper blade out from its holder by pulling the tabbed end out.

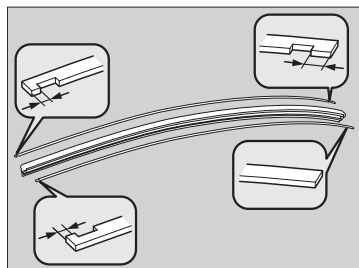

4. Remove the retainer from wiper blade and mount it to a new rubber blade.
5. Slide the wiper blade onto the holder.
 - ▶ Make sure it is engaged correctly, then install the wiper blade assembly onto the wiper arm.

» Changing the Rear Wiper Blade Rubber

NOTICE

When replacing the wiper blade, make sure not to drop the wiper blade or wiper arm down on the rear window.

Checking Tires

To safely operate your vehicle, your tires must be of the proper type and size, in good condition with adequate tread, and properly inflated.

■ Inflation Guidelines

Properly inflated tires provide the best combination of handling, tread life, and comfort. Refer to the driver's doorjamb label or specification's page for the specified pressure.

Underinflated tires wear unevenly, adversely affect handling and fuel economy, and are more likely to fail from overheating.

Overinflated tires make your vehicle ride harshly, are more prone to road hazard, and wear unevenly.

Every day before you drive, look at each of the tires. If one looks lower than the others, check the pressure with a tire gauge.

At least once a month or before long trips, use a gauge to measure the pressure in all tires, including the spare. Even tires in good condition can lose 1 to 2 psi (10 to 20 kPa, 0.1 to 0.2 kgf/cm²) per month.

■ Inspection Guidelines

Every time you check inflation, also examine the tires and valve stems.

Look for:

- Bumps or bulges on the side or in the tread. Replace the tire if you find any.
Cuts, splits, or cracks in the side of the tire. Replace it if you see fabric or cord.
- Remove any foreign objects and inspect for air leaks.
- Uneven tread wear. Have your dealer check the wheel alignment.
- Excessive tread wear.

📖 **Wear Indicators** [P.274](#)

» Checking Tires

⚠ WARNING

Using tires that are excessively worn or improperly inflated can cause a crash in which you can be seriously hurt or killed.

Follow all instructions in this owner's manual regarding tire inflation and maintenance.

Measure the air pressure when tires are cold. This means the vehicle has been parked for at least three hours, or driven less than 1 mile (1.6 km). If necessary, add or release air until the specified pressure is reached.

If checked when hot, tire pressure can be as much as 4–6 psi (30–40 kPa, 0.3–0.4 kgf/cm²) higher than if checked when cold.

Have a dealer check the tires if you feel a consistent vibration while driving. New tires and any that have been removed and reinstalled should be properly balanced.

Tire and Loading Information Label

The label attached to the driver's doorjamb provides necessary tire and loading information.

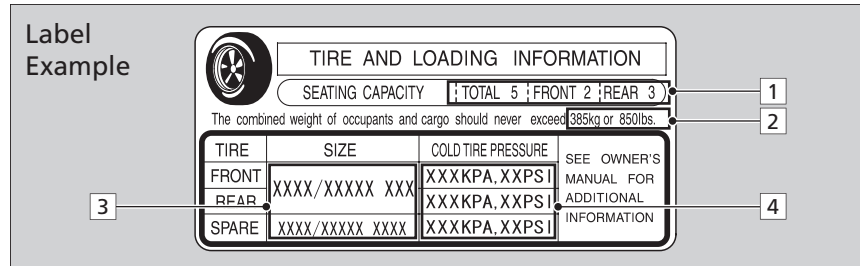

Tire Labeling

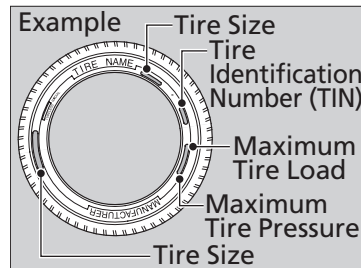

The tires that came on your vehicle have a number of markings. Those you should be aware of are described below.

Tire Size

Whenever tires are replaced, they should be replaced with tires of the same size.

❏ Tire and Loading Information Label

The tire and loading information label attached to the driver's doorjamb contains:

- 1 The number of people your vehicle can carry.
- 2 The total weight your vehicle can carry. Do not exceed this weight.
- 3 The original tire sizes for front, rear and spare.
- 4 The proper cold tire pressure for front, rear and spare.

❏ Tire Size

Following is an example of tire size with an explanation of what each component means.

P195/55 R16 86V

P: Vehicle type (P indicates passenger vehicle).

195: Tire width in millimeters.

55: Aspect ratio (the tire's section height as a percentage of its width).

R: Tire construction code (R indicates radial).

16: Rim diameter in inches.

86: Load index (a numerical code associated with the maximum load the tire can carry).

V: Speed symbol (an alphabetical code indicating the maximum speed rating).

■ Tire Identification Number (TIN)

The tire identification number (TIN) is a group of numbers and letters that look like the example in the side column. TIN is located on the sidewall of the tire.

■ Glossary of Tire Terminology

Cold Tire Pressure – The tire air pressure when the vehicle has been parked for at least three hours or driven less than 1 mile (1.6 km).

Load Rating – Means the maximum load that a tire is rated to carry for a given inflation pressure.

Maximum Inflation Pressure – The maximum tire air pressure that the tire can hold.

Maximum Load Rating – Means the load rating for a tire at the maximum permissible inflation pressure for that tire.

Recommended Inflation Pressure – The cold tire inflation pressure recommended by the manufacturer.

Treadwear Indicators (TWI) – Means the projections within the principal grooves designed to give a visual indication of the degrees of wear of the tread.

» Tire Identification Number (TIN)

DOT B97R FW6X 2209

DOT: This indicates that the tire meets all requirements of the U.S. Department of Transportation.

B97R: Manufacturer's identification mark.

FW6X: Tire type code.

2209: Date of manufacture.



DOT Tire Quality Grading (U.S. Vehicles)

The tires on your vehicle meet all U.S. Federal Safety Requirements. All tires are also graded for treadwear, traction, and temperature performance according to Department of Transportation (DOT) standards. The following explains these gradings.

■ Uniform Tire Quality Grading

Quality grades can be found where applicable on the tire sidewall between tread shoulder and maximum section width.

■ Treadwear

The treadwear grade is a comparative rating based on the wear rate of the tire when tested under controlled conditions on a specified government test course. For example, a tire graded 150 would wear one and one-half (1 1/2) times as well on the government course as a tire graded 100. The relative performance of tires depends upon the actual conditions of their use, however, and may depart significantly from the norm due to variations in driving habits, service practices and differences in road characteristics and climate.

☒ Uniform Tire Quality Grading

For example:

Treadwear 200
Traction AA
Temperature A

All passenger car tires must conform to Federal Safety Requirements in addition to these grades.

■ Traction

The traction grades, from highest to lowest, are AA, A, B, and C. Those grades represent the tire's ability to stop on wet pavement as measured under controlled conditions on specified government test surfaces of asphalt and concrete. A tire marked C may have poor traction performance.

■ Temperature

The temperature grades are A (the highest), B, and C, representing the tire's resistance to the generation of heat and its ability to dissipate heat when tested under controlled conditions on a specified indoor laboratory test wheel. Sustained high temperature can cause the material of the tire to degenerate and reduce tire life, and excessive temperature can lead to sudden tire failure. The grade C corresponds to a level of performance which all passenger car tires must meet under the Federal Motor Vehicle Safety Standard No. 109. Grades B and A represent higher levels of performance on the laboratory test wheel than the minimum required by law.

☒ Traction

Warning: The traction grade assigned to this tire is based on straight-ahead braking traction tests, and does not include acceleration, cornering, hydroplaning, or peak traction characteristics.

☒ Temperature

Warning: The temperature grade for this tire is established for a tire that is properly inflated and not overloaded. Excessive speed, underinflation, or excessive loading, either separately or in combination, can cause heat buildup and possible tire failure.

Wear Indicators

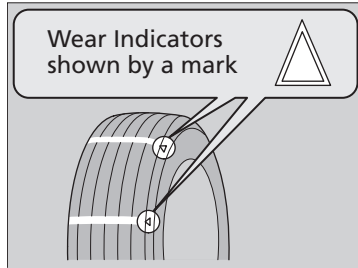

The groove where the wear indicator is located is 1/16 inch (1.6 mm) shallower than elsewhere on the tire. If the tread has worn so that the indicator is exposed, replace the tire.

Worn out tires have poor traction on wet roads.

Tire Service Life

The life of your tires is dependent on many factors, including driving habits, road conditions, vehicle loading, inflation pressure, maintenance history, speed, and environmental conditions (even when the tires are not in use).

In addition to your regular inspections and inflation pressure maintenance, it is recommended that you have annual inspections performed once the tires reach five years old. It is also recommended that all tires, including the spare, be removed from service after 10 years from the date of manufacture, regardless of their condition or state of wear.

Tire and Wheel Replacement

Replace your tires with radials of the same size, load range, speed rating, and maximum cold tire pressure rating (as shown on the tire's sidewall). Using tires of a different size or construction can cause the ABS and VSA® (vehicle stability assist) system to work incorrectly.

It is best to replace all four tires at the same time. If that isn't possible, replace the front or rear tires in pairs.

U.S. models only

If you replace a wheel, only use TPMS specified wheels approved for your vehicle.

» Tire and Wheel Replacement

⚠ WARNING

Installing improper tires on your vehicle can affect handling and stability. This can cause a crash in which you can be seriously hurt or killed.

Always use the size and type of tires recommended in this owner's manual.

Tire Rotation

Rotating tires according to the maintenance messages on the multi-information display helps to distribute wear more evenly and increase tire life.

■ Tires without Rotation Marks

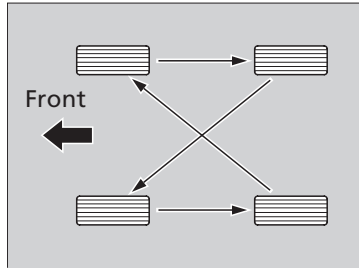

Rotate the tires as shown here.

■ Tires with Rotation Marks

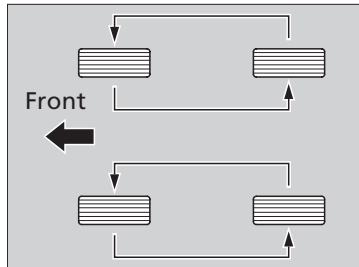

Rotate the tires as shown here.

⊗ Tire Rotation

Tires with directional tread patterns should only be rotated front to back (not from one side to the other).

Directional tires should be mounted with the rotation indication mark facing forward, as shown below.

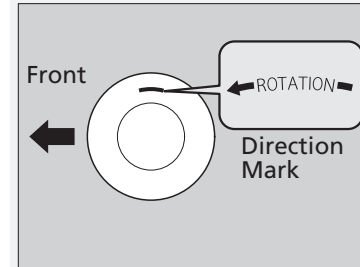

Winter Tires

If driving on snowy or frozen roads, mount all season marked “M + S” tires, snow tires, or tire chains; reduce speed; and maintain sufficient distance between vehicles when driving.

Be particularly careful when operating the steering wheel or brakes to prevent skidding.

Use tire chains, snow tires, or all season tires when necessary or according to the law.

When mounting, refer to the following points.

For winter tires:

- Select the size and load ranges that are the same as the original tires.
- Mount the tires to all four wheels.

For tire chains:

- Install them on the front tires only. Because your vehicle has limited tire clearance, Honda strongly recommends using the chains listed below:

Cable-type: SCC Radial Chain SC1030

- Follow the chain manufacturer’s instruction when installing. Mount them as tightly as you can.
- Check that the chains do not touch the brake lines or suspension.
- Drive slowly.

❖ Winter Tires

⚠ WARNING

Using the wrong chains, or not properly installing chains, can damage the brake lines and cause a crash in which you can be seriously injured or killed.

Follow all instructions in this owner’s manual regarding the selection and use of tire chains.

NOTICE

Traction devices that are the wrong size or improperly installed can damage your vehicle’s brake lines, suspension, body, and wheels. Stop driving if they are hitting any part of the vehicle.

When tire chains are mounted, follow the chain manufacturer’s instructions regarding vehicle operational limits.

Checking the 12 Volt Battery

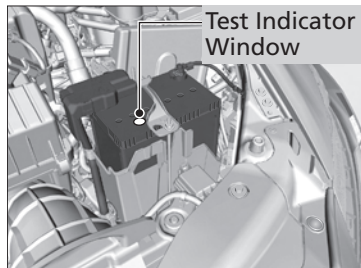

Check the battery condition monthly. Look at the test indicator window and check the terminals for corrosion.

If your vehicle's battery is disconnected or goes dead:

- The audio system is disabled.
 - **Entering the Security Code** P.140
- The clock resets.
 - **Setting the Clock** P.98
- The navigation system is disabled. A PIN code will be required.
 - **Refer to the navigation system manual.**

Charging the 12 Volt Battery

Disconnect both battery cables to prevent damaging your vehicle's electrical system. Always disconnect the negative (-) cable first, and reconnect it last.

12 Volt Battery

⚠ WARNING

The battery gives off explosive hydrogen gas during normal operation.

A spark or flame can cause the battery to explode with enough force to kill or seriously hurt you.

Wear protective clothing and a face shield, or have a skilled technician do any battery maintenance.

WARNING: Battery posts, terminals, and related accessories contain lead and lead compounds.

Wash your hands after handling.

The test indicator's color information is on the battery.

When you find corrosion, clean the battery terminals by applying a baking powder and water solution. Rinse the terminals with water. Cloth/towel dry the battery. Coat the terminals with grease to help prevent future corrosion.

If the 12 volt battery is disconnected or goes dead, the IMA battery level gauge reading may show less than the actual level the next time you turn the ignition switch to ON **II**. It will show the correct level after you drive for about 30 minutes.

Replacing the Battery

If the indicator does not come on when the button is pushed, replace the battery.

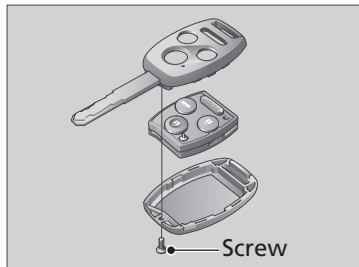

Battery type: CR1616

1. Unscrew the cover with a small Phillips-head screwdriver. Push a button to pry open the transmitter.
2. Open the keypad.
 - ▶ Wrap the small flat-tip screwdriver with a cloth to prevent scratching the transmitter.
3. Make sure to replace the battery with the correct polarity.

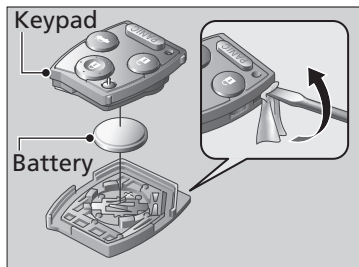

» Replacing the Battery

NOTICE

An improperly disposed of battery can hurt the environment. Always confirm local regulations for battery disposal.

Replacement batteries are commercially available or at a dealer.

If You Don't Use the Climate Control System Regularly

To insure oil is circulated in the system, occasionally turn on the A/C or set the defroster mode for several minutes with the engine idling.

Dust and Pollen Filter

The climate control system is equipped with a dust and pollen filter that collects pollen, dust, and other debris in the air, and removes odors such as diesel gas and tobacco. The maintenance minder messages will let you know when to replace the filter.

We recommend that you replace the dust and pollen filter sooner when using your vehicle in areas with high concentrations of dust.

☒ Dust and Pollen Filter

Using an air freshener may reduce the deodorizing effect of the dust and pollen filter, and may reduce its life.

If the airflow from the climate control system deteriorates noticeably, and the windows fog up easily, the filter may need to be replaced. Please contact a dealer for replacement.

Interior Care

Use a damp cloth with a mixture of mild detergent and warm water to remove dirt. Use a clean cloth to remove detergent residue.

Cleaning Seat Belts

Use a soft brush with a mixture of mild soap and warm water to clean the seat belts. Let the belts air dry. Wipe the openings of the seat belt anchors using a clean cloth.

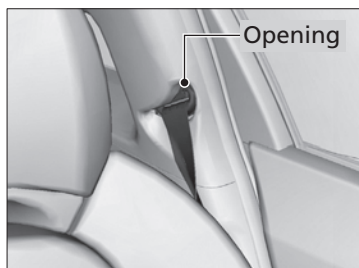

Interior Care

Do not spill liquids inside the vehicle. Electrical devices and systems may malfunction if liquids are splashed on them.

Do not use silicone based sprays on electrical devices such as audio devices and switches. Doing so may cause the items to malfunction or a fire inside the vehicle.

If a silicone based spray is inadvertently used on electrical devices, consult a dealer.

Depending on their composition, chemicals and liquid aromatics may cause discoloration, wrinkles, and cracking to resin-based parts and textiles. Do not use alkali solvents or organic solvents such as benzene or gasoline.

After using chemicals, make sure to gently wipe them off using a dry cloth.

Do not place used cloths on top of resin based parts or textiles for long periods of time without washing.

■ Floor Mats

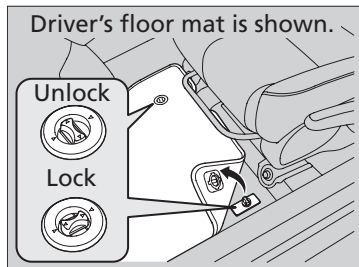

The driver's floor mat hooks over the floor anchors, which keep the mat from sliding forward. To remove the mat for cleaning, turn each anchor knob to the unlock position. When reinstalling the mat after cleaning, turn each knob to the lock position.

Do not put additional floor mats on top of the anchored mat.

■ Maintaining Genuine Leather*

Vacuum dirt and dust from the leather frequently. Pay close attention to the pleats and seams. Clean the leather with a soft cloth dampened with a 90% water and 10% neutral wool detergent solution. Then buff it with a clean, dry cloth. Remove any dust or dirt on leather surfaces immediately.

⊗ Floor Mats

If you use any floor mats that were not originally provided with your vehicle, make sure they are designed for your specific vehicle, fit correctly and are securely anchored by the floor anchors.

Exterior Care

Dust off the vehicle body after you drive.

Regularly inspect your vehicle for scratches on painted surfaces. A scratch on a painted surface can result in body rust. If you find a scratch, promptly repair it.

■ Washing the Vehicle

Wash the vehicle frequently. Also, make sure to wash the vehicle in the following circumstances:

- If driving on roads with road salt.
- If driving in coastal areas.
- If tar, soot, bird droppings, insects, or tree sap are stuck to painted surfaces.

■ Using an Automated Vehicle Wash

Fold in the door mirrors. Make sure to follow the instructions indicated on the automated vehicle wash.

■ Using High Pressure Cleaners

- Keep sufficient distance between the cleaning nozzle and the vehicle body.
- Take particular care around the windows. Standing too close may cause water to enter the vehicle interior. Do not spray water into the engine compartment.

⌘ Washing the Vehicle

Do not spray water directly into the air intake vents or engine compartment. It can cause a malfunction.

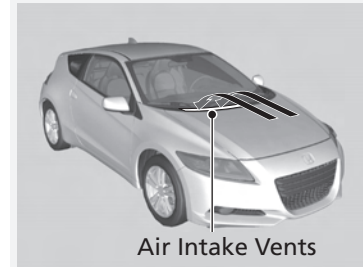

Air Intake Vents

Do not spray water onto the fuel fill door directly. A high-pressure spray may cause it to open.

■ Applying Wax

A good coat of automotive body wax helps protect your vehicle's paint from the elements. Wax will wear off over time and expose your vehicle's paint to the elements, so reapply as necessary.

■ Maintaining the Bumpers and Other Resin Coated Parts

If you get gasoline, oil, engine coolant, or battery fluid on resin coated parts, they may be stained or the coating may peel. Promptly wipe it away using a soft cloth.

■ Cleaning the Window

Wipe using a glass cleaner.

■ Maintaining Aluminum Wheels

Aluminum is susceptible to deterioration caused by salt and dirt. Use a sponge and mild detergent to wipe away road dirt or salt water promptly.

Be careful not to use harsh chemicals (including some commercial wheel cleaners) or a stiff brush. They can damage the clear coat of the aluminum alloy wheels that keeps the aluminum from corroding and tarnishing.

⌘ Applying Wax

NOTICE

Chemical solvents and strong cleaners can damage the paint, metal, and plastic on your vehicle. Wipe up spills immediately.

⌘ Maintaining the Bumpers and Other Resin Coated Parts

Ask a dealer about the correct coating material when you want to repair the painted surface of the parts made of resin.

⌘ Cleaning the Window

Wires are mounted to the inside of the rear window. Wipe along the same direction as the wires with a soft cloth so as not to damage them.

Handling the Unexpected

This chapter explains how to handle unexpected troubles.



Tools

Types of Tools 286

If a Tire Goes Flat

Changing a Flat Tire 287

Engine Does Not Start

Checking the Engine 293

Jump Starting 294

Shift Lever Does Not Move 296

Overheating

How to Handle Overheating 297

Indicator, Coming On/Blinking

If the Low Oil Pressure Indicator

Comes On 299

If the Charging System Indicator

Comes On 300

If the Malfunction Indicator Lamp

Comes On or Blinks 301

If the Brake System Indicator

Comes On 302

If the EPS Indicator Comes On 302

If the IMA Indicator Comes On 303

If the Low Tire Pressure/TPMS Indicator

Comes On or Blinks 303

Fuses

Fuse Locations 304

Inspecting and Changing Fuses 307

Emergency Towing 308

When You Cannot Open the Hatch 310

Types of Tools

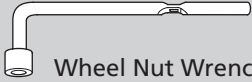

Wheel Nut Wrench/
Jack Handle



Jack Handle Bar

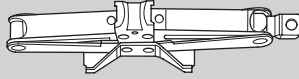

Jack



Detachable Towing Hook

Types of Tools

Using a Jack [P.290](#)

Changing a Flat Tire

If a tire goes flat while driving, grasp the steering wheel firmly, and brake gradually to reduce speed. Then, stop in a safe place. Replace the flat tire with the compact spare tire. Go to a dealer as soon as possible to have the full size tire repaired or replaced.

1. Park the vehicle on firm, level, and non-slippery ground.
2. Put the shift lever in **P** (CVT).
Put the shift lever in **R** (manual transmission).
3. Set the parking brake.
4. Turn on the hazard warning lights and turn the ignition switch to LOCK **0**.

Changing a Flat Tire

Periodically check the tire pressure of the compact spare. It should be set to the specified pressure. Specified Pressure: 60 psi (420 kPa, 4.2 kgf/cm²)

When driving with the compact spare tire, keep the vehicle speed under 50 mph (80 km/h). Replace with a full size tire as soon as possible.

The compact spare tire and wheel in your vehicle are specifically for this model. Do not use them with another vehicle. Do not use another type of compact spare tire or wheel with your vehicle.

Do not mount tire chains on a compact spare tire. If a chain-mounted front tire goes flat, remove one of the full-size rear tires and replace it with the compact spare tire. Remove the flat front tire and replace it with the full size tire that was removed from the rear. Mount the tire chains on the front tire.

■ Getting Ready to Replace the Flat Tire

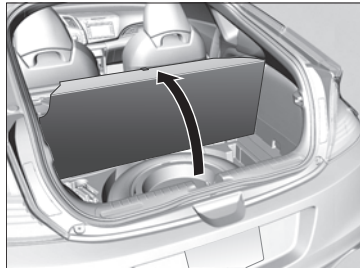

1. Pull the strap on the cargo area floor lid and open the lid.

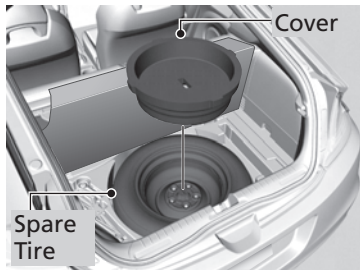

2. Remove the cover from the spare tire.

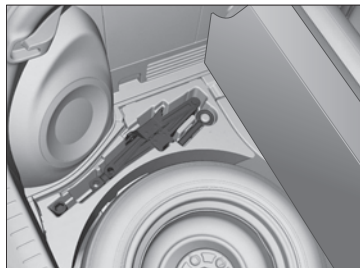

3. Take the jack and wheel nut wrench out of the tool case.
4. Unscrew the wing bolt, and remove the spacer cone. Then, remove the spare tire.

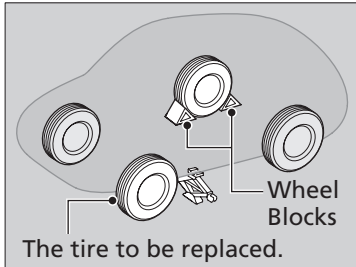

5. Place wheel blocks or rocks in front and rear of the wheel diagonal to the flat tire.

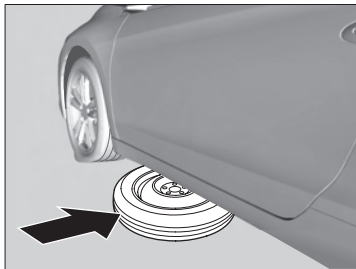

6. Place the compact spare tire (wheel side up) under the vehicle body, near the tire that needs to be replaced.



7. Loosen each wheel nut about one turn using the wheel nut wrench.

■ How to Set Up the Jack

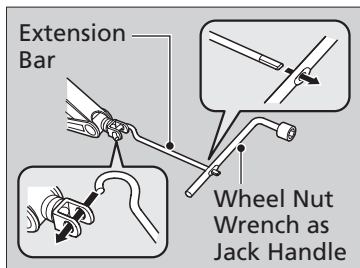
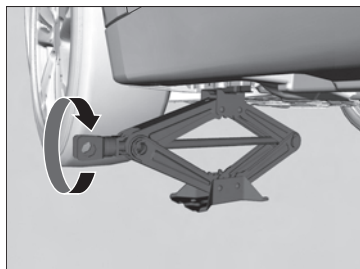
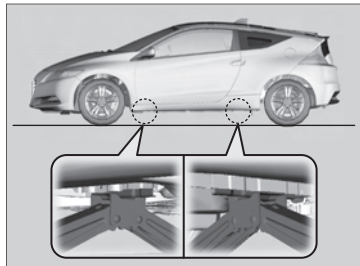

1. Place the jack under the jacking point closest to the tire to be changed.
2. Turn the end bracket (as shown in the image) clockwise until the top of the jack contacts the jacking point.
 - ▶ Make sure that the jacking point tab is resting in the jack notch.
3. Raise the vehicle, using the extension bar and the jack handle, until the tire is off the ground.

✕ Changing a Flat Tire

⚠ WARNING

The vehicle can easily roll off the jack, seriously injuring anyone underneath.

Follow the directions for changing a tire exactly, and never get under the vehicle when it is supported only by the jack.

Do not use the jack with people or luggage in the vehicle.

Use the jack provided in your vehicle. Other jacks may not support the weight ("load") or their shape may not match the jacking point. The following instructions must be followed to use the jack safely.

- Do not use while the engine is running.
- Use only where the ground is firm and level.
- Use only at the jacking points.
- Do not get in the vehicle while using the jack.
- Do not put anything on top of or underneath the jack.

■ Replacing the Flat Tire

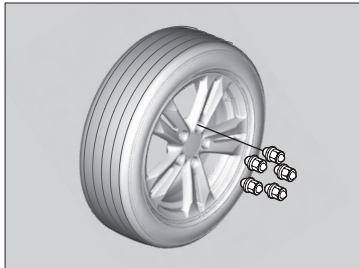

1. Remove the wheel nuts and flat tire.

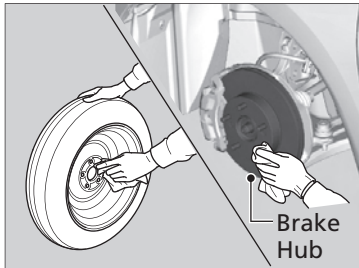

2. Wipe the mounting surfaces of the wheel with a clean cloth.
3. Mount the compact spare tire.
4. Screw the wheel nuts until they touch the lips around the mounting holes, and stop rotating.

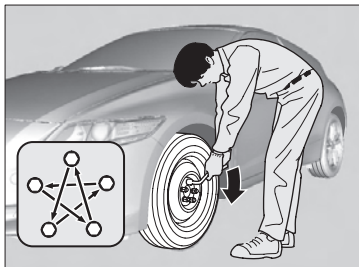

5. Lower the vehicle and remove the jack. Tighten the wheel nuts in the order indicated in the image. Go around, tightening the nuts, two to three times in this order.

Wheel nut torque:

80 lbf·ft (108 N·m, 11 kgf·m)

▣ Replacing the Flat Tire

Do not over tighten the wheel nuts by applying extra torque using your foot or a pipe.

■ Storing the Flat Tire

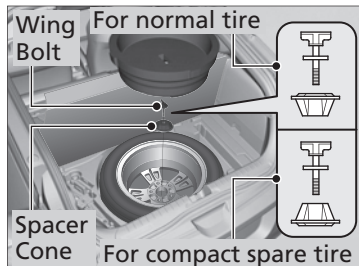

1. Remove the center cap and place the flat tire face down in the spare tire well.
2. Remove the spacer cone from the wing bolt, flip it over, and insert it back on the bolt. Secure the flat tire with the wing bolt.
3. Securely put the jack and wheel nut wrench back in the tool case in the cargo area.

■ TPMS and the Spare Tire

U.S. models only

If you replace a flat tire with the spare tire, the low tire pressure/TPMS indicator comes on while you are driving. After driving for a few miles (kilometers), the indicator will start blinking for a short time and then stay on. "CHECK TPMS SYSTEM" appears on the multi-information display, but this is normal.

If you replace the tire with a specified regular tire, the warning message on the multi-information display and the low tire pressure/TPMS indicator will go off after a few miles (kilometers).

» Storing the Flat Tire

⚠ WARNING

Loose items can fly around the interior in a crash and can seriously injure the occupants.
Store the wheel, jack, and tools securely before driving.

» TPMS and the Spare Tire

The system cannot monitor the pressure of the spare tire. Manually check the spare tire pressure to be sure that it is correct.

Use TPMS specific wheels. Each is equipped with a tire pressure sensor mounted inside the tire behind the valve stem.

Checking the Engine

If the engine does not start, turn the ignition switch to START  and check the starter.

» Checking the Engine

If you must start the vehicle immediately, use an assisting vehicle to jump start it.

» [Jump Starting P.294](#)

Starter Condition	Check List
<p>Starter will not start at all. Starter turns over very slowly. The 12 volt battery may be dead. Check each of the items on the right and respond accordingly.</p>	<p>Check brightness of the interior light. Turn on interior lights and check brightness.</p> <ul style="list-style-type: none">• If the interior lights are dim or do not come on at all » 12 Volt Battery Inspection and Maintenance P.278• If the interior lights come on normally » Fuse Inspection and Replacement P.304
<p>The starter turns over normally but... There may be a problem with the fuse. Check each of the items on the right and respond accordingly.</p>	<p>Review the engine start procedure. Follow its instructions, and try to start the engine again. » Starting the Engine P.197</p> <hr/> <p>Check the immobilizer system indicator. When the immobilizer system indicator is blinking, the engine cannot be started. » Immobilizer System P.105</p> <hr/> <p>Check the fuel level. There should be enough fuel in the tank. » Fuel Gauge P.14</p> <hr/> <p>Check the fuse. Check all fuses, or have the vehicle checked by a dealer. » Inspecting and Changing Fuses P.304</p> <hr/> <p>If the problem continues: » Emergency Towing P.308</p>

Jump Starting Procedure

Turn off the power to electric devices, such as audio and lights. Turn off the engine, then open the hood.

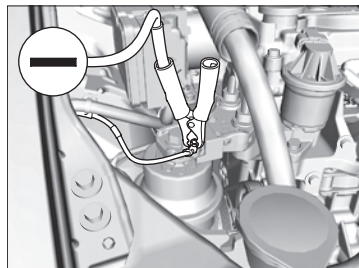
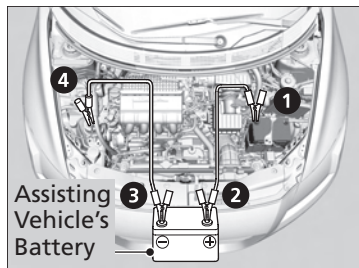

1. Connect the first jumper cable to your vehicle's battery \oplus terminal.
2. Connect the other end of the first jumper cable to the assisting vehicle's \oplus terminal.
▶ Use a 12 volt booster battery only.
3. Connect the second jumper cable to the assisting vehicle's \ominus terminal.
4. Connect the other end of the second jumper cable to the grounding strap as shown. Do not connect this jumper cable to any other part of the engine.
5. If your vehicle is connected to another vehicle, start the assisting vehicle's engine and increase its rpm slightly.
6. Attempt to start your vehicle's engine. If it turns over slowly, check that the jumper cables have good metal-to-metal contact.

Jump Starting

⚠ WARNING

A battery can explode if you do not follow the correct procedure, seriously injuring anyone nearby.

Keep all sparks, open flames, and smoking materials away from the battery.

Securely attach the jumper cables clips so that they do not come off when the engine vibrates. Also be careful not to tangle the jumper cables or allow the cable ends to touch each other while attaching or detaching the jumper cables.

Battery performance degrades in cold conditions and may prevent the engine from starting.

■ What to Do After the Engine Starts

Once your vehicle's engine has started, remove the jumper cables in the following order.

1. Disconnect the jumper cable from your vehicle's grounding strap.
2. Disconnect the other end of the jumper cable from the assisting vehicle's battery \ominus terminal.
3. Disconnect the jumper cable from your vehicle's battery \oplus terminal.
4. Disconnect the other end of the jumper cable from the assisting vehicle's battery \oplus terminal.

Have your vehicle inspected by a nearby service station or a dealer.

Shift Lever Does Not Move

Automatic transmission (CVT) model

Follow the procedure below if you cannot move the shift lever out of **P** position.

Releasing the Lock

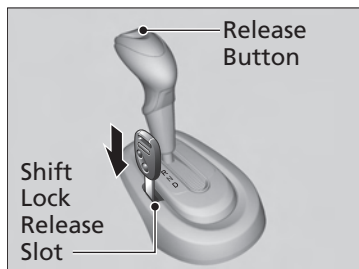
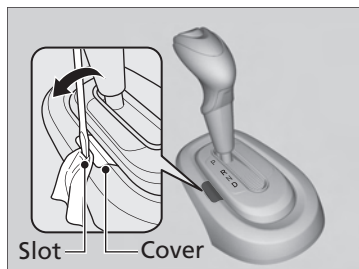

1. Set the parking brake.
2. Remove the key from the ignition switch.
3. Wrap a cloth around the tip of a small flat-tip screwdriver and remove the cover of the shift lock release slot.
 - ▶ Put the tip of the flat-tip screwdriver into the slot and remove it as shown in the image.
4. Insert the key into the shift lock release slot.
5. While pushing on the key, press the shift lever release button and place the shift lever into **N**.
 - ▶ The lock is now released. Have the shift lever checked by a dealer as soon as possible.

How to Handle Overheating

Overheating symptoms are as follows:

- The high temperature indicator comes on or the engine suddenly loses power.
- Steam is coming out of the engine compartment.

■ First Thing to Do

1. Immediately park the vehicle in a safe place.
 - ▶ Put the shift lever to **P** (CVT) or **N** (manual transmission) and set the parking brake. Turn off all accessories and turn on the hazard warning lights.
2. **No steam coming out:** Keep the engine running and open the hood.
Steam coming out: Turn off the engine and wait until steam goes away. Then, open the hood.

» How to Handle Overheating

⚠ WARNING

Steam and spray from an overheated engine can seriously scald you.

Do not open the hood if steam is coming out.

NOTICE

Continuing to drive with the high temperature indicator on may damage the engine.

■ Next Thing to Do

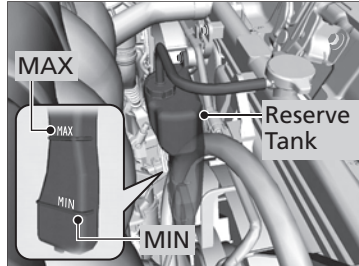

1. Check that the cooling fan is operating and stop the engine once the high temperature indicator goes off.
 - If the cooling fan is not operating, immediately stop the engine.
2. Once the engine has cooled down, inspect the coolant level and check the cooling system components for leaks.
 - If the coolant level in the reserve tank is low, add coolant until it reaches the MAX mark.
 - If there is no coolant in the reserve tank, check that the radiator is cool. Cover the radiator cap with a heavy cloth and open the cap. If necessary, add coolant up to the base of the filler neck, and put the cap back on.

■ Last Thing to Do

- Once the engine has cooled sufficiently, restart it and check the high temperature indicator.

If the high temperature indicator is off, resume driving. If it stays on, contact a dealer for repairs.

⊗ How to Handle Overheating

⚠ WARNING

Removing the radiator cap while the engine is hot can cause the coolant to spray out, seriously scalding you.

Always let the engine and radiator cool down before removing the radiator cap.

If the coolant is leaking, contact a dealer for repairs.

Use water as an emergency/temporary measure only. Have a dealer flush the system with proper antifreeze as soon as possible.

If the Low Oil Pressure Indicator Comes On



■ Reasons for the Indicator to Come On

Comes on when the engine oil pressure is low.

■ What to Do as Soon as the Indicator Comes On

1. Immediately park the vehicle in a safe place.
2. If necessary, turn the hazard warning lights on.

■ What to Do After Parking the Vehicle

1. Stop the engine and let it sit for about one minute.
2. Open the hood and check the oil level.
 - ▶ Add oil as necessary.
3. Start the engine and check the low oil pressure indicator.
 - ▶ The light goes out: Start driving again.
 - ▶ The light does not go out within 10 seconds: Stop the engine and contact a dealer for repairs immediately.

» If the Low Oil Pressure Indicator Comes On

NOTICE

Running the engine with low oil pressure can cause serious mechanical damage almost immediately.

If the Charging System Indicator Comes On



■ Reasons for the Indicator to Come On

Comes on when the 12 volt battery is not being charged.

■ What to Do When the Indicator Comes On

Turn off the climate control system, rear defogger, and other electrical systems, and immediately contact a dealer for repairs.

⌘ If the Charging System Indicator Comes On

If you need to stop temporarily, do not turn off the engine. Restarting the engine may rapidly discharge the 12 volt battery.

Manual transmission model

This indicator may also come on when the auto idle stop function is activated for a while. Restart the engine.

➤ **Auto Idle Stop (Manual Transmission)** P. 227

Automatic transmission (CVT) model

This indicator may also come on when the IMA battery charge drops below a desired level. The engine starts to recharge the battery.

➤ **Auto Idle Stop (CVT)** P. 224

The indicator goes off when the battery is being charged normally.

This indicator may blink after starting when the outside temperature is below -20°F (-30°C). It will stop blinking after the IMA battery warms up.

If the Malfunction Indicator Lamp Comes On or Blinks



■ Reasons for the Indicator Lamp to Come On or Blink

- Comes on when there is a problem with the engine emissions control system, or the fuel fill cap is missing or loose.
- Blinks when engine misfiring is detected.

■ What to Do When the Indicator Lamp Comes On

Avoid high speeds and immediately get your vehicle inspected at a dealer.

■ What to Do When the Indicator Lamp Blinks

Park the vehicle in a safe place with no flammable items and wait at least ten minutes or more with the engine stopped until it cools.

■ Tighten Fuel Fill Cap Message

■ The Message Appears on When:

An evaporative system leak is detected. This may be caused by the fuel fill cap being loose or not being installed.

■ What to Do When the Message Appears:

1. Stop the engine.
2. Check that the fuel fill cap is fully installed.
 - ▶ If not, loosen the cap, and then retighten it until it clicks at least once.
3. Drive for several days of normal driving.
 - ▶ The message should go off.

■ When the Malfunction Indicator Lamp Comes On

Malfunction indicator lamp comes on if the system continues to detect a leak of gasoline vapor. If this happens, check the fuel fill cap using the procedures described above.

» If the Malfunction Indicator Lamp Comes On or Blinks

NOTICE

If you drive with the malfunction indicator lamp on, the emissions control system and the engine could be damaged.

If the malfunction indicator lamp blinks again when restarting the engine, drive to the nearest dealer at 31 mph (50 km/h) or less. Have your vehicle inspected.

If the Brake System Indicator Comes On

U.S. ■ Reasons for the Indicator to Come On

BRAKE

- The brake fluid is low.
- There is a malfunction in the brake system.

Canada



■ What to Do When the Indicator Comes On While Driving

Press the brake pedal lightly to check pedal pressure.

- If normal, check the brake fluid level the next time you stop.
- If abnormal, take immediate action. If necessary, downshift the transmission to slow the vehicle using engine braking.

If the EPS Indicator Comes On



■ Reasons for the Indicator to Come On

- Comes on when there is a problem with EPS.
- If you depress the accelerator pedal repeatedly to increase the engine speed while the engine is idling, the indicator comes on, and sometimes the steering wheel becomes harder to operate.

■ What to Do When the Indicator Comes On

- Stop the vehicle in a safe place and restart the engine.

If the indicator comes on and stays on, immediately have your vehicle inspected by a dealer.

⌘ If the Brake System Indicator Comes On

Have your vehicle repaired immediately.

It is dangerous to drive with low brake fluid. If there is no resistance from the brake pedal, stop immediately in a safe place. If necessary downshift the gears.

If the brake system indicator and ABS indicator come on simultaneously, the brake distribution system is not working. This can result in vehicle instability under sudden braking. Have your vehicle inspected by a dealer immediately.

⌘ If the EPS Indicator Comes On

NOTICE

If the steering wheel is operated repeatedly or at an extremely low speed, or you hold the steering wheel on the full left or right position for a while, the system heats up. The system goes into a protective mode, and limits its performance. The steering wheel becomes harder and harder to operate. Once the system cools down, EPS is restored. Repeated operation under these conditions can eventually result in a damage to the system.

If the IMA Indicator Comes On



■ Reasons for Indicator to Come On

Comes on when there is a problem with the IMA system.

■ What to Do When the Indicator Comes On

Avoid high speeds and immediately get your vehicle inspected by a dealer.

If the Low Tire Pressure/TPMS Indicator Comes On or Blinks

U. S. models only



■ Reasons for the Indicator to Come On or Blink

A tire pressure is significantly low. If there is a problem with the TPMS or the compact spare tire is installed, the indicator blinks for about one minute, and then stays on.

■ What to Do When the Indicator Comes On

Stop your vehicle in a safe place. Check the tire pressure and adjust the pressure to the specified level. The specified tire pressure is on a label on the driver side doorjamb.

■ What to Do When the Indicator Blinks

Have the tire inspected by a dealer as soon as possible. If the compact spare tire has triggered the indicator to blink, change the tire to a full size tire. The indicator goes off after a while.

⌘ If the Low Tire Pressure/TPMS Indicator Comes On or Blinks

NOTICE

Driving on an extremely underinflated tire can cause it to overheat. An overheated tire can fail. Always inflate your tires to the prescribed level.

Fuse Locations

If any electrical devices are not working, turn the ignition switch to LOCK **0** and check to see if any applicable fuse is blown.

■ Engine Compartment Fuse Box

Located near the + terminal on the 12 volt battery.

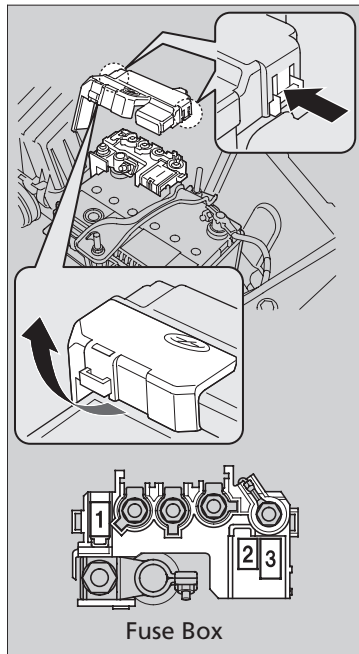

1. Pull on the tab to release the front of the cover.
2. Pull up the cover by pushing the two tabs as shown.
Replacement of engine compartment fuses should be done by a dealer.

■ Circuit Protected and Amps for Each Fuse

	Circuit Protected	Amps
1	Battery	100 A
2	EPS	70 A
3	Horn, Stop, Hazard	20 A

☒ Fuse Locations

Fuse locations are shown on the fuse box cover. Locate the fuse in question by the fuse number and box cover number.

Interior Fuse Box

Located under the driver side dashboard.

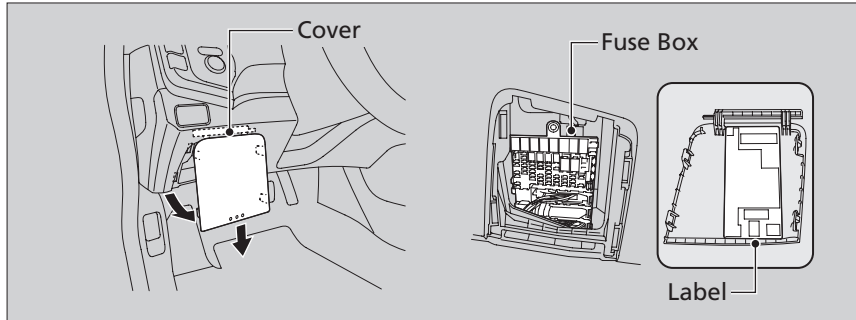

☒ Fuse Locations

Fuse locations are shown on the label on the back side of the cover. Locate the fuse in question by the fuse number and label number.

■ Circuit Protected and Amps for Each Fuse

	Circuit Protected	Amps
1	Back Up	15 A
2	TPMS*1	7.5 A
3	Driver's Power Window	20 A
4	-	-
5	Back-Up Light	10 A
6	SRS	10 A
7	Transmission*2	10 A
8	SRS	7.5 A
9	Fog Light*	20 A
10	A/C	7.5 A
11	ABS/VSA®	7.5 A
12	IMA	10 A

	Circuit Protected	Amps
13	Accessory Power Socket	20 A
14	Radio	7.5 A
15	Daytime Running Lights	7.5 A
16	Rear Wiper	10 A
17	Passenger's Power Window	20 A
18	-	-
19	-	-
20	Fuel Pump	15 A
21	Washer	15 A
22	Meter	7.5 A
23	Hazard	10 A
24	Stop/Horn	10 A

	Circuit Protected	Amps
25	Audio AMP*	20 A
26	LAF	10 A
27	Door Lock Main	20 A
28	Headlight Main	20 A
29	Small Light	10 A
30	Main Fan Motor	30 A
31	IGPS	7.5 A
32	Right Headlight Low*3	10 A
	Right Headlight Low (HID)*4	15 A

*1: U.S. models only

*2: Automatic transmission (CVT)

*3: Vehicle with halogen bulb low beam headlights

*4: Vehicle with discharge headlights

■ **Circuit Protected and Amps for Each Fuse**

	Circuit Protected	Amps
33	Ignition Coil	15 A
34	Left Headlight Low* ¹	10 A
	Left Headlight High* ²	10 A
35	Door Lock	7.5 A
36	Door Lock	10 A
37	ABS FSR/VSA® FSR	30 A
38	-	-
39	IGP	15 A
40	-	-
41	-	-
42	IMA 1	7.5 A
43	MG Clutch	7.5 A
44	STS	7.5 A
45	Door Lock	20 A
46	-	-
47	Sub Fan Motor	30 A
48	Left Headlight High* ¹	10 A
	Left Headlight Low (HID)* ²	15 A
49	Door Lock Motor 2 (UNLOCK)	7.5 A
50	-	-
51	Right Headlight High	10 A
52	DBW	15 A
53	IMA 2	15 A
54	-	-

	Circuit Protected	Amps
55	Heated Mirror*	10 A
56	Front Wiper	30 A
57	Blower Motor	30 A
58	ABS/VSA® MTR	30 A
59	Rear Defogger	40 A* ³
		30 A* ⁴
60	IG Main	50 A
61	-	-
62	-	-

*1: Vehicle with halogen bulb low beam headlights

*2: Vehicle with discharge headlights

*3: With heated door mirror

*4: Without heated door mirror

Inspecting and Changing Fuses

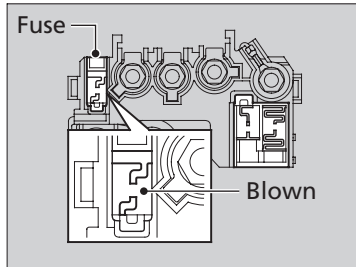

1. Turn the ignition switch to LOCK **0**. Turn headlights and all accessories off.
2. Check the fuses in the engine compartment.
 - If the fuse is blown, have it replaced by a dealer.

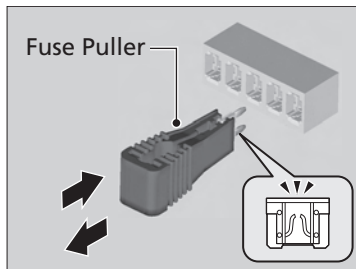

3. Inspect the small fuses in the vehicle interior.
 - If there is a burned out fuse, remove it with the fuse puller and replace it with a new one.

» Inspecting and Changing Fuses

NOTICE

Replacing a fuse with one that has a higher rating greatly increases the chances of damaging the electrical system. If you do not have a replacement fuse with the proper rating for the circuit, install one with a lower rating.

Replace fuse with a spare fuse of the same specified amperage.

Confirm the specified amperage using the charts on [P.304](#) to [P.306](#).

There is a fuse puller on the interior fuse box.

Call a professional towing service if you need to tow your vehicle.

■ Flat Bed Equipment

The operator loads your vehicle on the back of a truck.

This is the best way to transport your vehicle.

■ Wheel Lift Equipment

The tow truck uses two pivoting arms that go under the front tires and lift them off the ground. The rear tires remain on the ground. **This is an acceptable way to tow your vehicle.**

» Emergency Towing

NOTICE

Trying to lift or tow your vehicle by the bumpers will cause serious damage. The bumpers are not designed to support the vehicle's weight.

NOTICE

Improper towing such as towing behind a motorhome or other motor vehicle can damage the transmission.

Never tow your vehicle with just a rope or chain. It is very dangerous, since ropes or chains may shift from side to side or break.

■ If Your Vehicle Gets Stuck

Call a professional towing service if your vehicle gets stuck in sand, mud, or snow.

You can use the detachable towing hook to free the vehicle for very short distances.

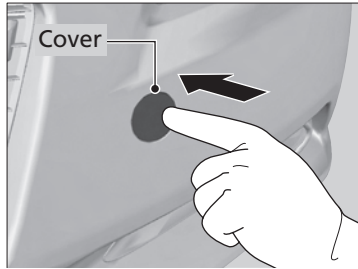

1. Push the right edge of the cover with your finger, then remove it.
2. Take the towing hook and the wheel nut wrench out of the cargo area.

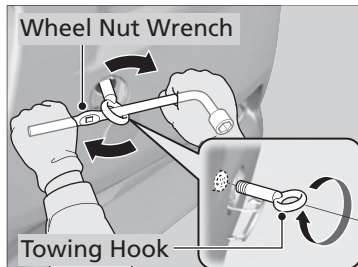

3. Screw the towing hook into the hole, and tighten it securely with the wheel nut wrench.

» If Your Vehicle Gets Stuck

NOTICE

To avoid damage to your vehicle, use the towing hook for straight, flat ground towing only. Do not tow at an angle. This hook should not be used to tow the vehicle onto a flat bed. Do not use it as a tie down.

Make sure to use the properly-designed and attached towing equipment.

NOTICE

Do not slip the clutch for a long time to get unstuck. This may overheat and damage the transmission.

■ What to Do When Unable to Open the Hatch

If you cannot open the hatch, use the following procedure.

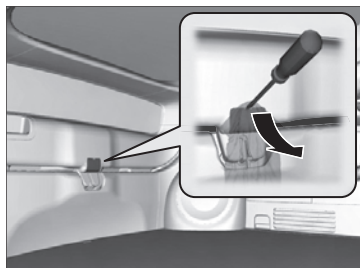

1. Remove the cover on the back of the hatch by prying it off with a small flat-tip screwdriver.
 - ▶ Wrap a flat-tip screwdriver with a cloth to prevent scratches.

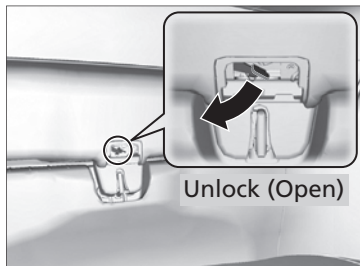

2. Push the release lever until the hatch unlocks. Push the hatch up to open.

⌘ What to Do When Unable to Open the Hatch

After taking these steps, contact a dealer to have the vehicle checked.

Information

This chapter includes your vehicle's specifications, locations of identification numbers, and other information required by regulation.

Specifications	312	Emissions Testing	
Identification Numbers		Testing of Readiness Codes	317
Vehicle Identification Number (VIN)	314	Authorized Manuals	319
Engine Number and Transmission		Customer Service Information	320
Number.....	314	Warranty Coverages	321
Devices that Emit Radio Waves	315		
Reporting Safety Defects			
(U.S. Vehicles).....	316		

■ Vehicle Specifications

Model	Honda CR-Z
No. of Passengers:	
Front	2
Rear	–
Total	2
Weights:	
Gross Vehicle	U.S.: 3,164 lbs (1,435 kg)
Weight Rating	Canada: 1,435 kg
Gross Axle	
Weight Rating (Front)	U.S.: 1,797 lbs (815 kg) Canada: 815 kg
Gross Axle	
Weight Rating (Rear)	U.S.: 1,378 lbs (625 kg) Canada: 625 kg
Air Conditioning:	
Refrigerant Type	HFC-134a (R-134a)
Charge Quantity	15.8 – 17.6 oz (450 – 500 g)
Lubricant Type	SP-10

■ Engine Specifications

Displacement	91 cu-in (1,497 cm ³)
Spark Plugs	NGK DIFR6A13G
	DENSO DK20PR-D13

■ Fuel

Fuel:	Unleaded gasoline, Pump
Type	octane number of 87 or higher
Fuel Tank Capacity	10.6 US gal (40 ℓ)

■ 12 Volt Battery

Capacity/Type	32AH(5)/40AH(20)
	34AH(5)/40AH(20)

■ Washer Fluid

Tank Capacity	U.S.: 2.6 US qt (2.5 ℓ)
	Canada: 4.8 US qt (4.5 ℓ)

■ Light Bulbs

Headlights (Low Beam)	35W (D4S)* ¹
	55W (H11)* ²
Headlights (High Beam)	60W (HB3)
Fog Lights*	55W (H11)
Front Turn Signal/Parking/ Side Marker Lights	28W/8W
Side Turn Signal Lights (on Door Mirrors)	LED
Brake/Taillights	LED
Rear Turn Signal Lights	21W (Amber)
Back-Up Lights	16W
Rear Side Marker Lights	3CP
High-Mount Brake Light	LED
License Plate Lights	5W
Cargo Area Light	5W
Interior Lights	
Front	8W
Rear	3.4W
Vanity Mirror Lights*	2W
Glove Box Light	1.4W
Courtesy Lights	2CP (3.8W)

*1: Vehicle with discharge headlights

*2: Vehicle with halogen bulb low beam headlights

■ **Brake/Clutch Fluid**

Specified	Honda Heavy Duty Brake Fluid DOT 3	
-----------	------------------------------------	--

■ **Transmission Fluid**

Specified (Automatic Transmission: CVT)	Honda CVTF (continuously variable transmission fluid)	3.0 US qt (2.8 ℓ) (Change)
Specified (Manual Transmission)	Honda Manual Transmission Fluid	1.5 US qt (1.4 ℓ) (Change)

■ **Engine Oil**

Recommended	Genuine Honda Motor Oil	API Premium grade OW-20
	Change	3.6 US qt (3.4 ℓ)
Capacity	Change including filter	3.8 US qt (3.6 ℓ)

■ **Engine Coolant**

Specified	Honda Long-Life Antifreeze/Coolant Type2	
Ratio	50/50 with distilled water	
Capacity (Automatic Transmission: CVT)	1.16 US gal (4.4 ℓ) (change including the remaining 0.116 US gal (0.44 ℓ) in the reserve tank)	
Capacity (Manual Transmission)	1.16 US gal (4.4 ℓ) (change including the remaining 0.116 US gal (0.44 ℓ) in the reserve tank)	

■ **Tire**

Regular	Size	P195/55R16 86V
	Pressure psi (kPa[kgf/cm ²])	30 (210 [2.1])
Compact Spare	Size	T135/80D15 99M
	Pressure psi (kPa[kgf/cm ²])	60 (420 [4.2])
Wheel Size	Regular	16 x 6J
	Compact Spare	15 x 4T

Vehicle Identification Number (VIN)

Your vehicle has a 17-digit vehicle identification number (VIN) used to register your vehicle for warranty purposes, and for licensing and insuring your vehicle. See the image below for the VIN locations.

Engine Number and Transmission Number

See the image below for the locations of your vehicle's engine number and transmission number.

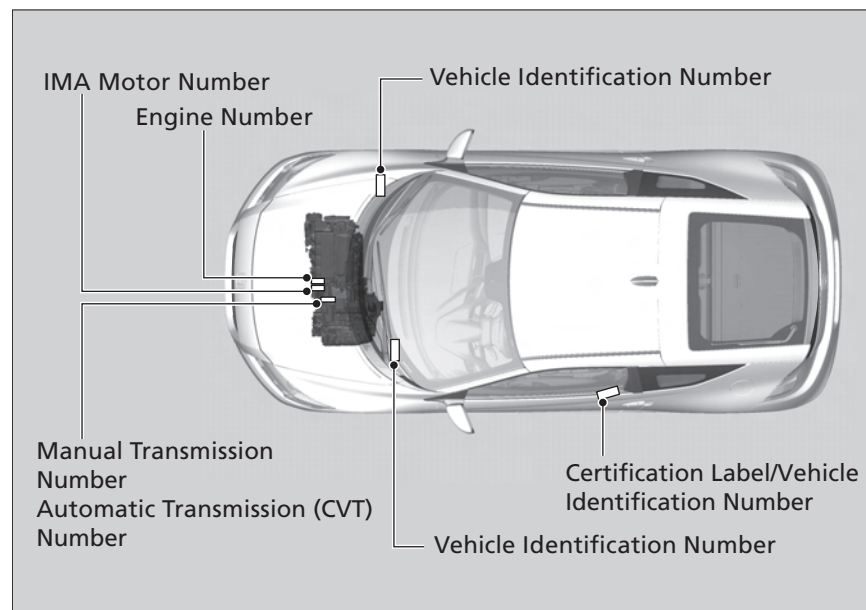

Devices that Emit Radio Waves

The following products and systems on your vehicle emit radio waves when in operation.

Audio System

Bluetooth® HandsFreeLink®

Immobilizer System

Remote Transmitter

Tire Pressure Monitoring System (TPMS) (U.S. models only)

Each of the above complies with the appropriate requirements or the required standards of FCC (Federal Communications Commission) and Industry Canada Standard, described below:

As required by the FCC:

This device complies with Part 15 of the FCC rules. Operation is subject to the following two conditions: (1) This device may not cause harmful interference, and (2) this device must accept any interference received, including interference that may cause undesired operation.

Changes or modifications not expressly approved by the party responsible for compliance could void the user's authority to operate the equipment.

This device complies with Industry Canada Standard RSS-210. Operation is subject to the following two conditions: (1) this device may not cause interference, and (2) this device must accept any interference that may cause undesired operation of the device.

If you believe that your vehicle has a defect which could cause a crash or could cause injury or death, you should immediately inform the National Highway Traffic Safety Administration (NHTSA) in addition to notifying American Honda Motor Co., Inc.

If NHTSA receives similar complaints, it may open an investigation, and if it finds that a safety defect exists in a group of vehicles, it may order a recall and remedy campaign. However, NHTSA cannot become involved in individual problems between you, your dealer, or American Honda Motor Co., Inc.

To contact NHTSA, you may call the Vehicle Safety Hotline toll-free at 1-888-327-4236 (TTY: 1-800-424-9153); go to <http://www.safercar.gov>; or write to: Administrator, NHTSA, 1200 New Jersey Avenue, SE., Washington, DC 20590. You can also obtain other information about motor vehicle safety from <http://www.safercar.gov>.

Testing of Readiness Codes

Your vehicle uses “readiness codes,” as part of its onboard self diagnostic system. Some States refer to these codes during testing to see if your vehicle’s emissions components are working properly. The codes may not be read if you go through the testing just after the battery has gone dead or been disconnected.

To check if they are set, turn the ignition switch to ON **II**, without starting the engine. The malfunction indicator lamp will come on for several seconds. If it then goes off, the readiness codes are set. If it blinks five times, the readiness codes are not set.

If you are required to have your vehicle tested before the readiness codes are ready, prepare the vehicle for retesting by doing the following:

1. Fill the gas tank to approximately 3/4 full.
2. Park the vehicle and leave the engine off for 6 hours or more.
3. Make sure the ambient temperature is between 40 °F and 95 °F (4 °C and 35 °C).
4. Start the engine without touching the accelerator pedal, and let it idle for 20 seconds.
5. Keep the vehicle in **P** (automatic transmission) or **N** (manual transmission). Increase the engine speed to 2,000 rpm, and hold it there for about 3 minutes.
6. Let the engine idle with your foot off the accelerator for 20 seconds.

» Testing of Readiness Codes

The readiness codes are erased when the 12 volt battery is disconnected, and set again only after several days of driving under a variety of conditions.

If a testing facility determines that the readiness codes are not set, you may be requested to return at a later date to complete the test.

If the testing facility determines the readiness codes are still not set, see a dealer.

7. Select a nearby, lightly traveled major highway where you can maintain a speed of 50 to 60 mph (80 to 97 km/h) for at least 20 minutes. Drive on the highway in **[D]** (automatic) or **[5]** (manual). Do not use cruise control. When traffic allows, drive for 90 seconds without moving the accelerator pedal. (Vehicle speed may vary slightly; this is okay.) If you cannot do this for a continuous 90 seconds because of traffic conditions, drive for at least 30 seconds, then repeat it two more times (for a total of 90 seconds).
8. Drive in city/suburban traffic for at least 10 minutes. When traffic conditions allow, let the vehicle coast for several seconds without using the accelerator pedal or the brake pedal.
9. Park the vehicle and leave the engine off for 30 minutes.

U.S. Owners:

The publications listed below can be purchased from Helm Incorporated. You can order a manual by phone at (800) 782-4356 (credit card orders only), or online at www.helminc.com.

Make an inquiry to Helm Inc. at (800) 782-4356 if you are interested in ordering other models' or other years' manuals.

Publication Form Number	Form Description
61SZT00	2011 Honda CR-Z Service Manual
61SZT00EL	2011 Honda CR-Z Electrical Troubleshooting Manual
61SZT30	2011 Honda CR-Z Body Repair Manual
31SZT600	2011 Honda CR-Z Owner's Manual
31SZT800	2011 Honda CR-Z Navigation System Owner's Manual
31SZTM00	2011 Honda CR-Z Honda Service History
31SZTQ00	2011 Honda CR-Z Technology Reference Guide
HON-R	Order Form for Previous Years-Indicate Year and Model Desired

Authorized Manuals

Service Manual:

Covers maintenance and recommended procedures for repair to engine and chassis components. It is written for the journeyman technician, but it is simple enough for most mechanically inclined owners to understand.

Electrical Troubleshooting Manual:

Complements the Service Manual by providing in-depth troubleshooting information for each electrical circuit in your vehicle.

Body Repair Manual:

Describes the procedures involved in the replacement of damaged body parts.

Honda dealership personnel are trained professionals.

They should be able to answer all your questions. If you encounter a problem that your dealership does not solve to your satisfaction, please discuss it with the dealership's service manager or general manager. If you are dissatisfied with the decision made by the dealership's management, contact Honda Customer Service.

U.S. Owners:

American Honda Motor Co., Inc.
Honda Automobile Customer Service
Mail Stop 500-2N-7A
1919 Torrance Blvd.
Torrance, CA 90501-2746
Tel: (800) 999-1009

Canadian Owners:

Customer Relations Honda Canada Inc.
Visit www.honda.ca for contact
information
Tel: (888) 9-HONDA-9
Fax: (877) 939-0909

In Puerto Rico and the U.S. Virgin

Islands:

Bella International
P.O. Box 190816
San Juan, PR 00919-0816
Tel: (787) 620-7546

Customer Service Information

When you call or write, please give us the following information:

- Vehicle Identification Number
 - ▣ **Vehicle Identification Number** [P.314](#)
- Date of purchase
- Odometer reading of your vehicle
- Your name, address, and telephone number
- A detailed description of the problem
- Name of the dealer who sold the vehicle to you

U.S. Owners

Your new vehicle is covered by these warranties:

New Vehicle Limited Warranty – covers your new vehicle, except for the emissions control systems, and accessories, against defects in materials and workmanship.

Emissions Control Systems Defects Warranty and Emissions Performance Warranty – these two warranties cover your vehicle's emissions control systems. Time, mileage, and coverage are conditional. Please read your warranty booklet for exact information.

Seat Belt Limited Warranty – a seat belt that fails to function properly is covered by a limited warranty. Please read your warranty booklet for details.

Rust Perforation Limited Warranty – all exterior body panels are covered for rust-through from the inside for the specified time period with no mileage limit.

Accessory Limited Warranty – Honda accessories are covered under this warranty. Time and mileage limits depend on the type of accessory and other factors. Please read your warranty booklet for details.

Replacement Parts Limited Warranty – covers all Honda replacement parts against defects in materials and workmanship.

Replacement Battery Limited Warranty – provides prorated coverage for a replacement battery purchased from your dealer.

Replacement Muffler Lifetime Limited Warranty – provides coverage for as long as the purchaser of the muffler owns the vehicle.

Restrictions and exclusions apply to all these warranties. Please read the 2011 Honda warranty information booklet that came with your vehicle for precise information on warranty coverages. Your vehicle's original tires are covered by their manufacturer. Tire warranty information is in a separate booklet.

Canadian Owners

Please refer to the 2011 warranty manual that came with your vehicle.

A

ABS (Anti-lock Brake System)	221
Accessories and Modifications	235
Accessory Power Socket	127
Active Head Restraints	122
Adding	249
Engine Coolant	252
Engine Oil	249
Window Washer	257
Additives, Engine Oil	247
Adjusting	117
Headlights	258
Mirrors	118
Seats	119
Steering Wheel	117
Temperature (Climate Control)	131
Airbags	41
Advanced Airbags	47
After a Collision	45
Airbag Care	55
Event Data Recorder	26
Front Airbags (SRS)	44
Indicator	52,71,74
Passenger Airbag Off Indicator	53
Sensors	41
Side Airbag	48
Side Airbag Cutoff System	50
Side Airbag Off Indicator	50
Side Curtain Airbag	51

Air Conditioning System	
(Climate Control System)	131
Changing the Mode	131
Defrosting the Windshield and Windows	132
Dust and Pollen Filter	280
Recirculation/Fresh Air Mode	131
Sensors	133
Using Automatic Climate Control	131
Air Pressure	270,313
Ambient Meter	8,14
AM/FM Audio	143,154
Anti-lock Brake System (ABS)	221
Indicator	70
ASST (Electric Motor Assist) Indicator	82
Auto Door Lock/Unlock	103
Automatic Lighting	111
Audio System	136
Auxiliary Input Jack	139
Error Messages	167
General Information	170
MP3/WMA/AAC	149,165
Recommended Devices	172
Recommended Discs	170
Remote Controls	169
Security Code	140
Theft Protection	140
USB Adapter Cable	138
USB Flash Memory Devices	137
Audio with Navigation System	151
Audio without Navigation System	141

Authorized Manual	319
Auto Idle Stop	224,227
Automatic Transmission (CVT)	224
Manual Transmission	227
Auto Idle Stop Indicator	76
Automatic Transmission (CVT)	201
Creep Aid System	199
Creeping	201
Fluid	254
Kickdown	201
Operating the Shift Lever	20,202
7-Speed Manual Shift Mode	204
Shifting	202
Shift Lever Does Not Move	296
Auxiliary Input Jack	139
Average Fuel Economy	87
Average Fuel Economy Records	87
Average Speed	87

B

Battery	278
Charging System Indicator	69,300
Jump Starting	294
Maintenance	
(Checking the 12 volt Battery)	278
Replacing	279
Battery Charge in Progress (CHRG)	
Indicator	82

Belts (Seat) 34

Beverage Holders 126

Bluetooth® HandsFreeLink® 173

Booster Seats 63

Brake System 219

 Anti-lock Brake System (ABS) 221

 Brake Assist System 222

 Fluid 256

 Foot Brake 220

 Indicator 68,302

 Parking Brake 219

Brightness Control (Instrument Panel) 115

Bulb Replacement 258

 Back-Up, Turn Signal and Rear Side Marker
 Lights 263

 Brake/Taillights 264

 Fog Lights 260

 Front Turn/Parking/Side Marker Lights 262

 Headlights 258

 High-Mount Brake Light 265

 License Plate 265

 Side Turn Signal/Emergency Indicator
 Lights 262

Bulb Specifications 312

C

Carbon Monoxide Hazard 64

Carrying Cargo 192,194

Certification Label 314

CD Player 145,156

Changing Bulbs 258

Charging System Indicator 69,300

Child Safety 56

Child Seat 56

 Booster Seats 63

 Child Seat for Infants 58

 Child Seat for Small Children 59

 Installing a Child Seat with a Lap/Shoulder
 Seat Belt 60

 Larger Children 62

 Rear Facing Child Seat 58

 Selecting a Child Seat 59

 Using Tether 61

CHRG (Battery Charge in Progress)
Indicator 82

Cleaning the Exterior 283

Cleaning the Interior 281

Climate Control System 131

 Defrosting the Windshield and Windows 132

 Dust and Pollen Filter 280

 Recirculation/Fresh Air Mode 131

 Sensors 133

 Using Automatic Climate Control
 Changing 131

Clock 98

Clutch Fluid 256

Compact Spare Tire 287,313

Controls 97

Coolant (Engine) 252

 Adding to the Radiator 253

 Adding to the Reserve Tank 252

 Overheating 297

 Temperature Indicators 73,74

Creeping
(Automatic Transmission–CVT) 201

Cruise Control 211

 Indicator 76

Cup Holder 126

Customer Service Information 320

Customized Features 90

D

Daytime Running Lights 112

Dead Battery 294

Defrosting the Windshield and
Windows 132

Detachable Towing Hook 309

Dimming

 Headlights 110

Dipstick (Engine Oil) 248

Directional Signals (Turn Signals) 110

Door Mirrors 118

Doors..... 99

 Auto Door Lock 103

 Auto Door Unlock 103

 Door and Hatch Open Indicator..... 33,72

 Keys 99

 Locking/Unlocking the Doors from

 Inside..... 102

 Locking/Unlocking the Doors from

 Outside..... 100

 Lockout Prevention System..... 101

DOT Tire Quality Grading..... 272

Driving..... 191

 Automatic Transmission (CVT)..... 201

 Braking..... 219

 Cruise Control..... 211

 Shifting Gear..... 207

 Starting the Engine..... 197

Dust and Pollen Filter..... 280

E

ECO Assist System..... 8

ECO Drive Bar..... 9,86

ECO Guide..... 9,86

ECO Mode Button..... 7,210

ECO Mode Indicator..... 7,210

ECO Score..... 9,85

Elapsed Time..... 87

Electric Motor Assist (ASST) Indicator..... 82

Electric Power Steering System (EPS) 72,302

 Indicator..... 72,302

Electric Stability Control (ESC)..... 214

Emergency..... 308

Emissions Testing (Readiness Codes)..... 317

Engine..... 314

 Coolant..... 252

 Jump Starting..... 294

 Oil..... 247

 Starting..... 197

Engine Coolant..... 252

 Adding to the Radiator..... 253

 Adding to the Reserve Tank..... 252

 Overheating..... 297

 Temperature Indicator..... 73,74

Engine Oil..... 247

 Adding..... 249

 Checking..... 248

 Displaying Oil Life..... 241

 Low Oil Pressure Indicator..... 68,299

 Recommended Engine Oil..... 247

EPS (Electric Power Steering System) 72,302

Exhaust Hazard (Carbon Monoxide)..... 64

Exterior Mirrors..... 118

Exterior Care (Cleaning)..... 283

F

Features..... 135

Filters

 Dust and Pollen..... 280

 Oil..... 250

Flat Tire..... 287

Floor Mats..... 282

Fluids

 Automatic Transmission (CVT)..... 254

 Brake/Clutch..... 256

 Engine Coolant..... 252

 Manual Transmission..... 255

 Window Washer..... 257

Fog Light Indicator..... 75

Folding Down the Separator..... 128

Foot Brake..... 220

Front Airbags (SRS)..... 44

Fuel..... 21,231

 Economy..... 234

 Gauge..... 81

 Instant Fuel Economy..... 82

 Low Fuel Indicator..... 70

 Range..... 87

 Recommendation..... 231

 Refueling..... 232

Fuel Economy 234
 Fuel Fill Cap 21,232
 Message 301
 Fuel Fill Door 21,232
 Fuses 304
 Inspecting and Changing 307
 Locations 304

G

Gasoline (Fuel)
 Economy 234
 Gauge 81
 Information 231
 Instant Fuel Economy 82
 Low Fuel Indicator 70
 Refueling 232
Gauges 81
Gear Shift Lever Positions 207
 Manual Transmission 207
Glass (Care) 284
Glove Box 125

H

Halogen Bulbs 258
HandsFreeLink (HFL) 173
 Cellular Phonebook Option 185
 Change Language 189
 Help Features 174
 Information Display 174
 Making a Call 179
 Menus 175
 Phone Setup 177
 Phonebook 183
 Receiving a Call 182
 Transferring a Call 182
 Muting a Call 182
 Sending Numbers or Names During
 a Call 183
 Search Imported Phonebook 185
Hatch 104
 Door/Hatch Open Indicator 72
 Unable to Open 310
Hazard Warning Button 2
Head Restraints 121
Headlights 110
 Aiming 258
 Automatic Operation 111
 Dimming 110,112
 Operating 110

Heated Door Mirrors 116
High Temperature Indicator 73
Hill Start Assist System 199
HFL (HandsFreeLink) 173
High Beam Indicator 74
Honda IMA System 10,12

I

Identification Numbers 314
 Engine and Transmission 314
 Vehicle Identification 314
Ignition Switch 109
Illumination Control 115
 Knob 115
IMA Battery Charge Level Indicator 82
IMA System Indicator 73
Immobilizer System 105
 Indicator 75

Indicators 68

 ABS (Anti-lock Brake System) 70

 Auto Idle Stop 76

 Charging System 69

 CRUISE CONTROL 76,212

 CRUISE MAIN 76,211

 Door/Hatch Open 72

 ECON Mode 77

 EPS (Electronic Power Steering System) 72

 Fog Light 75

 High Beam 74

 IMA System 73

 Immobilizer System 75

 Lights On 75

 Low Fuel 70

 Low Oil Pressure 68

 Low Tire Pressure/TPMS 72

 Malfunction Indicator Lamp 69

 Normal Mode 77

 Parking Brake and Brake System 68

 Seat Belt Reminder 70

 Security System 76

 Shift Up/Down 76

 Side Airbag Off 54,74

 Sport Mode 76

 Supplemental Restraint System 71

 Temperature 73,74

 Transmission 69

 Turn Signal 75

 VSA® (Vehicle Stability Assist) 71

 VSA® Off 71,215

Information Buttons 83

Instant Fuel Economy 82

Instrument Panel 67

 Brightness Control 115

Interior Lights 123

Interior Rearview Mirror 118

J

Jack (Wheel Nut Wrench) 290

Jump Starting 294

K

Key Number Tag 99

Keys 99

 Lockout Prevention 101

 Remote Transmitter 100

 Types and Functions 99

 Won't turn 24

Kickdown

 (Automatic Transmission–CVT) 201

L

Language (HFL) 189

Lights 110,258

 Automatic 111

 Bulb Replacement 258

 Daytime Running Lights 112

 Fog Lights 112

 High Beam Indicator Light 74

 Interior 123

 Light Switches 110

 Lights On Indicator 75

 Turn Signals 110

L Mode.....206
 Load Limits.....194
 Locking/Unlocking99
 Auto Door Lock/Unlock.....103
 From Inside.....102
 From Outside.....100
 Keys.....99
 Using a Key.....101
 Lockout Prevention System.....101
 Low Battery Charge (12 volt).....300
 Low Fuel Indicator.....70
 Low Oil Pressure Indicator.....68,299
 Low Temperature Indicator.....74
 Lubricant Specifications Chart.....313
 Luggage (Maximum Load Limit).....194

M

M (7-Speed Manual Shift Mode)
 Indicator.....203
Maintenance.....237
 Battery.....278
 Brake/Clutch Fluid.....256
 Cleaning.....281
 Climate Control.....280
 Coolant.....252
 Maintenance Minder™.....241
 Oil.....248
 Precautions.....238
 Radiator.....253
 Remote Transmitter.....279
 Replacing Light Bulbs.....258
 Safety.....239
 Schedule.....241
 Service Items.....243
 Tires.....269
 Transmission Fluid.....254
 Under the Hood.....245
Malfunction Indicator Lamp.....69,301
Manual Transmission.....207
Map Lights.....123
Maximum Load Limit.....194
Meters, Gauges.....81

Mirrors.....118
 Adjusting.....118
 Door.....118
 Exterior.....118
 Interior Rearview.....118
Modifications (and Accessories).....235
MP3.....145,149,156,158,165
Multi-Information Display.....83

N

Normal Mode Button.....7,210
Normal Mode Indicator.....77
Numbers (Identification).....314

O

- Odometer 84
- Oil (Engine) 247
 - Adding 249
 - Checking 248
 - Displaying Oil Life 241
 - Low Oil Pressure Indicator 68,299
 - Recommended Engine Oil 247,313
 - Viscosity 247
- Opening/Closing
 - Hatch 104
 - Hood 246
 - Power Windows 107
- Outside Temperature Display 84
- Overheating 297

P

- Paddle Shifters (7-Speed Manual Shift Mode) 20,204
- Panic Mode 100
- Parking 223,230
- Parking Brake 219
- Parking Brake and Brake System Indicator 68,302

- Passenger Airbag Off Indicator 53
- Passing Indicators 110
- Power Flow Monitor 88
- Power Windows 107
- Precautions While Driving 200
 - Rain 200
- Pregnant Women 39
- Puncture (Tire) 287

R

- Radiator 253
- Radio (AM/FM) 143,154
- Radio Data System (RDS) 144
- RDS (Radio Data System) 144
- Readiness Codes (Emissions Testing) 317
- Rear Cargo Console 128
- Rear Defogger/Heated Door Mirror Button 116
- Rearview Mirror 118
- Refueling 231
 - Fuel Gauge 14,81
 - Gasoline 231,312
 - Low Fuel Indicator 70

- Regulations 217,272,315
- Remote Transmitter 100
- Replacement
 - Battery 279
 - Bulbs 258
 - Fuses 304
 - Tires 275
 - Wiper Blade Rubber 266
- Reporting Safety Defects U.S. Vehicle 316
- Resetting a Trip Meter 84

S

- Safety Check 33
- Safety Labels 65
- Safety Message 27
- Seat Belts 34
 - Automatic Seat Belt Tensioners 36
 - Checking 40
 - Fastening 37
 - Installing a Child Seat with a Lap/Shoulder Seat Belt 60
 - Pregnant Women 39
 - Reminder 35
 - Warning Indicator 35,70
- Seats 119
 - Adjusting 119

Security System	105	Specifications	312,313	Tires	269
Immobilizer System Indicator	75	Specified Fuel	231,312	Air Pressure	270,313
Indicator	76	Speedometer	81	Checking and Maintaining	269
SEL/RESET Button	83	SPORT Mode Button	7,210	Inspection	269
Select Lever	20,202,207	SPORT Mode Indicator	76	Labeling	270
Operation	20,202,207	SRS Airbags (Airbags)	44	Puncture (Flat Tire)	287
Releasing	296	Starting the Engine	197	Regulations	272
Won't Move	296	Does Not Start	293	Rotation	276
Selecting a Child Seat	59	Jump Starting	294	Spare Tire	287,313
Selector Knob (Audio)	141	Steering Wheel	117	Tire Chains	277
Setting the Clock	98	Adjusting	117	Wear Indicators	274
7-Speed Manual Shift Mode	20,204,205	Stopping	223	Winter	277
Speed Position Indicator/M (7-Speed		Switches (Around the Steering Wheel)	2,3	Tire Pressure Monitoring System	
Manual Shift Mode) Indicator	20,203	Supplemental Restraint System (SRS)	44	(TPMS)	216
Shift Lever	202,207	System Message Indicator	73	Indicator	72,216,217
Shift Lever Positions	20,203	T		Tools	286
Automatic Transmission (CVT)	20,203	Tachometer	81	Towing a Trailer	196
Shift Up/Down Indicators	76,208	Temperature	73,74,84	Towing Your Vehicle	196
Shifting (Transmission)	202,207	Indicators	73,74	Emergency	308
Side Airbag	48	Outside Temperature Display	84	TPMS (Tire Pressure Monitoring	
Cutoff System	50	Temperature Sensor	133	System)	216
Off Indicator	50	3-Mode Drive System	7,210	Transmission	202,207,313
Side Curtain Airbag	51	Mode Buttons	7,210	Automatic (CVT)	202
Snow Tires	277	Time (Setting)	98	Fluid	254,255
Spare Tire	287,313			Manual	207
Spark Plugs	312			Number	314
				7-Speed Manual Shift Mode	20,204,205
				Shift Position Indicator	20,203

Trip Meter 84

Troubleshooting 285

 Blown Fuse 307

 Brake Pedal Vibrates 24

 Buzzer Sounds When Opening Door 25

 Emergency Towing 308

 Engine Won't Start 293

 Noise When Braking 25

 Overheating 297

 Puncture/Flat Tire 287

 Regular Gasoline 231,312

 Shift Lever Won't Move 296

 Warning Indicators 68

Turn signals 110

 Indicators (Instrument Panel) 75

U

USB Adapter 136,138

USB Device 137

Unlocking the Doors 99

V

Vanity Mirrors 5

Vehicle Identification Numbers 314

Vehicle Stability Assist (VSA®) 214

 Off Indicator 71,215

 Off Switch 215

 System Indicator 71,215

Ventilation 131

Viscosity (Oil) 247,313

VSA® (Vehicle Stability Assist) 214

W

Warning and Information Message 78

Warning Indicator On/Blinking 299

Warning Labels 65

Warranties (Warranty Manual provided separately) 321

Watts 312

Wear Indicators (Tire) 274

Wheel Nut Wrench (Jack Handle) 290

Windows (Opening and Closing) 107

Window Washers 113

 Adding/Refilling Fluid 257

 Switch 113

Windshield 113

 Cleaning 284

 Defrosting/Defogging 132

 Wipers and Washers 113

 Washer Fluid 257,312

 Wiper Blades 266

Winter Tires 277

 Snow Tires 277

 Tire Chains 277

Wipers and Washers 113

 Checking and Replacing Wiper Blades 266

WMA 145,149,156,158,165

Worn Tires 269