

2013 CR-Z

Online Reference Owner's Manual

This owner's manual should be considered a permanent part of the vehicle and should remain with the vehicle when it is sold.

This owner's manual covers all models of your vehicle. You may find descriptions of equipment and features that are not on your particular model.

Images throughout this owner's manual (including the front cover) represent features and equipment that are available on some, but not all, models. Your particular model may not have some of these features.

This owner's manual is for vehicles sold in the United States and Canada.

The information and specifications included in this publication were in effect at the time of approval for printing. Honda Motor Co., Ltd. reserves the right, however, to discontinue or change specifications or design at any time without notice and without incurring any obligation.

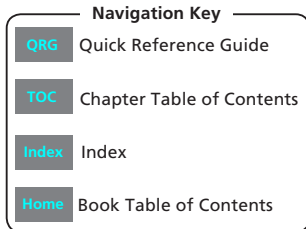

➤ [Safe Driving P. 27](#)

For Safe Driving [P. 28](#)

Seat Belts [P. 32](#)

Airbags [P. 39](#)

➤ [Instrument Panel P. 65](#)

Indicators [P. 66](#)

Gauges and Multi-Information Display [P. 81](#)

➤ [Controls P. 97](#)

Setting the Clock [P. 98](#)

Locking and Unlocking the Doors [P. 99](#)

Operating the Switches Around the Steering Wheel [P. 110](#)

Interior Lights/Interior Convenience Items [P. 126](#)

➤ [Features P. 137](#)

Audio System [P. 138](#)

Audio Error Messages [P. 153](#)

➤ [Driving P. 171](#)

Before Driving [P. 172](#)

Towing a Trailer [P. 177](#)

Multi-View Rear Camera [P. 213](#)

Refueling [P. 216](#)

Fuel Economy [P. 219](#)

➤ [Maintenance P. 221](#)

Before Performing Maintenance [P. 222](#)

Maintenance Minder™ [P. 225](#)

Checking and Maintaining Wiper Blades [P. 250](#)

Climate Control System Maintenance [P. 264](#)

➤ [Handling the Unexpected P. 269](#)

Tools [P. 270](#)

If a Tire Goes Flat [P. 271](#)

Overheating [P. 290](#)

Indicator, Coming On/Blinking [P. 292](#)

➤ [Information P. 305](#)

Specifications [P. 306](#)

Identification Numbers [P. 308](#)

Emissions Testing [P. 311](#)

Warranty Coverages [P. 313](#)

Contents

2013 CR-Z

Child Safety [P. 54](#)

Exhaust Gas Hazard [P. 62](#)

Safety Labels [P. 63](#)

Opening and Closing the Hatch [P. 104](#)
Adjusting the Mirrors [P. 119](#)
Climate Control System [P. 134](#)

Security System [P. 106](#)

Opening and Closing the Windows [P. 108](#)
Adjusting the Seats [P. 121](#)

General Information on the Audio System [P. 155](#)

Bluetooth® HandsFreeLink® [P. 158](#)

When Driving [P. 178](#)
Rearview Camera [P. 214](#)
Accessories and Modifications [P. 220](#)

Braking [P. 208](#)

Parking Your Vehicle [P. 212](#)

Maintenance Under the Hood [P. 229](#)
Checking and Maintaining Tires [P. 253](#)
Cleaning [P. 265](#)

Replacing Light Bulbs [P. 242](#)
12 Volt Battery [P. 262](#)

Remote Transmitter Care [P. 263](#)

Engine Does Not Start [P. 286](#)
Fuses [P. 297](#)

Jump Starting [P. 287](#)
Emergency Towing [P. 301](#)

Shift Lever Does Not Move [P. 289](#)
When You Cannot Open the Hatch [P. 303](#)

Devices that Emit Radio Waves [P. 309](#)
Authorized Manuals [P. 315](#)

Reporting Safety Defects [P. 310](#)
Customer Service Information [P. 316](#)

Quick Reference Guide [P. 2](#)

Safe Driving [P. 27](#)

Instrument Panel [P. 65](#)

Controls [P. 97](#)

Features [P. 137](#)

Driving [P. 171](#)

Maintenance [P. 221](#)

Handling the Unexpected [P. 269](#)

Information [P. 305](#)

Index [P. 317](#)

Navigation Key

QRG Quick Reference Guide

Index Index

TOC Chapter Table of Contents

Home Book Table of Contents

Visual Index

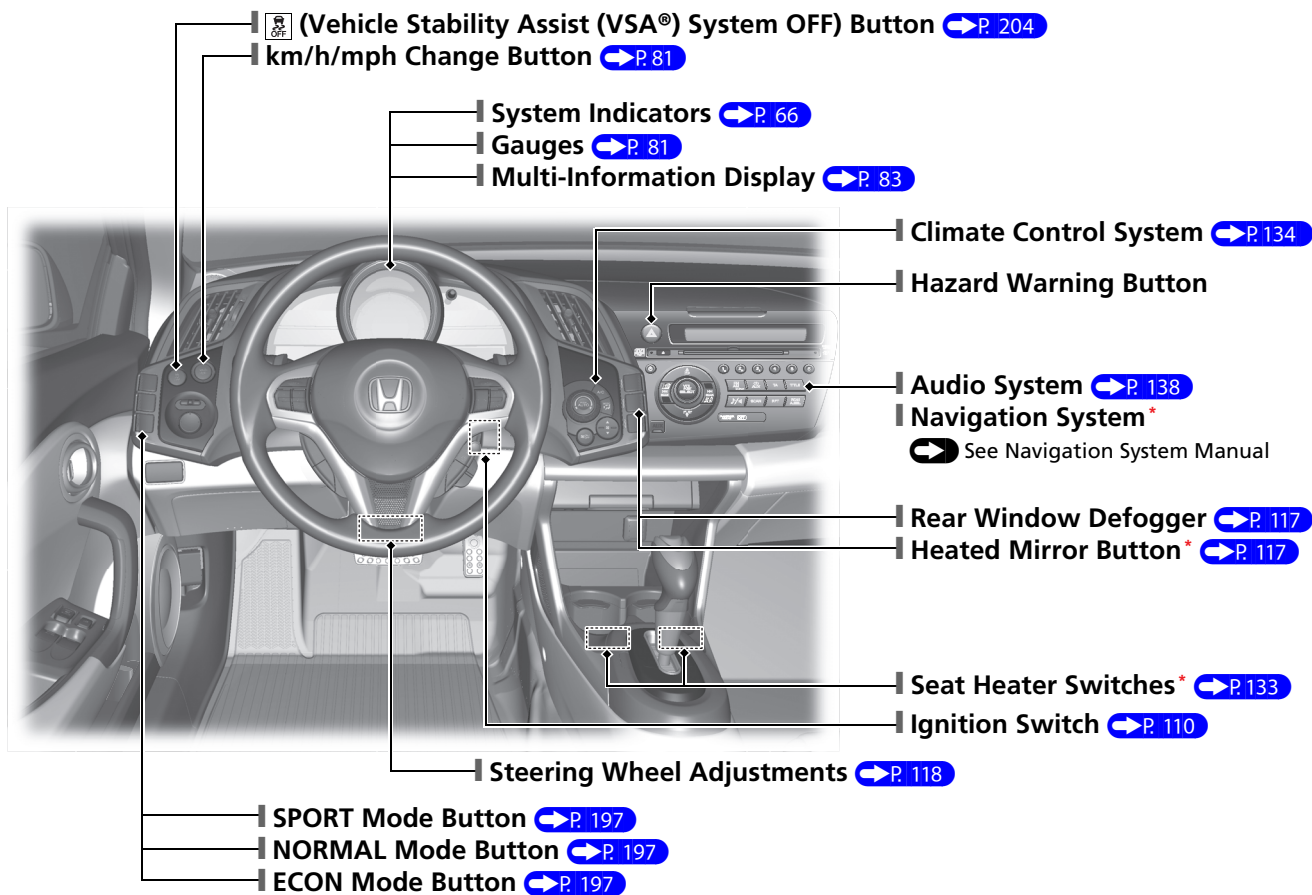

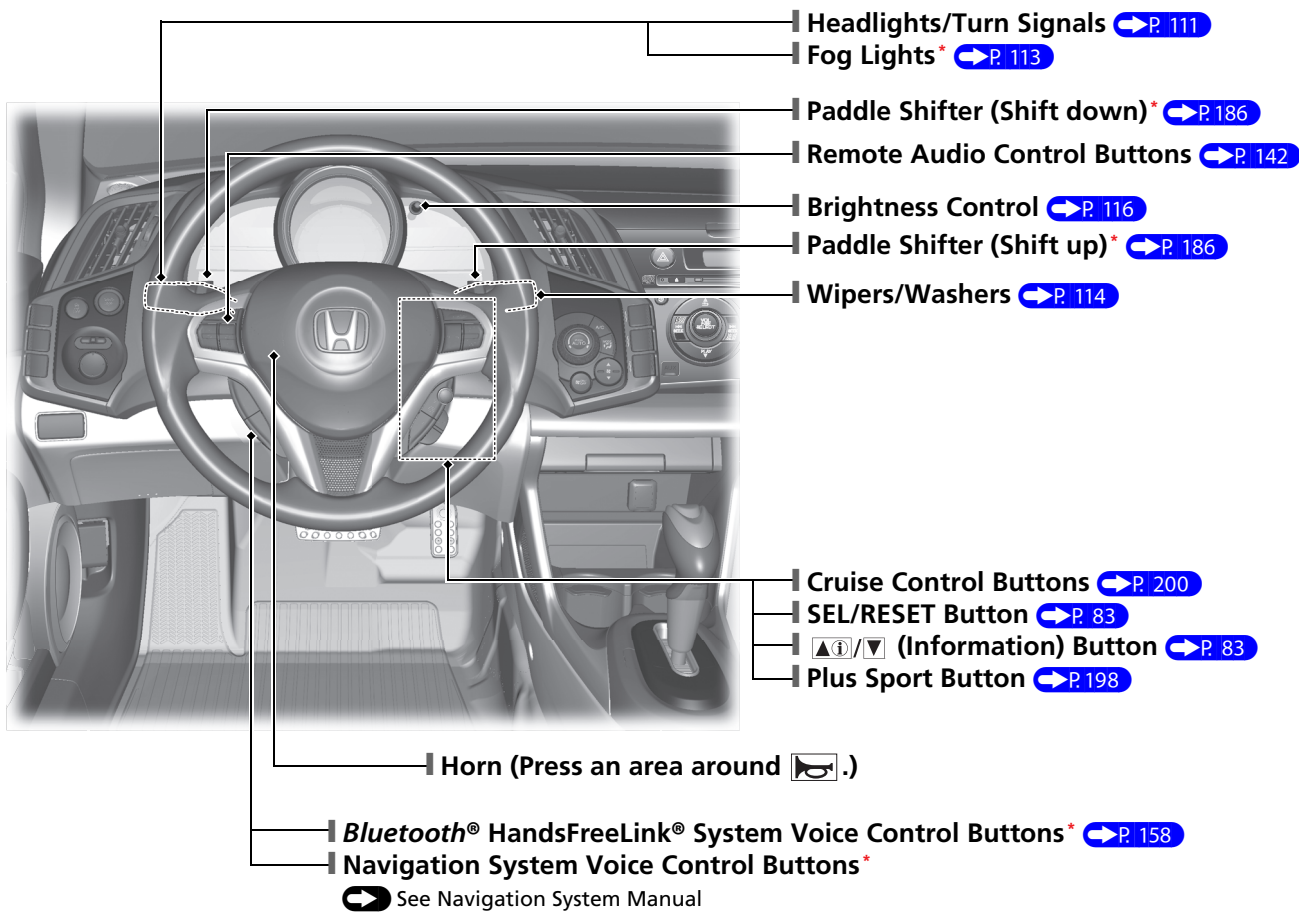

Visual Index

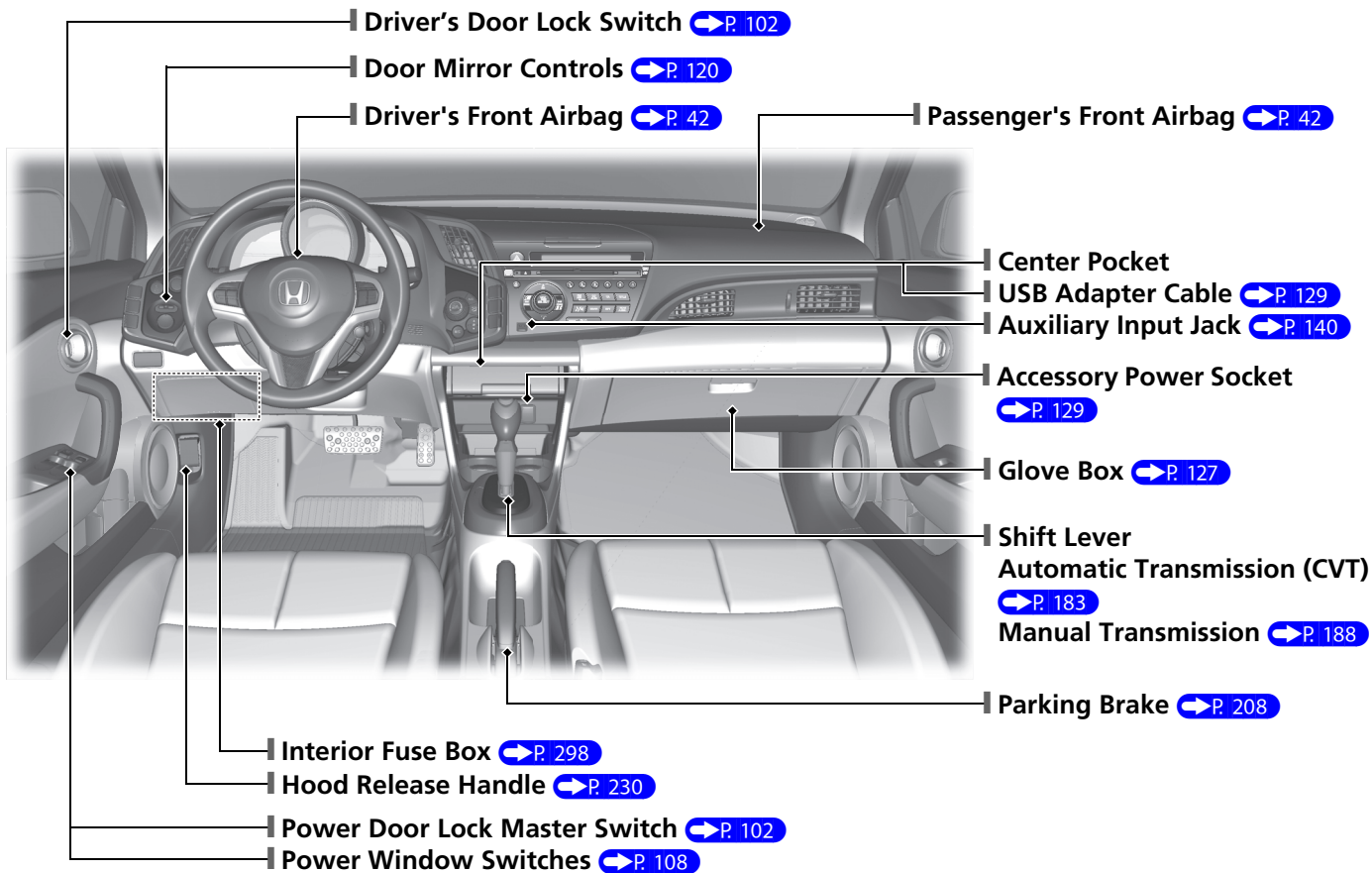

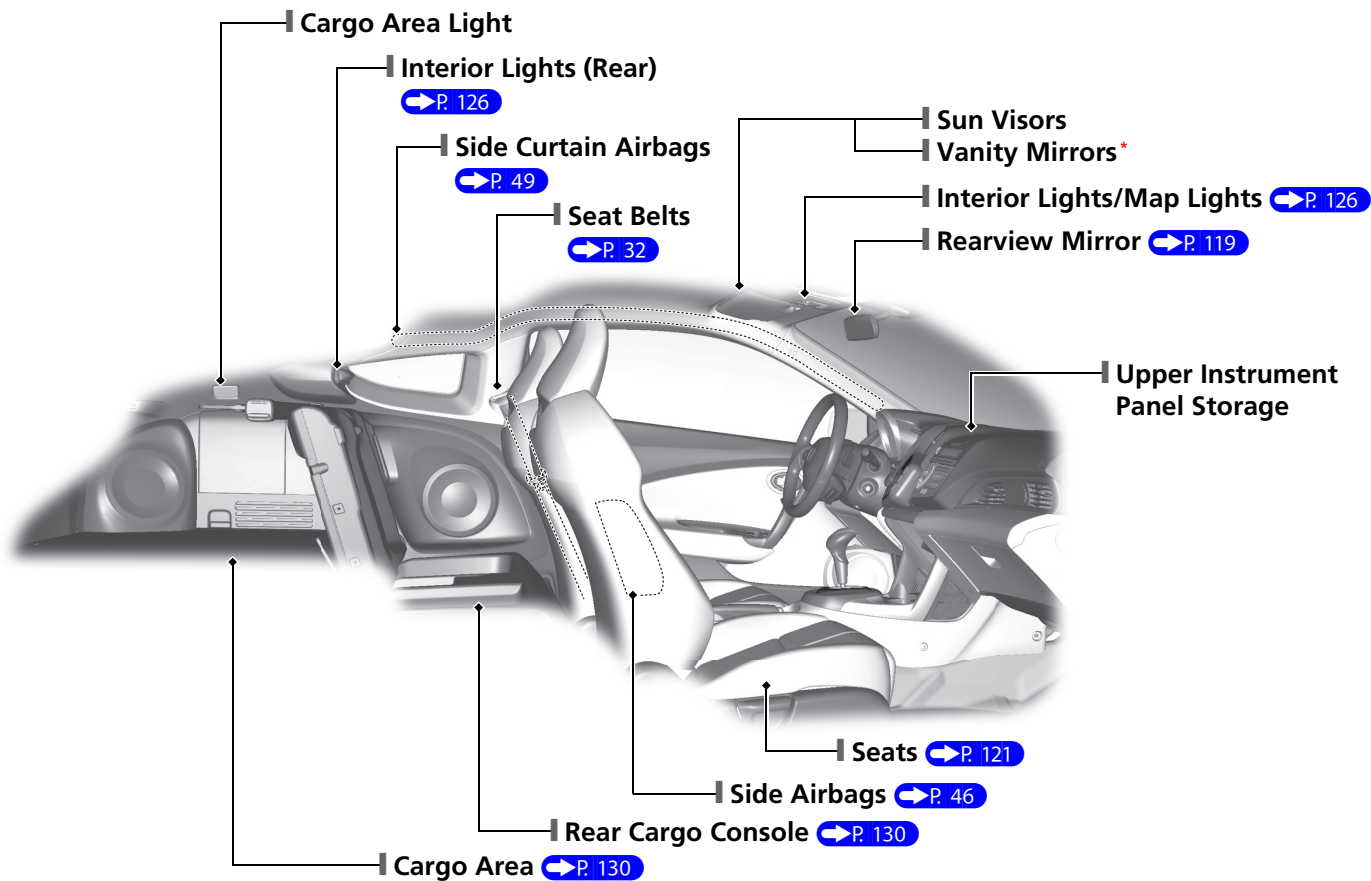

Visual Index

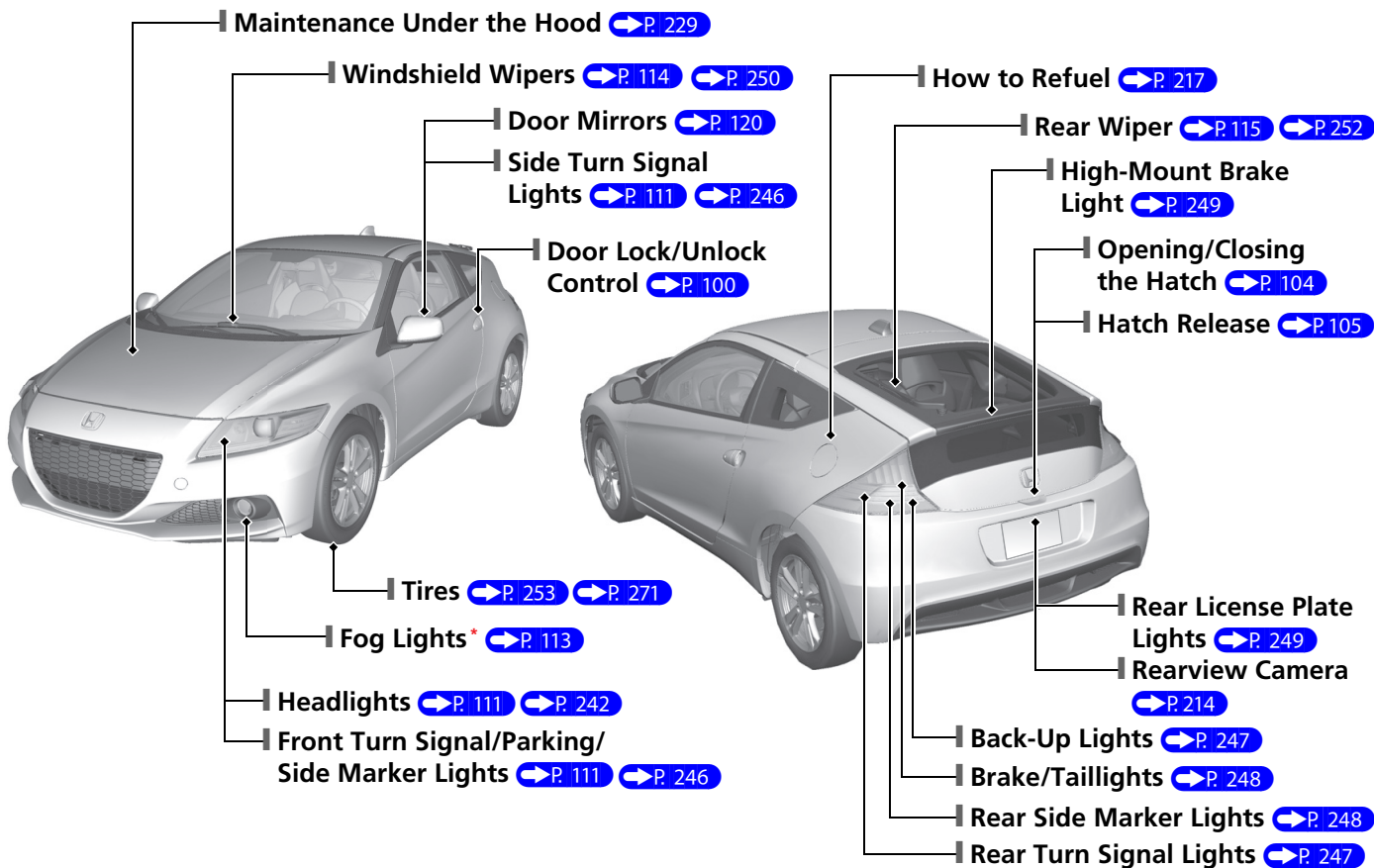

3-Mode Drive System

There are three driving modes for your vehicle: SPORT, NORMAL and ECON. Each mode offers a different level of driving performance. The mode buttons are located on the control panel. NORMAL mode, which is most suitable for all-purpose driving, is the default setting for your vehicle.

SPORT Mode

Increases engine performance and handling. Suitable for driving at hills or curves in a mountain, or driving in a suburb.

NORMAL Mode

Balances driving performance and fuel economy. Best for most driving situations.

ECON Mode

Maximizes fuel economy. Provides longer Auto Idle Stop operating time when the climate control system is in use.

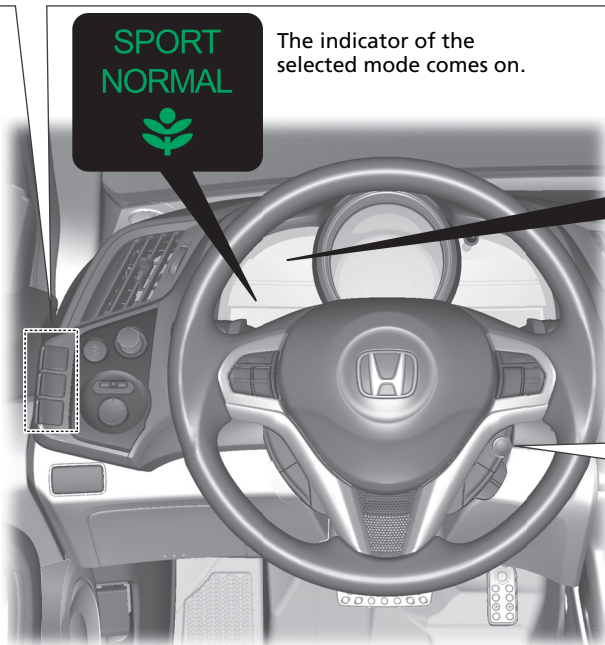

The indicator of the selected mode comes on.

Plus Sport System

Helps the vehicle to momentarily accelerate with more engine and electric motor assist power when you depress the accelerator pedal.



The indicator blinks when the Plus Sport System stands by to be activated, and when the system is in operation.

Plus Sport Button



Press the **S+** button, then depress the accelerator pedal to activate the Plus Sport System in any driving mode (SPORT, NORMAL, or ECON). This helps you to momentarily accelerate with more power when you depress the accelerator pedal.

Plus Sport System [▶ P.198](#)

Eco Assist System

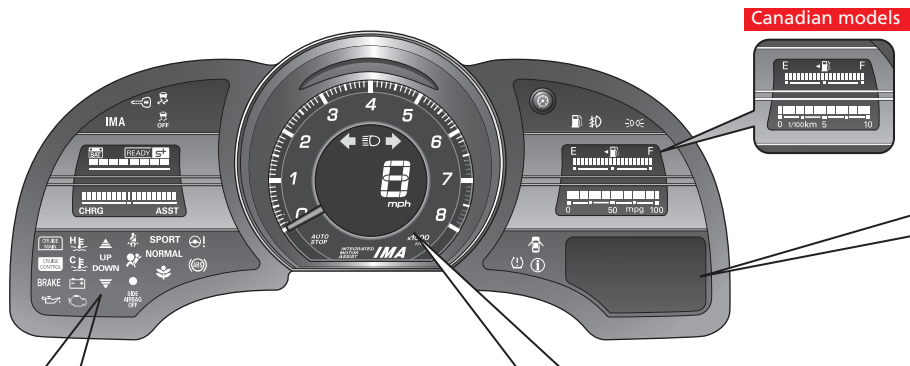

The Shift UP/DOWN Indicators*

→ P. 189

- These indicators alert you when it is appropriate to shift to attain better fuel economy.

 — Displays when shifting up is recommended.

UP
DOWN

 — Displays when shifting down is recommended.

The indicators do not come on in SPORT mode.

Ambient Meter

- Changes color to reflect your driving style.
 - Green:** Fuel efficient driving
 - Blue green:** Moderate acceleration/deceleration
 - Blue:** Aggressive acceleration/deceleration
- Changes to constant red when SPORT mode is selected.
- The ambient meter color changes in accordance with:
 - Automatic transmission (CVT) models**
Your brake or accelerator pedal operation.
 - Manual transmission models**
Your brake or accelerator pedal operation, and shift changes based on the shift up indicator.

* Not available on all models

Drive Cycle Score/Lifetime Points

- Comes on when the ignition switch is in LOCK [0].

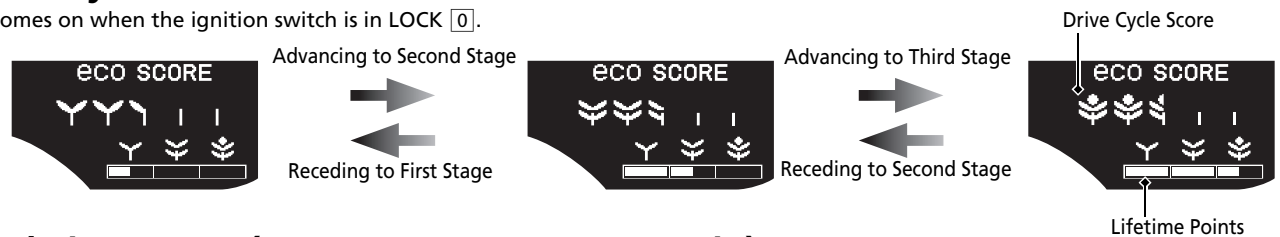

Real Time Score (represents your current trip) [P.86](#)

- Each time you turn the ignition switch to ON [I], the Ecological Drive display starts without any leaves on the plants. Leaves accumulate or diminish based on your driving style during the current trip.

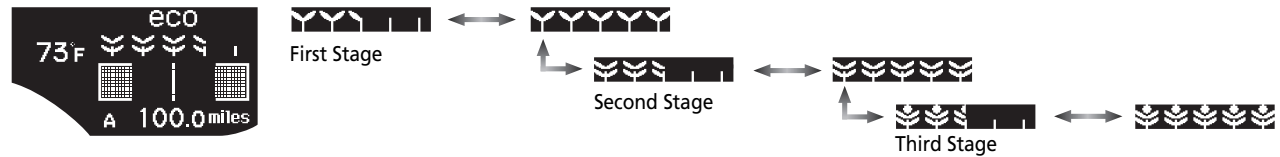

Ecological Guide Display Feedback with Eco Drive Bar [P.87](#)

- Keep the bar from extending too much to the left or right side. The shorter the bar is while driving, the higher the fuel economy becomes.

The bar extends to the right when you press the accelerator pedal.

Slow, steady acceleration/
Maximizes fuel economy



Moderate acceleration



Aggressive/Inconsistent acceleration



The bar extends to the left when you press the brake pedal.

Slow deceleration/
Maximizes fuel economy



Moderate deceleration



Aggressive deceleration



The Honda IMA System

The main power source for the Honda IMA system is the gasoline engine. The electric motor assists the engine to improve fuel economy, based on current operating conditions.

Tips to Improve Fuel Economy

To help your vehicle's fuel economy:

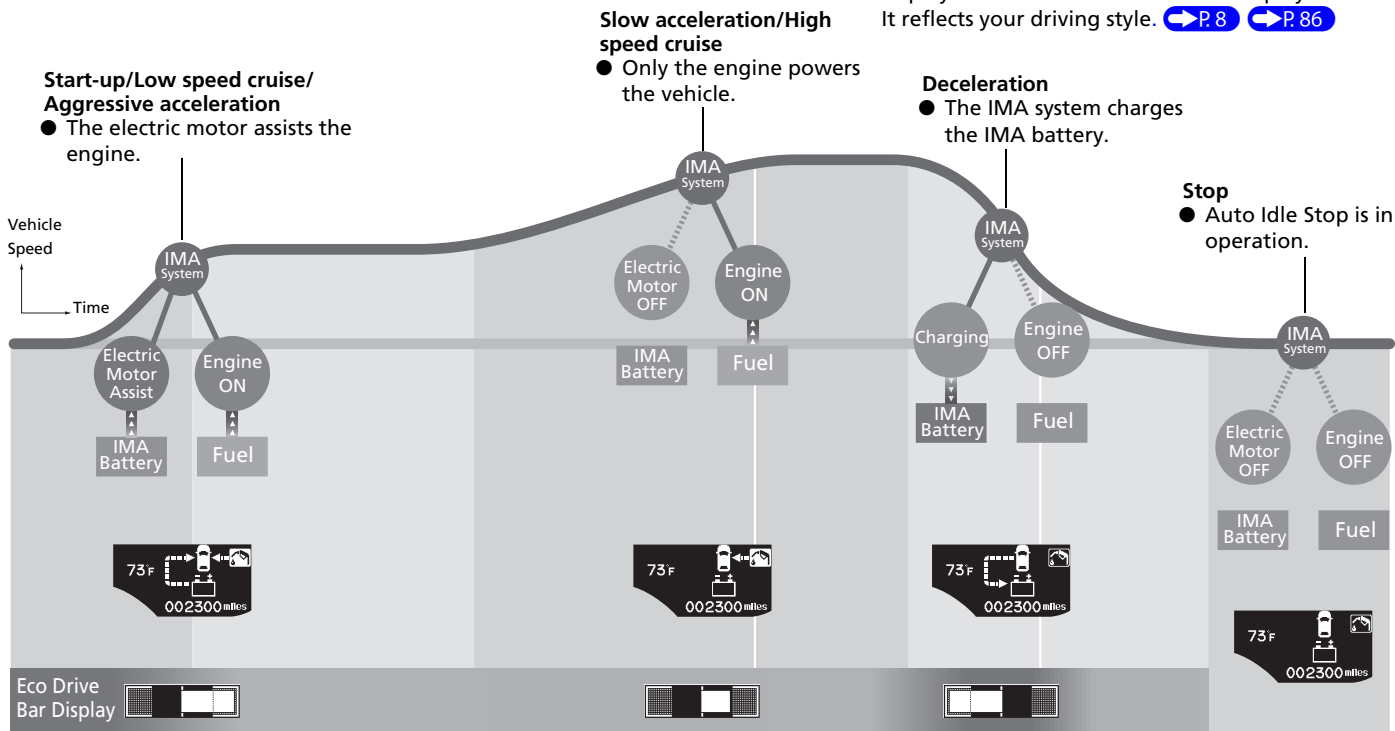

- Avoid aggressive acceleration/braking
- Monitor the ambient meter and the Eco drive bar displayed on the multi-information display. It reflects your driving style. [➔ P. 8](#) [➔ P. 86](#)



Auto Idle Stop Function

To improve fuel economy, the engine stops and then restarts as detailed below. When Auto Idle Stop is on, the **AUTO STOP** indicator blinks.

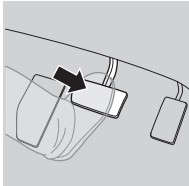
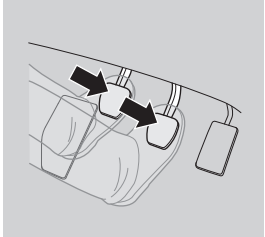
← P.191 → P.194

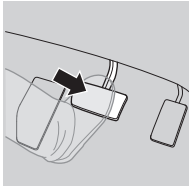
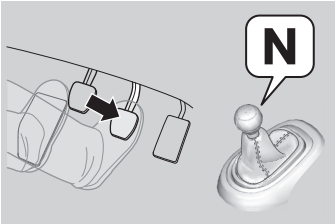
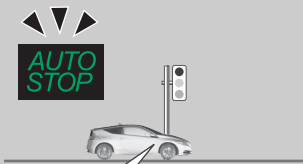
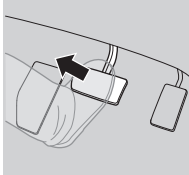
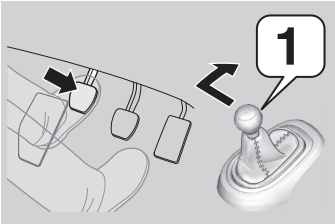
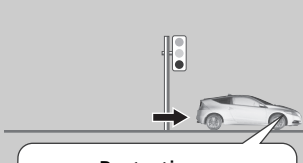
At	Automatic transmission (CVT)	Manual transmission	Engine status
Deceleration	<p>Depress the brake pedal. The vehicle speed goes below 6 mph (10 km/h).</p> 	<ol style="list-style-type: none"> 1. Depress the brake pedal. The vehicle speed goes below 19 mph (30 km/h). 2. Fully depress the clutch pedal. 	 <p>Turning off</p>
Stop	<p>Continue to depress the brake pedal.</p> 	<ul style="list-style-type: none"> • Continue to depress the brake pedal. • Move the shift lever to N. • Release the clutch pedal. 	 <p>Off</p>
Start-up	<p>Release the brake pedal.</p> 	<ol style="list-style-type: none"> 1. Fully depress the clutch pedal again. 2. Move the shift lever to 1. 3. Depress the accelerator pedal to resume driving. 	 <p>Restarting</p>

To Keep the IMA Battery in Good Condition

Drive your vehicle at least once a month, and drive for more than 30 minutes at a time. Parking your vehicle for an extended period can cause the IMA battery to weaken or decrease the IMA battery life.

Safety Precautions

Do not cover the air intake.

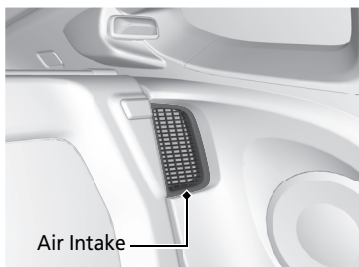

If the air intake is obstructed during vehicle operation, the IMA battery can become too hot. To protect the battery, the system may start limiting IMA battery output power and cause the IMA system and 12 volt battery charging system indicators to come on.

IMA System Indicator  P. 86

12 Volt Battery Charging System Indicator  P. 67

Do not touch the Honda IMA System

A high voltage current runs through Honda IMA System. Consult your authorized dealer when maintenance or repair is needed.

Do not spill any liquids on or around the IMA battery, as they can damage the IMA battery. If you accidentally spill liquids on or around the battery, ensure that the spill is completely wiped up as soon as possible.

The IMA system indicator may come on.

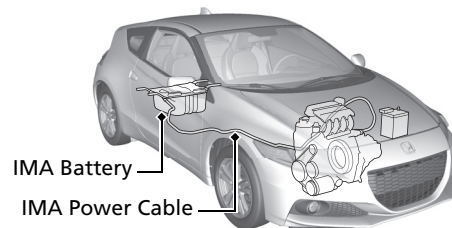

If a crash occurs

- Be careful of electric shock hazard.
 - ▶ If a crash severely damaged your vehicle, there is a possibility of electrical shock. Do not touch the IMA system components or its wiring (orange).
- Avoid contact with IMA battery fluid.
 - ▶ The battery fluid may leak as a result of a severe crash. Avoid any skin or eye contact with the fluid. The battery fluid is corrosive. If you accidentally touch it, flush the affected area(s) with a large quantity of water for at least five minutes, and seek medical attention immediately.
- Use a fire extinguisher for an electrical fire.
 - ▶ Attempting to extinguish an electrical fire with a small quantity of water can be dangerous.

When the vehicle is disposed

- The IMA battery is a Lithium ion battery. Honda collects and recycles used IMA batteries – consult with your dealer for proper battery disposal in the event your vehicle is not repairable.

Safe Driving [P.27](#)

ORG

Quick Reference Guide - 2013 CR-Z

Airbags [P.39](#)

- Your vehicle is fitted with airbags to help protect you and your passenger during a moderate-to-severe collision.

Child Safety [P.54](#)

- **Your vehicle is not recommended for child passengers.** If you decide to disregard our recommendations and transport a child passenger, the child should be properly restrained.
Never put a rear-facing child seat in the passenger's seat.

Exhaust Gas Hazard [P.62](#)

- Your vehicle emits dangerous exhaust gases that contain carbon monoxide. Do not run the engine in confined spaces where carbon monoxide gas can accumulate.

Seat Belts [P.32](#)

- Fasten your seat belt and sit upright well back in the seat.
- Check that your passenger is wearing their seat belt correctly.

Before Driving Checklist [P.172](#)

- Before driving, check that the seats, steering wheel, and mirrors have been properly adjusted.

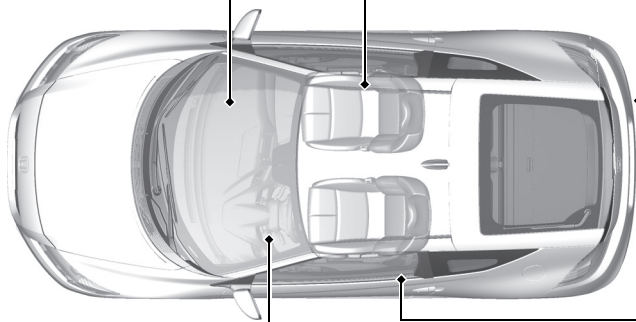

Fasten your lap belt as low as possible.



Index

Home











Instrument Panel ➔ P.65

Gauges ➔ P.81 / Multi-Information Display ➔ P.83 / System Indicators ➔ P.66

Lights Reminders





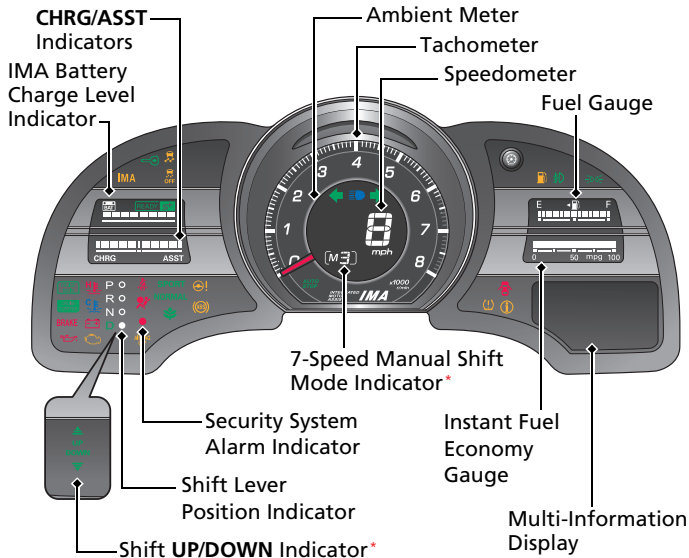

-  Lights On Indicator
-  High Beam Indicator
-  Fog Light Indicator*

System Indicators













-  Malfunction Indicator Lamp
-  Low Oil Pressure Indicator
-  12 Volt Battery Charging System Indicator
-  Anti-lock Brake System (ABS) Indicator
-  Vehicle Stability Assist (VSA®) System Indicator
-  VSA® OFF Indicator
-  Turn Signal and Hazard Warning Indicators
-  Electric Power Steering (EPS) System Indicator
-  Immobilizer System Indicator
-  IMA System Indicator
-  Auto Idle Stop Indicator



System Indicators

-  High Temperature Indicator
-  Low Temperature Indicator
-  Low Fuel Indicator
-  SPORT Mode Indicator
-  NORMAL Mode Indicator
-  ECON Mode Indicator

System Indicators

-  Seat Belt Reminder Indicator
-  **BRAKE**
U.S.
Canada
Parking Brake and Brake System Indicator (Red)
-  Supplemental Restraint System Indicator
-  **SIDE AIRBAG OFF**
U.S.
Canada
Side Airbag Off Indicator
-  **U.S. models only**
Low Tire Pressure/TPMS Indicator
-  Door/Hatch Open Indicator
-  **CRUISE MAIN**
Indicator
-  **CRUISE CONTROL**
Indicator
-  System Message Indicator
-  **READY S**
Plus Sport System Indicator
-  **READY**
Plus Sport READY Indicator
-  **S**
Plus Sport Indicator

Controls [P.97](#)

Clock [P.98](#)

Models without navigation system



- 1 Press the **FM/AM** button until you hear a beep. The displayed time begins flashing.
- 2 Press **1** (Hour) or **2** (Minute) to set the time. Press **3** (Reset) to set the time to the nearest hour.
- 3 Press the **FM/AM** button again to set the time.

Models with navigation system

The navigation system receives signals from GPS satellites, updating the clock automatically.

Turn Signals [P.111](#)

Turn Signal Control Lever

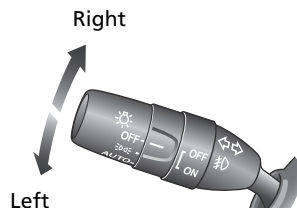

Lights [P.111](#)

Light Control Switches

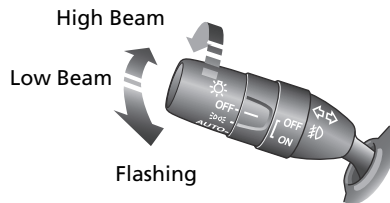

Wipers and Washers [P.114](#)

Wiper/Washer Control Lever

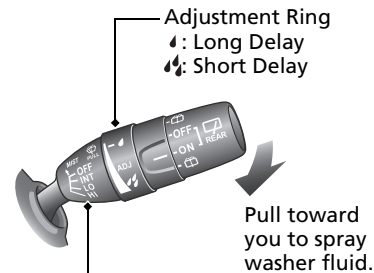

MIST
OFF

INT: Low speed with intermittent
LO: Low speed wipe
HI: High speed wipe

Steering Wheel P.118

- To adjust, pull the adjustment lever towards you, adjust to the desired position, then lock the lever back in place.

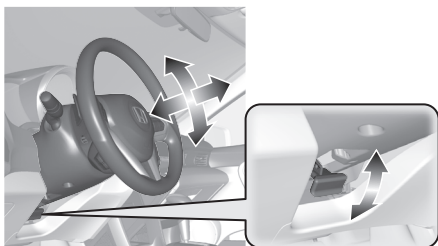

Hatch P.104

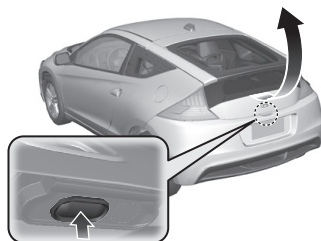

- With the doors unlocked, press the hatch release button on the hatch to open it.

Power Door Mirrors

 P.120

- With the ignition switch in ON , move the selector switch to L or R.
- Push the appropriate edge of the adjustment switch to adjust the mirror.

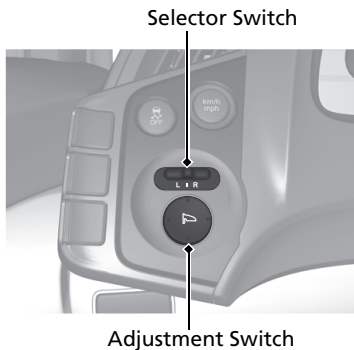

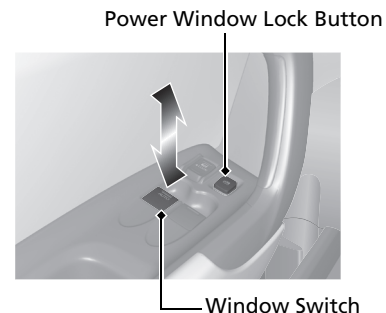

Power Windows P.108

- With the ignition switch in ON , open and close the power windows.
- If the power window lock button is in the off position, the passenger's window can be opened and closed with its own switch.
- If the power window lock button is in the on position, the passenger's window switch is disabled.



Climate Control System P.134

- Press the **AUTO** button to activate the climate control system.
- Press the  button to turn the system on or off.
- Press the  button to defrost the windshield.

Models with navigation system

The climate control system is voice operable. See the navigation system manual for complete details.

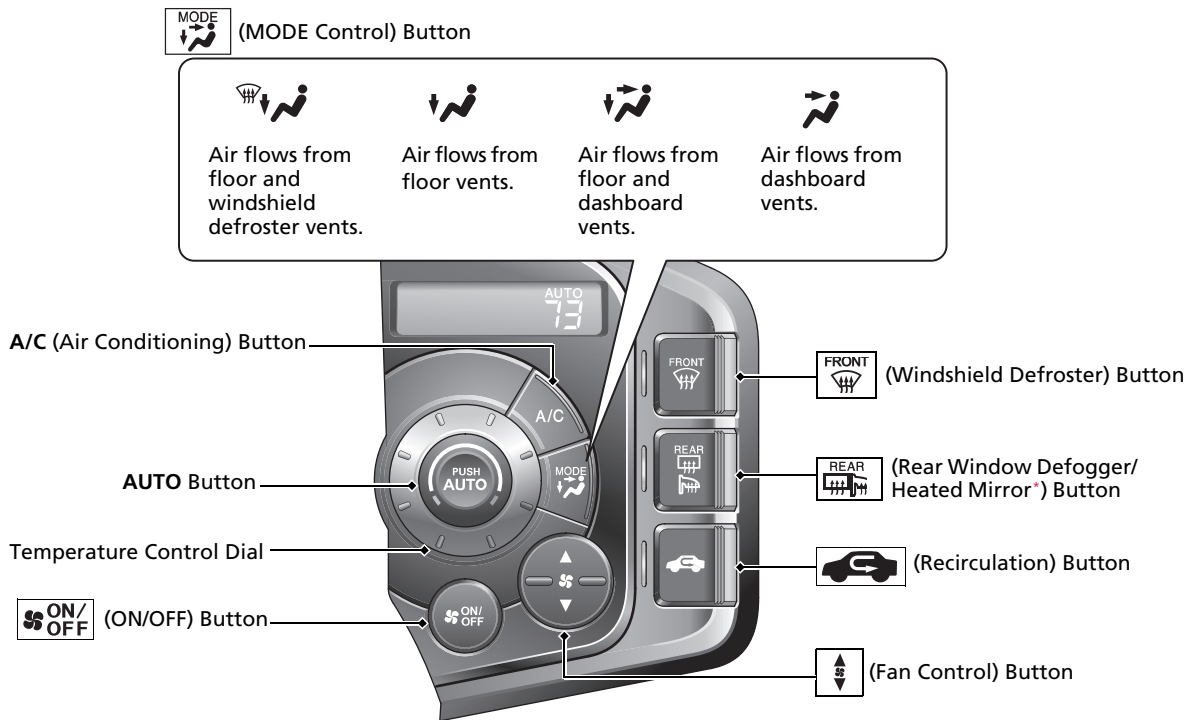

Features [P.137](#)

Audio System [P.138](#)

For navigation system operation  See Navigation System Manual

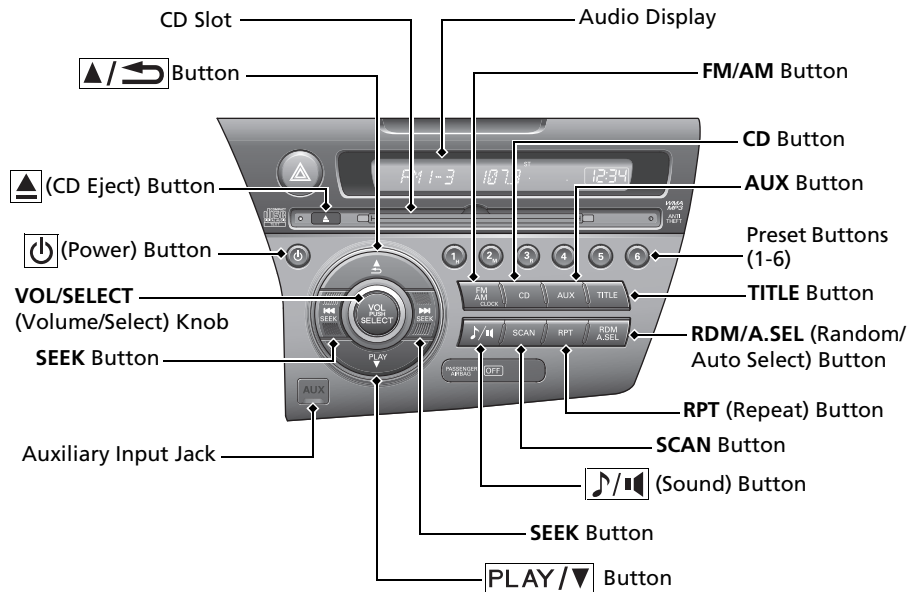

● Audio Remote Controls [P.142](#)

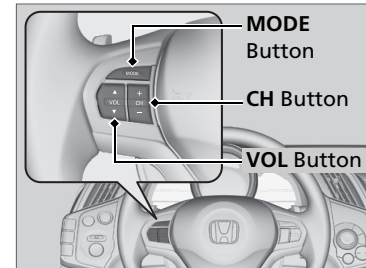

- **VOL (volume) Button**
Press and release ▲ / ▼ to adjust the volume up/down.
- **MODE Button**
Press and release to change the audio mode: FM1/FM2/AM/CD/AUX.
- **CH (channel) Button**
Radio: Press and release to change the preset station.
Press and hold to select the next or previous strong station.
CD/USB device:
Press and release to skip to the beginning of the next song or return to the beginning of the current song.
Press and hold to change a folder.

Driving ➔ P.171

Manual Transmission ➔ P.188

Automatic Transmission (CVT) ➔ P.183

➔ P.183

- Shift to **P** and depress the brake pedal when starting the engine.
- Shifting

Park

Turn off or start the engine. Transmission is locked.

P

Reverse

R

Neutral

Transmission is not locked.

N

Drive

Normal driving. 7-speed manual shift mode can be used. L mode is available.

D

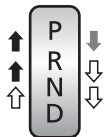
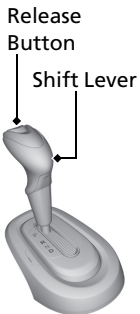

- ↓ Depress the brake pedal and press the release button to move out of **P**.
- ↑ ↓ Move the shift lever without pressing the release button.
- ↑ Press the release button to move the shift lever.

7-Speed Manual Shift Mode ➔ P.185

- Allows you to manually shift the transmission up or down without removing your hands from the steering wheel.

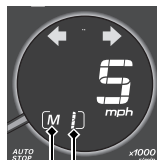

Shift Indicator

M Indicator

Shift Down **-**
Paddle Shifter

Shift Up **+**
Paddle Shifter

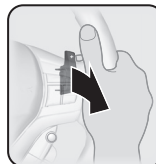

SPORT Mode

- Pulling a paddle shifter changes the mode from automatic transmission (CVT) to 7-speed manual shift mode. The **M** indicator and the selected speed number are displayed in the shift indicator.

NORMAL Mode/ECON Mode

- Pulling a paddle shifter temporarily changes the mode from automatic transmission (CVT) to 7-speed manual shift mode. The selected speed number is displayed in the shift indicator.

L (Low) Mode ➔ P.187

- Use Low to get more power when climbing steep hills.
- Pull the **+** and **-** paddle shifters at the same time until the shift indicator display changes to L.

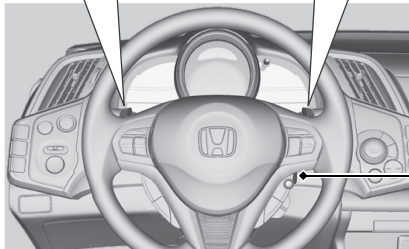

Ignition Switch

VSA® OFF Button [➔ P.204](#)

- The vehicle stability assist (VSA®) system helps stabilize the vehicle during cornering, and helps maintain traction while accelerating on loose or slippery road surfaces.
- VSA® comes on automatically every time you start the engine.
- To turn VSA® on or off, press and hold the  button until you hear a beep.

Cruise Control [➔ P.200](#)

- Cruise control allows you to maintain a set speed without keeping your foot on the accelerator pedal.
- To use cruise control, press the **CRUISE** button, then press **DECEL/SET** once you have achieved the desired speed above 25 mph or 40 km/h.

Tire Pressure Monitoring System (TPMS) [➔ P.205](#)

U.S. models only

- TPMS monitors tire pressure.
- TPMS is turned on automatically every time you start the engine.

Refueling [➔ P.216](#)

Fuel recommendation: Unleaded gasoline with a pump octane number 87 or higher required

Fuel tank capacity: 10.6 US gal (40 L)

- 1 Press and release the center of the rear edge of the fuel fill door. You hear a click. The door pops open slightly.
- 2 Turn the fuel fill cap slowly to remove the cap.
- 3 Place the cap in the holder on the fuel fill door.
- 4 After refueling, screw the cap back on until it clicks at least once.

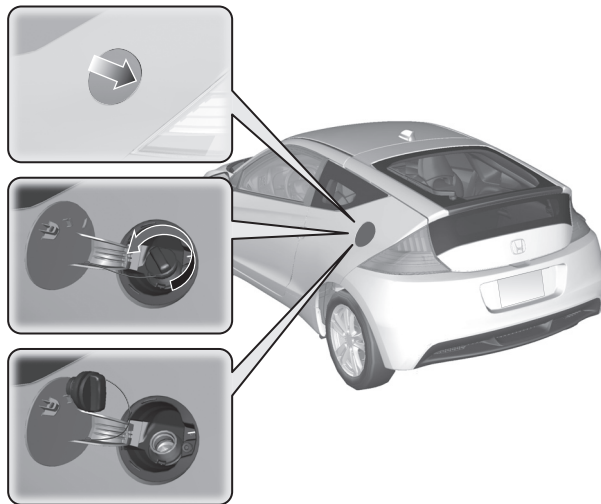

Maintenance [↔ P.221](#)

Under the Hood [↔ P.229](#)

- Check engine oil, engine coolant, and window washer fluid. Add when necessary.
- Check transmission fluid (CVT).
- Check brake fluid and clutch fluid.
- Check the 12 volt battery regularly.

- 1** Pull the hood release handle under the corner of the dashboard.

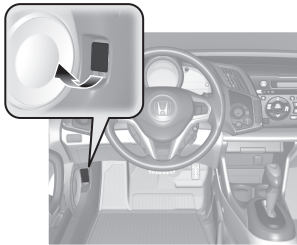

- 2** Locate the hood latch lever, pull the lever up, and lift up the hood.

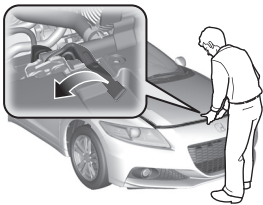

- 3** When finished, close the hood and make sure it is firmly locked in place.

Wiper Blades [↔ P.250](#)

- Replace blades if they leave streaks across the windshield.

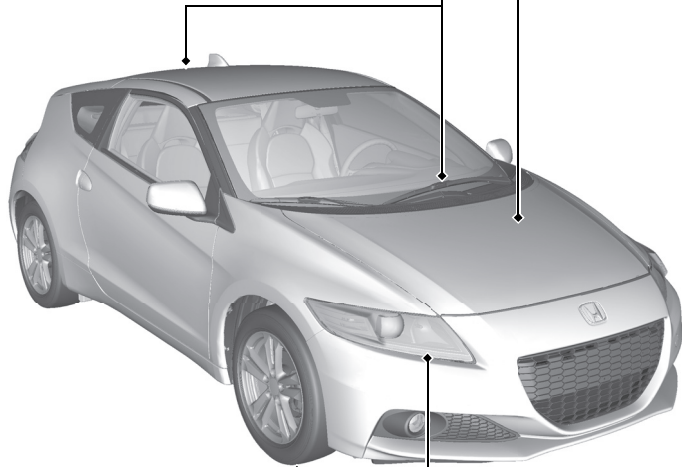

Tires [↔ P.253](#)

- Inspect tires and wheels regularly.
- Check tire pressures regularly.
- Install snow tires for winter driving.

Lights [↔ P.242](#)

- Inspect all lights regularly.

Handling the Unexpected ➔ P.269

Flat Tire ➔ P.271

- Park in a safe place and repair the flat tire using the temporary tire repair kit.

Models with an optional compact spare tire

- Park in a safe place and replace the flat tire with the compact spare tire in the cargo area.



Indicators Come On

➔ P.292

- Identify the indicator and consult the owner's manual.



Engine Won't Start ➔ P.286

- If the battery is dead, jump start using a booster battery.

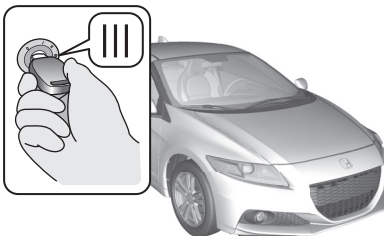

Blown Fuse ➔ P.297

- Check for a blown fuse if an electrical device does not operate.

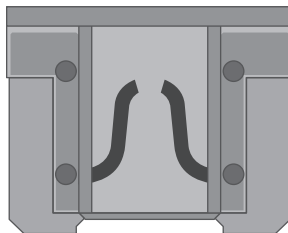

Overheating ➔ P.290

- Park in a safe location. If you do not see steam under the hood, open the hood, and let the engine cool down.



Emergency Towing ➔ P.301

- Call a professional towing service if you need to tow your vehicle.

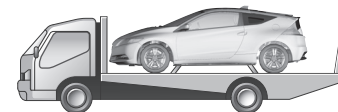

What to Do If

Q The ignition switch does not turn from **0** to **I**. Why?

A

- The steering wheel may be locked.
- Move the steering wheel left and right while turning the ignition key.

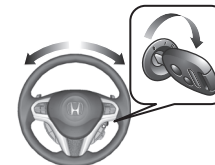

Q The ignition switch does not turn from **I** to **0** and I cannot remove the key. Why?

A The shift lever should be moved to **P** on the automatic transmission (CVT) model.

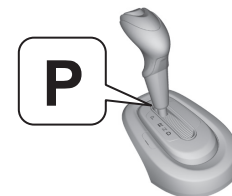

Q Why does the brake pedal pulsate slightly when applying the brakes?

A This can occur when the ABS activates, and does not indicate a problem. Apply firm, steady pressure on the brake pedal. Never pump the brake pedal.

Q Why do the doors lock after I unlocked the doors using a remote transmitter?

A If you do not open the doors within 30 seconds, the doors are relocked automatically for security.



Why does the beeper sound when I open the driver's door?



The beeper sounds when:

- The key is left in the ignition switch.
- The exterior lights are left on.
- The Auto Idle Stop is in operation.



Why does the beeper sound when I start driving?



The beeper sounds when:

- Driver and/or passenger are not wearing their seat belts.
- The parking brake lever is not fully released.



Why do I hear a screeching sound when I apply the brake pedal?



The brake pads may need to be replaced. Have your vehicle inspected by a dealer.

California Proposition 65 Warning

WARNING: This product contains or emits chemicals known to the state of California to cause cancer and birth defects or other reproductive harm.

Event Data Recorders

This vehicle is equipped with an event data recorder (EDR).

The main purpose of an EDR is to record, in certain crash or near crash-like situations, such as an air bag deployment or hitting a road obstacle, data that will assist in understanding how a vehicle's systems performed. **The EDR is designed to record data related to vehicle dynamics and safety systems for a short period of time, typically 30 seconds or less. The EDR in this vehicle is designed to record such data as:**

- **How various systems in your vehicle were operating;**
- **Whether or not the driver and passenger safety belts were buckled/fastened;**
- **How far (if at all) the driver was depressing the accelerator and/or brake pedal; and,**
- **How fast the vehicle was traveling.**

These data can help provide a better understanding of the circumstances in which crashes and injuries occur. NOTE: EDR data are recorded by your vehicle only if a non-trivial crash situation occurs; no data are recorded by the EDR under normal driving conditions and no personal data (e.g., name, gender, age, and crash location) are recorded. However, other parties, such as law enforcement, could combine the EDR data with the type of personally identifying data routinely acquired during a crash investigation.

To read data recorded by an EDR, special equipment is required, and access to the vehicle or the EDR is needed. In addition to the vehicle manufacturer, other parties, such as law enforcement, that have the special equipment, can read the information if they have access to the vehicle or the EDR.

The data belongs to the vehicle owner and may not be accessed by anyone else except as legally required or with the permission of the vehicle owner.

Service Diagnostic Recorders

This vehicle is equipped with service-related devices that record information about powertrain performance. The data can be used to verify emissions law requirements and/or help technicians diagnose and solve service problems. It may also be combined with data from other sources for research purposes, but it remains confidential.

California Perchlorate Contamination Prevention Act

The airbags, seat belt tensioners, and CR type batteries in this vehicle may contain perchlorate materials - special handling may apply. See www.dtsc.ca.gov/hazardouswaste/perchlorate/

As you read this manual, you will find information that is preceded by a **NOTICE** symbol. This information is intended to help you avoid damage to your vehicle, other property, or the environment.

A Few Words About Safety

Your safety, and the safety of others, is very important. And operating this vehicle safely is an important responsibility.

To help you make informed decisions about safety, we have provided operating procedures and other information on labels and in this manual. This information alerts you to potential hazards that could hurt you or others.

Of course, it is not practical or possible to warn you about all the hazards associated with operating or maintaining your vehicle. You must use your own good judgement.

You will find this important safety information in a variety of forms, including:

- **Safety Labels** - on the vehicle.
- **Safety Messages** - preceded by a safety alert symbol  and one of three signal words: **DANGER**, **WARNING**, or **CAUTION**. These signal words mean:

 **DANGER**

You **WILL** be **KILLED** or **SERIOUSLY HURT** if you don't follow instructions.

 **WARNING**

You **CAN** be **KILLED** or **SERIOUSLY HURT** if you don't follow instructions.

 **CAUTION**

You **CAN** be **HURT** if you don't follow instructions.

- **Safety Headings** - such as Important Safety Precautions.
- **Safety Section** - such as Safe Driving.
- **Instructions** - how to use this vehicle correctly and safely.

This entire book is filled with important safety information - please read it carefully.

Safe Driving

You can find many safety recommendations throughout this chapter, and throughout this manual.

For Safe Driving

Important Safety Precautions	28
Your Vehicle's Safety Features.....	30

Seat Belts

About Your Seat Belts.....	32
Fastening a Seat Belt.....	35
Seat Belt Inspection.....	38

Airbags

Airbag System Components.....	39
Types of Airbags	42
Front Airbags (SRS)	42
Side Airbags.....	46

Side Curtain Airbags	49
Airbag System Indicators.....	50
Airbag Care	53

Child Safety

Protecting Child Passengers	54
Safety of Infants and Small Children ..	56
Safety of Larger Children	60

Exhaust Gas Hazard

Carbon Monoxide Gas.....	62
--------------------------	----

Safety Labels

Label Locations	63
-----------------------	----

The following pages explain your vehicle's safety features and how to use them properly. The safety precautions below are ones that we consider to be among the most important.

Important Safety Precautions

■ Always wear your seat belt

A seat belt is your best protection in all types of collisions. Airbags are designed to supplement seat belts, not replace them. So even though your vehicle is equipped with airbags, make sure you and your passenger always wear your seat belts, and wear them properly.

■ Your vehicle is not recommended for child passengers

The National Highway Traffic Safety Administration and Transport Canada recommend that all children age 12 and under be properly restrained in a back seat. Since this vehicle does not have a back seat, we strongly recommend that you do not carry any child who is not large enough and mature enough to ride in front.

■ Be aware of airbag hazards

While airbags can save lives, they can cause serious or fatal injuries to occupants who sit too close to them, or are not properly restrained. Infants, young children, and short adults are at the greatest risk. Be sure to follow all instructions and warnings in this manual.

■ Don't drink and drive

Alcohol and driving don't mix. Even one drink can reduce your ability to respond to changing conditions, and your reaction time gets worse with every additional drink. So don't drink and drive, and don't let your friends drink and drive, either.

▣ Important Safety Precautions

Some states, provinces and territories prohibit the use of cell phones other than hands-free devices by the driver while driving.

Never carry an infant in a rear-facing child seat in this vehicle.

If an older child must ride in this vehicle, follow all child safety instructions and warnings in this manual.

[▶ Child Safety P. 54](#)

■ Pay appropriate attention to the task of driving safely

Engaging in cell phone conversation or other activities that keep you from paying close attention to the road, other vehicles, and pedestrians could lead to a crash. Remember, situations can change quickly, and only you can decide when it is safe to divert some attention away from driving.

■ Control your speed

Excessive speed is a major factor in crash injuries and deaths. Generally, the higher the speed, the greater the risk, but serious injuries can also occur at lower speeds. Never drive faster than is safe for current conditions, regardless of the maximum speed posted.

■ Keep your vehicle in safe condition

Having a tire blowout or a mechanical failure can be extremely hazardous. To reduce the possibility of such problems, check your tire pressures and condition frequently, and perform all regularly scheduled maintenance.

Your Vehicle's Safety Features

Your Vehicle's Safety Features

Your vehicle is equipped with many features that work together to help protect you and your passenger during a crash.

Some features do not require any action on your part. These include a strong steel framework that forms a safety cage around the passenger compartment, front and rear crush zones, a collapsible steering column, and tensioners that tighten the seat belts in a sufficient crash.

However, you and your passenger cannot take full advantage of these features unless you remain seated in the correct position and always wear your seat belts. In fact, some safety features can contribute to injuries if they are not used properly.

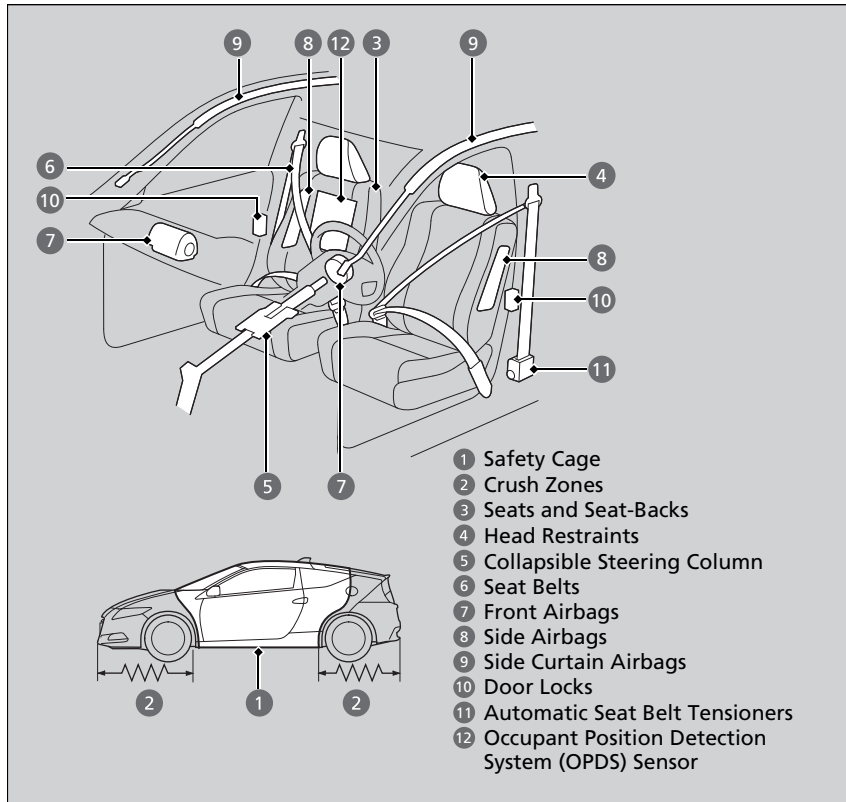

The following checklist will help you take an active role in protecting yourself and your passenger.

ORG

TOC

Safe Driving

Index

Home

Safety Checklist

For the safety of you and your passenger, make a habit of checking these items each time before you drive.

- After everyone has entered the vehicle, be sure both doors and the hatch are closed and locked. Locking the doors and the hatch helps prevent an occupant from being ejected and an outsider from unexpectedly opening a door or the hatch.
 - ▶ [Locking/Unlocking the Doors from the Inside P. 102](#)
- Adjust your seat to a position suitable for driving. Be sure the seats are adjusted as far to the rear as possible while allowing the driver to control the vehicle. Sitting too close to a front airbag can result in serious or fatal injury in a crash.
 - ▶ [Adjusting the Seats P. 121](#)
- Always wear your seat belt, and make sure you wear it properly. Confirm that any passenger is properly belted as well.
 - ▶ [Fastening a Seat Belt P. 35](#)
- If you choose to ignore our warnings and carry a child in this vehicle, make every effort to protect them by properly using a seat belt or a child seat according to the child's age, height, and weight.
 - ▶ [Child Safety P. 54](#)

▶▶ Safety Checklist

If the door/hatch open indicator is on, a door and/or the hatch is not completely closed. Close both doors and the hatch tightly until the indicator goes off.

▶ [Door/Hatch Open Indicator P. 69](#)

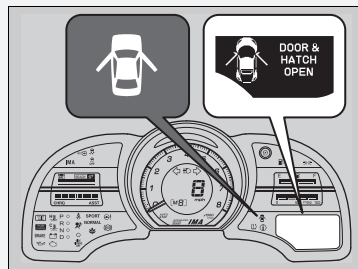

About Your Seat Belts

Seat belts are the single most effective safety device because they keep you connected to the vehicle so that you can take advantage of many built-in safety features. They also help keep you from being thrown against the inside of the vehicle, against a passenger, or out of the vehicle. When worn properly, seat belts also keep your body properly positioned in a crash so that you can take full advantage of the additional protection provided by the airbags.

In addition, seat belts help protect you in almost every type of crash, including:

- frontal impacts
- side impacts
- rear impacts
- rollovers

■ Lap/shoulder seat belts

Both seating positions are equipped with lap/shoulder seat belts with emergency locking retractors. In normal driving the retractor lets you move freely while keeping some tension on the belt. During a collision or sudden stop the retractor locks to restrain your body. The passenger's seat belt has a lockable retractor that must be properly activated when using a forward-facing child seat, should you choose to disregard our recommendations and install one.

➔ [Installing a Child Seat P. 58](#)

📖 About Your Seat Belts

WARNING

Not wearing a seat belt properly increases the chance of serious injury or death in a crash, even though your vehicle has airbags.

Be sure you and your passenger always wear seat belts and wear them properly.

Seat belts cannot completely protect you in every crash. But in most cases, seat belts can reduce your risk of serious injury.

Most states and all Canadian provinces and territories require you to wear seat belts.

■ Proper use of seat belts

Follow these guidelines for proper use:

- All occupants should sit upright, well back in the seat, and remain in that position for the duration of the trip. Slouching and leaning reduces the effectiveness of the belt and can increase the chance of serious injury in a crash.
- Never place the shoulder part of a lap/shoulder seat belt under your arm or behind your back. This could cause very serious injuries in a crash.
- Two people should never use the same seat belt. If they do, they could be very seriously injured in a crash.
- Do not put any accessories on the seat belts. Devices intended to improve comfort or reposition the shoulder part of a seat belt can reduce the protective capability and increase the chance of serious injury in a crash.

■ Seat Belt Reminder

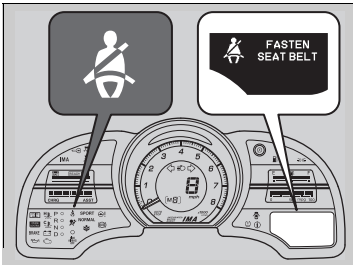

Your vehicle monitors seat belt use. If the ignition switch is turned to ON **II** before the driver's seat belt is fastened, a beeper will sound and the indicator will blink. If the driver does not fasten the belt before the beeper stops, the indicator will remain on.

The beeper will also periodically sound and the indicator will blink while driving until the driver's and passenger's seat belts are fastened.

▣ About Your Seat Belts

If your passenger moves around and extends the seat belt, the lockable retractor may activate. If this happens, release the retractor by unfastening the seat belt and allow the belt to retract completely. Then refasten the belt.

▣ Seat Belt Reminder

The indicator will also come on if a passenger does not fasten their seat belt within 6 seconds after the ignition switch is turned to ON **II**.

When no one is sitting in the passenger's seat, or a child or small adult is riding there, the indicator will not come on.

This is because the weight sensors in the seat cannot detect their presence.

Automatic Seat Belt Tensioners

The driver's and passenger's seats are equipped with automatic seat belt tensioners to enhance safety.

The tensioners automatically tighten the seat belts during a moderate-to-severe frontal collision, sometimes even if the collision is not severe enough to inflate the front airbags.

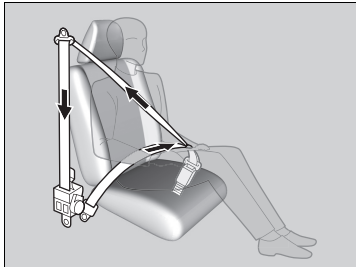

Automatic Seat Belt Tensioners

The seat belt tensioners can only operate once. If a tensioner is activated, the SRS indicator will come on. Have a dealer replace the tensioner and thoroughly inspect the seat belt system as it may not offer protection in a subsequent crash.

Fastening a Seat Belt

After adjusting your seat to the proper position, and while sitting upright and well back in the seat:

▶ [Adjusting the Seats P. 121](#)

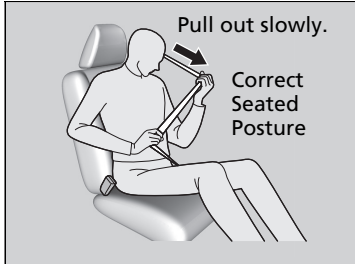

1. Pull the seat belt out slowly.

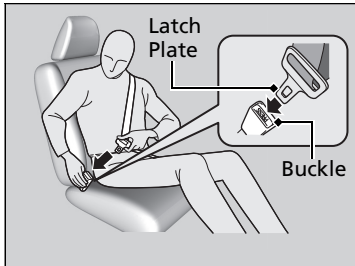

2. Insert the latch plate into the buckle, then tug on the belt to make sure the buckle is secure.

▶ Make sure that the belt is not twisted or caught on anything.

Fastening a Seat Belt

No one should sit in a seat with an inoperative seat belt or one that does not appear to be working correctly. Using a seat belt that is not working properly may not protect the occupant in a crash. Have a dealer check the belt as soon as possible.

Never insert any foreign objects into the buckle or retractor mechanism.

Continued



3. Position the lap part of the belt as low as possible across your hips, then pull up on the shoulder part of the belt so the lap part fits snugly. This lets your strong pelvic bones take the force of a crash and reduces the chance of internal injuries.
4. If necessary, pull up on the belt again to remove any slack, then check that the belt rests across the center of your chest and over your shoulder. This spreads the forces of a crash over the strongest bones in your upper body.

Fastening a Seat Belt

WARNING

Improperly positioning the seat belts can cause serious injury or death in a crash.

Make sure all seat belts are properly positioned before driving.

To release the belt, push the red **PRESS** button then guide the belt by hand until it has retracted completely.

When exiting the vehicle, be sure the belt is out of the way and will not get caught by closing the door.

Advice for Pregnant Women

If you are pregnant, the best way to protect yourself and your unborn child when driving or riding in a vehicle is to always wear a seat belt and keep the lap part of the belt as low as possible across the hips.

Wear the shoulder belt across the chest avoiding the abdomen.



Wear the lap part of the belt as low as possible across the hips.

Advice for Pregnant Women

Each time you have a checkup, ask your doctor if it is okay for you to drive.

To reduce the risk of injuries to both you and your unborn child that can be caused by an inflating front airbag:

- When driving, sit upright and adjust the seat as far back as possible while allowing full control of the vehicle.
- When sitting in the passenger's seat, adjust the seat as far back as possible.

Seat Belt Inspection

Regularly check the condition of your seat belts as follows:

- Pull each belt out fully, and look for frays, cuts, burns, and wear.
- Check that the latches work smoothly and the belts retract easily.
 - ▶ If a belt does not retract easily, cleaning the belt may correct the problem. Only use a mild soap and warm water. Do not use bleach or cleaning solvents. Make sure the belt is completely dry before allowing it to retract.

Any belt that is not in good condition or working properly will not provide proper protection and should be replaced as soon as possible.

A belt that has been worn during a crash may not provide the same level of protection in a subsequent crash. Have your seat belts inspected by a dealer after any collision.

▶▶ Seat Belt Inspection

WARNING

Not checking or maintaining seat belts can result in serious injury or death if the seat belts do not work properly when needed.

Check your seat belts regularly and have any problem corrected as soon as possible.

Airbag System Components

ORG

TOC

Safe Driving

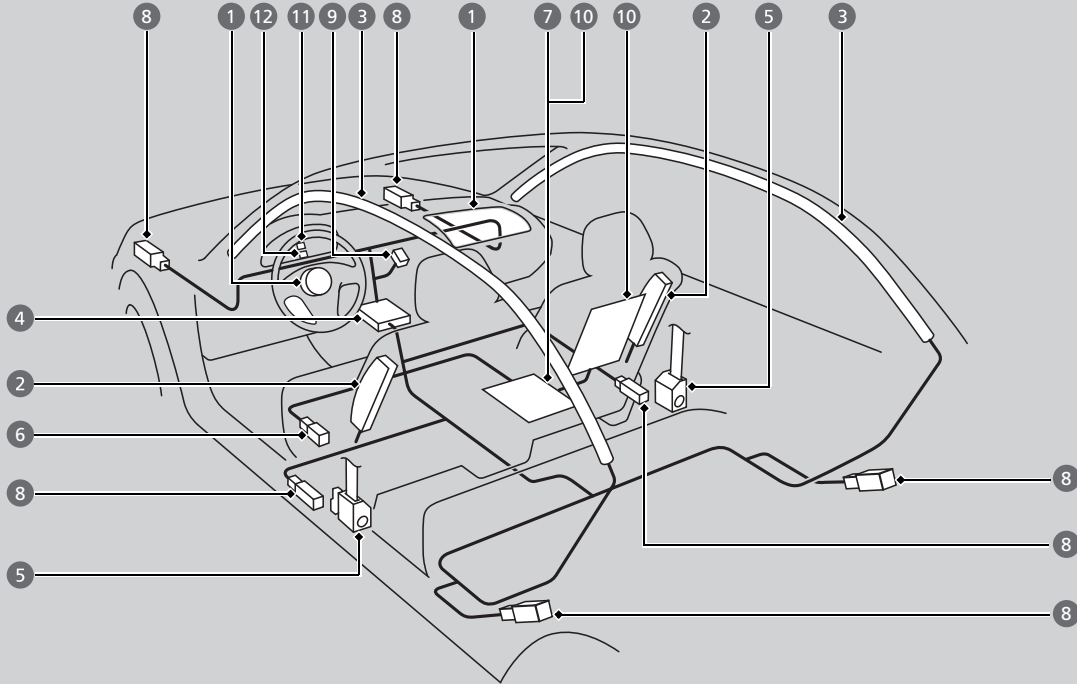

Index

Home

The front, front side, and side curtain airbags are deployed according to the direction and severity of impact. The airbag system includes:

- ① Two SRS (Supplemental Restraint System) front airbags. The driver's airbag is stored in the center of the steering wheel; the passenger's airbag is stored in the dashboard. Both are marked **SRS AIRBAG**.
- ② Two side airbags, one for the driver and one for a passenger. The airbags are stored in the outer edges of the seat-backs. Both are marked **SIDE AIRBAG**.
- ③ Two side curtain airbags, one for each side of the vehicle. The airbags are stored in the ceiling, above the side windows. The front and rear pillars are marked **SIDE CURTAIN AIRBAG**.
- ④ An electronic control unit that continually monitors and records information about the sensors, the airbag activators, the seat belt tensioners, and driver and passenger seat belt use when the ignition switch is in ON **II**.
- ⑤ Automatic seat belt tensioners. The driver's and passenger's seat belts incorporate sensors that detect whether or not they are fastened.
- ⑥ A driver's seat position sensor. If the seat is too far forward, the airbag will inflate with less force.
- ⑦ Weight sensors in the passenger's seat. The passenger's airbag will be turned off if the weight on the seat is 65 lbs (29 kg) or less (the weight of an infant or small child).
- ⑧ Impact sensors that can detect a moderate-to-severe front or side collision.
- ⑨ An indicator on the dashboard that alerts you that the passenger's front airbag has been turned off.
- ⑩ Sensors that can detect if a child or small statured adult is in the deployment path of the passenger's side airbag.
- ⑪ An indicator on the instrument panel that alerts you to a possible problem with your airbag system or seat belt tensioners.
- ⑫ An indicator on the instrument panel that alerts you that the passenger's side airbag has been turned off.

Important Facts about Your Airbags

Airbags can pose serious hazards. To do their job, airbags must inflate with tremendous force. So, while airbags help save lives, they can cause burns, bruises, and other minor injuries, sometimes even fatal ones if occupants are not wearing their seat belts properly and sitting correctly.

What you should do: Always wear your seat belt properly, and sit upright and as far back from the steering wheel as possible while allowing full control of the vehicle. A passenger should move their seat as far back from the dashboard as possible.

Remember, however, that no safety system can prevent all injuries or deaths that can occur in a severe crash, even when seat belts are properly worn and the airbags deploy.

Do not place hard or sharp objects between yourself and a front airbag.

Carrying hard or sharp objects on your lap, or driving with a pipe or other sharp object in your mouth, can result in injuries if your front airbag inflates.

Do not attach or place objects on the front airbag covers. Objects on the covers marked **SRS AIRBAG** could interfere with the proper operation of the airbags or be propelled inside the vehicle and hurt someone if the airbags inflate.

Important Facts about Your Airbags

Do not attempt to deactivate your airbags. Together, airbags and seat belts provide the best protection.

When driving, keep hands and arms out of the deployment path of the front airbag by holding each side of the steering wheel. Do not cross an arm over the airbag cover.

Types of Airbags

Your vehicle is equipped with three types of airbags:

- **Front airbags:** Airbags in front of the driver's and passenger's seats.
- **Side airbags:** Airbags in the driver's and passenger's seat-backs.
- **Side curtain airbags:** Airbags above the side windows.

Each is discussed in the following pages.

Front Airbags (SRS)

The front SRS airbags inflate in a moderate-to-severe frontal collision to help protect the head and chest of the driver and/or passenger.

SRS (Supplemental Restraint System) indicates that the airbags are designed to supplement seat belts, not replace them. Seat belts are the occupant's primary restraint system.

Housing Locations

The front airbags are housed in the center of the steering wheel for the driver, and in the dashboard for the passenger. Both airbags are marked **SRS AIRBAG**.

Types of Airbags

The airbags can inflate whenever the ignition switch is in ON [II].

After an airbag inflates in a crash, you may see a small amount of smoke. This is from the combustion process of the inflator material and is not harmful. People with respiratory problems may experience some temporary discomfort. If this occurs, get out of the vehicle as soon as it is safe to do so.

Front Airbags (SRS)

Dual-Stage, Multiple-Threshold Front Airbags (SRS)

Your vehicle is equipped with dual-stage, multiple-threshold front airbags (SRS).

During a frontal crash severe enough to cause one or both front airbags to deploy, the airbags can inflate at different rates, depending on the severity of the crash, whether or not the seat belts are latched, and/or other factors. Frontal airbags are designed to supplement the seat belts to help reduce the likelihood of head and chest injuries in frontal crashes.

Operation

Front airbags are designed to inflate during moderate-to-severe frontal collisions. When the vehicle decelerates suddenly, the sensors send information to the control unit which signals one or both front airbags to inflate.

A frontal collision can be either head-on or angled between two vehicles, or when a vehicle crashes into a stationary object, such as a concrete wall.

How the Front Airbags Work

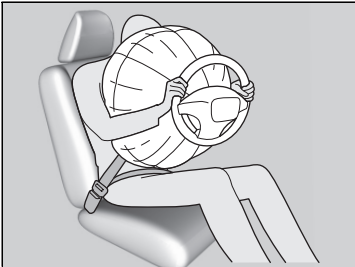

While your seat belt restrains your torso, the front airbag provides supplemental protection for your head and chest.

The front airbags deflate immediately so that they won't interfere with the driver's visibility or the ability to steer or operate other controls.

The total time for inflation and deflation is so fast that most occupants are not aware that the airbags deployed until they see them lying in front of them.

How the Front Airbags Work

Although the driver's and passenger's airbags normally inflate within a split second of each other, it is possible for only one airbag to deploy. This can happen if the severity of a collision is at the margin, or threshold, that determines whether or not the airbags will deploy. In such cases, the seat belt will provide sufficient protection, and the supplemental protection offered by the airbag would be minimal.

■ When front airbags should not deploy

Minor frontal crashes: Front airbags were designed to supplement seat belts and help save lives, not to prevent minor scrapes, or even broken bones that might occur during a less than moderate-to-severe frontal crash.

Side impacts: Front airbags can provide protection when a sudden deceleration causes a driver or passenger to move towards the front of the vehicle. Side airbags and side curtain airbags have been specifically designed to help reduce the severity of injuries that can occur during a moderate-to-severe side impact which can cause the driver or passenger to move towards the side of the vehicle.

Rear impacts: Head restraints and seat belts are your best protection during a rear impact. Front airbags cannot provide any significant protection and are not designed to deploy in such collisions.

Rollovers: Seat belts and, in vehicles equipped with a rollover sensor, side airbags, and side curtain airbags offer the best protection in a rollover. Because front airbags could provide little if any protection, they are not designed to deploy during a rollover.

■ When front airbags deploy with little or no visible damage

Because the airbag system senses sudden deceleration, a strong impact to the vehicle framework or suspension might cause one or more of the airbags to deploy. Examples include running into a curb, the edge of a hole, or other low fixed object that causes a sudden deceleration in the vehicle chassis. Since the impact is underneath the vehicle, damage may not be readily apparent.

■ When front airbags may not deploy, even though exterior damage appears severe

Since crushable body parts absorb crash energy during an impact, the amount of visible damage does not always indicate proper airbag operation. In fact, some collisions can result in severe damage but no airbag deployment because the airbags would not have been needed or would not have provided protection even if they had deployed.

Advanced Airbags

Your front airbags have advanced features to help reduce the likelihood of airbag related injuries to smaller occupants.

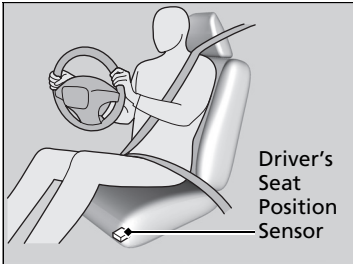

The driver's advanced front airbag system includes a seat position sensor.

If the seat is too far forward, the airbag inflates with less force, regardless of the severity of the impact.

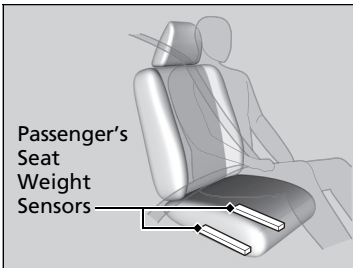

The passenger's advanced front airbag system has weight sensors.

Although Honda recommends against carrying an infant or small child in the passenger seat, if the sensors detect the weight of a child (up to about 65 lbs or 29 kg), the system will automatically turn off the passenger's front airbag.

Advanced Airbags

If there is a problem with the driver's seat position sensor, the SRS indicator will come on and the airbag will inflate with full (normal) force, regardless of the driver's seating position.

For both advanced front airbags to work properly:

- Do not spill any liquid on or under the seats.
- Do not put any object under the passenger's seat.
- Make sure any objects are positioned properly on the floor. Improperly positioned objects can interfere with the advanced airbag sensors.
- All occupants should sit upright and wear their seat belts properly.
- Do not place any cover over the passenger side dashboard.

Side Airbags

The side airbags help protect the upper torso of the driver or a passenger during a moderate-to-severe side impact.

Side Airbags

Do not attach accessories on or near the side airbags. They can interfere with the proper operation of the airbags, or hurt someone if an airbag inflates.

If the impact is on the passenger's side, the airbag may not deploy when there is no passenger in the passenger seat.

Do not cover or replace the seat-back covers without consulting a dealer. Improperly replacing or covering seat-back covers can prevent your side airbags from properly deploying during a side impact.

Housing Locations

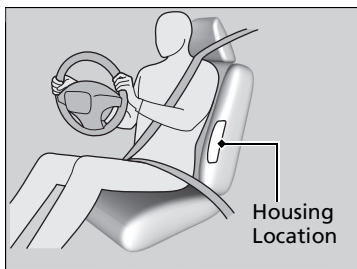

The side airbags are housed in the outside edge of the driver's and passenger's seat- backs.

Both are marked **SIDE AIRBAG**.

Operation

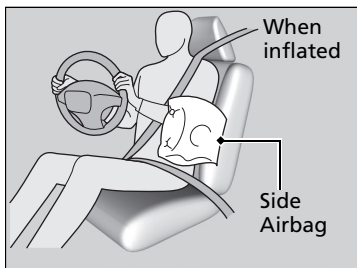

When the sensors detect a moderate-to-severe side impact, the control unit signals the side airbag on the impact side to immediately inflate.

■ When a side airbag deploys with little or no visible damage

Because the airbag system senses sudden acceleration, a strong impact to the side of the vehicle's framework can cause a side airbag to deploy. In such cases, there may be little or no damage, but the side impact sensors detected a severe enough impact to deploy the airbag.

■ When a side airbag may not deploy, even though visible damage appears severe

It is possible for a side airbag to not deploy during an impact that results in apparently severe damage. This can occur when the point of impact was towards the far front or rear of the vehicle, or when the vehicle's crushable body parts absorbed most of the crash energy. In either case, the side airbag would not have been needed nor provided protection even if it had deployed.

Side Airbag Cutoff System

To reduce the likelihood that a passenger may be injured by an inflating side airbag, the passenger side airbag is automatically turned off when:

- The height sensors detect a child or short-statured adult is seated in the passenger seat.
- The position sensor detects that the passenger is leaning into the deployment path of the side airbag.

When the side airbag cutoff system is activated, the side airbag off indicator comes on.

➤ [Side Airbag Off Indicator P. 52](#)

Side Airbag Off Indicator

If the side airbag off indicator comes on, have the passenger sit upright. A few seconds after the passenger is sitting properly, the side airbag will automatically be turned on, and the indicator will go off.

If the passenger is a child, the indicator will remain on so long as the child is seated. Since this vehicle does not have a back seat, we recommend that you do not carry any child who is not large enough and mature enough to ride in front.

Side Airbag Cutoff System

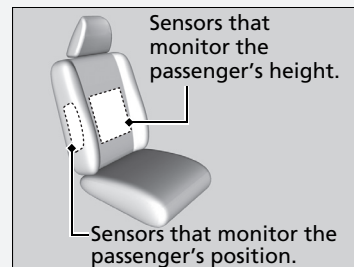

The sensors that monitor the passenger's height and body position may not work if:

- The seat-back is wet
- The passenger is touching a metal or other electrical conductive object
- A seat cushion is on the seat
- The passenger is wearing excessively thick clothing

Side Curtain Airbags

The side curtain airbags help protect the heads of the driver and a passenger during a moderate-to-severe side impact.

Housing Locations

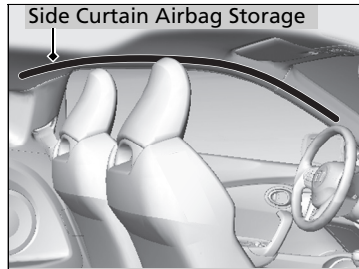

The side curtain airbags are located in the ceiling above the side windows on both sides of the vehicle.

Operation

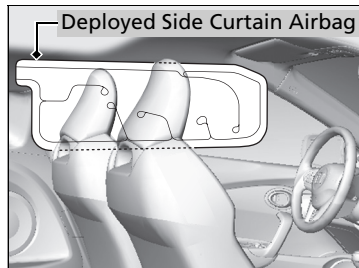

The side curtain airbag is designed to deploy in a moderate-to-severe side impact.

When side curtain airbags deploy in a frontal collision

One or both side curtain airbags may inflate in a moderate-to-severe angled frontal collision.

In this case, the side curtain airbags will deploy slightly after the front airbags.

Side Curtain Airbags

The side curtain airbags are most effective when an occupant is wearing their seat belt properly and sitting upright, well back in their seat.

Do not attach any objects to the side windows or roof pillars as they can interfere with the proper operation of the side curtain airbags.

Airbag System Indicators

If a problem occurs in the airbag system, the SRS indicator will come on and a message appears on the multi-information display.

■ SRS (Supplemental Restraint System) Indicator

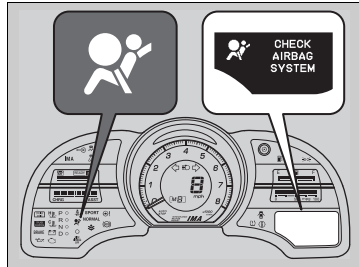

■ When the ignition switch is turned to ON

The indicator comes on for a few seconds, then goes off. This tells you the system is working properly.

If the indicator comes on at any other time, or does not come on at all, have the system checked by a dealer as soon as possible. If you don't, your airbags and seat belt tensioners may not work properly when they are needed.

SRS (Supplemental Restraint System) Indicator

WARNING

Ignoring the SRS indicator can result in serious injury or death if the airbag systems or tensioners do not work properly.

Have your vehicle checked by a dealer as soon as possible if the SRS indicator alerts you to a possible problem.

Passenger Airbag Off Indicator

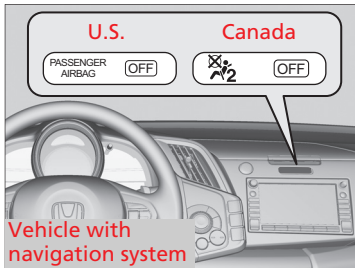
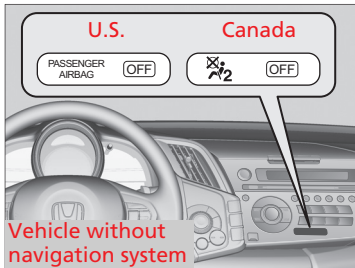

■ When the passenger airbag off indicator comes on

The indicator comes on to alert you that the passenger's front airbag has been turned off. This occurs when the passenger's weight sensors detect 65 lbs (29 kg) or less, the weight of an infant or small child, on the seat.

Your vehicle is not recommended for child passengers. Never put a rear-facing child seat in this vehicle.

If you decided to disregard our recommendations and transport a small child, they should be properly restrained.

▶ [Child Safety P. 54](#)

Objects placed on the seat can also cause the indicator to come on.

If the passenger seat is empty, the passenger's front airbag will not deploy and the indicator will not come on.

▶▶ Passenger Airbag Off Indicator

If the indicator comes on with no passenger and no objects on the passenger's seat, or with an adult riding there, something may be interfering with the weight sensors. Such as:

- An object hanging on the seat.
- An object pressing the rear of the seat-back.
- The seat or seat-back is forced back against cargo on the rear trays or floor behind it.
- An object placed under the passenger's seat.

If none of these conditions exist, have your vehicle checked by a dealer as soon as possible.

The passenger airbag off indicator may come on and goes off repeatedly if the total weight on the seat is near the airbag cutoff threshold.

Side Airbag Off Indicator

When the side airbag off indicator comes on

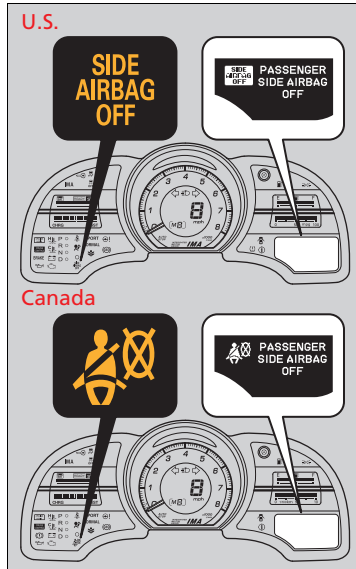

This indicator comes on if the passenger's side airbag has been turned off because the passenger is too small to be sitting in the passenger's seat, is slouching or not sitting upright, or has leaned into the airbag's deployment path.

Unless the passenger is a smaller statured adult or a child, the indicator should go off when the passenger returns to a proper upright sitting position.

Side Airbag Off Indicator

When you turn the ignition switch to ON **(II)**, the indicator should come on for a few seconds and then go out. If it doesn't come on, stays on, or comes on while driving without a passenger in the seat, have the system checked by a dealer as soon as possible.

Airbag Care

You do not need to, and should not, perform any maintenance on or replace any airbag system components yourself. However, you should have your vehicle inspected by a dealer in the following situations:

■ When the airbags have deployed

If an airbag has inflated, the control unit and other related parts must be replaced. Similarly, once an automatic seat belt tensioner has been activated, it must be replaced.

■ When the vehicle has been in a moderate-to-severe collision

Even if the airbags did not inflate, have your dealer inspect the following: the driver's seat position sensor, weight sensors in the passenger's seat, seat belt tensioners, and each seat belt that was worn during the crash.

■ Do not remove or modify a seat without consulting a dealer

This would likely disable the driver's seat position sensor or the weight sensors in the passenger's seat. If it is necessary to remove or modify a seat to accommodate a person with disabilities, contact a Honda dealer, or for U.S. vehicles, American Honda Automobile Customer Service at 800-999-1009 and for Canadian vehicles, Honda Canada Customer Relations at 888-9-HONDA-9.

✘ Airbag Care

We recommend against the use of salvaged airbag system components, including the airbag, tensioners, sensors, and control unit.

Protecting Child Passengers

Each year, many children are injured or killed in vehicle crashes because they are either unrestrained or not properly restrained. In fact, vehicle accidents are the number one cause of death of children age 12 and under.

To reduce the number of child deaths and injuries, every state, Canadian province and territory requires that children be properly restrained when they ride in a vehicle.

Since this vehicle does not have a back seat, Honda recommends that you do not carry a child, age 12 or under, as a passenger. This is because:

- An inflating front or side airbag can injure or kill a child sitting in the passenger's seat .
- A child in the passenger's seat is more likely to interfere with the driver's ability to safely control the vehicle.
- Statistics show that children of all sizes and ages are safer when they are properly restrained in a rear seat. Because this vehicle does not have a rear seat, we recommend that you do not carry a child aged 12 or under in this vehicle.

Protecting Child Passengers

WARNING

Children who are unrestrained or improperly restrained can be seriously injured or killed in a crash.

Any child too small for a seat belt should be properly restrained in a child seat. A larger child should be properly restrained with a seat belt, using a booster seat if necessary.

The National Highway Traffic Safety Administration and Transport Canada recommend that all children age 12 and under be properly restrained in a rear seat. Some states or provinces/territories have laws restricting where children may ride.

Never put a rear-facing child seat in this vehicle.

- Any child who is too small to wear a seat belt correctly must be restrained in an approved child seat that is properly secured to the vehicle using the lap belt portion of the lap/shoulder belt.
- Never hold a child on your lap because it is impossible to protect them in the event of a collision.
- Never put a seat belt over yourself and a child. During a crash, the belt would likely press deep into the child and cause serious or fatal injuries.
- Never let two children use the same seat belt. Both children could be very seriously injured in a crash.
- Do not allow children to operate the doors, windows or seat adjustments.
- Do not leave children in the vehicle unattended, especially in hot weather when the inside of the vehicle can get hot enough to kill them. They could also activate vehicle controls causing it to move unexpectedly.

Protecting Child Passengers

⚠ WARNING

Allowing a child to play with a seat belt or wrap one around their neck can result in serious injury or death.

Instruct children not to play with any seat belt and make sure any unused seat belt a child can reach is buckled, fully retracted, and locked.

To deactivate a lockable retractor, release the buckle and allow the seat belt to wind up all the way.

To remind you of the passenger's front airbag hazards and child safety, your vehicle has warning labels on the dashboard (U.S. models) and on the front visors. Please read and follow the instructions on these labels.

[➤ Safety Labels P. 63](#)

Safety of Infants and Small Children

Protecting Infants

An infant must be properly restrained in a rear-facing, reclining child seat until the infant reaches the seat maker's weight or height limit for the seat, and the infant is at least one year old. **Because rear-facing child seats should not be used in this vehicle, you should never carry an infant in this vehicle.**

Protecting Infants

WARNING

Placing a rear-facing child seat in the passenger's seat can result in serious injury or death during a crash.

Never install a rear-facing child seat in this vehicle.

Rear-facing child seats should never be installed in a forward facing position.

Protecting Smaller Children

Since this vehicle does not have a back seat, Honda recommends that you do not carry a child, age 12 or under, as a passenger.

This is because placing a forward-facing child seat in the passenger's seat can be hazardous, even with advanced front airbags that automatically turn the passenger's front airbag off.

If you choose to ignore our warnings and transport a small child in this vehicle, be sure to move the passenger seat as far to the rear as possible, and follow the instructions and guidelines in the following pages.

Selecting a Forward-facing Child Seat

Important consideration when selecting a child seat

Make sure the child seat meets the following three requirements:

- The child seat is the correct type and size for the child.
- The child seat is the correct type for the seating position.
- The child seat is compliant with Federal Motor Vehicle Safety Standard 213 or Canadian Motor Vehicle Safety Standard 213.

Protecting Smaller Children

⚠ WARNING

Placing a forward-facing child seat in the passenger's seat can result in serious injury or death if the front airbag inflates.

If you must place a forward-facing child seat in the passenger's seat, move the vehicle seat as far back as possible, and properly restrain the child.

Educate yourself about the laws and regulations regarding child seat use where you are driving, and follow the child seat manufacturer's instructions.

All child seats must be secured to the vehicle with the lap part of a lap/shoulder belt. A child whose seat is not properly secured to the vehicle can be endangered in a crash.

■ Installing a Child Seat

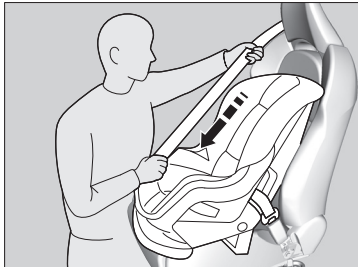
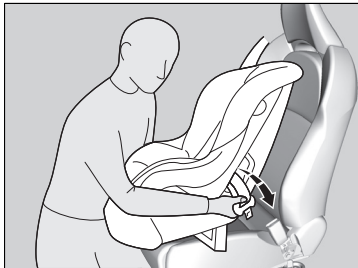

1. Move the passenger seat to the rearmost position.
2. Place the child seat on the passenger seat.
3. Route the seat belt through the child seat according to the seat maker's instructions, and insert the latch plate into the buckle.
 - ▶ Insert the latch plate fully until it clicks.
4. Slowly pull the shoulder part of the belt all the way out until it stops. This activates the lockable retractor.
5. Let the seat belt completely wind up into the retractor, then try to pull it out to make sure the retractor is locked.
 - ▶ If you are able to pull the shoulder belt out, the lockable retractor is not activated. Pull the seat belt all the way out, and repeat steps 3 – 5.
6. Grab the shoulder part of the seat belt near the buckle, and pull up to remove any slack from the lap part of the belt.
 - ▶ When doing this, place your weight on the child seat and push it into the vehicle seat.

☒ Installing a Child Seat

All child seats must be secured to the vehicle with the lap part of a lap/shoulder belt.

For your child's safety, when using a child seat installed using the vehicle's seat belt system, check that the seat is properly secured to the vehicle.

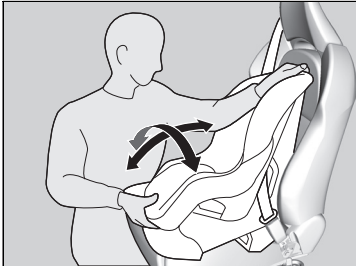

7. Make sure the child seat is firmly secured by rocking it forward and back and side to side; little movement should be felt.

■ Adding Security with a Tether

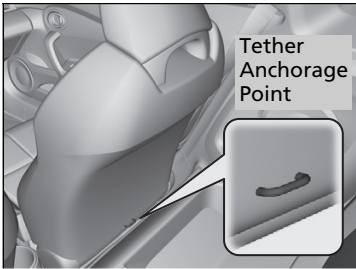

A tether anchorage point is provided behind the passenger seat. A child seat with a tether can be installed, so long as the base of the child seat is secured using a seat belt.

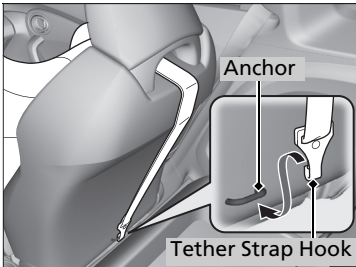

1. Route the tether strap through the head restraint legs. Make sure the strap is not twisted.
2. Secure the tether strap hook onto the anchor.
3. Tighten the tether strap as instructed by the child seat manufacturer.

▣ Installing a Child Seat

A child seat that is not properly secured will not adequately protect a child in a crash and may cause injury to the child or another vehicle occupant.

To deactivate a lockable retractor, release the buckle and allow the seat belt to wind up all the way.

▣ Adding Security with a Tether

Since a tether can provide additional security to the lap/shoulder seat belt installation, we recommend using a tether whenever one is available.

Safety of Larger Children

■ Protecting Larger Children

Since this vehicle does not have a back seat, Honda recommends that you do not carry a child age 12 or under as a passenger. This is because children who have outgrown child seats are also at risk of being injured or killed by an inflating passenger's front airbag. If a larger child must ride in this vehicle, the information in the following pages provides guidelines to help you decide when a given child may ride in this vehicle, and how to properly protect the child.

■ Checking Seat Belt Fit

When a child is too big for a child seat, secure the child in the passenger's seat using the lap/shoulder seat belt. Have the child sit upright and all the way back, then answer the following questions.



■ Checklist

- Do the child's knees bend comfortably over the edge of the seat?
- Does the shoulder belt cross between the child's neck and arm?
- Is the lap part of the seat belt as low as possible, touching the child's thighs?
- Will the child be able to stay seated like this for the whole trip?

If you answer yes to all these questions, the child is ready to wear the lap/shoulder seat belt correctly. If you answer no to any question, the child needs to ride on a booster seat until the seat belt fits properly without a booster seat.

▶ Safety of Larger Children

⚠ WARNING

Allowing a child age 12 or under to sit in the vehicle can result in injury or death if the passenger's front airbag inflates.

If a larger child must ride in the vehicle, move the vehicle seat as far to the rear as possible, have the child sit up properly and wear the seat belt properly, using a booster seat if needed.

Booster Seats

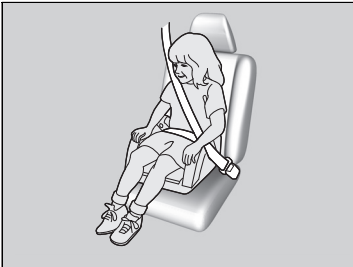

If a lap/shoulder seat belt cannot be used properly, position the child in a booster seat in the passenger's seating position. For the child's safety, check that the child meets the booster seat manufacturer's recommendations.

Protecting Larger Children-Final Checks

If you decide that a child can safely ride in this vehicle, be sure that:

- Make sure you read and fully understand the instructions and safety information in this manual.
- Move the passenger seat as far back as possible.
- Have the child sit upright and well back in the seat.
- Check that the seat belt is properly positioned so that the child is secure in the seat.

Monitoring a child passenger

We strongly recommend that you keep an eye on a child passenger. Even older, more mature children sometimes need to be reminded to fasten their seat belts and sit up properly.

Booster Seats

When installing a booster seat, make sure to read the instructions that came with it, and install the seat accordingly.

There are high- and low-type booster seats. Choose a booster seat that allows the child to wear the seat belt correctly.

Some U.S. states and Canadian provinces and territories require children to use a booster seat until they reach a given age or weight (e.g. 6 years or 60 lbs). Be sure to check current laws in the state or province, or territory where you intend to drive.

Carbon Monoxide Gas

The engine exhaust from this vehicle contains carbon monoxide, a colorless, odorless, and highly toxic gas. As long as you properly maintain your vehicle, carbon monoxide gas will not get into the interior.

■ Have the exhaust system inspected for leaks whenever

- The exhaust system is making an unusual noise.
- The exhaust system may have been damaged.
- The vehicle is raised for an oil change.

When you operate a vehicle with the hatch open, airflow can pull exhaust gas into the interior and create a hazardous condition. If you must drive with the hatch open, open both windows and set the climate control system as shown below.

1. Select the fresh air mode.
2. Select the  mode.
3. Set the fan speed to high.
4. Set the temperature control to a comfortable setting.

Adjust the climate control system in the same manner if you sit in your parked vehicle with the engine running.

Carbon Monoxide Gas

WARNING

Carbon monoxide gas is toxic. Breathing it can cause unconsciousness and even kill you.

Avoid any enclosed areas or activities that expose you to carbon monoxide.

An enclosed area such as a garage can quickly fill up with carbon monoxide gas. Do not run the engine with the garage door closed. Even when the garage door is open, drive out of the garage immediately after starting the engine.

Label Locations

These labels are in the locations shown. They warn you of potential hazards that can cause serious injury or death. Read these labels carefully.

If a label comes off or becomes hard to read (except for the U.S. dashboard label which may be removed by the owner), contact a dealer for a replacement.

Sun Visor

U.S. models

WARNING

EVEN WITH ADVANCED AIR BAGS

- Children can be killed or seriously injured by the air bag.
- Always use the proper seating for children.
- Never put a rear-facing child seat in the front.
- Always use seat belts and child restraints.
- See owner's manual for more information about air bags.

Canadian models

CAUTION

TO AVOID SERIOUS INJURY:

- FOR MAXIMUM SAFETY PROTECTION IN ALL TYPES OF CRASHES YOU MUST ALWAYS WEAR YOUR SAFETY BELT.
- DO NOT INSTALL REARWARD-FACING CHILD SEATS IN ANY FRONT PASSENGER SEAT POSITION.
- DO NOT SIT OR LEAN UNNECESSARILY CLOSE TO THE AIR BAG.
- DO NOT PLACE ANY OBJECTS OVER THE AIR BAG OR BETWEEN THE AIR BAG AND YOURSELF.
- SEE THE OWNER'S MANUAL FOR FURTHER INFORMATION AND EXPLANATIONS.

PRECAUTIONS:

POUR ÉVITER DES BLESSURES GRAVES:

- POUR PROFITER D'UNE PROTECTION MAXIMALE LORS D'UNE COLLISION BOUCLEZ TOUJOURS VOTRE CEINTURE DE SÉCURITÉ.
- N'INSTALLEZ JAMAIS UN SIÈGE POUR ENFANTS FAISANT FACE À L'ARRIÈRE SUR LE SIÈGE DU PASSAGER AVANT.
- NE VOUS APPUYEZ PAS ET NE VOUS ASSOYEZ PAS PRES DU COUSSIN GONFLABLE.
- NE DÉPOSEZ AUCUN OBJET SUR LE COUSSIN GONFLABLE ET VOUS.
- LISEZ LE GUIDE UTILISATEUR POUR DE PLUS AMPLES RENSEIGNEMENTS.

Separator

U.S. models

WARNING

This vehicle is not equipped with rear seats or seatbelts. Sitting in this area may result in injury or death, and may violate state laws. Only the driver and one front seat passenger may be safely seated in this vehicle.

Canadian models

WARNING

Ce véhicule n'est pas équipé de siège arrière ni de ceinture de sécurité arrière. S'asseoir dans cette zone peut causer des blessures sérieuses ou mortelles et/ou enfreindre des lois provinciales. Seuls le conducteur et le passager avant et un siège du passager peuvent être assés dans ce véhicule en sécurité.

AVERTISSEMENT

Ce véhicule n'est pas équipé de siège arrière ni de ceinture de sécurité arrière. S'asseoir dans cette zone peut causer des blessures sérieuses ou mortelles et/ou enfreindre des lois provinciales. Seuls le conducteur et le passager avant et un siège du passager peuvent être assés dans ce véhicule en sécurité.

Cargo Area

U.S. models

DANGER

HIGH VOLTAGE
You will be killed or hurt.

Before servicing:

- Always ignition key and shut off main switch.
- Check voltage at junction board terminal.
- Always wear eye shield and use the correct tools.
- Caution, read and follow service manual instructions.

Canadian models

DANGER	HAUTE TENSION
HIGH VOLTAGE You will be killed or hurt.	HAUTE TENSION Danger de blessures ou de mort.
Before servicing:	Avant le service:
Always ignition key and shut off main switch.	Toujours la clé sur le contact et fermer l'interrupteur principal.
Check voltage at junction board terminal.	Vérifier la tension à la borne des bornes de jonction.
Always wear eye shield and use the correct tools.	Toujours porter des lunettes de protection et utiliser les outils adéquats.
Caution, read and follow service manual instructions.	Attention, lisez et suivez les instructions du Manuel du propriétaire.

Dashboard

U.S. models only

This Vehicle is Equipped with Advanced Air Bags

Even with Advanced Air Bags

Children can be killed or seriously injured by the air bag. The back seat is the safest place for children. Never put a rear-facing child seat in the front. Always use seat belts and child restraints. See owner's manual for more information about air bags.

(to be removed by owner only)

Radiator Cap

DANGER
WARNING
危險 警告

▶ NEVER OPEN WHEN HOT. Hot coolant will scald you.
▶ N'ouvrez pas quand chaud. Le liquide refroidissant peut vous brûler.
▶ DO NOT REBRESSURE MOTOR OPERATOR.
▶ NE REBRESSUREZ PAS LE MOTEUR.

1.1

Doorjamb

U.S. models

SIDE AIRBAG

- This car is equipped with side airbags in the front seats and side curtain airbags.
- Do not lean against the door.
- See owner's manual for more information.

Canadian models

SIDE AIRBAG

- This car is equipped with side airbags in the front seats and side curtain airbags.
- Do not lean against the door.
- See owner's manual for more information.

COUSSIN GONFLABLE LATÉRAL



- Cette automobile est équipée de coussins portables latéraux dans les sièges avant ainsi que de coussins gonflables latéraux de type rideau.
- Né vous appuyez pas sur la porte.
- Consultez le Manuel du propriétaire pour en savoir plus.



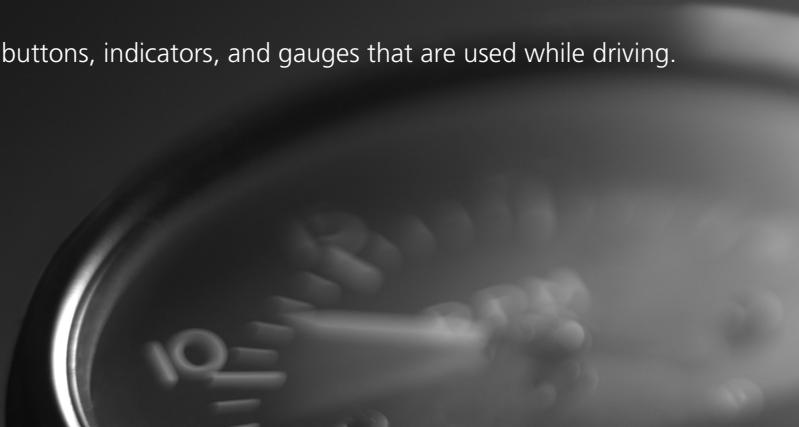

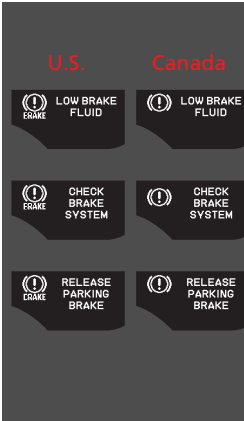

Instrument Panel

This chapter describes the buttons, indicators, and gauges that are used while driving.















- Indicators** 66
 - Multi-Information Display Warning and Information Messages..... 78
- Gauges and Multi-Information Display**
 - Gauges..... 81
 - Multi-Information Display 83









Indicator	Name	On/Blinking	Explanation	Message
	Parking Brake and Brake System Indicator (Red)	<ul style="list-style-type: none"> Comes on for a few seconds when you turn the ignition switch to ON [II], then goes off. Comes on when the parking brake is applied, and goes off when it is released. Comes on when the brake fluid level is low. Comes on if there is a problem with the brake system. The beeper sounds and the indicator comes on if you drive with the parking brake not fully released. 	<ul style="list-style-type: none"> Comes on while driving - Make sure the parking brake is released. Check the brake fluid level. <ul style="list-style-type: none"> ➤ What to do when the indicator comes on while driving P. 295 Comes on along with the ABS indicator - Have the vehicle checked by a dealer. <ul style="list-style-type: none"> ➤ If the Brake System Indicator (Red) Comes On P. 295 	
	Low Oil Pressure Indicator	<ul style="list-style-type: none"> Comes on when you turn the ignition switch to ON [II], and goes off when the engine starts. Comes on when the engine oil pressure is low. 	<ul style="list-style-type: none"> Comes on while driving - Immediately stop in a safe place. <ul style="list-style-type: none"> ➤ If the Low Oil Pressure Indicator Comes On P. 292 	





Indicator	Name	On/Blinking	Explanation	Message
	Malfunction Indicator Lamp	<ul style="list-style-type: none"> • Comes on when you turn the ignition switch to ON II, and goes off either when the engine starts or after several seconds if the engine is not started. If “readiness codes” have not been set, it blinks five times before it goes off. • Comes on if there is a problem with the emissions control system. • Blinks when a misfire in the engine’s cylinders is detected. 	<ul style="list-style-type: none"> • Readiness codes are part of the on board diagnostics for the emissions control systems. ► Testing of Readiness Codes P. 311 • Comes on while driving - Have the vehicle checked by a dealer. • Blinks while driving - Stop in a safe place where there are no flammable objects. Stop the engine for 10 minutes or more, and wait for it to cool down. Then, take the vehicle to a dealer. ► If the Malfunction Indicator Lamp Comes On or Blinks P. 294 	
	12 Volt Battery Charging System Indicator	<ul style="list-style-type: none"> • Comes on when you turn the ignition switch to ON II, and goes off when the engine starts. • Comes on when the 12 volt battery is not charging. 	<ul style="list-style-type: none"> • Comes on while driving - Turn off the climate control system and rear defogger in order to reduce electricity consumption. ► If the Charging System Indicator Comes On P. 293 	
	Transmission Indicator*	<ul style="list-style-type: none"> • Comes on for a few seconds when you turn the ignition switch to ON II, then goes off. • Blinks if the transmission system has a problem. 	<ul style="list-style-type: none"> • Blinks while driving - Avoid sudden starts and acceleration and have the vehicle checked by a dealer immediately. 	

* Not available on all models













Indicator	Name	On/Blinking	Explanation	Message
	Seat Belt Reminder Indicator	<ul style="list-style-type: none"> • Comes on and the beeper sounds if you are not wearing a seat belt when you turn the ignition switch to ON . • If the passenger is not wearing a seat belt, the indicator comes on about a few seconds later. • Blinks while driving if either you or your passenger has not fastened a seat belt. The beeper sounds and the indicator blinks at regular intervals. 	<ul style="list-style-type: none"> • The beeper stops and the indicator goes off when you and your passenger fasten your seat belts. • Stays on after you or your passenger has fastened the seat belt - A detection error may have occurred in the sensor. Have the vehicle checked by a dealer.  Seat Belt Reminder P. 33 	
	Low Fuel Indicator	<ul style="list-style-type: none"> • Comes on when the fuel reserve is running low (approximately 1.8 U.S. gal./6.9 Liter left). • Blinks if there is a problem with the fuel gauge. 	<ul style="list-style-type: none"> • Comes on - Refuel your vehicle as soon as possible. • Blinks - Have the vehicle checked by a dealer. 	







Indicator	Name	On/Blinking	Explanation	Message
	ABS (Anti-lock Brake System) Indicator	<ul style="list-style-type: none"> Comes on for a few seconds when you turn the ignition switch to ON II, then goes off. If it comes on at any other time, there is a problem with the ABS. 	<ul style="list-style-type: none"> Stays on constantly - Have the vehicle checked by a dealer. With this indicator on, your vehicle still has normal braking ability but no anti-lock function. ► ABS (Anti-lock Brake System) P. 210 	
	Supplemental Restraint System Indicator	<ul style="list-style-type: none"> Comes on for a few seconds when you turn the ignition switch to ON II, then goes off. Comes on if a problem with any of the following is detected: <ul style="list-style-type: none"> - Supplemental restraint system - Side airbag system - Side curtain airbag system - Seat belt tensioner 	<ul style="list-style-type: none"> Stays on constantly or does not come on at all - Have the vehicle checked by a dealer. 	
	Door/Hatch Open Indicator	<ul style="list-style-type: none"> Comes on for a few seconds if you turn the ignition switch to ON II, then goes off. Comes on if the hatch or either door is not completely closed. The beeper sounds and the indicator comes on if the hatch or either door is opened while driving. 	<ul style="list-style-type: none"> Goes off when both doors and the hatch are closed. 	





Indicator	Name	On/Blinking	Explanation	Message
	VSA® (Vehicle Stability Assist) System Indicator	<ul style="list-style-type: none"> • Comes on for a few seconds when you turn the ignition switch to ON , then goes off. • Blinks when VSA® is active. • Comes on if there is a problem with the VSA® system. • Comes on if there is a problem with the hill start assist system. • Comes on if there is a problem with the creep aid system (CVT) or the brake assist system. 	<ul style="list-style-type: none"> • Stays on constantly - Have the vehicle checked by a dealer.  VSA® (Vehicle Stability Assist), aka ESC (Electronic Stability Control), System P. 203 	 
	VSA® (Vehicle Stability Assist) OFF Indicator	<ul style="list-style-type: none"> • Comes on for a few seconds when you turn the ignition switch to ON , then goes off. • Comes on when you deactivate VSA®. 	 VSA® On and Off P. 204	—

Indicator	Name	On/Blinking	Explanation	Message
	EPS (Electric Power Steering) System Indicator	<ul style="list-style-type: none"> Comes on when you turn the ignition switch to ON II, and goes off when the engine starts. Comes on if there is a problem with the EPS (Electric Power Steering) System. 	<ul style="list-style-type: none"> Stays on constantly or does not come on at all - Have the vehicle checked by a dealer. ► If the EPS System Indicator Comes On P. 295 	
<p>U.S. models only</p> 	Low Tire Pressure/TPMS Indicator	<ul style="list-style-type: none"> Comes on for a few seconds when you turn the ignition switch to ON II. Comes on if the tire pressure of any of the tires becomes significantly low. Blinks for about one minute, and then stays on if there is a problem with the TPMS, or when a compact spare tire* is temporarily installed. 	<ul style="list-style-type: none"> Comes on while driving - Stop in a safe place, check tire pressures, and inflate the tire(s) if necessary. Blinks and remains on - Have the vehicle checked by a dealer. If the vehicle is fitted with a compact spare, get your regular tire repaired or replaced and put back on your vehicle as soon as you can. 	 















* Not available on all models

Indicator	Name	On/Blinking	Explanation	Message
	<p>High Temperature Indicator</p>	<ul style="list-style-type: none"> • Comes on for a few seconds when you turn the ignition switch to ON . • Blinks when the engine coolant temperature goes up, and stays on if the temperature continues to rise. 	<ul style="list-style-type: none"> • Blinks while driving - Drive slowly to prevent overheating. • Stays on while driving - Immediately stop in a safe place and allow the engine to cool.  Overheating P. 290 	
	<p>IMA System Indicator</p>	<ul style="list-style-type: none"> • Comes on for a few seconds when you turn the ignition switch to ON . • Comes on if there is a problem with the IMA system. 	<ul style="list-style-type: none"> • Remains on or does not come on at all - Avoid high speed driving and have the vehicle checked by a dealer as soon as possible.  If the IMA Indicator Comes On P. 296 	
	<p>System Message Indicator</p>	<ul style="list-style-type: none"> • Comes on for a few seconds when you turn the ignition switch to ON , then goes off. • Comes on along with a beep when a problem is detected. A system message on the multi-information display appears at the same time. 	<ul style="list-style-type: none"> • While the indicator is on, press the  (information) button to see the message again. • Refer to the Indicators information in this chapter when a system message appears on the multi-information display. Take the appropriate action for the message. • The multi-information display does not return to the normal screen unless the warning is canceled, or the  button is pressed. 	

Indicator	Name	On/Blinking	Explanation	Message
	Low Temperature Indicator	<ul style="list-style-type: none"> Comes on for a few seconds when you turn the ignition switch to ON . Comes on when the engine coolant temperature is low. 	<ul style="list-style-type: none"> If the indicator stays on after the engine has reached normal operating temperature, there may be a problem with the temperature sensors. Have the vehicle inspected by a dealer. 	—
	Side Airbag Off Indicator	<ul style="list-style-type: none"> Comes on for a few seconds when you turn the ignition switch to ON , then goes off. Comes on when the passenger side airbag system is automatically shut off. 	<ul style="list-style-type: none"> It does not mean there is a problem with your side airbags. Comes on when nobody is sitting in the passenger seat - Have the vehicle checked by a dealer. Comes on when someone is sitting in the seat - Have the passenger sit properly. 	 
	High Beam Indicator	<ul style="list-style-type: none"> Comes on when the high beam headlights are on. 	—	—

Indicator	Name	On/Blinking	Explanation	Message
	Turn Signal and Hazard Warning Indicators	<ul style="list-style-type: none"> The turn signal indicators blink when you operate the turn signal lever. If you press the hazard warning button, both indicators and all turn signals blink at the same time. 	<ul style="list-style-type: none"> Does not blink or blinks rapidly - A turn signal light bulb has blown. Change the bulb immediately. ▶ Replacing Light Bulbs P. 246 P. 247 	—
	Lights On Indicator	<ul style="list-style-type: none"> Comes on whenever the light switch is on, or in AUTO* when the exterior lights are on. 	<ul style="list-style-type: none"> If you remove the key from the ignition switch while the lights are on, a chime sounds when the driver's door is opened. 	—
	Fog Light Indicator*	<ul style="list-style-type: none"> Comes on when the fog lights are on. 	—	—
	Shift Lever Position Indicator*	<ul style="list-style-type: none"> Indicates in which position your shift lever is. 	▶ Shifting P. 183	—
	M (7-speed manual shift mode) Indicator/Shift Indicator*	<ul style="list-style-type: none"> Comes on when the 7-speed manual shift mode is applied. 	▶ 7-Speed Manual Shift Mode P. 185	—

Indicator	Name	On/Blinking	Explanation	Message
	Immobilizer System Indicator	<ul style="list-style-type: none"> Comes on briefly when you turn the ignition switch to ON II, then goes off. Comes on if the immobilizer system cannot recognize the key information. 	<ul style="list-style-type: none"> Blinks - You cannot start the engine. Turn the ignition switch to LOCK 0, pull the key out, and then insert the key and turn it to ON II again. Repeatedly blinks - The system may be malfunctioning. Have the vehicle checked by a dealer. Do not attempt to alter this system or add other devices to it. Electrical problems can occur. 	—
	Security System Alarm Indicator	<ul style="list-style-type: none"> Blinks when the Security System Alarm has been set. 	<p>➤ Security System Alarm P. 106</p>	—
	CRUISE MAIN Indicator	<ul style="list-style-type: none"> Comes on when you press the CRUISE button. 	<p>➤ Cruise Control P. 200</p>	—
	CRUISE CONTROL Indicator	<ul style="list-style-type: none"> Comes on if you have set a speed for cruise control. 	<p>➤ Cruise Control P. 200</p>	—
	Auto Idle Stop Indicator	<ul style="list-style-type: none"> Blinks when Auto Idle Stop is in operation. The engine automatically shuts off. 	<p>➤ Auto Idle Stop P. 191 P. 194</p>	—







Indicator	Name	On/Blinking	Explanation	Message
	Shift Up Indicator* ¹	<ul style="list-style-type: none"> Comes on briefly when you turn the ignition switch to ON . Comes on when shifting up is recommended. 	<p>▶ Shift Up/Down Indicators P. 189</p>	
	Shift Down Indicator* ¹	<ul style="list-style-type: none"> Comes on briefly when you turn the ignition switch to ON . Comes on when shifting down is recommended. 		
	SPORT Mode Indicator* ¹	<ul style="list-style-type: none"> Comes on for a few seconds when you turn the ignition switch to ON . Comes on when you press the SPORT mode button. 	<p>▶ 3-Mode Drive System P. 197</p>	
	NORMAL Mode Indicator* ¹	<ul style="list-style-type: none"> Comes on for a few seconds when you turn the ignition switch to ON . Comes on when you press the NORMAL mode button. 	<p>▶ 3-Mode Drive System P. 197</p>	
	ECON Mode Indicator* ¹	<ul style="list-style-type: none"> Comes on for a few seconds when you turn the ignition switch to ON . Comes on when you press the ECON mode button. 	<p>▶ 3-Mode Drive System P. 197</p>	



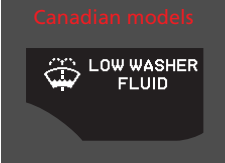

*1: The driving mode message on the multi-information display appears for a few seconds when you press the appropriate mode button.

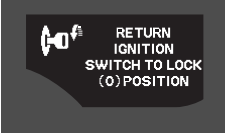
Indicator	Name	On/Blinking	Explanation	Message
	Plus Sport System Indicator	<ul style="list-style-type: none"> Comes on while certain conditions that can activate the Plus Sport System are met. 	➤ Plus Sport System P. 198	—
	Plus Sport READY Indicator	<ul style="list-style-type: none"> Comes on when the Plus Sport System is available. Stays on when the Plus Sport System stands by to be activated. Goes off when the system is in operation. 	➤ Plus Sport System P. 198	—
	Plus Sport Indicator	<ul style="list-style-type: none"> Comes on when the Plus Sport System is available. Blinks by pressing the S+ (Plus Sport) button when the Plus Sport System stands by to be activated. Blinks while the Plus Sport System is in operation. 	➤ Plus Sport System P. 198	—

Multi-Information Display Warning and Information Messages

The following messages appear only on the multi-information display. Press the  (information) button to see the message again with the system message indicator on.

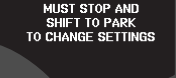
Message	Condition	Explanation
	<ul style="list-style-type: none"> Appears when the fuel fill cap is loose or is not installed. 	<p>➤ Tighten Fuel Cap Message P. 294</p>
	<ul style="list-style-type: none"> Appears if there is a problem with the DRL system. 	<ul style="list-style-type: none"> Have your vehicle checked by a dealer. <p>➤ Daytime Running Lights P. 113</p>
<p>Canadian models</p> 	<ul style="list-style-type: none"> Appears when the washer fluid is low. 	<ul style="list-style-type: none"> Refill washer fluid. <p>➤ Refilling Window Washer Fluid P. 241</p>
	<ul style="list-style-type: none"> Appears when the scheduled maintenance is due soon. Consequently, SERVICE DUE NOW and SERVICE PAST DUE follow. 	<p>➤ Maintenance Minder Messages on the Multi-Information Display P. 225</p>
	<ul style="list-style-type: none"> Appears when you open the driver's door while the ignition key is in ACCESSORY . 	<ul style="list-style-type: none"> Turn the ignition switch to LOCK , then remove the key.

Message	Condition	Explanation
 <p>ACCESSORY (I) POSITION</p>	<ul style="list-style-type: none"> Appears when the ignition key is turned to ACCESSORY I from ON II. (The driver's door is closed.) 	—
 <p>REMOVE KEY</p>	<ul style="list-style-type: none"> Appears when you open the driver's door while the ignition key is in LOCK 0. 	<ul style="list-style-type: none"> Remove the key from the ignition switch.
 <p>KEEP DRIVING TO CHARGE HYBRID BATTERY</p>	<ul style="list-style-type: none"> Appears when the IMA battery is significantly low. 	<ul style="list-style-type: none"> Drive continuously or, if necessary, allow the vehicle to idle in an open area until the message disappears.
 <p>MUST STOP AND SHIFT TO PARK TO CHANGE SETTINGS</p>  <p>MUST STOP AND SET PARK BRAKE TO CHANGE SETTINGS</p>	<ul style="list-style-type: none"> Appears while you are customizing the settings for the following reasons: <ul style="list-style-type: none"> Automatic transmission (CVT) models The shift lever is moved out of P. Manual transmission models The parking brake is released. 	<p>▶ How to customize P. 90</p>

Manual transmission models

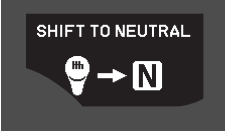
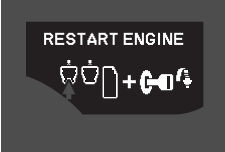
Message	Condition	Explanation
	<ul style="list-style-type: none"> Appears if the clutch pedal is not fully depressed while the Auto Idle Stop is in operation, and the engine is ready to restart. 	<ul style="list-style-type: none"> Fully depress the clutch pedal. <ul style="list-style-type: none"> Auto Idle Stop P. 194
	<ul style="list-style-type: none"> Appears when the shift lever is in any forward gear position, and the Auto Idle Stop operating time has continued for a while. 	<ul style="list-style-type: none"> Shift to N. <ul style="list-style-type: none"> Auto Idle Stop P. 194
	<ul style="list-style-type: none"> Appears when the engine does not automatically restart for the following reasons while the Auto Idle Stop is in operation. <ul style="list-style-type: none"> The IMA battery charge is low. There is a problem with the system. 	<ul style="list-style-type: none"> Manually start the engine. <ul style="list-style-type: none"> Starting the Engine P. 178

Gauges

Gauges include the speedometer, tachometer, fuel gauge, and related indicators. They are displayed when the ignition switch is in ON **[II]**.

Speedometer

Displays your driving speed in mph or km/h.

Tachometer

Shows the number of engine revolutions per minute.

Fuel Gauge

Displays the amount of fuel left in the fuel tank.

Instant Fuel Economy Gauge

Shows the instant fuel economy as a bar graph in mpg or l/100km.

⌘ Gauges

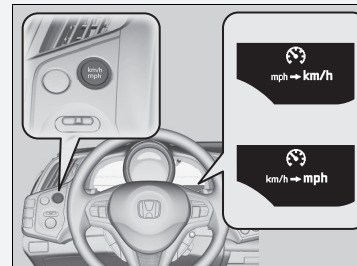

Press and hold the **km/h/mph** change button until you hear a beep. The speedometer reading and the displayed measurements switch between mph and km/h. The display change message appears for a few seconds.

⌘ Fuel Gauge

NOTICE

You should refuel when the reading approaches **[E]**. Running out of fuel can cause the engine to misfire, damaging the catalytic converter.

The actual amount of remaining fuel may differ from the fuel gauge reading.

⌘ Instant Fuel Economy Gauge

Press and hold the **km/h/mph** change button to switch the measurement.

■ IMA Battery Charge Level Indicator

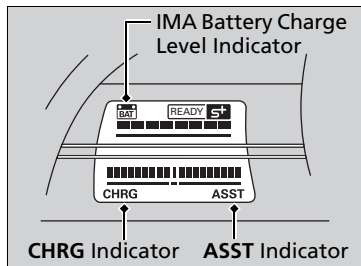

The remaining battery charge level is displayed as a bar graph.

■ Electric Motor Assist Indicator (ASST)

The degree to which the electric motor is assisting the engine is displayed by the **ASST** indicator bar.

■ Battery Charge in Progress (CHRG)

The degree to which the IMA battery is being charged is displayed by the **CHRG** indicator bar.

☒ IMA Battery Charge Level Indicator

The IMA battery charge level may decrease rapidly under the following conditions:

- When the 12 volt battery has been replaced.
- When the IMA battery has been disconnected.
- When the IMA battery control system is correcting its reading.

The charge level reading will be corrected automatically while driving.

☒ Electric Motor Assist Indicator (ASST)

If the IMA battery is too hot or too cool, the IMA battery's output power is limited to protect the battery. This disables the IMA assist and Auto Idle Stop, even though the battery is well-charged.

It takes a short time to normalize the IMA battery's output power depending on the weather.

Multi-Information Display

The multi-information display shows the odometer, trip meter, outside temperature, and other gauges. It also displays important messages such as warnings and other helpful information.

Switching the Display

Press the ▲(i)/▼ (information) button or the **SEL/RESET** button to change the display.

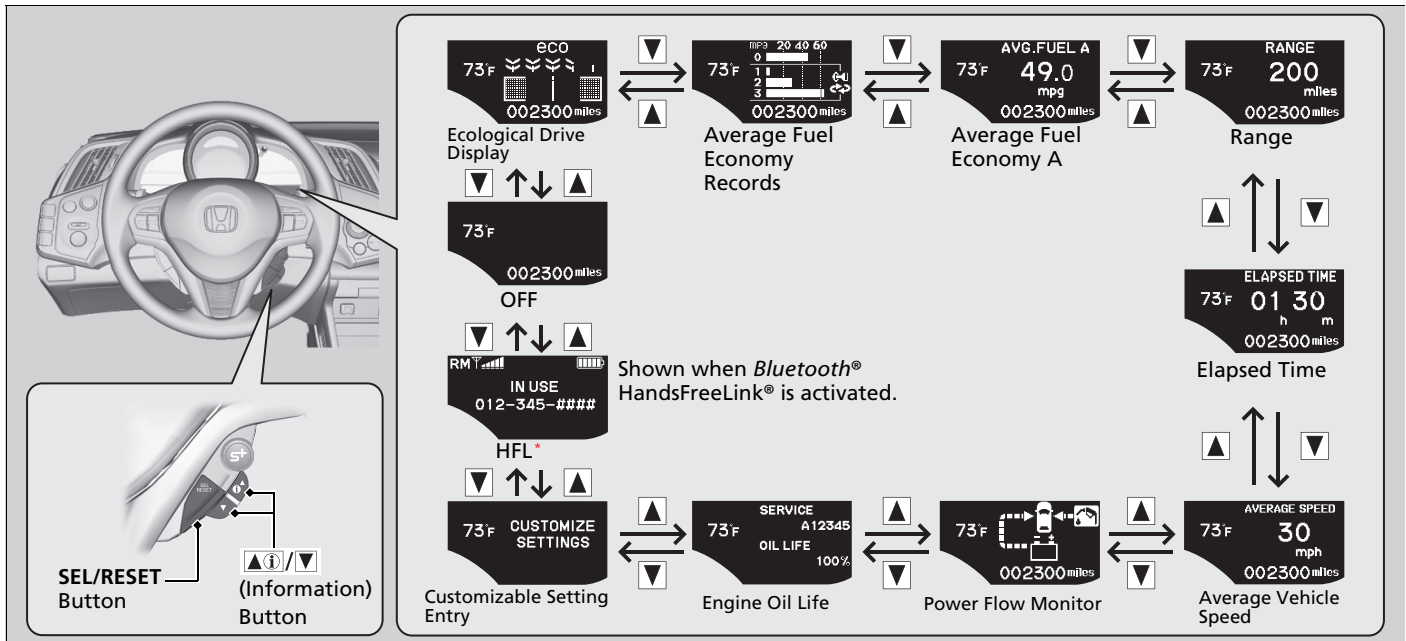

* Not available on all models

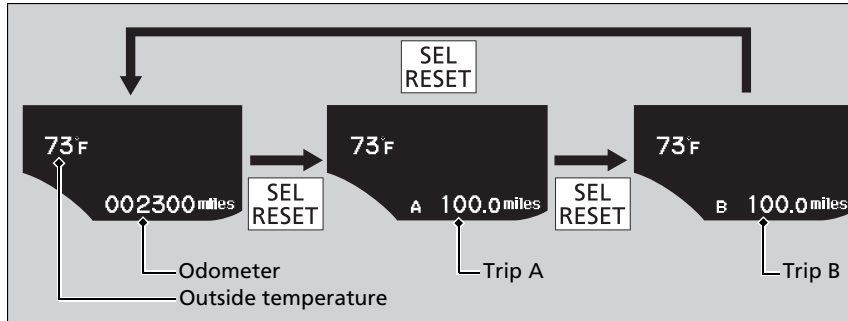

■ Odometer

Shows the total number of miles or kilometers that your vehicle has accumulated.

■ Trip Meter

Shows the total number of miles or kilometers driven since the last reset. Meters A and B can be used to measure 2 separate trips.

■ Resetting a trip meter

To reset a trip meter, display it, then press and hold the **SEL/RESET** button. The trip meter is reset to **0.0**.

☒ Trip Meter

Switch between trip meter A and trip meter B by pressing the **SEL/RESET** button.

■ Outside Temperature

Shows the outside temperature in Fahrenheit (U.S.) or Celsius (Canada).

■ Adjusting the outside temperature display

Adjust the temperature reading up to $\pm 5^{\circ}\text{F}$ or $\pm 3^{\circ}\text{C}$ if the temperature reading seems incorrect.

■ Range

Shows the estimated distance you can travel on the remaining fuel. This distance is estimated from the fuel economy of your trips in the past.

■ Elapsed Time

Shows the time during one drive cycle.

■ Average Speed

Shows the average speed in mph or km/h since the last time Trip A was reset.

⌘ Outside Temperature

The temperature sensor is in the front bumper. Road heat and exhaust from another vehicle can affect the temperature reading when your vehicle speed is less than 19 mph (30 km/h).

It may take several minutes for the display to be updated after the temperature reading has stabilized.

Use the multi-information display's customized features to correct the temperature.

➤ [Customized Features P. 90](#)

⌘ Elapsed Time

You can change the elapsed time reset criteria.

➤ [Customized Features P. 90](#)

Ecological Drive Display

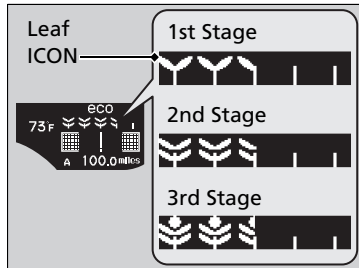

Real-Time score

The Eco assist scoring system is a point system you can use to monitor your driving style and its impact on fuel economy. Points are represented by leaf icons on the multi-information display. Leaves are:

- Accumulated when your driving style is fuel efficient.
- Deducted when your style is not fuel efficient.

Reset the system

To clear all leaves and lifetime points, complete the following steps within 30 seconds, and do not run the engine.

1. Automatic transmission (CVT) models

The shift lever must be in **P**.

Manual transmission models

The parking brake must be set.

2. Turn the ignition switch to ON **II**.
3. Make sure the **NORMAL** mode is selected.
4. Depress the brake pedal twice.
 - ▶ The ambient meter color changes from blue to green.
 - ▶ When the **METER COLOR CHANGE** setting on the multi-information display is off, the color stays in blue.
5. Press the **ECON** mode button.
6. Press the **NORMAL** mode button.
 - ▶ The ambient meter color turns off.
7. Turn the ignition switch to LOCK **0**.

Reset the system

If the ECON mode is on in step 2, press the **NORMAL** mode button. Turn the ignition switch to LOCK **0**, then go to step 1.

■ **Feedback with eco drive bar**

The bar extends to the right or left of the center line while driving. The more aggressive the acceleration is, the further the bar extends to the right. The more aggressive the deceleration is, the further the bar extends to the left. Keep the bar near the center line for better fuel economy while driving.

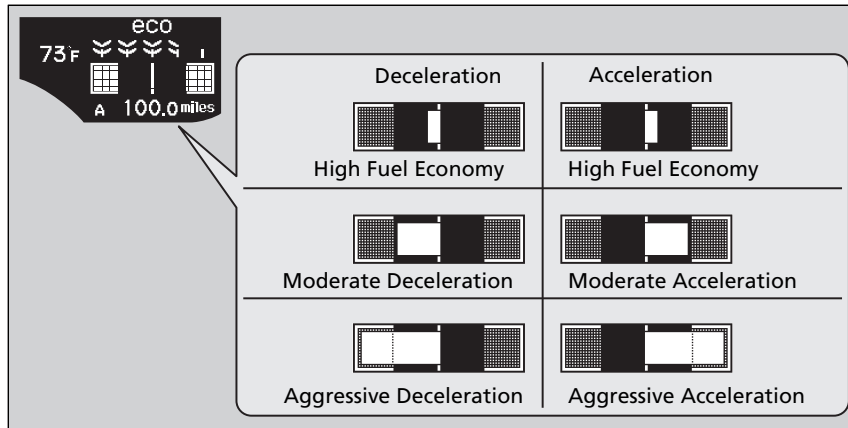

▶ Feedback with eco drive bar

Automatic transmission (CVT) models

The ambient meter color changes corresponding to the level of eco drive bar extension.

■ Average Fuel Economy Records

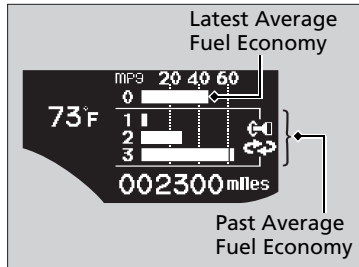

Shows the average fuel economy for the last three driving cycles (1-3), and the current driving cycle (0) in mpg or l/100 km.

Each time you turn the ignition switch to ON **II**, the display is updated, and the oldest record is deleted.

■ Average Fuel Economy

Shows the estimated average fuel economy of each trip meter in mpg or l/100 km. The display is updated at set intervals. When a trip meter is reset, its average fuel economy is also reset at the same time.

■ Engine Oil Life

Shows the remaining oil life and Maintenance Minder™.

➤ [Maintenance Minder™ P. 225](#)

■ Bluetooth® HandsFreeLink®*

Shows your paired cell phone's information.

➤ [Bluetooth® HandsFreeLink® P. 158](#)

☒ Average Fuel Economy

You can choose whether to reset trip A and average fuel economy A when you refuel.

➤ [Customized Features P. 90](#)

Power Flow Monitor

Displays engine and electric motor power flow – whether the system is assisting the engine or charging the battery.

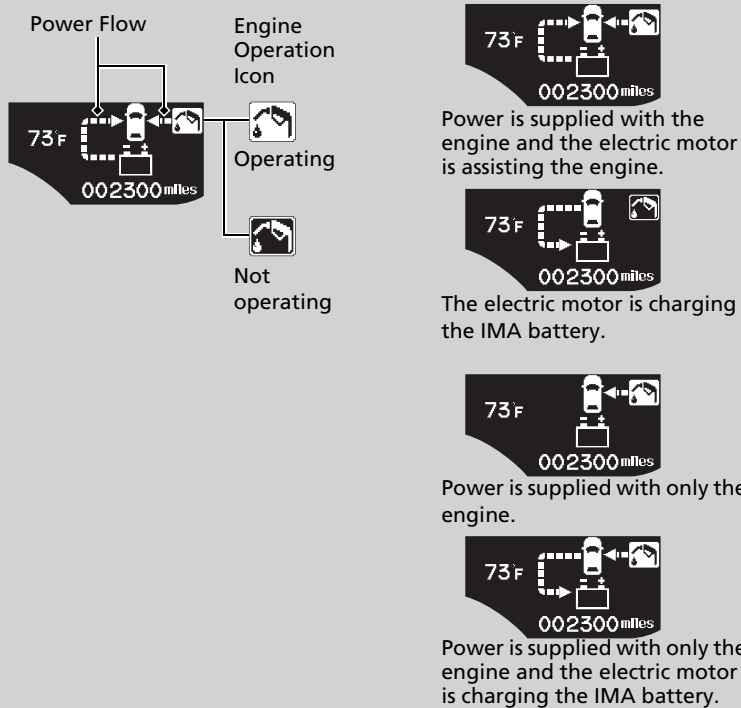

Power Flow Monitor



The displayed power flow may not correspond to the **ASST/CHRG** indicators directly.

- ▶ [Electric Motor Assist Indicator \(ASST\) P. 82](#)
- ▶ [Battery Charge in Progress \(CHRG\) P. 82](#)

■ Customized Features

Use the multi-information display to customize certain features.

■ How to customize

Select the **CUSTOMIZE SETTINGS** screen by pressing the  button while the ignition switch is in ON , the vehicle is at a complete stop, and the shift lever is in  (CVT), and the parking brake is set (manual transmission). Press the **SEL/RESET** button to select **CHG SETTING** screen.

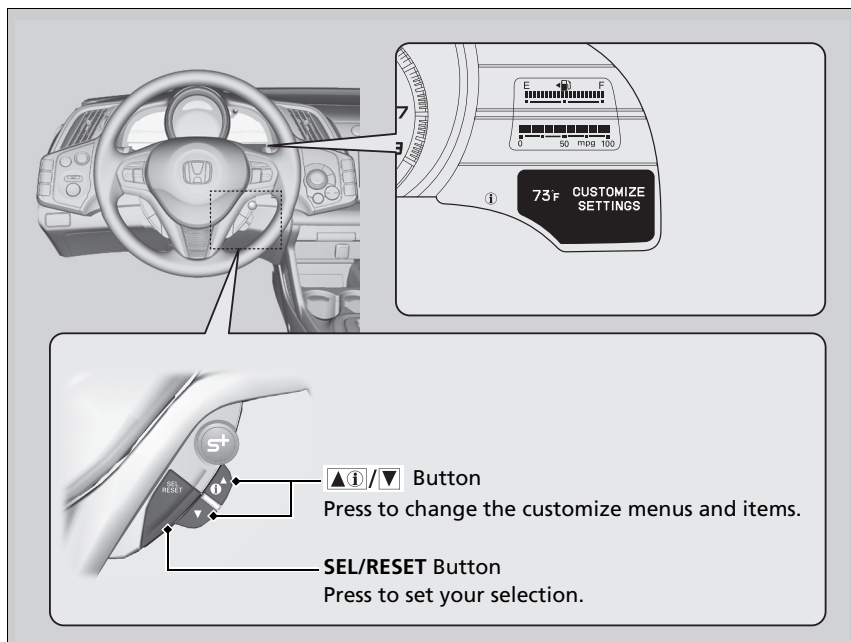

▶ Customized Features

To select customizing items, press the  button.

- ▶ [List of customizable options P. 92](#)
- ▶ [Example of customizing settings P. 94](#)

When you customize settings:

Automatic transmission (CVT) models

Shift to .

Manual transmission models

Set the parking brake.

■ Customization flow

Press the / button.

CUSTOMIZE SETTINGS

SEL/RESET

CHG SETTING

SEL/RESET

METER SETUP

SEL/RESET

DEFAULT ALL

EXIT

LIGHTING SETUP

SEL/RESET

DOOR SETUP

SEL/RESET

EXIT

- LANGUAGE SELECTION
- ADJUST OUTSIDE TEMP. DISPLAY
- TRIP A RESET with REFUEL
- ELAPSED TIME RESET
- HOLD ECON MODE
- METER COLOR CHANGE
- DISPLAY KM/MILES

- INTERIOR LIGHT DIMMING TIME
- AUTO LIGHT SENSITIVITY

Auto Light Sensitivity*

- AUTO DOOR LOCK
- AUTO DOOR UNLOCK
- DOOR LOCK MODE
- KEYLESS LOCK ACKNOWLEDGMENT
- SECURITY RELOCK TIMER

* Not available on all models

■ List of customizable options

Setup Group	Customizable Features	Description	Selectable settings
Meter Setup	Language Selection	Changes the displayed language.	English^{*1}, French, Spanish
	Adjust Outside Temp. Display	Adjusts the temperature reading by a few degrees.	-5°F ~ ±0°F^{*1} ~ +5°F -3°C ~ ±0°C^{*1} ~ +3°C
	Trip A Reset with Refuel	Sets Trip A and the average fuel economy to reset when you refuel.	ON, OFF^{*1}
	Elapsed Time Reset	Changes the resetting conditions of the elapsed time.	IGN OFF^{*1}, Trip A, Trip B
	Hold ECON Mode	Maintains ECON mode.	ON, OFF^{*1}
	Meter Color Change	Turns the ambient meter feature on and off.	ON^{*1}, OFF
	Display Km/Miles	Changes the displayed measurement on the multi-information display.	AUTO^{*1}, KM, MILES
Lighting Setup	Interior Light Dimming Time	Changes the length of time the interior lights stay on after you close the doors.	60 sec, 30 sec^{*1}, 15 sec
	Auto Light Sensitivity^{*2}	Changes the timing for the headlights to come on.	Max, High, Mid^{*1}, Low, Min

*1: Default Setting

*2: If equipped

Setup Group	Customizable Features	Description	Selectable settings
Door Setup	Auto Door Lock	Changes the setting for the automatic locking feature.	Shift from P (AT only), With VEH SPD ^{*1} , OFF
	Auto Door Unlock	Changes the setting for when the doors and the hatch unlock automatically.	Shift to P ^{*2} , IGN off ^{*3} , OFF Driver Door ^{*1} , All Doors
	Door Lock Mode	Sets up either the driver's door or both doors and the hatch to unlock on the first push of the remote.	Driver Door ^{*1} All Doors
	Key Lock Acknowledgment	LOCK/UNLOCK - The exterior lights flash LOCK (2nd push) - The beeper sounds	ON ^{*1} , OFF
	Security Relock Timer	Changes the time it takes for the doors and the hatch to relock and the security system to set after you unlock the vehicle without opening either door or the hatch.	90 sec, 60 sec, 30 sec ^{*1}
Default All	Sets/Cancel all the customized settings as default.		Set, Cancel

*1: Default Setting

*2: Default Setting on automatic transmission (CVT) models

*3: Default Setting on manual transmission models

■ Example of customizing settings

The steps for changing **TRIP A RESET with REFUEL** setting to ON are shown below.

The default setting for **TRIP A RESET with REFUEL** is OFF.

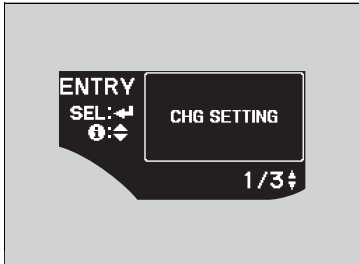

1. Press the button until **CUSTOMIZE SETTINGS** appears on the display, then press the **SEL/RESET** button.

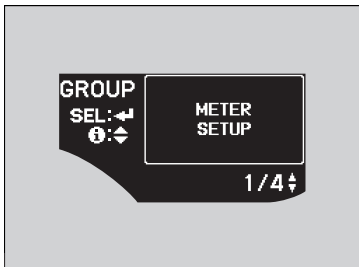

2. Press the **SEL/RESET** button.

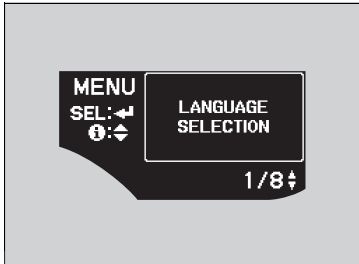

3. Press the **SEL/RESET** button again.

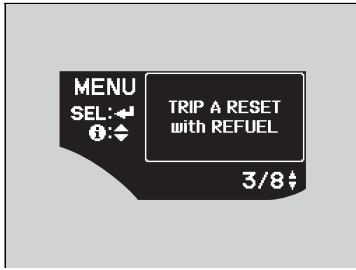

4. Press the /▼ button until **TRIP A RESET with REFUEL** appears on the display, then press the **SEL/RESET** button.

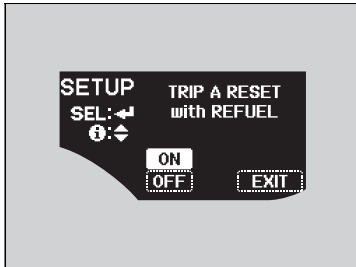

5. Press the /▼ button and select **ON**, then press the **SEL/RESET** button.

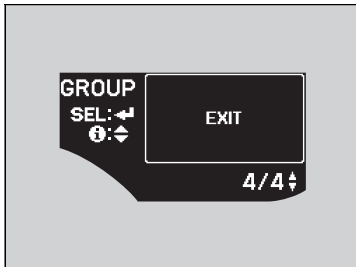

6. Press the /▼ button until **EXIT** appears in the display, then press the **SEL/RESET** button.

7. Repeat step 6 until you return to the normal screen.

Controls

This chapter explains how to operate the various controls necessary for driving.

Setting the Clock	98
Locking and Unlocking the Doors	
Key Types and Functions	99
Locking/Unlocking the Doors from the Outside	100
Locking/Unlocking the Doors from the Inside	102
Auto Door Locking/Unlocking	103
Opening and Closing the Hatch	104
Security System	
Immobilizer System	106
Security System Alarm.....	106
Opening and Closing the Windows	108

Operating the Switches Around the Steering Wheel	
Ignition Switch	110
Turn Signals	111
Light Switches.....	111
Fog Lights*	113
Daytime Running Lights	113
Wipers and Washers	114
Brightness Control	116
Rear Defogger/Heated Door Mirror*	
Button	117
Adjusting the Steering Wheel.....	118

Adjusting the Mirrors	
Interior Rearview Mirror	119
Power Door Mirrors	120
Adjusting the Seats	
Adjusting the Seat Positions.....	121
Interior Lights/Interior Convenience Items	
Interior Lights	126
Interior Convenience Items	127
Climate Control System	
Using Automatic Climate Control	134
Automatic Climate Control Sensors	136

* Not available on all models



Clock

Models without navigation system

You can adjust the time in the clock display, using the **CLOCK (AM/FM)** button with the ignition switch in ON .

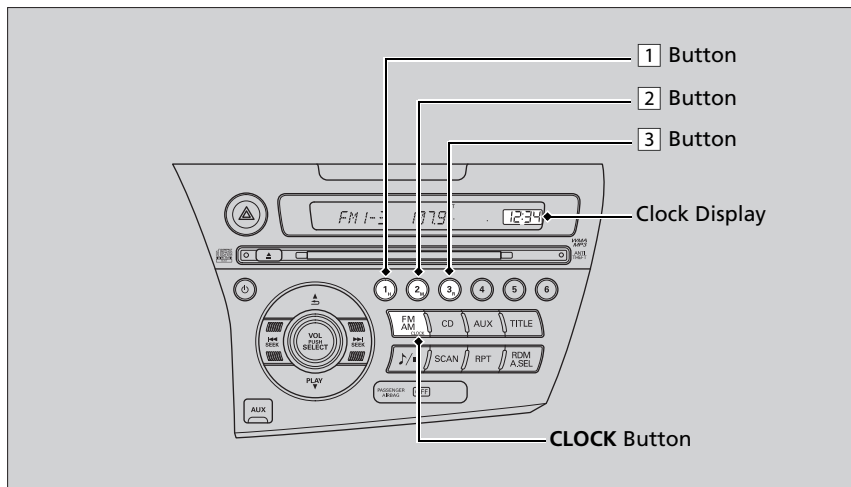
Adjusting the Time



1. Press and hold the **CLOCK** button until the clock display begins to blink.
2. Press the  (Hour) button to change the hours.
3. Press the  (Minute) button to change the minutes.
4. Press the **CLOCK** button to go back to the normal display.

⌘ Clock

To set the time to the nearest hour:
Press and hold the **CLOCK** button until the clock display begins to blink, then press the  (Reset) button.

Depending on the displayed time, the clock sets forward or backward.

Example:

1:06 will reset to 1:00

1:53 will reset to 2:00

Models with navigation system

The clock is automatically updated through the navigation system, so the time does not need to be adjusted.

Key Types and Functions

This vehicle comes with the following keys:

Keys

Key with Remote Transmitter



Use the key to start and stop the engine, and to lock and unlock all the doors and hatch.

You can also use the remote transmitter to lock and unlock the doors and hatch.

Key Number Tag



Contains a number that you will need if you purchase a replacement key.

Key Types and Functions

All of the keys have an immobilizer system. The immobilizer system helps to protect against vehicle theft.

[Immobilizer System P. 106](#)

The keys contain precision electronics.

Adhere to the following advice to prevent damage to the electronics:

- Do not leave the keys in direct sunlight, or in locations with high temperature or high humidity.
- Do not drop the keys or set heavy objects on them.
- Keep the keys away from liquids.
- Do not take the keys apart except for replacing the battery.

If the circuits in the keys are damaged, the engine may not start, and the remote transmitter may not work.

If the keys do not work properly, have them inspected by a dealer.

Key Number Tag

Keep the key number tag separate from the key in a safe place outside of your vehicle.

If you wish to purchase an additional key, contact a dealer.

If you lose your key and you cannot start the engine, contact a dealer.

Locking/Unlocking the Doors from the Outside

■ Using the Remote Transmitter

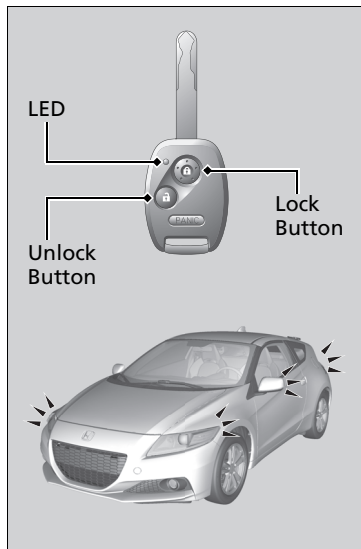

■ Locking the doors

Press the lock button.

Once:

- ▶ Some exterior lights flash, all the doors and hatch lock, and the security system sets.

Twice (within five seconds after the first push):

- ▶ A beeper sounds and verifies the security system is set.

■ Unlocking the doors

Press the unlock button.

Once:

- ▶ Some exterior lights flash twice, and the driver's door unlocks.

Twice:

- ▶ The passenger's door and the hatch unlock.

☒ Using the Remote Transmitter

If you do not open a door within 30 seconds of unlocking the vehicle with the remote transmitter, the doors and the hatch will automatically relock. You can change the relock timer setting.

☒ [Customized Features P. 90](#)

If the interior light switch is in the door activated position, the interior lights come on when you press the UNLOCK button.

No doors opened: The lights fade out after 30 seconds.

Doors relocked with the remote: The lights go off immediately.

☒ [Interior Lights P. 126](#)

The remote transmitter uses low-power signals, so the operating range may vary depending on the surroundings.

The remote will not lock the vehicle when a door or the hatch is open.

If the distance at which it works varies, the battery is probably low. Replace the button battery as soon as possible.

If the LED does not come on when you press a button, the battery is dead.

☒ [Replacing the Button Battery P. 263](#)

You can customize the door unlock mode setting.

☒ [Customized Features P. 90](#)

■ Locking/Unlocking the Doors Using a Key

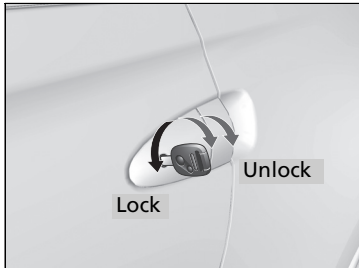

Fully insert the key and turn it.

■ Locking a Door Without Using a Key

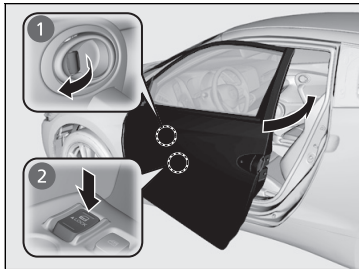

■ Locking the driver's door

Pull the lock tab rearward ① or push the master door lock switch in the lock direction ②, and close the door.

■ Locking the passenger's door

Pull the lock tab rearward and close the door.

■ Lockout prevention system

The doors and the hatch cannot be locked when the key is in the ignition switch, and either door or the hatch is open.

☒ Locking/Unlocking the Doors Using a Key

When you lock the driver's door with a key, all the doors and hatch lock at the same time. When unlocking, the driver's door unlocks first. Turn the key a second time within a few seconds to unlock the passenger's door and the hatch.

You can customize the door unlock mode setting.

[➤ Customized Features P. 90](#)

☒ Locking a Door Without Using a Key

When you lock the driver's door, all the doors and hatch lock at the same time. Make sure you have the key in your hand before locking the door to prevent it from being locked in the vehicle.

Locking/Unlocking the Doors from the Inside

■ Using the Lock Tab

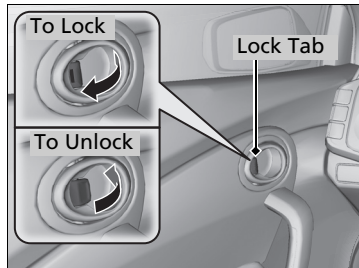

■ **Locking a door**
Pull the lock tab.

■ **Unlocking a door**
Push the lock tab in.

☒ Using the Lock Tab

When you lock the door using the lock tab on the driver's door, the other door and hatch lock at the same time.

When you unlock the door using the lock tab on the driver's door, only the driver's door will unlock.

■ Using the Master Door Lock Switch

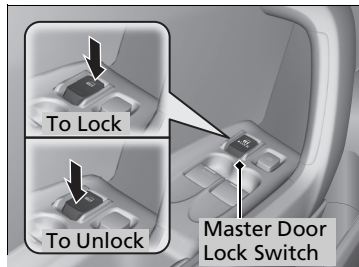

Press the master door lock switch in as shown to lock or unlock both doors and the hatch.

☒ Using the Master Door Lock Switch

When you lock/unlock the driver's door using the master lock switch, all the doors and hatch lock/unlock at the same time.

Auto Door Locking/Unlocking

Your vehicle locks all doors and unlocks the driver's door automatically when a certain condition is met.

Auto Door Locking

Drive lock mode

The auto door lock function automatically locks all the doors and hatch when the vehicle reaches about 10 mph (15 km/h).

Auto Door Unlocking

Automatic transmission (CVT) models

Park unlock mode

The driver's door unlocks when the shift lever is moved into **P** with the brake pedal depressed. The settings can be changed to unlock all doors.

Manual transmission models

Ignition switch unlock mode

The driver's door unlocks when the ignition switch is moved out of ON **II**. The settings can be changed to unlock all doors.

Auto Door Locking/Unlocking

You can turn off or change to another auto door locking/unlocking setting using the multi-information display.

[▶ Customized Features P. 90](#)

Precautions for Opening/Closing the Hatch

Always make sure individuals and objects are clear of the hatch before opening or closing it.

■ Opening the hatch

- Open the hatch all the way.
 - ▶ If it is not fully opened, the hatch may come down accidentally by its own weight.
- Be careful when it is windy. The wind may cause the hatch to close.

■ Closing the hatch

Keep the hatch closed while driving to:

- ▶ Avoid possible damage.
 - ▶ Prevent exhaust gas from leaking into the vehicle.
- 📄 [Carbon Monoxide Gas P. 62](#)

📄 Precautions for Opening/Closing the Hatch

Be careful not to hit your head on the hatch or to put your hands between the hatch and the cargo area when closing the hatch.

When you are storing or picking up luggage from the cargo area while the engine is idling, do not stand in front of the exhaust pipe. You may get burned.

Do not allow any passenger in the cargo space. They may get hurt during hard braking, a sudden acceleration, or a crash.

Opening/Closing the Hatch

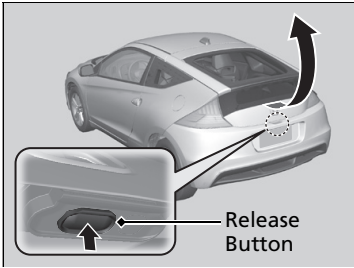

Push up the release button on the tailgate after the doors are unlocked.

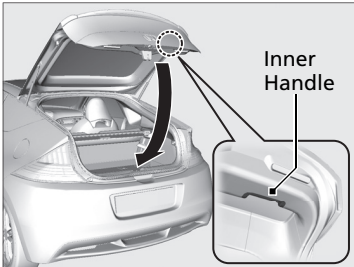

To close the hatch, grab the inner handle, pull the hatch down, and push it closed from outside.

Opening/Closing the Hatch

When the driver's door is locked, the hatch will lock when it is closed.

Immobilizer System

The immobilizer system prevents a key that has not been pre-registered from starting the engine. Each key contains electronic transmitters that use electronic signals to verify the key.

Pay attention to the following when inserting the key into the ignition switch:

- Do not allow objects that emit strong radio waves near the ignition switch.
- Make sure the key is not covered by or touching a metal object.
- Do not bring a key from another vehicle's immobilizer system near the ignition switch.

Security System Alarm

The security system alarm activates when the doors, hatch, or hood are opened without the key, or remote transmitter.

■ When the security system alarm activates

The horn sounds intermittently, and all of the exterior lights flash.

■ To deactivate the security system alarm

Unlock the vehicle using the key or remote transmitter or turn the ignition switch to ON **II**. The system, along with the horn and flashing lights, is deactivated.

☞ Immobilizer System

NOTICE

Leaving the ignition key in the vehicle can result in theft or accidental movement of the vehicle. Always take the ignition key with you whenever you leave the vehicle unattended.

Do not alter the system or add other devices to it. Doing so may damage the system and make your vehicle inoperable.

☞ Security System Alarm

The security alarm continues for a maximum of two minutes until the security system alarm deactivates.

■ Setting the security system alarm

The security system alarm automatically sets when the following conditions have been met:

- The ignition switch is in LOCK [0], and the key has been removed from the ignition switch.
- The hood is closed.
- Both doors and the hatch are locked with the key or the remote transmitter.

■ When the security system alarm sets

The security system alarm indicator in the instrument panel blinks. When the blinking interval changes after about 15 seconds, the security system alarm is set.

■ To cancel the security system alarm

The security system alarm is canceled when the vehicle is unlocked using the key or remote transmitter, or the ignition switch is turned to ON [II]. The security system alarm indicator goes off at the same time.

■ Panic Mode

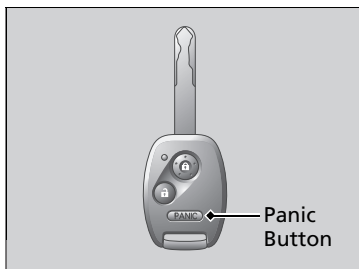

■ The panic button on the remote transmitter

If you press the panic button for approximately one second, the following will occur for about 30 seconds:

- The horn sounds.
- Some exterior lights flash.

■ Canceling panic mode

Press any button on the remote transmitter, or turn the ignition switch to ON [II].

▶▶ Security System Alarm

Do not set the security system alarm when someone is in the vehicle or a window is open. The system can accidentally activate when unlocking the door with the lock tab or the master door lock switch.

If the 12 volt battery goes dead after you have set the security system alarm, the security alarm may go off once the battery is recharged or replaced. If this occurs, deactivate the security system alarm by unlocking a door using the key or remote transmitter.

Do not attempt to alter this system or add another device to it.

Opening/Closing the Power Windows

The power windows can be opened and closed when the ignition switch is in ON **II**, using the switches on the doors. The driver side switches can be used to open and close both windows.

The power window lock button on the driver side must be switched off (not pushed in) to open and close the passenger's window from the passenger's side.

When the power window lock button is pushed in, you can only operate the driver's window. Turn the power window lock button on if a child rides in the passenger's seat.

Opening/Closing Windows with Auto-Open/Close Function

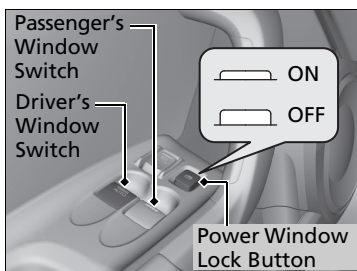

Automatic operation

To open: Push the switch down firmly.

To close: Pull the switch up firmly.

The window opens or closes completely. To stop the window at any time, push or pull the switch briefly.

Manual operation

To open: Push the switch down lightly.

To close: Pull the switch up lightly.

Release the switch when the window reaches the desired position.

Opening/Closing the Power Windows

WARNING

Closing a power window on someone's hands or fingers can cause serious injury.

Make sure your passenger is away from the window before closing it.

The power windows can be operated for up to 10 minutes after you turn the ignition switch off. Opening either door cancels this function.

Auto Reverse

If a power window senses resistance when closing automatically, it will stop closing and reverse direction.

The driver's window auto reverse function is disabled when you continuously pull up the switch.

The auto reverse function stops sensing when the window is almost closed to ensure that it fully closes.

■ Opening/Closing Windows without Auto-Open/Close Function

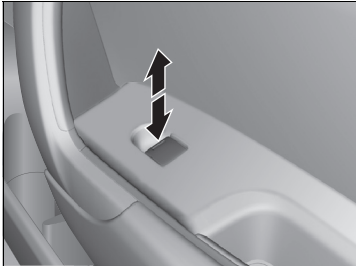

To open: Push the switch down.

To close: Pull the switch up.

Release the switch when the window reaches the desired position.

Ignition Switch

ORG

TOC

Controls

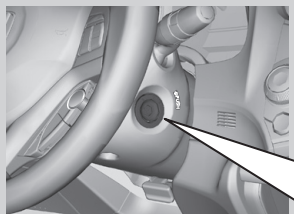

- 0 LOCK:** Insert and remove the key in this position.
- I ACCESSORY:** Operate the audio system and other accessories in this position.
- II ON:** This is the position when driving.
- III START:** This position is for starting the engine. The switch returns to ON **II** when you let go of the key.

Ignition Switch

Manual transmission models

⚠ WARNING

Removing the key from the ignition switch while driving locks the steering. This can cause you to lose control of the vehicle.

Remove the key from the ignition switch only when parked.

Automatic transmission (CVT) models

You cannot take the key out unless the shift lever is in **P**.

All models

If you open the driver's door when the key is in LOCK **0** or ACCESSORY **I**, a warning buzzer will sound to remind you to take the key out.

When this happens, the following messages appear on the multi-information display:

- In LOCK **0**: **REMOVE KEY**
- In ACCESSORY **I**: **RETURN IGNITION SWITCH TO LOCK (0) POSITION**

The buzzer will stop when you take the key out.

If the key won't turn from LOCK **0** to ACCESSORY **I**, turn the key while moving the steering wheel left and right. The steering wheel will unlock, allowing the key to turn.

Index

Home

Turn Signals

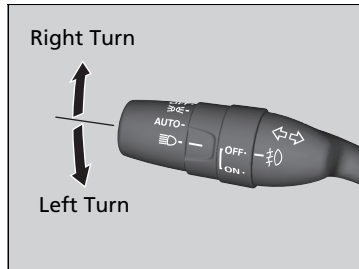

The turn signals can be used when the ignition switch is in ON **II**.

Light Switches

Manual Operation

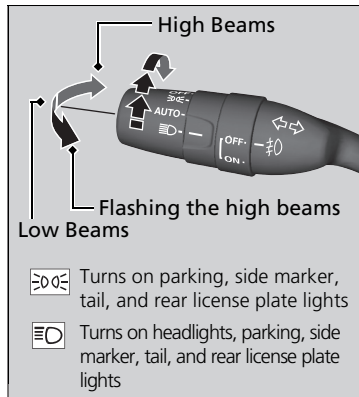

Rotating the light switch turns the lights on and off, regardless of the position of the ignition switch.

High beams

Push the lever forward until you hear a click.

Low beams

When in high beams, pull the lever back to return to low beams.

Flashing the high beams

Pull the lever back, and release it.

Light Switches

If you remove the key from the ignition switch while the lights are on, a chime sounds when the driver's door is opened.

Do not leave the lights on when the engine is off because it will cause the battery to discharge.

Models with high voltage discharge tube bulbs

Repeatedly turning the headlights on and off reduces the life of the HID headlight bulbs.

If you sense that the level of the headlights is abnormal, have the vehicle inspected by a dealer.

■ Automatic Lighting Control*

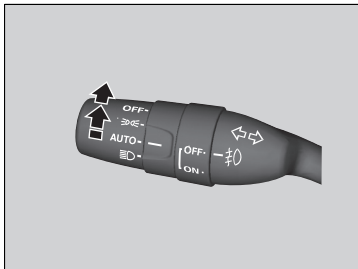

Automatic lighting control can be used when the ignition switch is in ON .

When you turn the light switch to **AUTO**, the headlights and other exterior lights will switch on and off automatically depending on the ambient brightness.

- ▶ You can change the AUTO light sensitivity setting.

▶ [Customized Features P. 90](#)

▣ Automatic Lighting Control*

We recommend that you turn on the lights manually when driving at night, in a dense fog, or in dark areas such as long tunnels or parking facilities.

The light sensor is in the location shown below. Do not cover this light sensor with anything; otherwise, the automatic lighting system may not work properly.

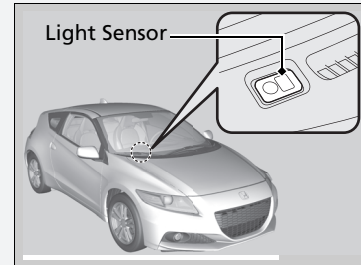

Adjust the AUTO light sensitivity as follows:

Setting	The exterior lights come on when the ambient light is at
MAX	
HIGH	
MID	
LOW	
MIN	

Fog Lights*

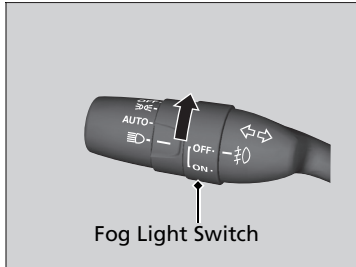

When the low beam headlights are on, turn the fog light switch on to use the fog lights.

⊞ Fog Lights*

When the fog lights are on, the indicator in the instrument panel will be on.

➤ [Indicators P. 66](#)



Daytime Running Lights

Models with bulb type parking lights

The high beam headlights come on slightly dimmer than normal when the following conditions have been met:

Models with LED type parking/daytime running lights

The parking/daytime running lights come on when the following conditions have been met:

- The ignition switch is in ON .
- The headlight switch is off, or in .
- The parking brake is released.

The lights remain on even if you set the parking brake. Turning off the ignition switch will turn off the daytime running lights.

Models with bulb type parking lights

The high beam headlights return to the original brightness once the headlight switch is turned on.

* Not available on all models

Wipers and Washers

■ Front Wiper/Washer

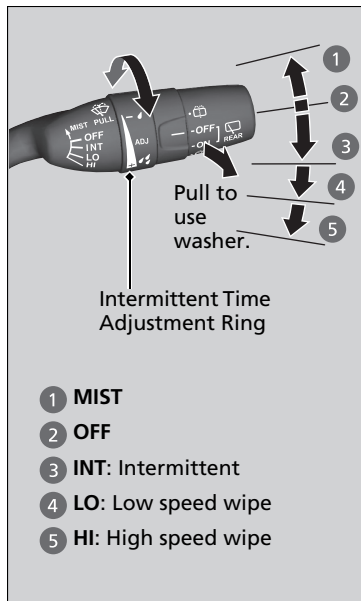

The windshield wipers and washers can be used when the ignition switch is in ON .

■ MIST

The wipers run at high speed until you release the lever.

■ Wiper switch (OFF, INT, LO, HI)

Change the wiper switch setting according to the amount of rain.

■ Adjusting the delay

Turn the adjustment ring to adjust the wiper delay.

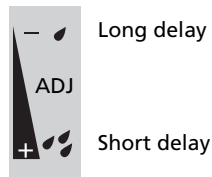

■ Washer

Sprays while you pull the lever toward you. When you release the lever, the wipers make two or three more sweeps before stopping.

» Wipers and Washers

NOTICE

Do not use the wipers when the windshield is dry. The windshield will get scratched, or the rubber blades will get damaged.

NOTICE

In cold weather, the blades may freeze to the windshield, becoming stuck.

Operating the wipers in this condition may damage the wipers. Use the defroster to warm the windshield, then turn the wipers on.

If the vehicle speeds up while the wipers are operating intermittently, the length of the wipe interval shortens. When the vehicle starts moving, the wipers make a single sweep. When the vehicle speeds up, the wiper operation's shortest delay setting  and the LO setting become the same.

Turn the washers off if no washer fluid comes out. The pump may get damaged.

Rear Wiper/Washer

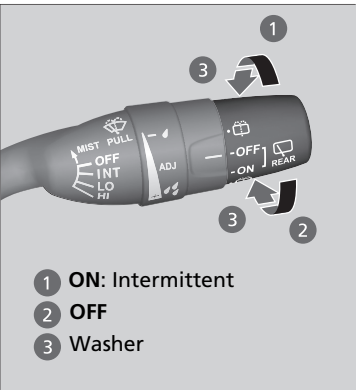

The rear wiper and washer can be used when the ignition switch is in ON [II].

Wiper switch (OFF, ON)

The wiper operates intermittently after completing a few sweeps.

Washer (WASHER)

Sprays while you rotate the switch to this position.

Hold it to activate the wiper and to spray the washer. Once released, it stops operating after a few more sweeps.

Operating in reverse

When you shift the transmission to [R] with the front wiper activated, the rear wiper operates automatically as follows even if its switch is off.

Front Wiper Position	Rear Wiper Operation
INT (Intermittent)	Intermittent
LO (Low speed wipe)	Continuous
HI (High speed wipe)	

Rear Wiper/Washer

If the wiper stops operating due to any obstacle such as the build-up of snow, park the vehicle in a safe place.

Rotate the wiper switch to **OFF**, and turn the ignition switch to ACCESSORY [I] or LOCK [0], then remove the obstacle.

The wiper motor is equipped with a breaker that may stop motor operation temporarily to prevent an overload. Wiper operation will return to normal within a few minutes, once the circuit has returned to normal.

Brightness Control

ORG

TOC

Controls

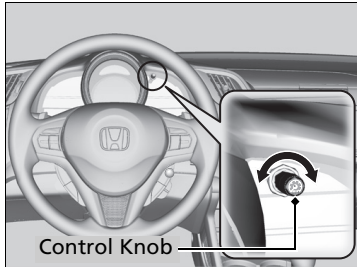

When the ignition switch is in ON , you can use the brightness control knob to adjust instrument panel brightness.

Brighten: Turn the knob to the right.

Dim: Turn the knob to the left.

You will hear a beeper when the brightness reaches minimum or maximum. The multi- information display will return to its original state several seconds after you adjust the brightness.

■ Brightness level indicator

The brightness level is shown on the multi- information display while you are adjusting it.

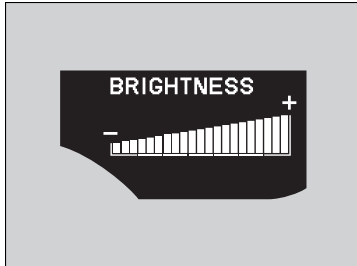

▶▶ Brightness Control

Instrument panel brightness varies, depending on whether the exterior lights are on or off. The instrument panel dims to reduce glare when they are on.

Pressing either   (information) button switches the display.

If you turn the knob to the right until the brightness display is up to max, the beeper sounds. This cancels the reduced instrument panel brightness when the parking lights are on.

The brightness can be set differently for when the exterior lights are on, and when they are off.

Index

Home

Rear Defogger/Heated Door Mirror* Button

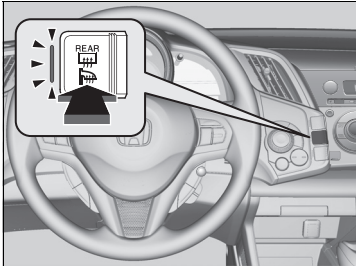

Press the rear defogger and heated door mirror button to defog the rear window and mirrors when the ignition switch is in ON .

The rear defogger and heated door mirrors automatically switch off after 10-30 minutes depending on the outside temperature. However, if the outside temperature is 32°F (0°C) or below, they do not automatically switch off.

Rear Defogger/Heated Door Mirror* Button

NOTICE

When cleaning the inside of the rear window, be careful not to damage the heating wires. It is critical to wipe the window from side to side along the defogger heating wires.

This system consumes a lot of power, so turn it off when the window has been defogged. Also, do not use the system for a long period when the engine is idling. This may weaken the 12 volt battery, making it difficult to start the engine.

Adjusting the Steering Wheel

The steering wheel height and distance from your body can be adjusted so that you can comfortably grip the steering wheel in an appropriate driving posture.

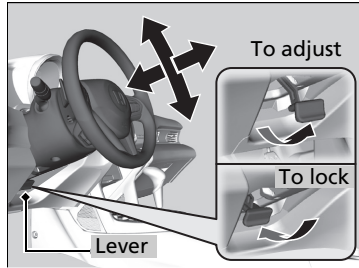

1. Pull the steering wheel adjustment lever up.
 - ▶ The steering wheel adjustment lever is under the steering column.
2. Move the steering wheel up or down, and in or out.
 - ▶ Make sure you can see the instrument panel gauges and indicators.
3. Push the steering wheel adjustment lever down to lock the steering wheel in position.
 - ▶ After adjusting the position, make sure you have securely locked the steering wheel in place by trying to move it up, down, in, and out.

Adjusting the Steering Wheel

WARNING

Adjusting the steering wheel position while driving may cause you to lose control of the vehicle and be seriously injured in a crash.

Adjust the steering wheel only when the vehicle is stopped.

Make any steering wheel adjustments before you start driving.

Interior Rearview Mirror

Adjust the angle of the rearview mirror when you are sitting in the correct driving position.

Rearview Mirror with Day and Night Positions*

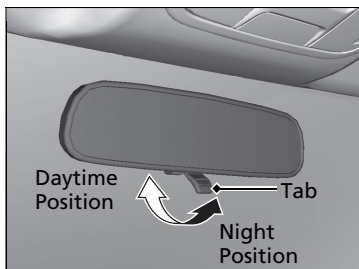

Flip the tab to switch the position. The night position will help to reduce the glare from headlights behind you when driving after dark.

Automatic Dimming Rearview Mirror

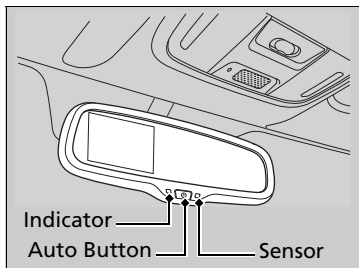

When driving after dark, the automatic dimming rearview mirror reduces the glare from headlights behind you. Press the auto button to turn this function on and off. When activated, the auto indicator comes on.

Adjusting the Mirrors

Keep the inside and outside mirrors clean and adjusted for best visibility.

Adjust the mirrors before you start driving.

[➤ Adjusting the Seat Positions P. 121](#)

Automatic Dimming Rearview Mirror

The auto dimming function cancels when the shift position is in **R**.

* Not available on all models

Power Door Mirrors

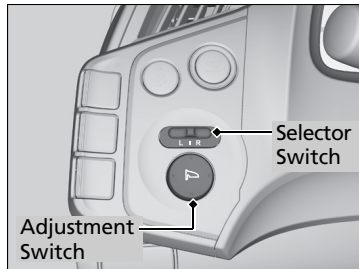

You can adjust the door mirrors when the ignition switch is in ON .

■ Mirror position adjustment

L/R selector switch: Select the left or right mirror. After adjusting the mirror, return the switch to the center position.

Mirror position adjustment switch: Press the switch left, right, up, or down to move the mirror.

■ Expanded View Driver's Mirror

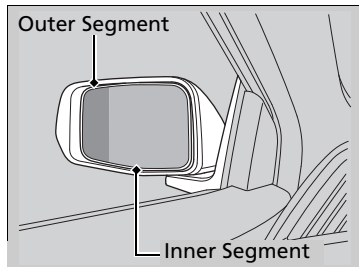

The driver side door mirror has outer and inner segments.

The outer segment is slightly curved to provide a wider angle view than a standard flat mirror. This wider view may help you check areas that are not visible using a standard door mirror.

Expanded View Driver's Mirror

Objects visible in the outer segment of the driver side door mirror appears smaller than objects in the rest of the mirror. But in fact, they are closer than they appear.

Do not rely on your mirrors. Always look to the side and behind your vehicle before changing lanes.

Adjusting the Seat Positions

ORG

Allow sufficient space.

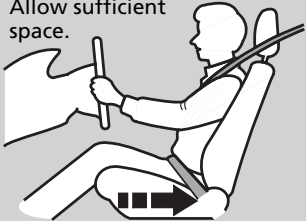

Move back.

Adjust the driver's seat as far back as possible while allowing you to maintain full control of the vehicle. You should be able to sit upright, well back in the seat and be able to adequately press the pedals without leaning forward, and grip the steering wheel comfortably. The passenger's seat should be adjusted in a similar manner, so that it is as far back from the front airbag in the dashboard as possible.

Adjusting the Seats

WARNING

Sitting too close to a front airbag can result in serious injury or death if the front airbags inflate.

Always sit as far back from the front airbags as possible while maintaining control of the vehicle.

The National Highway Traffic Safety Administration and Transport Canada recommend that drivers allow at least 10 inches (25 cm) between the center of the steering wheel and the chest.

Always make seat adjustments before driving.

Once a seat is adjusted correctly, rock it back and forth to make sure it is locked in position.

TOC

Controls

Height Adjustment

(Driver side only)

Pull up or push down the lever to raise or lower the seat.

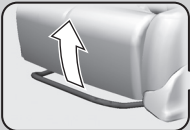

Horizontal Position Adjustment

Pull up on the bar to move the seat, then release the bar.

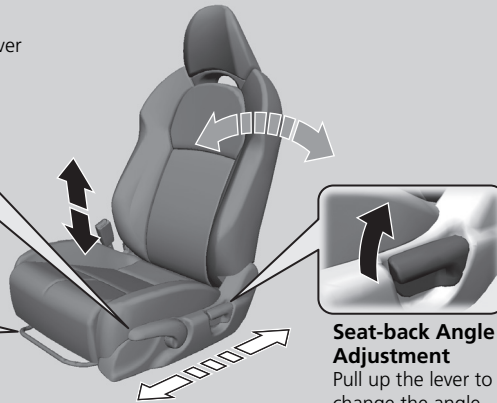

Driver's seat is shown.

Seat-back Angle Adjustment

Pull up the lever to change the angle.

Index

Home

Continued

■ Adjusting the Seat-Backs

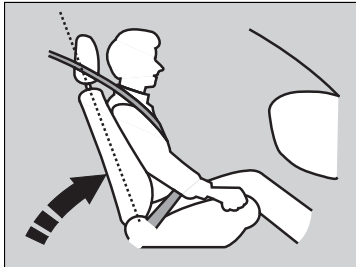

Adjust the driver's seat-back to a comfortable, upright position, leaving ample space between your chest and the airbag cover in the center of the steering wheel.

The passenger should also adjust their seat-back to a comfortable, upright position.

Reclining a seat-back so that the shoulder part of the belt no longer rests against the occupant's chest reduces the protective capability of the belt. It also increases the chance of sliding under the belt in a crash and being seriously injured. The farther a seat-back is reclined, the greater the risk of injury.

► Adjusting the Seat-Backs

⚠ WARNING

Reclining the seat-back too far can result in serious injury or death in a crash.

Adjust the seat-back to an upright position, and sit well back in the seat.

Do not put a cushion, or other object, between the seat-back and your back.

Doing so may interfere with proper seat belt or airbag operation.

If you cannot get far enough away from the steering wheel and still reach the controls, we recommend that you investigate whether some type of adaptive equipment may help.

Head Restraints

Your vehicle is equipped with head restraints in both seating positions. However, they are non-adjustable.

Head restraints are most effective for protection against whiplash and other rear-impact crash injuries.

Removing and Reinstalling the Head Restraints

Head restraints can be removed for cleaning or repair.

To remove the head restraint:

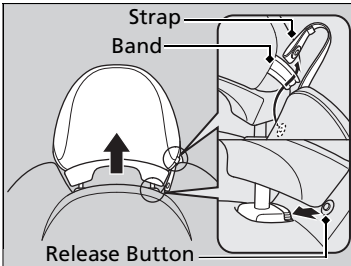

1. Unhook the strap on the outside edge of the seat-back.
2. Pull out the strap throughout the band on the outside under edge of the head restraint.
3. Push the release button, and pull the head restraint upward.

Head Restraints

⚠ WARNING

Failure to reinstall, or correctly reinstall, the head restraints can result in severe injury during a crash.

Always replace the head restraints before driving.

The driver's and passenger's seats have active head restraints.

➤ [Active Head Restraints P. 125](#)

To install the head restraint:

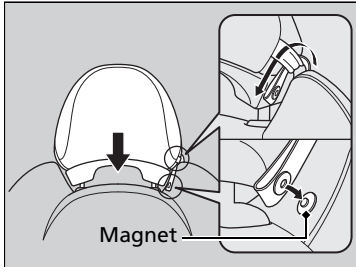

1. Put the legs back in place, then slightly lower it.
 - Do not push it down fully until it locks in place.
2. Insert the strap onto the band, then hook it to the magnet on the outside edge of the seat-back.
3. Push the head restraint down until it locks. Make sure the head restraint locks in place when you reinstall it.

■ Maintain a Proper Sitting Position

After all occupants have adjusted their seats, and put on their seat belts, it is very important that they continue to sit upright, well back in their seats, with their feet on the floor, until the vehicle is safely parked and the engine is off.

Sitting improperly can increase the chance of injury during a crash. For example, if an occupant slouches, lies down, turns sideways, sits forward, leans forward or sideways, or puts one or both feet up, the chance of injury during a crash is greatly increased.

In addition, an occupant who is out of position in the seat can be seriously or fatally injured in a crash by striking interior parts of the vehicle or being struck by an inflating front airbag.

►► Maintain a Proper Sitting Position

⚠ WARNING

Sitting improperly or out of position can result in serious injury or death in a crash.

Always sit upright, well back in the seat, with your feet on the floor.

Active Head Restraints

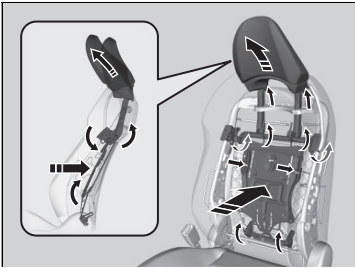

The driver's and passenger's seats have active head restraints. In a rear impact, an occupant properly secured by a seat belt will be pushed against the seat-back and the head restraint will move forward. This reduces the distance between the restraint and the occupant's head, which helps reduce the likelihood of whiplash and injuries to the neck and upper spine.

Active Head Restraints

In order for the active head restraints to operate properly:

- Do not hang any items on the head restraints, or from the restraint legs.
- Do not place any objects between an occupant and the seat-back.
- Install each restraint in its proper location.

After collision, the activated restraint should return to its normal position. If the restraint does not return to its normal position, or in the event of a severe collision, have the vehicle inspected by a dealer.

Interior Lights

Interior Light Switch

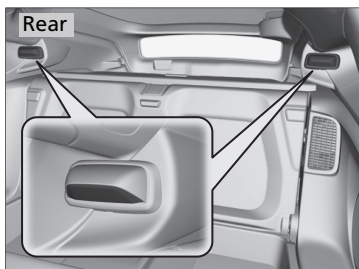
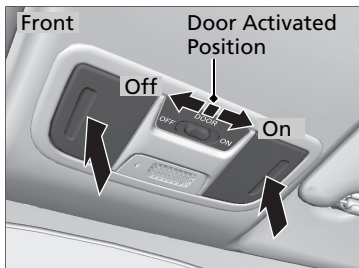

■ ON

The interior lights come on regardless of whether the doors are open or closed.

■ Door activated

The interior lights come on in the following situations:

- When either of the doors are opened.
- You unlock the driver's door.
- You remove the key from the ignition switch.

■ OFF

The interior lights remain off regardless of whether the doors are open or closed.

Each front interior light can be used as a map light. Each light can be turned on and off by pressing the lenses.

Interior Light Switch

In the door activated position, the interior lights fade out and go off about 30 seconds after the doors are closed.

The lights go off after 30 seconds in the following situations:

- When you unlock the driver's door but do not open it.
- When you remove the key from the ignition switch but do not open a door.

You can change the interior light dimming time.

[▶ Customized Features P. 90](#)

The interior lights go off immediately in the following situations:

- When you lock the driver's door.
- When you close the driver's door with the key in the ignition switch.
- When you turn the ignition switch to ON **[II]**.

If you leave either door open without the key in the ignition switch, the interior lights go off after about 15 minutes.

When the interior light switch is in the door activated position and either door is open, the front interior light will not go off when you press the lens.

Interior Convenience Items

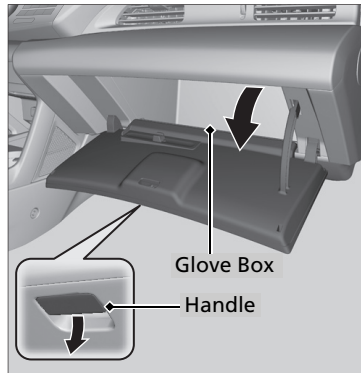

Glove Box

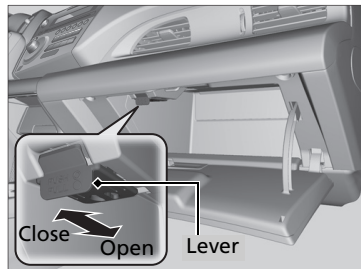

Pull the handle to open the glove box.



You can keep beverage bottles and cans cool with the air conditioning system.

1. Push the lever forward to open the air vent in the glove box.
2. Turn on the climate control system and adjust the temperature to cool.
3. Set the mode control  or .
 - The cool air is diverted through the air vent.

Glove Box

⚠ WARNING

An open glove box can cause serious injury to your passenger in a crash, even if the passenger is wearing the seat belt.

Always keep the glove box closed while driving.

Use only resealable containers or keep unopened cans in the glove box. Spilled liquids can damage the upholstery and electrical components in the glove box and inside the dashboard.

When the heater begins to divert warm air, the airflow into the glove box is shut off.

Beverage Holders

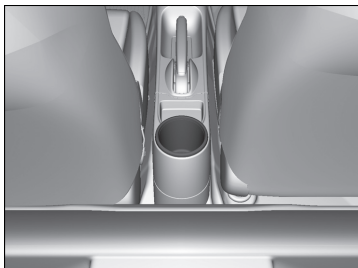
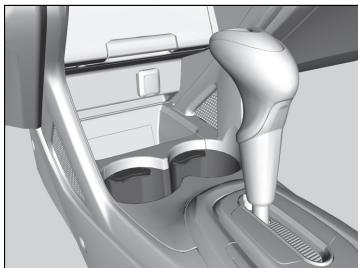

☒ Beverage Holders

NOTICE

Spilled liquids can damage the upholstery, carpeting, and electrical components in the interior.

Be careful when you are using the beverage holders. Hot liquid can scald you.

Accessory Power Socket

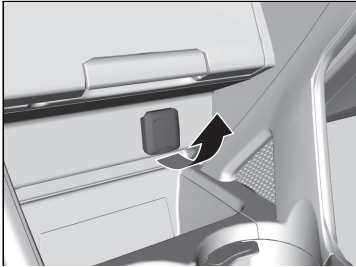

The accessory power socket can be used when the ignition switch is in ACCESSORY **I** or ON **II**.

Open the cover to use it.

Accessory Power Socket

NOTICE

Do not insert an automotive type cigarette lighter element.

This can overheat the power socket.

The accessory power socket is designed to supply power for 12 volt DC accessories that are rated 180 watts or less (15 amps).

To prevent 12 volt battery drain, only use the power socket with the engine running.

■ Rear Cargo Console

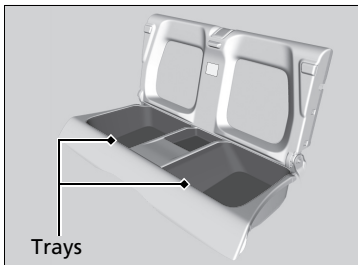

Rear trays to store small items are located on the rear cargo console.

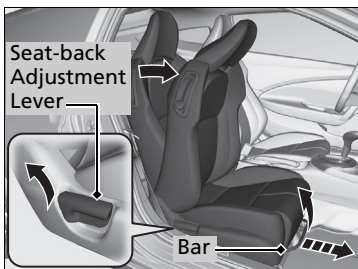

To access the rear cargo console, open the door, slide the seat by pulling up on the bar, then pull up on the seat-back adjustment lever.

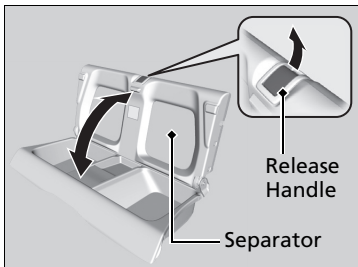

■ Separator

Folding down the separator will create more cargo area.

1. Remove any items from the rear trays.
2. Pull up the release handle on the top of the separator.

▣ Rear Cargo Console

⚠ WARNING

This vehicle is not equipped with rear seats or seatbelts.

Sitting in this area may result in injury or death, and may violate state laws.

Only the driver and one front seat passenger may be safely seated in this vehicle.

Make sure all items on the rear trays are secured. They could be thrown around and cause injury during a crash.

To return the separator upright, push it backwards until it locks.

Make sure that the folded separator does not press against the passenger seat, as this could cause the weight sensors to work improperly.

[▶ Side Airbag Off Indicator P. 48](#)

Make sure all items in the cargo area are secured. Loose items can fly forward if you have to brake hard.

■ Cargo Cover

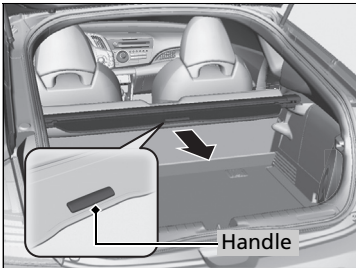

The cargo cover can be used to conceal your parcels and protect them from direct sunlight.

■ To extend:

Pull the handle on the center edge, then clip the mounting rods in the hooks on both sides of the hatch opening.

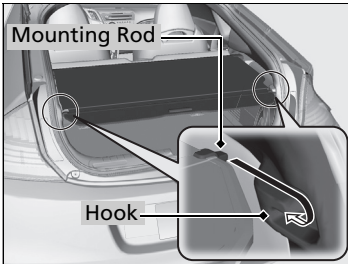

■ To retract:

Slip the rods out of the hooks, then slowly roll it back until it is completely retracted.

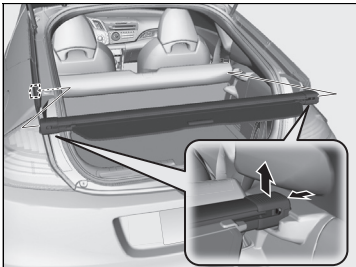

■ To remove:

Push either end of the housing inward, then lift it out of its position.

☒ Cargo Cover

Do not access parcels in the cargo area while driving. This may cause injury if you have to brake hard.

Do not stack objects higher than the top of the seat in the cargo area. They could block your view and be thrown about the vehicle during a sudden stop.

To prevent cargo cover damage:

- Do not place items on the cargo cover.
- Do not put weight on the cargo cover.

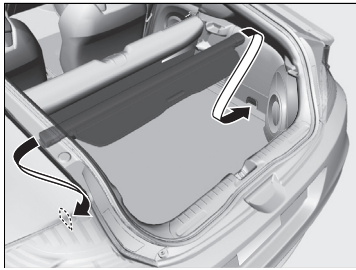

■ **To store:**

The housing unit can be stored on the cargo area floor to make more space available.

Push one end of the unit into the hole on one side panel, then insert the other end into the hole on the other side.

After storing the unit, rock it up and down to make sure it is securely placed.

Reverse this procedure to install the housing unit in place.

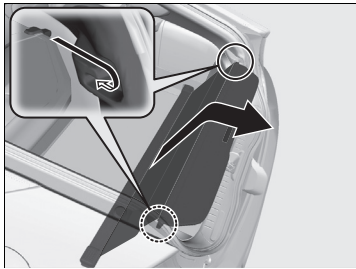

■ **To separate the cargo area into two:**

1. Pull out the cargo cover from its housing while it is stored on the cargo area floor.
2. Clip the mounting rods in the hooks at both sides of the hatch opening.

Seat Heaters*



The ignition switch must be in ON **II** to use the seat heaters. The **HI** setting heats the seats faster than the **LO** setting.

There is no heater in the passenger's seat-back due to the side airbag cutoff system.

While in **HI**, the heater cycles on and off.

- The appropriate indicator will be on while the seat heater is on. Briefly press the switch on the opposite side to turn the heater off. The indicator will be off. When a comfortable temperature is reached, select **LO** to keep the seat warm.

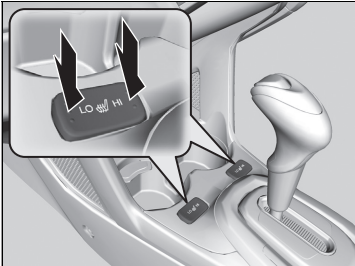

Seat Heaters*

⚠ WARNING

Heat induced burns are possible when using seat heaters.

Persons with a diminished ability to sense temperature (e.g., persons with diabetes, lower-limb nerve damage, or paralysis) or with sensitive skin should not use seat heaters.

Do not use the seat heaters even in **LO** when the engine is off. Under such conditions, the battery may be weakened, making the engine difficult to start.

In the **LO** setting, the heater runs continuously and does not automatically turn off.

* Not available on all models

Using Automatic Climate Control

The automatic climate control system maintains the interior temperature you select. The system also selects the proper mix of heated or cooled air that will as quickly as possible, raise or lower the interior temperature to your preference.

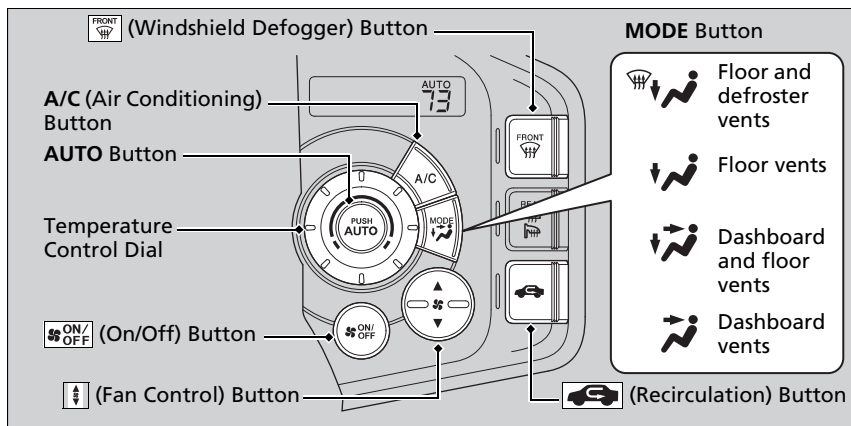

Use the system when the engine is running.

1. Press the **AUTO** button.
2. Adjust the interior temperature using the temperature control dial.
3. Press the **ON/OFF** button to cancel.

■ Switching between the recirculation and fresh air modes

Press the  button and switch the mode depending on environmental conditions.

Recirculation Mode (indicator on): Recirculates air from the vehicle's interior through the system.

Fresh Air Mode (indicator off): Maintains outside ventilation. Keep the system in fresh air mode in normal situations.

▣ Using Automatic Climate Control

If any buttons are pressed while using the climate control system in **AUTO**, the function of the button that was pressed will take priority.

The **AUTO** indicator will go off, but functions unrelated to the button that was pressed will be controlled automatically.

During the Auto Idle Stop, the air conditioning system will be turned off.

If the ECON mode is selected, the fan may also be turned off.

To prevent cold air from blowing in from outside, the fan may not start immediately when the **AUTO** button is pressed.

Once you have set the desired temperature, do not use the temperature control dial more than necessary.

Doing so may delay the time it takes to reach the set temperature.

If the interior is very warm, you can cool it down more rapidly by partially opening the windows, turning the system on **AUTO**, and setting the temperature to low. Change the fresh air mode to recirculation mode until the temperature cools down.

When you set the temperature to the lower or upper limit, **Lo** or **Hi** is displayed.

Pressing the **ON/OFF** button switches the climate control system between on and off. When turned on, the system returns to your last selection.

Defrosting the Windshield and Windows

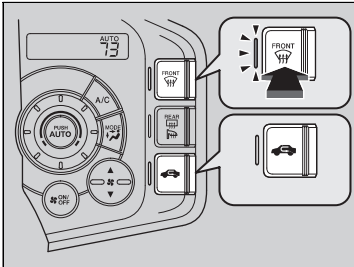



Pressing the  button turns the air conditioning system on and automatically switches the system to fresh air mode.

Press the  button again to turn off, the system returns to the previous settings.

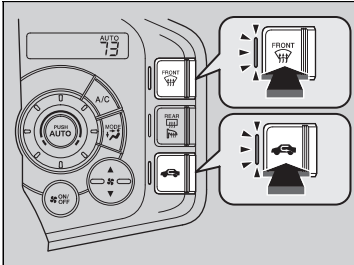
To rapidly defrost the windows



1. Press the  button.
2. Press the  button (the indicator on).

Defrosting the Windshield and Windows

For your safety, make sure you have a clear view through all the windows before driving.

Do not set the temperature near the upper or lower limit.

When cold air hits the windshield, the outside of the windshield may fog up.

If the side windows fog up, adjust the vents so that the air hits the side windows.

To rapidly defrost the windows

After defrosting the windows, switch over to fresh air mode. If you keep the system in recirculation mode, the windows may fog up from humidity. This impedes visibility.

Automatic transmission (CVT) models

Pressing the  button restarts the engine automatically during the Auto Idle Stop.

Manual transmission models

To defog during the Auto Idle Stop, restart the engine as follows.

1. Make sure the shift lever is in **[N]**.
2. Depress the clutch pedal fully.
3. Press the  button.

Automatic Climate Control Sensors

ORG

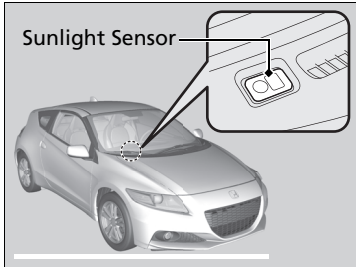

The automatic climate control system is equipped with a sunlight sensor, an interior temperature and humidity sensor. Do not cover or spill any liquid on them.

TOC

Controls

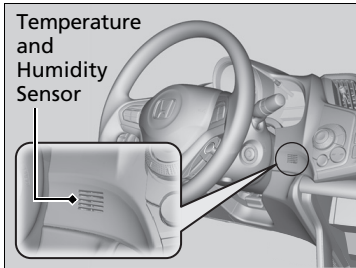

Index

Home

Features

This chapter describes how to operate technology features.

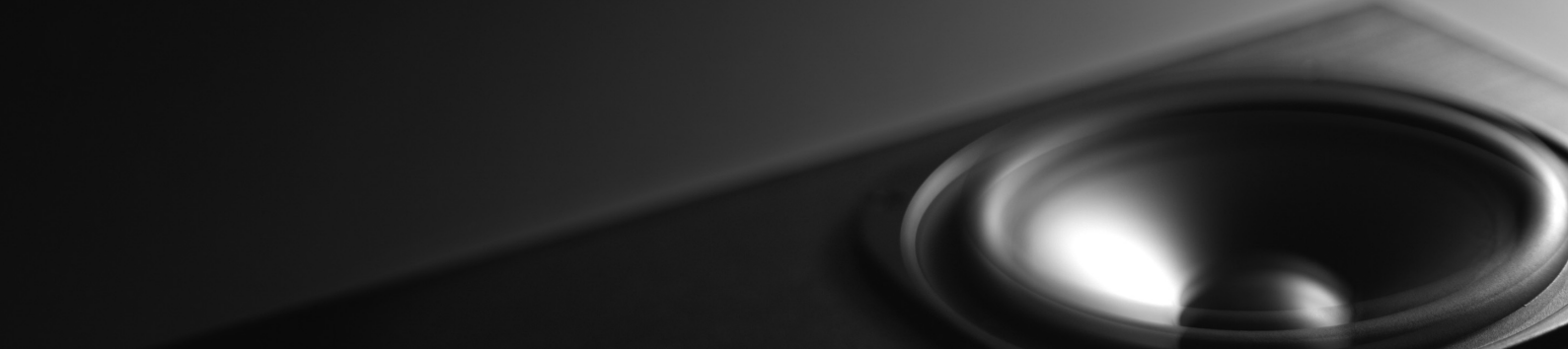

Audio System

- About Your Audio System..... 138
- USB Adapter Cable 139
- Auxiliary Input Jack 140
- Audio System Theft Protection..... 141
- Audio Remote Controls..... 142
- Audio System Basic Operation..... 143
- Playing the AM/FM Radio..... 145
- Playing a CD 147
- Playing an iPod®..... 149
- Playing a USB Flash Drive 151

Audio Error Messages

- CD Player..... 153
- iPod®/USB Flash Drive 154

General Information on the Audio System

- Recommended CDs 155
- Compatible iPod® and USB Flash Drives... 157

Bluetooth® HandsFreeLink®

- Using HFL 158
- HFL Menus 160

About Your Audio System

On models with navigation system, see the Navigation System Manual for operation of the audio system, *Bluetooth*® HandsFreeLink®, and voice commands for these features.

The audio system features AM/FM radio. It can also play audio CDs, WMA/MP3/AAC files, iPod®, and USB flash drives.

You can operate the audio system from the buttons and switches on the panel or the remote controls on the steering wheel.

About Your Audio System

Video CDs, DVDs, and 3-inch (8-cm) mini CDs are not supported.

iPod® is a registered trademark owned by Apple Inc.

Models with navigation system

You can operate the audio system by voice commands. See the navigation system manual for full details.

State or local laws may limit the circumstances in which you can launch or control your attached audio device.

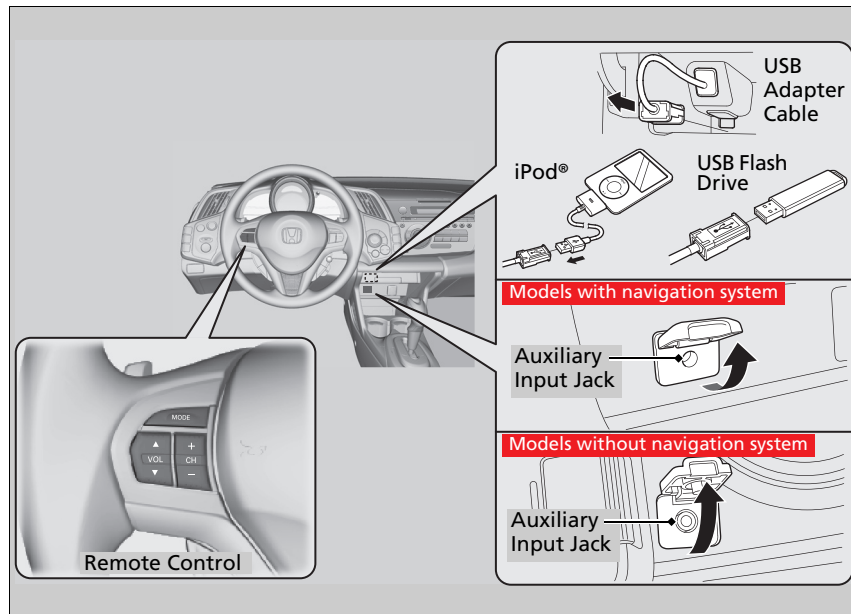

USB Adapter Cable

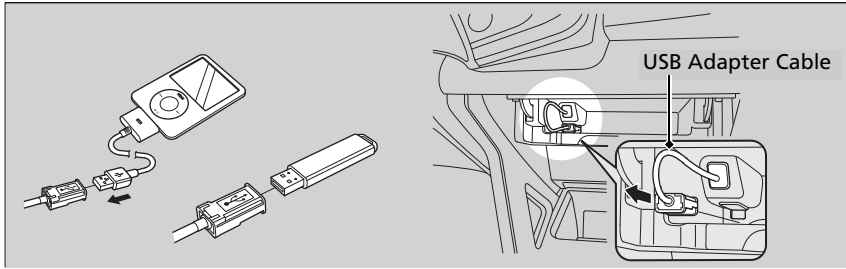

1. Pull up the center pocket lid.
2. Unclip the USB connector and loosen the adapter cable.
3. Install the iPod® dock connector or the USB flash drive to the USB connector.

⌘ USB Adapter Cable

- Do not leave the iPod® or USB flash drive in the vehicle. Direct sunlight and high temperatures may damage it.
- Do not use an extension cable with the USB adapter cable.
- Do not connect the iPod® or USB flash drive using a hub.
- Do not use a device such as a card reader or hard disk drive, as the device or your files may be damaged.
- We recommend backing up your data before using the device in your vehicle.
- Displayed messages may vary depending on the device model and software version.

If the audio system does not recognize the iPod®, try reconnecting it a few times or reboot the device. To reboot, follow the manufacturer's instructions provided with the iPod® or visit www.apple.com/ipod.

Auxiliary Input Jack

Use the jack to connect standard audio devices.

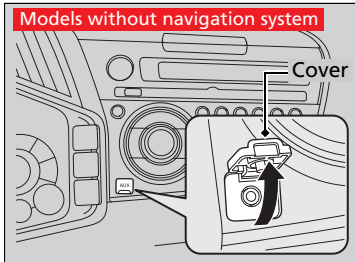

1. Open the **AUX** cover.
2. Connect a standard audio device to the input jack using a 1/8 inch (3.5 mm) stereo miniplug.
 - ▶ The audio system automatically switches to the AUX mode.

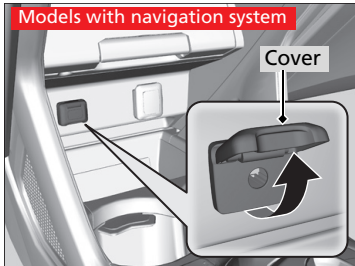

▶▶ Auxiliary Input Jack

To switch the mode, press any of the audio mode buttons. You can return to the AUX mode by pressing the **AUX** button.

You cannot use the auxiliary input jack if you replace the audio system.

Audio System Theft Protection

The audio system is disabled when it is disconnected from the power source, such as when the 12 volt battery is disconnected or goes dead.

■ Reactivating the audio system

1. Turn the ignition switch to ON **II**, and turn on the audio system.
 - ▶ If you turn the ignition switch to ACCESSORY **I**, you will be requested to enter the audio security code.
2. Enter the audio security code using the preset buttons.

If you enter an incorrect digit, continue to the last digit, then try again. If you do not enter the code correctly after 10 tries, leave the system for one hour before trying again, or visit a dealer to have the system reset.

🔗 Audio System Theft Protection

Find the audio system's security code and serial number label in your owner's manual kit.

We recommend that you write down the serial number in this owner's manual.

Do not store the label in your vehicle. If you lose the label, you must first retrieve the serial number, and then obtain the code.

You can find out about your serial number and security code from a dealer.

U.S. models

You can register the security code at Owner Link (owners.honda.com), and find information on how to retrieve the serial number and obtain the code at radio-navicode.honda.com.

Audio Remote Controls

Allows you to operate the audio system while driving.

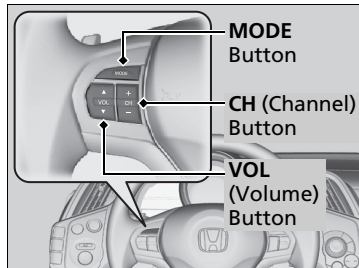

MODE Button

Cycles through the audio modes as follows:
FM1 → FM2 → AM → CD → AUX

VOL Button

Press ▲ : Increases the volume.

Press ▼ : Decreases the volume.

CH Button

- When listening to the radio

Press + : Selects the next preset radio station.

Press - : Selects the previous preset radio station.

Press and hold + : Selects the next strong station.

Press and hold - : Selects the previous strong station.

- When listening to a CD, iPod® or USB flash drive

Press + : Skips to the next song.

Press - : Goes back to the beginning of the current or previous song.

- When listening to a CD or USB flash drive

Press and hold + : Skips to the next folder.

Press and hold - : Goes back to the previous folder.

Audio Remote Controls

When in the AUX mode, the following is operable from the remote controls:

- iPod®/USB flash drive connected to the USB adapter cable

Audio System Basic Operation

To use the audio system function, the ignition switch must be in ACCESSORY **I** or ON **II**.

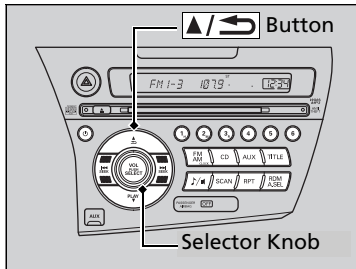

Use the selector knob to access some audio functions.

Selector knob: Rotate left or right to scroll through the available choices. Press  to set your selection.

 **button:** Press to select the Sound Setting mode.





 **button:** Press to go back to the previous display.

Audio System Basic Operation

These indications are used to show how to operate the selector knob.

Rotate  to select.

Press  to ENTER.

Press the MODE, , ,  or  button on the steering wheel to change any audio setting.

[▶ Audio Remote Controls P. 142](#)

■ Adjusting the Sound

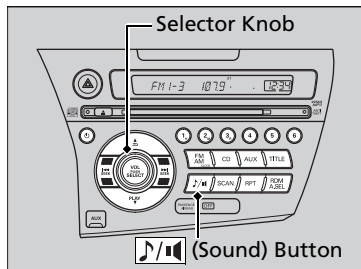

Press the button, and rotate to adjust the setting.

Each time you press the button, a sound mode switches as follows.

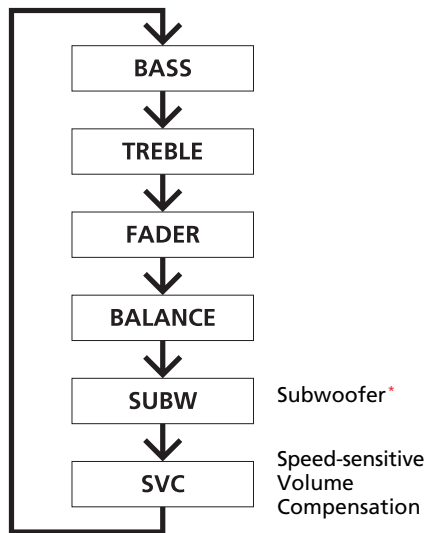

▶▶ Adjusting the Sound

When the adjustment level reaches the center, you will see **C** in the display.

The SVC has four modes: **OFF**, **LOW**, **MID**, and **HIGH**.

SVC adjusts the volume level based on the vehicle speed. As you go faster, audio volume increases. As you slow down, audio volume decreases.

Playing the AM/FM Radio

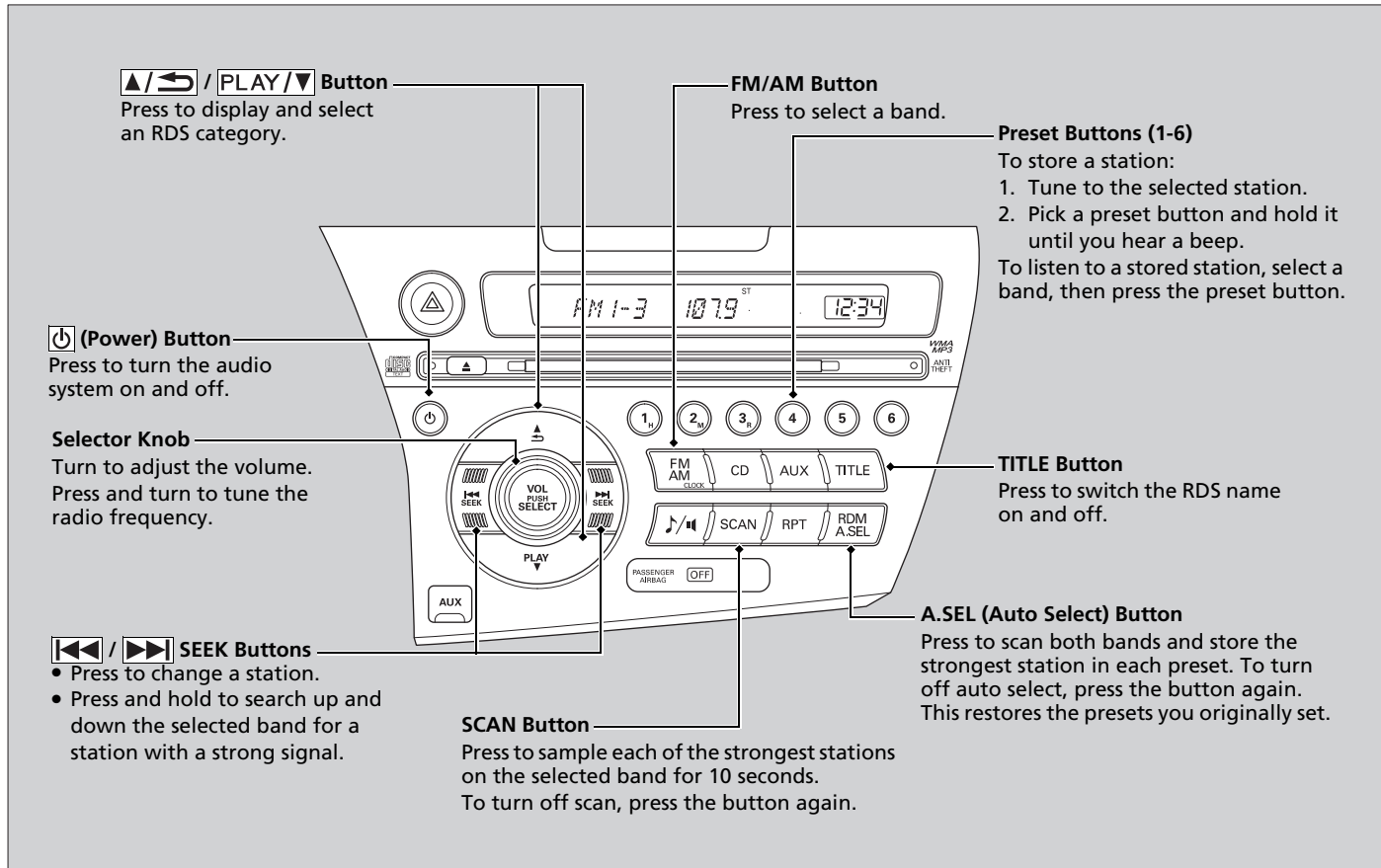

■ Auto Select (A.SEL)

Use the auto select feature to scan both bands and store the strongest station in each preset.

Press the **A.SEL** button to activate the feature.

To turn off auto select, press the **A.SEL** button again. This restores the presets you originally set.

■ Radio Data System (RDS)

Provides text data information related to your selected RDS capable FM station.

■ RDS INFO ON

Press the **TITLE** button while listening to an RDS capable station. **RDS INFO ON** appears, and the station name is displayed.

■ To find an RDS station from your selected program category

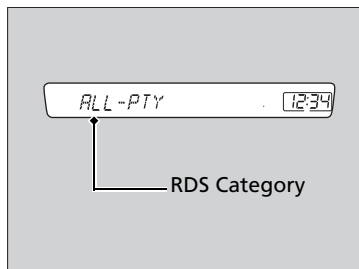

1. Press the **▲/◀** / **▶/▼** button to display and select an RDS category.
2. Use **SEEK** or **SCAN** to select an RDS station.

▶▶ Playing the AM/FM Radio

The **ST** indicator appears on the display indicating stereo FM broadcasts.

Stereo reproduction in AM is not available.

Switching the Audio Mode

Press the **MODE** button on the steering wheel.

[▶▶ Audio Remote Controls P. 142](#)

You can store six AM stations and twelve FM stations into the preset button memory. FM1 and FM2 let you store six stations each.

Auto Select function scans and stores up to six AM stations and twelve FM stations with a strong signal into the preset button memory.

If you do not like the stations auto select has stored, you can manually store your preferred frequencies.

▶▶ Radio Data System (RDS)



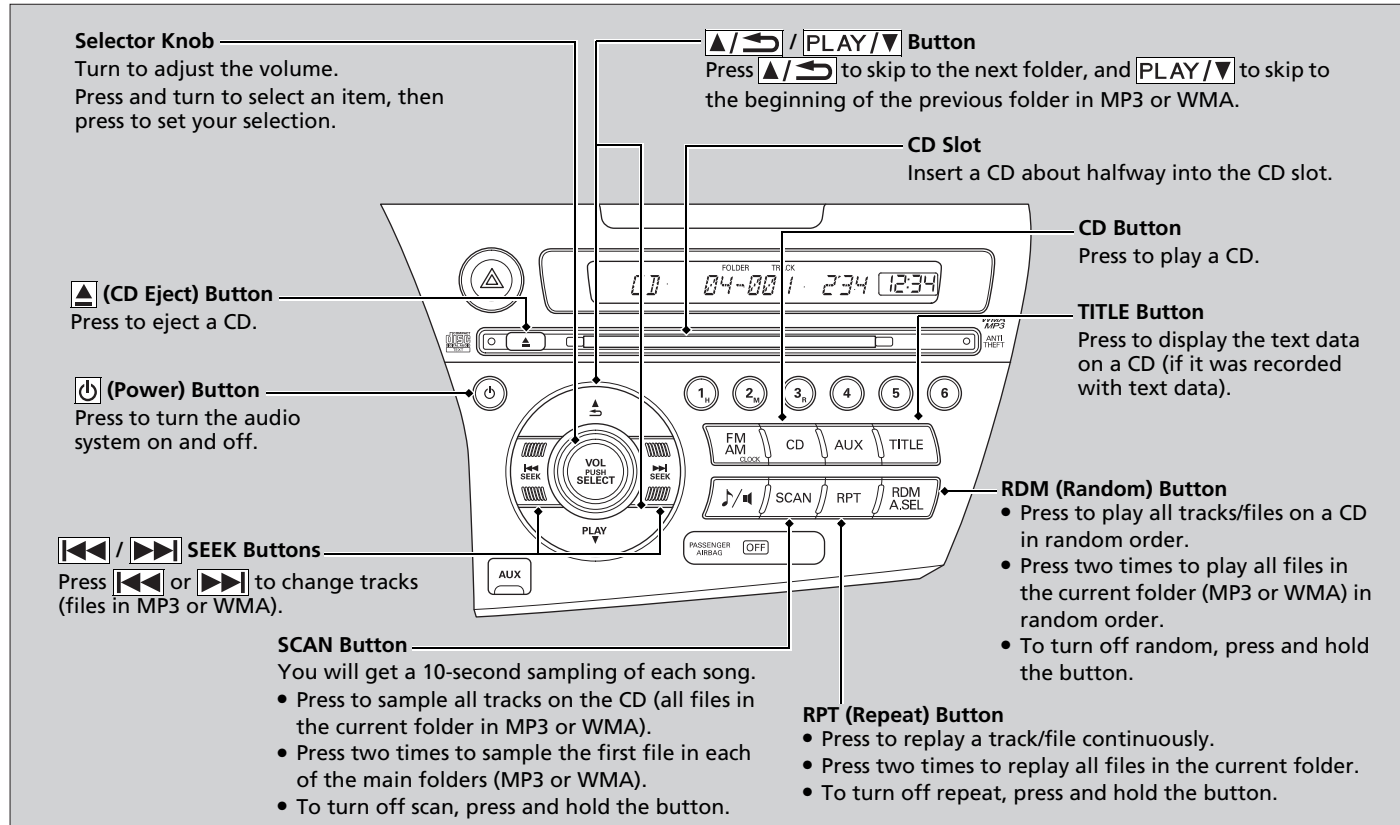

The display shows up to 31 characters of text data. Press and hold the **TITLE** button to see additional characters. **▷** indicates that the text data continues. The display goes back to the previous screen if you press and hold the button again.

Playing a CD

Your audio system supports audio CDs, CD-Rs and CD-RWs in either MP3 or WMA format. With the CD loaded, press the **CD** button.



How to Select a File from a Folder with the Selector Knob (MP3/WMA)

1. Press  to switch the display to a folder list.
2. Rotate  to select a folder.
▶ Press **PLAY/▼** button to play the first file on the selected folder.
3. Press  to change the display to a list of files in that folder.
4. Rotate  to select a file, then press .

▶▶ Playing a CD

NOTICE

Do not use CDs with adhesive labels. The label can cause the CD to jam in the unit.

WMA files protected by digital rights management (DRM) cannot be played.

The audio system displays **UNSUPPORTED**, then skips to the next file.

Text data appears on the display under the following circumstances:

- When you select a new folder, file, or track.
- When you change the audio mode to CD.
- When you insert a CD.

The display shows up to 31 characters of text data. Press and hold the **TITLE** button to see additional characters.  indicates that the text data continues. The display goes back to the previous screen if you press and hold the button again.

If you eject the CD but do not remove it from the slot, the system reloads the CD automatically after several seconds.



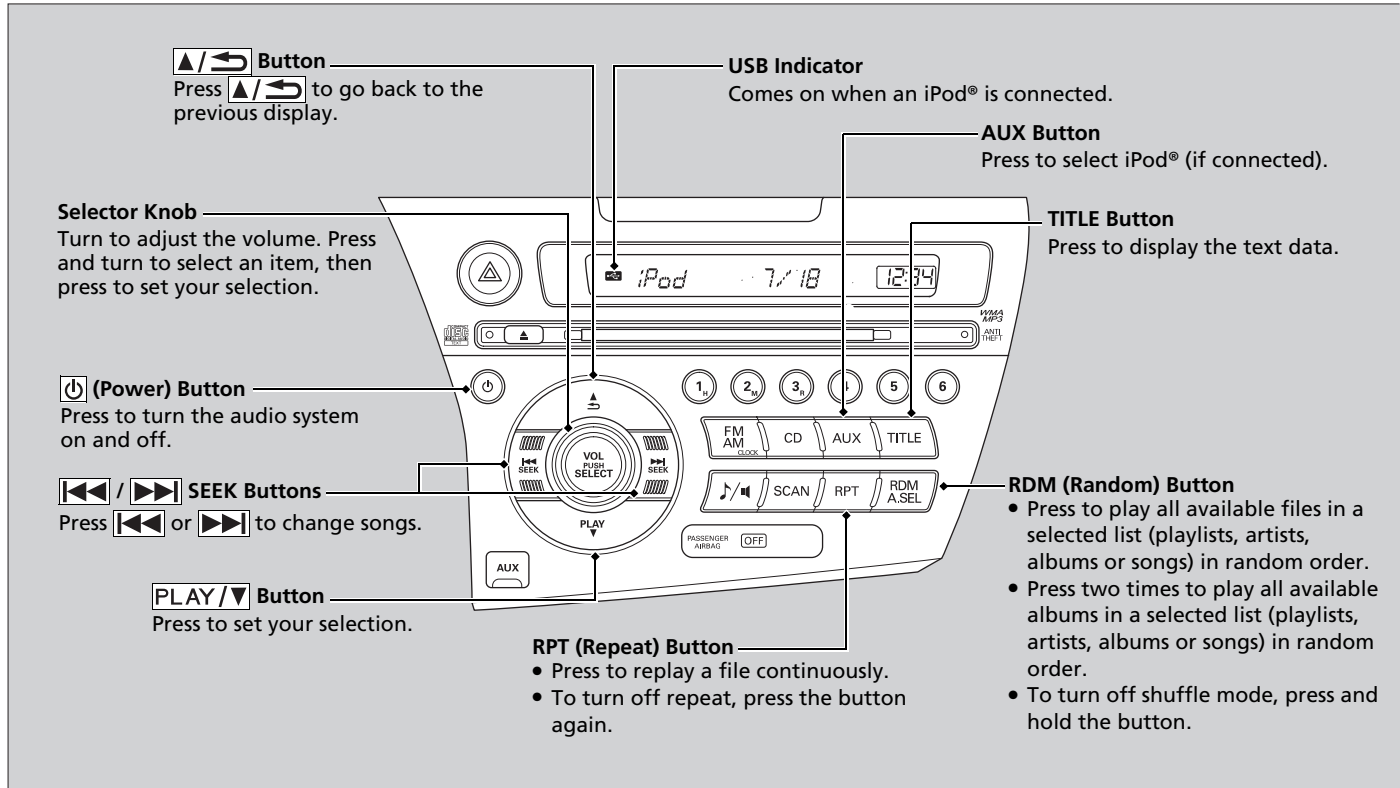

Playing an iPod®

Connect the iPod® using your dock connector to the USB adapter cable, then press the **AUX** button.

 **USB Adapter Cable** P. 139



■ How to Select a File from the iPod® Menu

1. Press  to display the iPod® menu.
2. Rotate  to select a menu.
3. Press  to display the items on that menu.
4. Rotate  to select an item, then press .

▶▶ Playing an iPod®

Available operating functions vary on models or versions. Some functions may not be available on the vehicle's audio system.

If there is a problem, you may see an error message on the display.

 [iPod®/USB Flash Drive P. 154](#)

Playing a USB Flash Drive

Your audio system reads and plays sound files on a USB flash drive in either MP3, WMA or AAC*1 format.

Connect your USB flash drive to the USB adapter cable, then press the **AUX** button.

▶ **USB Adapter Cable** P. 139

▲/◀ / ▶/▼ / PLAY/▼ Button
Press ▲/◀ to skip to the next folder, and ▶/▼ to skip to the beginning of the previous folder.

Selector Knob
Turn to adjust the volume. Press and turn to select an item, then press to set your selection.

(Power) Button
Press to turn the audio system on and off.

SEEK Buttons
Press ◀◀ or ▶▶ to change files.

SCAN Button
You will get a 10-second sampling of each file.

- Press to sample all files in the current folder.
- Press two times to sample the first file in each of the main folders.
- To turn off scan, press and hold the button.

USB Indicator
Comes on when a USB flash drive is connected.

AUX Button
Press to select USB flash drive (if connected).

TITLE Button
Press to display the text data.

RDM (Random) Button

- Press to play all files in random order.
- Press two times to play all files in the current folder in random order.
- To turn off random, press and hold the button.





RPT (Repeat) Button

- Press to replay a file continuously.
- Press two times to replay all files in the current folder.
- To turn off repeat, press and hold the button.

*1: Only AAC format files recorded with iTunes® are playable on this unit.

ORG
TOC
Features
Index
Home

■ How to Select a File from a Folder with the Selector Knob

1. Press  to switch the display to a folder list.
2. Rotate  to select a folder.
▶ Press **PLAY/▼** button to play the first file on the selected folder.
3. Press  to change the display to a list of files in that folder.
4. Rotate  to select a file, then press .

▶▶ Playing a USB Flash Drive

Use the recommended USB flash drives.

 [USB Flash Drives P. 157](#)

Files in WMA format protected by digital rights management (DRM) are not played.



The audio system displays **UNPLAYABLE FILE**, and then skips to the next file.

If there is a problem, you may see an error message on the display.

 [iPod®/USB Flash Drive P. 154](#)

CD Player

If a disc error occurs, you may see the following error messages.

Error Message	Cause	Solution
HEAT ERROR	High temperature	<ul style="list-style-type: none"> Turn the audio system off and allow the player to cool down until the error message is cleared.
UNSUPPORTED	Track/file format not supported	<ul style="list-style-type: none"> Current track/file will be skipped. The next supported track/file plays automatically.
BAD DISC PLEASE CHECK OWNERS MANUAL PUSH EJECT	Mechanical error	<ul style="list-style-type: none"> Press the  (eject) button and remove the disc, and check that the error message is cleared. Check that the disc is not damaged or deformed, and insert the disc again. <ul style="list-style-type: none"> Protecting CDs P. 156
MECH ERROR		<ul style="list-style-type: none"> If the error message reappears, press the  button, and pull out the disc. Insert a different disc. If the new disc plays, there is a problem with the first disc. If the error message repeats, or the disc cannot be removed, contact your dealer. Do not try to force the disc out of the player.
CHECK DISC	Disc error	<ul style="list-style-type: none"> Check that the disc is not damaged or deformed. <ul style="list-style-type: none"> Protecting CDs P. 156

iPod®/USB Flash Drive

If an error occurs while playing an iPod® or USB flash drive, you may see the following error messages. If you cannot clear the error message, contact a dealer.

Error Message	Solution
USB ERROR	Appears when there is a problem with the USB adapter unit. Check if the device is compatible with the USB adapter unit.
BAD USB DEVICE PLEASE CHECK OWNERS MANUAL	Appears when an incompatible device is connected. Disconnect the device. Then turn the audio system off, and turn it on again. Do not reconnect the device that caused the error.
iPod NO SONG	Appears when the iPod® is empty. Check that compatible files are stored on the device.
UNSUPPORTED VER.	Appears when an unsupported iPod® is connected. If it appears when a supported iPod® is connected, update the iPod® software to the newer version.
CONNECT RETRY	Appears when the system does not acknowledge the iPod®. Reconnect the iPod®.
UNPLAYABLE FILE	Appears when the files in the USB flash drive are DRM or an unsupported format. This error message appears for about 3 seconds, then plays the next song.
USB NO SONG	Appears when the USB flash drive is empty or there are no MP3, WMA, or AAC files in the USB flash drive. Check that compatible files are stored on the device.
UNSUPPORTED	Appears when an unsupported device is connected. If it appears when the supported device is connected, reconnect the device.

Recommended CDs

- Use only high-quality CD-R or CD-RW discs labeled for audio use.
- Use only CD-R or CD-RW discs on which the recordings are closed.
- Play only standard round-shaped CDs.

The CD packages or jackets should have one of these marks.



CDs with MP3 or WMA files

- Some software files may not allow for audio play or text data display.
- Some versions of MP3 or WMA formats may be unsupported.

Recommended CDs

A Dual-disc cannot play on this audio unit. If recorded under certain conditions, a CD-R or CD-RW may not play either.

■ Protecting CDs

Follow these precautions when handling or storing CDs:

- Store a CD in its case when it is not being played.
- When wiping a CD, use a soft clean cloth from the center to the outside edge.
- Handle a CD by its edge. Never touch either surface.
- Never insert foreign objects into the CD player.
- Keep CDs out of direct sunlight and extreme heat.
- Do not place stabilizer rings or labels on the CD.
- Avoid fingerprints, liquids, and felt-tip pens on the CD.

▶▶ Protecting CDs

NOTICE

Do not insert a damaged CD. It may be stuck inside and damage the audio unit.

Examples:

- Bubbled, wrinkled, labeled, and excessively thick CDs



Bubbled/
Wrinkled



With Label/
Sticker



Using
Printer Label
Kit



Sealed



With Plastic Ring

- Damaged CDs



Chipped/
Cracked



Warped



Burrs

- Poor quality CDs

- Small CDs



3-inch
(8-cm)
CD

Compatible iPod® and USB Flash Drives

■ iPod® Model Compatibility

Model
iPod ® (5th generation)
iPod classic ® 80GB/160GB
iPod classic ® 120GB
iPod classic ® 160GB (launch in 2009)
iPod nano ®
iPod touch ®

■ USB Flash Drives

- Use a recommended USB flash drive of 256 MB or higher.
- Some digital audio players may not be compatible.
- Some USB flash drives (e.g., a device with security lockout) may not work.
- Some software files may not allow for audio play or text data display.
- Some versions of MP3, WMA, or AAC formats may be unsupported.

▣ iPod® Model Compatibility

This system may not work with all software versions of these devices.

▣ USB Flash Drives

Files on the USB flash drive are played in their stored order. This order may be different from the order displayed on your PC or device.

Models with navigation system

For models with the navigation system, see Navigation System Manual for how to operate the *Bluetooth*® HandsFreeLink®.

Models without navigation system

Bluetooth® HandsFreeLink® (HFL) allows you to place and receive phone calls using your vehicle's audio system, without handling your cell phone.

Using HFL

HFL Buttons

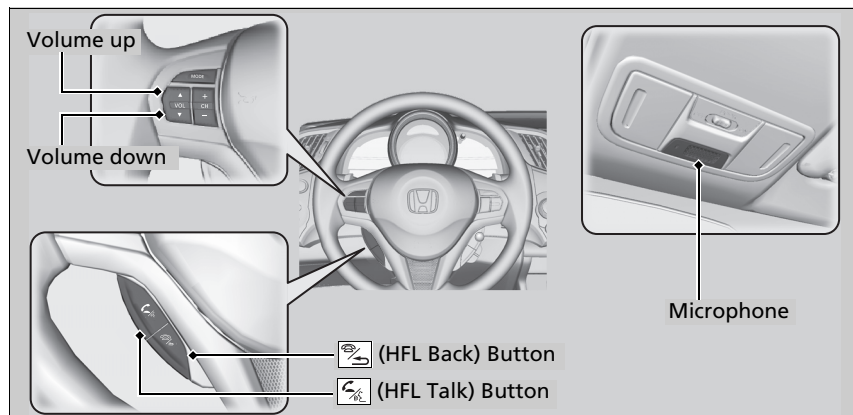

 **Button:** Press to give a command or answer a call.

 **Button:** Press to end a call, go back to the previous command, or cancel a command.

Bluetooth® HandsFreeLink®

To use HFL, you need a *Bluetooth*-compatible cell phone. For a list of compatible phones, pairing procedures, and special feature capabilities:

- **U.S.:** Visit www.handsfreelink.honda.com, or call (888) 528-7876.
- **Canada:** Visit www.handsfreelink.ca, or call (888) 528-7876.

Voice control tips

- Adjust or close the vents and all windows, as noise coming from them may interfere with the microphone.
- Press and release the  button before giving a command. Speak clearly and naturally after a beep.
- If the microphone picks up voices other than yours, the command may be misinterpreted.
- A command that consists of several words can be spoken together. For example, say "Call 123-456-7890" at once.
- When HFL is in use, navigation voice commands cannot be recognized.
- To change the volume level, use the audio system's volume knob or the remote audio controls on the steering wheel.

State or local laws may prohibit the operation of handheld electronic devices while operating a vehicle.

Help Features

- To hear general HFL information and help, say *“Tutorial.”*
- Say *“Hands-free help”* or *“Help”* any time to get help or hear a list of commands.

HFL Status Display

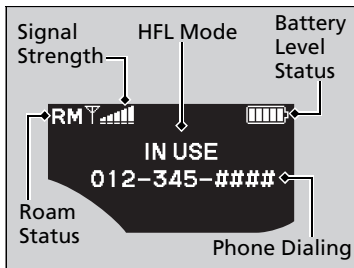

The multi-information display notifies you when there is an incoming call.

Bluetooth® HandsFreeLink®

Bluetooth® Wireless Technology

The *Bluetooth®* word mark and logos are registered trademarks owned by *Bluetooth SIG, Inc.*, and any use of such marks by Honda Motors Co., Ltd., is under license. Other trademarks and trade names are those of their respective owners.

HFL Limitations

An incoming call on HFL will interrupt the audio system when it is playing. It will resume when the call is ended.

HFL Status Display

The information that appears on the multi-information display varies between phone models.

You can change the system language to English, French, or Spanish.

▶ [Customized Features P. 90](#)

HFL Menus

The ignition switch must be in ACCESSORY **I** or ON **II** to use HFL.

▶ HFL Menu

To use HFL, you must first pair your *Bluetooth*-compatible cell phone to the system while the vehicle is parked.

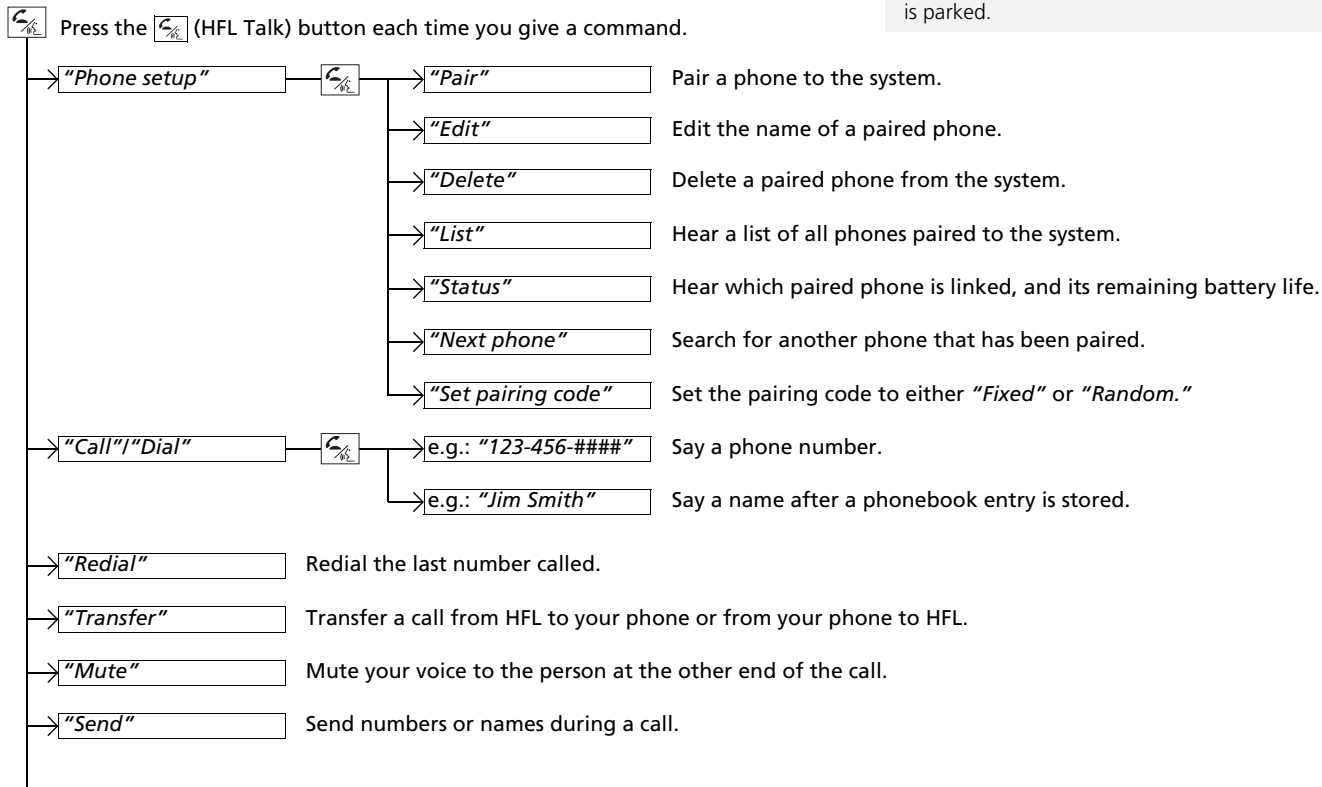

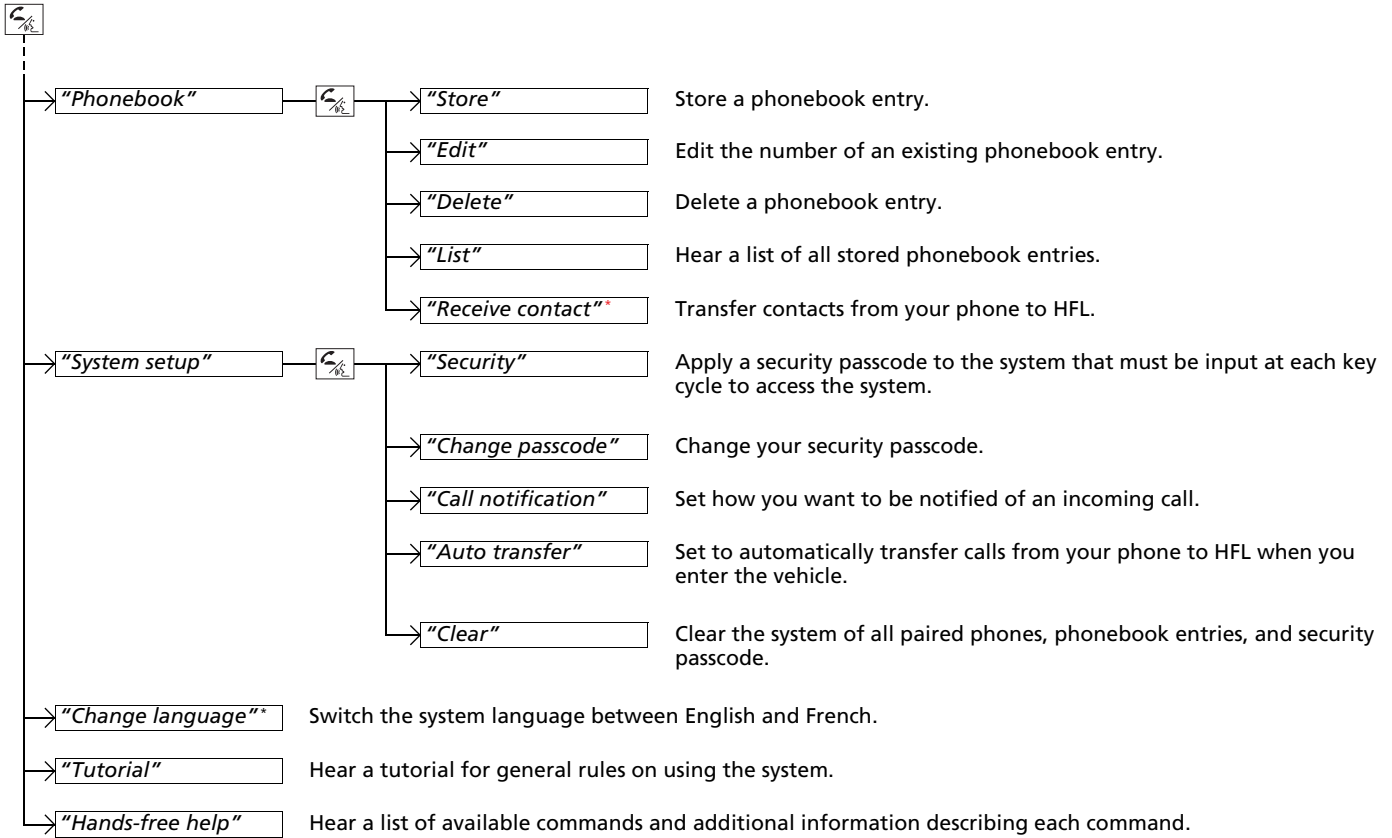

* Not available on all models

Phone Setup

■ To pair a cell phone

1. If no phone has been paired to the system before, HFL gives you information about how to pair the first phone.
If a phone has already been paired: say *"Phone Setup"* and *"Pair"* after the HFL prompts.
2. Follow the HFL prompts and put your phone in discovery or search mode.
▶ HFL gives you a four-digit code and begins searching for your phone.
3. When your phone finds a *Bluetooth*® device, select HFL from the options and enter the four-digit code.
4. Follow the HFL prompts and name the newly paired phone.

■ To rename a paired phone

1. Say *"Phone Setup."*
2. Say *"Edit"* after the prompts.
3. Follow the HFL prompts and rename the phone.
▶ If there is more than one phone paired to the system, HFL asks you which phone's name you want to change.

■ To delete a paired phone

1. Say *"Phone Setup."*
2. Say *"Delete"* after the prompts.
3. Follow the HFL prompts.
▶ HFL asks you which phone you want to delete.

Phone Setup

Press the  button and wait for a beep before giving a command.

Your *Bluetooth*-compatible phone must be paired to HFL before you can make and receive hands-free calls.

Phone Pairing Tips:

- You cannot pair your phone while the vehicle is moving.
- Your phone must be in the discoverable or search mode when pairing the phone. Refer to your phone's manual.
- Up to six phones can be paired.
- Your phone's battery may drain faster when it is paired to HFL.
- If your phone is not ready for pairing or not found by the system within three minutes, the system will time out and returns to idle.

■ To hear the name of all paired phones

1. Say "Phone Setup."
2. Say "List" after the prompts.
3. HFL reads out all the paired phone's names.

■ To hear which paired phone is currently linked

1. Say "Phone Setup."
2. Say "Status" after the prompts.
3. HFL tells you which phone is linked with the system.

■ To change the currently linked phone

1. Say "Phone Setup."
2. Say "Next Phone" after the prompts.
3. HFL disconnects the current phone, and searches for another paired phone.
4. Once another phone is found, it is connected to the system. HFL informs you which phone is now linked.

■ To change the pairing code setting

1. Say "Phone Setup."
2. Say "Set Pairing Code" after the prompts.
3. If you want HFL to create a random code each time you pair a phone, say "Random." If you want to create your own four-digit code, say "Fixed."
4. Follow the HFL prompts.

☒ Phone Setup

If no other phones are found or paired when trying to switch to another phone, HFL informs you that the original phone is linked again.

The "Status" and "Next Phone" commands use: Only one paired phone at a time can be linked to HFL. When there are two or more paired phones in the vehicle, the first paired phone that the system finds is linked.

■ Making a Call

You can make calls using any phone number or a name in the HFL phonebook, and redial the last number called.

■ Direct dialing a phone number

1. Say "Call" or "Dial."
2. Say the number you want to dial after the prompts.
3. Say "Call" or "Dial" after the prompts.

■ From the HFL phonebook

1. Say "Call" or "Dial."
2. Say the name stored in the HFL phonebook after the prompts.
3. Follow the HFL prompts.

■ To redial the last number called by HFL

Say "Redial."

■ To end a call

Press the  (HFL back) button.

☒ Making a Call



Press the  button and wait for a beep before giving a command.

HFL uses a Class 2 Bluetooth, with has a maximum range of about 30 feet (10 meters).

HFL allows you to talk up to 30 minutes after you remove the key from the ignition switch. However, this may weaken the vehicle's 12 volt battery.

Once a call is connected, you can hear the voice of the person you are calling through the audio speakers.

Receiving a Call

Press the  button to answer the call, or the  button to hang up. When there is an incoming call, a call notification (if activated) sounds and a message appears on the display.

Transferring a Call

You can transfer a call from HFL to your phone, or from your phone to HFL. Press the  button and say "Transfer."

Muting a Call

To mute or unmute your voice during a call, press and release the  button and say "Mute."

Receiving a Call

Call Waiting

Press the  button to put the current call on hold to answer the incoming call.

Press the  button again to return to the current call.

Ignore the incoming call if you do not want to answer it.

Press the  button if you want to hang up the current call and answer the incoming call.

■ Sending Numbers or Name During a Call

You can send numbers and names during a call. This is useful when calling a menu-driven phone system.

■ To send a number or name during a call

1. Say "Send."
2. Say the number or name you want to send after the prompts.
3. Follow the HFL prompts.

■ HFL Phonebook

You can store up to 50 names with their associated numbers in HFL. The numbers you store can be account numbers or passwords. These numbers can be sent to a menu-driven call.

■ To store a phonebook entry



1. Say "Phonebook."
2. Say "Store" after the prompts.
3. Say a name you want to list as your phonebook entry.
4. Say the number you want to store for the name entry.
5. Follow the HFL prompts and say "Enter" to store the entry.

■ To edit the number stored for a name

1. Say "Phonebook."
2. Say "Edit" after the prompts.
3. Say a name you want to edit. When asked, say the new number for that name.
4. Follow the HFL prompts and say "Enter" to store the entry.

▶▶ Sending Numbers or Name During a Call

Press the  button before a command.

To send a , say "Pound." To send a , say "Star."

▶▶ HFL Phonebook

- Avoid using duplicate name entries.
- Avoid using "home" as a name entry.
- It is easier for HFL to recognize a multisyllabic or longer name. For example, use "Peter" instead of "Pete," or "John Smith" instead of "John."

■ To delete a name

1. Say "Phonebook."
2. Say "Delete" after the prompts.
3. Say a name you want to delete.
4. Say "Yes," and follow the HFL prompts.

■ To list all names in the phonebook

1. Say "Phonebook."
2. Say "List" after the prompts.
3. HFL begins reading the names in the order they were stored.
4. When you hear a name you want to call, say "Call."

■ To store a specific phone number from your cell phone directly to the HFL phonebook *

1. Say "Phonebook."
2. Say "Receive Contact" after the prompts.
3. Follow the HFL prompts, select a number from your cell phone, and send it to HFL.
 - ▶ If it is not the number you want to store, say "Discard."
4. Say the name for that number.
5. Follow the HFL prompts to continue.

* Not available on all models

System Setup

This command group allows you to change or customize HFL basic settings.

■ To set a four-digit passcode to lock the HFL system for security

1. Say "System Setup."
2. Say "Security."
3. Follow the HFL prompts and say the four-digit number of your choice.
4. Follow the HFL prompts and confirm the number.

■ To change the security passcode

1. Say "System Setup."
2. Say "Change Passcode" after the prompts.
3. Say the new four-digit passcode after the HFL prompts.
4. Follow the HFL prompts.

■ To select a ring tone or a prompt as the incoming call notification

1. Say "System Setup."
2. Say "Call Notification" after the prompts.
3. Say "Ring Tone" or "Prompt" after the prompts. For no audible notification, say "Off."

System Setup

Press the  button before a command.

Once a passcode is set, you are required to enter the passcode with every new key cycle to use HFL. If you forget the code, go to your dealer to have the passcode reset. You can also cancel the passcode by clearing all the data stored in the HFL system.

[▶ To clear the system P. 169](#)

The default setting of the incoming notification is a prompt.

■ To activate or deactivate the auto transfer function

The call on your cell phone can be automatically transferred to HFL when you get into the vehicle and turn on the ignition switch.

1. Say "System Setup."
2. Say "Auto Transfer" after the prompts. HFL lets you know the current status.
3. Follow the HFL prompts to change the setting.

■ To clear the system

Paired phones, all stored or imported phonebook data, and any passcodes are erased.

1. Say "System Setup."
2. Say "Clear" after the prompts.
3. Follow the HFL prompts.

■ Change Language*

You can set the system language to French or English.

1. Say "Change Language."
2. Follow the HFL prompts.

If you have not named your paired phone in the selected language, HFL will ask you to name it in that language.

System Setup

Press the  button before a command.

You can clear the system when you have forgotten the passcode and cannot access HFL. When HFL asks you for the passcode, say "System Clear."

Change Language*

Press the  button before a command.

Quick Language Selection
If you want to change the language, to French for example, say "Français," and follow the prompt.

* Not available on all models

Driving

This chapter discusses driving, refueling, and information on items such as accessories.



- Before Driving**
 - Driving Preparation 172
 - Maximum Load Limit..... 175
- Towing a Trailer**
 - Towing Your Vehicle..... 177
- When Driving**
 - Starting the Engine 178
 - Precautions While Driving..... 181
 - Automatic Transmission (CVT)..... 182
 - Automatic transmission (CVT) models
 - Shifting 183
 - Manual transmission models
 - Shifting 188

- Automatic transmission (CVT) models
 - Auto Idle Stop 191
- Manual transmission models
 - Auto Idle Stop 194
 - 3-Mode Drive System..... 197
 - Plus Sport System 198
 - Cruise Control 200
 - VSA® (Vehicle Stability Assist), aka ESC (Electronic Stability Control), System .. 203
 - TPMS (Tire Pressure Monitoring System) 205
 - Tire Pressure Monitoring System (TPMS) - Required Federal Explanation 206
- Braking**
 - Brake System 208

- ABS (Anti-lock Brake System)..... 210
- Brake Assist System 211
- Parking Your Vehicle**
 - When Stopped 212
- Multi-View Rear Camera**..... 213
- Rearview Camera** 214
- Refueling**
 - Fuel Information 216
 - How to Refuel 217
- Fuel Economy**
 - Improving Fuel Economy..... 219
- Accessories and Modifications**
 - Accessories 220
 - Modifications 220

Driving Preparation

Check the following items before you start driving.

Exterior Checks

- Make sure there are no obstructions on the windows, door mirrors, exterior lights, or other parts of the vehicle.
 - ▶ Remove any frost, snow, or ice.
 - ▶ Remove any snow on the roof, as this can slip down and obstruct your field of vision while driving. If frozen solid, remove ice once it has softened.
 - ▶ When removing ice from around the wheels, be sure not to damage the wheel or wheel components.
- Make sure the hood is securely closed.
 - ▶ If the hood opens while driving, your front view will be blocked.
- Make sure the tires are in good condition.
 - ▶ Check air pressures, and check for damage and excessive wear.
 - ▶ [Checking and Maintaining Tires P. 253](#)
- Make sure there are no people or objects behind or around the vehicle.
 - ▶ There are blind spots from the inside.

Exterior Checks

NOTICE

When doors are frozen shut, use warm water around the door edges to melt any ice. Do not try to force them open, as this can damage the rubber trim around the doors. When done, wipe dry to avoid further freezing.

Do not pour warm water into the key cylinder. You will be unable to insert key if the water freezes in the hole.

Heat from the engine and exhaust can ignite flammable materials left under the hood, causing a fire. If you've parked your vehicle for an extended period, inspect and remove any debris that may have collected, such as dried grass and leaves that have fallen or have been carried in for use as a nest by a small animal.

Also check under the hood for leftover flammable materials after you or someone else has performed maintenance on your vehicle.

Interior Checks

- Store or secure all items on board properly.
 - ▶ Carrying too much cargo, or improperly storing it, can affect your vehicle's handling, stability, stopping distance, and tires, and make it unsafe.
 - [Maximum Load Limit P. 175](#)
- Do not pile items higher than the seat height.
 - ▶ They can block your view and may be thrown forward in the event of sudden braking.
- Do not place anything in the seat footwells. Make sure to secure the floor mats.
 - ▶ An object or unsecured floor mat can interfere with your brake and accelerator pedal operation while driving.
- If you have any animals on board, do not let them move around in the vehicle.
 - ▶ They may interfere with driving and a crash could occur.
- Securely close and lock both doors and the hatch.
 - [Locking/Unlocking the Doors from the Inside P. 102](#)
- Adjust your seating position properly.
 - [Adjusting the Seats P. 121](#)
- Adjust the mirrors and steering wheel properly for your driving.
 - ▶ Adjust them while sitting in the proper driving position.
 - [Adjusting the Mirrors P. 119](#)
 - [Adjusting the Steering Wheel P. 118](#)

Interior Checks

The headlight aim is set by the factory, and does not need to be adjusted. However, if you regularly carry heavy items in the cargo area, have the aiming readjusted at a dealer or by a qualified technician.

ORG

- Be sure items placed on the floor behind the driver's and passenger's seats cannot roll under the seats.
 - ▶ They can interfere with the driver's ability to operate the pedals, the operation of the seats, or the operation of the sensors under the seats.
- Everyone in the vehicle must fasten their seat belt.
 - ▶ [Fastening a Seat Belt P. 35](#)
- Make sure that the indicators in the instrument panel come on when you start the vehicle, and go off soon after.
 - ▶ Always have a dealer check the vehicle if a problem is indicated.
 - ▶ [Indicators P. 66](#)

TOC

Driving

Index

Home

Maximum Load Limit

The maximum load for your vehicle is 850 lbs (385 kg).
See Tire and Loading Information label attached to the driver's doorjamb.

Label Example

TIRE	SIZE	COLD TIRE PRESSURE	SEE OWNER'S MANUAL FOR ADDITIONAL INFORMATION
FRONT	XXXX/XXXXX XXX	XXXKPA, XXPSI	
REAR	XXXX/XXXXX XXX	XXXKPA, XXPSI	
SPARE	XXXX/XXXXX XXX	XXXKPA, XXPSI	

This figure includes the total weight of all occupants, cargo, and accessories, and the tongue load if you are towing a trailer.

Steps for Determining Correct Load Limit -

- (1) Locate the statement "The combined weight of occupants and cargo should never exceed XXX kg or XXX lbs." on your vehicle's placard.
- (2) Determine the combined weight of the driver and passengers that will be riding in your vehicle.
- (3) Subtract the combined weight of the driver and passengers from XXX kg or XXX lbs.
- (4) The resulting figure equals the available amount of cargo and luggage load capacity. For example, if the "XXX" amount equals 1,400 lbs. and there will be five 150 lb. passengers in your vehicle, the amount of available cargo and luggage load capacity is 650 lbs.
(1,400 - 750 (5 x 150) = 650 lbs.)

Maximum Load Limit

⚠ WARNING

Overloading or improper loading can affect handling and stability and cause a crash in which you can be hurt or killed.

Follow all load limits and other loading guidelines in this manual.

Gross Vehicle Weight Rating (GVWR):

The maximum allowable weight of the vehicle, all occupants, all accessories, and all cargo.

➤ [Specifications P. 306](#)

Gross Axle Weight Rating (GAWR):





The maximum allowable weight of the vehicle axle.

➤ [Specifications P. 306](#)

- (5) Determine the combined weight of luggage and cargo being loaded on the vehicle. That weight may not safely exceed the available cargo and luggage load capacity calculated in step 4.
- (6) If your vehicle will be towing a trailer, load from your trailer will be transferred to your vehicle. Consult this manual to determine how this reduces the available cargo and luggage load capacity of your vehicle.

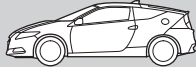
In addition, the total weight of the vehicle, all occupants, accessories, cargo, and trailer tongue load must not exceed the Gross Vehicle Weight Rating (GVWR) or the Gross Axle Weight Rating (GAWR). Both are on a label on the driver's doorjamb.

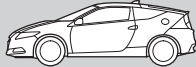
Load Limits Example

<p>Example 1</p>  <p>Max Load 450 lbs (204 kg)</p>	\geq	 <p>Passenger Weight 150 lbs x 1 = 150 lbs (68 kg x 1 = 68 kg)</p>	<p>+</p>	 <p>Cargo Weight 300 lbs (136 kg)</p>
<p>Example 2</p>  <p>Max Load 450 lbs (204 kg)</p>	\geq	 <p>Passenger Weight 150 lbs x 2 = 300 lbs (68 kg x 2 = 136 kg)</p>	<p>+</p>	 <p>Cargo Weight 150 lbs (68 kg)</p>

Your vehicle is not designed to tow a trailer. Attempting to do so can void your warranties.

Towing Your Vehicle

Your vehicle is not designed to be towed behind a motor home. If your vehicle needs to be towed in an emergency, refer to the emergency towing information.

[📄 Emergency Towing P. 301](#)

Starting the Engine

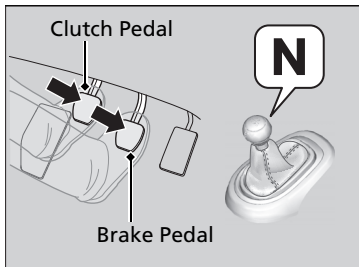
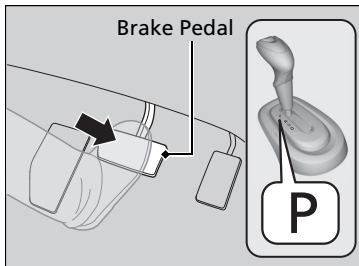
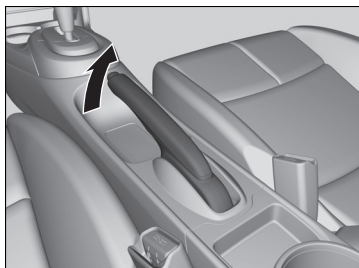

1. Make sure the parking brake is applied.

Automatic transmission (CVT) models

2. Check that the shift lever is in **P**, then depress the brake pedal.

▶ Although it is possible to start the vehicle in **N**, it is safer to start it in **P**.

Manual transmission models

2. Check that the shift lever is in **N**. Then depress the brake pedal with your right foot, and the clutch pedal with your left foot.

▶ The clutch pedal must be fully depressed to start the engine.

Starting the Engine

Keep your foot firmly on the brake pedal when starting the engine.

The engine is harder to start in cold weather and in thinner air found at altitudes above 8,000 feet (2,400 meters).

When starting the engine in cold weather, turn off all electrical accessories such as the lights, climate control system, and rear defogger in order to reduce battery drain.

If the exhaust system sounds abnormal or you can smell exhaust gas inside the vehicle, have your vehicle checked by a dealer. There may be a problem with the engine or exhaust system.

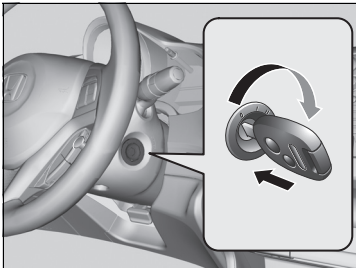

If you live in a region where winter is extremely cold, an engine block heater will improve starting and warming of the engine. If temperatures consistently below -22°F (-30°C) are expected, the coolant mixture should be charged to a higher concentration to prevent freezing. Consult a dealer for details.



3. Turn the ignition switch to START  without depressing the accelerator pedal.

Starting to Drive

Automatic transmission (CVT) models

1. Keeping your right foot on the brake pedal, release the parking brake. Check that the parking brake and brake system indicator has gone off.
➤ [Parking Brake P. 208](#)
2. Put the shift lever in . Select  when reversing.
3. Gradually release the brake pedal and gently depress the accelerator pedal to pull away.

Starting the Engine

Do not hold the key in START  for more than 15 seconds.

- If the engine does not start right away, wait for at least 10 seconds before trying again.
- If the engine starts, but then immediately stops, wait at least 10 seconds before repeating step 3 while gently depressing the accelerator pedal. Release the accelerator pedal once the engine starts.

The immobilizer system protects your vehicle from theft. If an improperly coded key (or other device) is used, the engine's fuel system is disabled

➤ [Immobilizer System P. 106](#)

■ Creep aid system

Automatic transmission (CVT) models

With the shift lever in **D** or **N**, this feature applies brake pressure briefly as you release the brake pedal to prevent the vehicle from moving unexpectedly.

■ Hill start assist system

Hill start assist keeps the brake engaged briefly to help prevent the vehicle from rolling on inclines as you move your foot from the brake pedal to the accelerator.

Manual transmission models

Depress the clutch pedal, and shift to **1** when facing uphill, or **R** when facing downhill, then release the brake pedal.

Automatic transmission (CVT) models

Move the shift lever to **D** or select the **L** mode when facing uphill, or **R** when facing downhill, then release the brake pedal.

☒ Hill start assist system

Hill start assist may not prevent the vehicle from rolling downhill on a very steep or slippery slope, and does not operate on small inclines.

Hill start assist is not a replacement for the parking brake.

Hill start assist will still operate even when VSA® is switched off.

Precautions While Driving

In Rain

Avoid driving in deep water and on flooded roads. This can damage the engine and driveline, and cause electrical component failure.

Other Precautions

If there is a strong impact with something under the vehicle, stop in a safe location. Check the underside of the vehicle for damage or any fluid leaks.

Precautions While Driving

NOTICE

Do not operate the shift lever while pressing the accelerator pedal. You could damage the transmission.

If the ignition switch is turned to ACCESSORY **[I]** or LOCK **[O]** while driving, the engine will shut down and all steering and brake power assist functions will stop, making it difficult to control the vehicle.

Do not put the shift lever in **[N]**, as you will lose engine braking (and acceleration) performance.

During the first 600 miles (1,000 km) of operation, avoid sudden acceleration or full throttle operation so as to not damage the engine or powertrain.

Avoid hard braking for the first 200 miles (300 km). You should also follow this when the brake pads are replaced.

NOTICE

Following can damage the under spoiler:

- Parking the vehicle by a parking block
- Parallel parking along the road shoulder
- Driving towards the bottom of a hill
- Driving up or down to a different surface level (such as a road shoulder)
- Driving on a rutted or bumpy road
- Driving on a road with potholes

Automatic Transmission (CVT)

■ Creeping

The engine runs at higher idle speed and creeping increases.
Keep the brake pedal firmly depressed when stopped.

■ Kickdown

Quickly depressing the accelerator pedal while driving uphill may cause the transmission to drop to a lower ratio, unexpectedly increasing vehicle speed.
Depress the accelerator pedal carefully, especially on slippery roads and curves.

Automatic transmission (CVT) models

Shifting

Change the shift position in accordance with your driving needs.

■ Shift lever positions

Release Button

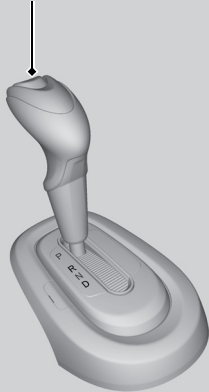

P Park
Used when parking or starting the engine

R Reverse
Used when reversing

N Neutral
Used when idling

D Drive
Used:

- For normal driving
- When temporarily driving in the 7-speed manual shift mode (when driving in ECON or NORMAL mode)
- For driving in the 7-speed manual shift mode (when driving in SPORT mode)
- For driving in L mode

☒ Shifting

You cannot turn the ignition switch to LOCK **[O]** and remove the key unless the shift lever is in **[P]**.

The vehicle may move forward very slightly even in **[N]** while the engine is cold. Depress the brake pedal firmly and, when necessary, apply the parking brake.

The engine may cut in and out in **[R]** or depending on the road condition, even when the engine speed is lower than the tachometer's red zone. This is the engine's computer working to protect the transmission.

Continued

■ Shift Lever Operation

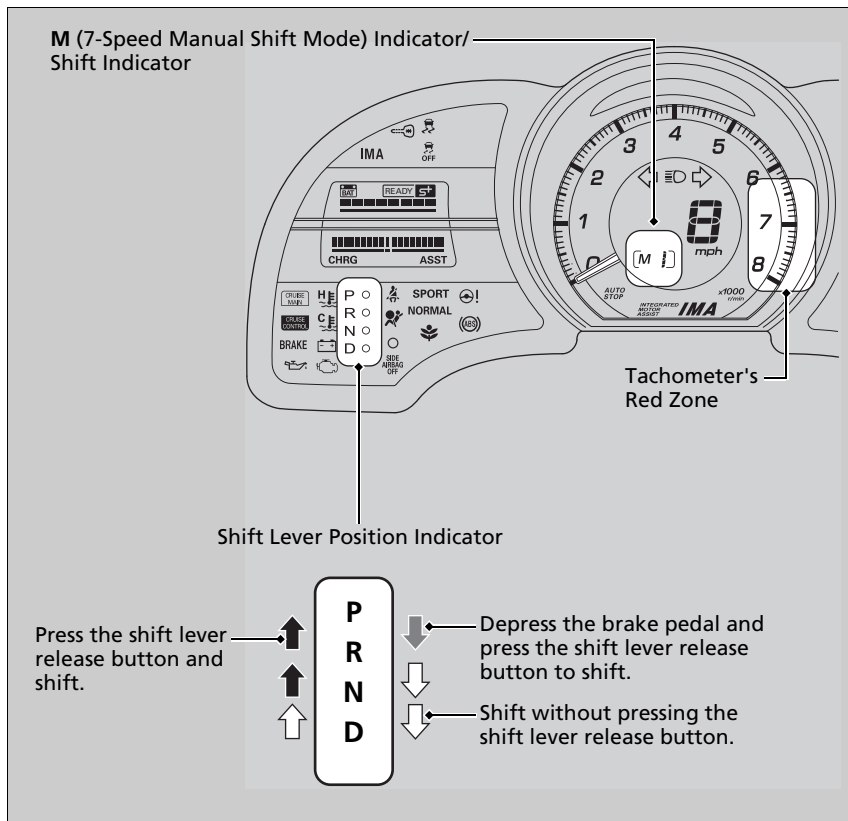

▶▶ Shift Lever Operation

NOTICE

When you change the shift lever from **D** to **R** and vice versa, come to a complete stop and keep the brake pedal depressed.

Operating the shift lever before the vehicle has come to a complete standstill can damage the transmission.

Use the shift lever position indicator to check the lever position before pulling away.

Whichever position the shift lever is in when driving, a blinking **D** indicator indicates a transmission problem.

Avoid sudden acceleration and have the transmission checked by a dealer as soon as possible.

The fuel supply may be cut off if you drive at engine speeds in or over the tachometer red zone (engine speed limit). If this happens, you may experience a slight jolt.

It may not be possible to operate the shift lever if the brake pedal is applied while the shift lever release button is held down.

Depress the brake pedal first.

■ 7-Speed Manual Shift Mode

Use the paddle shifters to change between 1st and 7th speeds without removing your hands from the steering wheel. The transmission switches to the 7-speed manual shift mode when you pull a paddle shifter while driving. This mode is useful when engine braking is needed.

You can cancel this mode by pressing any of the three driving mode buttons, or pulling the  paddle shifter for a few seconds.

■ When the driving mode is in ECON or NORMAL

The shift mode goes into the 7-speed manual shift mode temporarily, and the number is displayed in the shift indicator.

The 7-speed manual shift mode is canceled automatically if you drive at constant speed or accelerate, and the number in the shift indicator goes off.

The 7-speed manual shift mode is especially useful when reducing the vehicle speed temporarily before making a turn.

■ When the driving mode is in SPORT

The shift mode goes into the 7-speed manual shift mode. The **M** indicator and the speed number are displayed in the shift indicator. As the vehicle speed slows down, the transmission automatically shifts down accordingly. When the vehicle comes to a stop, it automatically shifts down into 1st.

If the vehicle speed increases and the engine speed reaches near the tachometer's red zone, the transmission automatically shifts up.

⊞ 7-Speed Manual Shift Mode

To improve fuel economy, the transmission may shift up to a higher speed than the seventh under certain circumstances. In this case, the number in the shift indicator remains as **7**.

In the 7-speed manual shift mode, the transmission shifts up or down by operating either paddle shifter under the following conditions:

Shift Up: The engine speed reaches the lowest threshold of the higher speed position.

Shift Down: The engine speed reaches the highest threshold of the lower speed position.

When the engine speed reaches near the tachometer's red zone, the transmission shifts up automatically.

When the engine speed reaches the lowest threshold of the selected speed position, the transmission shifts down automatically.

Operating the paddle shifters on slippery surfaces may cause the tires to lock up. In this case, the 7-speed manual shift mode is canceled and goes back to the normal D driving mode.

7-Speed Manual Shift Mode Operation

7-Speed Manual Shift Mode Operation

Each paddle shift operation makes a single speed change.

To change continuously, release the paddle shifter before pulling it again for the next speed.

Recommended Shift Points

Use this table as a guideline for efficient fuel economy and effective emission control.

Shift Up	Normal Acceleration
1 to 2	15 mph (24 km/h)
2 to 3	25 mph (40 km/h)
3 to 4	40 mph (64 km/h)
4 to 5	47 mph (76 km/h)
5 to 6	52 mph (84 km/h)
6 to 7	57 mph (92 km/h)

The shift indicator blinks when you cannot shift up or down. It indicates that your vehicle speed is not in its allowable shifting range.

Slightly accelerate to shift up and decelerate to shift down while the indicator is blinking.

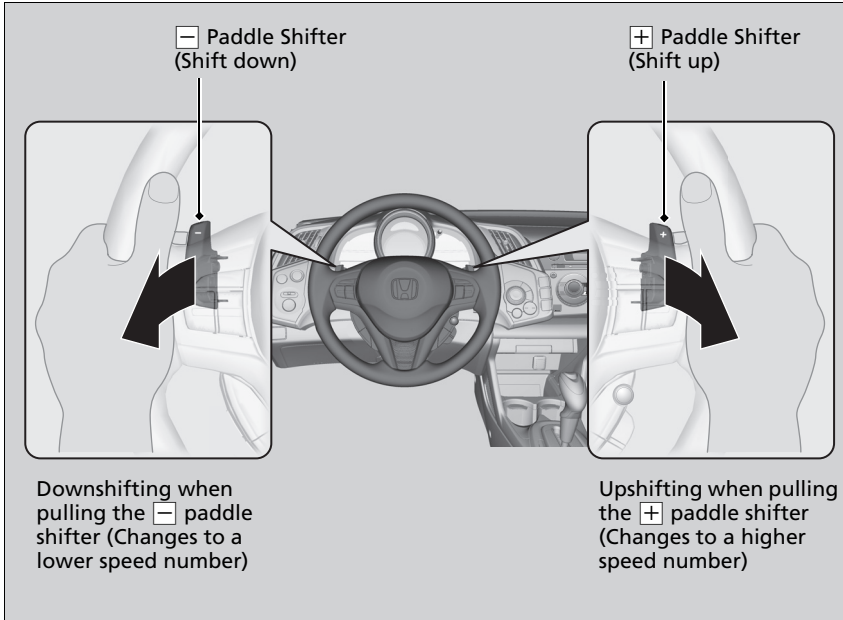

L Mode Operation

To switch to the L mode, pull and hold both paddle shifters (+ and -) at the same time with the shift lever in **D**.

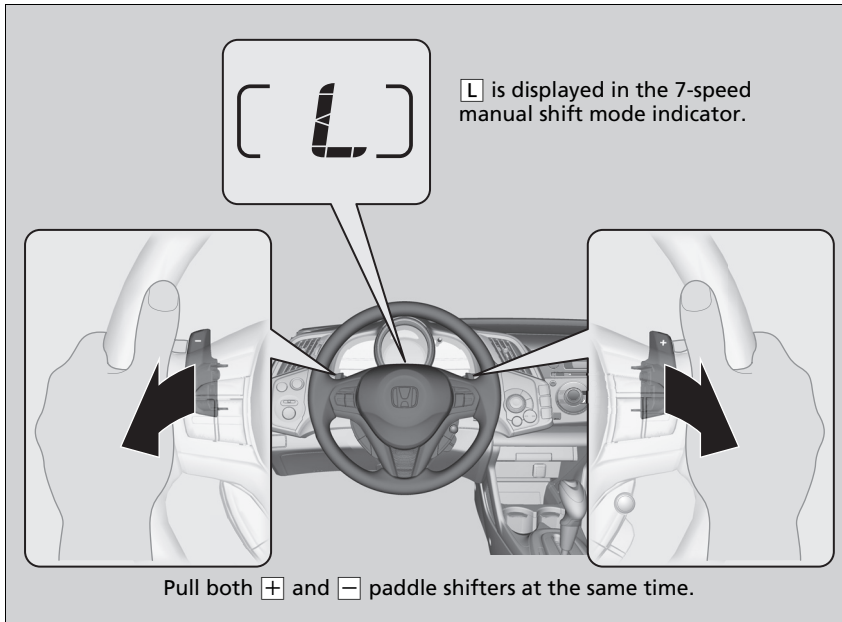

L Mode Operation

Use the L mode in the following situations:

- When you want to increase engine braking to maximum when in 7-speed manual shift mode
- When going up or down hills
- When the IMA battery is low

To cancel this mode, pull and hold both paddle shifters again, or press any of the three driving mode buttons. The **L** indicator goes off.

Manual transmission models

Shifting

Shift Lever Operation

Fully depress the clutch pedal to operate the shift lever and change gears, then slowly release the pedal.

Depress the clutch pedal, and pause for a few seconds before shifting into **R**, or shift into one of the forward gears for a moment. This stops the gears so they do not “grind.”

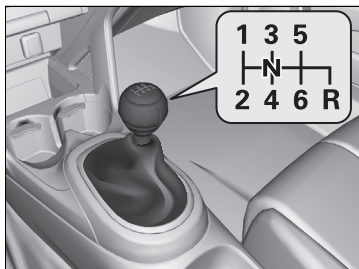

When you are not shifting, do not rest your foot on the clutch pedal. This can cause your clutch to wear out faster.

Shifting

NOTICE

Do not shift to **R** before the vehicle comes to a complete stop.

Shifting to **R** before stopping can damage the transmission.

Recommended Shift Points

Driving in the highest gear that allows the engine to run and accelerate smoothly helps to optimize fuel economy and effective emissions control. The following shift points are recommended:

Shift Up	Normal Acceleration
1st to 2nd	15 mph (24 km/h)
2nd to 3rd	25 mph (40 km/h)
3rd to 4th	40 mph (64 km/h)
4th to 5th	47 mph (76 km/h)
5th to 6th	52 mph (84 km/h)

If you exceed the maximum speed for the gear you are in, the engine speed will enter into the tachometer's red zone. When this happens, you may experience a slight jolt.

NOTICE

Before downshifting, make sure the engine will not go into the tachometer's red zone. Should this occur, it can severely damage your engine.

There is a metallic part on the shift lever. If you leave the vehicle parked outside for a long time on a hot day, be careful before moving the shift lever. Because of heat, the shift lever may be extremely hot. If the outside temperature is low, the shift lever may feel cold.

Shift Up/Down Indicators

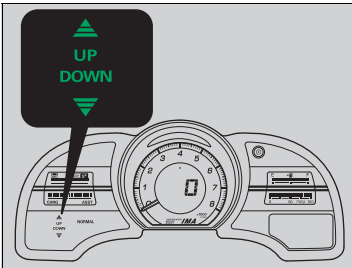

Come on to indicate when a gear change is appropriate to maintain the most fuel efficient driving style.

The shift up indicator: Comes on when shifting up is recommended.

The shift down indicator: Comes on when shifting down is recommended.

- ▶ The indicators do not come on in the SPORT mode.

Shift Up/Down Indicators

This indicator will not prompt you to downshift to increase engine braking. It is up to you to downshift to increase engine braking when driving downhill.

Always shift down at the appropriate vehicle speed.

The shift down indicator does not come on when downshifting from **2** to **1**.

Ambient meter color may change if you do not change gears when a shift indicator illuminates. This can result in a change in fuel economy.

Road and traffic conditions may require you to shift at times other than those indicated.

Reverse Lockout

The manual transmission has a lockout mechanism that stops you from accidentally shifting into **R** from a forward gear while the vehicle is moving above a certain speed.

If you cannot shift to **R** when the vehicle is stopped, do the following:

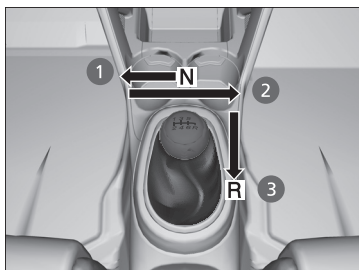

1. Depress the clutch pedal, move the shift lever all the way to the left, and shift to **R**.
2. If you still cannot shift into **R**, apply the parking brake, and turn the ignition switch to ACCESSORY **I** or LOCK **O**.
3. Depress the clutch pedal and shift into **R**.
4. Keep depressing the clutch pedal and start the engine.

Have the vehicle checked by a dealer if you have to go through this procedure repeatedly.

Automatic transmission (CVT) models

Auto Idle Stop

To help maximize fuel economy, Auto Idle Stop shuts off the engine when the vehicle comes to a stop, depending on environmental and vehicle operating conditions. The **AUTO STOP** indicator blinks at this time.

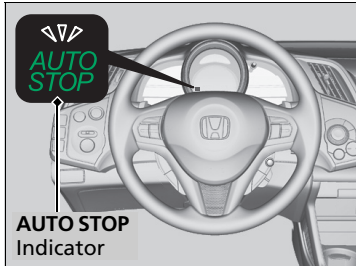

The engine then restarts once the vehicle is about to move again, and the indicator goes off.

If the driver's door is opened while the indicator is blinking, a buzzer sounds to notify you that the Auto Idle Stop function is in operation.

Auto Idle Stop

The duration of the Auto Idle Stop operation:

- **Increases** in the ECON mode, compared to normal or sport mode, with climate control in use.
- **Decreases** if you operate the wipers and climate control simultaneously.

■ Auto Idle Stop Activates When:

The vehicle stops with the shift lever in **[D]** and the brake pedal depressed.

■ Auto Idle Stop does not activate when:

- The low temperature indicator is on.
- The IMA battery charge is low.
- The bars of the **ASST/CHRG** indicators do not move when accelerating or decelerating.
- The transmission fluid temperature is low.
- The vehicle comes to a stop again before the vehicle speed reaches 9 mph (15 km/h) after the engine starts.
- Stopped on a steep incline.
- The shift lever is in a position other than **[D]** or **[N]**.
- Airflow from the climate control system increases. (Except when in ECON mode)
 - ▶ If you have selected the fan speed manually:
The display shows more than five vertical bars.
- Shift mode is in the L mode.
-  is on (the indicator is on).

■ Auto Idle Stop may not activate when:

- The climate control system is in use, and there is a significant difference between the set temperature and the actual interior temperature. (Except when in ECON mode).
- When humidity in the interior is high.
- The vehicle is stopped by braking suddenly.



▶ Auto Idle Stop Activates When:

The Auto Idle Stop may also activate when the brake pedal is depressed, and the vehicle slows down to a speed below 6 mph (10 km/h).

■ The Engine Automatically Restarts When:

The brake pedal is released.

■ The engine restarts even if the brake pedal is depressed when:

- The shift position is changed to .
- Shift mode set in the L mode.
- The accelerator pedal is depressed.
- The pressure to the brake pedal is reduced and the vehicle starts moving while stopped on an incline.
- The IMA battery charge becomes low.
- The low temperature indicator comes on.
- The climate control system is in use, and the difference between the set temperature and actual interior temperature becomes significant.
- The climate control system is being used to dehumidify the interior.
- The pressure on the brake pedal is repeatedly applied and released slightly.
- The  (windshield defogger) button is pressed.

Manual transmission models

Auto Idle Stop

To help maximize fuel economy, the engine automatically stops when the vehicle comes to a stop, depending on environmental and vehicle operating conditions. The **AUTO STOP** indicator blinks at this time. The engine then restarts once the vehicle is about to move again when you depress the clutch pedal fully, and the indicator goes off.

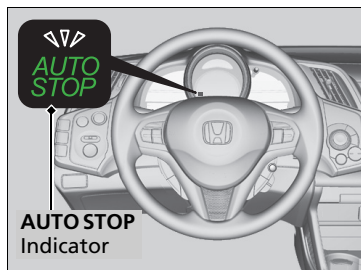

If the driver's door is opened while the indicator is blinking, a buzzer sounds to notify you that the Auto Idle Stop function is in operation.

Auto Idle Stop

If the Auto Idle Stop operating time lasts long enough to lower the 12 volt battery charge or the IMA battery charge, the engine may not restart automatically. Manually turn off the engine when you leave your vehicle.

The duration of Auto Idle Stop operation:

- **Increases** in the ECON mode, compared to normal or sport mode, with climate control in use.
- **Decreases** if you operate the wipers and climate control simultaneously.

Auto Idle Stop Activates When:

Stopping with the brake, the clutch pedal is fully depressed, and the shift lever is in **N**.

▶ To restart the engine automatically, depress the clutch pedal.

Auto Idle Stop does not activate when:

- The low temperature indicator is on.
- The IMA battery charge is low.
- The bars of the **ASST/CHRG** indicators do not move when accelerating or decelerating.
- The vehicle comes to a stop again before the vehicle speed reaches 9 mph (15 km/h) after the engine starts.
- The shift lever is in **R**.
- Airflow from the climate control system increases. (Except when in ECON mode)
 - ▶ If you have selected the fan speed manually:
The display shows more than five vertical bars.
-  is on (the indicator is on).

Auto Idle Stop may not activate when:

- The climate control system is in use, and there is a significant difference between the set temperature and the actual interior temperature. (Except when in ECON mode).
- When humidity in the interior is high.
- The vehicle is stopped by braking suddenly.

Auto Idle Stop Activates When:

The brake pedal is depressed, the vehicle slows down to a speed below 19 mph (30 km/h), and the clutch pedal is fully pressed.

The engine may not stop or restart automatically if you fail to fully depress the clutch pedal. Keeping the proper driving positions makes it easier for you to depress the clutch pedal fully.

▶ [Adjusting the Seats P. 121](#)

■ The Engine Automatically Restarts When:

The clutch pedal is fully depressed, and the shift lever is moved to a position other than **N**.

■ The engine automatically restarts when the clutch pedal is fully depressed even if the shift lever is in **N** when:

- The low temperature indicator comes on.
- The accelerator pedal is pressed.
- The IMA battery charge becomes low.
- The climate control system is in use, and the difference between the set temperature and actual interior temperature becomes significant.
- The climate control system is being used to dehumidify the interior.

The engine automatically restarts when the pressure on the brake pedal is repeatedly applied and released slightly during a stop. This applies even if the clutch pedal is not fully depressed.

■ When the Auto Idle Stop Indicator Starts Blinking Rapidly

Fully depress the clutch pedal.

- ▶ The engine automatically restarts.

▶▶ When the Auto Idle Stop Indicator Starts Blinking Rapidly

The indicator starts blinking rapidly under the following conditions:

- The **FRONT** (windshield defogger) button is pressed.
- When the climate control system is in use and moisture builds up inside the vehicle.
- When the climate control system is in use and the difference between the set temperature and the actual temperature inside the vehicle becomes significant.

3-Mode Drive System

Driving mode is in NORMAL when you turn the ignition switch to ON .

To change driving modes, press the desired mode button. The corresponding mode indicator comes on in the instrument panel, and the mode icon appears briefly on the multi-information display.

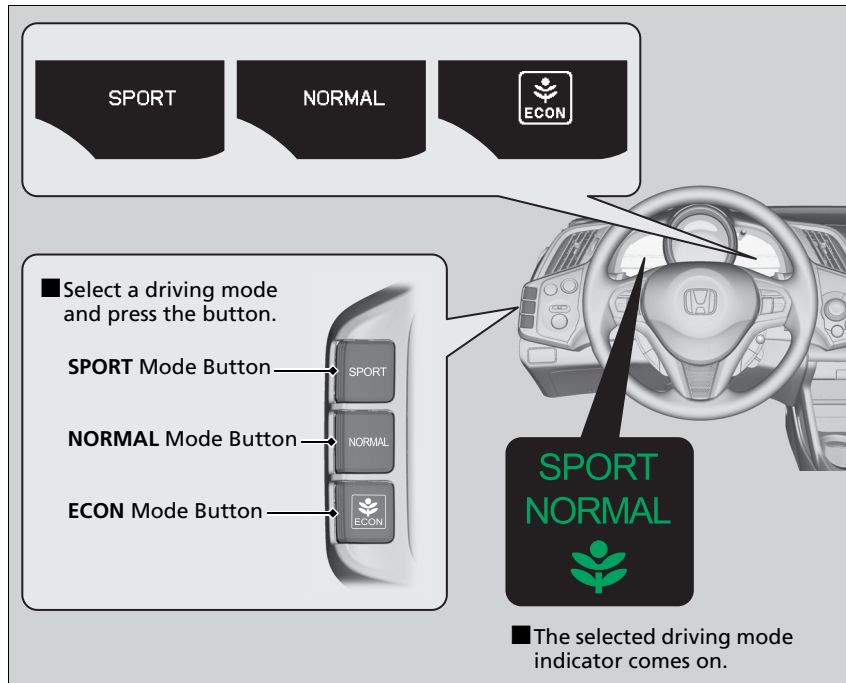

3-Mode Drive System

To keep the system in the ECON mode the next time the ignition switch is turned to ON , change the customized setting on the multi-information display.

[▶ Customized Features P. 90](#)

The ECON mode helps you improve your fuel economy by changing the engine, transmission, climate control system, cruise control, and IMA system performances.

While in the ECON mode, the climate control system has greater temperature fluctuations.

Plus Sport System

Helps the vehicle to momentarily accelerate with more engine and electric motor assist power when you depress the accelerator pedal.

This system can be used in any driving mode (SPORT, NORMAL, or ECON).

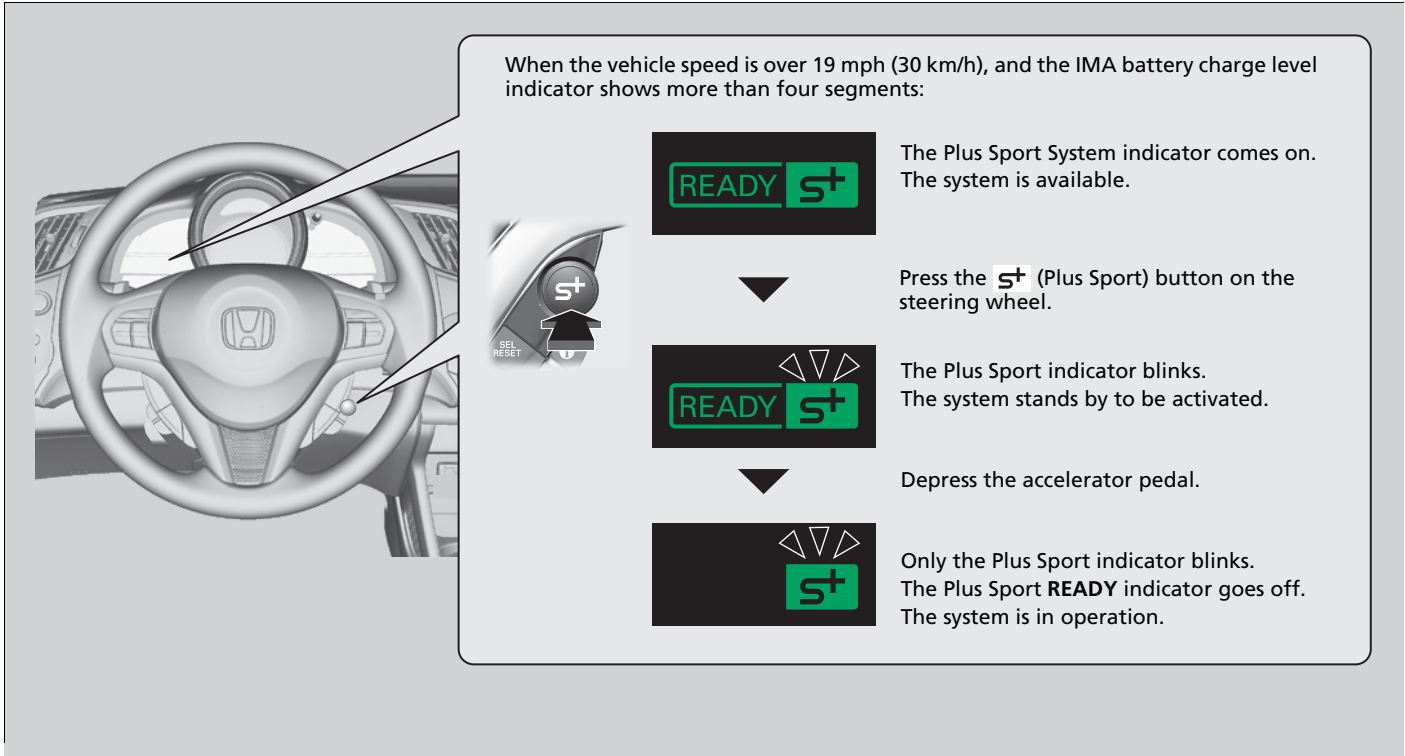

When the vehicle speed is over 19 mph (30 km/h), and the IMA battery charge level indicator shows more than four segments:

- The Plus Sport System indicator comes on. The system is available.
- ▼
- Press the **S+** (Plus Sport) button on the steering wheel.
- The Plus Sport indicator blinks. The system stands by to be activated.
- ▼
- Depress the accelerator pedal.
- Only the Plus Sport indicator blinks. The Plus Sport **READY** indicator goes off. The system is in operation.

■ To cancel the Plus Sport System:

To cancel the ready-to-be activated system:

- Do not depress the accelerator pedal for more than five seconds while the Plus Sport indicator is blinking.
- Press the **S+** button again.
- Depress the brake or clutch pedal.
 - ▶ The Plus Sport indicator stops blinking.

To stop the system in operation, do any of the following:

- Release the accelerator pedal.
- Press the **S+** button again.
 - ▶ The Plus Sport indicator stops blinking, then stays on, and the Plus Sport **READY** indicator comes on.

☒ To cancel the Plus Sport System:

The Plus Sport System automatically shuts itself off with the system ready to be activated, or cancels if the system is in operation when:

- You are making a sharp turn while driving.
- The wheel speed between the front and rear, or left and right tires becomes significantly different due to an icy or wet, and slippery road.

The ambient meter changes color to red in NORMAL and ECON mode while the system is in operation.

The Plus Sport System can momentarily accelerate your vehicle. However, it is still your responsibility to decide when to use the system. Drive safely at speeds appropriate for the conditions.

Cruise Control

Maintains a constant vehicle speed without having to keep your foot on the accelerator. Use cruise control on freeways or open roads where you can travel at a constant speed with little acceleration or deceleration.

⌘ Cruise Control

⚠ WARNING

Improper use of the cruise control can lead to a crash.

Use the cruise control only when traveling on open highways in good weather.

It may not be possible to maintain a constant speed when driving uphill or downhill.

When not using cruise control:
Turn off cruise control by pressing the **CRUISE** button.

While in the ECON mode, it may take relatively more time to accelerate to maintain the set speed.

Manual transmission models

When the engine speed slows down, try to downshift.

You can maintain the set speed if you change gear within five seconds.

When to use

- Vehicle speed for cruise control: Desired speed in a range above roughly 25 mph (40 km/h) ~

Always keep sufficient distance between you and the vehicle in front of you.



How to use

- Press the **CRUISE** button on the steering wheel.



CRUISE MAIN is on in the instrument panel. Cruise control is ready to use.

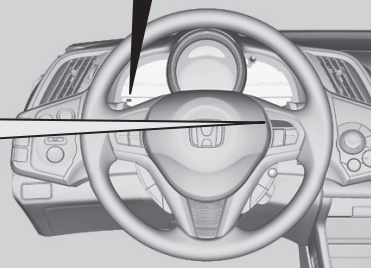

■ To Set the Vehicle Speed

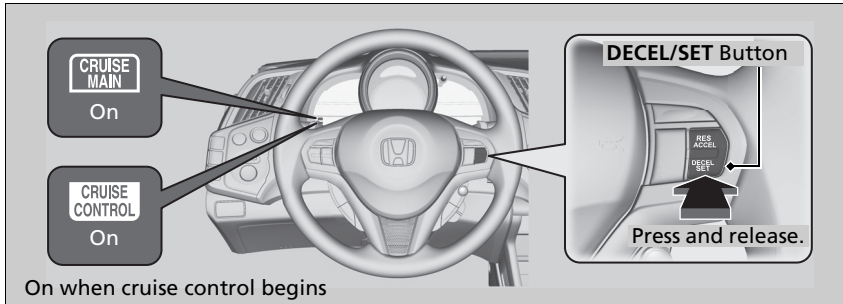

Take your foot off the pedal and press the **DECEL/SET** button when you reach the desired speed.

The moment you release the **DECEL/SET** button, the set speed is fixed, and cruise control begins. The **CRUISE CONTROL** indicator comes on.

■ To Adjust the Vehicle Speed

Increase or decrease the vehicle speed using the **RES/ACCEL** or **DECEL/SET** buttons on the steering wheel.

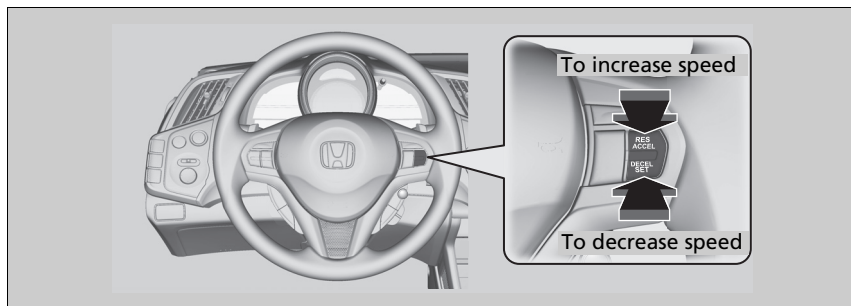

- Each time you press the button, the vehicle speed is increased or decreased by about 1 mph (1.6 km/h).
- If you keep the button pressed, the vehicle speed increases or decreases until you release it. This speed is then set.

■ To Cancel

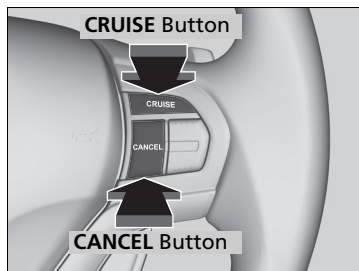

To cancel cruise control, do any of the following:

- Press the **CANCEL** button.
- Press the CRUISE button.
- Depress the brake pedal.
- **Manual transmission models**
- Depress the clutch pedal for five seconds or more.

The **CRUISE CONTROL** indicator goes off.

▶▶ To Adjust the Vehicle Speed

You can set the vehicle speed using the **DECEL/SET** button on the steering wheel when adjusting the speed with the accelerator and brake pedals.

▶▶ To Cancel

Resuming the prior set speed:
After cruise control has been canceled, you can still resume the prior set speed by pressing the **RES/ACCEL** button while driving at a speed of at least 25 mph (40 km/h) or more.

You cannot set or resume in the following situations:

- When vehicle speed is less than 25 mph (40 km/h)
- When the **CRUISE** button is turned off

At vehicle speeds of 22 mph (35 km/h) or less, cruise control is canceled automatically.

VSA® (Vehicle Stability Assist), aka ESC (Electronic Stability Control), System

VSA® helps to stabilize the vehicle during cornering if the vehicle turns more or less than what was intended. It also assists in maintaining traction on slippery surfaces. It does so by regulating engine output and selectively applying the brakes.

VSA® Operation

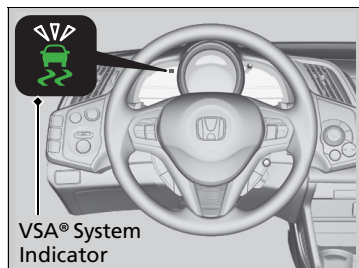

When VSA® activates, you may notice that the engine does not respond to the accelerator. You may also notice some noise from the hydraulic system. You will also see the indicator blink.

VSA® (Vehicle Stability Assist), aka ESC (Electronic Stability Control), System

The VSA® may not function properly if tire type and size are mixed. Make sure to use the same size and type of tire, and the air pressures as specified.

When the VSA® indicator comes on and stays on while driving, there may be a problem with the system. While this may not interfere with normal driving, have your vehicle checked by a dealer immediately.

VSA® cannot enhance stability in all driving situations and does not control the entire braking system. You still need to drive and corner at speeds appropriate for the conditions and always leave a sufficient margin of safety.

The main function of the VSA® system is generally known as Electronic Stability Control (ESC). The system also includes a traction control function.

■ VSA® On and Off



This button is on the driver side control panel. To turn the VSA® system on and off, press and hold it until you hear a beep.

VSA® will stop and the indicator will come on.

To turn it on again, press the  (VSA® OFF) button until you hear a beep.

VSA® is turned on every time you start the engine, even if you turned it off the last time you drove the vehicle.

▣ VSA® (Vehicle Stability Assist), aka ESC (Electronic Stability Control), System

Without VSA®, your vehicle will have normal braking and cornering ability, but it will not have VSA® traction and stability enhancement.

In certain unusual conditions when your vehicle gets stuck in shallow mud or fresh snow, it may be easier to free it with the VSA® temporarily switched off.

When the VSA® system is off, the traction control system is also off. You should only attempt to free your vehicle with the VSA® off if you are not able to free it when the VSA® is on.

Immediately after freeing your vehicle, be sure to switch VSA® on again. We do not recommend driving your vehicle with the VSA® and traction control systems switched off.

If the low tire pressure/TPMS indicator comes on or blinks, the VSA® system comes on automatically. In this case, you cannot turn the system off by pressing the  button.

You may hear a motor sound coming from the engine compartment while system checks are being performed immediately after starting the engine or while driving. This is normal.

U.S. models only

TPMS (Tire Pressure Monitoring System)

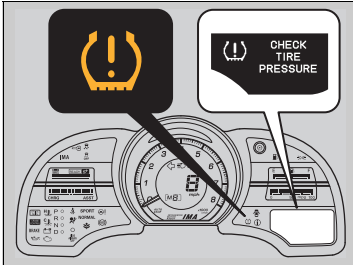

Monitors the tire pressure while you are driving. If your vehicle's tire pressure becomes significantly low, the low tire pressure/TPMS indicator comes on and a message appears on the multi-information display.

CHECK TIRE PRESSURE is displayed when a tire has significantly low pressure.

TPMS (Tire Pressure Monitoring System)

Conditions such as low ambient temperature and altitude change directly affect tire pressure and can trigger the low tire pressure/TPMS indicator to come on.

▶ If the Low Tire Pressure/TPMS Indicator Comes On or Blinks P. 296

Tire pressure checked and inflated in:

- Warm weather can become under-inflated in colder weather.
- Cold weather can become over-inflated in warmer weather.

The low tire pressure/TPMS indicator will not come on as a result of over inflation.

U.S. models

Tire Pressure Monitoring System (TPMS) - Required Federal Explanation

Each tire, including the spare (if provided), should be checked monthly when cold and inflated to the inflation pressure recommended by the vehicle manufacturer on the vehicle placard or tire inflation pressure label.

(If your vehicle has tires of a different size than the size indicated on the vehicle placard or tire inflation pressure label, you should determine the proper tire inflation pressure for those tires.)

As an added safety feature, your vehicle has been equipped with a tire pressure monitoring system (TPMS) that illuminates a low tire pressure telltale when one or more of your tires is significantly under-inflated.



Accordingly, when the low tire pressure telltale illuminates, you should stop and check your tires as soon as possible, and inflate them to the proper pressure.

Driving on a significantly under-inflated tire causes the tire to overheat and can lead to tire failure. Under-inflation also reduces fuel efficiency and tire tread life, and may affect the vehicle's handling and stopping ability.

ORG

TOC

Driving

Index

Home

ORG

Please note that the TPMS is not a substitute for proper tire maintenance, and it is the driver's responsibility to maintain correct tire pressure, even if under-inflation has not reached the level to trigger illumination of the TPMS low tire pressure telltale.

Your vehicle has also been equipped with a TPMS malfunction indicator to indicate when the system is not operating properly. The TPMS malfunction indicator is combined with the low tire pressure telltale. When the system detects a malfunction, the telltale will flash for approximately one minute and then remain continuously illuminated. This sequence will continue upon subsequent vehicle start-ups as long as the malfunction exists.

When the malfunction indicator is illuminated, the system may not be able to detect or signal low tire pressure as intended.

TOC

Driving

TPMS malfunctions may occur for a variety of reasons, including the installation of replacement or alternate tires or wheels on the vehicle that prevent the TPMS from functioning properly.

Always check the TPMS malfunction telltale after replacing one or more tires or wheels on your vehicle to ensure that the replacement or alternate tires and wheels allow the TPMS to continue to function properly.

Index

Home

Brake System

ORG

■ Parking Brake

Use the parking brake to keep the vehicle stationary when parking.

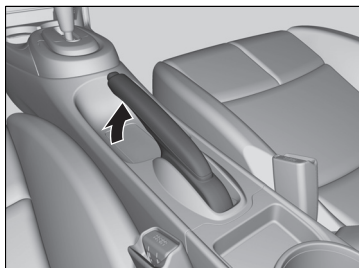

To apply:

Pull the lever fully up without pressing the release button.

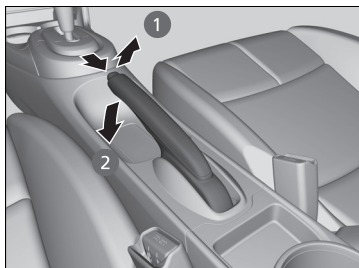

To release:

1. Pull the lever slightly, and press and hold the release button.
2. Lower the lever down all the way, then release the button.

» Parking Brake

NOTICE

Release the parking brake fully before driving. The rear brakes and axle can be damaged if you drive with the parking brake applied.

If you start driving without fully releasing the parking brake, a buzzer sounds as a warning, and **RELEASE PARKING BRAKE** appears on the multi-information display.

Always apply the parking brake when parking.

TOC

Driving

Index

Home

Foot Brake

Your vehicle is equipped with disc brakes at all four wheels. A vacuum power assist helps reduce the effort needed on the brake pedal. The brake assist system increases the stopping force when you depress the brake pedal hard in an emergency situation. The anti-lock brake system (ABS) helps you retain steering control when braking very hard.

➤ [Brake Assist System](#) P. 211

➤ [ABS \(Anti-lock Brake System\)](#) P. 210

⌘ Foot Brake

Check the brakes after driving through deep water, or if there is a buildup of road surface water. If necessary, dry the brakes by lightly depressing the pedal several times.

If you hear a continuous metallic friction sound when applying the brakes, the brake pads need to be replaced. Have the vehicle checked by a dealer.

Constantly using the brake pedal while going down a long hill builds up heat, which reduces the brake effectiveness. Apply engine braking by taking your foot off the accelerator pedal and downshifting to a lower gear. With manual transmission use a lower gear for greater engine braking.

Do not rest your foot on the brake pedal while driving, as it will lightly apply the brakes and cause them to lose effectiveness over time and reduce pad life. It will also confuse drivers behind you.

ABS (Anti-lock Brake System)

■ ABS

Helps prevent the wheels from locking up, and helps you retain steering control by pumping the brakes rapidly, much faster than you.

The electronic brake distribution (EBD) system, which is part of the ABS, also balances the front-to-rear braking distribution according to vehicle loading.

You should never pump the brake pedal. Let the ABS work for you by always keeping firm, steady pressure on the brake pedal. This is sometimes referred to as “stomp and steer.”

■ ABS operation

The brake pedal may pulsate slightly when the ABS is working. Keep holding the pedal firmly down. On dry pavement, you will need to press on the brake pedal very hard before the ABS activates. However, you may feel the ABS activate immediately if you are trying to stop on snow or ice.

When the vehicle speed goes under 6 mph (10 km/h), the ABS stops.

►► ABS (Anti-lock Brake System)

NOTICE

The ABS may not function correctly if you use an incorrect tire type and size.

When the **ABS** indicator comes on while driving, there may be a problem with the system.

While normal braking is not affected, there is a possibility of the ABS not operating. Have the vehicle checked by a dealer immediately.

The ABS does not reduce the time or distance it takes to stop the vehicle. It only helps with steering control during hard braking.

In the following cases, your vehicle may need more stopping distance than a vehicle without the ABS:

- When driving on rough road surfaces, including when driving on uneven surfaces, such as gravel or snow.
- When tire chains are installed.

You may hear a motor sound coming from the engine compartment while system checks are being performed immediately after starting the engine or while driving. This is normal.

Brake Assist System

■ Brake Assist System

Designed to assist the driver by generating greater braking force when you depress the brake pedal hard during emergency braking.

■ Brake assist system operation

Press the brake pedal firmly for more powerful braking.

When brake assist operates, the pedal may wiggle slightly and an operating noise may be heard. This is normal. Keep holding the brake pedal firmly down.

When Stopped

1. Depress the brake pedal firmly.
2. Firmly apply the parking brake.

Automatic transmission (CVT) models

3. Move the shift lever from **D** to **P**.

Manual transmission models

3. Move the shift lever to **1** or **R**.
4. Turn off the engine.

Always set the parking brake firmly, in particular if you are parked on an incline.

» Parking Your Vehicle

Do not park your vehicle near flammable objects, such as dry grass, oil, or timber. Heat from the exhaust can cause a fire.

» When Stopped

Automatic transmission (CVT) models

NOTICE

The following can damage the transmission:

- Depressing the accelerator and brake pedals simultaneously.
- Holding the vehicle in place when facing uphill by depressing the accelerator pedal.
- Moving the shift lever into **P** before the vehicle stops completely.

Raise the wiper arms when snow is expected.

About Your Multi-View Rear Camera

Models with navigation system

For models with the navigation system, see the Navigation System Manual.

⌘ About Your Multi-View Rear Camera

The rear camera view is restricted. You cannot see the corner ends of the bumper or what is underneath the bumper. Its unique lens also makes objects appear closer or farther than they actually are.

Visually confirm that it is safe to drive before backing up. Certain conditions (such as weather, lighting, and high temperatures) may also restrict the rear view. Do not rely in the rearview display which does not give you all information about conditions at the back of your vehicle.

If the camera lens is covered with dirt or moisture, use a soft, moist cloth to keep the lens clean and free of debris.

About Your Rearview Camera

ORG

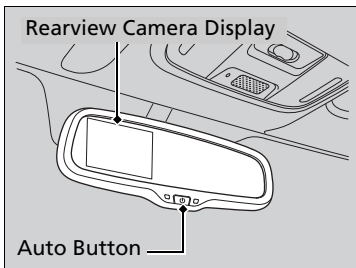

Models without navigation system

An image of the rear view is shown in your vehicle's rearview mirror when the shift lever is moved to **R**.

About Your Rearview Camera

The rear camera view is restricted. You cannot see the corner ends of the bumper or what is underneath the bumper. Its unique lens also makes objects appear closer or farther than they actually are.

Visually confirm that it is safe to drive before backing up. Certain conditions (such as weather, lighting, and high temperatures) may also restrict the rear view. Do not rely on the rearview display which does not give you all information about conditions at the back of your vehicle.

If the camera lens is covered with dirt or moisture, use a soft, moist cloth to keep the lens clean and free of debris.

The rearview display is turned on every time you shift to **R**.

The rearview mirror gets hot if the rearview display is used for an extended period.

To turn the guidelines on or off, press and hold the auto button for about three seconds. If you turn the guidelines off, they remain off until you turn them back on.

Rearview Camera Display Area

Screen display

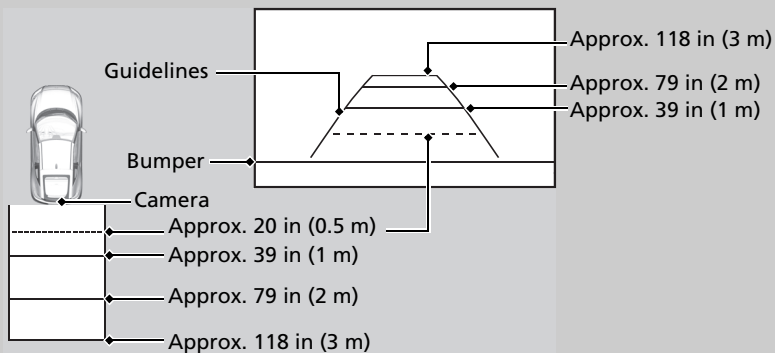

The rearview camera has a unique lens that makes objects appear closer or further than they actually are.

TOC

Driving

Index

Home

■ Customizing the Displayed Language

You can select the displayed language on the rearview mirror between English, French and Spanish.

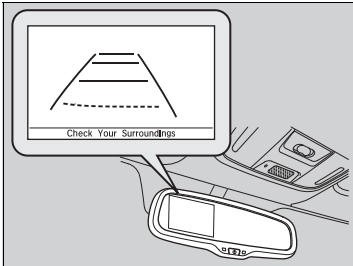

1. Move the shift lever to **R** to display the rearview monitor.
 - ▶ Make sure that the automatic dimming rearview mirror is on.
2. Press and hold the auto button for about six seconds or more.
 - ▶ The displayed operation guide message begins blinking.
3. Press the auto button to change the language while it is blinking.
 - ▶ Pressing the button switches the displayed language.
 - ▶ Your selection is set about five seconds after you stop adjusting.

Fuel Information

■ Fuel recommendation

Unleaded gasoline, pump octane number 87 or higher

Use of a lower octane gasoline can cause a persistent, heavy metallic knocking noise that can lead to engine damage.

■ Top tier detergent gasoline

Because the level of detergency and additives in gasoline vary in the market, Honda endorses the use of "TOP TIER Detergent Gasoline" where available to help maintain the performance and reliability of your vehicle. TOP TIER Detergent Gasoline meets a new gasoline standard jointly established by leading automotive manufacturers to meet the needs of today's advanced engines.

» Fuel Information

NOTICE

We recommend quality gasoline containing detergent additives that help prevent fuel system and engine deposits. In addition, in order to maintain good performance, fuel economy, and emissions control, we strongly recommend the use of gasoline that does NOT contain harmful manganese-based fuel additives such as MMT, if such gasoline is available.

Use of gasoline with these additives may adversely affect performance, and cause the malfunction indicator lamp on your instrument panel to come on. If this happens, contact a dealer for service. Some gasoline today is blended with oxygenates such as ethanol. Your vehicle is designed to operate on oxygenated gasoline containing up to 10% ethanol by volume. Do not use gasoline containing methanol. If you notice any undesirable operating symptoms, try another service station or switch to another brand of gasoline.

Qualifying gasoline retailers will, in most cases, identify their gasoline as having met “TOP TIER Detergent Gasoline” standards at the retail location. This fuel is guaranteed to contain the proper level of detergent additives and be free of metallic additives. The proper level of detergent additives, and absence of harmful metallic additives in gasoline, help avoid build-up of deposits in your engine and emission control system.

For further important fuel-related information for your vehicle, or on information on gasoline that does not contain MMT, visit www.hondacars.com. In Canada, visit www.honda.ca for additional information on gasoline. For more information on top tier gasoline, visit www.toptiergas.com.

■ Fuel tank capacity: 10.6 US gal (40 liters)

How to Refuel

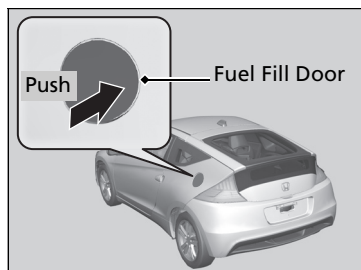

1. Stop your vehicle with the service station pump on the left side of the vehicle in the rear.
2. Turn off the engine.
3. Press the area indicated by the arrow to release the fuel fill door. You will hear a click.

▶▶ How to Refuel

⚠ WARNING

Gasoline is highly flammable and explosive. You can be burned or seriously injured when handling fuel.

- Stop the engine, and keep heat, sparks, and flame away.
- Handle fuel only outdoors.
- Wipe up spills immediately.

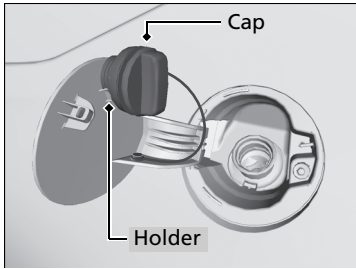
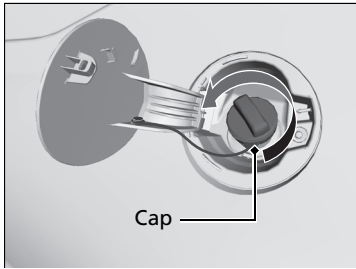

4. Remove the fuel fill cap slowly. If you hear a release of air, wait until this stops, then turn the knob slowly to open the fuel fill cap.

5. Place the fuel fill cap in the holder.

6. Insert the filler nozzle fully.

▶ When the tank is full, the fuel nozzle will click off automatically. This leaves space in the fuel tank in case the fuel expands with a change in the temperature.

7. After filling, replace the fuel fill cap, tightening it until you hear it click at least once.

▶ Shut the fuel fill door by hand.

How to Refuel

The filler nozzle automatically stops to leave space in the fuel tank so that fuel does not overflow as a result of changes in air temperature.

If the fuel nozzle keeps turning off when the tank is not full, there may be a problem with the pump's fuel vapor recovery system. Try filling at another pump. If this does not fix the problem, consult a dealer.

Do not continue to add fuel after the nozzle has automatically stopped. Additional fuel can exceed the full tank capacity.

Improving Fuel Economy

Fuel economy depends on several conditions, including driving conditions, your driving habits, the condition of your vehicle, and loading. Depending on these and other conditions, you may or may not achieve the rated fuel economy of this vehicle.

Maintenance and Fuel Economy

You can optimize your fuel economy with proper maintenance of your vehicle. Always maintain your vehicle in accordance with the messages displayed on the multi-information display.

- Use the recommended viscosity engine oil, displaying the API Certification Seal.
- Maintain the specified tire pressure.
- Do not load the vehicle with excess cargo.
- Keep your vehicle clean. A buildup of snow or mud on your vehicle's underside adds weight and increases wind resistance.

Improving Fuel Economy

Direct calculation is the recommended method to determine actual fuel consumed while driving.



In Canada, posted fuel economy numbers are established following a simulated test. For more information on how this test is performed, please visit <http://oee.nrcan.gc.ca/>

Accessories

When installing accessories, check the following:

- Do not install accessories on the windshield. They can obstruct your view and delay your reaction to driving conditions.
- Do not install accessories on the side pillars or across the side windows. Accessories installed in these areas may interfere with proper operation of the side curtain airbags.
- Be sure electronic accessories do not overload electrical circuits or interfere with proper operation of your vehicle.
[▶ Fuses P. 297](#)
- Before installing any electronic accessory, have the installer contact a dealer for assistance. If possible, have a dealer inspect the final installation.

▶ Accessories and Modifications

WARNING

Improper accessories or modifications can affect your vehicle's handling, stability, and performance, and cause a crash in which you can be seriously hurt or killed.

Follow all instructions in this owner's manual regarding accessories and modifications.

Honda Genuine accessories are recommended to ensure proper operation on your vehicle.

Modifications

Do not modify your vehicle or use non-Honda components that can affect its handling, stability, and reliability.

Overall vehicle performance can be affected. Always make sure all equipment is properly installed and maintained, and that it meets federal, state, province, territory, and local regulations.

Maintenance

This chapter discusses basic maintenance.



Before Performing Maintenance

Inspection and Maintenance	222
Safety When Performing Maintenance	223
Parts and Fluids Used in Maintenance Service	224

Maintenance Minder™

225

Maintenance Under the Hood

Maintenance Items Under the Hood	229
Opening the Hood	230
Recommended Engine Oil	231
Oil Check	232
Adding Engine Oil	233
Changing the Engine Oil and Oil Filter ..	234

Engine Coolant	236
Transmission Fluid	238
Brake/Clutch Fluid	240
Refilling Window Washer Fluid	241
Replacing Light Bulbs	242
Checking and Maintaining Wiper Blades	250
Checking and Maintaining Tires	
Checking Tires	253
Tire and Loading Information Label ..	254
Tire Labeling	254
DOT Tire Quality Grading (U.S. Vehicles) ..	256
Wear Indicators	258

Tire Service Life	258
Tire and Wheel Replacement	259
Tire Rotation	260
Winter Tires	261
12 Volt Battery	262
Remote Transmitter Care	
Replacing the Button Battery	263
Climate Control System Maintenance	264
Cleaning	
Interior Care	265
Exterior Care	267

Inspection and Maintenance

For your safety, perform all listed inspections and maintenance to keep your vehicle in good condition. If you become aware of any abnormality (noise, smell, insufficient brake fluid, oil residue on the ground, etc.), have your vehicle inspected by a dealer. (Note, however, that service at a dealer is not mandatory to keep your warranties in effect.) Refer to the separate maintenance booklet for detailed maintenance and inspection information.

Types of Inspection and Maintenance

Daily inspections

Perform inspections before long distance trips, when washing the vehicle, or when refueling.

Periodic inspections

- Check the continuously variable transmission fluid level monthly.
[➤ Continuously Variable Transmission Fluid P. 238](#)
- Check the brake fluid level monthly.
[➤ Brake/Clutch Fluid P. 240](#)
- Check the tire pressure monthly. Examine the tread for wear and foreign objects.
[➤ Checking and Maintaining Tires P. 253](#)
- Check the operation of the exterior lights monthly.
[➤ Replacing Light Bulbs P. 242](#)
- Check the condition of the wiper blades at least every six months.
[➤ Checking and Maintaining Wiper Blades P. 250](#)

Inspection and Maintenance

U.S. models

Maintenance, replacement, or repair of emissions control devices and systems may be done by any automotive repair establishment or individuals using parts that are "certified" to EPA standards.

According to state and federal regulations, failure to perform maintenance on the maintenance main items marked with # will not void your emissions warranties. However, all maintenance services should be performed in accordance with the intervals indicated by the multi-information display.

[➤ Maintenance Service Items P. 227](#)

If you want to perform complex maintenance tasks that require more skills and tools, you can purchase a subscription to the Service Express website at www.techinfo.honda.com.

[➤ Authorized Manuals P. 315](#)

If you want to perform maintenance yourself, make sure that you have the necessary tools and skills first. After performing maintenance, update the records in the separate maintenance booklet.

Safety When Performing Maintenance

Some of the most important safety precautions are given here. However, we cannot warn you of every conceivable hazard that can arise in performing maintenance. Only you can decide whether or not you should perform a given task.

Maintenance Safety

- To reduce the possibility of fire or explosion, keep cigarettes, sparks, and flames away from the battery and all fuel related parts.
- Never leave rags, towels, or other flammable objects under the hood.
 - ▶ Heat from the engine and exhaust can ignite them causing a fire.
- To clean parts, use a commercially available degreaser or parts cleaner, not gasoline.
- Wear eye protection and protective clothing when working with the 12 volt battery or compressed air.
- Engine exhaust contains carbon monoxide, which is poisonous and can kill you.
 - ▶ Only operate the engine if there is sufficient ventilation.

Vehicle Safety

- The vehicle must be in a stationary condition.
 - ▶ Make sure your vehicle is parked on level ground, the parking brake is set, and the engine is off.
- Be aware that hot parts can burn you.
 - ▶ Make sure to let the engine and exhaust system cool thoroughly before touching vehicle parts.
- Be aware that moving parts can injure you.
 - ▶ Do not start the engine unless instructed, and keep your hands and limbs away from moving parts.
- Do not touch the IMA battery and wiring (orange).

⚠ Safety When Performing Maintenance

⚠ WARNING

Improperly maintaining this vehicle or failing to correct a problem before driving can cause a crash in which you can be seriously hurt or killed.

Always follow the inspection and maintenance recommendations according to the schedules in this owner's manual.

⚠ WARNING

Failure to properly follow maintenance instructions and precautions can cause you to be seriously hurt or killed.

Always follow the procedures and precautions in this owner's manual.

Parts and Fluids Used in Maintenance Service

The use of Honda genuine parts and fluids is recommended when maintaining and servicing your vehicle. Honda genuine parts are manufactured according to the same high quality standards used in Honda vehicles.

If the engine oil life is less than 15%, you will see the Maintenance Minder messages appear on the multi-information display every time you turn the ignition switch to ON **II**. The messages notify you when to change the engine oil, or when to bring your vehicle to a dealer for indicated maintenance services.

To Use Maintenance Minder™

■ Displaying the Engine Oil Life and Maintenance Items

Maintenance items, which should be serviced at the same time that you replace the engine oil, appear on the multi-information display.

You can view them on the **engine oil life** screen when the remaining engine oil life is under 15 percent.

1. Turn the ignition switch to ON **II**.
2. Press the **▲(i)/▼** button repeatedly until the engine oil life appears on the multi-information display.

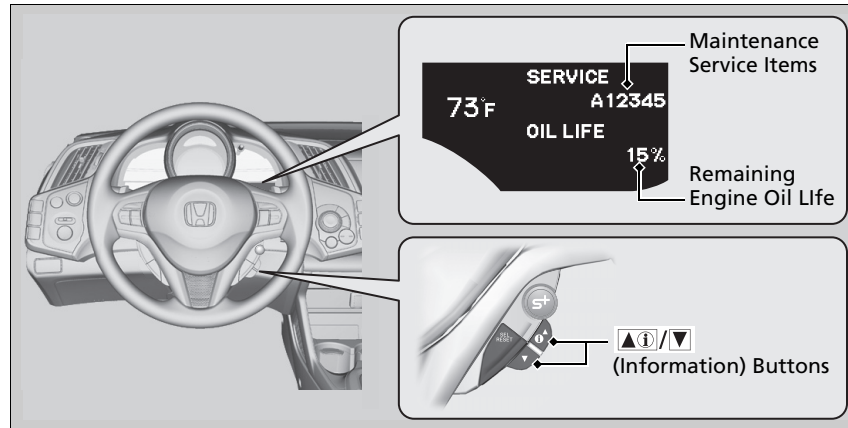

▣ Displaying the Engine Oil Life and Maintenance Items

Based on the engine operating conditions, the remaining engine oil life is calculated and displayed as a percentage.







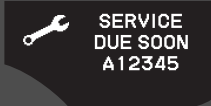

Displayed Engine Oil Life (%)	Calculated Engine Oil Life (%)
100	100 to 91
90	90 to 81
80	80 to 71
70	70 to 61
60	60 to 51
50	50 to 41
40	40 to 31
30	30 to 21
20	20 to 16
15	15 to 11
10	10 to 6
5	5 to 1
0	0

There is a list of maintenance main and sub items you can view on the multi-information display.

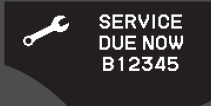
[▶ Maintenance Service Items P. 227](#)

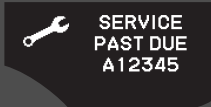
Continued

■ Maintenance Minder Messages on the Multi-Information Display

Maintenance Message	Oil Life Display	Explanation	Information
<p>SERVICE DUE SOON</p> 	<p>15 %</p> 	<p>The remaining engine oil life is 15 to 6 percent. Once you switch the display by pressing the  button (information) button, this message will go off.</p>	<p>The engine oil is approaching the end of its service life, and the maintenance items should be inspected and serviced soon.</p>
<p>SERVICE DUE NOW</p> 	<p>5 %</p> 	<p>The remaining engine oil life is 5 to 1 percent. Press the  button to switch to another display.</p>	<p>The engine oil has almost reached the end of its service life, and the maintenance items should be inspected and serviced as soon as possible.</p>
<p>SERVICE PAST DUE</p> 	<p>Negative Distance</p> <p>U.S.</p>  <p>Canada</p> 	<p>The remaining engine oil life has passed its service life, and a negative distance appears after driving over 10 miles (U.S. models) or 10 km (Canadian models). Press the  button to switch to another display.</p>	<p>The engine oil life has passed. The maintenance items must be inspected and serviced immediately.</p>

The system message indicator () comes on along with the Maintenance Minder message.

Maintenance Service Items

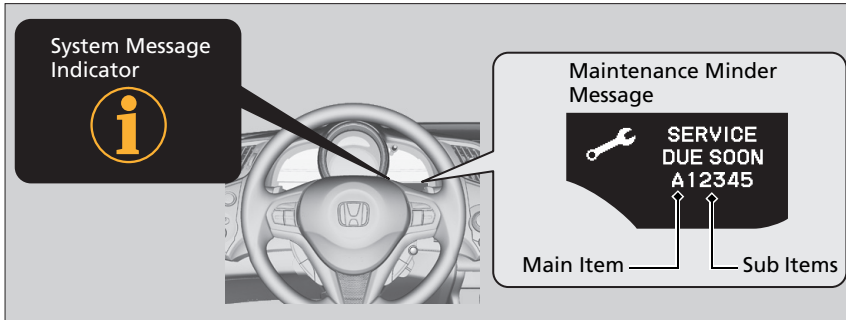

Maintenance Service Items

- Independent of the Maintenance Minder information, replace the brake fluid every 3 years.
- Inspect idle speed every 160,000 miles (256,000 km).
- Adjust the valves during services A, B, 1, 2, or 3 if they are noisy.

CODE	Maintenance Main Items
A	<ul style="list-style-type: none"> • Replace engine oil*1
B	<ul style="list-style-type: none"> • Replace engine oil*1 and oil filter • Inspect front and rear brakes • Check parking brake adjustment • Inspect tie rod ends, steering gearbox, and boots • Inspect suspension components • Inspect driveshaft boots • Inspect brake hoses and lines (Including ABS/VSA) • Inspect all fluid levels and condition of fluids • Inspect exhaust system# • Inspect fuel lines and connections# • Check expiration date for TRK bottle

CODE	Maintenance Sub Items
1	<ul style="list-style-type: none"> • Rotate tires
2	<ul style="list-style-type: none"> • Replace air cleaner element*2 • Replace dust and pollen filter*3 • Inspect drive belt
3	<ul style="list-style-type: none"> • Replace transmission fluid
4	<ul style="list-style-type: none"> • Replace spark plugs • Inspect valve clearance
5	<ul style="list-style-type: none"> • Replace engine coolant

*1: If you drive primarily in urban areas that have high concentrations of soot in the air from industry and from diesel-powered vehicles, replace the dust and pollen filter every 15,000 miles (24,000 km).

#: See information on maintenance and emissions warranty.



*1: If a message **SERVICE** does not appear more than 12 months after the display is reset, change the engine oil every year.

*2: If you drive primarily in dusty conditions, replace the air cleaner element every 15,000 miles (24,000 km).

■ Resetting the Display

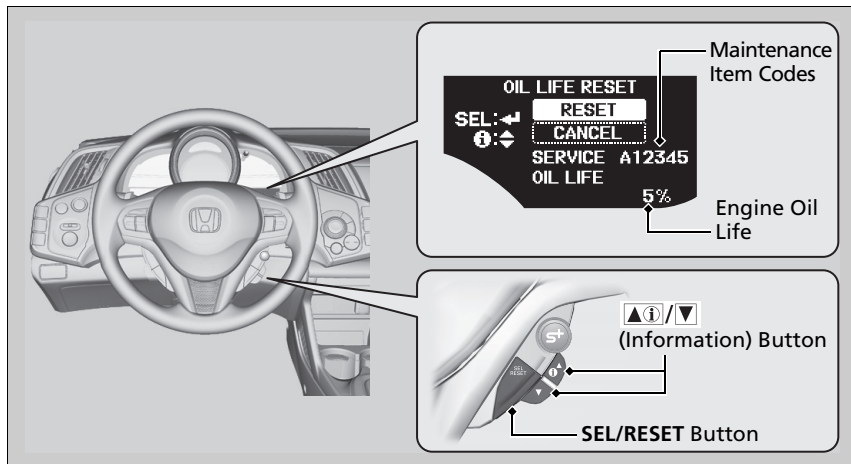
Reset the engine oil life display if you have performed the maintenance service.



1. Turn the ignition switch to ON .
2. Display the engine oil life by repeatedly pressing the  button.
3. Press and hold the **SEL/RESET** button for 10 seconds or more.
 - ▶ The oil life reset mode is displayed on the multi-information display.
4. Select **RESET** with the  button, then press the **SEL/RESET** button.
 - ▶ The displayed maintenance items disappear, and the engine oil life display returns to **100 %**.

To cancel the oil life reset mode, select **CANCEL**, then press the **SEL/RESET** button.

▶▶ Resetting the Display

NOTICE

Failure to reset the engine oil life after a maintenance service results in the system showing incorrect maintenance intervals, which can lead to serious mechanical problems.

The dealer will reset the engine oil life display after completing the required maintenance service. If someone other than a dealer performs maintenance service, reset the engine oil life display yourself.

Maintenance Items Under the Hood

ORG

TOC

Maintenance

Index

Home

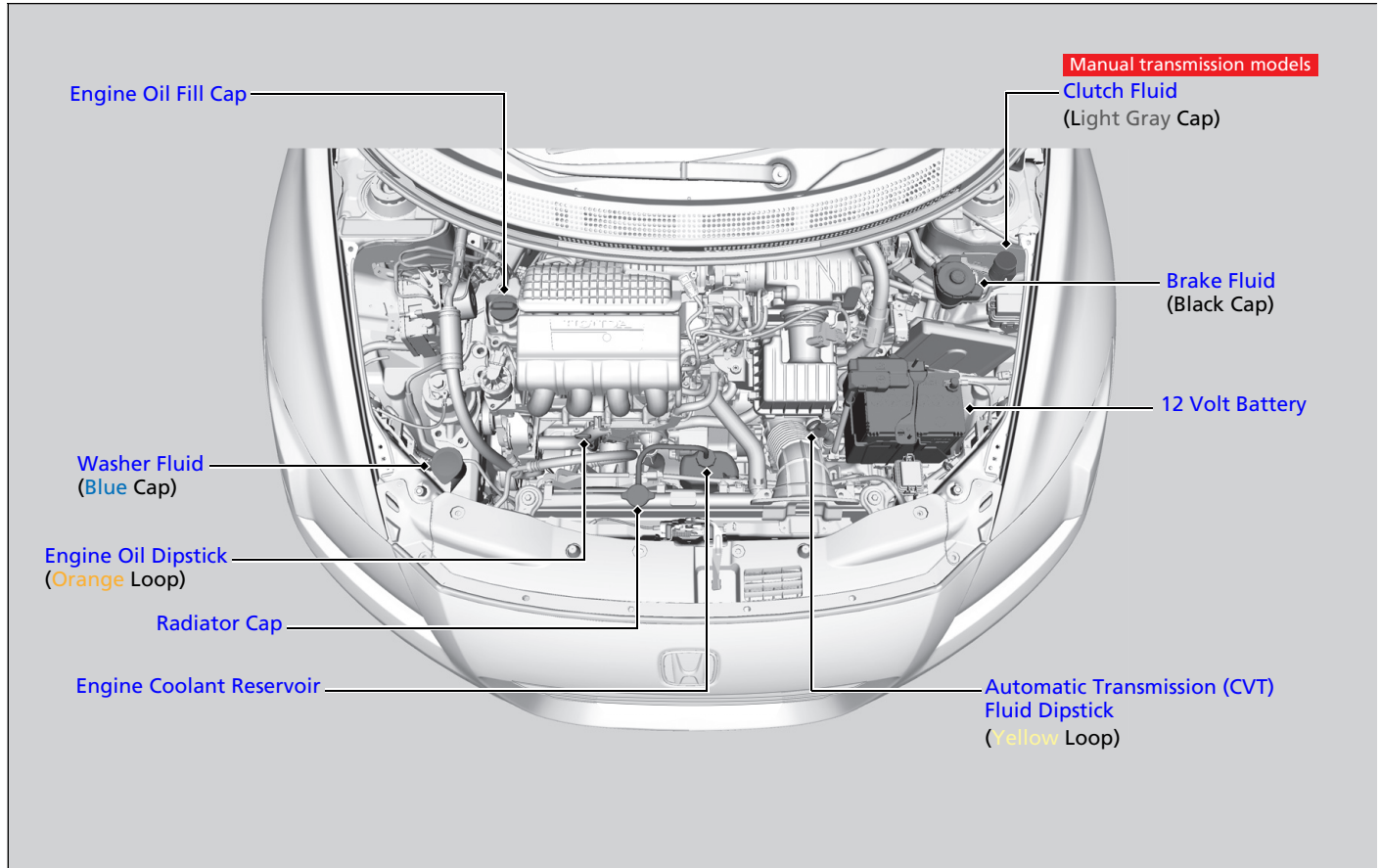

Opening the Hood

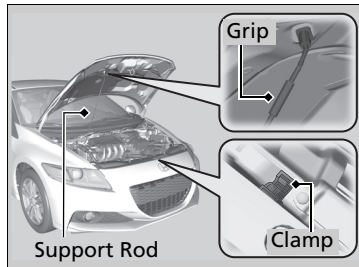
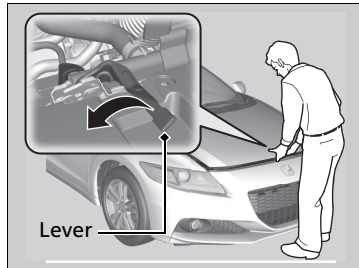
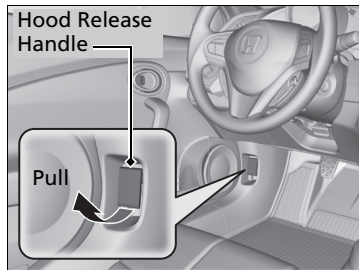

1. Park the vehicle on a level surface, and set the parking brake.
2. Pull the hood release handle under the lower left corner of the dashboard.
► The hood will pop up slightly.
3. Push up the hood latch lever in the center of the hood to release the lock mechanism, and open the hood.

4. Remove the support rod from the clamp using the grip. Mount the support rod in the hood.

When closing, remove the support rod, and stow it in the clamp, then gently lower the hood. Remove your hand at a height of approximately 12 inches (30 cm) and let the hood close.

►► Opening the Hood

NOTICE

Do not open the hood when the wiper arms are raised.

The hood will strike the wipers, and may damage either the hood or the wipers.

When closing the hood, check that the hood is securely latched.

If the hood latch lever moves stiffly, or if you can open the hood without lifting the lever, the latch mechanism should be cleaned and lubricated.

Do not open the hood while the Auto Idle Stop function is activated.

Recommended Engine Oil

- **Genuine Honda Motor Oil**
- **Premium-grade 0W-20 detergent oil with an API Certification Seal on the container.**



Oil is a major contributor to your engine's performance and longevity. If you drive the vehicle with insufficient or deteriorated oil, the engine may fail or be damaged.

This seal indicates the oil is energy conserving and that it meets the American Petroleum Institute's latest requirements.

Use a Genuine Honda Motor Oil or another commercial engine oil of suitable viscosity for the ambient temperature as shown.

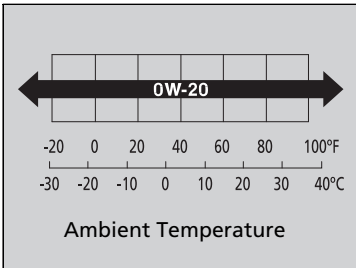

■ Synthetic oil

You may also use synthetic motor oil if it is labeled with the API Certification Seal and is the specified viscosity grade.

☒ Recommended Engine Oil

Engine Oil Additives

Your vehicle does not require oil additives. In fact, they may adversely affect the engine performance and durability.

Oil Check

We recommend that you check the engine oil level every time you refuel. Park the vehicle on level ground.

Wait approximately three minutes after turning the engine off before you check the oil.

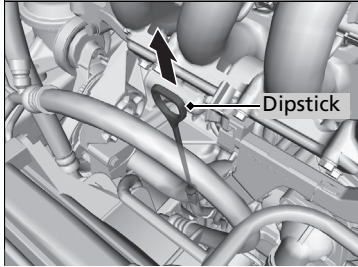

1. Remove the dipstick (orange loop).
2. Wipe the dipstick with a clean cloth or paper towel.
3. Insert the dipstick back all the way into its hole.

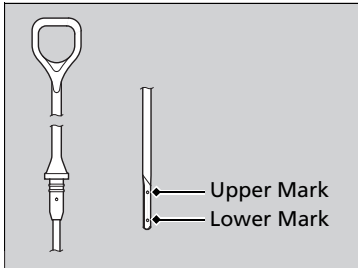

4. Remove the dipstick again, and check the level. It should be between the upper and lower marks. Add oil if necessary.

Oil Check

If the oil level is near or below the lower mark, slowly add oil being careful not to overfill.

Adding Engine Oil

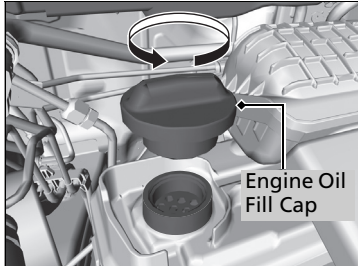

1. Unscrew and remove the engine oil fill cap.
2. Add oil slowly.
3. Reinstall the engine oil fill cap, and tighten it securely.
4. Wait for three minutes and recheck the engine oil dipstick.

⚠ Adding Engine Oil

If any oil spills, wipe it up immediately. Spilled oil may damage the engine compartment components.

NOTICE

Do not fill the engine oil above the upper mark. Overfilling the engine oil can result in leaks and engine damage.

Changing the Engine Oil and Oil Filter

You must change the engine oil and oil filter regularly in order to maintain the engine's lubrication. The engine may be damaged if they are not changed regularly.

Change the oil and filter in accordance with the maintenance message on the multi-information display.

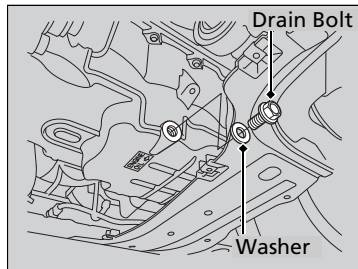
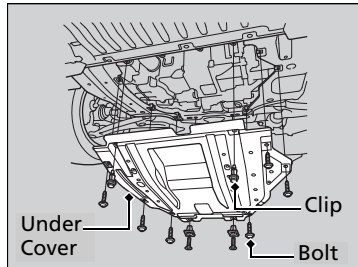

1. Run the engine until it reaches normal operating temperature, and then turn the engine off.
2. Open the hood and remove the engine oil fill cap.
3. Remove the bolts and clips on the undercarriage and remove the cover.
4. Remove the drain bolt and washer from the bottom of the engine, and drain the oil into a suitable container.

Changing the Engine Oil and Oil Filter

NOTICE

You may damage the environment if you do not dispose of the oil in a suitable way. If you are changing the oil by yourself, appropriately dispose of the used oil. Put the oil in a sealed container and take it to a recycling center. Do not throw the oil away into a garbage can or onto the ground.

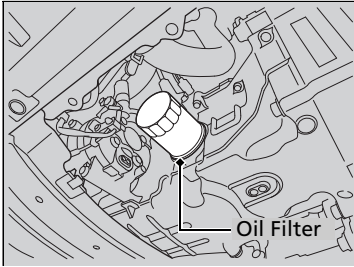

5. Remove the oil filter and dispose of the remaining oil.
6. Check that the filter gasket is not stuck to the engine contact surface.
 - If it is stuck, you must detach it.
7. Wipe away dirt and dust adhering to the contact surface of the engine block, and install a new oil filter.
 - Apply a light coat of new engine oil to the oil filter gasket.
8. Put a new washer on the drain bolt, then reinstall the drain bolt.
 - Tightening torque:
29 lbf·ft (39 N·m, 4.0 kgf·m)
9. Pour the recommended engine oil into the engine.
 - Engine oil change capacity (including filter):
3.8 US qt (3.6 L)
10. Reinstall the engine oil fill cap securely and start the engine.
11. Run the engine for a few minutes, and then check that there is no leak from the drain bolt or oil filter.
12. Stop the engine, wait for three minutes, and then check the oil level on the dipstick.
 - If necessary, add more engine oil.

✎ Changing the Engine Oil and Oil Filter

You will need a special wrench to replace the oil filter. You can buy this wrench from a dealer.

When installing the new oil filter, follow the instructions supplied with the oil filter.

Reinstall the engine oil fill cap. Start the engine. The low oil pressure indicator should go off within five seconds. If it does not, turn off the engine, and check your work.

Engine Coolant

Specified coolant: Honda Long Life Antifreeze/Coolant Type 2

This coolant is premixed with 50% antifreeze and 50% water. Do not add any straight antifreeze or water.

We recommend you check the engine coolant level every time you refuel. Check the reserve tank first. If it is completely empty, also check the coolant level in the radiator. Add the engine coolant accordingly.

Reserve Tank

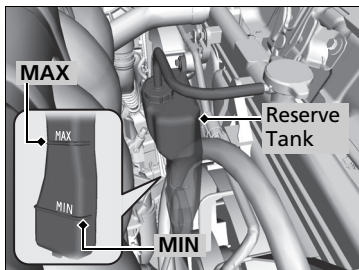

1. Check the amount of coolant in the reserve tank.

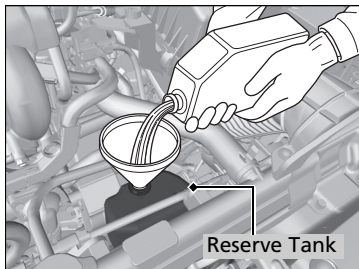

2. If the coolant level is below the **MIN** mark, add the specified coolant until it reaches the **MAX** mark.
3. Inspect the cooling system for leaks.

Engine Coolant

NOTICE

If temperatures consistently below -22°F (-30°C) are expected, the coolant mixture should be changed to a higher concentration. Consult a dealer for more information.

If Honda antifreeze/coolant is not available, you may use another major brand non-silicate coolant as a temporary replacement. Check that it is a high quality coolant recommended for aluminum engines. Continued use of any non-Honda coolant can result in corrosion, causing the cooling system to malfunction or fail. Have the cooling system flushed and refilled with Honda antifreeze/coolant as soon as possible.

Do not add rust inhibitors or other additives to your vehicle's cooling system. They may not be compatible with the coolant or with the engine components.

Radiator

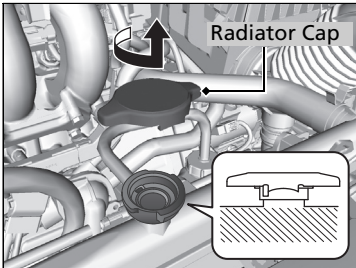

1. **Make sure the engine and radiator are cool.**
2. Turn the radiator cap counterclockwise and relieve any pressure in the cooling system. Do not push the cap down when turning.
3. Push down and turn the radiator cap counterclockwise to remove it.
4. The coolant level should be up to the base of the filler neck. Add coolant if it is low.
5. Put the radiator cap back on, and tighten it fully.
6. Pour coolant into the reserve tank until it reaches the **MAX** mark. Put the cap back on the reserve tank.

⌘ Radiator

⚠ WARNING

Removing the radiator cap while the engine is hot can cause the coolant to spray out, seriously scalding you.

Always let the engine and radiator cool down before removing the radiator cap.

NOTICE

Pour the fluid slowly and carefully so you do not spill any. Clean up any spills immediately; they can damage components in the engine compartment.

Transmission Fluid

Automatic Transmission Fluid

Continuously Variable Transmission (CVT)

Specified fluid: Honda CVTF (continuously variable transmission fluid)

Check the fluid level when the engine is at normal operating temperature.

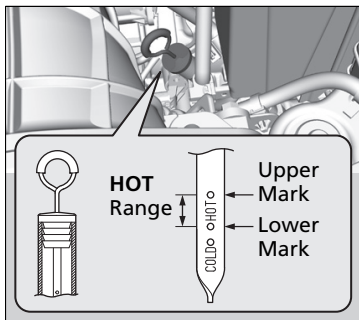

1. Park on level ground, and start the engine.
2. Wait until the radiator fan starts and then turn off the engine.
 - ▶ Perform step 3 after waiting for about 60 seconds (less than 90 seconds).
3. Remove the dipstick (yellow loop) from the transmission and wipe it with a clean cloth.
4. Insert the dipstick all the way back into the transmission securely, as shown in the image.
5. Remove the dipstick and check the fluid level.
 - ▶ It should be between the upper and lower marks in the **HOT** range.
6. If the level is below the lower mark, add fluid into the dipstick hole to bring it to the level between the upper and lower marks, and have your vehicle checked by a dealer immediately.

Automatic Transmission Fluid

NOTICE

Do not mix Honda CVTF with other transmission fluids.

Using a transmission fluid other than Honda CVTF may adversely affect the operation and durability of your vehicle's transmission, and damage the transmission.

Any damage caused by using a transmission fluid that is not equivalent to Honda CVTF is not covered by Honda's new vehicle warranty.

NOTICE

Pour the fluid slowly and carefully so you do not spill any. Clean up any spills immediately; they can damage components in the engine compartment.

Manual Transmission Fluid

Specified fluid: Honda Manual Transmission Fluid (MTF)

Check the fluid level when the engine is at normal operating temperature.

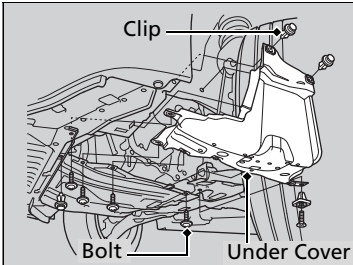

1. Park the vehicle on level ground.
2. Remove the bolts with a wrench and clips with a flat-tip screwdriver, then carefully remove the under cover.

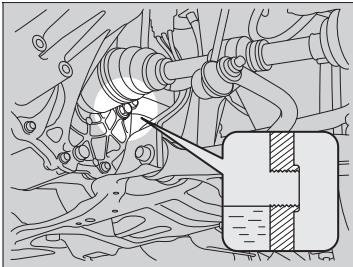

3. Remove the transmission filler bolt and washer. Carefully feel inside the bolt hole with your fingers.
 - Check if the fluid level is up to the edge of the bolt hole.
4. If the fluid level is not up to the edge of the bolt hole, add Honda Manual Transmission Fluid (MTF) until it runs out of the hole.
5. Put a new washer on the filler bolt, then reinstall the filler bolt.
 - Tightening torque:
33 lbf·ft (44 N·m, 4.5 kgf·m)
6. Reinstall the under cover with the bolts and clips.

Manual Transmission Fluid

If Honda MTF is not available, you may use the API certificated SAE 0 W-20 or 5 W-20 viscosity motor oil as a temporary measure.

Replace with MTF as soon as possible. Motor oil does not contain the proper additives for the transmission and continued use can cause decreased shifting performance and lead to transmission damage.

Brake/Clutch Fluid

Specified fluid: Honda Heavy Duty Brake Fluid DOT 3

Use the same fluid for both the brakes and clutch.

Checking the Brake Fluid

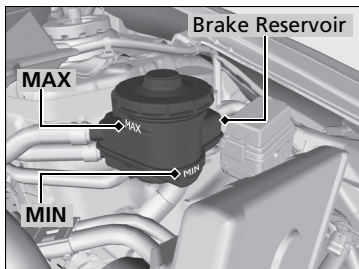

The fluid level should be between the **MIN** and **MAX** marks on the side of the reservoir.

Checking the Brake Fluid

NOTICE

Brake fluid marked DOT 5 is not compatible with your vehicle's braking system and can cause extensive damage.

If the specified brake fluid is not available, you should use only DOT 3 or DOT 4 fluid from a sealed container as a temporary replacement.

Using any non-Honda brake fluid can cause corrosion and decrease the longevity of the system. Have the brake system flushed and refilled with Honda Heavy Duty Brake Fluid DOT 3 as soon as possible.

If the brake fluid level is at or below the **MIN** mark, have a dealer inspected for leaks or worn brake pads as soon as possible.

Checking the Clutch Fluid

If the clutch fluid level is at or below the **MIN** mark, have the system inspected for leaks or an excessively worn clutch plate by a dealer.

Manual transmission models

Checking the Clutch Fluid

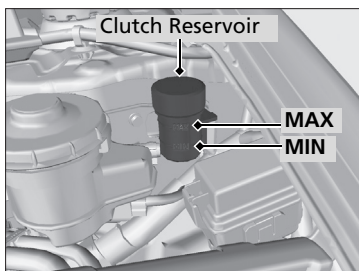

The fluid level should be between the **MIN** and **MAX** marks on the side of the reservoir.

Refilling Window Washer Fluid

Models with washer fluid level gauge

Check the amount of window washer fluid using the washer fluid level gauge on the cap.

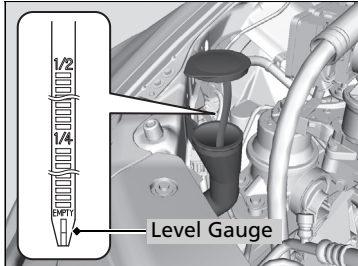

If the level is low, fill the washer reservoir.

Models with washer level sensor

If the washer fluid is low, a message appears on the multi-information display.

Pour the washer fluid carefully. Do not overflow the reservoir.

Refilling Window Washer Fluid

NOTICE

Do not use engine antifreeze or a vinegar/water solution in the washer reservoir.

Antifreeze can damage your vehicle's paint. A vinegar/water solution can damage the washer pump.

Headlight Bulbs

When replacing, use the following bulbs.

High beam headlight: 60 W (HB3 for halogen bulb type)

Low beam headlight: 55 W (H11 for halogen bulb type)
35W (D4S for high voltage discharge)

High Beam Headlight

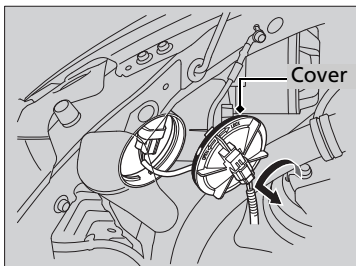

1. Remove the cover.

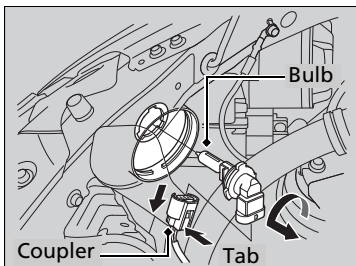

2. Push the tab to remove the coupler.

3. Rotate the old bulb to the left to remove.

4. Insert a new bulb into the headlight assembly and turn it to the right.

5. Insert the coupler into the connector of the bulb.

Headlight Bulbs

NOTICE

Halogen bulbs get very hot when lit.

Oil, perspiration, or a scratch on the glass can cause the bulb to overheat and shatter.

The headlight aim is set by the factory, and does not need to be adjusted. However, if you regularly carry heavy items in the cargo area, have the aiming readjusted at a dealer or by a qualified technician.

When replacing a halogen bulb, handle it by its base, and protect the glass from contact with your skin or hard objects. If you touch the glass, clean it with denatured alcohol and a clean cloth.

The exterior lights' inside lenses (headlights, brake lights, etc.) may fog temporarily after a car wash or while driving in the rain. This does not impact the exterior light function.

However, if you see a large amount of water or ice accumulated inside the lenses, have your vehicle inspected by a dealer.

■ Low Beam Headlights (High Voltage Discharge Type)*

High voltage can remain in the circuit for a long period of time after the light is switched off. Do not attempt to inspect or replace the high voltage discharge type bulbs yourself. Ask a dealer to inspect and replace low beam headlights.

■ Low Beam Headlights (Halogen Headlights)*

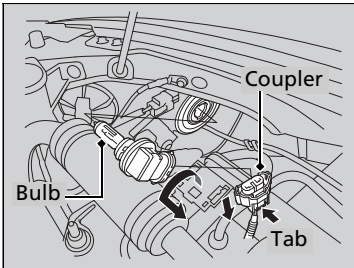

1. Push the tab to remove the coupler.
2. Rotate the old bulb to the left to remove.
3. Insert a new bulb into the headlight assembly and turn it to the right.
4. Insert the coupler into the connector of the bulb.

* Not available on all models

Fog Light Bulbs*

When replacing, use the following bulbs.

Fog Lights: 35 W (H8 for halogen bulb type)

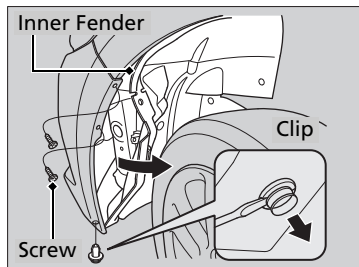

1. Turn the steering wheel all the way to the opposite side from the fog light being replaced.
Passenger side: Turn the steering wheel to the left.
Driver side: Turn the steering wheel to the right.
2. Remove the clip and screws, and pull the inner fender back.

► Fog Light Bulbs*

NOTICE

Halogen bulbs get very hot when lit. Oil, perspiration, or a scratch on the glass can cause the bulb to overheat and shatter.

When replacing a halogen bulb, handle it by its plastic case, and protect the glass from contact with your skin or hard objects. If you touch the glass, clean it with denatured alcohol and a clean cloth.

Insert a flat-tip screwdriver, lift and remove the central pin to remove the clip.

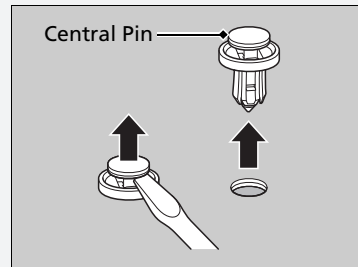

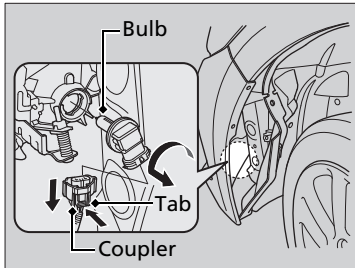

3. Push the tab to remove the coupler.
4. Rotate the old bulb to the left to remove.
5. Insert a new bulb into the light assembly and turn it to the right.
6. Insert the coupler into the connector of the bulb.

▶ Fog Light Bulbs*

Insert the clip with the central pin raised, and push until it is flat.

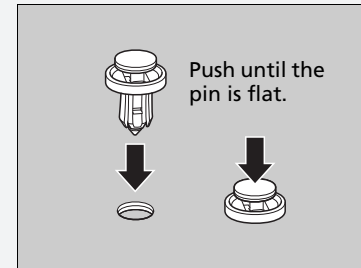

* Not available on all models

Front Turn Signal/Parking*/Side Marker Light Bulbs

When replacing, use the following bulbs.

Front Turn Signal/Parking/Side Marker Light: 28W/8 W

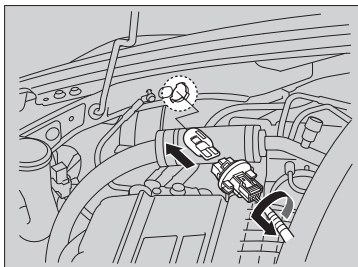

1. Turn the socket to the left and remove it, then remove the old bulb.
2. Insert a new bulb.

Models with LED type parking/daytime running lights

Parking/Daytime Running Light Bulbs

Parking/daytime running light bulbs are LED type. Have an authorized Honda dealer inspect and replace the light bulbs.

Side Turn Signal/Emergency Indicator Light Bulbs

Door mirrors have the side turn signal lights. Have an authorized Honda dealer inspect and replace the light bulbs.

Back-Up Light, Rear Turn Signal Light and Rear Side Marker Light Bulbs

When replacing, use the following bulbs.

- Back-Up Light: 16 W**
- Rear Turn Signal Light: 21 W (Amber)**
- Rear Side Marker Light: 3 CP**

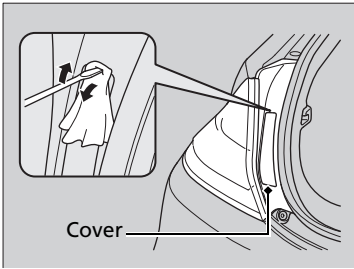

1. Pry on the edge of the cover using a flat-tip screwdriver to remove the cover.
 - ▶ Wrap the flat-tip screwdriver with a cloth to prevent scratches.

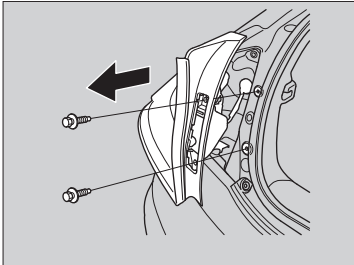

2. Remove the bolts.
3. Pull the light assembly out of the rear pillar.

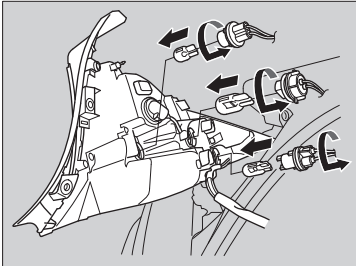

4. Turn the socket to the left and remove it, then remove the old bulb.
5. Insert a new bulb.

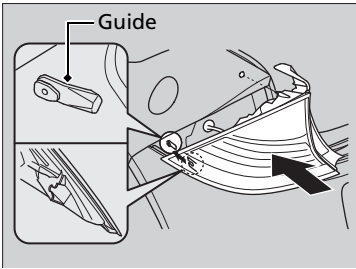

6. Reinstall the light assembly by sliding it on to the guide on the body.

Brake/Taillight Bulbs

Brake/rear taillight bulbs are LED type. Have an authorized Honda dealer inspect and replace the light bulbs.

Rear License Plate Light Bulbs

When replacing, use the following bulb.

Rear License Plate Light: 5 W

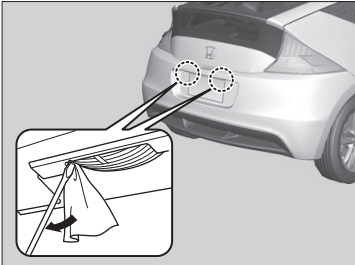

1. Remove the lens by prying on the edge of the lens using a flat-tip screwdriver.
 - ▶ Wrap the flat-tip screwdriver with a cloth to prevent scratches.

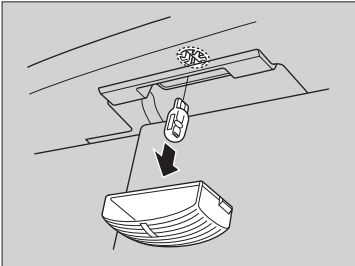

2. Remove the old bulb and insert a new bulb.

High-Mount Brake Light Bulbs

High-mount brake light bulbs are LED type. Have an authorized Honda dealer inspect and replace the light bulbs.

Checking Wiper Blades

If the wiper blade rubber has deteriorated, it will leave streaks and the metal wiper arm may scratch the window glass.

Changing the Front Wiper Blade Rubber

Changing the Front Wiper Blade Rubber

NOTICE

Avoid dropping the wiper arm; it may damage the windshield.

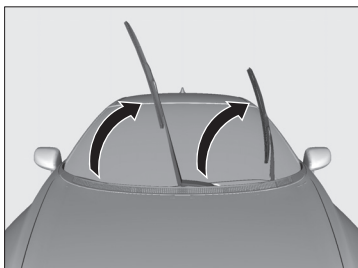

1. Lift the driver side wiper arm first, then the passenger side.

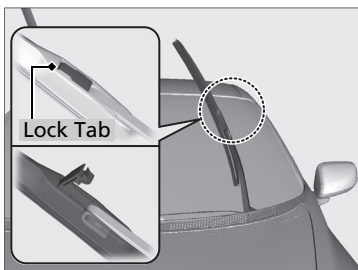

2. Push the lock tab up.
3. Slide the blade from the wiper arm.

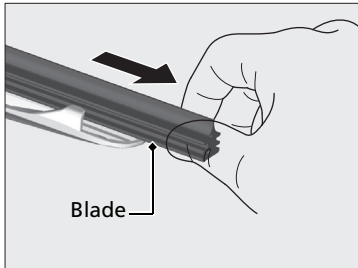

4. Slide the wiper blade out from its holder by pulling the tabbed end out.

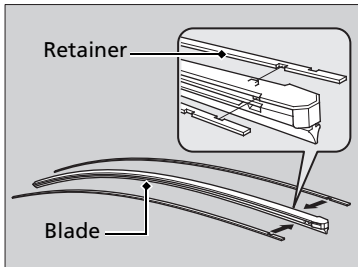

5. Remove the retainer from the rubber blade that has been removed, and mount to a new rubber blade.
▶ Correctly align the rubber protrusion and the retainer grooves.

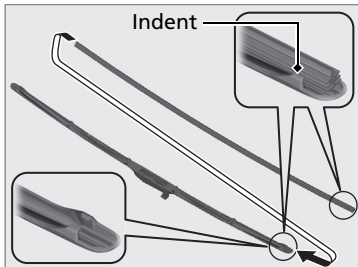

6. Slide the new wiper blade onto the holder from the bottom end.
▶ The tab on the holder should fit in the indent of the wiper blade.

7. Slide the wiper blade onto the wiper arm, then push down the lock tab.

8. Lower the passenger side wiper arm first, then the driver side.

Changing the Rear Wiper Blade Rubber

ORG

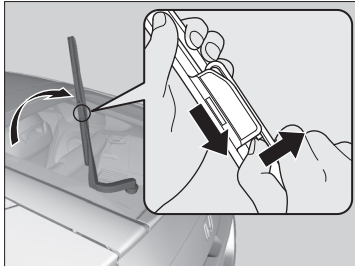

1. Raise the wiper arm off.
2. Slide the wiper blade out from the wiper arm while pushing the lock tab.

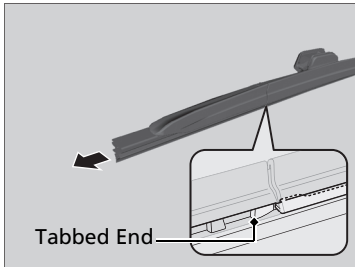

3. Slide the wiper blade out from its holder by pulling the tabbed end out.

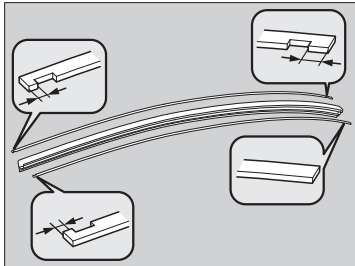

4. Remove the retainer from wiper blade and mount it to a new rubber blade.
5. Slide the wiper blade onto the holder.
 - ▶ Make sure it is engaged correctly, then install the wiper blade assembly onto the wiper arm.

Changing the Rear Wiper Blade Rubber

NOTICE

Avoid dropping the wiper arm; it may damage the rear window.

TOC

Maintenance

Index

Home

Checking Tires

To safely operate your vehicle, your tires must be of the proper type and size, in good condition with adequate tread, and properly inflated.

■ Inflation guidelines

Properly inflated tires provide the best combination of handling, tread life, and comfort. Refer to the driver's doorjamb label or specification's page for the specified pressure.

Underinflated tires wear unevenly, adversely affect handling and fuel economy, and are more likely to fail from overheating.

Overinflated tires make your vehicle ride harshly, are more prone to road hazards, and wear unevenly.

Every day before you drive, look at each of the tires. If one looks lower than the others, check the pressure with a tire gauge.

At least once a month or before long trips, use a gauge to measure the pressure in all tires, including the spare*. Even tires in good condition can lose 1 to 2 psi (10 to 20 kPa, 0.1 to 0.2 kgf/cm²) per month.

■ Inspection guidelines

Every time you check inflation, also examine the tires and valve stems.

Look for:

- Bumps or bulges on the side or in the tread. Replace the tire if you find any cuts, splits, or cracks in the side of the tire. Replace it if you see fabric or cord.
- Remove any foreign objects and inspect for air leaks.
- Uneven tread wear. Have a dealer check the wheel alignment.
- Excessive tread wear.
 - ➔ [Wear Indicators P. 258](#)
- Cracks or other damage around valve stem.

* Not available on all models

☒ Checking Tires

⚠ WARNING

Using tires that are excessively worn or improperly inflated can cause a crash in which you can be seriously hurt or killed.

Follow all instructions in this owner's manual regarding tire inflation and maintenance.

Measure the air pressure when tires are cold. This means the vehicle has been parked for at least three hours, or driven less than 1 mile (1.6 km). If necessary, add or release air until the specified pressure is reached.

If checked when hot, tire pressure can be as much as 4–6 psi (30–40 kPa, 0.3–0.4 kgf/cm²) higher than if checked when cold.

Have a dealer check the tires if you feel a consistent vibration while driving. New tires and any that have been removed and reinstalled should be properly balanced.

Tire and Loading Information Label

The label attached to the driver’s doorjamb provides necessary tire and loading information.

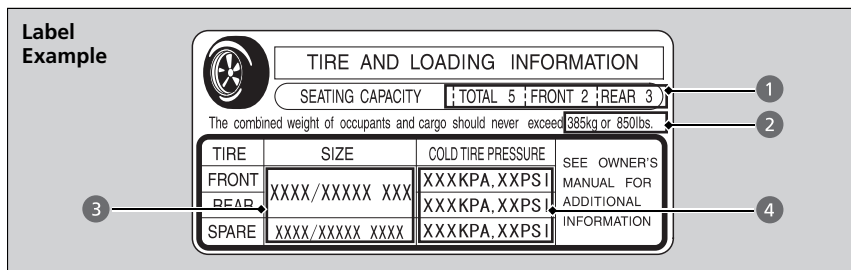

▶▶ Tire and Loading Information Label

The tire and loading information label attached to the driver’s doorjamb contains:

- 1 The number of people your vehicle can carry.
- 2 The total weight your vehicle can carry. Do not exceed this weight.
- 3 The original tire sizes for front, rear, and spare.
- 4 The proper cold tire pressure for front, rear, and spare.

Tire Labeling

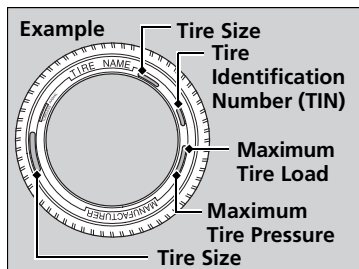

The tires that came on your vehicle have a number of markings. Those you should be aware of are described below.

▶▶ Tire Size

Following is an example of tire size with an explanation of what each component means.

P195/55 R16 86V

- P:** Vehicle type (P indicates passenger vehicle).
- 195:** Tire width in millimeters.
- 55:** Aspect ratio (the tire’s section height as a percentage of its width).
- R:** Tire construction code (R indicates radial).
- 16:** Rim diameter in inches.
- 86:** Load index (a numerical code associated with the maximum load the tire can carry).
- V:** Speed symbol (an alphabetical code indicating the maximum speed rating).

■ Tire Size

Whenever tires are replaced, they should be replaced with tires of the same size.

■ Tire Identification Number (TIN)

The tire identification number (TIN) is a group of numbers and letters that look like the example in the side column. TIN is located on the sidewall of the tire.

■ Glossary of Tire Terminology

Cold Tire Pressure – The tire air pressure when the vehicle has been parked for at least three hours or driven less than 1 mile (1.6 km).

Load Rating – Means the maximum load that a tire is rated to carry for a given inflation pressure.

Maximum Inflation Pressure – The maximum tire air pressure that the tire can hold.

Maximum Load Rating – Means the load rating for a tire at the maximum permissible inflation pressure for that tire.

Recommended Inflation Pressure – The cold tire inflation pressure recommended by the manufacturer.

Treadwear Indicators (TWI) – Means the projections within the principal grooves designed to give a visual indication of the degrees of wear of the tread.

☒ Tire Identification Number (TIN)

DOT B97R FW6X 2209

DOT: This indicates that the tire meets all requirements of the U.S. Department of Transportation.

B97R: Manufacturer's identification mark.

FW6X: Tire type code.

22 09: Date of manufacture.

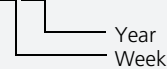

DOT Tire Quality Grading (U.S. Vehicles)

The tires on your vehicle meet all U.S. Federal Safety Requirements. All tires are also graded for treadwear, traction, and temperature performance according to Department of Transportation (DOT) standards. The following explains these gradings.

■ Uniform Tire Quality Grading

Quality grades can be found where applicable on the tire sidewall between tread holder and maximum section width.

■ Treadwear

The treadwear grade is a comparative rating based on the wear rate of the tire when tested under controlled conditions on a specified government test course. For example, a tire graded 150 would wear one and one-half (1 1/2) times as well on the government course as a tire graded 100. The relative performance of tires depends upon the actual conditions of their use, however, and may depart significantly from the norm due to variations in driving habits, service practices and differences in road characteristics and climate.

☒ Uniform Tire Quality Grading

For example:

Treadwear 200

Traction AA

Temperature A

All passenger car tires must conform to Federal Safety Requirements in addition to these grades.

Traction

The traction grades, from highest to lowest, are AA, A, B, and C. Those grades represent the tire's ability to stop on wet pavement as measured under controlled conditions on specified government test surfaces of asphalt and concrete. A tire marked C may have poor traction performance.

Temperature

The temperature grades are A (the highest), B, and C, representing the tire's resistance to the generation of heat and its ability to dissipate heat when tested under controlled conditions on a specified indoor laboratory test wheel. Sustained high temperature can cause the material of the tire to degenerate and reduce tire life, and excessive temperature can lead to sudden tire failure. The grade C corresponds to a level of performance which all passenger car tires must meet under the Federal Motor Vehicle Safety Standard No. 109. Grades B and A represent higher levels of performance on the laboratory test wheel than the minimum required by law.

☒ Traction

Warning: The traction grade assigned to this tire is based on straight-ahead braking traction tests, and does not include acceleration, cornering, hydroplaning, or peak traction characteristics.

☒ Temperature

Warning: The temperature grade for this tire is established for a tire that is properly inflated and not overloaded. Excessive speed, underinflation, or excessive loading, either separately or in combination, can cause heat buildup and possible tire failure.

Wear Indicators

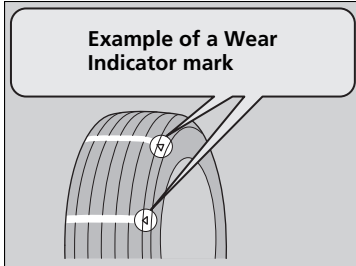

The groove where the wear indicator is located is 1/16 inch (1.6 mm) shallower than elsewhere on the tire. If the tread has worn so that the indicator is exposed, replace the tire.

Worn out tires have poor traction on wet roads.

Tire Service Life

The life of your tires is dependent on many factors, including driving habits, road conditions, vehicle loading, inflation pressure, maintenance history, speed, and environmental conditions (even when the tires are not in use).

In addition to regular inspections and inflation pressure maintenance, it is recommended that you have annual inspections performed once the tires reach five years old. All tires, including the spare, should be removed from service after 10 years from the date of manufacture, regardless of their condition or state of wear.

Tire and Wheel Replacement

Replace your tires with radials of the same size, load range, speed rating, and maximum cold tire pressure rating (as shown on the tire's sidewall). Using tires of a different size or construction can cause the ABS and VSA® (vehicle stability assist) system to work incorrectly.

It is best to replace all four tires at the same time. If that isn't possible, replace the front or rear tires in pairs.

Make sure that the wheel's specifications match those of the original wheels.

U.S. models only

If you replace a wheel, only use TPMS specified wheels approved for your vehicle.

▶▶ Tire and Wheel Replacement

⚠ WARNING

Installing improper tires on your vehicle can affect handling and stability. This can cause a crash in which you can be seriously hurt or killed.

Always use the size and type of tires recommended in this owner's manual.

Tire Rotation

Rotating tires according to the maintenance messages on the multi-information display helps to distribute wear more evenly and increase tire life.

■ Tires without rotation marks

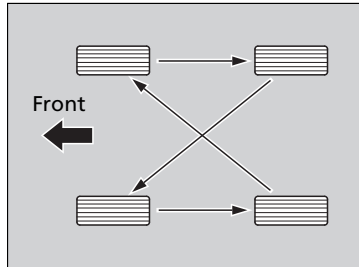

Rotate the tires as shown here.

■ Tires with rotation marks

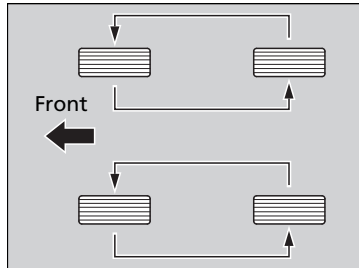

Rotate the tires as shown here.

▶▶ Tire Rotation

Tires with directional tread patterns should only be rotated front to back (not from one side to the other). Directional tires should be mounted with the rotation indication mark facing forward, as shown below.

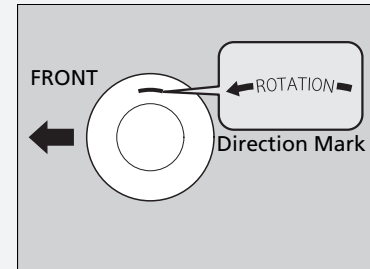

When the tires are rotated, make sure the air pressures are checked.

Winter Tires

If driving on snowy or frozen roads, mount all season marked **M+S** tires, snow tires, or tire chains; reduce speed; and maintain sufficient distance between vehicles when driving.

Be particularly careful when operating the steering wheel or brakes to prevent skidding.

Use tire chains, snow tires, or all season tires when necessary or according to the law.

When mounting, refer to the following points.

For winter tires:

- Select the size and load ranges that are the same as the original tires.
- Mount the tires to all four wheels.

For tire chains:

- Install them on the front tires only.
- Because your vehicle has limited tire clearance, we strongly recommend using the chains listed below:

Models with P195/55 R16 tires

Cable-type: SCC Radial Chain SC1030

Models with 205/45 R17 tires *1

Not recommended to use any type of chains

*1: On 205/45R17 tires, you cannot install any type of tire chains. If you have to use tire chains, replace the original tires with the 195/55R16 tires.

- Follow the chain manufacturer's instruction when installing. Mount them as tightly as you can.
- Check that the chains do not touch the brake lines or suspension.
- Drive slowly.

Winter Tires

⚠ WARNING

Using the wrong chains, or not properly installing chains, can damage the brake lines and cause a crash in which you can be seriously injured or killed.

Follow all instructions in this owner's manual regarding the selection and use of tire chains.

NOTICE

Traction devices that are the wrong size or improperly installed can damage your vehicle's brake lines, suspension, body, and wheels. Stop driving if they are hitting any part of the vehicle.

When tire chains are mounted, follow the chain manufacturer's instructions regarding vehicle operational limits.

If your vehicle is equipped with summer tires, be aware that these tires are not designed for winter driving conditions. For more information, contact a dealer.

Checking the 12 Volt Battery

ORG

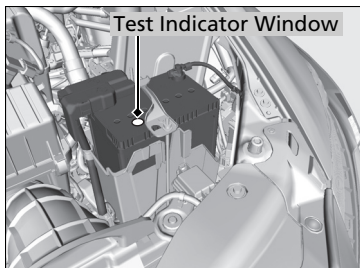

Check the battery condition monthly. Look at the test indicator window and check the terminals for corrosion.

If your vehicle's battery is disconnected or goes dead:

- The audio system is disabled.
➤ [Reactivating the audio system P. 141](#)
- The clock resets.
➤ [Setting the Clock P. 98](#)
- The navigation system* is disabled. A PIN code will be required.
➤ [Refer to the navigation system manual](#)

Charging the 12 Volt Battery

Disconnect both battery cables to prevent damaging your vehicle's electrical system. Always disconnect the negative (-) cable first, and reconnect it last.

12 Volt Battery

⚠ WARNING

The battery gives off explosive hydrogen gas during normal operation.

A spark or flame can cause the battery to explode with enough force to kill or seriously hurt you.

When conducting any battery maintenance, wear protective clothing and a face shield, or have a skilled technician do it.

WARNING: Battery post, terminals, and related accessories contain lead and lead compounds.
Wash your hands after handling.

The test indicator's color information is on the battery.

When you find corrosion, clean the battery terminals by applying a baking powder and water solution. Clean terminals with a damp towel. Cloth/towel dry the battery. Coat the terminals with grease to help prevent future corrosion.

TOC

Maintenance

Index

Home

Replacing the Button Battery

If the indicator does not come on when the button is pressed, replace the battery.

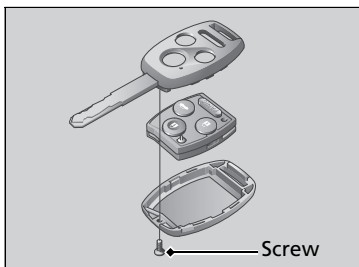

Battery type: CR1616

1. Unscrew the cover with a small Phillips-head screwdriver. Press a button to pry open the transmitter.

2. Open the keypad.

▶ Wrap the small flat-tip screwdriver with a cloth to prevent scratching the transmitter.

3. Make sure to replace the battery with the correct polarity.

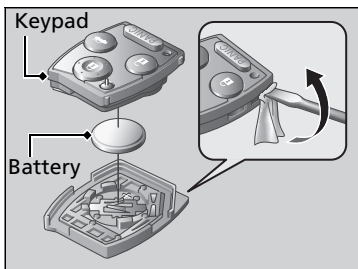

Replacing the Button Battery

NOTICE

An improperly disposed of battery can damage the environment. Always confirm local regulations for battery disposal.

Replacement batteries are commercially available or at a dealer.

Dust and Pollen Filter

The Climate Control system is equipped with a dust and pollen filter that collects pollen, dust, and other debris in the air. The Maintenance Minder™ messages will let you know when to replace the filter.

We recommend that you replace the dust and pollen filter sooner when using your vehicle in areas with high concentrations of dust.

» Dust and Pollen Filter

If the airflow from the climate control system deteriorates noticeably, and the windows fog up easily, the filter may need to be replaced. Please contact a dealer for replacement.

Interior Care

Use a damp cloth with a mixture of mild detergent and warm water to remove dirt. Use a clean cloth to remove detergent residue.

Cleaning Seat Belts

Use a soft brush with a mixture of mild soap and warm water to clean the seat belts. Let the belts air dry. Wipe the openings of the seat belt anchors using a clean cloth.

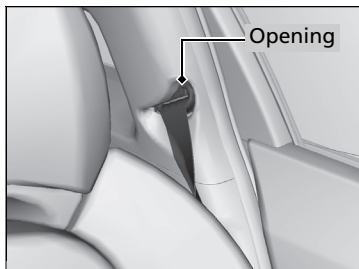

Interior Care

Do not spill liquids inside the vehicle.

Electrical devices and systems may malfunction if liquids are splashed on them.

Do not use silicone based sprays on electrical devices such as audio devices and switches.

Doing so may cause the items to malfunction or a fire inside the vehicle.

If a silicone based spray is inadvertently used on electrical devices, consult a dealer.

Depending on their composition, chemicals and liquid aromatics may cause discoloration, wrinkles, and cracking to resin-based parts and textiles. Do not use alkali solvents or organic solvents such as benzene or gasoline.

After using chemicals, make sure to gently wipe them off using a dry cloth.

Do not place used cloths on top of resin based parts or textiles for long periods of time without washing.

■ Floor Mats

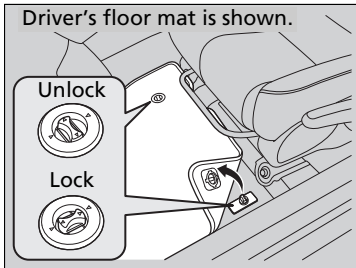

The driver's floor mat hooks over the floor anchors, which keep the mat from sliding forward. To remove a mat for cleaning, turn the anchor knobs to the unlock position. When reinstalling the mat after cleaning, turn the knobs to the lock position.

Do not put additional floor mats on top of the anchored mat.

▣ Floor Mats

If you use any floor mats that were not originally provided with your vehicle, make sure they are designed for your specific vehicle, fit correctly, and are securely anchored by the floor anchors.

■ Maintaining Genuine Leather*

Vacuum dirt and dust from the leather frequently. Pay close attention to the pleats and seams. Clean the leather with a soft cloth dampened with a 90% water and 10% neutral soap solution. Then buff it with a clean, dry cloth. Remove any dust or dirt on leather surfaces immediately.

Exterior Care

Dust off the vehicle body after you drive.

Regularly inspect your vehicle for scratches on painted surfaces. A scratch on a painted surface can result in body rust. If you find a scratch, promptly repair it.

■ Washing the Vehicle

Wash the vehicle regularly. Wash more frequently when driving in the following conditions:

- If driving on roads with road salt.
- If driving in coastal areas.
- If tar, soot, bird droppings, insects, or tree sap are stuck to painted surfaces.

■ Using an Automated Car Wash

Fold in the door mirrors. Make sure to follow the instructions indicated on the automated car wash.

■ Using High Pressure Cleaners

- Keep sufficient distance between the cleaning nozzle and the vehicle body.
- Take particular care around the windows. Standing too close may cause water to enter the vehicle interior. Do not spray water into the engine compartment.

▶▶ Washing the Vehicle

Do not spray water into the air intake vents or engine compartment. It can cause a malfunction.

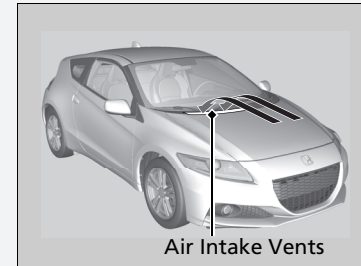

Air Intake Vents

Do not spray water onto the fuel fill door directly. A high-pressure spray may cause it to open.

Continued

■ Applying Wax

A good coat of automotive body wax helps protect your vehicle's paint from the elements. Wax will wear off over time and expose your vehicle's paint to the elements, so reapply as necessary.

■ Maintaining the Bumpers and Other Resin Coated Parts

If you get gasoline, oil, engine coolant, or battery fluid on resin coated parts, they may be stained or the coating may peel. Promptly wipe it away using a soft cloth and clean water.

■ Cleaning the Window

Wipe using a glass cleaner.

■ Maintaining Aluminum Wheels

Aluminum is susceptible to deterioration caused by salt and other road contaminants. Use a sponge and mild detergent to wipe away promptly. Be careful not to use harsh chemicals (including some commercial wheel cleaners) or a stiff brush. They can damage the clear coat of the aluminum alloy wheels that helps keep the aluminum from corroding and tarnishing.

▶▶ Applying Wax

NOTICE

Chemical solvents and strong cleaners can damage the paint, metal, and plastic on your vehicle. Wipe up spills immediately.

▶▶ Maintaining the Bumpers and Other Resin Coated Parts

Ask a dealer about the correct coating material when you want to repair the painted surface of the parts made of resin.

▶▶ Cleaning the Window

Wires are mounted to the inside of the rear window. Wipe along the same direction as the wires with a soft cloth so as not to damage them.

Handling the Unexpected

This chapter explains how to handle unexpected troubles.

Tools

Types of Tools..... 270

If a Tire Goes Flat

Changing a Flat Tire* 271

Temporarily Repairing a Flat Tire..... 277

Engine Does Not Start

Checking the Engine 286

Jump Starting..... 287

Shift Lever Does Not Move..... 289

Overheating

How to Handle Overheating..... 290

Indicator, Coming On/Blinking

If the Low Oil Pressure Indicator
Comes On 292

If the Charging System Indicator
Comes On 293

If the Malfunction Indicator Lamp
Comes On or Blinks 294

If the Brake System Indicator (Red)
Comes On 295

If the EPS System Indicator Comes On.. 295

If the IMA Indicator Comes On..... 296

If the Low Tire Pressure/TPMS Indicator
Comes On or Blinks 296

Fuses

Fuse Locations 297

Inspecting and Changing Fuses.....300

Emergency Towing..... 301

When You Cannot Open the Hatch303

Types of Tools

Types of Tools

The tools were stored in the cargo area.

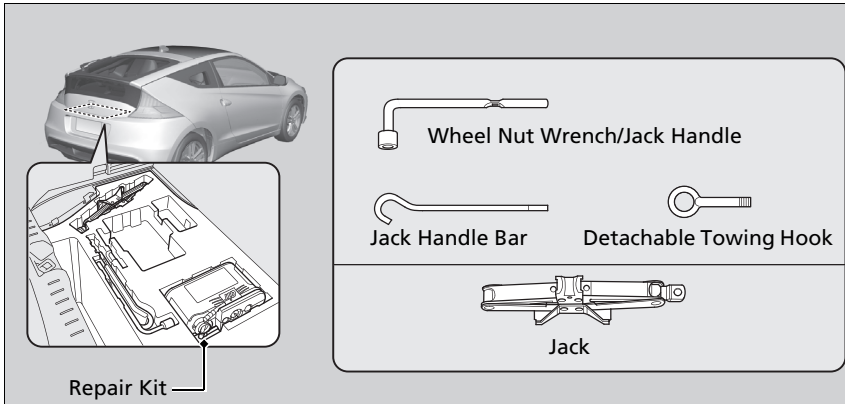

Repair Kit

Changing a Flat Tire*

If a tire goes flat while driving, grasp the steering wheel firmly, and brake gradually to reduce speed. Then, stop in a safe place. Replace the flat tire with a compact spare tire. Go to a dealer as soon as possible to have the full-size tire repaired or replaced.

1. Park the vehicle on firm, level, and non-slippery surface and apply the parking brake.

Automatic transmission (CVT) models

2. Move the shift lever to **P**.

Manual transmission models

2. Move the shift lever to **R**.

All models

3. Turn on the hazard warning lights and turn the ignition switch to LOCK **0**.

Changing a Flat Tire*

Follow compact spare precautions:

Periodically check the tire pressure of the compact spare. It should be set to the specified pressure.
Specified Pressure: 60 psi (420 kPa, 4.2 kgf/cm²)

When driving with the compact spare tire, keep the vehicle speed under 50 mph (80 km/h). Replace with a full-size tire as soon as possible.

The compact spare tire and wheel in your vehicle are specifically for this model.

Do not use them with another vehicle.

Do not use another type of compact spare tire or wheel with your vehicle.

Do not mount tire chains on a compact spare tire. If a chain-mounted front tire goes flat, remove one of the full-size rear tires and replace it with the compact spare tire. Remove the flat front tire and replace it with the full-size tire that was removed from the rear. Mount the tire chains on the front tire.

NOTICE

Do not use a puncture-repairing agent, other than the one provided in the kit that came with your vehicle. If used, you may permanently damage the tire pressure sensor.

* Not available on all models

■ Getting Ready to Replace the Flat Tire

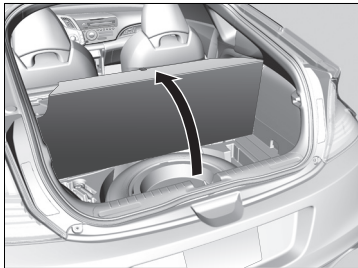

1. Pull the strap on the cargo area floor lid and open the lid.

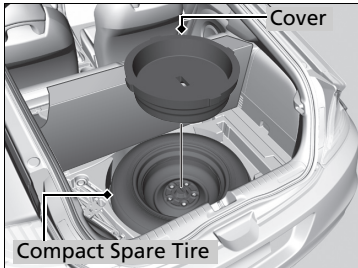

2. Remove the cover from the compact spare tire.

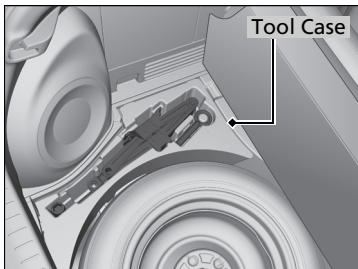

3. Take the jack, jack handle bar, and wheel nut wrench out of the tool case.
4. Unscrew the wing bolt, and remove the spacer cone. Then, remove the compact spare tire.

ORG

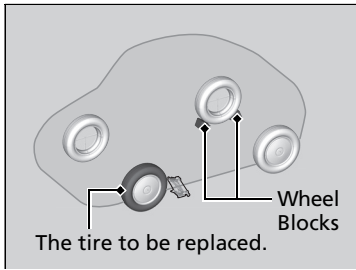

5. Place a wheel block or rock in front and rear of the wheel diagonal to the flat tire.

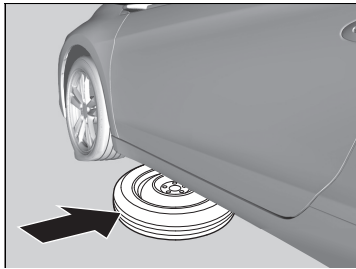

6. Place the compact spare tire (wheel side up) under the vehicle body, near the tire that needs to be replaced.



7. Loosen each wheel nut about one turn using the wheel nut wrench.

Handling the Unexpected

TOC

Index

Home

Continued

How to Set Up the Jack

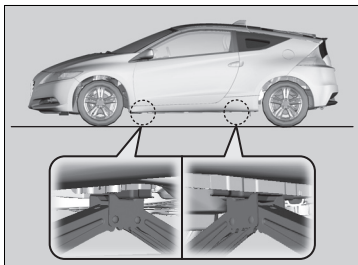

1. Place the jack under the jacking point closest to the tire to be changed.

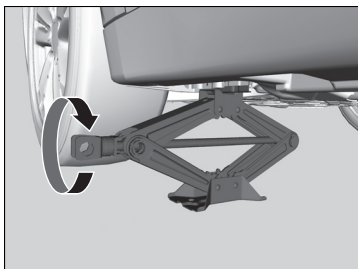

2. Turn the end bracket (as shown in the image) clockwise until the top of the jack contacts the jacking point.
▶ Make sure that the jacking point tab is resting in the jack notch.

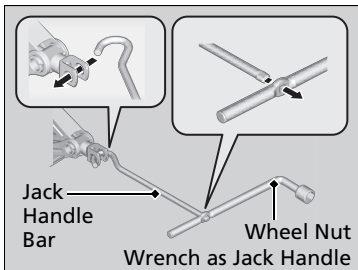

3. Raise the vehicle, using the jack handle bar and the jack handle, until the tire is off the ground.

How to Set Up the Jack

⚠ WARNING

The vehicle can easily roll off the jack, seriously injuring anyone underneath.

Follow the directions for changing a tire exactly, and never get under the vehicle when it is supported only by the jack.

Do not use the jack with people or luggage in the vehicle.

Use the jack provided in your vehicle. Other jacks may not support the weight ("load") or their shape may not match.

The following instructions must be followed to use the jack safely.

- Do not use while the engine is running.
- Use only where the ground is firm and level.
- Use only at the jacking points.
- Do not get in the vehicle while using the jack.
- Do not put anything on top of or underneath the jack.

Replacing the Flat Tire

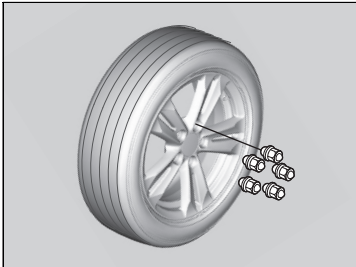

1. Remove the wheel nuts and flat tire.

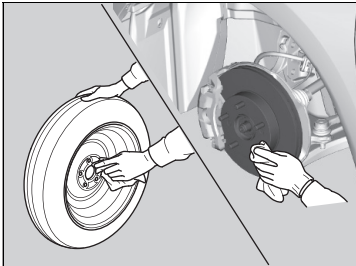

2. Wipe the mounting surfaces of the wheel with a clean cloth.

3. Mount the compact spare tire.

4. Screw the wheel nuts until they touch the lips around the mounting holes, and stop rotating.

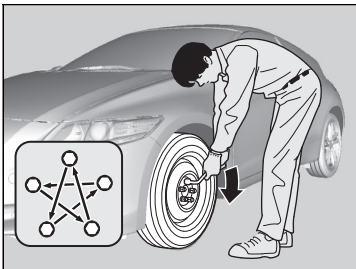

5. Lower the vehicle and remove the jack. Tighten the wheel nuts in the order indicated in the image. Go around, tightening the nuts, two to three times in this order.

Wheel nut torque:

80 lbf·ft (108 N·m, 11 kgf·m)

Replacing the Flat Tire

Do not over tighten the wheel nuts by applying extra torque using your foot or a pipe.

■ Storing the Flat Tire

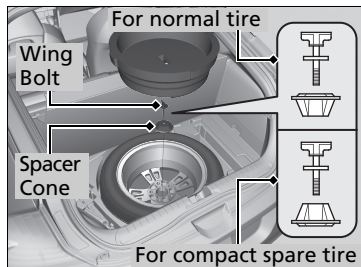

1. Remove the center cap.
2. Place the flat tire face down in the compact spare tire well.
3. Remove the spacer cone from the wing bolt, flip it over, and insert it back on the bolt. Secure the flat tire with the wing bolt.
4. Securely put the jack and wheel nut wrench back in the tool case in the cargo area.

■ TPMS and the Compact Spare Tire

U.S. models only

If you replace a flat tire with the spare tire, the low tire pressure/TPMS indicator comes on while you are driving. After driving for a few miles (kilometers), the indicator will start blinking for a short time and then stay on. **CHECK TPMS SYSTEM** appears on the multi-information display, but this is normal.

If you replace the tire with a specified regular tire, the warning message on the multi-information display and the low tire pressure/TPMS indicator will go off after a few miles (kilometers).

▶▶ Storing the Flat Tire

⚠ WARNING

Loose items can fly around the interior in a crash and can seriously injure the occupants.
Store the wheel, jack, and tools securely before driving.

▶▶ TPMS and the Compact Spare Tire

The system cannot monitor the pressure of the compact spare tire. Manually check the compact spare tire pressure to be sure that it is correct.

Use TPMS specific wheels. Each is equipped with a tire pressure sensor mounted inside the tire behind the valve stem.

Temporarily Repairing a Flat Tire

This vehicle is not equipped with a spare tire. If the tire has a large cut or is otherwise severely damaged, you will need to have the vehicle towed. If the tire only has a small puncture, from a nail for instance, you can use the temporary tire repair kit so that you can drive to the nearest service station for a more permanent repair.

If a tire goes flat while driving, grasp the steering wheel firmly, and brake gradually to reduce speed. Then stop in a safe place.

1. Park the vehicle on firm, level, and non-slippery surface, and apply the parking brake.

Automatic transmission (CVT) models

2. Move the shift lever to **P**.

Manual transmission models

2. Move the shift lever to **R**.

All models

3. Turn on the hazard warning lights and turn the ignition switch to LOCK **0**.

Getting Ready to Temporarily Repair the Flat Tire

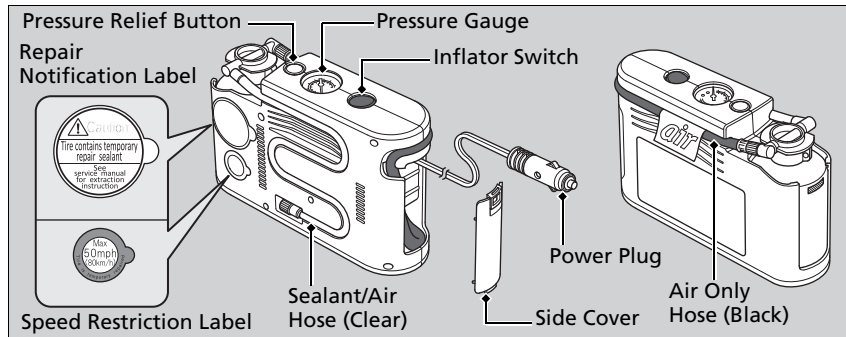

Temporarily Repairing a Flat Tire

The kit should not be used in the following situations. Instead, contact a dealer or a roadside assistant to have the vehicle towed.

- The tire sealant has expired.
- More than two tires are punctured.
- The puncture or cut is larger than 3/16 inch (4 mm).
- The tire side wall is damaged or the puncture is outside the contact area.



When the puncture is:	Kit Use
Smaller than 3/16 inch (4 mm)	Yes
Larger than 3/16 inch (4 mm)	No

- Damage has been caused by driving with the tire extremely under inflated.
- The tire bead is no longer seated.
- The rim is damaged.

Do not remove a nail or screw that punctured the tire. If you remove it from the tire, you may not be able to repair the puncture using the kit.

NOTICE

Do not use a puncture-repairing agent other than the one provided in the kit that came with your vehicle. If a different agent is used, you may permanently damage the tire pressure sensor.

Continued

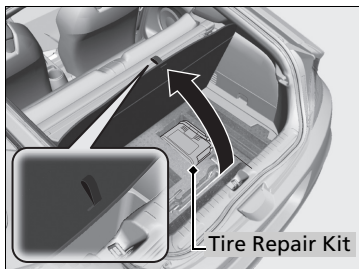

1. Pull the strap and take the kit out of the case.

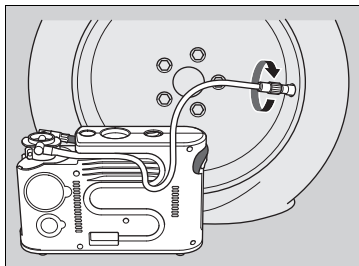

2. Place the kit upright, on flat ground near the flat tire, and away from traffic. Do not place the kit on its side.

▶▶ Getting Ready to Temporarily Repair the Flat Tire

When making a temporary repair, carefully read the instruction manual provided with the kit.

Injecting Sealant and Air

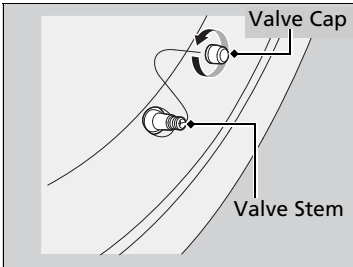

1. Remove the valve cap from the tire valve stem.

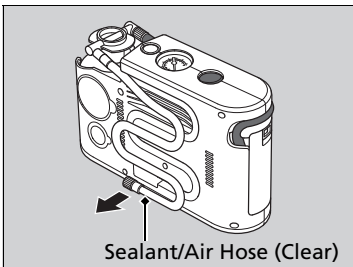

2. Remove the sealant/air hose (clear) from the packaging.

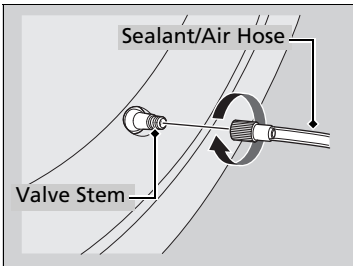

3. Attach the sealant/air hose onto the tire valve stem. Screw it until it is tight.

Injecting Sealant and Air

WARNING

Tire sealant contains substances that are harmful and can be fatal if swallowed.

If accidentally swallowed, do not induce vomiting. Drink plenty of water and get medical attention immediately.

For skin or eye contact, flush with cool water and get medical attention if necessary.

In cold temperatures, the sealant may not flow easily. In this situation, warm it up for five minutes before using.

The sealant can permanently stain clothing and other materials. Be careful during handling and wipe away any spills immediately.

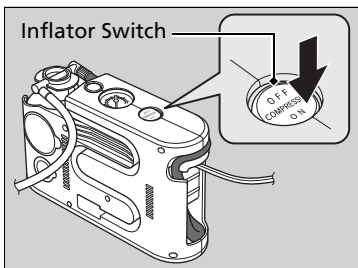
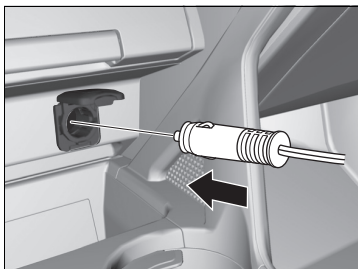

4. Remove the side cover, then pull out the power plug.
5. Plug in the compressor to the accessory power socket.
 - ▶ Be careful not to pinch the cord in a door or window.
6. Start the engine.
 - ▶ Keep the engine running while injecting sealant and air.
 - ▶ [Carbon Monoxide Gas](#) P. 62
7. Press the inflator switch to turn on the compressor.
 - ▶ The compressor starts injecting sealant and air into the tire.
8. Continue to add air after the sealant injection is complete.
9. After the air pressure reaches the required pressure, turn off the inflator switch.
 - ▶ To check the pressure, occasionally turn off the compressor and read the gauge.

▶▶ Injecting Sealant and Air

⚠ WARNING

Running the engine with the vehicle in an enclosed or even partly enclosed area can cause a rapid build-up of toxic carbon monoxide. Breathing this colorless, odorless gas can cause unconsciousness and even death. Only run the engine to power the air compressor with the vehicle outdoors.

NOTICE

Do not operate the temporary tire repair kit compressor for more than 15 minutes. The accessory power socket and compressor can overheat and become permanently damaged.

There is an accessory power socket in the front console panel.

▶ [Accessory Power Socket](#) P. 129

Until the sealant injection is complete, the pressure shown on the pressure gauge will appear higher than actual. After the sealant injection is complete the pressure will drop and then begin to rise again as the tire is inflated with air. This is normal. To accurately measure the air pressure using the gauge, turn the air compressor off only after the sealant injection is complete.

See the driver's doorjamb or the specifications in this manual for the required air pressure.

▶ [Specifications](#) P. 306

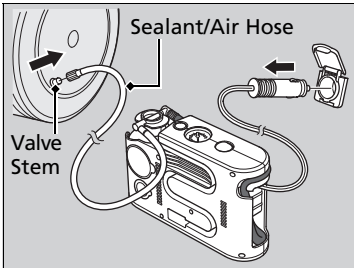

10. Unplug the power plug from the accessory power socket.

► Handle the compressor and the power plug carefully. They may be hot in operation.

11. Unscrew the sealant/air hose from the tire valve stem. Reinstall the valve cap.

12. Press the pressure relief button until the gauge returns to 0 psi (0 kPa).

13. Apply the repair notification label to the flat surface of the wheel.

► The wheel surface must be clean to ensure the label adheres properly.

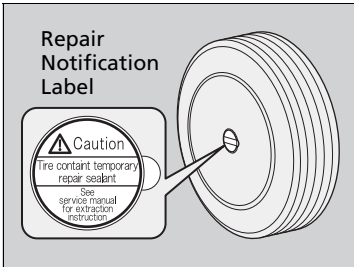

► Injecting Sealant and Air

If the required air pressure is not reached within 10 minutes, the tire may be too severely damaged for the kit to provide the necessary seal and your vehicle will need to be towed.

See a Honda dealer for a replacement sealant bottle and proper disposal of an empty bottle.

■ Distributing the Sealant in the Tire

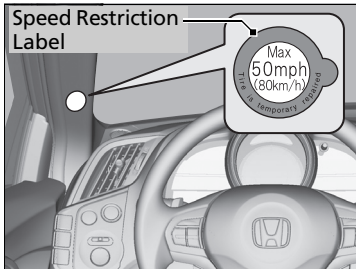

1. Apply the speed restriction label to the location as shown.
2. Drive the vehicle for about 10 minutes.
 - ▶ Do not exceed 50 mph (80 km/h).
3. Stop the vehicle in a safe place.

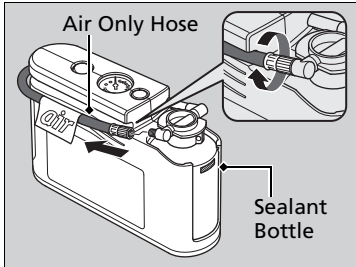

4. Unscrew the air only hose (black) to remove it from the sealant bottle.

▶▶ Distributing the Sealant in the Tire

Stop and recheck the air pressure after every 10 minutes of driving as necessary until you reach the nearest service station where you should have the tire permanently repaired or replaced.

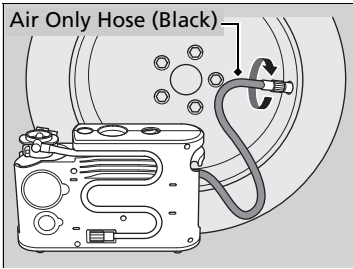

5. Recheck the air pressure using the air only hose (black) on the compressor.
 - ▶ Do not turn the air compressor on to check the pressure.

▶ **Inflating An Under-inflated Tire**
P. 284

6. If the air pressure is:
 - ▶ Less than 19 psi (130 kPa):
Do not add air or continue driving. The leak is too severe. Call for help and have your vehicle towed.
▶ **Emergency Towing** P. 301
 - ▶ The required air pressure or more:
Continue driving for another 10 minutes or until you reach the nearest service station. Do not exceed 50 mph (80 km/h).
 - ▶ If the air pressure does not go down after the 10 minutes driving, you do not need to check the pressure any more.
 - ▶ Greater than 19 psi (130 kPa), but less than the required air pressure:
Use the air compressor to inflate the tire to the required air pressure.
▶ **Inflating An Under-inflated Tire** P. 284
Then drive carefully for 10 more minutes or until you reach the nearest service station. Do not exceed 50 mph (80 km/h).
 - ▶ You should repeat this procedures as long as the air pressure is within this range.

7. Repackage and properly stow the kit.

▶ Distributing the Sealant in the Tire

See the driver's doorjamb or the specifications in this manual for the required air pressure.

▶ **Specifications** P. 306

⚠ WARNING

Running the engine with the vehicle in an enclosed or even partly enclosed area can cause a rapid build-up of toxic carbon monoxide.

Breathing this colorless, odorless gas can cause unconsciousness and even death. Only run the engine to power the air compressor with the vehicle outdoors.

■ Inflating An Under-inflated Tire

You can use the kit to inflate a non-punctured under-inflated tire.

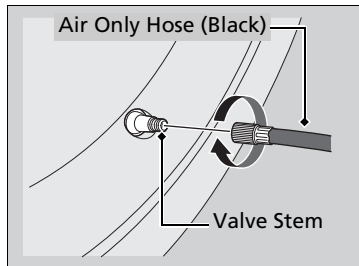
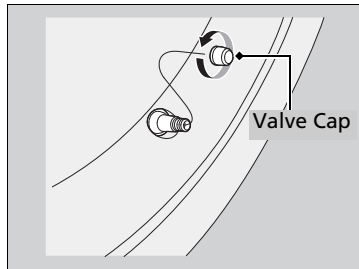
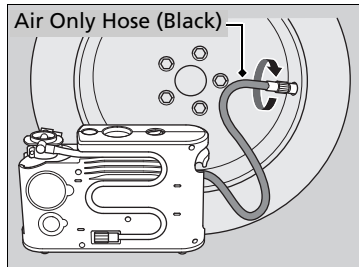

1. Pull the strap on the cargo area floor lid and open the lid.
▶ **Getting Ready to Temporarily Repair the Flat Tire** P. 277
2. Remove the kit from the case.
3. Place the kit upright on flat ground near the tire to be inflated, away from traffic. Do not place the kit on its side.
4. Unscrew the air only hose (black) to remove it from the sealant bottle.
5. Remove the valve cap.
6. Attach the air only hose onto the tire valve stem. Screw it until it is tight.

▶▶ Inflating An Under-inflated Tire

NOTICE

Do not operate the temporary tire repair kit compressor for more than 15 minutes. The accessory power socket and compressor can overheat and become permanently damaged.

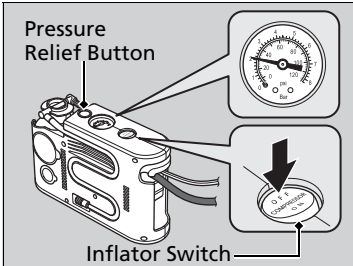
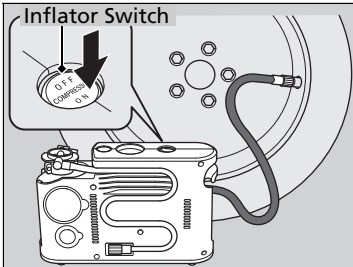
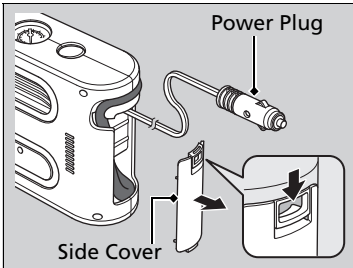

7. Remove the side cover, then pull out the power plug.
 8. Plug in the compressor to the accessory power socket.
 - Be careful not to pinch the cord in a door or window.
 9. Start the engine.
 - Keep the engine running while injecting air.
- ⚠ Carbon Monoxide Gas P. 62**
10. Press the inflator switch to turn on the compressor.
 - The compressor starts to inject air into the tire.
 11. Inflate the tire to the specified air pressure.
 12. Turn off the inflator switch.
 - Check the pressure gauge on the air compressor.
 - If overinflated, press the pressure relief button.
 13. Unplug the compressor from the accessory power socket.
 14. Unscrew the air only hose from the tire valve stem. Reinstall the valve cap.
 15. Press the pressure relief button until the gauge returns to 0 psi (0 kPa).
 16. Repackage and properly stow the kit.

► Inflating An Under-inflated Tire

⚠ WARNING

Running the engine with the vehicle in an enclosed or even partly enclosed area can cause a rapid build-up of toxic carbon monoxide. Breathing this colorless, odorless gas can cause unconsciousness and even death. Only run the engine to power the air compressor with the vehicle outdoors.

Checking the Engine

If the engine does not start, turn the ignition switch to START  and check the starter.

Checking the Engine

If you must start the vehicle immediately, use an assisting vehicle to jump start it.

[Jump Starting P. 287](#)

Starter condition

Checklist

Starter doesn't turn or turns over slowly.

The 12 volt battery may be dead. Check each of the items on the right and respond accordingly.

The starter turns over normally but the engine doesn't start.

There may be a problem with the fuse. Check each of the items on the right and respond accordingly.

Check brightness of the interior light.

Turn on interior lights and check brightness.

- If the interior lights are dim or do not come on at all
[Checking the 12 Volt Battery P. 262](#)
- If the interior lights come on normally
[Inspecting and Changing Fuses P. 300](#)

Review the engine start procedure.

Follow its instructions, and try to start the engine again.

[Starting the Engine P. 178](#)

Check the immobilizer system indicator.

When the immobilizer system indicator is blinking, the engine cannot be started.

[Immobilizer System P. 106](#)

Check the fuel level.

There should be enough fuel in the tank.

[Fuel Gauge P. 81](#)

Check the fuse.

Check all fuses, or have the vehicle checked by a dealer.

[Inspecting and Changing Fuses P. 300](#)

If the problem continues:

[Emergency Towing P. 301](#)

Jump Starting Procedure

Turn off the power to electric devices, such as audio and lights. Turn off the engine, then open the hood.

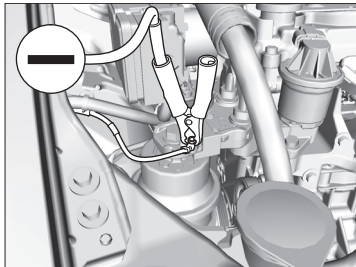
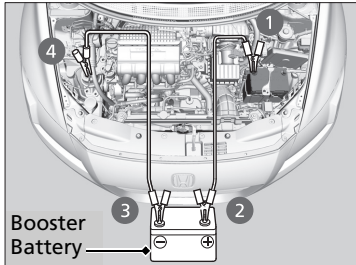

1. Connect the first jumper cable to your vehicle's \oplus terminal.
2. Connect the other end of the first jumper cable to the booster battery \oplus terminal.
▶ Use a 12 volt booster battery only.
3. Connect the second jumper cable to the booster battery \ominus terminal.
4. Connect the other end of the second jumper cable to the grounding strap as shown.
Do not connect this jumper cable to any other part.
5. If your vehicle is connected to another vehicle, start the assisting vehicle's engine and increase its rpm slightly.
6. Attempt to start your vehicle's engine. If it turns over slowly, check that the jumper cables have good metal-to-metal contact.

Jump Starting

⚠ WARNING

A battery can explode if you do not follow the correct procedure, seriously injuring anyone nearby.

Keep all sparks, open flames, and smoking materials away from the battery.

Securely attach the jumper cables clips so that they do not come off when the engine vibrates. Also be careful not to tangle the jumper cables or allow the cable ends to touch each other while attaching or detaching the jumper cables.

Battery performance degrades in cold conditions and may prevent the engine from starting.

■ What to Do After the Engine Starts

Once your vehicle's engine has started, remove the jumper cables in the following order.

1. Disconnect the jumper cable from your vehicle's ground.
2. Disconnect the other end of the jumper cable from the booster battery \ominus terminal.
3. Disconnect the jumper cable from your vehicle's \oplus terminal.
4. Disconnect the other end of the jumper cable from the booster battery \oplus terminal.

Have your vehicle inspected by a nearby service station or a dealer.

Automatic transmission (CVT) models

Follow the procedure below if you cannot move the shift lever out of the **P** position.

Releasing the Lock

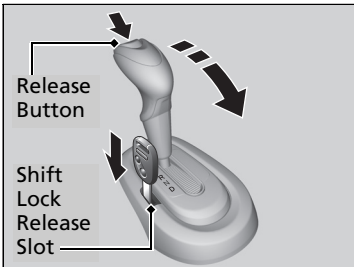
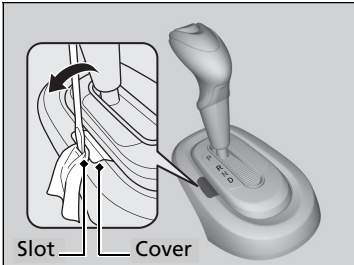

1. Set the parking brake.
2. Remove the key from the ignition switch.
3. Wrap a cloth around the tip of a small flat-tip screwdriver. Put it into the shift lock release slot as shown in the image, and remove the cover.
4. Insert the key into the shift lock release slot.
5. While pushing the key down, press the shift lever release button and place the shift lever into **N**.
 - ▶ The lock is now released. Have the shift lever checked by a dealer as soon as possible.

How to Handle Overheating

Overheating symptoms are as follows:

- The high temperature indicator comes on or the engine suddenly loses power.
- Steam or spray comes out of the engine compartment.

■ First thing to do

1. Immediately park the vehicle in a safe place.
2. Turn off all accessories and turn on the hazard warning lights.
 - ▶ **No steam or spray present:** Keep the engine running and open the hood.
 - ▶ **Steam or spray is present:** Turn off the engine and wait until it subsides. Then open the hood.

🔧 How to Handle Overheating

WARNING

Steam and spray from an overheated engine can seriously scald you.

Do not open the hood if steam is coming out.

NOTICE

Continuing to drive with the high temperature indicator on may damage the engine.

■ Next thing to do

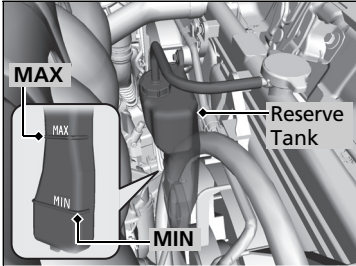

1. Check that the cooling fan is operating and stop the engine once the high temperature indicator goes off.
 - If the cooling fan is not operating, immediately stop the engine.
2. Once the engine has cooled down, inspect the coolant level and check the cooling system components for leaks.
 - If the coolant level in the reserve tank is low, add coolant until it reaches the **MAX** mark.
 - If there is no coolant in the reserve tank, check that the radiator is cool. Cover the radiator cap with a heavy cloth and open the cap. If necessary, add coolant up to the base of the filler neck, and put the cap back on.

■ Last thing to do

Once the engine has cooled sufficiently, restart it and check the high temperature indicator.

If the high temperature indicator is off, resume driving. If it stays on, contact a dealer for repairs.

►► How to Handle Overheating

⚠ WARNING

Removing the radiator cap while the engine is hot can cause the coolant to spray out, seriously scalding you.

Always let the engine and radiator cool down before removing the radiator cap.

If the coolant is leaking, contact a dealer for repairs.

Use water as an emergency/temporary measure only. Have a dealer flush the system with proper antifreeze as soon as possible.

If the Low Oil Pressure Indicator Comes On



■ Reasons for the indicator to come on

Comes on when the engine oil pressure is low.

■ What to do as soon as the indicator comes on

1. Immediately park the vehicle on level ground in a safe place.
2. If necessary, turn the hazard warning lights on.

■ What to do after parking the vehicle

1. Stop the engine and let it sit for about three minutes.
2. Open the hood and check the oil level.
 - ▶ Add oil as necessary.
 - ▶ [Oil Check P. 232](#)
3. Start the engine and check the low oil pressure indicator.
 - ▶ The light goes out: Start driving again.
 - ▶ The light does not go out within 10 seconds: Stop the engine and contact a dealer for repairs immediately.

▶ If the Low Oil Pressure Indicator Comes On

NOTICE

Running the engine with low oil pressure can cause serious mechanical damage almost immediately.

If the Charging System Indicator Comes On



■ Reasons for the indicator to come on

Comes on when the 12 volt battery is not being charged.

■ What to do when the indicator comes on

Turn off the climate control system, rear defogger, and other electrical systems, and immediately contact a dealer for repairs.

▶▶ If the Charging System Indicator Comes On

If you need to stop temporarily, do not turn off the engine. Restarting the engine may rapidly discharge the 12 volt battery.

Manual transmission models

This indicator may also come on when the Auto Idle Stop function is activated for a while. Restart the engine.

➤ [Auto Idle Stop P. 194](#)

Automatic transmission (CVT) models

This indicator may also come on when the IMA battery charge drops below a desired level. The engine starts to recharge the battery.

➤ [Auto Idle Stop P. 191](#)

The indicator goes off when the battery is being charged normally.

This indicator may blink after starting when the outside temperature is below -20°F (-30°C). It will stop blinking after the IMA battery warms up.

If the Malfunction Indicator Lamp Comes On or Blinks

▶▶ If the Malfunction Indicator Lamp Comes On or Blinks



■ Reasons for the indicator lamp to come on or blink

- Comes on when there is a problem with the engine emissions control system, or the fuel fill cap is missing, or loose.
- Blinks when engine misfiring is detected.

■ What to do when the indicator lamp comes on

Avoid high speeds and immediately get your vehicle inspected at a dealer.

■ What to do when the indicator lamp blinks

Park the vehicle in a safe place with no flammable items and wait at least ten minutes or more with the engine stopped until it cools.

NOTICE

If you drive with the malfunction indicator lamp on, the emissions control system and the engine could be damaged.

If the malfunction indicator lamp blinks again when restarting the engine, drive to the nearest dealer at 31 mph (50 km/h) or less. Have your vehicle inspected.

■ Tighten Fuel Cap Message

■ The message appears on when:

An evaporative system leak is detected. This may be caused by the fuel fill cap being loose or not being installed.

■ What to do when the message appears:

1. Stop the engine.
2. Check that the fuel fill cap is fully installed.
 - ▶ If not, loosen the cap, and then retighten it until it clicks at least once.
3. Drive for several days of normal driving.
 - ▶ The message should go off.

■ When the malfunction indicator lamp comes on

Malfunction indicator lamp comes on if the system continues to detect a leak of gasoline vapor. If this happens, check the fuel fill cap using the procedures described above.

If the Brake System Indicator (Red) Comes On

U.S.

BRAKE

■ Reasons for the indicator to come on

- The brake fluid is low.
- There is a malfunction in the brake system.

Canada



■ What to do when the indicator comes on while driving

Press the brake pedal lightly to check pedal pressure.

- If normal, check the brake fluid level the next time you stop.
- If abnormal, take immediate action. If necessary, downshift the transmission to slow the vehicle using engine braking.

☒ If the Brake System Indicator (Red) Comes On

Have your vehicle repaired immediately. It is dangerous to drive with low brake fluid. If there is no resistance from the brake pedal, stop immediately in a safe place. If necessary downshift the gears.

If the brake system indicator and **ABS** indicator come on simultaneously, the electronic brake distribution system is not working. This can result in vehicle instability under sudden braking. Have your vehicle inspected by a dealer immediately.

☒ If the EPS System Indicator Comes On

NOTICE

If you repeatedly turn the steering wheel at an extremely low speed, or hold the steering wheel on the full left or right position for a while, the system heats up. The system goes into a protective mode, and limits its performance. The steering wheel becomes harder and harder to operate. Once the system cools down, EPS is restored. Repeated operation under these conditions can eventually damage the system.

If the EPS System Indicator Comes On



■ Reasons for the indicator to come on

- Comes on when there is a problem with EPS system.
- If you depress the accelerator pedal repeatedly to increase the engine speed while the engine is idling, the indicator comes on, and sometimes the steering wheel becomes harder to operate.

■ What to do when the indicator comes on

Stop the vehicle in a safe place and restart the engine.

If the indicator comes on and stays on, immediately have your vehicle inspected by a dealer.

If the IMA Indicator Comes On



■ Reasons for the indicator to come on

Comes on when there is a problem with the IMA system.

■ What to do when the indicator come on

Avoid high speeds and immediately get your vehicle inspected by a dealer.

U.S. models

If the Low Tire Pressure/ TPMS Indicator Comes On or Blinks



■ Reasons for the indicator to come on or blink

A tire pressure is significantly low. If there is a problem with the TPMS or the compact spare tire* is installed, the indicator blinks for about one minute, and then stays on.

■ What to do when the indicator comes on

Drive carefully and avoid abrupt cornering and hard braking. Stop your vehicle in a safe place. Check the tire pressure and adjust the pressure to the specified level. The specified tire pressure is on a label on the driver side doorjamb.

■ What to do when the indicator blinks, then remains on

Have the tire inspected by a dealer as soon as possible. If the compact spare tire* causes the indicator to blink, change the tire to a full-size tire. The indicator goes off after driving for a few miles (kilometers).

▶▶ If the Low Tire Pressure/TPMS Indicator Comes On or Blinks

NOTICE

Driving on an extremely underinflated tire can cause it to overheat. An overheated tire can fail. Always inflate your tires to the prescribed level.

Fuse Locations

If any electrical devices are not working, turn the ignition switch to LOCK  and check to see if any applicable fuse is blown.

Engine Compartment Fuse Box

Located near the ⊕ terminal on the 12 volt battery.

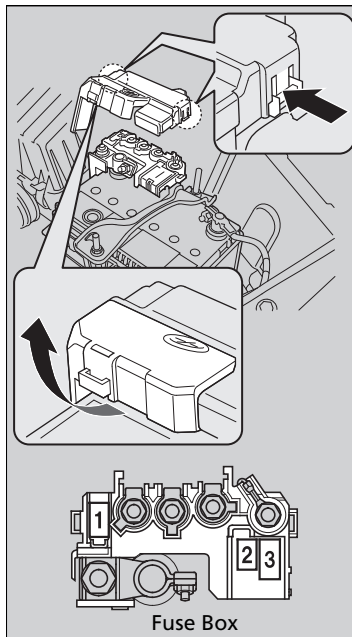

Fuse Box

Fuse locations are shown on the fuse box cover.

Locate the fuse in question by the fuse number and box cover number.

1. Pull on the tab to release the front of the cover.
2. Pull up the cover by pushing the two tabs as shown.
Replacement of engine compartment fuses should be done by a dealer.

■ Circuit protected and fuse rating

	Circuit Protected	Amps
1	Battery	100 A
2	EPS	70 A
3	Horn, Stop, Hazard	20 A

ORG

■ Interior Fuse Box

Located under the driver side dashboard.

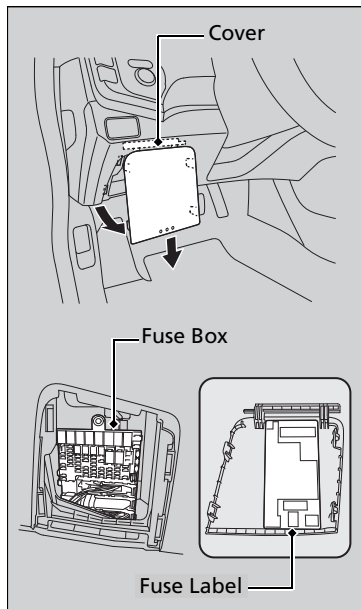

Fuse locations are shown on the label on the back side of the cover.

Locate the fuse in question by the fuse number and label number.

■ Circuit protected and fuse rating

	Circuit Protected	Amps
1	Back UP	15 A
2	TPMS* ¹	7.5 A
3	Driver's Power Window	20 A
4	–	–
5	Back-Up Light	10 A
6	SRS	10 A
7	Transmission SOL* ²	10 A
8	SRS	7.5 A
9	Fog Light* ³	20 A
10	A/C	7.5 A
11	ABS/VSA®	7.5 A
12	IMA	10 A
13	Accessory Power Socket	20 A
14	Radio	7.5 A
15	Daytime Running Lights	7.5 A
16	Rear Wiper	10 A
17	Passenger's Power Window	20 A
18	–	–
19	–	–
20	Fuel Pump	15 A

	Circuit Protected	Amps
21	Washer	15 A
22	Meter	7.5 A
23	Hazard	10 A
24	Stop/Horn	10 A
25	Audio AMP* ³	20 A
26	LAF	10 A
27	Door Lock Main	20 A
28	Headlight Main	20 A
29	Small Light	10 A
30	Main Fan Motor	30 A
31	IGPS	7.5 A
32	Right Headlight Low* ³	10 A
	Right Headlight Low (HID)* ⁴	15 A
33	Ignition Coil	15 A
34	Left Headlight Low* ³	10 A
	Left Headlight High* ⁴	10 A
35	Door Lock	7.5 A
36	Door Lock	10 A
37	ABS FSR/VSA® FSR	30 A
38	–	–

*1:U.S. models only

*2:Automatic transmission (CVT)

*3:Vehicle with halogen bulb low beam headlights

*4:Vehicle with discharge headlights

Handling the Unexpected

TOC

Index

Home

■ Circuit protected and fuse rating

	Circuit Protected	Amps
39	IGP	15 A
40	Heated Seat *	10 A
41	– ^{*1}	–
	Daytime Running Lights ^{*2}	7.5 A
42	IMA 1	7.5 A
43	MG Clutch	7.5 A
44	STS	7.5 A
45	Door Lock	20 A
46	–	–
47	Sub Fan Motor	30 A
48	Left Headlight High ^{*1}	10 A
	Left Headlight Low (HID) ^{*2}	15 A
49	Door Lock Motor 2 (UNLOCK)	7.5 A
50	–	–
51	Right Headlight High	10 A
52	DBW	15 A
53	IMA 2	15 A
54	–	–

	Circuit Protected	Amps
55	Heated Mirror [*]	10 A
56	Front Wiper	30 A
57	Blower Motor	30 A
58	ABS/VSA® MTR	30 A
59	Rear Defogger	40 A ^{*3} 30 A ^{*4}
60	IG Main	50 A
61	–	–
62	–	–

*1: Vehicle with halogen bulb low beam headlights

*2: Vehicle with discharge headlights

*3: With heated door mirror

*4: Without heated door mirror

Handling the Unexpected

* Not available on all models

Inspecting and Changing Fuses

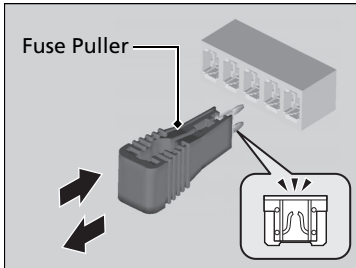
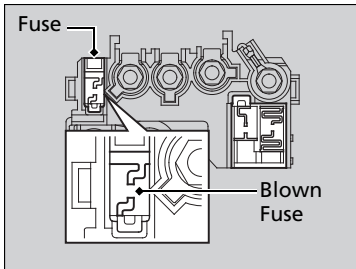

1. Turn the ignition switch to LOCK **0**. Turn headlights and all accessories off.
2. Check the fuses in the engine compartment.
 - If the fuse is blown, have it replaced by a dealer.
3. Inspect the small fuses in the vehicle interior.
 - If there is a burned out fuse, remove it with the fuse puller and replace it with a new one.

Inspecting and Changing Fuses

NOTICE

Replacing a fuse with one that has a higher rating greatly increases the chances of damaging the electrical system.

Replace fuse with a spare fuse of the same specified amperage.

Confirm the specified amperage using the charts on [P. 297](#) to [P. 298](#).

There is a fuse puller on the fuse box.

Call a professional towing service if you need to tow your vehicle.

■ Flat bed equipment

The operator loads your vehicle on the back of a truck.

This is the best way to transport your vehicle.

■ Wheel lift equipment

The tow truck uses two pivoting arms that go under the front tires and lift them off the ground. The rear tires remain on the ground. **This is an acceptable way to tow your vehicle.**

» Emergency Towing

NOTICE

Trying to lift or tow your vehicle by the bumpers will cause serious damage. The bumpers are not designed to support the vehicle's weight.

NOTICE

Improper towing such as towing behind a motorhome or other motor vehicle can damage the transmission.

Never tow your vehicle with just a rope or chain. It is very dangerous, since ropes or chains may shift from side to side or break.

■ Towing Hook

For very short distances, such as freeing the vehicle, you can use the detachable towing hook that mounts on the anchor in the front bumper.

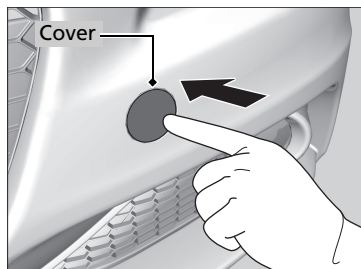

1. Push the right edge of the cover with your finger, then remove it.
2. Take the towing hook and the wheel nut wrench out of the cargo area.

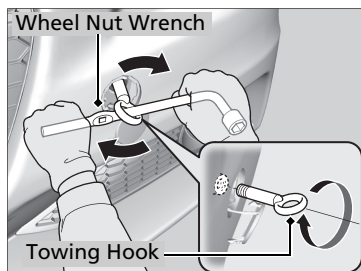

3. Screw the towing hook into the hole, and tighten it with the wheel nut wrench.

▶▶ Towing Hook

NOTICE

To avoid damage to your vehicle, use the towing hook for straight, flat ground towing only. Do not tow at an angle. This hook should not be used to tow the vehicle onto a flat bed. Do not use it as a tie down.

Make sure to use the properly-designed and attached towing equipment.

NOTICE

Do not slip the clutch for a long time to get unstuck. This may overheat and damage the transmission.

What to Do When Unable to Open the Hatch

If you cannot open the hatch, use the following procedure.



1. Remove the cover on the back of the hatch by prying it off with a small flat-tip screwdriver.
 - ▶ Wrap the flat-tip screwdriver with a cloth to prevent scratches.

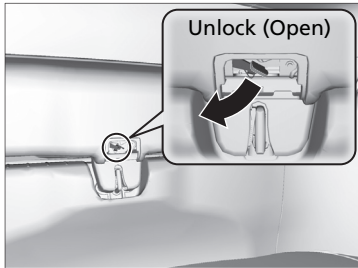

2. Push the release lever until the hatch unlocks. Push the hatch up to open.

What to Do When Unable to Open the Hatch

After taking these steps, contact a dealer to have the vehicle checked.

When you open the hatch from inside, make sure there is enough space around the hatch, and it does not hit anyone or any object.

Information

This chapter includes your vehicle's specifications, locations of identification numbers, and other information required by regulation.



- Specifications** 306
- Identification Numbers**
 - Vehicle Identification Number (VIN).. 308
 - Engine Number and Transmission Number..... 308
- Devices that Emit Radio Waves** 309
- Reporting Safety Defects** 310

- Emissions Testing**
 - Testing of Readiness Codes..... 311
- Warranty Coverages** 313
- Authorized Manuals**..... 315
- Customer Service Information**..... 316

■ Vehicle Specifications

Model	CR-Z
No. of Passengers:	
Front	2
Rear	-
Total	2
Weights:	
Gross Vehicle	U.S.: 3,263 lbs (1,480 kg)
Weight Rating	Canada: 1,480 kg
Gross Axle Weight	
Rating (Front)	U.S.: 1,819 lbs (825 kg)
	Canada: 825 kg
Gross Axle Weight	
Rating (Rear)	U.S.: 1,455 lbs (660 kg)
	Canada: 660 kg
Air Conditioning:	
Refrigerant Type	HFC-134a (R-134a)
Charge Quantity	15.8 – 17.6 oz (450 – 500 g)
Lubricant Type	SP-10

■ Engine Specifications

Displacement	91 cu-in (1,497 cm ³)
Spark Plugs	NGK DIFR6D13
	DENSO DK20PR-D13

■ Fuel

Fuel:	Unleaded gasoline, Pump octane number of 87 or higher
Fuel Tank Capacity	10.6 US gal (40 L)

■ 12 Volt Battery

Capacity/Type	32AH(5)/40AH(20)
	34AH(5)/40AH(20)

■ Washer Fluid

Tank Capacity	U.S.: 2.6 US qt (2.5 L)
	Canada: 5.12 US qt (4.85 L)

■ Light Bulbs

Headlights (Low Beam)	35W (D4S) ^{*1}
	55W (H11) ^{*2}
Headlights (High Beam)	60W (HB3)
Fog Lights *	35W (H8)
Front Turn Signal/Parking/Side Marker Lights	28W/8W
Rear Side Marker Lights	3CP
Brake/Taillights	LED
Side Turn Signal Lights (on Door Mirrors)	LED
Back-Up Lights	16W
Rear Turn Signal Lights	21W (Amber)
High-Mount Brake Lights	LED
License Plate Light	5W
Cargo Area Light	5W
Interior Lights	
Front	8W
Rear	3.4W
Vanity Mirror Lights *	2W
Glove Box Light	1.4W
Courtesy Lights	2CP (3.8W)

*1: Vehicle with discharge headlights

*2: Vehicle with halogen bulb low beam headlights

■ Brake Fluid

Specified	Honda Heavy Duty Brake Fluid DOT 3
-----------	------------------------------------

■ Automatic Transmission (CVT) Fluid

Specified	Honda CVTF (continuously variable transmission fluid)
Capacity	Change 3.0 US qt (2.8 L)

■ Manual Transmission Fluid

Specified	Honda Manual Transmission Fluid
Capacity	Change 1.5 US qt (1.4 L)

■ Engine Oil

Recommended	-Genuine Honda Motor Oil 0W-20 -API Premium-grade 0W-20 detergent oil
Change	3.6 US qt (3.4 L)
Capacity	Change including filter 3.8 US qt (3.6 L)

■ Engine Coolant

Specified	Honda Long-Life Antifreeze/Coolant Type2
Ratio	50/50 with distilled water
Capacity	1.17 US gal (4.42 L) ^{*1} 1.15 US gal (4.35 L) ^{*2} (change including the remaining 0.116 US gal (0.44 L) in the reserve tank)

*1: Manual transmission models
*2: Automatic transmission (CVT) models

■ Tire

Regular	Size	P195/55R16 86V 205/45R17 84W ^{*3}
	Front	30 psi (210 kPa [2.1 kgf/cm ²])
		32 psi (220 kPa [2.2 kgf/cm ²]) ^{*4}
	Rear	30 psi (210 kPa [2.1 kgf/cm ²])
30 psi (210 kPa [2.1 kgf/cm ²]) ^{*4}		
Compact Spare [*]	Size	T135/80D15 99M
Wheel Size	Regular	16 x 6J
	Compact Spare [*]	17 x 6.5J ^{*3} 15 x 4T

*3: Optional on Canadian models
*4: 205/45R17 tires

* Not available on all models

Vehicle Identification Number (VIN)

Your vehicle has a 17-digit vehicle identification number (VIN) used to register your vehicle for warranty purposes, and for licensing and insuring your vehicle. See the image below for the VIN locations.

Engine Number and Transmission Number

See the image below for the locations of your vehicle's engine number and transmission number.

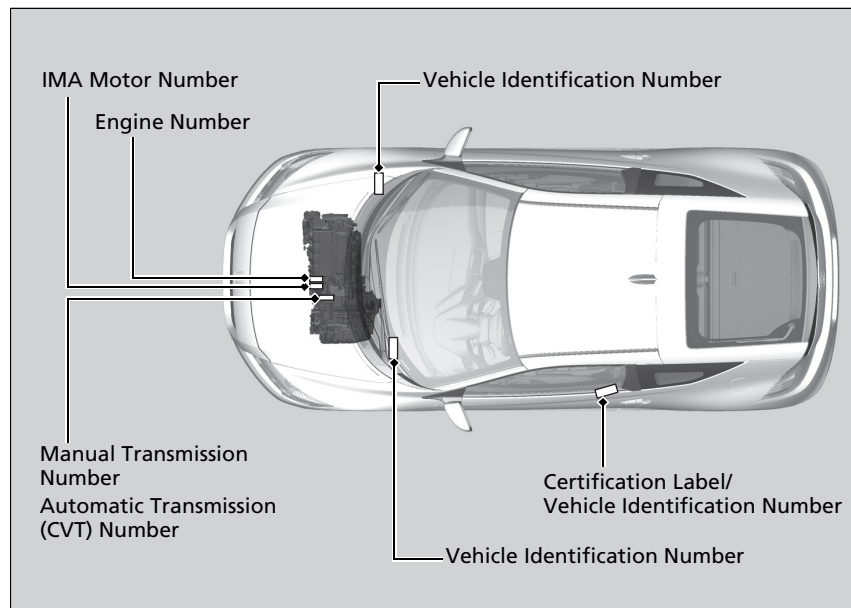

The following products and systems on your vehicle emit radio waves when in operation.

Audio System

Bluetooth® HandsFreeLink®

Immobilizer System

Remote Transmitter

Tire Pressure Monitoring System (TPMS) (U.S. models only)

Each of the above complies with the appropriate requirements or the required standards of FCC (Federal Communications Commission) and Industry Canada Standard, described below:

As required by the FCC:

This device complies with Part 15 of the FCC rules. Operation is subject to the following two conditions: (1) This device may not cause harmful interference, and (2) this device must accept any interference received, including interference that may cause undesired operation.

Changes or modifications not expressly approved by the party responsible for compliance could void the user's authority to operate the equipment.

This device complies with Industry Canada Standard RSS-Gen/210/310. Operation is subject to the following two conditions: (1) this device may not cause interference, and (2) this device must accept any interference, including interference that may cause undesired operation of the device.

In the U.S.

If you believe that your vehicle has a defect which could cause a crash or could cause injury or death, you should immediately inform the National Highway Traffic Safety Administration (NHTSA) in addition to notifying American Honda Motor Co., Inc.

If NHTSA receives similar complaints, it may open an investigation, and if it finds that a safety defect exists in a group of vehicles, it may order a recall and remedy campaign. However, NHTSA cannot become involved in individual problems between you, your dealer, or American Honda Motor Co., Inc.

To contact NHTSA, you may call the Vehicle Safety Hotline toll-free at 1-888-327-4236 (TTY: 1-800-424-9153);

go to <http://www.safercar.gov>

or write to: Administrator, NHTSA,
1200 New Jersey Avenue, SE.,
Washington, DC 20590.

You can also obtain other information about motor vehicle safety from <http://www.safercar.gov>.

In Canada

If you believe that your vehicle has a defect which could cause a crash or could cause injury or death, you should immediately inform Honda Canada Inc. and you may also inform Transport Canada.

If Transport Canada receives similar complaints, it may open an investigation, and if it finds that a safety defect exists in a group of vehicles, it may lead to a recall and remedy campaign. However, Transport Canada cannot become involved in individual problems between you, your dealer, or Honda Canada Inc.

To contact Transport Canada's Defect Investigations and Recalls Division, you may call 1-800-333-0510. For more information on reporting safety defects or about motor vehicle safety, go to <http://www.tc.gc.ca/roadsafety>.

Testing of Readiness Codes

Your vehicle uses “readiness codes,” as part of its onboard self diagnostic system. Some states refer to these codes during testing to see if your vehicle’s emissions components are working properly.

The codes may not be read if you go through the testing just after the battery has gone dead or been disconnected.

To check if they are set, turn the ignition switch to ON **II**, without starting the engine. The malfunction indicator lamp will come on for several seconds. If it then goes off, the readiness codes are set. If it blinks five times, the readiness codes are not set.

If you are required to have your vehicle tested before the readiness codes are ready, prepare the vehicle for retesting by doing the following:

1. Fill the gas tank to approximately 3/4 full.
2. Park the vehicle and leave the engine off for 6 hours or more.
3. Make sure the ambient temperature is between 40 °F and 95 °F (4 °C and 35 °C).
4. Start the engine without touching the accelerator pedal, and let it idle for 20 seconds.
5. Keep the vehicle in **P** (automatic transmission) or **N** (manual transmission). Increase the engine speed to 2,000 rpm, and hold it there for about 3 minutes.
6. Let the engine idle with your foot off the accelerator for 20 seconds.

Testing of Readiness Codes

The readiness codes are erased when the 12 volt battery is disconnected, and set again only after several days of driving under a variety of conditions.

If a testing facility determines that the readiness codes are not set, you may be requested to return at a later date to complete the test.

If the testing facility determines the readiness codes are still not set, see a dealer.

Continued

7. Select a nearby, lightly traveled major highway where you can maintain a speed of 50 to 60 mph (80 to 97 km/h) for at least 20 minutes. Drive on the highway in **D** (automatic) or 5th (manual). Do not use cruise control. When traffic allows, drive for 90 seconds without moving the accelerator pedal. (Vehicle speed may vary slightly; this is okay.) If you cannot do this for a continuous 90 seconds because of traffic conditions, drive for at least 30 seconds, then repeat it two more times (for a total of 90 seconds).
8. Drive in city/suburban traffic for at least 10 minutes. When traffic conditions allow, let the vehicle coast for several seconds without using the accelerator pedal or the brake pedal.
9. Park the vehicle and leave the engine off for 30 minutes.

■ U.S. Owners

Your new vehicle is covered by these warranties:

New Vehicle Limited Warranty – covers your new vehicle, except for the emissions control systems and accessories, against defects in materials and workmanship.

Emissions Control Systems Defects Warranty and Emissions Performance Warranty – these two warranties cover your vehicle's emissions control systems. Time, mileage, and coverage are conditional. Please read your warranty booklet for exact information.

Seat Belt Limited Warranty – a seat belt that fails to function properly is covered by a limited warranty. Please read your warranty booklet for details.

Rust Perforation Limited Warranty – all exterior body panels are covered for rust-through from the inside for the specified time period with no mileage limit.

Accessory Limited Warranty – Honda accessories are covered under this warranty. Time and mileage limits depend on the type of accessory and other factors. Please read your warranty booklet for details.

Replacement Parts Limited Warranty – covers all Honda replacement parts against defects in materials and workmanship.

Replacement Battery Limited Warranty – provides prorated coverage for a replacement battery purchased from a dealer.

Replacement Muffler Lifetime Limited Warranty – provides coverage for as long as the purchaser of the muffler owns the vehicle.

Restrictions and exclusions apply to all these warranties. Please read the 2013 Honda warranty information booklet that came with your vehicle for precise information on warranty coverages. Your vehicle's original tires are covered by their manufacturer. Tire warranty information is in a separate booklet.

■ **Canadian Owners**

Please refer to the 2013 warranty manual that came with your vehicle.

■ Service Express

For electronic copies of service publications, you can purchase a subscription to Service Express. Visit techinfo.honda.com for pricing and options.

■ U.S. Owners

The publications listed below can be purchased from Helm Incorporated. You can order a manual by phone at (800) 782-4356 (credit card orders only), or online at www.helminc.com.

Make an inquiry to Helm Inc. at (800) 782-4356 if you are interested in ordering other models' or other years' manuals.

Publication Form Number	Form Description
61SZT02	2013 Honda CR-Z Service Manual
61SZT02EL	2013 Honda CR-Z Electrical Troubleshooting Manual
61SZT30	2011 Honda CR-Z Body Repair Manual
31SZT620	2013 Honda CR-Z Owner's Manual
31SZT820	2013 Honda CR-Z Navigation System Owner's Manual
31SZTM20	2013 Honda CR-Z Service History
31SZTQ20	2013 Honda CR-Z Technology Reference Guide
HON-R	Order Form for Previous Years- Indicate Year and Model Desired

Authorized Manuals

Service Manual:

Covers maintenance and recommended procedures for repair to engine and chassis components. It is written for the journeyman technician, but it is simple enough for most mechanically inclined owners to understand.

Electrical Troubleshooting Manual:

Complements the Service Manual by providing in-depth troubleshooting information for each electrical circuit in your vehicle.

Body Repair Manual:

Describes the procedures involved in the replacement of damaged body parts.

Honda dealership personnel are trained professionals.

They should be able to answer all your questions. If you encounter a problem that your dealership does not solve to your satisfaction, please discuss it with the dealership's service manager or general manager. If you are dissatisfied with the decision made by the dealership's management, contact Honda Customer Services.

U.S. Owners:

American Honda Motor Co., Inc.
Honda Automobile Customer Services
Mail Stop 500-2N-7A
1919 Torrance Blvd.
Torrance, CA 90501-2746
Tel: (800) 999-1009

Canadian Owners:

Honda Canada Inc.
Customer Relations
180 Honda Boulevard
Markham, ON
L6C 0H9
Tel: 1-888-9-HONDA-9
Fax: 1-877-939-0909
E-mail: Honda_cr@ch.honda.com

In Puerto Rico and the U.S. Virgin Islands:

Bella International
P.O. Box 190816
San Juan, PR 00919-0816
Tel: (787) 620-7546

Customer Service Information

When you call or write, please give us the following information:

- Vehicle Identification Number
 - **Vehicle Identification Number (VIN)**
P. 308
- Date of purchase
- Odometer reading of your vehicle
- Your name, address, and telephone number
- A detailed description of the problem
- Name of the dealer who sold the vehicle to you

Numbers

12 Volt Battery Charging System

Indicator	67
3-Mode Drive System	197
ECON Mode Indicator	76
NORMAL Mode Indicator	76
SPORT Mode Indicator	76
7-Speed Manual Shift Mode	185

A

ABS (Anti-lock Brake System)	210
Accessories and Modifications	220
Accessory Power Socket	129
Active Head Restraints	125
Additives	
Coolant	236
Engine Oil	231
Washer	241
Additives, Engine Oil	231
Adjusting	
Head Restraints	123
Headlights	242
Mirrors	119
Seats	121
Steering Wheel	118
Air Conditioning System	
(Climat Control System)	134
Changing the Mode	134
Defrosting the Windshield and Windows	135

Dust and Pollen Filter	264
Recirculation/Fresh Air Mode	134
Sensors	136
Using Automatic Climate Control	134
Air Pressure	253, 307
Airbags	39
Advanced Airbags	45
After a Collision	43
Airbag Care	53
Event Data Recorders	25
Front Airbags (SRS)	42
Indicator	50, 69, 73
Passenger Airbag Off Indicator	51
Sensors	45
Side Airbag Cutoff System	48
Side Airbag Off Indicator	48
Side Airbags	46
Side Curtain Airbags	49
AM/FM Audio	145
Anti-lock Brake System (ABS)	210
Indicator	69
ASST Indicator	82
Audio Remote Controls	18
Audio System	138
Adjusting the Sound	144
Auxiliary Input Jack	140
Error Messages	153
General Information	155
MP3/WMA/AAC	151
Radio Data System (RDS)	146
Reactivating	141

Recommended CDs	155
Recommended Drives	157
Security Code	141
Theft Protection	141
USB Adapter Cable	139
USB Flash Drives	157
Authorized Manuals	315
Auto Door Locking/Unlocking	103
Customize	90
Auto Idle Stop	
Automatic Transmission (CVT)	191
Manual Transmission	194
Auto Idle Stop Indicator	75
Automatic Lighting	112
Automatic Transmission (CVT)	182
7-Speed Manual Shift Mode	185, 186
Auto Idle Stop	191
Creeping	182
Fluid	238
Kickdown	182
L Mode	187
Operating the Shift Lever	184
Shift Lever Does Not Move	289
Shifting	183
Auxiliary Input Jack	140
Average Fuel Economy	88
Average Fuel Economy Records	88
Average Speed	85

B

Back-Up Light.....	247
Battery.....	262
Charging System Indicator.....	67, 293
Jump Starting.....	287
Maintenance	
(Checking the 12 Volt Battery).....	262
Maintenance	
(Replacing the Button Battery).....	263
Battery Charge in Progress (CHRG).....	82
Belts (Seat).....	32
Beverage Holders.....	128
Bluetooth® HandsFreeLink®.....	88, 158
Booster Seats (For Children).....	61
Brake System.....	208
Anti-lock Brake System (ABS).....	210
Brake Assist System.....	211
Brake System Indicator.....	295
Fluid.....	240
Foot Brake.....	209
Indicator.....	295
Parking Brake.....	208
Brightness Control (Instrument Panel)....	116
Bulb Replacement.....	242
Back-Up Lights.....	247
Brake/Taillight.....	248
Bulb Specifications.....	306
Fog Lights.....	244
Front Turn Signal/Parking/Side Marker	
Light.....	246
Headlights.....	242

High-Mount Brake Light.....	249
Parking/Daytime Running Light.....	246
Rear License Plate Light.....	249
Side Turn Signal/Emergency Indicator	
Light.....	246

C

Carbon Monoxide Gas.....	62
Cargo Cover.....	131
Carrying Cargo.....	173, 175
CD Player.....	147
Certification Label.....	308
Changing Bulbs.....	242
Charging System Indicator.....	67, 293
Child Safety.....	54
Child Seat.....	54
Booster Seats.....	61
Child Seat for Infants.....	56
Child Seat for Small Children.....	57
Installing a Child Seat.....	58
Larger Children.....	60
Selecting a Child Seat.....	57
Using a Tether.....	59
CHRG Indicator.....	82
Cleaning the Exterior.....	267
Cleaning the Interior.....	265
Climate Control System.....	134
Changing the Mode.....	134
Defrosting the Windshield and	
Windows.....	135

Dust and Pollen Filter.....	264
Recirculation/Fresh Air Mode.....	134
Sensors.....	136
Using Automatic Climate Control.....	134
Compact Spare Tire.....	271, 307
Controls.....	97
Coolant (Engine).....	236
Adding to the Radiator.....	237
Adding to the Reserve Tank.....	236
High Temperature Indicator.....	72
Low Temperature Indicator.....	73
Overheating.....	290
Creep Aid System.....	180
Creeping.....	182
Cruise Control.....	200
Indicator.....	75
Cup Holders.....	128
Customer Service Information.....	316
Customized Features.....	90

D

Daytime Running Lights.....	113
Dead Battery.....	287
Defrosting the Windshield and	
Windows.....	135
Devices that Emit Radio Waves.....	309
Dimming	
Headlights.....	111
Rearview Mirror.....	119, 120
Dipstick (Engine Oil).....	232

ORG	Directional Signals (Turn Signal).....	111	Ecological Drive Display	86	Exhaust Gas Hazard	
	Door Mirrors.....	120	ECON Mode	76, 197	(Carbon Monoxide).....	62
	Doors	99	Elapsed Time.....	85	Exterior Care (Cleaning).....	267
	Auto Door Locking.....	103	Electric Motor Assist Indicator (ASST)	82	Exterior Mirrors	119
	Auto Door Unlocking.....	103	Electric Power Steering (EPS) System			
	Door Open Indicator	69	Indicator.....	71, 295		
	Door/Hatch Open Indicator	31	Electronic Stability Control (ESC).....	203	F	
	Keys.....	99	Emergency	301	Features	137
	Locking/Unlocking the Doors from		Emissions Testing (Readiness Codes)	311	Filters.....	264
	the Inside	102	Engine	308	Dust and Pollen.....	264
	Locking/Unlocking the Doors from		Coolant	236	Oil.....	234
	the Outside	100	Jump Starting	287	Flat Tire	271
	Lockout Prevention System	101	Oil	231	Floor Mats.....	266
	DOT Tire Quality Grading.....	256	Starting	178	Fluids	
	Driving	171	Switch Buzzer	110	Automatic Transmission (CVT).....	238
	3-Mode Drive System	197	Engine Coolant	236	Brake	240
	Automatic Transmission (CVT).....	182	Adding to the Radiator	237	Clutch	240
	Braking.....	208	Adding to the Reserve Tank.....	236	Engine Coolant	236
	Cruise Control	200	High Temperature Indicator	72	Manual Transmission.....	239
	Manual Transmission	188	Low Temperature Indicator.....	73	Windshield Washer	241
	Plus Sport System.....	198	Overheating	290	Foot Brake	209
	Shifting Gear (Automatic Transmission)...	183	Engine Oil	231	Front Airbags (SRS).....	42
	Shifting Gear (Manual Transmission)	188	Adding	233	Front Wiper/Washer	114
	Starting the Engine	178	Checking.....	232	Fuel.....	20, 216
	Dust and Pollen Filter	264	Displaying Oil Life	225	Economy.....	219
			Low Oil Pressure Indicator.....	66, 292	Gauge.....	81
			Recommended Engine Oil.....	231	Instant Fuel Economy Gauge	81
E	Eco Assist System.....	8	Engine Oil Life	88	Low Fuel Indicator.....	68
	Eco Drive Bar	9, 87	Engine Oil Life	88	Range	85
	Eco Score	9, 86	EPS (Electric Power Steering)		Recommendation	216
			System	71, 295	Refueling.....	216

Fuel Economy	219	Phone Setup.....	162	Indicators	66
Fuel Fill Cap	20, 218	Hatch	104	7-Speed Manual Shift Mode.....	74
Message.....	294	Door/Hatch Open Indicator.....	31	ABS (Anti-lock Brake System).....	69
Fuel Fill Door	20, 217	Unable to Open.....	303	Auto Idle Stop.....	75
Fuses	297	Hazard Warning Button	2	Charging System.....	67, 293
Inspecting and Changing.....	300	Head Restraints	123	CRUISE CONTROL.....	75, 201
Locations.....	297, 298	Headlights	112	CRUISE MAIN.....	75, 200
		Aiming.....	242	Door Open.....	31
		Automatic Operation.....	112	ECON Mode.....	76
		Dimming.....	111, 113	EPS (Electric Power Steering)	
		Operating.....	111, 113	System.....	71, 295
G		Heaters (Seat)	133	Fog Light.....	74
Gasoline (Fuel)		HFL (HandsFreeLink®)	158	High Temperature.....	72
Economy.....	219	High Temperature Indicator	72	High-Beam.....	73
Gauge.....	81	High-Beam Indicator	73	IMA System.....	72
Information.....	216	Hill Start Assist System	180	Immobilizer System.....	75
Instant Fuel Economy.....	81	Honda IMA System	10	Lights On.....	74
Low Fuel Indicator.....	68			Low Fuel.....	68
Refueling.....	216			Low Oil Pressure.....	66, 292
Gauges	81			Low Temperature.....	73
Gear Shift Lever Positions				Low Tire Pressure/TPMS.....	71, 205
Automatic Transmission (CVT).....	183	I		Malfunction Indicator Lamp.....	67, 294
Glass (care)	267	Identification Numbers	308	NORMAL Mode.....	76
Glove Box	127	Engine and Transmission.....	308	Parking Brake and Brake System.....	66, 295
		Vehicle Identification.....	308	Plus Sport System.....	77
		Ignition Switch	110	Seat Belt Reminder.....	33, 68
		Illumination Control	116	Security System Alarm.....	75
		Knob.....	116	Shift Down.....	76
Halogen Bulbs	242	IMA Battery Charge Level Indicator	82	Shift Lever Position.....	74
Handling the Unexpected	269	IMA System Indicator	72	Shift Up.....	76
HandsFreeLink® (HFL)	158	Immobilizer System	106	Side Airbag Off.....	52, 73
HFL Buttons.....	158	Indicator.....	75		
HFL Menus.....	160				
HFL Status Display.....	159				

SPORT Mode.....	76	Kickdown	182
Supplemental Restraint System	50, 69	L	
System Message	72	L Mode	187
Transmission	67	Language (HFL)	159
Turn Signal	74	Lights	111, 242
VSA® (Vehicle Stability Assist)		Automatic	112
System	70, 203	Bulb Replacement.....	242
VSA® OFF.....	70, 204	Daytime Running Lights.....	113
Information	305	Fog Light Indicator.....	74
Instant Fuel Economy Gauge	81	High-Beam Indicator	73
Instrument Panel	65	Interior	126
Brightness Control	116	Light Switches	111
Interior Lights	126	Lights On Indicator	74
Interior Rearview Mirror	119	Turn Signals.....	111
J		Load Limits	175
Jack (Wheel Nut Wrench).....	274	Locking and Unlocking	99
Jump Starting.....	287	Auto Door Locking/Unlocking.....	103
K		From Inside.....	102
Key Number Tag	99	From Outside.....	100
Keyless Lockout Prevention.....	101	Keys	99
Keys.....	99	Using a Key	101
Lockout Prevention	101	Lockout Prevention System	101
Master Keys.....	99	Low Battery Charge (12 volt)	293
Number Tag.....	99	Low Fuel Indicator	68
Remote Transmitter	100	Low Oil Pressure Indicator	66, 292
Types and Functions.....	99	Low Temperature Indicator	73
Won't Turn	23	Lubricant Specifications Chart	306
		Luggage (Maximum Load Limit)	175

M**M (7-Speed Manual Shift Mode)**

Indicator	74
Maintenance	221
Battery	262
Brake Fluid	240
Cleaning	265
Climate Control.....	264
Clutch Fluid.....	240
Coolant.....	236
Maintenance Minder™	225
Oil.....	231
Precautions	222
Radiator	237
Remote Transmitter	263
Replacing Light Bulbs	242
Safety.....	223
Service Items	227
Tires.....	253
Transmission Fluid	238, 239
Under the Hood	229
Maintenance Minder™	225
Malfunction Indicator Lamp	67, 294
Manual Transmission	
Auto Idle Stop	194
Checking the Clutch Fluid	240
Fluid (MTF)	239
Operating the Shift Lever.....	188
Reverse Lockout	190
Shift UP/DOWN indicators	189
Shifting.....	188

Maximum Load Limit.....	175	Overheating.....	290	Rear Turn Signal Light.....	247
Meters, Gauges.....	81			Rearview Mirror.....	119
Mirrors.....	119	P		Rearview Mirror with Rearview Camera Display.....	214
Adjusting.....	119	Panic Mode.....	107	Refueling.....	216
Door.....	120	Parking.....	212	Fuel Gauge.....	81
Exterior.....	119	Parking Brake.....	208	Gasoline.....	216, 306
Interior Rearview.....	119	Parking Brake and Brake System Indicator.....	66, 295	Low Fuel Indicator.....	68
Modifications and Accessories.....	220	Passenger Airbag Off Indicator.....	51	Regulations.....	206, 255, 309
MP3.....	147, 151	Plus Sport System.....	77, 198	Remote Transmitter.....	100
Multi-Information Display.....	83	Plus Sport System Indicator.....	77	Replacement	
Multi-View Rear Camera.....	213	Power Door Mirror.....	120	Battery.....	262
N		Power Flow Monitor.....	89	Bulbs.....	242
NORMAL Mode.....	76, 197	Power Windows.....	108	Button Battery, Remote Transmitter.....	263
Numbers (Identification).....	308	Precautions While Driving.....	181	Fuses.....	297, 298
		Rain.....	181	Tires.....	259
		Pregnant Women.....	37	Wiper Blade Rubber.....	250, 252
		Puncture (Tire).....	271	Reporting Safety Defects.....	310
				Resetting a Trip Meter.....	84
O		R		S	
Odometer.....	84	Radiator.....	237	Safe Driving.....	27
Oil (Engine).....	231	Radio (AM/FM).....	145	Safety Check.....	31
Adding.....	233	Radio Data System (RDS).....	146	Safety Labels.....	63
Checking.....	232	Range.....	85	Safety Message.....	26
Displaying Oil Life.....	225	Readiness Code (Emissions Testing).....	311	Seat.....	121
Low Oil Pressure Indicator.....	66, 292	Rear Defogger/Heated Door Mirror Button.....	117	Adjusting.....	121
Recommended Engine Oil.....	231	Rear Luggage Console.....	130	Seat Heaters.....	133
Viscosity.....	231	Rear Side Marker Light.....	247	Seat Belts.....	32
Opening/Closing				Automatic Seat Belt Tensioners.....	34
Hood.....	230				
Power Windows.....	108				
Outside Temperature.....	85				

Checking	38	Spark Plugs	306	Tire Pressure Monitoring System (TPMS)	205
Fastening	35	Specifications	306	Indicator	71, 296
Installing a Child Seat	58	Specified Fuel	216, 306	Tires	253
Pregnant Women	37	Speedometer	81	Air Pressure	254, 307
Reminder	33	SPORT Mode	76, 197	Checking and Maintaining	253
Warning Indicator	33, 68	SRS Airbags (Airbags)	39	Compact Spare Tire	271, 307
Seat Heaters	133	Starting the Engine	178	Inspection	253
Security System		Does Not Start	286	Labeling	254
Immobilizer System Indicator	75	Engine Switch Buzzer	110	Puncture (Flat Tire)	271
Security System Alarm Indicator	75	Jump Starting	287	Regulations	256
SEL/RESET Button	90	Steering Wheel	118	Rotation	260
Selecting a Child Seat	57	Adjusting	118	Tire Chains	261
Selector Knob (Audio)	143	Stopping	212	Wear Indicators	258
Setting the Clock	98	Supplemental Restraint System (SRS)	42	Winter	261
Shift Lever	19	Switches		Tools	270
Automatic Transmission (CVT)	183	(Around the Steering Wheel)	2, 3, 110	Towing a Trailer	177
Operation	19	System Message Indicator	72	Towing Hook	302
Operation (Automatic Transmission)	184	T		Towing Your Vehicle	177
Operation (Manual Transmission)	188	Tachometer	81	Emergency	301
Releasing	289	Tailgate		TPMS	
Won't Move	289	Release Button	105	(Tire Pressure Monitoring System)	205
Shift Lever Position Indicator	184	Tailgate Release Button	105	Indicator	71, 296
Shifting		Temperature		Transmission	
Automatic Transmission (CVT)	183	High Temperature Indicator	72	Automatic (CVT)	183
Manual Transmission	188	Low Temperature Indicator	73	Fluid	238, 239
Side Airbags	46	Temperature Sensor	136	Manual	188
Cutoff System	48	Temporarily Repairing a Flat Tire	277	Number	308
Off Indicator	48	Time (Setting)	98	Shift Lever Position Indicator	184
Side Curtain Airbags	49			Trip Meter	84
Snow Tires	261				
Spare Tire	271, 307				

Troubleshooting	269
Blown Fuse	297, 298
Brake Pedal Vibrates	24
Buzzer Sounds When Opening Door	24
Emergency Towing	301
Engine Does Not Start	286
Noise When Braking	24
Overheating	290
Puncture/Flat Tire	271
Regular Gasoline	216, 306
Shift Lever Won't Move	289
Unable to Open the Hatch	303
Warning Indicators	66
Turn Signals	111
Indicators (Instrument Panel)	74

U

Unlocking the Doors	100
USB Adapter Cable	139
USB Flash Drive	157

V

Vanity Mirrors	5
Vehicle Identification Number	308
Vehicle Stability Assist (VSA®)	203
Off Button	204
Off Indicator	70
System Indicator	70
Ventilation	134
Viscosity (Oil)	231, 307
VSA® (Vehicle Stability Assist)	203

W

Warning and Information Messages	78
Warning Indicator On/Blinking	292
Warning Labels	63
Warranties (Warranty Manual provided separately)	313
Watts	306
Wear Indicators (Tire)	258
Wheel Nut Wrench (Jack Handle)	274
Window Washers	114
Adding/Refilling Fluid	241
Switch	114
Windows (Opening and Closing)	108
Windshield	114
Cleaning	268
Defrosting/Defogging	135
Washer Fluid	241
Wiper Blades	250, 252
Wipers and Washers	114
Winter Tires	261
Snow Tires	261
Tire Chains	261
Wipers and Washers	114
Checking and Maintaining Wiper Blades	250
WMA	147, 151