

HYUNDAI

2003 Owner's Manual

SANTA FE 



This Owner's Manual should be considered a part of the car and remain with it when it is sold for the use of the next owner.

OWNER'S I.D.

ORIGINAL OWNER _____

ADDRESS _____

CITY _____ STATE _____ ZIP CODE _____

DELIVERY DATE _____

(Date Sold to Original Retail purchaser)

DEALER NAME _____ DEALER NO. _____

ADDRESS _____

CITY _____ STATE _____ ZIP CODE _____

HYUNDAI

SANTA FE

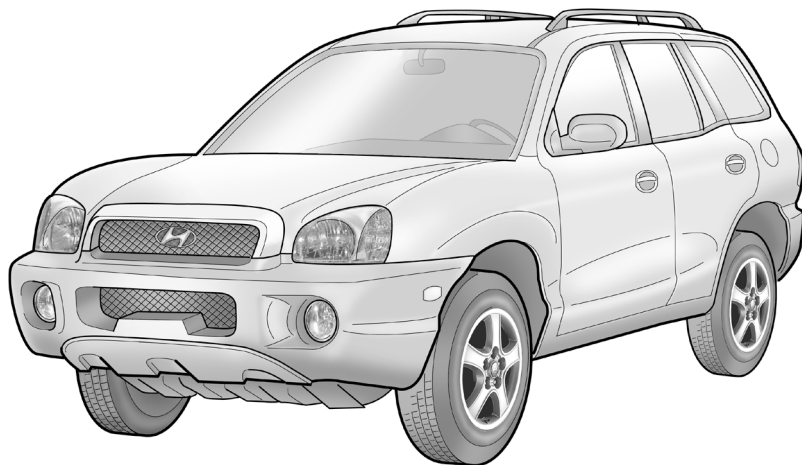

OWNER'S MANUAL

A030A020-AAT

Operation Maintenance Specifications

HSM002

All information in this Owner's Manual is current at the time of publication. However, Hyundai reserves the right to make changes at any time so that our policy of continual product improvement may be carried out.

This manual applies to all Hyundai **SANTA FE** models and includes descriptions and explanations of optional as well as standard equipment. As a result, you may find material in this manual that does not apply to your specific vehicle.

A010A02A-AAT

WARRANTIES FOR YOUR HYUNDAI VEHICLE

- o New Vehicle 60 Months/60,000 Miles Limited Warranty
- o New Vehicle 120 Months/100,000 Miles Limited Powertrain Warranty (first owner only)
- o Anti-Perforation Limited Warranty
- o Emission Defect Warranty - Federal Vehicle
- o California Emission Control System Warranty (if applicable)
- o Emission Performance Warranty - Federal Vehicle
- o Replacement Parts and Accessories Limited Warranty

NOTE:

Detailed warranty information is provided in your Hyundai Owner's Handbook.

A020A01A-AAT

RESPONSIBILITY FOR MAINTENANCE

The maintenance requirements for your new Hyundai are found in Section 5. As the owner, it is your responsibility to see that all maintenance operations specified by the manufacturer are carried out at the appropriate intervals. When the vehicle is used in severe driving conditions, more frequent maintenance is required for some operations. Maintenance requirements for severe operating conditions are also included in Section 5.

FOREWORD

Thank you for choosing Hyundai. We are pleased to welcome you to the growing number of discriminating people who drive Hyundais. The advanced engineering and high-quality construction of each Hyundai we build is something of which we're very proud.

Your Owner's Manual will introduce you to the features and operation of your new Hyundai. It is suggested that you read it carefully because the information it contains can contribute greatly to the satisfaction you receive from your new car.

The manufacturer also recommends that all service and maintenance on your car be performed by an authorized Hyundai dealer. Hyundai dealers are prepared to provide high-quality service, maintenance and any other assistance that may be required.

HYUNDAI MOTOR COMPANY

Note: Because future owners will also need the information included in this manual, if you sell this Hyundai, please leave the manual in the vehicle for their use. Thank you.



CAUTION:

Severe engine and transaxle damage may result from the use of poor quality fuels and lubricants that do not meet Hyundai specifications. You must always use high quality fuels and lubricants that meet the specifications listed on Page 9-4 in the Vehicle Specifications section of the Owner's Manual and which also appear in the Service Station Information on the back cover of the Owner's Manual.

Copyright 2003 Hyundai Motor Company. All rights reserved. No part of this publication may be reproduced, stored in any retrieval system or transmitted in any form or by any means without the prior written permission of Hyundai Motor Company.

A070A01A-AAT



CAUTION: MODIFICATIONS TO YOUR HYUNDAI

Your Hyundai should not be modified in any way. Such modifications may adversely affect the performance, safety or durability of your Hyundai and may, in addition, violate conditions of the limited warranties covering the vehicle. Certain modifications may also be in violation of regulations established by the U.S. Department of Transportation and other federal or state agencies.

A080A01S-AAT

TWO-WAY RADIO OR CELLULAR TELEPHONE INSTALLATION

Your vehicle is equipped with electronic fuel injection and other electronic components. It is possible for an improperly installed/adjusted two-way radio or cellular telephone to adversely affect electronic systems. For this reason, we recommend that you carefully follow the radio manufacturer's instructions or consult your Hyundai dealer for precautionary measures or special instructions if you choose to install one of these devices.

SAFETY AND VEHICLE DAMAGE WARNING

This manual includes information titled as WARNING, CAUTION and NOTE.
These titles indicate the following:



WARNING:

This indicates that a condition may result in harm, serious injury or death to you or other persons if the warning is not heeded. Follow the advice provided with the warning.



CAUTION:

This indicates that a condition may result in damage to your vehicle or its equipment if the caution is not heeded. Follow the advice provided with the caution.

NOTE:

This indicates that interesting or helpful information is being provided.

Guide to Hyundai Genuine Parts

1. What are Hyundai Genuine Parts?

Hyundai Genuine Parts are the same parts used by Hyundai Motor Company to manufacture vehicles. They are designed and tested for the optimum safety, performance, and reliability to our customers.

2. Why should you use genuine parts?

Hyundai Genuine Parts are engineered and built to meet rigid original manufacturing requirements. Using imitation, counterfeit or used salvage parts is not covered under the Hyundai New Vehicle Limited Warranty or any other Hyundai warranty. In addition, any damage to or failure of Genuine Hyundai Parts caused by the installation or failure of

an imitation, counterfeit or used salvage part is not covered by any Hyundai Warranty.

3. How can you tell if you are purchasing Hyundai Genuine Parts?

Look for the Hyundai Genuine Parts Logo on the package (see below).

Hyundai Genuine Parts exported to the United States are packaged with labels written only in English.

Hyundai Genuine Parts are only sold through authorized Hyundai Dealerships.

" To find the closest authorized dealer call 1-800-826-CARS "

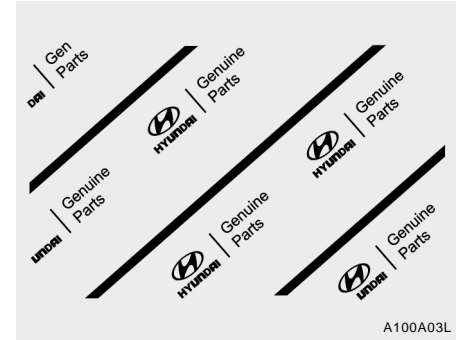

A100A03L



A100A01L

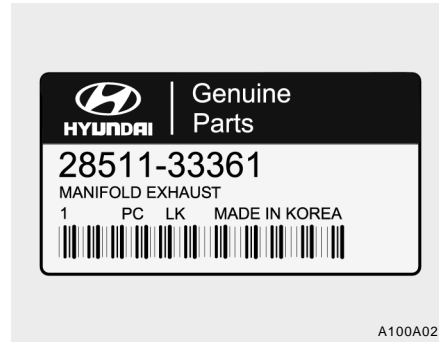

A100A02L

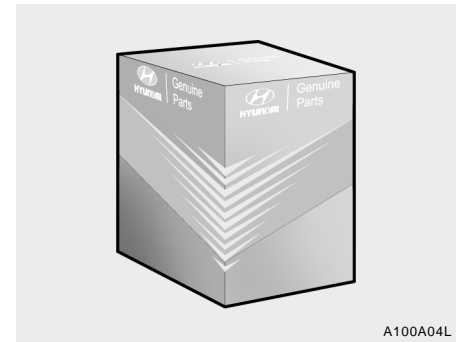

A100A04L

TABLE OF CONTENTS

SECTION	PAGE
1. FEATURES OF YOUR HYUNDAI	1-1
2. DRIVING YOUR HYUNDAI	2-1
3. WHAT TO DO IN AN EMERGENCY	3-1
4. CORROSION PREVENTION & APPEARANCE CARE	4-1
5. VEHICLE MAINTENANCE REQUIREMENTS	5-1
6. DO-IT-YOURSELF MAINTENANCE	6-1
7. EMISSION CONTROL SYSTEMS	7-1
8. CONSUMER INFORMATION & REPORTING SAFETY DEFECTS	8-1
9. VEHICLE SPECIFICATIONS	9-1
10. INDEX	10-1

1

2

3

4

5

6

7

8

9

10

B250A030-AAT

INSTRUMENTS AND CONTROLS

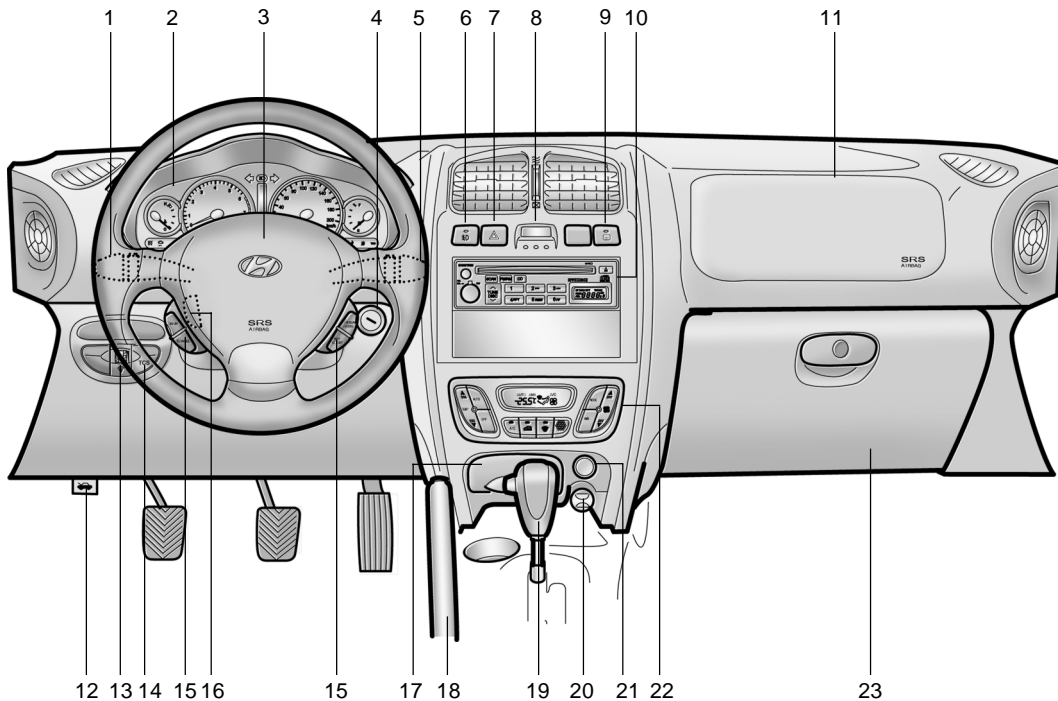

















1. Multi-Function Light Switch
2. Instrument Cluster
3. Horn and Driver's Airbag
4. Ignition Switch
5. Windshield Wiper/Washer Switch
6. Front Fog Light Switch (If installed)
7. Hazard Warning Light Switch
8. Digital Clock
9. Rear Window Defroster Switch
10. Audio System (If installed)
11. Passenger's Airbag
12. Hood Release Lever
13. Panel Brightness Control Knob (Rheostat Switch)
14. Traction Control Switch (If installed)
15. Cruise Control Switch (If installed)
16. Steering Wheel Tilt Lever
17. Ashtray
18. Parking Brake Lever
19. Shift Lever
20. Power Outlet
21. Cigarette Lighter
22. Heating/Air Conditioning Control Panel
23. Glove Box

**CAUTION:**

When installing a container of liquid air freshener inside the vehicle, do not place it near the instrument cluster nor on the instrument panel surface. If there is any leakage from the air freshener onto these areas (Instrument cluster, instrument panel or air ventilator), it may damage these parts. If the liquid from the air freshener does leak onto these areas, wash them with water immediately.

B255A030-AAT

INDICATOR SYMBOLS ON THE INSTRUMENT PANEL

	SRS (Airbag) Service Reminder Indicator		Door Ajar Warning Light and Chime
	Turn Signal Indicator Lights		Low Fuel Level Warning Light
	Seat Belt Reminder Light and Chime		Malfunction Indicator Light
	High Beam Indicator Light		ABS Service Reminder Indicator (If installed)
	Low Oil Pressure Warning Light		TCS Traction Control Indicator Light (If installed)
	Parking Brake/Low Brake Fluid Level Warning Light		TCS OFF Traction Control Off Indicator Light (If installed)
	Charging System Warning Light		CRUISE Cruise Indicator (If installed)
	Tail Gate Open Warning Light		4WD System Warning Light (If installed)

* A more detailed explanations of these items will be found beginning on page 1-37.

1. FEATURES OF YOUR HYUNDAI

Fuel Recommendations	1-2
Breaking in Your New Hyundai	1-3
Key	1-3
Door Locks (Theft-Alarm System)	1-4
Power Windows	1-10
Seat	1-10
Seat Belt	1-17
Child Restraint System	1-23
Supplemental Restraint (AIRBAG) system	1-29
Instrument Cluster and Indicator Lights	1-36
Warning Light and Indicator Lights	1-37
Multi-Function Light Switch	1-43
Windshield Wiper/Washer Switch	1-44
Sunroof	1-50
Homelink Mirror	1-56
Hood Release	1-63
Cruise Control	1-66
Heating and Cooling Control	1-69
Stereo Sound System	1-84
Audio System	1-86
Antenna	1-111

1-2 FEATURES OF YOUR HYUNDAI

B010A02A-AAT

FUEL RECOMMENDATIONS

Use Unleaded Gasoline

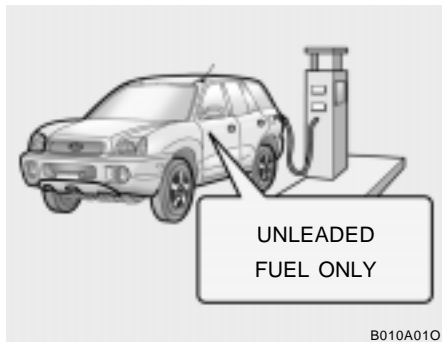

Unleaded gasoline with a Pump Octane Rating of 87 (Research Octane Number 91) or higher must be used in your Hyundai.

If leaded gasoline is used, it will cause the catalytic converter to become ineffective and the emission control system to malfunction. This can also result in increased maintenance expense.

To avoid accidental use of leaded fuel, the larger nozzle used with leaded gasoline at service stations cannot be inserted into the fuel tank opening of your Hyundai.



CAUTION:

- o Do not "TOP-OFF" after the first nozzle shut off when refueling.
- o The fuel cap must be tightened at least 3 clicks, otherwise "  " light may illuminate.

B010B01A-AAT

What About Gasohol?

Gasohol (a mixture of 90% unleaded gasoline and 10% ethanol or grain alcohol) may be used in your Hyundai. However, if your engine develops driveability problems, the use of 100% unleaded gasoline is recommended. Fuels with unspecified quantities of alcohol, or alcohols other than ethanol, should not be used.

B010C01A-AAT

Use of MTBE

Hyundai recommends that fuels containing MTBE (Methyl Tertiary Butyl Ether) over 15.0% vol. (Oxygen Content 2.7% weight) should not be used in your Hyundai.

Fuel containing MTBE over 15.0% vol. (Oxygen Content 2.7% weight) may reduce vehicle performance and produce vapor lock or hard starting.

B010D01A-AAT

Do Not Use Methanol

Fuels containing methanol (wood alcohol) should not be used in your Hyundai. This type of fuel can reduce vehicle performance and damage components of the fuel system.



CAUTION:

Your Hyundai's New Vehicle Limited Warranty may not cover damage to the fuel system and any performance problems that are caused by the use of fuels containing methanol or fuels containing MTBE (Methyl Tertiary Butyl Ether) over 15.0% vol. (Oxygen Content 2.7% weight.)

B010E01A-AAT

Gasolines for Cleaner Air

To help contribute to cleaner air, Hyundai recommends that you use gasolines treated with detergent additives, which help prevent deposit formation in the engine. These gasolines will help the engine run cleaner and enhance performance of the Emission Control System.

B010F01A-AAT

Operation in Foreign Countries

If you are going to drive your Hyundai in another country, be sure to:

- o Observe all regulations regarding registration and insurance.
- o Determine that acceptable fuel is available.

B020A01S-AAT

BREAKING IN YOUR NEW HYUNDAI During the First 1,200 Miles (2,000 Km)

No formal "break-in" procedure is required with your new Hyundai. However, you can contribute to the economical operation and durability of your Hyundai by observing the following recommendations during the first 1,200 miles (2,000 km).

- o Don't drive faster than 55 MPH (88 km/h).
- o While driving, keep your engine speed (rpm, or revolutions per minute) between 2,000 rpm and 4,000 rpm.
- o Use moderate acceleration. Don't start quickly or depress the accelerator pedal fully.
- o For the first 200 miles (300 km), try to avoid hard stops.
- o Don't lug the engine (in other words, don't drive so slowly in too high a gear that the engine "bucks"-shift to a lower gear).

- o Whether going fast or slow, vary your speed from time to time.
- o Don't let the engine idle longer than 3 minutes at one time.
- o Don't tow a trailer during the first 1,200 miles (2,000 km) of operation.

B030A01A-AAT

KEYS



B030A01B

For greater convenience, the same key operates all the locks in your Hyundai. However, because the doors can be locked without a key, carrying a spare key is recommended in case you accidentally lock one key inside the car.

B030B01A-AAT

Record Your Key Number

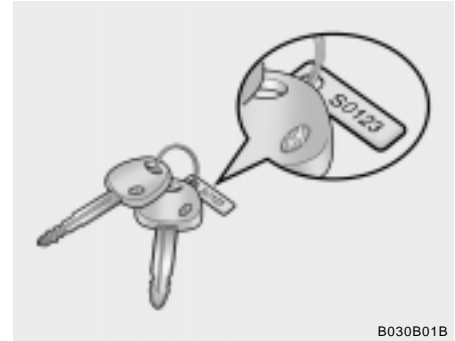

B030B01B

A code number is stamped on the number plate that came with the keys to your Hyundai. This key number plate should not be left with the keys but kept in a safe place, not in the vehicle. The key number should also be recorded in a place where it can be found in an emergency.

If you need additional keys, or if you should lose your keys, your authorized Hyundai dealer can make new keys if you can supply the key number.

1-4 FEATURES OF YOUR HYUNDAI

B030C01Y-AAT

ILLUMINATED IGNITION SWITCH (If installed)



Whenever a door is opened, the ignition switch will be illuminated for your convenience, provided the ignition switch is not in the "ON" position.

The light will go off approximately 10 seconds after closing the door or when the ignition switch is turned on.

B040A01A-AAT

DOOR LOCKS

! **WARNING:**

- o Unlocked doors can be dangerous. Before you drive away (especially if there are children in the car), be sure that all the doors are securely closed and locked so that the doors cannot be opened from the inside. This helps ensure that the doors will not be opened accidentally. Also, when combined with the proper use of seat belts, locking the doors helps keep occupants from being ejected from the car in case of an accident.
- o Before opening the door, always look for and avoid oncoming traffic.

B040B01O-AAT

Locking, unlocking front doors with a key

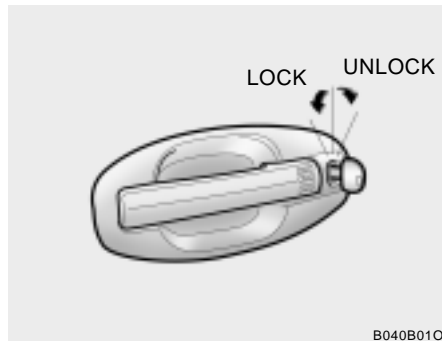

- o The door can be locked or unlocked with a key.
- o Lock the door by turning the key toward the front of the vehicle and unlock it by turning the key toward the rear.

NOTE:

The driver's door can be unlocked by turning the key once toward the rear. If you wish to unlock all doors, turn the key toward the rear within 4 seconds once more.

B040C01O-AAT

Locking From the Outside (Driver's side)

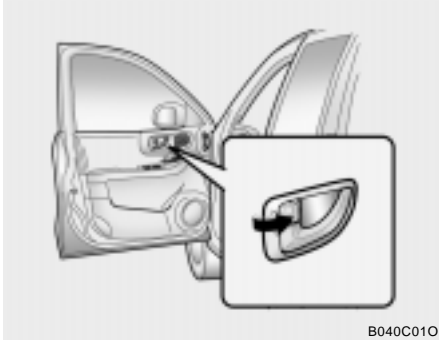

B040C01O

The doors can be locked without a key. To lock the doors, first push the inside lock switch to the "LOCK" position, so that the red mark on the switch is not visible, then close the door.

The door will not lock if the key is left in the ignition switch when the front doors are closed. This is normal.

NOTE:

- o When pushing the lock switch of the driver's door to the "LOCK", only the driver's door can be locked.
- o When locking the door this way, be careful not to lock the door with the ignition key left in the vehicle.

- o To prevent theft, always remove the ignition key, close all windows, and lock all doors when leaving your vehicle unattended.

B040D01O-AAT

Locking From the Inside (Driver's side)

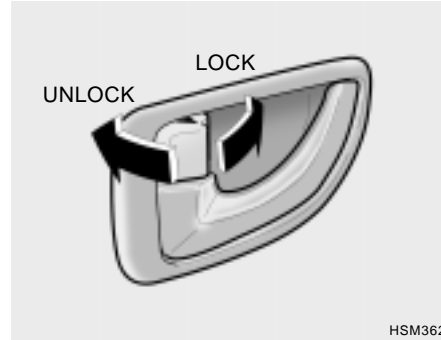

HSM362

To lock the doors from the inside, simply close the door and push the lock switch to the "LOCK" position. When this is done, neither the lock nor the inside door handle can be used.

NOTE:

- o When pushing the lock switch of the driver's door to the "LOCK", only the driver's door can be locked.
- o When the door is locked, the red mark on the switch is not visible.
- o The driver's door can be opened by pulling the inside door handle even if the lock switch is depressed.

B045C01O-AAT

Locking From the Outside (Passenger's side)

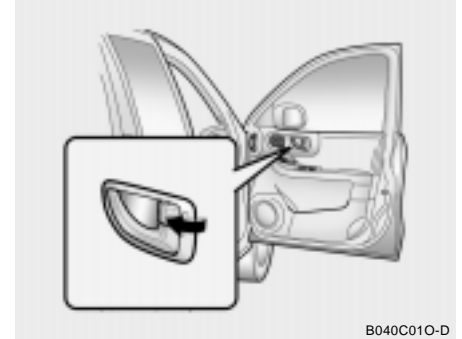

B040C01O-D

1-6 FEATURES OF YOUR HYUNDAI

The doors can be locked without a key. To lock the doors, first push the inside lock switch to the "LOCK" position, so that the red mark on the switch is not visible, then close the door.

The door will not lock if the key is left in the ignition switch when the front doors are closed. This is normal.

NOTE:

- o When pushing the lock switch of the passenger's door to the "LOCK", all doors can be locked.
- o When locking the door this way, be careful not to lock the door with the ignition key left in the vehicle.
- o To prevent theft, always remove the ignition key, close all windows, and lock all doors when leaving your vehicle unattended.

B045D010-AAT

Locking From the Inside (Passenger's side)

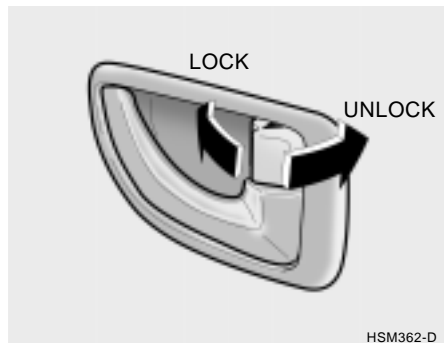

To lock the doors from the inside, simply close the door and push the lock switch to the "LOCK" position. When this is done, neither the outside nor the inside door handle can be used.

NOTE:



- o When pushing the lock switch of the passenger's door to the "LOCK", all doors can be locked.
- o When the door is locked, the red mark on the switch is not visible.

B040E03A-AAT

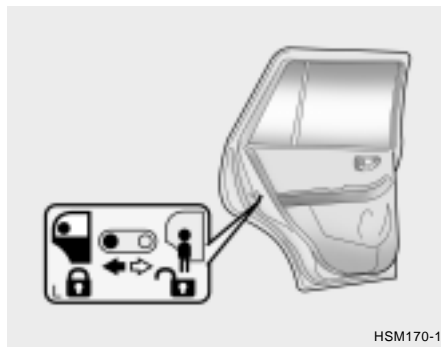
Child-Protector Rear Door Lock



Your Hyundai is equipped with a "child-protector" rear door lock assembly. When the lock mechanism is engaged, the rear door cannot be opened from the inside. It's use is recommended whenever there are small children in the rear seat.

To engage the child-protector feature so that the door cannot be opened from the inside, move the child-protector lever to the "  " position and close the door. Move the lever to the opposite direction of "  " position when normal door operation is desired.

If you wish to be able to open the door from the outside, pull the outside door handle to its up position.

B040G01O-AAT

Central Door Locks (If installed)

B040G01O

The central door locking switch is located on the driver's arm rest. It is operated by depressing the door lock switch. If any door is open when the switch is depressed, the door will remain locked when closed.

NOTE:

- o When pushing the "LOCK" of the driver's door lock switch, all vehicle doors will lock.
- o When pushing the "UNLOCK" of the switch, all vehicle doors will unlock.

B070A01O-AAT

**THEFT-ALARM SYSTEM
(If installed)**

This system is designed to provide protection from unauthorized entry into the car. This system is operated in four stages : the first is the "Armed" stage, the second is the "Alarm" stage, the third is the "Disarmed" stage and the fourth is the "Panic" stage. If triggered, the system provides an audible alarm.

B070B02O-AAT

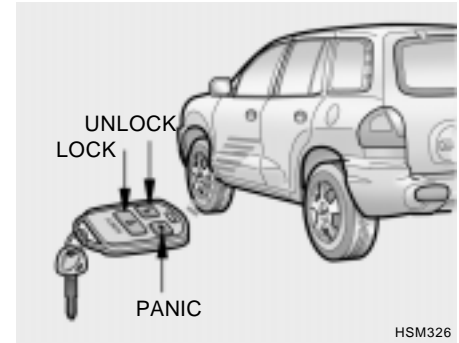
Armed Stage

HSM326

Park the car and stop the engine. Arm the system as described below.

- 1) Remove the ignition key from the ignition switch.
- 2) Make sure that the engine hood and tail gate are locked.
- 3) Lock the doors using the transmitter of the keyless entry system.

After completion of the steps above, the turn signal lights will blink once to indicate that the system is armed.

NOTE:

- o If any door, tail gate or engine hood remains open, the system will not be armed. If this happens, rearm the system as described above.
- o If the "LOCK" button is pressed once more within 4 seconds after pushing the "LOCK" button on the transmitter, the siren will sound once to indicate that the system is armed.



CAUTION:

Do not arm the system until all passengers have left the car. If the system is armed while a passenger(s) remains in the car, the alarm may be activated when the remaining passenger(s) leaves the car.

B070C01O-AAT

Alarm Stage

The alarm will be activated if any of the following occurs while the car is parked and the system is armed.

- 1) A front or rear door is opened without using the transmitter or the ignition key.
- 2) The tail gate is opened without using the transmitter or the ignition key.
- 3) The engine hood is opened.

The siren will sound and the turn signal lights will blink continuously for 27 seconds (This happens 3 times). To turn off the system, unlock the door or tail gate using the transmitter or the ignition key.



CAUTION:

Avoid trying to start the engine while the system is armed.

B070D03O-AAT

Disarmed Stage

The system will be disarmed by using the transmitter or the ignition key.

The driver's door is unlocked by depressing once the "UNLOCK" button on the transmitter. If you wish to unlock all doors, press the "UNLOCK" button on the transmitter again within 4 seconds.

Whenever the step above is completed, the turn signal lights will blink twice to indicate that the system is disarmed.

NOTE:

Once the system has been disarmed, it can not be rearmed except by repeating the arming procedures.

B070E01O-AAT

Panic Stage

1. Push the "PANIC" button on the transmitter.
2. At the same time, the siren will sound and the turn signal lights will blink for 30 seconds.
3. To turn off the system, push the "PANIC" button again on the transmitter.

B070F01O-AAT

Keyless Entry System (If installed)**Locking doors**

1. Close all doors.
2. Push the "LOCK" button on the transmitter.
3. At the same time all doors lock, the turn signal lights will blink once to indicate that the system is armed.

Unlocking doors

1. Push the "UNLOCK" button on the transmitter.
2. At the same time the driver's door unlocks, the turn signal lights will blink twice to indicate that the system is disarmed.

NOTE:

If you wish to unlock all doors, press the "UNLOCK" button on the transmitter again within 4 seconds.

B070E02HP-GAT

Replacing the battery

When the transmitter's battery begins to get weak, it may take several pushes on the button to lock or unlock the doors, and the LED will not light. Replace the battery as soon as possible.

Battery type : CR2032

Replacement instructions:

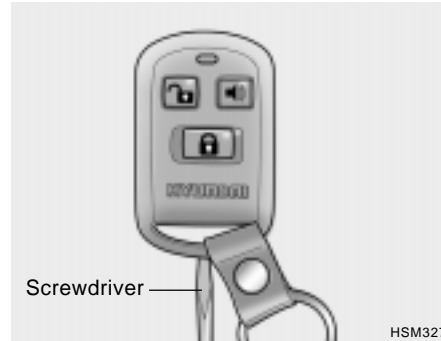

1. Separate the case with a blade screwdriver as shown in the illustration.

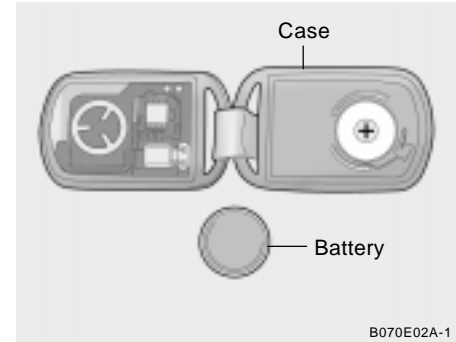

2. Remove the old battery from the case and note the polarity. Make sure the polarity of the new battery is the same(+side facing down), then insert it in the transmitter.

B060A02Y-AAT

POWER WINDOWS

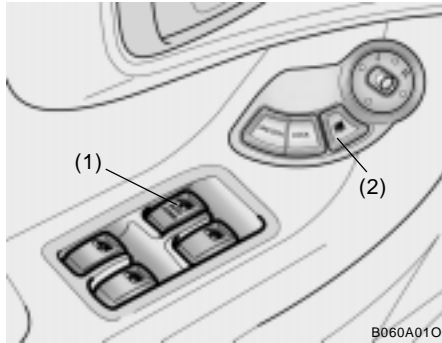

The power windows operate when the ignition key is in the "ON" position. The main switches are located on the driver's armrest and control the front and rear windows on both sides of the vehicle. The windows may be opened by depressing the appropriate window switch and closed by pulling up the switch. To open the window on the driver's side, press the switch(1) halfway down. The window moves as long as the switch is operated. To fully open the driver's window automatically, press the switch fully down. In automatic operation, the window will fully open even if you let go of the switch. To stop at the desired opening, pull up and release the switch. In order to prevent operation of the passenger front and rear windows, a window lock switch(2) is provided on the armrest of the

driver's door. To disable the power windows, press the window lock switch. To revert to normal operation, press the window lock switch a second time. The power windows can be operated for 30 seconds after the ignition key is turned to the "ACC" or the "LOCK" position. However while the front doors are opened with the key turned to "LOCK" and removed, the power windows cannot be operated.

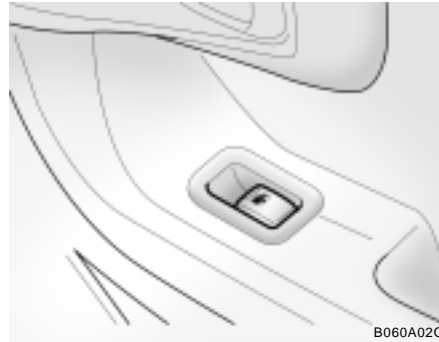

! **WARNING:**

- (1) Be careful that someone's head, hands and body are not trapped by a closing window.
- (2) Never try to operate the main switch on the driver's door and the individual door window switch in opposing directions at the same time. If this is done, the window will stop and cannot be opened or closed.
- (3) Do not leave children alone in the car. Always remove the ignition key for their safety.

B080A01A-AAT

ADJUSTABLE FRONT SEATS

! **WARNING:**

Never attempt to adjust the seat while the vehicle is moving. This could result in loss of control, or an accident which may cause death, serious injury, or property damage.

B080B01A-AAT

Adjusting Seat Forward and Rearward

To move the seat toward the front or rear, pull the lock release lever upward. This will release the seat on its track so you can move it forward or rearward to the desired position. When you find the position you want, release the lever and slide the seat forward or rearward on its track until it locks into the desired position and cannot be moved further.

B080C01A-AAT

Adjusting Seatback Angle

To recline the seatback, lean forward to take your weight off it, then pull up on the recliner control lever at the outside edge of the seat. Now lean back until the desired seatback angle is achieved. To lock the seatback into position, release the recliner control lever.

**WARNING:**

To minimize risk of severe injury in the event of a collision or a sudden stop, both the driver and passenger seatbacks should always be in an upright position while the vehicle is in motion. The protection provided by the seat belts and airbags in a frontal collision may be reduced significantly when the seatbacks are reclined. There is greater risk that the driver and passenger will slide under the seat belt which may result in serious injury if a crash occurs when the seatbacks are reclined. The seat belt cannot provide full protection to an occupant if the seat back is reclined.

B080D02A-AAT

Adjustable Headrests

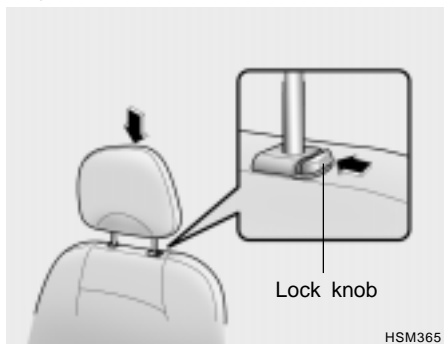

Headrests are designed to help reduce the risk of neck injuries.

To raise the headrest, pull it up. To lower it, push it down while pressing the lock knob.

! **WARNING:**

- o For maximum effectiveness in case of an accident, the headrest should be adjusted so the top of the headrest is at the same height as the top of the occupant's ears. The use of a cushion that holds the body away from the seatback is not recommended.
- o Do not operate the vehicle with the headrests removed as severe injury to an occupant may occur in the event of an accident. Headrests may provide protection against severe neck injuries when properly adjusted.

B080E01O-AAT

Lumbar Support Control (Driver's seat only) (If installed)

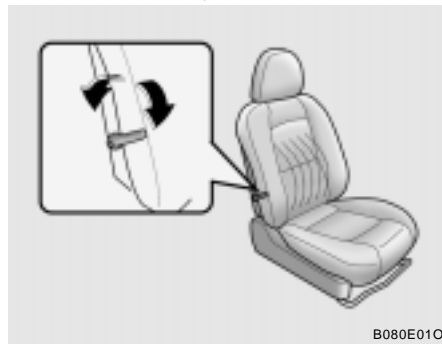

To adjust the lumbar support, turn the handle on the outboard or left side of the seat. To increase the amount of lumbar support, pull the lever forward. To decrease it, push the lever toward the rear.

B080F01A-AAT

Seat Cushion Height Adjustment (Driver's Seat Only) (If Installed)

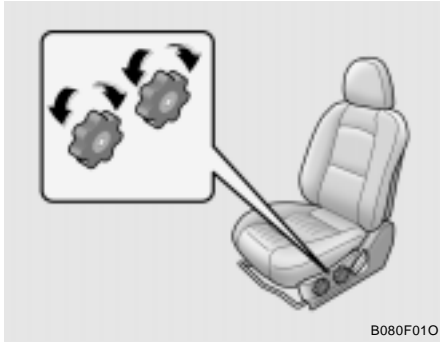

To raise or lower the front part of the seat cushion, turn the front knob forward or rearward. To raise or lower the rear part of the seat cushion, turn the rear knob forward or rearward.

B090A01Y-AAT

POWER DRIVER'S SEAT (If installed)

The driver's seat can be adjusted appropriately by using the control knob on the left side of the seat. Before driving, adjust the seat to the proper position so as to easily control the steering wheel, pedals and switches on the instrument panel.



CAUTION:

Do not operate two knobs at the same time.



WARNING:

- o Never attempt to adjust the seat while the vehicle is moving. This could result in loss of control, and an accident causing death, serious injury, or property damage.
- o Do not sit or lean unnecessarily close to the airbag to get better protection during its deployment in case of an accident.

B090B01Y-AAT

Adjusting Seat Forward and Rearward



Pull the control knob forward or backward to move the seat forward or backward to the desired position. Release the knob and then the seat will remain at that position.

1. Seat Back Reclining Control Knob
2. Seat Cushion Forward, Rearward and Height Adjusting Control Knob



WARNING:

To ensure the seat is locked securely, attempt to move the seat forward or rearward without using the control knob.

B090C01Y-AAT

Seat Cushion Height Adjustment



Move the front portion of the control knob up or down to raise or lower the front part of the seat cushion. Move the rear portion of the control knob up or down to raise or lower the rear part of the seat cushion.

B090D01Y-AAT

Adjusting Seatback Angle



Rotate the upper portion of the control knob forward or backward to recline the seatback to the desired position. Release the control knob and the seatback will remain in that position.



WARNING:

To minimize the risk of personal injury in the event of a collision or a sudden stop, both the driver's and passenger's seatback should remain in an upright position while the car is in motion. The protection provided by the seat belts and airbags may be reduced significantly when the seatbacks are reclined. There is a greater risk that the seat occupants will slide under the belt resulting in serious injury if a crash occurs when the seatbacks are reclined. The seat belt cannot provide full protection to an occupant if the seat back is reclined.

B080G01FC-AAT

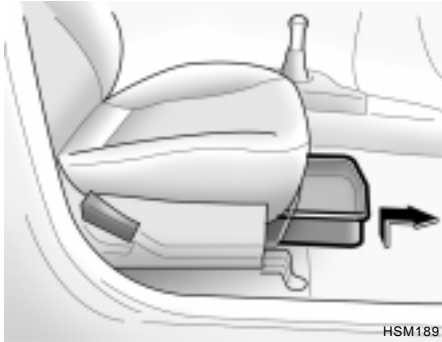
UNDER TRAY (If installed)

The tray is located under the front passenger's seat. It is opened by up and pulling forward.

**WARNING:**

To avoid the possibility of injury in case of an accident or a sudden stop, the tray should be kept closed when the car is in motion.

B100A02Y-AAT

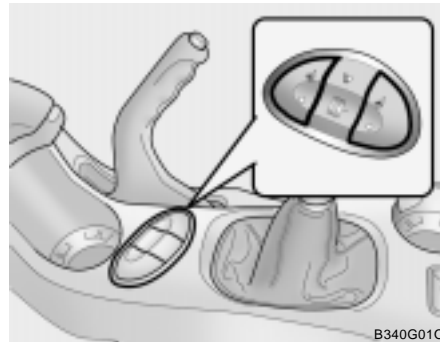
SEAT WARMER (If Installed)

The seat warmer is provided to warm the front seats during cold weather. With the ignition key in the "ON" position, push either of the switches to warm the driver's seat or the passenger's seat.

During mild weather or under conditions where the operation of the seat warmer is not needed, keep the switches in the "OFF" position.

NOTE:

- o The seat warmer will not operate if ambient temperature is higher than 82.4°F(28°C) ± 3.5°F(3.5°C).
- o If the seat warmer doesn't work when ambient temperature is lower than 75.2°F(24°C), it must be checked at authorized dealer.

B080I010-BAT

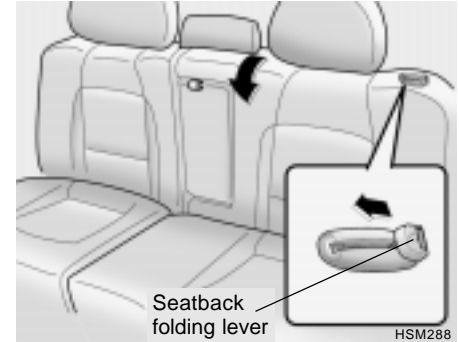
REAR SEAT**Adjusting Seatback Angle**

To recline the seatback, push the seatback folding lever toward the headrest, and release it after the desired seatback angle is achieved. When you recline the seatback to desired position, always be sure it has locked into position.

**CAUTION:**

When reclining the seatback, you should adjust the seatback folding lever while standing.

1-16 FEATURES OF YOUR HYUNDAI

B080A050-AAT

Folding Rear Seatback and Seat Cushion

For greater convenience, the entire seatback and seat cushion may be folded down and up.

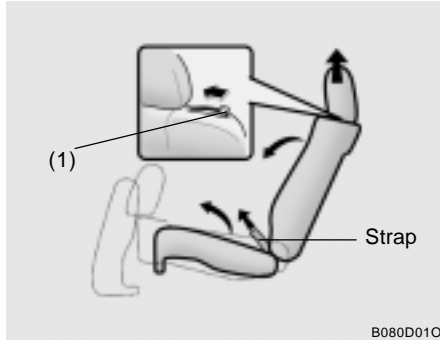

1. Remove the headrests.
2. Pull strap to fold up the seat cushion.
3. Push and hold the seatback folding lever (1) inward, then push down the seatback.

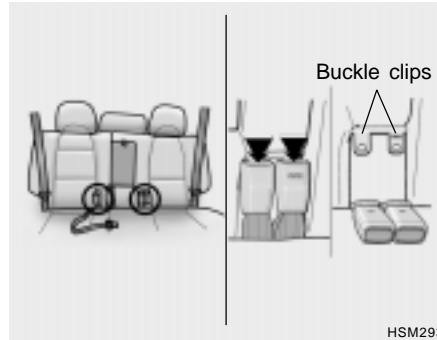

NOTE:

- o Before folding the seatback, place the rear seat belt buckles in the buckle clips on the seatback. This will prevent the seat belt buckles from becoming covered by the seat cushion when it is returned to the seating position.
- o The rear seat belt buckles must be removed from the buckle clips by pressing release button when in use.

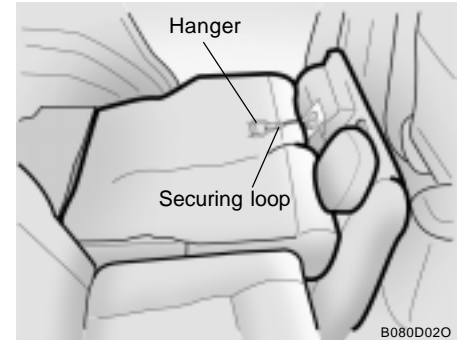

4. Hook the securing loop under the seat cushion to the hanger on the backside of the seatback.
 5. Insert the headrests between the seatback and the seat cushion.
 6. To return the seatback to its normal position, push the seatback folding lever and reverse the above procedure.
- o When you return the seatback to its upright position, always be sure it is locked into position by pulling and pushing on the top of the seatback.

**WARNING:**

- o The purpose of the fold-up rear seat cushion and the fold-down rear seat back is to allow you to carry more objects than could otherwise be accommodated. Do not allow passengers to sit on the cargo area while the car is moving. This is not a proper seating position and no seat belts are available for use when the seat back is folded down. This could result in serious injury or death in case of an accident or a sudden stop. Objects should not extend higher than the top of the front seatbacks. This could allow cargo to slide forward and cause injury or damage during sudden stops.
- o Make sure that the headrests are properly fixed in place to minimize the risk of severe injury in case of an accident.
- o When you return the rear seatback to its upright position after being folded down, be careful not to damage the seatbelt webbing or buckle. In addition, do not allow the seatbelt webbing or buckle to get caught or pinched in the rear seat.

B080P01B-GAT

REAR SEAT WARNING

B080P01O

For the safety of all passengers, luggage or other cargo should not be piled higher than the top of the seatback.

B150A02A-AAT

SEAT BELT PRECAUTIONS**WARNING:**

All occupants of the vehicle must wear their seat belts at all times. Note that this vehicle is equipped with a Supplemental Restraint (Airbag) System as discussed beginning on page 1-29. The seat belts must be used in conjunction with the supplemental airbag system. State laws require that some or all occupants of the vehicle use seat belts. The possibility of increased injury or severity of injury in an accident will be increased if this elementary safety precaution is not observed.

B150B03Y-AAT

Infant or Small Child

All 50 states have child restraint laws. You should be aware of the specific requirements in your state. Child and/or infant safety seats must be properly placed and installed in the rear seat. Information about the use of these restraints begins on page 1-23.



WARNING:

Every person in your vehicle needs to be properly restrained at all times, including infants and children. In a collision, an unrestrained child can become a "missile" inside the car. The force required to hold a child on your lap could be so great that you could not hold the child. Any child riding in the vehicle should always be in a proper restraint in the rear seat of the vehicle.

NOTE:

Small children are best protected from injury in an accident when properly restrained in the rear seat by a child restraint system that meets the requirements of the Federal Motor Vehicle Safety Standards. Before buying any child restraint system, make sure that it has a label certifying that it meets Motor Vehicle Safety Standard 213. The restraint must be appropriate for your child's height and weight. Check the label on the child restraint for this information. See page 1-23.

B150C02A-AAT

Larger Children

Children who are too large for child restraint systems should always occupy the rear seat and use the available lap/shoulder belts. The lap portion should be fastened snug on the hips and as low as possible. Check belt fit periodically. A child's squirming could put the belt out of position. Children are afforded the most safety in the event of an accident when they are restrained by a proper restraint system in the rear seat. If a larger child (over age 13) must be seated in the front seat, the child should be securely restrained by the available lap/shoulder belt and the seat should be placed in the rearmost position. Children under the age of 13 should be restrained securely in the rear seat. NEVER place a child under the age of 13 in the front seat. NEVER place a rear facing child seat in the front seat of a vehicle.

B150D01A-AAT

Pregnant Women

The use of a seat belt is recommended for pregnant women to lessen the chance of injury in an accident. When a seat belt is used, the lap belt portion should be placed as low and snugly as possible on the hips, not across the abdomen. For specific recommendations, consult a physician.

B150E01A-AAT

Injured Person

A seat belt should be used when an injured person is being transported. When this is necessary, you should consult a physician for recommendations.

B150F01A-AAT

One Person Per Belt

Two people (including children) should never attempt to use a single seat belt. This could increase the severity of injuries in case of an accident.

B150G01A-AAT

Do Not Lie Down

To reduce the chance of injuries in the event of an accident, and to achieve maximum effectiveness of the restraint system, all passengers should be sitting up and the front seats should be in an upright position when the car is moving. A seat belt cannot provide proper protection if the person is lying down in the rear seat or if the front seat is in a reclined position.

**WARNING:**

Sitting in a reclined position or lying down when your vehicle is in motion can be dangerous. Even if you buckle up, your seat belts can't do their job when you're reclined.

The shoulder belt can't do its job because it won't be against your body.

Instead, it will be in front of you. In a crash you could go into it with great force, receiving serious neck or other injuries.

The lap belt can't do its job either. In a crash the belt could go up over your abdomen.

The belt forces would be applied there, not at your strong pelvic bones.

This could cause serious internal injuries. For proper protection when the vehicle is in motion, have the seatback upright.

Then sit back in the seat and wear your seat belt properly. See page 1-20.

B160A01A-AAT

CARE OF SEAT BELTS

Seat belt systems should never be disassembled or modified. In addition, care should be taken to assure that seat belts and belt hardware are not damaged by seat hinges, doors or other abuse.

**WARNING:**

When you return the rear seatback to its upright position after the rear seatback was folded down, be careful not to damage the seat belt webbing or buckle. Be sure that the webbing or buckle does not get caught or pinched in the rear seat.

B160B01A-AAT

Periodic Inspection

It is recommended that all seat belts be inspected periodically for wear or damage of any kind. Parts of the system that are damaged should be replaced as soon as possible.

B160C01A-AAT

Keep Belts Clean and Dry

Seat belts should be kept clean and dry. If belts become dirty, they can be cleaned by using a mild soap solution and warm water. Bleach, dye, strong detergents or abrasives should not be used because they may damage and weaken the fabric.

B160D01A-AAT

When to Replace Seat Belts

Entire in-use seat belt assembly or assemblies should be replaced if the vehicle has been involved in an accident. This should be done even if no damage is visible. Additional questions concerning seat belt operation should be directed to your Hyundai Dealer.

B170A04Y-AAT

HEIGHT ADJUSTABLE FRONT SEAT SHOULDER BELT

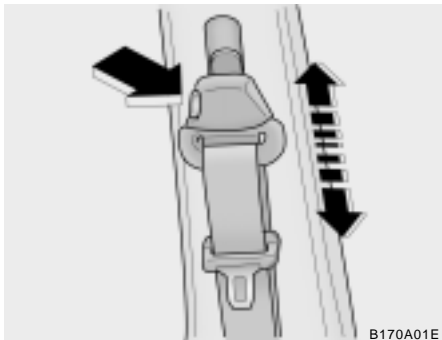

You can adjust the height of the shoulder belt anchor to one of the 4 positions for maximum comfort and safety.

If the height of the adjusting seat belt is too near your neck, you will not be getting the most effective protection. The shoulder portion should be adjusted so that it lies across your chest and midway over your shoulder nearest the door and not your neck.

To adjust the height of the seat belt anchor, lower or raise the height adjuster into an appropriate position. To raise the height adjuster, pull it up. To lower it, push it down while pressing the height adjuster button.

Release the button to lock the anchor into position. Try sliding the height adjuster to make sure that it has locked into the position.

! **WARNING:**

- o The height adjuster must be in the locked position when the vehicle is moving.
- o The misadjustment of height of the shoulder belt could reduce the effectiveness of the seat belt in a crash.

B180A01A-AAT

SEAT BELT-Driver's 3-Point System with Emergency Locking Retractor To Fasten Your Belt



To fasten your seat belt, pull it out of the retractor and insert the metal tab into the buckle. There will be an audible "click" when the tab locks into the buckle.

The seat belt automatically adjusts to the proper length only after the lap belt portion is adjusted manually so that it fits snugly around your hips. If you lean forward in a slow, easy motion, the belt will extend and let you move around. If there is a sudden stop or impact, however, the belt will lock into position. It will also lock if you try to lean forward too quickly.

NOTE:

If the driver's seat belt is not fastened when the ignition key is in the "ON" position, the seat belt warning light will flash and the warning chime will sound for approximately six seconds.

B190A01Y-AAT

SEAT BELTS-Front Passenger and Rear Seat 3-Point System with Combination Locking Retractor To Fasten Your Belt

Combination retractor type seat belts are installed in the rear seat positions to help accommodate the installation of child restraint systems. Although a combination retractor is also installed in the front passenger seat position, Hyundai strongly recommends that children always be seated in the rear seat. NEVER place any infant restraint system in the front seat of the vehicle.

This type of seat belt combines the features of both an emergency locking retractor seat belt and an automatic locking retractor seat belt. To fasten your seat belt, pull it out of the retractor and insert the metal tab into the buckle. There will be an audible "click" when the tab locks into the buckle. When not securing a child restraint, the seat belt operates in the same way as the driver's seat belt (Emergency Locking Retractor Type). It automatically adjusts to the proper length only after the lap belt portion of the seat belt is adjusted manually so that it fits snugly around your hips. When the seat belt is fully extended from the retractor to allow the installation of a child restraint system, the seat belt operation changes to allow the belt to retract, but not to extend. (Automatic Locking Retractor Type). See page 1-27.

NOTE:

Although the combination retractor provides the same level of protection for seated passengers in either emergency or automatic locking modes, it is recommended that seated passengers use the emergency locking feature for improved convenience. The automatic locking function is intended to facilitate child restraint installation. To convert from the automatic locking feature to the emergency locking operation mode, allow the unbuckled seat belt to fully retract.



WARNING:

- o For maximum restraint system protection, the seat belts must always be used whenever the car is moving.
- o Seat belts are most effective when seatbacks are in the upright position.
- o Children must always be seatbelted in the rear seats. Never allow children to ride in the front passenger seat.
- o The shoulder belt should be positioned midway over the shoulder nearest the door for the most effective protection. Never wear the seat belt under the arm nearest the door. Wearing the belt under the arm nearest the door could cause serious or fatal injuries in an accident.



WARNING:

- o Avoid wearing twisted seat belts. A twisted belt can't do its job as well. In a collision, it could even cut into you. Be sure the belt is straight and not twisted.
- o Be careful not to damage the belt webbing or hardware. If the belt webbing or hardware is damaged, replace it.

B200A01A-AAT

Adjusting Your Seat Belt



B200A01L

! **WARNING:**
 You should place the lap belt portion as low as possible and snugly across your hips, not on your waist. If the lap belt is located too high on your waist, it may increase the chance of injury in the event of a collision. Both arms should not be under or over the belt. Rather, one should be over and the other under, as shown in the illustration. Never wear the seat belt under the arm nearest the door.

B210A01A-AAT

To Release the Seat Belt



The seat belt is released by pressing the release button in the locking buckle. When it is released, the belt should automatically draw back into the retractor.

If this does not happen, check the belt to be sure it is not twisted, then try again.

B220A01A-AAT

SEAT BELTS (2-Point Static Type)

(Rear Seat Center)

To Fasten Your Seat Belt



To fasten a 2-point static type belt, insert the metal tab into the locking buckle. There will be an audible "click" when the tab locks into the buckle. Check to make sure the belt is properly locked and that the belt is not twisted.

B220B01A-AAT

Adjusting Your Seat Belt

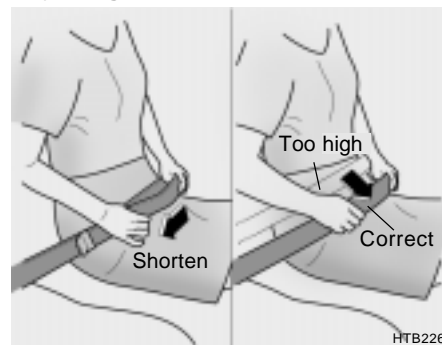

With a 2-point static type seat belt, the length must be adjusted manually so it fits snugly around your body. Fasten the belt and pull on the loose end to tighten. The belt should be placed as low as possible on your hips, not on your waist. If the belt is too high, it could increase the possibility of your being injured in an accident.

B220C01A-AAT

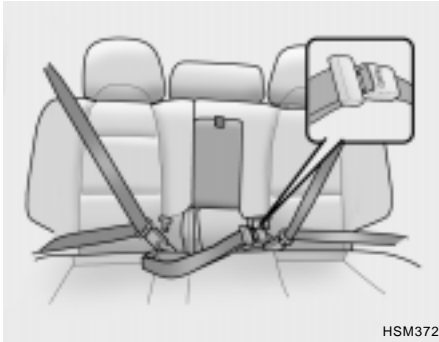
To Release the Seat Belt

HSM372

When you want to release the seat belt, press the button in the locking buckle.

**WARNING:**

The center lap belt latching mechanism is different from those for the rear seat shoulder belts. When fastening the rear seat shoulder belts or the center lap belt, make sure they are inserted into the correct buckles to obtain maximum protection from the seat belt system and assure proper operation.

B230A020-AAT

CHILD RESTRAINT SYSTEM

Children riding in the car should sit in the rear seat and must always be properly restrained to minimize the risk of injury in an accident, sudden stop or sudden maneuver. According to accident statistics provided by the National Highway Traffic Safety Administration (NHTSA), children are safer when properly restrained in the rear seats than in the front seat. Larger children not in a child restraint should use one of the seat belts provided.

All 50 states have child restraint laws. You should be aware of the specific requirements in your state. Child and/or infant safety seats must be properly placed and installed in the rear seat. You must use a commercially available child restraint system that meets the requirements of the Federal Motor Vehicle Safety Standards (FMVSS).

Children could be injured or killed in a crash if their restraints are not properly secured. For small children and babies, a child seat or infant seat must be used. Before buying a particular child restraint system, make sure it fits your car seat and seat belts, and fits your child. Follow all the instructions provided by the manufacturer when installing the child restraint system.

**WARNING:**

- o A child restraint system must be placed in the rear seat. Never install a child or infant seat on the front passenger's seat. Should an accident occur and cause the passenger side airbag to deploy, it could severely injure or kill an infant or child seated in an infant or child seat. Thus only use a child restraint in the rear seat of your vehicle.
- o Since a safety belt or child restraint system can become very hot if it is left in a closed vehicle, be sure and check the seat cover and buckles before placing a child there.
- o When the child restraint system is not in use, fasten it with a safety belt so that it will not be thrown forward in the case of a sudden stop or an accident.
- o Children who are too large to be in a child restraint should sit in the rear seat and be restrained with the available lap/shoulder belts. Never allow children to ride in the front passenger seat.

**WARNING:**

- o Always make sure that the shoulder belt portion of the lap/shoulder belt is positioned midway over the shoulder and never across the neck or behind the back. Moving the child closer to the center of the vehicle may help provide a good shoulder belt fit. The lap belt portion of the lap/shoulder belt must always be positioned as low as possible on the child's hips, and as snug as possible.

- o If the seat belt will not properly fit the child, Hyundai recommends the use of an approved booster seat in the rear seat in order to raise the child's seating height so that the seat belt will properly fit the child.

Before purchasing a booster seat, make sure that it meets applicable Federal Motor Vehicle Safety Standards and that it is satisfactory for use with this vehicle.

- o Never allow a child to stand up or kneel on the seat.
- o Never use an infant carrier or a child safety seat that "hooks" over a seatback; it may not provide adequate security in an accident.

**WARNING:**

- o Never allow a child to be held in a person's arms while they are in a moving vehicle, as this could result in serious injury to the child in the event of an accident or a sudden stop. Holding a child in a moving vehicle does not provide the child with any means of protection during an accident, even if the person holding the child is wearing a seat belt.

B230B01E-AAT

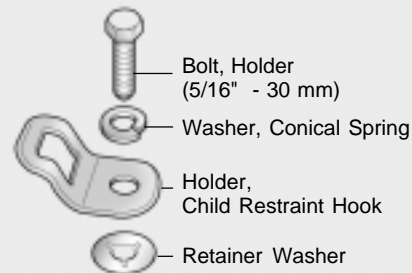
Using a Child Restraint System

HSM386

For small children and babies, the use of a child seat or infant seat is strongly recommended and may be required in your state. This child seat or infant seat should be of appropriate size for the child and should be installed in accordance with the manufacturer's instructions. It is further recommended that the seat be placed in the vehicle's rear seat since this can make an important contribution to safety. Your vehicle is provided with three child restraint hook holders for installing the child seat or infant seat.

B230C03O-AAT

Installing a Child Restraint Seat with the "Tether Anchorage" System

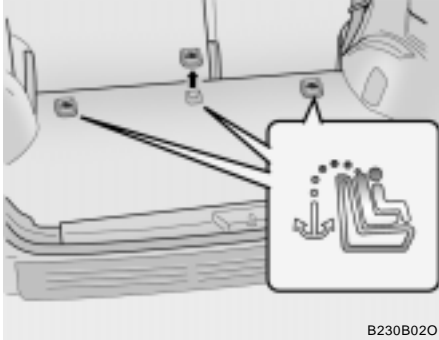

B230B02O

This symbol indicates the location of user ready tether anchorage.

Rear luggage compartment floor

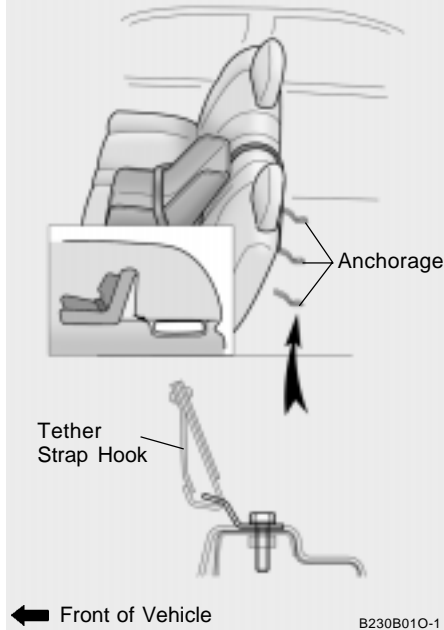

B230B01O-1

Three child restraint hook holders are located on the rear luggage compartment floor. To install the child restraint seat, connect the child restraint tether strap hook to the child restraint hook holder and tighten to secure the seat.

B230D03E-AAT

Securing the Child Restraint Seat with the "ISOFIX" system

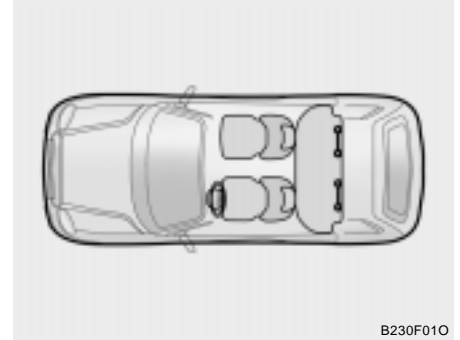

B230F01O

Some child seat manufacturers make safety seats that are labeled as ISOFIX or ISOFIX-compatible child seats. These seats include two rigid or webbing mounted attachments that connect to two ISOFIX anchors at specific seating positions in your vehicle. This type of child seat eliminates the need to use seat belts to attach the child seat for forward-facing child seats.

ISOFIX anchors have been provided in your vehicle. The ISOFIX anchors are located in the left and right outboard rear seating positions. There is no ISOFIX anchor provided for the center rear seating position.

**WARNING:**

- o Do not install a child restraint seat at the center of the rear seat using the vehicle's ISOFIX anchors. The ISOFIX anchors are only provided for the left and right outboard rear seating positions. Do not misuse the ISOFIX anchors by attempting to attach a child safety seat in the middle of the rear seat position to the ISOFIX anchors. In a crash, the child seat ISOFIX attachments may not be strong enough to secure the child restraint seat properly in the center of the rear seat and may break, causing serious injury or death.
- o Do not mount more than one child restraint to a single tether or to a child restraint lower anchorage point. The improper increased load may cause the anchorage points or tether anchor to break, causing serious injury or death.
- o Attach the ISOFIX or ISOFIX-compatible child seat only to the appropriate locations shown.
- o Always follow the installation and use instructions provided by the manufacturer of the child restraint.

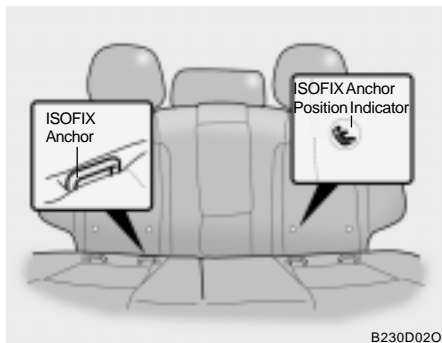

B230D020

The ISOFIX anchors are located between the seatback and the seat cushion of the rear seat left and right outboard seating positions.

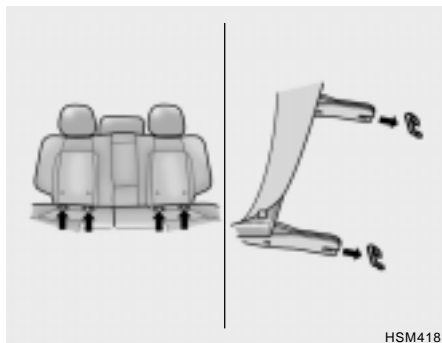

HSM418

Follow the child seat manufacturer's instructions to properly install safety seats with ISOFIX or ISOFIX-compatible attachments.

Once you have installed the ISOFIX child restraint seat, assure that the seat is properly attached to the ISOFIX and tether anchors. Also, test the safety seat before you place the child in it. Tilt the seat from side to side. Also try to tug the seat forward. Check to see if the anchors hold the seat in place.

**WARNING:**

If the child restraint seat is not anchored properly, the risk of a child being seriously injured or killed in a collision greatly increases.

B230F01A-AAT

Installation on Rear Seat Center Position



B235G02Y

Use the center seat belt for the rear seat to secure the child restraint system as illustrated. After installation of the child restraint system, rock the child seat back and forth, and side to side to ensure that it is properly secured by the seat belt.

If the child seat moves, readjust the length of the seat belt. Then, if equipped, insert the child restraint tether strap hook into the child restraint hook holder and tighten to secure the seat. Always refer to the child restraint system manufacturer's recommendation before installing the child restraint system in your vehicle.

B230G01O-AAT

Installation on Outboard Rear Seats

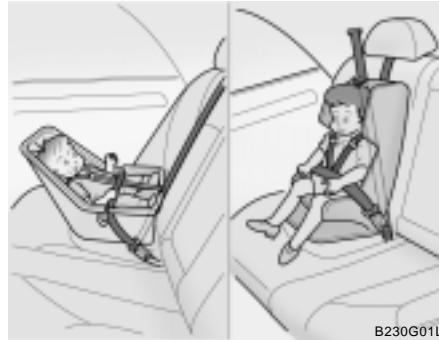

B230G01L

To install a child restraint system in the outboard rear seats, extend the shoulder/lap belt entirely from its retractor until a "click" is felt. This will engage the seat belt retractor automatic locking feature, which allows the seat belt to retract but not extend. Install the child restraint system, buckle the seat belt and allow the seat belt to take up any slack. Make sure that the lap portion of the belt is tight around the child restraint system and the shoulder portion of the belt is positioned so that it can not interfere with the child's head or neck. Also, double check to be sure that the retractor has engaged the Automatic Locking feature by trying to extend webbing out of the retractor. If the retractor is in the Automatic Locking mode, the belt will be locked. After installation of the child restraint system, try to move it in all directions to be sure the child

restraint system is securely installed. If you need to tighten the belt, pull more webbing toward the retractor. When you unbuckle the seat belt and allow it to retract, the retractor will automatically revert back to its normal seated passenger Emergency Locking usage condition.

NOTE:

- o Before installing the child restraint system in any seating position, read the instructions supplied by the child restraint system manufacturer.
- o If the seat belt does not operate as described, have the system checked immediately by your authorized Hyundai dealer.



WARNING:

- o If the retractor is not in the Automatic Locking mode, the child restraint system can move when your vehicle turns or stops abruptly.
- o Do not install any child restraint system in the front passenger seat. Should an accident occur and cause the passenger side airbag to deploy, it could severely injure or kill an infant or child seated in an infant or child seat. Therefore, only use a child restraint system in the rear seat of your vehicle.

1-28 FEATURES OF YOUR HYUNDAI

B180B01A-AAT

Pre-tensioner Seat Belt

Your Hyundai vehicle is equipped with driver's and front passenger's pre-tensioner seat belts. The purpose of the pre-tensioner is to make sure that the seat belts fit tightly against the occupant's body in certain frontal collisions. The pre-tensioner seat belts can be activated with the airbags.

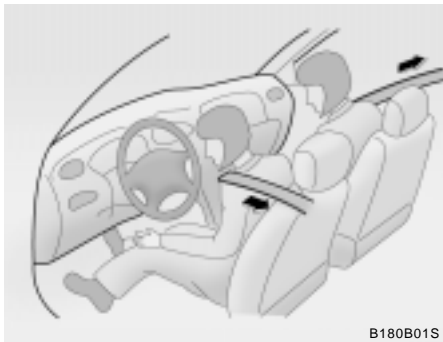

The pre-tensioner seat belt operates in a similar way as an Emergency Locking Retractor (ELR) type of seat belt. When the vehicle stops suddenly, or if the occupant tries to lean forward too quickly, the seat belt retractor will lock into position. However, in certain frontal collisions, the pre-tensioner will activate and pull the seat belt into tighter contact against the occupant's body.

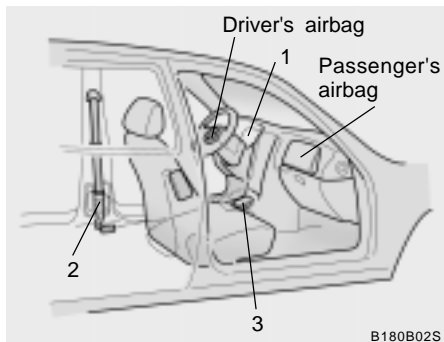

The seat belt pre-tensioner system consists mainly of the following components. Their locations are shown in the illustration.

1. SRS airbag warning light
2. Seat belt pre-tensioner assembly
3. SRS control module

! **WARNING:**
To obtain maximum benefit from a pre-tensioner seat belt:

1. The seat belt must be worn correctly.
2. The seat belt must be adjusted to the correct position.

NOTE:

- o Both the driver's and front passenger's pre-tensioner seat belts will be activated in certain frontal collisions. The pre-tensioner seat belts can be activated with the airbags. The pre-tensioners will be activated even if the seat belts are not being worn at the time of the collision.
- o When the pre-tensioner seat belts are activated, a loud noise may be heard and fine dust, which may appear to be smoke, may be visible in the passenger compartment. These are normal operating conditions and are not hazardous.
- o Although it is harmless, the fine dust may cause skin irritation and should not be breathed for prolonged periods. Wash your hands and face thoroughly after an accident in which the pre-tensioner seat belts were activated.

**CAUTION:**

- o Because the sensor that activates the SRS airbag is connected with pre-tensioner seat belt, the SRS airbag warning light  on the instrument panel will blink for approximately 6 seconds after the ignition key has been turned to the "ON" position, and then it should turn off.
- o If the pre-tensioner seat belt is not working properly, this warning light will illuminate even if there is no malfunction of SRS airbag system. If the SRS airbag warning light does not illuminate when the ignition key is turned to "ON" or if it remains illuminated after blinking for approximately 6 seconds, or if it illuminates while the vehicle is being driven, please have an authorized Hyundai dealer inspect the pre-tensioner seat belt or SRS airbag system as soon as possible.

**WARNING:**

- o Pre-tensioners are designed to operate only one time. After activation, pre-tensioner seat belts must be replaced. All seat belts, of any type, should always be replaced after they have been worn during a collision.
- o The pre-tensioner seat belt assembly mechanisms become hot during activation. Do not touch the pre-tensioner seat belt assemblies for several minutes after they have been activated.
- o Do not attempt to inspect or replace the pre-tensioner seat belts yourself. This must be done by an authorized Hyundai dealer.
- o Do not strike the pre-tensioner seat belt assemblies.
- o Do not attempt to service or repair the pre-tensioner seat belt system in any manner.
- o Improper handling of the pre-tensioner seat belt assemblies, and failure to heed the warnings to not strike, modify, inspect, replace, service or repair the pre-tensioner seat belt assemblies may lead to improper operation or inadvertent activation and serious injury.
- o Always wear the seat belts when driving or riding in a motor vehicle.

B240A02F-AAT

SUPPLEMENTAL RESTRAINT (AIRBAG) SYSTEM (SRS)

Driver's Airbag



B240A010

Your Hyundai is equipped with a Supplemental Restraint (Airbag) System. The indications of the system's presence are the letters "SRS AIRBAG" embossed on the airbag pad cover in the steering wheel and the passenger's side front panel pad above the glove box.

The Hyundai SRS consists of airbags installed under the pad covers in the center of the steering wheel and the passenger's side front panel above the glove box. The purpose of the SRS is to provide the vehicle's driver and the front passenger with additional protection when used together with the seat belt, in case of a frontal impact.

NOTE:

Be sure to read information about the SRS on the labels provided on the backside of the sun visor and in the glove box.

**WARNING:**

- o As its name implies, the SRS is designed to work with, and be supplemental to, the driver's and the passenger's three point seat belt systems and is not a substitute for them. Therefore, your seat belts must be worn at all times while the vehicle is in motion. The airbags deploy only in certain frontal impact conditions severe enough to likely cause significant injury to the vehicle occupants.
- o The SRS is designed to deploy the airbags only when an impact is sufficiently severe and when the impact angle is less than 30° from the forward longitudinal axis of the vehicle and will not deploy in side, rear or rollover impacts. Additionally, the airbags will only deploy once. Thus, seat belts must be worn at all times.
- o Front airbags are not intended to deploy in light collisions in which protection can be provided by the seat belt.

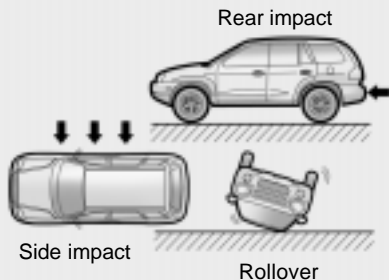
**WARNING:**

B240D010

- o Front airbags are not intended to deploy in side-impact, rear-impact or rollover crashes. In addition, airbags will not deploy in frontal crashes below the deployment threshold speed.
- o The driver should sit back as far as possible while still maintaining control of the vehicle. If you are sitting too close to the airbag, it can cause death or serious injury when it inflates.
- o No objects should be placed over or near the airbag modules on the steering wheel, instrument panel, and the front passenger's panel above the glove box, because any such object could cause harm if the vehicle is in a crash severe enough to cause the airbags to deploy.

**WARNING:**

- o If the airbags deploy, they must be replaced by an authorized Hyundai dealer.
- o Do not tamper with or disconnect SRS wiring, or other components of the SRS system. Doing so could result in injury, due to accidental firing of the airbags or by rendering the SRS inoperative.
- o Do not install a child restraint system in the front passenger seat position. A child restraint system must never be placed in the front seat. The infant or child could be severely injured or killed by an airbag deployment in case of an accident. Do not allow children to ride in the front passenger seat. If older children (teenagers and older) must ride in the front seat, make sure they are always properly belted and that the seat is moved back as far as possible.
- o For maximum safety protection in all types of crashes, all occupants including the driver should always wear their seat belts whether or not an airbag is also provided at their seating position to minimize the risk of severe injury or death in the event of a crash. Do not sit or lean unnecessarily close to the airbag while the vehicle is in motion.

**WARNING:**

- o The SRS airbag system must deploy very rapidly to provide protection in a crash. If an occupant is out of position because of not wearing a seat belt, the airbag may forcefully contact the occupant causing serious or fatal injuries.

B240B02A-AAT

SRS Components and Functions

B240B01L

The SRS consists of the following components:

- Driver's Airbag Module
- Passenger's Airbag Module
- Knee Bolster
- SRS Service Reminder Indicator (SRI)
- SRS Control Module (SRSCM)

The SRSCM continually monitors all elements while the ignition is "ON" to determine if a frontal or near-frontal impact is severe enough to require airbag deployment.



B240B02L

The SRS service reminder indicator (SRI) on the instrument panel will blink for about 6 seconds after the ignition key is turned to the "ON" position or after the engine is started, after which the SRI should go out.

The airbag modules are located both in the center of the steering wheel and in the front passenger's panel above the glove box. When the SRSCM detects a considerable impact to the front of the vehicle, it will automatically deploy the airbags.

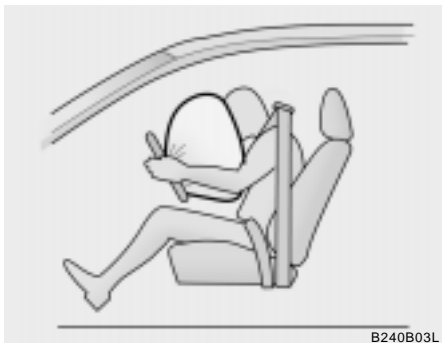

Upon deployment, tear seams molded directly into the pad covers will separate under pressure from the expansion of the airbags. Further opening of the covers then allows full inflation of the airbags.

A fully inflated airbag in combination with a properly worn seat belt slows the driver's or the passenger's forward motion, thus reducing the risk of head or chest injury.

After complete inflation, the airbag immediately starts deflating, enabling the driver to maintain forward visibility.

Passenger's Airbag



CAUTION:

When installing a container of liquid air freshener inside the vehicle, do not place it near the instrument cluster nor on the instrument panel surface. If there is any leakage from the air freshener onto these areas (Instrument cluster, instrument panel or air ventilator), it may damage these parts. If the liquid from the air freshener does leak onto these areas, wash them with water immediately.

Passenger's Airbag



WARNING:

- o When the SRS is activated, there may be a loud noise and fine dust will be released throughout the vehicle. These conditions are normal and are not hazardous. However, the fine dust generated during airbag deployment may cause skin irritation. Wash your hands and face thoroughly with lukewarm water and a mild soap after an accident in which the airbags were deployed.

**WARNING:**

- o The SRS can function only when the ignition key is in the "ON" position. If the SRS SRI does not come on, or continuously remains on, after flashing for about 6 seconds when the ignition key is turned to the "ON" position, or after the engine is started, comes on while driving, the SRS is not working properly. If this occurs, have your vehicle immediately inspected by your Hyundai dealer.
- o Before you replace a fuse or disconnect a battery terminal, turn the ignition key to the "LOCK" position or remove the ignition key. Never remove or replace the air bag related fuse(s) when the ignition key is in the "ON" position. Failure to heed this warning will cause the SRS SRI to illuminate.

B990B04Y-AAT

Side Impact Airbag (If installed)

B990B02Y

Your Hyundai is equipped with a side impact airbag in each front seat. The purpose of the airbag is to provide the vehicle's driver and/or the front passenger with additional protection than that offered by the seat belt alone. The side impact airbags are designed to deploy only during certain side-impact collisions, depending on the crash severity, angle, speed and point of impact. The side impact air bags are not designed to deploy in all side impact situations.

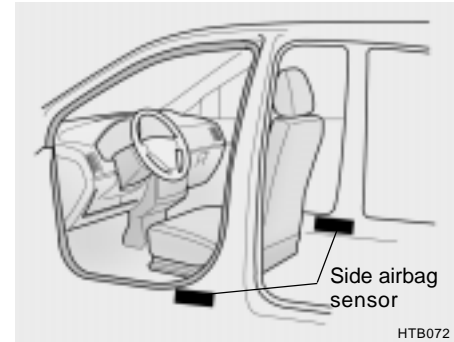

HTB072

**WARNING:**

- o The side impact airbag is supplemental to the driver's and the passenger's three point seat belt systems and is not a substitute for them. Therefore your seat belts must be worn at all times while the vehicle is in motion. The airbags deploy only in certain side impact conditions severe enough to cause significant injury to the vehicle occupants.

**WARNING:**

- o For best protection from the side impact airbag system and to avoid being injured by the deploying side impact airbag, both front seat occupants should sit in an upright position with the seat belt properly fastened. The driver's hands should be placed on the steering wheel at the 9:00 and 3:00 o'clock positions. The passenger's arms and hands should be placed in their laps.
- o Do not use any accessory seat covers.
- o Use of seat covers could reduce or prevent the effectiveness of the system.
- o Do not install any accessories on the side or near the side impact airbag.
- o Do not use excessive force on the side of the seat.
- o Do not place any objects over the airbag or between the airbag and yourself.
- o Do not place any objects (an umbrella, bag, etc.) between the front door and the front seat. Such objects may become dangerous projectiles and cause injury if the supplemental side impact air bag inflates.
- o To prevent unexpected deployment of the side impact air bag that may result in personal injury, avoid impact to the side airbag sensor when the ignition key is on.

B240C010-AAT

SRS Care

- o The SRS is virtually maintenance free and there are no parts you can safely service by yourself. The entire SRS system must be inspected by an authorized Hyundai dealer in 10 years after the date that the vehicle was manufactured.
- o Any work on the SRS system, such as removing, installing, repairing, or any work on the steering wheel must be performed by a qualified Hyundai technician. Improper handling of the airbag system may result in serious personal injury.



HSM393

**WARNING:**

- o Do not install a child restraint system in the front passenger seat position. A child restraint system must never be placed in the front seat. The infant or baby could be severely injured or killed by an airbag deployment in case of an accident.
- o Modification to SRS components or wiring, including the addition of any kind of badges to the pad covers or modifications to the body structure, can adversely affect SRS performance and lead to possible injury.
- o For cleaning the airbag pad covers, use only a soft, dry cloth or one which has been moistened with plain water. Solvents or cleaners could adversely affect the airbag covers and proper deployment of the system.
- o No objects should be placed over or near the airbag modules on the steering wheel, instrument panel, and the front passenger's panel above the glove box, because any such object could cause harm if the vehicle is in a crash severe enough to cause the airbags to inflate.
- o If the airbags inflate, they must be replaced by an authorized Hyundai dealer.

**WARNING:**

- o Do not tamper with or disconnect SRS wiring, or other components of the SRS system. Doing so could result in injury, due to accidental firing of the airbags or by rendering the SRS inoperative.
- o If components of the airbag system must be discarded, or if the vehicle must be scrapped, certain safety precautions must be observed. Your Hyundai dealer knows these precautions and can give you the necessary information. Failure to follow these precautions and procedures could increase the risk of personal injury.
- o If you sell your vehicle, make certain that this manual is transferred to the new owner.
- o If your car was flooded and has soaked carpeting or water on the floor, you shouldn't try to start the engine; have the car towed to an authorized Hyundai dealer.
- o Do not replace the bumper or the bumper guard with the one other than the Hyundai genuine parts. Otherwise, it can adversely affect SRS performance and lead to unexpected injury.

B260A030-AAT

INSTRUMENT CLUSTER AND INDICATOR LIGHTS

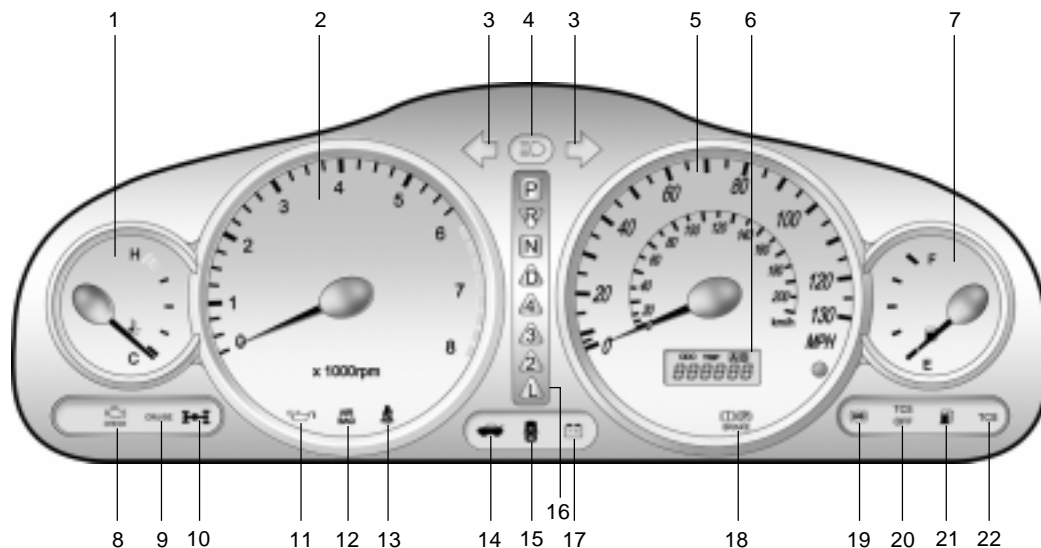

B260A010

1. Coolant Temperature Gauge
2. Tachometer
3. Turn Signal Indicator Light
4. High Beam Indicator Light
5. Speedometer
6. Odometer / Trip Odometer
7. Fuel Gauge
8. Malfunction Indicator Light (MIL)
9. Cruise Indicator (If installed)

10. 4WD System Warning Light (If installed)
11. Low Oil Pressure Warning Light
12. Supplemental Restraint System (Airbag) Service Reminder Indicator (SRI)
13. Seat Belt Warning Light
14. Tail Gate Open Warning Light
15. Door Ajar Warning Light
16. Automatic Transaxle Position Indicator Light (If installed)

17. Charging System Warning Light
18. Parking Brake/Low Brake Fluid Level Warning Light
19. ABS Service Reminder Indicator (If installed)
20. Traction Control Off indicator Light (If installed)
21. Low Fuel Warning Light
22. Traction Control Indicator Light (If installed)

B260B01A-AAT



SRS (Airbag) Service Reminder Indicator (SRI)

The SRS service reminder indicator (SRI) comes on and flashes for about 6 seconds after the ignition key is turned to the "ON" position or after the engine is started, after which it will go out.

This light also comes on when the SRS is not working properly. If the SRI does not come on, or continuously remains on after flashing for about 6 seconds when you turned the ignition key to the "ON" position or started the engine, or if it comes on while driving, have the SRS inspected by an authorized Hyundai Dealer.

B260D01A-AAT



Turn Signal Indicator Lights

The blinking green arrows on the instrument panel show the direction indicated by the turn signals. If the arrow comes on but does not blink, blinks more rapidly than normal, or does not illuminate at all, a malfunction in the turn signal system is indicated. Your dealer should be consulted for repairs.

B260E020-AAT



Seat Belt Reminder Light and Chime

The seat belt reminder light blinks until your seat belt is fastened when the ignition key is turned from the "OFF" position to "ON" or "START". And the warning chime will sound for 6 seconds.

B260F01A-AAT



High Beam Indicator Light

The high beam indicator light comes on whenever the headlights are switched to the high beam or flash position.

B260G01A-AAT



Low Oil Pressure Warning Light



CAUTION:

If the low oil pressure warning light stays on while the engine is running, serious engine damage may result. The oil pressure warning light comes on whenever there is insufficient oil pressure. In normal operation, it should come on when the ignition switch is turned on, then go out when the engine is started. If the oil pressure warning light stays on while the engine is running, there is a serious malfunction.

If this happens, stop the car as soon as it is safe to do so, turn off the engine and check the oil level. If the oil level is low, fill the engine oil to the proper level and start the engine again. If the light stays on with the engine running, turn the engine off immediately. In any instance where the oil light stays on when the engine is running, the engine should be checked by a Hyundai dealer before the car is driven again.

B260H02A-AAT



Parking Brake/Low Brake Fluid Level Warning Light



WARNING:

If you suspect brake trouble, have your brakes checked by a Hyundai dealer as soon as possible. Driving your car with a problem in either the brake electrical system or brake hydraulic system is dangerous, and could result in a serious injury or death.

Warning Light Operation

The parking brake/brake fluid level warning light should come on when the parking brake is applied and the ignition switch is turned to "ON" or "START". After the engine is started, the light should go out when the parking brake is released.

If the parking brake is not applied, the warning light should come on when the ignition switch is turned to "ON" or "START", then go out when the engine starts. If the light comes on at any other time, you should slow the vehicle and bring it to a complete stop in a safe location off the roadway.

The brake fluid level warning light indicates that the brake fluid level in the brake master cylinder is low and hydraulic brake fluid conforming to DOT 3 or DOT 4 specifications should be added. After adding fluid, if no other trouble is found, the car should be immediately and carefully driven to a Hyundai dealer for inspection. If further trouble is experienced, the vehicle should not be driven at all but taken to a dealer by a professional towing service or some other safe method.

Your Hyundai is equipped with dual-diagonal braking systems. This means you still have braking on two wheels even if one of the dual systems should fail. With only one of the dual systems working, more than normal pedal travel and greater pedal pressure are required to stop the car. Also, the car will not stop in as short a distance with only half of the brake system working. If the brakes fail while you are driving, shift to a lower gear for additional engine braking and stop the car as soon as it is safe to do so.

B260J01A-AAT



Charging System Warning Light

The charging system warning light should come on when the ignition is turned on, then go out when the engine is running. If the light stays on while the engine is running, there is a malfunction in the electrical charging system. If the light comes on while you are driving, stop, turn off the engine and check under the hood. First, make certain the generator drive belt is in place. If it is, check the tension of the belt. Do this as shown on page 6-19 by pushing down on the center of the belt. And then have the system checked by your Hyundai dealer.

B260B01B-GAT



Tail Gate Open Warning Light

This light remains on unless the tail gate is completely closed.

B260L01Y-AAT



Door Ajar Warning Light and Chime

The door ajar warning light warns you that a door is not completely closed and the chime warns you that driver's side front door is not completely closed.

NOTE:

To remind you not to lock the key inside the car, the warning light comes on whenever the key is in the "LOCK" position and a door is open. The warning chime only sounds whenever the key is in the "LOCK" position and driver's side front door is open. The chime sounds and the light remains on until the key is removed from the ignition.

B260M01A-AAT



Low Fuel Level Warning Light

The low fuel level warning light comes on when the fuel tank is approaching empty. When it comes on, you should add fuel as soon as possible. Driving with the fuel level warning light on or with the fuel level below "E" can cause the engine to misfire and damage the catalytic converter.

B260N01A-AAT



Malfunction Indicator Light

This light illuminates when there is a malfunction of an exhaust gas related component, and the system is not functioning properly so that the exhaust gas regulation values are not satisfied. This light will also illuminate when the ignition key is turned to the "ON" position, and will go out in a few seconds. If it illuminates while driving, or does not illuminate when the ignition key is turned to the "ON" position, take your car to your nearest authorized Hyundai dealer and have the system checked.

B260P02Y-GAT



ABS Service Reminder Indicator (If installed)

When the key is turned to the "ON" position, the Anti-Lock Brake System will come on and then go off in a few seconds. If the ABS SRI remains on, comes on while driving, or does not come on when the key is turned to the "ON" position, this indicates that there may be a problem with the ABS.

If this occurs, have your vehicle checked by your Hyundai dealer as soon as possible. The normal braking system will still be operational, but without the assistance of the anti-lock brake system.



WARNING:

If both ABS SRI and Parking Brake/Brake fluid level warning lights remain "ON" or come on while driving, there may be a problem with E.B.D (Electronic Brake Force Distribution).

If this occurs, avoid sudden stops and have your vehicle checked by your Hyundai dealer as soon as possible.

B260C01O-GAT



Traction Control Indicator Light (If installed)

The traction control indicator change operation according to the ignition switch position and whether or not the system is in operation.

They will also illuminate when the ignition key is turned to the "ON" position, but should go out after the engine starts. If the TCS indicator stays on, take your car to your authorized Hyundai dealer and have the system checked. See section 2 for more information about the TCS.

B265C01O-AAT



Traction Control Indicator Lights (3.5 L only) (If installed)

The traction control indicators change operation according to the ignition switch position and whether the system is in operation or not.

They will illuminate when the ignition key is turned to the "ON" position, but should go out after three seconds. If the TCS or TCS-OFF indicator stays on, take your car to your authorized Hyundai dealer and have the system checked. See section 2 for more information about the TCS.

B260Q03O-DAT



Cruise Indicator (If installed)

The cruise indicator light in the instrument cluster is illuminated when the cruise control ON/OFF switch is pushed on the steering wheel.

The indicator light does not illuminate when the cruise control ON/OFF switch is pushed again. Information about the use of cruise control is beginning on page 1-66.

B260T01O-GAT



4WD System Warning Light (If installed)

When the key is turned to the "ON" position, the 4WD(Four Wheel Drive) system warning light will come on and then go off in a few seconds.



CAUTION:

If the 4WD system warning light () blinks while driving, this indicates that there is a malfunction in the 4WD system. If this occurs, have your vehicle checked by an authorized Hyundai dealer as soon as possible.

B270A01A-AAT

BRAKE PAD WEAR WARNING SOUND

The front disc brake pads have wear indicators that should make a high-pitched squealing or scraping noise when new pads are needed. The sound may come and go or be heard all the time when the vehicle is moving. It may also be heard when the brake pedal is pushed down firmly. Excessive rotor damage will result if the worn pads are not replaced. See your Hyundai dealer immediately.

B270B01O-AAT

PARKING START WARNING SOUND

If the vehicle driven at over 2mph(3km/h) more 2~3 seconds, the warning chime will sound continuously when the parking brake engaged.

B280A01A-AAT

FUEL GAUGE



B280A01O

The needle on the gauge indicates the approximate fuel level in the fuel tank. The fuel capacity is given in Section 9.

B290A01A-AAT

ENGINE COOLANT TEMPERATURE GAUGE



B290A01O



WARNING:

Never remove the radiator cap when the engine is hot. The engine coolant is under pressure and could erupt and cause severe burns. Wait until the engine is cool before adding coolant to the reservoir.

The needle on the engine coolant temperature gauge should stay in the normal range. If it moves across the dial to "H" (Hot), pull over and stop as soon as possible and turn off the engine. Then open the hood and, after the engine has cooled, check the coolant reservoir level and the water pump drive belt. If you suspect cooling system trouble, have your cooling system checked by a Hyundai dealer as soon as possible.

B330A01Y-AAT

TACHOMETER



B330A01O

The tachometer registers the speed of your engine in revolutions per minute (rpm). It is useful to help you shift at the appropriate engine speed to avoid lugging or over-revving the engine.



CAUTION:

The engine should not be raced to such a speed that the needle enters the red zone on the tachometer face. This can cause severe engine damage and may void your warranty.

B300A01A-AAT

SPEEDOMETER



B300A01O

Your Hyundai's speedometer is calibrated in miles per hour (on the outer scale) and kilometers per hour (on the inner scale).

B310B02E-AAT

ODOMETER/TRIP ODOMETER



Odometer

Records the total distance the vehicle has been driven.

NOTE:

Federal law forbids alteration of the odometer of any vehicle with the intent to change the number of the odometer. The alteration may void your warranty coverage.

Function of digital odometer/trip odometer

pushing in the reset switch under the right side of the speedometer when the ignition switch is turned "ON" displays the following sequence:

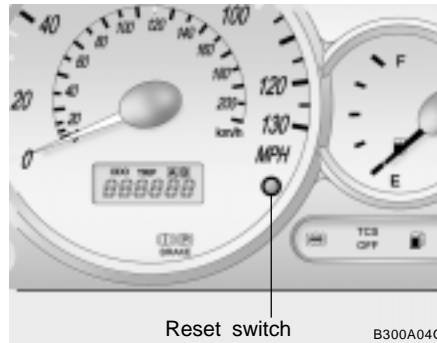
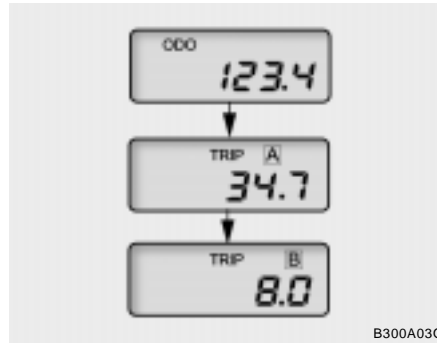

1. Odometer

The odometer records the total driving distance in miles.

2,3 Trip odometer

Records the distance of 2 trips in miles.

TRIP A: first distance you have traveled from your origination point to a first destination.

TRIP B: Second distance from the first destination to the final destination.

To shift from TRIP A to TRIP B, press the reset switch. When pressed for 2 seconds, it will reset to 0.

B340A01A-AAT

COMBINATION TURN SIGNAL, HEADLIGHT AND HIGH-BEAM SWITCH

Turn Signal Operation

Pulling down on the lever causes the turn signals on the left side of the car to blink. Pushing upwards on the lever causes the turn signals on the right side of the car to blink. As the turn is completed, the lever will automatically return to the center position and turn off the turn signals at the same time. If either turn signal indicator light blinks more rapidly than usual, goes on but does not blink, or does not go on at all, there is a malfunction in the system. Check for a burned-out fuse or bulb or see your Hyundai dealer.

B340B01A-AAT

Lane Change Signal

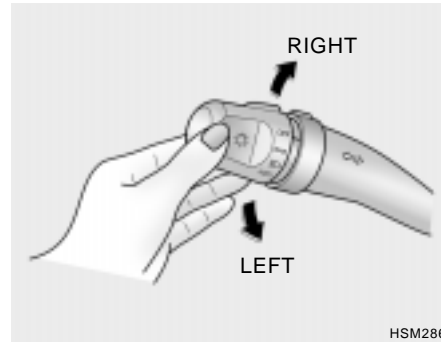

To indicate a lane change, move the lever up or down to a point where it begins flashing. The lever will automatically return to the center position when released.

B340C03A-AAT

Headlight Switch

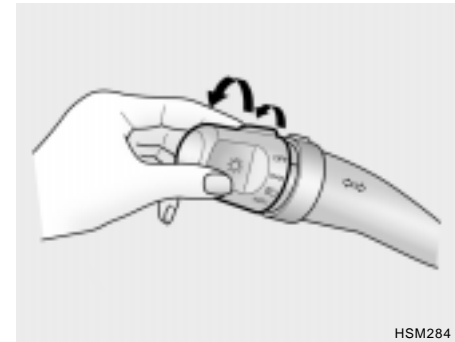

To operate the headlights, turn the barrel on the end of the multi-function switch. The first position turns on the parking lights, sidelights, tail lights and instrument panel lights. The second position turns on the headlights.

NOTE:

The ignition must be in the "ON" position to turn on the headlights.

Parking light auto cut

If you do not turn the parking lights "OFF" after driving, the parking lights will automatically shut "OFF" when the driver's door is opened. To turn them "ON" again, you must simply turn the ignition key to the "ON" position.

1-44 FEATURES OF YOUR HYUNDAI

B340D01A-AAT

High-beam Switch

To turn on the headlight high beams, push the lever forward (away from you). The High Beam Indicator Light will come on at the same time. For low beams, pull the lever back toward you.

B340E01A-AAT

Headlight Flasher

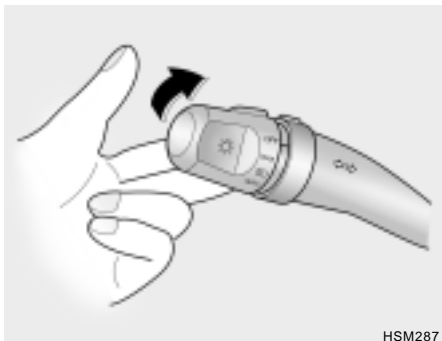

To flash the headlights, pull the switch lever toward you, then release it. The headlights can be flashed even though the headlight switch is in the "OFF" position.

B340F01L-GAT

Auto Light (If installed)

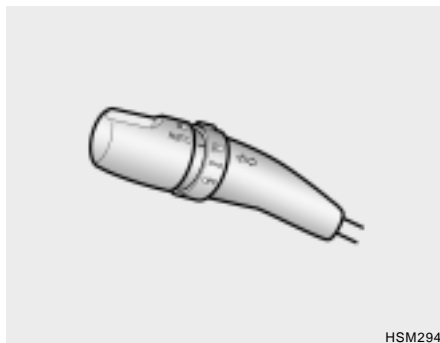

To operate the auto light, turn the barrel on the end of the multi-function switch. If you set the multi-function switch to "AUTO", the tail lights and headlights will be turned automatically on or off according to external illumination.

B350A01A-AAT

WINDSHIELD WIPER AND WASHER SWITCH

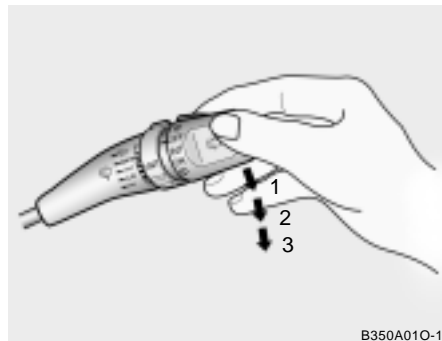

The windshield wiper switch has three positions:

1. Intermittent wiper operation
2. Low-speed operation
3. High-speed operation

NOTE:

To prevent damage to the wiper system, do not attempt to wipe away heavy accumulations of snow or ice. Accumulated snow and ice should be removed manually. If there is only a light layer of snow or ice, operate the heater in the defrost mode to melt the snow or ice before using the wiper.

B350B01O-GAT

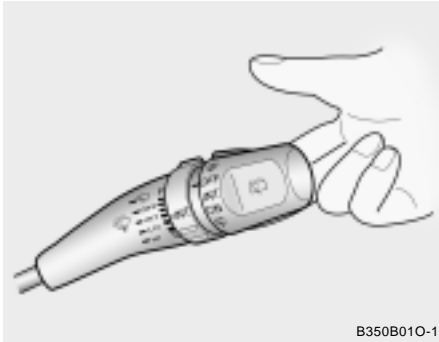
Windshield Washer Operation

B350B01O-1

To use the windshield washer, pull the wiper/washer lever toward the steering wheel. When the washer lever is operated, the wipers automatically make two passes across the windshield. The washer continues to operate until the lever is released.

NOTE:

- o Do not operate the washer more than 15 seconds at a time or when the fluid reservoir is empty.
- o In icy or freezing weather, be sure the wiper blades are not frozen to the glass prior to operating the wipers.
- o In areas where water freezes in winter, use windshield washer antifreeze.

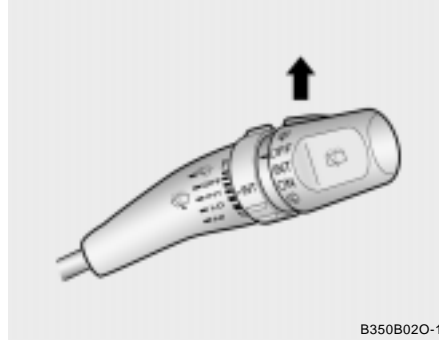
Mist Wiper Operation

B350B02O-1

If a single wipe is desired in mist, push the windshield wiper and washer control lever upwards.

B350C01O-AAT

Adjustable Intermittent Wiper Operation

B350C01O-1

To use the intermittent wiper feature, place the wiper switch in the "INT" position. With the switch in this position, the interval between wipes can be varied from approximately 1 to 18 seconds by turning the interval adjuster barrel. It also can be varied by vehicle speeds within same time.

B350A01O-AAT

Tailgate Wiper And Washer Switch

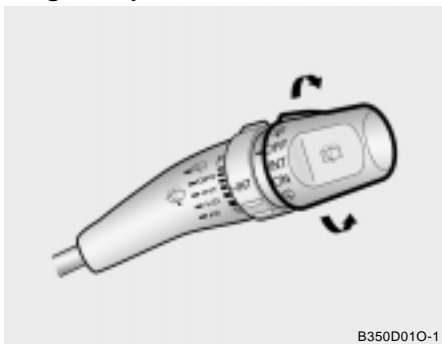

1.  : The washer fluid will be sprayed onto the rear window and the wiper operates while the rear window wiper barrel is placed in this position.
2. OFF
3. INT : To use the intermittent wiper feature, place the rear window wiper barrel in the
4. ON : When the point indicate "ON", the rear window wiper operates continuously.

B360A01A-AAT

FRONT FOG LIGHT SWITCH (If installed)



To turn on the front fog lights, push the switch. They will light when the headlight switch is in the second position and the ignition key is in the "ON" position.

B370A01A-AAT

HAZARD WARNING SYSTEM

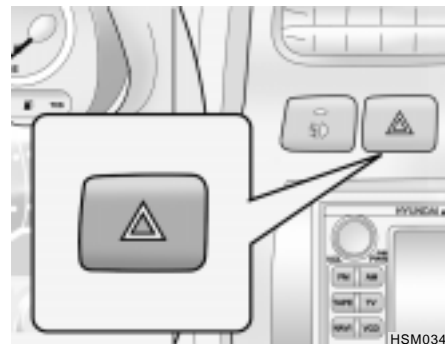

The hazard warning system should be used whenever you find it necessary to stop the car in a hazardous location. When you must make such an emergency stop, always pull off the road as far as possible.

The hazard warning lights are turned on by pushing in the hazard switch. This causes all turn signal lights to blink. The hazard warning lights will operate even though the key is not in the ignition.

To turn the hazard warning lights off, push the switch a second time.

B380A01A-AAT

REAR WINDOW DEFROSTER SWITCH

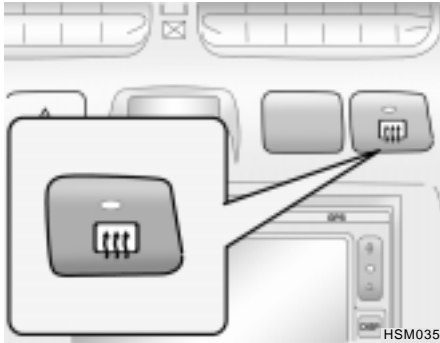

HSM035

The rear window defroster is turned on by pushing in the switch. To turn the defroster off, push the switch a second time. The rear window defroster automatically turns itself off after about 15 minutes. To restart the defroster cycle, push in the switch again after it has turned itself off.



CAUTION:

Do not clean the inner side of the rear window glass with an abrasive type of glass cleaner or use a scraper to remove foreign deposits from the inner surface of the glass as this may cause damage to the defroster elements.

NOTE:

The ignition must be in the "ON" position for the rear window defroster to operate.

B400A01A-AAT

DIGITAL CLOCK (If installed)

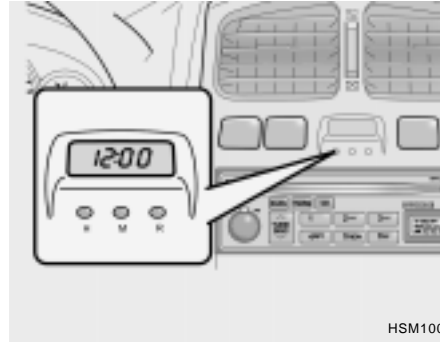

HSM100

There are three control buttons for the digital clock. Their functions are:

HOUR - Push "H" to advance the hour indicated.

MIN - Push "M" to advance the minute indicated.

RESET - Push "R" to reset minutes to ":00" to facilitate resetting the clock to the correct time. When this is done:

Pressing "R" between 10 : 30 and 11 : 29 changes the readout to 11 : 00.

Pressing "R" between 11 : 30 and 12 : 29 changes the readout to 12 : 00.

B400B01O-GAT

DIGITAL CALENDAR (With sunroof)

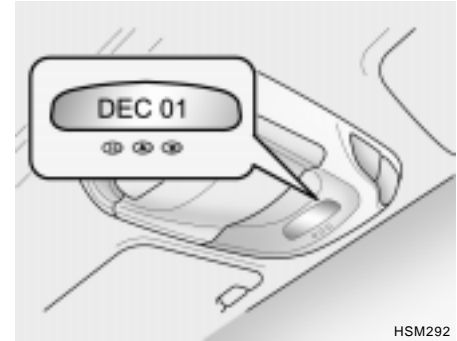

HSM292

How to adjust the date

1. Whenever "M" button is pushed, the "YEAR", "MONTH" and "DAY" each blinks in order.
2. Adjust the date by pushing "▲ (UP)", "▼ (DOWN)" button when the year/month/day blinks.
3. After adjusting the date, push "M" button once more and the adjustment is completed.

How to adjust the hour

1. If you push "M" button for longer than "3 sec" from the date adjusting mode, the "YEAR" blinks and the "HOUR" blinks. And if you push "M" button once more, the "MINUTE" blinks.

1-48 FEATURES OF YOUR HYUNDAI

- Adjust the date by pushing "▲ (UP)", "▼ (DOWN)" button when the hour/minute blinks.
- After adjusting the time, push "M" button once more and all adjustment is completed.

NOTE:

When the battery has been reconnected or charged, set the date and time as described above. However, the first adjusting mode is set on DEC 01.

B410A01A-AAT

INSTRUMENT PANEL LIGHT CONTROL (RHEOSTAT)

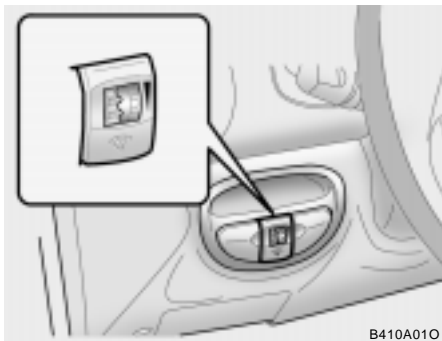

The instrument panel lights can be made brighter or dimmer by turning the instrument panel light control knob.

B420A01A-AAT

CIGARETTE LIGHTER

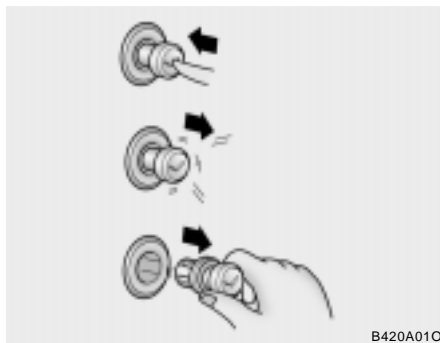

For the cigarette lighter to work, the key must be in the "ACC" position or the "ON" position. To use the cigarette lighter, push it all the way into its socket. When the element has heated, the lighter will pop out to the "ready" position. Do not hold the cigarette lighter pressed in. This can damage the heating element and create a fire hazard.

If it is necessary to replace the cigarette lighter, use only a genuine Hyundai replacement or its approved equivalent.

B500D06O-GAT

POWER OUTLET (If installed)

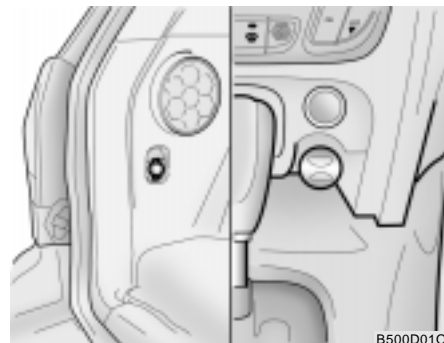

These are located in the quarter trim and on the center facia panel.

These supply 12V electric power to operate electric accessories or equipment only when the key is in the "ON" or "ACC" position.

B430A01O-AAT

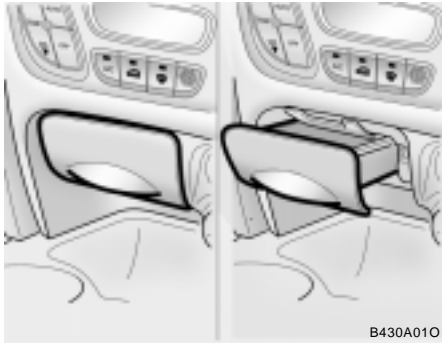
FRONT ASHTRAY

B430A01O

The front ashtray may be opened by pulling it out by its grip.
To clean the ashtray, the plastic receptacle should be removed and lift the receptacle out.

B440A01Y-AAT

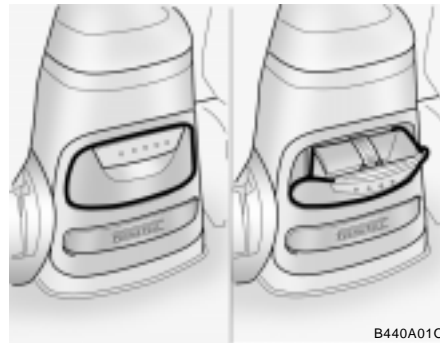
REAR ASHTRAY

B440A01O

The rear ashtray may be opened by pulling it out by its top edge. To remove the ashtray to empty or clean it, lift it up slightly and pull it all the way out.

B450A01O-AAT

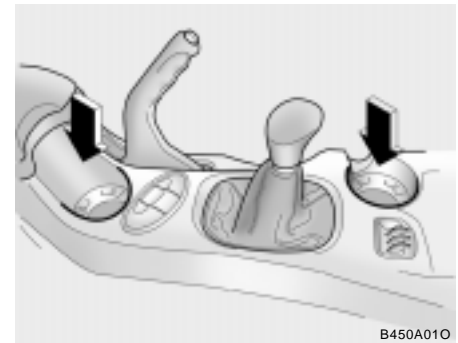
DRINK HOLDER

B450A01O

The drink holder is located on the main console and may be used for holding cups or cans.

**WARNING:**

Do not place objects other than cups or cans in the drink holder. The objects can be thrown out in the event of a sudden stop or an accident, possibly injuring the passengers in the vehicle.

B450B02O-AAT

REAR DRINK HOLDER (If installed)

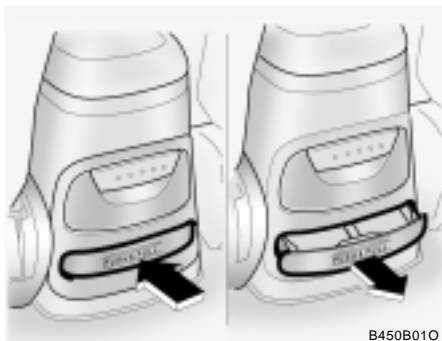

The rear drink holder is located on the rear main console and may be used for holding cups or cans. The rear drink holder can be used by pushing and pulling it at its top edge.



CAUTION:

Place the drink holder in its closed position when not in use.



WARNING:

Do not place anything excepting drinks on the drink holder. Such objects can be thrown out, possibly injuring persons in the vehicle during sudden braking or in the event of an accident.

B460A01Y-AAT

SUNROOF (If installed) Sun Shade

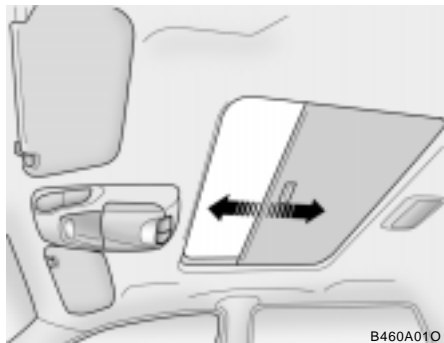

Your HYUNDAI is equipped with a sliding sunshade which you can manually adjust to let in light with the sunroof closed, or to block sunlight.



WARNING:

Never adjust the sunshade while driving.

B460B01GK-GAT

Opening the Sunroof System

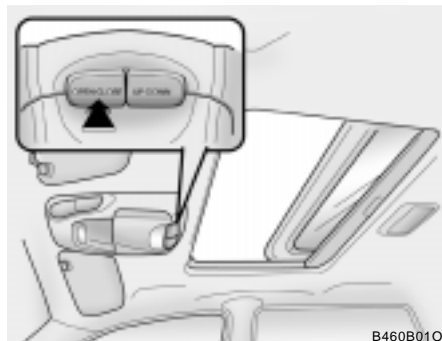

The sunroof can be electrically opened or closed with the ignition key in the "ON" position. The sunroof is moved to its fully open position by pushing the "Open" switch, and to stop at the desired position, push in any switches (Open, Close, Up, Down).

To close, press and hold the "CLOSE" button. Release the button when the sunroof reaches the desired position.



WARNING:

- o Do not close a sunroof if anyone's hands, arms or body are between the sliding glass and the sunroof sash, as this could result in injury.
- o Do not place your head or arms out of the sunroof opening at any time.

**CAUTION:**

- o Do not open the sunroof in severely cold temperature or when it is covered with ice or snow.
- o Periodically remove any dirt that may have accumulated on the guide rails.

B460C01GK-AAT

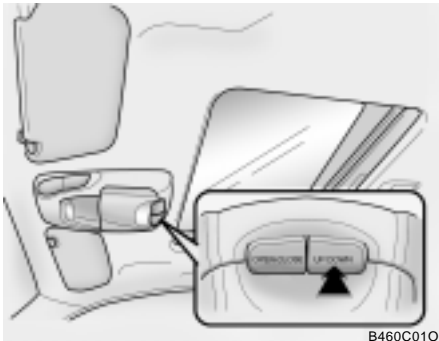
Tilting the Sunroof System

B460C01O

The sunroof is moved to its fully tilt up position by pushing the "UP" switch, and to stop at the desired position, push in any switches (Open, Close, Up, Down).

To tilt down, press and hold the "DOWN" button. Release the button when the sunroof reaches the desired position.

NOTE:

After washing the car or after there is rain, be sure to wipe off any water that is on the sunroof before operating it.

B460D01O-GAT

Manual Operation of Sunroof

If the sunroof does not electrically operate:

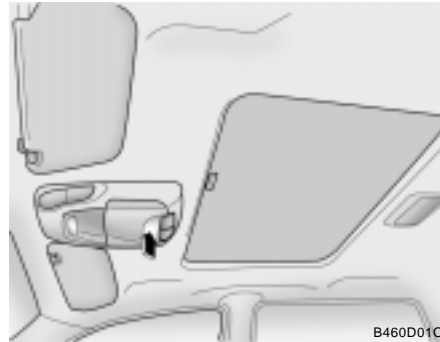

B460D01O

1. Open the spectacle case.

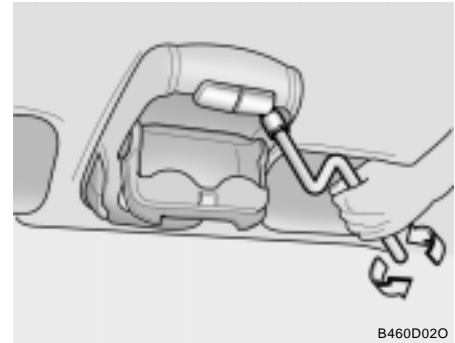

B460D02O

2. Turn the hexagonal bolts counterclockwise to remove the overhead console with a socket wrench.

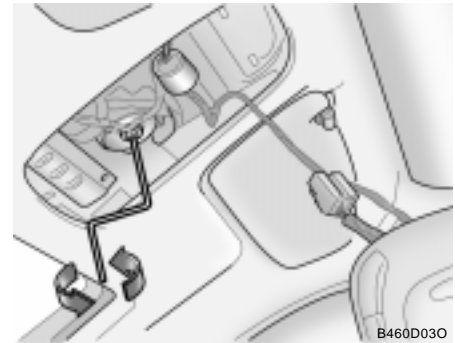

B460D03O

1-52 FEATURES OF YOUR HYUNDAI

3. Insert the hexagonal head wrench provided with the vehicle into the socket. This wrench can be found in the vehicle's glove box.
4. Turn the wrench clockwise to open or counterclockwise to close.

B480B01O-AAT

MAP LIGHT

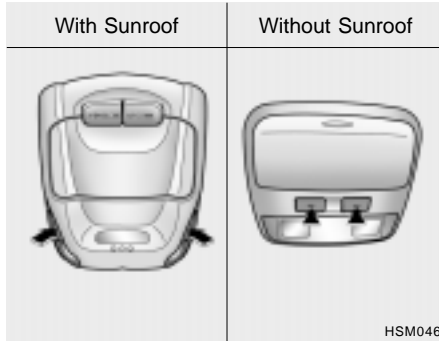

Push in the map light switch to turn the light on or off. This light produces a spot beam for convenient use as a map light at night or as a personal light for the driver and the passenger.

B490A02Y-AAT

INTERIOR LIGHT

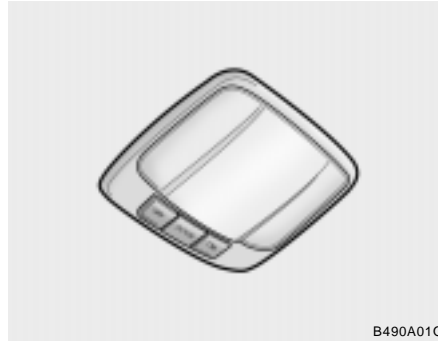

The interior courtesy light has three buttons. The three buttons are:

o DOOR

In the "DOOR" position, the interior courtesy light comes on when any door is opened regardless of the ignition key position. The light goes out gradually 6 seconds after the door is closed.

o ON

In the "ON" position, the light stays on at all times.

o OFF

In the "OFF" position, the light stays off at all times even though a door is open.

B491A02F-GAT

SPECTACLE CASE (If Installed)

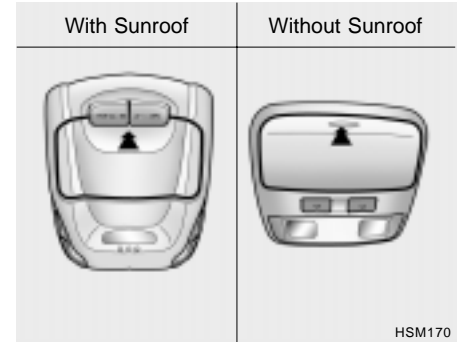

The spectacle case is located on the front overhead console.

Push the end of the cover to open the spectacle case.

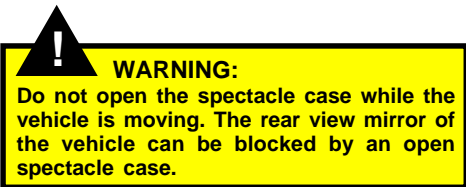

B500A01S-AAT

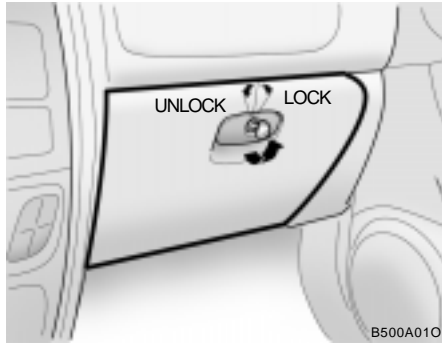
GLOVE BOX**WARNING:**

To avoid the possibility of injury in case of an accident or a sudden stop, the glove box door should be kept closed when the car is in motion.

- o To open the glove box, pull on the glove box release lever.
- o The glove box door can be locked (and unlocked) with the key (if installed).

B510A01A-AAT

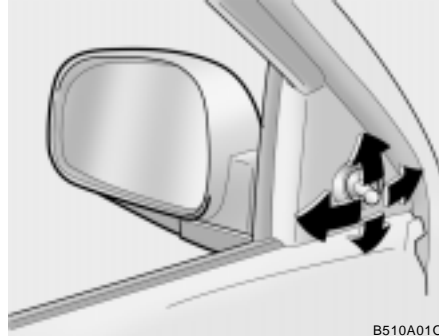
OUTSIDE REAR VIEW MIRROR**Manual Type**

The outside rearview mirrors are equipped with a remote control for your convenience. It is operated by the control lever in the bottom front corner of the window.

Before driving away, always check that your mirrors are positioned so you can see behind you, both to the left and right sides, as well as directly behind your vehicle. When using the mirror, always exercise caution when attempting to judge the distance of vehicles behind or along side of you.

**CAUTION:**

If the mirror control is jammed with ice, do not attempt to break it free using the control handle or by manipulating the face of the mirror. Use an approved spray de-icer (not radiator antifreeze) to release the frozen mechanism or move the vehicle to a warm place and allow the ice to melt.

B510B01Y-AAT

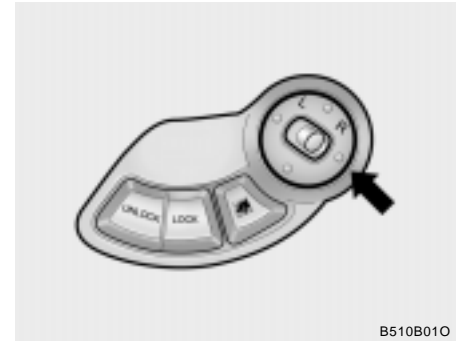
Electric Type (If installed)

1-54 FEATURES OF YOUR HYUNDAI

The outside rearview mirrors can be adjusted to your preferred rear vision, both directly behind the vehicle, and to the rear of the left and right sides.

The remote control outside rearview mirror switch controls the adjustments for both right and left outside mirrors.

To adjust the position of either mirror:

1. Move the selecting switch to the right or left to activate the adjustable mechanism for the corresponding door mirror.
2. Now, adjust mirror angle by depressing the appropriate perimeter switch as illustrated.

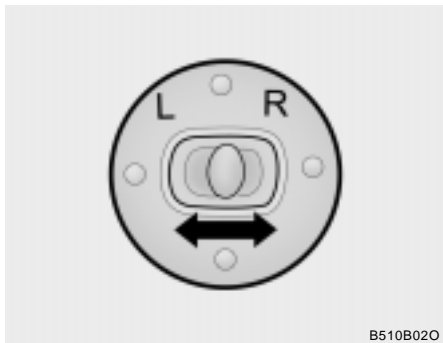

CAUTION:

- o Do not operate the switch continuously for an unnecessary length of time.
- o Scraping ice from the mirror face could cause permanent damage. To remove any ice, use a sponge, soft cloth or approved de-icer.



WARNING:

Be careful when judging the size or distance of any object seen in the passenger side rear view mirror. It is a convex mirror with a curved surface. Any objects seen in this mirror are closer than they appear.

B510D01Y-AAT

OUTSIDE REAR VIEW MIRROR HEATER (If installed)

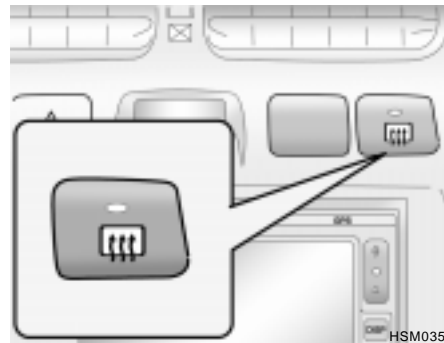

The outside rearview mirror heater is actuated in connection with the rear window defroster. To heat the outside rearview mirror glass, push in the switch for the rear window defroster. The rearview mirror glass will be heated for defrosting or defogging and will give you improved rear vision in inclement weather conditions. Push the switch again to turn the heater off. The outside rearview mirror heater automatically turns itself off after 15 minutes.

B510C01A-AAT

FOLDING THE OUTSIDE REAR VIEW MIRRORS

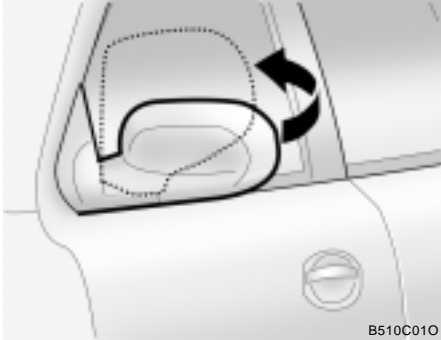

B510C010

To fold the outside rear view mirrors, push them toward the rear.
The outside rear view mirrors can be folded rearward for parking in narrow areas.



WARNING:

Do not adjust or fold the outside rear view mirrors while the vehicle is moving. This could result in loss of control, and an accident which could cause death, serious injury or property damage.

B520A01A-AAT

DAY/NIGHT INSIDE REAR VIEW MIRROR

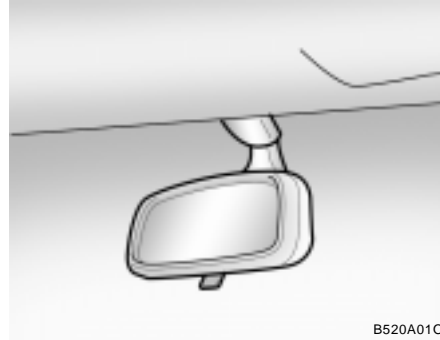

B520A010

Your Hyundai is equipped with a day/night inside rear view mirror. The "night" position is selected by flipping the tab at the bottom of the mirror toward you. In the "night" position, the glare of headlights of cars behind you is reduced.

B520B01O-GAT

DAY/NIGHT REAR VIEW MIRROR (Electric type) (If installed)

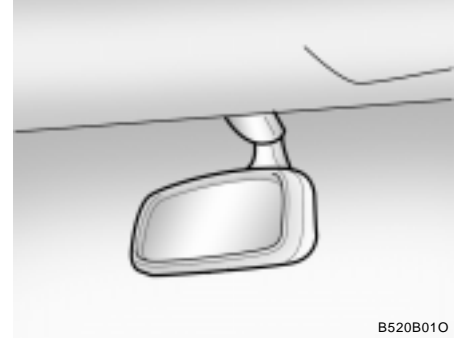

B520B010

The electric type day/night inside rearview mirror controls automatically the glare of headlights of the car behind you. Adjust the rearview mirror to the desired position.

B520C01L-GAT

HOMELINK MIRROR (If installed)

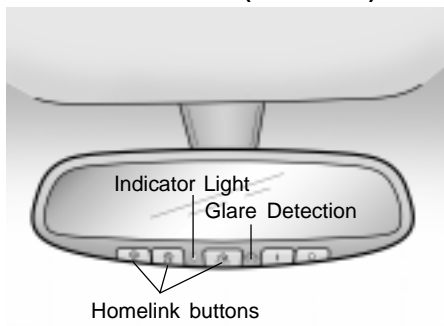

Your new vehicle may be equipped with an automatic night vision mirror. During nighttime driving, this feature will automatically detect and reduce dangerous rearview mirror glare.

Your new mirror also comes with an integrated HomeLink Universal Transceiver, which allows you to program the mirror to activate your garage door(s), estate gate, home lighting, etc. The mirror actually learns the codes from your various existing transmitters.

Automatic-Dimming Function

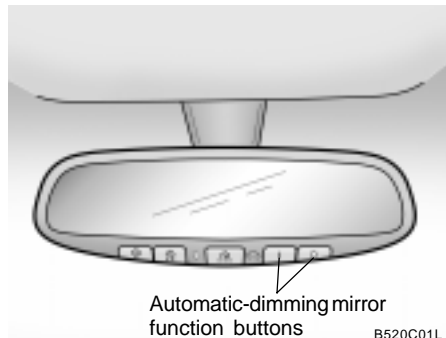

To assist you during nighttime driving, your mirror will automatically dim upon detecting glare from the vehicles behind you.

Press the  button to turn the automatic-dimming function off. The mirror indicator light will turn off.

Press the  button to turn the automatic-dimming function on. The mirror indicator light will illuminate.

NOTE:

The mirror defaults to the "on" position each time the vehicle is started.

HOMELINK PROGRAMMING



CAUTION:

- o Make sure people and/or objects are out of the way of any garage doors or gates you may be operating during the programming procedures.
- o Keep original transmitters for potential future programming needs, or in case you sell the vehicle.
- o In the event you do sell your vehicle, it's recommended you erase your programmed HomeLink mirror buttons.



WARNING:

Do not use HomeLink with any garage door opener that lacks the safety stop and reverse feature as required by federal safety standards (includes garage doors manufactured before April 1, 1982), as these doors can increase the risk of serious injury or death. Call 1-800-355-3515 or visit www.homelink.com for more information.

NOTE:

If programming a garage door opener or gate, it is advised to unplug the device during the "cycling" process to prevent possible motor burnout.

Programming

Your vehicle may require that the ignition switch to be turned to the "ACC" position to program and/or operate HomeLink system. It is also recommended that a new battery be placed in the handheld transmitter of the device being programmed to HomeLink for quicker programming and accurate transmission of the radio-frequency.

Follow these steps to program your HomeLink mirror:

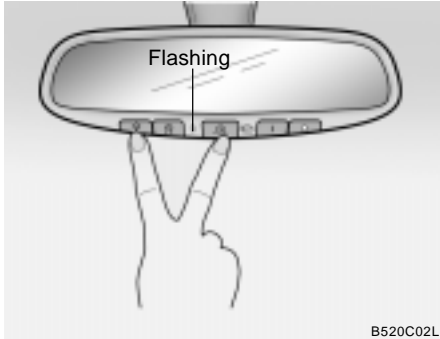

1. When programming the buttons for the first time, press and hold the two outside HomeLink buttons (⏏, ⏏), releasing when the indicator light begins to flash (approximately 20 seconds). This procedure erases the factory-set default codes. Do not perform this step when programming additional transmitters.

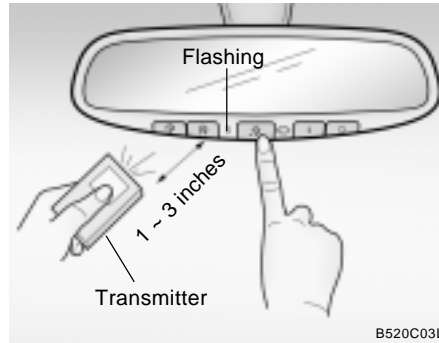

2. Hold the transmitter of the device you want to program 1 to 3 inches away from the bottom of the mirror. Simultaneously press the handheld transmitter button and the HomeLink button you wish to program. The indicator light will flash slowly at first, then rapidly, indicating successful programming.
3. If the garage door opener or other device you wish to program is rolling-code equipped, proceed to the "Rolling Code Programming" section.
4. Repeat step 2 to program the remaining HomeLink buttons.

Additional Programming for Rolling Code Devices

For any rolling-code-equipped device; follow the steps below after completing the "Programming" section. A second person may make the following steps easier.

1. Locate the "learn" or "smart" button on the device's motor head unit. The exact location and color of the button varies by product brand, but is usually referenced in the device's owner's manual. Contact HomeLink at 1-800-355-3515 or www.homelink.com for help.
2. Press and release the "learn" or "smart" button on the device's motor head unit.

NOTE:

You now have 30 seconds to initiate step 3.

3. Return to the vehicle and firmly press and release the programmed HomeLink button. Press and release the same HomeLink button a second time to complete the programming process. (Some devices may require you to press and release a third time to complete the programming.)
4. Now HomeLink mirror and rolling-code-equipped device should be synchronized. The remaining HomeLink buttons may now be programmed if this has not been done previously.

Operating HomeLink

Simply press the appropriate HomeLink button to activate the trained product (garage door, security system, entry door lock, estate gate, lighting, etc.). The original handheld transmitters may also be used at any time.

Erasing Programmed Buttons

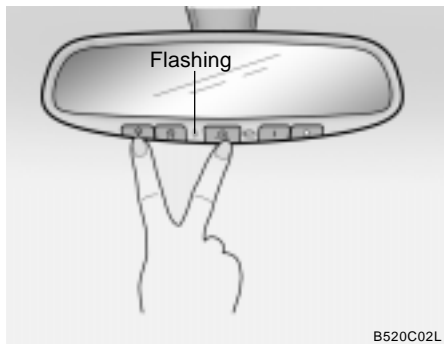

To erase the three HomeLink buttons, press and hold the two outside buttons until the indicator light begins to flash (after 20 seconds). Release both buttons.

Individual buttons cannot be erased, but can be reprogrammed.

Reprogramming a Single HomeLink Button

To program a device to HomeLink using a HomeLink button previously trained, follow these steps:

1. Press and hold the desired HomeLink button. Do not release until step 4 has been completed.
2. When the indicator light begins to flash slowly (after 20 seconds), hold the handheld transmitter 1 to 3 inches away from the bottom of the mirror.
3. Press and hold the transmitter button (or, if necessary, press and "cycle," as described in the "Gate Operator & Canadian Programming" portion of this text).
4. The HomeLink indicator light will flash slowly at first, then rapidly, indicating successful programming. Release both buttons.

Gate Operator Programming & Canadian Programming

During programming, your handheld transmitter may automatically stop transmitting. Continue to press and hold the HomeLink button while you press and repress ("cycle") your handheld transmitter every two seconds until the frequency signal has been learned. The indicator light will flash slowly at first and then rapidly upon successful programming.

Accessories

For more information on HomeLink and HomeLink-compatible products, or to purchase HomeLink accessories, call 1-800-355-3515 or visit www.homeink.com.

B530A01A-AAT

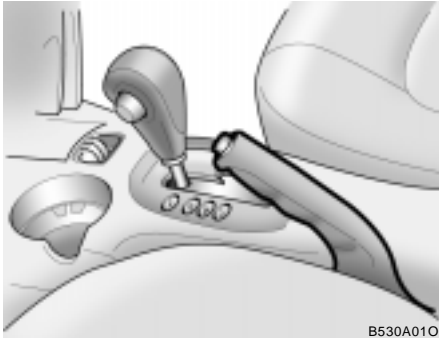
PARKING BRAKE

B530A01O

Always engage the parking brake before leaving the car. This also turns on the parking brake indicator light when the key is in the "ON" or "START" position. Before driving away, be sure that the parking brake is fully released and the indicator light is off.

- o To engage the parking brake, pull the lever up as far as possible.
- o To release the parking brake, pull up and press the thumb button. Then, while holding the button in, lower the brake lever.

B540A01O-AAT

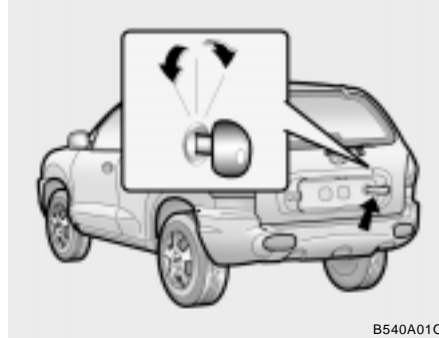
TAIL GATE

B540A01O

! WARNING:
The tail gate should always be kept completely closed while the vehicle is in motion. If it is left open or ajar, poisonous exhaust gases may enter the car resulting in serious illness or death to the occupants. See additional warnings concerning exhaust gases on page 2-2.

- o The tail gate is opened by first turning the key clockwise to release the lock, then raising the door manually.
- o To close, lower the door, then press down on it until it locks. To be sure the door is securely fastened, always try to pull it up again.

B540B02O-AAT

Tail gate Window

B540B01O

- o When you push the tail gate window release button to open the tail gate window, it will spring up slightly. Raise the tail gate window. The window will raise completely by itself after it has been raised halfway.
- o To close the tail gate window, lower the tail gate window, and it will close by itself. To be sure the tail gate window is securely fastened, always try to pull it up again.

NOTE:

The tail gate window lock is operated in connection with the tail gate lock. To open the tail gate window make sure the tail gate is unlocked with a key or the central door locking switch.

B640A01S-AAT

CARGO SECURITY SCREEN (If installed)

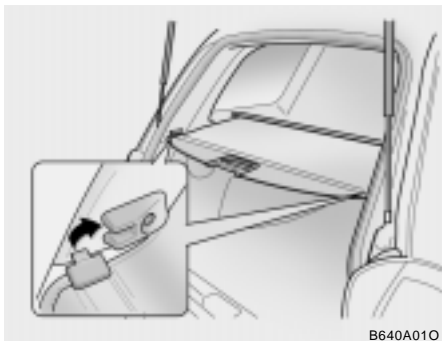

To use the security screen, pull it out of the retractor and hook it to the anchors as illustrated.

B650A01S-AAT

Stowage Precautions

1. Do not place objects on the cargo security screen. Such objects may be thrown about inside the vehicle and possibly injure vehicle occupants during an accident or when braking.
2. For better fuel economy, do not carry unnecessary weight.
3. Never allow anyone to ride in the luggage compartment. It is designed for luggage only.
4. Try to maintain the balance of the vehicle and locate the weight as far forward as possible.

B540D02O-GAT

LUGGAGE NET

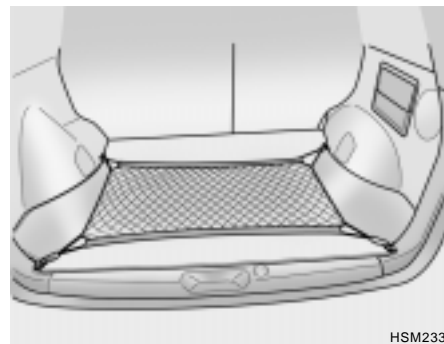

Some objects can be kept in the net in the luggage compartment.
Use the luggage net on the floor of the luggage compartment to prevent objects from sliding.



WARNING:

Avoid eye injury. **DO NOT** overstretch. **ALWAYS** keep face and body out of recoil path. **DO NOT** use when strap has visible signs of wear or damage.

**CAUTION:**

Do not place the fragile or bulky objects in the luggage compartment to prevent the damage.

B630A02O-AAT

ROOF RACK (If installed)

B630A01O

If your Hyundai has a roof rack, you can load things on top of your vehicle. Crossrails and fixing components to adapt the roof rack on your vehicle may be obtained from an authorized Hyundai dealer.

**CAUTION:**

- o The following specifications are recommended when loading cargo or luggage.

ROOF RACK

75 lbs (34 kg) Evenly Distributed

- o Loading cargo or luggage above 75 lbs (34 kg) on the roof rack may damage your vehicle.
When you carry large objects, never let them hang over the rear or the sides of your vehicle.
- o To prevent damage or loss of cargo as you are driving, check frequently to make sure the luggage carrier and cargo are still securely fastened.
- o Always drive your vehicle at a moderate speed.
- o To use the roof rails as a roof rack, you must fit the roof rails with two or more crossrails or equivalent before carrying cargo or luggage on the roof.
- o When crossrail is adapted, you can load things on the roof rack
- o Loading cargo or luggage over specification on the roof rack may damage stability of your vehicle.

B550A01A-AAT

HIGH-MOUNTED REAR STOP LIGHT (If installed)

B550A01O

In addition to the lower-mounted rear stoplights on either side of the car, the high mounted rear stoplight in the center of the rear window also lights when the brakes are applied.

B560B01O-AAT

AUTO FUEL CUT SWITCH

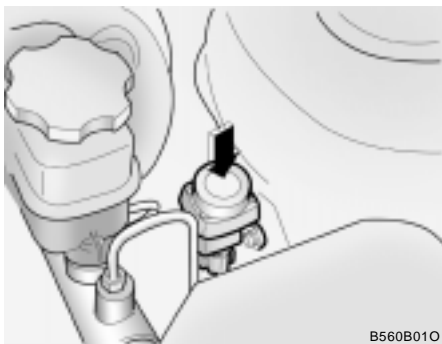

The auto fuel cut switch is located on the driver's side of the engine compartment. In the event of a collision or sudden impact, the auto fuel cut device cuts off the fuel supply. If this device is activated, it must be reset by pressing in on the top of the switch before the engine can be restarted.



WARNING:

Before resetting the auto fuel cut switch, the fuel line should be checked for fuel leaks.

B560A02S-AAT

REMOTE FUEL-FILLER LID RELEASE

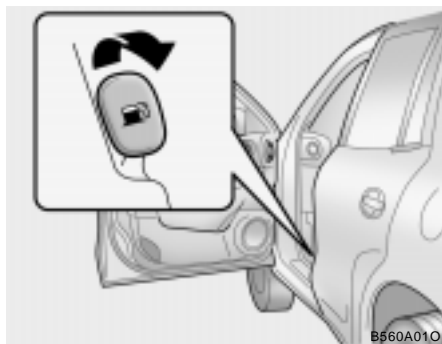

The fuel-filler lid may be opened from inside the vehicle by pulling up on the fuel-filler lid opener located on the front floor area on the left side of the car.

NOTE:

If the fuel-filler lid will not open because ice has formed around it, tap lightly or push on the lid to break the ice and release the lid. Do not pry on the lid. If necessary, spray around the lid with an approved de-icer fluid (do not use radiator anti-freeze) or move the vehicle to a warm place and allow the ice to melt.

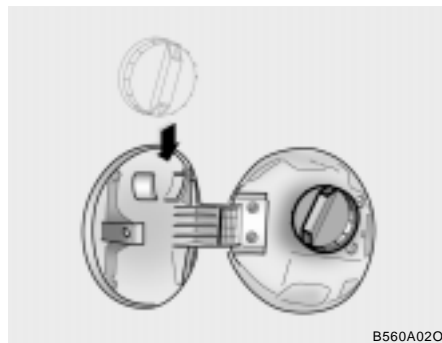

WARNING:

- o The fuel cap must be tightened at least 3 clicks, otherwise "  " light will illuminate.
- o Gasoline vapors are dangerous. Before refueling, always stop the engine and never allow sparks or open flames near the filler area. If you need to replace the filler cap, use a genuine Hyundai replacement part.

**WARNING:**

- o If you open the fuel filler cap during high ambient temperatures, a slight "pressure sound" may be heard. This is normal and not a cause for concern. Whenever you open the fuel filler cap, turn it slowly.
- o Make sure the fuel filler cap is replaced and securely seated after fueling. Failure to replace or fully seat the fuel filler cap will result in fuel vapors escaping into the atmosphere and the check engine "MIL" indicator illuminating.
- o Do not "TOP-OFF" after the first nozzle shut off when refueling.

B570A01L-GAT

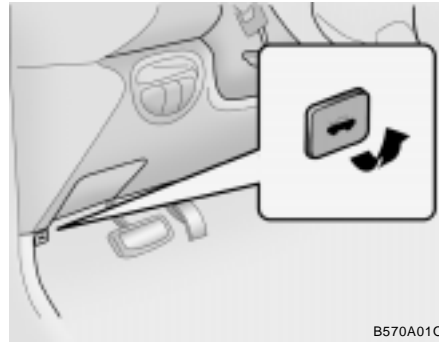
HOOD RELEASE

B570A01O

1. Pull the release knob to unlatch the hood.
2. Press the safety catch lever up and lift the hood.
3. Raise the hood by hand.

When closing the hood, slowly close the hood and make sure it locks into place.

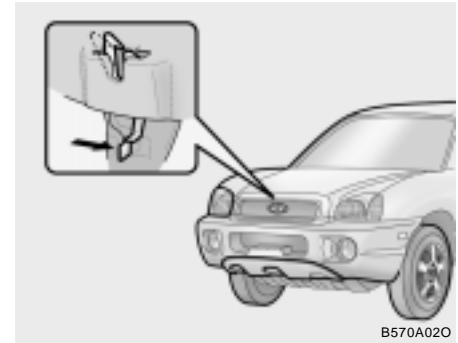

B570A02O

**WARNING:**

- o Always double check to be sure that the hood is firmly latched before driving away. If it is not latched, the hood could fly open while the vehicle is being driven, causing a total loss of visibility, which might result in an accident.
- o Do not move the vehicle with the hood in the raised position, as vision is obstructed and the hood could fall or be damaged.

B571A03Y-AAT

FLOOR MAT ANCHOR

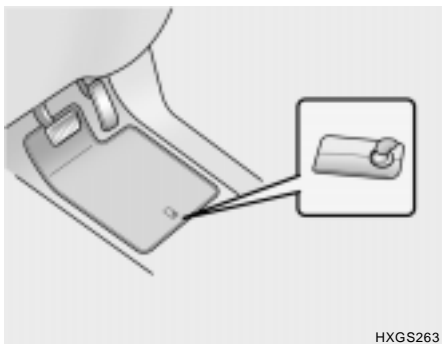

HXGS263

To use a floor mat on the front floor carpet, make sure it attaches to the floor mat anchor in your vehicle. This keeps the floor mat from sliding forward.



WARNING:

- o Make sure the floor mat is properly placed on the floor carpet. If the floor mat slips and interferes with the movement of the pedals during driving, it may cause an accident.
- o Don't put an additional floor mat on the top of the fixed mat, otherwise the additional mat may slide forward and interfere with the movement of the pedals.

B580A01A-AAT

SUN VISOR

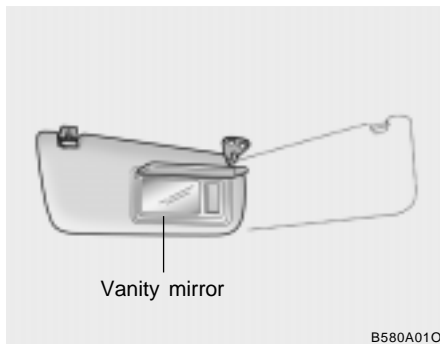

B580A01O

Your Hyundai is equipped with sun visors to give the driver and front passenger either frontal or sideward shade. The sun visors are fitted on both sides on all models. To reduce glare or to shut out direct rays of the sun, turn the sun visor down to block the annoyance.

A vanity mirror is provided on the back of the sun visor for the driver and front passenger.

NOTE:

The Supplemental Restraint System (SRS) label containing useful information can be found on the back of each sun visor.



WARNING:

Do not place the sun visor in such a manner that it obscures visibility of the roadway, traffic or other objects.

B580B01O-AAT

Illuminated Vanity Mirror (If installed)

Opening the lid of the vanity mirror on the driver and passenger's side will automatically turn on the mirror light when the vehicle lights are on.

B600A02Y-AAT

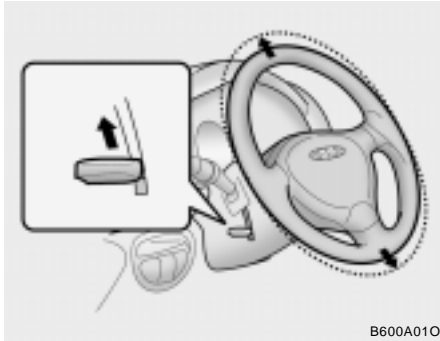
STEERING WHEEL TILT LEVER

To adjust the steering wheel:

1. Pull the lever upward and hold it to unlock.
2. Raise or lower the steering wheel to the desired position.
3. After adjustment, release the lever.

**WARNING:**

Do not attempt to adjust the steering wheel while driving as this may result in loss of control of the vehicle and serious injury or death.

B620A01S-AAT

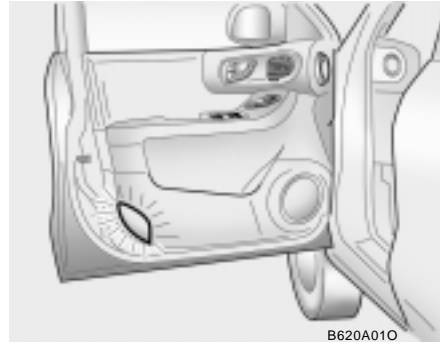
FRONT DOOR EDGE WARNING LIGHT (If installed)

A red light comes on when the front door is opened. The purpose of this light is to assist when you get in or out and also to warn passing vehicles.

B610A01L-GAT

HORN

Press the pad on the steering wheel to sound the horn.

B611A01Y-AAT

REAR SEAT ARM REST (If installed)



This arm rest is located in the center of the rear seat back.

B660A01S-AAT

CRUISE CONTROL (If installed)

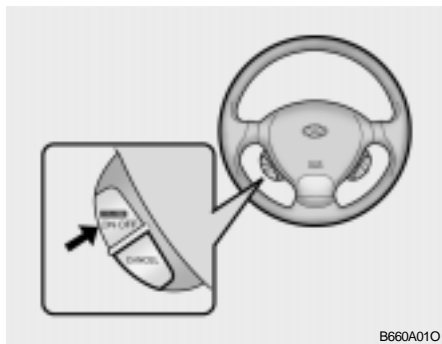

The cruise control system provides automatic speed control for your comfort when driving on freeways, tollroads, or other noncongested highways. This system is designed to function above approximately 25 mph (40 km/h).

B660B02O-AAT

To Set the Cruise Speed

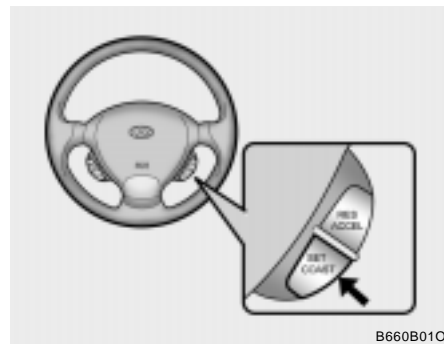

1. Push the cruise control ON/OFF button. The "CRUISE" indicator light in the instrument cluster will illuminate. This turns the system on.
2. Accelerate to desired cruising speed above 25 mph (40 km/h).
3. Push the "SET" (COAST) button after you have set the vehicle speed at the desired speed.
4. Remove your foot from the accelerator pedal and the desired speed will automatically be maintained.
5. To increase speed, temporarily depress the accelerator pedal enough for the vehicle to exceed the preset speed. When you remove your foot from the accelerator pedal, the vehicle will return to the speed you have set.

B660C02S-AAT

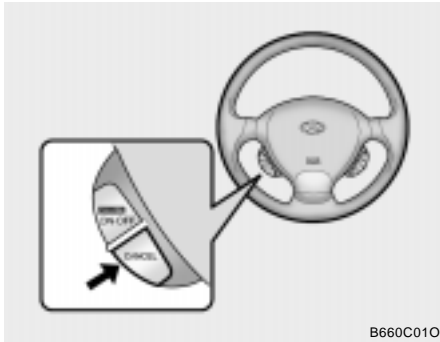
To cancel the cruise speed

B660C010

Do one of the following:

- o Push the "CANCEL" button.
- o Depress the brake pedal.
- o Depress the clutch pedal (Manual transaxle).
- o Shift the selector lever to "N" position (Automatic transaxle).
- o Decrease the vehicle speed lower than the memory speed by 12 mph (20 km/h).
- o Decrease the vehicle speed to less than 25 mph (40 km/h).
- o Release the "MAIN" button.

B660D010-AAT

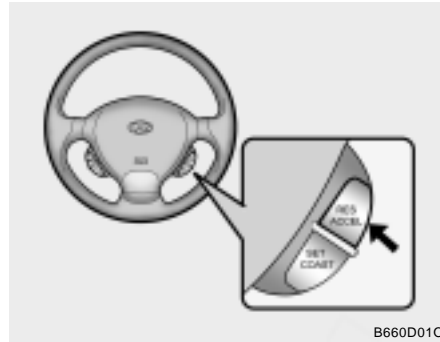
To Resume the Preset Speed

B660D010

The vehicle will automatically resume the speed set prior to cancellation when you push the "RESUME (ACCEL)" button, providing the vehicle speed is above 25 mph (40 km/h).

B660E01Y-AAT

To Reset at a Faster Speed

1. Push the "RESUME (ACCEL)" button and hold it.
2. Accelerate to desired speed and release the "RESUME (ACCEL)" switch. While the control switch is held, the vehicle will gradually gain speed.

B660F010-GAT

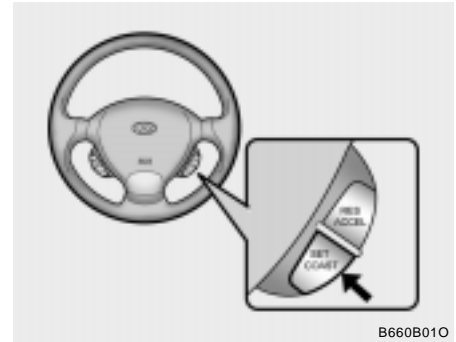
To Reset at a Slower Speed

B660B010

1. Push the "SET (COAST)" button and hold it. While the control button is pushed, the vehicle speed will gradually decrease.
2. When the desired speed is obtained, release the control button.



WARNING:

- o Keep the main switch off when not using the cruise control.
- o Do not use the cruise control when it may not be safe to keep the car at a constant speed, for instance, driving in heavy or varying traffic, or on slippery (rainy, icy or snow-covered) or winding roads or over 6% up-hill or down-hill roads.
- o Pay particular attention to the driving conditions whenever using the cruise control system.
- o During cruise-control driving with a manual transaxle vehicle, do not shift into neutral without depressing the clutch pedal, or the engine will be overrevved. If this happens, depress the clutch pedal or release the main switch.
- o During normal cruise control operation, when the "SET" button is activated or reactivated after applying the brakes, the cruise control will energize after approximately 3 seconds. This delay is normal.

B710A010-GAT

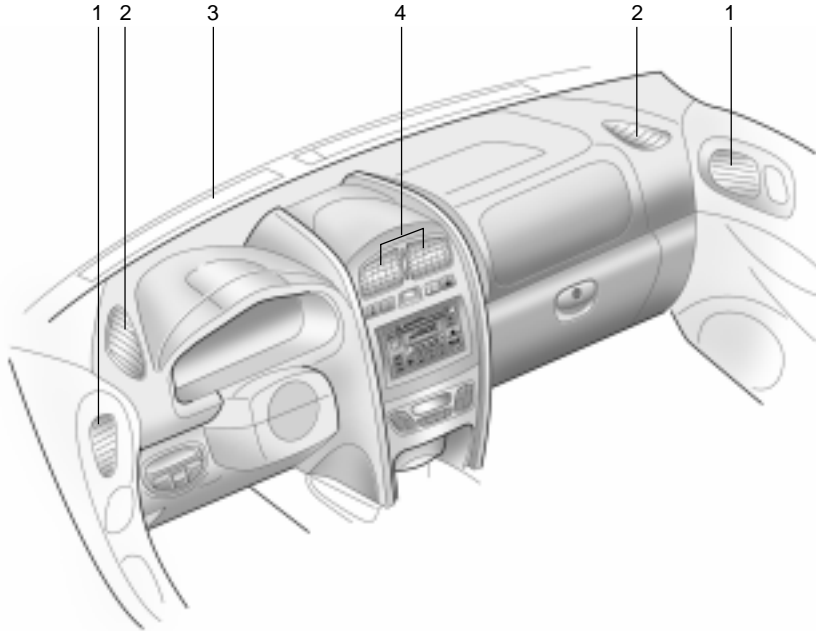
HEATING AND COOLING CONTROL (If installed)

1. Side Ventilator
2. Side Defroster Nozzle
3. Windshield Defroster Nozzle
4. Center Ventilator

B710B010-AAT

CENTER VENTILATOR

The center ventilators are located in the middle of the dashboard. To change the direction of the air flow, move the knob in the center of the vent up-and-down and side-to-side. The center vent knobs control the amount of outside air entering the vehicle through the center vents. The vents are opened when the vent knob is moved to "≡" position. The vents are closed when the vent knob is moved to "⊠". Keep these vents clear of any obstructions.

B710C010-AAT

SIDE VENTILATOR

The side ventilators are located on each side of the front door. To change the direction of the air flow, move the knob in the center of the vent up-and-down and side-to-side. The side vent knobs control the amount of outside air entering the vehicle through the side vents. The vents are opened when the vent knob is moved to "≡" position. The vents are closed when the vent knob is moved to "⊠". Keep these vents clear of any obstructions.

HSM417

B670A030-AAT

HEATING AND VENTILATION

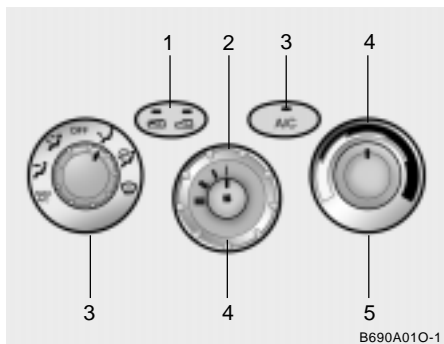

There are three controls and two switches for the heating and cooling system. They are:

1. Air intake control switch
2. Air conditioning switch
3. Air flow control
4. Fan speed control
5. Temperature control

B670B010-AAT

Fan Speed Control (Blower Control)

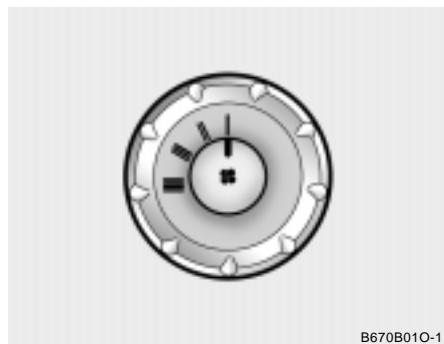

This is used to select the blower fan speed. The blower fan speed, and therefore the volume of air delivered from the system, may be controlled manually by setting the blower control between the "1" and "4" position.

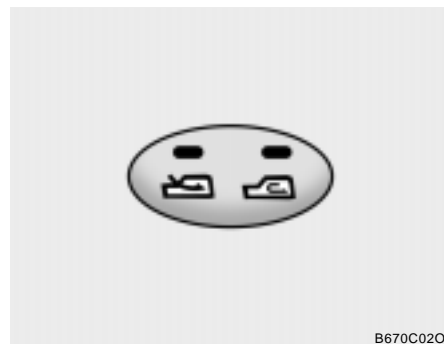

B670C010-AAT

Air Intake Control Switch



This is used to select fresh outside air or recirculating inside air.

-  Fresh
-  Recirculation

With the "" mode selected, air enters the vehicle from outside and is heated or cooled according to the other functions selected. With the "" mode selected, air from within the passenger compartment is drawn through the heating system and heated or cooled according to the other functions selected.

NOTE:

- o It should be noted that prolonged operation of the heating system in "☀️" mode will give rise to fogging of the windshield and side windows and the air within the passenger compartment will become stale. In addition prolonged use of the air conditioning with the "❄️" mode selected may result in the air within the passenger compartment becoming excessively dry.
- o When the ignition switch is turned "ON" the air intake control switch will change to "☀️" mode. But, the air intake control switch will change to "☀️" mode when the ignition switch is turned "ON" with the MAX A/C mode selected.

B670D020-AAT

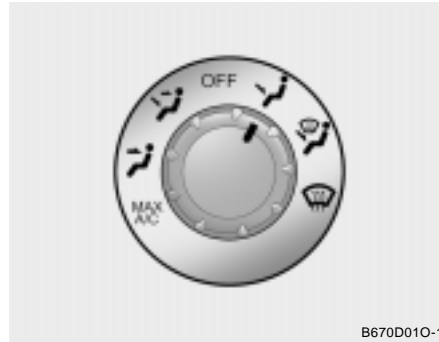
Air Flow Control

B670D010-1

This is used to turn the blower fan on/off and to direct the flow of air. Air can be directed to the floor, dashboard outlets, or windshield. Five symbols are used to represent Face, Bi-Level, Floor, Floor-Defrost and Defrost air position. The "OFF" mode is used to turn the blower fan off. The MAX A/C mode is used to cool the inside of the vehicle faster.

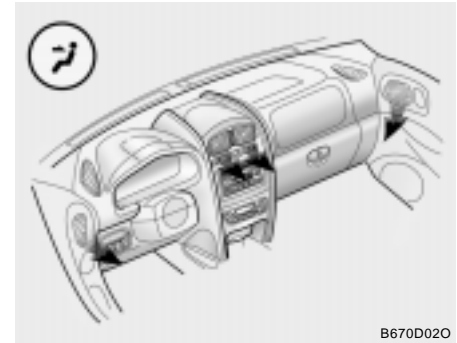

B670D020

**Face-Level**

Selecting the "Face" mode will cause air to be discharged through the face level vents.

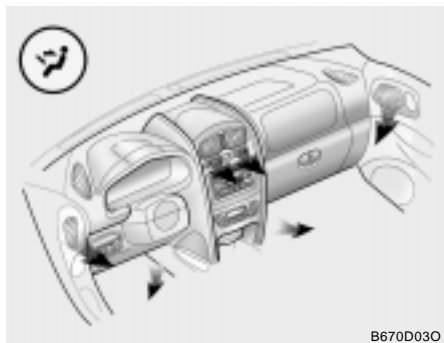

Bi-Level

Air is discharged through the face vents and the floor vents. This makes it possible to have cooler air from the dashboard vents and warmer air from the floor outlets at the same time.

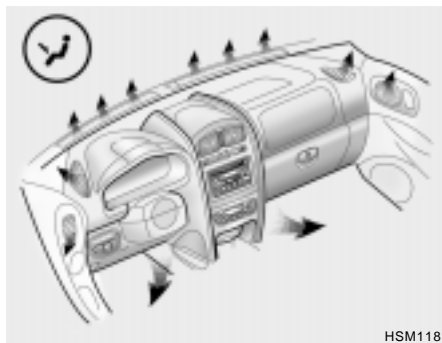

Floor-Level

Air is discharged through the floor vents, windshield defroster nozzle, side defroster nozzle and side ventilator.

If the "Floor" mode is selected, the "Fresh" mode will be activated.

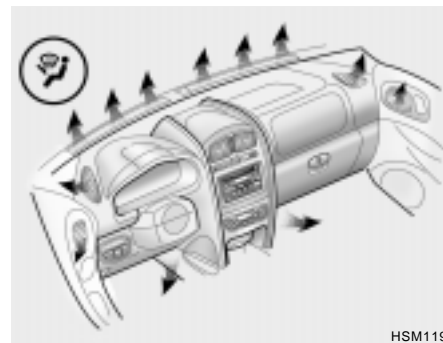

Floor-Defrost Level

Air is discharged through the windshield defroster nozzle, the floor vents, side defroster nozzle and side ventilator.

If the "Floor-Defrost" mode is selected, the A/C will turn on automatically and "Fresh" mode will be activated.

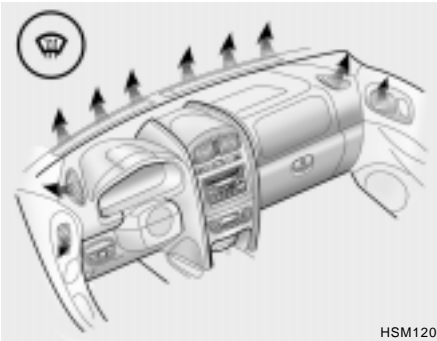

HSM120



Defrost-Level

Air is discharged through the windshield defroster nozzle, side defroster nozzle and side ventilator.

If the "Defrost" mode is selected, the A/C will turn on automatically and "Fresh" mode will be activated.

NOTE:

If the "Floor-Defrost" or "Defrost" mode is selected, the air conditioning will not turn off by pushing the A/C button.

If the air flow control is set to the defrost or the floor-defrost mode, the A/C will be on automatically and the A/C will not off until the air flow control is set to the another mode except the defrost mode and the floor-defrost mode. Although the A/C switch indicator is turned off, this is normal operation.

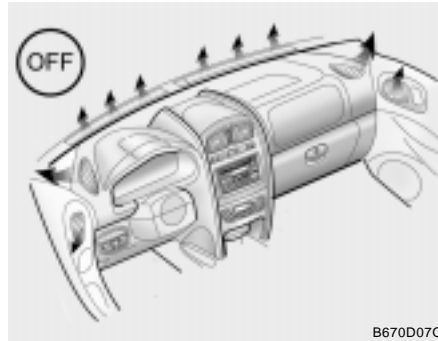

B670D070

OFF Off-Level

Air is discharged through the windshield defroster nozzle, side defroster nozzle and side ventilator.

If the "Off" mode is selected, the "Fresh" mode will be activated and the air will blow in through the windshield defroster nozzle while driving.

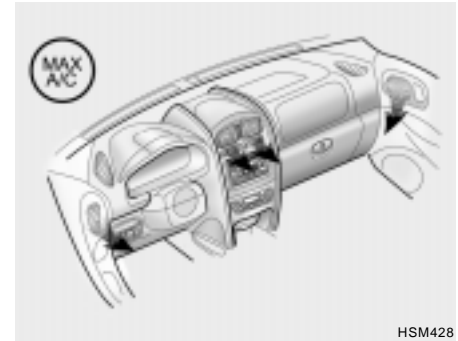









HSM428

MAX A/C MAX A/C-Level

Air is discharged through the face level vents. If the "MAX A/C" mode is selected, the A/C will turn on automatically and "Recirculation" mode will be activated.

NOTE:

- o The air intake control switch will change to "🚪" mode when the ignition switch is turned "ON" with the MAX A/C mode selected.
- o When you change to another mode from MAX A/C, the A/C and the air intake control switch are set to the following chart.

	A/C	Air Intake Control Switch
	ON	 or 
	ON or OFF *	
OFF	OFF	
	ON or OFF *	
	ON	
	ON	
	ON	

* The A/C or the air intake control switch returns to its former setting.

B670E02A-AAT
Temperature Control

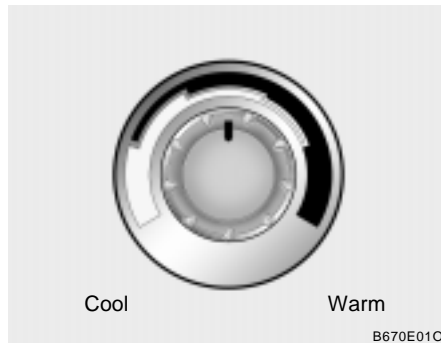

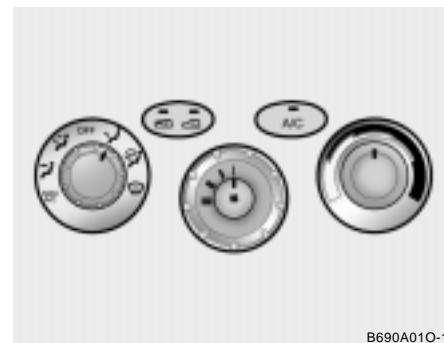

This control is used to adjust the degree of heating or cooling desired.

B690A01O-AAT
HEATING CONTROLS



For normal heating operation, set the air flow control to the floor () position. (The "Fresh" mode will be activated.)

For faster heating, the air intake control switch should be set in the recirculate () position.

If the windows fog up, set the air flow control to the defrost () position (The A/C will turn on automatically and "Fresh" mode will be activated.)

For maximum heat, move the temperature control to "Warm".

B700A01O-AAT

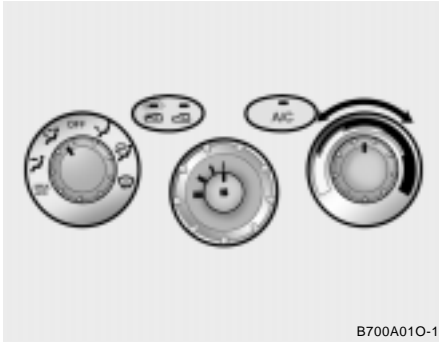
BI-LEVEL HEATING

B700A01O-1

Your Hyundai is equipped with bi-level heating controls. This makes it possible to have cooler air from the dashboard vents and warmer air from the floor outlets at the same time. To use this feature:

- o Set the air intake control switch to the fresh air (🚗) position.
- o Set the air flow control at the bi-level (↕) position.
- o Set the temperature control between "Cool" and "Warm".

B710A01O-AAT

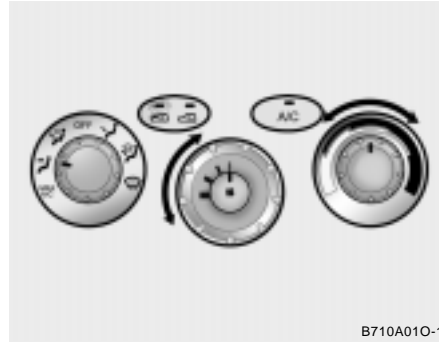
VENTILATION

B710A01O-1

To operate the ventilation system:

- o Set the air intake control switch to the fresh air (🚗) position.
- o To direct all intake air to the dashboard vents, set the airflow control to the face (↕) position.
- o Adjust the fan speed control to the desired speed.
- o Set the temperature control between "Cool" and "Warm".

B740A01S-AAT

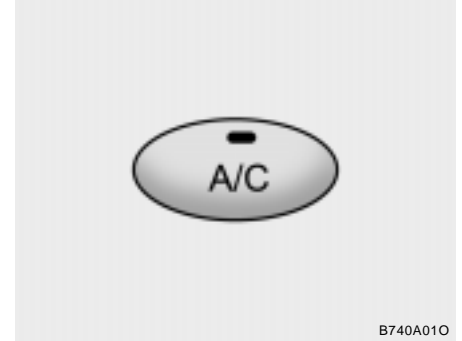
AIR CONDITIONING SYSTEM**Air Conditioning Switch**

B740A01O

The air conditioning is turned on or off by pushing the A/C button on the heating/air conditioning control panel.

B740B02O-AAT

Air Conditioning Operation

(If installed)

Cooling

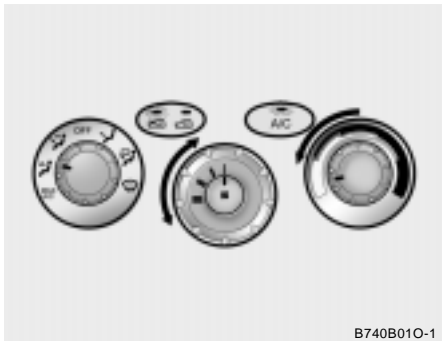

B740B01O-1

To use the air conditioning to cool the interior:

- o Set the side vent control to "☒", to shut off the outside air entry.
- o Set the air flow control to the face (☺) position.
- o Turn on the air conditioning switch by pushing in on the switch. The air conditioning indicator light should come on at the same time.
- o Set the air intake control switch to the fresh air (☺) position.
- o Set the temperature control to "Cool". ("Cool" provides maximum cooling. The temperature may be moderated by moving the control toward "Warm".)

- o Adjust the fan control to the desired speed. For greater cooling, turn the fan control to one of the higher speeds or temporarily select the recirculate (☒) position on the air intake control switch.

B740C02O-AAT

De-Humidified Heating

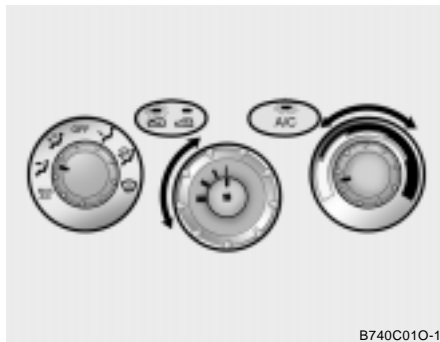

B740C01O-1

For dehumidified heating:

- o Set the air flow control to the face (☺) position.
- o Turn on the air conditioning switch. The air conditioning indicator light should come on at the same time.
- o Set the air intake control switch to the fresh air (☺) position.
- o Adjust the fan control to the desired speed.
- o For more rapid action, set the fan at one of the higher speeds.
- o Adjust the temperature control to provide the desired amount of warmth.

B730A01FC-GAT

Operation Tips

- o To keep dust or unpleasant fumes from entering the car through the ventilation system, temporarily set the air intake control switch to the ☒ position. Be sure to return the control switch to the ☺ position when the irritation has passed to keep fresh air in the vehicle. This will help keep the driver alert and comfortable.
- o Air for the heating/cooling system is drawn in through the grilles just ahead of the windshield. Care should be taken that these are not blocked by leaves, snow, ice or other obstructions.
- o To prevent interior fog on the windshield, set the air intake control switch to the fresh air (☺) position and fan speed to the desired position.

B720A02E-AAT

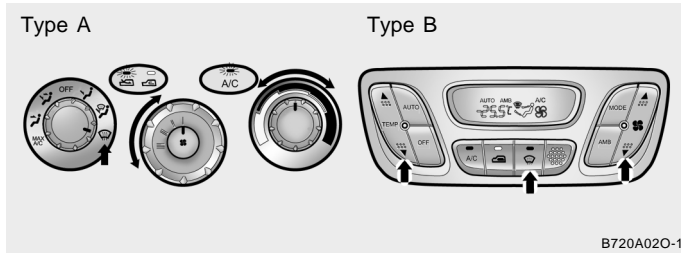
DEFROSTING/DEFOGGING

B720A02O-1

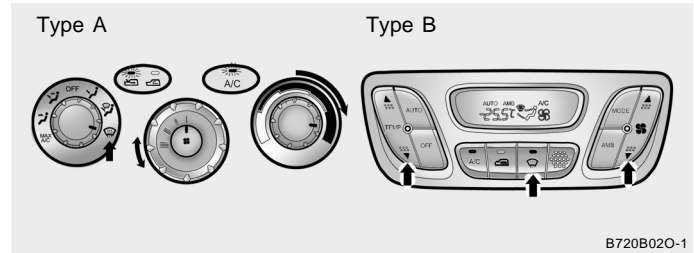

B720B02O-1

Use the heating/ventilation system to defrost or defog the windshield:

To remove interior fog on the windshield;

- o Set the air flow control to the defrost (☞) position. (The A/C will turn on automatically and the "Fresh" mode will be activated.)
- o Set the temperature control to the desired position.
- o Set the fan speed control between "1" and "4" position.

NOTE:

When the A/C is operated continuously on the floor-defrost level (☞) or defrost level (☞), it may cause fog to form on the exterior windshield. If this occurs, set the air flow control to the face level position (☞) and fan speed control to the low position.

To remove frost or exterior fog on the windshield;

- o Set the air flow control to the defrost (☞) position. (The A/C will turn on automatically and the "Fresh" mode will be activated.)
- o Set the temperature control to warm.
- o Set the fan speed control to position "3" or "4".

B970A01Y-AAT

AUTOMATIC HEATING AND COOLING CONTROL SYSTEM (If installed)

Your Hyundai is equipped with an automatic heating and cooling control system controlled by simply setting the desired temperature.

B970B01O-AAT

Heating and Cooling Controls

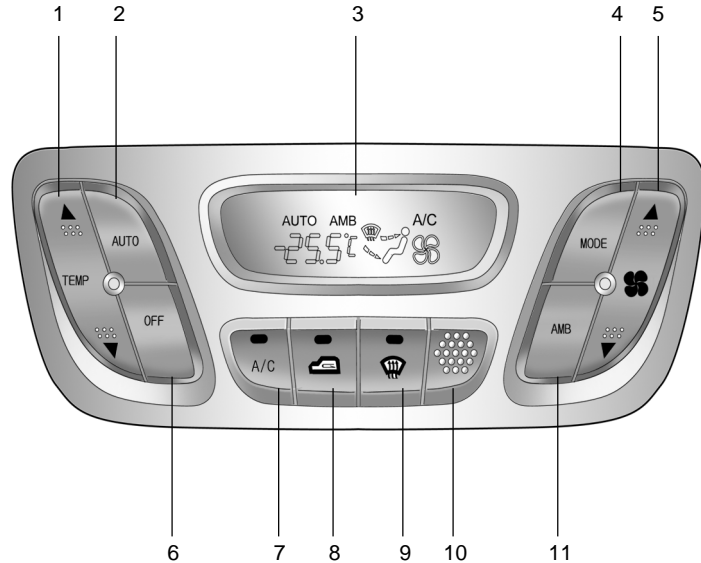

B970B01O

1. Temperature Control Button
2. AUTO (Automatic Control) Switch
3. Display Window
4. Air Flow Control Switch
5. Blower Fan Speed Control Switch

6. OFF Switch
7. Air Conditioning Switch
8. Air Intake Control Switch
9. Defroster Switch
10. Inside Temperature Sensor
11. Ambient Switch

B970C02O-AAT

Automatic Operation

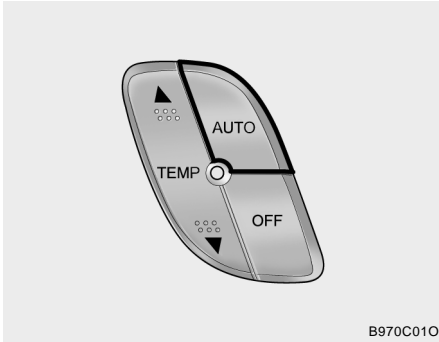

The FATC (Full Automatic Temperature Control) system automatically controls the heating and cooling by doing as follows:

1. Push the "AUTO" switch. The indicator light will come on confirming that the Face, Floor and/or Bi-Level modes as well as the blower speed and, air conditioner will be controlled automatically.
2. Push the "TEMP" button to set the desired temperature.

The temperature will increase to the maximum 90°F(32°C) by pushing on the ▲ button. Each push of the button will cause the temperature to increase by 1°F(0.5°C). The temperature will decrease to the minimum 62°F(17°C) by pushing on the ▼ button. Each push of the button will cause the temperature to decrease by 1°F(0.5°C).

NOTE:

If the battery has been discharged or disconnected, the temperature mode will reset to centigrade degree.

This is a normal condition and you can adjust the temperature mode from centigrade to fahrenheit as follows; Press the TEMP down (▼) button 3 seconds or more with the [AMB] button held down. The display shows that the unit of temperature is adjusted to centigrade or fahrenheit (°C → °F or °F → °C).

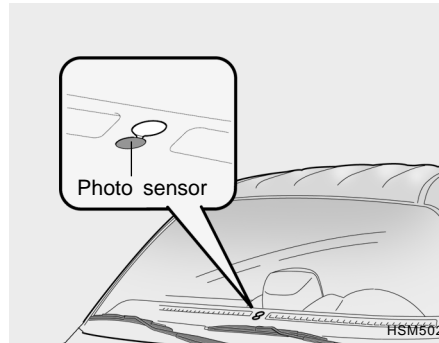

NOTE:

Never place things on the sensor which is located in the car on the instrument panel to ensure better control of the heating and cooling system.

B995A01O-GAT

AMBIENT SWITCH

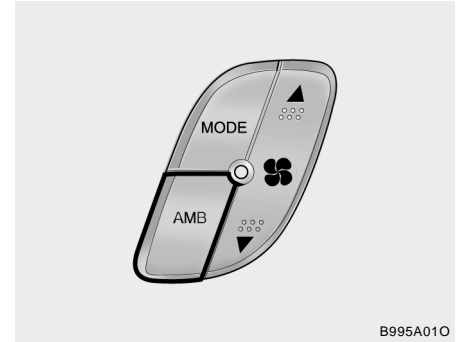

Pressing the "AMB" button displays the ambient temperature on display window.

B980A01Y-AAT

MANUAL OPERATION

The heating and cooling system can be controlled manually as well as by pushing buttons other than the "AUTO" button. At this state, the system sequentially works according to the order of buttons selected.

The function of the buttons which are not selected will be controlled automatically. Press the "AUTO" button in order to convert to automatic control of the system.

B980B01Y-AAT

Fan Speed Control

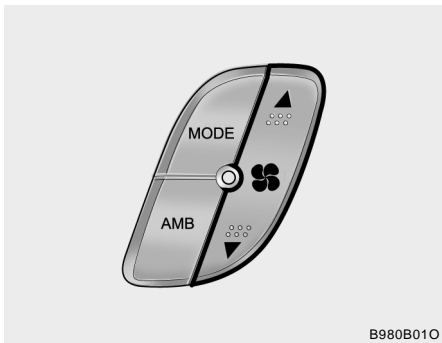

The fan speed can be set to the desired speed by pressing the appropriate fan speed control button. The higher the fan speed is, the more air is delivered. Pressing the "OFF" button turns off the fan.

B670C02S-AAT

Air Intake Control Switch

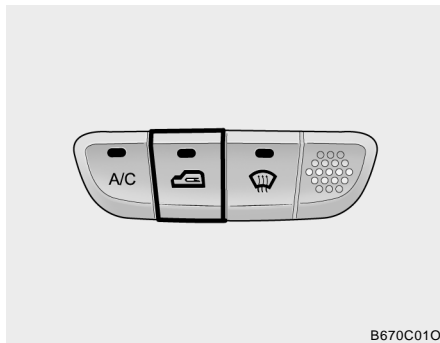

This is used to select fresh outside air or recirculation inside air.

To change the air intake control mode, (Fresh mode, Recirculation mode) push the control button.

FRESH MODE (🚗): The indicator light on the button goes off when the air intake control is fresh mode.

RECIRCULATION MODE (🔄): The indicator light on the button is illuminated when the air intake control is recirculation mode.

With the "Fresh" mode selected, air enters the vehicle from the outside and is heated or cooled according to the function selected.

With the "Recirculation" mode selected, air from within the passenger compartment will be drawn through the heating system and heated or cooled according to the function selected.

NOTE:

- o It should be noted that prolonged operation of the heating system in "recirculation" mode will give rise to fogging of the windshield and side windows and the air within the passenger compartment will become stale. In addition, prolonged use of the air conditioning with the "Recirculation" mode selected may result in the air within the passenger compartment becoming excessively dry.
- o When the ignition switch is turned "ON" the air intake control will change to "FRESH" mode (regardless of switch position). This is normal operation. The air intake control operates in "AUTO" mode when turning the ignition to the "ON" position if the "AUTO" mode was used before shutting off the engine.

B980D01Y-AAT

Heating and Cooling System Off

Press the "OFF" button to stop the operation of the heating and cooling system.

B980E010-AAT

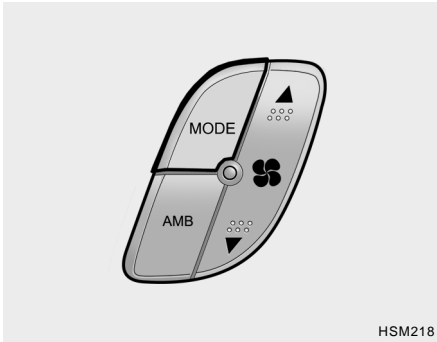
Air Flow Control

HSM218

This is used to direct the flow of air. Air can be directed to the floor, dashboard outlets, or windshield. Four symbols are used to represent Face, Bi-Level, Floor and Floor-Defrost position.

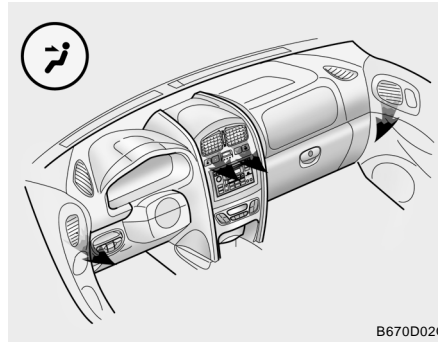

B670D020

**Face-Level**

When selecting the "Face-Level", the indicator light will come on, causing air to be discharged through the face level vents.

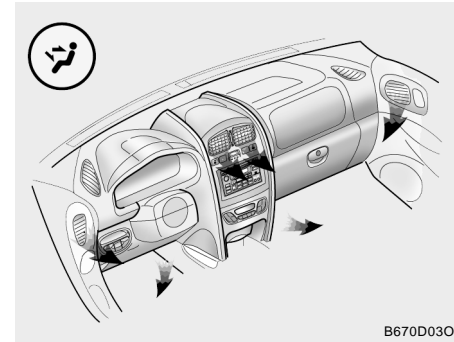

B670D030

**Bi-Level**

When selecting the "Bi-Level", the indicator light will come on and the air will be discharged through the face vents and the floor vents. This makes it possible to have cooler air from the dashboard vents and warmer air from the floor outlets at the same time.

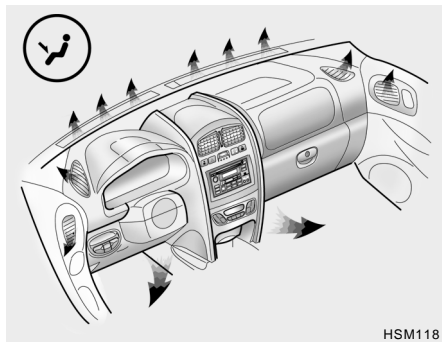

 **Floor-Level**

When selecting the "Floor-Level", the indicator light will come on and the air will be discharged through the floor vents, windshield defroster nozzle, side defroster nozzle and side ventilator.

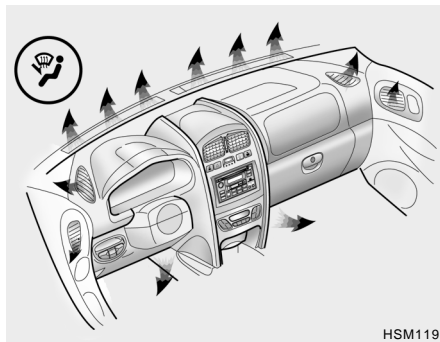

 **Floor-Defrost Level**

When selecting the "Floor-Defrost Level", the indicator light will come on and the air will be discharged through the windshield defroster nozzle, the floor vents, side defroster nozzle and side ventilator.

B980F010-AAT

Defrost switch

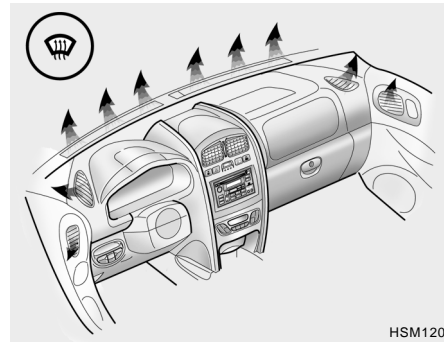

When the "Defrost" button is pressed, the "Fresh" mode will be automatically selected and the air will be discharged through the windshield defroster nozzle, side defroster nozzle and side ventilator.

To assist in defrosting, the air conditioning will operate if ambient temperature is higher than 38.3°F(3.5°C) and automatically turns off if the ambient temperature drops below 38.3°F(3.5°C).

B740D01Y-AAT

Operation Tips

- o If the interior of the car is hot when you first get in, open the windows for a few minutes to expel the hot air.
- o When you are using the air conditioning system, keep all windows closed to keep hot air out.
- o When moving slowly, as in heavy traffic, shift to a lower gear. This increases engine speed, which in turn increases the speed of the air conditioning compressor.
- o On steep grades, turn the air conditioning off to avoid the possibility of the engine overheating.
- o During winter months or in periods when the air conditioning is not used regularly, run the air conditioning once every month for a few minutes. This will help circulate the lubricants and keep your system in peak operating condition.

B750A02A-AAT

STEREO SOUND SYSTEM

How Car Audio Works

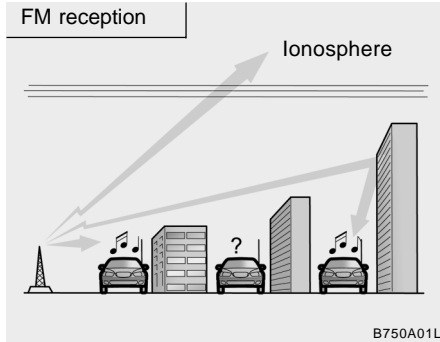

AM and FM radio signals are broadcast from transmitter towers located around your city. They are intercepted by the radio antenna on your car. This signal is then received by the radio and sent to your car speakers.

When a strong radio signal has reached your vehicle, the precise engineering of your audio system ensures high quality reproduction. However, in some cases the signal coming to your vehicle may not be strong and clear. This can be due to factors such as the distance from the radio station, closeness of other strong radio stations or the presence of buildings, bridges or other large obstructions in the area.

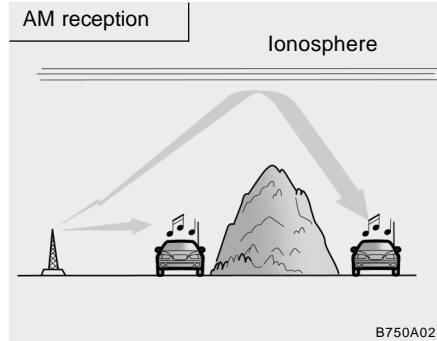

AM broadcasts can be received at greater distances than FM broadcasts. This is because AM radio waves are transmitted at low frequencies. These long, low frequency radio waves can follow the curvature of the earth rather than travelling straight out into the atmosphere. In addition, they curve around obstructions so that they can provide better signal coverage.

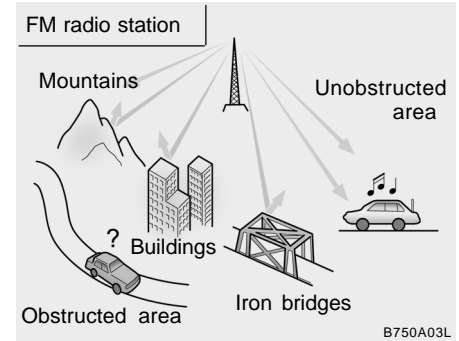

FM broadcasts are transmitted at high frequencies and do not bend to follow the earth's surface. Because of this, FM broadcasts generally begin to fade at short distances from the station. Also, FM signals are easily affected by buildings, mountains, or other obstructions. These can result in certain listening conditions which might lead you to believe a problem exists with your radio. The following conditions are normal and do not indicate radio trouble:

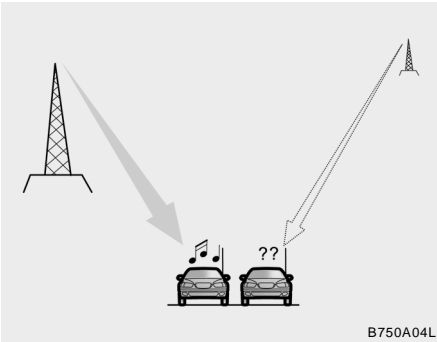

- o Fading - As your car moves away from the radio station, the signal will weaken and sound will begin to fade. When this occurs, we suggest that you select another stronger station.
- o Flutter/Static - Weak FM signals or large obstructions between the transmitter and your radio can disturb the signal causing static or fluttering noises to occur. Reducing the treble level may lessen this effect until the disturbance clears.

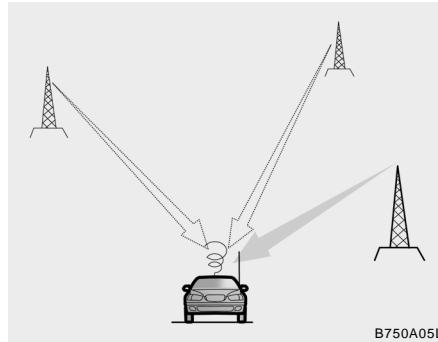

- o Station Swapping - As an FM signal weakens, another more powerful signal near the same frequency may begin to play. This is because your radio is designed to lock onto the clearest signal. If this occurs, select another station with a stronger signal.
- o Multi-Path Cancellation - Radio signals being received from several directions can cause distortion or fluttering. This can be caused by a direct and reflected signal from the same station, or by signals from two stations with close frequencies. If this occurs, select another station until the condition has passed.

B750B02Y-AAT

Using a cellular phone or a two-way radio

When a cellular phone is used inside the vehicle, noise may be produced from the audio equipment. This does not mean that something is wrong with the audio equipment. In such a case, use the cellular phone at a place as far as possible from the audio equipment.



CAUTION:

When using a communication system such as a cellular phone or a radio set inside the vehicle, a separate external antenna must be fitted. When a cellular phone or a radio set is used with an internal antenna alone, it may interfere with the vehicle's electrical system and adversely affect safe operation of the vehicle.



WARNING:

Don't use a cellular phone when you are driving, you must stop at a safe place to use a cellular phone.

H260A01O-AAT

STEREO RADIO OPERATION (H260) (If installed)

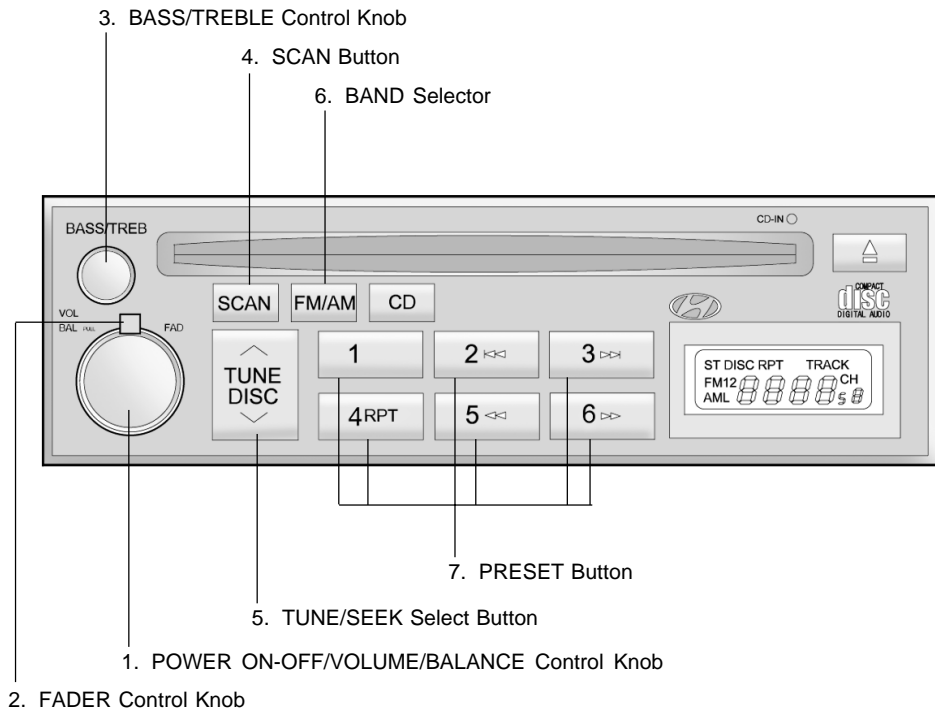

H260B030-AAT

1. POWER ON-OFF Control Knob

The radio unit may be operated when the ignition key is in the "ACC" or "ON" position. Press the knob to switch the power on. The LCD shows the radio frequency in the radio mode or the CD track indicator in the CD mode. To switch the power off, press the knob again.

VOLUME Control

Rotate the knob clockwise to increase the volume and turn the knob counterclockwise to reduce the volume.

BALANCE Control

Pull and turn the control knob clockwise to emphasize right speaker sound. (Left speaker sound will be attenuated.) When the control knob is turned counterclockwise, left speaker sound will be emphasized. (Right speaker sound will be attenuated.)

2. FAD (Fader Control) Knob

Turn the control knob counterclockwise to emphasize front speaker sound. (Rear speaker sound will be attenuated.) When the control knob is turned clockwise, rear speaker sound will be emphasized. (Front speaker sound will be attenuated.)

3. BASS Control Knob

Press to pop the knob out and turn to the left or right for the desired bass tone.

TREB (Treble Control) Knob

Pull the bass control knob further out. Turn to the left or right for the desired treble tone.

4. SCAN Button

When the scan button is pressed, the frequency will increase and the receivable stations will be tuned in one after another, receiving each station for 5 seconds. To stop scanning, press the scan button again.

5. TUNE (Manual) Select Button

Press the (∧) side or (∨) side to increase or to decrease the frequency. Press either button and hold down to continuously scroll. Release button once the desired station is reached.

SEEK Operation (Automatic Channel Selection)

Press the TUNE select button for 0.5 sec or more. Releasing it will automatically tune to the next available station with a beep sound. When the (∧) side is pressed longer than 0.5 second, releasing will automatically tune to the next higher frequency and when the (∨) side is pressed longer than 0.5 second, releasing will automatically tune to the next lower frequency.

6. BAND Selector

Pressing the **[FM/AM]** button changes the AM, FM1 and FM2 bands. The mode selected is displayed on LCD.

7. PRESET STATION SELECT Button

Six (6) stations for AM, FM or FM2 respectively can be preset in the electronic memory circuit on this unit.

HOW TO PRESET STATIONS

Six AM and twelve FM stations may be programmed into the memory of the radio. Then, by simply pressing the band select button and/or one of the six station select buttons, you may recall any of these stations instantly. To program the stations, follow these steps:

- o Press band selector to set the band for AM, FM or FM2.
- o Select the desired station to be stored by seek, scan or manual tuning.
- o Determine the preset station select button you wish to use to access that station.
- o Press the station select button for more than two seconds. A select button indicator will show in the display indicating which select button you have depressed. The frequency display will flash after it has been stored into the memory.
You should then release the button, and proceed to program the next desired station. A total of 18 stations can be programmed by selecting one AM and two FM stations per button.
- o When completed, any preset station may be recalled by selecting AM, FM or FM2 band and the appropriate station button.

H260B01O-AAT

COMPACT DISC PLAYER OPERATION (H260) (If installed)

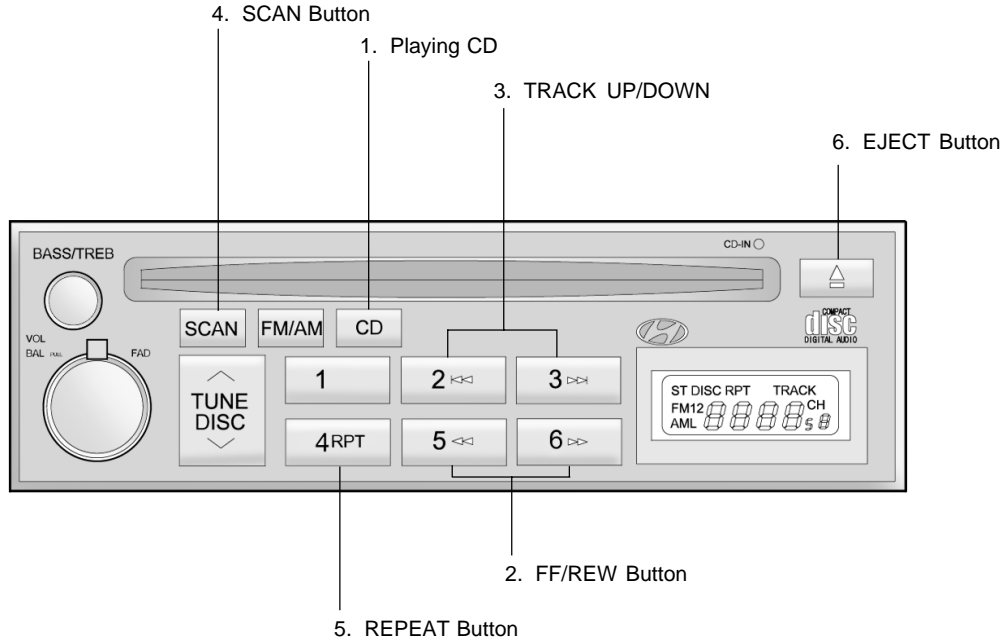

B260D02O-AAT

1. Playing CD

- o Insert the CD with the label facing upward.
- o Insert the CD to start CD playback, during radio operation.
- o When a disc is in the CD deck, if you press the CD button, the CD player will begin playing even if the radio is being used.
- o The CD player can be used when the ignition switch is in either the "ON" or "ACC" position.

2. FF/REW (▶▶/◀◀)

If you want to fast forward or reverse through the compact disc track, push and hold the FF (▶▶) or REW (◀◀) button.

When you release the button, the compact disc player will resume playing.

3. TRACK UP/DOWN

- o The desired track on the disc currently being played can be selected using the track number.
- o Press ▶▶ once to skip forward to the beginning of the next track. Press ◀◀ once to skip back to the beginning of the track.

4. SCAN Button

- o Press the SCAN button to playback the first 10 seconds of each track.
- o Press the SCAN button again within 10 sec. when you have reached the desired track.

5. REPEAT Button

- o To repeat the track you are currently listening to, press the RPT button. To cancel , press again.
- o If you do not release RPT operation when the track ends, it will automatically be replayed. This process will be continued until you push the button again.

6. EJECT Button

When the EJECT button  is pressed with a CD loaded, the CD will eject.

NOTE:

- o **If the CD does not operate properly or if the ER2 fault code is displayed, use one of two methods to reset the CD deck function.**
 - Remove the audio fuse for 5 minutes. Then, reinstall the audio fuse.
 - Disconnect the negative terminal of the battery and wait 5 minutes. Then reconnect the negative battery terminal.
- o **To assure proper operation of the unit, keep the vehicle interior temperature within a normal range by using the vehicle's air conditioning or heating system.**
- o **When replacing the fuse, replace it with a fuse having the correct capacity.**

- o **The preset station frequencies are all erased when the car battery is disconnected. Therefore, all data will have to be set again if this should occur.**
- o **Do not add any oil to the rotating parts. Keep magnets, screwdrivers and other metallic objects away from the tape mechanism and head.**
- o **This equipment is designed to be used only in a 12 volt DC battery system with negative ground.**
- o **This unit is made of precision parts. Do not attempt to disassemble or adjust any parts.**
- o **When driving your vehicle, be sure to keep the volume of the unit set low enough to allow you to hear sounds coming from the outside.**
- o **Do not expose this equipment (including the speakers) to water or excessive moisture.**

B890A02O-AAT

AUDIO FAULT CODE

If you see any error indication in the display while using the CD mode, find the cause in the chart below. If you cannot clear the error indication, take the car to your Hyundai dealer.

INDICATION	CAUSE	SOLUTION
Er2	CD DECK MECHANICAL ERROR (EJECT ERROR, LOADING ERROR)	After resetting the audio, push the eject button. If disc is not ejected, consult your hyundai dealer.
Er3	FOCUS ERROR DATA READ ERROR	Make sure the disc is not scratched or damaged. Press the eject button and pull out the disc. Then insert a normal cd disc.
Er6	DISC ERROR	Check if the disc is inserted correctly in the cd player. Make sure the disc is not scratched or damaged.

D285A01O-AAT

STEREO RADIO OPERATION (D-285) (If installed)

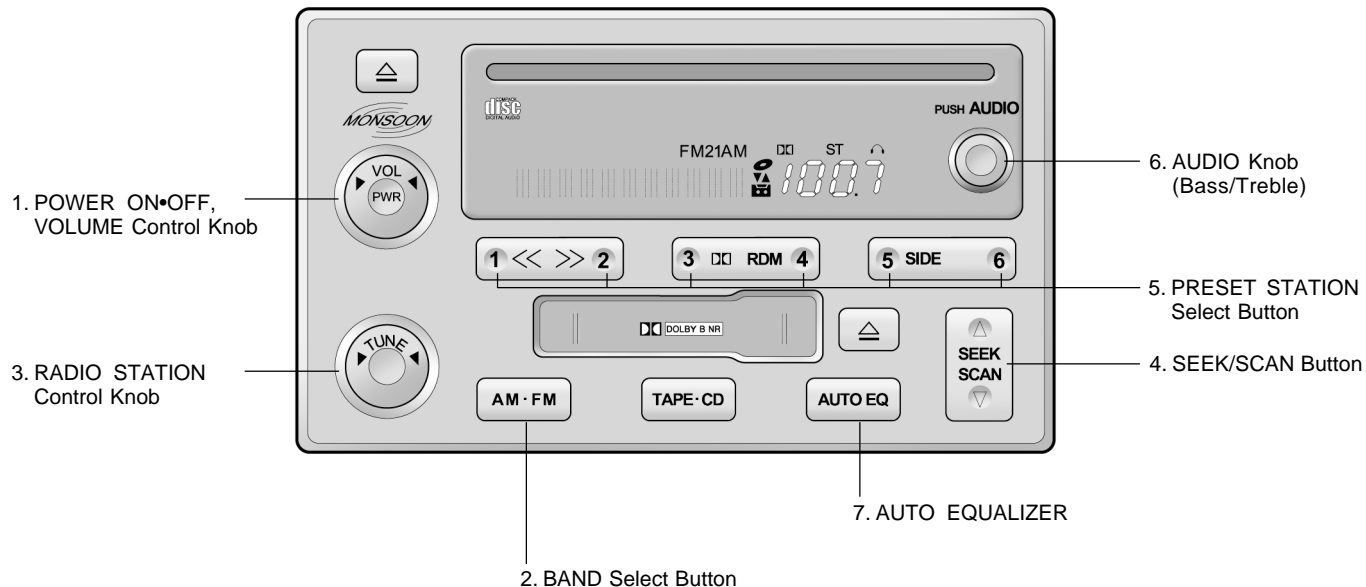

D285B01O-AAT

1. POWER ON•OFF Control Knob

Press this knob to turn the system on and off.

VOLUME Control

Turn the knob clockwise to increase volume.
Turn it counterclockwise to decrease volume.

2. BAND Select Button

Press this button to switch between AM, FM1 and FM2. The display will show your selection.

3. RADIO STATION Control Knob

Turn this knob to choose radio stations.

4. SEEK/SCAN Button

Press the up or down arrow to seek to the next or previous station and stay there. The sound will mute while seeking.



Press and hold one of the arrows for more than two seconds. The radio will produce one beep. The radio will produce one beep. The radio will scan to each stations, play for a few seconds, then go on to the next station. Press one of the arrows or one of the pushbuttons again to stop scanning. SCAN will be displayed whenever the

tuner is in the scan mode. In FM mode, this function will scan through the current band such as FM1 or FM2. The radio will scan stations with a strong signal only. The sound will mute while scanning.

5. PRESET STATION Select Button

The six numbered pushbuttons let you return to your favorite stations. You can set up to 18 stations (six AM, six FM1 and six FM2) by performing the following steps:

1. Turn the radio on.
2. Press BAND select button to select AM, FM1 of FM2.
3. Tune in the desired station.
4. Press AUTO EQ to choose the bass and treble equalization that best suits the type of station you are listening to.
5. Press and hold one of the six numbered pushbuttons. The radio will produce one beep. Whenever you press that numbered pushbutton, the station you set will return and the bass and treble equalization that you selected will also be automatically selected for that pushbutton.
6. Repeat the above steps for each pushbutton.

**6. AUDIO Knob
Setting the Tone (BASS/Treble)**

Push and release the AUDIO knob until BASS or TREB appears on the display. Turn the knob clockwise or counterclockwise to increase or decrease. The display will show the bass or treble level. If a station is weak or noisy, you may want to decrease the treble.

To adjust bass and treble to the middle position, push and hold the AUDIO knob. The radio will produce one beep and adjust the display level to the middle position.

To adjust all tone and speaker controls to the middle position, push and hold the AUDIO knob when no tone or speaker control is displayed. The radio will produce one beep and display CENTERED.

Adjusting the Speakers (Balance/Fade)

To adjust the balance between the right and left speakers, push and release the AUDIO knob until BAL appears on the display. Turn the knob clockwise to move the sound to the right speakers and counterclockwise to move the sound to the left speakers.

To adjust the fade between the front and rear speakers push and release the AUDIO knob until FADE appears on the display. Turn the knob clockwise to move the sound to the front speakers and counterclockwise to move the sound to the rear speakers.

The middle position balances the sound between the speakers. To adjust the balance and fade to the middle position, push the AUDIO knob then push it again and hold it until you hear one beep. The balance and fade will be adjusted to the middle position and the display will show the speaker balance.

To adjust all tone and speaker controls to the middle position, push and hold the AUDIO knob when no tone or speaker control is display ALL with the level display in the middle position.

7. AUTO EQUALIZER

This feature allows you to choose bass and treble equalization settings designed for country jazz, news, pop, rock and classical stations.

Each time you press the AUTO TONE button, this feature will change to one of the preset equalization settings previously listed.

To return the bass and treble to the custom mode, push and release the AUDIO knob until custom is displayed.

8. Tips About Your Audio System

Hearing damage from loud noise is almost undetectable until it is too late. Your hearing can adapt to higher volumes of sound. Sound that seems normal can be loud and harmful to your hearing. Take precautions by adjusting the volume control on your radio to a safe sound level before your hearing adapts to it.

To help avoid hearing loss or damage do the following:

1. Adjust the volume knob to the lowest setting.
2. Increase volume slowly until you hear comfortably and clearly.

D285C01O-AAT

CASSETTE TAPE PLAYER OPERATION (D-285) (If installed)

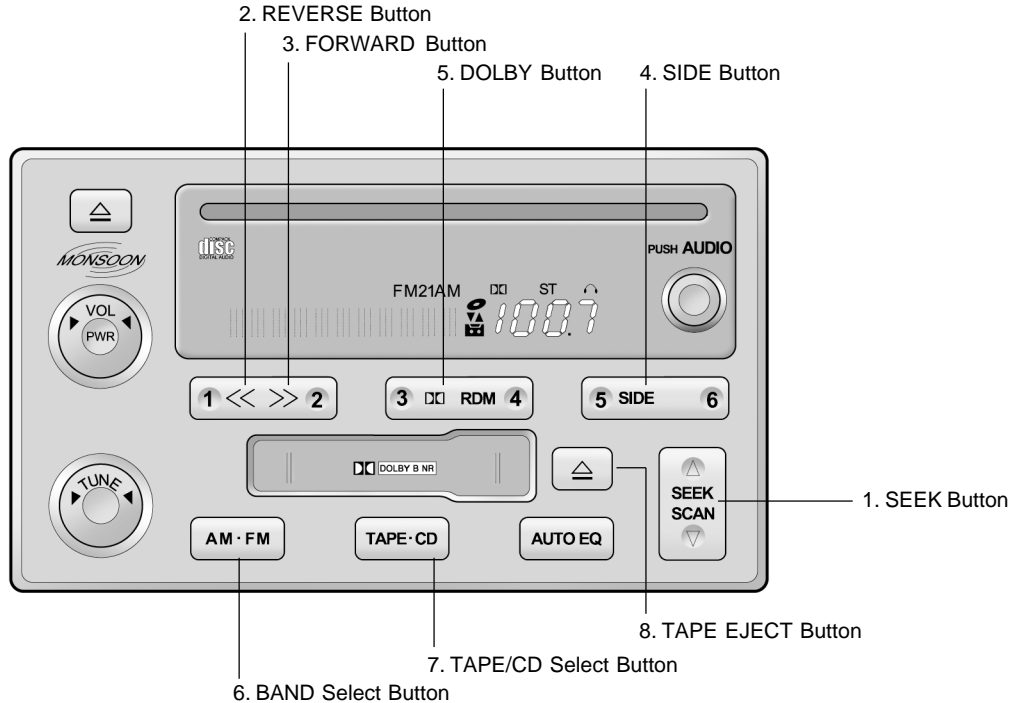

D285D01O-AAT

Playing a Cassette Tape

Your tape player is built to work best with tapes that are up to 30 to 45 minutes long on each side. Tapes longer than that are so thin they may not work well in this player. The longer side with the tape visible should face to the right. If the ignition is on, but the radio is off, the tape can be inserted and will begin playing. A tape symbol is shown on the display whenever a tape is inserted. If you hear nothing but a garbled sound, the tape may not be in squarely. Press EJECT to remove the tape and start over.

While the tape is playing, use the VOL, AUDIO and SEEK controls just as you do for the radio. The display will show TAPE and an arrow showing which side of the tape is playing. You can insert a tape when the ignition is off. If an error appears on the display, see "Cassette Tape Message" later in this section.

1. SEEK Button

SEEK

Press this pushbutton to go to the next selection on the tape if you press pushbutton more than once, the player will continue moving forward through the tape. SEEK and a positive number will appear on the display. Your tape must have at least three seconds of silence between each selection for next to work. The sound still mute while seeking.

SEEK

Press this pushbutton to go to the previous selection on the tape if the selection has been playing for less than three seconds. If this pushbutton is pressed and the current selection had been playing for more than 13 seconds, it will go to the beginning of the previous selection or the beginning of the current selection, depending upon the position on the tape. SEEK and a negative number will appear on the display while the cassette player is in the previous mode. If this pushbutton is pressed additional times or held, the radio will go to the displayed number of previous selections up to 9. SEEK and a negative number will appear on the display. Your tape must have at least three seconds of silence between each selection for previous to work. The sound will mute while seeking.

2. REVERSE Button

Press this pushbutton to reverse the tape rapidly. Press it again to return to playing speed. The radio will play the last selected station while the tape reverses. The station frequency and REV will appear on the display. You may select stations during reverse operation by using TUNE, SEEK or PRESET SCAN.

3. FORWARD Button

Press this pushbutton to advance quickly to another part of the tape. Press this pushbutton again to return to playing speed. The radio will play the last selected station while the tape advances. The station frequency and FWD will appear on the display. You may select stations during forward operation by using TUNE, SEEK or PRESET SCAN.

4. SIDE Button

Press this pushbutton to play the other side of the tape.

5. (Dolby)

Press this pushbutton to reduce background noise. DOLBY B ON will appear on the display. Press it again to turn Dolby B off. DOLBY B OFF will appear on the display. Dolby Noise Reduction is manufactured under a license from Dolby Laboratories Licensing Corporation. Dolby and the double-D symbol are trademarks of Dolby laboratories Licensing Corporation.

6. BAND Select Button

Press this button to listen to the radio when a tape is playing. The tape will stop but remain in the player.

7. TAPE/CD Select Button

Press this button to play a tape when listening to the radio. Press TAPE/CD to switch between the tape and compact disc if both are loaded. The inactive tape or CD will remain safe inside the radio for future listening.

8. Cassette Tape EJECT Button

Press this button located to the right of the cassette tape slot to eject a tape. The tape is ejected with the radio off. Cassette tape may be loaded with the radio off.

9. Cassette Tape Messages

CHECK TAPE

If this message appears on the radio display, the tape won't play because of one of the following errors.

- o The tape is tight and the player can't turn the tape hubs. Remove the tape. Hold the tape with the open end down and try to turn the right hub counterclockwise with a pencil. Turn the tape over and repeat. If the hubs do not turn easily, your tape may be damaged and should not be used in the player. Try a new tape to make sure your player is working properly.
- o The tape is broken. Try a new tape.
- o The tape is wrapped around the tape head. Attempt to get the cassette out. Try a new tape.

CLEAN

If this message appears on the display, the cassette tape player needs to be cleaned. It will still play tapes, but you should clean it as soon as possible to prevent damage to the tapes and player. See "Care of Your Cassette Tape Player" in the Index.

If any error occurs repeatedly or if an error can't be corrected, contact your dealer.

10. Care of Your Cassette Tape Player

A tape player that is not cleaned regularly can cause reduced sound quality, reined cassettes or a damaged mechanism. Cassette tapes should be stored in their case away from contaminants, direct sunlight and extreme heat. If they aren't they may not operate properly or may cause failure of the tape player.

Your tape player should be cleaned regularly after every 59 hours of use. Your radio may display CLEAN to indicate that you have used your tape player needs to be cleaned. It will still play tapes, but you should clean it as soon as possible to prevent damage to your tapes and player. If you notice a reduction in sound quality, try a known good cassette to see if it is the tape or the tape player or fault. If this other cassette has no improvement in sound quality, clean the tape player.

The recommended cleaning method for your cassette tape player is the use of a scrubbing action, non-abrasive cleaning cassette with pads which scrub the tape head as the hubs of the cleaner cassette turn. The recommended cleaning cassette is available through your dealer.

When cleaning the cassette tape player with the recommended non-abrasive cleaning cassette, it is possible that the cassette may eject, because the cut tape detection feature on your radio may recognize it as a broken tape. To prevent the cleaning cassette from being ejected, use the following steps:

1. Turn the ignition to ON or ACC.
2. Turn the radio off.
3. Press and hold the TAPE/CD select button for five seconds. READY will appear on the display and a cassette symbol will flash for five second.
4. Insert the scrubbing action cleaning cassette.
5. Eject the cleaning cassette after the manufacturer's recommended cleaning time.

When the cleaning cassette has been ejected, the broken tape detection feature is active again.

You may also choose a non-scrubbing action, wet-type cleaner which uses a cassette with a fabrica belt to clean the tape head. This type of cleaning cassette will not eject on its own. A non-scrubbing action cleaner may not clean as thoroughly as the scrubbing type cleaner. The use of a non-scrubbing action, dry-tape cleaning cassette is not recommended.

After you clean the player, press and hold the EJECT button for five seconds to reset the CLEAN indicator. The radio will display CLEANED to show the indicator was reset.

Cassettes are subject to wear and the sound quality may degrade over time. Always make sure the cassette tape is in good condition before you have your tape player serviced.

D285E010-AAT

COMPACT DISC PLAYER OPERATION (D-285) (If installed)

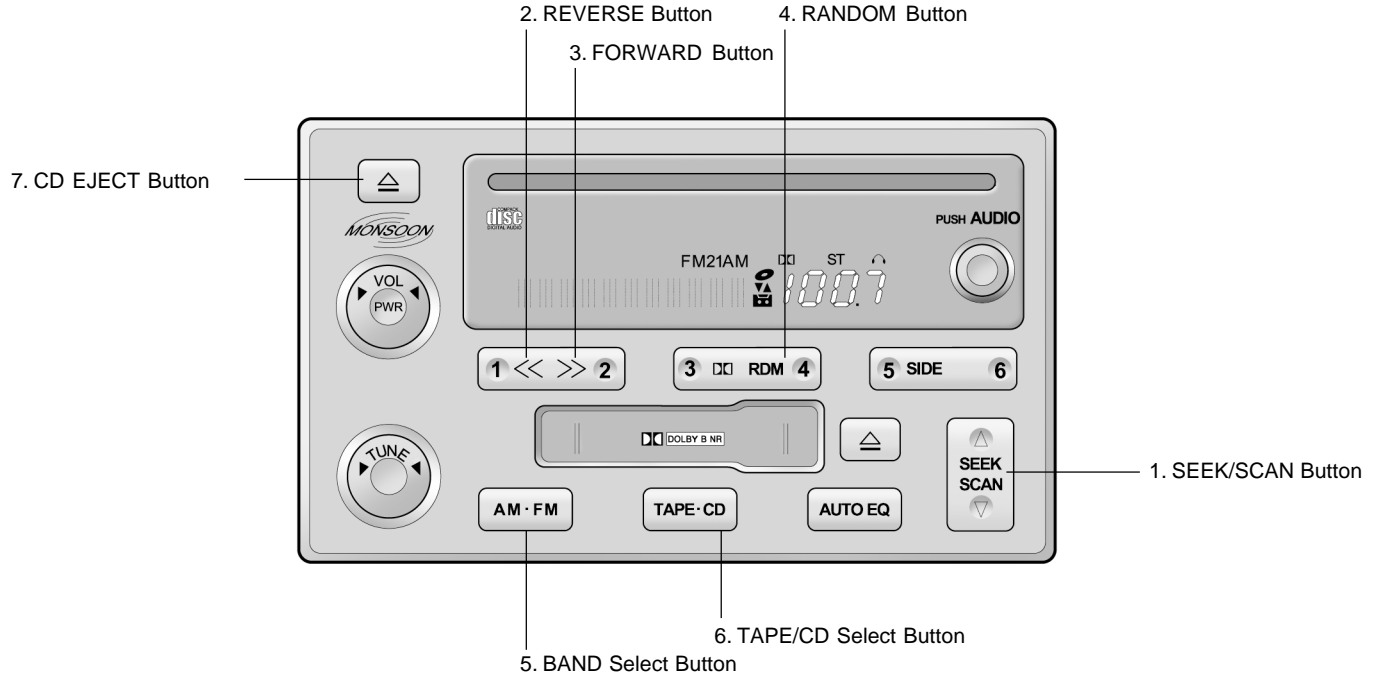

D285F01O-AAT

Playing a Compact Disc

Insert a disc partway into the slot. Label side up. The player will pull it in and the disc should begin playing. The display will show the CD symbol. You can insert a compact disc with the ignition off.

1. SEEK/SCAN Button

SEEK

Press this Pushbutton to go to the next TRACK and the track number will appear on the display. If you hold this pushbutton or press it more than once, the player will continue moving forward through the disc. The sound will mute while seeking.

SEEK

Press this Pushbutton to go to the previous track if the current track has been playing for less than eight seconds. If this pushbutton is pressed and the current track has been playing for more than eight seconds, it will go to the beginning of the current track. TRACK and the track number will appear on the display. If you hold this pushbutton or press it more than once, the player will continue moving back through the disc. The sound will mute while seeking.

SCAN

Press and hold either SEEK SCAN arrow for more than two seconds until SCAN appears on the display and you hear a beep. Use SEEK SCAN to listen to each track for a few seconds. The sounds will mute while scanning. SCAN will appear on the display. Press either SEEK SCAN arrow again, to stop scanning.

2. REVERSE Button

Press and hold this pushbutton to reverse quickly within a track. Press and hold this pushbutton for less than two seconds to reverse at six times the normal playing speed. Press and hold it for more than two seconds to reverse at 17 times the normal playing speed. Release it to play the passage. The display will show ET and the elapsed time.

3. FORWARD Button

Press and hold this pushbutton to advance quickly within a track. Press and hold this pushbutton for less than two seconds to advance at six times the normal playing speed. Press and hold it for more than two seconds to advance at 17 times the normal playing speed. Release it to play the passage. The display will show ET and the elapsed time.

4. RANDOM Button

Press this pushbutton to hear the tracks in random, rather than sequential, order. RDM will appear on the display. RDM T and the track number will appear on the display when each track starts to play. Press it again to turn off random play. RDM OFF will appear on the display.

5. BAND Select Button

Press this button to listen to the radio when a disc is playing. The disc will stop but remain in the player.

6. TAPE/CD Select Button

Press this button to play a CD when listening to the radio. Press TAPE CD to switch between the tape and compact disc if both are loaded. The inactive tape or CD will remain safely inside the radio for future listening.

7. CD EJECT Button

Press this button, located to the left of the CD slot, to eject a CD. Eject may be activated with either the ignition or radio off. CDs may be loaded with the radio and ignition off.

8. Care of Your Compact Discs

Handle disc careful. Store them in their original cases or other protective cases away from direct sunlight and dust. If the surface of a disc is soiled, dampen a clean, soft cloth in a mild, neutral detergent solution and clean it, wiping from the center to the edge.

Be sure never to touch the side without writing when handling discs. Pick up discs by grasping the outer edges or the edge of the hole and the outer edge.

9. Care of Your Compact Disc Player

The use of CD lens cleaner discs is not advised, due to the risk of contaminating the lens of the CD optics with lubricants internal to the CD mechanism.

10. CD Adapter Kits

It is possible to use a portable CD player adapter kit with your cassette tape player after disabling the tight/loose tape sensing feature on your tape player.

To disable the feature, use the following steps:

1. Turn the radio off.
2. Press and hold the TAPE CD Button. The radio will display READY and flash the cassette icon.
3. Insert the adapter into the cassette slot. It will power up the radio and begin playing

This override routine will remain active until EJECT button is pressed.

NOTE:

Before you add any sound equipment to your vehicle--like a tape player, CB radio, mobile telephone or two-way radio--be sure you can add what you want. If you can, it's very important to do it properly. Added sound equipment may interfere with the operation of your vehicle's engine, Delphi Electronics radio or other systems, and even damage them. Your vehicle's systems may interfere with the operation of sound equipment that has been added improperly. So, before adding sound equipment, check with your dealer and be sure to check federal rules covering mobile radio and telephone units.

D295A010-AAT

STEREO RADIO OPERATION (D-295) (If installed)

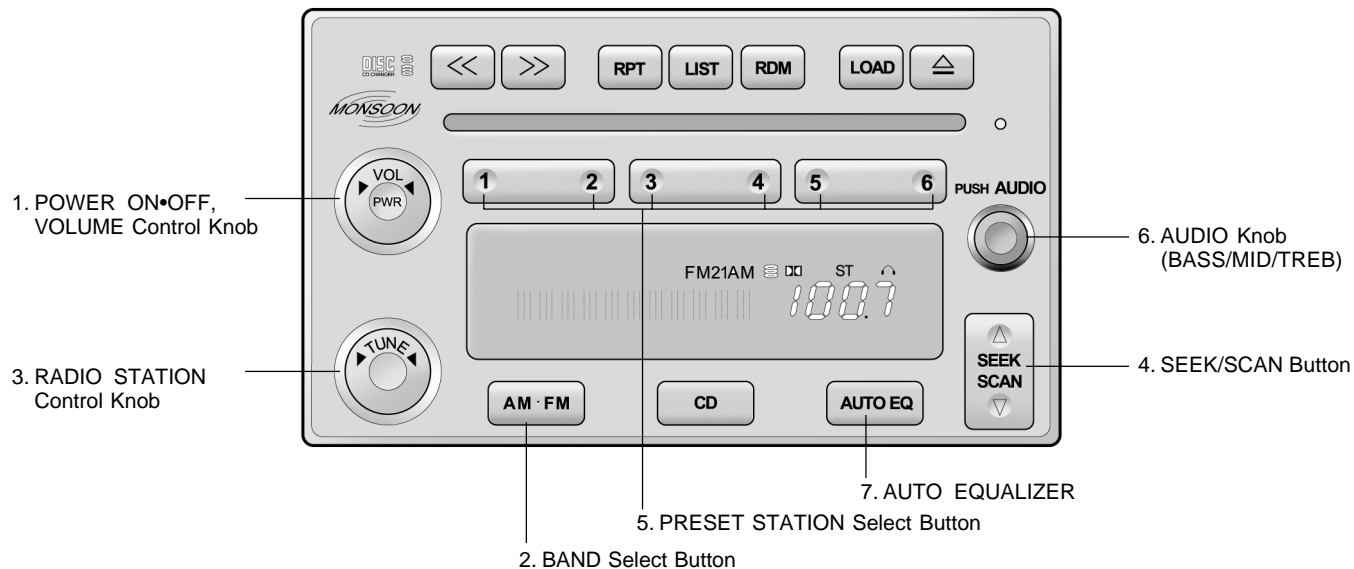

D295B01O-AAT

1. POWER ON•OFF Control Knob

Press this knob to turn the system on and off.

VOLUME Control

To increase volume, turn the knob clockwise. Turn it counterclockwise to decrease volume.

2. BAND Select Button

Press this button to switch between AM, FM1 and FM2. Then Display shows your selection.

3. RADIO STATION Control Knob

Turn this knob to select radio stations.

4. SEEK/SCAN Button**SEEK**

Press the up or down arrow to go to the next higher or lower station and stay there. The sound will mute while seeking.

SCAN

Press and hold either SEEK/SCAN arrow for two seconds until SCAN appears on the display and you hear a beep. Use SCAN to listen to stations for a few seconds. The radio will go to a station, stop for a few seconds, then go to the next station. Press either SEEK/SCAN arrow again to stop scanning. If you press SEEK/SCAN for more than four seconds, the radio will change to preset scan mode. Then sound will mute while scanning.

5. PRESET STATION Select Button

The six numbered pushbuttons let you return to your favorite stations. You can set up to 18 stations (six AM, six FM1 and six FM2) by performing the following steps:

1. Turn the radio on.
2. Press AM · FM to select the band.
3. Tune in the desired station.
4. Press AUTO EQ to select the equalization that best suited type of station selected.
5. Press and hold one of the six numbered buttons until you hear a beep. Whenever you press that numbered button, the station you set will return and the equalization that you selected will also be automatically selected for that button.
6. Repeat the above steps for each pushbutton.

PRESET SCAN

Press and hold either SEEK/SCAN arrow for more than four seconds, PRESET SCAN will appear on the display. You will hear a double beep. Use PERSET SCAN to listen to each of your preset stations for a few seconds. The radio will go to a preset station stored on your pushbuttons, stop for a few seconds, then go on to the next preset stations. Press either SEEK/SCAN arrow again to stop scanning presets.

6. AUDIO Knob**BASS**

Press the AUDIO knob until BASS appears on the display. Turn the knob to increase or decrease bass. When you use this control, the radio's tone setting will switch to custom mode. To set the bass to the middle position, select BASS and press and hold the AUDIO knob. The radio will produce one beep and set the display level to zero. To set all tone and speaker controls to the middle position, press and hold the AUDIO knob when no tone or speaker control is active. The radio will produce one beep and CENTERED will appear on the display.

MID

Press the AUDIO knob until MID appears on the display. Turn the knob to increase or decrease mid. When you use this control, the radio's tone setting will switch to custom mode.

To set the mid to the middle position, select MID and press and hold the AUDIO knob. The radio will produce one beep and set the display level to zero. To set all tone and speaker controls to the middle position, press and hold the AUDIO knob when no tone or speaker control is active. Then radio will produce one beep and CENTERED will appear on the display.

TREB

Press the AUDIO knob until TREB appears on the display. Turn the knob to increase to decrease treble. When you use this control, the radio's tone setting will switch to custom mode. If a station is weak or noisy, you may want to decrease the treble.

To set treble to the middle position, select TREB and press and hold the AUDIO knob. The radio will produce one beep and set the display level to zero. To set all tone and speaker controls to the middle position, press and hold the AUDIO knob when no tone or speaker control is active. The radio will produce one beep and CENTERED will appear on the display.

7. AUTO EQUALIZER Button

This feature allows you to choose preset bass, mid and treble equalization settings designed for country, jazz, talk, pop, rock and classical stations. The last setting will appear on the display when you first press AUTO EQ. Each time you press AUTO EQ, another setting will appear on the display. Press AUTO EQ again country disappear and CUSTOM will appear. Tone control will return to the BASS, MID and TREB. Also, if you alter BASS, MID, or TREB while in an auto EQ setting, the radio will return to CUSTOM. CUSTOM will appear on the display.

8. Adjusting the Speakers

BAL-FADE

The AUDIO knob adjusts balance and fade. To adjust balance, press the AUDIO knob until BAL appears on the display. Turn the knob to adjust the sound to the left or right speakers. The middle position balances the sound between the speakers. To adjust fade, press and hold the AUDIO knob until FAD appears on the display. Turn the knob to adjust the sound to the front or rear speakers. The middle position balances the sound between the speakers.

To set the balance and fade to the middle position, select balance or fade and press and hold the AUDIO knob.

The radio will beep once and will set the display level to the middle position. To set all tone and speaker controls to the middle position, press and hold the AUDIO knob when tone or speaker controls are not active. The radio will produce one beep and CENTERED will appear on the display.

D295C010-AAT

COMPACT DISC PLAYER OPERATION (D-295) (If installed)

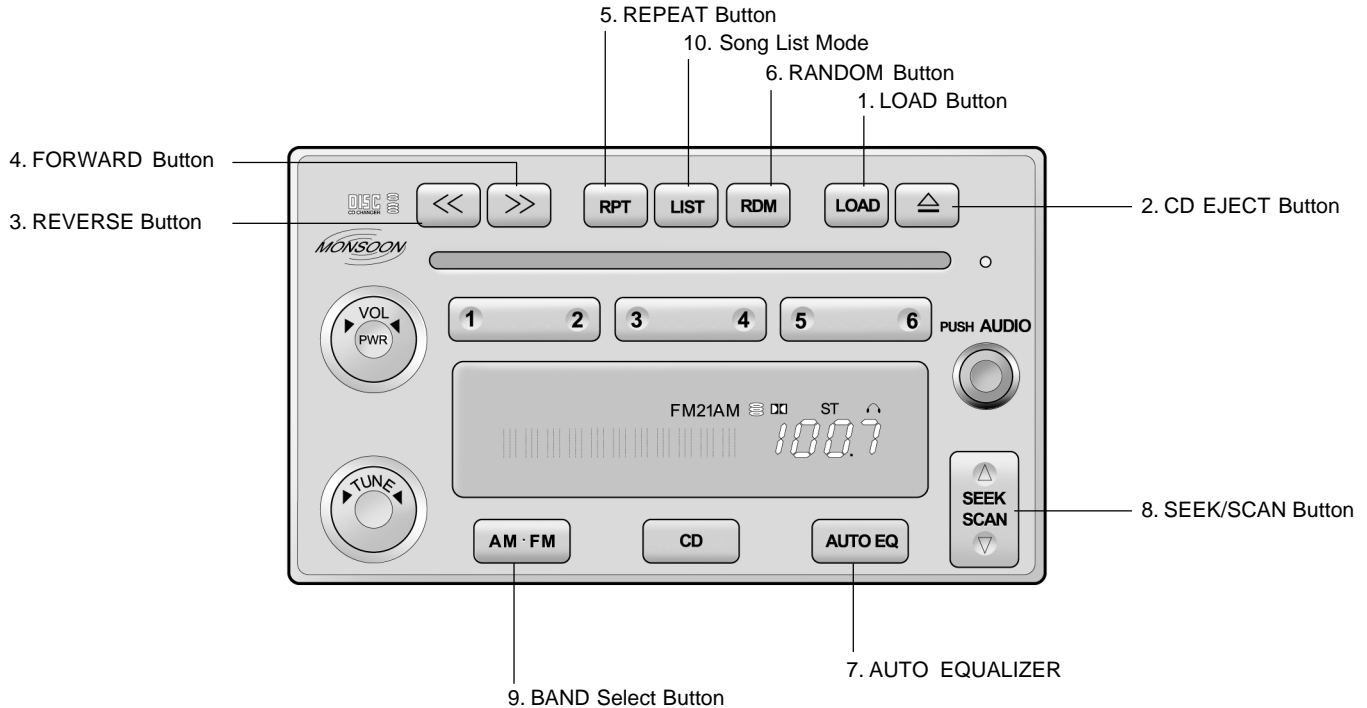

D295D01O-AAT

1. LOAD Button

This compact disc playing will accommodate up to six discs.

To insert one disc do the following:

1. Turn the ignition on.
2. Press and release the LOAD Button.
3. Wait for the light, located to the right of the slot, to turn green.
4. Load a disc. Insert a disc partway into the slot, label side up. The player will pull the disc in.

When the disc is inserted, the CD symbol will be displayed. If you select an EQ setting for your disc, it will be activated each time you play a disc. If the radio is on or off, the disc will begin to play automatically.

To inset multiple discs do the followings:

1. Turn the ignition on.
2. Press and hold the LOAD button for two seconds.
You will then hear two beeps and the light, located to the right of the slot, will begin to flash.
3. Once the light stops flashing and turns green. Load a disc. Insert a disc partway into the slot, label side up.

The player will pull the disc in.

Once the disc is loaded, the light will begin flashing again. Once the light stop flashing and turns green you can then load another disc. The disc player takes up to six discs. Do not try to load more than six.

When a disc is inserted, the CD symbol will be displayed. If more than one disc has been loaded, number for each disc will be displayed. If you select an EQ setting for your disc, it will be activated each time you play a disc.

If the radio is on or off, the last disc loaded will begin to play automatically.

4. To load more than one disc but less than six, complete Steps 1, 2 and 3. When you have finished loading discs, with the radio on or off, press LOAD to cancel the loading function. The radio will begin to play the last CD loaded.

As each new track starts to play, the track number will appear on the display.

Playing a Specific Loaded CD

For every CD loaded, a number will appear on the radio display. To play a specific CD, first press the CD select button to start playing a CD. Then press the numbered button that corresponds to the CD you want to play. A small bar will appear under the CD number that is playing, it could be due to one of the following conditions:

- o The road is too rough. The disc should play when the road is smoother.
- o The disc is dirty, scratched, wet or upside down.
- o The air is very humid. If so, wait about an hour and try again.

If any error occurs repeatedly or if an error can't be corrected, please contact your dealer. If your radio displays an error message, write it down and provide it to your dealer when reporting the problem.

2. CD EJECT Button

This button will eject a disc or discs, if you have multiple discs loaded. To eject a disc or discs from the disc player perform one of the following steps:

- o Press and release the eject button to eject the disc that is currently playing.
- o To eject all of the discs, press this button for two seconds, you will hear three beeps, and the light will flash to let you know when a disc is being ejected.

When the eject button is pressed, the receiver will eject the disc and REMOVE CD will be displayed. You can now remove the disc. If the disc is not removed, after 25 seconds, the disc will be automatically pulled back into the receiver. If you try to push the disc back into the receiver, before the 25 second time period is

complete, the receiver will sense an error and will try to eject the disc several times before stopping. You cannot repeatedly press the eject button to eject the disc after you have tried to push the CD in manually. The receiver's 25-second eject timer will reset at each press of eject, which will cause the receiver to not eject the disc until the 25-second time period has elapsed.

Once the player stops and the disc is ejected, remove the disc. After removing the disc, press the VOLUME PWR knob off and then on again. This will clear the disc-sensing feature and enable discs to be loaded into the player again.

3. REVERSE Button

Press and hold this button reverse quickly within a track. Release it to play the passage. You will hear sound at a reduced volume. The display will show elapsed time.

4. FORWARD Button

Press and hold this button to advance quickly within a track. Release it to play the passage. You will hear sound at a reduced volume. The display will show elapsed time.

5. REPEAT Button

With repeat button, you can repeat one track or an entire disc. To use repeat, do the following:

- o To repeat the track you are listening to, press and release the RPT button. RPT track will appear on the display. Press RPT again to turn it off.
- o To repeat the disc you are listening to, press and hold the RPT button for two seconds. Press RPT again to turn it off.

6. RANDOM Button

With random, you can listen to the tracks in random, rather than sequential order, on all of the discs or on one disc.

To use random, do the following:

- o Press and release the RDM button to play the tracks on all of the discs that are loaded, in random order. RDM will appear in the display. Press RDM to turn it off.
- o To play the tracks on the disc you are listening to in random order, press and hold RDM for more than two seconds. You will hear three beeps and RDM will appear on the display. Press RDM again to turn it off.

7. AUTO EQUALIZER

Press AUTO EQ to select the desired preset equalization setting while playing a compact disc. The equalization will be automatically set whenever you play a compact disc.

8. SEEK/SCAN BUTTON

SEEK

Press the down arrow while playing a CD to go to the start of the current track if more than ten seconds have played. Press the up arrow to go to the next track. If you press the button more than once, the player will continue moving backward or forward through the disc.

SCAN

Press and hold either SEEK SCAN arrow for more than two seconds until SCAN appears on the display and you hear a beep. Use SEEK SCAN to listen to each track for a few seconds. The sounds will mute while scanning. SCAN will appear on the display. Press either SEEK SCAN arrow again, to stop scanning.

DISC SCAN

Press and hold either SEEK SCAN arrow for more than four seconds until DISC SCAN appears on the display and you hear a beep. Use DISC SCAN to listen to the first track, for ten seconds of each disc loaded. The sound will mute while scanning to the next track. DISC SCAN will appear on the display. Press either SEEK SCAN arrow again, to stop scanning.

9. BAND Select Button

Press this button to play the radio when a disc is in the player.

10. Using Song List Mode

The integrated 6-disc CD changer has a feature called song list. This feature is capable of saving 20 track selections.

To save tracks into SONG LIST perform the following steps:

1. The disc player must be on with at least one disc loaded. See "LOAD/EJECT" previously for more information.
2. The disc changer must not be in song list mode. S-LIST should not appear in the display. If S-LIST is present, press SONG LIST to turn it off.
3. Select the desired disc by pressing the numbered pushbutton and then use the SEEK SCAN up arrow button to locate the track that you want to save. The track will begin to play.
4. Press and hold LIST for two or more seconds to save the track into memory. When LIST is pressed a beep will be heard immediately. After two seconds of pressing LIST continuously, two beeps will sound, to confirm that the track has been saved.
5. Repeat Steps 3 and 4 for saving other selections.

To play the song list, press LIST. One beep will be heard and SLIST will appear on the display. The recorded tracks will begin to play in the order that they were saved.

You may seek through the song list by using the SEEK SCAN arrows. Seeking past the last saved track will return you to the first saved track.

To delete tracks from SONG LIST perform the following steps:

1. The disc player must be turned on.
2. Press SONG LIST to turn song list on. S-LIST will appear on the display.
3. Press the SEEK SCAN arrows to select the desired track to be deleted.
4. Press and hold the SONG LIST button for two seconds. When pressing SONG LIST one beep will be heard immediately. After two seconds of pressing the SONG LIST button continuously, two beeps will be heard, to confirm that the track had been deleted.
5. To delete entire lists, press and hold LIST button for > 4 seconds when pressing list, one beep will be heard immediately. After two seconds of pressing the LIST button continuously, two beeps will be heard. After 4 seconds, a beep would be heard to confirm that all the tracks had been deleted and display will show SLIST_EMPTY.

B850A02F-AAT

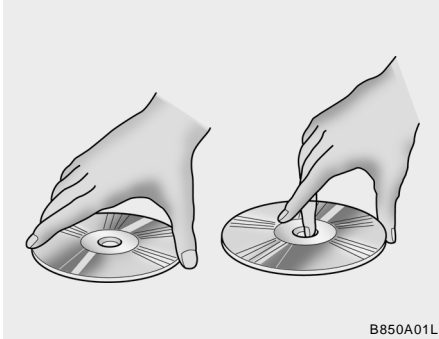
CARE OF DISC**Proper Handling**

B850A01L

Handle your disc as shown. Do not drop the disc. Hold the disc so you will not leave fingerprints on the surface. If the surface is scratched, it may cause the pickup to skip signal tracks. Do not affix tape, paper, or gummed labels on the disc. Do not write on the disc.

Damaged Disc

Do not attempt to play damaged, warped or cracked discs. These could severely damage the playback mechanism.

Storage

When not in use, place your discs in their individual case and store them in a cool place away from the sun, heat, and dust. Do not grip or pull out the disc with your hand while the disc is being pulled into the unit by the self loading mechanism.

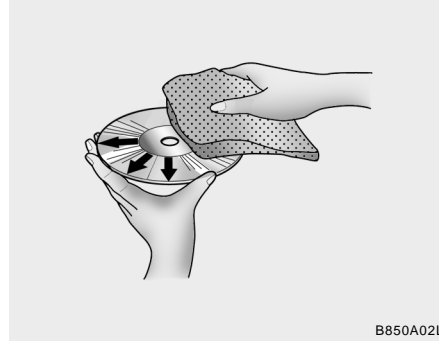
Keep Your Discs Clean

B850A02L

Fingerprints, dust, or soil on the surface of a disc could cause the pickup to skip signal tracks. Wipe the surface clean with a clean soft cloth. If the surface is heavily soiled, dampen a clean soft cloth in a solution of mild neutral detergent to wipe it clean. See drawing.

B860A01A-AAT

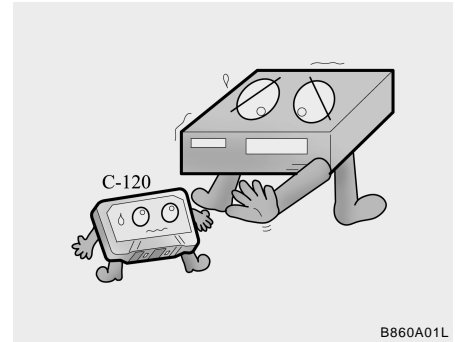
CARE OF CASSETTE TAPES

B860A01L

Proper care of your cassette tapes will extend the tape life and increase your listening enjoyment. Always protect your tapes and cassette cases from direct sunlight, severely cold and dusty conditions. When not in use, cassettes should always be stored in the original protective cassette case. When the vehicle is very hot or cold, allow the interior temperature to become more comfortable before listening to your cassettes.

- o Never leave a cassette inserted in the player when not being played. This could damage the tape player unit and the cassette tape.
- o We strongly recommend against the use of tapes longer than C-60 (60 minutes total). Tapes such as C-120 or C-180 are very thin and do not perform as well in the automotive environment.

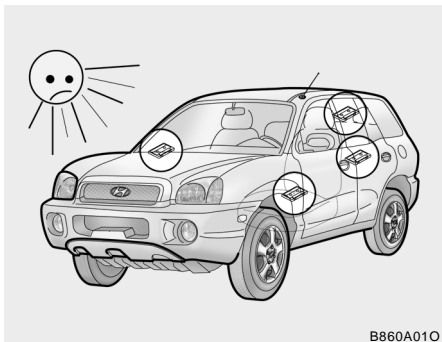

B860A01O

- o Be sure that the cassette label is not loose or peeling off or tape ejection may be difficult.
- o Never touch or soil the actual audio tape surfaces.
- o Keep all magnetized objects, such as electric motors, speakers or transformers away from your cassette tapes and tape player unit.
- o Store cassettes in a cool, dry place with the open side facing down to prevent dust from settling in the cassette body.
- o Avoid repeated fast reverse usage to replay one given tune or tape section. This can cause poor tape winding to occur, and eventually cause excessive internal drag and poor audio quality in the cassette. If this occurs, it can sometimes be corrected by fast winding the tape from end to end several times. If this does not correct the problem, do not continue to use the tape in your vehicle.

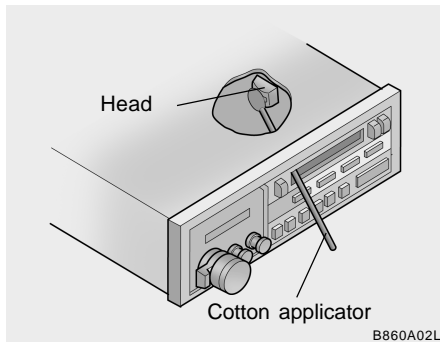

B860A02L

- o The playback head, capstan and pinch rollers will develop a coating of tape residue that can result in deterioration of sound quality, such as a wavering sound. They should be cleaned monthly using a commercially available head cleaning tape or special solution available from audio specialty shops. Follow the supplier's directions carefully and never oil any part of the tape player unit.
- o Always be sure that the tape is tightly wound on its reel before inserting in the player. Rotate a pencil in the drive sprockets to wind up any slack.

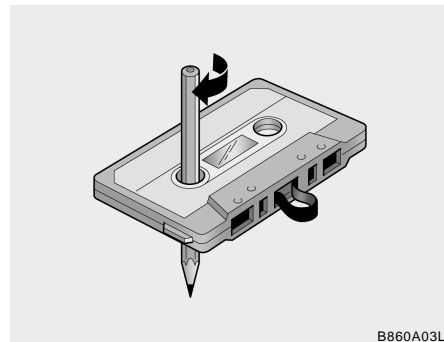

B860A03L

NOTE:

Look at a tape before you insert it. If the tape is loose, tighten it by turning one of the hubs with a pencil or your finger. If the label is peeling off, do not put it in the drive mechanism.

Do not leave tapes sitting where they are exposed to hot, warm, or high humidity, such as on top of the dashboard or in the player. If a tape is excessively hot or cold, let it reach a moderate temperature before putting it in the player.

2. DRIVING YOUR HYUNDAI

Before Starting the Engine	2-3
Key Positions	2-4
Starting	2-5
Operating the Manual Transaxle	2-5
Automatic Transaxle	2-7
Anti-Lock Brake System (ABS)	2-10
Brake Traction Control System (BTCS)	2-11
Full Traction Control System (FTCS)	2-12
Full-Time 4WD Operation	2-13
Limited-Slip Differential	2-15
Good Braking Practices	2-15
Driving for Economy	2-16
Winter Driving	2-17
Trailer or Vehicle Towing	2-19



WARNING: ENGINE EXHAUST CAN BE DANGEROUS!

C010A010-AAT

Engine exhaust fumes can be extremely dangerous. If, at any time, you smell exhaust fumes inside the vehicle, open the windows immediately.

Engine exhaust, some of its constituents, and certain vehicle components contain or emit chemicals known to the State of California to cause cancer and birth defects and reproductive harm. In addition, certain fluids contained in vehicles and certain products of component wear contain or emit chemicals known to the State of California to cause cancer and birth defects or other reproductive harm.

o Do not inhale exhaust fumes.

Exhaust fumes contain carbon monoxide, a colorless, odorless gas that can cause unconsciousness and death by asphyxiation.

o Be sure the exhaust system does not leak.

The exhaust system should be checked whenever the vehicle is raised to change the oil or for any other purpose. If you hear a change in the sound of the exhaust or if you drive over something that strikes the underneath side of the car, have the exhaust system checked as soon as possible by your Hyundai dealer.

o Do not run the engine in an enclosed area.

Letting the engine idle in your garage, even with the garage door open, is a hazardous practice. Never run the engine in your garage any longer than it takes to start the engine and back the car out.

o Avoid idling the engine for prolonged periods with people inside the car.

If it is necessary to idle the engine for a prolonged period with people inside the car, be sure to do so only in an open area with the air intake set at "Fresh" and fan operating at one of the higher speeds so fresh air is drawn into the interior.

If you must drive with the tail gate open because you are carrying objects that make this necessary:

1. Close all windows.
2. Open side vents.
3. Set the air intake control at "Fresh", the air flow control at "Floor" or "Face" and the fan at one of the higher speeds.

To assure proper operation of the ventilation system, be sure the ventilation air intakes located just in front of the windshield are kept clear of snow, ice, leaves or other obstructions.

**WARNING:**

- o The 2WD Santa Fe is not designed for off-road use. The 4WD Santa Fe is designed primarily for use on paved roads. However, occasional use in off-highway conditions such as established unpaved roads and non-challenging off-road trails is allowed. The 4WD Santa Fe is not designed for blazing new trails, challenging off-road conditions, or unpaved hill climbing. Exceeding the conditions that were intended for the vehicle's primary design may result in injury or death.
- o Utility vehicle has a significantly higher collision rate than other type of vehicles.
- o Utility vehicle have higher ground clearance and a narrower track to make them capable of performing in a wide variety of off-road applications. Specific design characteristics give them a higher center of gravity than ordinary cars. An advantage of the higher ground clearance is a better view of the road allowing you to anticipate problem. They are not designed for cornering at the same speeds as conventional 2-wheel drive vehicles any more than low-slung sports cars are designed to perform satisfactorily under off-road conditions. If at all possible, avoid sharp turns or abrupt maneuvers. As with other vehicles of this type, failure to operate this vehicle correctly may result in loss of control or vehicle rollover.

**WARNING:**

- o In a collision crash, an unbelted person is significantly more likely to die than a person wearing a seatbelt.

C020A01A-AAT

BEFORE STARTING THE ENGINE

Before you start the engine, you should always:

1. Look around the vehicle to be sure there are no flat tires, puddles of oil, water or other indications of possible trouble.
2. After entering the car, check to be sure the parking brake is engaged.
3. Check that all windows, and lights are clean.
4. Check that the interior and exterior mirrors are clean and in position.
5. Check your seat, seatback and headrest to be sure they are in their proper positions.
6. Lock all the doors.
7. Fasten your seat belt and be sure that all other occupants have fastened theirs.
8. Turn off all lights and accessories that are not needed.
9. When you turn the ignition switch to "ON", check that all appropriate warning lights are operating and that you have sufficient fuel.
10. Check the operation of warning lights and all bulbs when key is in the "ON" position.

C030A01E-AAT

COMBINATION IGNITION SWITCH**To Start the Engine**

- o If your Hyundai is equipped with a manual transaxle, place the shift lever in neutral and depress the clutch pedal fully.
- o If your Hyundai has an automatic transaxle, place the shift lever in "P" (park).
- o To start the engine, insert the ignition key and turn it to the "START" position. Release it as soon as the engine starts. Do not hold the key in the "START" position for more than 15 seconds.

NOTE:

- o **For safety, the engine will not start if the clutch pedal is not depressed fully (Manual Transaxle) or the shift lever is not in "P" or "N" Position (Automatic Transaxle).**
- o **The ignition key cannot be turned from "ACC" position to "LOCK" position unless the shift lever is in the "P" (Park) position or the negative battery terminal is disconnected from the battery. To remove the key, always confirm that the shift lever is securely positioned in "P" (Park) (For Automatic Transaxle)**
- o **For additional information about starting, see page 2-5.**

C040A01A-AAT

KEY POSITIONS

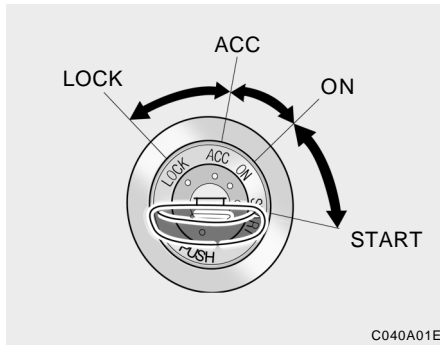

CAUTION:

The engine should not be turned off or the key removed from the ignition key cylinder while the car is in motion. The steering wheel is locked by removing the key.

o "START"

The engine is started in this position. It will crank until you release the key.

NOTE:

Do not hold the key in the "START" position for more than 15 seconds.

o "ON"

When the key is in the "ON" position, the ignition is on and all accessories may be turned on. If the engine is not running, the key should not be left in the "ON" position. This will discharge the battery and may also damage the ignition system.

o "ACC"

With the key in the "ACC" position, radio and other accessories may be operated. If you open the driver's door with the key in the "ACC" or "LOCK" position, the chime will sound to remind you that the key should be removed.

o "LOCK"

The key can be removed or inserted in this position. Steering is locked by removing the key. When unlocking the steering, insert the key, and then turn the steering wheel and key simultaneously.

C070C01A-AAT

To remove the ignition key

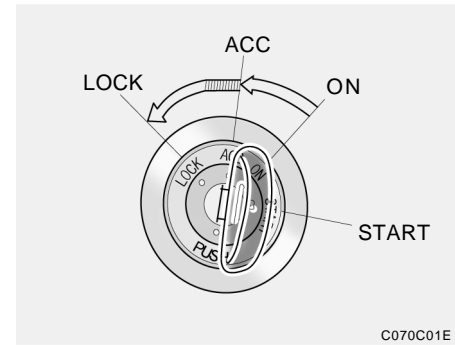

1. Turn the ignition key to the "ACC" position.
2. Simultaneously push and turn the ignition key counterclockwise from the "ACC" position to the "LOCK" position.
3. The key can be removed in the "LOCK" position.

C050A01A-AAT

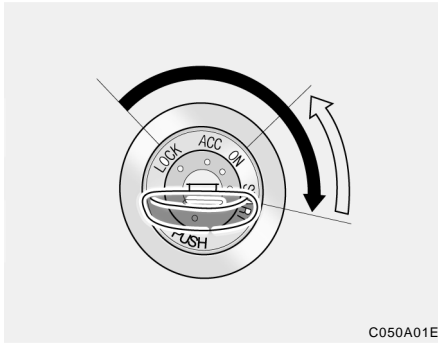
STARTING

C050A01E

**WARNING:**

Never run the engine in a closed or poorly ventilated area any longer than is needed to move your car in or out of the area. The carbon monoxide gas emitted is odorless and can cause serious injury or death.

C050B01A-AAT

Normal Conditions:

The Starting Procedure:

1. Insert key, and fasten the seat belt.
2. Depress the clutch pedal fully and place the gearshift lever (manual transaxle) in neutral or the selector lever (automatic transaxle) in "P" (park) position.
3. After turning the ignition key to the "ON" position, make certain all warning lights and gauges are functioning properly before starting the engine.

**WARNING:**

Be sure that the clutch is fully depressed when starting a manual transaxle vehicle. Your manual transaxle equipped vehicle will not start unless the clutch pedal is fully depressed. On a manual transaxle equipped vehicle that can be started without depressing the clutch, there is the potential to cause damage to the vehicle or injury to someone inside or outside the vehicle as a result of the forward or backward movement of the vehicle that will occur if the clutch is not depressed when the vehicle is started.

4. Turn the ignition key to the "Start" position and release it when the engine starts. After the engine has started, allow the engine to run for 10 to 20 seconds prior to placing the vehicle in gear. The starter should not be operated for more than 15 seconds at a time. Wait 15-30 seconds between starting attempts to protect the starter from overheating.

C070A01A-AAT

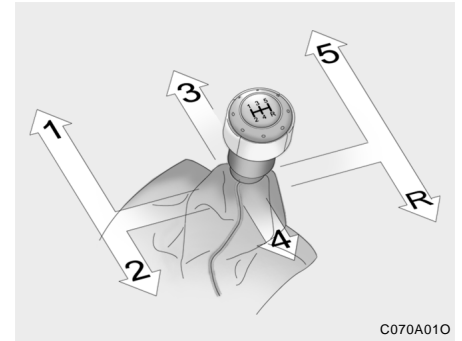
OPERATING THE MANUAL TRANSAXLE

C070A01O

Your Hyundai's manual transaxle has a conventional shift pattern. This shift pattern is imprinted on the shift knob. The transaxle is fully synchronized in all forward gears so shifting to either a higher or a lower gear is easily accomplished.

NOTE:

- o To shift into reverse, rest the lever in neutral for at least 3 seconds after your car is completely stopped. Then move the lever into the reverse position.
- o During cold weather, shifting may be difficult until the transaxle lubricant has warmed up. This is normal and not harmful to the transaxle.
- o If you've come to a complete stop and it's hard to shift into 1st or R(Reverse), put the shift lever in N(Neutral) position and release the clutch. Press the clutch pedal back down, and then shift into 1st or R(Reverse) gear position.
- o Do not use the shift lever as a handrest during driving, as this can result in premature wear of the transaxle shift forks.

**CAUTION:**

When downshifting from fifth gear to fourth gear, caution should be taken not to inadvertently press the gear lever sideways in such a manner that second gear is engaged. Such a drastic downshift may cause the engine speed to increase to the point that the tachometer will enter the red-zone. Such over-revving of the engine may possibly cause engine damage.

C070B01A-AAT

Using the Clutch

The clutch should be pressed all the way to the floor before shifting, then released slowly. The clutch pedal should always be used after fully returning to the original position. Do not rest your foot on the clutch pedal while driving. This can cause unnecessary wear.

Do not partially engage the clutch to hold the car on an incline. This causes unnecessary wear. Use the parking brake to hold the car on an incline. Do not operate the clutch pedal rapidly and repeatedly.

C070D02A-AAT

Good Driving Practices

- o Never take the car out of gear and coast down a hill. This is extremely hazardous. Always leave the car in gear.
- o Don't "ride" the brakes. This can cause them to overheat and malfunction. Instead, when you are driving down a long hill, slow down and shift to a lower gear. When you do this, engine braking will help slow the car.
- o Slow down before shifting to a lower gear. This will help avoid over-revving the engine, which can cause damage.
- o Slow down when you encounter cross winds. This gives you much better control of your car.
- o Be sure the car is completely stopped before you attempt to shift into reverse. The transaxle can be damaged if you do not. To

shift into reverse, depress the clutch, move the shift lever to neutral, wait three seconds, then shift to the reverse position.

- o Exercise extreme caution when driving on a slippery surface. Be especially careful when braking, accelerating or shifting gears. On a slippery surface, an abrupt change in vehicle speed can cause the drive wheels to lose traction and the vehicle to go out of control.

**WARNING:**

- o Avoid high cornering speeds.
- o Do not make quick steering wheel movements, such as sharp lane changes or fast, sharp turns.
- o Always wear your seat belts.
- o The risk of rollover is greatly increased if you lose control of your vehicle at highway speeds.
- o Loss of control often occurs if two or more wheels drop off the roadway and the driver oversteers to reenter the roadway.
- o In the event your vehicle leaves the roadway, do not steer sharply. Instead, slow down before pulling back into the travel lanes.
- o In a collision crash, an unbelted person is significantly more likely to die than a person wearing a seatbelt.
- o Never exceed posted speed limits.

C070E02A-AAT

Recommended Shift Points

Shift from-to	Recommended mph (km/h)
1-2	15 (20)
2-3	25 (40)
3-4	35 (55)
4-5	45 (75)

The shift points as shown on the chart are recommended for optimum fuel economy and performance.

C090A010-GAT

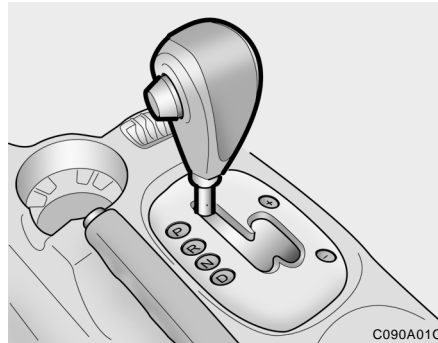
AUTOMATIC TRANSAXLE

C090A010



The highly efficient Hyundai automatic transaxle has four forward speeds and one reverse speed. The individual speeds are selected automatically, depending on the position of the speed selector lever. The selector lever has 2 gates; the main gate and the manual gate.

NOTE:

For information on manual gate operation, refer to "Sports Mode".

In the main gate, the selector lever has 4 positions, and is equipped with a button to avoid inadvertent wrong selection.

NOTE:

-  Depress the brake pedal and push the button when shifting.
-  Push the button when shifting.
-  The selector lever can be shifted freely.

The first few shifts on a new vehicle, or if the battery has been disconnected, may be somewhat abrupt. This is a normal condition, and the shifting sequence will adjust after shifts are cycled a few times by the T.C.M (Transmission Control Module).

**CAUTION:**

Never shift into "R" or "P" position while the vehicle is moving.

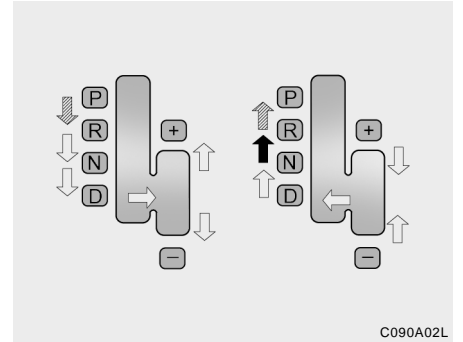

C090A02L

The indicator lights in the instrument cluster indicate the selector lever position when the ignition is switched "ON". During "D" range operation, green lights indicate the gear currently in use.

C090B01A-AAT

The function of each position is as follows:

o P (Park):

Use to hold the vehicle in place when parked or while starting the engine; shift the selector lever to the "P" (Park) position. Whenever parking the car, apply the parking brake and shift the selector lever to the "P" (Park) position.



CAUTION:

Never place the selector lever in the "P" (Park) position unless the vehicle is fully stopped. Failure to observe this caution will cause severe damage to the transaxle.

C090C01A-AAT

o R (Reverse):

Use for backing up the vehicle. Bring the car to a complete stop before shifting the selector lever to "R" position.

C090D02O-AAT

o N (Neutral):

In the "N" position, the transaxle is in neutral, which means that no gears are engaged. The engine can be started with the shift lever in "N" position, although this is not recommended except if the engine stalls while the car is moving.

C090E01O-AAT

o D (Drive):

Use for normal driving. The transaxle will automatically shift through a four gear sequence.

C090F01O-GAT

Sports Mode

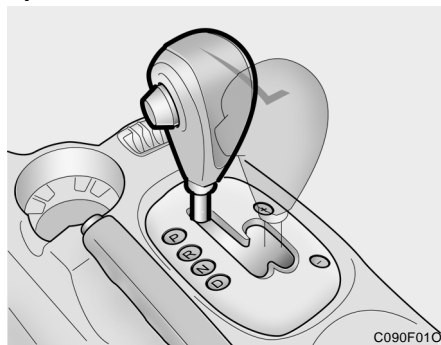

Whether the vehicle is stationary or in motion, sports mode is selected by pushing the selector lever from the "D" position into the manual gate. To return to "D" range operation, push the selector lever back into the main gate. In sports mode, moving the selector lever backwards and forwards can make rapid gearshifts simple. In contrast to a manual transaxle, the sports mode allows gearshifts with the accelerator pedal depressed.

UP (+) : Push the lever forward once to shift up one gear.

DOWN (-) : Pull the lever backwards once to shift down one gear.

SKIP : By rapidly moving the selector forward or backward twice, it is possible to skip one gear, i.e. 1st to 3rd or 3rd to 1st .

**CAUTION:**

- o In sports mode, The driver must execute upward shifts in accordance with prevailing road conditions, taking care to keep the engine speed below the red zone.
- o For engine protection, upward shifts are made automatically when the engine rpm reaches the red zone.
- o By rapidly moving the selector lever backwards (-) twice it is possible to skip one gear, i.e., 3rd to 1st, 4th to 2nd. Since sudden engine braking and/or rapid acceleration can cause a loss of traction, however, downshifts must be made carefully in accordance with the vehicle's speed.

NOTE:

- o In sports mode, only the four forward gears can be selected. To reverse or park the vehicle, move the selector lever to the "R" or "P" position as required.
- o In sports mode, downward shifts are made automatically when the vehicle slows down. When the vehicle stops, 1st gear is automatically selected.
- o To maintain the required levels of vehicle performance and safety, the system may not execute certain gearshifts when the selector lever is operated.

- o Before driving away from a stop on a slippery road, push the selector lever forward into the +(UP) position. This causes the transaxle to shift into 2nd gear which is better for smooth driving away on a slippery road. Push the selector lever to the -(DOWN) side to shift back to 1st gear.

C090H01Y-AAT

NOTE:

- o For smooth and safe operation, depress the brake pedal when shifting from "Neutral" position or "Park" position to a forward or reverse gear.
- o The ignition key must be in the "ON" position and the brake pedal fully depressed in order to move the shift lever from the "P" (Park) position to any of the other positions.
- o It is always possible to shift from "R", "N", "D", "2", "3", "L" position to "P" position. The vehicle must be fully stopped to avoid transaxle damage.

C090I01Y-AAT

**CAUTION:**

- o Shift into "R" and "P" position only when the vehicle has completely stopped.
- o Do not accelerate the engine in reverse or any of the forward positions with the brakes applied.
- o Always apply the footbrake when shifting from "P" or "N", to "R", "D", "2", "3" or "L" position.
- o Do not use the "P" (Park) position in place of the parking brake. Always set the parking brake, shift the transaxle into "P" (Park) position and turn off the ignition when you leave the vehicle, even momentarily. Never leave the vehicle unattended while the engine is running.
- o Check the automatic transaxle fluid level regularly, and add fluid as necessary. See the maintenance for the proper fluid recommendation.

C090N01Y-AAT

Good Driving Practices

- Never move the gear selector lever from "P" or "N" to any other position with the accelerator pedal depressed.
- Never move the gear selector lever into "P" when the vehicle is in motion.
- Be sure the car is completely stopped before you attempt to shift into "R".
- Never take the car out of gear and coast down a hill. This may be extremely hazardous. Always leave the car in gear when moving.
- Do not "ride" the brakes. This can cause them to overheat and malfunction. Instead, when you are driving down a long hill, slow down and shift to a lower gear. When you do this, engine braking will help slow the car.
- Slow down before shifting to a lower gear. Otherwise, the lower gear may not be engaged.
- Always use the parking brake. Do not depend on placing the transaxle in "P" to keep the car from moving.
- Exercise extreme caution when driving on a slippery surface. Be especially careful when braking, accelerating or shifting gears. On a slippery surface, an abrupt change in vehicle speed can cause the drive wheels to lose traction and the vehicle to go out of control.



WARNING:

- Avoid high cornering speeds.
- Do not make quick steering wheel movements, such as sharp lane changes or fast, sharp turns.
- Always wear your seat belts.
- The risk of rollover is greatly increased if you lose control of your vehicle at highway speeds.
- Loss of control often occurs if two or more wheels drop off the roadway and the driver oversteers to reenter the roadway.
- In the event your vehicle leaves the roadway, do not steer sharply. Instead, slow down before pulling back into the travel lanes.
- In a collision crash, an unbelted person is significantly more likely to die than a person wearing a seatbelt.
- Never exceed posted speed limits.

C120A02A-AAT

ANTI-LOCK BRAKE SYSTEM (ABS) (If installed)

The Anti-Lock Brake System (ABS) is designed to prevent wheel lock-up during sudden braking or on hazardous road surfaces. The ABS control module monitors the wheel speed and controls the pressure applied to each brake. Thus, in emergency situations or on slick roads, ABS will increase vehicle control during braking.

NOTE:

During ABS operation, a slight pulsation may be felt in the brake pedal when the brakes are applied. Also, a noise may be heard in the engine compartment while braking. These conditions are normal and indicate that the anti-lock brake system is functioning properly.



WARNING:

ABS will not prevent accidents due to improper or dangerous driving maneuvers. Even though vehicle control is improved during emergency braking, always maintain a safe distance between you and objects ahead. Vehicle speeds should always be reduced during extreme road conditions.

The braking distance for cars equipped with an anti-lock braking system may be longer than for those without it in the following road conditions.

**WARNING:**

- o Driving on rough, gravel or snow-covered roads.
- o Driving with tire chains installed.
- o Driving on roads where the road surface is pitted or has different surface height.

During these conditions the vehicle should be driven at reduced speeds. The safety features of an ABS equipped vehicle should not be tested by high speed driving or cornering. This could endanger the safety of yourself or others.

C300A02O-AAT

BRAKE TRACTION CONTROL SYSTEM (BTCS) (If installed)

On slippery road surfaces, the traction control system (TCS) limits the drive wheels from spinning excessively, thus helping the car to accelerate. It also provides sufficient driving force and steering performance as the car turns at accelerated speeds.

SLIP Control

Limits the drive wheels from spinning excessively during starting or while making accelerated turns on slippery roads to avoid losing the driving force of the driven wheels.

Driving hints

TCS does not actively apply brakes. Be sure to decelerate the car sufficiently before entering curves.

**CAUTION:**

When the TCS indicator blinks, SLIP function has been activated. It also means that the road is slippery or your car is accelerating excessively. In this situation, release foot pressure from the accelerator pedal and maintain moderate speed.

**WARNING:**

Traction control is only a driving aid; all normal precautions for driving in inclement weather and on slippery road surfaces should be observed.

C300B01O-GAT

TCS ON Mode

In the TCS ON mode, the TCS indicator light in the instrument cluster will blink.

NOTE:

- 1) Turn off the engine. Then restart the engine, and the TCS mode will automatically turn ON.
- 2) When the traction control system is operating properly, you can feel a slight pulsation in the vehicle. This is only the effect of brake control and indicates nothing unusual.
- 3) When the engine starts, a click is heard from the engine compartment; however, this is only the sound of traction control being checked.
- 4) When moving out of the mud or fresh snow, pressing the accelerator pedal may not cause the engine speed to increase.

C300D020-AAT

Indicator and Warning

The indicator should illuminate when the ignition key is turned to ON or START but should go out after three seconds.

If the indicator does not illuminate, have it checked by an authorized dealer.

Should there be any unusual conditions in the device while driving, TCS illuminates as a warning.

If TCS illuminates, pull your car to a safe place and stop the engine. Then, start the engine again to check if the TCS indicator goes out.

If the indicator remains lit even after the engine has been started, have your car checked by an authorized Hyundai dealer.

NOTE:

When TCS indicator illuminates, traction control is automatically deactivated for safety.

C310A010-AAT

FULL TRACTION CONTROL SYSTEM (FTCS) (3.5 L only) (If installed)

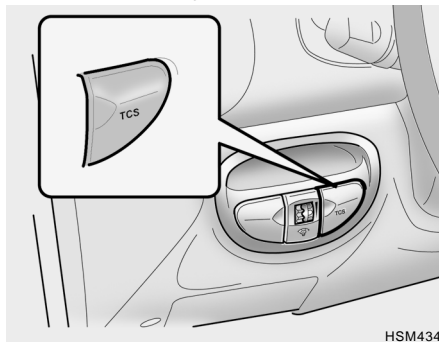

On slippery road surfaces, the traction control system (TCS) limits the drive wheels from spinning excessively, thus helping the car to accelerate. It also provides sufficient driving force and steering performance as the car turns at accelerated speeds.

SLIP Control

Limits the drive wheels from spinning excessively during starting or while making accelerated turns on slippery roads to avoid losing the driving force of the front wheels.

Driving hints

TCS does not actively apply brakes. Be sure to decelerate the car sufficiently before entering curves.



CAUTION:

When the TCS indicator blinks, SLIP control has been activated. It also means that the road is slippery or your car is accelerating excessively. In this situation, release foot pressure from the accelerator pedal and maintain moderate speed.



WARNING:

Traction control is only a driving aid; all normal precautions for driving in inclement weather and on slippery road surfaces should be observed.

C310B01O-AAT

TCS ON/OFF Mode

In the TCS-ON mode, the TCS indicator light in the instrument cluster will blink.

If you turn the system off by pressing the TCS switch, the TCS-OFF indicator light will come on and stay on. In the TCS-OFF mode, the SLIP control will be deactivated. Adjust your driving accordingly. To turn the system back on, press the switch again. The TCS-OFF indicator light should go off.

NOTE:

- 1) Turn off the engine. Then restart the engine, and the TCS mode will automatically turn ON.
- 2) When the traction control system is operating properly, you can feel a slight pulsation in the vehicle. This is only the effect of brake control and indicates nothing unusual.
- 3) When the engine starts, a click is heard from the engine compartment; however, this is only the sound of traction control being checked.
- 4) When moving out of the mud or fresh snow, pressing the accelerator pedal may not cause the engine speed to increase.

C310D01O-AAT

Indicators and Warning

The indicators should illuminate when the ignition key is turned to ON or START but should go out after three seconds.

If the indicators do not illuminate, or the TCS or TCS-OFF indicator does not go out after 3 seconds, have it checked by an authorized dealer.

Should there be any unusual conditions in the device while driving, TCS-OFF indicator illuminates as a warning.

If TCS-OFF indicator illuminates, pull your car to a safe place and stop the engine. Then, start the engine again to check if the TCS-OFF indicator goes out.

If the indicator remains lit even after the engine has been started, have your car checked by an authorized Hyundai dealer.

NOTE:

- 1) When TCS-OFF indicator illuminates, traction control is automatically deactivated for safety.
- 2) This warning function is not provided when the driver selects the TCS-OFF mode.

C350A02O-AAT

Full-Time 4WD Operation (If installed)

Engine power can be delivered to all front and rear wheels for maximum power. Full-time 4WD is useful when good traction is required, such as, when driving on slippery, wet or snow-covered roads and when moving out of mud. These vehicles, however, are not designed for challenging off-road use. Full-time 4WD vehicles are designed primarily to improve traction and performance on paved roads and highways in wet and/or slippery conditions. Occasional off-road use such as established unpaved roads and trails is OK. It is always important when traveling off-highway that the driver carefully reduce their speed to a level that does not exceed the safe operating speed for those conditions. In general, off-road conditions provide less traction and braking effectiveness than on road conditions. These factors must be carefully considered when driving off-road. Keeping the vehicle in contact with the driving surface and under control in these conditions is always the driver's responsibility for the safety of him/herself and his or her passengers.

**WARNING:**

This vehicle is designed primarily for on road use. Driving the vehicle in challenging off-road conditions for which it was not designed may result in damage to the vehicle. Driving in conditions that exceed the vehicle's intended design or the driver's experience level may result in severe injury or death.

Driving 4WD Safely

- (1) Be sure to wear the seat belt.
- (2) Do not drive in challenging off-road conditions or areas that exceed the vehicle's basic design intent or the driver's experience level.
- (3) Drive at lower speeds in strong crosswinds. Because of your vehicle's high center of gravity, its stability will be affected in crosswinds. Slower speeds ensure better vehicle control.
- (4) Check the brake condition after driving in wet or muddy conditions. Press the brake several times as you move slowly until you feel normal braking forces return.
- (5) Do not drive the vehicle through water. (i.e. streams, rivers, lakes, etc.)
- (6) The stopping distance of the full-time 4WD vehicle differs very little from that of the 2WD vehicle.

When driving on a snow-covered road or a slippery, muddy surface, make sure that you keep a sufficient distance between your vehicle and the one ahead of you.

- (7) Since the driving torque is always applied to the 4 wheels, the performance of the full-time 4WD vehicle is greatly affected by the condition of the tires. Be sure to equip it with all four tires of the same size and type.
 - o When replacement of any of the tires or disc wheels is necessary, replace all of them.
 - o Rotate the tires and check the tire pressure at regular intervals.
- (8) **The full-time 4WD vehicle cannot be towed by an ordinary tow truck. Make sure that the vehicle is towed with its four wheels raised off the ground.**
 - o Roadside Assistance Program: Off-roading is not covered. To receive service, the vehicle must be on a publicly maintained road.
 - o If the vehicle is towed with its only two wheels raised off the ground, the 4WD system could be damaged.
 - o In unavoidable case, if the vehicle is being towed with all four wheels on the ground, it should be towed only forward direction with rope.
 - o While towing, check the following items.
 1. The ignition switch is in "ACC" or "ON".
 2. Place the shift lever in neutral (For Automatic Transaxle, "N" position).
 3. Release the parking brake.

NOTE:

To avoid serious damage to your 4WD vehicle, limit towing to 10 mph and not for more than 1 mile at ANY TIME.

- (9) For speedometer test or inspection/maintenance (I/M) program of SANTA FE 4WD, use a four wheel chassis dynamometer.

**CAUTION:**

Never engage the parking brake while performing these tests.

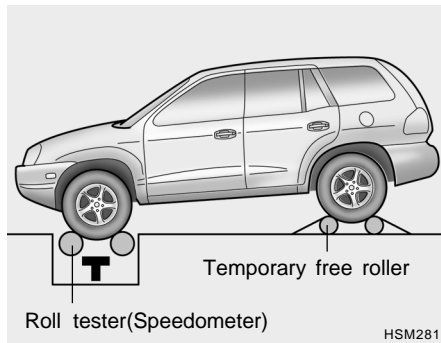

- o In rare cases when it's unavoidable that a 4WD vehicle is to be inspected for speedometer test on 2WD roll tester, strictly follow the procedures next.

1. Check the tire pressures recommended for your vehicle.
2. Place the front wheels on the roll tester for speedometer as shown in the illustration.
3. Release the parking brake.
4. Place the rear wheels on the temporary free roller as shown in the illustration.

**WARNING:**

Keep away from the front of the vehicle while inspecting. This is very dangerous as the vehicle can jump forward and cause serious injury or death.

- (10) When using tire chains, always attach them to the front wheels.
- (11) If the front or rear wheels get stuck in the mud, do not spin them recklessly. The 4WD system could be damaged.

**CAUTION:**

- o While the full-time 4WD vehicle is being raised on a jack, never start the engine or cause the tires to rotate. There is the danger that rotating tires touching the ground could cause the vehicle to go off the jack and to jump forward.

- o If one of the front or rear wheels begins to spin in mud, snow, etc., the vehicle can sometimes be driven out by depressing the accelerator pedal further; however, avoid running the engine continuously at high rpm because doing so could damage the 4WD system.

**WARNING:**

- o Avoid high cornering speeds.
- o Do not make quick steering wheel movements, such as sharp lane charges or fast, sharp turns.
- o The risk of rollover is greatly increased if you lose control of your vehicle at highway speeds.
- o In a collision crash, an unbelted person is significantly more likely to die a person wears a seatbelt.
- o Loss of control often occurs if two or more wheels drop off the roadway and the driver oversteers to reenter the roadway.
- o In the event your vehicle leaves the roadway, do not steer sharply. Instead, slow down before pulling back into the travel lanes.

D190A01O-GAT

Limited-Slip Differential (If installed)

A limited-slip differential, if equipped, is for the rear wheel differential only. The features of this limited-slip differential are described below: Just as with a conventional differential, the wheel on one side is allowed to turn at a different speed from the wheel on the other side when the vehicle is cornering. The difference between the limited-slip differential and a conventional differential is that if the wheel on one side of the vehicle loses traction, a greater amount of torque is applied to the rear wheel on the other side to improve traction.

C130A01A-AAT

GOOD BRAKING PRACTICES**WARNING:**

Nothing should be carried on top of the cargo area cover behind the rear seat. If there were an accident or a sudden stop, such objects could move forward and cause damage to the vehicle or injure the occupants.

- o After being parked, check to be sure the parking brake is not engaged and that the parking brake indicator light is out before driving away.
- o Driving through water may get the brakes wet. They can also get wet when the car is washed. Wet brakes can be dangerous! Your car will not stop as quickly if the brakes are wet. Wet brakes may cause the car to pull to one side. To dry the brakes, apply the brakes lightly until the braking action returns to normal, taking care to keep the car under control at all times. If the braking action does not return to normal, stop as soon as it is safe to do so and call your Hyundai dealer for assistance.
- o Don't coast down hills with the car out of gear. This is extremely hazardous. Keep the car in gear at all times, use the brakes to slow down, then shift to a lower gear so that engine braking will help you maintain a safe speed.
- o Don't "ride" the brake pedal. Resting your foot on the brake pedal while driving can be dangerous because it can result in the brakes overheating and losing their effectiveness. It also increases the wear of the brake components.
- o If a tire goes flat while you are driving, apply the brakes gently and keep the car pointed straight ahead while you slow down. When you are moving slowly enough for it to be safe to do so, pull off the road and stop in a safe place.
- o If your car is equipped with an automatic transaxle, don't let your car creep forward. To avoid creeping forward, keep your foot on the brake pedal when the car is stopped.
- o Use caution when parking on a hill. Engage the parking brake and place the gear selector lever in "P" (automatic transaxle) or in first or reverse gear (manual transaxle). If your car is facing downhill, turn the front wheels into the curb to help keep the car from rolling. If your car is facing uphill, turn the front wheels away from the curb to help keep the car from rolling. If there is no curb or if it is required by other conditions to keep the car from rolling, block the wheels.
- o Under some conditions your parking brake can freeze in the engaged position. This is most likely to happen when there is an accumulation of snow or ice around or near the rear brakes or if the brakes are wet. If there is a risk that the parking brake may freeze, apply it only temporarily while you put the gear selector lever in "P" (automatic) or in first or reverse gear (manual transaxle) and block the rear wheels so the car cannot roll. Then release the parking brake.
- o Do not hold the vehicle on the upgrade with the accelerator pedal. This can cause the transaxle to overheat. Always use the brake pedal or parking brake.

C140A01A-AAT

DRIVING FOR ECONOMY

You can save fuel and get more miles from your car if you follow these suggestions:

- o Drive smoothly. Accelerate at a moderate rate. Don't make "jack-rabbit" starts or full-throttle shifts and maintain a steady cruising speed. Don't race between stoplights. Try to adjust your speed to that of the other traffic so you don't have to change speeds unnecessarily. Avoid heavy traffic whenever possible. Always maintain a safe distance from other vehicles so you can avoid unnecessary braking. This also reduces brake wear.
- o Drive at a moderate speed. The faster you drive, the more fuel your car uses. Driving at a moderate speed, especially on the highway, is one of the most effective ways to reduce fuel consumption.
- o Don't "ride" the brake or clutch pedal. This can increase fuel consumption and also increase wear on these components. In addition, driving with your foot resting on the brake pedal may cause the brakes to overheat, which reduces their effectiveness and may lead to more serious consequences.
- o Take care of your tires. Keep them inflated to the recommended pressure. Incorrect inflation, either too much or too little, results in unnecessary tire wear. Check the tire pressures at least once a month.

- o Be sure that the wheels are aligned correctly. Improper alignment can result from hitting curbs or driving too fast over irregular surfaces. Poor alignment causes faster tire wear and may also result in other problems as well as greater fuel consumption.
- o Keep your car in good condition. For better fuel economy and reduced maintenance costs, maintain your car in accordance with the maintenance schedule in Section 5. If you drive your car in severe conditions, more frequent maintenance is required (see Section 5 for details).
- o Keep your car clean. For maximum service, your Hyundai should be kept clean and free of corrosive materials. It is especially important that mud, dirt, ice, etc. not be allowed to accumulate on the underside of the car. This extra weight can result in increased fuel consumption and also contribute to corrosion.
- o Travel lightly. Don't carry unnecessary weight in your car. Weight reduces fuel economy.
- o Don't let the engine idle longer than necessary. If you are waiting (and not in traffic), turn off your engine and restart only when you're ready to go.
- o Remember, your Hyundai does not require extended warm-up. As soon as the engine is running smoothly, you can drive away. In very cold weather, however, give your engine a slightly longer warm-up period.

- o Don't "lug" or "over-rev" the engine. Lugging is driving too slowly in too high a gear resulting in the engine bucking. If this happens, shift to a lower gear. Over-revving is racing the engine beyond its safe limit. This can be avoided by shifting at the recommended speeds.
- o Use your air conditioning sparingly. The air conditioning system is operated by engine power so your fuel economy is reduced when you use it.

C150A01A-AAT

SMOOTH CORNERING

Avoid braking or gear changing in corners, especially when roads are wet. Ideally, corners should always be taken under gentle acceleration. If you follow these suggestions, tire wear will be held to a minimum.

C160A01A-AAT

WINTER DRIVING

The more severe weather conditions of winter result in greater wear and other problems. To minimize the problems of winter driving, you should follow these suggestions:

C160B01A-AAT

Snowy or Icy Conditions

To drive your vehicle in deep snow, it may be necessary to use snow tires or to install tire chains on your tires. If snow tires are needed, it is necessary to select tires equivalent in size and type of the original equipment tires. Failure to do so may adversely affect the safety and handling of your car. Furthermore, speeding, rapid acceleration, sudden brake applications, and sharp turns are potentially very hazardous practices.

During deceleration, use engine braking to the fullest extent. Sudden brake applications on snowy or icy roads may cause skids to occur. You need to keep sufficient distance between the vehicle in operation in front and your vehicle. Also, apply the brake gently. It should be noted that installing tire chains on the tire will provide a greater driving force, but will not prevent side skids.

NOTE:

Tire chains are not legal in all states. Check state laws before fitting tire chains.

C160C01A-AAT

Use High Quality Ethylene Glycol Coolant

Your Hyundai is delivered with high quality ethylene glycol coolant in the cooling system. It is the only type of coolant that should be used because it helps prevent corrosion in the cooling system, lubricates the water pump and prevents freezing. Be sure to replace or replenish your coolant in accordance with the maintenance schedule in Section 5. Before winter, have your coolant tested to assure that its freezing point is sufficient for the temperatures anticipated during the winter.

C160D01A-AAT

Check Battery and Cables

Winter puts additional burdens on the battery system. Visually inspect the battery and cables as described in Section 6. The level of charge in your battery can be checked by your Hyundai dealer or a service station.

C160E01A-AAT

Change to "Winter Weight" Oil if Necessary

In some climates it is recommended that a lower viscosity "winter weight" oil be used during cold weather. See Section 9 for recommendations. If you aren't sure what weight oil you should use, consult your Hyundai dealer.

C160F01A-AAT

Check Spark Plugs and Ignition System

Inspect your spark plugs as described in Section 6 and replace them if necessary. Also check all ignition wiring and components to be sure they are not cracked, worn or damaged in any way.

C160G01A-AAT

To Keep Locks from Freezing

To keep the locks from freezing, squirt an approved de-icer fluid or glycerine into the key opening. If a lock is covered with ice, squirt it with an approved de-icing fluid to remove the ice. If the lock is frozen internally, you may be able to thaw it out by using a heated key. Handle the heated key with care to avoid burning the fingers.

C160H01A-AAT

Use Approved Anti-Freeze in Window Washer System

To keep the water in the window washer system from freezing, add an approved anti-freeze solution in accordance with instructions on the container. Window washer anti-freeze is available from Hyundai dealers and most auto parts outlets. Do not use engine coolant or other types of anti-freeze as these may damage the finish.

C160I01A-AAT

Don't Let Your Parking Brake Freeze

Under some conditions your parking brake can freeze in the engaged position. This is most likely to happen when there is an accumulation of snow or ice around or near the rear brakes or if the brakes are wet. If there is a risk the parking brake may freeze, apply it only temporarily while you put the gear selector lever in "P" (automatic) or in first or reverse gear (manual transaxle) and block the rear wheels so the car cannot roll. Then release the parking brake.

C160J01A-AAT

Don't Let Ice and Snow Accumulate Underneath

Under some conditions, snow and ice can build up under the fenders and interfere with the steering. When driving in severe winter conditions where this may happen, you should periodically check underneath the car to be sure the movement of the front wheels and the steering components is not obstructed.

C160K01A-AAT

Carry Emergency Equipment

Depending on the severity of the weather where you drive your car, you should carry appropriate emergency equipment. Some of the items you may want to carry include tire chains, tow straps or chains, flashlight, emergency flares, sand, a shovel, jumper cables, a window scraper, gloves, ground cloth, coveralls, a blanket, etc.

C170A01A-AAT

**HIGHER SPEED MOTORING
Pre-Trip Inspections****1. Tires:**

Adjust the tire inflation pressures to specification. Low tire inflation pressures will result in overheating and possible failure of the tires. Avoid using worn or damaged tires which may result in reduced traction or tire failure.

NOTE:

Never exceed the maximum tire inflation pressure shown on the tires.

2. Fuel, engine coolant and engine oil:

High speed travel consumes 1.5 times more fuel than urban motoring. Do not forget to check both engine coolant and engine oil.

3. Drive belt:

A loose or damaged drive belt may result in overheating of the engine.

C180A01A-AAT

USE OF LIGHTS

Check your lights regularly for correct operation and always keep them clean. When driving during the day in conditions of poor visibility, it is helpful to drive with headlights on low beam. This enables you to be seen as well as to see.

C190A01S-AAT

TRAILER OR VEHICLE TOWING

If you are considering towing with your car, you should first check with your State's Department of Motor Vehicles to determine their legal requirements.

Since laws vary from State to State the requirements for towing trailers, cars, or other types of vehicles or apparatus may differ. Ask your Hyundai dealer for further details before towing.

**CAUTION:**

Do not do any towing with your car during its first 1,200 miles (2,000 km) in order to allow the engine to properly break in. Failure to heed this caution may result in serious engine or transaxle damage.

C190B01S-AAT

Trailer Hitches

Select the proper hitch and ball combination, making sure that its location is compatible with that of the trailer or vehicle being towed. Use a quality non-equalizing hitch which distributes the tongue load uniformly throughout the chassis.

The hitch should be bolted securely to the car and installed by a qualified technician. **DO NOT USE A HITCH DESIGNED FOR TEMPORARY INSTALLATION AND NEVER USE ONE THAT ATTACHES ONLY TO THE BUMPER.**

C190C01Y-AAT

Trailer Brakes

If your trailer is equipped with a braking system, make sure it conforms to federal and/or local regulations and that it is properly installed and operating correctly.

NOTE:

If you tow a trailer or vehicle, your car will require more frequent maintenance due to the additional load. See Maintenance Under Severe Usage Conditions" on page 5-6.

**CAUTION:**

- o Never connect a trailer brake system directly to the vehicle brake system.
- o When towing a trailer on steep grades (in excess of 12%) pay close attention to the engine coolant temperature gauge to ensure the engine does not overheat. If the needle of the coolant temperature gauge moves across the dial towards "H" (HOT), pull over and stop as soon as it is safe to do so, and allow the engine to idle until it cools down. You may proceed once the engine has cooled sufficiently.

C190D01S-AAT

Safety Chains

Should the hitch connection between your car and the trailer or vehicle you are towing fail, the trailer or vehicle could wander dangerously across other lanes of traffic and ultimately leave the roadway. To eliminate this potentially dangerous situation, safety chains, attached between your car and the trailer or towed vehicle, are required in most states.

C190E02O-AAT

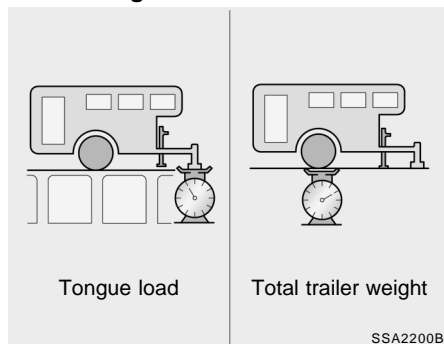
Trailer Weight Limit

- o Keep the tongue load 10% of the total trailer load.
- o $\frac{\text{Tongue load}}{\text{Total trailer weight}} \times 100 = 10\% \text{ (MAX)}$
- o Tongue loads can be increased or decreased by re-distributing the load in the trailer.
This can be verified by checking the total weight of the loaded trailer and then checking the load on the tongue.

NOTE:

1. Never load the trailer with more weight in the back than in the front. About 60% of the trailer load should be in the front half on the trailer and the remaining 40% in the rear.
2. The total gross vehicle weight with trailer must not exceed the Gross Vehicle Weight Rating (GVWR) shown on the vehicle identification plate (see page 8-2). The total gross vehicle weight is the combined weight of the vehicle, driver, all passengers and their luggage, cargo, hitch, trailer tongue load and other optional equipment.
3. The front or rear axle weight must not exceed the Gross Axle Weight Rating (GAWR) shown on the vehicle identification plate (see page 8-2). It is possible that your towing package does not exceed the GVWR but exceeds the GAWR. Improper trailer loading and/or too much luggage in the cargo area can overload the rear axle. Redistribute the load and check the axle weight again.

**CAUTION:**

The following specifications are recommended when towing a trailer. The loaded trailer weight cannot safely exceed the values in the chart.

Lbs. (kg)

	Engine	Maximum Towable Weight		
		Trailer	Tongue	
With Brake	2.4(2WD)	Type A	1700(771)	170(77.1)
		Type B	1200(544)	120(54.4)
	2.7(2WD)	Type A	3200(1452)	320(145.2)
		Type B	2700(1225)	270(122.5)
	2.7(4WD)	Type A	2700(1225)	270(122.5)
		Type B	2200(998)	220(99.8)
3.5(2WD)	Type A	3300(1497)	330(149.7)	
	Type B	2800(1270)	280(127)	
3.5(4WD)	Type A	2800(1270)	280(127)	
	Type B	2300(1043)	230(104.3)	
Without Brake	2.4(2WD)	1000(453)	100(45.3)	
	2.7(2WD)	1200(544)	120(54.4)	
	2.7(4WD)			
	3.5(2WD)			
	3.5(4WD)			
Without Brake +ABS	2.4(2WD)	1200(544)	120(54.4)	
	2.7(2WD)	1500(680)	150(68.0)	
	2.7(4WD)			
	3.5(2WD)			
	3.5(4WD)			

Type A : Vehicle carrying 2 passengers

Type B : Vehicle carrying 5 passengers



WARNING:

- o Improperly loading your car and trailer can seriously affect its steering and braking performance causing a crash which could cause serious injury or death.
- o Do not exceed 45 mph or the posted towing speed limit, whichever is lower.

4. The gross combination weight (sum of your vehicle weight plus its load and the total trailer weight) must not exceed the following.

Lbs. (kg)

Engine	Combination Weight	
	2WD	4WD
2.4	6000(2721)	-
2.7	7700(3493)	7400(3357)
3.5	7800(3538)	7500(3402)

C190F010-AAT

Trailer or Vehicle Towing Tips

1. Before towing, check hitch and safety chain connections as well as proper operation of the trailer running lights, brake lights, and turn signals.
2. Trailer towing requires more fuel than normal conditions.
3. To maintain engine braking efficiency and electrical charging performance, do not use fifth gear (manual transaxle) or overdrive (automatic transaxle).
4. Always secure items in the trailer to prevent load shift while driving.
5. Check the condition and air pressure of all tires on the trailer and your car. Low tire pressure can seriously affect the handling. Also check the spare tire.
6. The vehicle/trailer combination is more affected by crosswind and buffeting. When being passed by a large vehicle, keep a constant speed and steer straight ahead. If there is too much wind buffeting slow down to get out of the other vehicle's air turbulence.
7. When parking your car and trailer, especially on a hill, be sure to follow all the normal precautions. Turn your front wheel into the curb, set the parking brake firmly, and put the transaxle in 1st or Reverse (manual) or Park (automatic). In addition, place wheel chocks at each of the trailer's tires.

8. If the trailer has electric brakes, start your vehicle and trailer moving, and then apply the trailer brake controller by hand to be sure the brakes are working. This lets you check your electrical connection at the same time.
9. During your trip, check occasionally to be sure that the load is secure, and that the lights and any trailer brakes are still working.
10. Avoid jerky starts, sudden acceleration or sudden stops.
11. Avoid sharp turns and rapid lane changes.
12. Avoid holding the brake pedal down too long or too frequently. This could cause the brakes to overheat, resulting in reduced braking efficiency.
13. When going down a hill, shift into a lower gear and use the engine braking effect.
When ascending a long grade, downshift the transaxle to a lower gear and reduce speed to reduce chances of engine overloading and/or overheating.
14. If you have to stop while going uphill, do not hold the vehicle in place by pressing on the accelerator. This can cause the automatic transaxle to overheat. Use the parking brake or footbrake.
15. If the transmission shifts frequently while going up a hill, shift down one gear.

NOTE:

When towing check transaxle fluid more frequently.



CAUTION:

If overheating should occur when towing, (the temperature gauge reads near red zone), taking the following action may reduce or eliminate the problem.

1. Turn off the air conditioner.
2. Reduce highway speed.
3. Select a lower gear when going uphill.
4. While in stop and go traffic, place the gear selector in park or neutral and idle the engine at a higher speed.

B870C01A-GAT

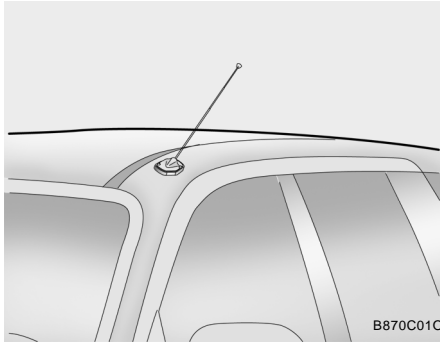
ANTENNA**Manual Antenna**

Your car uses a manual stainless steel antenna to receive both AM and FM broadcast signals. Pull up the antenna using your fingers, as shown in the drawing.

**CAUTION:**

Before entering an automatic car wash or a place with a low height clearance such as a residential or commercial garage, be sure that the antenna is fully retracted.

B880C02B-GAT

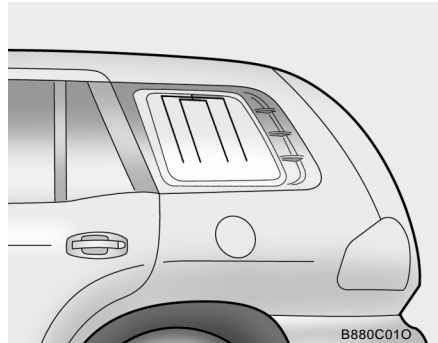
Glass Antenna (If installed)

When the radio power switch is turned on while the ignition key is in either the "ON" or "ACC" position, your car will receive both AM and FM broadcast signals through the antenna in the rear quarter glass.

**CAUTION:**

- o Do not clean the inner side of the rear quarter glass with an abrasive type of glass cleaner or use a scraper to remove foreign deposits from the inner surface of the glass as this may cause damage to the antenna elements.
- o Avoid adding metallic coating such as Ni, Cd, and so on. These can disturb receiving AM and FM broadcast signals.

3. WHAT TO DO IN AN EMERGENCY

If the Engine will not Start	3-2
Jump Starting	3-2
If the Engine Overheats	3-3
Spare Tire	3-4
If You Have a Flat Tire	3-5
If Your Car Must be Towed	3-9
Emergency Towing	3-11
If You Lose Your Keys	3-11

3-2 WHAT TO DO IN AN EMERGENCY

D010A01A-AAT

IF THE ENGINE WILL NOT START



WARNING:

If the engine will not start, do not push or pull the car to start it. This could result in a collision or cause other damage. In addition, push or pull starting may cause the catalytic converter to be overloaded and create a fire hazard.

D010B02A-AAT

If Engine Doesn't Turn Over or Turns Over Slowly

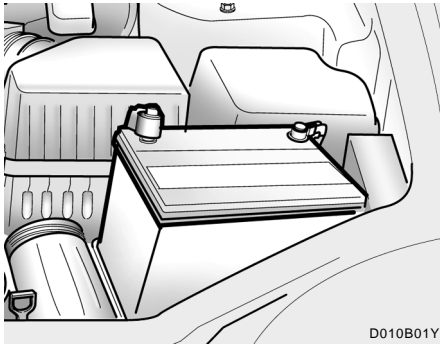

1. If your car has an automatic transaxle, be sure the gear selector lever is in "N" or "P" and the emergency brake is set.

2. Check the battery connections to be sure they are clean and tight.
3. Turn on the interior light. If the light dims or goes out when you operate the starter, the battery is discharged.
4. Check the starter connections to be sure they are securely tightened.
5. Do not push or pull the vehicle to start it. See instructions for "Jump Starting".

D010C01Y-AAT

If Engine Turns Over Normally but Does Not Start

1. Check fuel level.
2. Check all connectors at ignition, coil and spark plugs. Re-connect any that may be disconnected or loose.
3. Check the fuel line in the engine room.
4. If engine still refuses to start, call a Hyundai dealer or seek other qualified assistance.

D010D01A-AAT

If Engine Stalls While Driving

1. Reduce your speed gradually, keeping a straight line. Move cautiously off the road to a safe place.
2. Turn on your emergency flashers.
3. Try to start the engine again. If your vehicle will not start, contact a Hyundai dealer or seek other qualified assistance.

D020A02A-AAT

JUMP STARTING

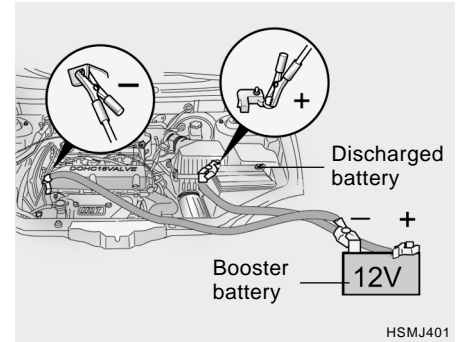

WARNING:

The gas produced by the battery during the jump-start operation is highly explosive. If these instructions are not followed exactly, serious personal injury and damage to the vehicle may occur! If you are not sure how to follow this procedure, seek qualified assistance. Automobile batteries contain sulfuric acid. This is poisonous and highly corrosive. When jump starting, wear protective glasses and be careful not to get acid on yourself, your clothing or on the car.

- o If you should accidentally get acid on your skin or in your eyes, immediately remove any contaminated clothing and flush the area with clear water for at least 15 minutes. Then promptly obtain medical attention. If you must be transported to an emergency facility, continue to apply water to the affected area with a sponge or cloth.
- o The gas produced by the battery during the jump-start operation is highly explosive. Do not smoke or allow a spark or an open flame in the vicinity.
- o The battery being used to provide the jump start must be 12-volt. If you cannot determine that it is a 12-volt battery, do not attempt to use it for the jump start.
- o To jump start a car with a discharged battery, follow this procedure exactly:
 1. If the booster battery is installed in another vehicle, be sure the two vehicles are not touching.
 2. Turn off all unnecessary lights and accessories in both vehicles.
 3. Attach the clamps of the jumper cable in the exact location shown on the illustration. First, attach one clamp of the jumper cable to the positive (+) post or cable of the discharged battery. Then attach the other end of the same cable to the positive (+) post or cable of the booster battery. Next, using the other cable, attach one clamp to the negative (-) post or cable of the booster battery. Then attach the other end of that cable to a solid

metal part of the engine away from the battery. Do not connect the cable to any moving part.

4. Start the engine in the car with the booster battery and let it run for a few minutes. This will help to assure that the booster battery is fully charged. During the jumping operation, run the engine in this vehicle at about 2,000 rpm.
5. Start the engine in the car with the discharged battery using the normal starting procedure. After the engine starts, leave the jumper cables connected and let the engine run at fast idle or about 2,000 rpm for several minutes.
6. Carefully remove the jumper cables in the reverse order of attachment.

If you do not know why your battery became discharged (because the lights were left on, etc.), have the charging system checked by your Hyundai dealer.

D030A01A-AAT

IF THE ENGINE OVERHEATS

If your temperature gauge indicates overheating, you experience a loss of power, or hear loud pinging or knocking, the engine is probably too hot. If this happens, you should:

1. Pull off the road and stop as soon as it is safe to do so.
2. Place the gear selector lever in "P" (automatic), or neutral (manual transaxle) and set the parking brake. If the air conditioning is on, turn it off.
3. If engine coolant is running out under the car or steam is coming out from the hood, stop the engine. Do not open the hood until the coolant has stopped running or the steaming has stopped. If there is no visible loss of engine coolant and no steam, leave the engine running and check to be sure the engine cooling fan is operating. If the fan is not running, turn the engine off.
4. Check to see if the water pump drive belt is missing. If it is not missing, check to see that it is tight. If the drive belt seems to be satisfactory, check for coolant leaking from the radiator, hoses or under the car. (If the air conditioning had been in use, it is normal for cold water to be draining from it when you stop).

! WARNING:
 While the engine is running, keep hair, hands and clothing away from moving parts such as the fan and drive belts to prevent injury.

- If the water pump drive belt is broken or engine coolant is leaking out, stop the engine immediately and call the nearest Hyundai dealer for assistance.

! WARNING:
 Do not remove the radiator cap when the engine is hot. This can allow coolant to be blown out of the opening and cause serious burns.

- If you cannot find the cause of the overheating, wait until the engine temperature has returned to normal. Then, if coolant has been lost, carefully remove the radiator cap and add coolant to bring the fluid level in the reservoir up to the halfway mark.
- Proceed with caution, keeping alert for further signs of overheating. If overheating happens again, call a Hyundai dealer for assistance.

! CAUTION:
 Serious loss of coolant indicates there is a leak in the cooling system and this should be checked as soon as possible by a Hyundai dealer.

D040A01A-GAT
SPARE TIRE

The following instructions for the FULL SIZE spare tire should be observed:

Check inflation pressure as soon as practical after installing the spare tire, and adjust to the specified pressure. The tire pressure should be periodically checked and maintained at the specified pressure while the tire is stored.

Spare Tire Pressure

Tire Size	Full Size
Inflation Pressure	30 psi (207 kPa)

D040B02B-GAT

Handling the Spare Tire

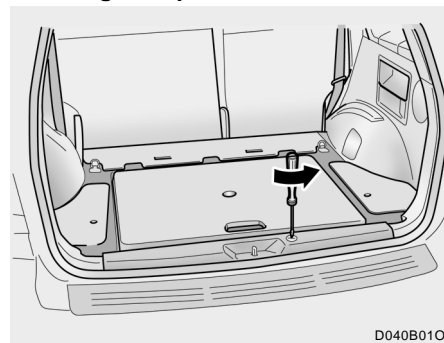

To remove the spare tire

- Open the tail gate.
- Remove the mounting bolt cover with a screw driver or coin.

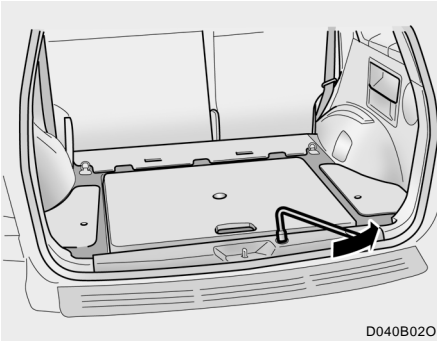

D040B020

3. Loosen the mounting bolt with a wheel nut wrench.

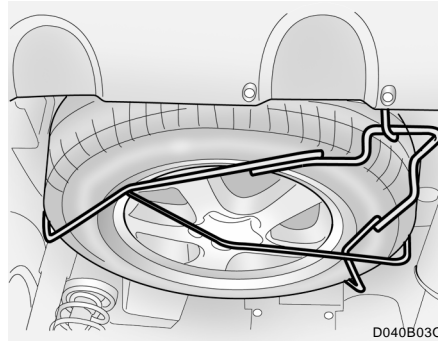

D040B030

4. Lift up the hanger and separate it from the holder, then lower the hanger and remove the spare tire.

To reinstall the spare tire

1. Set the spare tire on the center of the hanger, and then raise the hanger and hook it onto the holder.
2. Tighten the mounting bolt with the wheel nut wrench.
3. Install the mounting bolt cover with a screw driver.

D050A02A-AAT

IF YOU HAVE A FLAT TIRE

If a tire goes flat while you are driving:

1. Take your foot off the accelerator pedal and let the car slow down while driving straight ahead. Do not apply the brakes immediately or attempt to pull off the road as this may cause a loss of control. When the car has slowed to such a speed that it is safe to do so, brake carefully and pull off the road. Drive off the road as far as possible and park on firm, level ground. If you are on a divided highway, do not park in the median area between the two traffic lanes.
2. When the car is stopped, turn on your emergency hazard flashers, set the parking brake and put the transaxle in "P" (automatic) or reverse (manual transaxle).
3. Have all passengers get out of the car. Be sure they all get out on the side of the car that is away from traffic.
4. Change the tire following the instructions provided as follows.

3-6 WHAT TO DO IN AN EMERGENCY

D060A01A-AAT

CHANGING A FLAT TIRE

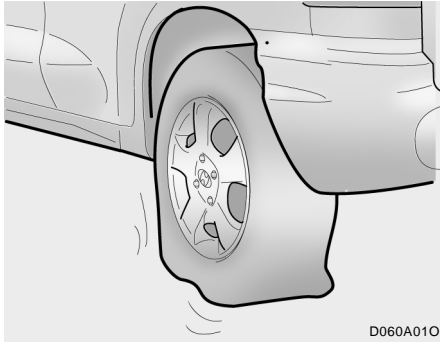

The procedure described on the following pages can be used to rotate tires as well as to change a flat tire. When preparing to change a flat tire, check to be sure the gear selector lever is in "P" (automatic) or reverse gear (manual transaxle) and that the parking brake is set, then:

D060B02O-AAT

1. Obtain Spare Tire and Tool

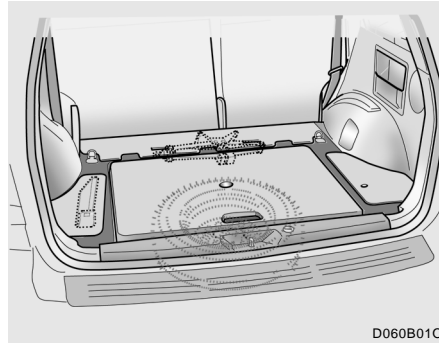

Remove the spare tire and remove the jack and tool bag from the luggage compartment.

NOTE:

The spare tire is located underneath the car.

D060C01A-AAT

2. Block the Wheel

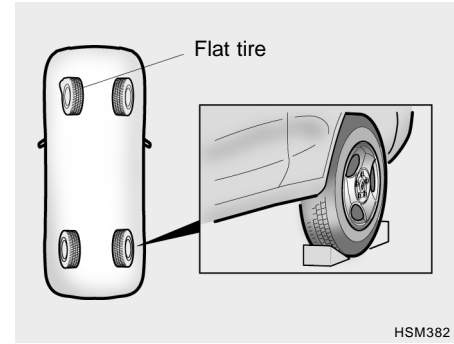

Block the wheel that is diagonally opposite from the flat to keep the vehicle from rolling when the car is raised on the jack.

D060D01A-AAT

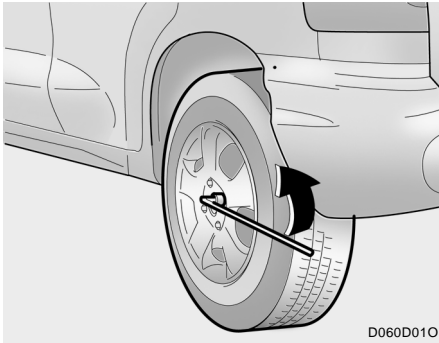
3. Loosen Wheel Nuts

D060D01O

The wheel nuts should be loosened slightly before raising the car. To loosen the nuts, turn the wrench handle counterclockwise. When doing this, be sure that the socket is seated completely over the nut so it cannot slip off. For maximum leverage, position the wrench so the handle is to the left as shown in the drawing. Then, while holding the wrench near the end of the handle, push down on it with steady pressure. Do not remove the nuts at this time. Just loosen them about one-half turn.

D060E01A-AAT

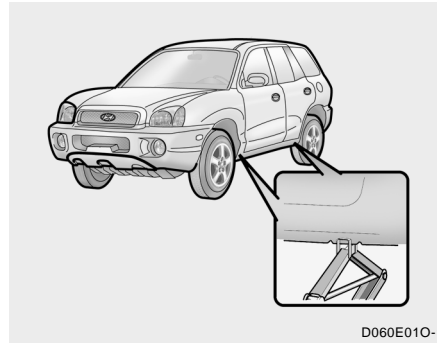
4. Put the Jack in Place

D060E01O-1

The base of the jack should be placed on firm, level ground. The jack should be positioned as shown in the drawing.

D060F02E-AAT

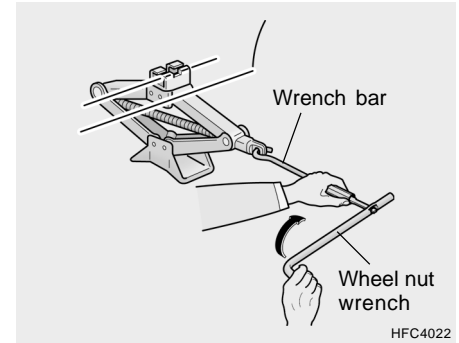
5. Raising the Car

HFC4022

After inserting a bar into the wheel nut wrench, install the bar into the jack as shown in the drawing. To raise the vehicle, turn the wheel nut wrench clockwise. As the jack begins to raise the vehicle, double check that it is properly positioned and will not slip. If the jack is on soft ground or sand, place a board, brick, flat stone or other object under the base of the jack to keep it from sinking.

Raise the car high enough so that the fully inflated spare tire can be installed. To do this, you will need more ground clearance than is required to remove the flat tire.



WARNING:

Do not get under the car when it is supported by the jack! This is very dangerous as the vehicle could fall and cause serious injury or death. No one should stay in the car while the jack is being used.

D060G02Y-AAT

6. Changing Wheels

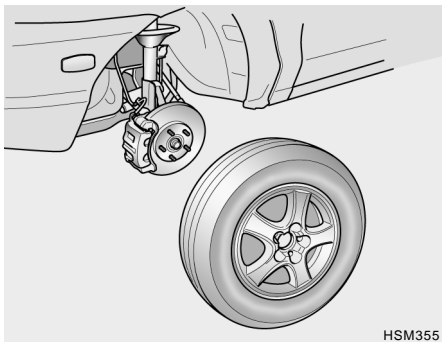

Loosen the wheel nuts and remove them with your fingers. Slide the wheel off the studs and lay it flat so it cannot roll away. To put the wheel on the hub, pick up the spare tire, line up the holes with the studs and slide the wheel onto them. If this is difficult, tip the wheel slightly and get the top hole in the wheel lined up with the top stud. Then jiggle the wheel back and forth until the wheel can be slid over the other studs.

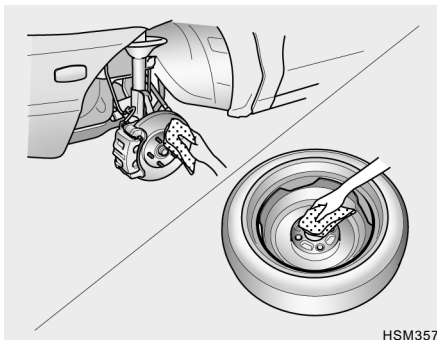

WARNING:

Wheels and wheel covers may have sharp edges. Handle them carefully to avoid possible severe injury. Before putting the wheel into place, be sure that there is nothing on the hub or wheel (such as mud, tar, gravel, etc.) that interferes with the wheel from fitting solidly against the hub. If there is, remove it. If there is not good contact on the mounting surface between the wheel and hub, the wheel nuts could come loose and cause the loss of a wheel. Loss of a wheel may result in loss of control of the vehicle. This may cause serious injury or death.

D060H02A-AAT

7. Reinstall Wheel Nuts

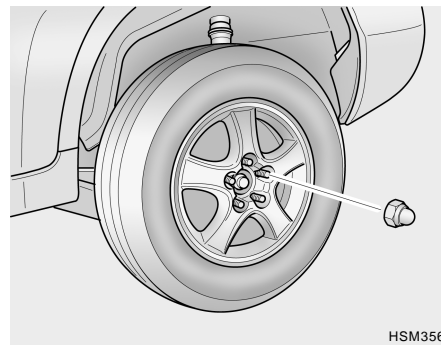

To reinstall the wheel, hold it on the studs, put the wheel nuts on the studs and tighten them finger tight. The nuts should be installed with their small diameter ends directed inward. Jiggle the tire to be sure it is completely seated, then tighten the nuts as much as possible with your fingers again.

D060101E-AAT

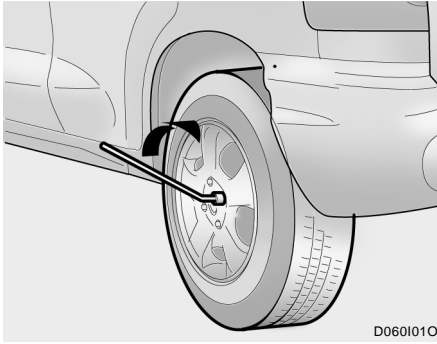
8. Lower Vehicle and Tighten Nuts

D060101O

Lower the car to the ground by turning the wheel nut wrench counterclockwise. Then position the wrench as shown in the drawing and tighten the wheel nuts. Be sure the socket is seated completely over the nut. Do not stand on the wrench handle or use an extension pipe over the wrench handle.

Go around the wheel tightening every other nut until they are all tight. Then double-check each nut for tightness. After changing wheels, have a technician tighten the wheel nuts to their proper torque as soon as possible.

Wheel nut tightening torque:
Steel wheel & aluminium alloy wheel:
65-80 lb.ft (900-1,100 kg.cm)

D060J02O-AAT

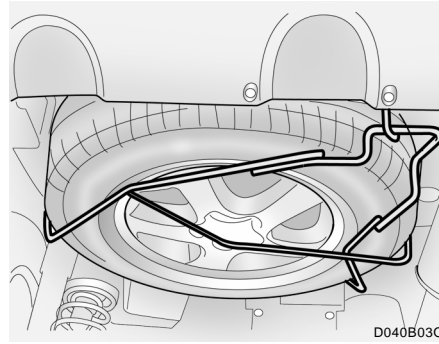
After Changing Wheels

D040B03O

If you have a tire gauge, remove the valve cap and check the air pressure. If the pressure is lower than recommended, drive slowly to the nearest service station and inflate to the correct pressure. If it is too high, adjust it until it is correct. Always reinstall the valve cap after checking or adjusting tire pressure. If the cap is not replaced, air may leak from the tire. If you lose a valve cap, buy another and install it as soon as possible.

After you have changed wheels, always secure the flat tire in its place and return the jack and tools to their proper storage locations.

D080A01A-AAT

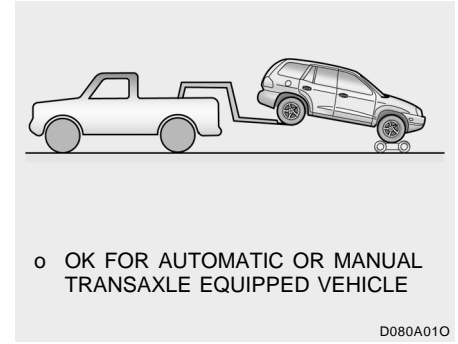
IF YOUR CAR MUST BE TOWED

- o OK FOR AUTOMATIC OR MANUAL TRANSAXLE EQUIPPED VEHICLE

D080A01O



CAUTION:
Your car can be damaged if towed incorrectly!

If your car has to be towed, it should be done by your Hyundai dealer or a commercial tow truck service. This will help assure that your car is not damaged in towing. Also, professionals are generally aware of state and local laws governing towing. In any case, rather than risk damage to your car, it is suggested that you show this information to the tow truck operator. Be sure that a safety chain system is used and that all state and local laws are observed.

D080B020-AAT

Towing a Car With Manual Transaxle

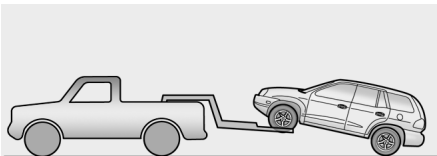

- o DO NOT TOW 4WD
- o OK FOR AUTOMATIC OR MANUAL TRANSAXLE EQUIPPED VEHICLE WITH NO DAMAGE (except 4WD)

D080B010-1

- o If the car is being towed with the rear wheels on the ground, be sure the parking brake is released.
- o If the car is being towed with the front wheels on the ground, be sure that the transaxle is in neutral. Also, be sure that the ignition key is in the "ACC" position. This is necessary to prevent damage to the steering lock mechanism, which is not designed to hold the front wheels straight while the car is being towed.
- o If any of the loaded wheels or suspension components are damaged, a towing dolly must be used.



CAUTION:

- o When towing the 2WD vehicle with the rear wheels on the ground, the vehicle should be towed with wheel lift type truck.
- o Otherwise, the CV joint boot can interfere with the towing hook caused by insufficient clearance resulting in CV joint boot damage.
- o 4 Wheel Drive cannot be towed with a tow truck. It must be towed by lifting all 4 wheels.

D080C02A-AAT

Towing a Car With Automatic Transaxle

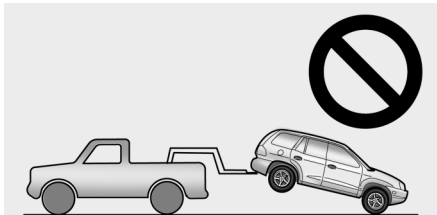

- o DO NOT TOW 4WD
- o NOT OK FOR AUTOMATIC TRANSAXLE EQUIPPED VEHICLE
- o OK FOR MANUAL TRANSAXLE (except 4WD)

D080C010



CAUTION:

A car with an automatic transaxle should never be towed from the rear with the front wheels on the ground. This can cause serious damage to the transaxle. If the car must be towed from the rear, a towing dolly must be used under the front wheels.

If the car is being towed with the rear wheels on the ground, be sure the parking brake is released.

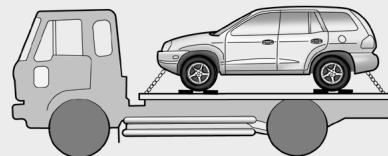

- o OK FOR AUTOMATIC OR MANUAL TRANSAXLE EQUIPPED VEHICLE

D080C020

NOTE:

Before towing, check the level of the transaxle fluid. If it is below the "HOT" mark on the dipstick, add fluid. If you cannot add fluid, a towing dolly must be used as described above.

D080D020-AAT

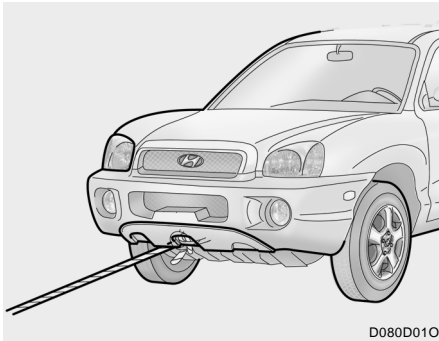
Emergency Towing

D080D010

For emergency towing when no commercial tow vehicle is available, attach a tow cable, chain or strap to one of the tie-down hooks under the front of your car. Be very careful when attempting this procedure when the vehicle is on any unpaved surface to avoid damage to your vehicle.

Nor should towing be attempted if the wheels, drive train, axles, steering or brakes are damaged. Before towing, be sure the transaxle is in neutral and the key is in "ACC" (with the engine off) or in the "ON" position (with the engine running). A driver must be in the towed car to steer it and operate the brakes.

NOTE:

To avoid serious damage to your 4WD vehicle, limit the towing to 10 mph and not for more than 1 mile at ANY TIME.

**CAUTION:**

If the car is being towed with all four wheels on the ground, it can be towed only from the front. Be sure that the transaxle is in neutral. Do not tow at speeds greater than 30 mph (50 km/h) and for more than 15 miles (25 km). Be sure the steering is unlocked by placing the key in the "ACC" position. A driver must be in the towed vehicle to operate the steering and brakes.

D120A01A-AAT

IF YOU LOSE YOUR KEYS

If you lose your keys, many Hyundai dealers can make you a new key if you have your key number.

If you lock the keys inside your car and you cannot obtain a new key, many Hyundai dealers can use special tools to open the door for you.

4. CORROSION PREVENTION & APPEARANCE CARE

Corrosion Protection	4-2
To Help Prevent Corrosion	4-2
Washing and Waxing	4-3
Cleaning the Interior	4-4

E010A01A-AAT

CORROSION PROTECTION

Protecting Your Hyundai from Corrosion

By using the most advanced design and construction practices to combat corrosion, Hyundai produces cars of the highest quality. However, this is only part of the job. To achieve the long-term corrosion resistance your Hyundai can deliver, the owner's cooperation and assistance is also required.

E010B01A-AAT

Common Causes of Corrosion

The most common causes of corrosion on your car are:

- o Road salt, dirt and moisture that is allowed to accumulate underneath the car.
- o Removal of paint or protective coatings by stones, gravel, abrasion or minor scrapes and dents which leave unprotected metal exposed to corrosion.

E010C01A-AAT

High-Corrosion Areas

If you live in an area where your car is regularly exposed to corrosive materials, corrosion protection is particularly important. Some of the common causes of accelerated corrosion are road salts, dust control chemicals, ocean air and industrial pollution.

E010D01A-AAT

Moisture Breeds Corrosion

Moisture creates the conditions in which corrosion is most likely to occur. For example, corrosion is accelerated by high humidity, particularly when temperatures are just above freezing. In such conditions, the corrosive material is kept in contact with the car surfaces by moisture that is slow to evaporate.

Mud is particularly corrosive because it is slow to dry and holds moisture in contact with the vehicle. Although the mud appears to be dry, it can still retain the moisture and promote corrosion.

High temperatures can also accelerate corrosion of parts that are not properly ventilated so the moisture can be dispersed. For all these reasons, it is particularly important to keep your car clean and free of mud or accumulations of other materials. This applies not only to the visible surfaces but particularly to the underside of the car.

E020A01A-AAT

TO HELP PREVENT CORROSION

You can help prevent corrosion from getting started by observing the following:

E020B01A-AAT

Keep Your Car Clean

The best way to prevent corrosion is to keep your car clean and free of corrosive materials. Attention to the underside of the car is particularly important.

- o If you live in a high-corrosion area — where road salts are used, near the ocean, areas with industrial pollution, acid rain, etc.—, you should take extra care to prevent corrosion. In winter, hose off the underside of your car at least once a month and be sure to clean the underside thoroughly when winter is over.
- o When cleaning underneath the car, give particular attention to the components under the fenders and other areas that are hidden from view. Do a thorough job; just dampening the accumulated mud rather than washing it away will accelerate corrosion rather than prevent it. Water under high pressure and steam are particularly effective in removing accumulated mud and corrosive materials.
- o When cleaning lower door panels, rocker panels and frame members, be sure that drain holes are kept open so that moisture can escape and not be trapped inside to accelerate corrosion.

E020C01A-AAT

Keep Your Garage Dry

Don't park your car in a damp, poorly ventilated garage. This creates a favorable environment for corrosion. This is particularly true if you wash your car in the garage or drive it into the garage when it is still wet or covered with snow, ice or mud. Even a heated garage can contribute to corrosion unless it is well ventilated so moisture is dispersed.

E020D01A-AAT

Keep Paint and Trim in Good Condition

Scratches or chips in the finish should be covered with "touch-up" paint as soon as possible to reduce the possibility of corrosion. If bare metal is showing through, the attention of a qualified body and paint shop is recommended.

E020E01A-AAT

Don't Neglect the Interior

Moisture can collect under the floor mats and carpeting to cause corrosion. Check under the mats periodically to be sure the carpeting is dry. Use particular care if you carry fertilizers, cleaning materials or chemicals in the car. These should be carried only in proper containers and any spills or leaks should be cleaned up, flushed with clear water and thoroughly dried.

E030A01A-AAT

WASHING AND WAXING**Washing Your Hyundai**

Never wash your car when the surface is hot from being in the sun. Always wash your car in the shade.

Wash your car frequently. Dirt is abrasive and can scratch the paint if it is not removed. Air pollution or acid rain may damage the paint and trim through chemical action if pollutants are allowed to remain in contact with the surface. If you live near the ocean or in an area where road salts or dust control chemicals are used, you should pay particular attention to the underside of the car. Start by rinsing the car to remove dust and loose dirt. In winter, or if you have driven through mud or muddy water, be sure to thoroughly clean the underside as well. Use a hard direct stream of water to remove accumulations of mud or corrosive materials. Use a good quality car-washing solution and follow the manufacturer's directions on the package. These are available at your Hyundai dealer or auto parts outlet. Don't use strong household detergents, gasoline, strong solvents or abrasive cleaning powders as these may damage the finish.

Use a clean sponge or cloth, rinse it frequently and don't damage the finish by rubbing too hard. For stubborn spots, dampen them frequently and remove them a little at a time.

To clean whitewall tires, use a stiff brush or soapy steel-wool scouring pad.

To clean plastic wheel covers, use a clean sponge or soft cloth and water.

To clean cast aluminum alloy wheels, use a mild soap or neutral detergent. Do not use abrasive cleaners. Protect the bare-metal surfaces by cleaning, polishing and waxing. Because aluminum is subject to corrosion, be sure to give aluminum alloy wheels special attention in winter. If you drive on salted roads, clean the wheels thoroughly afterwards.

After washing, be sure to rinse thoroughly. If soapy water dries on the finish, streaking will result.

When the weather is warm and the humidity low, you may find it necessary to rinse each section immediately after washing to avoid streaking.

After rinsing, dry the car using a damp chamois or soft, absorbent cloth. The reason for drying the car is to remove water from the car so it will dry without water spots. Don't rub, this can damage the finish.

If you find any nicks or scratches in the paint, use touch-up paint to cover them to prevent corrosion. To protect the paintwork of the car against corrosion, you must clean your Hyundai (at least once a month). Give special attention to the removal of salt, mud and other substances on the underside of the splashboards of the car. Make sure that the outlets and the

underside of the doors are open. Paint damage can be caused by small accumulation of tar, industrial precipitation, tree resin, insects and bird droppings, when not removed immediately. If water alone is not strong enough to remove the accumulated dirt, use a mild car washing solution. Be sure to rinse the surface after washing to remove the solution. Never allow the solution to dry on the painted surfaces.

E030B01A-AAT

Spot Cleaning

Don't use gasoline, strong solvents or corrosive cleaning agents. These can damage the finish of the car. To remove road tar, use turpentine on a clean, soft cloth. Be gentle. To remove dead insects or tree sap, use warm water and mild soap or car-washing solution. Soak the spot and rub gently. If the paint has lost its luster, use a commercial car-cleaning polish.

E030C01A-AAT

Polishing and Waxing

Always wash and dry the car before polishing or waxing or using a combination cleaner and wax. Use a good quality commercial product and follow the manufacturer's directions on the container. Polish and wax the bright trim pieces as well as the paint.

E030D01A-AAT

When to Wax Again

You should polish and wax the car again when water no longer beads on a clean surface but spreads out over a larger area.

E030E01A-AAT

Maintaining Bumpers

Special precautions must be observed to preserve the appearance of the bumpers on your Hyundai. They are:

- o Be careful not to spill battery electrolyte or hydraulic brake fluid on the bumpers. If you do, wash it off immediately with clear water.
- o Be gentle when cleaning the bumper surfaces. They are made of soft plastic and the surface can be damaged if mistreated. Do not use abrasive cleaners. Use warm water and mild soap or car-washing solution.
- o Do not expose the bumpers to high temperatures. For example, if you have your car repainted, do not leave the bumpers on the car if the car is going to be placed in a high-temperature paint booth.

E040A01A-AAT

CLEANING THE INTERIOR

To Clean the Vinyl Upholstery

To clean the vinyl upholstery, first remove loose dirt and dust with a vacuum cleaner. Then apply a solution of mild soap or detergent and water using a clean sponge or soft cloth. Allow this to stay on the surface to loosen the dirt, then wipe with a clean damp sponge or cloth. If all the dirt stains are not removed, repeat this procedure until the upholstery is clean. Do not use gasoline, solvent, paint thinner or other strong cleaners.

E040B01A-AAT

To Clean the Leather Upholstery (If installed)

In the normal course of use, leather upholstered surfaces will, like any material, pick-up dust and dirt. This dust and dirt must be cleaned off or it may work into the surface of the leather, causing damage.

Fine leather needs care, and should be cleaned when necessary. Washing leather thoroughly with soap and water will keep your leather lustrous, beautiful and ensure you have many years of wear.

Take a piece of cheese cloth and using any mild soap and lukewarm water, work up a good lather. Thoroughly wash the leather. Wipe clean with a slightly damp cloth and dry with soft cloth.

Do this as often as the leather becomes soiled.

During tanning operations, sufficient oils are incorporated through processing that none need be applied during the life of the leather. Oil applied to the finished surface will in no way help the leather and may do more harm than good. Varnishes and furniture polishes should never be used under any conditions.

E040C01A-AAT

Cleaning the Carpets

Use a foam-type carpet cleaner. Cleaners of this type are available in aerosol cans in liquid form or powder. Read the instructions and follow them exactly. Using a vacuum cleaner with the appropriate attachment, remove as much dirt from the carpets as possible. Apply the foam following the manufacturer's directions, then rub in overlapping circles. Do not add water. These cleaners work best when the carpet is kept as dry as possible.

E040D01A-AAT

Cleaning the Seat Belts

To clean the seat belts, use a cloth or sponge with mild soap or detergent and warm water. Do not use strong detergents, dye, bleach or abrasive materials on the seat belts as this may weaken the fabric.

While cleaning the belts, inspect them for excessive wear, cuts, fraying or other signs of damage and replace them if necessary.

E040E01A-AAT

Cleaning the Windows

You may use any household window cleaner on the windows. However, when cleaning the inside of the rear window be careful not to damage the rear window defroster wiring.

E050A01A-AAT

Any Questions?

If you have any questions about the care of your car, consult your Hyundai dealer.

5. VEHICLE MAINTENANCE REQUIREMENTS

Maintenance Intervals	5-2
Scheduled Maintenance	5-4
Maintenance under Severe Usage Conditions	5-6
Explanation of Scheduled Maintenance Items	5-7

5-2 VEHICLE MAINTENANCE REQUIREMENTS

F010A01A-AAT

MAINTENANCE INTERVALS

Service Requirements

To ensure that you receive the greatest number of miles of satisfying operation from your Hyundai, certain maintenance procedures must be performed. Although careful design and engineering have reduced these to a minimum, those that are required are of the utmost importance.

It is your responsibility to have these maintenance procedures performed to comply with the terms of the warranties covering your new Hyundai. The Owner's Handbook supplied with your new vehicle provides further information about these warranties.

F010B01A-AAT

Maintenance Requirements

The maintenance required for your Hyundai can be divided into three main areas:

- o Specified scheduled procedures
- o General checks
- o Do-it-yourself maintenance

F010C01A-AAT

Specified Scheduled Procedures

These are the procedures such as inspections, adjustments and replacements that are listed in the maintenance charts starting on page 5-4. These procedures must be performed at the intervals shown in the maintenance schedule to assure that your warranty remains in effect. Although it is strongly recommended that they be performed by the trained technicians at your Hyundai dealer, these procedures may be performed at any qualified service facility.

It is suggested that genuine Hyundai service parts be used for any required repairs or replacements. Other parts of equivalent quality such as engine oil, engine coolant, manual or auto transaxle oil, brake fluid and so on which are not supplied by Hyundai Motor Company or its distributor may be used without affecting your warranty coverage but you should always be sure these are equivalent to the quality of the original Hyundai parts. Your Owner's Handbook provides further information about your warranty coverage.

F010D02A-AAT

General Checks

These are the regular checks you should perform when you drive your Hyundai or you fill the fuel tank. A list of these items will be found on page 6-5.

F010E01A-AAT

Do-It-Yourself Maintenance

If you are mechanically inclined, own a few tools that are required and want to take the time to do so, you can inspect and service a number of items. For more information about doing it yourself, see Section 6.

F010F01A-AAT

A Few Tips

- o Whenever you have your Hyundai serviced, keep copies of the service records in your glovebox. This will help ensure that you can document that the required procedures have been performed to keep your warranties in effect. This is especially important when service is not performed by an authorized Hyundai dealer.
- o If you choose to do your own maintenance and repairs, you may find it helpful to have an official Hyundai Shop Manual. A copy of this publication may be purchased at your Hyundai dealer's parts department.

F020A02Y-AAT

SCHEDULED MAINTENANCE REQUIREMENTS

- o Inspection should be performed any time a malfunction is experienced or suspected.
- o Receipts for all emission control system services should be retained to demonstrate compliance with conditions of the emissions system warranty.
- o After 120 months or 150,000 miles (240,000 km), continue to follow the prescribed maintenance intervals.
- o For severe usage maintenance requirements, see page 5-6 of this section.

5-4 VEHICLE MAINTENANCE REQUIREMENTS

F030A01A-AAT

SCHEDULED MAINTENANCE

The following maintenance services must be performed to ensure good emission control and performance. Keep receipts for all vehicle emission services to protect your warranty. Where both mileage and time are shown, the frequency of service is determined by whichever occurs first.

F030B01O-AAT

R :Replace I : Inspect and, after Inspection, clean, adjust, repair or replace if necessary.

No.	DESCRIPTION	MILES X 1000	7.5	15	22.5	30	37.5	45	52.5	60	67.5	75	82.5	90	97.5	105	112.5	120	127.5	135	142.5	150
		KILOMETERS X 1000	12	24	36	48	60	72	84	96	108	120	132	144	156	168	180	192	204	216	228	240
		MONTHS	6	12	18	24	30	36	42	48	54	60	66	72	78	84	90	96	102	108	114	120
EMISSION CONTROL ITEMS																						
1	ENGINE OIL AND FILTER	R	R	R	R	R	R	R	R	R	R	R	R	R	R	R	R	R	R	R	R	R
2	FUEL FILTER								R							R						
3	FUEL LINES, FUEL HOSES AND CONNECTIONS				I				I					I				I				I
4	VACUUM HOSE								I							I						
5	CRANKCASE VENTILATION HOSE				I				I					I				I				I
6	VAPOR HOSE AND FUEL FILLER CAP				I				I					I				I				I
7	AIR CLEANER FILTER					R				R				R				R				R
8	SPARK PLUGS (PLATINUM COATED)									R								R				

F030C040-AAT

R : Replace I : Inspect and, after inspection, clean, adjust, repair or replace if necessary

No.	DESCRIPTION	MILES X 1000	7.5	15	22.5	30	37.5	45	52.5	60	67.5	75	82.5	90	97.5	105	112.5	120	127.5	135	142.5	150	
		KILOMETERS X 1000	12	24	36	48	60	72	84	96	108	120	132	144	156	168	180	192	204	216	228	240	
		MONTHS	6	12	18	24	30	36	42	48	54	60	66	72	78	84	90	96	102	108	114	120	
GENERAL ITEMS																							
1	DRIVE BELT	2.4 DOHC (ALT, W/PUMP)				I				R				I					R				I
		2.7 V6 / 3.5 V6 (ALT, P/STR'G, A/CON)	I	I	I	I	I	I	I	I	I	R	I	I	I	I	I	I	I	I	I	I	R
2	COOLANT				R					R				R					R				R
3	TIMING BELT				I					R**				I					R**				I
4	MANUAL TRANSAXLE OIL				I					I				I					I				I
5	AUTOMATIC TRANSAXLE FLUID AND FILTER		I		I		I		I	I	I				R				I		I		I
6	BRAKE FLUID				I					I				I					I				I
7	BRAKE HOSES AND LINES		I		I		I			I		I		I		I			I		I		I
8	REAR BRAKE DRUMS/LININGS, PARKING BRAKE				I					I				I					I				I
9	BRAKE PADS, CALIPERS AND ROTORS		I		I		I		I	I	I			I		I			I		I		I
10	EXHAUST PIPE AND MUFFLER		I		I		I			I		I		I					I		I		I
11	SUSPENSION MOUNTING BOLTS		I		I		I			I		I		I					I		I		I
12	STEERING GEAR BOX, LINKAGE & BOOTS / LOWER ARM BALL JOINT		I		I		I			I		I		I					I		I		I
13	POWER STEERING PUMP BELT AND HOSES				I					I				I					I				I
14	DRIVESHAFTS AND BOOTS		I		I		I			I				I					I		I		I
15	AIR CONDITIONING REFRIGERANT		I		I		I			I				I					I		I		I
16	TRANSFER CASE OIL (4WD)																						
17	REAR AXLE OIL (4WD)																						
18	PROPELLAR SHAFT CLEAN, BOLT RETIGHTEN (4WD)		I		I		I			I				I					I		I		I

Note :

*1. For california, this maintenance is recommended, but not required.

*2. Inspect every 25,000 miles (40,000 km)and replace every 62,000 miles (100,000 km)

*3. With LSD- Inspect every 25,000 miles (40,000 km) and replace every 50,000 miles (80,000 km)
 Without LSD- Inspect every 25,000 miles (40,000 km)

5-6 VEHICLE MAINTENANCE REQUIREMENTS

F040A020-AAT

MAINTENANCE UNDER SEVERE USAGE CONDITIONS

The following items must be serviced more frequently on cars normally used under severe driving conditions. Refer to the chart below for the appropriate maintenance intervals.

R : Replace I : Inspect and, after inspection, clean, adjust, repair or replace if necessary

MAINTENANCE ITEM		MAINTENANCE OPERATION	MAINTENANCE INTERVALS	DRIVING CONDITION
ENGINE OIL AND FILTER		R	EVERY 3,000 MILES (4,800 KM) OR 3 MONTHS	A, B, C, F, H
AIR CLEANER FILTER		R	MORE FREQUENTLY	C, E
SPARK PLUGS		R	MORE FREQUENTLY	B, H
BRAKE PADS, CALIPERS AND ROTORS		I	MORE FREQUENTLY	C, D, G, H
REAR BRAKE DRUMS/LININGS/PADS, PARKING BRAKE		I	MORE FREQUENTLY	C, D, G, H
STEERING GEAR BOX, LINKAGE & BOOTS/ LOWER ARM BALL JOINT		I	MORE FREQUENTLY	C, D, E, F, G
DRIVESHAFTS AND BOOTS		I	EVERY 7,500 MILES (12,000 KM) OR 6 MONTHS	C, E, F
MANUAL TRANSAXLE OIL		R	EVERY 60,000 MILES (96,000 KM)	A, C, D, E, F, G, H, I, J
AUTOMATIC TRANSAXLE FLUID AND FILTER		R	EVERY 30,000 MILES (48,000 KM)	A, C, E, F, G, H, I
TRANSFER CASE OIL (4WD) *1		R	EVERY 25,000 MILES (40,000 KM)	C, E, G, I
REAR AXLE OIL (4WD) *1	With LSD	R	EVERY 25,000 MILES (40,000 KM)	C, E, G, I
	Without LSD		EVERY 50,000 MILES (80,000 KM)	

SEVERE DRIVING CONDITIONS

A - Repeated short distance driving

B - Extensive idling

C - Driving in dusty, rough roads

D - Driving in areas using salt or other corrosive materials or in very cold weather

E - Driving in sandy areas

F - More than 50% driving in heavy city traffic during hot weather above 90°F (32°C)

G - Driving in mountainous areas

H - Towing a trailer

I - Driving as a patrol car, taxi, other commercial use and vehicle towing

J - Driving over 100 mph

*1. Transfer case Oil and Rear Axle Oil should be changed anytime they have been submerged in water.

F060A01A-AAT

EXPLANATION OF SCHEDULED MAINTENANCE ITEMS

F060M01A-AAT

o Engine Oil and Filter

The engine oil and filter should be changed at the intervals specified in the maintenance schedule. If the car is being driven in severe conditions, more frequent oil and filter changes are required.

F060C01A-AAT

o Fuel Filter

A clogged filter can limit the speed at which the vehicle may be driven, damage the emission system and cause hard starting. If an excessive amount of foreign matter accumulates in the fuel tank, the filter may require replacement more frequently.

After installing a new filter, run the engine for several minutes, and check for leaks at the connections. Fuel filters should be installed by trained technicians.

F060B01A-AAT

o Drive Belts

Inspect all drive belts for evidence of cuts, cracks, excessive wear or oil saturation and replace if necessary. Drive belts should be checked periodically for proper tension and adjusted as necessary.

F060D01A-AAT

o Fuel Lines, Fuel Hoses and Connections

Check the fuel lines, fuel hoses and connections for leakage and damage. Have a trained technician replace any damaged or leaking parts immediately.

F060F01A-AAT

o Vacuum, Crankcase Ventilation Hoses

Inspect the surface of hoses for evidence of heat and/or mechanical damage. Hard and brittle rubber, cracking, tears, cuts, abrasions, and excessive swelling indicate deterioration. Particular attention should be paid to examine those hose surfaces nearest to high heat sources, such as the exhaust manifold.

Inspect the hose routing to assure that the hoses do not come in contact with any heat source, sharp edges or moving component which might cause heat damage or mechanical wear. Inspect all hose connections, such as clamps and couplings, to make sure they are secure, and that no leaks are present. Hoses should be replaced immediately if there is any evidence of deterioration or damage.

F060G01A-AAT

o Vapor Hose and Fuel Filler Cap

The vapor hose and fuel filler cap should be inspected at those intervals specified in the maintenance schedule. Make sure that a new vapor hose or fuel filler cap is correctly replaced.

F060H01A-AAT

o Air cleaner filter

A Genuine Hyundai air cleaner filter is recommended when the filter is replaced.

F060J01A-AAT

o Spark plugs

Make sure to install new spark plugs of the correct heat range.

F060E01A-AAT

o Timing belt

Inspect all parts related to the timing belt for damage and deformation. Replace any damaged parts immediately.

F070C01A-AAT

o Coolant

The coolant should be changed at the intervals specified in the maintenance schedule.

5-8 VEHICLE MAINTENANCE REQUIREMENTS

F070D01A-AAT

o Manual transaxle oil

Inspect the manual transaxle oil according to the maintenance schedule.

NOTE:

If the oil level is low, check for possible leaks before adding oil. Do not overfill.

F070E03A-AAT

o Automatic Transaxle Fluid and Filter

The fluid level should be in the "HOT" range of the dipstick, after the engine and transaxle are at normal operating temperature. Check the automatic transaxle fluid level with the engine running and the transaxle in neutral, with the parking brake properly applied. Use GENUINE HYUNDAI ATF or DIAMOND ATF SP-III or SK ATF SP-III when adding or changing fluid.

F070F01A-AAT

o Brake Hoses and Lines

Visually check for proper installation, chafing, cracks, deterioration and any leakage. Replace any deteriorated or damaged parts immediately.

F070G02A-AAT

o Brake Fluid

Check brake fluid level in the brake fluid reservoir. The level should be between "MIN" and "MAX" marks on the side of the reservoir. Use only hydraulic brake fluid conforming to DOT 3 or DOT 4.

F070H01A-AAT

o Rear Brake Drums and Linings/ Parking Brake

Check the rear brake drums and linings for scoring, burning, leaking fluid, broken parts, and excessive wear. Inspect the parking brake system including the parking brake lever and cables. For detailed service procedures, refer to the Shop Manual.

F070J01A-AAT

o Brake Pads, Calipers and Rotors

Check the pads for excessive wear, discs for run out and wear, and calipers for fluid leakage.

F070K01A-AAT

o Exhaust Pipe and Muffler

Visually inspect the exhaust pipes, muffler and hangers for cracks, deterioration, or damage. Start the engine and listen carefully for any exhaust gas leakage. Tighten connections or replace parts as necessary.

F070L01A-AAT

o Suspension Mounting Bolts

Check the suspension connections for looseness or damage. Retighten to the specified torque.

F070M01A-AAT

o Steering Gear Box, Linkage & Boots/ Lower Arm Ball Joint

With the vehicle stopped and engine off, check for excessive free-play in the steering wheel. Check the linkage for bends or damage. Check the dust boots and ball joints for deterioration, cracks, or damage. Replace any damaged parts.

F070N01A-AAT

o Power Steering Pump, Belt and Hoses

Check the power steering pump and hoses for leakage and damage. Replace any damaged or leaking parts immediately. Inspect the power steering belt for evidence of cuts, cracks, excessive wear, oiliness and proper tension. Replace or adjust it if necessary.

F070P01A-AAT

o Driveshafts and Boots

Check the drive shafts, boots and clamps for cracks, deterioration, or damage. Replace any damaged parts and, if necessary, repack the grease.

F070Q01A-AAT

o Air Conditioning Refrigerant

Check the air conditioning lines and connections for leakage and damage. Check air conditioning performance according to the relevant shop manual if necessary.

6. Do-It-Yourself Maintenance

Engine Compartment	6-2
General Checks	6-5
Checking the Engine Oil	6-6
Changing the Oil and Filter	6-7
Checking and Changing the Engine Coolant	6-8
Spark Plugs	6-10
Changing the Air Cleaner Filter	6-12
Checking the Transaxle Oil (Manual)	6-13
Checking the Transaxle Fluid (Automatic)	6-13
Checking the Brakes	6-15
Air Conditioning Care	6-17
Checking Drive Belts	6-19
Checking and Replacing Fuses	6-20
Checking the Battery	6-21
Power Steering Fluid Level	6-22
Replacement of Light Bulbs	6-24

6-2 DO-IT-YOURSELF MAINTENANCE

G010A010-AAT

ENGINE COMPARTMENT (2.4 DOHC)

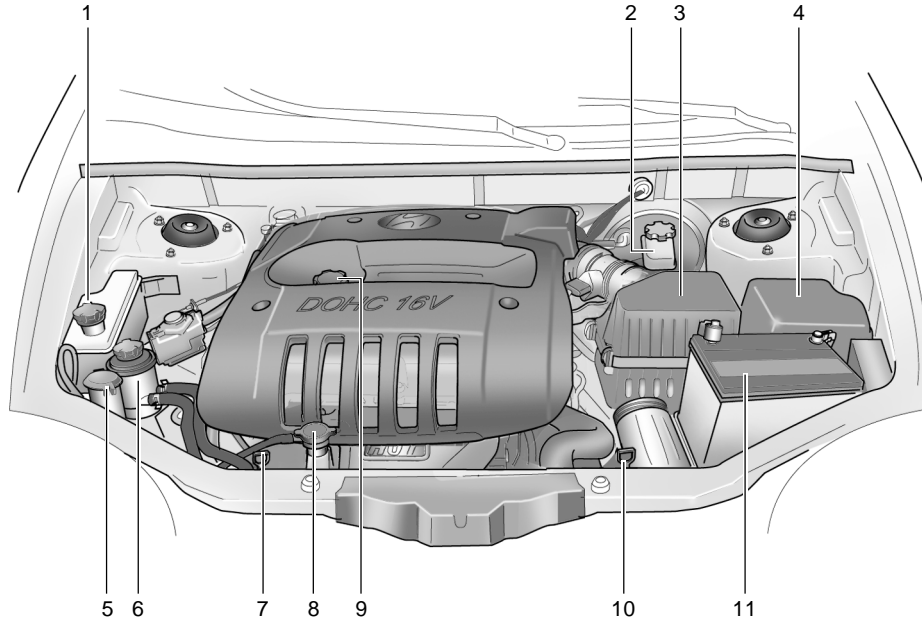

HSM241

1. Coolant reservoir cap
2. Brake & Clutch fluid reservoir
3. Air cleaner
4. Fuse and Relay box

5. Windshield washer fluid reservoir
6. Power steering fluid reservoir
7. Engine oil level dipstick
8. Radiator cap

9. Engine oil filler cap
10. Automatic transaxle fluid level dipstick
(Vehicle with Automatic Transaxle)
11. Battery

G010B01O-AAT

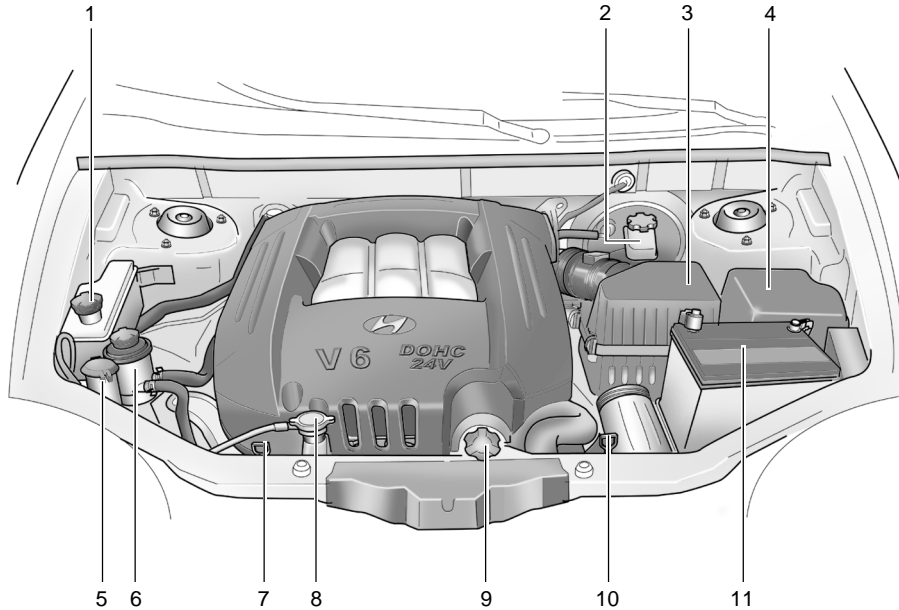
ENGINE COMPARTMENT (2.7 V6)

G010B01O

1. Coolant reservoir cap
2. Brake & Clutch fluid reservoir
3. Air cleaner
4. Fuse and Relay box

5. Windshield washer fluid reservoir
6. Power steering fluid reservoir
7. Engine oil level dipstick
8. Radiator cap

9. Engine oil filler cap
10. Automatic transaxle fluid level dipstick
(Vehicle with Automatic Transaxle)
11. Battery

6-4 DO-IT-YOURSELF MAINTENANCE

G010C010-AAT

ENGINE COMPARTMENT (3.5 V6)

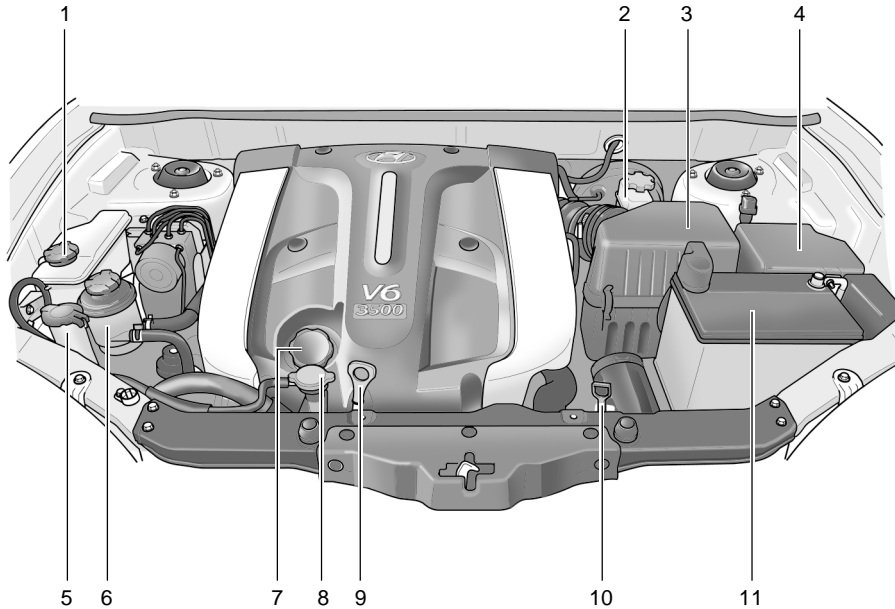

1. Coolant reservoir cap
2. Brake fluid reservoir
3. Air cleaner
4. Fuse and Relay box

5. Windshield washer fluid reservoir
6. Power steering fluid reservoir
7. Engine oil filler cap
8. Radiator cap

9. Engine oil level dipstick
10. Automatic transaxle fluid level dipstick
11. Battery

HSM424

G020A01A-AAT

GENERAL CHECKS**Engine Compartment**

The following should be checked regularly:

- o Engine oil level and condition
- o Transaxle fluid level and condition
- o Brake fluid level
- o Clutch fluid level
- o Engine coolant level
- o Windshield washer fluid level
- o Accessory drive belt condition
- o Engine Coolant hose condition
- o Fluid leaks (on or below components)
- o Power steering fluid level
- o Battery condition
- o Air filter condition

G020B01A-AAT

Vehicle Exterior

The following should be checked monthly:

- o Overall appearance and condition
- o Wheel condition and wheel nut torque
- o Exhaust system condition
- o Light condition and operation
- o Windshield glass condition
- o Wiper blade condition
- o Paint condition and body corrosion
- o Fluid leaks
- o Door and hood lock condition
- o Tire pressure and condition (including spare tire)

G020C01A-AAT

Vehicle Interior

The following should be checked each time when the vehicle is driven:

- o Lights operation
- o Windshield wiper operation
- o Horn operation
- o Defroster, heating system operation (and air conditioning, if installed)
- o Steering operation and condition
- o Mirror condition and operation
- o Turn signal operation
- o Accelerator pedal operation
- o Brake operation, including parking brake
- o Manual transaxle operation, including clutch operation
- o Automatic transaxle operation, including "Park" mechanism operation
- o Seat control condition and operation
- o Seat belt condition and operation
- o Sunvisor operation

If you notice anything that does not operate correctly or appears to be functioning incorrectly, inspect it carefully and seek assistance from your Hyundai dealer if service is needed.

6-6 DO-IT-YOURSELF MAINTENANCE

G030A01A-AAT

CHECKING THE ENGINE OIL

Engine oil is essential to the performance and service of the engine. It is suggested that you check the oil level at least once a week in normal use and more often if you are on a trip or driving in severe conditions.

G030B01A-AAT

Recommended Oil

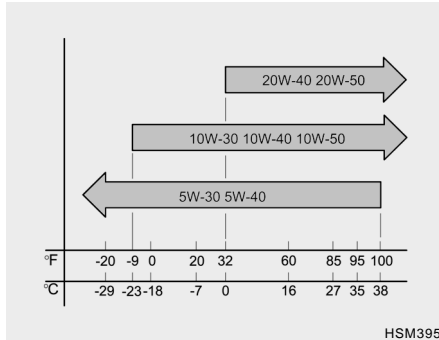

SH, SG or SG/CD (API) multi-grade and fuel efficient oil is recommended.

G030C02A-AAT

To Check the Oil Level

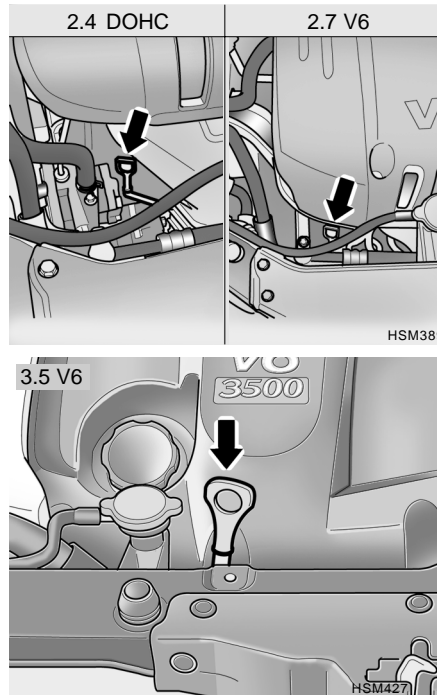

Before checking the oil, warm up the engine to the normal operating temperature and be sure your car is parked on level ground. Turn the engine off.

Wait five minutes, then remove the dipstick, wipe it off, fully reinsert the dipstick and withdraw it again. Then note the highest level the oil has reached on the dipstick. It should be between the upper ("F") and lower ("L") range.

G030D01A-AAT

Adding Oil

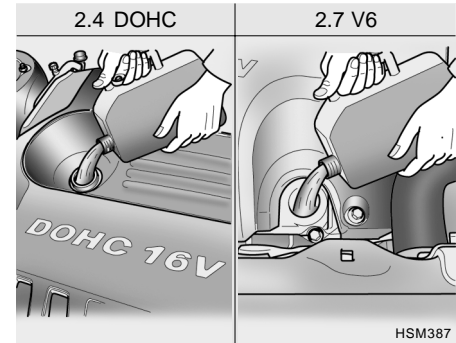

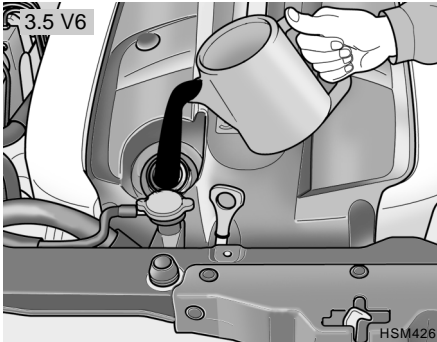

If the oil level is close to or below the "L" mark, add oil until it reaches the "F" mark. To add oil:

1. Remove the oil filler cap by turning it counterclockwise.
2. Add oil, then check the level again. Do not overfill.
3. Replace the cap by turning it clockwise.

The distance between the "F" and "L" marks is equal to about 1 quart of oil.

G040A03A-GAT

CHANGING THE OIL AND FILTER

2.4 DOHC

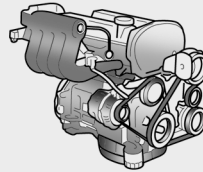

2.7 V6

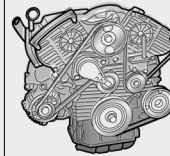

HSM394

3.5 V6

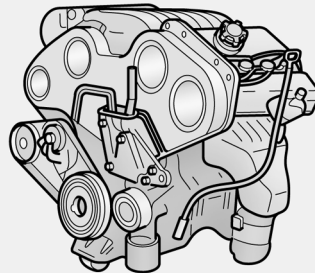

G040A02L

The engine oil and filter should be changed at those intervals specified in the maintenance schedule in Section 5. If the car is being driven in severe conditions, more frequent oil and filter changes are required.

The procedure for changing the oil and filter is as follows:

1. Park the car on level ground and set the parking brake. Start the engine and let it warm up until the needle on the coolant temperature gauge moves above the lowest mark. Turn the engine off and place the gear selector lever in "P" (automatic) or reverse gear (manual transaxle).
2. Open the hood and remove the engine oil filler cap.
3. Slide underneath the car and loosen the drain plug by turning it counterclockwise with a wrench of the proper size. Be sure that a drain pan is in position to catch the oil as it drains out, then remove the drain plug.



WARNING:

Be very careful when draining the engine oil as it may be hot enough to burn you!

6-8 DO-IT-YOURSELF MAINTENANCE

- When the oil has stopped draining, replace the drain plug using a new washer and retighten by turning it clockwise.

Oil pan drain plug tightening torque:
3.5 ~ 4.5 kgf.m

- Remove the oil filter by turning it counter-clockwise with a oil filter wrench of the proper size. A certain amount of oil will come out when you remove the filter. So be sure to have your drain pan in place underneath it.
- Install a new oil filter in accordance with the instructions on the carton or on the filter itself. Do not over-tighten. (**Tightening torque : 1.2 ~ 1.6 kgf.m**) Be sure that the mounting surface on the engine is clean and that the old gasket is removed completely. Lubricate the new gasket on the filter with clean engine oil before installation.
- Refill the crankcase with the recommended engine oil. Refer to the specification in chapter 9 for engine oil capacity.
- Start the engine and check to be sure no oil is leaking from the drain plug or oil filter.
- Shut off the engine and recheck the oil level.

NOTE:

Always dispose of used engine oil in an environmentally acceptable manner. It is suggested that it be placed in a sealed container and taken to a service station for reclamation. Do not pour the oil on the ground or put it in with the household trash.

! **WARNING:**
Used motor oil may cause irritation or cancer of the skin if left in contact with the skin for prolonged periods of time. Wash your hands thoroughly with soap and warm water as soon as possible after handling used oil.

G050A01A-AAT

CHECKING AND CHANGING THE ENGINE COOLANT

! **WARNING:**
Do not remove the radiator cap when the engine is hot. When the engine is hot, the engine coolant is under pressure and may erupt through the opening if the cap is removed. You could be seriously burned if you do not observe this precaution. Do not remove the radiator cap until the radiator is cool to the touch.

G050B01A-AAT

Recommended Engine Coolant

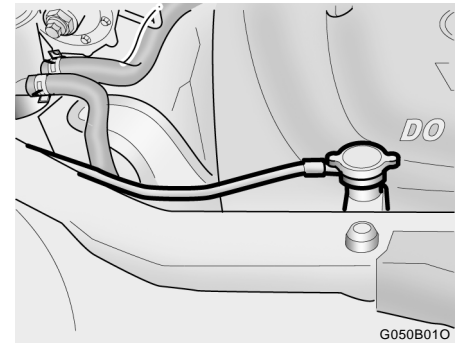

Use a high quality ethylene-glycol coolant in a 50/50 mix with water. The engine coolant should be compatible with aluminum engine parts. Additional corrosion inhibitors or additives should not be used. The cooling system must be maintained with the correct concentration and type of engine coolant to prevent freezing and corrosion. Never allow the concentration of antifreeze to exceed the 60% level or go below the 35% level, or damage to the cooling system may result. For proper concentration when adding or replacing the engine coolant, refer to the following table.

Ambient temperature °C (°F)	Engine Coolant concentration	
	Antifreeze solution	Water
-15 (5)	35%	65%
-25 (-13)	40%	60%
-35 (-31)	50%	50%
-45 (-49)	60%	40%

G050C01A-AAT

To Check the Coolant Level

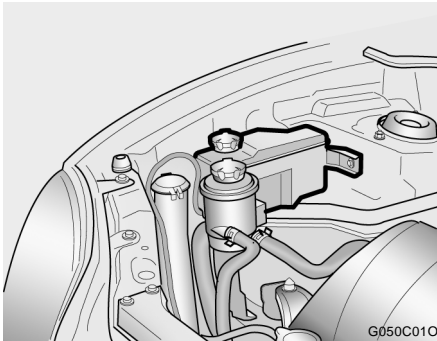

G050C010

The coolant level can be seen on the side of the plastic coolant reservoir. The level of the coolant should be between the "L" and "F" lines on the reservoir when the engine is cool. If the level is below the "L" mark, add engine coolant to bring it up between "L" and "F". If the level is low,

inspect for coolant leaks and recheck the fluid level frequently. If the level drops again, visit your Hyundai dealer for an inspection and diagnosis of the reason.

G050D02A-AAT

To Change the Engine Coolant

The engine coolant should be changed at those intervals specified in the vehicle maintenance schedule in Section 5.

CAUTION:

Engine coolant can damage the finish of your car. If you spill engine coolant on the car, wash it off thoroughly with clean water.

1. Park the car on level ground, set the parking brake and remove the radiator cap when cool.
2. Be sure your drain receptacle is in place. Open the drain cock on the radiator. Allow all the engine coolant to drain from the cooling system, then securely close the drain cock.
3. Check Section 9 for the capacity of the cooling system in your car. Then, following the manufacturer's directions on the engine coolant container, add the appropriate quantity of coolant to the radiator.

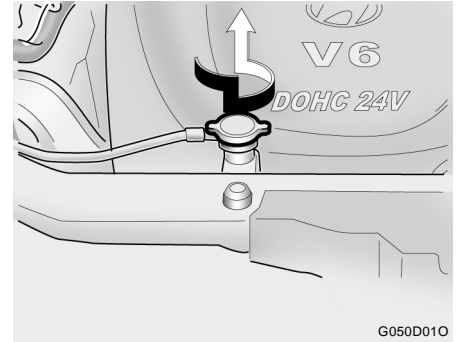

G050D010

4. Turn the radiator cap counterclockwise without pressing down on it, until it stops. This relieves any pressure remaining in the cooling system. And remove the radiator cap by pushing down and turning counterclockwise.
Now fill the radiator with clean demineralized or distilled water. Continue to add clean demineralized or distilled water in small quantities until the fluid level stays up in the radiator neck.

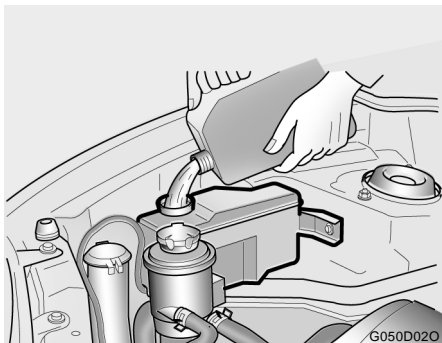

5. Start the engine, top off the radiator with water and then add coolant to the reservoir until the level is between "L" and "F".
6. Replace the radiator and reservoir caps and check to be sure the drain cocks are fully closed and not leaking.

**WARNING:**

The cooling fan is controlled by engine coolant temperature and may sometimes operate even when the engine is not running. Use extreme caution when working near the blades of the coolant fan so that you are not injured by a rotating fan blade. As the engine coolant temperature decreases, the fan will automatically shut off. This is a normal condition.

G060A010-AAT

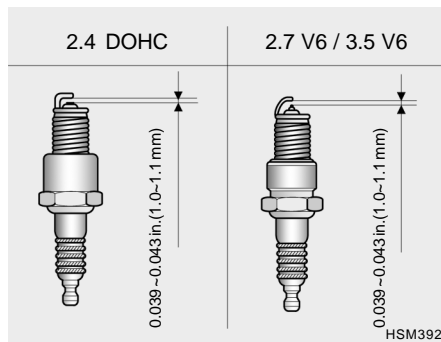
SPARK PLUGS

Your engine was originally equipped with platinum-tipped spark plugs. Platinum-tipped spark plugs will last longer than conventional type spark plugs and can be identified by blue lines on the ceramic shell.

NOTE:

Do not clean or regap platinum-tipped spark plugs.

G060B020-AAT

Replacing the Spark Plugs

The spark plugs should be changed at the intervals specified in the vehicle maintenance schedule in Section 5 or whenever engine performance indicates they should be changed. Symptoms that suggest poor spark plug performance include engine misfiring under load, loss of fuel economy, poor acceleration, etc. When spark plugs are replaced, always use spark plugs recommended by Hyundai. The use of other spark plugs can result in loss of performance, radio interference or engine damage.

NOTE:

- o When replacing the spark plugs, **genuine Hyundai replacement parts are recommended.**
- o **It is recommended that the spark plug should be changed by an authorized Hyundai dealer. (2.7 L, 3.5 L)**

Recommended Spark Plugs:

Type	Remark
RN10PYP4 (CHAMPION) PGR5C-11 (NGK)	2.4 L
RC10PYPB4 (CHAMPION) PFR5N-11 (NGK)	2.7 L / 3.5 L

G060C010-AAT

Changing the Spark Plugs

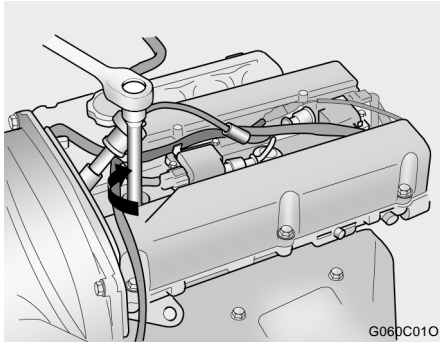

You will find it easier to change spark plugs if the engine is cold. Always change one spark plug at a time. This helps avoid getting the wires mixed up.

1. Remove the center cover (2.4 L) on the engine rocker cover.
2. Using a clean cloth, remove any dirt that has accumulated around the base of the spark plug so it cannot fall into the cylinder when the spark plug is removed.
3. To remove the spark plug cable, pull straight up on the insulated connector, not the cable. Pulling on the cable may damage the carbon core conductor.

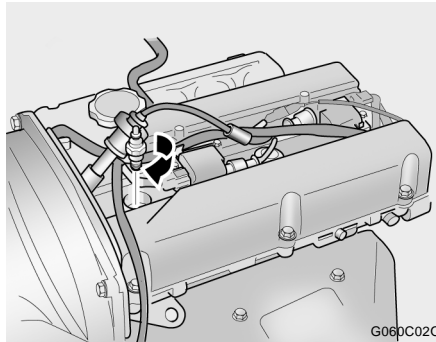

! **WARNING:**
 It is recommended that the engine be cool or cold when changing the spark plugs. If the engine is hot, you could burn yourself on the insulated connector, the spark plug or the engine itself.

4. When preparing to remove the old spark plug, guide the socket down over the spark plug, being careful not to damage the ceramic insulator.
5. To remove the old spark plug, turn the wrench handle in a counterclockwise direction.
6. To install the new spark plug, guide the socket down over the spark plug, being careful not to damage the ceramic insulator.

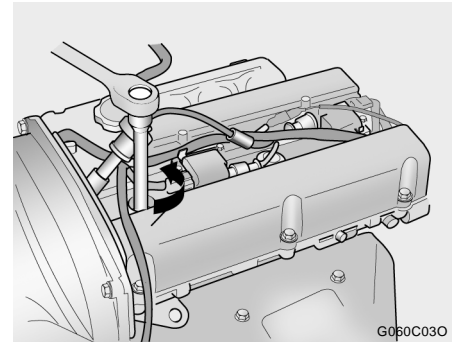
**NOTE:**

Spark plugs should be tightened to specification. Over-tightening can damage the threads in the aluminum cylinder head. Also, leaving them too loose can cause the spark plug to get very hot and possibly result in damage to the engine.

7. Replace the cable by pushing the insulated connector directly down onto the electrode. Check to be sure it has snapped into place and can't fall off.

G070A02Y-AAT

CHANGING THE AIR CLEANER FILTER



G070A01O

The replacement of air cleaner filter is performed in the following manner.

1. Unsnap the clips around the cover.
2. When this is done, the cover can be lifted off, the old filter removed and the new filter put in its place.

Genuine Hyundai replacement parts are recommended.



CAUTION:

Operating your vehicle without a proper air cleaner filter in place can result in excessive engine wear.

G080A02A-AAT

WINDSHIELD WIPER BLADES

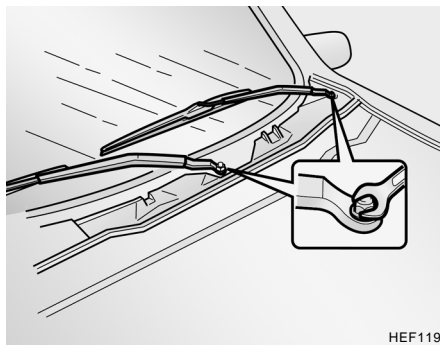

HEF119

The wiper blades should be carefully inspected from time to time and cleaned to remove accumulations of road film or other debris. To clean the wiper blades and arms, use a clean sponge or cloth with a mild soap or detergent and water. If the wipers continue to streak or smear the glass, replace them with genuine Hyundai replacement parts or their equivalent.

NOTE:

- o Do not operate the wipers on dry glass. This can result in more rapid wear of the wiper blades and may scratch the glass.
- o Keep the blade rubber out of contact with petroleum products such as engine oil, gasoline, etc.

G090A01O-AAT

FILLING THE WASHER RESERVOIR

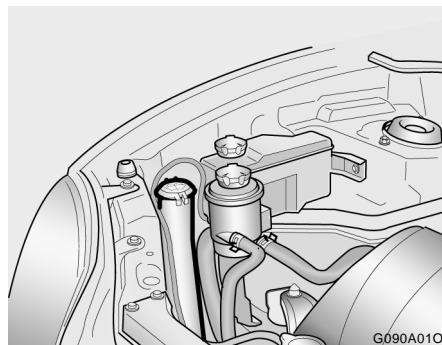

G090A01O

The washer fluid reservoir supplies fluid to the windshield washer system.

A good quality washer fluid should be used to fill the washer reservoir. The fluid level should be checked more frequently during bad weather or whenever the washer system is in more frequent use.

The capacity of the washer reservoir is 3.59 U.S. quarts (3.4 Liters).



CAUTION:

- o Radiator anti-freeze (engine coolant) should not be used in the washer system because it will damage the car's finish.
- o The washer lever should not be pulled and the washer should not be operated if the washer reservoir is empty. This can damage the washer fluid pump.

G100A020-AAT

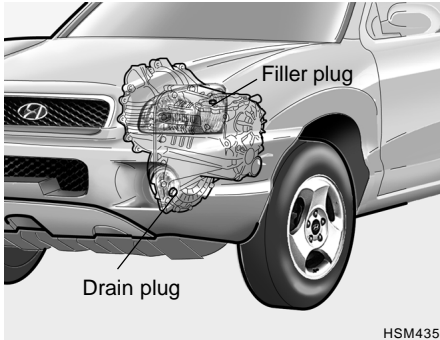
CHECKING THE TRANSAXLE OIL (MANUAL)

Transaxle lubricant in the manual transaxle should be checked at those intervals specified in the vehicle maintenance schedule in Section 5.

Recommended Oil

Use only HYUNDAI GENUINE PARTS MTF 75W/90 (API GL-4) or EQUIVALENT in the manual transaxle.

Manual Transaxle Oil Capacity

The oil capacity of the manual transaxle is 2.43 U.S. quarts (2.3 liters).

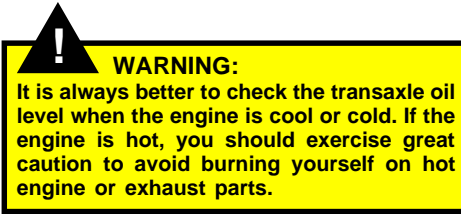

G100B02A-AAT

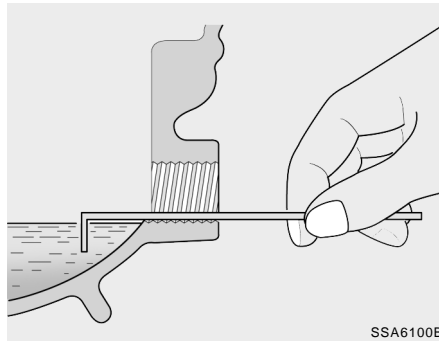
To Check the Manual Transaxle Fluid Level

Park the car on level ground with the engine off.

1. Using a wrench of the correct size, loosen the oil filler plug by turning it counterclockwise and remove it with your fingers.

2. Use your finger or suitable tool to feel inside the hole. The oil level should be at its bottom edge. If it is not, check for leaks before adding oil. To refill the transaxle or bring the oil level up, add oil slowly until it reaches the proper level. Do not overfill.
3. Replace the plug and washer, screw it in with your fingers and then tighten securely with the wrench.

G110A01A-AAT

CHECKING THE TRANSAXLE FLUID (AUTOMATIC)

Transaxle fluid in the automatic transaxle should be checked at those intervals specified in the vehicle maintenance schedule in Section 5.

G110B03A-AAT

Recommended Fluid

Your Hyundai automatic transaxle is specially designed to operate with HYUNDAI GENUINE ATF or DIAMOND ATF SP-III or SK ATF SP-III. Damage caused by a nonspecified fluid is not covered by your new vehicle limited warranty.

G110C01O-AAT

Transaxle Fluid Capacity

The fluid capacity of the automatic transaxle is 8.98 U.S. quarts (8.5 liters).



WARNING:

The transaxle fluid level should be checked when the engine is at normal operating temperature. This means that the engine, radiator, exhaust system etc., are very hot so you should exercise great care not to burn yourself during this procedure.

G110D02Y-AAT

To Check the Transaxle Fluid Level

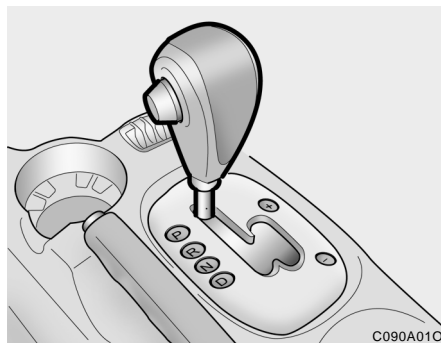

Park the car on level ground with the parking brake engaged. When the transaxle fluid level is checked, the transaxle fluid should be at normal operating temperature and the engine idling.

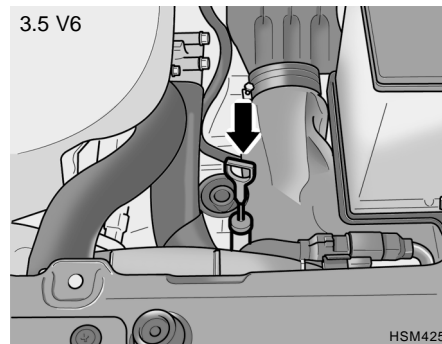
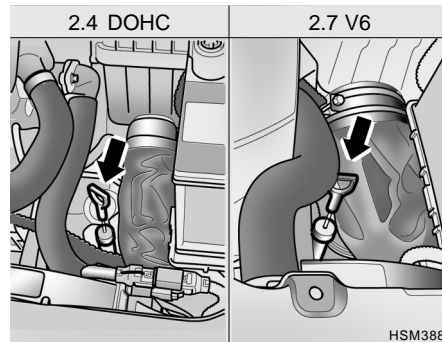

While the engine is idling, apply the brakes and move the gear selector lever from "P" to each of its other positions — "R", "N", "D", "2", "3", "L" — and then return to "N" or "P". With the engine still idling:

1. Open the hood, being careful to keep hands, long hair and clothing clear of any moving parts.
2. Remove the transaxle dipstick, wipe it clean, reinsert the dipstick as far as it will go, then remove it again. Now check the fluid level on the dipstick. It should be in the "HOT" range on the dipstick.
3. If the transaxle fluid level is low, use a funnel to add transaxle fluid through the dipstick tube until the level reaches the "HOT" range. Do not overfill.

Fluid level should be within "HOT" range

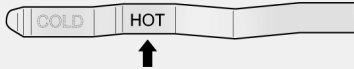

G110D03Y



WARNING:

The cooling fan is controlled by engine coolant temperature and may sometimes operate even when the engine is not running. Use extreme caution when working near the blades of the cooling fan, so that you are not injured by a rotating fan blade. As the engine coolant temperature decreases, the fan will automatically shut off. This is a normal condition.

G120A01A-AAT

CHECKING THE BRAKES



CAUTION:

Because brakes are essential to the safe operation of the car, it is suggested that they be checked and inspected by your Hyundai dealer. The brakes should be checked and inspected for wear at those intervals specified in the vehicle maintenance schedule in Section 5.

G120B01A-AAT

Checking the Brake Fluid Level



WARNING:

Use caution when handling brake fluid. It can damage your vision if it gets into your eyes. It will also damage your vehicle's paint if spilled on it and not removed immediately.

G120C02A-AAT

Recommended Brake Fluid

Use only hydraulic brake fluid conforming to DOT 3 or DOT 4 specifications in your braking system. Follow the instructions printed on the container.

G120D01A-AAT

To Check the Fluid Level

The fluid level in the brake fluid reservoir should be checked periodically. The level should be between the "MIN" and "MAX" marks on the side of the reservoir. If the level is at or below the "MIN" mark, carefully add fluid to bring it up to "MAX". Do not overfill.

G120E02A-AAT

Adding Brake Fluid

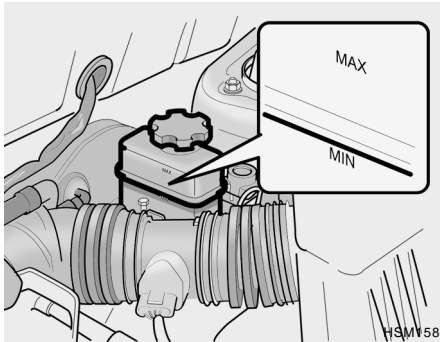

! **WARNING:**
Handle brake fluid carefully. It can damage your vision if it gets into your eyes. Use only DOT 3 or DOT 4 specification fluid from a sealed container. Do not allow the fluid can or reservoir to remain open any longer than required. This will prevent entry of dirt and moisture which can damage the brake system and cause improper operation.

To add brake fluid, first wipe away any dirt then unscrew the fluid reservoir cap. Slowly pour the recommended fluid into the reservoir. Do not overfill. Carefully replace the cap on the reservoir and tighten.

G130A01A-AAT

CHECKING THE CLUTCH FLUID

To Check the Clutch Fluid

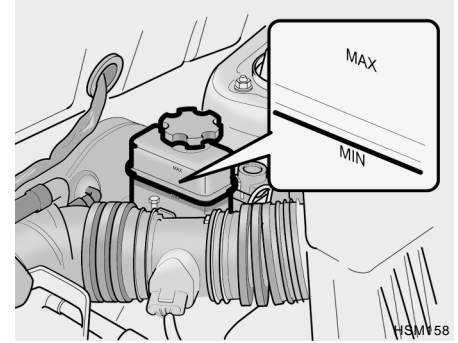

The clutch fluid level in the master cylinder should be checked when performing other under hood services. The system should be checked for leakage at the same time. Check to make certain that the clutch fluid level is always between the "MAX" and "MIN" level markings on the fluid reservoir. Fill as required. Fluid loss indicates a leak in the clutch system which should be inspected and repaired immediately. Consult your Hyundai dealer.

G130B02A-AAT

To Replace the Fluid

Recommended brake fluid conforming to DOT 3 or DOT 4 specification should be used. The reservoir cap must be fully tightened to avoid contamination from foreign matter or moisture.

NOTE:

Do not allow any other liquids to contaminate the brake fluid. Seal damage will result.

**WARNING:**

Use caution when handling brake fluid. It can damage your vision if you get it in your eyes. It will also damage your vehicle's paint if spilled on it and not removed immediately.

G140A01A-AAT

AIR CONDITIONING CARE**Keeping the Condenser Clean**

The air conditioning condenser (and engine radiator) should be checked periodically for accumulation of dirt, dead insects, leaves, etc. These can interfere with maximum cooling efficiency. When removing such accumulations, brush or hose them away carefully to avoid bending the cooling fans.

G140B01A-AAT

Checking the Air Conditioning Operation

1. Start the engine and let it run at a fast idle for several minutes with the air conditioning set at the maximum cold setting.
2. If the air coming out of the in-dash vents is not cold, have the air conditioning system inspected by your Hyundai dealer.

**CAUTION:**

Running the air conditioning system for extended periods of time with a low refrigerant level may damage the compressor.

G140C01A-AAT

Lubrication

To lubricate the compressor and the seals in the system, the air conditioning should be run for at least 10 minutes each week. This is particularly important during cool weather when the air conditioning system is not otherwise in use.

G140D01A-AAT

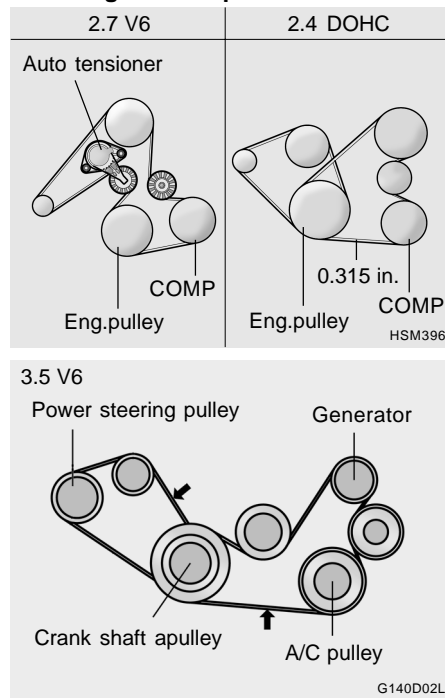
Checking the Compressor Drive Belt

6-18 DO-IT-YOURSELF MAINTENANCE

When the air conditioning is being used regularly, the compressor drive belt tension should be checked at least once a month with the engine turned off.

To check the drive belt tension, press down on the belt halfway between the engine crankshaft and compressor pulleys. Pressing with your finger, you should not be able to deflect this belt anymore than 1/3 of an inch. If you have the instruments to check it, with a force of 22 lb. (98N), the deflection should be 0.315 inches (approx 8.0 mm). If the belt is too loose, have it adjusted by your Hyundai dealer.

G150A01A-AAT

CHECKING STEERING WHEEL FREE-PLAY

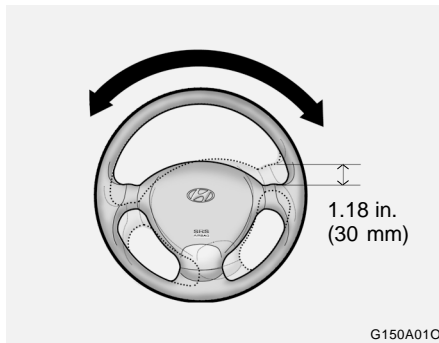

To check the steering wheel free-play, stop the car with the wheels pointed straight ahead and gently move the steering wheel back and forth. Use very light finger pressure and be sensitive to changes in resistance that mark the limits of the free-play. If the free-play is greater than specified, have it inspected by your Hyundai dealer and adjusted or repaired if necessary.

G160A01A-AAT

CHECKING CLUTCH PEDAL FREE-PLAY

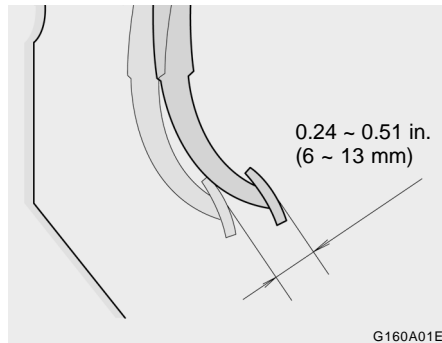

With the engine off, press lightly on the clutch pedal until you feel a change in resistance. This is the clutch pedal free-play. The free-play should be within the limits specified in the illustration. If it is not, have it inspected by your Hyundai dealer and adjusted or repaired if necessary.

G170A01A-AAT

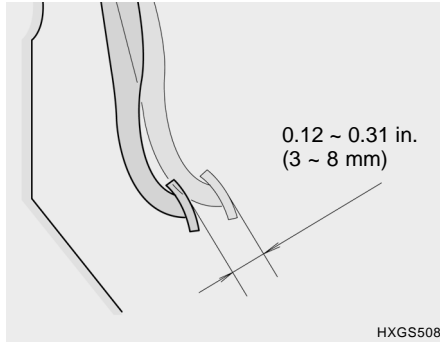
**CHECKING BRAKE PEDAL
FREE-PLAY**

With the engine off, press down on the brake pedal several times to reduce the vacuum in the brake booster.

Then, using your hand, press down slowly on the brake pedal until you feel a change in resistance. This is the brake pedal free-play. The free-play should be within the limits specified in the illustration above. If it is not, have it inspected by your Hyundai dealer and adjusted or repaired if necessary.

G180A01A-AAT

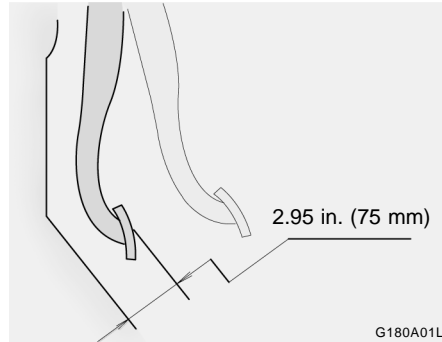
**CHECKING BRAKE PEDAL
CLEARANCE**

You need a helper to check the brake pedal clearance. With the engine running, have your helper press down on the brake pedal several times and then hold it down with a force of about 110 lbs (50 kg, 490 N). The brake pedal clearance is the distance from the top surface of the brake pedal to the asphalt sheeting under the floor mat.

If the brake pedal clearance is not within the limits specified in the illustration, have it inspected by your Hyundai dealer and adjusted or repaired if necessary.

G190A01A-AAT

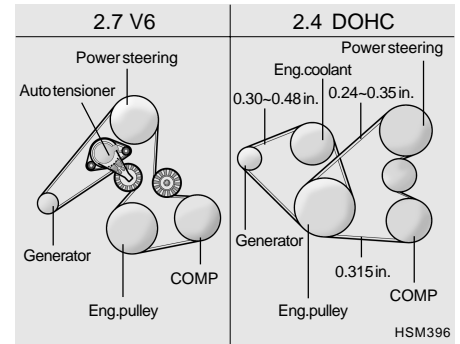
CHECKING DRIVE BELTS

3.5 V6

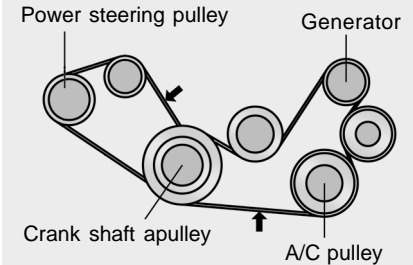

G140D02L

Drive belts should be checked periodically for proper tension and adjusted if necessary. At the same time, belts should be examined for cracks, wear, fraying or other evidence of deterioration and replaced if necessary.

Belt routing should also be checked to be sure there is no interference between the belts and other parts of the engine. After a belt is replaced, the new belt should be adjusted again after two or three weeks to eliminate slack resulting from initial stretching after use.

G200A01A-AAT

CHECKING AND REPLACING FUSES

Replacing a Fusible Link

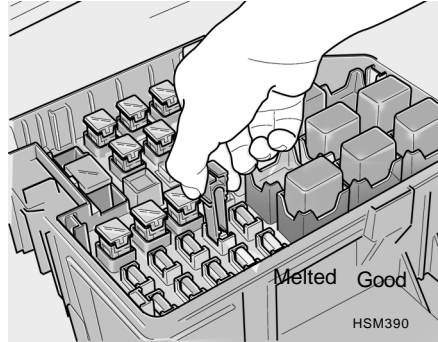

A fusible link will melt if the electrical circuits from the battery are ever overloaded, thus preventing damage to the entire wiring harness. (This could be caused by a short in the system drawing too much current.) If this ever happens, have a Hyundai dealer determine the cause, repair the system and replace the fusible link. The fusible links are located in a relay box for easy inspection.



CAUTION:

When replacing a fusible link, never use anything but a new fusible link with the same or lower amperage rating. Never use a piece of wire or a higher-rated fusible link. This could result in serious damage and create a fire hazard.

G200B01A-AAT

Replacing Accessory Fuse

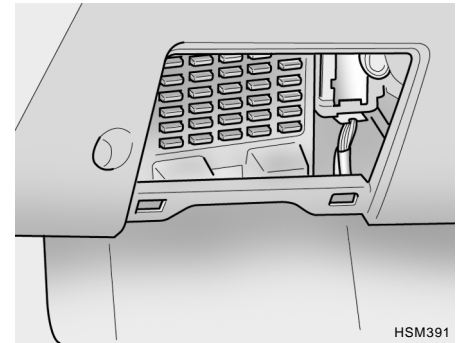

The fuse box for the lights and other electrical accessories will be found low on the dashboard on the driver's side. Inside the box you will find a list showing the circuits protected by each fuse.

If any of your car's lights or other electrical accessories stop working, a blown fuse could be the reason. If the fuse has burned out, you will see that the metal strip inside the fuse has burned through. If you suspect a blown fuse, follow this procedure:

1. Turn off the ignition and all other switches.
2. Open the fuse box and examine each fuse. Remove each fuse by pulling it toward you (a small "fuse puller" tool is contained in the fuse box to simplify this operation).

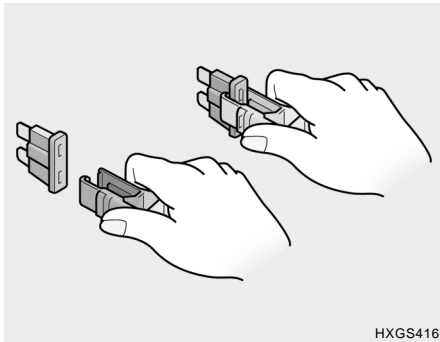

3. Be sure to check all other fuses even if you find one that appears to have burned out.
4. Replace the blown fuse by pressing a new fuse of the same rating into place. The fuse should be a snug fit. If it is not, have the fuse clip repaired or replaced by a Hyundai dealer.

If you do not have a spare fuse, you may be able to borrow a fuse of the same or lower rating from an accessory you can temporarily get along without (the radio or cigarette lighter, for example). Always remember to replace the borrowed fuse.

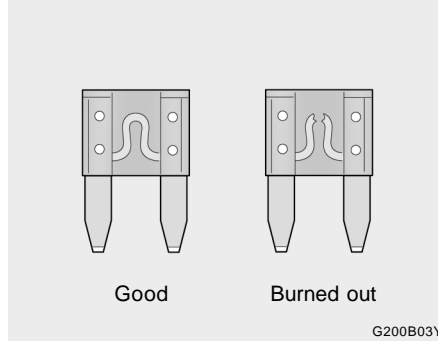

CAUTION:

A burned-out fuse indicates that there is a problem in the electrical circuit. If you replace a fuse and it blows as soon as the accessory is turned on, the problem is serious and should be referred to a Hyundai dealer for diagnosis and repair. Never replace a fuse with anything except a fuse with the same or a lower amperage rating. A higher capacity fuse could cause damage and create a fire hazard.

G210A01A-AAT

CHECKING THE BATTERY



WARNING:

Batteries can be dangerous! When working with batteries, carefully observe the following precautions to avoid serious injuries.

The fluid in the battery contains a strong solution of sulfuric acid, which is poisonous and highly corrosive. Be careful not to spill it on yourself or the car. If you do spill battery fluid on yourself, immediately do the following:

- o If battery fluid is on your skin, flush the affected areas with water for at least 15 minutes and then seek medical assistance.
- o If battery fluid is in your eyes, rinse out your eyes with water and get medical assistance as soon as possible. While you are being driven to get medical assistance, continue to rinse your eyes by using a sponge or soft cloth saturated with water.
- o If you swallow battery fluid, drink a large quantity of water or milk followed by milk of magnesia, eat a raw egg or drink vegetable oil. Get medical assistance as soon as possible.

While batteries are being charged (either by a battery charger or by the vehicle's generator), they produce explosive gases. Always observe these warnings to prevent injuries from occurring:

6-22 DO-IT-YOURSELF MAINTENANCE

- o Charge batteries only in a well ventilated area.
- o Do not permit flames, sparks or smoking in the area.
- o Keep children away from the area.

G210B02A-AAT

Checking the Battery

Keep the battery clean. Any evidence of corrosion around the battery posts or terminals should be removed using a solution of household baking soda and warm water. After the battery terminals are dry, cover them with a light coating of grease.



PROPOSITION 65 WARNING:

Battery posts, terminals, and related accessories contain lead and lead compounds, chemicals known to the state of California to cause cancer and reproductive harm. Wash hands after handling.

G220A01A-AAT

CHECKING ELECTRIC COOLING FANS



WARNING:

The cooling fan is controlled by engine coolant temperature and may sometimes operate even when the engine is not running. Use extreme caution when working near the blades of the coolant fan, so that you are not injured by a rotating fan blade. As the engine coolant temperature decreases the fan will automatically shut off. This is a normal condition.

G220B01A-AAT

Checking Engine Cooling Fan

The engine cooling fan should come on automatically if the engine coolant temperature is high.

G220C01A-AAT

Checking Condenser Cooling Fan

The condenser coolant fan should come on automatically whenever the air conditioning is in operation.

G230A03A-AAT

POWER STEERING FLUID LEVEL

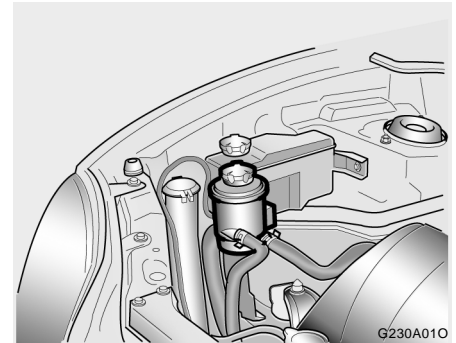

The power steering fluid level should be checked regularly. To check the power steering fluid level, be sure the engine is "OFF", then check to make certain that the power steering fluid level is between the "MAX" and "MIN" level markings on the fluid reservoir.

NOTE:

Grinding noise from the power steering pump may be heard immediately after the engine is started in extremely cold conditions (below - 4°F). If the noise stops during warm up, there is no abnormal function in the system. It is due to a power steering fluid characteristic in extremely cold conditions.

Recommended Fluid

Use PSF-3 type fluid

NOTE:

Do not start the engine when the power steering oil reservoir is empty.

G240A01A-AAT

POWER STEERING HOSES

It is suggested that you check the power steering hose connections for fluid leakage at regular intervals. The power steering hoses should be replaced if there is severe surface cracking, scuffing or worn spots. Deterioration of the hose could cause premature failure.

G250A01A-AAT

FOR MORE INFORMATION ABOUT YOUR HYUNDAI

If you desire additional information about maintaining and servicing your Hyundai, you may purchase a factory Shop Manual at your Hyundai dealer's parts department. This is the same manual used by dealership technicians and while it is highly technical it can be useful in obtaining a better understanding of your car and how it works.

G290A020-AAT

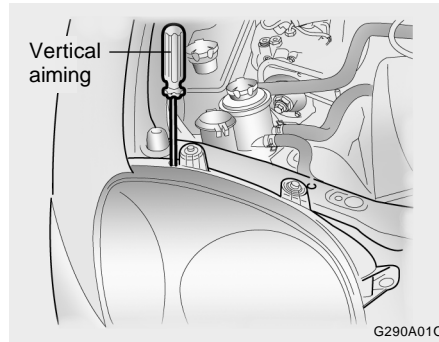
HEADLIGHT AIMING ADJUSTMENT

Before performing aiming adjustment, make sure of the following.

1. Keep all tires inflated to the correct pressure.
2. Place the vehicle on level ground and press the front bumper & rear bumper down several times.
Place vehicle at a distance of 118.1 in. (3m) from the test wall.
3. See that the vehicle is unloaded (except for full levels of coolant, engine oil and fuel, and spare tire, jack, and tools). Have the driver or equivalent weight placed in driver's seat.
4. Clean the head light lenses and turn on the headlights (Low beam).
5. Open the hood.

6. Draw the vertical line (through the center of each headlight beam pattern) and the horizontal line (through the center of each headlight beam pattern) on the aiming screen. And then, draw the parallel line at 0.8 in. (21 mm) under the horizontal line.
7. Adjust each cut-off line of the low beam to the parallel line with a phillips screwdriver - **VERTICAL AIMING.**

**WARNING:**

Horizontal aiming should be adjusted by an authorized Hyundai dealer.

G290B01Y-AAT

Adjustment After Headlight Assembly Replacement

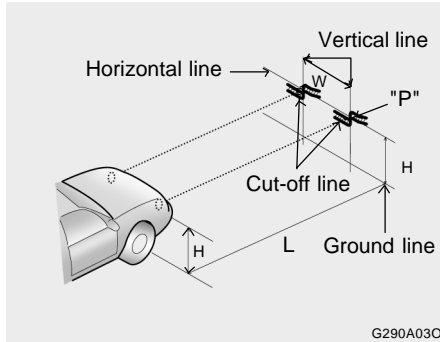

If the vehicle has had front body repair and the headlight assembly has been replaced, the headlight aiming should be checked using an aiming chart as shown in the illustration. Turn on the headlight switch. (Low Beam Position)

1. Adjust headlights so that main axis of light is parallel to center line of the body and is aligned with point "P" shown in the illustration.
2. Dotted lines in the illustration show the center of headlights.

SPECIFICATION:

"H";
Horizontal center line of headlights from ground: 2WD : 32.5 in.(822 mm)
4WD : 33.3 in.(843 mm)

"W";
Distance between each headlight center:
46.5 in.(1,178 mm)

"L";
Distance between the headlights and the wall that the lights are tested against:
118 in. (3,000 mm).

G260A01L-AAT

REPLACEMENT OF LIGHT BULBS

Before attempting to replace a light bulb, be sure the switch is turned to the "OFF" position. The next paragraph shows how to reach the light bulbs so they may be changed. Be sure to replace the burned-out bulb with one of the same number and wattage rating.

See page 6-30 for the wattage description.



CAUTION:

Keep the lamps out of contact with petroleum products, such as oil, gasoline, etc.

G270A01O-AAT

Headlight and Front Turn Signal Light

1. Allow the bulb to cool. Wear eye protection.
2. Open the engine hood.
3. Always grasp the bulb by its plastic base, avoid touching the glass.

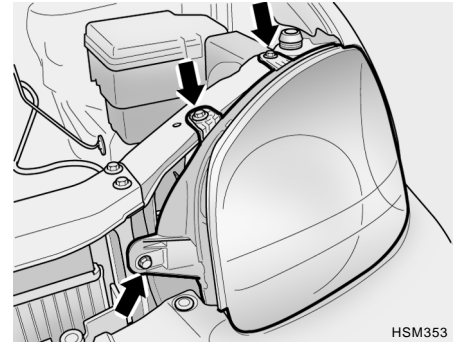

4. Using a socket wrench of the correct size, remove the headlight assembly mounting bolts.

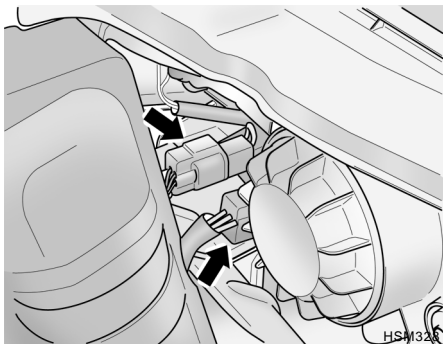

5. Disconnect the power cord from the bulb base in the back of the headlight.

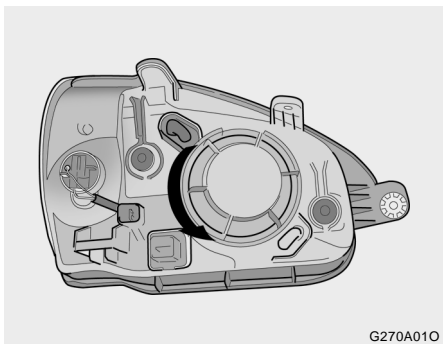

6. Turn the plastic cover counterclockwise and remove it.

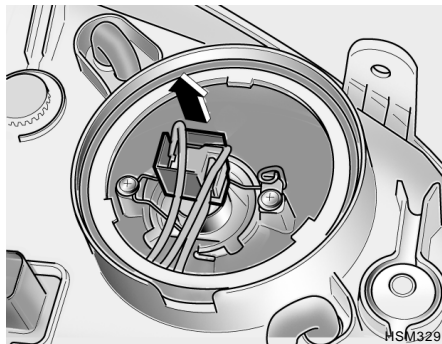

7. Disconnect the power cord from the bulb base in the back of the headlight.

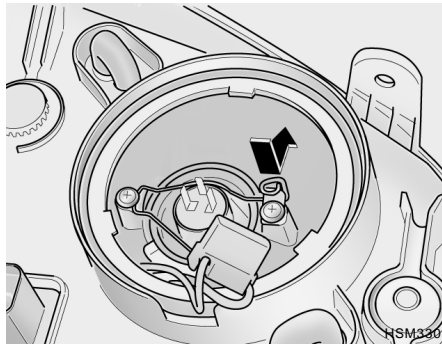

8. Push the bulb spring to remove the headlight bulb.

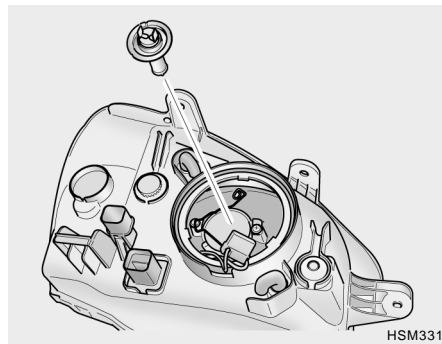

9. Remove the protective cap from the replacement bulb and install the new bulb by matching the plastic base with the headlight hole. Reattach the bulb spring and reconnect the power cord.
10. Use the protective cap and carton to promptly dispose of the old bulb.
11. Check for proper headlight aim.

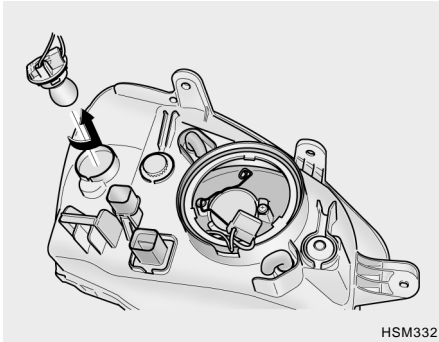

HSM332

12. To replace the front turn signal light bulb, take it out from the bulb holder and install the new bulb.



G270A030

! WARNING:
 This halogen bulb contains gas under pressure and if impacted could shatter, resulting in flying fragments. Always wear eye protection when servicing the bulb. Protect the bulb against abrasions or scratches and against liquids when lighted. Turn the bulb on only when installing in a headlight. Replace the headlight if damaged or cracked. Keep the bulb out of the reach of children and dispose of the used bulb with care.

G270B010-AAT

Rear Combination Light

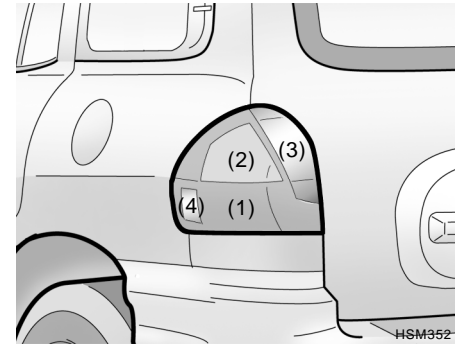

HSM352

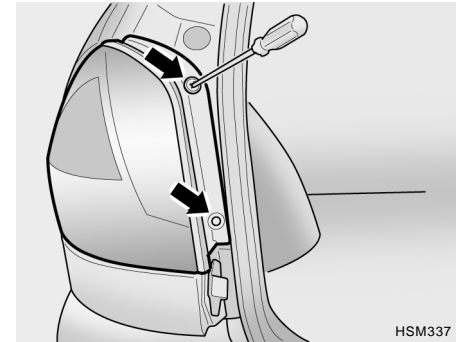

HSM337

1. Open the tail gate.
2. Remove the mounting screws as shown with a phillips screwdriver.

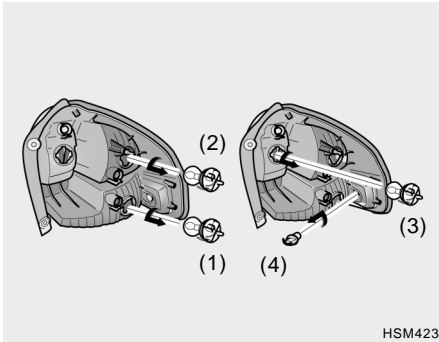

HSM423

3. To replace the rear combination light (stop/tail light, turn signal light, back-up light, side mark light), take it out from the bulb holder by turning it counterclockwise.

- (1) Stop/Tail light
- (2) Turn signal light
- (3) Back-up light
- (4) Side mark light

4. Install the new bulb.

G270C010-AAT

Luggage Compartment Light

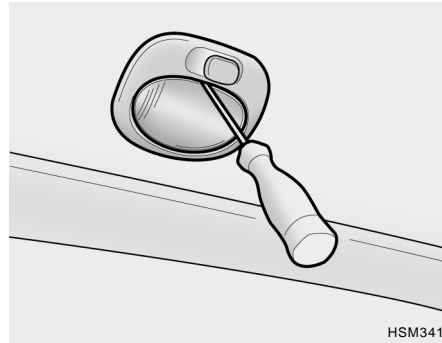

HSM341

1. Open the tail gate.
2. Remove the cover with a flat-head screwdriver.



HSM342

3. Replace with a new bulb.

G270E010-AAT

Front Side Mark Light

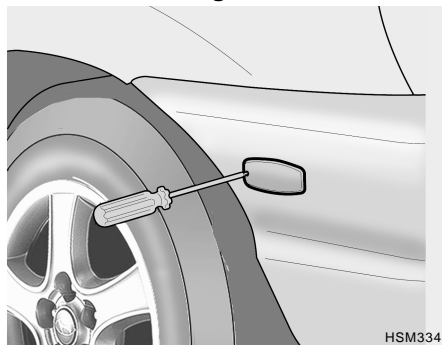

HSM334

1. Remove the cover with a phillips screwdriver.

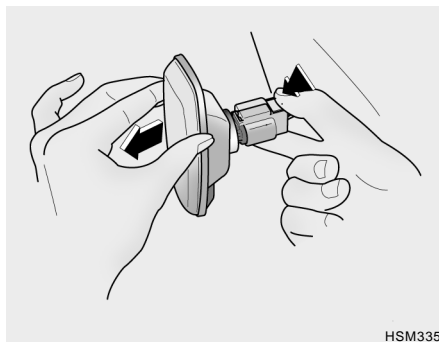

HSM335

2. Disconnect the power code.

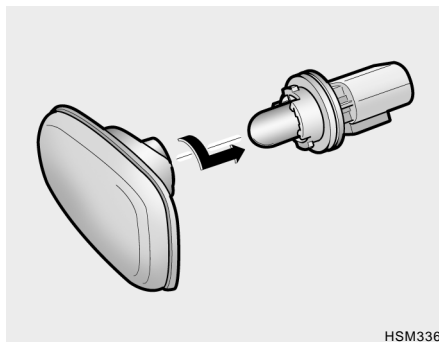

HSM336

3. Replace with a new bulb.

G270G010-AAT

Interior Light



HSM343

1. Remove the cover with a flat-head screwdriver.

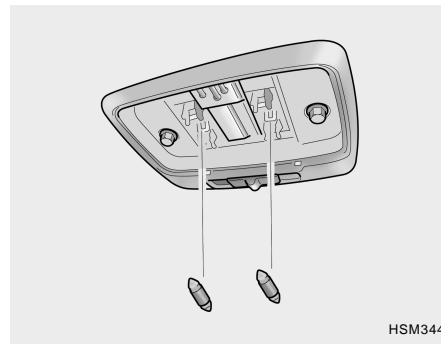

HSM344

2. Replace with a new bulb.

G270H01O-AAT

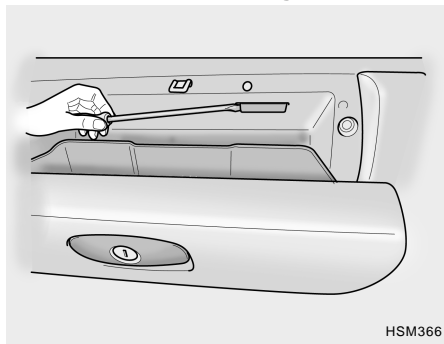
Glove Box Illuminated Light

1. Open the glove box.
2. Remove the cover with a flat-head screwdriver.



3. Disconnect the power cord.

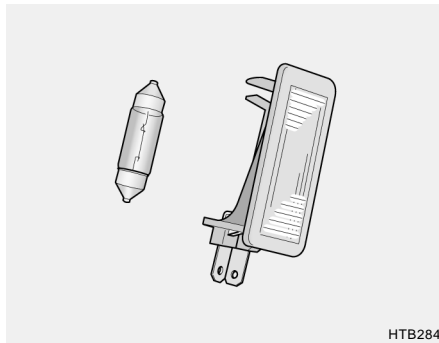

4. Replace with a new bulb.

6-30 DO-IT-YOURSELF MAINTENANCE

G280A020-AAT

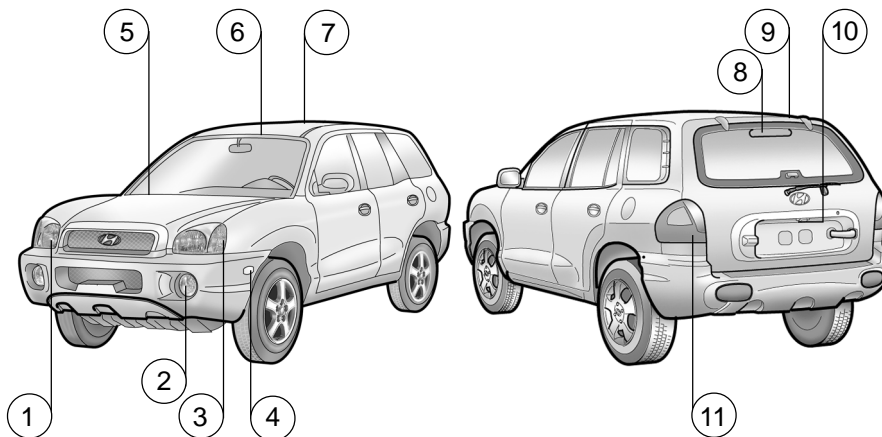

G280A010

No.	Part Name	Wattage	No.	Part Name	Wattage
1	Head Light (Low/High)	55/60	9	Luggage Compartment Light	10
2	Front Fog Light (If installed)	55	10	License Plate Light	5
3	Turn Signal Light	28	11	Rear Combination Light	27/8
4	Side Mark Light	5		Stop/Tail Light	
5	Glove Box Illuminated Light	10		Turn Signal Light	
6	Map Light	15		Back-up Light	
7	Interior Light	10		Rear Side Mark Light	
8	High Mounted Rear Stop Light	17			5

7. EMISSION CONTROL SYSTEMS

Emission Control System	7-2
EGR System	7-2
Catalytic Converter	7-3

7-2 EMISSION CONTROL SYSTEMS

H010A020-AAT

EMISSION CONTROL SYSTEM

Your Hyundai is equipped with an emission control system to meet all requirements of the U.S. Environmental Protection Agency or California Air Resources Board.

There are three emission control systems which are as follows.

- (1) Crankcase emission control system
- (2) Evaporative emission control system
- (3) Exhaust emission control system

In order to assure the proper function of the emission control systems, it is recommended that you have your car inspected and maintained by an authorized Hyundai dealer in accordance with the maintenance schedule in this manual.

Caution for Inspection and Maintenance Test (V6 Vehicle with Traction Control System)

- o To prevent the vehicle from misfiring during dynamometer testing, disconnect the ABS connector in the engine compartment. (2.7 V6 only)
- o For more information, see shop manual (Wheel Speed Sensor).
- o After the dynamometer testing is completed, erase the ABS/TCS DTC (Diagnostic Trouble Code) with a GST (Generic Scan Tool) or Hi-Scan Pro.

H010B01A-AAT

1. Crankcase Emission Control System

The positive crankcase ventilation system is employed to prevent air pollution caused by blow-by gases being emitted from the crankcase. This system supplies filtered air to the crankcase through the air intake hose. Inside the crankcase, the fresh air mixes with blow-by gases, which then pass through the PCV valve and into the induction system.

H010C01S-AAT

2. Evaporative Emission Control (Including ORVR: Onboard Refueling Vapor Recovery) System

The Evaporative Emission Control System is designed to prevent fuel vapors from escaping into the atmosphere.

(The ORVR system is designed to allow the vapors from of the fuel tank to be loaded into a canister while refueling at the gas station, preventing the escape of fuel vapors into the atmosphere.)

Canister

Fuel vapors generated inside the fuel tank are absorbed and stored in the canister. When the engine is running, the fuel vapors absorbed in the canister are drawn into the induction system through the purge control solenoid valve.

Purge Control Solenoid Valve (PCSV)

The purge control solenoid valve is controlled by the Engine Control Module (ECM); when the engine coolant temperature is low during idling, the PCSV closes so that evaporated fuel is not taken into the engine. After the engine warms-up during ordinary driving, the PCSV opens to introduce evaporated fuel to the engine.

H010D01A-AAT

3. Exhaust Emission Control System

The Exhaust Emission Control System is a highly effective system which controls exhaust emissions while maintaining good vehicle performance.

H010E01Y-AAT

EGR SYSTEM (If installed)

This system helps reduce nitrogen oxides by recirculating a part of the exhaust gas into the engine, thereby reducing cylinder combustion temperature, which results in lower output of oxides of nitrogen.

H020A01A-AAT

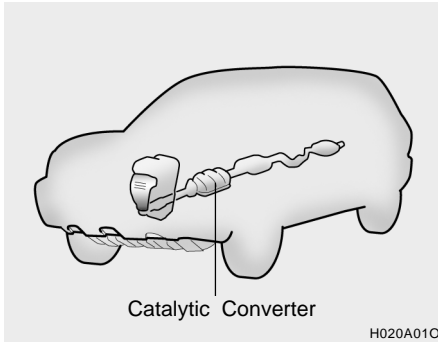
CATALYTIC CONVERTER

All Hyundai vehicles are equipped with a monolith type three-way catalytic converter to reduce the carbon monoxide, hydrocarbons and nitrogen oxides contained in the exhaust gas. Exhaust gases passing through the catalytic converter cause it to operate at a very high temperature. The introduction of large amounts of unburned gasoline into the exhaust may cause the catalytic converter to overheat and create a fire hazard. This risk may be reduced by observing the following:

! **WARNING:**

- o Use unleaded fuel only.
- o Maintain the engine in good operating condition. Extremely high catalytic converter temperatures can result from improper operation of the electrical, ignition or multiport electronic fuel injection.
- o If your engine stalls, pings, knocks, or is hard to start, have your Hyundai dealer inspect and repair the problem as soon as possible.
- o Avoid driving with a very low fuel level. Running out of gasoline may cause the engine to misfire and result in damage to the catalytic converter.
- o Avoid idling the engine for periods longer than 10 minutes.
- o The vehicle should not be pushed or pulled to get started. This may cause the catalytic converter to overheat and create a fire hazard.
- o Do not touch the catalytic converter or any other part of the exhaust system while the catalytic converter is hot. Shut off the engine, wait for at least one hour before touching the catalytic converter or any other part of the exhaust system.
- o Remember that your Hyundai dealer is your best source of assistance.

! **WARNING:**

- o Do not stop your Hyundai over any combustible material such as grass, paper, leaves or rags. These materials might contact the hot catalytic converter and a fire might result.

8. CONSUMER INFORMATION & REPORTING SAFETY DEFECTS

Vehicle Identification Number (VIN)	8-2
Engine Number	8-2
Recommended Inflation Pressures	8-2
Snow Tires	8-3
Tire Chains	8-3
Tire Rotation	8-4
Tire Balancing	8-4
Tire Traction	8-4
When to Replace Tires	8-4
Spare Tire and Tools	8-5
Warranties for Your Hyundai Vehicle	8-5
Consumer Information	8-6
Reporting Safety Defects	8-7

I010A01A-AAT

VEHICLE IDENTIFICATION NUMBER (VIN)

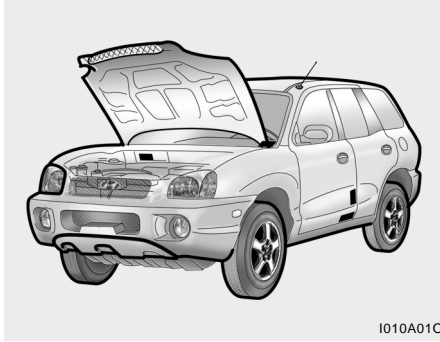

I010A01O

The vehicle identification number (VIN) is the number used in registering your car and in all legal matters pertaining to its ownership, etc. It can be found in three different places on your car:

1. On the bulkhead between the engine and passenger compartments.
2. On the left top side of the instrument panel where it can be seen by looking down through the windshield.
3. On the lower side of the center pillar outer panel.

I010B01A-AAT

Engine Number

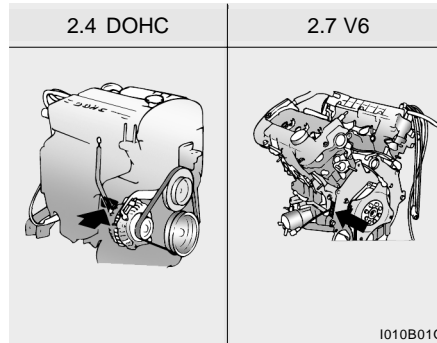

I010B01O

3.5 V6

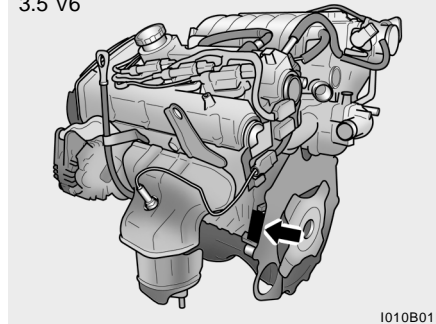

I010B01L

The engine number is stamped on the engine block as shown in the drawing.

I020A01A-AAT

TIRE INFORMATION

The tires supplied on your new Hyundai are chosen to provide the best performance for normal driving.

I030A02S-AAT

RECOMMENDED INFLATION PRESSURES

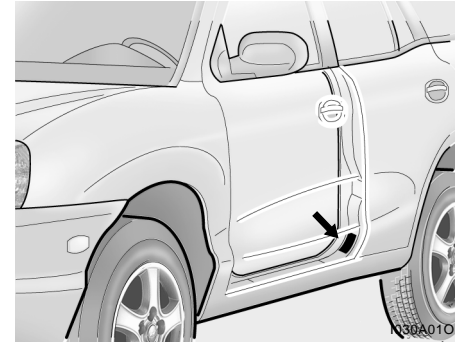

I030A01O

The tire label located on the driver's side of the center pillar outer panel gives the tire pressures recommended for your vehicle.

RIM SIZE	TIRE SIZE	PRESSURE, kPa (PSI)			
		UP TO 2 PERSONS		UP TO MAX. LOAD	
		FRONT	REAR	FRONT	REAR
6.5Jx16	225/70R16	207(30)	207(30)	221(32)	221(32)

These pressures were chosen to provide the most satisfactory combination of ride comfort, tire wear and stability under normal conditions. Tire pressures should be checked at least monthly. Proper tire inflation pressures should be maintained for these reasons:

- o Lower-than-recommended tire pressures cause uneven tread wear and poor handling.
- o Higher-than-recommended tire pressures increase the chance of damage from impacts and cause uneven tread wear.



CAUTION:

Always observe the following:

- o Check pressures when the tires are cold. That is, after the car has been parked for at least three hours and hasn't been driven more than one mile or 1.6 km since starting up.
- o Check the pressure of your spare tire each time you check the pressure of other tires.
- o Never overload your car. Be especially careful about overloading if you equip your car with a luggage rack or car top carrier.

I040A01O-AAT

SNOW TIRES

If you equip your car with snow tires, they should be the same size and have the same load capacity as the original tires. Snow tires should be installed on all four wheels; otherwise, poor handling may result.

Snow tires should carry 4 psi (28 kPa) more air pressure than the pressure recommended for the standard tires on the tire label on the driver's side of the center pillar, or up to the maximum pressure shown on the tire sidewall whichever is less.

Do not drive faster than 75 mph (120 km/h) when your car is equipped with snow tires.

I050A03A-AAT

TIRE CHAINS

Tire chains, if necessary, should be installed on the front wheels. Be sure that the chains are installed in accordance with the manufacturer's instructions.

To minimize tire and chain wear, do not continue to use tire chains when they are no longer needed.



WARNING:

- o When driving on roads covered with snow or ice, drive at less than 20 mph (30 km/h).
- o Use the SAE "S" class or wire & plastic chains.
- o If you have noise caused by chains contacting the body, retighten the chain to avoid contact with the vehicle body.
- o To prevent body damage, retighten the chains after driving 0.3 ~ 0.6 miles.

I060A010-AAT

TIRE ROTATION

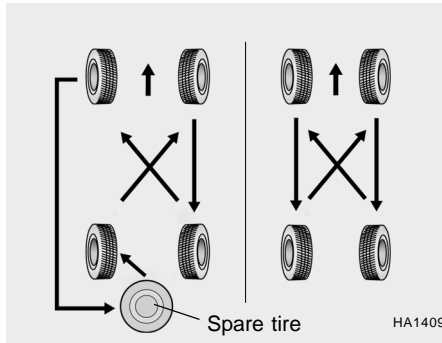

Tires should be rotated every 7,500 miles (12,000 km). If you notice that tires are wearing unevenly between rotations, have the car checked by a Hyundai dealer so the cause may be corrected.

After rotating, adjust the tire pressures and be sure to check wheel nut torque.



CAUTION:

Do not mix bias-ply and radial-ply under any circumstances. This may cause dangerous handling characteristics.

I070A01A-AAT

TIRE BALANCING

A tire that is out of balance may affect handling and tire wear. The tires on your Hyundai were balanced before the car was delivered but may need balancing again during the years you own the car.

Whenever a tire is dismantled for repair, it should be rebalanced before being reinstalled on the car.

I080A01A-AAT

TIRE TRACTION

Tire traction can be reduced if you drive on worn tires, tires that are improperly inflated or on slippery road surfaces. Tires should be replaced when tread wear indicators appear. To reduce the possibility of losing control, slow down whenever there is rain, snow or ice on the road.

I090A01A-AAT

WHEN TO REPLACE TIRES

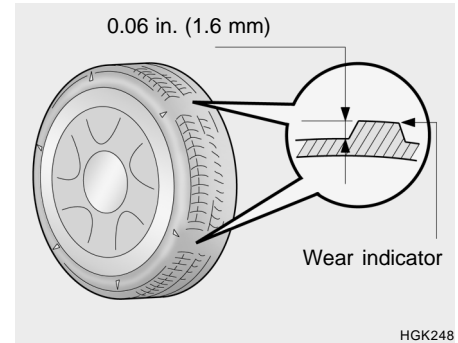

The original tires on your car have tread wear indicators. The tread wear indicators appear when the tread depth is 0.06 in. (1.6 mm). The tire should be replaced when these appear as a solid bar across two or more grooves of the tread. Always replace your tires with those of the recommended size. If you change wheels, the new wheel's rim width and offset must meet Hyundai specification.

**WARNING:**

- o Driving on worn-out tires is dangerous! Worn-out tires can cause loss of braking effectiveness, steering control and traction. When replacing tires, never mix radial and bias ply tires on the same car. If you replace radial tires with bias-ply tires, they must be installed in sets of four.
- o Using tires and wheels of other than the recommended sizes could cause unusual handling characteristics that could cause death, serious injury, or property damage.
- o Wheels that do not meet Hyundai's dimensional specifications may fit poorly and result in damage to the vehicle, including broken wheel studs.

I100A02E-AAT

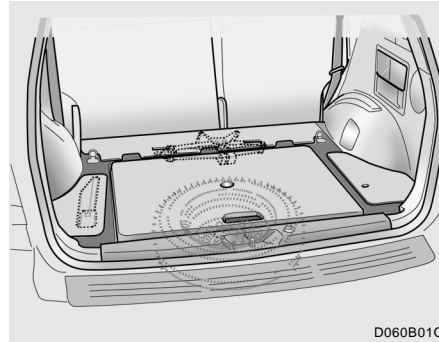
SPARE TIRE AND TOOLS

D060B010

Your Hyundai is delivered with the following:

Spare tire and wheel
 Wheel nut wrench, Wrench bar
 Jack

I110A01A-AAT

SHOP MANUAL

A Hyundai Shop Manual is available from your authorized Hyundai dealer. It's written for professional technicians, but is simple enough for most mechanically-inclined owners to understand.

I120A02A-AAT

WARRANTIES FOR YOUR HYUNDAI VEHICLE

- o New vehicle 60 Months/60,000 Miles Limited Warranty.
- o New vehicle 120 Months/100,000 Miles Limited Powertrain Warranty (first owner only).
- o Anti-Perforation Limited Warranty
- o Emission Defect Warranty - Federal Vehicle
- o California Emission Control System Warranty (if applicable)
- o Emission Performance Warranty Federal vehicle
- o Replacement Parts and Accessories Limited Warranty

NOTE:

Detailed warranty information is provided in your Hyundai Owner's Handbook.

I130A01A-AAT

CONSUMER INFORMATION

This consumer information has been prepared in accordance with regulations issued by the National Highway Traffic Safety Administration of the U.S. Department of Transportation. It provides the purchasers and/or prospective purchasers of Hyundai automobiles with information on uniform tire quality grading. Your Hyundai dealer will help answer any questions you may have as you read this information.

I130B03A-AAT

Tire Quality Grading

Department of Transportation quality grades - All passenger vehicle tires must conform to Federal Safety Standards in addition to these grades. These quality grades are molded on the sidewall.

Treadwear - The treadwear grade is a comparative rating based on the wear rate of the tire when tested under controlled conditions on a specified government test course. For example, a tire graded 150 would wear one and a half (1 - 1/2) times as well on the government course as a tire graded 100. The relative performance of tires depends upon the actual conditions of their use, however, and may depart significantly from the norm due to variations in driving habits, service practices and differences in road characteristics and climate.

Traction AA, A, B, C - The traction grades, from highest to lowest, are AA, A, B, and C. Those grades represent the tire's ability to stop on wet pavement as measured under controlled conditions on specified government test surfaces of asphalt and concrete. A tire marked C may have poor traction performance.



WARNING:

The traction grade assigned to this tire is based on straight-ahead braking traction tests, and does not include acceleration, cornering, hydroplaning, or peak traction characteristics.

Temperature A, B, C - The temperature grades are A (the highest), B, and C, representing the tire's resistance to the generation of heat and its ability to dissipate heat when tested under controlled conditions on a specified indoor laboratory test wheel. Sustained high temperature can cause the material of the tire to degenerate and reduce tire life, and excessive temperature can lead to sudden tire failure. The grade C corresponds to a level of performance which all passenger car tires must meet under the Federal Motor Vehicle Safety Standard No. 109. Grades B and A represent higher levels of performance on the laboratory test wheel than the minimum required by law.



WARNING:

The temperature grade for this tire is established for a tire that is properly inflated and not overloaded. Excessive speed, underinflation, or excessive loading, either separately or in combination, can cause heat buildup and possible tire failure.

Uniform Tire Quality Grading - Quality grades can be found on the tire sidewall between the tread shoulder and the maximum section width. For example :
Treadwear 200 Traction AA Temperature A

I130D02A-AAT

Hyundai motor vehicles are designed and manufactured to meet or exceed all applicable safety standards.

For your safety, however, we strongly urge you to read and follow all directions in this Owner's Manual, particularly the information under the headings "**NOTE**", "**CAUTION**" and "**WARNING**".

If, after reading this manual, you have any questions regarding the operation of your vehicle, please contact your nearest Hyundai Motor America Regional Office as listed below:

Eastern Region : Connecticut, Delaware, Maine, Maryland, Massachusetts, New Hampshire, New Jersey, New York, Pennsylvania, Rhode Island, Vermont, Virginia, West Virginia.

Eastern Region
1100 Cranbury South River Road
Jamesburg, NJ 08831
(800) 633-5151

Southern Region: Alabama, Arkansas, Florida, Georgia, Louisiana, Mississippi, North Carolina, South Carolina, Oklahoma, Tennessee, Texas.

Southern Region
270 Riverside parkway, Suite A
Austell, GA 30168
(800) 633-5151

Central Region: Illinois, Indiana, Missouri, Iowa, Kansas, Kentucky, Michigan, Minnesota, Nebraska, North Dakota, South Dakota, Ohio, Wisconsin.

Central Region
700 No. Enterprise Street
Aurora, Illinois 60504
(800) 633-5151

Western Region: Alaska, Hawaii, Arizona, California, Colorado, Idaho, Montana, Nevada, New Mexico, Oregon, Texas, Utah, Washington, Wyoming.

Western Region
10550 Talbert Avenue
P.O.Box 20850
Fountain Valley, California 92728-0850
(800) 633-5151

I130C01A-AAT

REPORTING SAFETY DEFECTS

If you believe that your vehicle has a defect which could cause a crash or could cause injury or death, you should immediately inform the National Highway Traffic Safety Administration (NHTSA) in addition to notifying HYUNDAI MOTOR AMERICA. If NHTSA receives similar complaints, it may open an investigation, and if it finds that a safety defect exists in a group of vehicles, it may order a recall and remedy campaign. However, NHTSA cannot become involved in individual problems between you, your dealer, or HYUNDAI MOTOR AMERICA.

To contact NHTSA, you may either call the Auto Safety Hotline toll-free at 1-888-327-4236 or write to: NHTSA, U.S. Department of Transportation, Washington, D.C. 20590. You can also obtain other information about motor vehicle safety from the Hotline.

9. VEHICLE SPECIFICATIONS

Measurement	9-2
Engine	9-3
Lubrication Chart	9-4

9-2 VEHICLE SPECIFICATIONS

J010A010-AAT

MEASUREMENT

Overall length		177.1 in. (4500 mm)
Overall width		71.5 in. (1820 mm)
Overall height (unladen)		65.9 in. (1675 mm)
Wheel base		103.1in. (2620 mm)
Wheel tread	Front	60.6 in. (1540 mm)
	Rear	60.6 in. (1540 mm)

J020A010-AAT

POWER STEERING

Type	Rack and pinion
Wheel free play	0 ~ 1.18 in. (0 ~ 30 mm)
Rack stroke	5.5 in. (142 mm)
Oil pump type	Vane type

J030A010-AAT

TIRE

psi (kpa)

Tire	Size	Tire pressure
Standard	225/70 R16	30 (207)

J040A020-AAT

ELECTRICAL

Item	2.4 DOHC	2.7 V6	3.5 V6
Battery	MF 68 AH (12 V)		
Generator	110A (13.5 V)		120A (13.5 V)

J050A010-AAT

BRAKE

Type	Dual hydraulic with brake booster
Front brake type	Ventilated disc
Rear brake type	Disc type
Parking brake	Cable operated on rear wheel

J060A010-AAT

FUEL SYSTEM

Fuel tank capacity	19 us.gal (15.8 imp.gal, 72 liter)
--------------------	------------------------------------

J070A020-AAT

ENGINE

ITEMS		SPECIFICATIONS		
		2.4 DOHC	2.7 V6	3.5 V6
Engine Type		4-Cyl., In-line DOHC	6-Cyl., V-type DOHC	6-Cyl., V-type DOHC
Bore x Stroke in. (mm)		3.41 x 3.94 (86.5 x 100)	3.41 x 2.95 (86.7 x 75)	3.66 x 3.38 (93 x 85.8)
Displacement cu.in. (cc)		143.5 (2,351)	162.1 (2,656)	213.4 (3,497)
Firing order		1 - 3 - 4 - 2	1 - 2 - 3 - 4 - 5 - 6	1 - 2 - 3 - 4 - 5 - 6
Spark plug	Type	CHAMPION : RN10PYP4	CHAMPION : RC10PYPB4	
		NGK : PGR5C-11	NGK : PFR5N-11	
	Gap	0.039 - 0.043 in. (1.0 - 1.1 mm)		
Idle speed (rpm) - N, D, A/C OFF		800 ± 100	700 ± 100	
Ignition timing (base)		BTDC 7° ± 5°	BTDC 12° ± 5°	BTDC 10° ± 5°
Oil grade (API)		SH, SG or SG/CD and ABOVE multigrade and fuel-efficient oil		

9-4 VEHICLE SPECIFICATIONS

J080A04O-AAT

LUBRICATION CHART

Item		Oil & Coolant Standard	
Engine		API SH,	Hot Climate : SAE 20W-40, 20W-50 (ABOVE 32°F or 0°C)
		SG or	Normal Climate : SAE 10W-30 10W-40, 10W-50 (ABOVE -10°F or -23°C)
		SG/CD	Cold Climate : SAE 5W-30 5W-40 (BELOW 100°F or 38°C)
Transaxle	Manual	HYUNDAI GENUINE PARTS MTF 75W/90 (API GL-4)	
	Auto	HYUNDAI GENUINE ATF, DIAMOND ATF SP-III or SK ATF SP-III	
Coolant		Ethylene glycol base for aluminum radiator	
Transfer case		API GL-5, SAE 80W/90 (SHELL SPIRAX AX Equivalent)	
Rear axle		API GL-5, SAE 80W/90 (SHELL SPIRAX AX Equivalent)	
Power steering		PSF-3 type fluid	
Brakes and clutch fluid		DOT 3, DOT 4 or Equivalent	

J080A040-AAT

LUBRICATION CHART

Item		Quantity (US. QTS) (Imp.qts, liter)		
		2.4 DOHC	2.7 V6	3.5 V6
Engine		Drain & refill; Without oil filter : 4.23 (3.52, 4.0) With oil filter : 4.54 (3.78, 4.3)	Drain & refill; Without oil filter : 4.44 (3.7, 4.2) With oil filter : 4.76 (3.96, 4.5)	Drain & refill; Without oil filter : 4.23 (3.52, 4.0) With oil filter : 4.54 (3.78, 4.3)
Transaxle	Manual	2.43 (2.02, 2.3)		-
	Auto	8.98 (7.48, 8.5)		
Coolant		7.4 (6.16, 7.0)		8.66 (7.21, 8.2)
Transfer case		0.85 (0.7, 0.8)		
Rear axle		1.16 (0.97,1.1)		
Power steering		0.95 (0.79, 0.9)		1.06 (0.88, 1.0)
Brakes and clutch fluid		As required		

10.INDEX

A

Air bag	1-29
Air Cleaner Filter	6-12
Air Conditioning	
Care	6-17
Operation	1-76, 6-17
Switch	1-75
Antenna	1-111
Ashtray	1-49
Audio System	
Cassete tape player operation (D-285)	1-95
Compact disc player operation (H260)	1-89
Compact disc player operation (D-285)	1-99
Compact disc player operation (D-295)	1-105
Stereo radio operation (H260)	1-86
Stereo radio operation (D-285)	1-92
Stereo radio operation (D-295)	1-102

B

Battery	2-18, 6-21
Brake	
Anti-lock brake system	2-10
Brake traction control system (BTCS)	2-11
Checking the brakes	6-15
Fluid	6-15
Pedal clearance	6-19
Pedal free-play	6-19
Practices	2-15
Breaking-In your New Hyundai	1-3

C

Calendar	1-47
Care of Cassette Tapes	1-109
Care of Disc	1-109
Cargo Security Screen	1-60
Catalytic Converter	7-3
Child-Protector Rear Door Lock	1-6
Child Restraint System	1-23
Installing a Child Restraint Seat with the "Tether Anchorage" System	1-25
Securing the Child Restraint Seat with the "ISOFIX" System	1-25
Cigarette Lighter	1-48
Clock	1-47
Clutch	
Checking fluid	6-16
Pedal free-play	6-18
Combination Light	
Auto light	1-44
Headlight flasher	1-44
Headlight switch	1-43
High-beam switch	1-44
Lane change signal	1-43
Parking light auto cut	1-43
Turn signal operation	1-43
Consumer Information	8-6
Cooling Fans	6-22
Corrosion protection	
Cleaning the interior	4-4
Protecting your Hyundai from corrosion	4-2
Washing and waxing	4-3
Cruise Control	1-66

D

Defrosting / Defogging	1-77
Door	
Locking, unlocking front door with a key	1-4
Drink Holder	1-49
Drive Belts	6-19
Driving	
Driving for economy	2-16
Smooth cornering	2-17
Winter driving	2-17

E

Emission Control System	7-2
Engine	
Before starting the engine	2-3
Compartment (2.4 DOHC)	6-2
Compartment (2.7 V6)	6-3
Compartment (3.5 V6)	6-4
Coolant	6-8
Coolant temperature gauge	1-41
If the engine overheats	3-3
Number	8-2
Oil	6-6
Starting	2-5
Engine Exhaust Can Be Dangerous	2-2

F

Fan Speed Control	1-70
Floor Mat Anchor	1-64
Fog Light	
Front	1-46

Front Seats

Adjustable front seats	1-10
Adjustable headrests	1-12
Adjusting seat forward and rearward	1-11
Adjusting seatback angle	1-11

Fuel

Auto fuel cut switch	1-62
Capacity	9-2
Gauge	1-40
Recommendations	1-2

Fuel Filler Lid

Remote release	1-62
----------------------	------

Full-time 4WD Operation	2-13
-------------------------------	------

Fuses	6-20
-------------	------

G

General Checks	6-5
Glove Box	1-53

H

Hazard Warning System	1-46
-----------------------------	------

Heating and Cooling Control	1-69
-----------------------------------	------

Heating and Ventilation

Air flow control	1-71
Air intake control	1-70
Bi-level heating	1-75
Defrosting / Defogging	1-77
Fan speed control (Blower control)	1-70
Temperature control	1-74

High-Mounted Rear Stoplight	1-61
-----------------------------------	------

Homelink Mirror	1-56
-----------------------	------

10-4 INDEX

Hood Release	1-63
Horn	1-65

I

Ignition Switch	2-3
Instrument Cluster and Indicator Lights	1-36
Instrument Panel Light Control (Rheostat)	1-48

J

Jump Starting	3-2
---------------------	-----

K

Key	1-3
If you lose your keys	3-11
Positions	2-4

L

Light Bulbs Replacement	6-24
Limited-Slip Differential	2-15
Luggage Net	1-60

M

Maintenance Intervals

Explanation of scheduled maintenance items	5-7
Maintenance under severe usage conditions	5-6
Scheduled maintenance	5-4
Service requirements	5-2

Mirrors

Day-night inside rearview mirror	1-55
Outside rear view mirror	1-53

O

Odometer / Trip Odometer	1-42
--------------------------------	------

P

Parking Brake	1-59
Power Driver's Seat	1-13
Power Outlet	1-48
Power Steering Fluid Level	6-22

R

Rear Seat

Adjusting seatback angle	1-15
Folding rear seatback and seat cushion	1-16
Rear Window Defroster Switch	1-47
Reporting Safety Defects	8-7
Roof Rack	1-61

S

Seat

Front	1-10
Rear	1-15
Seat warmer	1-15

Seat Belts

3-point system	1-20
2-point static type	1-22
Pretensioner seat belt	1-28
Adjusting your seat belt	1-21, 1-22
Care of seat belts	1-19
Precautions	1-17

Shop Manual	8-5
Sound	
Brake pad warning sound	1-40
Parking start warning sound	1-40
Spark Plugs	6-10
Spectacle Case	1-52
Speedometer	1-41
Starting Procedure	2-5
Steering Wheel Free play	6-18
Steering Wheel Tilt Lever	1-65
Stereo Sound System	1-84
Sunroof	1-50
Sun visor	1-64
T	
Tachometer	1-41
Tail Gate	1-59
Tail gate window	1-59
Theft-Alarm System	1-7
Tires	
Balancing	8-4
Chains	8-3
Changing a flat tire	3-6
If you have a flat tire	3-5
Information	8-2
Pressure	8-2
Replacement	8-4
Rotation	8-4
Snow tires	8-3
Spare tire	3-4
Traction	8-4

Towing	
A trailer (or vehicle)	2-19
Emergency	3-11
If your car must be towed	3-9
Traction Control System	2-11 ~ 2-13
Transaxle	
Automatic	2-7
Automatic transaxle fluid checking	6-13
Manual	2-5
Manual transaxle oil checking	6-13

V

Vehicle Identification Number	8-2
Vehicle Specifications	
Engine	9-3
Lubrication chart	9-4 ~ 9-5
Measurement	9-2

W

Warning Lights and Indicator Lights	1-37
Windows	
Power	1-10
Windshield Wiper and Washer	1-44
Tail gate wiper and washer switch	1-46
Windshield Wiper Blades	6-12

SERVICE STATION INFORMATION

FUEL:

UNLEADED gasoline only
Pump Octane Rating of 87 (Research Octane Number 91) or higher.

FUEL TANK CAPACITY

US.gal (Imp.gal., liter) 19 (15.8, 72)

TIRE PRESSURE:

See the label on the driver's side of the center pillar outer panel.

OTHER TIRE INFORMATION:

See pages 8-2 through 8-6.

HOOD RELEASE:

Pull handle under left side of dash.

ENGINE OIL:

API grade SH, SG or SG/CD multigrade and fuel efficient oil. Use SAE 10W-30, 10W-40 or 10W-50 if normal temperatures are above -10°F (-23°C). For other viscosity recommendations, see page 6-6 or 9-4.

MANUAL TRANSAXLE:

HYUNDAI GENUINE PARTS MTF 75W/90 (API GL-4) Oil level should be up to filler-bolt hole in housing beside differential.

AUTOMATIC TRANSAXLE:

Apply the parking brake, with the engine running, shift the selector lever through all ranges and return to "N" (Neutral) position. Then check the level of fluid on the dipstick. Use only HYUNDAI GENUINE ATF available at your dealer or DIAMOND ATF SP-III or SK ATF SP-III.

QUICK INDEX

- o Car will not start 3-2
- o Flat tire 3-5
- o Warning light/chime comes on 1-37 ~ 1-40
- o Engine overheats 3-3
- o Towing of your vehicle 3-9
- o Starting the engine 2-5
- o Driving tips for first 1,200 miles (2,000 km) 1-3
- o Scheduled maintenance 5-4
- o Reporting safety defects 8-7