

1991 Civic Hatchback/Sedan Online Reference Owner's Manual

Use these links (and links throughout this manual) to navigate through this reference.

For a printed owner's manual, click on authorized manuals or go to www.helminc.com.

Contents

Owner's Identification

Features & Safety **2**

What you should know before driving your car.

Starting & Driving..... **54**

What gas to use, how to change gears, etc.

Maintenance..... **68**

The Required Maintenance Schedule and some items you can service.

Emergency Service..... **103**

Changing a flat, jump starting, towing.

Consumer Information..... **121**

Reporting Safety Detects, warranty service, vehicle identification numbers, etc.

Index **129**

Gas Station Information

This Owner's Manual should be considered a permanent part of the vehicle, and must remain with the vehicle at time of resale.

| OWNER'S I.D. | | |
|--------------------|--|----------|
| OWNER | _____ | |
| ADDRESS | _____ | |
| CITY | STATE | ZIP CODE |
| CITY | STATE | ZIP CODE |
| V.I.N. | _____ | |
| DELIVERY DATE | _____ | |
| | (Date sold to original retail purchaser) | |
| DEALER NAME | DEALER NO. | _____ |
| DEALER NAME | DEALER NO. | _____ |
| ADDRESS | _____ | |
| CITY | STATE | ZIP CODE |
| CITY | STATE | ZIP CODE |
| OWNER'S SIGNATURE | _____ | |
| DEALER'S SIGNATURE | _____ | |

The information and specifications included in this publication were in effect at the time of approval for printing. Honda Motor Co., Ltd. reserves the right however, to discontinue or change specifications or design at any time without notice and without incurring any obligation whatever.

Introduction

This manual contains important information about the safe operation and maintenance of your car.

We urge you to read it carefully, become familiar with the controls it describes, and follow its recommendations, to help make your driving trouble-free and enjoyable.

Statements or labels on the product preceded by the following words are of special significance:

▲ DANGER indicates severe personal injury or death will result if instructions are not followed.

▲ WARNING indicates a strong possibility of severe personal injury or death if instructions are not followed.

CAUTION: means hazards or unsafe practices which could cause minor personal injury or product or property damage.

NOTE: gives helpful information.

Break-in Period

During the first 600 miles (1,000 km) of driving, avoid full throttle starts and cruising for extended periods at a constant speed.

NOTE:

- This break-in procedure also applies to exchanged or overhauled engines.
- During and after the break-in period, drive the car at moderate speeds until the engine is fully warmed up.

During the first 200 miles (300 km), try to avoid severe braking. Brake misuse during this period will reduce future braking efficiency.

Remember, your Honda Automobile dealer knows your car best, and should be consulted for service assistance and advice.

Keys and Locks

Keys

(Hatchback)

Your car is supplied with two identical keys that fit the ignition and all locks. You should keep one of them in a safe place, away from the car, as a spare.

(Sedan)

Your car is supplied with a master key that fits the ignition and all locks, and a valet key that fits the ignition and doors but not the trunk or trunk remote release.

The valet key is provided for times when you must leave the key with a parking attendant or repair person, but still want to keep valuables safely locked-up.

Write down the numbers stamped on your keys and keep the information in your wallet or purse in case you ever need to have duplicates made. The keys are double edged, so you can insert them in the locks with either edge up.

Door Locks

(Hatchback)

You can lock the doors by pushing the tabs forward.

(Sedan)

You can lock the doors by pushing the tabs down.

The doors must be unlocked before you can open them. The passenger doors can be locked when open, and will stay locked when you close them; the driver's door cannot be locked when open unless you hold the door handle open. The front doors can be locked and unlocked from the outside with the key.

Hatchback

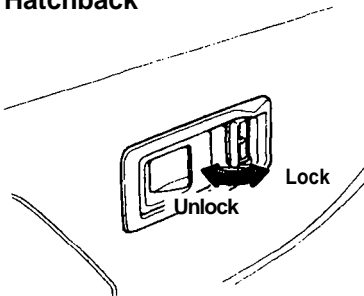

Sedan

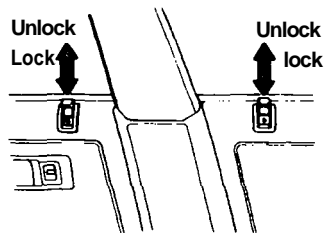

(cont'd)

Keys and Locks (cont'd)

Power Door Locks (LX/EX Sedan)

All doors can be simultaneously locked and unlocked by operating the master door lock switch.

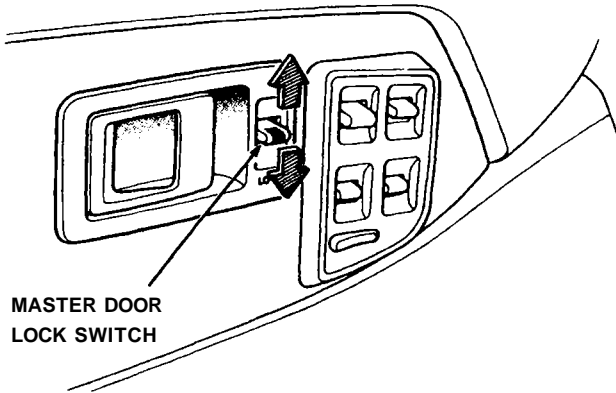

In addition, the passenger doors will lock automatically when the lock tab on the driver's door is pushed down, or when the driver's door is locked from the outside with the key.

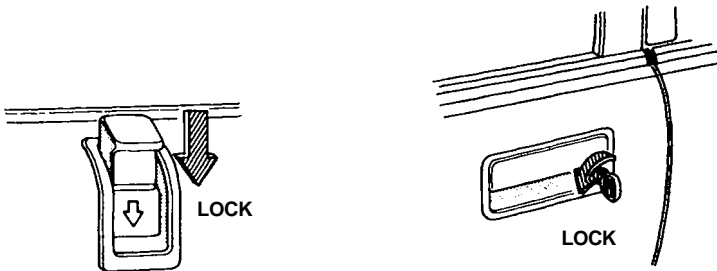

Hatch/Trunk Lid Lock (Hatchback)

To open the hatch from outside, put the ignition key in the lock and turn clockwise.

The hatch can be opened by pulling up the lever at the left side of the driver's seat.

(Sedan)

The trunk can be opened by pulling up the lever at the left side of the driver's seat.

To open the trunk lid from the outside, put the master key in the lock and turn clockwise. The trunk lid opener lever is lockable with the master key.

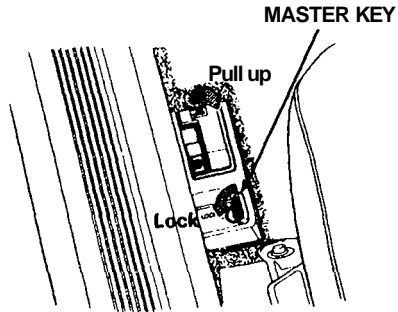
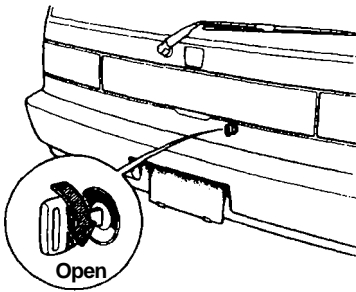

⚠️ WARNING

Keep the hatch/trunk lid closed while driving, to keep poisonous carbon monoxide exhaust fumes out of the interior; prolonged exposure can cause unconsciousness that may lead to death.

Child Proof Door Locks (Sedan)

The child proof door locks are designed to prevent accidental opening of the rear doors. To activate the locks, push down the lock tabs located on each door, then close the doors. When the doors are locked in this way, they can only be opened from the outside.

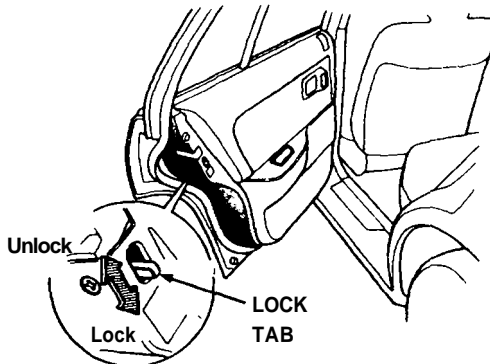

Seats

Front Seat

Adjust the seat position by pulling up on the adjustment lever under the front edge of the seat cushion, and sliding the seat to the desired position. Then release the lever and make sure the seat is locked in position by moving it back and forth.

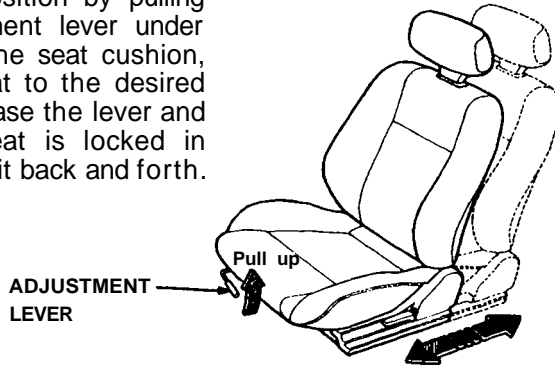

The angle of the seat-back can be changed by pulling up on the lever at the outside edge of the seat and leaning forward or back. Release the lever and let the seat lock into place when it reaches the desired angle.

Seat belts are most effective when the driver and passenger are sitting up straight and well back in each seat.

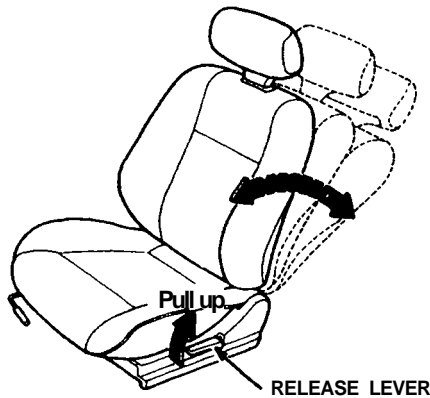

▲ WARNING

- Do not adjust the driver's seat while the car is moving; the seat could move suddenly, causing loss of vehicle control.
- To reduce the risk of sliding under the seat belts in a collision, the seat-backs should be reclined no more than is necessary for comfort.

To Get In/Out of Rear Seat (Hatchback)

The right front seat has a release lever within easy reach of rear passengers: push it forward to release the seat-back for access to or from the rear seat. The driver's seat will also tilt forward by husing the seat angle lever.

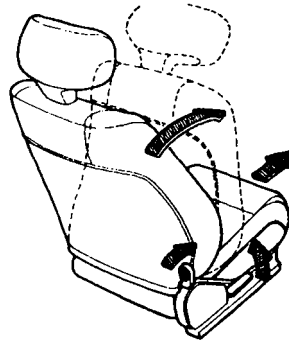

Head Restraints

The head restraints are designed to help reduce injuries due to whiplash. They are located at the top of each seat-back. The front head restraints have several height positions. They can be adjusted by pulling up to the recommended position. To lower them, slide the button next to the restraint's height bar, while pushing the restraint down.

(Sedan only)

The rear head restraints have also several height positions. Adjust so the top of the restraint is approximately level with the tops of your ears.

If a head restraint must be removed (for cleaning, fabric repair, etc.) pull the restraint up to its highest position, then slide the button while pulling the restraint out.

To reinstall, reverse the above procedure.

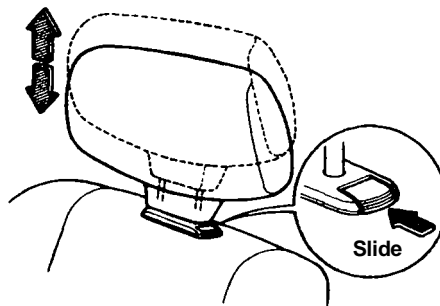

⚠ WARNING

- Do not drive the car with head restraints removed.
- Do not try to adjust head restraints while driving.

(cont'd)

Seats (cont'd)

Rear Seat (Hatchback)

If you need more luggage space, the rear seat-back can be folded down. Pull the release on the top of the seat-back and fold the seat-back down.

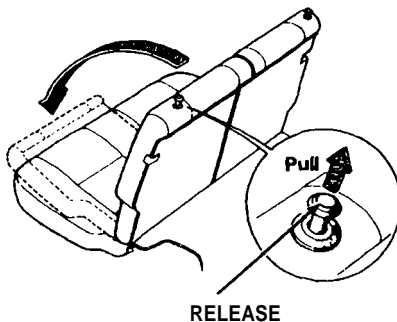

Trunk Access from Rear Seat (Sedan)

The rear seat-back can be released by turning the lock on the rear shelf with the master key and pulling down the top of the seat-back. This allows you access to the trunk and makes it possible to carry long objects inside the car.

The rear seat-back can also be released from inside the trunk by pulling the release.

⚠ WARNING

- Passengers or pets must not sit on the folded portion of the rear seat.
- Make sure any luggage or cargo within the trunk, or extending through the rear seat trunk access is secured.
- Make sure the seat-back latches engage securely when the seat-back is returned to its normal position.

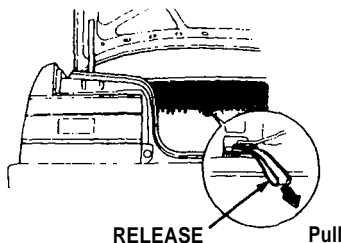
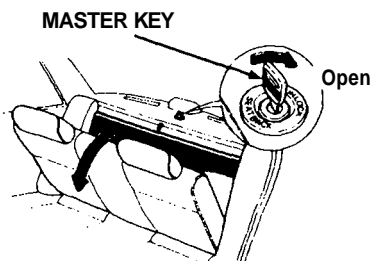

When closing the rear seat trunk access, push the seat-back firmly into place, then pull on the top of the seat-back to make sure it is secure.

CAUTION:

Make sure both rear shoulder belts are positioned in front of the rear seat-backs whenever the seat-backs are in their upright position.

Luggage Cover (DX/Si Hatchback)

You can reach the luggage compartment from either the outside or inside of the vehicle. To open the front part of the cover, pull the cover up. The rear part of the cover can be also opened merely by lifting up on it.

If you need more luggage height with the seat-back upright, fold the rear section of the cover forward or slide the latches on both sides to the rear and lift the cover out.

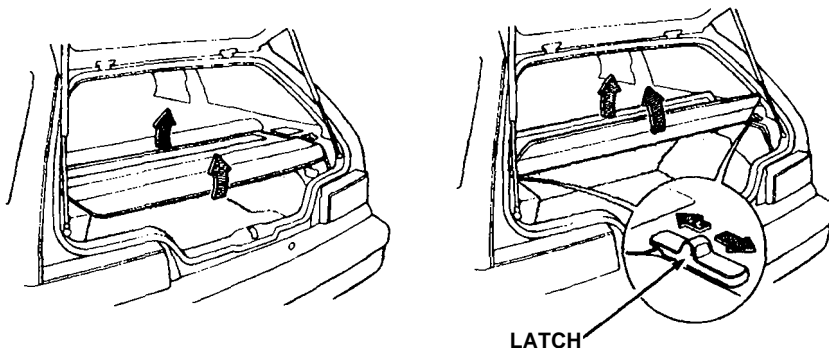

▲ WARNING

- Weight limits shown on the label located in the glove box must be observed. The total weight of passengers and cargo must not exceed the total weight limit on the label.

(Except STD Hatchback)

- Do not store any items on the shelf behind the rear seat; they may become dangerous projectiles in a collision.

(Hatchback only)

- Make sure the seat-back latches engage securely when the seat-back is returned to its normal position.
- When transporting luggage or other cargo, do not pile it higher than the front seats. This precaution will help prevent such items from becoming dangerous projectiles in an accident.
- Cargo weight should be distributed as far forward as possible for better vehicle handling.

(Sedan only)

- Store any luggage or cargo in the trunk. If you are carrying more items than will fit in the trunk, use the floor space between the front and rear seats.

Seat Belts

Your Honda is provided with seat belts to minimize the chance of injury to yourself and your passengers in a sudden stop or accident. For precautions on using seat belts for children, babies and pregnant women, see pages [21](#) — [25](#).

Seat belts are most effective when the driver and passengers are sitting up straight and well back in the seat.

▲ WARNING

In the event of a collision, occupants not wearing seat belts could be seriously or fatally injured. Make sure you and all your passengers ALWAYS put on the seat belts before driving away.

CAUTION:

Be careful the seat helts are not damaged by catching or entangling in the door or seat mechanism.

NOTE:

The front seat belt restraint system is different on the car you use. See pages [11](#) through [14](#) for the automatic ("passive") shoulder belt system on the Sedan. See pages [15](#) through [18](#) for the automatic ("passive") lap/shoulder belt system on the Hatchback.

[Sedan]

Wearing the Front Seat Belts

The front seats have automatic ("passive") restraint systems consisting of shoulder belts and knee bolsters. For your safety, the manual lap belts must be worn together with the automatic shoulder belts. The shoulder belts must remain permanently latched. The automatic and manual belts have emergency locking retractors designed to lock only during a sudden stop or impact. Otherwise, they allow some freedom of movement in the seat.

Operation

1. Enter the car and close the door completely. Move the seat a comfortable distance from the steering wheel, sit straight up and well back in the seat.

▲ WARNING

Never drive the car with the doors ajar. The front doors must be closed completely for the front seat belts to function properly.

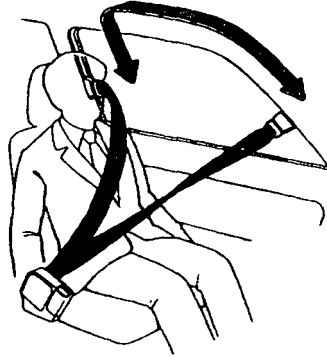

2. Turn the ignition ON. The shoulder belt buckle will move to its rear locked position. The length of the shoulder belt will adjust automatically to your body and seating position. Make sure the shoulder belt goes over your shoulder and across your body to evenly distribute the belt's restraining force. If the belt is too near your neck and throat, move toward the center of the seat.

▲ WARNING

Normal movement of the shoulder belt buckle may cause injury. Be sure all parts of your body, especially fingers and hands, are clear of the shoulder buckle while it is moving.

(cont'd)

Seat Belts (cont'd)

CAUTION:

If the sunvisor is positioned near the door area, movement of the seat belt buckle can damage the sunvisor. Before opening or closing a front door, turning the ignition on or removing the key from the ignition, make sure the sunvisor is returned to its clip above the windshield.

NOTE:

- If the door is not closed completely, the shoulder belt buckle will not move and the door warning light will come on (see page 14).
- If the door is opened with the ignition on, the buckle will release itself from its locked position and move forward.
- If the shoulder belt buckle stops halfway or does not move at all, see page 113 for shoulder belt buckle operation.

3. Take hold of the lap belt's tongue plate and pull it from its retractor. Be sure the belt is not twisted or caught on anything.

NOTE:

If pulled too fast, the belt will lock. If this happens, allow the belt to retract then pull it out more slowly.

4. Push the tongue plate into the buckle until it clicks locked. Position the belt across your lap, low on your hipbone and below your abdomen. This way, if the car is involved in an accident you would be less likely to slide under the seat belts.

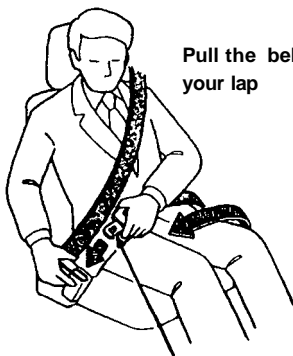

Pull the belt across
your lap

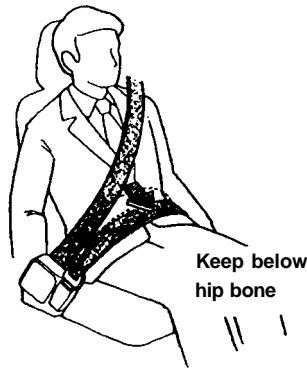

Keep below
hip bone

TONGUE PLATE

⚠ WARNING

Avoid placing the lap belt across your abdomen. In the event of a collision, the pressure of the belt on the abdomen may increase the extent of injury.

- Never use one belt for more than one person, child or adult.
- Comfort clips sold on the open market are not recommended since they could impair the function and safety of the belts.
- Make sure the strap of the shoulder belt and the lap belt are not crossed.
- Do not wear the shoulder portion of the belt under your arm or out of position. Such use could increase the chance and amount of injury in an accident.

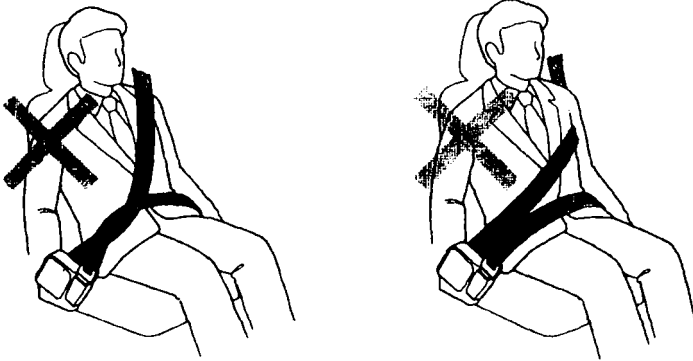

Releasing the Seat Belts

1. To release the manual lap belt, push the "PRESS" button in the buckle, the belt should retract automatically when released.
2. The driver's shoulder belt buckle will release and travel to its off position when the key is removed from the ignition.
3. The shoulder belt buckle will also release and travel to its off position when the door is opened.

Emergency Belt Release

The shoulder belt should always remain buckled. In case of an emergency, however, the shoulder belt can be released from the shoulder belt buckle by pushing the button.

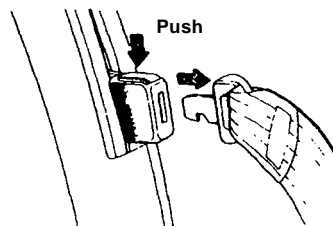

Relatch the shoulder belt before operating the car, making sure the belt is not twisted.

▲ WARNING

Driving with a twisted seat belt can increase your chance and extent of injury during a collision. Be sure the shoulder belt is not twisted before driving the car.

(cont'd)

Seat Belts (cont'd)

Fasten Seat Belt Warning Light and Warning Beeper

Lap Belt Warning Indicator:

Both the  light and the warning beeper will go on for about six seconds if the ignition switch is turned on when the driver's lap belt is not fastened. The beeper will not go on if the driver's lap belt is fastened, but the warning light will come on for about six seconds each time, to remind the driver to have passengers put their belts on.



Automatic Shoulder Belt Warning Indicator:

The warning light will come on if either of the automatic shoulder belts is unlatched with the ignition ON. The beeper will sound for approximately six seconds while the warning light is ON. Related the belt: the light should go off when the belt is latched.

The warning light will also come on while the shoulder belt buckle moves from its front off position to its rear locked position.

Automatic Shoulder Belt Malfunction Indicator:

The warning light will flash and the beeper will sound rapidly if either shoulder belt buckle stops before completing its full cycle (see page [113](#) for normal operation).

NOTE:

If the shoulder belt's tensioner mechanism locks and prevents the buckle from moving fully forward when you want to get out, recycle the system by closing the door and reopening it.

The buckle should move fully forward; if it does not, recline the seat-back and use Emergency Belt Release (see page [13](#)).

When the system does not function by either method, have the system checked by an authorized Honda dealer.

⚠ WARNING

If the light and beeper do not function at all or if they come on even with the belts latched and doors fully closed, it indicates a malfunction in the seat belt system. In the event of a collision, severe personal injury could result. The system should be checked immediately by an authorized Honda dealer.

[Hatchback]

Wearing the Front Seat Belts

The automatic ("passive") lap/shoulder belt systems with emergency locking retractors are designed to lock only during a sudden stop or impact. Otherwise, they allow you some freedom of movement in the seat. The lap/shoulder belt must remain permanently latched.

NOTE:

The motion sensing lock mechanisms for the front belts are located in each door. Therefore, if a door is opened too quickly, the belt may lock and the door cannot be opened further. If this happens, close the door and open it again more slowly.

- Enter the car and close the door completely.
If a door is not completely closed, the warning lights in the ceiling and in the instrument panel will come on and the beeper will sound when the ignition switch is turned on (see page 17).
- The driver's seat should be moved to a comfortable distance from the steering wheel.
Sit straight up and well back in the seat.
- The seat belt should fit snugly against your body. The shoulder portion of the belt should go over your shoulder and across your body to evenly distribute the belt's restraining force.
- Check that the lap portion of the belt is positioned low on your hipbone and below your abdomen. This way, if the car is involved in an accident, you will be less likely to slide under the seat belts.
- If the belt is too near your neck and throat, move toward the center of the seat.

⚠ WARNING

Never drive the car with the doors ajar. The front doors must be closed completely for the front seat belts to function properly.

(cont'd)

Seat Belts (cont'd)

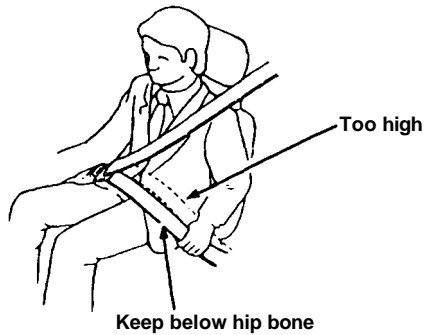

▲ WARNING

- Avoid placing the lap belt across your abdomen. In the event of a collision, the pressure of the belt on the abdomen may increase the extent of injury.
- Do not wear the shoulder portion of the belt under your arm or out of position. Such use could increase the chance and amount of injury in an accident.
- Never use one belt for more than one person, child or adult.
- Comfort clips sold on the open market are not recommended since they could impair the function and safety of the belts.

Emergency Belt Release

The front belts should remain permanently latched. However, an emergency release button is provided as shown.

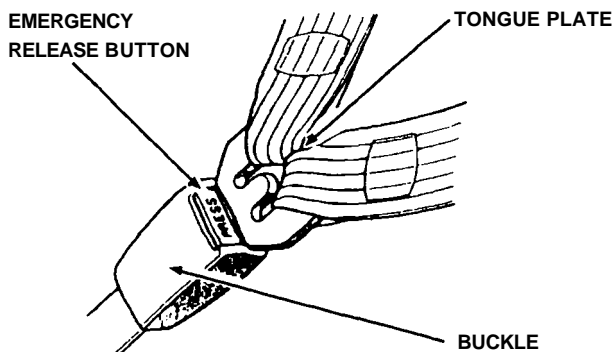

Front Seat Belt Warning Light and Warning Beeper

There are four warning lights in the car. Two of them are in the instrument panel and the other two lights are in the ceiling behind the rearview mirror. Each warning light will go on for about two seconds, when the ignition switch is turned on.

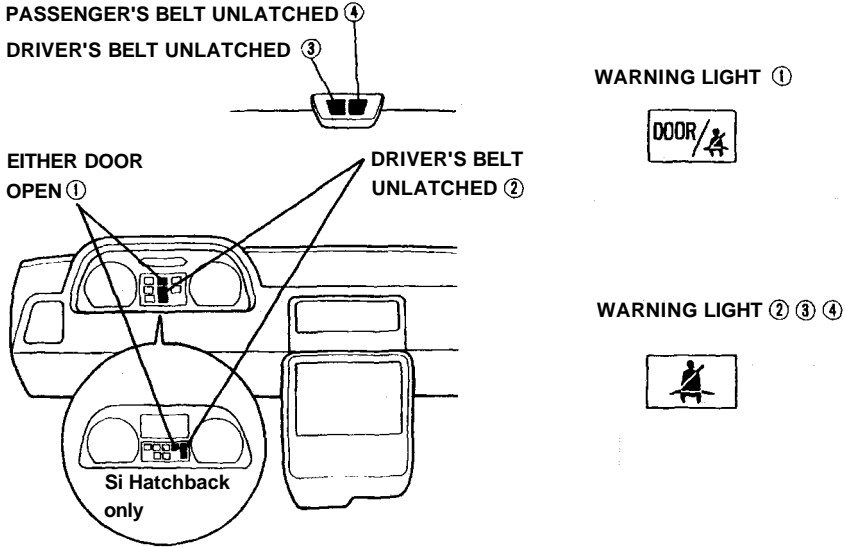

Warning Light Indicators



Either Door Open

The warning light in the instrument panel will come on when the ignition is switched on. The beeper will also sound for approximately six seconds. Confirm which door is open and close the door completely, the lights will go out.

If either door is opened while the car is being driven, the beeper and all four warning lights will come on and stay on. If this happens, pull off the highway, stop the car immediately and close whichever door is open. The warning lights and beeper should go off.

(cont'd)

Seat Belts (cont'd)



Driver's Belt Unlatched

The warning lights in the ceiling and in the instrument panel will come on and stay on if the driver's belt is not latched. The beeper will sound for approximately six seconds when the ignition is turned on. Relatch the belt; the light should go off.



Front Passenger's Belt Unlatched

The warning light in the ceiling will come on and stay on if the front passenger's seat belt is not securely latched, the beeper sound for approximately six seconds. Relatch the belt; the light should go off.

▲ WARNING

If the lights and beeper do not function at all or if they come on even with the belts latched and doors fully closed, it indicates a malfunction in the seat belt system. In the event of a collision, severe personal injury could result. The system should be checked immediately by an authorized Honda dealer.

Buckling the Rear Seat Belts

In the rear seat, there are two one-piece combination lap/shoulder belts and a center lap belt.

The seat-backs and seat belts provide best restraint when the occupant is sitting well back and straight up in the seat.

The right and left rear seat belts are one-piece combination lap/shoulder belts with an emergency locking retractor designed to lock only during a sudden stop or impact. Otherwise, they allow you some freedom of movement in the seat.

NOTE:

The emergency locking system of the rear seat belts will also be activated if you pull the belt too fast. If this happens, release the belt slightly then pull it out more slowly.

1. Take hold of the tongue plate and pull the belt across your lap. Be sure the belt is not twisted or caught on anything.

Pull the belt across your lap

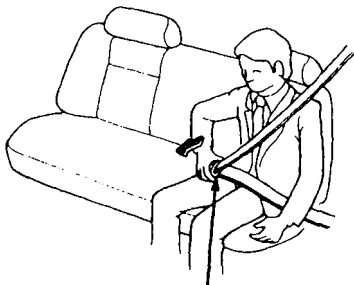

TONGUE PLATE

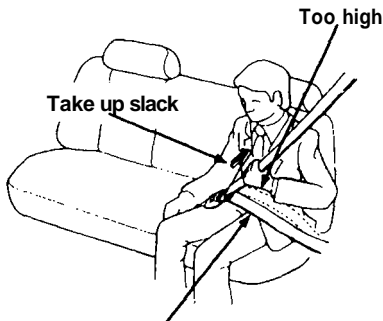

Keep below hip bone

2. Push the tongue plate into the buckle until it clicks locked.

The seat belt should fit snugly against your body. The shoulder portion of the belt should go over your shoulder and across your body to evenly distribute the belt's restraining force.

Check that the lap portion of the belt is positioned low on your hipbone and below your abdomen. This way, if the car is involved in an accident, you will be less likely to slide under the seat belts.

If the belt is too near your neck and throat, move toward the center of the seat.

⚠ WARNING

Avoid placing the lap belt across your abdomen. In the event of a collision, the pressure of the belt on the abdomen may increase the extent of injury.

(cont'd)

Seat Belts (cont'd)

- To release the seat belt, push the **"PRESS"** button in the buckle; the belt should retract automatically when released. If the belt does not fully retract, pull it out and check for kinks or twists.

CAUTION:

Make sure both rear shoulder belts are positioned in front of the rear seat-backs whenever the seat-backs are in their upright position.

Rear Center Seat Belt

Adjust the center lap belt length to fit snugly but comfortably when buckled.

A slack belt will greatly reduce the protection afforded to the wearer. Hold the tongue plate perpendicular to the belt as shown.

* To shorten, pull the end of the belt away from the tongue plate.

* To lengthen, pull the tongue plate.

Push the tongue plate into the buckle until it clicks locked. Position the belt across your lap, not your abdomen, as low on your hips as possible.

⚠ WARNING

Avoid placing the lap belt across your abdomen. In the event of a collision, the pressure of the belt on the abdomen may increase the extent of injury.

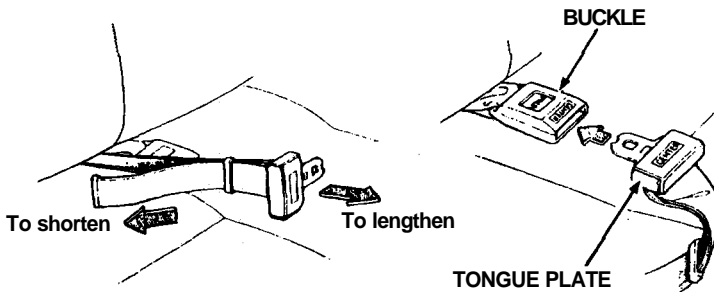

Child Restraint

Children riding in the car should be restrained to minimize the risk of injury in an accident, sudden stop or sudden maneuver.

According to accident statistics provided to the National Highway Traffic Safety Administration (NHTSA), children are safer when properly restrained in the rear seating positions than in the front seat.

For smaller children, we strongly recommend the use of a commercially available child restraint system that meets the Federal Motor Vehicle Safety Standard (FMVSS) because it offers the most protection against injury. All states now have laws which require that small children must be seated in a child passenger seat restraint system. Check local laws.

Before buying a particular child restraint system, make sure it fits your car seat and seat belts, and fits your child. Follow the child seat manufacturer's instructions when installing the seat.

Children who have outgrown the child restraint system should use one of the seat belts.

- Make sure the belt is snug against the child's body with the shoulder portion going over the shoulder and across the body to evenly distribute the belt's restraining force.
- Check that the lap portion of the belt is positioned low on the child's hipbone and below the abdomen.
This way if the car is involved in an accident, the child would be less likely to slide under the seat belts.
- If the belt is too close to the child's neck or throat, you may want to consider putting the child in an automobile booster seat that meets the Federal Motor Vehicle Safety Standard (FMVSS).

▲ WARNING

- **Children should never ride unrestrained in an automobile.**
- **Never use an infant carrier or child safety seat that "hooks" over a seat-back; it may not provide adequate security in an accident.**
- **Never allow a child to be held in a person's arms while they are in a moving vehicle. Holding a child in a moving vehicle does not provide the child with any means of protection during an accident, even if the person holding the child is wearing a seat belt.**

(cont'd)

Seat Belts (cont'd)

[Hatchback]

Installation of Child Seat

All child restraint systems are designed to be secured by lap belts or the lap belt portion of a lap-shoulder belt. Children could be endangered in a crash, if their child restraints are not properly secured. Follow the child seat manufacturer's instructions when installing the seat.

Your Honda automobile is equipped with attachment points specifically for a rear seat mounted child restraint system which uses a top tether.

The tether attachment points are located on the rear panel beside the taillight bulb inspection cover.

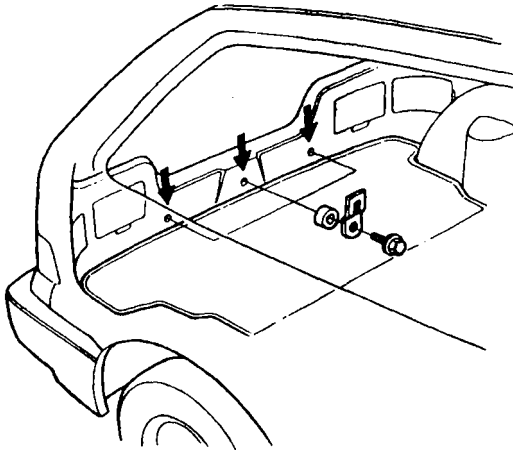

The automatic lap/shoulder restraint system at the front passenger seat cannot be used to secure a child restraint system. Instead, an optional lap belt must be installed specifically for securing a child restraint system. Two anchor points have been provided behind the front passenger seat for installation. The optional lap belt is available from your Honda dealer.

To Install A Child Seat

1. Remove the anchor point plugs with a coin or a screwdriver and install the optional lap belt with the fasteners that came with the belt.
2. Once the optional lap belt is installed, follow the instructions that came with the child restraint system for proper attachment.

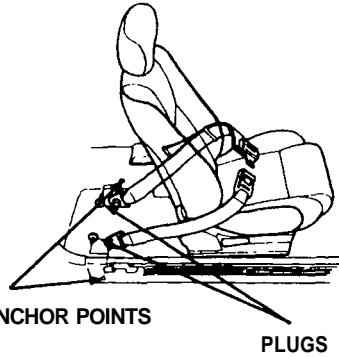

▲ WARNING

- **Do not use the automatic lap/shoulder belt to secure the child seat. It will not give enough protection to the child seat and the child on it.**
- **The optional lap belt is for a child seat only. Do not use it for any other purpose.**
- **When the child restraint system is not in use, remove it from the car or secure it with the seat belt to keep it from becoming a projectile in the event of an accident.**

NOTE:

- See your Honda dealer for installation of the optional lap belt or the child restraint system.
- When not in use, make sure the optional lap belt does not get caught in the passenger's door or seat mechanism.

(cont'd)

Seat Belts (cont'd)

[Sedan]

Installation of Child Seat

All child restraint systems are designed to be secured by lap belts or the lap belt portion of a lap-shoulder belt. The automatic shoulder belt system at the front passenger seat should not be used to secure the child restraint system. If a child seat must be installed on the front seat, place the shoulder portion of the belt behind the child seat and secure the child seat with the lap belt only.

Children could be endangered in a crash, if their child restraints are not properly secured. Follow the child seat manufacturer's instructions when installing the seat.

Your Honda automobile is equipped with attachment points specifically for a rear seat mounted child restraint system which uses a top tether.

The tether attachment points are located on the rear tray, just behind the rear seat-back.

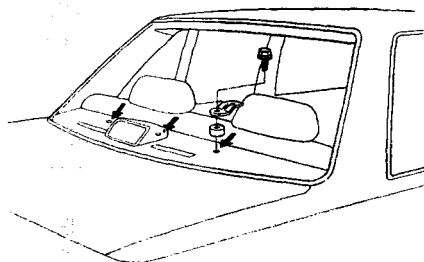

⚠ WARNING

When the child restraint system is not in use, remove it from the car or secure it with the seat belt to keep it from becoming a projectile in the event of an accident.

NOTE:

See your Honda dealer for installation of the child restraint system.

Pregnant Women

A pregnant woman should use the shoulder and lap belts to help lessen the chance of injury and/or the amount of injury in an accident.

▲ WARNING

It is desirable that a pregnant woman ask her doctor at each medical check-up if she can drive, and also ask about the most appropriate way of wearing the lap/shoulder belt.

Lap belts should be worn as low and snugly as possible over the hips.

Inspection

All parts of the seat belts, including the belt fabric, should be regularly inspected for fraying, loosening, wear and other damage. Keep the belts in good condition at all times to reduce the chance of being injured in an accident, and to minimize any injuries that do occur. Make sure the buckles, retractors, tongue plates, guides and anchors all work properly.

Don't let anything get inside the buckle or the retractor; it could cause latch or retractor failure.

Cleaning

The belts should always be kept clean and dry; wet or damp belts can cause rewinding problems. To clean the belts, pull them all the way out of their retractors and use warm water and a mild soap; then let them air-dry fully extended, in the shade, with the car windows open.

▲ WARNING

- **Never bleach, dye or clean the belts with chemical solvents; it will weaken the fabric.**
- **Do not remove the seat belts from the car to wash them.**

Replacement

Replace the seat belt if:

1. The belting is cut, punctured, burned, etc.
2. The buckle or retractor does not work properly.
3. It was being worn at the time of a collision (also check for deformation damage at all seat belt anchor points).
4. Its condition is questionable.

Instrument Panel

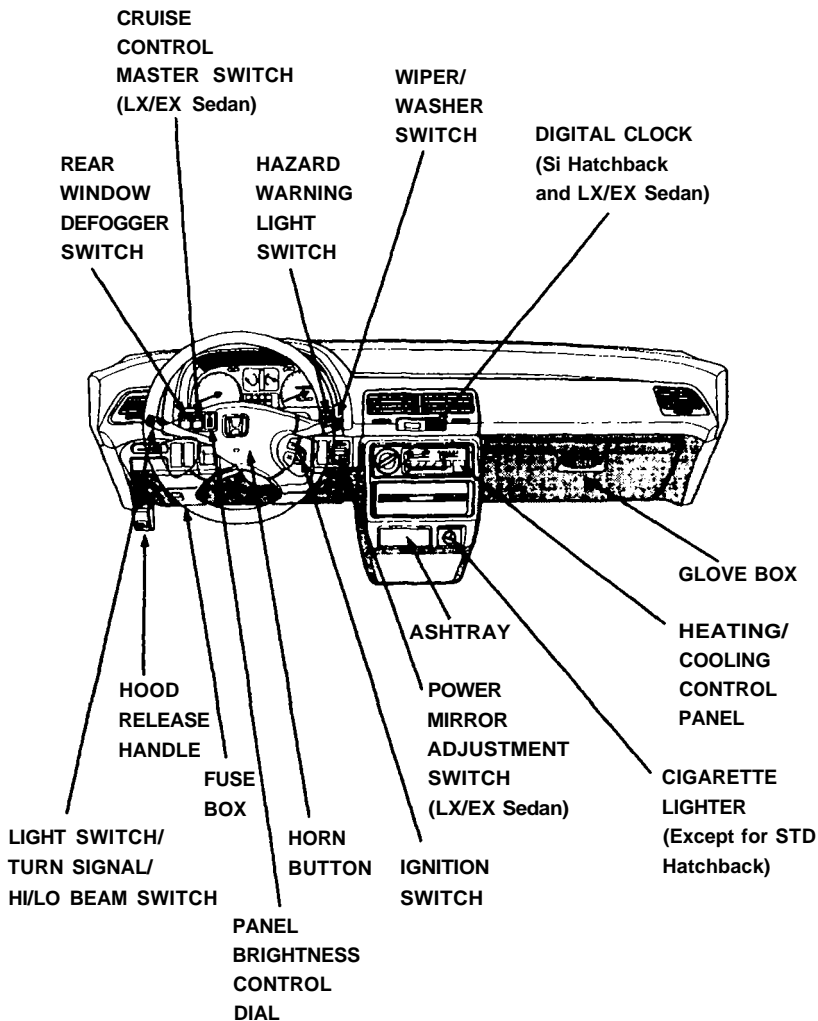

Si Hatchback and LX/EX Sedan

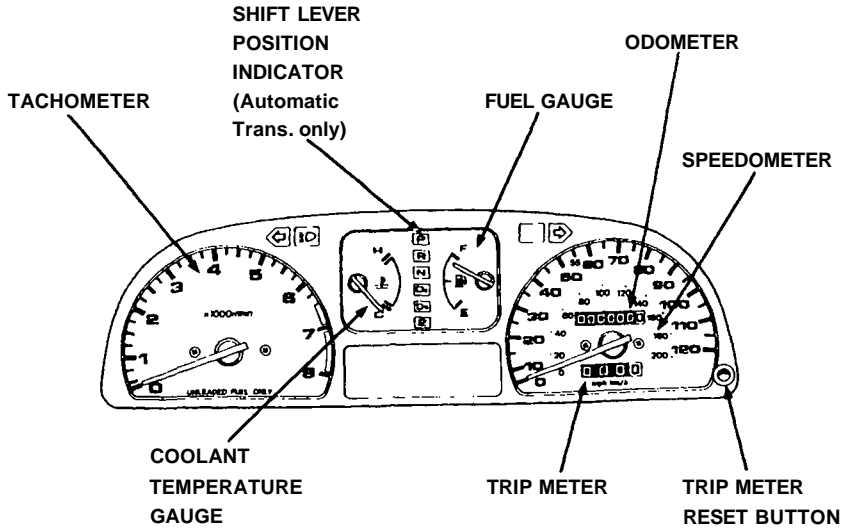

STD/DX Hatchback and DX Sedan

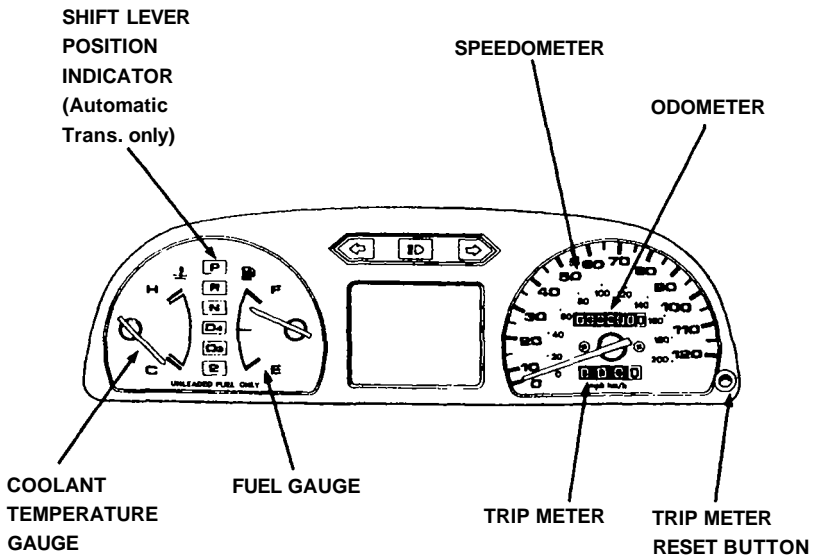

Gauges

Speedometer

The speed is indicated in miles per hour (outside scale) and kilometers per hour (inside).

Odometer

The numbers on the odometer indicate miles. The odometer registers total distance traveled, and serves as your guide for determining when periodic maintenance is due. Federal law makes it illegal to alter the odometer of any motor vehicle with the intent to change the number of miles indicated.

Trip Meter

The numbers on the trip meter indicate miles. The trip meter can be returned to zero by pushing in the reset button. Use it for checking fuel consumption or distance traveled per trip.

Tachometer (Si Hatchback and LX/EX Sedan)

The tachometer indicates engine speed in revolutions per minute. The beginning of the RED ZONE indicates the maximum allowable engine R.P.M. Do not run the engine with the tachometer indicator needle in the RED ZONE.

Fuel Gauge

FUEL TANK CAPACITY: 45 ℓ (11.9 US gal, 9.9 Imp gal)

As a convenience, the gauge continues to show the same fuel level as when the ignition was last on. After refueling, the gauge will slowly change to the new fuel level when the ignition is switched on. When the needle first indicates E (empty), you have a usable reserve left in the tank of about:
4 ℓ (1.1 US gal, 0.9 Imp gal)

Coolant Temperature Gauge

CAUTION:

The needle should stay within the white range. If the needle reaches the red line at "H" (Hot), pull safely off the road, stop the engine and check the coolant level in the reserve tank on the driver's side of the radiator under the hood.

▲ WARNING

Do not remove the radiator cap when the engine is hot. The coolant is under pressure and may blow out and scald you.

Warning and Indicator Lights

Si Hatchback and LX/EX Sedan

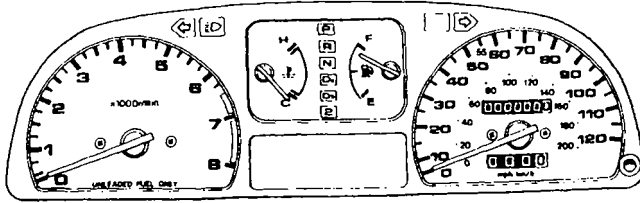

STD/DX Hatchback and DX Sedan

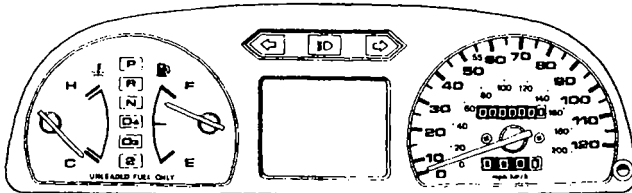

Shift Lever Position Indicator (Automatic Transmission only)

A lighted indicator between the fuel and coolant temperature gauges shows which gear you have selected.



Turn Signal/Hazard Warning Indicator Lights

When the turn signal lever is pushed for left or right turns, the appropriate green indicator arrow on the instrument panel will blink along with the signal. Pushing the hazard warning switch will make all turn signals and both arrows blink (see page 37).

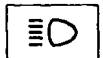

Headlight High Beam Indicator Light

This blue indicator light will go on whenever the high beams are switched on (see page 36).

(cont'd)

Warning and Indicator Lights (cont'd)

DX Sedan



STD/DX Hatchback



Oil Pressure Warning Light

The oil pressure warning light will come on, and remain on, if there is insufficient oil pressure or when the ignition switch is turned on with the engine not running. If the light should come on while driving, get the car off the road as soon as you can, turn the engine off and check the engine oil level (see page 75).

Even if the oil level is correct, the engine should be checked by a Honda dealer before the car is driven again.

NOTE:

The oil pressure warning light will only light as a result of low oil pressure. It is not directly an oil level indicator.

CAUTION:

Running the engine while the oil pressure warning light is on constantly may cause immediate and severe engine damage.



Charging System Warning Light

The charging system warning light comes on when there is a problem with the electrical charging system or when the ignition switch is turned on with the engine not running. If the light comes on while driving, get off the road, stop the car and turn off the ignition. Then check the alternator belt for proper tension.

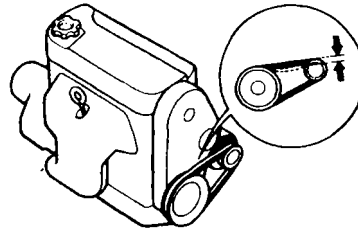

To check the belt tension, push with about 98 N (22 lb) of force on the middle of the belt as shown. The belt should deflect about: 9.0 — 11.0 mm (0.35 — 0.43 in)

⚠ WARNING

If the engine has been running, some engine components may be hot enough to burn you.

NOTE:

If necessary, have the charging system checked by an authorized Honda dealer.

LX/EX Sedan

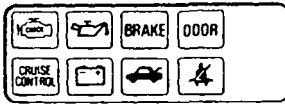

Si Hatchback

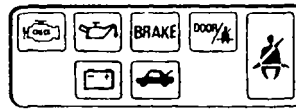

Check Engine Warning Light

This light comes on for a couple of seconds each time the ignition is turned on. It will also come on, and remain on, if there is a malfunction in the emission control system. If the light comes on while driving, avoid driving at high speed, and have the system checked by a Honda dealer as soon as possible.

BRAKE

Parking Brake/Brake Failure Warning Light

Check the brake warning light every time you start the car. With the parking brake set, the warning light should go on when the ignition switch is turned to II or III. With the parking brake released, the light should go on when the ignition switch is turned to III. If the light goes on at any other time, it means the brake fluid level in the master cylinder reservoir is too low; add fluid and have your dealer check for leaks and brake pad wear immediately. (See page 84)



(Hatchback) /



Seat Belt Reminder Light

The seat belt reminder light comes on when the ignition switch is turned on (see pages 14 and 17).



Hatch/Trunk-open Indicator Light

This light will go on when you turn on the ignition switch if the hatch/trunk is not fully closed.



Cruise Control Indicator Light (LX/EX Sedan)

When the cruise control system is on, this indicator light is on (see page 39).

DOOR

Door Warning Light (Sedan)

If a door is open when the ignition is switched on, this light will go on and stay on until the door is closed.

Tilt Steering

Tilt Steering (DX/Si Hatchback and Sedan)

The steering wheel position can be adjusted to suit the driver preference.

1. Push the lever located on the left side of the steering column all the way down and hold it while adjusting the steering wheel to the desired position.

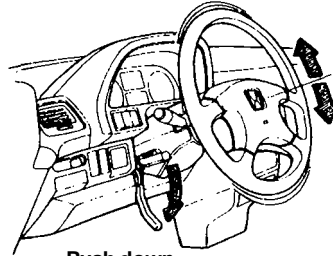

2. Hold the steering wheel in the desired position and pull the lever all the way up to lock it in place.

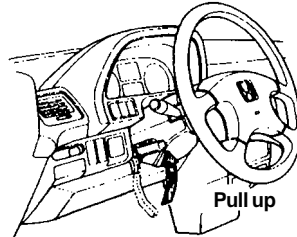

▲ WARNING

- Do not adjust the steering wheel position while driving.
- After adjusting the steering wheel position, make sure it is securely locked in place by "rocking" it up and down slightly.

Windshield Wipers/Washer/Defogger

Windshield Wipers (DX/Si Hatchback and Sedan)

Switch the wipers to INT for intermittent operation; LO for low speed operation; and HI for high speed operation.

(INT: Except STD Hatchback)

In fog or very light rain, push the lever down to the MIST position for temporary high speed operation of the wipers. The wipers will return to the rest position and the motor will shut off as soon as you release the lever.

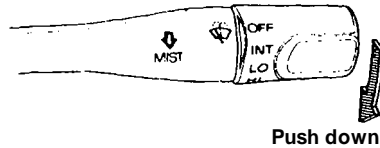
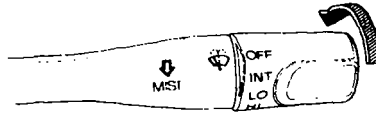

Windshield Washer

Pull the wiper switch lever toward you to turn on the washer.

Check the washer fluid regularly, especially during bad weather or whenever the washer has been in frequent use.

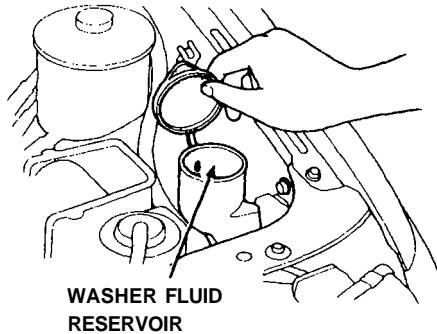
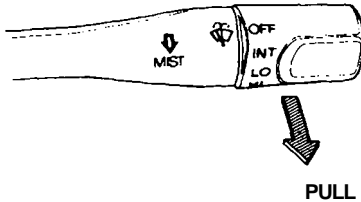

WINDSHIELD WASHER

RESERVOIR CAPACITY: 2.5 ℓ (2.6 US qt, 2.2 Imp qt)

Use a good quality commercial washer fluid for all-weather cleaning.

(cont'd)

Windshield Wipers/Washer/Defogger (cont'd)

CAUTION:

- Do not use radiator antifreeze in the windshield washer; it will damage the paint.
- Do not use a vinegar/water combination in the windshield washer; it will damage the pump.
- Prolonged operation of the washer without fluid may damage the pump.

In freezing weather, warm the windshield with the defrosters before using the washer. This will help prevent icing which could seriously impair visibility.

Rear Window Wiper/Washer (DX/Si Hatchback)

Switch to "ON" to activate the rear wiper. Turn and hold the switch one more step clockwise to "  " to activate the washer and wiper; or turn and hold the switch one step counterclockwise from "OFF" to activate the washer only. The rear washer uses the same fluid reservoir as the front washer.

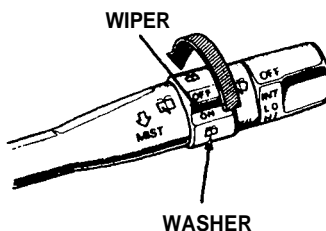

Rear Window Defogger

Push the switch to turn the defogger on or off. The indicator will light when the defogger is on. The switch will turn off automatically 25 minutes after it is turned on.

INDICATOR

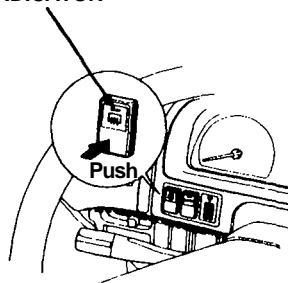

CAUTION:

When cleaning the inside of the rear window, be careful not to damage the printed heater wires on the rear window. Wipe the window horizontally along the wires, not up and down.

Rearview Mirrors

Keep the inside and outside mirrors clean and adjusted for best visibility. Be sure to adjust mirror angles before you start driving.

The inside mirror has day and night positions. The night position reduces glare from the headlights of vehicles behind you. Flip the small tab on the bottom of the mirror forward or backward to select day or night position.

The outside mirror can be adjusted by moving the knob on the inside of the driver's door.

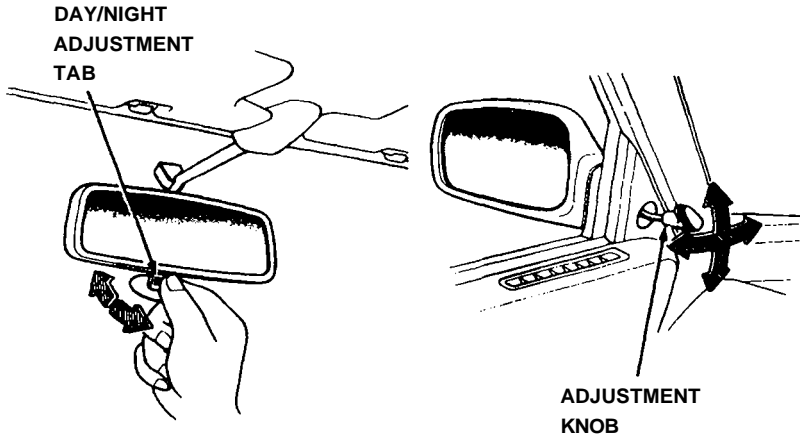

On the LX and EX Sedan:

With the ignition switch in the "II" position, move the main switch to L (for driver's side) or R (for passenger's side), then use the adjustment switch to adjust the outside mirror to the correct angle. After the mirrors have been adjusted, return the main switch to the center (off) position.

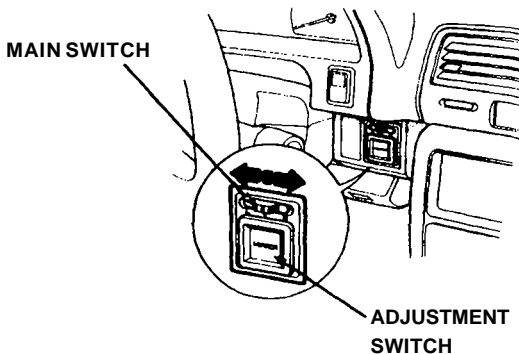

NOTE:

Be sure to adjust mirror angles before you start driving.

Lights

Turn Signals

Push the turn signal lever down to signal a left turn, and up for a right turn. The indicator and appropriate signal lights will blink. The lever will return automatically to its original position when the steering wheel is returned to straight ahead.

For lane changing, you can signal by pushing the lever part way up or down (to the first stop) and holding it there; the lever will return to its original position when you release it. If either turn signal indicator lights up but does not blink, blinks faster than usual or does not light up at all, check for a burned out bulb or fuse.

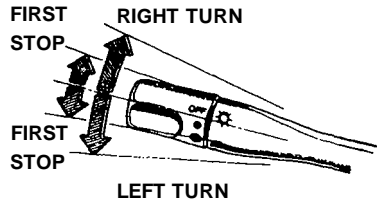

Headlights

Turn the light switch to the first position (●) for taillights, side marker lights, position lights, license plate lights, and instrument panel lights. Turn to the second position (●) to add the headlights.

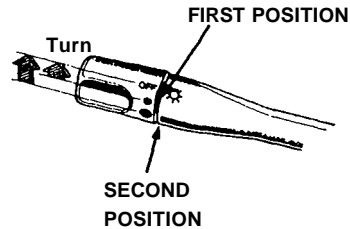

High Beam/Low Beam Switch

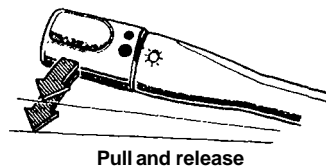

The headlights may be switched between low beam and high beam by pulling the turn signal lever towards you. The blue high beam indicator light will be on when the high beam is on.



Headlight Flasher

To flash the headlights, pull lightly on the turn signal lever and release.

Hazard Warning System

This system should be used only when your car is stopped under emergency or hazardous conditions. To activate, push the hazard warning switch (). The front and rear turn signals will blink simultaneously and both indicator lights will flash. Push the switch () again to turn the system off.

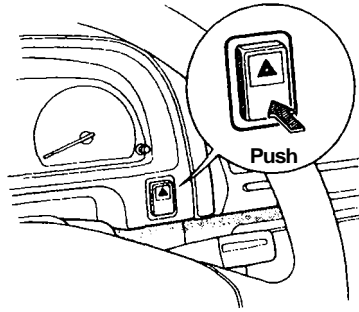

Panel Brightness Control

When the light switch is in either of the two "ON" positions, the intensity of the instrument lights can be adjusted by turning the panel brightness control dial.

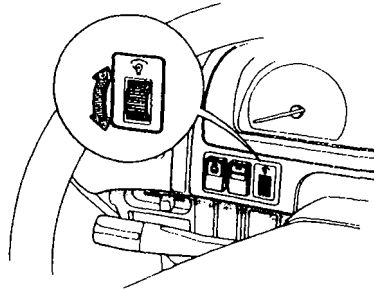

Interior Light

The interior light has a three position switch. The light is off all the time in the OFF position. In the middle position, it goes on only when a door is opened. In the ON position, it is on all the time.

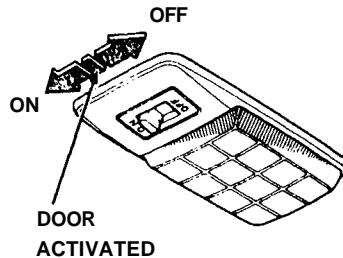

(cont'd)

Lights (cont'd)

Luggage Area Light (Except for STD Hatchback)

(Hatchback)

The luggage area light has a two-position switch. In the first position it is OFF all the time, in the second position it goes ON only when the hatch or trunk lid is opened.

(Sedan)

The trunk compartment light goes on when the trunk lid is opened.

Hatchback

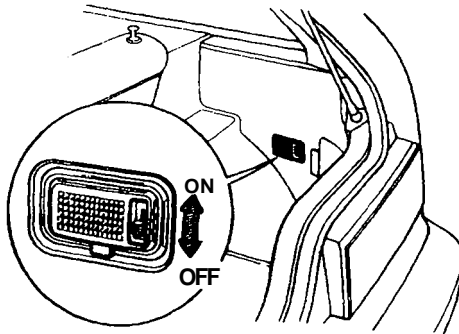

Cruise Control (LX/EX Sedan)

Cruise Control

The Cruise Control system allows you to set and automatically maintain any speed above 25 mph (40 km/h) without keeping your foot on the accelerator. As its name implies, it is meant for cruising on straight, uncongested highways or freeways. It is not recommended to be used in traffic, on winding roads or in bad weather conditions where the driver should have total control.

To Set the Cruise Control:

Push the CRUISE CONTROL master switch on the dash; the indicator light will come on.

Accelerate to the desired speed, then push and release the SET switch on the steering wheel. The Cruise Control light on the instrument panel will come on.

The speed you were going when you released the SET switch is the speed the Cruise Control will hold. You can then "fine tune" the set speed by briefly holding and releasing the SET switch to decrease it a few mph or pushing the RESUME switch to slightly increase it.

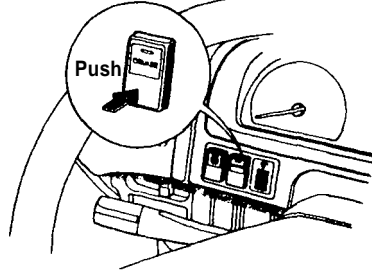

To Cancel the Cruise Control:

Simply push the CRUISE CONTROL master switch and the indicator light will go off (this also erases the memory of the set speed).

If you must temporarily disengage the system (but you wish to retain the memory of the set speed): tap the brake pedal, or the clutch pedal (manual transmission) or move the automatic transmission shift lever to N (Neutral). If you are still going above 25 mph (40km/h), you can return to the set speed by simply pushing the RESUME switch. If the car has decelerated below approximately 25 mph (40 km/h), you can return to the set speed by using the accelerator conventionally until your speed is above 25 mph (40km/h) and then pushing the RESUME switch.

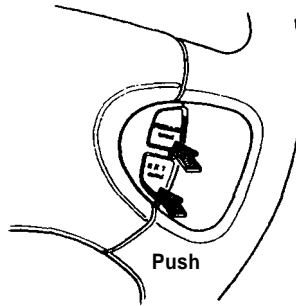

(cont'd)

Cruise Control (cont'd)

To Change the Set Speed:

To a faster speed — For gradual acceleration with your foot off the accelerator, push and hold the RESUME switch until you reach the desired speed; release the switch and the system's memory will be re-programmed to the new speed.

For faster acceleration, push the accelerator until you reach the desired speed, then push and release the SET switch to re-program the system.

To a slower speed — push and hold the SET switch and the car will coast; when you reach the desired slower speed, release the switch and the system will be re-programmed.

For temporary acceleration above the set speed, such as for passing, use the accelerator pedal conventionally. When you want to return to the set speed, take your foot off the accelerator and coast without applying the brakes.

▲ WARNING

The Cruise Control automates the function of the accelerator pedal to maintain your car at a constant speed. This can be a convenience on long trips, but it can also be a danger if there are many other cars on the road or if the road is unfamiliar. Pay strict attention to the responsibility of driving whenever using the Cruise Control.

CAUTION:

Because the Cruise Control directly activates the accelerator pedal, don't rest your foot under the pedal when the Cruise Control is on; it may pull the pedal down onto your foot.

NOTE:

- With Cruise Control on, your speed will still vary slightly, particularly when going up or down hills.
- Do not drive with your foot on the brake or clutch pedal (manual transmission), as this will cause the Cruise Control to disengage.

Hood

To open, pull back on the handle under the left side of the dash.

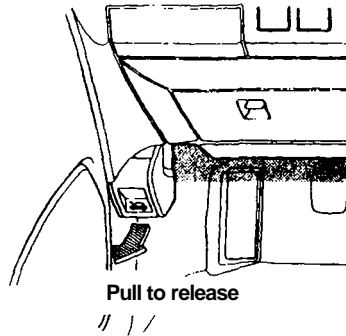

The hood latch is spring-loaded, so the hood will pop up slightly. Release the safety catch under the front center of the hood by pushing the rubber-tipped handle up. Lift the hood and prop it open with the support rod. To close, take the support rod down, and return it to its clip, then lower the hood until it is approximately one foot from the closed position, then let it drop. Be sure the hood is securely latched before driving away.

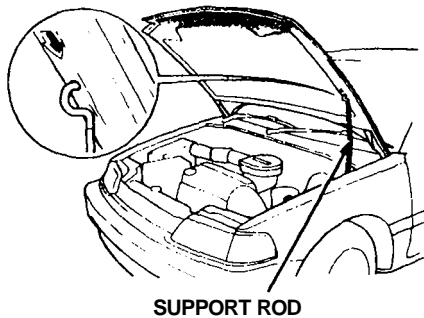
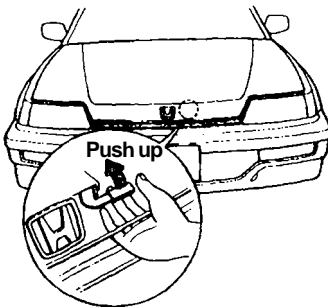

Clock, Glove Box and Parking Brake

Digital Clock (Si Hatchback and LX/EX Sedan)

The time is displayed continuously when the ignition is on.

At all other times, push in on the lid to display the time.

To adjust the time:

1. Lower the lid.
2. Push the minute button (MIN.) and hold it until the numbers advance to the desired minutes.
3. Push the hour button (HOUR) and hold it until the numbers advance to the desired hour.
4. The RESET button allows you to synchronize your clock to the closest hour. If the time on the clock is before the half hour, pressing the RESET button will return the time to the previous hour. If the time is beyond the half hour, the RESET button will change the time to the next hour.

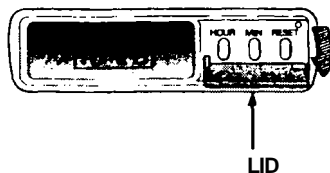

NOTE:

Be careful not to push the HOUR, MIN. or RESET buttons accidentally. Pushing any of them will change the clock's time setting.

Glove Box

Open by pushing the knob as shown.

Close with a firm push.

▲ WARNING

Do not drive the car with the glove box door open; it could cause injury in an accident.

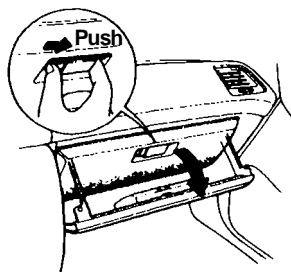

Parking Brake

To apply the parking brake, pull up on the lever. To release it, pull up slightly, push the button, and lower the lever; when fully released, the BRAKE warning light will go out.

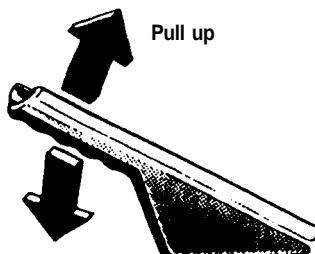

Power Windows (LX/EX Sedan)

The power windows can be operated only when the ignition switch is in the "II" position.

The operation of the windows is controlled by the main switch located in the master control panel on the driver's door. When the main switch is off, only the driver's door window can be opened and closed.

When the main switch is on, all door windows can be opened and closed by the driver, using the appropriate switch in the master control panel, and the passenger windows can be opened and closed by the passengers, using the switch located on each passenger door.

When opening or closing a window, push and hold either the "up" or "down" side of the switch until the window reaches the desired position, then release.

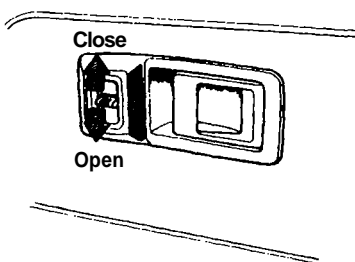
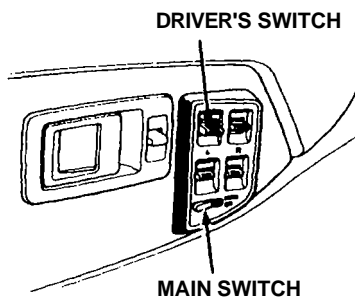

NOTE:

The driver's window can be opened fully, without the driver having to hold the switch down, simply by pushing the switch past the first "stop."

▲ WARNING

- Be sure, before closing any window, that all hands, arms and other obstructions are clear of the window frame and glass; severe personal injury could result.
- Always keep the main switch in the off position when children are in the car; injury may result from unintentional window operation.

Cigarette Lighter and Ashtrays

Cigarette Lighter (Except STD Hatchback)

Push in to heat up. It will automatically release when the element is hot. DO NOT hold it in while it is heating up, it may overheat and damage the lighter and the heating element.

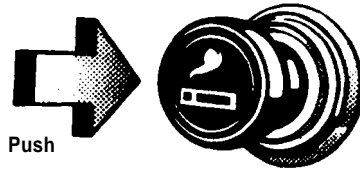

Front Ashtray

Open the ashtray by pulling its bottom edge toward you.

To remove it, pull it out further while pushing down on the spring loaded plate inside.

To install, reverse the removal procedure.

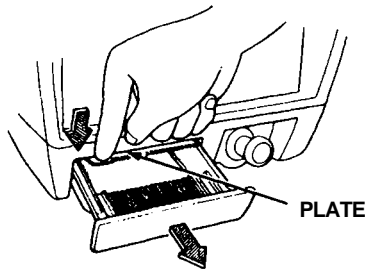

Rear Ashtray

The rear ashtray is located at the rear of the center console. It is opened by pulling out the top edge.

To remove it, open the ashtray and release its bottom edge by pulling up, then out. To install, reverse the removal procedure.

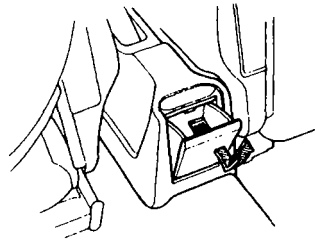

CAUTION:

Do not use the ashtrays as trash containers; use them only for extinguished cigarettes. Putting lit cigarettes or matches in an ashtray with other combustible materials may cause a fire.

Heating and Cooling

The vents, heater and air conditioner are combined in one system; adjusting four basic controls to different settings can provide a full range of interior temperatures for safe and comfortable driving.
Air conditioner: optional

Ventilation

The flow-through ventilation system can provide fresh air to the interior when the car is moving or stopped, even with the windows closed.

NOTE:

For proper air flow, the flow-through vents must not be covered. Keep the air inlet at the base of the windshield free of leaves or other debris.

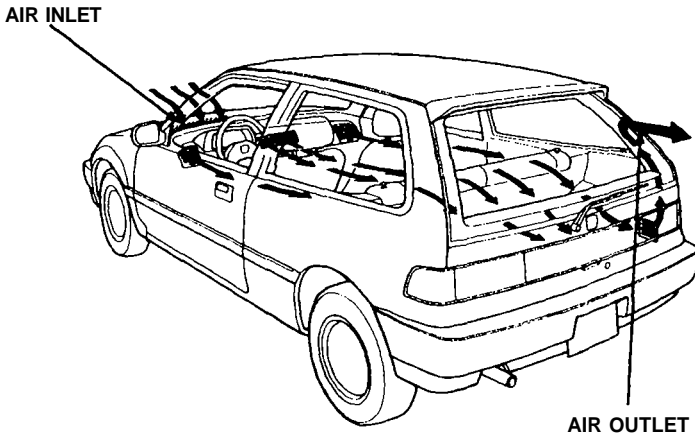

You can adjust the controls to direct cool or warm outside air throughout the car for defogging windows, heating, or cooling by turning on the fan.

(cont'd)

Heating and Cooling (cont'd)

Dash Vents

The corner vents can be used for flow-through ventilation, or for heating and air conditioning. When the car is moving, the driver's corner vent can also route fresh air directly from the outside by sliding the corner vent lever below it to the right and shutting it off from the heater and air conditioner system.

The louvers in the corner and center vents can be tilted up or down and right or left, to change the direction of air flow.

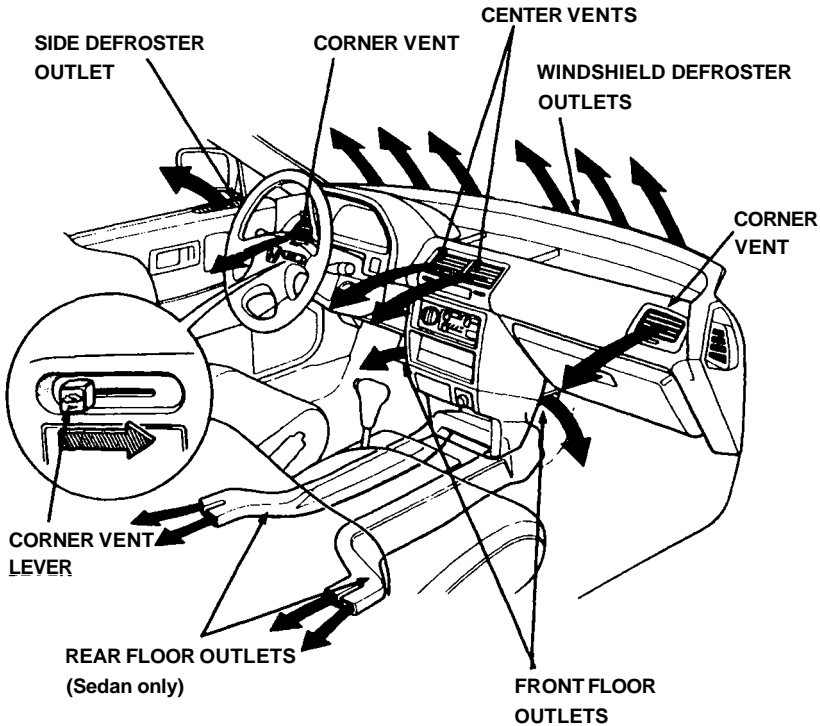

What the Controls Do:

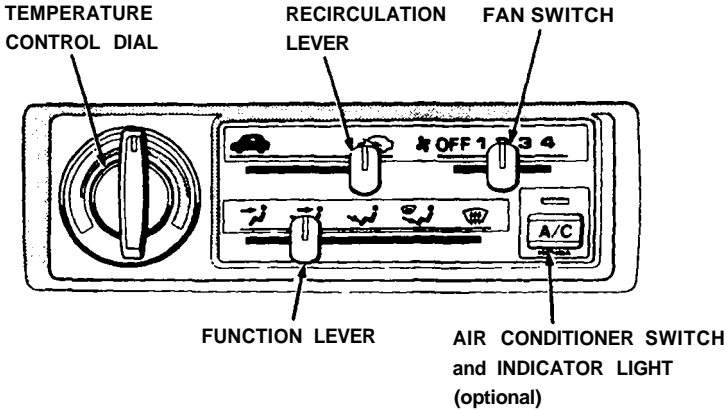

Fan Switch

Switch the fan to low (1), medium (2), medium high (3) or high speed (4), to circulate warm, cool, or outside air, depending on where the temperature control dial and function levers are set.

Function Lever

Slide the lever right or left to direct outside air or recirculated (inside) air to and from the heater, air conditioner and vents.

Temperature Control Dial

Turn the dial clockwise to make air warmer with the function lever in any position.

Air Conditioner Switch (optional)

With the fan on, push the A/C switch to operate the air conditioner; the indicator light will come on.



Push the switch again to turn the air conditioner off.

(cont'd)

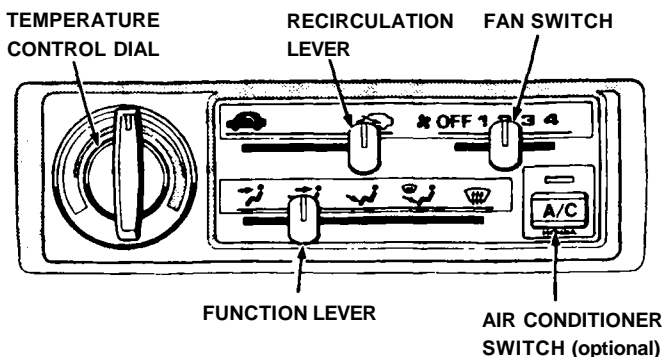

Heating and Cooling (cont'd)



Recirculation Lever



Sliding the lever from the  position to the  position shuts off outside air and recirculates the air inside the car. If the heater or air conditioner is on, and you want to warm up or cool down the interior more quickly, or keep smoke or dust out of the car without losing the heat or cool function, simply slide the lever to the  position.

NOTE:

The windows may become fogged if the system is in the  position for an extended period of time with the air conditioner off. As soon as the interior is warmed, slide the lever to the  position.

How to Use the Controls

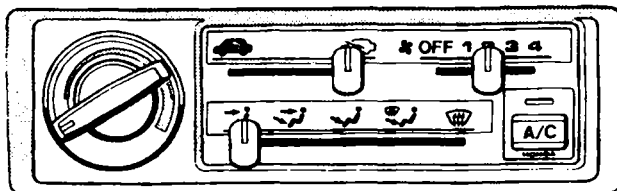

To Ventilate

Turn the temperature control dial counterclockwise, slide the recirculation lever to the  position and the function lever to the  position. Switch the fan on and outside air will flow through the corner and center vents. To change air distribution, slide the function lever to the  position, and outside air will also flow from the floor level outlet at the heater.



To Cool (with optional air conditioner)

To cool the car down quickly, slide the recirculation lever to the  position, start the engine, turn the temperature control dial counterclockwise all the way, switch the fan to high (4), push the A/C button in, and open the window briefly.

Then close the windows and corner vents, slide the function lever to the  position and the recirculation lever to the  position so inside air will recirculate to the air conditioner for maximum cooling.

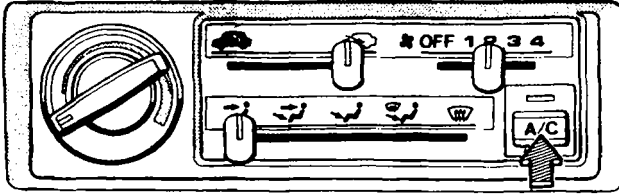



When the interior has cooled sufficiently, switch the fan to the desired speed, then slide the recirculation lever to  to direct fresh (outside) air to the air conditioner.

When using the air conditioner in heavy traffic, or while driving up long hills, watch the coolant temperature gauge: if the needle moves near the "H" end of the scale, turn the air conditioner off by pushing the A/C button; leave it off until the needle goes back into the middle of the scale.



(cont'd)

Heating and Cooling (cont'd)

To Heat

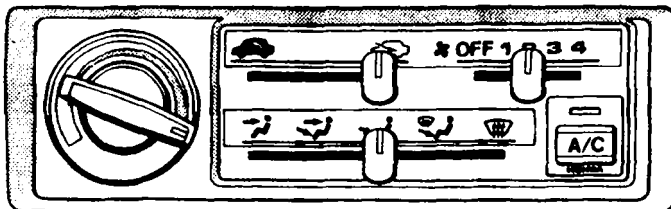
Switch the fan on, turn the temperature control dial clockwise, slide the function lever to the  position and the recirculation lever to the  position, and warmed (outside) air will begin flowing from the floor outlets.



To warm up the interior quickly, slide the recirculation lever to the  position so inside air will recirculate to the heater. The windows may become fogged if the system is in the  position for an extended period of time. As soon as the interior is warmed, slide the lever to the  position.

To Dehumidify (with optional air conditioner)

Because an air conditioner dehumidifies as it works, you can use it in cool or cold weather to help defog the windows. Just switch the fan on, push the A/C button, select the desired function and adjust the temperature control dial to a comfortable setting.

NOTE:

This setting is desirable for most operating conditions in ambient temperatures above approximately 32°F (0°C).

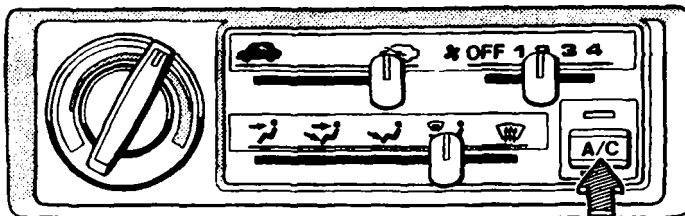

To Defrost

To defrost or defog the windshield and door windows, turn the temperature control dial clockwise, slide the function lever to the  (defrost) position, and switch the fan on.

If there is actual frost on the windows, first select the  position.

If the windows are fogged, select the  position. Warmed air will then flow from the windshield and side defroster vents.

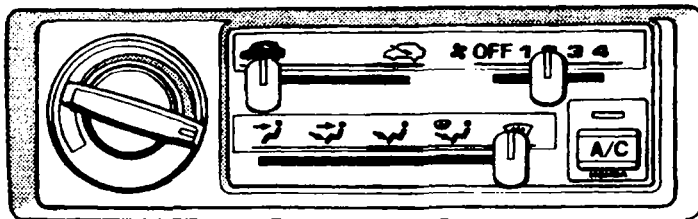

To Turn Everything OFF

Slide all levers to the left, turn the temperature control dial counterclockwise all the way, and push the A/C switch off.

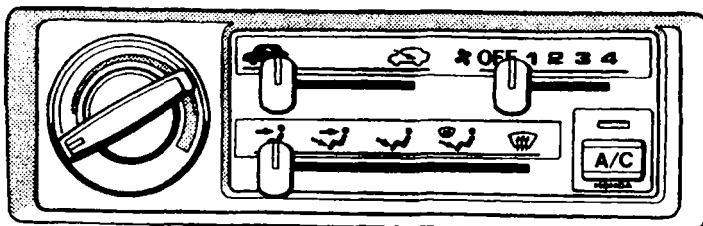

NOTE:

This setting should only be used in cold weather for the first few minutes of driving to prevent cold air from blowing into the cabin. Under normal operating conditions, the fan should always be kept ON to prevent the accumulation of stale air in the system.



Sunroof (Si Hatchback)

Sunroof

To open the sunroof, push and hold the  switch. To close the sunroof, push and hold the  switch. Release the switch when the roof gets to the position you want.

Do not hold the switch on after the sunroof has fully opened or closed, or you may damage the sunroof motor.

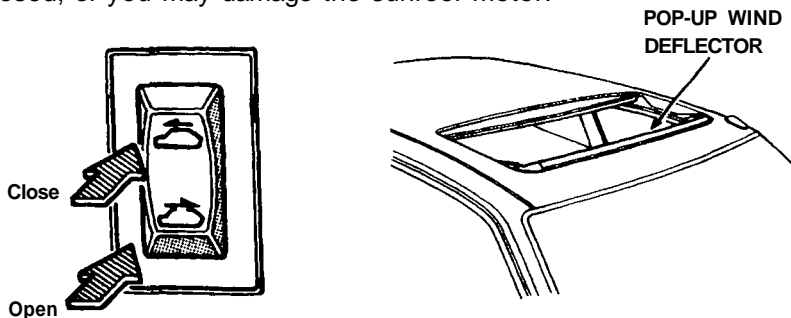

▲ WARNING

- Do not allow any part of your body to extend through the sunroof while the vehicle is in motion. In the event of a collision or sudden application of the brakes, severe personal injury could result.
- To avoid the possibility of injury while closing the sunroof, never allow any part of your body to extend through the opening.

CAUTION:

Operating the sunroof in severe cold or when it is covered with snow or ice may cause damage to the sunroof.

Sunshade

As well as the sunroof, there is a sliding sunshade which you can adjust to let in light with the roof closed, or to block out light entirely. The sunshade automatically opens as you open the sunroof.

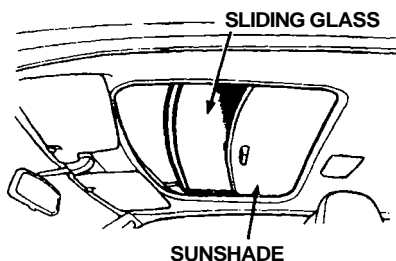

If the Sunroof Won't Close

The sunroof can be closed manually, if the control switch will not close it.

1. Remove the round plug near the rear center of the headliner.
2. Insert the sunroof wrench (from the tool kit) into the socket.

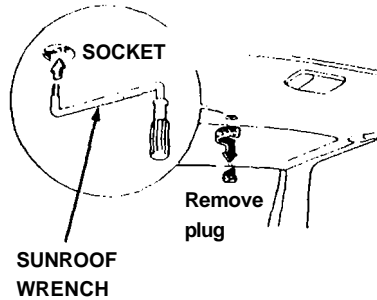

3. Turn the wrench counterclockwise until the roof closes and seats into its locked position (about ten turns).
4. Replace the plug.

Maintenance

Periodically pour a little water down the drain holes to make sure they are not plugged. If they are free, water should drop on the ground behind each front wheel.

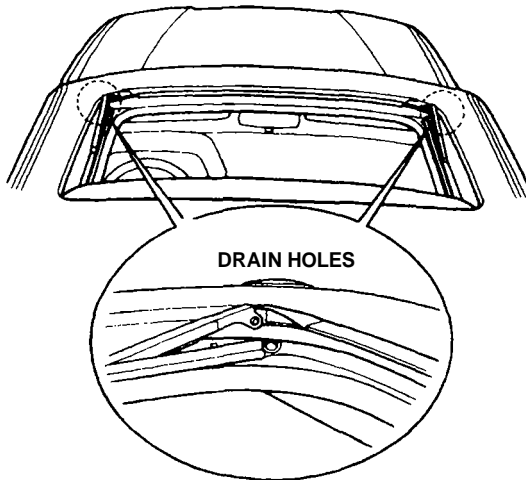

CAUTION:

Do not put weight on the sunroof or force it open or closed, you may damage the mechanism.

Gasoline

For proper operation of your car's emission controls, your engine is designed to use unleaded fuel only.

CAUTION:

Using leaded or even low-lead gasoline could damage some of your emission controls, and also void their coverage under the emission controls warranty.

Use gasoline from pumps labeled unleaded, with a pump octane number of 86 or higher. The pump octane number is an average of the Research (R) octane and Motor (M) octane numbers. Use of a lower octane gasoline can cause persistent, heavy "spark knock" (a metallic rapping noise), which can lead to engine damage if severe.

CAUTION:

If you notice steady spark knock while holding a steady speed on a level road, try changing brands of gasoline. If the spark knock persists, consult your Honda dealer. Failure to do so is considered misuse, and misuse is not covered under the New Car Warranty.

Occasionally you may notice light spark knock while accelerating or driving up hills. This is no cause for concern, it simply means your engine is running at its most economical.

Gasoline Containing Alcohol

If you decide to use a gasoline containing alcohol ("gasohol"), be sure its octane rating is at least as high as that recommended for unleaded gasoline. There are two types of "gasohol": that containing ethanol, and that containing methanol. Do not use gasohol that contains more than 10% ethanol. Do not use gasoline containing methanol (methyl or wood alcohol) that does not also contain cosolvents and corrosion inhibitors for methanol. Never use gasoline containing more than 5% methanol, even if it has cosolvents and corrosion inhibitors.

NOTE.

- Fuel system damage or vehicle performance problems resulting from the use of such fuels is not covered under the new car warranties. Honda cannot endorse the use of fuels containing methanol since evidence of their suitability is as yet incomplete.
- Before purchasing fuel from an unfamiliar station, try to confirm whether the fuel contains alcohol, of what kind, and how much. If you notice any undesirable operating symptoms after using a gasoline that contains alcohol; or one that you think contains alcohol, switch to an unleaded gasoline, as recommended above.

Operation In Foreign Countries

In order to comply with U.S. Federal Emissions Regulations, you must use unleaded fuels of the recommended octane rating. These fuels may not be available in other countries. If you intend taking your car outside the U.S. or Canada, write to American Honda Consumer Affairs (stating the year and model of your car) at the address below for information regarding modifications you may need to have done.

American Honda Motor Co., Inc.
Consumer Affairs
1919 Torrance Blvd.
Torrance, CA 90501-2722

Fuel Filler Door and Cap

▲ WARNING

Gasoline is extremely flammable and is explosive under certain conditions. Perform this operation in a well-ventilated area with the engine stopped. Do not smoke or allow open flames or sparks in the area or where gasoline is stored.

The fuel filler door is opened by pulling up on the lever at the left side of the driver's seat.

The door will lock automatically when closed; push it until it clicks.

CAUTION:

You may hear a hiss when you open the filler cap. This sound is residual pressure escaping from the fuel tank. Open the cap slowly and remove the cap after the hissing stops. Fuel spray may cause injury. Do not overfill the tank; fill only until the gas pump clicks off automatically and never top off.

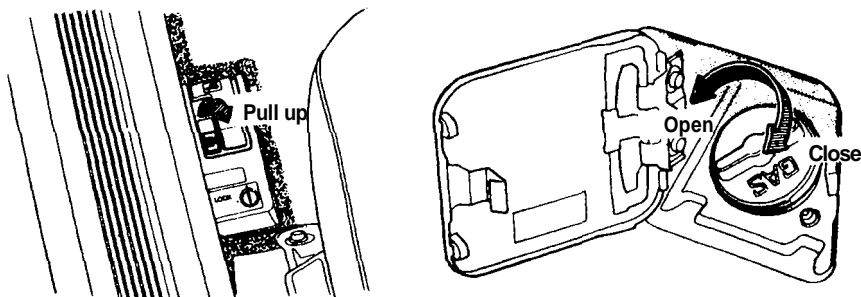

(cont'd)

Gasoline (cont'd)

⚠️ WARNING

Fuel vapor is extremely hazardous under certain conditions. Always stop the engine before refueling, and never refuel near sparks or open flames.

CAUTION:

When reinstalling the fuel cap, be sure both tabs on the cap are engaged in the slots of the filler neck and turn the cap until it stops. If you replace the cap, use only a genuine Honda replacement part or its equivalent. Failure to use the proper part could cause serious fuel system problems.

How to Improve Your Gas Mileage:

- Drive at a smooth, steady pace to avoid unnecessary decelerations and stops — accelerating back to speed uses more fuel.
- Plan trips to avoid rush hour traffic if possible.
- Make sure the parking brake is completely released.
- Consolidate trips whenever possible.
- Keep vehicle weight to a minimum by removing unnecessary items from the luggage area.
- Whenever possible, use fresh air from the dash vents to keep cool when driving; open windows, or use of the optional air conditioning both affect fuel economy.
- Keep the tires adjusted to the recommended pressure.

Tire Pressure (measured cold):

| | | |
|---------------|-------|------------------|
| STD Hatchback | front | 240 kPa (35 psi) |
| | rear | 220 kPa (32 psi) |
| DX Hatchback | front | 220 kPa (32 psi) |
| | rear | 220 kPa (32 psi) |
| Si Hatchback | front | 195 kPa (28 psi) |
| | rear | 195 kPa (28 psi) |
| DX Sedan | front | 220 kPa (32 psi) |
| | rear | 220 kPa (32 psi) |
| LX Sedan | front | 180 kPa (26 psi) |
| | rear | 180 kPa (26 psi) |
| EX Sedan | front | 180 kPa (26 psi) |
| | rear | 180 kPa (26 psi) |

Condition of Your Car

You can only get maximum fuel economy if your car is in top running condition. Have all required maintenance done at the proper intervals. Check tire pressures and tire wear frequently. If tire wear is uneven, have the alignment checked by your Honda dealer. Proper alignment saves gasoline and prolongs tire life.

Ignition Switch

The combined ignition switch/anti-theft lock is located on the right side of the steering column and has four positions:

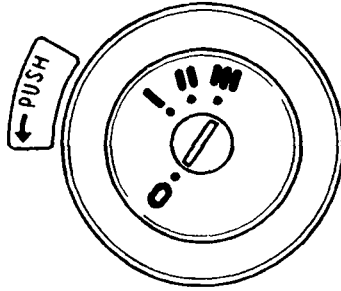

- **0-LOCK position:** The key can be removed or inserted in this position. To remove the key, push it in at position I, then turn it to 0 and pull it out. When the key is removed, the steering column will lock.

NOTE:

On cars equipped with automatic transmissions, the transmission must be in Park before pushing and turning the key to the 0-LOCK position.

⚠ WARNING

Never turn the ignition switch to the lock position or remove the key while the car is in motion; the steering wheel can lock causing a loss of directional control, and an accident could result.

- **I-ACCESSORY position:** In this position, the accessory circuit is on, but the ignition circuit is off.
If the key is difficult to turn from the 0 to the I position, turn the steering wheel slightly to relieve pressure on the lock.
- **II-ON position:** This is the normal running position.
- **III-START position:** The starter will engage when the key is turned to this position.

To remind you to remove the ignition key when leaving your car, a beeper will sound if the key is still in the ignition when you open the driver's door. The beeper system is deactivated when you turn the ignition to 0 (Lock) and fully remove the key.

Starting the Engine

Before Starting

Manual Transmission:

1. Apply the parking brake.
2. Push the clutch pedal all the way in (see NOTE below).
3. Shift the transmission to neutral.

NOTE:

On cars equipped with manual transmissions, the engine will not crank unless the clutch pedal is fully depressed.

Automatic Transmission:

1. Make sure the shift lever is in Park (P).
2. Apply the parking brake and the foot brake.

NOTE:

- When starting in cold weather, keep all unnecessary electrical circuits off (lights, defogger, etc.) for the best battery output.
- Do not crank the engine for more than 15 seconds at a time. Wait 10 seconds before going to the next step.

Starting the Engine

1. With your foot off the accelerator start the engine by turning the key to the III position.
2. If the engine won't start within 15 seconds or starts but fails to continue to run, push the accelerator pedal halfway, and hold it there while cranking the engine. Once the engine starts, release the accelerator gradually as the engine speeds up.
3. If it doesn't start within 15 seconds, push the accelerator pedal down to the floor and hold it there while cranking in order to clear flooding. Try step 2 again.

Cold Weather at High Altitude Starting

1. When starting in cold weather at high altitude (above 8,000 feet), push the accelerator pedal about halfway and hold it there while cranking the engine. Once the engine starts, release the accelerator gradually as the engine speeds up.
2. If it doesn't start within 15 seconds, push the accelerator pedal down to the floor and hold it there while cranking in order to clear flooding. Try step 1 again.

NOTE:

If the outside temperature is below freezing, or if your car has not been driven for several days, warm up the engine for a few minutes before driving.

Before driving away, check that:

- The doors are closed properly.
- The mirrors are properly adjusted, and the windows clean.
- The driver and passengers are wearing properly adjusted seat belts.
- The head restraints are properly adjusted.
- The warning and indicator lights are operating properly.
- The brake pedal feels normal.
- All luggage and cargo is secured.
- Nothing is interfering with the driver's feet or blocking vision to the rear.

While driving remember to:

- Always drive defensively; expect the unexpected.
- Reduce your speed during night hours and bad weather.
- Follow at a safe distance; don't tailgate.
- Get off the highway when you are tired; stop and take a rest.

When stopping for repairs:

- Park the car well off the road.
- Turn on the hazard warning flasher.
- Use flares or other warning devices to warn other motorists.

After parking your car:

- Apply the parking brake and shift to first gear if equipped with manual transmission, or PARK on automatic transmission equipped cars.
- Make sure the sunroof and windows are closed and the doors are locked.
- If parked on a hill:
 1. Turn the front wheels away from the curb if facing uphill.
 2. Turn the front wheels toward the curb if facing downhill.
- Never leave children unattended in a parked car.
- Take your keys.



Engine Exhaust Gas Warning

A properly maintained car is your best protection against exhaust gas entering the passenger compartment.

The exhaust system should be thoroughly inspected by a competent mechanic whenever:

- The car is raised for oil change.
- You notice a change in the sound of the exhaust.
- The exhaust system or the rear or underside of the car is damaged.

WARNING

- **Avoid breathing exhaust gases. They contain carbon monoxide, which is a colorless, odorless gas that can cause loss of consciousness and eventual death. If you suspect that exhaust gas is entering the passenger compartment, have the cause determined and corrected as soon as possible. If you must drive under these conditions, drive only with all windows fully open.**
- **Do not drive with the hatch/trunk lid open. An open hatch/trunk may draw exhaust gases into the passenger compartment. If you must drive with the hatch/trunk open, drive only with all the windows wide open.**
- **Do not run the engine in confined areas, such as garages, any longer than necessary to move the car in or out.**
- **If you must sit in a parked car with the engine running for more than a short time, adjust the heating/ventilation system as follows:**
 1. **Set the function lever to the  position.**
 2. **Set the temperature control dial for best comfort.**
 3. **Set the recirculation lever to the  position.**
 4. **Turn the fan to the highest speed.**

NOTE:

To insure proper operation of the car's ventilation system, keep the front air inlet clear of snow, mud, leaves or other obstructions.

Shifting the 4 or 5 Speed

The fully synchronized manual transmission is very easy to shift up or down. When you slow down for traffic, steep hills, or corners, shift to a lower gear before the engine starts to labor. When descending steep grades, select a lower gear to help maintain a safe speed and to prevent the brakes from overheating.

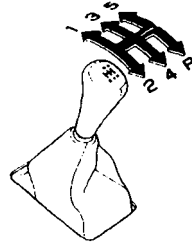

When shifting, depress the clutch pedal fully, shift gears and then release the clutch gradually. Do not speed-shift; allow time for the gears to synchronize.

To prevent grinding the gears when shifting into reverse, hold the clutch pedal depressed briefly before shifting, or shift the lever into one of the forward gears before selecting reverse.

On 5 speed transmissions, a safety lockout prevents accidental shifting straight from 5th to Reverse.

▲ WARNING

Avoid rapid acceleration or sudden deceleration when either or both driving wheels are on a slippery surface. Decreased traction could cause loss of directional control.

Clutch Pedal Adjustment

Clutch pedal free travel must be adjusted periodically to compensate for lining wear. There should be approximately 25 mm (1 in) of pedal free travel. If not, or if the clutch seems to slip or you have difficulty shifting, have your dealer check the clutch adjustment.

CAUTION:

- **Do not drive with your foot on the clutch pedal as this will cause premature wear of clutch components.**
- **Do not shift into reverse while the car is moving.**
- **Driving with the clutch pedal free travel improperly adjusted can cause premature wear of the clutch components.**

(cont'd)

Shifting the 4 or 5 Speed (cont'd)

Recommended Shift Speeds

For best fuel economy, and effective emission control, shift at the speeds shown:

STD Hatchback

| Shift up | Normal Acceleration |
|------------|---------------------|
| 1st to 2nd | 15 mph (24 km/h) |
| 2nd to 3rd | 25 mph (40 km/h) |
| 3rd to 4th | 40 mph (64 km/h) |

DX Hatchback and Sedan

| Shift up | Normal Acceleration | Cruise From Acceleration |
|------------|---------------------|--------------------------|
| 1st to 2nd | 15 mph (24 km/h) | 9 mph (14 km/h) |
| 2nd to 3rd | 27 mph (43 km/h) | 20 mph (32 km/h) |
| 3rd to 4th | 39 mph (62 km/h) | 33 mph (53 km/h) |
| 4th to 5th | 53 mph (85 km/h) | 48 mph (77 km/h) |

Si Hatchback

| Shift up | Normal Acceleration | Cruise From Acceleration |
|------------|---------------------|--------------------------|
| 1st to 2nd | 14 mph (22 km/h) | 7 mph (11 km/h) |
| 2nd to 3rd | 25 mph (40 km/h) | 20 mph (32 km/h) |
| 3rd to 4th | 36 mph (58 km/h) | 30 mph (48 km/h) |
| 4th to 5th | 49 mph (78 km/h) | 45 mph (72 km/h) |

Maximum Allowable Speeds

The speeds shown below are the maximum at which the car can be driven or downshifted in each gear without over-revving the engine.

| Model Gear | STD Hatchback | DX Hatchback |
|---------------|-------------------|-------------------|
| 1st | 30 mph (49 km/h) | 35 mph (56 km/h) |
| 2nd | 60 mph (97 km/h) | 60 mph (97 km/h) |
| 3rd | 96 mph (155 km/h) | 91 mph (146 km/h) |



| Model Gear | Si Hatchback | Sedan |
|---------------|-------------------|-------------------|
| 1st | 30 mph (49 km/h) | 32 mph (52 km/h) |
| 2nd | 52 mph (84 km/h) | 55 mph (89 km/h) |
| 3rd | 79 mph (127 km/h) | 83 mph (134 km/h) |

Shifting the Automatic

The automatic transmission shift lever has a locking mechanism to prevent accidental shifting into Reverse (R), Park (P) or 2nd (2). Also, an Automatic Shift Lock prevents you from shifting out of Park unless the brake pedal is already depressed and the ignition switch is in the II position.

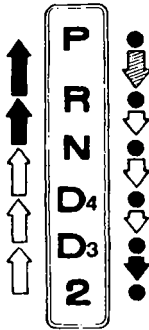
Push the button on the shift handle to shift into 2nd, Reverse or Park; depress the brake pedal and then push the button on the shift handle to shift out of Park.



-  : Depress the brake pedal first and push the button, then shift.
-  : Push the button, then shift.
-  : Shift as desired.

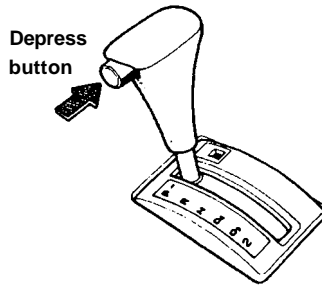

If you cannot shift out of Park with the brake pedal depressed and the ignition switch in the II position:

1. Turn the ignition switch off and remove the key.
2. Insert the key in the Shift Lock Release located to the right of the shift lever.
3. Press and hold the key down, then press the button on the shift handle and move the shift lever to Neutral.
4. Return the key to the ignition switch, depress the brake pedal and restart the engine.

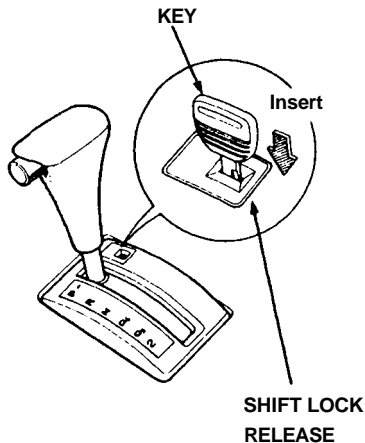

NOTE:

If you encounter any problem shifting out of Park, have your authorized Honda dealer check the system as soon as possible.

Operating Tips

For smoother operation, apply the brakes when shifting from Neutral or Park to a forward or reverse gear.

When parking: bring the car to a stop with the foot brake, hold the brake on and shift into Park, set the hand brake and then turn off the engine.

NOTE:

Your 4 speed automatic transmission is equipped with a torque converter lock-up clutch. Because of this, you may notice what feels like an extra shift as the clutch engages.

CAUTION:

- **Shift into P only after the car has come to a complete stop.**
- **Shift into or out of R only after the car has come to a complete stop.**
- **Do not "rev-up" the engine when the brake is on and the shift lever is in D₄, D₃, 2 or R.**
- **When stopped on a hill, use the brakes to hold your position, not the accelerator pedal.**
- **Do not shift from N or P into D₄, D₃, 2 or R when the engine is above idle speed. Before shifting into gear, make sure your foot is firmly on the brake pedal.**
- **Do not rest your hand on the shift lever or push the shift button while driving.**

(cont'd)

Shifting the Automatic (cont'd)

Driving Technique

D₄-4th

Use the D₄ range for normal in-town and highway driving. The car will start off in 1st and shift automatically to 2nd, 3rd, and 4th. The further down you push the accelerator, the later the transmission will shift and the faster the car will accelerate.

D₃-3rd

Use of D₃ will allow the transmission to start off in 1st and shift automatically to 2nd and 3rd. Use D₃ when climbing grades to prevent the transmission from "hunting" between 3rd and 4th gear; or when increased braking is needed.

NOTE:

If rapid acceleration is necessary, depress the accelerator to the floor; the transmission will automatically shift down according to load and engine speed. This applies to both D₄ and D₃ ranges.

2-2nd

Use 2nd gear for increased engine braking when driving downhill, and increased power when driving uphill; also for driving on slippery roads, and freeing the car from mud or sand, where 1st gear could provide too much power and cause skidding or wheelspin. The maximum recommended speed in 2nd gear is:
62 mph (100 km/h)

R-Reverse

CAUTION:

Shift into or out of reverse only after the car has come to a complete stop; the transmission may be damaged if you shift while the car is moving.

P-Park

CAUTION:

Use this position when starting the engine, or when parking. Shift into Park only when the car is COMPLETELY stopped.

N-Neutral

Use when starting the engine or during prolonged idling in traffic.

Maintenance Schedule and Records

Your Honda automobile must be properly maintained to ensure that it is in peak operating condition and the emission levels are within the standards set by the Federal Clean Air Act.

The following instructions and maintenance procedures are based on the assumption that your car will be used exclusively for the purpose for which it was designed:

1. To carry passengers and cargo within the load limits shown on the label in the glove box.
2. To be driven on reasonable road surfaces within legal limits.
3. To generally be driven daily over a distance of several miles.
4. Use gasoline from pumps labeled unleaded, with a pump octane number of 86 or higher. The pump octane number is an average of the Research (R) octane and Motor (M) octane numbers.

NOTE:

Failures which occur due to a lack of maintenance will not be covered under warranty.

The Required Maintenance Schedule* specifies all maintenance required to keep your car in peak operating condition. Work should be done by a Honda dealer but may be done by any qualified service facility or individual who is competent in this type of work.

Maintenance, replacement, or repair of emission control devices and systems may be done by any automotive repair establishment or individual using parts that are "certified" to EPA standards.

After the maintenance has been done, be sure to complete the Maintenance Records on pages 71 — 73. All required maintenance is considered normal owner operating cost and you will be charged for it by your dealer.

- * For vehicles sold in California, maintenance operations indicated by *3 on page 70 are recommended by the manufacturer. Other maintenance operations are required by California regulations and condition the emission warranty.

Check the following items at each fuel stop:

1. Engine oil level.
2. Radiator coolant level.

Check the following items periodically:

1. Brakes: for braking efficiency, brake pedal travel and hydraulic fluid level.
2. Lights: for operation of headlights, taillights, side marker lights, stoplights, turn signals and back-up lights.
3. Tires: for correct pressures (including spare); inspect for cuts and uneven or excessive wear. Rotate every 7,500 miles (12,000 km) in the pattern shown on page 97.
4. Steering: for excessive play or vibration while driving.
5. Exhaust system: for leaks or loose mounts.
6. Wipers: for operation of windshield wipers and washer, and condition of wiper blades.
7. Seat belts: for condition of fabric and buckles, and operation of the restraint mechanism.
8. Battery condition.
9. Clutch adjustment (clutch pedal free travel).

(cont'd)

Maintenance Schedule and Records (cont'd)

| | | | | | | | |
|---|--|--|----------------|----|----|----------------|-----|
| Service at the interval listed x 1,000 miles (or km) or after that number of months, whichever comes first. | R- Replace | *1 Tension adjustment only. | | | | | |
| | C- Clean | *2 Thereafter, replace every 2 years or 30,000 miles (48,000 km), whichever comes first. | | | | | |
| | I- Inspect | *3 For cars sold in California, this service is recommended only; for other areas, it is required. | | | | | |
| | After inspection, clean, adjust, repair or replace if necessary. | *4 For cars with automatic transmission, sold in California. | | | | | |
| | x1,000 miles | 15 | 30 | 45 | 60 | 75 | 90 |
| | x1,000 km | 24 | 48 | 72 | 96 | 120 | 144 |
| | months | 12 | 24 | 36 | 48 | 60 | 72 |
| Idle speed and idle CO | | | | | I | | |
| Valve clearance | | I | I | I | I | I | I |
| Alternator drive belt | | | I ¹ | | I | | |
| Timing belt | | | | | | | R |
| Water pump | | | | | | | I |
| ♦ Engine oil and oil filter ♦ | Replace every 7,500 miles (12,000 km) or 6 months. | | | | | | |
| Transmission oil | | | R | | R | | R |
| Radiator coolant ♦ | | | | R | | R ² | |
| Cooling system hoses and connections E.G.R.system ⁴ | | | I | | I | | I |
| Air cleaner element | | | R | | R | | R |
| Fuel filter and hoses | | | | | R | | |
| Fuel line connections | | | I ³ | | I | | I |
| Evaporative emission control system | | | | | I | | |
| Ignition timing and control system | | | | | I | | |
| Spark plugs | | | R | | R | | R |
| Distributor cap and rotor | | | | | I | | |
| Ignition wiring | | | | | I | | |
| Positive crankcase ventilation valve | | | | | I | | |
| Brake hoses and lines | | I | I | I | I | I | I |
| Brake fluid | | | R | | R | | R |
| ♦ Front brake discs and calipers | | I | I | I | I | I | I |
| Front brake pads | Inspect every 7,500 miles (12,000 km) or 6 months. | | | | | | |
| Rear brake drums, wheel cylinders and linings | | | I | | I | | I |
| Parking brake | | I | I | | I | | I |
| ♦ Clutch release arm travel | Inspect every 7,500 miles (12,000 km) or 6 months. | | | | | | |
| Exhaust pipe and muffler | | I | I | I | I | I | I |
| Suspension mounting bolts | | I | I | I | I | I | I |
| Front wheel alignment | | I | I | I | I | I | I |
| Steering operation, tie rod ends, steering gear box and boots | | I | I | | I | | I |
| ♦ Power steering system (if equipped) | | I | I | I | I | I | I |
| Power steering pump belt (if equipped) | | | I ¹ | | I | | I |
| Catalytic converter heat shield | | | | | I | | |

♦ Check oil and coolant level at each fuel stop.

♦ Under severe driving conditions, service these items twice as often. (See page 72)

Required Maintenance Record

- Have your servicing dealer record all Required Maintenance below.
- Keep receipts for all work done on your car.

| | | |
|--------------------------------------|-----------------|---------|
| 7,500 MI. 12,000 km (or 6 Mo.) | (Sign or Stamp) | Mileage |
| | | Date |
| 15,000 MI. 24,000 km (or 12 Mo.) | (Sign or Stamp) | Mileage |
| | | Date |
| 22,500 MI. 36,000 km (or 18 Mo.) | (Sign or Stamp) | Mileage |
| | | Date |
| 30,000 MI. 48,000 km (or 24 Mo.) | (Sign or Stamp) | Mileage |
| | | Date |
| 37,500 MI. 60,000 km (or 30 Mo.) | (Sign or Stamp) | Mileage |
| | | Date |
| 45,000 MI. 72,000 km (or 36 Mo.) | (Sign or Stamp) | Mileage |
| | | Date |
| 52,500 MI. 84,000 km (or 42 Mo.) | (Sign or Stamp) | Mileage |
| | | Date |
| 60,000 MI. 96,000 km (or 48 Mo.) | (Sign or Stamp) | Mileage |
| | | Date |
| 67,500 MI. 108,000 km (or 54 Mo.) | (Sign or Stamp) | Mileage |
| | | Date |
| 75,000 MI. 120,000 km (or 60 Mo.) | (Sign or Stamp) | Mileage |
| | | Date |
| 82,500 MI. 132,000 km (or 66 Mo.) | (Sign or Stamp) | Mileage |
| | | Date |
| 90,000 MI. 144,000 km (or 72 Mo.) | (Sign or Stamp) | Mileage |
| | | Date |

(cont'd)

Maintenance Schedule and Records (cont'd)

Severe Driving Conditions

CAUTION:

The following items must be serviced more frequently on cars normally used under severe driving conditions. Refer to the chart below for the appropriate maintenance intervals.

Severe driving conditions include:

- A: Repeated short distance driving
- B: Driving in dusty conditions
- C: Driving in severe cold weather
- D: Driving in areas using road salt or other corrosive materials
- E: Driving on rough and/or muddy roads

| Condition | Maintenance item | Maintenance operation | Interval |
|-----------|--------------------------------|-----------------------|---|
| A B . . . | Engine oil and oil filter | R | Every 3,750 miles (6,000 km) or 3 months |
| A B . D E | Front brake discs and calipers | I | Every 7,500 miles (12,000 km) or 6 months |
| A B C . E | Clutch release arm travel | I | Every 3,750 miles (6,000 km) or 3 months |
| . B C . E | Power steering system | I | Every 7,500 miles (12,000 km) or 6 months |

R- Replace

I - Inspect

After inspection, clean, adjust, repair or replace if necessary.

Non-Scheduled Maintenance Record

Record additional maintenance for severe driving conditions or non-scheduled maintenance on this page. (See page 70)

| | | |
|-------------------------------|-----------------|---------|
| Maintenance Performed: | (Sign or Stamp) | Mileage |
| | | Date |
| Maintenance Performed: | (Sign or Stamp) | Mileage |
| | | Date |
| Maintenance Performed: | (Sign or Stamp) | Mileage |
| | | Date |
| Maintenance Performed: | (Sign or Stamp) | Mileage |
| | | Date |
| Maintenance Performed: | (Sign or Stamp) | Mileage |
| | | Date |

| | | |
|-------------------------------|-----------------|---------|
| Maintenance Performed: | (Sign or Stamp) | Mileage |
| | | Date |
| Maintenance Performed: | (Sign or Stamp) | Mileage |
| | | Date |
| Maintenance Performed: | (Sign or Stamp) | Mileage |
| | | Date |
| Maintenance Performed: | (Sign or Stamp) | Mileage |
| | | Date |
| Maintenance Performed: | (Sign or Stamp) | Mileage |
| | | Date |
| Maintenance Performed: | (Sign or Stamp) | Mileage |
| | | Date |
| Maintenance Performed: | (Sign or Stamp) | Mileage |
| | | Date |
| Maintenance Performed: | (Sign or Stamp) | Mileage |
| | | Date |
| Maintenance Performed: | (Sign or Stamp) | Mileage |
| | | Date |
| Maintenance Performed: | (Sign or Stamp) | Mileage |
| | | Date |
| Maintenance Performed: | (Sign or Stamp) | Mileage |
| | | Date |
| Maintenance Performed: | (Sign or Stamp) | Mileage |
| | | Date |
| Maintenance Performed: | (Sign or Stamp) | Mileage |
| | | Date |
| Maintenance Performed: | (Sign or Stamp) | Mileage |
| | | Date |

Fluid Locations

AUTOMATIC TRANSMISSION
FLUID DIPSTICK

ENGINE OIL
FILLER CAP

POWER STEERING
FLUID RESERVOIR

BRAKE FLUID
RESERVOIR

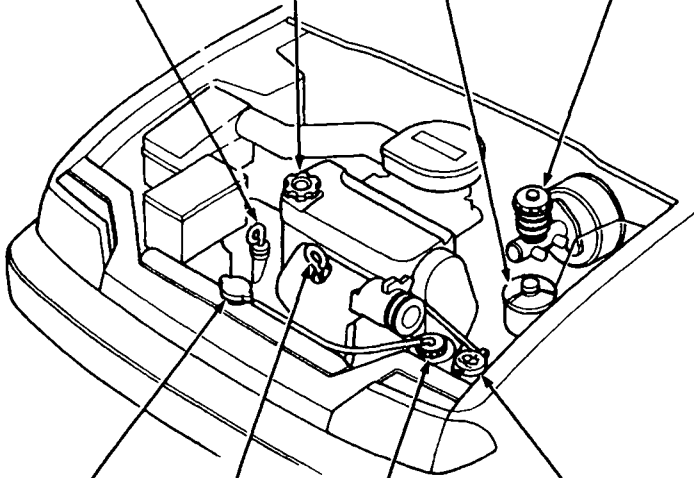

RADIATOR
CAP

ENGINE OIL
DIPSTICK

WASHER FLUID
RESERVOIR CAP

RADIATOR RESERVE
TANK CAP

Engine Oil and Filter

Checking

Check the engine oil a couple of minutes after shutting the engine off, with the car parked on level ground. Remove the dipstick and wipe it clean. Re-insert it all the way down, then pull it out and read the level. The level should be between the upper and lower marks.

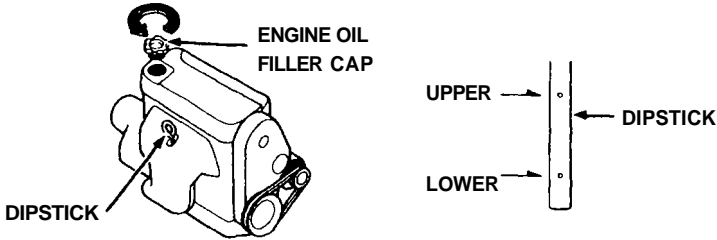

Adding

If the level has dropped close to the lower mark, add oil until it is even with the upper mark.

1. Turn the oil filler cap counterclockwise to remove. Add oil, then check the level again. Do not overfill.
2. Reinstall the cap and twist clockwise until it stops.

CAUTION:

- Be sure the oil filler cap is correctly replaced before starting the engine.
- Engine oil is a major factor affecting the performance and service life of the engine, you should use only a premium quality detergent oil labeled SG grade.

Some oil labels may also include additional designations of quality such as CC or CD. However, these are acceptable only when used together with SG.

LOOK FOR THIS LABEL ON THE OIL CONTAINER

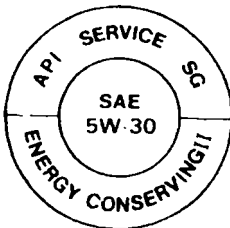

Use the proper viscosity oil for the climate in which you drive:

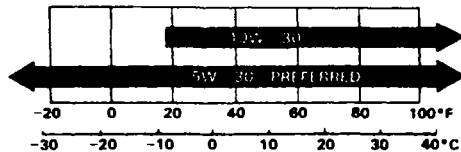

Ambient Temperature

NOTE:

5W-30 viscosity oil is recommended for improved fuel economy.

(cont'd)

Engine Oil and Filter (cont'd)

Fuel Efficient Oil

For the best fuel economy from your car, it is recommended that you use a fuel efficient SG grade oil. This oil is usually identified by the words such as: "Energy Conserving II," "Gas Saving," and "Fuel Saving," etc.

Changing Oil and Filter

Engine oil and filter should be changed together every 6 months or 7,500 miles (12,000 km), whichever comes first. The filter is located on the engine block, below the intake manifold. A special "cap type" oil filter wrench is required (available from your Honda dealer). Use only a genuine Honda filter or its equivalent.

CAUTION:

The oil filter cannot easily be removed from above the engine. For this reason it is recommended that the oil filter change be done by a skilled mechanic.

1. Start the car to warm up the engine, then shut it off.
2. Remove the engine oil filler cap and drain bolt, and drain the oil.

▲ WARNING

A warmed-up engine and the oil in it are hot; be careful not to burn yourself.

3. Remove the oil filter and let the remaining oil drain out.
4. Install a new filter according to the instructions on or with the filter.
5. Reinstall the drain bolt with a new washer and tighten it securely. Refill the engine with the recommended oil, to the upper mark on the dipstick.

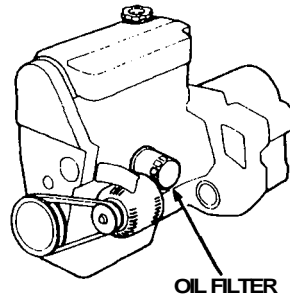
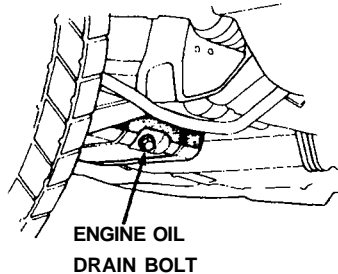

ENGINE OIL CAPACITY (including filter):
3.5 ℓ (3.7 US qt, 3.1 Imp qt)

6. Reinstall the filler cap securely.
7. Start the engine and make sure oil is not leaking from the drain bolt or the filter.
8. Shut off the engine and recheck the oil level.

NOTE:

Please dispose of used motor oil in a manner that is compatible with the environment. We suggest you take it in a sealed container to your local service station for reclamation. Do not throw it in the trash or pour it on the ground.

CAUTION:

Used motor oil may cause skin cancer if repeatedly left in contact with the skin for prolonged periods. Although this is unlikely unless you handle used oil on a daily basis, it is still advisable to thoroughly wash your hands with soap and water as soon as possible after handling used oil.

Transmission Oil/Fluid Check

Transmission oil/fluid must be checked with the engine off and the car on level ground.

⚠ WARNING

If the engine has been running, some engine components may be hot enough to burn you.

CAUTION:

If the oil/fluid level is low, check for possible leaks before adding oil. Do not overfill.

Since the transmission and differential are in the same housing, you are actually checking both oil/fluid levels in one procedure. Change transmission oil/fluid according to the Maintenance Schedule on page 70.

Manual

Remove the oil filler bolt (beside the right axle). Feel inside the bolt hole with your finger. If the oil is up to the bottom edge of the hole, the oil level is correct. If it is not, slowly add oil until it runs out of the hole, then reinstall the bolt and tighten it securely with a wrench.

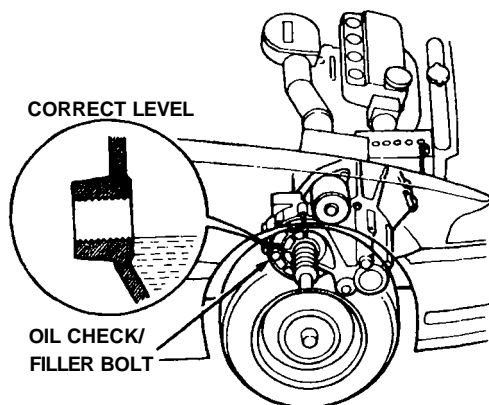

MANUAL TRANSMISSION

OIL CHANGE CAPACITY: 1.8 ℓ (1.9 US qt, 1.6 Imp qt)

Use only SF or SG grade motor oil when adding or changing transmission oil.

Use the proper viscosity oil for the climate in which you drive:

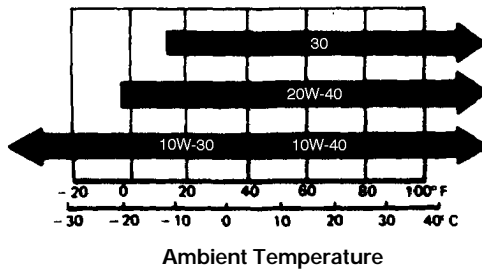

Automatic

The automatic transmission fluid level is checked (with the engine off and the car on level ground) using the dipstick on the passenger side of the transmission housing. Remove the dipstick and wipe it

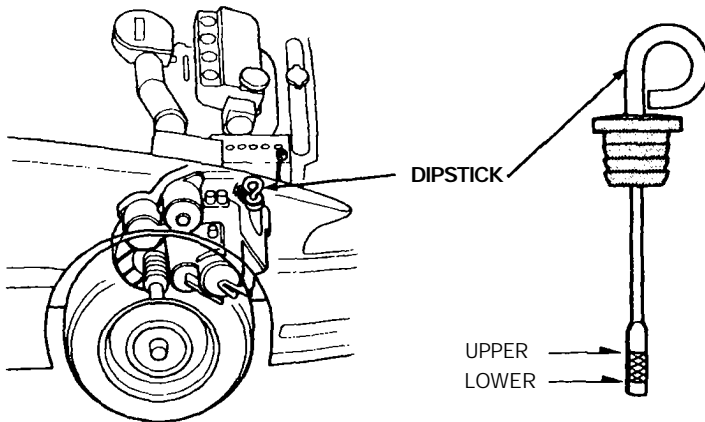

Insert the dipstick and remove it. The fluid level should be between the upper and lower marks.

If necessary, add fluid and recheck. Use only DEXRON® II Automatic Transmission Fluid (A.T.F.) when adding or changing fluid. After checking the fluid level, push the dipstick in securely

AUTOMATIC TRANSMISSION

FLUID CHANGE CAPACITY: 2.4 **l** (2.5 US qt, 2.1 Imp qt)

Cooling System

The engine in your Honda contains a number of aluminum parts. Therefore, it requires an antifreeze/coolant specifically formulated to protect the aluminum parts from corrosion. Failure to use a suitable antifreeze/coolant may seriously shorten the life of the engine as the result of rapid corrosion damage. Some antifreeze/coolants, although labelled for use in engines containing aluminum, may not provide adequate protection for your engine.

Therefore, use only a Honda **RECOMMENDED** antifreeze/coolant. CHECK WITH YOUR AUTHORIZED HONDA DEALER.

For best corrosion protection, the mixture of coolant and water must be maintained year-round at 50/50. Concentrations less than 50% coolant may not provide sufficient protection against corrosion and freezing. Concentrations of greater than 60% coolant will impair cooling efficiency and are not recommended. Low-mineral drinking water or distilled water should be mixed with the antifreeze/coolant. Coolant loss should be replenished by a mixture containing the proper concentration of antifreeze and water. Do not mix different antifreeze/coolants.

Do not use additional rust inhibitors or anti-rust products, as they may not be compatible with the radiator coolant.

ENGINE DAMAGE CAUSED BY IMPROPER COOLANT USAGE IS NOT COVERED BY THE NEW CAR WARRANTY.

Checking Coolant

Check the coolant level in the reserve tank when the engine is at normal operating temperature.

WARNING

Do not remove the radiator cap when the engine is hot; the coolant is under pressure and could severely scald you.

- If the level is below the MAX mark, but still visible, add a 50/50 solution of antifreeze and water to bring it up to MAX.
- If there is no coolant in the reserve tank, the cooling system should be checked for leaks and repaired if necessary. Coolant must then be added to the radiator.

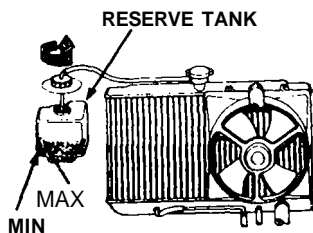

CAUTION:

Radiator coolant will damage paint. Quickly rinse any spilled coolant from painted surfaces.

Wait until the engine is cool, then turn the radiator cap counterclockwise until it stops. **DO NOT PRESS DOWN WHILE TURNING THE CAP.** After any remaining pressure has been relieved, remove the cap by pressing down and again turning it counterclockwise. Add enough coolant to fill the radiator, and reinstall the cap. Be sure to tighten it securely. Fill the reserve tank up to the MAX mark with the engine cold.

Maintenance

1. Check the freeze protection level of the coolant with a hydrometer.
2. Keep the front of the radiator free of dirt and debris.
3. Check hoses and hose clamps regularly.

Replacing Coolant

Replace coolant at 36 months or 45,000 miles (72,000 km), whichever comes first. Thereafter, replace every 2 years or 30,000 miles (48,000 km), whichever comes first.

RADIATOR COOLANT

REFILL CAPACITY:

| | |
|--------------------------|------------------------------------|
| (excluding reserve tank) | 0.4 ℓ (0.11 US gal, 0.09 Imp gal) |
| Manual transmission | 4.0 ℓ (1.06 US gal, 0.88 Imp gal) |
| | 4.1 ℓ (1.08 US gal, 0.90 Imp gal)* |
| Automatic transmission | 4.0 ℓ (1.06 US gal, 0.88 Imp gal)* |
| | 4.5 ℓ (1.19 US gal, 0.99 Imp gal) |

* : DX Hatchback and DX/LX Sedan

(cont'd)

Cooling System (cont'd)

1. Set the heater temperature control dial to maximum heat.
2. Remove the radiator cap, splash shield and drain plug when the radiator is cool, and drain the radiator.

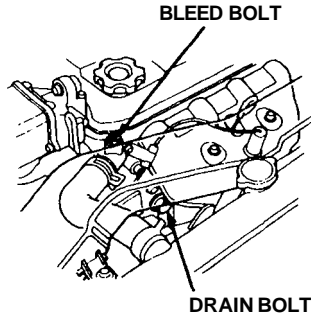
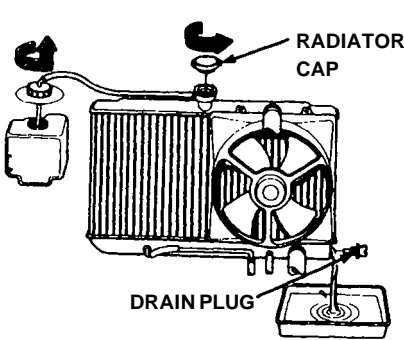

3. Remove the drain bolt from the front side of the cylinder block, and drain the engine and heater.
4. Apply non-hardening sealant to the drain bolt threads, then reinstall the bolt and tighten it securely.
5. Tighten the radiator drain plug securely.
6. Mix the recommended antifreeze with an equal amount of low-mineral or distilled water and fill the reservoir to maximum, as illustrated.

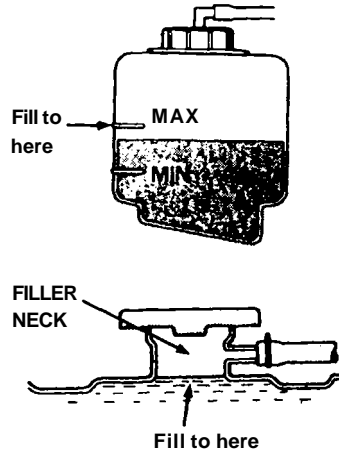

7. Loosen the air bleed bolt in the thermostat housing, then fill the radiator to the filler neck with the coolant mixture. Tighten the bleed bolt as soon as coolant starts to run out in a steady stream without bubbles.
8. With the radiator cap off, start the engine and let it run until warmed up (fan goes on at least twice). Then, if necessary, add more coolant mix to bring the level back up to the filler neck.
9. Put the radiator cap on, then run the engine again and check for leaks.

Brake System Design

The diagonally-separated dual service brake system is designed so half the system will still provide braking action if the other half fails.

Stopping the car after losing the brake fluid from half the system will

require more pedal pressure and pedal travel than normal. Also, the distance required to stop will be longer using only half the brake system. If the brakes fail suddenly, downshift to a lower gear for increased engine braking, and pull off the road as soon as possible.

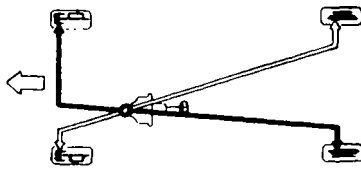

▲ WARNING

- It is dangerous to drive your car with a problem in either the brake electrical or hydraulic system; have your dealer check both systems if you suspect brake trouble.
- Driving through deep water may affect the brakes. Check their effectiveness by pressing the brake pedal gently. If the car does not slow down at the normal rate, continue gently applying the brakes, while maintaining a safe speed, until they dry out and normal performance returns.
- Do not ride the brakes. In other words, don't put your foot on the brake pedal unless you intend to brake. This causes excessive brake wear and can damage, or lead to loss of braking effectiveness through overheating. Your brake lights may also confuse drivers behind you.

Brake Wear

Both front and rear brakes should be inspected for wear at the intervals shown in the Maintenance Schedule on page 70.

When the brakes require maintenance, use only genuine Honda replacement parts or their equivalent.

(cont'd)

Brakes (cont'd)

Front Brake Wear Indicators

Your car is equipped with audible front brake wear indicators. When the brake pads wear to point that they should be replaced, they will make a "screeching" sound when the wheels are rolling and when the brakes are applied.

NOTE:

Due to some driving habits or climates, brakes may "squeal" when you first apply them or when you have them partially applied; this is normal, and does not indicate excessive wear. The wear indicator makes a "screeching" sound while the brakes are applied.

Brake Fluid

Check the fluid level in the brake reservoir periodically; it should be between the MAX and MIN marks on the reservoir.

If the level is near the MIN mark, add fluid to raise it to the MAX mark. Do not overfill. Use only brake fluid manufactured to DOT 3 or DOT 4 specifications (see reservoir cap) from a sealed container. Follow the manufacturer's instructions printed on the can.

NOTE:

A low brake fluid level may be an indication of brake pad wear or of brake fluid leakage. You should have your brakes checked if the brake fluid level in the reservoir is low before re-filling it.

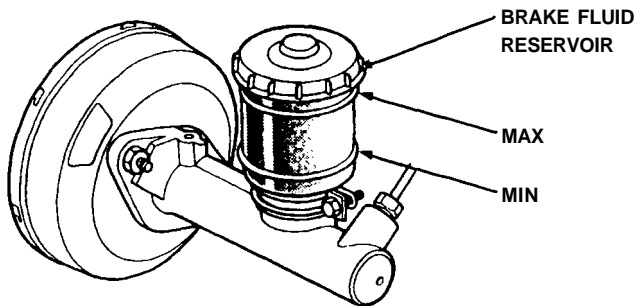

CAUTION:

The arrow on the reservoir cap must be pointing forward after the cap is installed. Make sure the brake warning switch wiring doesn't get caught between the cap and top edge of the reservoir.

Power Steering

The Sedan (except DX with manual transmission) and DX Hatchback with automatic transmission are equipped with power steering. The power steering on your car provides easy handling while parking and maneuvering in traffic, without loss of road "feel" at highway speeds. An engine-driven hydraulic pump provides full power assist at low speeds and decreasing assist as the car goes faster.

CAUTION:

If the power steering system should fail, or if the engine should stall, the car can still be steered. However, much greater effort will be required, particularly in sharp turns at low speed.

NOTE:

You may feel a slight clunk or knock when turning the wheel with the engine off. This is a normal condition due to the design of the system.

Power Steering Fluid

Check the power steering fluid level with the engine cold and the car parked on level ground. Make sure the fluid level is between the upper and lower marks on the reservoir. If the level has dropped close to or below the lower mark, check for leaks before adding fluid to the upper mark. Do not overfill.

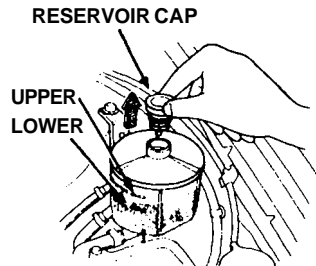

CAUTION:

Use only genuine Honda power steering fluid. The use of other fluids such as A.T.F. or other manufacturer's power steering fluid will damage the system.

Air and Fuel Filters

Air Filter

Replace the air filter every 24 months or 30,000 miles (48,000 km), whichever comes first (more often in extremely dusty conditions).

Replacement

Remove the four screws holding the air filter cover halves together. Remove the top half of the air filter cover. Replace the filter. Reinstall the cover and screws securely.

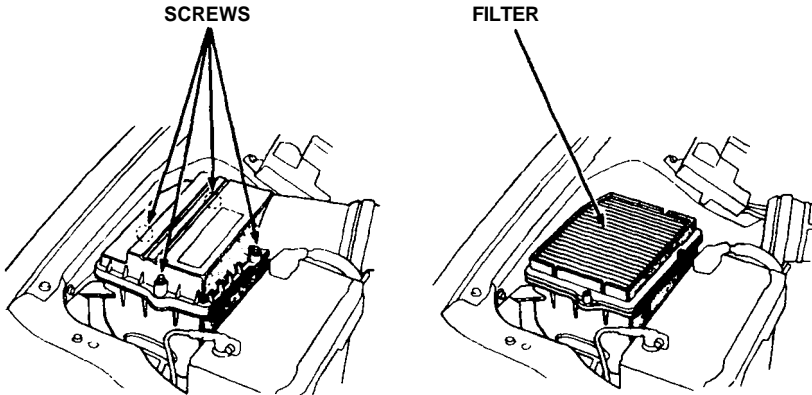

Fuel Filters

The fuel filter is located in the engine compartment, on the right center of the lower dashboard. It should be replaced at 60,000 miles (96,000 km) or 48 months whichever comes first, or any time you suspect contaminated gas may have clogged it.

CAUTION:

Because the fuel system is under pressure, the filter should be replaced only by a qualified Honda technician.

Spark Plugs

Spark plugs should be replaced every 24 months or 30,000 miles (48,000 km), whichever comes first.

Recommended spark plugs:

| | |
|---|--|
| For all normal driving | BCPR6E—11 (NGK) BCPR6EY—N11 (NGK) Q20PR—U11 (ND) RC9YCN4 (CHAMPION) |
| For hot climates or continuous high speed driving | BCPR7E—11 (NGK) BCPR7EY—N11 (NGK) Q22PR—U11 (ND) |

CAUTION:

Never use spark plugs with an improper heat range; they will adversely affect engine performance and durability.

Spark Plug Replacement

Replace plugs one at a time, so you don't get the wires mixed up.

1. Clean any dirt from around the spark plug base.
2. Disconnect the plug cap, then remove and discard the old plug.
3. Check the gap of the new spark plug before installation.

Plug gap should be:

- 1.1 mm (0.04 in)
4. Thread the new spark plug in by hand to prevent cross-threading.
5. After the plug seats against the cylinder head, tighten 1/2 turn with a spark plug wrench to compress the washer.
6. Reinstall the spark plug cap.

CAUTION:

The spark plugs must be securely tightened, but not overtightened. A plug that's too loose can get very hot and possibly damage the engine; one that's too tight could damage the threads in the cylinder head.

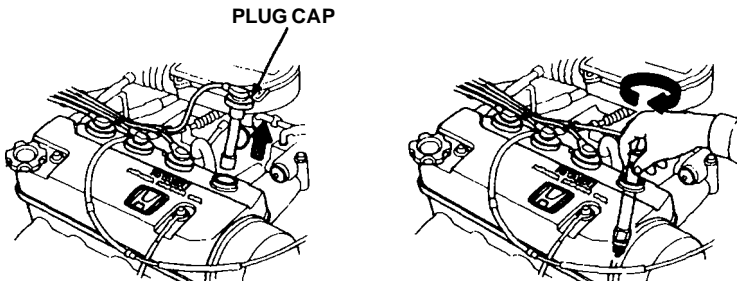

Wiper Blades

For maximum visibility, replace worn or cracked wiper blades when you notice they do not wipe the windshield cleanly or smoothly.

To Replace Worn-out Blades

1. Detach the blade assembly from the arm by pressing the lock tab in, then pushing the blade toward the base of the arm.

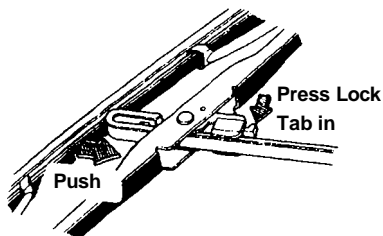

2. Firmly grasp the end of the blade rubber and pull until the tabs are free of the metal support.

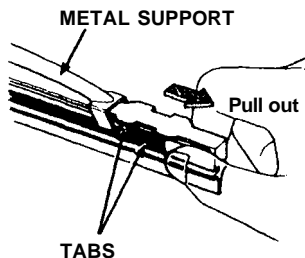

3. Remove the metal retainers from the worn-out blade rubber and put them in a new blade rubber.

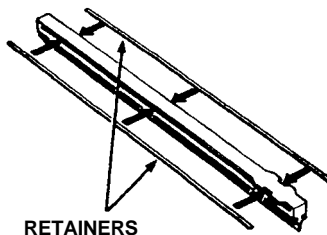

4. Insert the new blade rubber from the opposite side of the blade tabs and position the tabs in the metal support.

Battery

The condition of the battery can be determined by checking the test indicator. Service as required according to the label on the battery.

Any corrosion around the positive and negative terminals should be washed off with a solution of baking soda and warm water. Dry the terminals and then coat them with grease.

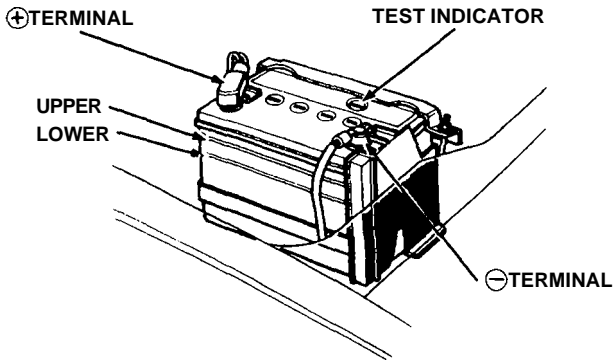

▲ WARNING

- The battery gives off explosive gases; keep sparks, flames and cigarettes away. Provide adequate ventilation when charging or using the battery in an enclosed space.
- The battery contains sulfuric acid (electrolyte). Contact with skin or eyes may cause severe burns. Wear protective clothing and a face shield.
 - If electrolyte gets on your skin, flush with water.
 - If electrolyte gets in your eyes, flush with water for at least 15 minutes and call a physician immediately.
- Electrolyte is poisonous.
 - If swallowed, drink large quantities of water or milk and follow with milk of magnesia or vegetable oil and get immediate medical assistance.

KEEP OUT OF REACH OF CHILDREN.

Fuse Replacement

The fuse box is located under the dashboard on the driver's side. The circuits protected by each fuse are listed inside the box.

Hatchback

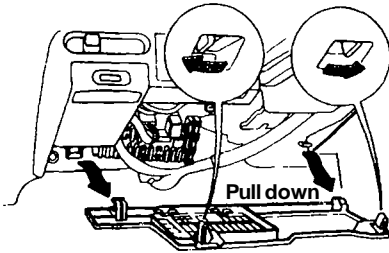

Sedan

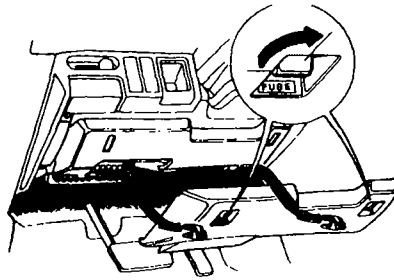

(Sedan)

The fuses for automatic shoulder belt buckle motor are installed on the ⊕ terminal of the battery.

If any of your car's lights, accessories, or controls don't work, check their fuses. If a fuse has blown, the wire inside it will be burned through.

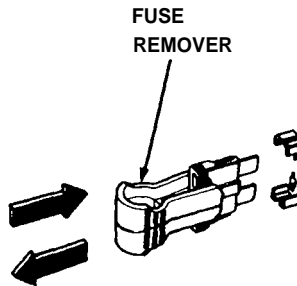
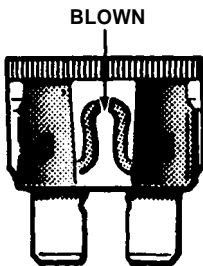

Checking the fuses:

1. Turn off the ignition and all other switches.
2. If you find a blown or possibly faulty fuse, use the fuse remover, stored beside the spare fuse to pull the blown fuse out of its clips.
3. Check all other fuses as well as the one you suspect.
4. Push in a new fuse of the same rating, and make sure it fits tightly in the clips. If it fits loosely, have your dealer fix it.
If you don't have a spare, take a fuse of the same rating (or lower) out of a circuit you may not need, like the radio or cigarette lighter. Remember to replace the borrowed fuse and the missing spares.

CAUTION:

A blown fuse may be just a symptom of some other problem. If a new fuse blows right away, the cause should be diagnosed and corrected by a qualified Honda technician. Never replace a fuse with anything but another fuse of the same or lower rating. A higher capacity fuse could cause damage and even start a fire.

The main fuse and some primary fuses are installed on the right front fender beside the battery.

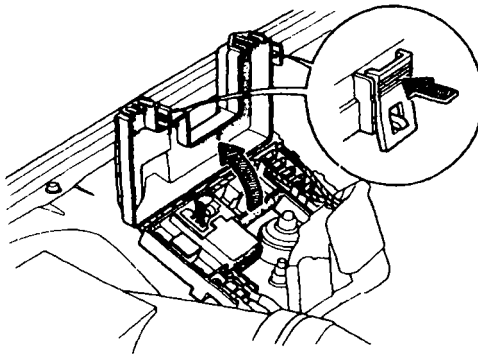

If the circuits from the battery are ever overloaded (by a short in the system drawing too much current for example) the main or a primary fuse will blow, preventing damage to the entire wiring harness. If the main fuse blows, have a Honda dealer check the system, repair the cause, and replace the fuse.

CAUTION:

- The electrical system is protected by fuses that are designed to fail and prevent damage to the wire harness. Always replace blown fuses with the same rating as specified to prevent wiring damage that can result in a possible fire.
- For proper electrical contact after replacing these fuses, make sure all screws are tight.

Bulb Replacement

NOTE:

See pages [117](#) and [120](#) for bulb specifications.

Front turn signal lights

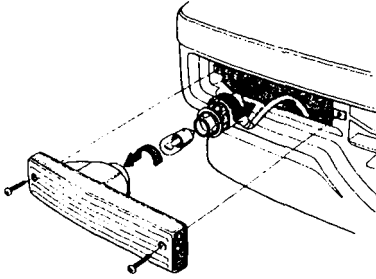

Front side marker and turn signal lights/position lights

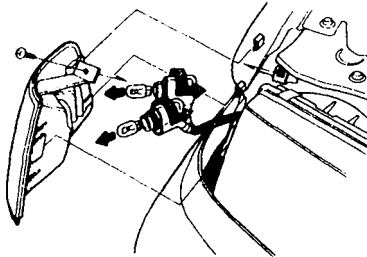

License plate lights

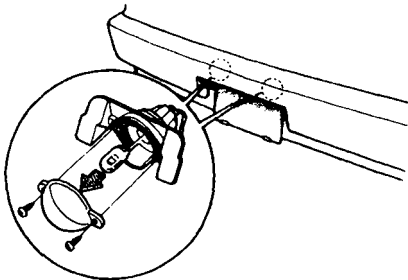

Back-up lights (Sedan)

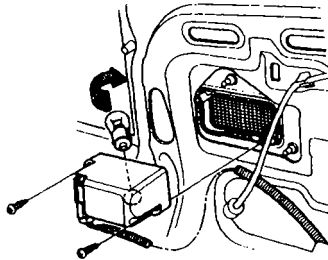

Rear side marker, turn signal, brake/taillights and back-up lights
(Back-up lights: Hatchback only)

(Hatchback)

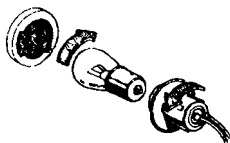
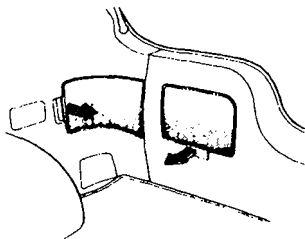

Interior light

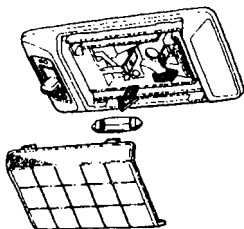

High-mount brake light

(Hatchback)

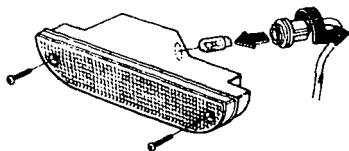

(Sedan)

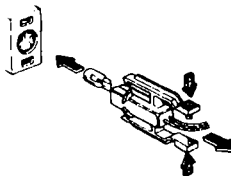
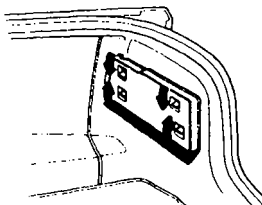

Luggage area light
(except for STD Hatchback)

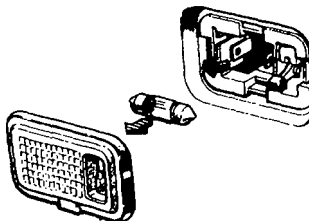

(Sedan)

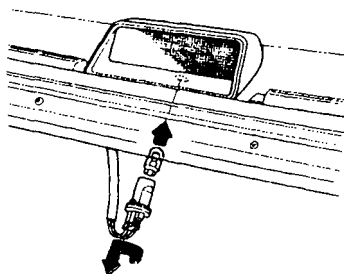

Tires

The factory installed tires on your car were selected to match the car's performance capabilities and to provide the best combination of handling, ride comfort and tread wear.

We recommend that you get the same size, type, and grade of tires when replacement is necessary. If your tires have an all-season tread design, the model name will be followed by the marking: "M + S" (mud and snow) or "all-season".

If you decide not to get the same brand of tires as those originally installed, you should make sure that the replacements are the radial type, of the same size, load range and speed rating as the original tires.

If you have any questions about your car's tires, please contact your Honda dealer.

Inflation Pressures

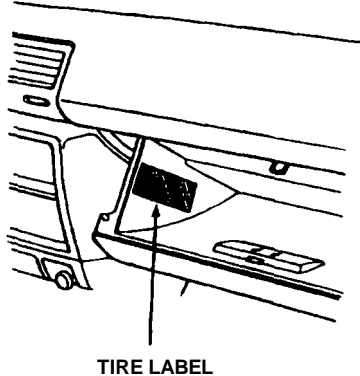

The tire label in the glove box lists recommended tire pressures for carrying loads up to the limit shown. (Tire pressures are also listed on the back cover of this manual.)

These pressures were chosen to provide you with the best combination of tread life, riding comfort and stability under normal driving conditions.

Improper inflation can reduce both tire life and load carrying capacity. Check the tire pressures at least once a month, including the spare.

Lower pressure than recommended lets the tread and side walls flex too much, causing increased tire temperatures, uneven wear, and poor handling. Pressure higher than recommended can make the tire too stiff, increasing the chance of damage from road hazards, and also causing uneven wear.

CAUTION:

- **Check tire pressure when the tires are cold.**
(After the car has been parked for more than 3 hours or driven less than 1 mile/1.6 km.)
- **Tire pressure may increase as much as 41 kPa (6 psi) when the tire is hot, so NEVER ADJUST tire pressure when the tires are hot.**
- **Never inflate load range B tires to more than 220 kPa (32 psi) cold.**
- **Cars with luggage racks or cartop carriers DO NOT have greater load limits than those on the label.**

Winter Driving

Tires marked "M + S" or "all season" have an all-weather tread design and should be suitable for most driving conditions. However, snow tires and tire chains may be required under some conditions. If your tires do not have these markings, they may not be suitable for winter driving conditions. We recommend snow tires or tire chains for snow and icy conditions.

Snow Tires

If you use snow tires, they should be of the same size, construction and load capacity as the original tires on your car. Snow tires must be installed in sets of four, or they may cause poor handling. Driving with snow tires on dry roads can reduce your car's performance during acceleration, turning and stopping.

If you need further information on snow tires, please contact your Honda dealer.

Tire Chains

Use chains only when you have to. Check with local authorities or Provinces for requirements prior to installing tire chains. Make sure the chains are the right size for your tires. Install them only on the drive wheels of your car, and do so as tightly as possible, following the manufacturer's instructions. If metal chains are used, they must be SAE Class "S." Cable type traction devices can also be used.

Drive slowly with chains installed. If you hear the chains contacting your car's body or chassis, stop and tighten them.

(cont'd)

Tires (cont'd)

CAUTION:

- If the contact continues, slow down until it stops or your car can be damaged.
- Chains that are the wrong size or improperly installed can damage your car's brake lines, suspension, body, and wheels.

If you need further information on tire chains, please see your Honda dealer.

Remove the chains as soon as the road is clear of ice and snow.

Tire Replacement

Honda recommends that you replace tires in sets of four, or in pairs, front or rear. If you need to replace only one tire, mount the new tire opposite the tire showing the least amount of wear.

For instance, if the left front tire shows the least amount of wear, mount the new tire on the front right side.

The original tires on your car have tread wear indicators to indicate when they should be replaced. The indicators appear as bands about 12.7 mm (1/2 in) wide when the tire tread depth is less than 1.6mm (1/16 in). When indicators appear across two or more grooves in a row, you should replace the tire.

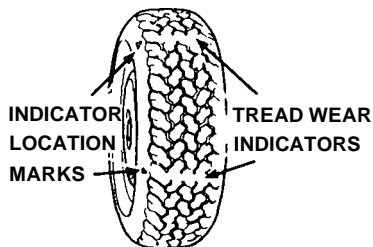

▲ WARNING

Driving on worn-out tires is very hazardous, and will reduce braking effectiveness, steering accuracy and traction.

When replacing tires, use only the recommended tire size. Wheel rim widths and offsets must be those recommended by American Honda Motor Co., Inc. Contact the Zone Office nearest you as shown on the inside of the back cover.

▲ WARNING

Tires and wheels other than those recommended may be unsafe. Do not mix radial and bias ply tires on the same car.

Tire Balancing

⚠ WARNING

Unbalanced tires may affect handling and tire wear. A tire should always be rebalanced after it has been dismantled from the wheel.

Your original tires were properly balanced before the car left the factory, but may need rebalancing at some time during the life of the tire. Tire balancing for the COMPACT spare is not necessary.

Tire Rotation

Tires may wear unevenly when used for a long time in the same position on the car. To avoid this, rotate the tires every 7,500 miles (12,000 km). If abnormal or uneven wear develops between rotations, the cause should be found and corrected as soon as possible. The illustration shows how the tires can be rotated. The COMPACT spare tire must not be included in tire rotation.

NOTE:

Front brake pads should be inspected for wear whenever the tires are rotated.

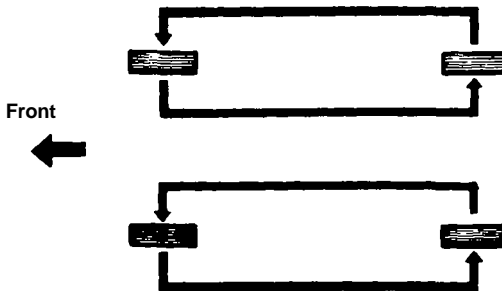

Tire Traction

⚠ WARNING

Worn tires or slippery road surfaces can reduce driving, cornering and braking traction. To reduce the possibility of losing traction, slow down when the road gets slippery, replace tires when wear indicators are visible, and KEEP TIRES PROPERLY INFLATED.

Air Conditioner Care

Condenser and Radiator

Check the engine radiator and the air conditioner condenser (in front of the radiator) for accumulated dirt, insects or leaves. Carefully brush or hose them off to assure maximum cooling performance.

CAUTION:

Radiator and condenser fins are very thin and easily damaged; do not bend them with the high water pressure or brush.

Compressor Drive Belt

Check the compressor belt tension monthly, during periods when you use the air conditioner a lot.

⚠ WARNING

If the engine has been running, some engine components may be hot enough to burn you.

When pushed with 98 N (22 lb) of force midway between the compressor drive pulley and the engine crankshaft pulley, the belt should deflect about:

9.0 — 11.0 mm (0.35 — 0.43 in)

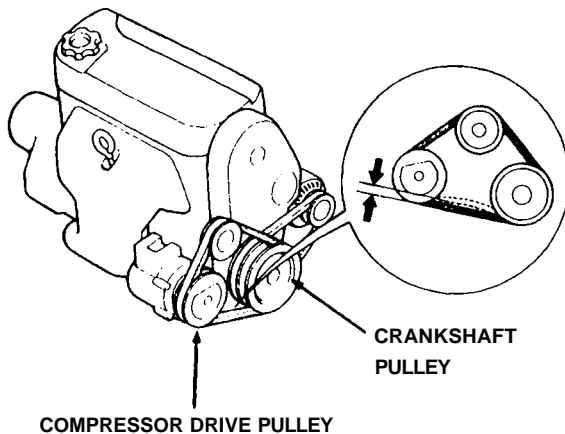

System Maintenance

Run your air conditioner at least once a week for about ten minutes, even during the off season, to lubricate the seals and the inside of the compressor and, to verify that the system is functional.

If the air conditioner is not cooling properly, it may indicate an undercharged system. Have your dealer check the system for leaks, then evacuate and charge the system with refrigerant 12.

Charging quantity:

850 — 950 g (30.1 — 33.6 oz)

CAUTION:

Prolonged use of an undercharged system may damage the compressor.

Appearance Care

Interior Trim

Remove dust and loose dirt with a vacuum cleaner.

Wipe the vinyl with a clean, damp cloth or sponge. Stains can be removed with a commercially available vinyl cleaner.

CAUTION:

Do not use thinner, gasoline, kerosene, naphtha or other solvents on the interior. They are toxic, flammable and hazardous and could damage the material you're cleaning.

Windows

A 10 to 1 mix of water and white vinegar, or a commercially available glass cleaner may be used to clean windows and to remove the dust film sometimes caused by the ingredients used in interior vinyls and plastics.

NOTE:

Do not put this solution in the windshield washer reservoir, it will damage the windshield washer pump.

Be careful not to scratch or damage the defogger wires when cleaning the inside of the rear window; wipe the window horizontally along the wires, not up and down.

Dry the windows with a lint-free cloth or paper towel. Keep all the windows clean for maximum visibility.

Exterior Care

Washing

Rinse all loose dirt off the car by spraying it with lukewarm or cold water. Do not use hot water.

Wash using a soft-bristle brush, sponge or cloth with water containing a mild detergent such as a liquid dishwashing detergent.

Remove oil, tar, tree sap, etc., with tar remover or turpentine. Remove road salt, insects, etc., with mild detergent and lukewarm water. Any of these substances may damage the finish if left on painted surfaces.

Rinse the car well. Promptly wipe with a chamois or soft towel to prevent water-spotting. Do not let water or soap air-dry on painted surfaces.

During wiping, inspect the surface for stone chips and scratches; paint them with touch-up paint so they won't rust (touch-up paint is available through your Honda dealer).

For further instructions on corrosion protection, refer to the Rust Prevention section on following page.

Waxing

Wax the car when water will no longer "bead" on the paint.

Always wash and dry the car before you wax it.

Use a good quality liquid or paste wax, and follow the manufacturer's instructions. Wax all the metal trim to keep its luster.

NOTE:

Removing oil, tar, etc., with a spot remover will usually strip the wax from the surrounding finish. Be sure to re-wax these areas even if the rest of the car does not yet need waxing.

Rust Prevention

Rusting is likely to occur in parts of the car where water is trapped or where there is continual dampness.

- Water will collect inside doors and body panels if drain holes become clogged.
- Water which seeps under or soaks floor mats will subject floor sections to prolonged wetness or dampness.
- Road dirt or sand, which collects and fills recesses on the underside of the car, retains moisture long after the rest of the car has dried.

The removal of paint and undercoating by stones, gravel, and minor accidents immediately exposes metal to air and moisture.

Rusting is increased by high humidity and by the presence of corrosive substances in the air or on the roads.

- Salt used for road de-icing will coat the bottom of the car and hasten rusting.
- Localities with high humidity have greater potential for rust problems, especially where salt is also present on the road or in moist sea air.
- Industrial pollution will accelerate the deterioration of paint finishes and promote rusting.

(cont'd)

Appearance Care (cont'd)

Preventive Service

Check all drain holes in the doors and body panels for clogging and clear if necessary. When washing your car, also clean the underside of the car by using high pressure water; ① above subframe, ② inside front fender, ③ rear suspension, ④ inside rear wheel housing, and ⑤ under rear bumper.

After washing your car or after heavy rain, check for leaks. While checking for leaks, lift the floor mats in the passenger, cargo and spare tire areas, and check beneath them. Water can collect in these areas and remain unseen for prolonged periods. Dry any wet areas of your car's interior. Remove and dry wet floor mats. Have leaks repaired as soon as possible.

After driving your car, wipe off any road dirt or salt on the radio antenna, with it fully extended.

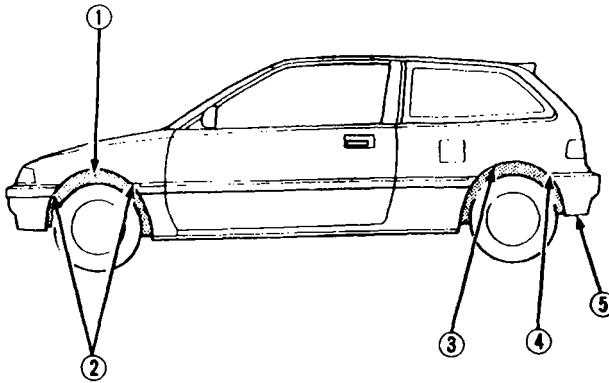

Replacement Body and Fender Parts

If your vehicle incurs body damage and requires replacement parts, we encourage you to use only Genuine Honda sheet metal body and fender parts. Many insurance companies are specifying imitation sheet metal parts for collision repairs in an effort to reduce claim costs; however, if imitation parts are used the following conditions may apply:

- There is no assurance that imitation parts will equal the fit and finish of Genuine Honda sheet metal parts; and in our experience they often do not.
- There is no assurance that imitation parts will resist corrosion as well as Genuine Honda sheet metal parts.
- Imitation sheet metal parts are not covered by the Honda Limited Warranty.

To ensure your continued satisfaction with your Honda vehicle in the event of an accident, contact your insurance adjuster and insist on Genuine Honda parts in the repair of your vehicle.

Spare Tire

COMPACT Spare Tire

Your car is supplied with a COMPACT spare tire and wheel for temporary use only in the event of a flat tire. Use the COMPACT spare only when you have to, and only to go as far as the next garage or dealer to have the regular tire repaired and reinstalled.

Because you will rarely use the COMPACT spare, be sure to regularly check its condition and air pressure (415 kPa, 60 psi), so it will be ready when you need it. This type of tire holds less air at higher pressure than a regular tire, so it will inflate (or deflate if there is a leak) more rapidly; check its pressure often and add air gradually if it needs any.

▲ WARNING

- The COMPACT spare tire has a different tire size, air pressure requirement, tread life and maximum speed rating than the four regular tires on your car. Disregarding these warnings may result in tire failure, loss of vehicle control and possible injury to vehicle occupants.
- Do not exceed 50 mph (80 km/h) under any circumstances when using the COMPACT spare.
- Do not mount snow chains on the COMPACT spare. They will not fit properly and will damage the tire and possibly your car. If you must use the COMPACT spare when driving on roads covered with snow or ice, use it as one of the rear tires and mount chains only on the front two regular tires.

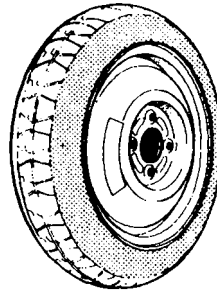

- The COMPACT spare tire has a much shorter tread life than regular tires. Replace the tire as soon as tread wear indicators appear as solid bands across the tread. Replace with a tire of exactly the same size and construction.

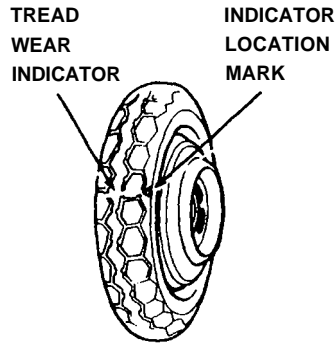

- The COMPACT spare tire and wheel set was designed especially for your car; do not use it on any other vehicle; do not install any other tire on this wheel which is not identical to the original in size and construction, and do not use the COMPACT spare tire on any other wheel.
- Because the COMPACT spare is smaller in size and higher in air pressure than a regular tire, it will ride more harshly with less ground clearance and may have less traction on some road surfaces. Drive cautiously.

Changing a Flat Tire

▲ WARNING

Do not attempt to change a tire unless the car is on firm, level ground and well out of the flow of traffic.

Park the car on a firm, level surface, apply the parking brake, turn on the hazard warning switch and put the transmission in gear (Park for automatic).

1. Remove the jack, lug wrench/jack handle and jack handle extension (in the tool bag) from the location shown.

NOTE:

To remove the jack, release its tension against the mount by turning the screw counterclockwise.

Hatchback

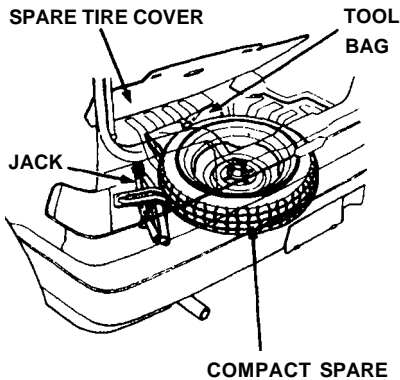

Sedan

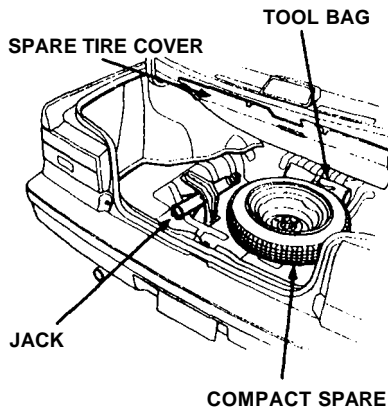

2. Remove the spare tire.
3. Place blocks in front and back of the wheel diagonally opposite the tire you are changing.
4. Use the lug wrench/jack handle to loosen the wheel lug nuts counterclockwise one-half turn.

▲ WARNING

Follow tire changing preparations and procedures carefully to reduce the possibility of injury. The jack is designed for changing tires only. **STAND CLEAR, DO NOT** get under the car and **DO NOT** run the engine when the car is supported only by the jack.

5. Place the jack under the jack point nearest the wheel you are removing; align the jack head so the car frame will fit in the recess as you raise the jack.

⚠ WARNING

To reduce the possibility of injury, be sure to use the jack provided with the car and the correct jacking points; never use any other part of the car for jack support.

6. Set the jack handle extension in the connector on the end of the jack and install the lug wrench/jack handle. Turn the lug wrench/jack handle clockwise until the tire is slightly off the ground.

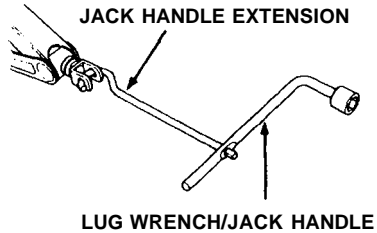
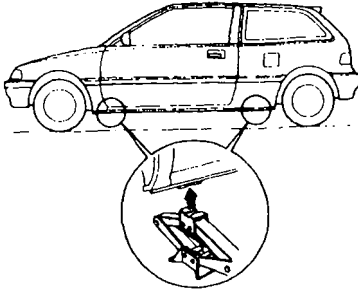

7. Remove the center cap by turning the lock to 90°.
(Center cap: EX Sedan)

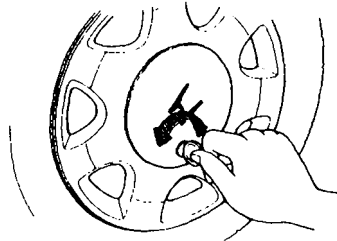

8. Remove the lug nuts, wheel cover and wheel.
(Wheel cover: Si/DX Hatchback and LX/EX Sedan)

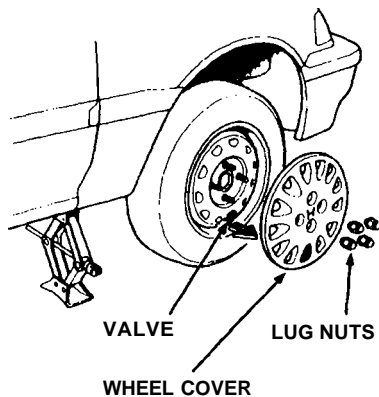

(cont'd)

Changing a Flat Tire (cont'd)

9. Everytime you install the wheel on the brake hub, use a rag to wipe any dirt off the mounting surface of the hub and the wheel. This will assure a tight, even contact between the wheel and hub.

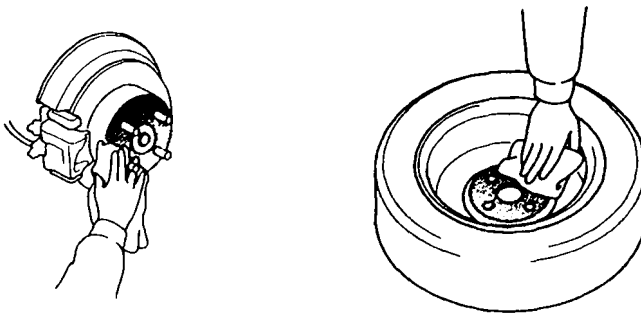

10. Install the spare, and lug nuts hand tight.

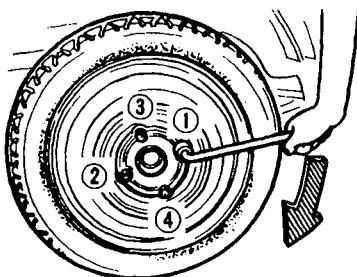

TIGHTENING TORQUE

110 N.m(11 kg-m,80 lb-ft)

11. Lower the car, remove the jack, then tighten the lug nuts securely in an "X" pattern as shown.
12. Tighten the lug nuts to the recommended torque is:
110 N.m (11 kg-m,80 lb-ft)
If a torque wrench was not used, ask an authorized Honda dealer to verify the torque as soon as possible.

13. Repair or replace the damaged tire as soon as you can, reinstall it in its original position, then put the spare back in the car.

CAUTION:

Always stow the jack, tools and tire securely to prevent them from becoming dangerous projectiles in an accident.

14. Secure the tire and the spacer as shown in the illustration.

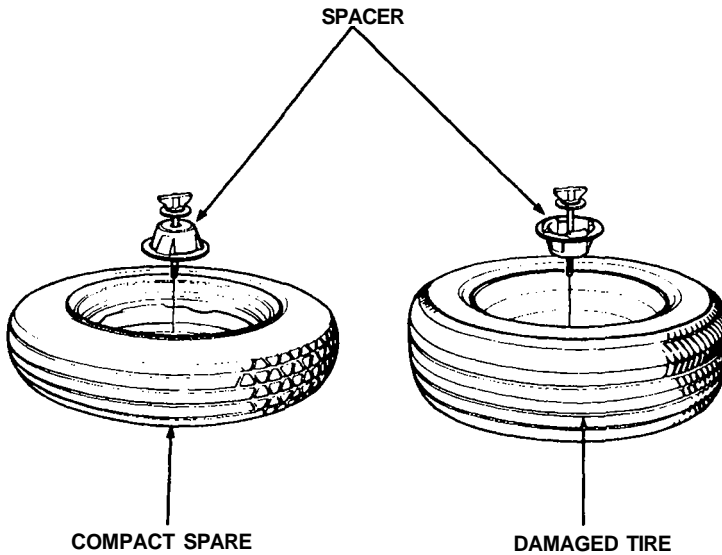

Jump Starting

To start a car with a dead battery, use another battery of the same voltage, and the proper jumper cables.

⚠️ WARNING

- Procedures other than those below could cause injury or damage from battery acid spray, explosion or charging system overload.
- Never connect the jumper cable directly to the negative post of the "dead" battery.
- Never allow the two cars to touch each other.
- Never allow the jumper cable clamps to touch each other.
- Never lean over the battery when making connections.
- Never attempt to jump start a vehicle with a frozen battery. The battery could rupture and explode. If you suspect a frozen battery, remove the vent caps and check the fluid. If there seems to be no fluid, or if you see ice, do not attempt a jump start until the fluid thaws.

CAUTION:

If jumper cables are connected backwards, the car's main fuse may blow.

1. Turn off all lights, heater and other electrical loads, set parking brake, and shift the transmission to Neutral or Park.
2. Use one cable to connect the positive terminal of the booster battery to the positive terminal of the "dead" battery.
3. Use the other cable to connect the negative terminal of the booster battery to the engine at the ground cable as shown.
4. To remove the cables, reverse the above procedures exactly.

⚠️ WARNING

DO NOT push or tow a car to start it. The forward surge when the engine starts could cause a collision. Also, under some conditions, the catalytic converter could be damaged. A car equipped with an automatic transmission cannot be started by pushing or towing.

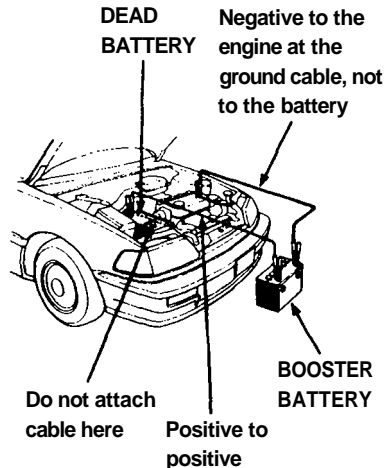

If towing is necessary, contact a professional towing service. Your authorized Honda dealer can assist you with detailed towing instructions.

WARNING

Never use tow chains or rope to tow a car; your ability to safely control the car may be adversely affected.

We recommend the following:

Flat Bed Equipment—Entire car is winched on a flat bed vehicle. This is the best way of transporting your Honda.

Wheel Lift Type—Tow with the front wheels off the ground.

If the car can only be towed with the front wheels on the ground: make sure the transmission is full of fluid (see pages 78 — 79) and tow with the transmission in neutral (N) and the ignition key in the 1 position.

CAUTION:

To avoid serious damage on automatic transmission cars, first start the engine and shift to D4, then to N and shut the engine off. If the engine does not run or the transmission cannot be shifted while the engine is running, the car must be transported on flat bed equipment.

Check local regulations for towing.

CAUTION:

- Do not exceed 35 mph (55 km/h) or tow for distances of more than 50 miles (80 km).
- If a sling type tow is used, the tow truck driver should position wood spacer blocks between your car's frame and the chains and lift straps to avoid damaging the bumper and the body.
- Do not use the bumpers to lift the car or to support the car's weight while towing.

If Your Car Gets Stuck

If your car gets stuck in sand, mud, or snow, call a professional towing service for assistance in getting your car out.

CAUTION:

- **Do not rev up the engine and allow the wheels to spin freely at high speed. Severe transmission damage may result if the wheels are allowed to spin for more than a few seconds.**
- **DO NOT try to free a car with automatic transmission from snow, etc. by rocking the car alternately between forward and reverse gears. Severe transmission damage may result from shifting into gear with the wheels moving.**

Shoulder Belt Buckle (Sedan)

Proceed as follows if the shoulder belt buckle stalls.

1. Lift the hood and remove the cover from the fuse case (for the automatic shoulder belt buckle motor) located on the battery's ⊕ terminal.
2. Remove the fuse for the automatic ("passive") shoulder belt buckle motor that does not work.

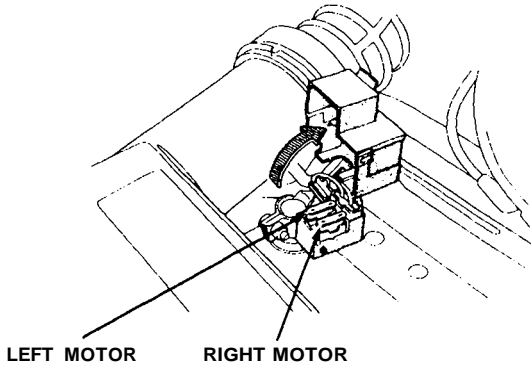

3. If the fuse has blown, replacing it with a new fuse of the same amperage should allow the shoulder belt buckle motor to work. However, if the fuse hasn't blown, or if a new fuse did not solve the problem, remove the fuse and operate the motor manually.

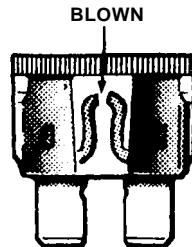

CAUTION:

Always remove the fuse before manually operating the shoulder belt buckle motor, otherwise the motor may suddenly activate.

(cont'd)

Shoulder Belt Buckle (cont'd) (Sedan)

4. Remove the cover located on the center pillar.

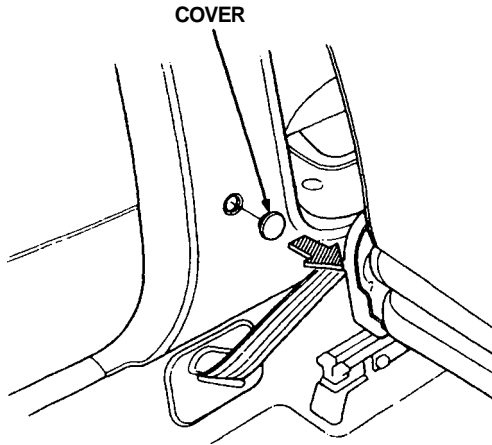

5. Set the wrench extension into the wrench grip (both provided in the tool bag) then insert the wrench into the socket and turn it counterclockwise until the shoulder belt buckle reaches its rear locked position.

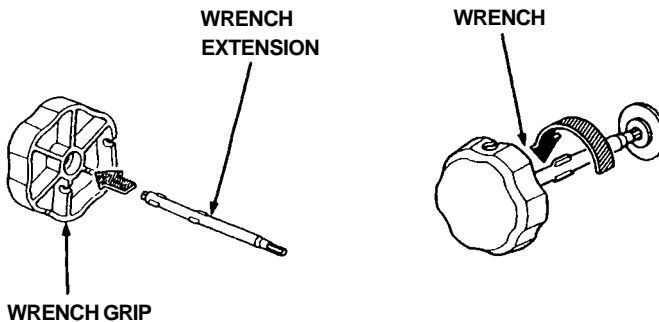

NOTE:

After the manual operation, make sure that the seat belt warning light is off and the shoulder belt buckle is seated properly in its locked position.

6. Replace the cover on the center pillar.
7. Reinstall the fuse, the fuse remover and both fuse box covers.

Specifications(Hatchback)

| Dimensions | | STD | DX | Si |
|-------------------|-------|---------------------|----------------|----------------|
| | | HATCH- BACK | HATCH- BACK | HATCH- BACK |
| Length | | 3,991 mm (157.1 in) | | |
| Width | | 1,685 mm (66.3 in) | | |
| Height | | 1,333 mm (52.5 in) | | |
| Wheelbase | | 2,500 mm (98.4 in) | | |
| Track | Front | 1,450 mm (57.1 in) | | |
| | Rear | 1,456 mm (57.3 in) | | |

Weights

| | |
|-----------------------------|---|
| Gross vehicle weight rating | See the certification plate attached to the driver's door jamb. |
|-----------------------------|---|

Capacities

| Fuel tank | | 45 ℓ (11.9 US gal , 9.9 Imp gal) | | | |
|-----------------------------------|--------------------------------|----------------------------------|------------------------------------|------------------------------------|------------------------------------|
| Radiator coolant | Manual transmission | Change*1 | 4.0 ℓ (1.06 US gal , 0.88 Imp gal) | 4.1 ℓ (1.08 US gal , 0.90 Imp gal) | 4.0 ℓ (1.06 US gal , 0.88 Imp gal) |
| | | Total | 5.0 ℓ (1.32 US gal , 1.10 Imp gal) | 5.1 ℓ (1.35 US gal , 1.12 Imp gal) | 5.0 ℓ (1.32 US gal , 1.10 Imp gal) |
| Automatic transmission | Automatic transmission | Change*1 | / | 4.0 ℓ (1.06 US gal , 0.88 Imp gal) | / |
| | | Total | / | 5.0 ℓ (1.32 US gal , 1.10 Imp gal) | / |
| Engine Oil | Change*2 | 3.5 ℓ (3.7 US qt , 3.1 Imp qt) | | | |
| | | 4.0 ℓ (4.2 US qt , 3.5 Imp qt) | | | |
| Manual transmission oil | Change | 1.8 ℓ (1.9 US qt , 1.6 Imp qt) | | | |
| | | 1.9 ℓ (2.0 US qt , 1.7 Imp qt) | | | |
| Automatic transmission fluid | Change | 2.4 ℓ (2.5 US qt , 2.1 Imp qt) | | | |
| | | 5.4 ℓ (5.7 US qt , 4.8 Imp qt) | | | |
| Windshield washer fluid reservoir | 2.5 ℓ (2.6 US qt , 2.2 Imp qt) | | | | |

*1 Excluding the coolant in the reserve tank and that remaining in the engine:
0.4 ℓ (0.11 US gal, 0.09 Imp gal)

*2 Excluding the oil remaining in the engine but including that remaining in the oil filter.

(cont'd)

Specifications (cont'd) (Hatchback)

| | STD HATCH- BACK | DX HATCH- BACK | Si HATCH- BACK |
|-------------------|---|----------------------|---------------------------------------|
| Engine | | | |
| Type | Water cooled, 4-stroke OHC gasoline engine | | |
| Bore x Stroke | 75.0×84.5 mm (2.952×3.326 in) | | 75.0×90.0 mm (2.952×3.543 in) |
| Displacement | 1,493 cm ³ (91.1 cu-in) | | 1,590 cm ³ (97.0 cu-in) |
| Compression ratio | 9.2 | | 9.1 |
| Spark plug | See spark plug maintenance section page 87. | | |

Tires

| | |
|---------------|---|
| Size/Pressure | See the tire label attached to the inside of the glove box. |
|---------------|---|

Alignment

| | | |
|--------|-------|------------------|
| Toe-in | Front | 0 mm (0.0 in) |
| | Rear | 2.0 mm (0.08 in) |
| Camber | Front | 0° |
| | Rear | -0° 26' |
| Caster | Front | 2° 59' |

Battery

| | |
|----------|------------|
| Capacity | 12V - 47AH |
|----------|------------|

Fuses

| | |
|------------------|---|
| In the fuse box | See the fuse label attached to the inside of the fuse compartment door under the dashboard. |
| In the relay box | See the fuse label attached to the relay box cover under the hood. |

| Lights | | STD | DX | Si |
|--------------------------|-------|----------------|-------------------------|----------------|
| | | HATCH- BACK | HATCH- BACK | HATCH- BACK |
| Headlights | | | 12V — 65/55W | |
| Front turn signal lights | | | 12V — 45CP (SAE 3497) | |
| Rear turn signal lights | | | 12V — 32CP (SAE 1156) | |
| Stop/Taillights | | | 12V — 32/2CP (SAE 2057) | |
| Side marker lights | Front | | 12V — 5W | |
| | Rear | | 12V — 3CP (SAE 168) | |
| Back-up lights | | | 12V — 32/2CP (SAE 2057) | |
| License plate lights | | | 12V — 8W | |
| Interior light | | | 12V — 5W | |
| Luggage area light | | | 12V — 3.4W | |
| High-mount brake lamp | | | 12V — 21CP | |

Specifications (Sedan)

| Dimensions | | DX | LX | EX |
|------------|-------|---------------------|-------|-------|
| | | SEDAN | SEDAN | SEDAN |
| Length | | 4,288 mm (168.8 in) | | |
| Width | | 1,695 mm (66.7 in) | | |
| Height | | 1,360 mm (53.5 in) | | |
| Wheelbase | | 2,500 mm (98.4 in) | | |
| Track | Front | 1,450 mm (57.1 in) | | |
| | Rear | 1,456 mm (57.3 in) | | |

Weights

| | |
|-----------------------------|--|
| Gross vehicle weight rating | See the certification plate attached to the left rear door jamb. |
|-----------------------------|--|

Capacities

| Fuel tank | | 45 ℓ (11.9 US gal , 9.9 Imp gal) | | |
|-----------------------------------|----------------------|------------------------------------|------------------------------------|------------------------------------|
| Radiator coolant | Change* ¹ | 4.1 ℓ (1.08 US gal , 0.90 Imp gal) | 4.1 ℓ (1.08 US gal , 0.90 Imp gal) | 4.0 ℓ (1.06 US gal , 0.88 Imp gal) |
| | | Total | 5.1 ℓ (1.35 US gal , 1.12 Imp gal) | 5.1 ℓ (1.35 US gal , 1.12 Imp gal) |
| Automatic transmission | Change* ¹ | 4.0 ℓ (1.06 US gal , 0.88 Imp gal) | 4.0 ℓ (1.06 US gal , 0.88 Imp gal) | 4.5 ℓ (1.19 US gal , 0.99 Imp gal) |
| | | Total | 5.0 ℓ (1.32 US gal , 1.10 Imp gal) | 5.0 ℓ (1.32 US gal , 1.10 Imp gal) |
| Engine Oil | Change* ² | 3.5 ℓ (3.7 US qt , 3.1 Imp qt) | | |
| | Total | 4.0 ℓ (4.2 US qt , 3.5 Imp qt) | | |
| Manual transmission oil | Change | 1.8 ℓ (1.9 US qt , 1.6 Imp qt) | | |
| | Total | 1.9 ℓ (2.0 US qt , 1.7 Imp qt) | | |
| Automatic transmission fluid | Change | 2.4 ℓ (2.5 US qt , 2.1 Imp qt) | | |
| | Total | 5.4 ℓ (5.7 US qt , 4.8 Imp qt) | | |
| Windshield washer fluid reservoir | | 2.5 ℓ (2.6 US qt , 2.2 Imp qt) | | |

*1 Excluding the coolant in the reserve tank and that remaining in the engine:
0.4 ℓ (0.11 US gal, 0.09 Imp gal)

*2 Excluding the oil remaining in the engine but including that remaining in the oil filter.

| Engine | DX | LX | EX |
|-------------------|---|-------|---------------------------------------|
| | SEDAN | SEDAN | SEDAN |
| Type | Water cooled, 4-stroke OHC gasoline engine | | |
| Bore x Stroke | 75.0×84.5 mm (2.952×3.326 in) | | 75.0×90.0 mm (2.952×3.543 in) |
| Displacement | 1,493 cm ³ (91.1 cu-in) | | 1,690 cm ³ (97.0 cu-in) |
| Compression ratio | 9.2 | | 9.1 |
| Spark plug | See spark plug maintenance section page 87. | | |

Tires

| | |
|---------------|---|
| Size/Pressure | See the tire label attached to the inside of the glove box. |
|---------------|---|

Alignment

| | | |
|--------|-------|------------------|
| Toe-in | Front | 0 mm (0.0 in) |
| | Rear | 2.0 mm (0.08 in) |
| Camber | Front | 0° |
| | Rear | -0° 26' |
| Caster | Front | 2° 59' |

Battery

| | |
|----------|------------|
| Capacity | 12V - 47AH |
|----------|------------|

Fuses

| | |
|------------------|---|
| In the fuse box | See the fuse label attached to the inside of the fuse compartment door under the dashboard. |
| In the relay box | See the fuse label attached to the relay box cover under the hood. |

(cont'd)

Specifications (cont'd) (Sedan)

| Lights | | DX | LX | EX |
|--------------------------|------|-------------------------|--------------|--------------|
| | | SEDAN | SEDAN | SEDAN |
| Headlights | | 12V — 65/55W | | |
| Front turn signal lights | | 12V — 45CP (SAE 3497) | | |
| Rear turn signal lights | | 12V — 32CP (SAE 1156) | | |
| Stop/Taillights | | 12V — 32/2CP (SAE 2057) | | |
| Side marker lights | Fron | 12V — 5W | | |
| | Rear | 12V — 3CP (SAE 168) | | |
| Back-up lights | | 12V — 32/2CP (SAE 2057) | | |
| License plate lights | | 12V — 8W | | |
| Interior light | | 12V — 5W | | |
| Luggage area light | | 12V — 3.4W | | |
| High-mount brake lamp | | 12V — 21CP | | |

Identification Numbers

The Vehicle Identification Number (V.I.N.) is stamped on a plate attached to the top left side of the dashboard.

It also appears on the Certification label attached to the door jamb, as well as under the hood on the body, directly behind the engine.

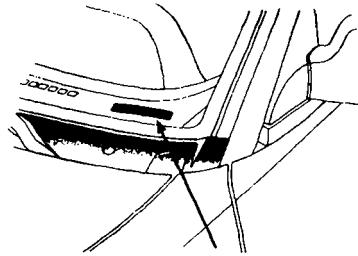

**VEHICLE
IDENTIFICATION
NUMBER**

NOTE:

The V.I.N. is also provided in bar code on the Certification label.

Hatchback

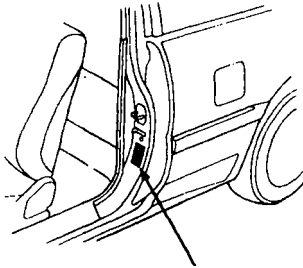

CERTIFICATION LABEL

Sedan

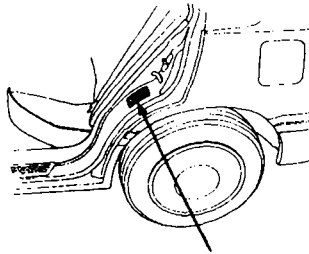

CERTIFICATION LABEL

**AUTOMATIC
TRANSMISSION
NUMBER**

**VEHICLE
IDENTIFICATION
NUMBER**

**MANUAL
TRANSMISSION NUMBER**

ENGINE NUMBER

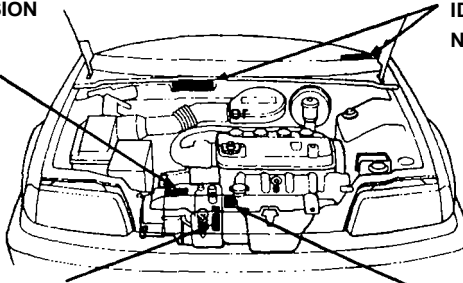

The Engine Number is stamped on the right front side of the engine block.

The Transmission Number appears on a label on the top edge of the transmission where it attaches to the engine.

NOTE:

Do not mistake the transmission number for the engine number.

DOT Tire Quality Grades

The tires on your car meet Federal Safety Requirements. All tires are also "graded" according to Department of Transportation (DOT) standards for tread wear, traction and temperature.

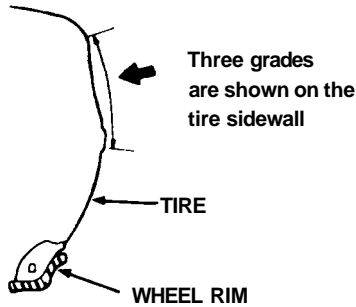

Tread Wear

The tread wear grade is a comparative rating based on the wear rate of the tire when tested under controlled conditions on a specified government test course. For example, a tire graded 150 would wear one and one half (1-1/2) times as well on the government course as a tire graded 100.

The relative performance of tires depends upon the actual conditions of their use, however, and may depart significantly from the norm due to variations in driving habits, service practices and differences in road characteristics and climate.

Traction

The traction grades, from highest to lowest, are A, B, and C, and they represent the tire's ability to stop on wet pavement as measured under controlled conditions on specified government test surfaces of asphalt and concrete. A tire marked C may have poor traction performance.

▲ WARNING

The traction grades assigned are based on braking (straight ahead) traction tests and do not include cornering (turning) traction.

Temperature

The temperature grades are A (the highest), B and C representing the tire's resistance to the generation of heat and its ability to dissipate heat when tested under controlled conditions on a specified indoor laboratory test wheel. Sustained high temperature can cause the material of the tire to degenerate and reduce tire life, and excessive temperature can lead to sudden tire failure. The grade C corresponds to a level of performance which all passenger car tires must meet under the Federal Motor Vehicle Safety Standard No. 109. Grades B and A represent higher levels of performance on the laboratory test wheel than the minimum required by law.

▲ WARNING

The tire temperature grade is established for a tire that is properly inflated and not overloaded. Excessive speed, underinflation, or excessive loading, either separately or in combination, can cause heat buildup and possible tire failure.

Emission Controls

Sources of Emissions

The combustion process produces carbon monoxide, oxides of nitrogen and hydrocarbons. The evaporation of fuel in the fuel tank also produces hydrocarbons. Control of oxides of nitrogen and hydrocarbons is very important since, under certain conditions, when subjected to sunlight, they react to form photochemical smog. Carbon monoxide does not react to form smog, but it is toxic.

Honda Motor Co., Ltd. has developed a number of systems which are highly effective in reducing carbon monoxide, oxides of nitrogen and hydrocarbons.

The Clean Air Act

The Clean Air Act requires all vehicle manufacturers to explain in writing, the operation and maintenance of their emission control systems.

Maintenance instructions are included on pages [68](#) — [73](#) ; the operation of each system is explained on the following.

Replacement Parts

The emission control systems on your new Honda were designed, built and certified to conform with the Federal regulations implementing the Clean Air Act. Honda recommends only the use of new, genuine Honda parts or their equivalent. The use of other replacement parts which are not of equivalent quality may impair the effectiveness of your car's emission control systems.

Crankcase Emission Control System

To prevent crankcase emissions, your car is equipped with a Positive Crankcase Ventilation (PCV) System which routes blowby gases from the crankcase, through the PCV valve and intake manifold, into the combustion chamber.

Evaporative Emission Control System

The Evaporative Emission Control System is designed to prevent fuel vapors from escaping into the atmosphere.

Fuel vapors from the fuel tank are directed into the charcoal canister where they are adsorbed and stored while the engine is stopped or idling. When the coolant temperature rises to a certain value, the vapors are drawn into the engine through the throttle body and the intake manifold during normal engine operation.

Engine Exhaust Emission Controls

The engine exhaust emission control systems are designed to control combustion during idle, acceleration, cruise, and deceleration. These systems are entirely separate from the crankcase and evaporative emission control systems described previously.

- **HONDA PGM-FI System**

The PGM-FI system consists of three independent sub-systems; Air Intake, Electronic Control and Fuel Control, thus allowing more accurate control of air/fuel ratios under all operating conditions. The Electronic Control Unit (ECU) detects the amount of air drawn into the cylinders and determines the amount of fuel to be injected to provide the optimum air/fuel ratio for all engine needs.

- **Ignition Timing Control System**

This system automatically controls the ignition timing to reduce the amount of HC and NO_x.

- **Catalytic Converter
Three Way Catalyst**

The catalyst is used to convert hydrocarbons (HC), carbon monoxide (CO) and oxides of nitrogen (NO_x) in the exhaust gas, to carbon dioxide (CO₂), dinitrogen (N₂) and water vapor.

- **Exhaust Gas Recirculation (EGR)
(California automatic models except EX Sedan)**

The EGR system is designed to control the formation of oxides of nitrogen (NO_x) caused when fuel mixture burns at high temperature. It works by recirculating exhaust gas through the EGR valve and intake manifold into the combustion chambers where it reduces peak temperature by diluting the air/fuel mixture.

Catalytic Converter

A catalytic converter is installed in the exhaust system to help clean-up the harmful exhaust gases that can cause air pollution.

To be effective, the converter must work at high temperature, so don't park your car over dry grass, leaves or anything else that could burn easily.

To stay effective, the converter must not be contaminated by leaded gasoline; use only unleaded gas as explained on page [54](#).

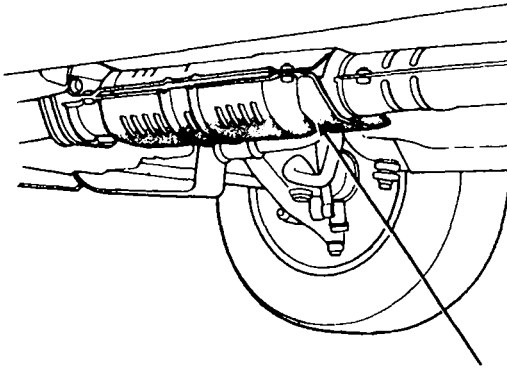

CATALYTIC CONVERTER

CAUTION:

The converter can be overheated and damaged if it's fed too much unburned fuel mixture from the engine, so:

- Don't push or tow the car to start it; if the battery is dead, jump start the car as shown on page [110](#).
- Don't turn the key off while the engine is running above idle speed.
- Don't change the ignition timing, or remove any emission control parts.
- Use only the spark plugs specified in this manual.
- Don't keep driving your car if it isn't running properly, or if its CHARGE warning light comes on; have it checked by your Honda dealer.

Warranty Service

Warranty

The following warranties are provided with every new vehicle.

1. New Car Limited Warranty
2. Emission Control Systems Defects Warranty
3. Emission Performance Warranty
4. Original Equipment Battery Limited Warranty
5. Rust Perforation Limited Warranty
6. Accessory Limited Warranty
7. Replacement Parts Limited Warranty
8. Replacement Muffler Lifetime Limited Warranty
9. Seat Belt Limited Warranty
10. Replacement Battery Limited Warranty

Your car's original tires are covered by their manufacturer. Tire warranty information is in a separate booklet.

All warranty details pertaining to your car can be found in the Warranty booklet provided with your new car except the required maintenance schedule which is contained here in the Owner's Manual.

If you are unable to obtain warranty service or are dissatisfied with the warranty decision or service you received at an authorized Honda dealership, you should review the matter with that dealership's Service Manager. This will normally resolve your problem. If it does not resolve your problem you should appeal the decision with the owner of the dealership. Please bear in mind that your problem will likely be resolved at the dealership, using the dealer's facilities, equipment and personnel. So it is very important that your initial contact be with the dealer or his management.

After following these steps, if you wish to have the matter reviewed by American Honda you should contact the Zone Office serving your area, as shown on the map on the inside of the back cover. When contacting American Honda, please provide the Zone Office with the following information:

- Vehicle Identification Number
- Servicing Dealer Name and Address
- Date of Purchase
- Mileage on your Car
- Your Name, Address, and Phone Number
- Nature of Problem
- Selling Dealer

After a review of the facts, you will be advised of what can be done.

Reporting Safety Defects

If you believe that your vehicle has a defect which could cause a crash or could cause injury or death, you should immediately inform the National Highway Traffic Safety Administration (NHTSA) in addition to notifying American Honda Motor Co., Inc.

If NHTSA receives similar complaints, it may open an investigation, and if it finds that a safety defect exists in a group of vehicles, it may order a recall and remedy campaign.

However, NHTSA cannot become involved in individual problems between you, your dealer, or American Honda Motor Co., Inc.

To contact NHTSA, you may either call the Auto Safety Hotline toll-free at 1-800-424-9393 (or 366-0123 in Washington, D.C. area) or write to:

NHTSA, U.S. Department of Transportation
Washington, D.C. 20590.

You can also obtain other information about motor vehicle safety from the Hotline.

A

| | |
|-------------------------------------|-----|
| Air Conditioner | |
| Operation..... | 47 |
| Service..... | 98 |
| Air Filter..... | 86 |
| Air Pressure, Tires..... | 94 |
| Antifreeze.. See "Radiator Coolant" | |
| Anti-theft Steering Column Lock | |
| System | 57 |
| Appearance Care..... | 100 |
| Ashtrays..... | 44 |
| Automatic Seat Belt..... | 10 |
| Automatic Transmission | |
| Driving Technique..... | 66 |
| Fluid..... | 79 |
| Operation..... | 64 |

B

| | |
|-----------------------------------|-----|
| Battery | |
| Charging System Warning Light | |
| | 30 |
| Jump Starting | 110 |
| Maintenance..... | 89 |
| Specification (Hatchback).... | 116 |
| Specification (Sedan)..... | 119 |
| Beeper System | |
| Fasten Seat Belt Beeper | |
| (Sedan)..... | 11 |
| (Hatchback)..... | 15 |
| Belts, Seat..... See "Seat Belts" | |
| Body Repair..... | 102 |
| Brake Warning Light..... | 31 |
| Brakes | |
| Brake Failure Warning Light.... | 31 |
| Brake Fluid..... | 84 |
| Brake System Design..... | 83 |
| Brake Wear Indicators..... | 84 |
| Parking Brake..... | 42 |
| Parking Brake Warning Light.. | 31 |
| Break-in Period..... | 2 |
| Bulb | |
| Replacement..... | 92 |
| Specification (Hatchback).... | 117 |
| Specification (Sedan)..... | 120 |
| Buzzer..... See "Beeper System" | |

C

| | |
|-----------------------------|-----|
| Capacities (Hatchback)..... | 115 |
|-----------------------------|-----|

| | |
|---------------------------------|-----|
| Capacities (Sedan)..... | 118 |
| Care and Cleaning..... | 99 |
| Catalytic Converter..... | 126 |
| Certification Label..... | 121 |
| Chains, Tires..... | 95 |
| Check Engine Warning Light..... | 31 |
| Child Proof Door Locks..... | 5 |
| Child Restraint System..... | 21 |
| Cigarette Lighter..... | 44 |
| Clock..... | 42 |
| Clutch Pedal Adjustment..... | 61 |
| Compact Spare Tire..... | 104 |
| Coolant Temperature Gauge | 28 |
| Cooling (with A/C)..... | 49 |
| Cooling System..... | 80 |
| Crankcase Emission Control | |
| System..... | 124 |
| Cruise Control | |
| Operation..... | 39 |
| Indicator..... | 31 |

D

| | |
|-----------------------------|----|
| Defogger..... | 34 |
| Defroster..... | 51 |
| Doors | |
| Child Proof Door Locks..... | 5 |
| Locks..... | 3 |
| Power Locks..... | 4 |

E

| | |
|--------------------------------|-----|
| Emergency | |
| Changing a Flat Tire..... | 105 |
| Hazard Warning System | 37 |
| If Your Car Gets Stuck..... | 112 |
| Jump Starting..... | 110 |
| Shoulder Belt Buckle..... | 113 |
| Towing..... | 111 |
| Warning and Indicator Lights.. | 29 |
| Emission Controls..... | 124 |
| Engine | |
| Coolant..... | 80 |
| Coolant Temperature Gauge... | 28 |
| Exhaust Controls..... | 125 |
| Identification Number..... | 121 |
| Oil and Filter..... | 76 |
| OH Pressure Warning Light..... | 30 |
| Specification (Hatchback).... | 116 |

(cont'd)

Index (cont'd)

| | |
|--|-----|
| Specification (Sedan)..... | 119 |
| Engine Exhaust Gas Warning..... | 60 |
| Evaporative Emission Control System..... | 125 |
| Exterior Care..... | 99 |

F

| | |
|-------------------------------------|-----------|
| Filters | |
| Air..... | 86 |
| Engine Oil..... | 76 |
| Fuel..... | 86 |
| Fluid..... | See "Oil" |
| Foreign Countries, Operation in.... | 55 |
| Front Seat Adjustment..... | 6 |
| Fuel | |
| Filler Door and Cap..... | 55 |
| Fitter..... | 86 |
| Gasohol..... | 54 |
| Gasoline | 54 |
| Gauge..... | 28 |
| Requirement..... | 54 |
| Fuse | |
| Checking and Replacing | 91 |
| Specification (Hatchback).... | 116 |
| Specification (Sedan)..... | 119 |

G

| | |
|--------------------------|----------------------------|
| Gasoline..... | See "Fuel" |
| Gas Station Information. | back cover |
| Gauges..... | 28 |
| Glove Box..... | 42 |

H

| | |
|---|----|
| Hatch..... | 5 |
| Hatch/Trunk-open Indicator Light | 31 |
| Hazard Warning System..... | 37 |
| Headlights | |
| Flasher..... | 36 |
| High Beam Indicator..... | 29 |
| High Beam/Low Beam Switch | 36 |
| Switch..... | 36 |
| Headlight High Beam Indicator Light | 29 |
| Head Restraints..... | 7 |
| Heating..... | 50 |

| | |
|--------------------------------|----|
| High Beam Indicator Light..... | 29 |
| Switch..... | 36 |
| Hood Latch..... | 41 |

I

| | |
|---|-----|
| Identification Numbers..... | 121 |
| Ignition | |
| Keys..... | 3 |
| Switch..... | 57 |
| Indicator Lights..... | 29 |
| Inflation Pressures, Tire..... | 94 |
| Instrument Panel..... | 26 |
| Instrument Panel Brightness Control | 37 |
| Interior Light..... | 37 |
| Interior Trim Care | 99 |

J

| | |
|--------------------|-----|
| Jack..... | 106 |
| Jump Starting..... | 110 |

K

| | |
|---------------------------|----|
| Keys | |
| Door Locks..... | 3 |
| Hatch/Trunk Lid Lock..... | 5 |
| Ignition..... | 57 |
| Keys..... | 3 |

L

| | |
|---------------------------------------|------------------------------------|
| Lap/Shoulder Belts | See " Seat Belts " |
| Light | |
| Bulb Replacement..... | 92 |
| Fuse Replacement..... | 90 |
| Operation..... | 36 |
| Warning and Indicator Lights.. | 29 |
| Locks | |
| Anti-theft Steering Column Lock | 57 |
| Child Proof Door Locks | 5 |
| Doors..... | 3 |
| Fuel Filler Door..... | 55 |
| Hatch/Trunk Lid..... | 5 |
| Power Doors..... | 4 |
| Luggage Area Light..... | 38 |
| Luggage Cover..... | 9 |

M

| | |
|--------------------------------|--------------|
| Maintenance | |
| Non-Scheduled Maintenance | |
| Record..... | 72 |
| Scheduled Maintenance | |
| Record..... | 71 |
| Schedule..... | 68 |
| Severe Driving Conditions..... | 72 |
| Manual Transmission | |
| Clutch Pedal Adjustment..... | 61 |
| Maximum Allowable Speeds.. | 63 |
| Oil..... | 78 |
| Recommended Shift Speeds.. | 62 |
| Shifting..... | 61 |
| Meters, Gauges..... | See "Gauges" |
| Mirrors | |
| Power Mirrors..... | 35 |
| Rearview Mirrors..... | 35 |

N

| | |
|------------------------------|-----|
| Numbers, Identification..... | 121 |
|------------------------------|-----|

O

| | |
|-------------------------------------|----|
| Octane Rating, Gasoline. See "Fuel" | |
| Odometer..... | 28 |
| Oil | |
| Engine Oil..... | 75 |
| Fluid Locations..... | 74 |
| Oil Pressure Warning Light.... | 30 |
| Power Steering Fluid..... | 85 |
| Transmission Oil/Fluid..... | 78 |
| Operation In Foreign Countries..... | 55 |

P

| | |
|--------------------------------|-----|
| Panel Brightness Control..... | 37 |
| Parking Brake..... | 42 |
| Passive Belt..... | 10 |
| PGM-FI | |
| System..... | 125 |
| Power | |
| Door Locks..... | 4 |
| Mirrors..... | 35 |
| Steering..... | 85 |
| Windows..... | 43 |
| Pregnant Women..... | 25 |
| Pressures, Tire Inflation..... | 94 |
| Preventive Service..... | 102 |

R

| | |
|---------------------------|----------------------|
| Radiator Coolant..... | 80 |
| Rear Seat..... | 8 |
| Rearview Mirrors..... | 35 |
| Rear Window Defogger..... | 34 |
| Rear Window Wiper..... | 34 |
| Reminder Lights | |
| | See "Warning Lights" |
| Replacement | |
| Air Filter..... | 86 |
| Bulb..... | 92 |
| Engine Oil..... | 76 |
| Fuel Filter..... | 86 |
| Fuse..... | 90 |
| Oil Filter..... | 76 |
| Radiator Coolant..... | 82 |
| Spark Plugs..... | 87 |
| Tire..... | 94 |
| Wiper Blades..... | 88 |
| Rust Prevention..... | 101 |

S

| | |
|---------------------------------|-----|
| Safety Defects, Reporting..... | 128 |
| Safety Items..... | 59 |
| Seats | |
| Adjustment..... | 6 |
| Head Restraints..... | 7 |
| Seat Belt Reminder Light | |
| and Beeper (Sedan)..... | 14 |
| Seat Belt Reminder Light | |
| and Beeper (Hatchback)..... | 17 |
| Seat Belts | |
| Anchor Points (Hatchback).... | 22 |
| Anchor Points (Sedan)..... | 24 |
| Automatic Belt..... | 10 |
| Buckling the Front | |
| Seat Belts (Sedan)..... | 11 |
| Buckling the Front | |
| Seat Belts (Hatchback)..... | 15 |
| Buckling the Rear Seat Belts .. | 19 |
| Child Restraint..... | 21 |
| Cleaning..... | 25 |
| Fasten Seat Belt Reminder Light | |
| and Beeper (Sedan)..... | 14 |
| Fasten Seat Belt Reminder Light | |
| and Beeper (Hatchback)..... | 17 |

(cont'd)

Index (cont'd)

| | |
|--------------------------------|-----|
| Inspection..... | 25 |
| Passive Belt..... | 10 |
| Pregnant Women..... | 25 |
| Rear Center Seat Belt..... | 20 |
| Replacement..... | 25 |
| Shoulder Belt Buckle..... | 113 |
| Seats | |
| Front Seat..... | 6 |
| Head Restraints..... | 7 |
| Rear Seat..... | 8 |
| Shifting | |
| Automatic..... | 64 |
| Manual..... | 61 |
| Spare Tire | |
| Changing a Flat Tire..... | 106 |
| COMPACT Spara Tire..... | 104 |
| Spark Plugs | |
| Replacement..... | 87 |
| Specifications (Hatchback) .. | 116 |
| Specifications (Sedan)..... | 119 |
| Speedometer..... | 28 |
| Starting the Engine..... | 58 |
| Steering | |
| Anti-theft Column Lock | 57 |
| Power Steering..... | 85 |
| Tilt Steering..... | 32 |
| Stuck Car..... | 112 |
| Sunroof..... | 52 |
| If the Sunroof Won't Close.... | 53 |
| Maintenance..... | 53 |
| Operation..... | 52 |
| Sunshade..... | 52 |

T

| | |
|---------------------------------|-----|
| Tachometer..... | 28 |
| Temperature Gauge, Coolant..... | 28 |
| Tilt Steering..... | 32 |
| Tire | |
| Air Pressure..... | 94 |
| Balancing..... | 97 |
| Chains..... | 95 |
| Changing a Flat Tire..... | 106 |
| COMPACT Spare..... | 104 |
| DOT Tire Quality Grades..... | 122 |
| Inflation Pressures..... | 94 |
| Requirement..... | 96 |
| Rotation..... | 97 |
| Snow Tire..... | 95 |
| Spare Tire..... | 104 |
| Specification (Hatchback).... | 116 |

| | |
|----------------------------------|-----|
| Specification (Sedan)..... | 119 |
| Tools..... | 105 |
| Towing..... | 111 |
| Transmission | |
| Capacity..... | 79 |
| Identification Number..... | 121 |
| Oil/Fluid..... | 78 |
| Shifting the Automatic..... | 64 |
| Shifting the Manual..... | 61 |
| Transmission..... | 78 |
| Treadwear..... | 122 |
| Trip Meter..... | 28 |
| Trunk Access From Rear Seat..... | 8 |
| Trunk Lid..... | 5 |
| Turn Signals..... | 36 |

V

| | |
|-----------------------------------|-----|
| Vehicle Identification Number.... | 121 |
| Ventilation..... | 45 |

W

| | |
|--------------------------|-----|
| Warning Lights..... | 29 |
| Warranty Service..... | 127 |
| Washer | |
| Rear Window Washer..... | 34 |
| Reservoir Capacity..... | 33 |
| Windshield Washer..... | 33 |
| Washing..... | 100 |
| Waxing..... | 101 |
| Windows | |
| Appearance Care..... | 100 |
| Power Windows..... | 43 |
| Windshield Defogger..... | 51 |
| Windshield Washer..... | 33 |
| Windshield Wipers..... | 33 |
| Wiper Blades | 88 |
| Wipers | |
| Rear Window Wiper..... | 34 |
| Windshield Wipers..... | 33 |

Authorized Manuals

A Factory-Authorized Manual is Available for Your Vehicle.

The following publications covering the operation and servicing of your vehicle can be obtained from Helm Incorporated either by filling out the reverse side of this form or, for credit card holders, calling toll-free. For manuals prior to the year shown below, contact Helm Inc., Box 07280, Detroit, Michigan 48207, or call (313) 883-1430.

| Publication Form Number | Form Description | Price Each* |
|--------------------------------|---|--------------------|
| 61SH303 | 1991 CIVIC Service Manual | \$54.00 |
| 61SH303EL | 1991 CIVIC Electrical Troubleshooting Manual | \$33.00 |
| 61SH330 | 1988-1991 CIVIC Body Repair Manual | \$30.00 |
| 31SH3630 | 1991 CIVIC Owner's Manual | \$16.00 |
| HON-R | Order Form for Previous Years- Indicate Year and Model Desired. | FREE |

*Prices are subject to change without notice and without incurring obligation. If order is to be placed after April 1998, contact Helm for current prices and availability.

Service Manual

This manual covers maintenance and recommended procedures for repair to engine and chassis components. It is written for the journeyman mechanic, but is simple enough for most mechanically-inclined owners to understand.

Electrical Troubleshooting Manual

This manual compliments the Service Manual by providing in-depth troubleshooting information for each electrical circuit in your car.

Body Repair Manual

This manual describes the procedures involved in the replacement of damaged body parts.

ORDER TOLL FREE: 1-800-782-4356

(NOTE: For Credit Card Holder Orders Only)

Monday – Friday 8:30 A.M. – 6:00 P.M. EST

(MINIMUM CREDIT CARD PURCHASE \$10.00)

(OR)

By completing this form you can order the materials desired. You can pay by check or money order, or charge to your credit card. Mail to Helm, Incorporated at the address shown below.

| | | | | | | | |
|---|-------------------------|---------------|------|------|-------------------------------------|-------------|--------|
| 1 9 9 1 H O N | PUBLICATION FORM NUMBER | VEHICLE MODEL | | QTY. | PRICE EACH* | TOTAL PRICE | |
| | | NAME | YEAR | | | | |
| | | | | | | | |
| | | | | | | | |
| | | | | | | | |
| <p>*Prices are effective until April '98. After that date contact Helm, Incorporated for current prices and stock availability.</p> <p>Orders are mailed within 10 days. Please allow adequate time for delivery.</p> | | | | | TOTAL MATERIAL | | |
| | | | | | MICH. PURCHASES ADD 6% SALES TAX | | |
| | | | | | HANDLING CHARGE | | \$5.00 |
| | | | | | GRAND TOTAL | | |

| | | |
|--------------------------------|--|----------------------------|
| S H I P T O | NOTE: Dealers and Companies please provide dealer or company name, and also the name of the person to whose attention the shipment should be sent. For purchases outside U.S.A. please write to the address below for a quotation. | |
| | CUSTOMER NAME _____ | ATTENTION _____ |
| | STREET ADDRESS-NO. P.O. BOX NUMBER _____ | APARTMENT NUMBER _____ |
| | CITY _____ | STATE _____ ZIP CODE _____ |
| | DAYTIME TELEPHONE NUMBER _____ | AREA CODE () _____ |

| | | |
|---------------------------------|---|---|
| P A Y M E N T | <input type="checkbox"/> Check or money order enclosed payable to Helm Inc. U.S. funds only Do not send cash. | |
| | <input type="checkbox"/> Master Card <input type="checkbox"/> VISA <input type="checkbox"/> Check here if your billing address is different from the shipping address shown below. | |
| | Account Number <input style="width: 20px; height: 15px; border: 1px solid black;" type="text"/> <input style="width: 20px; height: 15px; border: 1px solid black;" type="text"/> <input style="width: 20px; height: 15px; border: 1px solid black;" type="text"/> <input style="width: 20px; height: 15px; border: 1px solid black;" type="text"/> <input style="width: 20px; height: 15px; border: 1px solid black;" type="text"/> <input style="width: 20px; height: 15px; border: 1px solid black;" type="text"/> <input style="width: 20px; height: 15px; border: 1px solid black;" type="text"/> <input style="width: 20px; height: 15px; border: 1px solid black;" type="text"/> <input style="width: 20px; height: 15px; border: 1px solid black;" type="text"/> | Expiration Mo-Yr <input style="width: 20px; height: 15px; border: 1px solid black;" type="text"/> <input style="width: 20px; height: 15px; border: 1px solid black;" type="text"/> <input style="width: 20px; height: 15px; border: 1px solid black;" type="text"/> |
| | _____ CUSTOMER SIGNATURE | |
| | _____ DATE | |

These Publications cannot be returned for credit without receiving advance authorization within 14 days of delivery. On returns, a restocking fee may be applied against the original order.



P.O. BOX 07280 • DETROIT, MICHIGAN 48207 • (313)883-1430

Zone Office Locations

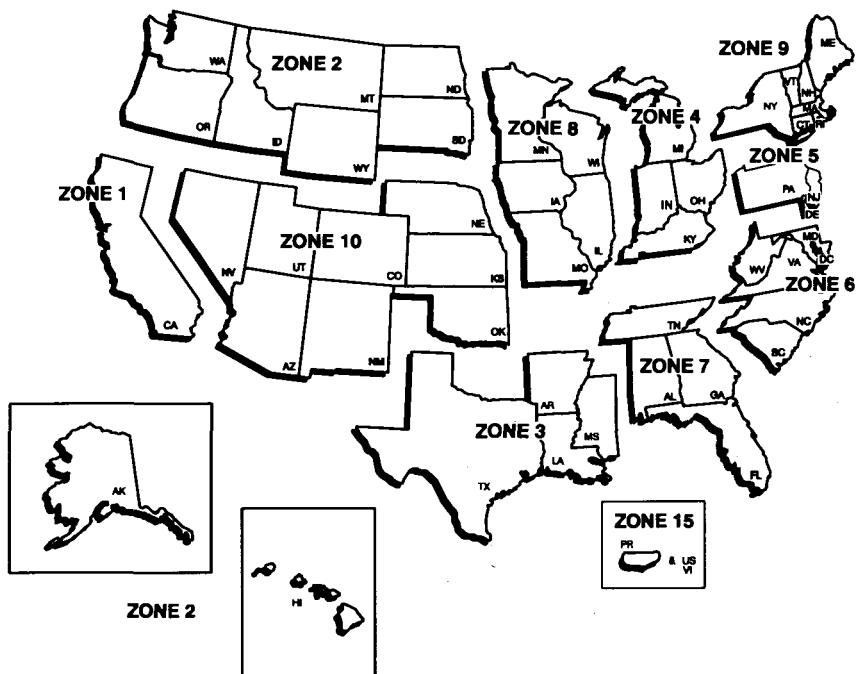

1 Western Zone
 P.O. Box 2260
 700 Van Ness Avenue
 Torrance, California
 90509-2260
 (310) 781-4565

2 Northwestern Zone
 P.O. Box 20186
 12439 N.E. Airport Way
 Portland, Oregon 97220
 (503) 256-0943
 (also includes Alaska
 and Hawaii)

3 South Central Zone
 4529 Royal Lane
 Irving, Texas 75063
 (214)929-5481

4 Central Zone
 101 South Stanfield Road
 Troy, Ohio 45373
 (513) 332-6250

5 Northeastern Zone
 P.O. Box 337
 Eastgate Industrial Park
 115 Gaither Drive
 Moorestown, New Jersey 08057
 (609) 235-5533
 Includes: NYC Metro area and
 Fairfield County, CT area

6 Mid-Atlantic Zone
 902 Wind River Ln., Suite 200
 Gaithersburg, Maryland 20878
 (301) 990-2020

7 Southeastern Zone
 1500 Morrison Parkway
 Alpha retta, Georgia 30201
 (770) 442-2045

8 North Central Zone
 601 Campus Drive, Suite A-9
 Arlington Heights, Illinois 60004
 (847) 870-5600

9 New England Zone
 555 Old County Road
 Windsor Locks, Connecticut 06096
 (203) 623-3310
 See Zone 5 for: NYC Metro area
 and Fairfield County, CT area

10 West Central Zone
 1600 South Abilene Street, Suite D
 Aurora, Colorado 80012

15 Puerto Rico and U.S. V.I.
 Bella International
 P.O. Box 190816
 San Juan, PR 00919-0816
 (787) 250-8070

The above addresses and telephone numbers are subject to change. If you cannot reach your Zone office, ask your Honda dealer for the current information.

Gas Station Information

Gasoline: UNLEADED only
Pump octane of 86 or higher.

Gas Tank-Capacity: 45 l (11.9 US gal, 9.9 Imp gal)

Tire Pressure (measured cold) front/rear

STD Hatchback: 240 kPa (35 psi) / 220 kPa (32 psi)
DX Hatchback: 220 kPa (32 psi) / 220 kPa (32 psi)
Si Hatchback: 195 kPa (28 psi) / 195 kPa (28 psi)
DX Sedan: 220 kPa (32 psi) / 220 kPa (32 psi)
LX Sedan: 180 kPa (26 psi) / 180 kPa (26 psi)
EX Sedan: 180 kPa (26 psi) / 180 kPa (26 psi)
Compact Spare: 415 kPa (60 psi)

Other Tire Information See "Tires" pages [94-97](#).

Hood Release Pull handle under left side of dash.

Engine Oil: Use "Energy Conserving II" SG grade oil.
5W-30 preferred (see page [75](#) for complete viscosity recommendations).
Capacity (including filter):
3.5 l (3.7 US qt, 3.1 Imp qt)

Manual Transmission Oil:

Use SF or SG grade oil.
10W-30 or 10W-40 preferred (see page [78](#) for complete viscosity recommendations).
Capacity (including differential):
1.8 l (1.9 US qt, 1.6 Imp qt)
(Oil should be up to filler bolt hole in housing beside right axle)

Automatic Transmission Fluid:

Use DEXRON® II type Automatic Transmission Fluid (ATF). Remove dipstick from right end of transmission, wipe off, reinsert, remove and read fluid level - do not force the rubber plug in when reading fluid level or replacing dipstick.
Capacity (including differential):
2.4 l (2.5 US qt, 2.1 Imp qt)

Power Steering Fluid

Use only Honda power steering fluid: do not use ATF or any other brand of power steering fluid because it will damage the system.

AMERICAN HONDA MOTOR CO., INC.
1919 Torrance Blvd., Torrance California 90501



© 1991 Honda Motor Co., Ltd. - All Rights Reserved

31SH3630
00X31-SH3-6302

CRES 1009805
PRINTED IN U.S.A.