

This manual deals with the operation and care of your Volvo.



Welcome to the world-wide family of Volvo owners. We trust that you will enjoy many years of safe driving in your Volvo, an automobile designed with your safety and comfort in mind. To help ensure your satisfaction with this vehicle, we encourage you to familiarize yourself with the equipment descriptions, operating instructions and maintenance requirements/recommendations in this manual. We also urge you and your passengers to wear seat belts at all times in this (or any other) automobile. And, of course, please do not operate a vehicle if you may be affected by alcohol, medication or any impairment that could hinder your ability to drive.

Your Volvo is designed to meet all applicable safety and emission standards, as evidenced by the certification labels attached to the driver's door opening and on the left wheel housing in the engine compartment.

## Volvo and the environment

Volvo is committed to the well being of our customers. As a natural part of this commitment, we care about the environment in which we all live. Caring for the environment means an everyday involvement in reducing our environmental impact.

Volvo's environmental activities are based on a holistic view, which means we consider the overall environmental impact of a product throughout its complete life cycle. In this context, design, production, product use, and recycling

are all important considerations.

In production, Volvo has partly or completely phased out several chemicals including freons, lead chromates, naphthanates, asbestos, mercury and cadmium; and reduced the amount of chemicals used in our plants 50% since 1991.

In use, Volvo was the first in the world to introduce into production a three-way catalytic converter with a Lambda sond, now called oxygen sensor, in 1976. The current version of this highly efficient system reduces emissions of harmful substances (CO, HC, NOx) from the exhaust pipe by approximately 95% and the search to eliminate the remaining emissions continues. Volvo is the only automobile manufacturer to offer CFC-free retrofit kits for the air conditioning system for all models back to the M/Y 1975 240. Advanced electronic engine controls, refined purification systems and cleaner fuels are bringing us closer to our goal.

After Volvo cars and parts have fulfilled their use, recycling is the next critical step in completing the life cycle. The metal content is about 75% of the total weight of the car, which makes the car among the most recycled industrial products. In order to have efficient and well controlled recycling, many Volvo variants have printed dismantling manuals indicating the weight and material of individual components. For Volvo, all homogeneous plastic parts weighing more than 1.7 oz. (50 grams) are marked with international symbols that indicate how the component is to be sorted for recycling.

In addition to continuous environmental refinement of conventional gasoline-powered internal combustion engines, Volvo is actively looking at advanced technology alternative-fuel vehicles.

When you drive a Volvo, you become our partner in the work to lessen the car's impact on the environment. To reduce your vehicle's environmental impact, you can:

- Maintain proper air pressure in your tires. Tests have shown decreased fuel economy with improperly inflated tires
- Follow the recommended maintenance schedule
- Drive at a constant speed
- See an authorized Volvo retailer as soon as possible for inspection if the check engine (malfunction indicator) lamp illuminates, or stays on after the vehicle has started
- Properly dispose of any vehicle related waste such as used motor oil, used batteries, brake pads, etc.
- When cleaning your car, use Volvo's own car care products, all of which have systematically been adapted to the environment.

## Contents

### Important

**Before you operate your car for the first time, please familiarize yourself with the [BREAK-IN information on page 56](#). You should also be familiar with the information in the first three chapters of this manual. Information contained in the balance of the manual is extremely useful and should be studied after operating the vehicle for the first time.**

**This manual is structured so that it can be used for reference. It should thus be kept in the car for ready access. Do not export your Volvo to another country before investigating the country's applicable safety and exhaust emission requirements. In some cases it may be difficult or impossible to comply with these requirements. Modifications to the emission control system(s) may render your Volvo not certifiable for legal operation in the U.S., Canada or other countries.**

All information, illustrations and specifications contained in this manual are based on the latest product information available at the time of publication. Volvo reserves the right to make model changes at any time, or to change specifications or design, without notice and without incurring obligation.

**CAUTION:** Certain models have reduced ground clearance due to the design of the front spoiler. Please observe caution when e.g., driving onto garage hoists, through drifted snow or when other road debris is encountered, or when parking near curbs

©1997 Volvo Cars of North America Inc.

## Contents

<a href="#">Chapter 1 - Occupant safety</a>	<a href="#">1</a>
<a href="#">Chapter 2 - Instruments, switches and controls</a>	<a href="#">15</a>
<a href="#">Chapter 3 - Body and interior</a>	<a href="#">39</a>
<a href="#">Chapter 4 - Starting and driving</a>	<a href="#">55</a>
<a href="#">Chapter 5 - Wheels and tires</a>	<a href="#">75</a>
<a href="#">Chapter 6 - In case of an emergency</a>	<a href="#">81</a>
<a href="#">Chapter 7 - Car care</a>	<a href="#">99</a>
<a href="#">Chapter 8 - Volvo Service</a>	<a href="#">105</a>
<a href="#">Chapter 9 - Specifications</a>	<a href="#">123</a>
<a href="#">Chapter 10 - Audio systems</a>	<a href="#">131</a>
<a href="#">Index</a>	<a href="#">188</a>



[Top of Page](#)

# Chapter 1 - Occupant safety

pg. 1 Occupant safety

## Occupant safety

Despite our strongest recommendations, and your best intentions, not wearing a seat belt is like believing "It'll never happen to me!". Volvo urges you and all adult occupants of your car to wear seat belts and ensure that children are properly restrained, using an infant, car or booster seat determined by age, weight and height.

Fact: In every state and province, some type of child-restraint legislation has been passed. Additionally, most states and provinces have already made it mandatory for occupants of a car to use seat belts.

So, urging you to "buckle up" is not just our recommendation - legislation in your state or province may mandate seat belt usage. The few seconds it takes to buckle up may one day allow you to say, "It's a good thing I was wearing my seat belt".



[Seat belts](#) 2

[Volvo SRS](#) 4

[Side Impact Protection System - \(SIPS\) air bag](#) 8

[Child safety](#) 9

[Occupant safety](#) 12

[Reporting Safety Defects](#) 12

pg. 2 Seat belts

## Seat belts

**Always fasten the seat belts before you drive or ride.**

Two lights above the rear view mirror will be illuminated for 4-8 seconds after the starting (ignition) key is turned to the driving position. A chime will sound at the same time if the driver has not fastened his seat belt. The rear seats are provided with self-retracting inertia reel belts. The front seats are provided with single roller belts with tensioners.

*Adjusting the shoulder belt*

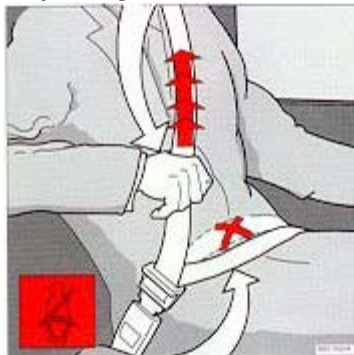

*Lap portion of the seat belt should sit low*

**To buckle:**

Pull the belt out far enough to insert the latch plate into the receptacle (buckle for rear seats) until a distinct snapping sound is heard. The seat belt retractor is normally "unlocked" and you can move freely, provided that the shoulder belt is not pulled out too far. The retractor will lock up as follows:

- if the belt is pulled out rapidly
- during braking and acceleration
- if the vehicle is leaning excessively
- when driving in turns

For the seat belt to provide maximum protection in the event of an accident, it must be worn correctly. When wearing the seat belt remember:

- The belt should not be twisted or turned.
- The lap belt must be positioned low on the hips (not pressing against the abdomen).
- The shoulder section of the front seat belts adjusts automatically to the driver's height.

Make sure that the shoulder belt is rolled up into its retractor and that the shoulder and lap belts are taut.

Before exiting the car, check that the seat belt retracts fully after being unbuckled.

If necessary, guide the belt back into the retractor slot.

**NOTE:** Legislation in your state or province may mandate seat belt usage.

[For information on securing child seats, please refer to page 11.](#)

**WARNING!**

- Any device used to induce slack into the shoulder belt portion of the three-point belt system will have a detrimental effect on the amount of protection available to you in the event of a collision. The seat back should not be tilted too far back. The shoulder belt must be taut in order to function properly.
- Do not use child safety seats or child booster cushions/backrests in the front passenger's seat. We also recommend that children who have outgrown these devices sit in the rear with the seat belt properly fastened.
- The rear seat of the Volvo C70 is intended for two occupants only. Only two three-point seat belts are provided. The center position should never be used to seat a passenger.

pg. 3 Seat belts

**During pregnancy**

Pregnant women should always wear seat belts. Remember that the belt should always be positioned in such a way as to avoid any possible pressure on the abdomen. The lap portion of the belt should be located low, as shown in the above illustration.

## **WARNING!**

- The rear seat of the Volvo C70 is intended for two occupants only. Only two three-point seat belts are provided. The center position should never be used to seat a passenger.
- Never use a seat belt for more than one occupant.
- Never wear the shoulder portion of the belt under the arm, behind the back or otherwise out of position. Such use could cause injury in event of accident.
- As the seat belts lose much of their strength when exposed to violent stretching, they should be replaced after any collision, even if they may appear to be undamaged.
- Never repair the belt on your own; have this done by an authorized Volvo retailer only.
- Any device used to induce slack into the shoulder belt portion of the three-point belt system will have a detrimental effect on the amount of protection available to you in the event of a collision.
- The seat back should not be tilted too far back. The shoulder belt must be taut in order to function properly.



[Contents](#) | [Top of Page](#)

## Chapter 2 - Instruments, switches and controls

pg. 14 Instruments, switches and controls

Click on numbered item below for more information

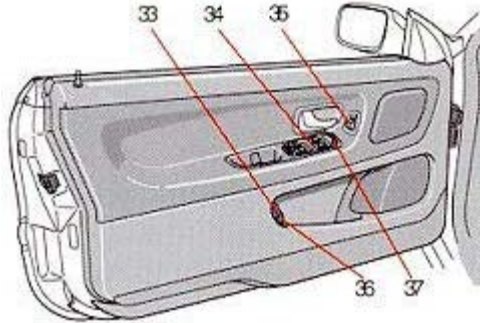
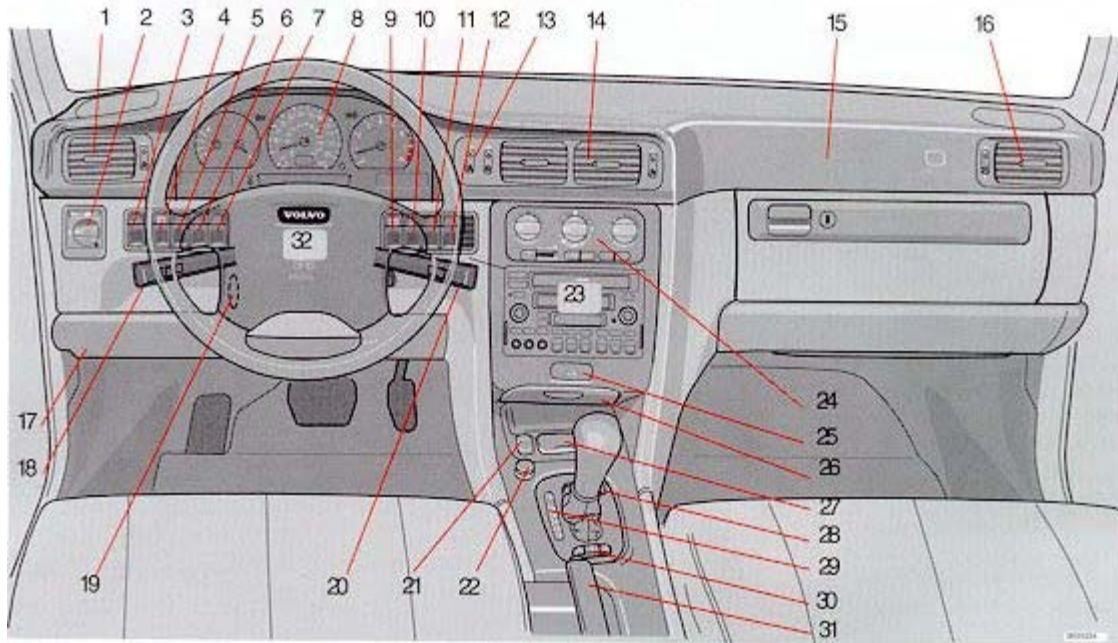

pg. 15 Instruments, switches and controls

	Page
1 <a href="#">Air vents</a>	33
2 <a href="#">Headlights, parking lights</a>	20
3 <a href="#">Instrument illumination</a>	22
4 <a href="#">Rear fog light</a>	22
5 <a href="#">Front fog lights (optional)</a>	22
6 Space for additional equipment	
7 Space for additional equipment	
8 <a href="#">Instruments</a>	14-15
9 <a href="#">Traction control system (optional)</a>	23
10 <a href="#">Trip computer (optional)</a>	26-28

11 <a href="#">Electrically operated sun roof (optional)</a>	41
12 <a href="#">Rear window demister/heated door mirrors</a>	23
13 <a href="#">Air mix</a>	33
14 <a href="#">Air vents</a>	33
15 <a href="#">Passenger side air bag (SRS) hatch</a>	4-6
16 <a href="#">Air vents</a>	33
17 <a href="#">Hood release</a>	51
18 <a href="#">Turn signals, high/low beams</a>	20
<a href="#">Cruise control</a>	29
19 <a href="#">Adjustable steering wheel</a>	32
20 <a href="#">Windshield wiper/washer</a>	21
21 <a href="#">Heated front seats (optional)</a>	30
22 <a href="#">Auxiliary socket</a>	31
23 <a href="#">Audio systems</a>	131
24 <a href="#">Heating and ventilation controls</a>	33-35
25 <a href="#">Hazard warning flashers</a>	23
26 <a href="#">Ashtray</a>	31
27 Coin holder	
28 <a href="#">Shiftlock release button (automatic transmission only)</a>	97
29 <a href="#">Gear selector shift positions</a>	60-62
30 <a href="#">Transmission mode selectors</a>	62
31 <a href="#">Parking brake</a>	30
32 <a href="#">Horn/SRS</a>	4-6
33 <a href="#">Trunk open control</a>	52
34 <a href="#">Power window controls</a>	36
35 <a href="#">Power mirror controls</a>	48
36 <a href="#">Fuel tank open control</a>	37
37 <a href="#">Central locking button</a>	36

Some of the items above are available on certain models only.

### **Shiftlock (automatic transmission only)**

When your car is parked, the gear selector is locked in the (P)ark position. To release the selector from this position, turn the ignition key to position II (or start the engine), depress the brake pedal, press the button on the front side of the gear selector and move the selector from (P)ark.

#### **If it is necessary to manually override the shiftlock system:**

- Turn the starting (ignition) key to position I
- Press firmly on the "SHIFTLOCK OVERRIDE" button located near the base of the gear selector.
- While holding the override button down, press the button on the front of the gear selector.
- Move the gear selector from the (P)ark position.

### **Keylock (automatic transmission only)**

This means that when you switch off the ignition, the gear selector must be in the (P)ark position before the starting (ignition) key can be removed from the ignition switch.

### **Anti-lock Brake System (ABS)**



The ABS system in your car performs a self-diagnostic test when the vehicle first reaches the speed of approximately 12 mph (20 km/h). The brake pedal will pulsate several times and a sound may be audible from the ABS control module. This is normal.

## Fuel tank cover

The fuel tank cover is locked and must be popped open using the control on the driver's door.

The pages in this section provide detailed descriptions of the vehicle's instruments and controls. Note that vehicles may be equipped differently, depending on special legal requirements.

## pg. 16 Instruments

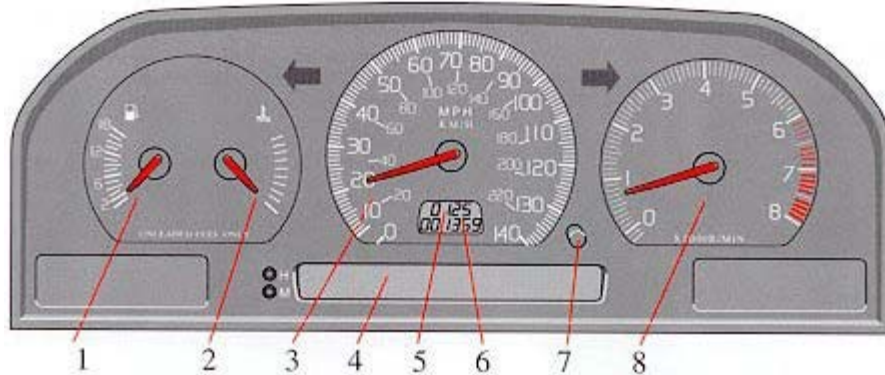

### 1 Fuel gauge

The fuel tank holds approximately 18.4 US gals. (70 liters). When the warning light comes on there is approximately 1.8 US gals. (8 liters) of fuel remaining. [See "Refueling" for further information.](#)

### 2 Temperature gauge

**Do not drive the car with the pointer in the red range.** The pointer should be approximately midway on the gauge face when driving. If the pointer approaches the red range repeatedly, check coolant level. [See page 130.](#)

### 3 Speedometer

### 4 Clock, ambient temperature sensor, trip computer (certain models)

### 5 Odometer

### 6 Trip odometer

Used for measuring shorter distances. The last digit indicates 1/10 mile/kilometer.

### 7 Trip odometer reset button

### 8 Tachometer

Reads thousands of engine rpm. The engine should not be operated in red range. **The highest permitted constant engine speed** is 6,200 rpm.





## Chapter 3 - Body and interior

pg. 39 Body and interior

### Body and interior

The seats, sun roof, mirrors, etc. are described on the following pages.

[Storage compartments](#) 40

[Sun roof](#) 41

[Keys, doors and locks](#) 42

[Remote keyless entry system](#) 43

[Alarm](#) 44

[Front seats](#) 46

[Rear/side view mirrors](#) 48

[Interior lights, Vanity mirrors](#) 49

[Long load storage](#) 50

[Hood](#) 51

[Opening the trunk](#) 52

[Trunk light, Spare tire, Jack](#) 53

[Securing cargo, Avoiding battery drain](#) 54

pg. 40 Storage compartments

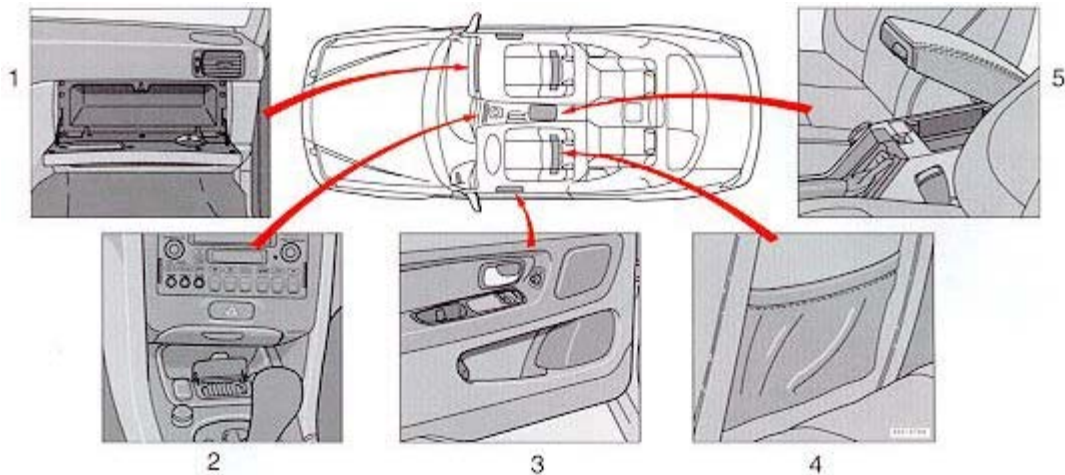

1 Glove compartment

2 Coin holder

3 Compartment in door

4 Pocket on rear of front seat

5 Compartment between front seats/Cup holder

**WARNING!** Packages on the rear window shelf can obscure vision and may become dangerous projectiles in the event of a sudden stop or an accident.

pg. 41 Sun roof (option)

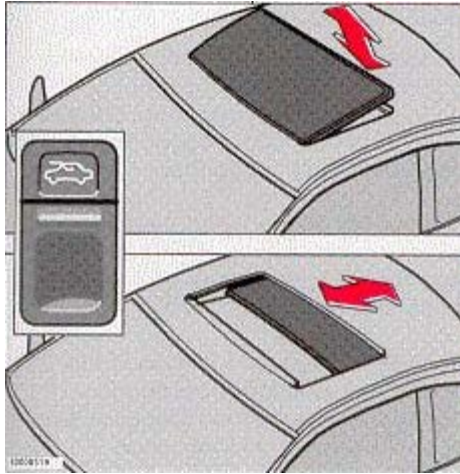

*Sliding sun roof*

### **Electrically-operated sun roof**

The switch for operating the sun roof is located on the instrument panel. The starting (ignition) key must first be turned to the drive position (position II). The sun roof is also equipped with a one-touch, AUTO-open function.

- **AUTO-open:** Press the lower section of the switch once to automatically open the sun roof. **The AUTO-open function can be stopped at any time by pressing the switch.**
- **To close the sun roof:** Depress the upper section of the switch *until the sun roof has closed completely.*

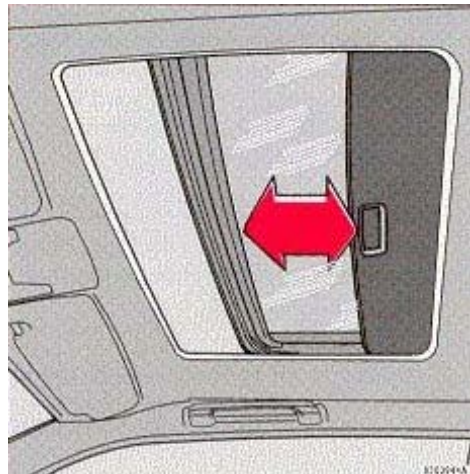

*Sun visor*

- **To open the rear edge of the sun roof (ventilation position):** With the sun roof closed, depress the upper section of the switch. To close, depress the lower section of the switch until the sun roof has closed completely.
- **To slide open the sun roof:** Depress the lower section of the switch until the sun roof has opened to the position you prefer or hold the switch until the sun roof reaches the "comfort position"\*. Depress the lower section of the switch again to open the sun roof completely.

\* A position where the sun roof is not quite fully open. This position helps alleviate "rumbling" wind noise.

**Sun visor:** The sun roof also features a sliding sun visor. The visor slides back automatically when the sun roof is opened and also slides back slightly when the sun roof is opened to the ventilation position. The visor must be closed manually.

**CAUTION:** Do not close the sun visor when the sun roof is in the ventilation position as this could damage the mechanism.

**NOTE:**

- The electrically-operated sun roof has an overload protecting circuit breaker (fuse no. 37) which is activated when an object blocks the sun roof. Should this occur, remove the object and wait 20 seconds for the circuit breaker to reset. The sun roof should then function normally. Also check fuse no. 35.

**WARNING!** The sun roof must never be obstructed in any way when in operation.

pg. 42 Keys, doors and locks

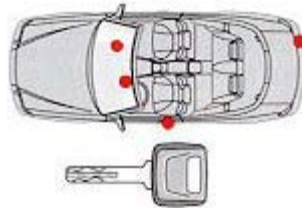

**Master key**

This key operates all locks (ignition switch/steering wheel lock, driver's door, trunk and glove compartment).

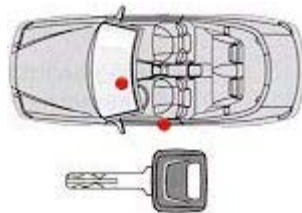

**Service key**

This key operates the driver's door and the ignition switch/steering wheel lock.

**NOTE:**

- As an added anti-theft measure, new keys have been developed which may take slightly longer to copy or replace if the original keys are misplaced. Duplicate keys may be ordered from your Volvo retailer.
- The key number codes are stamped on a separate tag supplied with the keys. This tag should be separated from the key ring and kept in a safe place.

**Doors and locks**

Your car is equipped with a central locking system.

The key, used on the driver's door, the remote control, or central locking button, will lock/unlock both doors, and the trunk.

**Turn the key once** to unlock the driver's door only.

**Turn the key again (within 10 seconds)** to unlock both doors and the trunk.

One turn with the key towards lock in the drivers door locks both doors and the trunk.

Use the switch on the front door armrests to lock/unlock the car from the inside.

Check the action of the buttons on the other door to verify its function (lock/unlock).

**WARNING!** The doors should not be locked while driving. In case of an accident, this may hinder rapid access to the occupants of the vehicle.

**NOTE:** If a door is not closed completely, the courtesy lights will stay on and a chime will sound until the door is closed.

---



[Contents](#) | [Top of Page](#)

## Chapter 4 - Starting and driving

pg. 55 Starting and driving

### Starting and driving

This section on starting and driving contains items such as starting the engine, operating the gear selector, towing, trailers, etc.

<a href="#">Break-in period</a>	<a href="#">56</a>
<a href="#">Fuel requirements, Refueling</a>	<a href="#">56-57</a>
<a href="#">Driving economy</a>	<a href="#">58</a>
<a href="#">Starting the engine</a>	<a href="#">59</a>
<a href="#">Manual transmission</a>	<a href="#">60</a>
<a href="#">Automatic transmission</a>	<a href="#">61</a>
<a href="#">Points to remember</a>	<a href="#">64</a>
<a href="#">Emergency towing</a>	<a href="#">66</a>
<a href="#">Vehicle towing information</a>	<a href="#">67</a>
<a href="#">Jump starting</a>	<a href="#">68</a>
<a href="#">Three-way catalytic converter</a>	<a href="#">69</a>
<a href="#">Brake system, ABS</a>	<a href="#">70</a>
<a href="#">Trailer towing</a>	<a href="#">71</a>
<a href="#">Winter driving</a>	<a href="#">72</a>
<a href="#">Long distance trips</a>	<a href="#">73</a>

pg. 56 Break-in period, Fuel requirements

### A new car should be broken-in

Refrain from utilizing your car's full driving potential during the first 1,200 miles (2,000 km) including the "kick-down" function (automatic transmission).

#### NOTE - ENGINE OIL:

Although some oil consumption occurs during normal engine operation, more oil is consumed when the engine is new as the internal parts generate higher friction while wearing-in to each other. **From the time the engine is new until the first service is performed, the oil consumption could be higher than normal. For this reason, it is especially important to check the oil every time you refuel your car during this period. [See page 114.](#)**

In general, the rate of oil consumption depends on such factors as: engine temperature, length of trip, driving conditions, oil viscosity and quality, engine speed and acceleration/deceleration.

Checking your engine oil level each time the car is refueled is one of the most important items you can perform to help keep your car in good running order.

## Manual transmission

The following speeds should not be exceeded during the break-in period:

	<b>Up to 600 miles (1000 km)</b>	<b>600 - 1,200 miles (1000 - 2000 km)</b>
<b>1st gear</b>	20 mph (30 km/h)	25 mph (40 km/h)
<b>2nd gear</b>	30 mph (50 km/h)	40 mph (70 km/h)
<b>3rd gear</b>	45 mph (80 km/h)	65 mph (100 km/h)
<b>4th gear</b>	70 mph (110 km/h)	80 mph (130 km/h)
<b>5th gear/overdrive</b>	80 mph (130 km/h)	95 mph (150 km/h)

**Posted speed limits should not be exceeded.**

## Deposit control gasoline (detergent additives)

Volvo recommends the use of gasoline containing deposit control additives. These additives have shown to be efficient in keeping injectors and intake valves clean. Consistent use of deposit control gasolines will help ensure good driveability and fuel economy. If you are not sure whether the gasoline contains deposit control additives, check with the service station operator.

## Unleaded Fuel

Each Volvo has a three-way catalytic converter and must use only unleaded gasoline. U.S. and Canadian regulations require that pumps delivering unleaded gasoline be labeled "UNLEADED". Only these pumps have nozzles which fit your car's filler inlet. It is unlawful to dispense leaded fuel into a vehicle labeled "unleaded gasoline only". Leaded gasoline damages the three-way catalytic converter and the heated oxygen sensor system. Repeated use of leaded gasoline will lessen the effectiveness of the emission control system and could result in loss of emission warranty coverage. State and local vehicle inspection programs will make detection of misfueling easier, possibly resulting in emission test failure for misfueled vehicles.

**NOTE:** Some U.S. and Canadian gasolines contain an octane enhancing additive called methyl-cyclopentadienyl manganese tricarbonyl (MMT). If such fuels are used, your Emission Control System performance may be affected, and the Malfunction Indicator Lamp located on your instrument panel may light. If this occurs, please return your vehicle to an authorized Volvo retailer for service.

pg. 57 Fuel requirements, Refueling

## Octane Rating

Volvo engines are designed for optimum performance on unleaded premium gasoline with an octane rating. AKI of 91, or above. AKI (ANTI KNOCK INDEX) is an average of the Research Octane Number, RON, and the Motor Octane Number, MON,  $(RON + MON / 2)$ .

The minimum octane requirement is AKI 87 (RON 91).

## Gasoline containing alcohol and ethers

### "Oxygenated fuels"

Some fuel suppliers sell gasoline containing "oxygenates" which are usually alcohols or ethers. In some areas, state or local laws require that the service pump be marked indicating use of alcohol or ethers. However, there are areas in which the pumps are unmarked. If you are not sure whether there is alcohol or ethers in the gasoline you buy, check with the service station operator.

To meet seasonal air quality restrictions, some states require the use of "oxygenated" fuel in certain areas.

Volvo allows the use of the following "oxygenated fuels"; however, the octane ratings listed on this page must still be met.

**Alcohol — Ethanol**



Fuels containing up to 10% ethanol by volume may be used.  
Ethanol may also be referred to as Ethyl alcohol, or "Gasohol".

### **Ethers — MTBE**

Fuels containing up to 15% MTBE may be used.

## **Refueling**

The fuel filler cap is located inside the fuel tank cover on the right rear fender.

**NOTE:** The fuel tank cover is locked and must be popped open using the control on the driver's door ([see page 37](#)).

### **Open fuel filler cap slowly during hot weather conditions.**

When filling, hang the cap on the special bracket on the inside of the fuel tank cover.

**NOTE:** Turn the ignition off or to position I when refueling. If the ignition is on, an incorrect reading could occur in the fuel gauge (low fuel level will be indicated).

After filling the tank, install the cap and turn until a "click" is heard.

The fuel tank is designed to hold approximately 18.4 US gal. (70 liters) with sufficient volume left over to accommodate possible expansion of the fuel in hot weather. Be aware that the "usable" tank will be somewhat less than the specified maximum. When the fuel level is low, such factors as ambient temperature, the fuel's "vapor pressure" characteristics, and terrain can affect the fuel pumps' ability to supply the engine with an adequate supply of fuel. Therefore, it is advisable to refuel as soon as possible when the needle nears the red zone, or when the fuel warning light comes on.

### **CAUTION:**

- Do not refuel with the engine running. After refueling, close the fuel filler cap by turning it clockwise until it clicks into place.
- Allow for fuel expansion by not overfilling the tank. Overfilling could also cause damage to the emission control systems.

**NOTE:** If the fuel filler cap is not closed tightly or if the engine is running when the car is refueled, the Malfunction Indicator Lamp may indicate a fault. Use only Volvo original or approved fuel filler caps.

**CAUTION:** Avoid spilling gasoline during refueling. Gasolines containing alcohol can cause damage to painted surfaces, which may not be covered under the New Vehicle Limited Warranty.  
Do not use gasoline containing methanol (methyl alcohol, wood alcohol). This practice can result in vehicle performance deterioration and can damage critical parts in the fuel system. Such damage may not be covered under the New Vehicle Limited Warranty.



## Chapter 5 - Wheels and tires

pg. 75 Wheels and tires

### Wheels and tires

The handling and riding comfort of the vehicle is dependent on the inflation pressure and the type of tires fitted. Read the following pages carefully.

[General information, Wear indicator, Tire economy, Flat spots](#) 76

[Snow chains, Winter tires](#) 77

[Inflation pressure](#) 78

[Uniform tire quality grading](#) 79

pg. 76 Wheels and tires

### General information

**Your vehicle is equipped with tires according to the tire information label located on the rear facing side of the right front door.**

The following is an **example** of a tire designation code 225/50R16:

**225** = tire width in mm.

**50** = tire profile. This is the relationship (in percent) between the section height and the width of the tire.

**R** = radial tires.

**16** = diameter in inches.

The tires have good road holding characteristics and offer good handling on dry and wet surfaces. It should be noted however that the tires have been developed to give these features on snow/ice-free surfaces. **Certain models are equipped with "all-season" tires, which provide a somewhat higher degree of winter roadholding on slippery surfaces than tires without the "all-season" rating.** However, for optimum road holding on icy or snow covered roads - **we recommend suitable winter tires on all four wheels.** When replacing tires, be sure that the new tires are the same size designation, type (radial) and preferably from the same manufacturer, on all four wheels. Otherwise there is a risk of altering the car's road-holding and handling characteristics.

**NOTE:** When storing wheel/tire assemblies (e.g. winter tires and wheels), either stand the assemblies upright or suspend them off the ground. Laying wheel/tire assemblies on their sides for prolonged periods can cause wheel and/or tire damage.

### Wear indicator

The tires have a so-called "wear indicator" in the form of a number of narrow strips running across or parallel to the tread. When approx. 1/16" (1.6 mm) is left on the tread, these strips show up and indicate that the tire should be replaced.

Tires with less than 1/16" (1.6 mm) tread have a very poor grip in rain or snow.

When replacing worn tires, it is recommended that the tire be identical in type (radial) and size as the one being replaced. Using a tire of the same make (manufacturer) will prevent alteration of the driving characteristics of the vehicle.

### To improve tire economy:

- Maintain correct tire pressure.
- Drive smoothly: avoid fast starts, hard braking and tire screeching.
- Tire wear increases with speed.
- Correct front wheel alignment is very important.
- Unbalanced wheels impair tire economy and driving comfort.
- If the wheels are rotated, they should be kept on the same side of the car so that they revolve in the same direction as prior to rotation.
- Hitting curbs or potholes can damage the tires and/or wheels permanently.

### **Flat spots**

All tires become warm during use. After cooling, when the vehicle is parked, the tires have a tendency to distort slightly, forming flat spots. These flat spots can cause vibrations similar to the vibrations caused by unbalanced wheels. They do, however, disappear when the tire warms up. The degree to which the flat spots form depends on the type of cord used in the tire. Remember that, in cold weather, it takes longer for the tire to warm up and consequently longer for the flat spot to disappear.

**CAUTION:** The car must not be driven with wheels of different dimensions. The use of different size wheels can seriously damage your car's transmission.

pg. 77 Wheels and tires (cont.)

### **Snow chains**

Snow tire chains can be used on your Volvo with the following restrictions:

- Snow chains should be installed on front wheels only. Use only Volvo approved snow chains.
- Snow chains may be mounted on tire dimension 195/65R15. Tire dimension 205/55R16 requires a special type of snow chain. Consult your Volvo retailer. Snow chains may not be used on 205/55R16 tires.

If accessory, aftermarket or "custom" tires and wheels are installed and are of a size different than the original tires and wheels, chains in some cases CANNOT be used. Snow chains cannot be used on those turbo-charged models fitted with all-season tires 225/50R16 or 225/45R17 or 225/40R18. Sufficient clearances between chains and brakes, suspension and body components must be maintained.

- Some strap-on type chains will interfere with brake components and therefore CANNOT be used.

Consult your Volvo retailer for additional snow chain information.

### **CAUTION:**

- Check local regulations regarding the use of snow chains before installing.
- Always follow the chains manufacturer's installation instructions carefully. Install chains as tightly as possible and re-tighten periodically.
- Never exceed the chain manufacturer's specified maximum speed limit. (Under no circumstances should that limit be higher than 30 mph (45 km/h).
- Avoid bumps, holes or sharp turns when driving with snow chains.
- The handling of the vehicle can be adversely affected when driving with chains. Avoid fast or sharp turns as well as locked wheel braking.

### **Snow tires, studded tires \***

#### **Tires for winter use:**

**Owners who live in or regularly commute through areas with sustained periods of snow or icy driving conditions are strongly advised to fit suitable winter tires to help retain the highest degree of traction.**

It is important to install winter tires **on all four wheels** to help retain traction during cornering, braking and accelerating. Failure to do so could reduce traction to an unsafe level or adversely affect handling. Do not mix tires of

different design as this could also negatively affect overall tire road grip. **Volvo recommends 195/65 R15 winter tires on 15" steel wheels on all C70 models including those equipped with 16", 17" or 18" wheels.**

Winter tires wear more quickly on dry roads in warm weather. They should be removed when the winter driving season has ended.

**Studded tires** should be run-in 300-600 miles (500-1000 km) during which the car should be driven as smoothly as possible to give the studs the opportunity to seat properly in the tires. The car tires should have the same rotational direction throughout their entire lifetime. In other words, if you wish to rotate the wheels, make sure that the same wheels are always on the same side of the car.

**NOTE:** Please consult state or local regulations restricting the use of studded winter tires before installing such tires.

\* Where permitted

pg. 78 Wheels and tires (cont.)

### Checking and correcting tire pressure

- Check the tire pressure when refueling.
- The tire pressure should be corrected only when the tires are cold.
- With warm tires, correct only when the pressure is too low. The tire temperature rises after driving just a few miles.

### Vehicle Loading

The tires on your Volvo will perform to specifications at all normal loads when inflated as recommended on the tire information label\* located on the rear facing edge of the passenger's door. This label lists both the tire and vehicle design limits.

Do not load your car beyond the load limits indicated.

\* Please note that the tire information label indicates pressures for both comfort and fuel economy.

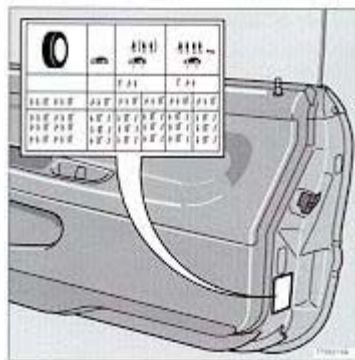

*Tire pressure label*

pg. 79 Wheels and tires (cont.)

### Uniform tire quality grading

**ALL PASSENGER CAR TIRES MUST CONFORM TO FEDERAL SAFETY REQUIREMENTS IN ADDITION TO THESE GRADES**

### TREADWEAR

The treadwear grade is a comparative rating based on the wear rate of the tire when tested under controlled conditions on a specified government test course. For example, a tire graded at 150 would wear one and one half (1 1/2) times as

well on the government course as a tire graded 100. The relative performance of tires depends upon the actual conditions of their use, however, and many depart significantly from the norm due to variation in driving habits, service practices and differences in road characteristics and climate.

### **TRACTION**

The traction grades, from highest to lowest, are AA, A, B, and C, as measured under controlled conditions on specified government test surfaces of asphalt and concrete. A tire marked C may have poor traction performance.

**WARNING!** The traction grade assigned to this tire is based on braking (straight-ahead) traction tests and does not include cornering (turning) traction.

### **TEMPERATURE**

The temperature grades are AA (the highest), A, B, and C, representing the tire's resistance to the generation of heat and its ability to dissipate heat when tested under controlled conditions on a specified indoor laboratory test wheel. Sustained high temperature can cause the material of the tire to degenerate and reduce tire life, and excessive temperature can lead to sudden tire failure. The grade C corresponds to a level of performance which all passenger car tires must meet under the Federal Motor Safety Standard No. 109. Grades B and A represent higher levels of performance on the laboratory test wheel than the minimum required by law.

**WARNING!** The temperature grade for this tire is established for a tire that is properly inflated and not overloaded. Excessive speed, underinflation, or excessive loading, either separately or in combination, can cause heat buildup and possible tire failure.



[Contents](#) | [Top of Page](#)

## Chapter 6 - In case of emergency

pg. 81 In case of an emergency

### In case of an emergency

Even if you maintain your car in good running condition, there is always the possibility that something might go wrong and prevent you from driving, such as a punctured tire, blown fuse or bulb, etc. For additional information, see section "ON CALL Road Assistance".

[Wheel changing](#) [82-83](#)

[Spare tire](#) [84](#)

[Replacing bulbs](#) [85-90](#)

[Replacing fuses](#) [91-93](#)

[Installation of accessories](#) [94](#)

[Replacing wiper blades](#) [95-96](#)

[In case of emergency](#) [97](#)

pg. 82 Wheel changing

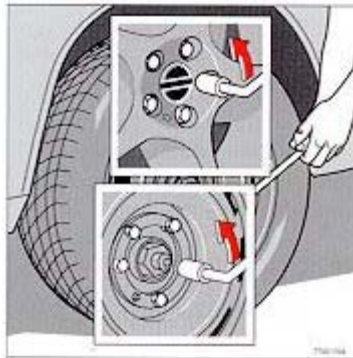

*Loosen wheel bolts*

### Changing a wheel

The spare wheel is located under the carpet on the trunk floor. The jack and crank are secured in the wheel recess.

- Engage the parking brake.
- Put the gear selector in (P)ark (automatic) or in Reverse (manual).
- With the car still on the ground, use the lug wrench to loosen the wheel bolts 1/2 - 1 turn. Turn the bolts counterclockwise to loosen.
- Fold out the crank handle on the jack by pressing the nob on the handle downward. To attach the jack, refer to the illustration on the following page.

**NOTE:** To avoid excessive wear and the necessity of rebalancing, mark and reinstall wheels in same location and position as before removal. To lessen the chance of imbalance, each wheel hub is equipped with a guide stud to ensure

that a removed wheel can be reinstalled in its original position (as when changing over to winter tires/wheels).

### CAUTION:

- The car must not be driven with wheels of different dimensions or with a spare tire other than the one that came with the car. The use of different size wheels can seriously damage your car's transmission.

pg. 83 Wheel changing (cont.)



*Jack attachment*

There is a jack attachment located in the center on each side of the car. Position the jack on the bar in the attachment as shown in illustration **A** above and crank while simultaneously guiding the base of the jack to the ground. **The base of the jack must be flat on a level, firm, non-slippery surface. Before raising the car check that the jack is still correctly positioned in the attachment.** Raise the vehicle until both wheels on the side of the car where the jack is attached are lifted off the ground. Unscrew the wheel bolts completely and carefully remove the wheel so as not to damage the thread on the studs.

### Installing the wheel

Clean the contact surfaces on the wheel and hub. Lift the wheel and place it on the hub. Make sure that you align the wheel with the guide stud on the wheel hub prior to installation. Install the wheel bolts crosswise (see illustration) and tighten by turning lightly clockwise. Lower the vehicle to the ground and alternately tighten the nuts to 81 ft. lbs. (110 Nm). Install the wheel cap (where applicable).



*Correct tightening order for wheel bolts*

### WARNING!

- The jack's attachment must engage the bar in the jack attachment (A). The car's weight must not rest on the jack's attachment (B).
- Be sure the jack is on a firm, level, non-slippery surface.
- Never allow any part of your body to be extended under a car supported by a jack.
- Use the jack intended for the car when replacing a wheel. For any other job, use stands to support the end of the car being worked on.
- Apply the parking brake, select position P (automatic transmission) or Reverse gear (manual transmission).
- Block the wheels standing on the ground, use rigid wooden blocks or large stones.
- The jack should be kept well-greased.

**CAUTION:** Correct tightening torque on wheel bolts must be observed. The wheel bolts should never be greased or lubricated. The extended, chromed wheel bolts must not be used with steel rims, as they make it impossible to fit the hub caps.

pg. 84 Spare tire



### **Temporary Spare (certain models)**

The spare tire of your car is what is called a "Temporary Spare". It has the following designation: T115/70 R15 or T125/90R15.

Recommended tire pressure (see decal on fuel filler flap) should be maintained irrespective of which position on the car the Temporary Spare tire is used on.

In the event of damage to this tire a new one can be purchased from your Volvo retailer.

**CAUTION:** The car must not be driven with wheels of different dimensions or with a spare tire other than the one that came with the car. The use of different size wheels can seriously damage your car's transmission.

### **WARNING!**

Current legislation prohibits the use of the "Temporary Spare" tire other than as a temporary replacement for a punctured tire. In other words, it must be replaced as soon as possible by a standard tire. Roadholding, etc., may be affected with the "Temporary Spare" in use. Do not, therefore, exceed 50 mph (80 km/h).



[Contents](#) | [Top of Page](#)



## Car care

Car care includes not only maintaining the appearance of the car, but also protecting the car exterior from the effects of air pollution, rain, mud or road salt. The paintwork should also be touched up immediately, if damaged, to prevent rust formation.

### Paint touch-up 100-101

#### Washing 102

#### Automatic car washing, Polishing and waxing 103

#### Cleaning the upholstery 104

## Paint touch-up

Paint damage requires immediate attention to avoid rusting. Make it a habit to check the finish regularly - when washing the car for instance. Touch up if necessary.

Paint repairs require special equipment and skill. Contact your Volvo retailer for any extensive damage.

Minor scratches can be repaired by using Volvo touch-up paint.

**NOTE:** When ordering touch-up paint from your Volvo retailer, use the paint code indicated on the model plate. The plate is located in the engine compartment, on the inside of the left front fender.



## Minor stone chips and scratches

Material:

Primer - can

Paint - touch-up bottle

Brush

Masking tape

**NOTE:** When touching up the car, it should be clean and dry. The surface temperature should be above 60° F (15° C).

## Scars on the surface

If the stone chip has not penetrated down to the metal and undamaged layer of paint remains, the touch-up paint can be applied as soon as the spot has been cleaned.

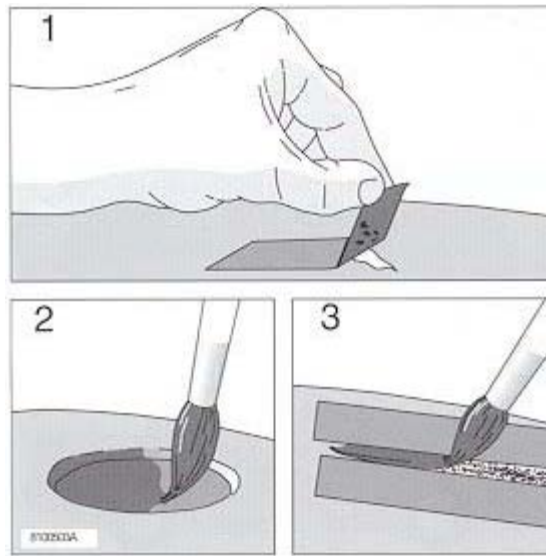

## Deep scratches

1. Place a strip of masking tape over the damaged surface. Pull the tape off so that any loose flakes of paint adhere to it.
2. Thoroughly mix the primer and apply it with a small brush.  
When the primer surface is dry, the paint can be applied using a brush. Mix the paint thoroughly; apply several thin paint coats and let dry after each application.
3. If there is a longer scratch, you may want to protect surrounding paint by masking it off.



### **Service - an investment**

An investment which will pay dividends in the form of improved reliability, durability, and resale value.

<u>Label information</u>	<u>106</u>
<u>Maintenance service, Warranty</u>	<u>107</u>
<u>Maintenance schedule</u>	<u>108-109</u>
<u>Servicing</u>	<u>110-111</u>
<u>Fuel/emissions systems</u>	<u>112</u>
<u>Lubrication</u>	<u>113</u>
<u>Engine oil</u>	<u>114-115</u>
<u>Power steering fluid, Brake/clutch system fluid reservoir</u>	<u>116</u>
<u>Automatic transmission fluid</u>	<u>117</u>
<u>Drive belt</u>	<u>118</u>
<u>Windshield washer nozzle, Washer fluid reservoir</u>	<u>119</u>
<u>Coolant</u>	<u>120</u>
<u>Engine compartment</u>	<u>121</u>
<u>Battery maintenance</u>	<u>122</u>

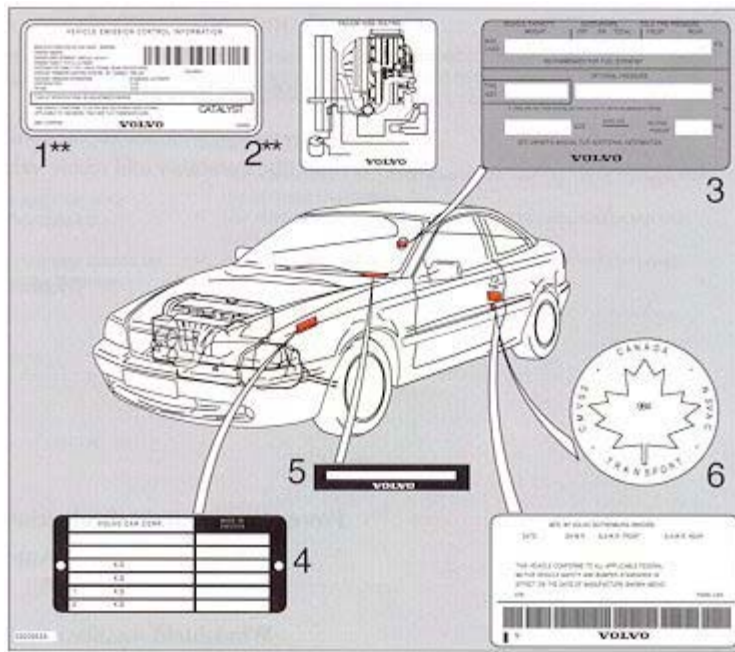

### 1 Vehicle Emission Control Information

Your Volvo is designed to meet all applicable emission standards, as evidenced by the certification label on the underside of the hood. For further information regarding these regulations, please consult your Volvo retailer.

### 2 Vacuum hose routing

(underside of hood)

### 3 Loads and Tire Pressures

(on rear edge of passenger's door)

### 4 Model plate

Vehicle Identification Number (VIN). Codes for color and upholstery, etc. The plate is located in the engine compartment, on the inside of left front fender.

### 5 Vehicle Identification Number (VIN) \*

The VIN plate is located on the top left surface of the dashboard. The VIN is also stamped on the right hand door pillar.

### 6 Federal Motor Vehicle Safety Standards (FMVSS) specifications (USA) and Ministry of Transport (CMVSS) Standards (Canada)

Your Volvo is designed to meet all applicable safety standards, as evidenced by the certification label on the facing side of the driver's door. For further information regarding these regulations, please consult your Volvo retailer.

\* The Vehicle Identification Number (VIN) should always be quoted in all correspondence concerning your vehicle with the retailer and when ordering parts.

\*\* These decals are located on the underside of the hood.

**All specifications are subject to change without notice.**

pg. 107 Maintenance service, Warranty

## Maintenance service

Volvo advises you to follow the service program which is outlined in the "Maintenance Records Manual". This maintenance program contains inspections and services necessary for the proper function of your car. The maintenance services contain several checks which require special instruments and tools and therefore must be performed by a qualified technician. To keep your Volvo in top condition, specify time tested and proven Genuine Volvo Parts and Accessories.

## **The Federal Clean Air Act - U.S.**

The Clean Air Act requires vehicle manufacturers to furnish written instructions to the ultimate purchaser to assure the proper functioning of those components that control emissions. [The maintenance instructions listed in the "Servicing" section](#) of this Manual represent the minimum maintenance required. These services are not covered by the warranty. You will be required to pay for labor and material used. Refer to your Warranty booklet for further details.

## **Maintenance services**

Your Volvo has passed several major inspections before being delivered to you, according to Volvo specifications. The maintenance services outlined in this book should be performed as indicated. The extended maintenance service intervals make it even more advisable to follow this program. Inspection and service should also be performed any time a malfunction is observed or suspected. It is recommended that receipts for vehicle emission services be retained in the event that questions arise concerning maintenance. See your "Maintenance Records Manual".

## **Applicable warranties - U.S.**

In accordance with U.S. Federal Regulations, the following list of applicable U.S. warranties is provided. For Canadian specification vehicles, see your separate warranty booklet.

- New Car Limited Warranty
- Parts and Accessories Limited Warranty
- Corrosion Protection Limited Warranty
- Seatbelt and Supplemental Restraint Systems Limited Warranty
- Emission Design and Defect Warranty
- Emission Performance Warranty

These are the Federal warranties; other warranties are provided as required by state law. Refer to your separate Warranty booklet for detailed information concerning each of the warranties.



[Contents](#) | [Top of Page](#)

# Chapter 9 - Specifications

pg. 123 Specifications

## Specifications

This chapter contains facts and figures pertaining to the technical specifications of your car.

[Oil/Fluids specifications](#) [124](#)

[Engine specifications](#) [125](#)

[Cooling/fuel/distributor ignition systems](#) [126](#)

[Front/rear suspensions](#) [126](#)

[Transmission, Capacities, Vehicle loading](#) [127](#)

[Electrical system/bulbs](#) [128](#)

[Dimensions and weights](#) [129](#)

[Service manuals, Road assistance](#) [130](#)

pg. 124 Oil/fluid specifications

## Oil quality

### Meeting API specification SG, SG/CD, SH or Energy Conserving (EC) II

For best fuel economy and engine protection, consult with your authorized Volvo retailer for recommended oils. Oil with a different quality rating may not provide adequate engine protection. Synthetic oils complying with oil quality requirements are recommended for : driving in areas of sustained temperature extremes (hot or cold), when towing a trailer over long distances or for prolonged driving in mountainous areas.

**Extra oil additives must not be used unless advised by an authorized Volvo retailer.**

**NOTE:** SAE 15 W-40 oil should only be used in extreme operating conditions such as trailer towing in sustained ambient temperatures over 104° F (40° C). However, SAE 10W-30 synthetic oil would be a better alternative in such conditions.

**SAE 15W-30 should not be used under normal operating conditions.**

## Viscosity (stable ambient temperatures):

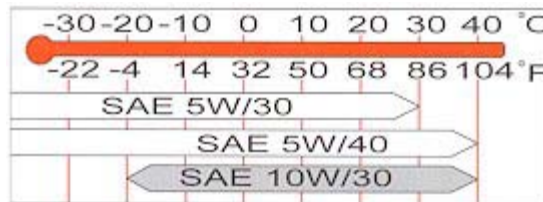

<b>Engine oil</b>	<b>Quality:</b> Meeting API specification SG or SH	<b>Capacity</b> (incl. filter): 6.1 US qts. (5.8 liters)*
<b>Automatic transmission fluid</b>	<b>Quality:</b> ATF Dexron IIE/ III and Mercon	<b>Capacity:</b> 8 US qts. (7.6 liters)

<b>Manual transmission fluid</b>	<b>Quality:</b> Volvo synthetic gearbox oil 1161423	<b>Capacity:</b> 2.2 US qts (2.1 liters)
<b>Power steering fluid</b>	<b>Quality:</b> ATF	<b>Capacity:</b> 0.85 US qts. (0.8 liters)
<b>Brake fluid</b>	<b>Quality:</b> DOT 4+	<b>Capacity:</b> 0.64 US qts. (0.6 liters)

\* Add 0.95 qts. (0.9 liters) if the oil cooler has been drained

**All specifications are subject to change without notice.**

pg. 125 Engine

## Engine

Liquid-cooled gasoline, 5-cylinder, in-line engine. Aluminum alloy cylinder block with cast-iron cylinder liners cast directly into block. Aluminum alloy cylinder head with double overhead camshafts and separate intake and outlet channels.

Engine lubrication is provided by an eccentric pump driven from the crankshaft. Full-flow type oil filter. Exhaust emission control accomplished by multiport fuel injection, heated oxygen sensor(s) and three-way catalytic converter.

### Designation: Volvo B 5254 T

Output	190 hp at 5100 rpm (142 kw 85 rps)
Max torque	199 ft. lbs. at 1800-4998 rpm (270 Nm/30-83.3 rps)
Number of cylinders	5
Bore	3.27" (83 mm)
Stroke	3.54" (90 mm)
Displacement	2.4 liters
Compression ratio	9.0:1
Number of valves	20
Valve clearance	Self-adjusting

### Designation: Volvo B 5234 T3

Output	236 hp at 5100 rpm (176 kw/85 rps)
Max torque	243 ft. lbs. at 2700-5100 rpm (330 Nm/45-85 rps)
Number of cylinders	5
Bore	3.19" (81 mm)
Stroke	3.54" (90 mm)
Displacement	2.3 liters
Compression ratio	8.5:1
Number of valves	20
Valve clearance	Self-adjusting

**All specifications are subject to change without notice.**



[Contents](#) | [Top of Page](#)

# Chapter 10 - Audio systems

pg. 131 Audio systems

## Audio systems

This chapter describes the audio system in your car.

[SC-813](#) [132](#)

[SC-816](#) [145](#)

[SC-900](#) [161](#)

[General Information](#) [184](#)

pg. 132 Audio system SC-813 (certain models)

The following pages describe the use of your SC-813 Cassette radio and CD remote control



- |                                  |  |  |
|----------------------------------|--|--|
| 1. On/off (push)                 | 11. Dolby B NR button                      | 19. Cassette slot  |
| 2.                               | 12. Cassette eject                         | 20. Display  |
| 3. Volume (turn)                 | 13. Not in use                             | 21. Waveband selector (AM)   |
| 4. Pause/Mute (push)             | 14. Scan                                   | 22. Waveband selectors (FM)  |
| 5. Balance (pull)                | 15. Auto seek memory                       | 23. Anti-theft LED   |
| 6. Active Sound Control          | 16.  |  |
| 7. CD changer selector           | 17. Seek tuning up/down                    | <b>TP</b> = Applicable only in Tape Mode                                   |
| 8.                               | 18. <b>TP</b> -Next/Previous song          | <b>CD</b> = Applicable only when in CD mode and connected to a CD changer. |
| 9. Tape mode selector            | 19. <b>CD</b> -Next UP/Previous DOWN track |  |
| 10. Tape direction selector PROG | 20.  |  |
| 11. Bass control                 | 21. Manual tuning                          |  |
| 12. Treble control               | 22. <b>TP</b> -fast forward/Rewind         |  |
| 13. Fader control                | 23. <b>CD</b> -Music search UP/DOWN        |  |
| 14.                              | 24. RND button                             |  |
| 15. Preset buttons               |  |  |
| 16. CD-Disc No. selector         |  |  |
| 17. PROG - Reversing             |  |  |



the tape

pg. 133 Anti-theft code



## Anti-theft code

The radio features anti-theft circuitry. If the set is removed from the vehicle or if the battery power is disconnected, a special code must be entered to enable operation of the set.

**Refer to the radio code card supplied with your vehicle or ask your retailer for the correct code.**

When the car is parked with the ignition key removed, the anti-theft LED will flash.



## To enter the code

After installation or when the set has been disconnected from power, the set displays "COdE" when it is switched on. Enter the 4-digit code using the preset buttons. If the correct code is entered, "on" is displayed and the set is ready to use.

If you enter an incorrect code you must enter the correct code again from the beginning.



## Incorrect code

If an incorrect code has been entered "rPt" is displayed. Enter the correct code.

After three unsuccessful coding attempts the set will lock and remain locked for two hours. "OFF" is displayed.

## During this waiting period:

- the battery must be connected
- the ignition key must be turned to position I
- the unit must be turned on

Make sure the headlights are turned off to help prevent battery drain (please refer to [page 24 for information on turning the headlights off](#)). Enter the code again once this time has elapsed.



[Contents](#) | [Top of Page](#)

**A**

[ABS](#).....17  
[Air conditioning](#).....35  
[Air mix](#).....33  
[Air vents](#).....33  
[Airbag \(SIPS\)](#).....8  
[Airbag \(SRS\)](#).....4  
[Alarm](#).....44  
[Ambient temperature sensor](#).....25  
[Anti-lock Brake System \(ABS\)](#).....17,19,70  
[Ashtrays](#).....31  
 Audio systems  
     [General information](#).....184  
     [SC-813](#).....132  
     [SC-816](#).....145  
     [SC-900](#).....161  
[Auto-dim \(rear-view mirror\)](#).....48  
[Automatic car washing](#).....103  
[Automatic daytime running lights](#).....24  
[Automatic transmission](#).....61,62,63,127  
     [Driving mode selector](#).....62  
[Automatic transmission fluid](#).....117,124

**B**

[Battery](#).....72,128  
[Battery drain - avoiding](#).....54  
[Battery maintenance](#).....122  
[Booster cushion](#).....11  
[Brake failure warning light](#).....17,18  
[Brake fluid](#).....116,124  
[Brake fluid warning light](#).....18  
[Brake system](#).....70  
[Brake warning light](#).....17  
[Break-in period](#).....56  
[Bulb failure warning](#).....17,19  
[Bulbs](#).....128  
[Bulbs - replacing](#).....85

**C**

[Capacities](#).....127  
[Catalytic converter](#).....69  
[Central locking button](#).....36  
[Chains \(snow\)](#).....77  
[Changing a wheel](#).....82  
[Child booster cushion](#).....11  
[Child Restraint Anchorages](#).....9  
[Child safety](#).....11  
[Clock](#).....16  
[Clock - resetting](#).....25  
[Clutch fluid](#).....116  
[Coolant - checking/changing](#).....120  
[Coolant level sensor](#).....19  
[Coolant level warning light](#).....17  
[Cooling system](#).....64,126  
[Courtesy lights - front](#).....49  
[Cruise control](#).....29

**D**

[Daytime running lights](#).....20,24  
[Demister - rear window](#).....23  
[Dimensions](#).....129  
[Distributor ignition system](#).....126  
[Doors and locks](#).....42  
[Drive belt](#).....118  
[Driving economy](#).....58

**E**

<a href="#">ECC - Electronic Climate Control</a>	<a href="#">34, 35</a>
<a href="#">Electrical system</a>	<a href="#">64, 128</a>
<a href="#">Electrically heated front seats</a>	<a href="#">30</a>
<a href="#">Electrically operated front seats</a>	<a href="#">46, 47</a>
<a href="#">Electrically operated sun roof</a>	<a href="#">41</a>
<a href="#">Electrically-operated windows</a>	<a href="#">36</a>
<a href="#">Emergency towing</a>	<a href="#">66</a>
<a href="#">Emergency warning flashers</a>	<a href="#">23</a>
<a href="#">Engine</a>	<a href="#">125</a>
<a href="#">Engine compartment</a>	<a href="#">121</a>
<a href="#">Engine oil</a>	<a href="#">114, 115, 124</a>
<a href="#">Engine oil - checking/changing</a>	<a href="#">114</a>
<a href="#">Engine oil pressure</a>	<a href="#">17</a>

## **F**

<a href="#">Fog light - rear</a>	<a href="#">17, 22</a>
<a href="#">Fog lights - front</a>	<a href="#">22</a>
<a href="#">Front courtesy lights</a>	<a href="#">49</a>
<a href="#">Front fog lights</a>	<a href="#">22</a>
<a href="#">Front seats</a>	<a href="#">46</a>
<a href="#">Front seats - heated</a>	<a href="#">30</a>
<a href="#">Front seats - memory function</a>	<a href="#">46</a>
<a href="#">Front suspension</a>	<a href="#">126</a>
<a href="#">Fuel gauge</a>	<a href="#">16</a>
<a href="#">Fuel level</a>	<a href="#">17</a>
<a href="#">Fuel requirements</a>	<a href="#">56</a>
<a href="#">Fuel system</a>	<a href="#">126</a>
<a href="#">Fuel tank cover - opening</a>	<a href="#">15, 37, 57</a>
<a href="#">    opening manually</a>	<a href="#">97</a>
<a href="#">Fuses</a>	<a href="#">91, 92, 93</a>
<a href="#">Fuses - replacing</a>	<a href="#">91</a>

## **G**

<a href="#">Gas tank cover - opening</a>	<a href="#">15, 37, 57</a>
<a href="#">    opening manually</a>	<a href="#">97</a>
<a href="#">Generator</a>	<a href="#">17, 128</a>
<a href="#">Generator warning light</a>	<a href="#">18</a>

## **H**

<a href="#">Hand brake</a>	<a href="#">30</a>
<a href="#">Handling</a>	<a href="#">65</a>
<a href="#">Hazard warning flashers</a>	<a href="#">23</a>
<a href="#">Headlight wiper blades - replacing</a>	<a href="#">96</a>
<a href="#">Headlights</a>	<a href="#">20</a>
<a href="#">Heated front seats</a>	<a href="#">30</a>
<a href="#">Heated side-view mirrors</a>	<a href="#">23</a>
<a href="#">Heating</a>	<a href="#">35</a>
<a href="#">Heating and air conditioning</a>	<a href="#">33</a>
<a href="#">High beams</a>	<a href="#">17</a>
<a href="#">Hoisting the car</a>	<a href="#">110</a>
<a href="#">Hood</a>	<a href="#">51</a>

## **I**

<a href="#">Ignition switch</a>	<a href="#">21</a>
<a href="#">Instrument illumination</a>	<a href="#">22</a>
<a href="#">Instruments</a>	<a href="#">14, 15</a>

## **J**

<a href="#">Jack</a>	<a href="#">53, 82, 83</a>
<a href="#">Jump starting</a>	<a href="#">68</a>

## **K**

<a href="#">Keyless entry system</a>	<a href="#">43</a>
<a href="#">Keylock</a>	<a href="#">59</a>
<a href="#">Keys</a>	<a href="#">42</a>
<a href="#">Kick-down</a>	<a href="#">61</a>

## **L**

<a href="#">Label information</a>	<a href="#">106</a>
<a href="#">Lifting the car</a>	<a href="#">110</a>
<a href="#">Locks</a>	<a href="#">42</a>
<a href="#">Long distance trips</a>	<a href="#">73</a>
<a href="#">Long load storage</a>	<a href="#">50</a>
<a href="#">Lubrication</a>	<a href="#">113</a>

## M

<a href="#">Maintenance schedule</a>	<a href="#">108</a>
<a href="#">Maintenance service</a>	<a href="#">107</a>
<a href="#">Malfunction indicator lamp</a>	<a href="#">17, 18</a>
<a href="#">Manual transmission</a>	<a href="#">60, 127</a>
<a href="#">Manual transmission fluid</a>	<a href="#">124</a>
<a href="#">Memory function - front seats</a>	<a href="#">46</a>
<a href="#">Mirrors - rear/side view</a>	<a href="#">48</a>

## O

<a href="#">Occupant safety</a>	<a href="#">12</a>
<a href="#">Octane rating</a>	<a href="#">57</a>
<a href="#">Odometer</a>	<a href="#">16</a>
<a href="#">Oil (engine)</a>	<a href="#">114, 115, 124</a>
<a href="#">Oil pressure warning light</a>	<a href="#">18</a>
<a href="#">On-call</a>	<a href="#">130</a>

## P

<a href="#">Paint touch-up</a>	<a href="#">100</a>
<a href="#">Parking brake</a>	<a href="#">17, 30</a>
<a href="#">Parking brake reminder light</a>	<a href="#">18</a>
<a href="#">Parking lights</a>	<a href="#">20</a>
<a href="#">Polishing</a>	<a href="#">103</a>
<a href="#">Power seats</a>	<a href="#">46, 47</a>
<a href="#">Power steering fluid</a>	<a href="#">116, 124</a>

## R

Radio	
<a href="#">General information</a>	<a href="#">184</a>
<a href="#">SC-813</a>	<a href="#">132</a>
<a href="#">SC-816</a>	<a href="#">145</a>
<a href="#">SC-900</a>	<a href="#">161</a>
<a href="#">Radio Data System - RDS</a>	<a href="#">166</a>
<a href="#">Reading lights</a>	<a href="#">49</a>
<a href="#">Rear (side) windows - opening</a>	<a href="#">37</a>
<a href="#">Rear fog light</a>	<a href="#">17, 22</a>
<a href="#">Rear suspension</a>	<a href="#">126</a>
<a href="#">Rear window demister</a>	<a href="#">23</a>
<a href="#">Rear/side-view mirrors</a>	<a href="#">48</a>
<a href="#">Refueling</a>	<a href="#">57</a>
<a href="#">Remote control (central locking system)</a>	<a href="#">43</a>
<a href="#">Remote keyless entry system</a>	<a href="#">43</a>
<a href="#">Replacing bulbs</a>	<a href="#">85, 86, 87, 88, 89, 90</a>
<a href="#">Replacing fuses</a>	<a href="#">91</a>
<a href="#">Reporting Safety Defects</a>	<a href="#">12</a>
<a href="#">Road Assistance</a>	<a href="#">130</a>
<a href="#">Roadholding</a>	<a href="#">65</a>
<a href="#">Roof rails/racks</a>	<a href="#">65</a>

## S

<a href="#">Safety defects (reporting)</a>	<a href="#">12</a>
<a href="#">Seat belt maintenance</a>	<a href="#">12</a>
<a href="#">Seat belts</a>	<a href="#">2, 3, 10</a>
<a href="#">Automatic Locking Retractor</a>	<a href="#">10</a>
<a href="#">Emergency Locking Retractor</a>	<a href="#">10</a>
<a href="#">Seat belts - cleaning</a>	<a href="#">104</a>
<a href="#">Seats</a>	<a href="#">46</a>
<a href="#">Seats - heated</a>	<a href="#">30</a>
<a href="#">Service reminder indicator</a>	<a href="#">17, 19</a>
<a href="#">Servicing</a>	<a href="#">110, 111, 112</a>
<a href="#">Shift lock</a>	<a href="#">59, 61</a>
<a href="#">Shiftlock release (override)</a>	<a href="#">97</a>
<a href="#">Side Impact Protection System (SIPS)</a>	<a href="#">8</a>
<a href="#">Side-view mirrors - heated</a>	<a href="#">23</a>

<a href="#">SIPS</a>	<a href="#">8</a>
<a href="#">Snow chains</a>	<a href="#">77</a>
<a href="#">Snow tires</a>	<a href="#">77</a>
<a href="#">Spare tire</a>	<a href="#">53, 84</a>
<a href="#">Spark plugs</a>	<a href="#">126</a>
<a href="#">Spark plugs - replacing</a>	<a href="#">110</a>
<a href="#">Specifications</a>	<a href="#">123</a>
<a href="#">SRS</a>	<a href="#">5, 6, 7</a>
<a href="#">SRS (airbag)</a>	<a href="#">4</a>
<a href="#">SRS diagnostic system</a>	<a href="#">19</a>
<a href="#">SRS warning light</a>	<a href="#">5, 17, 19</a>
<a href="#">Starting the engine</a>	<a href="#">59</a>
<a href="#">Steering wheel adjustment</a>	<a href="#">32</a>
<a href="#">Steering wheel lock</a>	<a href="#">21</a>
<a href="#">Storage compartments</a>	<a href="#">40</a>
<a href="#">Studded tires</a>	<a href="#">77</a>
<a href="#">Sun roof</a>	<a href="#">23, 41</a>
<a href="#">Supplemental Restraint System (SRS)</a>	<a href="#">4</a>

## T

<a href="#">Tachometer</a>	<a href="#">16</a>
<a href="#">Temperature gauge</a>	<a href="#">16</a>
<a href="#">Temporary spare tire</a>	<a href="#">84</a>
<a href="#">Three-way catalytic converter</a>	<a href="#">69</a>
<a href="#">Tire pressure</a>	<a href="#">78</a>
<a href="#">Tires - changing</a>	<a href="#">82</a>
<a href="#">Towing</a>	<a href="#">66, 67</a>
<a href="#">Towing a trailer</a>	<a href="#">71</a>
<a href="#">Traction Control System (TRACS)</a>	<a href="#">17, 19, 23</a>
<a href="#">Trailer towing</a>	<a href="#">71</a>
<a href="#">Trip computer</a>	<a href="#">23, 26, 27, 28</a>
<a href="#">Trip odometer</a>	<a href="#">16</a>
<a href="#">Trunk - opening/locking</a>	<a href="#">52</a>
<a href="#">Trunk light</a>	<a href="#">53</a>
<a href="#">Turn signals</a>	<a href="#">17, 20</a>

## U

<a href="#">Uniform tire quality grading</a>	<a href="#">79</a>
<a href="#">Upholstery - cleaning</a>	<a href="#">104</a>

## V

<a href="#">Vanity mirrors</a>	<a href="#">49</a>
<a href="#">Vehicle Identification Number (VIN)</a>	<a href="#">106</a>
<a href="#">Vehicle loading</a>	<a href="#">127</a>
<a href="#">Volvo On Call</a>	<a href="#">130</a>

## W

<a href="#">Warning flashers</a>	<a href="#">23</a>
<a href="#">Warning lights</a>	<a href="#">18, 19</a>
<a href="#">Warranty</a>	<a href="#">107</a>
<a href="#">Washer fluid level</a>	<a href="#">17</a>
<a href="#">Washer fluid reservoir</a>	<a href="#">119</a>
<a href="#">Washing</a>	<a href="#">102</a>
<a href="#">Waxing</a>	<a href="#">103</a>
<a href="#">Weights</a>	<a href="#">129</a>
<a href="#">Wheel changing</a>	<a href="#">82, 83</a>
<a href="#">Wheels and tires</a>	<a href="#">76</a>
<a href="#">Windows - electrically-operated</a>	<a href="#">36</a>
<a href="#">Windshield washer nozzles</a>	<a href="#">119</a>
<a href="#">Windshield washers/wipers</a>	<a href="#">21</a>
<a href="#">Windshield wiper blades - replacing</a>	<a href="#">95</a>
<a href="#">Winter driving</a>	<a href="#">72</a>

