

2003 VOLVO S40 & V40

This manual deals with the operation and care of your Volvo.

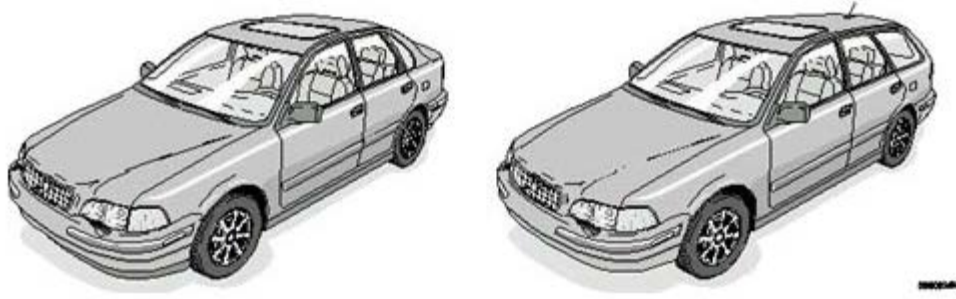

Welcome to the worldwide family of Volvo owners. We trust that you will enjoy many years of safe driving in your Volvo, an automobile designed with your safety and comfort in mind. To help ensure your satisfaction with this vehicle, we encourage you to familiarize yourself with the equipment descriptions, operating instructions and maintenance requirements/recommendations in this manual. We also urge you and your passengers to wear seat belts at all times in this (or any other) automobile. And, of course, please do not operate a vehicle if you may be affected by alcohol, medication or any impairment that could hinder your ability to drive.

Your Volvo is designed to meet all applicable safety and emission standards, as evidenced by the certification labels attached to the driver's door opening and on the left wheel housing in the engine compartment.

For further information please contact your retailer, or:

In the USA:

Volvo Cars of North America
Customer Relations
P.O. Box 914
Rockleigh, New Jersey 07647-0914
800-458-1552

In the Canada:

Volvo Cars of Canada. Ltd.
175 Gordon Baker Road
Willowdale, Ontario M2H 2N7
800-663-8255

We also invite you to visit our home page on the Internet at:

<http://www.volvocars.com>

Contents

Contents

[Chapter 1 - Occupant safety](#)

[Chapter 2 - Instruments, switches and controls](#)

[Chapter 3 - Body and interior](#)

[Chapter 4 - Starting and driving](#)

[Chapter 5 - Wheels and tires](#)

[Chapter 6 - In case of an emergency](#)

[Chapter 7 - Car care](#)

[Chapter 8 - Volvo Service](#)

[Chapter 9 - Specifications](#)

[Chapter 10 - Audio systems](#)

[Index](#)

[Back Cover](#)

General information

Important

Before you operate your car for the first time please familiarize yourself with the engine oil consumption information and refueling recommendations on [pages 62 and 63](#). You should also be familiar with the information in the first four chapters of this manual.

Information contained in the balance of the manual is extremely useful and should be read after operating the vehicle for the first time.

The manual is structured so that it can be used for reference. For this reason, it should be kept in the car for ready access.

Do not export your Volvo to another country before investigating that country's applicable safety and exhaust emission requirements. In some cases it may be difficult or impossible to comply with these requirements. Modifications to the emission control system(s) may render your Volvo not certifiable for legal operation in the U.S., Canada and other countries.

All information, illustrations and specifications contained in this manual are based on the latest product information available at the time of publication. Please note that some vehicles may be equipped differently, depending on special legal requirements and that optional equipment described in this manual may not be available in all markets.

Volvo reserves the right to make model changes at any time, or to change specifications or design, without notice and without incurring obligation.

CALIFORNIA Proposition 65 Warning

WARNING! Engine exhaust, some of its constituents, and certain vehicle components contain or emit chemicals known to the state of California to cause cancer, and birth defects or other reproductive harm. In addition, certain fluids contained in vehicles and certain products of component wear contain or emit chemicals known to the State of California to cause cancer, and birth defects or other reproductive harm.

Shiftlock

When your car is parked, the gear selector is locked in the (P)ark position. To release the selector from this position, turn the ignition key to position II (or start the engine), depress the brake pedal, press the button on the front of the gear selector knob and move the selector from (P)ark.

If it is necessary to manually override the shiftlock system:

- Turn the starting (ignition) key to position I
- Press firmly on the "SHIFTLOCK OVERRIDE" button located at the base of the gear selector
- While holding the override button down, press the button on the front of the gear selector
- Move the selector from the (P)ark position.

Keylock

When you switch off the ignition, the gear selector must be in the (P)ark position before the key can be removed.

Anti-lock Brake System (ABS)

The ABS system in your car performs a self-diagnostic test when the vehicle first reaches the speed of approximately 4 mph (6 km/h). The brake pedal will pulsate several times and a sound may be audible from the ABS control module. This is normal.

Fuel filler door

When you lock the doors, the fuel filler door also locks, with a delay of 10 minutes. When all doors are unlocked, the fuel filler door is also unlocked. Your key, keyless remote, and the door lock button in the driver's door control pod will all unlock the fuel filler door. To open the unlocked fuel filler door, press at the forward edge of the door. See [pages 42](#) for information about locking and unlocking features.

© 2002 Volvo Cars of North America LLC.

Volvo and the environment

Volvo is committed to the well being of our customers. As a natural part of this commitment, we care about the environment in which we all live. Caring for the environment means an everyday involvement in reducing our environmental impact.

Volvo's environmental activities are based on a holistic view, which means we consider the overall environmental impact of a product throughout its complete life cycle. In this context, design, production, product use, and recycling are all important considerations.

In production, Volvo has partly or completely phased out several chemicals including freons, lead chromates, naphthanates, asbestos, mercury and cadmium; and reduced the amount of chemicals used in our plants 50% since 1991.

In use, Volvo was the first in the world to introduce into production a three-way catalytic converter with a Lambda sond, now called oxygen sensor, in 1976. The current version of this highly efficient system reduces emissions of harmful substances (CO, HC, NOx) from the exhaust pipe by approximately 95% and the search to eliminate the remaining emissions continues. Volvo is the only automobile manufacturer to offer CFC-free retrofit kits for the air conditioning system for all models as far back as the M/Y 1975 240. Advanced electronic engine controls, refined purification systems and cleaner fuels are bringing us closer to our goal.

After Volvo cars and parts have fulfilled their use, recycling is the next critical step in completing the life cycle. The metal content is about 75% of the total weight of a car, which makes the car among the most recycled industrial products. In order to have efficient and well controlled recycling, many Volvo variants have printed dismantling manuals, indicating the weight and material of individual components. For Volvo, all homogeneous plastic parts weighing more than 1.7 oz. (50 grams) are marked with international symbols that indicate how the component is to be sorted for recycling.

In addition to continuous environmental refinement of conventional gasoline-powered internal combustion engines, Volvo is actively looking at advanced technology alternative-fuel vehicles.

When you drive a Volvo, you become our partner in the work to lessen the car's impact on the environment.

To reduce your vehicle's environmental impact, you can:

- Maintain proper air pressure in your tires. Tests have shown decreased fuel economy with improperly inflated tires
- Follow the recommended maintenance schedule in your Warranty and Service Records Information booklet.
- Drive at a constant speed
- See an authorized Volvo retailer as soon as possible for inspection if the check engine (malfunction indicator) lamp illuminates, or stays on after the vehicle has started
- Properly dispose of any vehicle related waste such as used motor oil, used batteries, brake pads, etc.
- When cleaning your car, use Volvo's own car care products, all of which have systematically been adapted to the environment

For additional information regarding the environmental activities in which Volvo Cars of North America, LLC. and Volvo Car Corporation are involved, visit our Internet Home Page at:

<http://www.volvocars.com>



[Top of Page](#)

2 0 0 3
VOLVO
S40 & V40

Chapter 1 - Occupant safety

pg. 1 Occupant safety

Occupant safety

Not wearing a seat belt is like believing "It'll never happen to me!" Volvo, the inventor of the three-point seat belt, urges you and all adult occupants of your car to wear seat belts and ensure that children are properly restrained, using an infant, car or booster seat determined by age, weight and height. Volvo also believes **no child should sit in the front seat of a car and that no one under 4 feet 7 inches (140 cm) should ride as a passenger in the front seat of any vehicle equipped with a passenger side airbag.**

Fact: In every state and province, some type of child-restraint legislation has been passed. Additionally, most states and provinces have already made it mandatory for occupants of a car to use seat belts.

So, urging you to "buckle up" is not just our recommendation - legislation in your state or province may mandate seat belt usage. The few seconds it takes to buckle up may one day allow you to say, "It's a good thing I was wearing my seat belt".



[Seat belts](#) 2

[Volvo SRS](#) 4

[Side Impact Protection System - \(SIPS\) airbag](#) 8

[WHIPS](#) 9

[IC system](#) 10

[Child safety, Booster cushion](#) 11

[Child restraint anchorages](#) 14

[Reporting Safety Defects](#) 16

pg. 2 Seat belts

Seat belts

Always fasten the seat belts before you drive or ride.

Two lights above the rear view mirror will be illuminated for 4-8 seconds after the starting (ignition) key is turned to the driving position. A chime will sound at the same time if the driver has not fastened his or her seat belt. The rear seats are provided with self-retracting inertial reel belts. The front seats are provided with single roller belts with tensioners.

To buckle:

Pull the belt out far enough to insert the latch plate into the buckle until a distinct snapping sound is heard. The seat belt retractor is normally "unlocked" and you can move freely, provided that the shoulder belt is not pulled out too far. The retractor will lock up as follows:

- if the belt is pulled out rapidly
- during braking and acceleration
- if the vehicle is leaning excessively
- when driving in turns

For the seat belt to provide maximum protection in the event of an accident, it must be worn correctly. When wearing the seat belt remember:

- The belt should not be twisted or turned.
- The lap belt must be positioned low on the hips (not pressing against the abdomen).
- The shoulder section of the front seat belts adjusts automatically to the driver's height.

Adjusting the shoulder belt

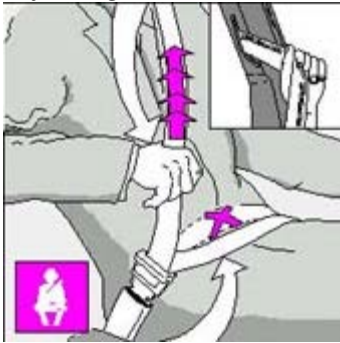

Lap portion of the seat belt should sit low

- Make sure that the shoulder belt is rolled up into its retractor and that the shoulder and lap belts are taut.
- Before exiting the car, check that the seat belt retracts fully after being unbuckled. If necessary, guide the belt back into the retractor slot.

NOTE: Legislation in your state or province may mandate seat belt usage.



During pregnancy

Pregnant women should always wear seat belts. Remember that the belt should always be positioned in such a way as to avoid any possible pressure on the abdomen. The lap portion of the belt should be located low, as shown in the above illustration.

pg. 3 Seat belts, Head restraints

WARNING!

- Never use a seat belt for more than one occupant.
- Never wear the shoulder portion of the belt under the arm, behind the back or otherwise out of position. Such use could cause injury in the event of an accident.
- As the seat belts lose much of their strength when exposed to violent stretching, they should be replaced after any collision, even if they appear to be undamaged.
- Never repair the belt on your own; have this work done by an authorized Volvo retailer only.
- Any device used to induce slack into the shoulder belt portion of the three-point belt system will have a detrimental effect on the amount of protection available to you in the event of a collision.
- The seat back should not be tilted too far back. The shoulder belt must be taut in order to function properly.
- Do not use child safety seats or child booster cushions/backrests in the front passenger's seat. We also recommend that children who have outgrown these devices sit in the rear seat with the seat belt properly fastened.



Rear head restraints

The rear head restraints can be adjusted according to the passenger's height. The restraint should be carefully adjusted to support the occupant's head.

The head restraint can be **raised** by pulling straight up or **lowered** by pressing the catch (1) at the base of the left head restraint support and pushing down.

Removing/replacing the head restraints

When folding the rear seats flat for carrying cargo ([see page 55](#)), head restraints should be fully removed by pulling all the way up, pressing the catch at base of the left support and pulling the head restraint all the way out. Be sure to reinstall and adjust head restraints to their proper position before allowing passengers to occupy the seats.

pg. 4 Volvo SRS

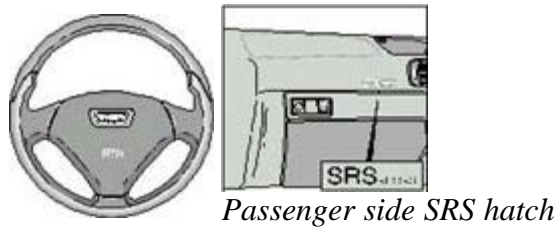

Passenger side SRS hatch

As an enhancement to the three-point seat belt system, your Volvo is equipped with a Supplemental Restraint System (SRS). The Volvo SRS consists of an airbag (2) on both the driver's and passenger's sides and seat belt tensioners in both front door pillars (4). The system is designed to supplement the protection provided by the three-point seat belt system.

The SRS system is indicated by the "SRS" embossed on the steering wheel pad and above the glove compartment, and by decals on both sun visors and on the far right side of the dash.

The airbags are folded and located in the steering wheel hub and above the glove compartment. They are designed to deploy during certain frontal or front-angular collisions, impacts, or decelerations, depending on the crash severity, angle, speed and object impacted. The airbags may also deploy in certain non-frontal collisions where rapid deceleration occurs.

The airbag system includes inflators (1) surrounded by the airbags (2) and front seat belt tensioners for both of the front seats (4). To deploy the system, the sensor (3) activates the gas generators causing the airbags to be inflated with nitrogen gas. As the movement of the seats' occupants compresses the airbags, some of the gas is expelled at a controlled rate to provide better cushioning. Both seat belt tensioners also deploy, minimizing any seat belt slack.

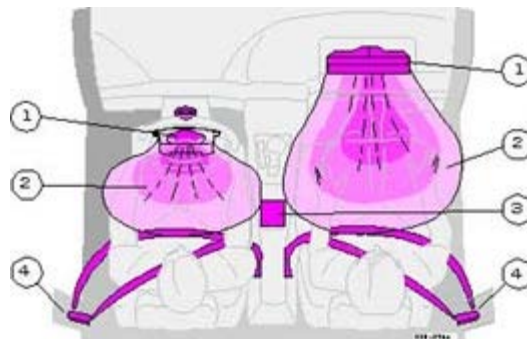

The entire process, including inflation and deflation of the airbags, takes approximately two-tenths of a second.

WARNING!

- As its name implies, SRS is designed to be a SUPPLEMENT to - not a replacement for - the three-point belt system. For maximum protection, wear seat belts at all times. Be aware that no system can prevent all possible injuries that may occur in an accident.
- When installing any optional equipment, make sure that the SRS system is not damaged. Do not attempt to service any component of the SRS yourself. Attempting to do so may result in serious personal injury. If a problem arises, take your car to the nearest authorized Volvo retailer for inspection as soon as possible.

pg. 5 Volvo SRS



A self-diagnostic system incorporated into the sensor monitors the SRS, SIPS and IC-system. If a fault is detected, the "SRS" warning light will illuminate. The light is included in the warning/indicator light cluster in the instrument panel. Normally, the SRS warning lamp should light up when the ignition is switched on and should go out after 5 seconds or when the engine is started. Check that this light is functioning properly every time the car is started.

The following items are monitored by the self-diagnostic system:

- Sensor unit
- SRS wiring
- Inflators

WARNING!

Never drive an SRS equipped car with your hands on the steering wheel pad / airbag housing.

No objects, accessory equipment or stickers may be placed on, attached to or installed near the SRS cover in the center of the steering wheel, the SRS cover above the glove compartment or the area affected by airbag deployment.

If the SRS warning light stays on after the engine has started or if it comes on while you are driving, drive the car to the nearest authorized Volvo retailer for inspection as soon as possible.



SRS decal on door pillar driver's side

There is no maintenance to perform on the SRS yourself. The month and year shown on the decal on the door pillar indicate when you should contact your Volvo retailer for specific servicing or replacement of airbags and seatbelt tensioners. This service must be performed by an authorized Volvo retailer.

Should you have any questions about the SRS system, please contact your authorized Volvo retailer or Volvo Customer Support:

In the USA:	In Canada:
Volvo Cars of North America	Volvo Cars of Canada Ltd.
Customer Relations	175 Gordon Baker Road
P.O. Box 914	Willowdale, Ontario M2H 2N7
Rockleigh, New Jersey 07647-0914	1-800-663-8255
800-458-1552	



SRS texts on outside of both sun visors



SRS texts on inside of both sun visors



SRS texts on the passenger's dash



SRS text at far right of dash

WARNING!

Do not use child safety seats or child booster cushions/backrests in the front passenger's seat. We also recommend that children who have outgrown these devices sit in the rear seat with the seat belt properly fastened.

NOTE: Deployment of SRS components occurs only one time during an accident. In a collision where deployment occurs, the airbags and seat belt tensioners activate. Some noise occurs and a small amount of powder is released. The release of the powder may appear as smoke-like matter. This is a normal characteristic and does not indicate fire.

NOTE: Volvo's dual-threshold airbags use special sensors that are integrated with the front seat buckles. The point at which the airbag deploys is determined by whether or not the seat belt is being used, as well as, the severity of the collision. Collisions can occur where only one of the airbags deploys.

WARNING!

- Children must never be allowed in the front passenger seat. Volvo recommends that ALL occupants (adults and children) shorter than 4 feet 7 inches (140 cm) be seated in the back seat of any vehicle with a front passenger side airbag.
- Occupants in the front passenger's seat must never sit on the edge of the seat, sit leaning toward the instrument panel or otherwise sit out of position. The occupant's back must be as upright as comfort allows and be against the seat back with the seat belt properly fastened.
- Feet must be on the floor, e.g. not on the dash, seat or out of the window.
- No objects or accessory equipment, e.g. dash covers, may be placed on, attached to or installed near the SRS hatch (the area above the glove compartment) or the area affected by airbag deployment (see illustration on [page 4](#)).
- There should be no loose articles, e.g. coffee cups, on the floor, seat or dash area.
- Never try to open the SRS cover on the steering wheel or the passenger side SRS seam. This should only be done by an authorized Volvo service technician.
- Failure to follow these instructions can result in injury to the vehicle occupants in an accident.

NOTE: The information on this page does not pertain to the Side Impact Protection System airbags.

When are the airbags deployed?

The SRS system is designed to deploy during certain frontal or front-angular collisions, impacts, or decelerations, depending on the crash severity, angle, speed and object impacted. The SRS sensor is designed to react to both the impact of the collision and the inertial forces generated by it and to determine if the intensity of the collision is sufficient for the airbags to be deployed.

WARNING!

The SRS is designed to help prevent serious injury. Deployment occurs very quickly and with considerable force. During normal deployment and depending on variables such as seating position, one may experience abrasions, bruises, swellings, or other injuries as a result of airbag deployment.

If the airbags have been deployed, we recommend the following:

- Have the car towed to an authorized Volvo retailer. Never drive with the airbags deployed.
- Have an authorized Volvo retailer replace the SRS system components.
- Use only new, Genuine Volvo Parts when replacing SRS components (airbags, seat belts, tensioners, etc.).

When are the airbags NOT deployed?

Not all frontal collisions activate the SRS system. If the collision involves a non-rigid object (e.g., a snow drift or bush), or a rigid, fixed object at a low speed, the SRS system will not necessarily deploy. Front airbags do not normally deploy in a side impact collision, in a collision from the rear or in a rollover situation. The amount of damage to the bodywork does not reliably indicate if the airbags should have deployed or not.

Seat belts - the heart of the Volvo safety system

The heart of the Volvo safety system is the **three-point seat belt** (a Volvo invention)! In order for the SRS system to

provide the protection intended, seat belts must be worn at all times by everyone in the car.

The SRS system is a supplement to the seat belts.

WARNING!

If your car has been subjected to flood conditions (e.g. soaked carpeting/standing water on the floor of the vehicle) or if your car has become flood-damaged in any way, do not attempt to start the vehicle or put the key in the ignition before disconnecting the battery (see below). This may cause airbag deployment which could result in personal injury. Have the car towed to an authorized Volvo retailer for repairs.

Before attempting to tow the car, use the following procedure to override the shiftlock system to move the gear selector to the neutral position.

- Disconnect the battery
- Wait at least one minute
- Insert the key in the ignition and turn it to position 1
- Press firmly on the shiftlock override button (located near the base of the gear selector)
- While holding the override button down, move the gear selector from the park position.

WARNING!

Never drive with the airbags deployed. The fact that they hang out can impair the steering of your car. Other safety systems can also be damaged. The smoke and dust formed when the airbags are deployed can cause skin and eye irritation in the event of prolonged exposure.



[Contents](#) | [Top of Page](#)

**2 0 0 3
VOLVO
S40 & V40**

Chapter 2 - Instruments, switches and controls

pg. 17 Instruments, switches and controls

Instruments, switches and controls

Instruments, switches, controls etc. are described on the following pages.

<u>Instruments</u>	<u>18</u>
<u>Indicator and warning lights</u>	<u>21</u>
<u>Headlights, Parking lights, Instrument illumination, Fog lights</u>	<u>24</u>
<u>Turn signals, Home Safe lighting, Wipers/washers</u>	<u>25</u>
<u>Ignition switch/steering wheel lock, Flashers, Heated rear window/mirrors</u>	<u>26</u>
<u>Trip Computer</u>	<u>27</u>
<u>Dynamic Stability Assistance</u>	<u>30</u>
<u>Cruise control</u>	<u>31</u>
<u>Heated seats, Parking brake</u>	<u>32</u>
<u>Auxiliary socket, Cupholder</u>	<u>33</u>
<u>Steering wheel adjustment</u>	<u>34</u>
<u>Heating, Ventilation and Air Conditioning</u>	<u>35</u>
<u>Electrically operated windows</u>	<u>38</u>

pg. 18 Instruments, switches and controls

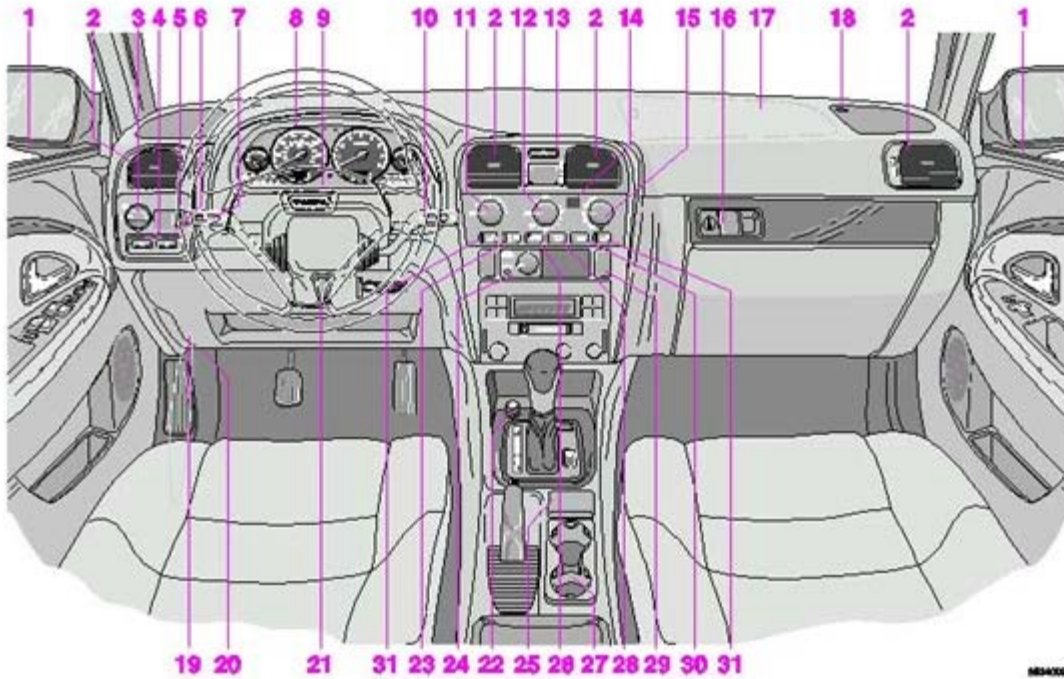

pg. 19 Instruments, switches and controls

The pages in this section provide detailed descriptions of the vehicle's instruments and controls. Note that vehicles may be equipped differently, depending on special legal requirements.

	Page
1 Adjustable door mirrors	50
2 Air vents	35
3 Headlight switch	24
4 Front foglight	24
5 Instrument lighting	24
6 Rear foglight	24
7 Turn signals, high/low beams, Home Safe Lighting, cruise control	25, 31
8 Instruments, indicator and warning lights	20-21
9 Horn	
10 Windshield wash/wipe, headlight wash/wipe	25
11 Blower control	36
12 Air distribution control	36
13 Hazard warning flashers	26
14 Passenger compartment temperature sensor	36
15 Temperature control	36
16 Glove compartment	45
17 Passenger airbag	4
18 Sunlight sensor for electronic climate control and LED for immobilizer and alarm	37, 44
19 Fuse box	96-97

20 Hood latch	53
21 Steering wheel height adjustment	34
22 12-volt electrical outlet	33
23 AC on and off	36
24 Trip Computer	27
25 Coin holder	33
26 Recirculation	36-37
27 Cupholder	33
28 Defroster - door mirrors/rear window	26
29 Not in use	-
30 Dynamic Stability Assistance (DSA)	30
31 Controls for heated front seats	32
32 Switch for selecting door mirror left and right	50
33 Control for adjusting door mirrors	50
34 Door lock switch	42
35 Window left and right front	38
36 Window left and right rear	38
37 Cut-out switch windows rear	38

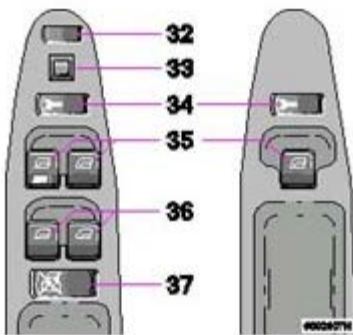

Some of the items listed on this page are available on certain models only.

pg. 20 Instruments

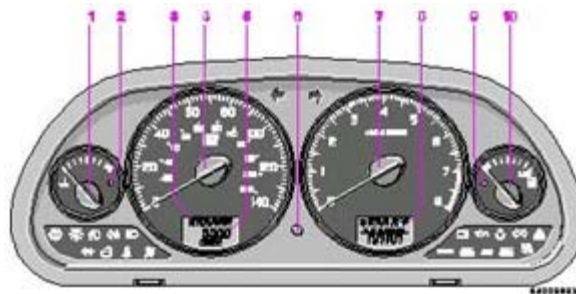

1 Coolant temperature gauge

Do not drive the car with the pointer in the red range. The pointer should be approximately midway on the gauge face when driving. If the pointer approaches the red range repeatedly, check coolant level. See [page 117](#).

2 Coolant temperature warning light

If this light comes on while driving, the coolant temperature is too high. Stop the engine and check the coolant level in the expansion tank. See [page 117](#).

3 Odometer

4 Speedometer

The longer the knob is turned, the faster the setting will change.

5 Trip odometer

This indicator measures shorter distances. The last digit indicates 1/10 mile/kilometer.

6 Button for setting clock/resetting trip odometer

In both cases, the ignition must be switched on

Clock: Without pressing the button, turn it clockwise to advance the clock, or counterclockwise to set the clock back.

Trip odometer: Press the button to reset the trip odometer.

7 Tachometer

Reads thousands of engine rpm. The needle should never be in the solid red range.

8 Clock, Trip Computer/Ambient temperature

NOTE: See [page 27- 29](#) for information on the trip computer.

9 Low fuel level warning light

When this light comes on, there are approximately 1.9 US gal. (7 liters) of fuel remaining in the tank.

10 Fuel gauge

Fuel tank capacity: 16 US gallons (60 liters).

When refuelling the fuel gauge needle will not register until the volume of gasoline in the tank exceeds 3.2 US gal. (12 liters).

pg. 21 Indicator and warning lights

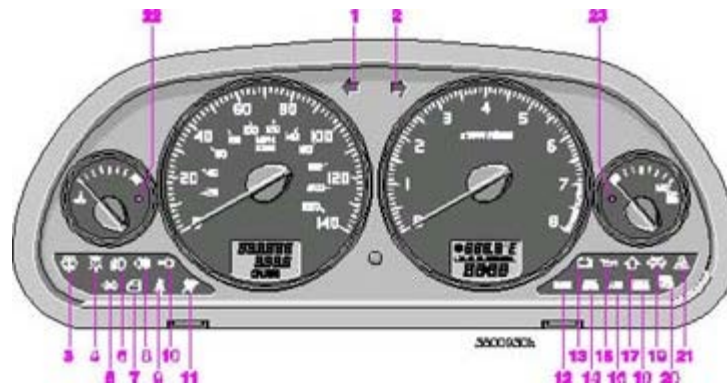

- 1 Turn signal, left
- 2 Turn signal, right
- 3 Low washer fluid level
- 4 Brake light* failure warning
- 5 Turn signals - trailer (certain models)
- 6 Front fog lights on
- 7 Door open
- 8 Rear fog light on
- 9 Seat belt warning

- 10 High beams on
- 11 Fault in SRS system
- 12 Brake circuit not working (brake fluid level too low) and EBD
- 13 Battery charge failure
- 14 Parking brake applied
- 15 Low oil pressure
- 16 ABS (anti-lock brakes) malfunction
- 17 Automatic transmission: position W, 4 or 3 or L
- 18 Malfunction indicator light
- 19 Immobilizer on
- 20 Service Reminder Indicator
- 21 DSA (option)
- 22 High coolant temperature warning light
- 23 Low fuel warning light

Starting check

After a few seconds, all lights except 16 and 19 will go out. Once the engine starts, these lights will also go out.

* Indicates failure of a brake light, not failure of the braking system (see item 12).

pg. 22 Warning lights

The warning lights described on [pages 22 and 23](#) should never stay on when driving

When the ignition key is turned on and before the engine starts, all of the warning lights should go on to test the function of the bulbs. Should a light not go off after the engine has started, the system indicated should be inspected. However, the parking brake reminder light will not go off until the parking brake has been fully released.

Supplemental Restraint System (SRS)

If the light comes on (or stays on after the vehicle has started), the SRS diagnostic system has detected a fault. Drive to an authorized Volvo retailer for an inspection of the system. See the SRS section for more information.

Oil pressure warning light

If the light comes on while driving, stop the car and then stop the engine immediately and check the engine oil level. See [page 114](#). If the light stays on after restart, have the car towed to the nearest authorized Volvo retailer. After hard driving, the light may come on occasionally when the engine is idling. This is normal, provided it goes off when the engine speed is increased.

Parking brake reminder light

This light will be on when the parking brake (hand brake) is applied. The parking brake lever is situated between the front seats.

Canadian models are equipped with this warning light: 

WARNING!

If the fluid level is below the lowest MIN mark in the brake fluid reservoir: **DO NOT DRIVE.** Tow the car to a Volvo retailer and have the brake system checked and any leakage repaired.

Brake failure warning light

If the light comes on while driving or braking, stop immediately, open the hood and check the brake fluid level in the reservoir. See [page 116](#) for reservoir position.

If the control lamp still stays on, the EBD (Electronic Brakeforce Distribution) is not working.

Drive to your Volvo retailer. See ABS control lamp and also [page 73](#).

Canadian models are equipped with this warning light: 

Bulb failure warning light

The light will come on if one of the brake light bulbs are defective when the brake pedal is pressed.

Check the fuse and bulb. See sections "Replacing bulbs" and "fuses".

pg. 23 Warning lights, Daytime Running Lights

DSA (option)

Dynamic Stability Assistance

This is a system which helps keep the drive wheels from spinning. The light **flashes** if the road surface is slippery, the wheels are spinning and the system is working.

The control light comes on if a fault occurs in the DSA system. It also comes on if the system is switched off via the switch.

For more information see [page 30](#).

Service Reminder Light

This light will come on according to preset service intervals or after 750 hours of driving or after 12 months, whichever occurs first. It is a reminder to the driver that the service interval has been exceeded. The light will stay on for 2 minutes after start until reset by the servicing retailer.

Anti-lock Brake system (ABS)

If the warning lamp lights up there is a malfunction of the ABS system (the standard braking system will however function). The vehicle should be driven to a Volvo retailer for inspection.

See [page 73](#) for additional information.

Malfunction Indicator Lamp

On-Board Diagnostics II (OBDII): As you drive, a computer called "OBDII" monitors your car's engine, transmission, electrical and emission systems. The CHECK ENGINE light will light up if the computer senses a condition that potentially may need correcting. When this happens, please have your car checked by a Volvo retailer as soon as possible.

A CHECK ENGINE light may have many causes. Sometimes, you may not notice a change in your car's behavior. Even so, an uncorrected condition could hurt fuel economy, emission cleanliness, and driveability. Extended driving without correcting the cause could even damage other components in your car.

Canadian models are equipped with this warning light: 

NOTE: If the fuel filler cap is not closed tightly or if the engine is running when the car is refueled, the Check Engine Lamp may indicate a fault. However, your vehicle's performance will not be affected. Use only Volvo original or approved fuel filler caps.

Daytime Running Lights:

The S40 and V40 come from the factory with daytime running lights activated. Carry out the following steps if you will deactivate them (in the U.S. only *). These steps may be carried out again to reactivate and deactivate the daytime running lights as desired.

Programming for On or OFF

Turn the headlight switch to position .

Turn the ignition key in position II.

Pull the turn signal lever towards you and hold it while turning the headlight switch to position 0.

WARNING!

Do not activate or deactivate the daytime running lights while driving. Laws in your area may mandate the use of daytime running lights. Check your local laws before deactivating daytime running lights.

* The use of daytime running lights is mandatory in Canada.

pg. 24 Headlights, Parking lights, Instrument illumination, Fog lights

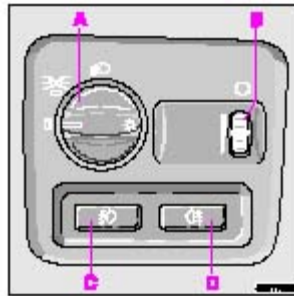

A Headlights and parking lights

0 Switch position

Ignition key in positions 0+I: All lights switched off.

Ignition key in position II:

Low beam headlights on (+ front and rear parking lights, license plate light and instrument lighting).

Switch position

Parking lights front and rear.

Ignition key in positions 0, I and II

Parking lights should only be used when the car is parked, **never** when the car is being driven.

It also switches on the position lights in bumpers, and license plate light (and the instrument lights in position II).

Switch position

Ignition key in positions 0 and I: All lights off.

Ignition key in position II: Headlights on (+ parking lights front and rear, license plate light, position lights in the bumpers and instrument lights).

Note: You have to turn the light switch to this position in order to switch on high beams.

B Instrument lighting dimmer

Instrument lighting can be dimmed to 6% of maximum lighting.

C Rear fog light *

The rear fog light (located in the driver's side tail light cluster) is considerably brighter than the normal tail lights and should be used only when the atmospheric conditions, such as fog, rain, snow, smoke or dust reduce the daytime or night-time visibility of other vehicles to less than 500 ft (150 meters).

- Rear fog light: press  - headlights or front fog lights must be activated

D Front Fog lights

Ignition key must always be in position II.

Headlight or parking lights must be activated

- Front fog lights (option): press 

Switching fog lights off

To switch the fog lights off, press the appropriate fog light switch again.

If headlights or parking lights are switched off, the fog lights will also go out. The fog lights are also switched off when the ignition is switched off and must be switched back on manually if required when the ignition is switched on again.

The front fog lights switch off automatically when the high beams are switched on.

* By design, there is one rear fog light only, located in the driver's side tail light cluster.

pg. 25 Turn signals, Home Safe lighting, Wipers/washers

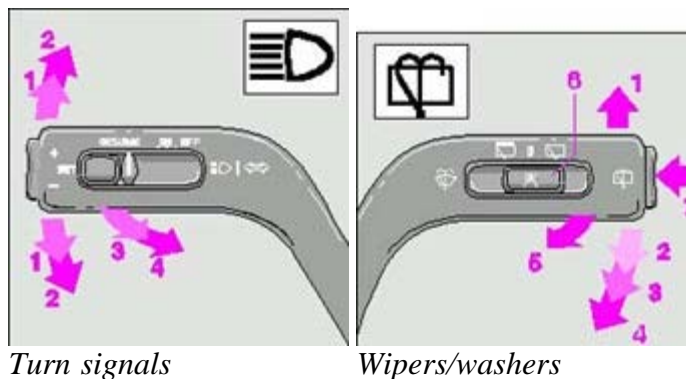

Turn signals

1 Lane change position. In maneuvers such as lane changing, the driver can flash the turn signals by moving the turn signal lever to the first stop and holding it there. The lever will return to the neutral position when released.

2 Signal lever engaged for normal turns.

3 High beam/low beam switch (headlights on).

Move the lever towards the steering wheel and release it.

4 Headlight flasher (headlights off).

Move the lever towards the steering wheel. The headlight high beam will be on until the lever is released.

NOTE: A defective turn signal bulb will cause the turn signal indicator and remaining signal lights to flash more rapidly than normal.

Home Safe lighting

When you leave your car at night, you can make use of the exterior courtesy lighting function:

- Remove the key from the ignition switch.
- Pull the turn signal lever towards the steering wheel (as when using the headlight flasher function).

The low beam headlights will now remain on for 30 seconds to light your way.
Repeat the above measures if you want to switch off the Home Safe Lighting.

Wipers/washers

1 "Single sweep" position:

The switch returns automatically when released.

2 Intermittent wiper

The wipers will sweep approximately every 5 seconds (car speed depending).

3 Wipers, normal speed

4 Wipers, high speed

5 Windshield wiper/washer, headlight wiper/washer.

The wipers will make 2-3 sweeps across the windshield and headlights and 1 additional sweep after 3 seconds.

6 Tailgate window wiper (V40)

The tailgate wiper switch has three positions:

 : Intermittent

O : Off

 : Continuous

Tip function When pressing switch 7 briefly the wiper will make one sweep, independent of the interval

Backing up When the vehicle is put into reverse with the windshield wipers on and tailgate wiper off, the rear window wiper will come on for two sweeps.

7 Tailgate window washer (V40)

The washer keeps working for as long as you keep the button depressed.

The wiper will make 2-3 sweeps after the lever is released and 1 sweep after 3 seconds.



2 0 0 3
VOLVO
S40 & V40

Chapter 3 - Body and interior

pg. 39 Body and interior

Body and interior

The seats, sun roof, mirrors, etc. are described on the following pages.

<u>Keys</u>	<u>40</u>
<u>Remote keyless entry system</u>	<u>41</u>
<u>Doors and locks</u>	<u>42</u>
<u>Alarm</u>	<u>43</u>
<u>Trunk/Tailgate/Glove compartment</u>	<u>45</u>
<u>Opening the trunk from the inside (S40)</u>	<u>46</u>
<u>Front seats</u>	<u>47</u>
<u>Child safety locks</u>	<u>49</u>
<u>Rear/side view mirrors/Vanity mirrors</u>	<u>50</u>
<u>Interior lights, Sunroof</u>	<u>51</u>
<u>Sunroof</u>	<u>52</u>
<u>Hood/Luggage cover</u>	<u>53</u>
<u>Storage compartments</u>	<u>54</u>
<u>Folding rear seat</u>	<u>55</u>
<u>Securing cargo</u>	<u>56</u>
<u>Cargo space/Trunk light, Spare tire, Jack</u>	<u>57</u>
<u>Side cargo net, Cargo net</u>	<u>58</u>
<u>Weight distribution, Handling, Roadholding, Roof racks</u>	<u>59</u>

pg. 40 Keys

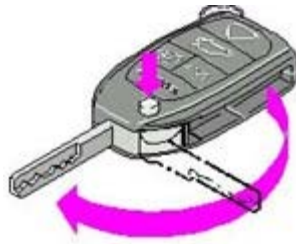

Key

The master key is integrated into the remote keyless entry system's remote control.

- To fold out the key, press the button indicated by the downward pointing arrow in the illustration above.
- To retract the key, press the button and fold the key into the slot in the remote control.

The key activates all locks (ignition switch/steering wheel lock, all doors, fuel filler door, trunk/tailgate), and locks/unlocks the glove compartment.

Service Key (Valet key)

This key (grey in color) activates only ignition switch/steering wheel lock and all doors, including the fuel filler door.

Immobilizer (start inhibitor)

Each of the keys supplied with your car is electronically coded. When the key is inserted into the ignition switch, the code is transmitted to and compared with a code stored in the start inhibitor module. The car can only be started if a properly coded key is used.

If you misplace a key, take the other keys to an authorized Volvo retailer. The existing code in the start inhibitor module and all the keys will be erased as an anti-theft measure and a new code will be programmed in.

NOTE:

You should never keep more than one of your ignition keys on the ring at the same time. This could cause conflicting signals to be transmitted to the ignition switch, making it impossible to start the car.

This device complies with part 15 of the FCC rules. Operation is subject to the following condition: (1) This device may not cause harmful interference, and (2) this device must accept any interference received, including interference that may cause undesired operation.

pg. 41 Remote keyless entry system

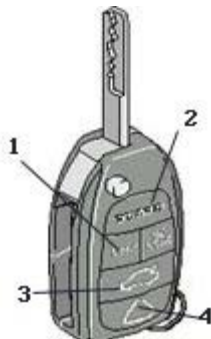

1 - Lock, 2-Unlock, 3-Open trunk/tailgate, 4-Panic button*

Remote keyless entry system

Your car is equipped with a remote control transmitter. This transmitter uses a radio frequency which will allow

"keyless" entry into the passenger compartment or the trunk. You will be supplied with two coded key ring transmitters, which will enable you to lock/unlock all doors and the trunk/tailgate and fuel filler door from a distance of 10-15 feet (3-5 meters).

The Remote also activates/deactivates the alarm system that comes standard with this car.

The car can also be locked/unlocked with the key.

This device complies with part 15 of the FCC rules. Operation is subject to the following condition: (1) This device may not cause harmful interference, and (2) this device must accept any interference received, including interference that may cause undesired operation.

Using the remote control

- Press the **LOCK** button once to lock all doors and trunk/tailgate.
- Press the **UNLOCK** button **once** to unlock the driver's door and the fuel filler door only. Press this button again (within 10 seconds) to unlock other doors, trunk/tailgate.
- Press the **OPEN trunk/tailgate** button to unlock the tailgate/trunk.

NOTE: If only the driver's door is unlocked, the lock will automatically reengage (re-lock) and the alarm will be set after 2 minutes unless the door has been opened.

The lock/unlock and alarm features can also be utilized by using the keys. See the following page.

Remote control not functioning.

If the remote control is not functioning, the car can be opened using the master or service key in the driver's door.

Note: The remote control will not function if a key is left in the ignition switch.

WARNING!

Volvo does not recommend using the transmitter to lock the doors from inside the car. The alarm would be activated and would sound when one of the doors is opened. The doors must not be locked using the remote transmitter while the vehicle is occupied. In case of an accident, this may hinder rapid access to the occupants of the vehicle.

*Panic function

In an emergency situation, this feature can be used to attract attention, if you are within 10-15 feet (3-5) meters of the car.

Activate the "panic" function by pressing the red panic button on the remote control for at least 3 seconds or by pressing this button twice within 3 seconds. The turn signals will flash, the interior lights will go on and the alarm will sound.

The "panic" alarm can be turned off after 5 seconds by pressing any of the buttons on the remote control or it will stop automatically after 25 seconds.

NOTE: The panic button will **NOT** unlock the car.

pg. 42 Doors and locks

Doors and locks

Your car is equipped with a central locking system.

The key (used on the driver's door) the remote control, or central locking button, will lock/unlock all doors, trunk/tailgate.

Turn the key once to unlock the driver's door and the fuel filler door.

Turn the key again within 10 seconds to unlock other doors, trunk/tailgate.

One turn with the key towards "lock" in the driver's door locks all doors, trunk/tailgate and fuel filler door with a 10 minutes delay in the fuel filler door.

WARNING!

If the doors are locked while driving, this may hinder rapid access to the occupants of the car in the event of an accident. (Also see information on "Child safety locks").

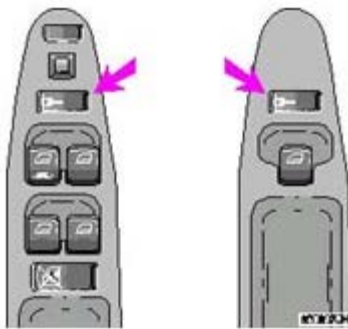

Central locking button

Central locking switch

You can use the button to lock or unlock all doors (unlock only for 25 seconds after locking by remote).

LEFT side of button: lock

RIGHT side of button: unlock

Note: If the key is in the ignition switch and you close the driver's door, the driver's door will be immediately unlocked again in order to prevent accidentally locking the car with the keys left inside the car.

pg. 43 Alarm

Alarm

The radio signal emitted from the transmitter, which is used to set/unset the alarm, is a "rolling code" signal. This means that the signal is changed randomly for each transmission and is intended to help prevent unauthorized recording of the code.

When armed (set), the alarm continuously monitors a number of points on the car. The following conditions will set off the alarm:

- The hood is opened
- The trunk/tailgate is opened
- A door is opened
- The ignition switch is tampered with

The alarm will sound for 30 second intervals, with a 10 second pause between intervals. This function cannot be interrupted.

- If the battery or the siren are disconnected, the alarm will sound for five minutes

Arming (setting) the alarm

The alarm can be armed in the following ways:

- Press the LOCK button on the remote control (the turn signals will flash to confirm that the car is locked and the alarm is armed)
- Lock the car using the key in the driver's door (the LED on the dashboard will blink to indicate that the alarm is armed)

Disarming the alarm

Press the UNLOCK button on the remote control or unlock the driver's door with the key.

Turning off (stopping) the alarm

If the alarm is sounding, it can be stopped by pressing the UNLOCK button on the remote control or by unlocking the driver's door with the key.

Visual alarm signal

If the alarm is set off, a visual alarm signal is given by flashing all turn signals and turning on the interior lighting for approximately 5 minutes.

Audible alarm signal

If the alarm is set off, an audible alarm signal is given by the backup siren. One alarm cycle lasts for 30 seconds.

pg. 44 Alarm

LED alarm status signals

The status of the alarm system is indicated by the red LED at the right side of the dash:

- LED off - the alarm is not armed (set)
- LED flashes once per second - the alarm is armed (set)
- LED flashes rapidly before the ignition is switched on - the alarm has been triggered
- LED flashes rapidly for 15 seconds after the ignition has been switched on - a fault has been detected in the alarm system. Contact a Volvo retailer.

Automatic relock

If only the driver's door is unlocked with the remote control, the lock will automatically reengage (re-lock) and the alarm will be set after 2 minutes unless the door has been opened.

CAUTION: Do not attempt to service or repair any components of the alarm system yourself. This should only be done by an authorized Volvo retailer.

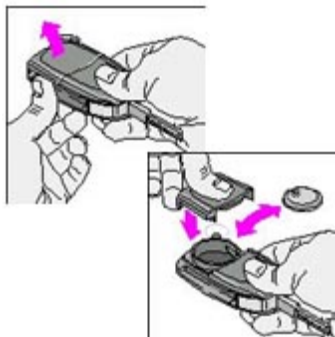

Battery

Each remote transmitter is powered by a three-volt battery, type CR 2025. If the range of the transmitter is noticeably reduced, this indicates that the battery is weak and should be replaced.

Replacing the battery

1. Open the remote control by twisting a coin in the ring between the front and rear sections (leave the ring in place).
2. Replace the battery, with the plus-side upward (see illustration).
3. Reinstall the cover, making sure it is secured tightly.

pg. 45 Trunk/Tailgate, Glove compartment

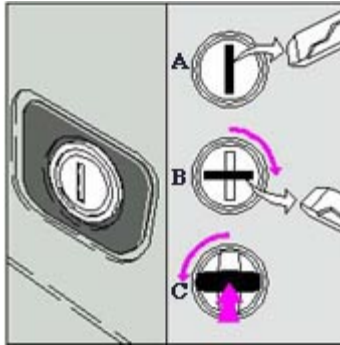

Opening/unlocking the trunk/tailgate

The trunk/tailgate locks are incorporated in the central locking system and are locked or unlocked when the driver's door is locked/unlocked.

Once unlocked, the trunk/tailgate may be opened by pushing in on the lock cylinder while raising the trunk lid/tailgate.

A - Remove key vertically: Trunk/tailgate remains locked (disconnected from the central locking system).

B - Turn key clockwise and remove: Trunk/tailgate are locked/unlocked with the central locking system.

C - Turn key counterclockwise: Insert key and open lock without using central locking system. The key cannot be removed.

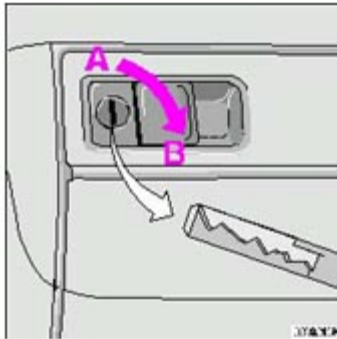

Glove compartment

The glove compartment can be locked with the key.

A unlocked

B locked



2003
VOLVO
S40 & V40

Chapter 4 - Starting and driving

pg. 61 Starting and driving

Starting and driving

This section on starting and driving contains items such as starting the engine, operating the gear selector, towing, trailers, etc.

[Fuel requirements, Refueling](#) 62

[Driving economy](#) 64

[Starting the engine](#) 65

[Automatic transmission](#) 66

[Points to remember](#) 68

[Emergency towing](#) 70

[Vehicle towing information](#) 71

[Jump starting, Proposition 65 Battery Warning](#) 72

[Brake system, ABS](#) 73

[Electronic Brake-Force Distribution \(EBD\)](#) 74

[Winter driving, Before a long distance trip](#) 75

[Detachable trailer hitch, installing/removing](#) 76

[Trailer towing](#) 78

pg. 62 Fuel requirements

Deposit control (detergent) gasoline

Volvo recommends the use of detergent gasoline to control engine deposits. Detergent gasoline is effective in keeping injectors and intake valves clean. Consistent use of deposit control gasolines will help ensure good driveability and fuel economy. If you are not sure whether the gasoline contains deposit control additives, check with the service station operator.

Unleaded fuel

Each Volvo has a three-way catalytic converter and must use only unleaded gasoline. U.S. and Canadian regulations require that pumps delivering unleaded gasoline be labeled "UNLEADED". Only these pumps have nozzles which fit your car's filler inlet. It is unlawful to dispense leaded fuel into a vehicle labeled "unleaded gasoline only". Leaded gasoline damages the three-way catalytic converter and the heated oxygen sensor system. Repeated use of leaded gasoline will lessen the effectiveness of the emission control system and could result in loss of emission warranty coverage. State and local vehicle inspection programs will make detection of misfueling easier, possibly resulting in emission test failure for misfueled vehicles.

NOTE: Some U.S. and Canadian gasolines contain an octane enhancing additive called methyl-cyclopentadienyl manganese tricarbonyl (MMT). If such fuels are used, your Emission Control System performance may be affected, and the Check Engine Lamp located on your instrument panel may light. If this occurs, please return your vehicle to an authorized Volvo retailer for service.

Carbon Monoxide - Important Warning

Carbon monoxide is a poisonous, colorless, and odorless gas. It is present in all exhaust gases. If you ever smell exhaust fumes inside the vehicle, make sure the passenger compartment is ventilated, and immediately return the vehicle to your retailer for correction.

Fuel Formulations

Do not use gasoline that contains lead as a knock inhibitor, and do not use lead additives. Besides damaging the exhaust emission control systems on your car, lead has been strongly linked to certain forms of cancer. Many fuels contain benzene as a solvent. Unburned benzene has been strongly linked to certain forms of cancer. If you live in an area where you must fill your own gas tank, take precautions. These may include:

- standing upwind away from the filler nozzle while refueling
- refueling only at gas stations with vapor recovery systems that fully seal the mouth of the filler neck during refueling
- wear neoprene gloves while handling a fuel filler nozzle.

Use of Additives

With the exception of gas line antifreeze during winter months, do not add solvents, thickeners, or other store-bought additives to your car's fuel, cooling, or lubricating systems. Overuse may damage your engine, and some of these additives contain organically volatile chemicals. Do not needlessly expose yourself to these chemicals.

ENGINE OIL

Although some oil consumption occurs during normal engine operation, more oil is consumed when the engine is new as the internal parts generate higher friction while wearing in to each other. **From the time the engine is new until the first service is performed, the oil consumption could be higher than normal. For this reason, it is especially important to check the oil every time you refuel your car during this period. See [page 114](#).**

pg. 63 Fuel requirements, Refueling

Octane rating

Volvo engines are designed for optimum performance on unleaded premium gasoline with an octane rating. AKI of 91, or above. AKI (ANTI KNOCK INDEX) is an average of the Research Octane Number, RON, and the Motor Octane Number, MON. $(RON + MON/2)$.

The minimum octane requirement is AKI 87 (RON 91).

Gasoline containing alcohol and ethers

"Oxygenated fuels"

Some fuel suppliers sell gasoline containing "oxygenates" which are usually alcohols or ethers. In some areas, state or local laws require that the service pump be marked indicating use of alcohols or ethers.

However, there are areas in which the pumps are unmarked. If you are not sure whether there is alcohol or ethers in the

gasoline you buy, check with the service station operator. To meet seasonal air quality standards, some areas require the use of "oxygenated" fuel.

Volvo allows the use of the following "oxygenated fuels; however, the octane ratings listed on this page must still be met.

Alcohol — Ethanol

Fuels containing up to 10% ethanol by volume may be used.

Ethanol may also be referred to as Ethyl alcohol, or "Gasohol".

Ethers — MTBE

Fuels containing up to 15% MTBE may be used.

Refueling

The fuel tank is designed to hold approximately: 16 US gallons (60 liters) with sufficient volume left over to accommodate possible expansion of the fuel in hot weather.

Fuel filler door

The fuel filler door (on the left rear fender) is unlocked along with the car's central locking system.

Open fuel filler cap slowly during hot weather.

CAUTION:

- Do not refuel with the engine running *. Turn the ignition off or to position I. If the ignition is on, an incorrect reading could occur in the fuel gauge.
- After refueling, close the fuel filler cap by turning it clockwise until it *clicks* into place *.
- Avoid spilling gasoline during refueling. Gasoline containing alcohol can cause paint damage that may not be covered under the New Vehicle Limited Warranty.
- Do not use gasolines containing methanol (methyl alcohol, wood alcohol). This practice can result in vehicle performance deterioration and can damage critical parts in the fuel system. Such damage may not be covered under the New Vehicle Limited Warranty.
- Do not overfill the fuel tank. Overfilling could damage the emission control system.

** If the fuel filler cap is not closed tightly or if the engine is running when the car is refueled, the Check Engine Lamp may indicate a fault. However, your vehicle's performance will not be affected. Use only Volvo original or approved fuel filler caps.*

pg. 64 Driving economy

Economical driving conserves natural resources

Better driving economy may be obtained by thinking ahead, avoiding rapid starts and stops and adjusting the speed of your vehicle to immediate traffic conditions. Observe the following rules:

- Bring the engine to normal operating temperature as soon as possible by driving with a light foot on the accelerator pedal for the first few minutes of operation. A cold engine uses more fuel and is subject to increased wear.
- Whenever possible, avoid using the car for short trips. Short trips do not allow the engine to reach normal operating temperature.
- Drive carefully and avoid rapid acceleration and hard braking.
- Do not exceed posted speed limits.
- Avoid carrying unnecessary items (extra load) in the car.
- Maintain correct tire pressure. Check tire pressure regularly (check when tires are cold).
- Remove snow tires when threat of snow or ice has ended.

Note that roof racks, ski racks, etc., increase air resistance and thereby fuel consumption.

- Avoid using automatic transmission kick-down feature unless necessary.
- Avoid using the air conditioning when it is not required. When engaged, the air conditioner's compressor places an additional load on the engine. However, please note that fuel consumption is lower with the air conditioning on than it is when driving with the air conditioning switched off and the windows down.
- Utilizing the fuel consumption modes in the Trip Computer can help you "learn" how to drive more economically.

Other factors which decrease gas mileage are:

- Dirty air cleaner
- Dirty engine oil and clogged oil filter
- Dragging brakes
- Incorrect front end alignment

Some of the above mentioned items and others are checked at the standard Maintenance Service intervals.

NOTE: The automatic transmission's (D)rive position should be used as often as possible to help improve fuel economy.

WARNING!

- It is recommended that tires of the same make and dimensions be used on all four wheels (including the use of snow tires). Do not use bias ply tires as this will adversely alter vehicle handling characteristics. Maintain correct tire pressure.
- Do not drive with trunk lid open! A warning light in the instrument panel will indicate that the trunk is open. Poisonous exhaust gases may enter via the open trunk lid. If the trunk lid/tailgate must be kept open for any reason, proceed as follows:
 - Close the windows.
 - Set the ventilation system control to air flow to floor, windshield and side windows and blower control to its highest setting.

pg. 65 Starting the engine

Starting and stopping

1. Fasten the seat belt.

WARNING!

Before starting, check that the seat, steering wheel and mirrors are adjusted properly. Make sure the brake pedal can be depressed completely. Move the seat closer if necessary. Refer to section "front seats".

2. Make sure the gear selector is in the Park position.

3. **Without touching the accelerator pedal**, turn the ignition key to the starting position. Allow the starter to operate for up to 5 seconds. Release the key as soon as the engine starts. If the engine fails to start, repeat step 3. For cold starts at altitudes above 6000 ft (1800 meters), depress the accelerator pedal halfway and turn the key to the starting position. Release the pedal slowly when the engine starts. Depress the brake pedal and release the parking brake.

4. To release the gear selector from the (P)ark position, the ignition key must be in position II and the brake pedal must be depressed.

NOTE: Your car is equipped with a **KEYLOCK** system. When the engine is switched off, the gear selector must be in the (**P**)ark position before the starting key can be removed from the ignition switch.

5. Select the desired gear. The gear engages after a slight delay which is especially noticeable when selecting R.

CAUTION:

The engine should be idling; never accelerate until after you feel the gear engage! Too rapid acceleration immediately after selecting a gear will cause harsh engagement and premature transmission wear.

NOTE: Selecting P or N when idling at a standstill for prolonged periods of time will help prevent overheating of transmission oil.

Ignition sleep mode

If the key is turned to "drive" position (see [page 26](#)) for several minutes without the engine running, the car's starting system will power down to "sleep" mode. To start the car, momentarily turn the key back to the "locked" position. Then start the car as you would normally do.

WARNING!

Always place the gear selector in Park and apply the parking brake before leaving the vehicle. Never leave the car unattended with the engine running.

Always open the garage doors fully before starting the engine inside a garage to ensure adequate ventilation. The exhaust gases contain carbon monoxide, which is invisible and odorless but very poisonous.

CAUTION:

Never race the engine **immediately after starting**. Oil flow may not reach some lubricating points fast enough to prevent engine damage.

Do not race the engine just prior to switching off!

pg. 66 Automatic transmission

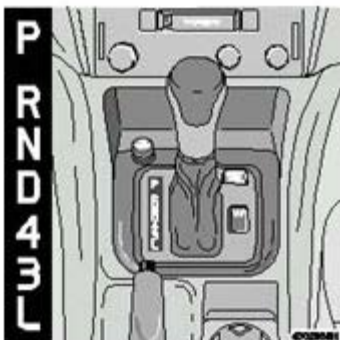

Gear selector positions

P Park

The transmission must be in Park position to start the engine, and to allow removal of the key from the ignition when you leave the car. The car should be stationary when you select P! In the position P the transmission is mechanically locked. Always apply the parking brake when parking!

Shift lock

In order to move the gear selector from P position to the other gear positions the key must be in driving position (position II) and the brake pedal must be depressed. See [page 99](#) for information on how to move the gear selector manually in case of a dead battery.

R Reverse

The car must be at a standstill before you select Reverse gear.

N Neutral position

The N position is the neutral position. The engine can be started, but no gear is selected. Apply the parking brake when the car is stationary with the gear selector in position N.

D Driving position

D is the normal driving position. The gear selector automatically shifts up and down between the transmission gears, based on the level of acceleration and the speed. The car should be stationary when you select D from position R.

4 Low gear position

Shifting up and down between the 1st, 2nd, 3rd, and 4th occurs automatically.

Shifting up to Drive does not occur.

Position 4 can be used:

- for mountain driving
- for driving with trailer
- to increase the engine braking

3 Low gear position

Shifting up and down between the 1st, 2nd, and 3rd occurs automatically.

The 4th and Drive gears will not be engaged.

Position 3 can be used:

- for mountain driving
- for driving with trailer
- to increase the engine braking

L Low gear position

Choose position L if you want to drive with the 1st or 2nd gear engaged. Position L gives the best possible engine braking effect when, for example, mountain driving.

Shifting up to 5th does not occur.

Position 4 can be used:

- for mountain driving
- for driving with trailer
- to increase the engine braking

Downshifting protection

There is a built in protection in the transmission which prevents over revving in the engine when you select one of the low gear positions.

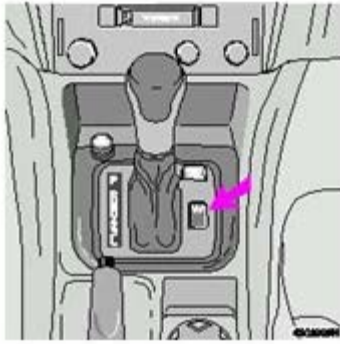

W - Winter/Wet Weather

Use the W button to turn the Winter/Wet Weather function on or off.

The Winter/Wet Weather function limits downshifting during acceleration, helping to reduce wheel spin. Because downshifting is limited in W mode, performance may seem sluggish and fuel economy may be reduced.

W mode is recommended for acceleration from a standstill on rain-slicked roads.

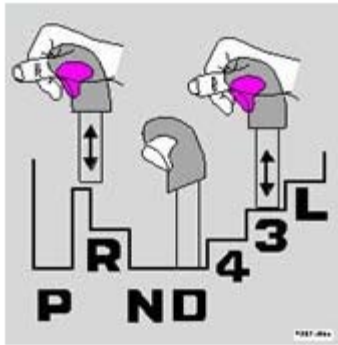

Automatic transmission -shift gate positions

The gear selector can be moved freely between N and D. Selections of other positions are obtained by depressing the selector knob prior to moving the selector.

Slightly depressing the selector knob allows selection of positions R, N, D, 4, 3 and L. Fully depressing the selector knob allows selection of position P. This is also necessary when initially bringing the selector out of position P. Fully depressing the selector knob permits shifting freely between all positions.

Kick-down

Automatic shift to a lower gear (kick-down) is achieved by depressing the accelerator pedal fully and briskly. An upshift will be achieved when approaching the top speed for a particular gear or by releasing the accelerator pedal slightly. Kick-down can be used for maximum acceleration or when passing at highway speeds. Avoid using the kick-down function during the break-in period (first 1,200 miles of vehicle operation).

Transmission Lamp

If the indicator lamp (see [page 21 item 18](#)) begins to flash, this is an indication of a fault in the automatic transmission. The Check Engine Lamp will also light up if a fault is detected. If the transmission does not shift properly, place the gear selector in position L. Please contact your Volvo retailer if this occurs.



2 0 0 3
VOLVO
S40 & V40

Chapter 5 - Wheels and tires

pg. 79 Wheels and tires

Wheels and tires

The handling and riding comfort of the vehicle is dependent on the inflation pressure and the type of tires fitted. Read the following pages carefully.

[General information, Wear indicator, Tire economy, Flat spots](#) **80**

[Snow chains, Snow tires, Studded tires](#) **81**

[Inflation pressure, Tire rotation](#) **82**

[Uniform tire quality grading](#) **83**

["Special spare" tire](#) **84**

pg. 80 Wheels and tires

General information

Your vehicle is equipped with tires according to the tire information label located on the inside of the fuel filler door.

The following is an **example** of a tire designation code 195/60R15:

195 = tire width in mm.

60 = tire profile. This is the relationship (in percent) between the section height and width of the tire.

R = radial tires.

15 = diameter in inches.

The tires have good road holding characteristics and offer good handling on dry and wet surfaces. It should be noted however that the tires have been developed to give these features on snow/icefree surfaces. However, for optimum road holding on icy or snow covered roads **we recommend suitable winter tires on all four wheels**. When replacing tires, be sure that the new tires are the same size designation, type (radial) and from the same manufacturer, on all four wheels. Otherwise there is a risk of altering the car's roadholding and handling characteristics.

NOTE: When storing wheel/tire assemblies (e.g. winter tires and wheels), either stand the assemblies upright, or suspend them off the ground. Laying wheel/tire assemblies on their sides for prolonged periods can cause wheel and/or

tire damage.

Wear indicator

The tires have a so-called "wear indicator" in the form of a number of narrow strips running across or parallel to the tread. When approx. 1/16" (1.6 mm) is left on the tread, these strips become visible and indicate that the tire should be replaced.

Tires with less than 1/16" (1.6 mm) tread have a very poor grip in rain or snow.

When replacing worn tires, it is recommended that the tire be identical in type (radial) and size as the one being replaced. Using a tire of the same make (manufacturer) will prevent alteration of the driving characteristics of the vehicle.

To improve tire economy:

- Maintain correct tire pressure. See the tire pressure label on the inside of the fuel filler door.
- Drive smoothly: avoid fast starts, hard braking and tire screeching.
- Tire wear increases with speed.
- Correct front wheel alignment is very important.
- Unbalanced wheels impair tire economy and driving comfort.
- If the wheels are rotated, they should be kept on the same side of the car so that they revolve in the same direction as prior to rotation.
- Hitting curbs or potholes can damage the tires and/or wheels permanently.

Flat spots

All tires become warm during use. After cooling, when the vehicle is parked, the tires have a tendency to distort slightly, forming flat spots. These flat spots can cause vibrations similar to the vibrations caused by unbalanced wheels. They do, however, disappear when the tire warms up. The degree to which flat spots form depends on the type of cord used in the tire. Remember that, in cold weather, it takes longer for the tire to warm up and consequently longer for the flat spot to disappear.

pg. 81 Wheels and tires

Snow chains

Snow chains can be used on your Volvo with the following restrictions:

- Snow chains should be installed on front wheels only. Use only Volvo approved snow chains.
 - Snow chains may only be mounted on approved snow tires 185/65 R15. Consult your Volvo retailer.
- If accessory, aftermarket or "custom" tires and wheels are installed and are of a size different than the original tires and wheels, chains in some cases CANNOT be used. Sufficient clearances between chains and brakes, suspension and body components must be maintained.
- Some strap on type chains will interfere with brake components and therefore CANNOT be used.
- Consult your Volvo retailer for additional snow chain information.

CAUTION:

- Check local regulations regarding the use of snow chains before installing.
- Always follow the chain manufacturer's installation instructions carefully. Install chains as tightly as possible and retighten periodically.
- Never exceed the chain manufacturer's specified maximum speed limit. (Under no circumstances should that limit be higher than 30 mph (45 km/h)).
- Avoid bumps, holes or sharp turns when driving with snow chains.
- The handling of the vehicle can be adversely affected when driving with chains. Avoid fast or sharp turns as well as locked wheel braking.

Snow tires, studded tires *

Tires for winter use:

Owners who live in or regularly commute through areas with sustained periods of snow or icy driving conditions are strongly advised to fit suitable winter tires to help retain the highest degree of traction.

It is important to install winter tires **on all four wheels** to help retain traction during cornering, braking, and accelerating. Failure to do so could reduce traction to an unsafe level or adversely affect handling. Do not mix tires of different design as this could also negatively affect overall tire road grip. **Volvo recommends 185/65 R15 winter tires on 15" steel rims on all S/V 40 models.**

Winter tires wear more quickly on dry roads in warm weather. They should be removed when the winter driving season has ended.

Studded tires should be run-in 300-600 miles (50-1000 km) during which the car should be driven as smoothly as possible to give the studs the opportunity to seat properly in the tires. The car tires should have the same rotational direction throughout their entire lifetime. In other words, if you wish to rotate the wheels, make sure that the same wheels are always on the same side of the car.

NOTE: Please consult state or provincial regulations restricting the use of studded winter tires before installing such tires.

* Where permitted.

pg. 82 Wheels and tires

Checking and correcting tire pressure

- Refer to the tire pressure label located on the inside of the fuel filler door. The tire pressures shown on the top line of the label will provide best fuel economy. The tire pressures shown on the second line will provide a softer ride, but may reduce fuel economy.
- Check the tire pressure when refueling.
- The tire pressure should be corrected only when the tires are cold.
- With warm tires, correct only when the pressure is too low. The tire temperature rises after driving just a few miles.

Vehicle loading

The tires on your Volvo will perform to specifications at all normal loads when inflated as recommended on the tire information label located on the inside of the fuel filler door*. This label also lists vehicle load limits. Do not load your car beyond the indicated limits.

*Please note that the tire information label indicates pressure for both comfort and fuel economy.



Tire pressure label on fuel filler door

Tire rotation

Volvo recommends rotating the tires every 7,500 miles (12,000 km) and 15,000 miles (24,000 km). Tires should be rotated front-to-back/back-to-front only. Tires must maintain the same direction of rotation throughout their lifetime, and should never be rotated from one side of the vehicle to the other.

pg. 83 Wheels and tires

Uniform tire quality grading

ALL PASSENGER CAR TIRES MUST CONFORM TO FEDERAL SAFETY REQUIREMENTS IN ADDITION TO THESE GRADES

TREADWEAR

The treadwear grade is a comparative rating based on the wear rate of the tire when tested under controlled conditions on a specified government test course. For example, a tire graded 150 would wear one and one half (1 1/2) times as well on the government course as a tire graded 100. The relative performance of tires depends upon the actual conditions of their use, however, and many depart significantly from the norm due to variation in driving habits, service practices and differences in road characteristics and climate.

TRACTION

The traction grades, from highest to lowest, are AA, A, B, and C, as measured under controlled conditions on specified government test surfaces of asphalt and concrete. A tire marked C may have poor traction performance.

WARNING!

The traction grade assigned to this tire is based on braking (straight-ahead) traction tests and does not reflect cornering (turning) traction.

TEMPERATURE

The temperature grades are AA (the highest), A, B, and C, representing the tire's resistance to the generation of heat and its ability to dissipate heat when tested under controlled conditions on a specified indoor laboratory test wheel. Sustained high temperature can cause the material of the tire to degenerate and reduce tire life, and excessive temperature can lead to sudden tire failure. The grade C corresponds to a level of performance which all passenger car tires must meet under the Federal Motor Safety Standard No. 109. Grades B and A represent higher levels of performance on the laboratory test wheel than the minimum required by law.

UNIFORM TIRE QUALITY GRADING

LOCATING THE GRADE

Quality grades can be found where applicable on the tire sidewall between tread shoulder and maximum section width.

Treadwear 200 Traction AA Temperature A

WARNING!

The temperature grade for this tire is established for a tire that is properly inflated and not overloaded. Excessive speed, underinflation, or excessive loading, either separately or in combination, can cause heat buildup and possible tire failure.

pg. 84 Spare tire

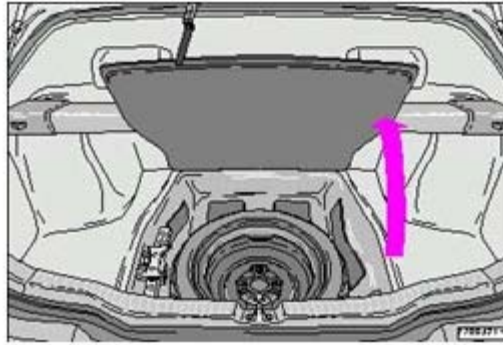

Special Spare The spare tire in your car is called a "Special Spare". It has the following designation: 125/90 R15 96M.

Recommended tire pressure (see the bottom line of the decal on the fuel filler door) should be maintained irrespective of which position on the car the Special Spare tire is used.

In the event of damage to this tire, a new one can be purchased from your Volvo retailer.

CAUTION: The car must not be driven with wheels of different dimensions or with a spare tire other than the one that came with the car. The use of different size wheels can seriously damage your car's transmission.

WARNING!

Current legislation prohibits the use of the "Special Spare" tire other than as a temporary replacement for a punctured tire. In other words, it must be replaced as soon as possible by a standard tire. Roadholding, etc., may be affected with the "Special Spare" in use. Do not, therefore, exceed 50 mph (80 km/h).

CAUTION: We recommend that you switch the DSA system off whenever you use the "Special Spare" tire that does not match the diameter of your other tires. See [page 30](#).



[Contents](#) | [Top of Page](#)

**2003
VOLVO
S40 & V40**

Chapter 6 - In case of an emergency

pg. 85 In case of an emergency

In case of an emergency

Even if you maintain your car in good running condition, there is always the possibility that something might go wrong and prevent you from driving, such as a punctured tire, blown fuse or bulb, etc. For additional information, see section "ON CALL Road Assistance" in [chapter 9](#).

[Tool kit, Jack](#) **86**

[Tire changing](#) **87**

[Replacing bulbs](#) **89**

[Replacing fuses](#) **95**

[Replacing wiper blades](#) **98**

[In case of emergency](#) **99**

[Manually closing the sun roof](#) **100**

pg. 86 Tool kit, Jack

Tool kit and jack

The tool kit and jack are under the carpet in the cargo space floor, next to the spare wheel.

Contents of tool kit

1. Combined screwdriver/socket wrench
2. Lug wrench
3. Crank (for the jack)
4. Gloves

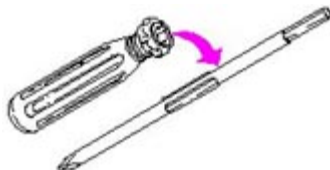

The screwdriver is combined with the socket wrench. The tools can be alternated by pulling the shaft out of the handle and re-inserting the opposite end of the shaft into the handle.

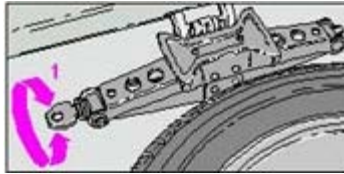

Removing the jack

Remove the spare tire out. Loosen the jack slightly by turning the axle (1) and remove it from the retaining clip.

Replacing the jack

Put the jack in the clip and turn axle (1) until the jack is securely in place.

Replace the tools in the same place.

WARNING!

- The jack (see the following pages) must be correctly placed in the jack attachment.
- Be sure the jack is on a firm, level, non-slippery surface.
- Never allow any part of your body to be extended under a car supported by a jack.
- Use the jack intended for the car when replacing a wheel. For any other job, use stands to support the side of the car being worked on.
- Apply the parking brake and put the gear selector in position P.
- Block the wheels standing on the ground, use rigid wooden blocks or large stones.
- The jack should be kept well-greased.
- Use gloves

pg. 87 Tire changing

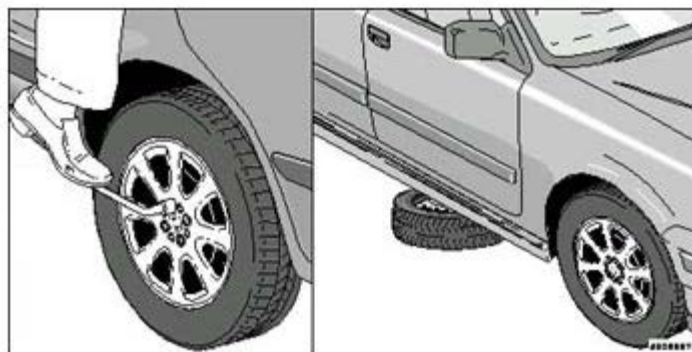

Loosen wheel bolts

Changing a tire

- Engage the parking brake.
- Put the gear selector in (P)ark.

Get all the passengers to move to a safe place outside the car.

- **Close all doors.**
- Block the wheels remaining on the ground with wooden blocks, stones or something similar.
- With the car still on the ground, use the lug wrench to loosen the wheel lugs 1/2 - 1 turn. Position the lug wrench so that you apply force in a downward direction. Never lift up on the lug wrench to loosen or tighten lugs.
- Turn the bolts counterclockwise to loosen. If necessary, press down on the lug wrench with your foot to loosen the lugs.

CAUTION:

- The car must not be driven with wheels of different dimensions or with a spare tire other than the one that came with the car. The use of different size wheels can seriously damage your car's transmission.

pg. 88 Wheel changing

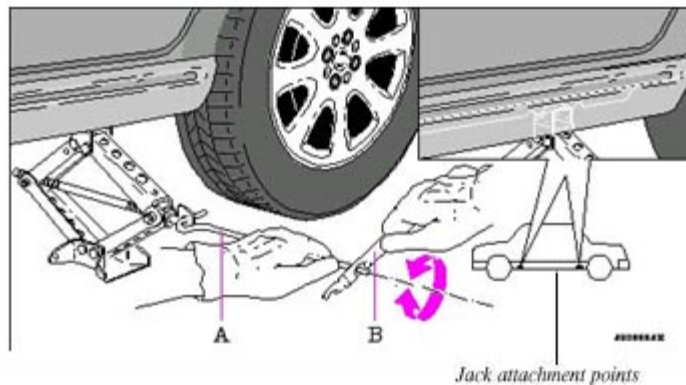

Attaching the jack

There are two jack attachment points located on each side of the car. These attachment points are marked by arrows on the outside of the cover over the bottom sill (see illustration).

Check that the **doors are closed** and stay closed all the time the car is jacked up.

- Position the jack under the two notches closest to the wheel to be changed.
 - Attach the crank to the jack (A).
 - Attach the lug wrench (B) to the crank.
 - Raise the jack by cranking it clockwise. **Be sure the jack engages the attachment point correctly.**
- The base of the jack must be flat on a level, firm, non-slippery surface. Before raising the car, check that the jack is still correctly positioned in the attachment point.**
- Raise the car until the wheel to be changed is lifted off the ground.
 - Unscrew the wheel bolts completely and carefully remove the wheel so as not to damage the thread on the studs.

WARNING!

The jack must be correctly placed in the jack attachment.

Installing the wheel

- Clean the contact surfaces on the wheel and hub.

- Lift the wheel and place it on the hub.
- Install the wheel lugs and tighten handtight.
- Using the lug wrench. Tighten crosswise until all lugs are snug.
- Lower the vehicle to the ground and alternately tighten the lugs crosswise to 81 ft. lbs. (110 Nm).
- Install the wheel cover (where applicable).

CAUTION:

- Correct tightening torque on wheel lugs must be observed. The wheel lugs should never be greased or lubricated. Extended, chromed wheel lugs must not be used with steel rims, as they make it impossible to fit the hub caps.

pg. 89 Replacing bulbs

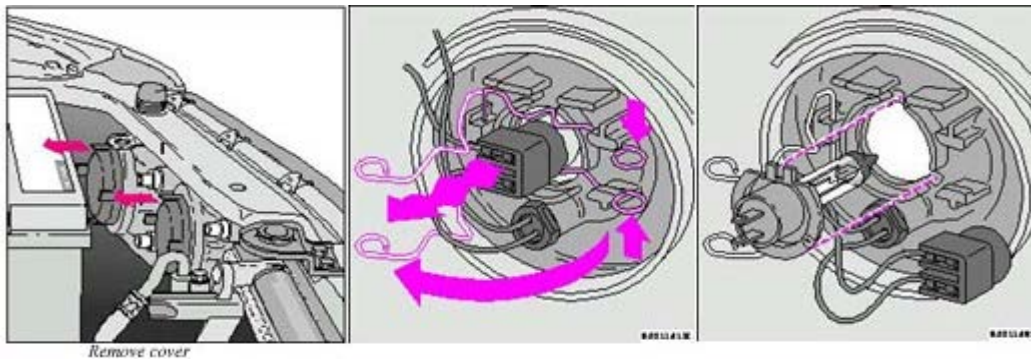

Removing high/low beam headlight bulbs

- Your car is fitted with separate high and low beam bulbs.
- Switch off the lights and remove the ignition key.
- Open the hood.
- Pull off the rubber cover from the rear of the bulb unit to be replaced.
- Release the retaining spring and withdraw the connector/bulb from the headlight unit. Pull the bulb out of the connector.

NOTE: Never touch the glass of a bulb with your fingers: this could leave traces of grease or oil on the glass which then evaporate and may damage the reflector.

pg. 90 Replacing bulbs

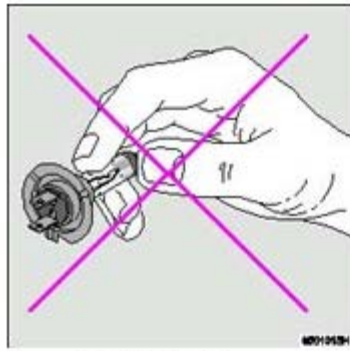

Never touch the glass

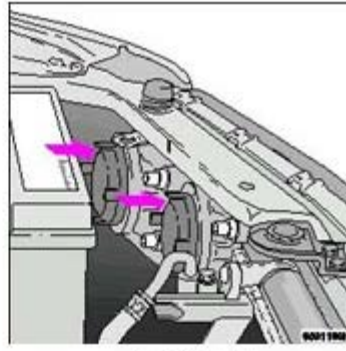

Replacing cover

Installing high/low beam headlight bulbs

- Insert the new bulb in the headlight unit
- Reconnect the connector and wiring.
- Press the retaining spring over the connector/bulb until it clicks into position.
- Reinstall the rubber cover at the rear of the headlight unit.
- Put the hard plastic cover in place above the headlight housing and press the tab down to secure the cover.

NOTE: Never touch the glass of a bulb with your fingers: this could leave traces of grease or oil on the glass which then evaporate and may damage the reflector.

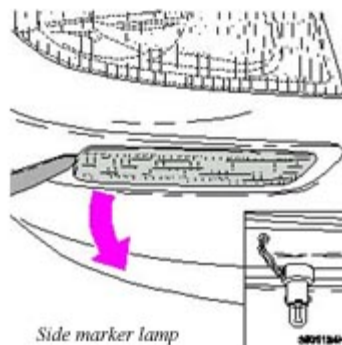

Side marker lamp

Side marker lamp replacement

Slide the lamp insert backward and pull out. Try to loosen the lamp insert with your fingers if possible. Otherwise use a stiff piece of plastic or wood to protect the paint. Turn the bulb holder counter-clockwise and pull out. Replace with a new bulb. Press in the bulb holder and twist clockwise. Reinstall the lamp insert by pressing it into the bodywork.

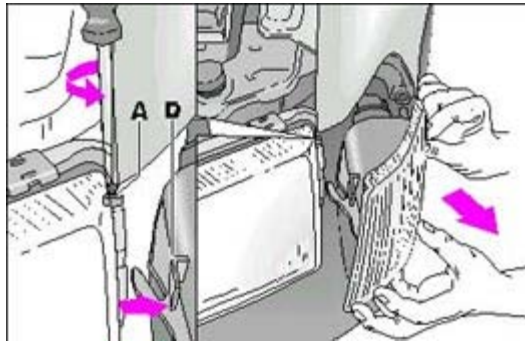

Front direction indicators and parking lights

Removing the bulb:

- Loosen the screw (A) between the headlight and direction indicator housings (max. 2 complete turns counterclockwise), using the screwdriver supplied in the tool kit.
- Press clip (D) and move the direction indicator housing forward.
- With the wiring still attached, turn bulb holder slightly counterclockwise and withdraw it from the lamp housing.
- Pull the bulb to remove.

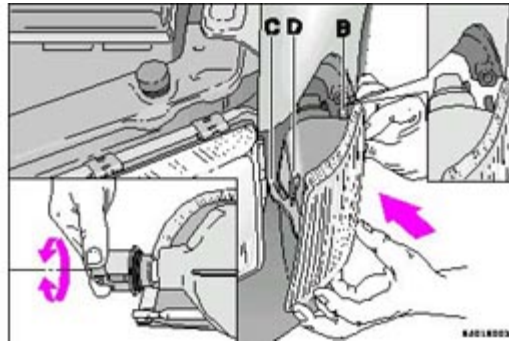

Replacement

- Insert a new bulb in the holder.
- Re-insert the bulb holder in the lamp housing and turn it clockwise until it clicks into place.
- Press the lamp housing into place.

Make sure that locating pin (B) fits into the hole in the fender and slotted hole (C) around the screw.

- Tighten the screw.

pg. 92 Replacing bulbs

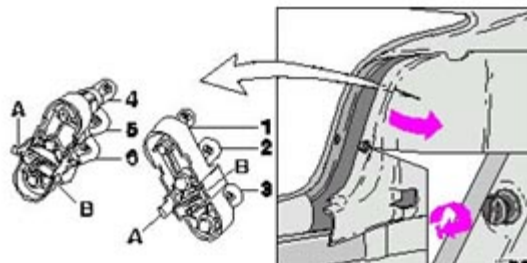

Replacement of rear light bulbs - S40

All the bulbs in the rear light unit are replaced from inside the trunk

Procedure:

- Switch off the lights and remove the ignition key.
- Turn the clip 90° and pull it out. Fold the panel in the boot towards the middle so as to get access to the bulb holder.
- Push catches A and B in and remove the bulb holder. The bulbs are held in the bulb holder.
- Leave the connector and cables connected to the bulb holder.
- Remove the bulb by pressing it inwards and turning it a few degrees counterclockwise.
- Insert a new bulb into the bulb holder and replace the holder. Check that the bulb works and refit the panel.

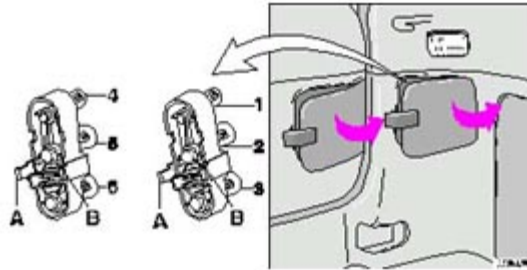

Replacement of rear light bulbs - V40

All the bulbs in the rear light unit are replaced from inside the cargo area.

Procedure:

- Switch off the lights and remove the ignition key.
- Open the cover in the panel
- Push catches A and B in and remove the bulb holder. The bulbs are held in the bulb holder.
- Leave the connector and cables connected to the bulb holder.
- Remove the bulb by pressing it inwards and turning it a few degrees counterclockwise.
- Insert a new bulb into the bulb holder and replace the holder. Check that the bulb works and refit the cover.

1 Tail light (rear parking light)	5W
2 Direction indicator	21W
3 Brake light	21W
4 Tail light	5W
5 Backup light	21W
6 Rear fog light (Left side only)	21W

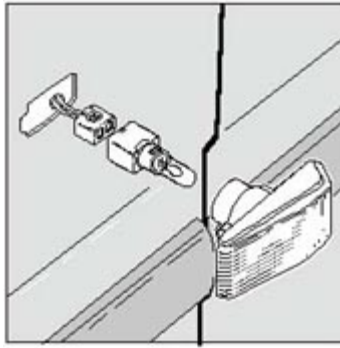

Side direction indicator

1. Slide the lens forward and pull out the rear edge.
2. Pull out the entire lens/bulb unit.
3. With the lens toward you, turn the bulb holder 1/4 turn (the wires should not be disconnected from the holder) and pull out the bulb holder from the lens unit.
4. Pull the old bulb straight out and press a new one into place.
5. Replace the entire unit in the reverse order.

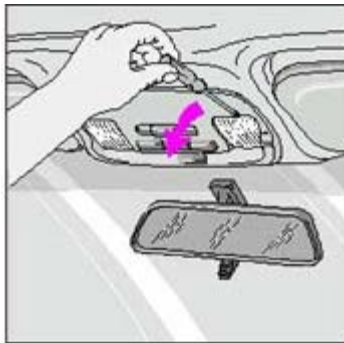

Insert screwdriver, turn and pull downward

Front courtesy lights

- Switch off the ignition.
- Insert a flat screwdriver and turn carefully to loosen the glass lens.
- Replace the bulb and press the glass lens back into place.

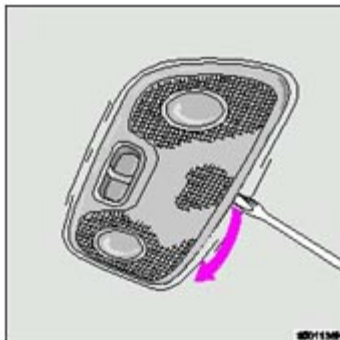

Insert a screwdriver and turn

Rear reading lights

- Switch off the ignition.
- Insert a screwdriver and turn to loosen the lens unit.

- Replace the bulb and press the lens unit back into place.
-



[Contents](#) | [Top of Page](#)

**2 0 0 3
VOLVO
S40 & V40**

Chapter 7 - Car care

pg. 101 Car care

Car care

Car care includes not only maintaining the appearance of the car, but also protecting the car exterior from the effects of air pollution, rain, mud or road salt. The paintwork should also be touched up immediately, if damaged, to prevent rust formation.

[Paint touchup](#) **102**

[Washing](#) **103**

[Automatic car washing, Polishing and waxing](#) **104**

[Cleaning the upholstery](#) **105**

pg. 102 Paint touch up

Paint touchup

Paint damage requires immediate attention to avoid rusting. Make it a habit to check the finish regularly - when washing the car for instance. Touchup if necessary.

Paint repairs require special equipment and skill. Contact your Volvo retailer for any extensive damage.

Minor scratches can be repaired by using Volvo touchup paint.

NOTE: When ordering touchup paint from your Volvo retailer, use the paint code indicated on the model plate. The plate is located in the rear wall of the engine compartment (firewall).

Minor stone chips and scratches

Material:

Primer - can

Paint - touch-up bottle

Brush

Masking tape

NOTE: When touching up the car, it should be clean and dry. The surface temperature should be above 60° F (15° C).

Scratches on the surface If the stone chip has not penetrated down to the metal and an undamaged layer of paint remains, the touchup paint can be applied as soon as the spot has been cleaned.



Deep scratches

1. Place a strip of masking tape over the damaged surface. Pull the tape off so that any loose flakes of paint adhere to it.
2. Thoroughly mix the primer and apply it with a small brush. When the primer surface is dry, the paint can be applied using a brush. Mix the paint thoroughly; apply several thin paint coats and let dry after each application.
3. If there is a longer scratch, you may want to protect surrounding paint by masking it off.

pg. 103 Washing

Washing the car

- The car should be washed at regular intervals since dirt, dust, insects and tar spots adhere to the paint and may cause damage.

NOTE: It is particularly important to wash the car frequently in the wintertime to prevent corrosion, when salt has been used on the roads.

- When washing the car, do not expose it to direct sunlight. Use lukewarm water to soften the dirt before you wash with a sponge, and plenty of water, to avoid scratching.
- **Bird droppings:** Remove from paintwork as soon as possible. Otherwise the finish may be permanently damaged.
- A detergent can be used to facilitate the softening of dirt and oil.
- A water-soluble grease solvent may be used in cases of sticky dirt. However, use a wash place equipped with a drainage separator.
- Dry the car with a clean chamois and remember to clean the drain holes in the doors and rocker panels.
- The power radio antenna (sedans) must be dried after washing.
- Tar spots can be removed with kerosene or tar remover after the car has been washed.
- A stiff-bristle brush and lukewarm soapy water can be used to clean the wiper blades. Frequent cleaning improves visibility considerably.
- Wash off the dirt from the underside (wheel housings fenders, etc.).
- In areas of high industrial fallout, more frequent washing is recommended.

CAUTION: During high pressure washing, the spray nozzle must never be closer to the vehicle than 13" (30 cm). Do not spray into the locks.

- When washing or steam cleaning the engine, avoid spraying water or steam directly on the electrical components or toward the rear side of the engine.
- After cleaning the engine, the spark plug wells should be inspected for water and blown dry if necessary.

Suitable detergents

Special car washing detergents should be used. A suitable mixture is about 2.5 fl. oz. (8.5 cl) of detergent to 2.6 US gal. (10 liters) of warm water. After washing with a detergent the car should be well rinsed with clean water.

WARNING!

- When the car is driven immediately after being washed, apply the brakes several times in order to remove any moisture from the brake linings.
- Engine cleaning agents should not be used when the engine is warm. This may constitute a fire risk.

NOTE: When washing the car, remember to remove dirt from the drain holes in the doors and sills. Painted Bumpers: Wash the painted bumpers with the same cleaning agent used on the rest of the car. Never clean the bumpers with gasoline or paint thinner. Difficult spots can be removed with denatured alcohol. To avoid scratches, do not dry the bumpers with paper.

pg. 104 Automatic car washing, Polishing and waxing

Automatic washing simple and quick

Brushless car washes are recommended. An automatic wash is a simple and quick way to clean your car, but it is worth remembering that it may not be as thorough as when you yourself go over the car with sponge and water. Keeping the underbody clean is most important, especially in the winter. Some automatic washers do not have facilities for washing the underbody.

Before driving into an automatic wash, make sure that side view mirrors, auxiliary lamps, etc., are secure, otherwise there is risk of the machine dislodging them. You should also lower the antenna (sedans).

We do NOT recommend washing your car in an automatic wash during the first six months because the paint will not have hardened sufficiently.

Polishing and waxing

Normally, polishing is not required during the first year after delivery, however, waxing is recommended.

Before applying polish or wax the car must be washed and dried. Tar spots can be removed with kerosene or tar remover. Difficult spots may require a fine rubbing compound.

After polishing use liquid or paste wax.

Several commercially available products contain both polish and wax.

Waxing alone does not substitute for polishing of a dull surface.

A wide range of polymer-based car waxes can be purchased today. These waxes are easy to use and produce a long-lasting, high-gloss finish that protects the bodywork against oxidation, road dirt and fading.

Note: Polishing removes oxidized paint from the surface. This

Cleaning the upholstery

The **fabric** can be cleaned with soapy water or a detergent. For more difficult spots caused by oil, ice cream, shoe polish, grease, etc., use a clothing/fabric stain remover.

The **plastic** in the upholstery can be cleaned with a soft cloth and mild soap solution.

Leather upholstery/suede-like upholstery (Alcantera™) can be cleaned with a soft cloth and mild soap solution. For more difficult spots, Volvo offers a leather care kit.

Under no circumstances should gasoline, naphtha or similar cleaning agents be used on the plastic or the leather since these can cause damage.

Cleaning the seat belt

Clean only with lukewarm water and mild soap solution.

Cleaning floor mats

The floor mats should be vacuumed or brushed clean regularly, especially during winter when they should be taken out for drying. Spots on textile mats can be removed with a mild detergent. Make sure the carpets are properly secured in the fixation points on the floor.

Bear in mind

- Take extra care when removing stains such as ink or lipstick since the coloring can spread.
- Use solvents sparingly. Too much solvent can damage the seat padding.
- Start from the outside of the stain and work toward the center.



**2 0 0 3
VOLVO
S40 & V40**

Chapter 8 - Volvo Service

pg. 107 Volvo Service

Service - an investment

An investment which will pay dividends in the form of improved reliability, durability and resale value.

[Label information](#) **108**

[Maintenance service, Warranty](#) **109**

[Emissions maintenance](#) **110**

[Engine compartment](#) **111**

[Fuel/emissions systems](#) **112**

[Lubrication](#) **113**

[Engine oil](#) **114**

[Power steering fluid, Brake fluid reservoir](#) **116**

[Coolant, drive belt](#) **117**

[Washer fluid reservoir](#) **118**

[Battery maintenance, Proposition 65 Battery Warning](#) **119**

pg. 108 Label information

1 Vehicle Emission Control Information

Your Volvo is designed to meet all applicable emission standards, as evidenced by the certification label on the underside of the hood. For further information regarding these regulations, please consult your Volvo retailer.

2 Vacuum hose routing

(underside of hood)

3 Loads and Tire Pressures

(on inside of fuel filler door)

4 Model plate

Vehicle Identification Number (VIN). Codes for color and upholstery, etc. The plate is located in the engine compartment.

5 Vehicle Identification Number (VIN) *

The VIN plate is located on the top left surface of the dashboard.

6 Federal Motor Vehicle Safety Standards (FMVSS) specifications (USA) and Ministry of Transport (CMVSS) standards (Canada)

Your Volvo is designed to meet all applicable safety standards, as evidenced by the certification label on the facing side of the driver's door. For further information regarding these regulations, please consult your Volvo retailer.

7 Child safety latch label

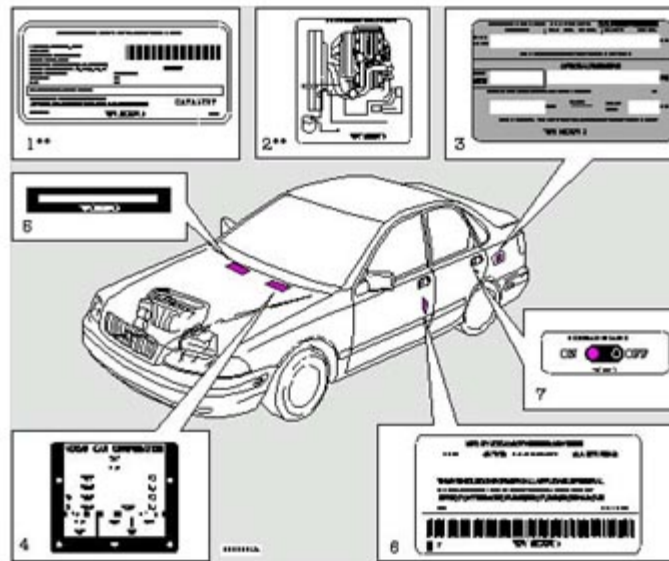

* The Vehicle Identification Number (VIN) should always be quoted in all correspondence concerning your vehicle with the retailer and when ordering parts.

** These decals are located on the underside of the hood.

All specifications are subject to change without notice.

pg. 109 Maintenance service, Warranty

Maintenance service

Volvo advises you to follow the service program which is outlined in the "Warranty and Service Records Information booklet". This maintenance program contains inspections and services necessary for the proper function of your car. The maintenance services contain several checks which require special instruments and tools and therefore must be performed by a qualified technician. To keep your Volvo in top condition, specify time-tested and proven Genuine Volvo Parts and Accessories.

The Federal Clean Air Act - U.S.

The Clean Air Act requires vehicle manufacturers to furnish written instructions to the ultimate purchaser to assure the proper servicing and function of the components that control emissions. These services, which are listed in the

"Warranty and Service Records Information booklet," are not covered by the warranty. You will be required to pay for labor and material used.

Maintenance services

Your Volvo has passed several major inspections before it was delivered to you, accordance with Volvo specifications. The maintenance services outlined in the Warranty and Service Records Information booklet, many of which will positively affect your vehicle's emissions, should be performed as indicated. It is recommended that receipts for vehicle emission services be retained in case questions arise concerning maintenance.

Inspection and service should also be performed anytime a malfunction is observed or suspected.

[Page 110](#) provides more information about maintenance of emission-related components.

Applicable warranties

In accordance with U.S. Federal Regulations, the following list of applicable U.S. warranties is provided. For Canadian specification vehicles, see your separate warranty booklet.

- New Car Limited Warranty
- Parts and Accessories Limited Warranty
- Corrosion Protection Limited Warranty
- Seat belt and Supplemental Restraint Systems Limited Warranty
- Emission Design and Defect Warranty
- Emission Performance Warranty

These are the Federal warranties; other warranties are provided as required by state law. Refer to your separate "Warranty and Service Records Information booklet" for detailed information concerning each of the warranties.

pg. 110 Emission maintenance

Periodic maintenance helps minimize emissions

Periodic maintenance will help keep your vehicle running well. Your Warranty and Service Records Information booklet provides a comprehensive periodic maintenance schedule up to 150,000 miles (240,000 km) of vehicle service. The schedule includes components that affect vehicle emissions. This page describes some of the emission-related components.

Engine air filter

The engine air filter cleans particles from air entering the engine. Replace the engine air filter cartridge with a new one every 37,500 miles (60,000 km) under normal driving conditions. Replace the cartridge more often when the vehicle is driven under dirty and dusty conditions. The cartridge cannot be cleaned, and should always be replaced with a new one.

Fuel filter

The fuel filter should be replaced at 105,000 miles (168,000 km). The filter is replaced as a complete unit. Replace more frequently if contaminated fuel is introduced into the tank, or if there is reason to suspect that this has occurred.

Fuel system, including filler cap, tank, lines and connections

The ability of the fuel system to contain hydrocarbons depends upon a leak-free system. Inspect fuel lines every 30,000 miles (48,000 km). Check for proper sealing of the fuel filler cap which contains "O" ring seals.

NOTE: If the fuel filler cap is not closed tightly or if the engine is running when the car is refueled, the Check Engine light (Malfunction indicator) may indicate a fault. However, your vehicle's performance will not be affected. Use only Volvo original or approved fuel filler caps.

Timing belt

For proper functioning of the vehicle and its emission control systems, the timing belt and belt tensioner must be replaced every 105,000 miles (168,000 km). Engine damage will occur if the belt fails.

PCV system

(on turbocharged models)

The nipple in the intake manifold and the filter at the end of the PCV hose in the air cleaner should be inspected and cleaned at 105,000 miles (168,000 km) and thereafter, again at 150,000 mile (240,000 km) intervals.

Spark plugs

The spark plugs should be replaced every 45,000 miles (72,000 km) under normal driving conditions. City driving or fast highway driving may necessitate replacement sooner.

Under normal driving conditions, spark plugs require no maintenance between replacement intervals. When installing new plugs, be sure to use the right type and to tighten them correctly. When changing the plugs, clean the terminals and rubber seals. Also check that the suppressor connectors are in good condition. Cracked or damaged connectors should be replaced.

pg. 111 Engine compartment

Engine compartment S40/V40

- 1 Power brakes
- 2 Brake fluid reservoir
- 3 Fusebox
- 4 Engine air cleaner
- 5 Battery
- 7 Radiator
- 8 Oil filter
- 10 Engine oil dipstick
- 11 Generator
- 12 Windshield/headlight washer fluid reservoir
- 13 Power steering pump
- 14 Power steering fluid reservoir
- 15 Engine oil filler cap
- 16 Coolant expansion tank
- 17 Windshield wiper motor
- 18 Chassis number

- A ABS
- B Air conditioning compressor
- C Air conditioning condenser
- D Air conditioning accumulator

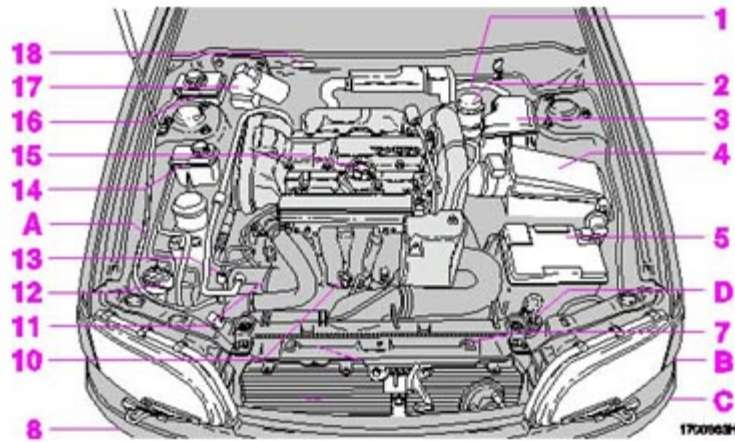

WARNING!

The coolant fan may start or continue to operate (for up to 6 minutes) after the engine has been switched off.

pg. 112 Fuel/emissions systems

Fuel system

The fuel system is all-electronic and is microprocessor-controlled. It can continually compensate for variation in engine load, speed and temperature to give the best economy and power. A mass air flow sensor measures the inducted air. In this way the system can make instantaneous adjustments for changes in air temperature or density, thus always assuring the best economy with the lowest possible exhaust emissions.

Heated oxygen sensor

This is an emission control system designed to reduce emissions and improve fuel economy. The heated oxygen sensor monitors the composition of the exhaust gases leaving the engine. The exhaust gas analysis is fed into an electronic module. This adjusts the air-fuel ratio to provide optimum conditions for combustion and efficient reduction of the three major pollutants (hydrocarbons, carbon monoxide and oxides of nitrogen (NOx)) by a three-way catalytic converter.

Crankcase ventilation

The engine is provided with positive crankcase ventilation which prevents crankcase gases from being released into the atmosphere. Instead, the crankcase gases are admitted to the intake manifold and cylinders.

Evaporative control system

The car is equipped with an evaporative control system which prevents gasoline vapor from being released into the atmosphere.

The system consists of a fuel tank with filler pipe and cap, a rollover valve, a Fill Limit Vent Valve (FLVV), vapor vent lines, a charcoal canister, a purge line, a purge control valve and engine connections. In addition, there is a pressure sensor connected to the fuel tank and a filter-protected Canister Close Valve (CCV) on the atmospheric side of the canister, for system diagnosis.

The gasoline vapor is channeled through the rollover valve and the FLVV via the vapor vent lines into the charcoal canister, where it is stored. When the engine is started, the gasoline vapor is drawn from the charcoal canister to the engine's air intake system and into the combustion process.

NOTE:

- If the fuel filler cap is not closed tightly or if the engine is running when the car is refueled, the Check Engine light

may illuminate.

- During a transitional period, a small number of service stations may still have fuel nozzles that are not compatible with the fuel filler neck on cars equipped with the evaporative emission control system mandated by the U.S. Environmental Protection Agency and the California Air Resources Board. If you experience difficulties in refueling your vehicle, please ask the gas station attendant for assistance.
-

CAUTION:

Fuel must not be siphoned from the fuel tank. This will damage the evaporative emission control system.



[Contents](#) | [Top of Page](#)

2 0 0 3
VOLVO
S40 & V40

Chapter 9 - Specifications

pg. 121 Specifications

Specifications

This chapter contains facts and figures pertaining to the technical specifications of your car.

[Oil/fluids specifications](#) [122](#)

[Engine specifications](#) [123](#)

[Cooling/fuel/distributor ignition systems](#) [124](#)

[Front/rear suspensions](#) [124](#)

[Transmission, Capacities, Vehicle loading](#) [125](#)

[Electrical system/bulbs](#) [126](#)

[Dimensions/weights](#) [127](#)

[Volvo On Call roadside assistance](#) [128](#)

pg. 122 Oil/fluid specifications

Oil quality

Meeting minimum ILSAC specification GF-2, including ACEA A1, API SJ, SJ/CF and SJ/Energy Conserving.

Oil additives must not be used

Viscosity (stable ambient temperatures):

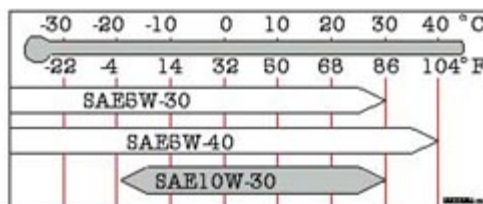

Engine oil	Quality: Meeting minimum ILSAC specification GF-2, including ACEA A1, API SJ, SJ/CF and SJ/Energy Conserving.	Capacity (incl. filter): 5.7 US qts (5.4 liters). Capacity (excl. filter): 5.3 US qts (5.0 liters)
Automatic transmission fluid	Quality: JWS-3309 P/N 1161540	Capacity: 8 US qts. (7.6 liters)
Power steering fluid	Quality: ATF oil	Capacity: 1.05 US qts. (1 liters)
Brake fluid	Quality: DOT 4+ boiling point >536°F (280°C), P/N 9437433	Capacity: 0.42 US qts. (0.4 liters)

All specifications are subject to change without notice.

pg. 123 Engine

Engine

Liquid-cooled, gasoline, inline, 4-cylinder, turbocharged engine. Aluminum alloy cylinder block with cast-iron cylinder liners cast directly into the block. Aluminum alloy cylinder head with double overhead camshafts and separate intake and outlet channels.

Engine lubrication is provided by an eccentric pump driven from the crankshaft. Full-flow type oil filter. Exhaust emission control is accomplished by multiport fuel injection, a heated oxygen sensor and a three-way catalytic converter.

Designation: **Volvo B 4204 T4**

Output	170 hp at 5500 rpm (127 kW at 92 rps)
Max torque	177 ft. lbs. at 1800-5000 rpm (240 Nm at 30-75 rps)
Number of cylinders	4
Bore	3.27" (83 mm)
Stroke	3.54" (90 mm)
Displacement	1.95 liters (118.9 cu. in.)
Compression ratio	9.0:1
Number of valves	16
Valve clearance	mechanical

All specifications are subject to change without notice.

pg. 124 Specifications

Cooling system

Type: Positive pressure, closed system

Thermostat begins to open at 186° F (90° C)

Coolant: Volvo original coolant/antifreeze (50/50 water-antifreeze mix).

Capacity: 6 US qts. (5.7 liters)

Fuel system

The engine is equipped with a multipoint fuel injection system.

Distributor ignition system

Firing order: 1-3-4-2

Distributor ignition setting: Not adjustable

Spark plugs: Champion RC8PYP or equivalent

Spark plug gap: 0.0315" (0.80 mm)

Tightening torque: 18.4 ft. lbs. (25 Nm)

WARNING!

The distributor ignition system operates at very high voltages. Special safety precautions must be followed to prevent injury. Always turn the ignition off when:

- Replacing distributor ignition components e.g. plugs, coil, etc.
- Do not touch any part of the distributor ignition system while the engine is running. This may result in unintended movements and body injury.

All specifications are subject to change without notice.

Front suspension

Spring strut suspension with integrated shock absorbers and control arms linked to the support frame. Power assisted rack and pinion steering. Safety type steering column.

The alignment specifications apply to a car at curb weight (without passengers or cargo).

Toe-in measured on the wheel rims: 1.4 mm +/- 0.2 mm

Toe-in measured on tire sides: 2.0 mm +/- 0.4 mm

Rear suspension

Multilink individual rear wheel suspension with longitudinal support arms, double link arms and track rods.

Toe-in measured on the tire sides: 2.6 mm +/- 0.8 mm

pg. 125 Specifications

Power transmission

Automatic transmission: AW 55-50

5-speed automatic electronically controlled gearbox comprising a hydraulic torque converter with a lockup function; planetary gear, integrated final drive. Operation via a floor mounted gear selector lever. Drive shafts with symmetrical joint location. Overdrive.

Final drive ratio 2.44:1

Reduction ratios

1st gear 4.77:1

2nd gear 3.00:1

3rd gear 1.96:1

4th gear 1.32:1

5th gear 1.02:1

Reverse 3.23:1

Capacities

Fuel tank : 16 US gal. (60 liters)
 Cooling system : 6 US qts. (5.7 liters)
 Engine oil (incl. filter) : 5.7 US qts. (5.4 liters)
 Engine oil (excl. filter) : 5.3 US qts. (5.0 liters)
 Automatic transmission : 8 US qts (7.6 liters)
 Power steering fluid : 1.05 US qts (1 liters)
 Washer fluid reservoir : 3.9 US qts. (3.75 liters)
 Brake system : 0.42 US qts (0.4 liters)

Vehicle loading

The tires on your Volvo should perform to specifications at all normal loads when inflated as recommended on the tire information label. The label is located on the inside of the fuel filler door. The label also lists vehicle load limits. Do not load your car beyond the indicated limits.

WARNING!
 Improperly inflated tires will reduce tire life, adversely affect vehicle handling and can possibly lead to failure resulting in loss of vehicle control without prior warning.

All specifications are subject to change without notice.

pg. 126 Specifications

Electrical system

12 Volt, negative ground.
 Voltage-controlled generator. Single-wire system with chassis and engine used as conductors.

Battery

Voltage: 12 Volt, capacity: 600 A/100 min
 The battery contains corrosive and poisonous acids. It is of the utmost importance that old batteries are disposed of correctly. Your Volvo retailer can assist you in this matter.

Generator

Rated output: 120 A

Bulbs

Bulb	US no.	Power	Socket	No/bulbs
Headlights				
High beam	H7	55W	-	2
Low beam	H7	55W	-	2
Parking lights and Turn signals, front	3457NA	26/7W/30/2.2cp	W2.5 16q	2
Turn signals, rear	1156	21W/32cp	BA 15 s	2
Side direction indicators	-	5W	W 2.1x9.5 d	2
Tail lights	67	5W/4cp	BA 15 s	4
Brake lights	1156	21W/32cp	BA 15 s	2
Backup lights	1156	21W/32cp	BA 15 s	2
Rear fog light	1156	21W/32cp	BA 15 s	1
Front fog lights	H3	55 W	PK22.5	2

License plate light (S40)	-	5 W	W 2.1x9.5 d	2
License plate light (V40)	-	5 W	SV8.5	2
Door step courtesy lights	-	10W	SV8.5	2
Trunk light	-	5 W	SV 8.5	1
Vanity mirror lights	-	1.2 W	SV5.5	2
Front courtesy lights	-	5 W	SV5.5	2
Rear reading lights	-	5 W	W 2.1x9.5 d	2

All specifications are subject to change without notice.

pg. 127 Specifications

Dimensions

Length	S40/V40	178.0 in. (452 cm)
Width	S40/V40	67.7 in. (172 cm)
Height	S40/V40	55.9 in. (142 cm)
Wheel base	S40/V40	100.4 in. (255 cm)
Track, front	S40/V40	57.1 in. (145 cm)
Track, rear	S40/V40	57.9 in. (147 cm)
Turning circle:	S40/V40	34.8 ft. (10.6 m)
Cargo capacity:		
	S40	13.2 ft ³ (374 liters)
	V40	33.5 ft ³ (948 liters)
	Max width of load opening	27.6 in. (67 cm)
	Max height of load opening	20.1 in. (51 cm)

Weights

Gross Vehicle Weight (GVW):

S40	3924 lbs (1780 kg)
V40	3968 lbs (1800 kg)

Capacity Weight:

S40	826 lbs (375 kg)
V40	826 lbs (375 kg)

Permissible axle weight, front:

S40	2090 lbs (950 kg)
V40	2090 lbs (950 kg)

Permissible axle weight, rear:

S40	1870 lbs (850 kg)
V40	1920 lbs (870 kg)

Permissible axle weight total:

S40	3920 lbs (1780 kg)
V40	3970 lbs (1800 kg)

Curb weight:

S40	3068 lbs (1392 kg)
V40	3118 lbs (1414 kg)
The max permissible axle loads or the gross vehicle weight must not be exceeded.	
Max roof load *	220 lbs (100 kg)
Max trailer weight	
(w/o brakes)	1000 lbs (455 kg)
(with brakes)	2000 lbs (908 kg)
Max tongue weight **	110 lbs (50 kg)

* For non-Volvo roof racks, check the manufacturer's weight specifications. The maximum permitted roof load weight may not be exceeded

** Please refer to section "Trailer towing"

WARNING!

When adding accessories, equipment, luggage and other cargo to your vehicle, the total loaded weight capacity of the vehicle must not be exceeded.

All specifications are subject to change without notice.

pg. 128 On Call Roadside Assistance

Volvo On Call Roadside Assistance



Your new Volvo comes with a four year On Call Roadside Assistance program. Additional information, features, and benefits are described in a separate information package in your glove compartment.

If you have misplaced your package, dial:

In the U.S.A.

1-800-63-VOLVO (1-800-638-6586)

In Canada:

1-800-263-0475



Technician certification

In addition to Volvo factory training, Volvo supports certification by the National Institute for Automotive Excellence (A.S.E.). Certified technicians have demonstrated a high degree of competence in specific areas. Besides passing exams each technicians must also have worked in the field for two or more years before a certificate is issued. These professional technicians are best able to analyze vehicle problems and perform the necessary service procedures to keep your Volvo at peak operating condition.



[Contents](#) | [Top of Page](#)

2003
VOLVO
S40 & V40

Chapter 10 - Audio systems

pg. 129 Audio systems

Audio systems

This chapter describes the audio system in your car.

[Anti-theft](#) [130](#)

[Audio system HU-415](#) [131](#)

[Audio system HU-615](#) [132](#)

[CD player HU-615](#) [137](#)

[Advanced user mode](#) [141](#)

[Technical data audio](#) [142](#)

pg. 130 Anti-theft code - HU-415 and HU-615

Anti-theft code

The radio features anti-theft circuitry. If the set is removed from the vehicle or if the battery power is disconnected, a special code must be entered to enable operation of the set.

Your Volvo retailer will supply you with this code.

NOTE: Volvo recommends that you store the radio code in a safe place.

A red LED will flash when the key had been removed **from the ignition to confirm that the anti-theft circuitry has been activated.**

To enter the code

After installation or when the set has been disconnected from power, the set displays "input CODE ****" when it is switched on.

Enter the 4-digit code using the **1-20/DISC** knob. Select a number for a digit by rotating the **1-20/DISC** knob. And then push the knob to enter the number. Repeat the procedure for all 4 digits.

If the correct code is entered the set is ready to use.

If you enter an incorrect code you must enter the correct code again from the beginning.

Incorrect code

If an incorrect code has been entered "Error" is displayed. Enter the correct code. After three unsuccessful coding attempts the set will lock and remain locked for two hours.

"OFF" is displayed.

During this waiting period:

- the battery must be connected
- the ignition key must be turned to position I
- the unit must be turned on

Make sure the headlights are turned off to help prevent battery drain.

Enter the code again once 2 hours have elapsed.

pg. 131 Audio system HU-415

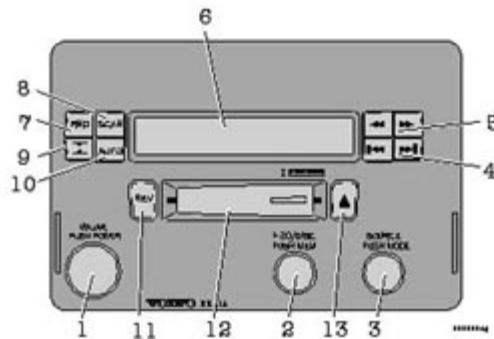

1. **Switch On/off** (push)

Volume (turn)

2. **Selector knob:**

Select the channel (turn)

CD changer - Selecting disc (turn)

Program radio frequency in a channel (push)

3. **Selector knob for choosing (turn) :**

Radio

Cassette

CD changer (option)

Mode knob (push) for setting:

Bass, Treble, Fader and Balance

4. **Radio** - Station seek up/down

Cassette position - Selecting next/previous track

CD position - Selecting next/previous track

5. **Radio** - Manual station selection

Cassette position - Fast winding forward/ backwards

CD-position - Fast winding forwards/ backwards

6. **Display**

7. **Random for CD** (Description for CD is applicable when a CD Changer is connected)

8. **SCAN**

9. **Dolby B NR noise reduction**

10. **Auto store of radio stations**

11. **Tape direction selector/**

12. **Cassette opening**

13. **Tape eject**

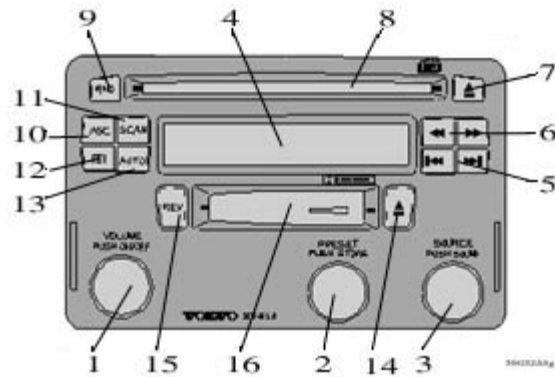

1. **Switch On/off** (push)

Volume (turn)

2. **Selector knob:**

Select the channel (turn)

CD changer - Selecting disc (turn)

Program radio frequency in a channel (push)

3. **Selector knob for choosing :**

Radio

Cassette

CD player

CD changer

Mode knob (push) for setting:

Bass, Treble, Fader and Balance

4. **Display**

5. **Radio** - Station seek up/down

Cassette position - Selecting next/ previous track

CD position - Selecting next/previous track

6. **Radio** - Manual station selection

Cassette position - Fast winding forward/reverse

CD-position - Fast winding forwards/ backwards

7. **CD eject**

8. **CD slot**

9. **Random for CD**

10. **ASC - Active sound control**

11. **SCAN**

12. **Traffic information**

13. **Dolby B NR noise reduction**

14 **Tape eject**

15 **Tape direction selector/**

16. **Cassette opening**



HU-415

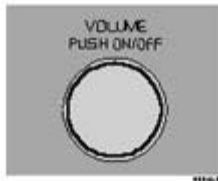

HU-615

Switch on/off

Press button to switch on or turn off the radio.

Volume control

Turn knob clockwise to increase volume. Volume control is electronic and does not have an end stop.



HU-415

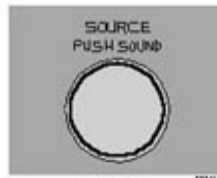

HU-615

Bass, Treble and Balance left-right, Fade

Press the "SOURCE" button to bring up bass, treble or balance. Adjust by turning the source knob left or right. The selected function is shown in the display.



HU-415

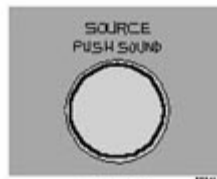

HU-615

Radio Band selector

Turn the "SOURCE" knob to select FM or AM. The station and Band are displayed. You can also select cassette deck, CD or CD changer, if connected, with this knob.

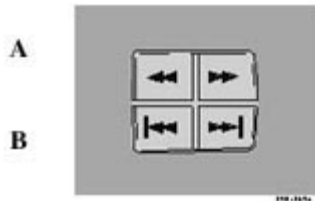

A - Setting station

Press the left side of the button to select lower frequencies and the right side for higher frequencies. Set frequencies are displayed.

B - Station seek up/down

Press on the left or right sides of the button to seek lower or higher frequencies. The radio seeks the next audible station and sets it. Press the button again if you wish to continue seek.



Auto store of radio stations

This function seeks and stores up to 10 strong AM or FM stations in a separate memory. This function is especially useful in areas where you are not familiar with the radio stations.

1. Press the "AUTO" button. A number of stations with strong signals (maximum 10) from the set wavelength are now stored automatically in the memory. "AUTO" is displayed. If there is no station with sufficient signal strength "NO STATION" is displayed.
2. Turn "1-20/DISC" button if you wish to change to another of the preset stations. A new station is set with every turn.
3. Press again to leave AUTO mode. To start a new auto search, press the AUTO button for approximately 2 seconds.

pg. 135 Audio system



Scan function

Press the SCAN button to start the station scan function. When a station is found, scanning stops for several seconds, after which scanning will continue.

Press the SCAN button when a station has been found if you would like to listen to that station and to discontinue the scan function.

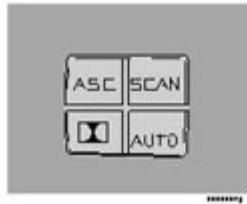

Active sound control (ASC)

The ASC (Active Sound Control) automatically adapts volume to vehicle speed. Press the ASC button for several seconds to switch this function ON or OFF. "ASC ON" or "ASC OFF" will be shown in the display for several seconds.

pg. 136 Cassette

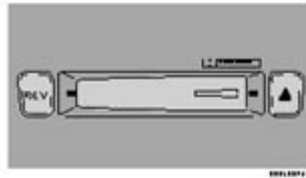

Cassette opening

Slide cassette into the cassette opening with the tape to the right (side 1 or A upwards). TAPE A or TAPE B is displayed. When one side has finished playing, the unit will automatically begin playing the other side. If a cassette is already installed in the cassette deck, select cassette play by turning the "SOURCE" knob.

Tape eject

If you press the button, the tape stops and the cassette is ejected. To select a new program source turn the "SOURCE" knob. The cassette can be inserted or ejected even when the unit is switched off.





Dolby B Noise reduction

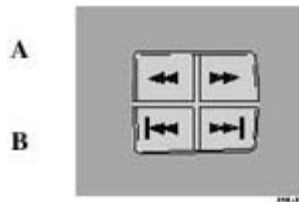

The function is preset. Carry out the following if you wish to switch it off: hold the button  depressed until the Dolby symbol in the display goes out. Press the same button again to reactivate the Dolby function.



A - Fast winding

The tape can be wound forward with "  " and backwards with "  ". During fast winding "FF" (forward) respectively "REW" (backward) is displayed. Fast winding is interrupted if you press the button again.

B - Next track, Previous track

If you press "  " button the tape automatically winds forward to the next track. If you press "  " button the tape automatically winds backwards to the previous track. For the function to operate there must be at least 5 seconds break

between the tracks.

pg. 137 CD Player



CD player - on

Insert a CD disc. If you have already done this, select CD by turning the "SOURCE" knob.

CD eject

If you press this button the CD stops playing and the disc is ejected.

NOTE: For traffic safety reasons you have twelve seconds to handle the ejected CD disc. Then the CD disc reinserts again.

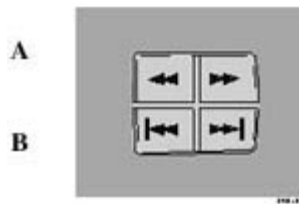

A - Fast winding

Press "◀◀" or "▶▶" to seek within a track.

B - Skipping or Selecting a track

Press "▶|" to skip to the previous track or "◀|" to skip to the next track. The track number is shown in the display.

pg. 138 CD Player



Random

Press "RANDOM" to connect the random function. The unit plays tracks from the disc in random order. "RND" (random) is displayed as long as the function is activated.

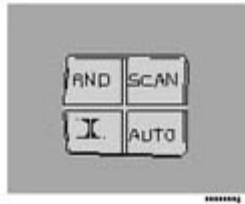

Scan

Press "SCAN" for a longer period to connect the scan function. The unit plays the first 10 seconds of each track. "SCAN" is displayed as long as the function is activated.

pg. 139 CD Changer (option)



CD changer - on

Turn "SOURCE" to activate CD changer position. The CD changer continues playing the disc and track that was playing last. If the CD changer magazine is empty "LOAD CARTRIDGE" is displayed.

Selecting disc

Turn the "1-20 DISC" knob. The disc number and track is displayed.

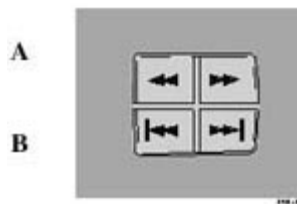

A - Fast winding

Press "▶▶" or "◀◀" to seek within a track.

B - Skipping or Selecting a track

Press "▶|" to skip to the previous track or "◀◀" to skip to the next track. The track number is shown in the display.

pg. 140 CD Changer (option)



Random

Press "RND" to connect the random function. The unit plays tracks from the magazine in random order. "RANDOM" is displayed as long as the function is activated.



Scan

Press "SCAN" for a longer period to connect the scan function. The unit plays the first 10 seconds of each track. "SCAN" is displayed as long as the function is activated.

pg. 141 AUM (Advanced User Mode)

AUM (Advanced User Mode)

- With the radio switched off, press and hold the volume wheel down for at least 5 seconds to start the AUM function.
- Turn the **1-20/DISC** knob to choose an AUM function (see function list below).
- When the function has been chosen, the function's default position flashes. Press the **1-20/DISC** knob to choose an alternative (e.g. ON/OFF, LOW/MID/HIGH, etc., depending on the function).
- Continue to choose function/alternative.

To reset all AUM functions to factory settings, turn the **1-20/DISC** knob until "**SET TO DEFAULT**" is shown in the display, and then press the same knob. All AUM settings are reset to default position and the radio reverts to normal status (music, news, etc.).

To *save* any changes and revert to normal position, turn the **1-20/DISC** knob until "**BACK and SAVE**" are shown in the display, and press the same knob.

To revert to normal position without saving the changes, turn the **1-20/DISC** knob until "**BACK without SAVE**" is shown in the display, and press the same knob.

AUM functions (starting position "default" is underscored)

- SET TO DEFAULT (See left-hand column).
- ASC (Active Sound Control) ON/OFF - The ASC function automatically matches the sound volume to the speed of the car.
- ASC TABLE - Choose level of the ASC function (LOW/MID/HIGH)..
- SRC ON/OFF- Use this function to activate/deactivate the function which reduces the noise in poor reception conditions. The function is normally used when the radio is in AM mode.
- SRC TABLE - Choose level of SRC function (LOW/MID/HIGH).
- DOLBY NR ON/OFF - Activates/ deactivates Dolby noise reduction when you listen to a cassette tape (HU 415/615).
- BACK and SAVE (See left-hand column).
- BACK without SAVE (See left-hand column).

pg. 142 Technical data - Audio

HU-415

Output: 4 x 25 W

Impedance: 4 Ohm.

Voltage required: 12 V, negative ground

Radio

Frequency: U (FM) 87.5 - 108 Mhz

M (AM) 522 - 1611 kHz

L (AM) 153 - 279 kHz

HU-615

Output: 4 x 25 W

Impedance: 4 Ohm.

Voltage required: 12 V, negative ground

Radio

Frequency: U (FM) 87.5 - 108 Mhz

M (AM) 522 - 1611 kHz

L (AM) 153 - 279 kHz

Changing radio tuning modes

The radio tuning mode can be changed from "US" to "AUS" (for areas where it is possible to listen to stations broadcast from outside the U.S.). to change modes:

1. Switch the radio off.
2. Push and hold the MEM knob, and press the POWER button.
3. Press the MEM knob to select the desired tuning mode (US or AUS)
4. Turn the MEM knob to "Back and save"
5. Press the MEM knob to save the setting.

Alarm

"Alarm!" is displayed when an alarm message is sent. The function is used to warn the driver of serious accidents or catastrophes, collapsed bridges, earthquakes or nuclear accidents for example.

Dolby noise reduction is manufactured under license from Dolby Laboratories Licensing Corporation. "Dolby", "Pro-Logic" and the double D symbol  are trademarks of Dolby Laboratories Licensing Corporations. The Dolby Pro Logic Surround System is manufactured under licence from Dolby Laboratories Licensing Corporation.



2 0 0 3
VOLVO
S40 & V40

INDEX

pg. 143 - 145 Index

A	
ABS	23,73
Adjustable steering wheel	34
Advanced user Mode (AUM) - radio	141
Air conditioning	37
Air distribution	36
Air filter - engine	110
Air vents	35
Airbag (SIPS)	8
Airbag (SRS)	4
Alarm	43
Anti-lock Brake System (ABS)	23,73
Anti-theft code	130
Antifreeze	75,117
Ashtrays	33
Audio system HU-415	131
Audio system HU-615	132
Audio systems	129
AUM - Advanced user Mode - radio	141
Automatic car washing	104
Automatic transmission	67,68,69,125
Automatic transmission fluid	122
Auxiliary socket	33
B	
Battery	75,126
Battery maintenance	119
Booster cushion	11
Brake failure warning light	22
Brake fluid	116,122
Brake fluid warning light	22
Brake system	73,74

Bulb failure warning	22
Bulbs	126
C	
Cabin air filter	35
Capacities	125
Center head restraint	3
Central locking switch	42
Chains - winter driving	81
Changing a wheel	87
Child booster cushion	11
Child Restraint Anchorages	14
Child safety	15
Child safety locks - rear doors	49
Concealed storage bin (wagon)	59
Coolant - checking/changing	117
Cooling system	68,124
Cruise control	31
D	
Daytime Running Lights	23
Detachable trailer hitch - installing	76
Detachable trailer hitch - removing	77
Dimensions	127
Doors and locks	42
Drive belt	117
Driving economy	64
Dynamic Stability Assistance (DSA)	30
E	
EBD	74
ECC - Electronic Climate Control	36,37
Electrical outlet	33
Electrical system	69,126
Electrically operated driver's seat	50
Electrically operated front seats	48
Emergency towing	70
Emergency warning flashers	26
Emissions systems	112
Engine	123
Engine air filter	110
Engine compartment	111
Engine oil	115,122
Engine oil - checking/changing	114
F	
Fog light - rear	24
Fog lights	24

Folding rear seat (sedan)	55
Folding rear seat	55
Front seats	47,48
Front seats - heated	32
Front suspension	124
Fuel filter	110
Fuel system	110, 112,124
Fuel tank cover - opening	63
Fuse box, Passenger compartment	96
Fuses	95,96,97
Fuses in engine compartment	97
G	
Gas tank cover - opening	63
Generator	126
H	
Hand brake	32
Handling	59
Hazard warning flashers	26
Headlight bulbs, replacing	90
Heated front seats	32
Heating	37
Heating and air conditioning	35
Home Safe lighting	25
Hood	53
I	
IC system	10
Ignition switch	26
Immobilizer (start inhibitor)	40
Instruments	18,19
Integrated booster cushion	11
ISOFIX fasteners	12
J	
Jack	86
Jack (sedan)	57
Jump starting	72
K	
Keyless entry system	41
Keylock	65
Keys	40,41
Kick-down	67
L	
Label information	108
Locks	42
Long distance trips	75

Lubrication	113
Luggage strap (V40)	56
Lumbar support	47,48
M	
Maintenance service	109
Malfunction indicator lamp	23
Manual transmission fluid	122
Manually closing the sun roof	100
Mirrors - rear/side view	50
O	
Occupant safety	16
Octane rating	63
Oil - engine	115
Oil pressure warning light	22
Opening the trunk from the inside S40	46
P	
Paint touchup	102
Parking brake	32
Parking brake reminder light	22
PCV system	110
Polishing	104
Power seats	48
Power steering fluid	116,122
PROPOSITION 65 WARNING	72,119
R	
Radio tuning modes - changing	142
Rear fog light	24
Rear suspension	124
Rear waste bin	34
Refueling	63
Remote control (central locking system)	41
Remote keyless entry system	41
Replacing bulbs	90, 92, 93, 94
Replacing fuses	95
Replacing number plate lighting - V40	94
Reporting safety defects	16
Road assistance	128
Roadholding	59
Roof rails/racks	59
S	
Safety defects - reporting	16
Safety locks - child	49
Seat belt maintenance	16
Seat belts	2,3

Seat belts - cleaning	105
Seats	47
Service reminder indicator	23
Servicing	111
Shift lock	66
Shiftlock release	99
Shiftlock release (override)	99
Side Impact Protection System (SIPS)	8
Side marker lamp replacement	90
Side-view mirrors - heated	26
SIPS	8
Snow chains	81
Snow tires	81
Spare tire	84
Spare tire (sedan)	57
Spark plugs	110, 124
Specifications	121
SRS	5,6,7
SRS diagnostic system	22
SRS warning light	5,22
Start inhibitor (immobilizer)	40
Starting the engine	65
Steering wheel adjustment	34
Steering wheel lock	26
Storage compartments	54
Studded tires	81
Sun roof	51,52
T	
Tachometer	20
Tailgate (opening/locking)	45
Technical data - Audio	142
Temperature gauge	20
Temporary spare tire	84
Timing belt	110
Tires changing	87
Tire pressure	82
Tires	80
Tires - changing	87
Tool kit	86
Towing	70,71
Towing a trailer	78
Traction Control System (TRACS)	23,74
Trailer hitch - detachable	76
Trailer towing	78

Transmission Lamp	67
Trip Computer	27
Trip odometer	20
Trunk - opening from the inside - S40	46
Tuning modes, radio - changing	142
Turn signals	25
U	
UNIFORM TIRE QUALITY GRADING	83
Uniform tire quality grading	83
Upholstery - cleaning	105
V	
Vanity mirrors	51
Vehicle Identification Number (VIN)	108
Vehicle loading	125
Volvo On Call	128
Volvo SRS	4
W	
W - Winter/Wet Weather	67
Warning flashers	26
Warning lights	22,23
Warranty	109
Washer fluid reservoir	118
Washing	103
Waste bin - rear	34
Waxing	104
Weights	127
Wheel changing	86, 87, 88
Wheels and tires	80
Whiplash Protection System (WHIPS)	9
WHIPS	9
Windows - electrically-operated	38
Windshield wiper blades - replacing	98
Winter driving	75



2003 VOLVO S40 & V40

Back Cover

Back Cover

Accessory Installation - Important Warning

- We strongly recommend that Volvo owners install only genuine, Volvo-approved accessories, and that accessory installations be performed only by the factory-trained technicians at your authorized Volvo retailer.
- Genuine Volvo accessories are tested to ensure compatibility with the performance, safety, and emission systems in your car. Additionally, your authorized Volvo retailer knows where accessories may and may not be safely installed in your Volvo. In all cases, please consult your authorized Volvo retailer before installing any accessory in or on your car.
- Accessories that have not been approved by Volvo may or may not be specifically tested for compatibility with your car. Additionally, an inexperienced installer may not be familiar with some of your car's systems.
- Any of your car's performance and safety systems could be adversely affected if you install accessories that Volvo has not tested, or if you allow accessories to be installed by someone unfamiliar with your car.
- Damage caused by unapproved or improperly installed accessories may not be covered by your new car warranty. See your Warranty and Service Records Information booklet for more warranty information. Volvo assumes no responsibility for death, injury, or expenses that may result from the installation of non-genuine accessories.

Driver Distraction

- Driver distraction results from driver activities that are not directly related to controlling the car in the driving environment. Your new Volvo is, or can be, equipped with many feature-rich entertainment and communication systems. These include hands-free cellular telephones, navigation systems, and multipurpose audio systems. You may also own other portable electronic devices for your own convenience. When used properly and safely, they enrich the driving experience. Improperly used, any of these could cause a distraction.
- For all of these systems, we want to provide the following warning that reflects the strong Volvo concern for your safety:
 - Never use these devices or any feature of your vehicle in a way that distracts you from the task of driving safely. Distraction can lead to a serious accident.
 - In addition to this general warning, we offer the following guidance regarding specific newer features that may be found in your vehicles:
 - Never use a hand-held cellular telephone while driving. Some jurisdictions prohibit cellular telephone use by a driver while the vehicle is moving.
 - If your car is equipped with a navigation system, set and make changes to your travel itinerary only with the vehicle parked.
 - Never program your audio system while the vehicle is moving. Program radio presets with the vehicle parked, and use your programmed presets to make radio use quicker and simpler.
 - Never use portable computers or personal digital assistants while the vehicle is moving.

A driver has a responsibility to do everything possible to ensure his or her own safety and the safety of passengers in

the vehicle and others sharing the roadway. Avoiding distractions is part of that responsibility.

Octane rating, see [page 63](#)

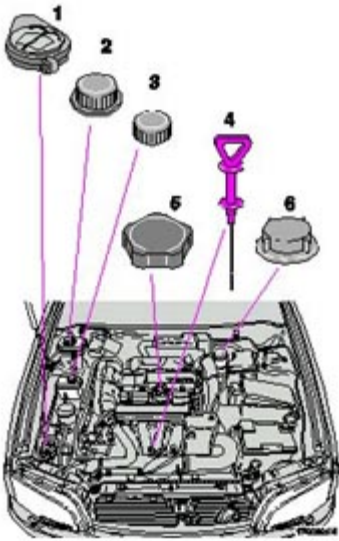

The following should be checked regularly: *

1 Washer fluid reservoir should be filled with water and solvent (wintertime: windshield washer anti-freeze). See [page 118](#).

2 Coolant level should be between the expansion tank marks. Mixture: 50% anti-freeze and 50% water. See [page 117](#).

3 Power steering - When cold, the level must not be above the MAX mark. Top up if necessary with ATF fluid. See [page 116](#).

4 Engine oil level should be between the dipstick marks. The distance between the marks represents approx. 2 US qts. (1.9 liters). See [page 114](#).

5 Oil filler cap

6 Brake fluid - check, without removing the cap, that the level is above the MIN mark. Use brake fluid DOT 4+. See [page 116](#).

* Engine oil should be checked each time the car is refuelled.

Tire pressure, see label located on inside of fuel filler door.



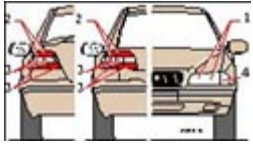

- 1 (2x) 55W H7
- 2 5 W/4cp BA 15s
- 3 21 W/32cp BA 15s
- 4 26/7W/30/2,2cp W2,.5 16q

VOLVO

Volvo Car Corporation

Göteborg, Sweden



[Contents](#) | [Top of Page](#)