



C-Class

Coupé

Owner's Manual



Mercedes-Benz

Nur für internen Gebrauch / For internal use only

Symbols

In this manual, you will find the following symbols:

WARNING

Warning notes make you aware dangers which could pose a threat to your health or life, or to the health and life of others.

Environmental note

Environmental notes provide you with information on environmentally aware actions or disposal.

 Notes on material damage alert you to dangers that could lead to damage to your vehicle.

 These symbols indicate useful instructions or further information that could be helpful to you.

▶ This symbol designates an instruction you must follow.

▶ Several consecutive symbols indicate an instruction with several steps.

(▷ page) This symbol tells you where you can find further information on a topic.

▷▷ This symbol indicates a warning or an instruction that is continued on the next page.

Display This text indicates a message on the multifunction/COMAND display.

Parts of the software in the vehicle are protected by copyright © 2005
The FreeType Project
<http://www.freetype.org>. All rights reserved.

Welcome to the world of Mercedes-Benz

Before you first drive off, read this Owner's Manual carefully and familiarise yourself with your vehicle. For your own safety and a longer vehicle life, follow the instructions and warning notices in this manual. Disregarding them may lead to damage to the vehicle or personal injury.

The equipment or model designation of your vehicle may vary according to:

- Model
- Order
- Country variant
- Availability

The illustrations in this manual show a left-hand-drive vehicle. On right-hand-drive vehicles, the layout of components and controls differs accordingly.

Mercedes-Benz is constantly updating its vehicles to the state of the art.

Mercedes-Benz therefore reserves the right to introduce changes in the following areas:

- Design
- Equipment
- Technical features

The equipment in your vehicle may therefore differ from that shown in the descriptions and illustrations.

The following are integral components of the vehicle:

- Owner's Manual
- Service Booklet
- Equipment-dependent supplements

Keep printed copies of the documents in the vehicle at all times. If you sell the vehicle, always pass the documents on to the new owner.

i You can get to know the important features of your vehicle in the interactive Owner's Manual on the Internet at:

**[http://www.mercedes-benz.de/
betriebsanleitung](http://www.mercedes-benz.de/betriebsanleitung)**

The technical documentation team at Daimler AG wishes you safe and pleasant motoring.



Index	4	At a glance	31
Introduction	25	Safety	47
		Opening and closing	81
		Seats, steering wheel and mirrors ..	103
		Lights and windscreen wipers	117
		Climate control	133
		Driving and parking	147
		On-board computer and displays	215
		Stowing and features	293
		Maintenance and care	311
		Breakdown assistance	327
		Wheels and tyres	345
		Technical data	369

1, 2, 3 ...

12-button multifunction steering wheel	
Operating the on-board computer .	220
Overview	41
12 V socket	
see Socket	
4-button multifunction steering wheel	
Operating the on-board computer .	217
Overview	40

A

ABS (Anti-lock Braking System)	
Display message (12-button multifunction steering wheel)	247
Display message (4-button multifunction steering wheel)	242
Function/notes	71
Important safety notes	71
Warning lamp	282
Activating/deactivating air-recirculation mode	140
Activating/deactivating cooling with air dehumidification	136
Active Blind Spot Assist	
Display message (12-button multifunction steering wheel)	266
Function/notes	203
Switching on/off (on-board computer, 12-button multifunction steering wheel)	229
Towing a trailer	206
Active Driving Assistance package .	203
Active Lane Keeping Assist	
Display message (12-button multifunction steering wheel)	265
Function/notes	206
Switching on/off (on-board computer, 12-button multifunction steering wheel)	230
Towing a trailer	203, 209
Active light function	122
ADAPTIVE BRAKE	77
Adaptive brake lamps	73

Adaptive Highbeam Assist

Display message (12-button multifunction steering wheel)	258
Function/notes	123
Switching on/off	123, 124

Adaptive Main-beam Assist

Switching on/off (on-board computer)	232
--	-----

Additional speedometer**Additives (engine oil)****Adjusting the headlamp range****Airbags**

Front airbag (driver, front passenger)	52
Important safety guidelines	50
Kneebag	52
Pelvis airbag	53
Sidebag	53
Triggering	49
Windowbag	54

Air-conditioning system

 see Climate control

Air filter

Display message (12-button multifunction steering wheel)	263
Display message (4-button multifunction steering wheel)	260

Air pressure

 see Tyre pressure

Air vents

Glove compartment	146
Important safety notes	145
Rear	146
Setting	145
Setting the centre air vents	146
Setting the side air vents	146

Alarm system

 see ATA (Anti-Theft Alarm system)

AMG menu (on-board computer)**Anti-glare film****Anti-lock braking system**

 see ABS (Anti-lock Braking System)

Anti-Theft Alarm system

 see ATA (Anti-Theft Alarm system)

Aquaplaning**Ashtray**

- Assistance graphic (on-board computer, 12-button multifunction steering wheel)** 228
- ASSYST PLUS**
 - Displaying a service message 312
 - Hiding a service message 312
 - Notes 312, 313
 - Resetting the service interval display 313
 - Service message 312
 - Special service requirements 313
- ATA (anti-theft alarm system)**
 - Activating/deactivating 79
- ATA (Anti-Theft Alarm system)**
 - Function 79
 - Interior motion sensor 80
 - Switching off the alarm 79
 - Tow-away protection 79
- ATTENTION ASSIST**
 - Activating/deactivating 229
 - Display message (12-button multifunction steering wheel) 264
 - Function/notes 198
- Audio DVD (12-button multifunction steering wheel)** 225
- Audio menu (on-board computer, 12-button multifunction steering wheel)** 225
- Audio menu (on-board computer)** ... 225
- Authorised workshop**
 - see Qualified specialist workshop
- AUTO lights**
 - Display message (12-button multifunction steering wheel) 257
 - Display message (4-button multifunction steering wheel) 255
 - see Lights
- Automatic engine start (ECO start/stop function)** 154
- Automatic engine switch-off (ECO start/stop function)** 153
- Automatic headlamp mode** 119
- Automatic transmission**
 - Accelerator pedal position 160
 - Automatic drive program 161
 - Changing gear 159
 - Display message (4-button multifunction steering wheel) 273
 - Driving tips 160
 - Emergency running mode 165
 - Kickdown 160
 - Manual drive program 163
 - Overview 158
 - Problem (fault) 165
 - Program selector button 160
 - Pulling away 152
 - Releasing the parking lock manually 165
 - Selector lever 159
 - Shift ranges 162
 - Starting the engine 151
 - Steering wheel gearshift paddles ... 161
 - Trailer towing 160
 - Transmission position display 159
 - Transmission positions 159
- Automatic transmission emergency running mode** 165
- Automatic transmissions**
 - Display message (12-button multifunction steering wheel) 275
- Auxiliary heating**
 - Activating/deactivating 142
 - Activating/deactivating (on the centre console) 142
 - Display message (12-button multifunction steering wheel) 277
 - Important safety notes 141
 - Problem (display message) 145
 - Remote control 142
 - Setting (on-board computer, 12-button multifunction steering wheel) 234
 - Setting the departure time 144
- Auxiliary ventilation**
 - Activating/deactivating 142
 - Activating/deactivating (on the centre console) 142
 - Problem (display message) 145
 - Remote control 142
- Axle load, permissible (trailer towing)** 382

- B**
- Bag hook** 297
- Ball coupling**
 Folding in 212
 Folding out 211
- BAS (Brake Assist System)** 71
- BAS PLUS (Brake Assist System PLUS)** 71
- Battery (key)**
 Checking 85
 Important safety notes 85
 Replacing 85
- Battery (vehicle)**
 Charging 337
 Display message (12-button multifunction steering wheel) 262
 Display message (4-button multifunction steering wheel) 259
 Important safety notes 334
 Jump starting 338
- Belt**
 see Seat belt
- Belt force limiters (activation)** 49
- Belt tensioner**
 Activation 49
 Function 58
- Blind Spot Assist**
 Activating/deactivating 229
 Display message (12-button multifunction steering wheel) 266
 Notes/function 200
 Trailer towing 201
 see Active Blind Spot Assist
- Bonnet**
 Active bonnet (pedestrian protection) 314
 Closing 315
 Display message (12-button multifunction steering wheel) 276
 Display message (4-button multifunction steering wheel) 274
 Important safety notes 313
 Opening 315
- Boot**
 Emergency release 94
 Important safety notes 91
 Locking separately 93
 Opening (automatically from inside) 93
 Opening (automatically from outside) 92
- Boot lid**
 Display message (12-button multifunction steering wheel) 276
 Display message (4-button multifunction steering wheel) 274
 Opening/closing 91
 Opening dimensions 380
- Boot load (maximum)** 380
- Brake Assist**
 see BAS (Brake Assist System)
- Brake fluid**
 Display message (12-button multifunction steering wheel) 249
 Display message (4-button multifunction steering wheel) 244
 Notes 378
- Brake lamp**
 Display message (12-button multifunction steering wheel) 256
 Display message (4-button multifunction steering wheel) 253
- Brake lamps**
 Adaptive 73
 Changing bulbs 129
- Brakes**
 ABS 71
 BAS 71
 BAS PLUS 71
 Brake fluid (notes) 378
 Display message (12-button multifunction steering wheel) 247
 Display message (4-button multifunction steering wheel) 242
 Driving tips 172
 High-performance brake system 173
 Important safety notes 172
 Parking brake 170
 Warning lamp 282
- Breakdown**
 see Flat tyre
 see Towing away/tow-starting
- Bulbs**
 see Replacing bulbs

C

Calling up a fault

see Display messages

Car

see Vehicle

Care

Automatic car wash	319
Carpets	325
Display	324
Exterior lighting	322
Gear or selector lever	324
High-pressure cleaner	320
Interior	324
Matt paintwork	321
Notes	319
Paint	321
Plastic trim	324
Reversing camera	323
Roof lining	325
Seat belt	325
Seat cover	324
Sensors	322
Steering wheel	324
Tail pipes	323
Trim pieces	324
Washing by hand	320
Wheels	320
Windows	321
Wiper blades	322
Wooden trim	324

Car wash (care)	319
------------------------------	------------

CD player/CD changer (12-button multifunction steering wheel)	225
--	------------

Central locking

Automatic locking (on-board computer)	234
Locking/unlocking (key)	83

Centre console

Lower section	43
Upper section	42

Changing bulbs

Brake lamps	129
Cornering light function	128
Dipped-beam headlamps	127
Main-beam headlamps	127
Parking lamps (front)	127

Reversing lamps	129
Standing lamps	127

Children

child seat lock	62
In the vehicle	59
Restraint systems	59

Child seat

Automatic recognition	62
ISOFIX	63
On the front-passenger seat	61
Problem (malfunction)	70
Recommendations	68
Suitable positions	66
Top Tether	64

Child seat lock	62
------------------------------	-----------

Cigarette lighter	301
--------------------------------	------------

Cleaning

Mirror turn signal	322
Trailer tow hitch	323

Climate control

Auxiliary heating/ventilation	141
Controlling automatically	137
Convenience opening/closing (air-recirculation mode)	140
Cooling with air dehumidification ..	136
Demisting the windows	139
Demisting the windscreen	138
Important safety notes	134
Indicator lamp	137
Notes on using THERMATIC automatic climate control	135
Overview of systems	134
Problems with cooling with air dehumidification	137
Problem with the rear window heating	140
Setting the air distribution	137
Setting the airflow	138
Setting the air vents	145
Setting the temperature	137
Switching air-recirculation mode on/off	140
Switching on/off	136
Switching the rear window heating on/off	139

- Switching the ZONE function on/off 138
- THERMATIC automatic climate control (2-zone) 135
- Clock**
- Setting (4-button multifunction steering wheel) 219
- Cockpit**
- Overview 32
- see Instrument cluster
- COMAND Online**
- see separate operating instructions
- Combination switch** 121
- Constant headlamp mode**
- see Daytime driving lights
- Consumption statistics**
- On-board computer (12-button multifunction steering wheel) 222
- On-board computer (4-button multifunction steering wheel) 218
- Convenience closing feature** 96
- Convenience opening/closing (air-recirculation mode)** 140
- Convenience opening feature** 96
- Coolant (engine)**
- Checking the level 318
- Display message (12-button multifunction steering wheel) 261
- Display message (4-button multifunction steering wheel) 258
- Important safety notes 378
- Temperature display (12-button multifunction steering wheel; AMG) 236
- Temperature gauge (12-button multifunction steering wheel) 219
- Temperature gauge (4-button multifunction steering wheel) 216
- Warning lamp 288
- Cooling**
- see Climate control
- Copyright** 29
- Cornering lamps**
- Changing bulbs 128
- Cornering light function**
- Display message (12-button multifunction steering wheel) 255
- Display message (4-button multifunction steering wheel) 252
- Function/notes 122
- Cover**
- see Roller sunblind
- Crash-responsive emergency lighting** 125
- Cruise control**
- Cruise control lever 175
- Deactivating 176
- Display message (12-button multifunction steering wheel) 268
- Display message (4-button multifunction steering wheel) 263
- Driving system 174
- Important safety notes 174
- LIM indicator lamp 175
- Selecting 175
- Setting a speed 176
- Storing and maintaining current speed 175
- Cup holder**
- Centre console 299
- Important safety notes 299
- Rear compartment 300

D

Data

see Technical data

Date

Setting (4-button multifunction steering wheel) 219

Daytime driving lamps

Switching on/off (on-board computer, 12-button multifunction steering wheel) 231

Daytime driving lights

Display message (12-button multifunction steering wheel) 257

Display message (4-button multifunction steering wheel) 254

Switching on/off (on-board computer, 4-button multifunction steering wheel)	218	KEYLESS-GO	278
Switching on/off (switch)	119	Lights	252
Declarations of conformity	27	Safety systems	242
Delayed switch-off		Tyres	270
Exterior lighting (12-button multifunction steering wheel)	232	Vehicle	273
Interior lighting (12-button multifunction steering wheel)	233	Distance recorder	
Diagnostics connection	27	12-button multifunction steering wheel	222
Diesel	375	Distance warning signal (warning lamp)	290
Digital speedometer	223	DISTRONIC PLUS	
Dipped beam		Activation conditions	181
Display message (4-button multifunction steering wheel)	252	Deactivating	185
Dipped-beam headlamps		Display message (12-button multifunction steering wheel)	267
Changing bulbs	127	Displays in the multifunction display	185
Display message (12-button multifunction steering wheel)	255	Driving tips	186
Setting for driving abroad (symmetrical)	118	Function/notes	179
Setting for driving on the right/left	232	Important safety notes	179
Switching on/off	119	Selecting	181
Display (cleaning instructions)	324	Setting the specified minimum distance	184
Display message (12-button multifunction steering wheel)		Warning lamp	290
ASSYST PLUS	312	Door	
Calling up	241	Automatic door locking feature (on-board computer, 12-button multifunction steering wheel)	234
Driving systems	264	Automatic locking (switch)	90
Engine	261	Central locking/unlocking (key)	83
General notes	240	Control panel	45
Hiding	240	Display message (12-button multifunction steering wheel)	276
Key	279	Display message (4-button multifunction steering wheel)	274
KEYLESS-GO	279	Emergency locking	91
Lights	255	Emergency unlocking	90
Safety systems	247	Important safety notes	88
Tyres	271	Opening (from the inside)	89
Vehicle	275	Drive program	
Display message (4-button multifunction steering wheel)		Automatic	161
ASSYST PLUS	312	Display	159
Calling up	240	Manual	163
Driving systems	263	Drive program selector	161
Engine	258	Driver's door	
General notes	240	see Door	
Hiding	240	Drive system	
Key	278	Active Blind Spot Assist	203

Driving abroad	
Service24h	313
Symmetrical dipped beam	118
Driving on flooded roads	173
Driving safety system	
BAS PLUS (Brake Assist System PLUS)	71
Electronic Brake-force Distribution ..	76
ESP® (Electronic Stability Program)	73, 74
ETS/4ETS (Electronic Traction System)	73
Important safety guidelines	70
Driving safety systems	
ABS (Anti-lock Braking System)	71
ADAPTIVE BRAKE	77
Adaptive brake lamps	73
BAS (Brake Assist System)	71
Overview	70
PRE-SAFE® Brake	77
Driving system	
Active Lane Keeping Assist	206
Display message (12-button multifunction steering wheel)	264
Display message (4-button multifunction steering wheel)	263
Driving systems	
Active Driving Assistance package	203
ATTENTION ASSIST	198
Blind Spot Assist	200
Cruise control	174
Distronic Plus	179
Dynamic handling package with sports mode	187
HOLD function	188
Lane Keeping Assist	202
Lane package	200
Parking Guidance	194
PARKTRONIC	191
RACE START (AMG vehicles)	190
Reversing camera	197
Speed Limit Assist	198
SPEEDTRONIC	177
Driving tips	
Aquaplaning	173
Automatic transmission	160
Brakes	172
DISTRONIC PLUS	186
Downhill gradient	172
Driving abroad	118
Driving in winter	174
Driving on flooded roads	173
Driving on wet roads	173
General	171
Icy road surfaces	174
Limited braking efficiency on salted roads	172
New brake pads/linings	173
Running-in tips	148
Snow chains	349
Symmetrical dipped beam	118
Towing a trailer	209
Wet road surface	172
Dynamic handling package with sports mode	187
E	
EASY-ENTRY feature	107
Activating/deactivating (12-button multifunction steering wheel) ..	235
Function/notes	111
EASY-EXIT feature	
Activating/deactivating (12-button multifunction steering wheel) ..	235
Crash-responsive	112
Function/notes	111
EBD (electronic brake force distribution)	
Display message (12 button multifunction steering wheel)	248
Function/notes	76
EBD (Electronic Brake-force Distribution)	
Display message (4-button multifunction steering wheel)	243
ECO display	
Function/notes	171
On-board computer (12-button multifunction steering wheel)	223
ECO start/stop function	
Automatic engine start	154
Automatic engine switch-off	153
Deactivating/activating	154
General information	153

- Important safety notes 153
- Introduction 153
- Electrical fuses**
 - see Fuses
- Electromagnetic compatibility**
 - Declaration of conformity 27
- Electronic brake force distribution**
 - see EBD (electronic brake force distribution)
- Electronic Stability Program**
 - see ESP® (Electronic Stability Program)
- Emergency key**
 - Unlocking the driver's door 90
- Emergency key element**
 - Function/notes 84
 - Locking vehicle 91
- Emergency release**
 - Driver's door 90
- Emergency spare wheel**
 - General notes 365
 - Important safety notes 365
 - Storage location 366
 - Technical data 367
- Emergency unlocking**
 - Boot 94
 - Vehicle 90
- Engine**
 - ECO start/stop function 153
 - Engine number 372
 - Jump-starting 338
 - Running irregularly 156
 - Starting problems 156
 - Starting the engine with the key 151
 - Starting with KEYLESS GO 151
 - Stopping 169
 - Tow-starting (vehicle) 342
 - Warning lamp (engine diagnostics) 288
- Engine electronics**
 - Notes 370
 - Problem (fault) 156
- Engine jump starting**
 - see Jump starting (engine)
- Engine oil**
 - Additives 377
 - Checking the oil level 316
 - Checking the oil level using the dipstick 316
 - Display message (12-button multifunction steering wheel) 262
 - Display message (4-button multifunction steering wheel) 260
 - Filling capacity 377
 - Notes about oil grades 376
 - Notes on oil level/consumption 316
 - Temperature (12-button multifunction steering wheel) 236
 - Topping up 317
 - Viscosity 377
- Environmental protection**
 - Returning an end-of-life vehicle 25
- ESP® (Electronic Stability Program)**
 - AMG menu (on-board computer) ... 237
 - Deactivating/activating (AMG vehicles) 75
 - Deactivating/activating (except AMG vehicles) 228
 - Deactivating/activating (notes; except AMG vehicles) 74
 - Display message (12-button multifunction steering wheel) 247
 - Display message (4-button multifunction steering wheel) 242
 - ETS/4ETS 73
 - Function/notes 73, 74
 - Important safety guidelines 73
 - Trailer stabilisation 76
 - Warning lamp 284
- ETS/4ETS (Electronic Traction System)** 73
- Exhaust tail pipe (cleaning instructions)** 323
- Exterior lighting**
 - Settings options 118
 - see Lights
- Exterior mirrors**
 - Adjusting 112
 - Anti-dazzle mode (automatic) 114
 - Folding in/out (automatically) 113
 - Folding in/out (electrically) 113
 - Folding in (12-button multifunction steering wheel) 236
 - Out of position (troubleshooting) ... 114

- Parking position 114
 Resetting 113
 Storing settings (memory function) 115
- F**
- Fault message**
 see Display messages
- Filler cap**
 see Fuel filler flap
- Fire extinguisher** 329
- First-aid kit** 328
- Fitting a wheel**
 Removing a wheel 359
- Fitting wheels**
 Fitting a wheel 359
 Lowering the vehicle 360
 Preparing the vehicle 357
 Raising the vehicle 358
 Securing the vehicle against rolling away 357
- Flat tyre**
 MOExtended run-flat system 330
 Preparing the vehicle 330
 TIREFIT kit 331
 see Emergency spare wheel
- Floormat** 309
- Foglamps**
 Extended range 123
 Switching on/off 120
- Frequencies**
 Garage door opener 306
 Mobile phone 370
 Two-way radio 370
- Front foglamp**
 Display message (12-button multifunction steering wheel) 256
- Front foglamps**
 Display message (4-button multifunction steering wheel) 253
- Fuel**
 Additives 375
 Consumption information 376
 Displaying the range (12-button multifunction steering wheel) 223
 Displaying the range (4-button multifunction steering wheel) 218
 E10 374
 Grade (petrol) 374
 Important safety notes 373
 Notes for AMG vehicles 374
 Problem (malfunction) 168
 Quality (diesel) 375
 Refuelling 165
 Tank content/reserve fuel 373
 Tank content display (12-button multifunction steering wheel) 37
 Tank content display (4-button multifunction steering wheel) 34
- Fuel consumption**
 Current (12-button multifunction steering wheel) 223
- Fuel filler flap**
 Opening/closing 166
- Fuel filter**
 Display message (12-button multifunction steering wheel) 263
 Display message (4-button multifunction steering wheel) 260
- Fuel reserve**
 Display message (12-button multifunction steering wheel) 263
 Display message (4-button multifunction steering wheel) 260
 see Fuel
- Fuel tank**
 Capacity 373
 Problem (malfunction) 168
- Fuse allocation chart (vehicle tool kit)** 329
- Fuses**
 Allocation chart 343
 Before changing 343
 Fuse box in the boot 344
 Fuse box in the engine compartment 343
 Important safety notes 343
- G**
- Garage door opener**
 Clearing the memory 306
 Frequencies 306
 Important safety notes 304

Opening/closing the garage door ..	305
Programming (button in the rear-view mirror)	304
Gear indicator (12-button multifunction steering wheel)	236
Gear or selector lever (cleaning instructions)	324
Gearshift program	
SETUP (on-board computer)	237
Genuine Mercedes-Benz parts	25
Glove compartment	295

H

Handbrake	
see Parking brake	
Hazard warning lamps	121
Headlamp	
Cleaning system (function)	122
Cleaning system (notes)	379
Headlamps	
Misting up	124
Topping up the cleaning system	318
see Automatic headlamp mode	
Head restraints	
Adjusting	106
Adjusting (electrically)	107
Adjusting (manually)	107
see NECK-PRO head restraints	
Heating	
see Climate control	
High-pressure cleaners	320
Hill start assist	152
HOLD function	
Deactivating	189
Display message (12-button multifunction steering wheel)	265
Display message (4-button multifunction steering wheel)	263
Function/notes	188

I

Ignition lock	
see Key positions	
Immobiliser	78

Indicator and warning lamps	
Coolant	288
DISTRONIC PLUS	290
Engine diagnostics	288
Overview (12-button multifunction steering wheel)	39
Overview (4-button multifunction steering wheel)	36
SPORT handling mode	285

Indicator lamps

 see Warning and indicator lamps

Indicators

 see Turn signals

Insect protection on the radiator	315
---	-----

Instrument cluster (12-button multifunction steering wheel)

Indicator and warning lamps	39
Overview	37
Settings	230

Instrument cluster (4-button multifunction steering wheel)

Indicator and warning lamps	36
Overview	34

Instrument cluster lighting

Multifunction steering wheel with 12 buttons	219
Multifunction steering wheel with 4 buttons	216

Intelligent Light System

Activating/deactivating (12-button multifunction steering wheel) ..	232
Display message (12-button multifunction steering wheel)	257
Overview	122
Setting the dipped-beam headlamps for driving on the right/left .	232

Interior lighting

Automatic control system	125
Delayed switch-off (12-button multifunction steering wheel)	233
Emergency lighting	125
Manual control	125
Overview	125
Reading lamp	125

Interior motion sensor	80
-------------------------------------	----

ISOFIX child seat securing system	63
---	----

- J**
- Jack**
- Storage location 329
 - Using 358
- Jump starting (engine)** 338
- K**
- Key**
- Changing the battery 85
 - Checking the battery 85
 - Convenience closing feature 96
 - Convenience opening feature 96
 - Display message (4-button multifunction steering wheel) 278
 - Door central locking/unlocking 83
 - Emergency key element 84
 - Important safety notes 82
 - Loss 87
 - Modifying the programming 84
 - Positions (ignition lock) 149
 - Problem (malfunction) 87
 - Starting the engine 151
- KEYLESS-GO**
- Convenience closing 96
 - Display message (12-button multifunction display) 279
 - Display message (4-button multifunction display) 278
 - Locking 83
 - Start/Stop button 149
 - Starting the engine 151
 - Unlocking 83
- Key positions**
- Key 149
 - KEYLESS GO 149
- Keys**
- Display message (12-button multifunction steering wheel) 279
- Kickdown**
- Driving tips 160
 - Manual drive program 164
- Kneebag** 52
- L**
- Lamps**
- see Warning and indicator lamps
- Lane detection (automatic)**
- see Lane Keeping Assist
- Lane Keeping Assist**
- Activating/deactivating 230
 - Display message (12-button multifunction steering wheel) 265
 - Function/information 202
- Lane package** 200
- Lap time (RACETIMER)** 237
- Lashing eyelets** 297
- Lights**
- Activating/deactivating the exterior lighting delayed switch-off (12-button multifunction steering wheel) 232
 - Activating/deactivating the interior lighting delayed switch-off (12-button multifunction steering wheel) 233
 - Active light function 122
 - Automatic headlamp mode 119
 - Cornering light function 122
 - Dipped-beam headlamps 119
 - Driving abroad 118
 - Foglamps 120
 - Foglamps (extended range) 123
 - Hazard warning lamps 121
 - Headlamp flasher 121
 - Headlamp range 120
 - Light switch 118
 - Main-beam headlamps 121
 - Motorway mode 123
 - Parking lamps 120
 - Rear foglamp 120
 - Side lamps 120
 - Switching Adaptive Highbeam Assist on/off 232
 - Switching the daytime driving lights on/off (12-button multifunction steering wheel) 231
 - Switching the daytime driving lights on/off (4-button multifunction steering wheel) 218

- Switching the daytime driving lights on/off (switch) 119
 - Switching the surround lighting on/off (12-button multifunction steering wheel) 232
 - Turn signals 121
 - see Interior lighting
 - see Replacing bulbs
 - Light sensor**
 - Display message (12-button multifunction steering wheel) 257
 - Display message (4-button multifunction steering wheel) 255
 - LIM indicator lamp**
 - Cruise control 175
 - DISTRONIC PLUS 180
 - Variable SPEEDTRONIC 177
 - Limiting the speed**
 - see SPEEDTRONIC
 - Loading guidelines** 294
 - Locking**
 - see Central locking
 - Locking (doors)**
 - Automatic 90
 - Emergency locking 91
 - From inside (central locking button) 89
 - Locking centrally**
 - see Central locking
 - Locking verification signal (on-board computer)** 234
 - Lumbar support**
 - Adjusting the 4-way lumbar support 108
 - Luxury multifunction steering wheel**
 - see On-board computer (12-button multifunction steering wheel)
- M**
- M+S tyres** 348
 - Main beam**
 - Display message (4-button multifunction steering wheel) 253
 - Main-beam headlamps**
 - Changing bulbs 127
 - Display message (12-button multifunction steering wheel) 256
 - Switching on/off 121
 - Maintenance**
 - see ASSYST PLUS
 - Manual transmission**
 - Engaging reverse gear 158
 - Gear lever 157
 - Pulling away 152
 - Shifting to neutral 158
 - Shift recommendation 158
 - Starting the engine 151
 - Matt finish (cleaning instructions)** . . 321
 - Memory card (audio)** 225
 - Memory function** 115
 - Mercedes-Benz Service Centre**
 - see Qualified specialist workshop
 - Message memory**
 - 12-button multifunction steering wheel 241
 - 4-button multifunction steering wheel 240
 - Messages**
 - see Display messages
 - Mirror**
 - see Vanity mirror (in sun visor)
 - Mirrors**
 - see Exterior mirrors
 - see Rear-view mirror
 - Mobile phone**
 - Frequencies 370
 - Installation 370
 - Menu (on-board computer) 226
 - Notes/placing in the bracket 302
 - Transmission output (maximum) 370
 - Mobile telephone**
 - Pre-installed bracket 303
 - Modifying the programming (key)** 84
 - MOExtended run-flat system** 330
 - Motorway mode** 123
 - MP3**
 - Operating 225
 - see Separate operating instructions

- Multifunction display**
 - 4-button multifunction steering wheel 217
 - Permanent display (12-button multifunction steering wheel) 231
 - Multi-function display**
 - 12-button multifunction steering wheel 221
 - Multifunction steering wheel (12 buttons)**
 - see On-board computer (12-button multifunction steering wheel)
 - Multifunction steering wheel (4 buttons)**
 - see On-board computer (4-button multifunction steering wheel)
-
- N
- Navigation**
 - Menu (on-board computer) 224
 - On-board computer (12-button multifunction steering wheel) 224
 - see separate operating instructions
 - NECK-PRO head restraints**
 - Operation 55
 - Resetting after being triggered 55
 - Notes on running in a new vehicle ..** 148
-
- O
- Occupant safety**
 - Children in the vehicle 59
 - Important safety notes 48
 - Odometer**
 - 4-button multifunction steering wheel 218
 - see Total distance recorder
 - see Trip meter
 - Oil**
 - see Engine oil
 - On-board computer**
 - RACETIMER 237
 - On-board computer (12-button multifunction steering wheel)**
 - AMG menu 236
 - Assist menu 227
 - Audio menu 225
 - Convenience submenu 235
 - DISTRONIC PLUS 185
 - Important safety notes 216
 - Instrument cluster submenu 230
 - Lights submenu 231
 - Menu overview 222
 - Navigation menu 224
 - Operating 220
 - Operating the video DVD 226
 - Range 223
 - Service menu 230
 - Standard display submenu 222
 - Telephone menu 226
 - Trip menu 222
 - On-board computer (12-button multifunction steering wheel)**
 - Displaying service messages 312
 - Display messages 240
 - Heating submenu 234
 - Message memory 241
 - Vehicle submenu 233
 - On-board computer (12-button multifunction steering wheel) Settings menu** 230
 - On-board computer (12-button multifunction steering wheel) submenu**
 - Factory setting 236
 - On-board computer (4-button multifunction steering wheel)**
 - Important safety notes 216
 - Menu overview 218
 - Switching daytime driving lights on/off 218
 - On-board computer (4-button multifunction steering wheel)**
 - Displaying service messages 312
 - Display messages 240
 - Individual vehicle settings 217
 - Message memory 240
 - Operating 217
 - Range 218
 - Standard display 218
 - Time/date 219
 - Trip computer 218
 - Opening and closing the side trim panels** 128

- Operating instructions**
 Vehicle equipment 26
- Operating safety**
 Declaration of conformity 27
 Important safety note 26
- Operating system**
 see On-board computer
- Outside temperature**
 Display (12-button multifunction steering wheel) 220
 Display (4-button multifunction steering wheel) 217
- Overhead control panel** 44
- P**
- Paint code** 372
- Paintwork (cleaning instructions)** ... 321
- Panic alarm** 48
- Panorama sliding sunroof**
 Important safety information 98
 Opening/closing 99
 Opening/closing the roller sun-blind 100
 Problem (malfunction) 100
 Rain closing feature 99
 Resetting 100
- Park Assist**
 Parking Guidance 194
- Parking** 169
 Important safety notes 169
 Parking brake 170
 Position of exterior mirror, front-passenger side 114
 Reversing camera 197
 see PARKTRONIC
- Parking aid**
 see Exterior mirrors
 see PARKTRONIC
- Parking assistance**
 see PARKTRONIC
- Parking brake** 170
 Display message (12-button multifunction steering wheel) 248
 Display message (4-button multifunction steering wheel) 243
 Notes/function 170
- Parking Guidance**
 Display message (12-button multifunction steering wheel) 266
 Important safety notes 194
 Trailer towing 196
- Parking lamp**
 Display message (12-button multifunction steering wheel) 257
 Display message (4-button multifunction steering wheel) 254
- Parking lamps**
 Changing bulbs 127
 Switching on/off 120
- PARKTRONIC**
 Deactivating/activating 193
 Driving system 191
 Function/notes 191
 Important safety notes 191
 Problem (fault) 194
 Sensor range 191
 Trailer towing 193
 Warning display 192
- PASS AIRBAG OFF**
 see PASSENGER AIRBAG OFF
- PASSENGER AIRBAG OFF**
 Indicator lamp 62
 Problem (malfunction) 70
- Petrol** 374
- Plastic trim (cleaning instructions)** . 324
- Power windows**
 see Side windows
- PRE-SAFE® (preventative occupant protection)**
 Display message (12-button multifunction steering wheel) 249
 Display message (4-button multifunction steering wheel) 244
- PRE-SAFE® (preventive occupant safety system)**
 Operation 54
- PRE-SAFE® Brake**
 Activating/deactivating 229
 Display message (12-button multifunction steering wheel) 250
 Function/notes 77
 Warning lamp 290
- Program selector button** 160

Protection of the environment

General notes 25

Pulling away

Automatic transmission 152

Manual transmission 152

Q

Qualified specialist workshop 28

R

RACE START (AMG vehicles) 190

RACETIMER (on-board computer) 237

Radar sensor system

Activating/deactivating 234

Display message (12-button multifunction steering wheel) 265

Radiator cover 315

Radio

Selecting a station (12-button multifunction steering wheel) 225
see separate operating instructions

Radio-based vehicle components

Declaration of conformity 27

Rain closing feature (panorama sliding sunroof) 99

Range (fuel)

Displaying (12-button multifunction steering wheel) 223

Displaying (4-button multifunction steering wheel) 218

Reading lamp 125

Rear compartment

Setting the air vents 146

Rear-compartment seat belt status indicator 58

Rear foglamp

Display message (12-button multifunction steering wheel) 256

Display message (4-button multifunction steering wheel) 254

Switching on/off 120

Rear seat (folding the backrest forwards/back) 296

Rear-view mirror

Anti-dazzle mode (automatic) 114

Dipping (manual) 112

Rear window heating

Problem (fault) 140

Switching on/off 139

Refuelling

Fuel gauge 34

Important safety notes 165

Notes for AMG vehicles 374

Refuelling process 166

see Fuel

Releasing the parking lock manually (automatic transmission) 165

Remote control

Auxiliary heating/ventilation 142

Changing the batteries (auxiliary heating) 144

Garage door opener 304

Programming (garage door opener) 304

Replacing bulbs

Important safety notes 125

Overview of bulb types 126

Replacing the battery (auxiliary heating remote control) 144

Reserve (fuel tank)

see Fuel

Reserve fuel

Display message (12-button multifunction steering wheel) 263

Display message (4-button multifunction steering wheel) 260

Warning lamp 288

Restraint system

see SRS (Supplemental Restraint System)

Rev counter

12-button multifunction steering wheel 219

4-button multifunction steering wheel 217

Reverse gear

Engaging (automatic transmission) 159

Engaging (manual transmission) 158

Reversing camera

Cleaning instructions 323

Function/notes 197

Reversing feature

Panorama sliding sunroof 98

Side windows 95

- Reversing function**
 Boot lid 91
 Roller sunblind 99
- Reversing lamp**
 Changing bulbs 129
 Display message (12-button multifunction steering wheel) 257
 Display message (4-button multifunction steering wheel) 254
- Roller blind**
 see Roller sunblind
- Roller sunblind**
 Opening/closing 100
 Panorama sliding sunroof 99
- Roof carrier** 298
- Roof lining and carpets (cleaning instructions)** 325
- Roof load (maximum)** 380
- Route (navigation)**
 see Route guidance (navigation)
- Route guidance (navigation)** 224
- S**
- Safety**
 Children in the vehicle 59
 Child restraint systems 59
- Safety system**
 see Driving safety system
- Seat**
 Seat backrest display message (12-button multifunction steering wheel) 276
 Seat backrest display message (4-button multifunction steering wheel) 274
- Seat belt**
 Activating/deactivating seat-belt adjustment (12-button multifunction steering wheel) 236
 Adjusting the driver's and front-passenger seat belt 57
 Belt force limiter 58
 Belt tensioner 58
 Cleaning 325
 Display message (12-button multifunction steering wheel) 250
 Display message (4-button multifunction steering wheel) 245
 Fastening 57
 Important safety guidelines 56
 Rear seat belt status indicator 58
 Releasing 58
 Warning lamp 281
 Warning lamp (function) 58
- Seats**
 Adjusting (electrically) 106
 Adjusting (manually and electrically) 106
 Adjusting the 4-way lumbar support 108
 Adjusting the head restraint 106
 Cleaning the cover 324
 Correct driver's seat position 104
 Folding the backrests forward/back 107
 Important safety notes 105
 Seat heating problem 110
 Seat ventilation problem 110
 Storing settings (memory function) 115
 Switching seat heating on/off 108
 Switching the seat ventilation on/off 110
- Sensors (cleaning instructions)** 322
- Service**
 see ASSYST PLUS
- Service menu (12-button multifunction steering wheel)** 230
- Service products**
 Brake fluid 378
 Coolant (engine) 378
 Engine oil 376
 Fuel 372
 Important safety notes 372
 Washer fluid 379
- Settings**
 Factory (12-button multifunction steering wheel) 236
 On-board computer (12-button multifunction steering wheel) 230
- Setting the air distribution** 137
- Setting the airflow** 138
- SETUP (on-board computer)** 237
- Shifting to neutral (manual transmission)** 158

- Sidebag** 53
- Side lamps**
 - Changing bulbs 127
 - Switching on/off 120
- Side marker lamp**
 - Display message (12-button multifunction steering wheel) 257
 - Display message (4-button multifunction steering wheel) 254
- Side windows**
 - Convenience closing 96
 - Convenience opening 96
 - Important safety notes 94
 - Opening/closing 95
 - Problem (malfunction) 97
 - resetting 97
- Sliding sunroof**
 - see Panorama sliding sunroof
- Snow chains** 349
- Socket**
 - Centre console 302
 - Rear compartment 302
- Sockets**
 - General notes 302
- Spare wheel**
 - Storage location 366
- Specialist workshop** 28
- Speed, controlling**
 - see Cruise control
- Speed Limit Assist**
 - Activating/deactivating the warning function 228
 - Displaying 228
 - Display message (12-button multifunction steering wheel) 264
 - Display message in the multifunction display 199
 - Important safety notes 199
- Speedometer**
 - Activating/deactivating the additional speedometer 231
 - Digital 223
 - In the instrument cluster (12-button multifunction steering wheel) 37
 - In the instrument cluster (4-button multifunction steering wheel) 34
- Segments 220
- Selecting the unit of measurement
see Instrument cluster
- SPEEDTRONIC**
 - Deactivating variable 178
 - Display message (12-button multifunction steering wheel) 268
 - Display message (4-button multifunction steering wheel) 263
 - Function/notes 177
 - Important safety notes 177
 - LIM indicator lamp 177
 - Permanent 179
 - Selecting 178
 - Storing the current speed 178
 - Variable 177
- SPORT handling mode**
 - Activating/deactivating (AMG vehicles) 75
 - Warning lamp 285
- SRS (Supplemental Restraint System)**
 - Display message (12-button multifunction steering wheel) 251
 - Display message (4-button multifunction steering wheel) 245
 - Introduction 49
 - Warning lamp 287
 - Warning lamp (function) 49
- Start/stop function**
 - see ECO start/stop function
- Starting (engine)** 150
- Steering**
 - Display message (12-button multifunction steering wheel) 277
 - Display message (4-button multifunction steering wheel) 275
- Steering wheel**
 - Adjusting (electrically) 111
 - Adjusting (manually) 111
 - Buttons (12-button multifunction steering wheel) 220
 - Buttons (4-button multifunction steering wheel) 217
 - Cleaning 324
 - Gearshift paddles 161
 - Important safety notes 110
 - Storing settings (memory function) 115

- Steering wheel gearshift paddles** 161
- Stopwatch (RACETIMER)** 237
- Stowage areas** 294
- Stowage compartments**
- Armrest (under) 295
 - Centre console 295
 - Cup holder 299
 - Glove compartment 295
 - Important safety information 294
- Stowage net** 296
- Stowage space**
- Stowage net 296
- Stowage well beneath the boot floor** 298
- Summer opening**
- see Convenience opening feature
- Summer tyres** 348
- Sun visor** 300
- Supplemental Restraint System**
- see SRS (Supplemental Restraint System)
- Surround lighting (12-button multifunction steering wheel)** 232
- Switching off the alarm (ATA)** 79

T

- Tail lamp**
- Display message (12-button multifunction steering wheel) 256
 - Display message (4-button multifunction steering wheel) 253
- Tank**
- see Fuel tank
- Tank content**
- Displaying the range (12-button multifunction steering wheel) 223
 - Displaying the range (4-button multifunction steering wheel) 218
 - Fuel gauge (12-button multifunction steering wheel) 37
 - Fuel gauge (4-button multifunction steering wheel) 34
- Technical data**
- Capacities 372
 - Emergency spare wheel 367
 - Information 370
 - Trailer loads 382
 - Tyres/wheels 361
 - Vehicle data 380
- Telephone**
- Accepting a call 226
 - Display message (12-button multifunction steering wheel) 278
 - Menu (on-board computer) 226
 - Number from the phone book 227
 - Redialling 227
 - Rejecting/ending a call 227
 - Telephone compartment 295
- Temperature**
- Coolant (12-button multifunction steering wheel; AMG) 236
 - Coolant (12-button multifunction steering wheel) 219
 - Coolant (4-button multifunction steering wheel) 216
 - Engine oil (12-button multifunction steering wheel) 236
 - Outside temperature (12-button multifunction steering wheel) 220
 - Outside temperature (4-button multifunction steering wheel) 217
 - Setting (climate control) 137
- TEMPOMAT**
- Function/notes 174
- Theft-deterrent system**
- ATA (Anti-Theft Alarm system) 79
 - Immobiliser 78
- Through-loading feature** 296
- Time**
- Setting the clock (4-button multifunction steering wheel) 219
 - see Separate Owner's manual
- Timing (RACETIMER)** 237
- TIREFIT kit** 331
- Top Tether** 64
- Total distance recorder**
- Displaying (12-button multifunction steering wheel) 222
 - Displaying (4-button multifunction steering wheel) 218
- Tow-away protection** 79
- Towing**
- Important safety notes 340
 - With the rear axle raised 341

- Towing a trailer**
- Active Blind Spot Assist 206
 - Active Lane Keeping Assist 203, 209
 - Axle load, permissible 382
 - Bulb failure indicator for LED lamps 213
 - Lights display message (12-button multifunction steering wheel) .. 255
 - Lights display message (4-button multifunction steering wheel) 252
 - Trailer tow hitch display message (12-button multifunction steering wheel) 277
 - Trailer tow hitch display message (4-button multifunction steering wheel) 275
- Towing away**
- Fitting the towing eye 341
 - Removing the towing eye 341
 - With both axles on the ground 342
- Tow-starting**
- Emergency engine starting 342
 - Fitting the towing eye 341
 - Important safety notes 340
 - Removing the towing eye 341
- Trailer coupling**
- see Towing a trailer
- Trailer towing**
- 7-pin connector 214
 - Blind Spot Assist 201
 - Cleaning the trailer tow hitch 323
 - Coupling up a trailer 212
 - Decoupling a trailer 212
 - Driving tips 209
 - Folding in the ball coupling 212
 - Folding out the ball coupling 211
 - Important safety notes 209
 - Mounting dimensions 381
 - Parking Guidance 196
 - Parktronic 193
 - Power supply 213
 - Shift range 160
 - Trailer loads 382
- Transmission**
- see Automatic transmission
 - see Manual transmission
- Transporting the vehicle** 342
- Trim pieces (cleaning instructions)** . 324
- Trip computer**
- On-board computer (12-button multifunction steering wheel) 222
 - On-board computer (4-button multifunction steering wheel) 218
- Trip meter**
- Displaying/resetting (4-button multifunction steering wheel) 218
 - Displaying (12-button multifunction steering wheel) 222
 - Resetting (12-button multifunction steering wheel) 223
- Turn signal**
- Display message (12-button multifunction steering wheel) 256
 - Display message (4-button multifunction steering wheel) 253
- Turn signals**
- Switching on/off 121
- Two-way radio**
- Frequencies 370
 - Installation 370
 - Transmission output (maximum) 370
- Type identification plate**
- see Vehicle identification plate
- Tyre pressure**
- Calling up (on-board computer) 353
 - Display message (12-button multifunction steering wheel) 271
 - Display message (4-button multifunction steering wheel) 270
 - Important safety notes 353
 - Not reached (TIREFIT) 333
 - Pressure loss warning 351
 - Reached (TIREFIT) 333
 - Recommended 350
- Tyre pressure loss warning**
- General notes 351
 - Important safety notes 351
 - Restarting 352
- Tyre pressure monitor**
- Checking the tyre pressure electronically 354
 - Function/notes 353
 - General notes 353
 - Important safety notes 353
 - Restarting 355

- Warning lamp 291
 Warning message 354
- Tyres**
- Changing a wheel 356
 Checking 347
 Direction of rotation 356
 Display message (12-button multifunction steering wheel) 271
 Display message (4-button multifunction steering wheel) 270
 Important safety notes 346
 M+S tyres 348
 MOExtended tyres 330
 Replacing 356
 Service life 348
 Storing 356
 Summer tyres 348
 Tyre size (data) 361
 Tyre tread 347
 see Flat tyre
- U**
- Unlocking**
- Emergency unlocking 90
 From inside the vehicle (central unlocking button) 89
- V**
- Vanity mirror (in sun visor)** 300
- Variable SPEEDTRONIC**
 see SPEEDTRONIC
- Vehicle**
- Correct use 28
 Data acquisition 28
 Electronics 370
 Emergency locking 91
 Emergency unlocking 90
 Equipment 26
 Implied warranty 28
 Individual settings 230
 Leaving parked up 170
 Locking (in an emergency) 91
 Locking (key) 83
 Lowering 360
 Pulling away 152
 Raising 358
 Registration 28
- Securing from rolling away 357
 Towing away 340
 Tow-starting 340
 Transporting 342
 Unlocking (in an emergency) 90
 Unlocking (key) 83
 Vehicle data 380
- Vehicle data** 380
- Vehicle dimensions** 380
- Vehicle emergency locking** 91
- Vehicle identification number**
 see VIN
- Vehicle identification plate** 372
- Vehicle tool kit** 329
- Video (DVD)** 226
- Video DVD (12-button multifunction steering wheel)** 226
- VIN** 372
- W**
- Warning and indicator lamps**
- ABS 282
 Brakes 282
 Distance warning signal 290
 ESP® 284
 ESP® OFF 285
 Fuel tank 288
 LIM (cruise control) 175
 LIM (DISTRONIC PLUS) 180
 LIM (variable SPEEDTRONIC) 177
 PASSENGER AIRBAG OFF 62
 Reserve fuel 288
 Seat belt 281
 SRS 287
 Tyre pressure monitor 291
- Warning triangle** 328
- Washer fluid**
- Display message (12-button multifunction steering wheel) 278
 Display message (4-button multifunction steering wheel) 275
- Wheel bolt tightening torque** 360
- Wheel chock** 357
- Wheels**
- Changing/replacing 356
 Changing a wheel 356
 Checking 347

Cleaning	320
Cleaning (warning)	356
Emergency spare wheel	365
Fitting a new wheel	359
Fitting a wheel	357
Important safety notes	346
Removing a wheel	359
Storing	356
Tightening torque	360
Wheel size/tyre size	361

Windowbag

Display message (12-button multifunction steering wheel)	252
Display message (4-button multifunction steering wheel)	246
Operation	54

Windows

Cleaning	321
see Side windows	

Windscreen

Demisting	138
see Windscreen	

Windscreen washer fluid

see Windscreen washer system

Windscreen washer system

Notes	379
-------------	-----

Windscreen wipers

Problem (malfunction)	132
Replacing the wiper blades	130
Switching on/off	129

Winter operation

Important safety notes	348
Radiator cover	315
Slippery road surfaces	174
Snow chains	349

Winter tyres

Limiting the speed (on-board computer)	233
M+S tyres	348

Wiper blades

Cleaning	322
Important safety notes	130
Replacing	130

Wooden trim (cleaning instructions) 324

Workshop

see Qualified specialist workshop

Z

ZONE function

Switching on/off	138
------------------------	-----

Protection of the environment

General notes

Environmental note

Daimler's declared policy is one of comprehensive environmental protection.

Our objectives are to use the natural resources which form the basis of our existence on this planet sparingly and in a manner which takes the requirements of both nature and humanity into consideration.

You too can help to protect the environment by operating your vehicle in an environmentally-responsible manner.

Fuel consumption and the rate of engine, transmission, brake and tyre wear depend on the following factors:

- operating conditions of your vehicle
- your personal driving style

You can influence both factors. Therefore, please bear the following in mind:

Operating conditions:

- avoid short trips, as these increase fuel consumption.
- observe the correct tyre pressure.
- do not carry any unnecessary weight in the vehicle.
- remove the roof rack once you no longer need it.
- a regularly serviced vehicle will contribute to environmental protection. You should therefore adhere to the service intervals.
- all maintenance work should be carried out at a qualified specialist workshop.

Personal driving style:

- do not depress the accelerator pedal when starting the engine.
- do not warm up the engine when the vehicle is stationary.
- drive carefully and maintain a safe distance from the vehicle in front.
- avoid frequent, sudden acceleration and braking.

- change gear in good time and use each gear only up to $\frac{2}{3}$ of its maximum engine speed.
- switch off the engine in stationary traffic.
- monitor the vehicle's fuel consumption.

Returning an end-of-life vehicle

EU countries only:

Mercedes-Benz will take back your old vehicle to dispose of it in an environmentally-responsible manner in accordance with the European Union (EU) End of Life Vehicles Directive.

There is a network of return points and disassembly plants available. You can return your vehicle to these plants free of charge. This makes a valuable contribution to the recycling process and the conservation of resources.

For further information on recycling old vehicles, recovery and the terms of the policy, visit the Mercedes-Benz homepage.

Genuine Mercedes-Benz parts

Environmental note

Daimler AG also supplies reconditioned assemblies and parts which are of the same quality as new parts. For these, the same warranty applies as for new parts.

! Airbags and seat belt tensioners, as well as control units and sensors for these restraint systems, may be installed in the following areas of your vehicle:

- doors
- door pillars
- door sills
- seats
- dashboard
- instrument cluster
- centre console

Do not install accessories such as audio systems in these areas. Do not carry out repairs or welding. You could impair the operating efficiency of the restraint systems.

Have accessories retrofitted at a qualified specialist workshop.

You could jeopardise the operating safety of your vehicle if you use parts, tyres and wheels as well as accessories relevant to safety which have not been approved by Mercedes. This could lead to malfunctions in safety-relevant systems, e.g. the brake system. Use only genuine Mercedes-Benz parts or parts of equal quality. Only use tyres, wheels and accessories that have been specifically approved for your vehicle.

Mercedes-Benz tests genuine parts and conversion parts and accessories that have been specifically approved for your vehicle for their reliability, safety and suitability. Despite ongoing market research, Mercedes-Benz is unable to assess other parts. Mercedes-Benz therefore accepts no responsibility for the use of such parts in Mercedes-Benz vehicles, even if they have been officially approved or independently approved by a testing centre. In Germany, certain parts are only officially approved for installation or modification if they comply with legal requirements. This also applies to some other countries. All genuine Mercedes-Benz parts meet the approval requirements. The use of non-approved parts may invalidate the vehicle's general operating permit.

This is the case:

- if they cause a change of the vehicle type from that for which the vehicle's general operating permit was granted
- if other road users could be endangered
- if the emission or noise levels are adversely affected

Always specify the vehicle identification number (VIN) (▷ page 372) when ordering genuine Mercedes-Benz parts.

Owner's Manual

Vehicle equipment

This Owner's Manual describes all models and all standard and optional equipment available for your vehicle at the time of publication of the Owner's Manual. Country-specific differences are possible. Note that your vehicle may not be fitted with all features described. This is also the case for systems and functions relevant to safety. Therefore, the equipment on your vehicle may differ from that in the descriptions and illustrations.

The original purchase contract documentation for your vehicle contains a list of all of the systems in your vehicle.

Should you have any questions concerning equipment and operation, please consult a Mercedes-Benz Service Centre.

The Owner's Manual and Service Booklet are important documents and should be kept in the vehicle.

Operating safety

Important safety notes

WARNING

If you do not have the prescribed service/maintenance work or necessary repairs carried out, this could result in malfunctions or system failures. There is a risk of an accident. Always have the prescribed service/maintenance work as well as necessary repairs carried out at a qualified specialist workshop.

WARNING

If you switch off the ignition while driving, safety-relevant functions are only available with limitations, or not at all. This could affect, for example, the power steering and the brake boosting effect. You will require considerably more effort to steer and brake. There is a risk of an accident.

Do not switch off the ignition while driving.

⚠ WARNING

Modifications to electronic components, their software as well as wiring could effect their function and/or the operation of other networked components. This could in particular also be the case for systems relevant to safety. They might not function properly any more and/or jeopardise the operational safety of the vehicle. There is an increased risk of an accident and injury.

Do not attempt to modify the wiring as well as electronic components or their software. Always have work on electrical and electronic components carried out at a qualified specialist workshop.

! There is a risk of damage to the vehicle if:

- the vehicle makes contact with the ground, e.g. on a high kerb or a loose road surface
- you drive too quickly over an obstacle, e.g. a kerb or a pothole
- a heavy object hits the underbody or chassis component

In these or similar situations, the vehicle body, the underbody, chassis components, wheels or tyres could be damaged even if this is not visible. Components that have been damaged in this way can unexpectedly fail or no longer be able to assimilate the loads occurring in the event of an accident.

If the underbody panelling is damaged, flammable material, such as leaves, grass or twigs, could collect between the underbody and underbody panelling. These materials could ignite if they remain in contact with hot components of the exhaust system for an extended period.

Have the vehicle checked and repaired immediately at a qualified specialist workshop. If you become aware when continuing the journey that driving safety has been effected, stop as soon as possible in accordance with the traffic conditions. In

such cases, consult a qualified specialist workshop.

Declarations of conformity**Wireless vehicle components**

The following information applies to all components of the vehicle and the information systems and communication devices integrated into the vehicle which receive and/or transmit radio waves:

The components of this vehicle that receive and/or transmit radio waves are compliant with the basic requirements and all other relevant conditions of Directive 1999/5/EC. You can obtain further information from any Mercedes-Benz Service Centre.

Electromagnetic compatibility

The electromagnetic compatibility of the vehicle components has been checked and certified according to the currently valid version of Regulation ECE-R 10.

Diagnostics connection

The diagnostics connection is only intended for the connection of diagnostic equipment at a qualified specialist workshop.

⚠ WARNING

If you connect equipment to a diagnostics connection in the vehicle, it can affect the operation of the vehicle systems. This may affect the operating safety of the vehicle. There is a risk of an accident.

Do not connect any equipment to a diagnostics connection in the vehicle.

⚠ WARNING

Objects in the driver's footwell may restrict the clearance around the pedals or block a depressed pedal. This jeopardises the operating and road safety of the vehicle. There is a risk of an accident.

Stow all objects securely in the vehicle so that they do not get into the driver's footwell. Always fit the floor mats securely and as prescribed in order to ensure that there is always sufficient room for the pedals. Do not use loose floor mats and do not place several floor mats on top of one another.

! If the engine is switched off and equipment on the diagnostics connection is used, the starter battery may discharge.

Connecting equipment to the diagnostics connection can lead to emissions monitoring information being reset, for example. This may lead to the vehicle failing to meet the requirements of the next emissions test during the main inspection.

Qualified specialist workshop

A qualified specialist workshop has the necessary special skills, tools and qualifications to correctly carry out any necessary work on your vehicle. This particularly applies to work relevant to safety.

Observe the notes in the Service Booklet. Always have the following work carried out at a qualified specialist workshop:

- work relevant to safety
- service and maintenance work
- repair work
- modifications, installations and conversions
- work on electronic components

Mercedes-Benz recommends that you use a Mercedes-Benz Service Centre.

Vehicle registration

Mercedes-Benz may ask its Service Centres to carry out technical inspections on certain vehicles. The quality or safety of the vehicle is improved as a result of the inspection.

Mercedes-Benz can only inform you about vehicle checks if it has your registration data.

It is possible that your vehicle has not yet been registered in your name in the following cases:

- if your vehicle was not purchased at an authorised specialist dealer.
- if your vehicle has not yet been examined at a Mercedes-Benz Service Centre.

It is advisable to register your vehicle with a Mercedes-Benz Service Centre.

Inform Mercedes-Benz as soon as possible about any change in address or vehicle ownership. You can do this at a Mercedes-Benz Service Centre, for example.

Correct use

If you remove any warning stickers, you or others could fail to recognise certain dangers. Leave warning stickers in position.

Observe the following information when driving your vehicle:

- the safety notes in this manual
- the technical data in this manual
- traffic rules and regulations
- laws and safety standards pertaining to motor vehicles

Implied warranty

! Follow the instructions in this manual about the proper operation of your vehicle as well as about possible vehicle damage. Damage to your vehicle that arises from culpable contraventions against these instructions are not covered either by Mercedes-Benz implied warranty or by the New or Used-Vehicle Warranty.

Data stored in the vehicle

A wide range of electronic components in your vehicle contain data memories.

These data memories temporarily or permanently store technical information about:

- the vehicle's operating state
- events
- faults

In general, this technical information documents the state of a component, a module, a system or the surroundings.

These include, for example:

- operating conditions of system components, e.g. fluid levels
- the vehicle's status messages and those of its individual components, e.g. number of wheel revolutions/speed, deceleration in movement, lateral acceleration, accelerator pedal position
- malfunctions and defects in important system components, e.g. lights, brakes
- vehicle reactions and operating conditions in special driving situations, e.g. airbag deployment, intervention of stability control systems
- ambient conditions, e.g. outside temperature

This data is of an exclusively technical nature and can be used to:

- assist in recognising and rectifying faults and defects
- analyse vehicle functions, e.g. after an accident
- optimise vehicle functions

The data cannot be used to trace the vehicle's movements.

When your vehicle is serviced, technical information can be read from the event data memory and fault data memory.

Services include, for example:

- repair services
- service processes
- warranties
- quality assurance

It is read by employees of the service network (including manufacturers) using special diag-

nostic testers. More detailed information is obtained from it, if required.

After a fault has been rectified, the information is deleted from the fault memory or is continually overwritten.

When operating the vehicle, situations are conceivable in which this technical data, in connection with other information (if necessary, under consultation with an authorised expert), could be traced to a person.

Examples include:

- accident reports
- damage to the vehicle
- witness statements

Further additional functions that have been contractually agreed upon with the customer allow certain vehicle data to be conveyed by the vehicle as well. The additional functions include, for example, vehicle location in case of an emergency.

Copyright information

General notes

Information on licences for free and open-source software used in your vehicle and its electronic components is available on the following website:

<http://www.mercedes-benz.com/opensource>

Cockpit	32
Instrument cluster (4-button steering wheel)	34
Instrument cluster (12-button steering wheel)	37
Multifunction steering wheel	40
Centre console	42
Overhead control panel	44
Door control panel	45

Cockpit

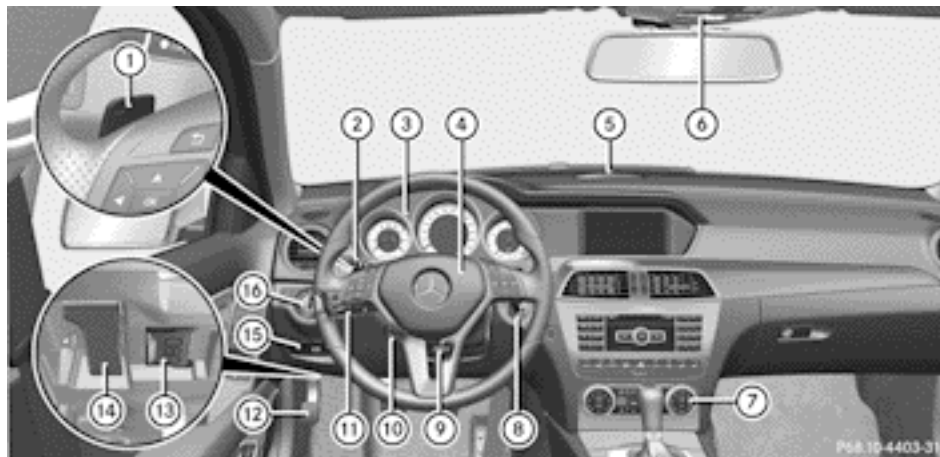

	Function	Page
①	Automatic transmission: steering wheel gearshift paddles	161
②	Combination switch	121
③	Instrument cluster (4-but- ton steering wheel)	34
	Instrument cluster (12-but- ton steering wheel)	37
④	Horn	
⑤	PARKTRONIC warning dis- play	191
⑥	Overhead control panel	44
⑦	Climate control systems	134

	Function	Page
⑧	Ignition lock	149
	Start/Stop button	149
⑨	Adjusts the steering wheel manually	110
⑩	Adjusts the steering wheel electrically	110
⑪	Cruise control lever	175
⑫	Parking brake	170
⑬	Diagnostics connection	27
⑭	Opens the bonnet	315
⑮	Releases the parking brake	170
⑯	Light switch	118

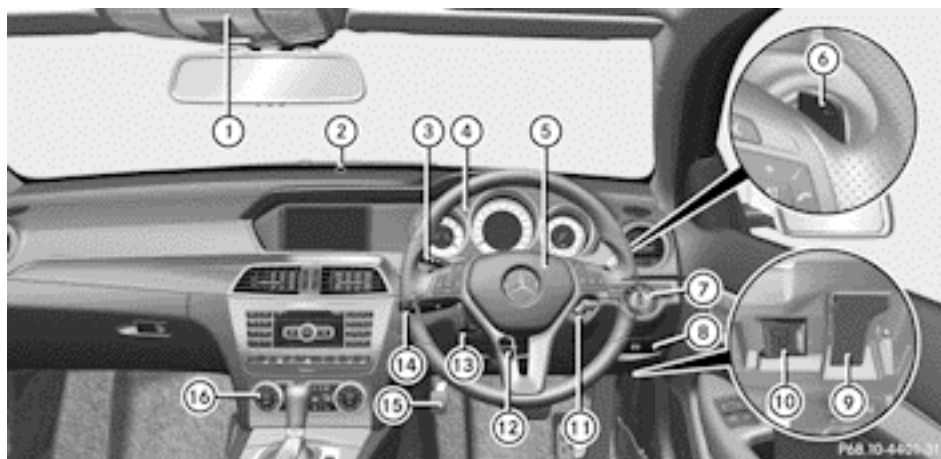

	Function	Page		Function	Page
①	Overhead control panel	44	⑧	Releases the parking brake	170
②	PARKTRONIC warning display	191	⑨	Opens the bonnet	315
③	Combination switch	121	⑩	Diagnostics connection	27
④	Instrument cluster (4-button steering wheel)	34	⑪	Ignition lock	149
	Instrument cluster (12-button steering wheel)	37		Start/Stop button	149
⑤	Horn		⑫	Adjusts the steering wheel manually	110
⑥	Automatic transmission: steering wheel gearshift paddles	161	⑬	Adjusts the steering wheel electrically	110
⑦	Light switch	118	⑭	Cruise control lever	175
			⑮	Parking brake	170
			⑯	Climate control systems	134

Instrument cluster (4-button steering wheel)

Displays and controls



i Instrument cluster: kilometres

	Function	Page
①	Fuel gauge	
②	Coolant temperature	216
③	Speedometer	
④	Rev counter	217
⑤	ECO start/stop function	153
	Automatic transmission:	
	Transmission position and drive program	159
	Manual transmission:	
	Gearshift recommendation	158
	Outside temperature	217
	HOLD function	188
	Stored limit speed	177

	Function	Page
⑥	Multifunction display	217
⑦	Time	219
	Automatic transmission:	
	Outside temperature (vehicles for the United Kingdom: speed in km/h)	217
	HOLD function	188
	Stored limit speed	177
⑧	Instrument cluster lighting	216

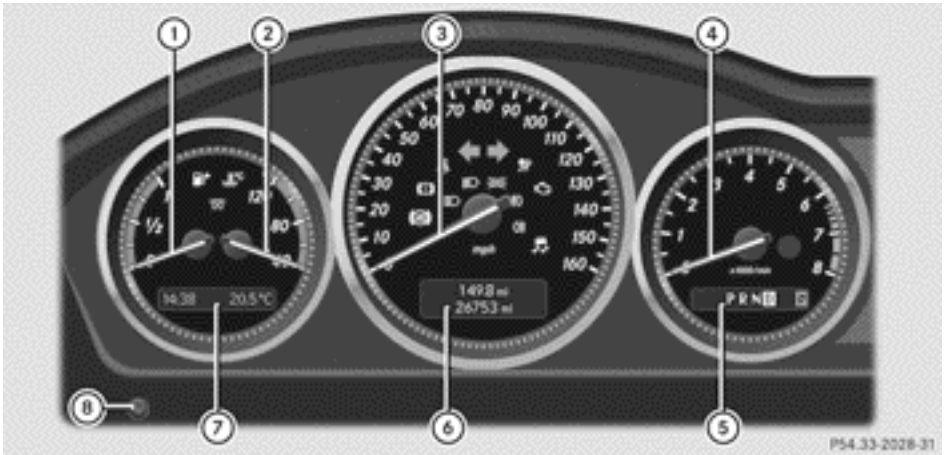

i Instrument cluster: miles

	Function	Page
①	Fuel gauge	
②	Coolant temperature	216
③	Speedometer	
④	Rev counter	217
⑤	ECO start/stop function	153
	Automatic transmission:	
	Transmission position and drive program	
	Manual transmission:	
	Gearshift recommendation	158
	Outside temperature	217
	HOLD function	188
	Stored limit speed	177

	Function	Page
⑥	Multifunction display	217
⑦	Time	219
	Automatic transmission:	
	Outside temperature (vehicles for the United Kingdom: speed in km/h)	217
	HOLD function	188
	Stored limit speed	177
⑧	Instrument cluster lighting	216

Warning and indicator lamps

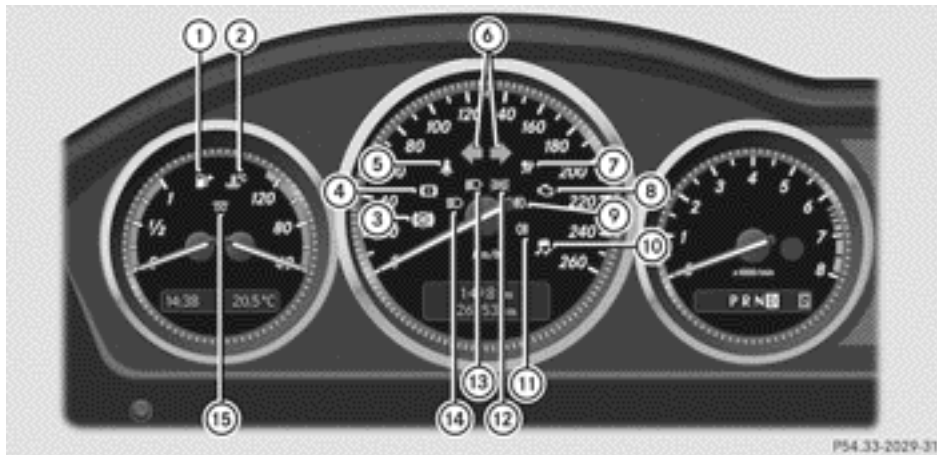

P54.33-2029-31

	Function	Page
①	Reserve fuel	288
②	Coolant	288
③	ABS	282
④	Brakes	282
⑤	Seat belt	281
⑥	Turn signals	121
⑦	SRS	287
⑧	Engine diagnostics	288
⑨	Front foglamps	120

	Function	Page
⑩	ESP®	284
⑪	Rear foglamp	120
⑫	Side lamps	120
⑬	Dipped-beam headlamps	119
⑭	Main-beam headlamp	121
⑮	Diesel engine: pre-glow	151

Instrument cluster (12-button steering wheel)

Displays and controls

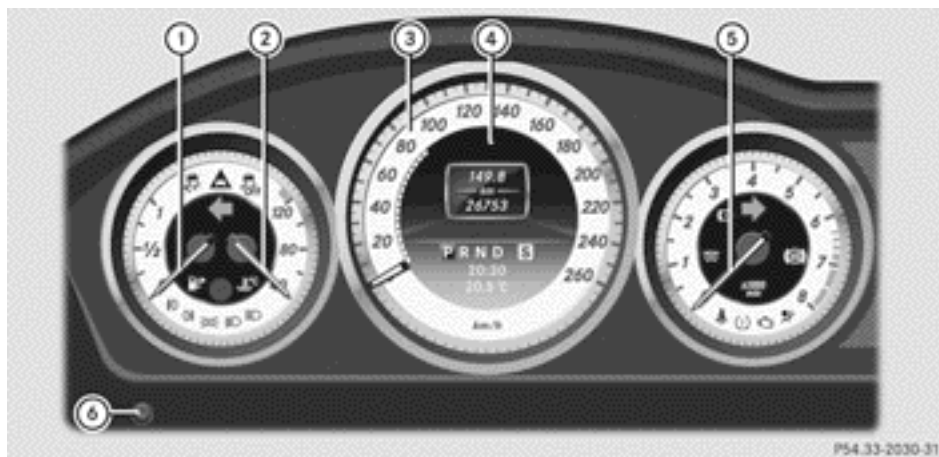

P54.33-2030-31

i Instrument cluster: kilometres

	Function	Page
①	Fuel gauge	
②	Coolant temperature	219
③	Speedometer with segments	220

	Function	Page
④	Multifunction display	221
⑤	Rev counter	219
⑥	Instrument cluster lighting	219

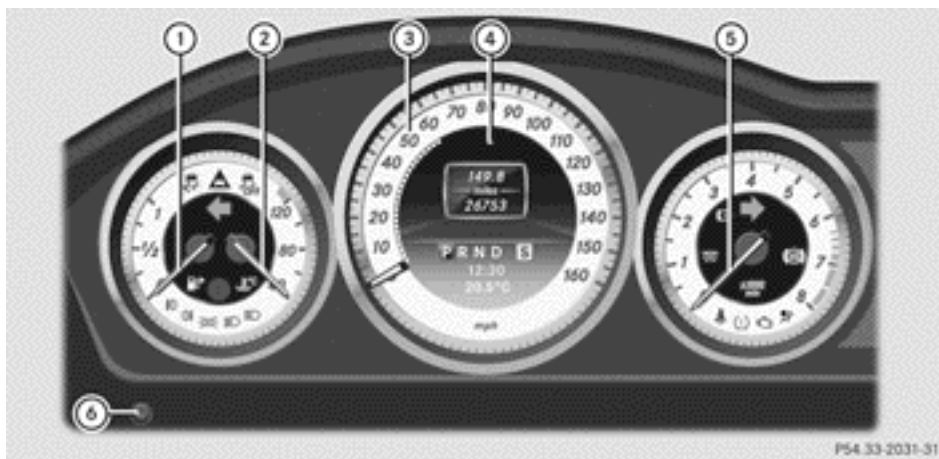

P54.33-2031-31









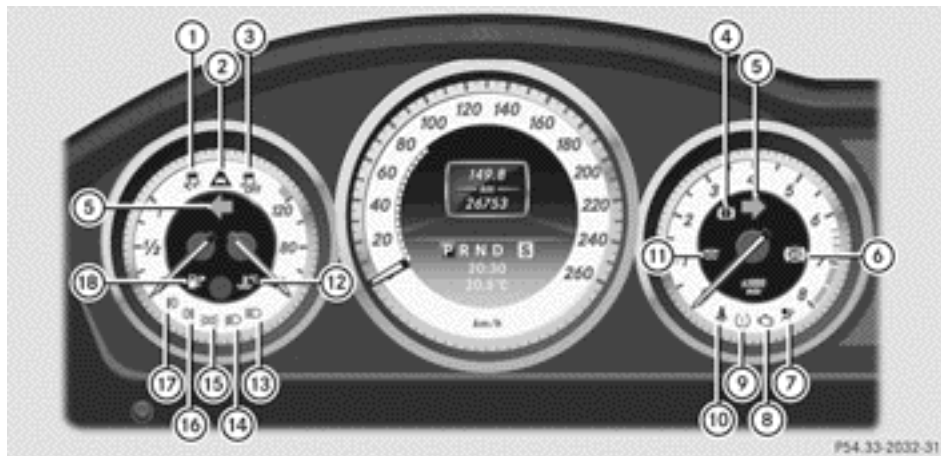











i Instrument cluster: miles

	Function	Page
①	Fuel gauge	
②	Coolant temperature	219
③	Speedometer with segments	220

	Function	Page
④	Multifunction display	221
⑤	Rev counter	219
⑥	Instrument cluster lighting	219

Warning and indicator lamps







	Function	Page		Function	Page
①	 ESP®  SPORT handling mode in AMG vehicles	284 285	⑪	 Diesel engine: pre-glow  ESP® in AMG vehicles	151 285
②	 Distance warning	290	⑫	 Coolant	288
③	 ESP® OFF	284	⑬	 Main-beam head-lamps	121
④	 Brakes	282	⑭	 Dipped-beam head-lamps	119
⑤	 Turn signals	121	⑮	 Side lamps	120
⑥	 ABS	282	⑯	 Rear foglamp	120
⑦	 SRS	287	⑰	 Front foglamps	120
⑧	 Engine diagnostics	288	⑱	 Reserve fuel	288
⑨	 Tyre pressure monitor	291			
⑩	 Seat belt	281			

Multifunction steering wheel

4-button multifunction steering wheel















	Function	Page
①	Multifunction display	217
②	Audio display; see the separate operating instructions	
③	 Increases the volume	
④	 Decreases the volume	
⑤	 Scrolls through lists Resets values Hides display messages	

	Function	Page
⑥	 Press briefly: Selects a menu Press and hold: Selects the standard display	

12-button multifunction steering wheel







	Function	Page
①	Multifunction display	221
②	Audio/COMAND display; see the separate operating instructions	
③	 Switches on LINGUA-TRONIC; see the separate operating instructions	
④	 Rejects or ends a call Exits telephone book/ redial memory  Makes or accepts a call Switches to the redial memory   Adjusts the volume  Mute	226



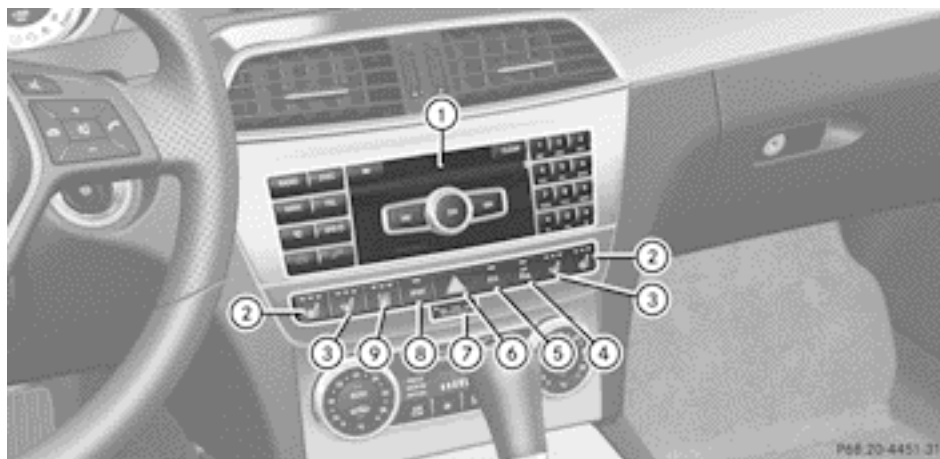

	Function	Page
⑤	  Selects a menu   Selects a submenu or scrolls through lists  Confirms the selection Hides display messages	220 220 240
⑥	 Back Switches off LINGUA-TRONIC; see the separate operating instructions	220

Centre console

Centre console, upper section



	Function	Page
①	Audio system/COMAND Online; see the separate operating instructions	
②	 Seat heating	108
③	 Seat ventilation	110
④	 PARKTRONIC	191
⑤	 ECO start/stop button	153

	Function	Page
⑥	 Hazard warning lamps	121
⑦	 PASSENGER AIRBAG OFF indicator lamp	62
⑧	 Dynamic driving package with sports mode	187
	 AMG vehicles: ESP®	75
⑨	 Auxiliary heating	141

Centre console, lower section

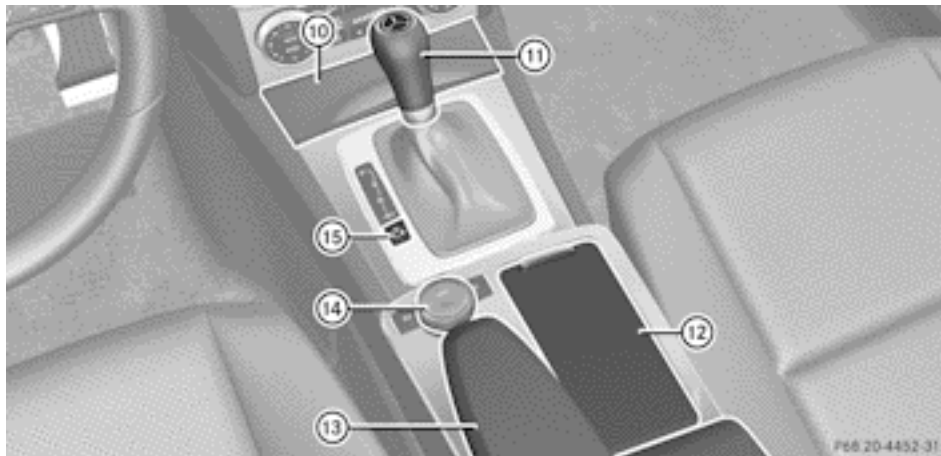





P66 20-4452-31

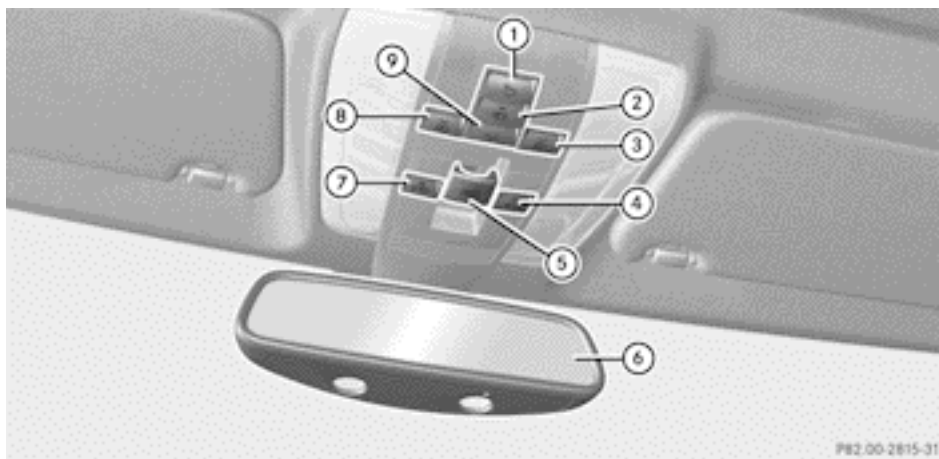

	Function	Page		Function	Page
⑩	Stowage compartment	294	⑬	Stowage compartment	294
	Ashtray	300		⑭	Audio/COMAND controller; see the separate operating instructions
	Cigarette lighter	301	⑮		 Selects the drive program
	Power socket	302			
⑪	Gear lever	157			
	Selector lever	159			
⑫	Stowage compartment	294			
	Cup holders	299			

Overhead control panel









P82.00.2815-31

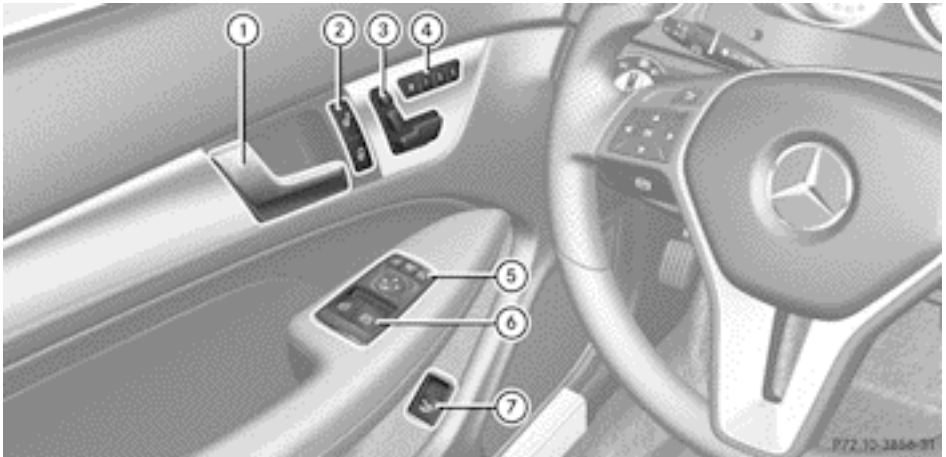

	Function	Page
①	 Switches the rear interior lighting on/off	125
②	 Switches the automatic interior lighting control on/off	125
③	 Switches the right-hand reading lamp on/off	125
④	 Deactivates tow-away protection	79
⑤	 Opens/closes the panorama sliding sunroof with roller sunblinds	99

	Function	Page
⑥	Rear-view mirror	112
⑦	 Deactivates the interior motion sensor	80
⑧	 Switches the left-hand reading lamp on/off	125
⑨	 Switches the front interior lighting on/off	125

Door control panel



	Function	Page
①	Opens the door	89
②	  Unlocks/locks the vehicle	89
③	Adjusts the seats electrically	106
④	    Stores settings for the seat, exterior mirrors and steering wheel	115

	Function	Page
⑤	 Adjusts and folds the exterior mirrors in/out electrically	112
⑥	 Opens/closes the side windows	95
⑦	 Opens the boot lid	93

Useful information	48
Panic alarm	48
Occupant safety	48
Children in the vehicle	59
Driving safety systems	70
Anti-theft systems	78

Useful information

- i** This Owner's Manual describes all models, series and optional equipment for your vehicle that were available at the time of going to press. National variations are possible. Note that your vehicle may not be equipped with all of the functions described. This is also the case for systems and functions relevant to safety.
- i** Read the information on qualified specialist workshops: (▷ page 28).

Panic alarm



- ▶ **To activate:** press **PANIC** button ① for at least one second.
An alarm sounds and the exterior lighting flashes.
 - ▶ **To deactivate:** press **PANIC** button ① again.
- or
- ▶ Insert the key into the ignition lock.
- or
- ▶ Press the KEYLESS-GO Start/Stop button.
The KEYLESS-GO key must be in the vehicle.
- i** The panic alarm function is only available in certain countries.

Occupant safety

Important safety notes

⚠ WARNING

Modifications to the restraint systems could result in them not functioning properly any more. The restraint systems could then no longer protect vehicle occupants as they are designed to do and could fail in the event of an accident or activate unexpectedly, for example. There is an increased risk of injury. Never modify parts of the restraint systems. Do not attempt to modify the wiring as well as electronic components or their software.

The airbag system can be adapted for a person with disabilities. For further information, consult a Mercedes-Benz Service Centre.

The seat belts, together with SRS (Supplemental Restraint System), are complementary, co-ordinated restraint systems (▷ page 49). They reduce the risk of injury in specific, pre-defined types of accident situations and thereby increase occupant safety. However, seat belts and airbags generally do not protect against objects penetrating the vehicle from the outside.

To ensure that the restraint systems can deliver their full potential protection, make sure that:

- the seat and head restraint are adjusted properly (▷ page 104)
- the seat belt has been fastened properly (▷ page 57)
- the airbags can inflate unrestricted if deployed (▷ page 50)
- the steering wheel is adjusted properly (▷ page 104)
- the restraint systems have not been modified

- i** An airbag increases the protection of vehicle occupants wearing a seat belt. However, airbags are only an additional restraint system that complements, but does not replace, the seat belt. All vehicle

occupants must wear their seat belt correctly at all times, even if the vehicle is equipped with airbags. The airbags are not deployed in all types of accidents. For example, if the protective capacity of correctly fastened seat belts is not increased by deploying the airbags, the airbags will not deploy. Airbag deployment only provides increased protection if the seat belt is worn correctly because:

- the seat belt helps to keep the vehicle occupant in the best position in relation to the airbag.
- in a head-on collision, for example, the seat belt prevents the vehicle occupant from being propelled towards the point of impact. It can thus reduce the risk of injury.

In accidents in which an airbag is deployed, it provides increased protection only if the seat belt is worn correctly.

SRS (Supplemental Restraint System)

Introduction

SRS consists of:

- the  SRS warning lamp
- airbags
- airbag control unit (with crash sensors)
- belt tensioners
- belt force limiters

SRS reduces the risk of occupants coming into contact with the vehicle's interior in the event of an accident. It can also reduce the forces to which occupants are subjected during an accident.

SRS warning lamp

WARNING

If SRS is malfunctioning, child restraint system components may be triggered unintentionally or might not be triggered at all in the event of an accident with a high rate of vehicle

deceleration. There is an increased risk of injury, possibly even fatal.



Have SRS checked and repaired immediately at a qualified specialist workshop.

SRS functions are checked regularly when you switch on the ignition and when the engine is running. Therefore, malfunctions can be detected in good time.

The  SRS warning lamp in the instrument cluster lights up when the ignition is switched on. It goes out no later than a few seconds after the engine is started.

The SRS components are in operational readiness when the  SRS warning lamp goes out while the engine is running.

A malfunction has occurred if:

- the  SRS warning lamp does not light up when the ignition is switched on
- the engine is running and the  SRS warning lamp does not go out after a few seconds
- the engine is running and the  SRS warning lamp lights up again

Triggering of belt tensioners and airbags

During the first stage of a collision, the airbag control unit evaluates important physical data relating to vehicle deceleration or acceleration, such as:

- duration
- direction
- magnitude

Based on the evaluation of this data, the airbag control unit pre-emptively triggers the belt tensioners in the first stage.

-  The front belt tensioners can only be triggered if the seat belt tongues on the front seats are correctly engaged in the seat belt buckles.

If there is an even higher rate of vehicle deceleration or acceleration in a longitudinal direction, the front airbags are also deployed.

Your vehicle has adaptive, two-stage front airbags. The airbag control unit evaluates vehicle deceleration or acceleration in the event of a collision. In the first deployment stage, the front airbag is filled with enough propellant gas to reduce the risk of injuries. The front airbag is fully deployed if a second deployment threshold is exceeded within a few milliseconds.

The belt tensioner and airbag triggering thresholds are variable and are adapted to the rate of deceleration or acceleration of the vehicle. This process is pre-emptive in nature. The triggering process must take place in good time at the start of the collision.

i Airbags are not deployed in all types of accidents. Also, not all airbags are deployed together in an accident. The different airbag systems work independently of each other.

How the airbag system works is determined by the severity of the collision detected, especially the vehicle deceleration or acceleration, and the apparent type of accident:

- head-on collision
- side impact
- rear impact

The rate of vehicle deceleration or acceleration and the direction of the force are essentially determined by:

- the distribution of forces during the collision
- the collision angle
- the deformation characteristics of the vehicle
- the characteristics of the object with which the vehicle has collided

Factors which can only be seen and measured after a collision has occurred do not play a decisive role in the deployment of an airbag, nor do they provide an indication of airbag deployment.

The vehicle may be deformed significantly, e.g. the bonnet or the wing, without an airbag being deployed. This is the case if only parts which are relatively easily deformed are affected and the rate of deceleration is not high. Conversely, airbags may be deployed even though the vehicle suffers only minor deformation. This is the case if, for example, very rigid vehicle parts such as longitudinal body members are hit, and sufficient deceleration occurs as a result.

Airbags

Important safety notes

WARNING

Airbags provide additional protection; they are not, however, a substitute for seat belts.

Observe the following notes to reduce the risk of serious or even fatal injury caused by airbag deployment:

- all vehicle occupants – in particular, pregnant women – must wear their seat belt correctly at all times and lean back against the backrest, which should be positioned as close to the vertical as possible. The head restraint must support the back of the head at about eye level.
- always secure children less than 1.50 m tall or under 12 years of age in suitable child restraint systems.
- all vehicle occupants must select a seat position that is as far away from the airbag as possible. The driver's seat position must allow the vehicle to be driven safely. The driver's chest should be as far away from the centre of the driver's airbag cover as possible.
- move the front-passenger seat as far back as possible. This is especially important if you have secured a child in a child restraint system on the front-passenger seat.
- vehicle occupants – in particular, children – must not lean their head into the area of

the window in which the sidebag/window-bag is deployed.

- rearward-facing child restraint systems must not be fitted to the front-passenger seat unless the front-passenger airbag has been disabled. On the front-passenger seat, the front-passenger airbag is disabled if a child restraint system with a transponder for automatic child seat recognition is fitted to the front-passenger seat in a vehicle equipped with automatic child seat recognition. The  PASSENGER AIRBAG OFF indicator lamp must be continuously lit.

If the front-passenger seat of your vehicle does not have automatic child seat recognition, or your rearward-facing child restraint system does not have a transponder for automatic child seat recognition, children must be secured in a child restraint system on a suitable seat in the rear. If you secure a forward-facing child restraint system to the front-passenger seat, you must move the front-passenger seat as far back as possible.

- make sure there are no heavy or sharp-edged objects in the pockets of clothing.
- do not lean forwards, e.g. over the cover of the driver's/front-passenger front airbag, particularly when the vehicle is in motion.
- do not put your feet on the dashboard.
- only hold the steering wheel on the outside. This allows the airbag to be fully deployed. You could be injured if the airbag is deployed and you are holding the inside of the steering wheel.
- do not lean on the doors from inside the vehicle.
- make sure that there are no people, animals or objects between the vehicle occupants and the area where the airbags are deployed.
- do not place any objects between the seat backrest and the door.

- do not hang any hard objects, e.g. coat hangers, on the grab handles or coat hooks.
- do not attach accessories, e.g. cup holders, to the doors.

It is not possible to rule out a risk of injury being caused by an airbag, due to the high speed at which the airbag must be deployed.

Airbag deployment slows down and restricts the movement of the vehicle occupant.

If the airbags are deployed, you will hear a bang and a small amount of powder may also be released. Only in rare cases will the bang affect your hearing. The powder that is released generally does not constitute a health hazard. The  SRS warning lamp lights up.

The airbag installation locations are identified by the AIRBAG symbol.

WARNING

If you modify the airbag covers or affix objects, e.g. stickers to them, the airbags may no longer function as intended. There is an increased risk of injury.

Never modify the airbag covers and do not affix any objects to them.

WARNING

Unsuitable seat covers may obstruct or even prevent deployment of the airbags integrated into the seats. The airbags may then fail to protect the vehicle occupants as intended. Operation of the automatic child seat recognition may also be impaired. There is an increased risk of injury, possibly even fatal.

Use only seat covers which have been specifically approved for the respective seat by Mercedes-Benz.

WARNING

After the driver's airbag has been deployed, the airbag parts are hot. There is a risk of injury.

Do not touch the airbag parts. Have deployed airbags replaced immediately at a qualified specialist workshop.

The airbag installation locations are identified by the AIRBAG symbol.

- ❗ After an airbag has been deployed, have the vehicle towed to the nearest qualified specialist workshop, even if your vehicle can still be driven.

Front airbags

The front airbags increase protection for the driver's and front-passenger's head and chest.



Driver's airbag ① deploys in front of the steering wheel; front-passenger front airbag ② deploys in front of and above the glove compartment.

They are deployed:

- at the start of an accident with a high rate of vehicle acceleration or deceleration in a longitudinal direction.
- if the system determines that airbag deployment can offer additional protection to that provided by the seat belt.
- independently of other airbags in the vehicle.

The release time of the front airbags is dependant upon the use of the seat belt.

Vehicles with automatic child seat recognition in the front-passenger seat: the front-passenger front airbag is only activated if the system determines that the front-

passenger seat is occupied. The PASSENGER AIRBAG OFF indicator lamp on the centre console does not light up (▷ page 62).

If a child restraint system is fitted to the front-passenger seat and the PASSENGER AIRBAG OFF indicator lamp on the centre console is not on:

- a child restraint system without a transponder for automatic child seat recognition has been fitted or
- a child restraint system with a transponder has been fitted incorrectly

❗ Do not place heavy objects on the front-passenger seat. This could cause the system to identify the seat as being occupied. In the event of an accident, the restraint systems on the front-passenger side may be triggered and have to be replaced.

Driver's kneebag

- ❗ The driver's kneebag is only available in certain countries.

The driver's kneebag increases protection of the driver against:

- knee injuries
- thigh injuries
- lower leg injuries



Driver's kneebag ① is always deployed along with the driver's airbag and inflates underneath the steering column.

Sidebags

WARNING

Unsuitable seat covers may obstruct or even prevent deployment of the airbags integrated into the seats. The airbags may then fail to protect the vehicle occupants as intended. Operation of the automatic child seat recognition may also be impaired. There is an increased risk of injury, possibly even fatal. Use only seat covers which have been specifically approved for the respective seat by Mercedes-Benz.

WARNING

Sensors to control the airbags are located in the doors. Modifications or work not performed correctly to the doors or door paneling, as well as damaged doors, can lead to the function of the sensors being impaired. The airbags might therefore not function properly any more. Consequently, the airbags cannot protect vehicle occupants as they are designed to do. This poses an increased risk of injury.

Never modify the doors or parts of the doors. Always have work on the doors or door paneling carried out at a qualified specialist workshop.

You should only use seat cover that have been approved for your vehicle by Mercedes-Benz. The seat covers must have a special tear seam for sidebags. Otherwise, the sidebags cannot deploy correctly and therefore cannot provide the intended protection in the event of an accident.

When deployed, the sidebags offer additional protection for the thorax of the vehicle occupants on the side of the vehicle on which the impact occurs. However, they do not protect the:

- head
- neck
- arms

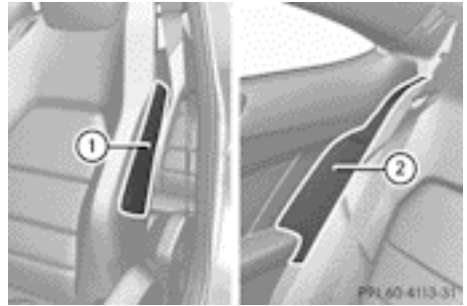

Front sidebags ① and rear sidebags ② deploy next to the outer seat cushions.

The sidebags are deployed:

- on the side on which an impact occurs
- at the start of an accident with a high rate of lateral vehicle deceleration or acceleration, e.g. in a side impact
- independently of the use of the seat belt
- independently of the front airbags
- independently of the belt tensioners

Pelvisbags

 Pelvisbags are only available in certain countries.

WARNING

If you wish to use seat covers, Mercedes-Benz recommends that, for safety reasons, you only use seat covers that have been approved for Mercedes-Benz vehicles.

The seat covers must have a special tear seam for sidebags/pelvisbags. Otherwise, the sidebag/pelvisbag cannot deploy correctly and would fail to provide the intended protection in the event of an accident. Appropriate seat covers can be obtained, for example, from a Mercedes-Benz Service Centre.

Pelvisbag deployment enhances the level of protection of the vehicle occupants on the side of the vehicle on which the impact occurs.

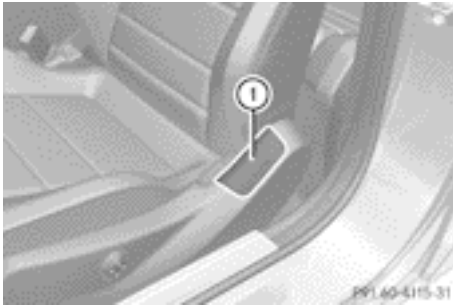

Pelvisbags ① deploy next to and below the outer seat cushions. They are deployed:

- on the side on which an impact occurs
- at the start of an accident with a high rate of lateral vehicle deceleration or acceleration, e.g. in a side impact
- independently of the use of the seat belt
- independently of the front airbags
- independently of the belt tensioners

Windowbags

The windowbags enhance the level of protection for the head (but not chest or arms), of the vehicle occupants on the side of the vehicle on which the impact occurs.

The windowbags are integrated into the side of the roof frame and deploy in the area extending from the front door (A-pillar) to the rear sidewall (C-pillar).

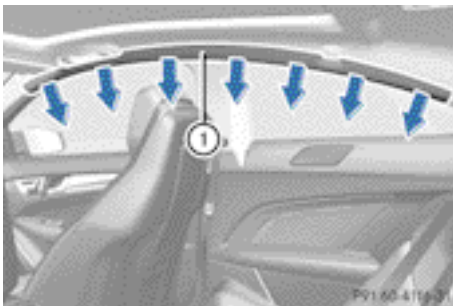

Windowbags ① are deployed:

- on the side on which an impact occurs
- at the start of an accident with a high rate of lateral vehicle deceleration or acceleration, e.g. in a side impact
- regardless of whether the front-passenger seat is occupied
- independently of the use of the seat belt
- independently of the front airbags

PRE-SAFE® (anticipatory occupant protection)

PRE-SAFE® takes pre-emptive measures to protect occupants in certain hazardous situations.

PRE-SAFE® intervenes:

- when BAS PLUS intervenes powerfully on vehicles with DISTRONIC PLUS
- if, on vehicles with DISTRONIC PLUS, the radar sensor system detects an imminent danger of collision in certain situations
- in critical driving situations, e.g. when physical limits are exceeded and the vehicle understeers or oversteers severely

PRE-SAFE® takes the following measures depending on the hazardous situation detected:

- the front seat belts are pre-tensioned.
- vehicles with the memory function: the front-passenger seat is adjusted if it is in an unfavourable position.
- if the vehicle skids, the panorama sliding sunroof and the side windows are closed so that only a small gap remains.

If the hazardous situation passes without resulting in an accident, PRE-SAFE® slackens the belt pretensioning. All settings made by PRE-SAFE® can then be reversed.

If the seat belts are not released:

- ▶ Move the backrest or seat back slightly, but only when the vehicle is stationary. Seat belt pretensioning is reduced and the locking mechanism is released.

WARNING

When adjusting the seat, make sure that nobody can become trapped.

- ❗ Make sure that there are no objects in the footwell or behind the seats when moving the seat back. There is a risk that the seats and/or the objects could be damaged.

More information about seat belt adjustment, a convenience function integrated into PRE-SAFE®, can be found in the "Seat belt adjustment" section (▷ page 57).

NECK-PRO head restraints

The NECK-PRO head restraints increase protection to the driver's and front passenger's head and neck. To this end, the NECK-PRO head restraints on the driver's and front-passenger seats are moved forwards and upwards in the event of a rear-end collision of a certain severity. This provides better head support.

WARNING

Only use head restraint covers which have been tested and approved by Mercedes-Benz for your vehicle model.

The use of non-approved head restraint covers may prevent NECK-PRO head restraints from triggering properly. Consequently, the NECK-PRO head restraints cannot provide the intended level of protection.

Consult a Mercedes-Benz Service Centre regarding availability.

The NECK-PRO head restraints reduce the likelihood of head and chest injuries. The NECK-PRO head restraints on the driver's and front-passenger seats are moved forwards and upwards in the event of a rear-end collision

of a certain severity. This provides better head support.

If the NECK-PRO head restraints have been triggered in an accident, reset the NECK-PRO head restraints on the driver's and front-passenger seat (▷ page 55). Otherwise, the additional protection will not be available in the event of another rear-end collision. You can recognise when NECK-PRO head restraints have been triggered by the fact that they have moved forwards and can no longer be adjusted.

Resetting a triggered NECK-PRO head restraint/NECK-PRO luxury head restraint

- ❗ Resetting the NECK-PRO head restraints requires a lot of strength. If you have difficulty resetting the NECK-PRO head restraints, have this work carried out at a qualified specialist workshop.

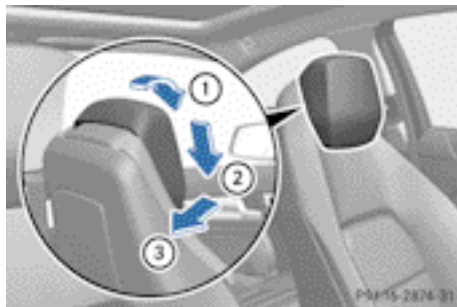

- ▶ Tilt the top of the NECK-PRO head restraint cushion forwards in the direction of arrow ①.
- ▶ Push the NECK-PRO head restraint cushion down in the direction of arrow ② as far as it will go.
- ▶ Firmly push the NECK-PRO head restraint cushion back in the direction of arrow ③ until the cushion engages.
- ▶ Repeat this procedure for the second NECK-PRO head restraint.

Seat belts

Important safety notes

Seat belts are the most effective means of restraining the movement of vehicle occupants in the event of an accident. This reduces the risk of vehicle occupants coming into contact with parts of the vehicle interior.

WARNING

A seat belt which is not worn correctly, or which has not been engaged in the seat belt buckle correctly, cannot provide the intended level of protection. Under certain circumstances, this could cause severe or even fatal injuries in the event of an accident.

Therefore, make sure that all occupants – in particular, pregnant women – wear their seat belts correctly at all times.

- The seat belt must fit snugly on your body and must not be twisted. Therefore, avoid wearing bulky clothing, e.g. a winter coat. The shoulder section of the belt must be routed across the centre of your shoulder – on no account across your neck or under your arm – and pulled tight against your upper body. The lap belt must always pass across your lap as low down as possible, i.e. over your hip joints – not across your abdomen. If necessary, push the seat belt slightly downwards and adjust it by pulling it in the direction the seat belt retracts.
- Do not route the seat belt strap over sharp or fragile objects. Please make sure that such objects are not on or in your clothing, e.g. spectacles, pens or keys etc. The seat belt strap could become damaged and tear during an accident and you or other vehicle occupants could be injured.
- Only one person should use each seat belt at any one time. Children must never travel sitting on the lap of another occupant. The child will not be secured in the event of an accident, heavy braking or sudden change of direction. This may result in the child or

other occupants being seriously or fatally injured.

- Persons under 1.50 m tall cannot wear the seat belts correctly. For this reason secure persons less than 1.50 m tall in specially designed, suitable restraint systems.
- Children under 1.50 m tall and younger than twelve years of age cannot wear the seat belts correctly. For this reason secure them in special suitable child restraint systems installed on a suitable seat. Additional information can be found in the Operating Instructions in the chapter "Safety", "Children in the Vehicle". Observe the installation instructions of the child restraint system manufacturer.
- Do not secure an object with a seat belt if the seat belt is also being used by one of the vehicle's occupants.

WARNING

The seat belt does not offer the intended level of protection if the backrest is not in the upright position. When braking or in the event of an accident, you could slide underneath the seat belt and sustain abdomen or neck injuries, for example. This poses an increased risk of injury or even fatal injury.

Adjust the seat properly before beginning your journey. Always make sure that the seat is in the upright position.

WARNING

Seat belts cannot perform their intended protective function if:

- they are damaged, modified, bleached or coloured, or are very dirty
- the seat belt buckle is damaged or very dirty
- modifications have been made to the seat belt tensioners or belt anchorages

In the event of an accident, seat belts can sustain damage that is not visible to the naked eye, e.g. due to glass splinters. Modified or damaged seat belts could tear or fail in the

event of an accident, for example. Modified belt tensioners could deploy unexpectedly or fail. There is an increased risk of serious or even fatal injuries.

Never make modifications to seat belts, belt tensioners, belt anchorages or seat belt retractors. Make sure that the seat belts are undamaged, are not worn and are clean.

Mercedes-Benz recommends that you only use seat belts which have been approved specifically for your vehicle by Mercedes-Benz.

Seat belts are the most effective means of restraining the movement of vehicle occupants in the event of an accident. This reduces the risk of vehicle occupants coming into contact with parts of the vehicle interior.

Fastening seat belts



- ▶ Adjust the seat and move the backrest to an almost vertical position (▷ page 104).
- ▶ Pull the seat belt smoothly through belt sash guide ①.
- ▶ Without twisting it, guide the shoulder section of the seat belt across the middle of your shoulder and the lap section across your pelvis.

- ▶ Engage belt tongue ② in buckle ③.

Seat belt adjustment: if necessary, the driver's and front-passenger seat belts automatically adjust to the upper body (▷ page 57).

- ▶ If necessary, pull upwards on the shoulder section of the seat belt to tighten the belt across your body.

The rear seat belts are equipped with a child-seat lock (▷ page 62). If you pull out the seat belt fully and then allow the inertia reel to retract it, the child-seat lock is activated. To deactivate the child seat lock, unfasten the seat belt and guide the belt tongue back to the belt sash guide.

For more information about releasing the seat belt with release button ④, see "Releasing seat belts" (▷ page 58).

Seat belt adjustment

The seat-belt adjustment function adjusts the driver's and front-passenger seat belt to the upper body of the occupants.

The belt strap is tightened slightly when:

- you engage the belt tongue in the belt buckle and you then turn the key to position 2 in the ignition lock.
- the key is in position 2 in the ignition lock and you then engage the belt tongue in the buckle.

The seat-belt adjustment will apply a certain tightening force if any slack is detected between the occupant and the seat belt. Do not hold on to the seat belt tightly while it is adjusting. On vehicles with a luxury multi-function steering wheel (12 buttons), you can switch the seat-belt adjustment on and off using the on-board computer (▷ page 236).

The seat-belt adjustment is an integral part of the PRE-SAFE® convenience function. More information about PRE-SAFE® can be found in the "PRE-SAFE® (anticipatory occupant protection)" section (▷ page 54).

Releasing the seat belts





- ▶ Press release button ④ on belt buckle ③.
- ▶ Guide belt tongue ② back to belt sash guide ①.

i If you have guided the seat belt back, it is turned 180°. This is necessary to ensure that the seat belt is not twisted and that it is routed correctly when the belt is fastened.

! Make sure that the seat belt is fully rolled up. Otherwise, the seat belt or belt tongue will be trapped in the door or in the seat mechanism. This could damage the door, the door trim panel and the seat belt. Damaged seat belts can no longer fulfil their protective function and must be replaced. Visit a qualified specialist workshop.

Belt warning for the driver and front passenger



The  seat belt warning lamp in the instrument cluster is a reminder for all occupants to fasten their seat belts. It may light up continuously or flash. In addition, a warning tone may sound.

The  seat belt warning lamp goes out and the warning tone ceases when the driver and the front passenger have fastened their seat belt.

For certain countries only: regardless of whether the driver and the front passenger have fastened their seat belts, the  seat belt warning lamp lights up for six seconds after the engine is started. It then goes out if the driver and the front passenger have fastened their seat belts.

i For more information on the  seat belt warning lamp, see "Warning and indicator lamps in the instrument cluster, seat belt" (> page 281).

Rear seat belt status indicator

The rear-compartment seat belt status indicator tells you if the rear passengers have their seat belts fastened. The rear-compartment seat belt status indicator indicates the rear seat on which the belt is fastened. The  symbol in the display indicates a fastened seat belt. If a seat belt is not fastened or if a seat is not occupied, the  symbol is displayed.

The rear-compartment seat belt status indicator appears in the multifunction display for around 30 seconds if:

- you drive off and reach a speed of approximately 10 km/h.
- the rear passengers fasten or unfasten their seat belts while the vehicle is in motion.
- someone gets in or out of the vehicle and the vehicle drives off again.

You can also cancel the rear seat belt status indicator immediately (> page 240).

i The status indicator for the rear-compartment seat belts is only available for certain countries.

Belt tensioners, belt force limiters

WARNING

Pyrotechnic seat belt tensioners that have been deployed are no longer operational and are unable to perform their intended protec-

tive function. This poses an increased risk of injury or even fatal injury.

Therefore, have pyrotechnic belt tensioners which have been triggered immediately replaced at a qualified specialist workshop.

! If the front-passenger seat is not occupied, do not engage the seat belt tongue in the buckle on the front-passenger seat. Otherwise, the belt tensioner could be triggered in the event of an accident.

i Vehicles with PRE-SAFE®: belt tensioners that are triggered by an electric motor can be deployed as often as desired and do not need to be replaced.

The seat belts are fitted with belt tensioners. The belt tensioners tighten the seat belts in an accident, pulling them close against the body.

Belt tensioners do not correct incorrect seat positions or incorrectly fastened seat belts. Belt tensioners do not pull vehicle occupants back towards the backrest.

The belt tensioners can only be activated when:

- the ignition is switched on
- the restraint systems are operational; see "SRS warning lamp" (> page 49)
- the belt tongue is engaged in the buckle on each of the three-point seat belts in front

The belt tensioners on the seats in the rear compartment are triggered independently of the lock status of the seat belts.

The belt tensioners are triggered depending on the type and severity of an accident:

- if, in the event of a head-on or rear-end collision the vehicle decelerates or accelerates rapidly in a longitudinal direction during the initial stages of the impact
- if, in the event of a side impact, on the side opposite the impact the vehicle decelerates or accelerates rapidly in a lateral direction

If the airbags are deployed, you will hear a bang, and a small amount of powder may also be released. Only in rare cases will the bang affect your hearing. The powder that is released generally does not constitute a health hazard and does not indicate that there is a fire in the vehicle. The powder may cause short-term breathing difficulties to persons suffering from asthma or other pulmonary conditions. In order to prevent potential breathing difficulties, you should leave the vehicle as soon as it is safe to do so. You can also open the window to allow fresh air to enter the vehicle interior. The  SRS warning lamp lights up.

If the seat belt is also fitted with a belt force limiter and this is triggered, the force exerted by the seat belt on the vehicle occupant is reduced.

The belt force limiters on the front seats are synchronised with the front airbags, which take on a part of the deceleration force. This results in the load being distributed over a greater area.

Children in the vehicle

Child restraint systems

Important safety notes

WARNING

To reduce the risk of serious or even fatal injury to the child in the event of a sudden change in direction, braking or an accident:

- Children less than 1.50 m tall and under twelve years of age must always be secured in special child restraint systems on a suitable vehicle seat. This is necessary because the seat belts are not designed for children.
- Do not transport children who are secured in rearward-facing child restraint systems on the front-passenger seat. Exception: if the vehicle is equipped with automatic child seat recognition on the front-passenger

seat and the child is secured in a child restraint system with transponders for automatic child seat recognition

- If you secure a forward-facing child restraint system to the front-passenger seat, you must move the front-passenger seat as far back as possible. When doing so, ensure that the shoulder belt strap from the belt outlet on the vehicle is routed towards the front to the shoulder belt guide on the child restraint system. Set the belt height adjustment so that the belt strap is routed towards the front along the bottom.
- Children must never travel sitting on the lap of another occupant. Due to the forces which occur in the event of a sudden change of direction, heavy braking or an accident, it would not be possible to restrain the child. The child could be thrown against parts of the vehicle interior and be seriously or even fatally injured.

WARNING

If the child restraint system is incorrectly fitted on the seat position suitable for this purpose, it cannot perform its intended protective function. In the event of an accident, sharp braking or a sudden change in direction, the child may not be held securely. There is an increased risk of serious or even fatal injuries.

Observe the manufacturer's installation instructions and the correct use for the child restraint system. Make sure that the entire surface of the child restraint system is resting on the seat surface. Never place objects under or behind the child restraint system, e.g. cushions. Only use child restraint systems with the original cover designed for them. Only replace damaged covers with genuine covers.

WARNING

If the child restraint system is fitted incorrectly or is not secured, it can come loose in the event of an accident, heavy braking or a

sudden change in direction. The child restraint system could be thrown about, striking vehicle occupants. There is an increased risk of injury, possibly even fatal.

Always fit child restraint systems properly, even if they are not being used. Make sure that you observe the child restraint system manufacturer's installation instructions.

WARNING

Child restraint systems or their securing systems that have been damaged or subjected to a load in an accident cannot perform their intended protective function. In the event of an accident, sharp braking or a sudden change in direction, the child may not be held securely. There is an increased risk of serious or even fatal injuries.

Immediately replace child restraint systems that have been damaged or subjected to a load in an accident. Have the child restraint securing systems checked in a qualified specialist workshop before fitting a child restraint system again.

WARNING

If children are left unsupervised in the vehicle, they could:

- open the doors, thus endangering other people or road users.
- get out and disrupt traffic.
- operate the vehicle's equipment.

Additionally, children could set the vehicle in motion if, for example, they:

- release the parking brake.
- shift the automatic transmission out of parking position P.
- shift the manual transmission into neutral.
- start the engine.

There is a risk of an accident and injury.

When leaving the vehicle, always take the key with you and lock the vehicle. Never leave children or animals unattended in the vehicle. Always keep the key out of reach of children.

⚠ WARNING

If persons (particularly children) are exposed to heat or cold for a prolonged period, there is a risk of serious or even fatal injuries. Never leave persons (particularly children) unattended in the vehicle.

⚠ WARNING

If the child restraint system is placed in direct sunlight, the parts could become very hot. Children could be suffer burns by touching these parts, in particular on the metallic parts of the child restraint system. There is a risk of injury.

If you and your child leave the vehicle, always make sure that the child restraint system is not in direct sunlight. Cover it with a blanket, for example. If the child restraint system has been exposed to direct sunlight, leave it to cool down before securing the child in it. Never leave children unattended in the vehicle.

If a child is travelling in your vehicle, secure the child using a child restraint system which is appropriate to the size, age and weight of the child. In order to correctly secure the child in the child restraint system, always comply with the child restraint system manufacturer's installation instructions. You should preferably fit the restraint system to a suitable rear seat. Make sure that the child is secured for the trip.

Mercedes-Benz recommends that you use the listed child restraint systems (▷ page 68). You can obtain further information about the correct child restraint system from any Mercedes-Benz Service Centre.

i It is advisable to use Mercedes-Benz care products to clean child restraint systems. You can obtain information about this at any Mercedes-Benz Service Centre.

Child restraint system on the front-passenger seat

Example: warning notice on the front-passenger sun visor



Warning symbol for a rearward-facing child restraint system

⚠ WARNING

If the front-passenger airbag is not disabled:

- a child secured in a child restraint system on the front-passenger seat could be seriously and even fatally injured by the front-passenger airbag deploying. This is especially a risk if the child is in the immediate vicinity of the front-passenger airbag when it deploys.
- never secure a child on the front-passenger seat in a rearward-facing child restraint system. Only secure a rearward-facing child restraint system on a suitable rear seat.
- always move the front-passenger seat to the rearmost position if you secure a child in a forward-facing child restraint system on the front-passenger seat.

The front-passenger airbag is not disabled:

- on vehicles without automatic child seat recognition on the front-passenger seat
- in vehicles with automatic child seat recognition in the front-passenger seat, if no special child restraint system with transponders for automatic child seat recognition in the front-passenger seat has been fitted
- on vehicles with automatic child seat recognition on the front-passenger seat, if the PASSENGER AIRBAG OFF indicator lamp  is not lit.

To make you aware of this danger, a corresponding warning sticker has been affixed on the dashboard and on both sides of the sun visor on the front-passenger side.

Information about recommended child restraint systems is available at any Mercedes-Benz Service Centre.

NEVER use a rearward facing child restraint on a seat protected by an ACTIVE AIRBAG in front of it, DEATH or SERIOUS INJURY to the CHILD can occur.

Child seat locks

The seat belts on the rear seats are fitted with a child seat lock. When enabled, the child-seat lock function ensures that the belt does not slacken once the child seat is secured.

Installing a child restraint system:

- ▶ Always comply with the manufacturer's installation instructions.
- ▶ Pull the seat belt smoothly from the inertia reel.
- ▶ Engage the seat belt tongue in the belt buckle.

Activating the child seat lock:

- ▶ Pull the seat belt out fully and let the inertia reel retract it again. While the seat belt is retracting, you should hear a ratcheting sound. The child seat lock function is enabled.
- ▶ Push down on the child restraint system to take up any slack.

Removing a child restraint system/deactivating the child seat lock:

- ▶ Always comply with the manufacturer's installation instructions.
- ▶ Press the seat belt release button and guide the belt tongue to the belt outlet. The child seat lock function is deactivated.

Automatic child seat recognition on the front-passenger seat



If the front-passenger seat of your vehicle does not have automatic child seat recognition, this is indicated by a special sticker. The sticker is affixed to the side of the dashboard on the front-passenger side. The sticker is visible when you open the front-passenger door.

Vehicles without automatic child seat recognition on the front-passenger seat: if you turn the key to position 2 in the ignition lock, the PASSENGER AIRBAG OFF indicator lamp lights up briefly. However, the indicator lamp has no function. It does not indicate that there is automatic child seat recognition on the front-passenger seat.



① PASSENGER AIRBAG OFF indicator lamp

The sensor system for child restraint systems in the front-passenger seat detects whether a special Mercedes-Benz child seat with a transponder for automatic child seat recognition has been fitted. In this case, PASSENGER AIRBAG OFF indicator lamp ① lights up. The front-passenger front airbag is disabled.

WARNING

If the  PASSENGER AIRBAG OFF indicator lamp does not light up when the child restraint system is fitted, the front-passenger front airbag has not been disabled. If the front-passenger front airbag deploys, the child could be seriously or even fatally injured.

Proceed as follows:

- do not use a rearward-facing child restraint system on the front-passenger seat.
- fit a rearward-facing child restraint system on a suitable rear seat.

or

- only use a forward-facing child restraint system on the front-passenger seat and move the front-passenger seat as far back as possible. When doing so, ensure that the shoulder belt strap from the belt outlet on the vehicle is routed towards the front to the shoulder belt guide on the child restraint system. Set the belt height adjustment so that the belt strap is routed towards the front along the bottom.
- have the automatic child seat recognition checked at a qualified specialist workshop.

To ensure that the automatic child seat recognition on the front-passenger seat functions/communicates correctly, never place objects, e.g. a cushion, under the child restraint system. The entire base of the child restraint system must always rest on the seat cushion. An incorrectly fitted child restraint system cannot perform its intended protective function in the event of an accident, and could lead to injuries.

i If the front-passenger front airbag is disabled by the automatic child seat recognition, the following remain enabled on the front-passenger side:

- the sidebag
- the pelvisbag
- the windowbag
- the belt tensioner

WARNING

Electronic devices on the front-passenger seat can affect the function of the automatic child seat recognition, for example:

- laptop
- mobile phone
- transponder cards such as ski passes or access passes

The front-passenger front airbag could deploy unintentionally or not function as intended during an accident. This poses an increased risk of injury or even fatal injury.

Do not place any of the devices mentioned above or similar devices on the front-passenger seat.

ISOFIX child seat securing system for the rear seats

ISOFIX is a standardised securing system for specially designed child restraint systems on the rear seats. Securing rings for two ISOFIX child restraint systems are fitted on the left and right of the rear seats.

⚠ WARNING

A child restraint system secured by the ISOFIX child seat securing system does not provide sufficient protection for children weighing more than 22 kg. For this reason, do not secure children weighing more than 22 kg in a child restraint system secured by the ISOFIX child seat securing system. If the child weighs more than 22 kg, secure the child restraint system with the vehicle seat belt as well. In addition, when fitting a child restraint system, be sure to observe the manufacturer's installation instructions and the instructions for correct use of the child restraint system.

⚠ WARNING

The child restraint system cannot perform its protective function if it is not correctly fitted to a suitable vehicle seat. The child cannot be restrained in the event of an accident, heavy braking or sudden changes of direction. The child could be seriously or even fatally injured. For this reason, when fitting a child restraint system, be sure to observe the manufacturer's installation instructions and the instructions for correct use of the child restraint system.

For safety reasons, when installing child restraint systems on the rear seats, only use child restraint systems with the ISOFIX child seat securing system, which are specially tested and approved for Mercedes-Benz vehicles.

An incorrectly fitted child restraint system could come loose and seriously or even fatally injure the child or other vehicle occupants. When fitting the child restraint system, always make sure that it is engaged correctly in the securing rings on both sides.

⚠ WARNING

Please note that if child restraint systems, or their retaining systems, are damaged or subjected to a load in an accident, they may not be able to provide their protective function. This could result in serious or even fatal inju-

ries to the secured child in the event of an accident, heavy braking or a sudden change in direction.

For this reason, have child restraint systems and their anchorages which have been damaged or subjected to a load in an accident checked immediately at a qualified specialist workshop.

The securing rings on the rear seats are covered by an upholstered lining.

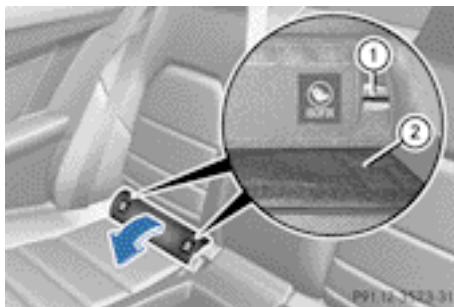

- ▶ Fold upholstery cover (2) and the Velcro fastener down.
- ▶ Install the ISOFIX child restraint systems on both securing rings (1). Comply with the manufacturer's instructions when installing the ISOFIX child restraint system.

Top Tether

Top Tether provides an additional connection between the child restraint system secured with ISOFIX and the rear seat. It helps reduce the risk of injury even further.

The Top Tether anchorage points are located in the rear compartment behind the head restraints.

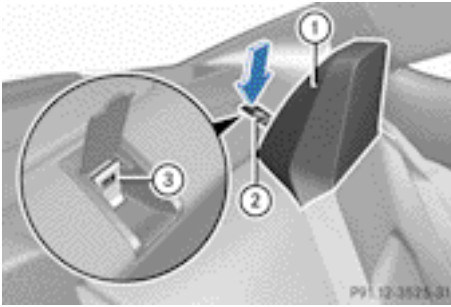

- ▶ Press down the rear of cover ② in the direction of the arrow. Cover ② is raised slightly at the front.
- ▶ Fold up cover ② of Top Tether anchorage ③.

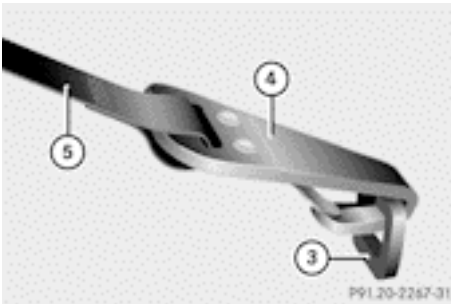

- ▶ Route Top Tether belts ⑤ on the left and right past head restraint ①.
- ▶ Hook Top Tether hook ④ into Top Tether anchorage ③.
- ▶ Make sure that Top Tether belt ⑤ is not twisted.
- ▶ Fit the ISOFIX child restraint system with Top Tether. Comply with the manufacturer's installation instructions when doing so. Make sure that Top Tether belt ⑤ is tight.

Suitable positioning of the child restraint systems

Only child restraint systems which are approved in accordance with the ECE standard ECE R44 are permitted for use in the vehicle.

Suitability of the seats for attaching belted child restraint systems

Key to the letters used in the following table:

- X Seat which is unsuitable for children in this weight category.
- U Suitable for child restraint systems in the "Universal" category that are approved for use in this weight category.
- UF Suitable for forward-facing child restraint systems that belong to the "Universal" category and are approved for use in this weight category.
- L Suitable for child restraint systems as recommended, see the following table of "Recommended child restraint systems" (▷ page 68).

Weight categories	Seat positions		
	Front-passenger seat		Rear seat
	Front-passenger front airbag is not disabled	The front-passenger airbag is disabled ¹	Left, right
Category 0: up to 10 kg	X	U ² , L ²	U, L
Category 0+: up to 13 kg	X	U ² , L ²	U, L
Category I: 9 to 18 kg	U ² , L ²	U ² , L ²	U, L
Category II: 15 to 25 kg	U ² , L ²	U ² , L ²	U, L
Category III: 22 to 36 kg	U ² , L ²	U ² , L ²	U, L

"Universal" category child restraint systems can be recognised by their orange approval label and the text "Universal".

¹ Vehicles with automatic child seat recognition in the front-passenger seat: a child restraint system of the "Universal" category with a transponder for automatic child seat recognition must be fitted. The PASSENGER AIRBAG OFF indicator lamp must be lit.

² Adjust the front-passenger seat to the rearmost position and the seat backrest to a position as close to vertical as possible.



Example: approval label on the child restraint system

"Universal" category child restraint systems can be used on the seats indicated with U, UF or IUF according to the tables "Suitability of the seats for attaching belted child restraint systems" or "Suitability of the seats for attaching an ISOFIX child restraint system".

Semi-universal child restraint systems are indicated by the text "semi-universal" on the approval label. These can be used if the vehicle and the seat are listed in the child restraint system manufacturer's vehicle model list. For more information, contact the child restraint system manufacturer or visit their website.

Suitability of the seats for attaching ISOFIX child restraint systems

Key to the letters used in the table:

- X ISOFIX position that is not suitable for ISOFIX child restraint systems in this weight category and/or size category.
- IUF Suitable for forward-facing ISOFIX child restraint systems that belong to the "Universal" category which are approved for use in this weight category.
- IL Suitable for ISOFIX child restraint systems as recommended; see the following table of "Recommended child restraint systems" (▷ page 68).

Weight categories	Size category	Equipment	Rear seat, left and right
Carry-cot	F	ISO/L1	X
	G	ISO/L2	X
0: up to 10 kg up to approximately 6 months	E	ISO/R1	IL
0+: up to 13 kg up to approximately 15 months	E	ISO/R1	IL
	D	ISO/R2	IL
	C	ISO/R3	IL ³
I: 9 to 18 kg	D	ISO/R2	IL
	C		

³ Adjust the front-passenger seat to the central upper position and the seat backrest to a position as close to vertical as possible.

Weight categories	Size category	Equipment	Rear seat, left and right
between approximately 9 months and 4 years		ISO/R3	IL ³
	B	ISO/F2	IUF
	B1	ISO/F2X	IUF
	A	ISO/F3	IUF

Recommended child restraint systems

When installing a child restraint system without a transponder for automatic child seat recognition on the front-passenger seat:

- Move the front-passenger seat to its rearmost position.

Weight categories	Manufacturer	Type	Approval number (E1 ...)	Order number (A 000 ...)	Automatic child seat recognition
Category 0: up to 10 kg up to approximately 6 months	Britax Römer	BABY SAFE PLUS ⁴	03 301146	970 10 00	Yes
			04 301146		
Group 0+: up to 13 kg up to approximately 15 months	Britax Römer	BABY SAFE PLUS ⁴	03 301146 04 301146	970 10 00	Yes
Category I: 9 to 18 kg between approximately 9 months and 4 years	Britax Römer	DUO PLUS ⁴	03 301133	970 11 00	Yes
			04 301133	970 16 00	No
Group II/III: 15 to 36 kg between approximately 4 and 12 years	Britax Römer	KIDFIX	04 301198	970 18 00	Yes
				970 19 00	No



³ Adjust the front-passenger seat to the central upper position and the seat backrest to a position as close to vertical as possible.

⁴ Move the front-passenger seat to the rearmost and highest position.

Suggested ISOFIX child restraint system from the Universal category

Weight categories	Size category	Manufacturer	Type	Approval number (E1 ...)	Order number	Automatic child seat recognition
Carry-cot	F	-	-	-	-	-
	G	-	-	-	-	-
Group 0: up to 10 kg	E	-	-	-	-	-
Group 0+: up to 13 kg	E	Britax Römer	BABY SAFE ISOFIX PLUS	04 301146	B6 6 86 8224	No
	D	-	-	-	-	-
	C	-	-	-	-	-
Group I: 9 to 18 kg	D	-	-	-	-	-
	C	-	-	-	-	-
	B	-	-	-	-	-
	B1	Britax Römer	DUO PLUS	03 301133 04 301133	A000 970 11 00	Yes
	A	-	-	-	-	-

Problems with automatic child seat recognition

Problem	Possible causes/consequences and ► Solutions
The PASSENGER AIR-BAG OFF indicator lamp on the centre console is lit.	A special Mercedes-Benz child seat with a transponder for automatic child seat recognition has been fitted to the front-passenger seat. The front-passenger front airbag has therefore been disabled as desired.
The PASSENGER AIR-BAG OFF indicator lamp on the centre console is lit. or The  SRS warning lamp lights up and/or the PASSENGER AIR-BAG OFF indicator lamp does not light up briefly when you switch the ignition on.	<p> WARNING</p> <p>There is no child seat fitted to the front-passenger seat. Automatic child seat recognition is malfunctioning. There is a risk of injury.</p> <p>► Remove electronic equipment from the front-passenger seat, e.g.:</p> <ul style="list-style-type: none"> • laptop • Mobile phone • cards with transponders, such as ski passes or access cards <p>If the PASSENGER AIRBAG OFF indicator lamp is still lit:</p> <p>► Visit a qualified specialist workshop.</p>

Driving safety systems

Driving safety systems overview

In this section, you will find information about the following driving safety systems:

- ABS (**A**nti-**l**ock **B**raking **S**ystem)
- BAS (**B**rake **A**ssist **S**ystem)
- BAS PLUS (**B**rake **A**ssist **S**ystem Plus)
- Adaptive brake lamps
- ESP® (**E**lectronic **S**tability **P**rogram)
- EBD (**e**lectronic **b**rake **f**orce **d**istribution)
- ADAPTIVE BRAKE
- PRE-SAFE® Brake

Important safety notes

If you fail to adapt your driving style or if you are inattentive, the driving safety systems can neither reduce the risk of accident nor override the laws of physics. Driving safety systems are merely aids designed to assist driving. You are responsible for the distance to

the vehicle in front, for vehicle speed and for braking in good time. Always adapt your driving style to suit the prevailing road, weather and traffic conditions and maintain a safe distance from the vehicle in front. Drive carefully.

i The driving safety systems described only work as effectively as possible when there is adequate contact between the tyres and the road surface. Please pay special attention to the notes on tyres, recommended minimum tyre tread depths, etc. (▷ page 346).

In wintry driving conditions, always use winter tyres (M+S tyres) and, if necessary, snow chains. Only in this way will the driving safety systems described in this section work as effectively as possible.

ABS (Anti-lock Braking System)

General notes

ABS regulates brake pressure in such a way that the wheels do not lock when you brake. This allows you to continue steering the vehicle when braking.

The yellow  ABS warning lamp in the instrument cluster lights up when the ignition is switched on. It goes out when the engine is running.

Important safety notes

- i** Observe the "Important safety notes" section (▷ page 70).

WARNING

If ABS is faulty, the wheels could lock when braking. The steerability and braking characteristics may be severely impaired. Additionally, further driving safety systems are deactivated. There is an increased danger of skidding and accidents.

Drive on carefully. Have ABS checked immediately at a qualified specialist workshop.

If ABS is malfunctioning, other systems, including driving safety systems, will also become inoperative. Observe the information on the ABS warning lamp (▷ page 282) and display messages which may be shown in the instrument cluster (▷ page 242) or (▷ page 247).

ABS works from a speed of about 8 km/h upwards, regardless of road-surface conditions. ABS works on slippery surfaces, even when you only brake gently.

Braking

- ▶ **If ABS intervenes:** continue to depress the brake pedal with force until the braking situation is over.
- ▶ **To make a full brake application:** depress the brake pedal with full force.

If ABS intervenes when braking, you will feel a pulsing in the brake pedal.

The pulsating brake pedal can be an indication of hazardous road conditions, and functions as a reminder to take extra care while driving.

BAS (Brake Assist)

General notes

BAS operates in emergency braking situations. If you depress the brake pedal quickly, BAS automatically boosts the braking force, thus shortening the stopping distance.

Important safety notes

- i** Observe the "Important safety notes" section (▷ page 70).

WARNING

If BAS is malfunctioning, the braking distance in an emergency braking situation is increased. There is a risk of accident.

In an emergency braking situation, depress the brake pedal with full force. ABS prevents the wheels from locking.

Braking

- ▶ Keep the brake pedal depressed firmly until the emergency braking situation is over. ABS prevents the wheels from locking.

The brakes will function as usual once you release the brake pedal. BAS is deactivated.

BAS PLUS (Brake Assist System Plus)

General notes

- i** Observe the "Important safety notes" section (▷ page 70).

BAS PLUS is only available on vehicles with DISTRONIC PLUS.

For BAS PLUS to assist you, the radar sensor system must be operational.

With the aid of the radar sensor system, BAS PLUS can detect obstacles that are in the path of your vehicle for an extended period of time.

If the radar sensor system is malfunctioning, BAS PLUS will not be available. The brake system is still available with complete brake boosting effect and BAS.

BAS PLUS can help you to minimise the risk of a collision with a vehicle or reduce the effects of such a collision. If BAS PLUS detects a danger of collision, you are assisted when braking.

Important safety notes

WARNING

BAS PLUS cannot always clearly identify objects and complex traffic situations.

In such cases, BAS PLUS may:

- intervene unnecessarily
- not intervene

There is a risk of an accident.

Always pay careful attention to the traffic situation and be ready to brake. Terminate the intervention in a non-critical driving situation.

WARNING

BAS PLUS does not react:

- to people or animals
- to oncoming vehicles
- to crossing traffic
- when cornering

As a result, BAS PLUS may not intervene in all critical situations. There is a risk of an accident.

Always pay careful attention to the traffic situation and be ready to brake.

In the event of snowfall or heavy rain, recognition can be impaired.

Recognition by the radar sensor system is also impaired in the event of:

- dirt on the sensors or the sensors are obscured
- interference by other radar sources
- strong radar reflections, for example, in multi-storey car parks
- a narrow vehicle travelling in front, e.g. a motorcycle
- a vehicle travelling in front on a different line

Following damage to the front end of the vehicle, have the radar sensor settings and operation checked at a qualified specialist workshop. This also applies to collisions at slow speeds where there is no visible damage to the front of the vehicle.

Function

To avoid a collision, BAS PLUS calculates the brake force necessary if:

- you approach an obstacle, and
- BAS PLUS has detected a risk of collision

When driving at a speed under 30 km/h:

if you depress the brake pedal, BAS PLUS is activated. Braking assistance from BAS PLUS is carried out at the last possible moment.

When driving at a speed above 30 km/h:

if you depress the brake pedal sharply, BAS PLUS automatically increases the brake pressure to a degree suited to the traffic situation. BAS PLUS provides braking assistance in hazardous situations with vehicles in front within a speed range between 7 km/h and 250 km/h.

At speeds of up to approximately 70 km/h, BAS PLUS can also detect stationary objects. Examples of stationary objects are stopped or parked vehicles.

 If BAS PLUS demands particularly high braking force, preventative passenger protection measures (PRE-SAFE®) are activated simultaneously.

- ▶ Keep the brake pedal depressed until the emergency braking situation is over. ABS prevents the wheels from locking.

BAS PLUS is deactivated and the brakes function as usual again, if:

- you release the brake pedal
- there is no longer a risk of collision
- no obstacle is detected in front of your vehicle

Adaptive brake lamps

- i** Adaptive brake lamps are only available in certain countries.

If you brake sharply from a speed of more than 50 km/h or if braking is assisted by BAS or BAS PLUS, the brake lamps flash rapidly. In this way, traffic travelling behind you is warned in an even more noticeable manner.

If you brake sharply from a speed of more than 70 km/h to a standstill, the hazard warning lamps are activated automatically. If the brakes are applied again, the brake lamps light up continuously. The hazard warning lamps switch off automatically if you travel faster than 10 km/h. You can also switch off the hazard warning lamps using the hazard warning button (▷ page 121).

ESP® (Electronic Stability Program)

General notes

- i** Observe the "Important safety notes" section (▷ page 70).

ESP® monitors driving stability and traction, i.e. power transmission between the tyres and the road surface.

If ESP® detects that the vehicle is deviating from the direction desired by the driver, one or more wheels are braked to stabilise the vehicle. The engine output is also modified to keep the vehicle on the desired course within physical limits. ESP® assists the driver when

pulling away on wet or slippery roads. ESP® can also stabilise the vehicle during braking.

ETS/4ETS (Electronic Traction System)

- i** Observe the "Important safety notes" section (▷ page 70).

ETS/4ETS traction control is part of ESP®. Traction control brakes the drive wheels individually if they spin. This enables you to pull away and accelerate on slippery surfaces, for example if the road surface is slippery on one side. In addition, more drive torque is transferred to the wheel or wheels with traction. Traction control remains active if you deactivate ESP®.

Important safety notes

- i** Observe the "Important safety notes" section (▷ page 70).

WARNING



If ESP® is malfunctioning, ESP® is unable to stabilise the vehicle. In addition, other driving safety systems are switched off. This increases the risk of skidding and an accident.

Drive on carefully. Have ESP® checked at a qualified specialist workshop.

- !** When testing the electric parking brake on a braking dynamometer, switch off the ignition. Application of the brakes by ESP® may otherwise destroy the brake system.

When towing your vehicle with the rear axle raised, observe the notes on ESP® (▷ page 341).

ESP® is deactivated if the  warning lamp in the instrument cluster lights up continuously when the engine is running.

If the  warning lamp and the  warning lamp are lit continuously, ESP® is not available due to a malfunction.

Observe the information on warning lamps (▷ page 284) and display messages which

may be shown in the instrument cluster (▷ page 242) or (▷ page 247).

- ❗ Only use wheels with the recommended tyre sizes. Only then will ESP® function properly.

Characteristics of ESP

General notes

If the  ESP warning lamp goes out before beginning the journey, ESP® is automatically active.

If ESP® intervenes, the  ESP® warning lamp flashes in the instrument cluster.

If ESP® intervenes:

- ▶ Do not deactivate ESP® under any circumstances.
- ▶ When pulling away, only depress the accelerator pedal as far as is necessary.
- ▶ Adapt your driving style to suit the prevailing road and weather conditions.

ECO start/stop function

The ECO start/stop function switches the engine off automatically if the vehicle stops moving. When pulling away again, the engine starts automatically. ESP® remains in its previously selected status. **Example:** if ESP® was deactivated before the engine was switched off, ESP® remains deactivated when the engine is switched on again.

Deactivating/activating ESP® (except AMG vehicles)

Important safety notes

- ❗ Observe the "Important safety notes" section (▷ page 70).

You can select between the following statuses of ESP:

- ESP® is activated.
- ESP® is deactivated.

WARNING

If you deactivate ESP®, ESP® no longer stabilises the vehicle. There is an increased risk of skidding and an accident.

Only deactivate ESP® in the situations described in the following.

It may be best to deactivate ESP® in the following situations:

- when using snow chains
 - in deep snow
 - on sand or gravel
- ❗ Activate ESP® as soon as the situations described above no longer apply. ESP® will otherwise not be able to stabilise the vehicle if the vehicle starts to skid or a wheel starts to spin.

Deactivating/activating ESP®

You can activate and deactivate ESP® using the on-board computer.

You cannot activate and deactivate ESP® on vehicles with a 4-button multifunction steering wheel.

- ▶ **To deactivate:**(▷ page 228).

The  ESP® OFF warning lamp in the instrument cluster lights up.

- ▶ **To activate:**(▷ page 228).

The  ESP® OFF warning lamp in the instrument cluster goes out.

Characteristics when ESP® is deactivated

If ESP® is deactivated and one or more wheels start to spin, the  ESP® warning lamp in the instrument cluster flashes. In such situations, ESP® will not stabilise the vehicle.

If you deactivate ESP®:

- ESP® no longer improves driving stability.
- engine torque is no longer limited and the drive wheels are able to spin.

The spinning of the wheels results in a cutting action for better traction on loose surfaces.

- traction control is still activated.
- ESP® still provides support when you brake.

Deactivating/activating ESP® (AMG vehicles)

Important safety notes

You can select between the following statuses of ESP:

- ESP® is activated.
- SPORT handling mode is activated.
- ESP® is deactivated.

WARNING

When SPORT handling mode is activated, there is a greater risk of skidding and accidents.

Only activate SPORT handling mode in the situations described in the following.

WARNING

If you deactivate ESP®, ESP® no longer stabilises the vehicle. There is an increased risk of skidding and an accident.

Only deactivate ESP® in the situations described in the following.

In the following situations, it may be better to activate SPORT handling mode or deactivate ESP®:

- when using snow chains
- in deep snow
- on sand or gravel
- on specially designated roads when the vehicle's own oversteering and understeering characteristics are desired

Driving in SPORT handling mode or without ESP® requires an extremely qualified and experienced driver.

-  Activate ESP® as soon as the situations described above no longer apply. ESP® will otherwise not be able to stabilise the vehi-

cle if the vehicle starts to skid or a wheel starts to spin.

Deactivating/activating ESP®





- ▶ **To activate SPORT handling mode:** briefly press button ①.

The  handling mode warning lamp in the instrument cluster lights up. The **SPORT handling mode** message appears in the multifunction display.



- ▶ **To deactivate SPORT handling mode:** briefly press button ①.

The  handling mode warning lamp in the instrument cluster goes out.

- ▶ **To deactivate ESP®:** press button ① until the  ESP® OFF warning lamp lights up in the instrument cluster.

The  OFF message appears in the multifunction display.

- ▶ **To activate ESP®:** briefly press button ①.

The  ESP® OFF warning lamp in the instrument cluster goes out. The  ESP® ON message appears in the multifunction display.

Characteristics of activated SPORT handling mode

If SPORT handling mode is activated and one or more wheels start to spin, the  ESP® warning lamp in the instrument cluster flashes. ESP® only stabilises the vehicle to a limited degree.

When SPORT handling mode is activated:

- ESP® only improves driving stability to a limited degree.
- traction control is still activated.
- engine torque is restricted to a limited degree and the drive wheels are able to spin.

The spinning of the wheels results in a cutting action for better traction on loose surfaces.

- ESP® still provides support when you brake.

Characteristics when ESP® is deactivated

If ESP® is deactivated and one or more wheels start to spin, the  ESP® warning lamp in the instrument cluster does not flash. In such situations, ESP® will not stabilise the vehicle.

If you deactivate ESP®:

- ESP® no longer improves driving stability.
- engine torque is restricted to a limited degree and the drive wheels are able to spin.

The spinning of the wheels results in a cutting action for better traction on loose surfaces.

- traction control is still activated.
- PRE-SAFE® is no longer available; nor is it activated if you brake firmly with assistance from ESP®.
- PRE-SAFE® Brake is no longer available; it is also not activated if you brake firmly with assistance from ESP®.
- ESP® still provides support when you brake.

ESP® trailer stabilisation

ESP® trailer stabilisation is not available in AMG vehicles.

WARNING

If road and weather conditions are poor, trailer stabilisation will not be able to prevent

the vehicle/trailer combination from swerving. Trailers with a high centre of gravity can tip over before ESP® can detect this. There is a risk of an accident.

Always adapt your driving style to the prevailing road and weather conditions.

If your vehicle/trailer combination begins to lurch, you can only stabilise the vehicle/trailer combination by depressing the brake firmly.

In this situation, ESP® assists you and can detect if the vehicle/trailer combination begins to lurch. ESP® slows the vehicle down by braking and limiting the engine output until the vehicle/trailer combination has stabilised.

Trailer stabilisation is active above speeds of about 65 km/h.

Trailer stabilisation does not work if ESP® is deactivated or disabled because of a malfunction.

EBD (electronic brake force distribution)

General notes

EBD monitors and controls the brake pressure on the rear wheels to improve driving stability while braking.

Important safety notes

-  Observe the "Important safety notes" section (> page 70).

WARNING

If EBD has malfunctioned, the rear wheels can still lock, e.g. under full braking. This increases the risk of skidding and an accident.

You should therefore adapt your driving style to the different handling characteristics. Have the brake system checked at a qualified specialist workshop.

Observe the notes on warning and indicator lamps (▷ page 282) as well as display messages (▷ page 243) (4-button multifunction steering wheel) and (▷ page 248) (12-button multifunction steering wheel).

ADAPTIVE BRAKE

ADAPTIVE BRAKE enhances braking safety and offers increased braking comfort. In addition to the braking function, ADAPTIVE BRAKE also has the HOLD function (▷ page 188) and hill start assist (▷ page 152). For further information, see "Driving tips" (▷ page 172).

PRE-SAFE® Brake

General notes

i Observe the "Important safety notes" section (▷ page 70).

PRE-SAFE® Brake is only available on vehicles with DISTRONIC PLUS.

For PRE-SAFE® Brake to assist you when driving, the radar sensor system must be operational.

With the help of the radar sensor system, PRE-SAFE® Brake can detect obstacles that are in front of your vehicle for an extended period of time.

PRE-SAFE® Brake can help you to minimise the risk of a collision with a vehicle ahead, and reduce the effects of such a collision. If PRE-SAFE® Brake has detected a risk of collision, you will be warned visually and acoustically as well as by automatic braking. PRE-SAFE® Brake cannot prevent a collision without your intervention.

Important safety notes

WARNING

PRE-SAFE® Brake will initially brake your vehicle by a partial application of the brakes if a danger of collision is detected. There may be

a collision unless you also brake. Automatic emergency braking cannot prevent a collision. There is a risk of an accident.

Always apply the brakes yourself and try to take evasive action.

WARNING

PRE-SAFE® Brake cannot always clearly identify objects and complex traffic conditions.

In these cases, PRE-SAFE® Brake may:

- give an unnecessary warning and then brake the vehicle
- neither give a warning nor intervene

There is a risk of an accident.

Always pay particular attention to the traffic situation and be ready to brake, especially if PRE-SAFE® Brake warns you. Terminate the intervention in a non-critical driving situation.

In order to maintain the appropriate distance to the vehicle in front and thus prevent a collision, you must apply the brakes yourself.

WARNING

PRE-SAFE® Brake does not react:

- to people or animals
- to oncoming vehicles
- to crossing traffic
- when cornering

As a result, PRE-SAFE® Brake may neither give warnings nor intervene in all critical situations. There is a risk of an accident.

Always pay careful attention to the traffic situation and be ready to brake.

In the event of snowfall or heavy rain, recognition can be impaired.

Recognition by the radar sensor system is also impaired in the event of:

- dirt on the sensors or the sensors are obscured
- interference by other radar sources
- strong radar reflections, for example, in multi-storey car parks

- a narrow vehicle travelling in front, e.g. a motorcycle
- a vehicle travelling in front on a different line

Following damage to the front end of the vehicle, have the radar sensor settings and operation checked at a qualified specialist workshop. This also applies to collisions at slow speeds where there is no visible damage to the front of the vehicle.

Function

► **To activate/deactivate:** activate or deactivate PRE-SAFE® Brake in the on-board computer (▷ page 229).

If the PRE-SAFE® Brake is not activated, the  symbol appears in the multifunction display.

This function will issue a warning if:

- at a speed of around 30 km/h or more the distance maintained to the vehicle travelling in front is insufficient for several seconds.

The  distance warning lamp then lights up in the instrument cluster.

- at a speed of approximately 7 km/h or more, you rapidly approach a vehicle in front.

An intermittent warning tone will then sound and the  distance warning lamp will light up in the instrument cluster.

- Brake immediately to defuse the situation. or
- Take evasive action provided it is safe to do so.

The PRE-SAFE® Brake function can also brake the vehicle automatically under the following conditions:

- the driver and front-passenger have their seat belts fastened and
- the vehicle speed is between approximately 7 km/h and 200 km/h

At speeds of up to approximately 70 km/h PRE-SAFE® Brake can also detect stationary objects. Examples of stationary objects are stopped or parked vehicles.

i If there is an increased risk of collision, preventive passenger protection measures (PRE-SAFE®) are activated.

If the risk of collision with the vehicle in front remains and you do not brake, take evasive action or accelerate significantly, the vehicle may perform automatic emergency braking, up to the point of full brake application. Automatic emergency braking is not performed until immediately prior to an imminent accident.

You can prevent the intervention of the PRE-SAFE® Brake at any time by:

- depressing the accelerator pedal further
- activating kickdown
- releasing the brake pedal

The braking action of PRE-SAFE® Brake is ended automatically if:

- you manoeuvre to avoid the obstacle
- there is no longer any danger of a collision
- there is no longer an obstacle detected in front of your vehicle

Anti-theft systems

Immobiliser

The immobiliser prevents your vehicle from being started without the correct key.

- **To activate with the key:** remove the key from the ignition lock.
- **To activate with KEYLESS-GO:** switch the ignition off and open the driver's door.
- **To deactivate:** switch on the ignition.

i The immobiliser is always deactivated when you start the engine.

ATA (Anti-Theft Alarm system)

A visual and audible alarm is triggered if the alarm system is primed and you open:

- a door
- the vehicle with the emergency key element
- the boot lid
- the bonnet

The alarm is not switched off, even if you close the open door that has triggered it, for example.



- ▶ **To prime:** lock the vehicle with the key or KEYLESS-GO.

Indicator lamp ① flashes. The alarm system is primed after approximately 15 seconds.

- ▶ **To switch off:** unlock the vehicle with the key or KEYLESS-GO.

- ▶ **To stop the alarm using the key:** insert the key into the ignition lock. The alarm is switched off.

or

- ▶ Press the  or  button on the key. The alarm is switched off.

- ▶ **To stop the alarm using KEYLESS-GO:** grasp the outside door handle. The key must be outside the vehicle. The alarm is switched off.

or

- ▶ Press the Start/Stop button on the dashboard. The key must be inside the vehicle. The alarm is switched off.

Tow-away protection

An audible and visual alarm is triggered if your vehicle's angle of inclination is altered while tow-away protection is primed. This occurs if the vehicle is jacked up on one side, for example.

- ▶ **To prime:** lock the vehicle with the key or KEYLESS-GO.

Tow-away protection is primed after approximately 30 seconds.

- ▶ **To switch off:** unlock the vehicle with the key or KEYLESS-GO.

Tow-away protection is switched off automatically.

To prevent a false alarm, deactivate tow-away protection manually if your vehicle:

- it is being transported
- it is being loaded onto a ferry or car transporter, for example
- is parked on a movable surface, e.g. in a split-level garage

Deactivating:

- ▶ Remove the key from the ignition lock.

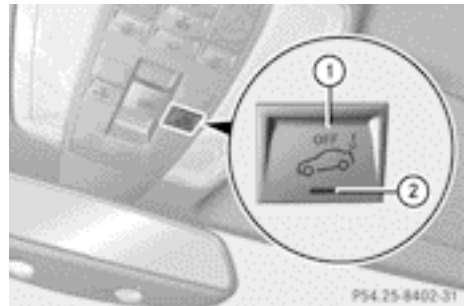

- ▶ Press button ①. Indicator lamp ② lights up briefly.
- ▶ Lock the vehicle with the key or KEYLESS-GO. Tow-away protection is deactivated.

Tow-away protection remains deactivated until:

- the vehicle is unlocked again
- a door is opened and closed again
- the vehicle is locked again

Interior motion sensor

When the interior motion sensor is primed, a visual and audible alarm is triggered if movement is detected in the vehicle interior. This occurs if someone reaches into the vehicle interior, for example.

To prime:

- ▶ Make sure that:
 - the side windows are closed.
 - the panorama sliding sunroof is closed.
 - there are no objects, e.g. mascots, hanging on the rear-view mirror or on the grab handles on the roof trim.

This will prevent false alarms.

- ▶ Lock the vehicle with the key or KEYLESS-GO.

The interior motion sensor is primed after approximately 30 seconds.

To switch off:

- ▶ Unlock the vehicle with the key or KEYLESS-GO.
The interior motion sensor is switched off automatically.

To prevent a false alarm, deactivate the interior motion sensor if you lock your vehicle and:

- people or animals remain in the vehicle.
- the side windows remain open.
- the panorama sliding sunroof remains open.

To deactivate:

- ▶ Remove the key from the ignition lock.



- ▶ Press button ①.
Indicator lamp ② flashes briefly.
- ▶ Lock the vehicle with the key or KEYLESS-GO.
The interior motion sensor is deactivated.

The interior motion sensor remains deactivated until:

- the vehicle is unlocked again
- a door is opened and closed again
- the vehicle is locked again

i UK only: your vehicle is equipped with a double lock function. The doors cannot be opened from the inside if the vehicle has been locked with the key (> page 89). Deactivate the interior motion sensor before you lock the vehicle with the key. The doors can then be opened from the inside after the vehicle has been locked from the outside with the key. Observe the "Important safety notes" (> page 88).

Useful information	82
Key	82
Doors	88
Boot	91
Side windows	94
Sliding sunroof	98

Useful information

- i** This Owner's Manual describes all models, series and optional equipment for your vehicle that were available at the time of going to press. National variations are possible. Note that your vehicle may not be equipped with all of the functions described. This is also the case for systems and functions relevant to safety.
- i** Read the information on qualified specialist workshops: (▷ page 28).

Key

Important safety notes

United Kingdom only:

WARNING

When the double locks are activated, the doors can no longer be opened from the inside. People in the vehicle can no longer get out, e.g. in hazardous situations. There is a risk of injury.

Therefore, do not leave any people unsupervised in the vehicle, particularly children, elderly people or people in need of special assistance. Do not activate the double lock when people are in the vehicle.

If the vehicle has been locked from the outside, the double lock function is activated as standard. It is then not possible to open the doors from inside the vehicle. You can deactivate the double lock function by deactivating the interior motion sensor (▷ page 80). The doors can then be opened from the inside after the vehicle has been locked from the outside. The anti-theft alarm system is triggered if the door is opened from the inside. Switch off the alarm (▷ page 79).

All countries:

WARNING

If children are left unsupervised in the vehicle, they could:

- open the doors, thus endangering other people or road users.
- get out and disrupt traffic.
- operate the vehicle's equipment.

Additionally, children could set the vehicle in motion if, for example, they:

- release the parking brake.
- shift the automatic transmission out of parking position P.
- shift the manual transmission into neutral.
- start the engine.

There is a risk of an accident and injury.

When leaving the vehicle, always take the key with you and lock the vehicle. Never leave children or animals unattended in the vehicle. Always keep the key out of reach of children.

WARNING

If persons (particularly children) are exposed to heat or cold for a prolonged period, there is a risk of serious or even fatal injuries. Never leave persons (particularly children) unattended in the vehicle.

WARNING

If you attach heavy or large objects to the key, the key could be unintentionally turned in the ignition lock. This could cause the engine to be switched off. There is a risk of an accident.

Do not attach any heavy or large objects to the key. Remove any bulky keyrings before inserting the key into the ignition lock.

- !** Keep the key away from strong magnetic fields. Otherwise, the remote control function could be affected.

Strong magnetic fields can occur in the vicinity of powerful electrical installations.



- Do not keep the KEYLESS-GO key:
 - with electronic devices, e.g. a mobile phone or another key
 - with metallic objects, e.g. coins or metal film
 - inside metallic objects, e.g. a metal case
 This can affect the key's functionality.

Key functions

The key centrally locks/unlocks:

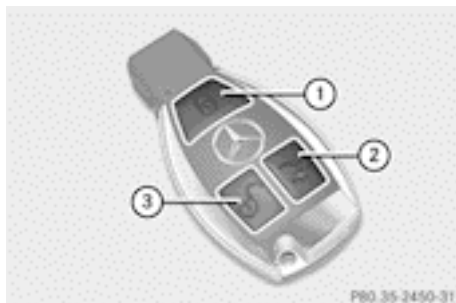
- the doors
- the boot lid
- the fuel filler flap



- ①  To lock the vehicle
- ②  To unlock the boot lid
- ③  To unlock the vehicle

When unlocking, the turn signals flash once. When locking, they flash three times.

When it is dark, the surround lighting also comes on if it is activated in the on-board computer (▷ page 232).

You can also set an audible signal to confirm that the vehicle has been locked. The audible signal can be activated and deactivated using the on-board computer (▷ page 234).

- **To unlock centrally:** press the  button.

If you do not open the vehicle within approximately 40 seconds of unlocking:

- the vehicle is locked again.
- the anti-theft system is primed again.

- **To lock centrally:** press the  button.

KEYLESS-GO

General notes

Bear in mind that the engine can be started by any of the vehicle occupants if there is a KEYLESS-GO key in the vehicle.

Locking and unlocking centrally

You can start, lock or unlock the vehicle using KEYLESS-GO. To do this, you only need carry the key with you. You can combine the KEYLESS-GO functions with the functions of a conventional key. Unlock the vehicle by using KEYLESS-GO, for instance, and lock it using the  button on the key.

When locking or unlocking with KEYLESS-GO, the distance between the key and the corresponding door handle must not be greater than 1 m.

KEYLESS-GO checks whether a valid key is in the vehicle by periodically establishing a radio connection between the vehicle and the key. This happens:

- when the external door handles are touched
- when starting the engine
- while the vehicle is in motion





- ▶ **To unlock the vehicle:** touch the inner surface of the door handle.
- ▶ **To lock the vehicle:** touch sensor surface ①.
- ▶ **Convenience closing feature:** touch recessed sensor surface ② for an extended period.



For further information on the convenience closing feature (▷ page 96).

If you pull the handle on the boot lid, the vehicle only unlocks the boot lid.

Changing the settings of the locking system



You can change the settings of the locking system. This means that only the driver's door and the fuel filler flap are unlocked when the vehicle is unlocked. This is useful if you frequently travel on your own.

- ▶ **To change the setting:** press and hold down the  and  buttons simultaneously for approximately six seconds until the battery check lamp (▷ page 85) flashes twice.



i If the setting of the locking system is changed within the signal range of the vehicle, pressing the  or  button:

- locks or
- unlocks the vehicle

The key now functions as follows:

- ▶ **To unlock the driver's door:** press the  button once.
- ▶ **To unlock centrally:** press the  button twice.
- ▶ **To lock centrally:** press the  button.

The KEYLESS-GO function is changed as follows:

- ▶ **To unlock the driver's door:** touch the inner surface of the door handle on the driver's door.
- ▶ **To unlock centrally:** touch the inner surface of the front-passenger door handle.
- ▶ **To lock centrally:** touch the outer sensor surface on one of the door handles (▷ page 83).
- ▶ **To restore the factory settings:** press and hold down the  and  buttons simultaneously for approximately six seconds until the battery check lamp flashes twice.

Emergency key element

General notes

If the vehicle can no longer be locked or unlocked with the key or the KEYLESS-GO key, use the emergency key element.

If you use the emergency key element to unlock and open the driver's door or the boot lid, the anti-theft alarm system will be triggered (▷ page 79).

- ▶ **To switch off the alarm:** insert the key into the ignition lock.

i **With KEYLESS-GO:** remove the Start/ Stop button from the ignition lock beforehand.

If you unlock the vehicle using the emergency key element, the fuel filler flap will not be unlocked automatically.

- ▶ **To unlock the fuel filler flap:** insert the key into the ignition lock.

Removing the emergency key element

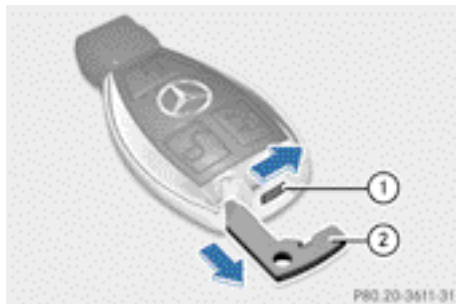

- ▶ Push release catch ① in the direction of the arrow and at the same time, remove emergency key element ② from the key.

Battery of the key

Important safety notes

Mercedes-Benz recommends that you have the batteries replaced at a qualified specialist workshop.

WARNING

Batteries contain toxic and corrosive substances. If batteries are swallowed, it can result in severe health problems. There is a risk of fatal injury.

Keep batteries out of the reach of children. If a battery is swallowed, seek medical attention immediately.

Environmental note



Batteries contain pollutants. It is illegal to dispose of them with the household rubbish. They must be collected separately and disposed of in an environmentally responsible recycling system.







Dispose of batteries in an environmentally responsible manner. Take discharged batteries to a qualified specialist workshop or to a col-

lection point for used batteries.

Checking the battery



- ▶ Press the  or  button. The battery is working properly if battery check lamp ① lights up briefly. If battery check lamp ① does not light up briefly during the test, the battery is discharged.

- ▶ If the key battery is checked within the signal reception range of the vehicle, pressing the  or  button:
 - locks or
 - unlocks the vehicle
- ▶ Change the battery (▷ page 85).
- ▶ You can get a battery at a qualified specialist workshop.

Replacing the battery

You require a CR 2025 3 V cell battery.



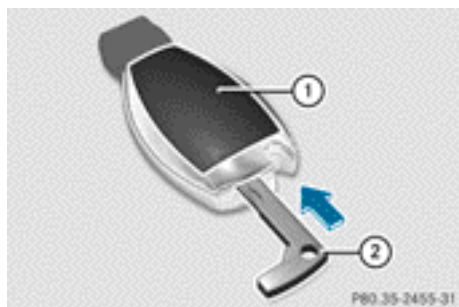

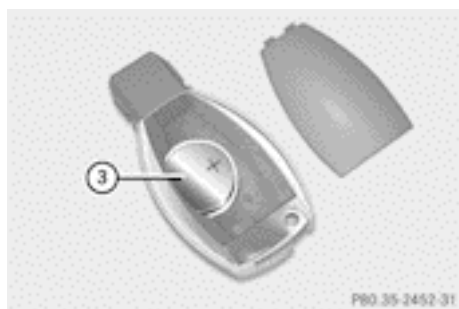

- ▶ Take the emergency key element out of the key (▷ page 84).



- ▶ Press emergency key element (2) into the opening in the key in the direction of the arrow until battery compartment cover (1) opens. While doing so, do not hold battery compartment cover (1) shut.
- ▶ Remove battery compartment cover (1).



- ▶ Repeatedly tap the key against your palm until battery (3) falls out.
- ▶ Insert the new battery with the positive terminal facing upwards. Use a lint-free cloth to do so.
- ▶ Make sure that the surface of the battery is free from lint, grease and all other forms of contamination.
- ▶ Insert the front tabs of battery compartment cover (1) into the housing and then press to close it.
- ▶ Insert emergency key element (2) into the key.
- ▶ Check the function of all key buttons on the vehicle.

Problems with the key	
Problem	Possible causes/consequences and ► Solutions
You cannot lock or unlock the vehicle using the key.	<p>The key battery is discharged or nearly discharged.</p> <ul style="list-style-type: none"> ► Try again to lock/unlock the vehicle using the remote control function of the key. Point the tip of the key at the driver's door handle from close range and press the  /  button. <p>If this does not work:</p> <ul style="list-style-type: none"> ► Check the key battery (▷ page 85) and replace it if necessary (▷ page 85). ► Lock (▷ page 90) or unlock (▷ page 91) the vehicle using the emergency key element.
	<p>The key is faulty.</p> <ul style="list-style-type: none"> ► Lock (▷ page 90) or unlock (▷ page 91) the vehicle using the emergency key element. ► Have the key checked at a qualified specialist workshop.
You can no longer lock or unlock the vehicle using KEYLESS-GO.	<p>There is interference from a powerful source of radio waves.</p> <ul style="list-style-type: none"> ► Lock/unlock the vehicle using the remote control function of the key. Point the tip of the key at the driver's door handle from close range and press the  /  button.
	<p>There is a fault with KEYLESS-GO.</p> <ul style="list-style-type: none"> ► Lock/unlock the vehicle using the remote control function of the key. Point the tip of the key at the driver's door handle from close range and press the  /  button. ► Have KEYLESS-GO checked at a qualified specialist workshop. <p>If this does not work:</p> <ul style="list-style-type: none"> ► Check the key battery (▷ page 85) and replace it if necessary (▷ page 85). ► Lock (▷ page 90) or unlock (▷ page 91) the vehicle using the emergency key element.
You have lost a key.	<ul style="list-style-type: none"> ► Have the key deactivated at a qualified specialist workshop. ► Report the loss immediately to the vehicle insurers. ► If necessary, have the locks changed as well.
You have lost the emergency key element.	<ul style="list-style-type: none"> ► Report the loss immediately to the vehicle insurers. ► If necessary, have the locks changed as well.

Problem	Possible causes/consequences and ► Solutions
The engine cannot be started using the key.	<p>The on-board voltage is too low.</p> <ul style="list-style-type: none"> ► Switch off non-essential consumers, e.g. seat heating or interior lighting, and try to start the engine again. <p>If this does not work:</p> <ul style="list-style-type: none"> ► Check the starter battery and charge it if necessary (▷ page 334). <p>or</p> <ul style="list-style-type: none"> ► Jump-start the vehicle (▷ page 338). <p>or</p> <ul style="list-style-type: none"> ► Consult a qualified specialist workshop.
The engine cannot be started using the key.	<p>The steering lock is mechanically blocked.</p> <ul style="list-style-type: none"> ► Remove the key and reinsert it into the ignition lock. While doing this, turn the steering wheel in both directions.
The engine cannot be started using KEYLESS-GO. The key is in the vehicle.	<p>A door is open. Therefore, the key cannot be detected as easily.</p> <ul style="list-style-type: none"> ► Close the door and try to start the vehicle again.
	<p>There is interference from a powerful source of radio waves.</p> <ul style="list-style-type: none"> ► Start your vehicle with the key in the ignition lock.

Doors

Important safety notes

United Kingdom only:

WARNING

When the double locks are activated, the doors can no longer be opened from the inside. People in the vehicle can no longer get out, e.g. in hazardous situations. There is a risk of injury.

Therefore, do not leave any people unsupervised in the vehicle, particularly children, elderly people or people in need of special assistance. Do not activate the double lock when people are in the vehicle.

If the vehicle has been locked from the outside, the double lock function is activated as standard. It is then not possible to open the doors from inside the vehicle. You can deactivate the double lock function by deactivat-

ing the interior motion sensor (▷ page 80). The doors can then be opened from the inside after the vehicle has been locked from the outside. The anti-theft alarm system is triggered if the door is opened from the inside. Switch off the alarm (▷ page 79).

All countries:

WARNING

If children are left unsupervised in the vehicle, they could:

- open the doors, thus endangering other people or road users.
- get out and disrupt traffic.
- operate the vehicle's equipment.

Additionally, children could set the vehicle in motion if, for example, they:

- release the parking brake.
- shift the automatic transmission out of parking position P.

- shift the manual transmission into neutral.
- start the engine.

There is a risk of an accident and injury.

When leaving the vehicle, always take the key with you and lock the vehicle. Never leave children or animals unattended in the vehicle. Always keep the key out of reach of children.

WARNING

If persons (particularly children) are exposed to heat or cold for a prolonged period, there is a risk of serious or even fatal injuries. Never leave persons (particularly children) unattended in the vehicle.

Stow luggage or loads preferably in the boot. Observe the loading guidelines (▷ page 294).

Unlocking and opening the doors from the inside

For all countries except the United Kingdom: you can open a door from inside the vehicle even if it has been locked.

Only for the United Kingdom: if the vehicle has been locked with the key from the outside, the double-lock function is activated as standard. It is then not possible to open the doors from inside the vehicle. You can deactivate the double lock function by deactivating the interior motion sensor (▷ page 80). The doors can then be opened from the inside after the vehicle has been locked from the outside. The anti-theft alarm system is triggered if the door is opened from the inside. Switch off the alarm (▷ page 79).

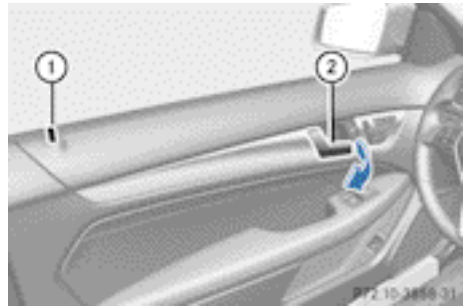

- ▶ Pull door handle (2).
If the door is locked, locking knob (1) pops up. The door is unlocked and can be opened.

Centrally locking and unlocking the vehicle from the inside

You can centrally lock or unlock the vehicle from the inside.

You cannot unlock the vehicle centrally from the inside if the vehicle has been locked with the key or KEYLESS-GO.

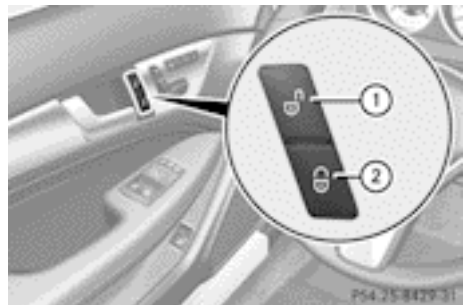

- ▶ **To unlock:** press button (1).
- ▶ **To lock:** press button (2).
If the front-passenger door is closed, the vehicle locks.

This does not lock or unlock the fuel filler flap.

For all countries except the United Kingdom: you can open a door from inside the vehicle even if it locked.

Only for the United Kingdom: if the vehicle has been locked with the key from the out-

side, the double-lock function is activated as standard. It is then not possible to open the doors from inside the vehicle. You can deactivate the double lock function by deactivating the interior motion sensor (▷ page 80). The doors can then be opened from the inside after the vehicle has been locked from the outside. The anti-theft alarm system is triggered if the door is opened from the inside. Switch off the alarm (▷ page 79).

If the vehicle has been locked using the locking button for the central locking, or has been locked automatically, and a door is opened from the inside:

- the vehicle will be fully unlocked if it had previously been fully unlocked
- only the door which has been opened from the inside is unlocked if only the driver's door had been previously unlocked

Automatic locking feature

The vehicle is locked automatically when the ignition is switched on and the wheels are turning.

You could therefore be locked out if:

- the vehicle is being pushed.
- the vehicle is being towed.
- the vehicle is being tested on a dynamometer.

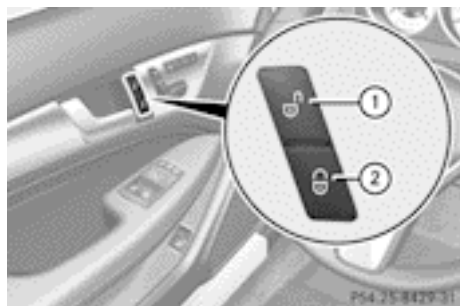

- ▶ **To deactivate:** press and hold button ① for about five seconds until a tone sounds.
- ▶ **To activate:** press and hold button ② for about five seconds until a tone sounds.

- ❗ If you press one of the two buttons and do not hear a tone, the relevant setting has already been selected.

On vehicles with a luxury multifunction steering wheel, you can also activate and deactivate the automatic locking via the on-board computer (▷ page 234).

Unlocking the driver's door (emergency key element)

If the vehicle can no longer be unlocked with the key, use the emergency key element.

If you use the emergency key element to unlock and open the driver's door, the anti-theft alarm system will be triggered (▷ page 79).

- ▶ Take the emergency key element out of the key (▷ page 84).
- ▶ Insert the emergency key element into the lock of the driver's door as far as it will go.



- ▶ Turn the emergency key element anti-clockwise to position 1. The door is unlocked.
- ❗ On right-hand-drive vehicles, turn the emergency key element clockwise.
- ▶ Turn the emergency key element back and remove it.
- ▶ Insert the emergency key element into the key.

Locking the vehicle (emergency key element)

If the vehicle can no longer be locked with the key, use the emergency key element.

- ▶ Open the driver's door.
- ▶ Close the front-passenger door and the boot lid.
- ▶ Press the locking button (▷ page 89).
- ▶ Check whether the locking knob on the front-passenger door is still visible. Press down the locking knob by hand, if necessary (▷ page 89).
- ▶ Close the driver's door.
- ▶ Take the emergency key element out of the key (▷ page 84).
- ▶ Insert the emergency key element into the lock of the driver's door as far as it will go.



- ▶ Turn the emergency key element clockwise as far as it will go to position **1**.
- i** On right-hand-drive vehicles, turn the emergency key element anti-clockwise.
- ▶ Turn the emergency key element back and remove it.
- ▶ Make sure that the doors and the boot lid are locked.
- ▶ Insert the emergency key element into the key.
- i** If you lock the vehicle as described above, the fuel filler flap is not locked. The anti-theft alarm system is not primed.

Boot

Important safety notes

⚠ WARNING

If persons (particularly children) are exposed to heat or cold for a prolonged period, there is a risk of serious or even fatal injuries. Never leave persons (particularly children) unattended in the vehicle.

⚠ WARNING

Combustion engines emit poisonous exhaust gases such as carbon monoxide. Exhaust gases can enter the vehicle interior if the boot lid is open when the engine is running, especially if the vehicle is in motion. There is a risk of poisoning.

Always switch off the engine before opening the boot lid. Never drive with the boot lid open.

! The boot lid swings upwards when opened. Therefore, make sure that there is sufficient clearance above the boot lid.

i Opening dimensions of the boot lid (▷ page 380).

Stow luggage or loads preferably in the boot. Observe the loading guidelines (▷ page 294).

Do not leave the key in the boot. You could otherwise lock yourself out.

The boot lid can be:

- opened and closed manually from outside
- opened automatically from outside
- opened automatically from inside
- locked separately
- unlocked with the emergency key element

Boot lid reversing feature

The boot lid is equipped with an automatic reversing feature. It reacts if a solid object obstructs or restricts the boot lid during the closing procedure. The boot lid opens again

automatically. The automatic reversing function is only an aid and is not a substitute for your attentiveness to the boot lid while it is closing.

WARNING

The reversing function does not react:

- to soft, light and thin objects, e.g. small fingers
- over the last 8 mm of the closing path

This means that the reversing feature cannot prevent someone being trapped in these situations. There is a risk of injury.

When closing make sure that no parts of the body are in the closing area.

If someone is trapped:

- press the  button on the key, or
- press the remote operating switch on the driver's door, or
- press the closing or locking button on the boot lid, or
- pull the boot lid handle

Opening/closing from the outside

Opening

- ▶ Press the  button on the key.

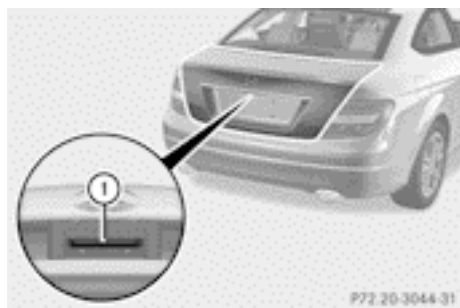

- ▶ Pull handle ①.
- ▶ Raise the boot lid.

Closing



- ▶ Pull the boot lid down using recess ①.
- ▶ If necessary, lock the vehicle with the  button on the key (▷ page 83) or with KEYLESS-GO (▷ page 83).
- i** If a KEYLESS-GO key is detected in the boot, the boot lid cannot be locked. It then opens again.

Opening automatically from outside

Important safety notes

United Kingdom only:

WARNING

When the double locks are activated, the doors can no longer be opened from the inside. People in the vehicle can no longer get out, e.g. in hazardous situations. There is a risk of injury.

Therefore, do not leave any people unsupervised in the vehicle, particularly children, elderly people or people in need of special assistance. Do not activate the double lock when people are in the vehicle.

If the vehicle has been locked from the outside, the double lock function is activated as standard. It is then not possible to open the doors from inside the vehicle. You can deactivate the double lock function by deactivating the interior motion sensor (▷ page 80). The doors can then be opened from the inside after the vehicle has been locked from the outside. The anti-theft alarm system is trig-

gered if the door is opened from the inside. Switch off the alarm (▷ page 79).

All countries:

⚠ WARNING

Parts of the body could become trapped during automatic closing of the boot lid. Moreover, people, e.g. children, may be standing in the closing area or may enter the closing area during the closing process. There is a risk of injury.

Make sure that nobody is in the vicinity of the closing area during the closing process.

Use one of the following options to stop the closing process:

- Press the  button on the key.
- Press the remote operating switch on the driver's door.
- Press the closing or locking button on the boot lid.
- Pull the boot lid handle.

! The boot lid swings upwards when opened. Therefore, make sure that there is sufficient clearance above the boot lid.

i Opening dimensions of the boot lid (▷ page 380).

Opening

You can open the boot lid automatically using the key or the handle in the boot lid.

▶ Press and hold the  button on the key until the boot lid opens.

or

▶ If the boot is unlocked, pull the boot lid handle and release it again immediately.

Opening automatically from inside

⚠ WARNING

Combustion engines emit poisonous exhaust gases such as carbon monoxide. Exhaust gases can enter the vehicle interior if the boot lid is open when the engine is running, espe-

cially if the vehicle is in motion. There is a risk of poisoning.

Always switch off the engine before opening the boot lid. Never drive with the boot lid open.

! The boot lid swings upwards when opened. Therefore, make sure that there is sufficient clearance above the boot lid.

i Opening dimensions of the boot lid (▷ page 380).

You can open the boot lid from the driver's seat when the vehicle is stationary and unlocked.



▶ **To open:** pull remote operating switch for boot lid **1** until the boot lid opens.

Locking the boot separately

The separate boot locking function is only available in certain countries.

You can lock the boot separately. If you then unlock the vehicle centrally, the boot remains locked and cannot be opened.

▶ Close the boot lid.

▶ Take the emergency key element out of the key (▷ page 84).

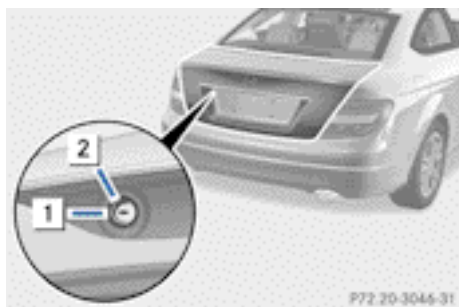

- ▶ Insert the emergency key element into the boot lid lock as far as the stop.
- ▶ Turn the emergency key element clockwise from position **1** to position **2**.
- ▶ Pull out the emergency key element.
- ▶ Insert the emergency key element into the key.

Unlocking the boot (emergency key element)

! The boot lid swings upwards when opened. Therefore, make sure that there is sufficient clearance above the boot lid.

If the boot cannot be unlocked with the key or KEYLESS-GO, use the emergency key element.

If you use the emergency key element to unlock and open the boot lid, the anti-theft alarm system will be triggered (▷ page 79).

- ▶ Take the emergency key element out of the key (▷ page 84).
- ▶ Insert the emergency key element into the boot lid lock as far as the stop.

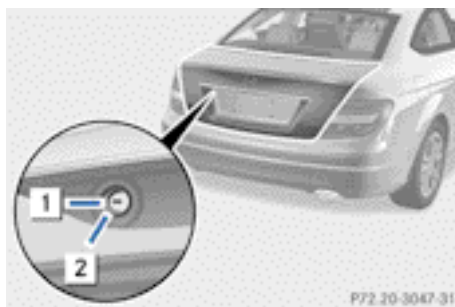

- ▶ Turn the emergency key element anti-clockwise from position **1** as far as it will go to position **2**. The boot is unlocked.
- ▶ Turn the emergency key element back to position **1** and remove it.
- ▶ Insert the emergency key element into the key.

i When you lock the vehicle (▷ page 91), the boot is also locked.

Side windows

Important safety notes

! WARNING

While opening the side windows, body parts could become trapped between the side window and the door frame as the side window moves. There is a risk of injury.

Make sure that nobody touches the side window during the opening procedure. If somebody becomes trapped, release the switch or pull the switch to close the side window again.

! WARNING

When a side window is closed, body parts may become trapped in the closing range. There is a risk of injury.

Ensure that there are no body parts in the closing range of the window when closing it. If somebody becomes trapped, release the button immediately or press the lower section of the button to open the side window again.

WARNING

If children are left unsupervised in the vehicle, they could:

- open the doors, thus endangering other people or road users.
- get out and disrupt traffic.
- operate the vehicle's equipment.

Additionally, children could set the vehicle in motion if, for example, they:

- release the parking brake.
- shift the automatic transmission out of parking position P.
- shift the manual transmission into neutral.
- start the engine.

There is a risk of an accident and injury.

When leaving the vehicle, always take the key with you and lock the vehicle. Never leave children or animals unattended in the vehicle. Always keep the key out of reach of children.

Side window reversing feature

The side windows are equipped with an automatic reversing feature. If a solid object blocks or restricts a side window during the closing process, the side window opens again automatically. The automatic reversing feature is however only an aid and is no substitute for your attention when closing a side window.

WARNING

The reversing function does not react:

- to soft, light and thin objects, e.g. small fingers
- over the last 4 mm of the closing movement
- during resetting
- when closing the side window again manually immediately after automatic reversing

This means that the reversing function cannot prevent someone being trapped in these situations. There is a risk of injury.

When closing make sure that no parts of the body are in the closing area. If someone becomes trapped, press the switch to open the side window again.

Opening and closing the side windows



- ① Left
- ② Right

The switches for all side windows are located on the driver's door. There is also a switch for the front-passenger side window on the front-passenger door.

The switches on the driver's door take precedence.

► Turn the key to position **1** or **2** in the ignition lock.

► **To open:** press the corresponding switch.

► **To close:** pull the corresponding switch.

i If you press the switch beyond the point of resistance, an automatic opening/closing process is started in the corresponding direction. You can stop automatic operation by pressing again.

i You can continue to operate the side windows after switching off the engine or removing the key. This function remains active for five minutes or until the driver's or front-passenger door is opened.

Convenience opening feature



You can ventilate the vehicle before you start driving. To do this, the key is used to carry out the following functions simultaneously:

- unlock the vehicle
- open the side windows
- open the panorama sliding sunroof and the roller sunblind
- switch on the seat ventilation for the driver's seat

i The convenience opening feature can only be operated using the key. The key must be close to the driver's door handle.

- ▶ Point the tip of the key at the driver's door handle.
- ▶ Press and hold the  button until the side windows and the panorama sunroof are in the desired position.

If the roller sunblind of the panorama sliding sunroof is closed, the roller sunblind is opened first.

- ▶ Press and hold the  button again until the panorama sliding sunroof is in the desired position.
- ▶ **To interrupt convenience opening:** release the  button.

Convenience closing feature

General notes

When you lock the vehicle, you can simultaneously:

- close the side windows
- close the panorama sliding sunroof

On vehicles with a panorama sliding sunroof, you can then close the roller sunblind.



WARNING

When the convenience closing feature is operating, parts of the body could become trapped in the closing area of the side window and the sliding sunroof. There is a risk of injury.

Observe the complete closing procedure when the convenience closing feature is operating. When closing make sure that no parts of the body are in the closing area.

Proceed as follows if someone is trapped:

With the key:

- release the  button.
- press and hold the  button until the side windows and the sliding sunroof or the panorama sliding sunroof open again.

With KEYLESS-GO:

- release the sensor surface on the door handle.
- pull the door handle immediately and hold it.



The side windows and the sliding sunroof or the panorama sliding sunroof open.

Using the key

i The key must be close to the driver's door handle.

- ▶ Point the tip of the key at the driver's door handle.
- ▶ Press and hold the  button until the side windows and the panorama sliding sunroof are fully closed.
- ▶ Make sure that all the side windows and the panorama sliding sunroof are closed.

On vehicles with a panorama sliding sunroof:

- ▶ Press and hold the  button again until the roller sunblind of the panorama sliding sunroof closes.
- ▶ **To interrupt convenience closing:** release the  button.

Using KEYLESS-GO

The KEYLESS-GO key must be outside the vehicle. All the doors must be closed.

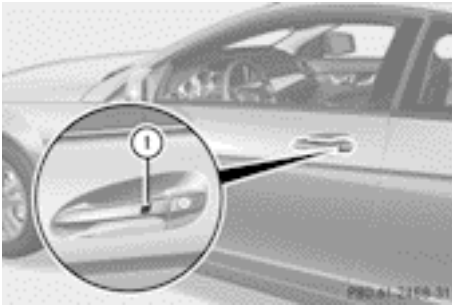

- ▶ Touch recessed sensor surface ① on the door handle until the side windows and the panorama sliding sunroof are fully closed.
- ❗ Make sure you only touch recessed sensor surface ①.
- ▶ Make sure that all the side windows and the panorama sliding sunroof are closed.

On vehicles with a panorama sliding sunroof:

- ▶ Touch recessed sensor surface ① on the door handle again until the roller sunblind of the panorama sliding sunroof closes.
- ▶ **To interrupt convenience closing:** release recessed sensor surface ① on the door handle.

Resetting the side windows

You must reset each side window if a side window can no longer be closed fully.

- ▶ Close all doors.
- ▶ Turn the key to position **1** or **2** in the ignition lock.
- ▶ Pull the corresponding switch on the door control panel until the side window is completely closed (▷ page 95).
- ▶ Hold the switch for an additional second.

If the side window opens again slightly:

- ▶ Immediately pull the corresponding switch on the door control panel until the side window is completely closed (▷ page 95).
- ▶ Hold the switch for an additional second.
- ▶ If the corresponding side window remains closed after the button has been released, the side window has been reset correctly. If this is not the case, repeat the steps above again.

Problems with the side windows

Problem: a side window cannot be closed because it is blocked by objects, e.g. leaves in the window guide.

- ▶ Remove the objects.
- ▶ Close the side window.

Problem: a side window cannot be closed and you cannot see the cause.

⚠ WARNING

If you close a side window again immediately after it has been blocked or reset, the side window closes with increased or maximum force. The reversing function is then not active. Parts of the body could be trapped in the closing area in the process. This poses an increased risk of injury or even fatal injury.

Make sure that no parts of the body are in the closing area. To stop the closing process, release the switch or push the switch again to reopen the side window.

If a side window is obstructed during closing and reopens again slightly:

- ▶ Immediately after the window blocks, pull the corresponding switch again until the side window has closed. The side window is closed with increased force.

If a side window is obstructed again during closing and reopens again slightly:

- ▶ Immediately after the window blocks, pull the corresponding switch again until the side window has closed.
The side window is closed without the anti-entrapment feature.

Sliding sunroof

Important safety notes

In the following section, the term "sliding sunroof" refers to the panorama sliding sunroof.

WARNING

While opening and closing the sliding sunroof, body parts in close proximity could become trapped. There is a risk of injury.

Make sure that no body parts are in close proximity during the opening and closing procedures.

If somebody becomes trapped:

- release the switch immediately, or
- during automatic operation, push the switch briefly in any direction

The opening or closing procedure will be stopped.

WARNING

If children operate the sliding sunroof they could become trapped, particularly if they are left unsupervised. There is a risk of injury.

When leaving the vehicle, always take the key with you and lock the vehicle. Never leave children unattended in the vehicle.

- ❗ Only open the panorama sliding sunroof if it is free of snow and ice. Otherwise, malfunctions may occur.

Do not allow anything to protrude from the sliding sunroof. Otherwise, the seals could be damaged.

- i Resonance noises can occur in addition to the usual airflow noises when the sliding

sunroof is open. They are caused by minor pressure fluctuations in the vehicle interior. Change the position of the sliding sunroof or open a side window slightly to reduce or eliminate these noises.

Sliding sunroof reversing feature

The sliding sunroof is equipped with an automatic reversing feature. If an object blocks or restricts the sliding sunroof during the closing process, the sliding sunroof opens again automatically. The automatic reversing feature is however only an aid and is no substitute for your attention when closing the sliding roof.

WARNING

The reversing function does not react:

- to soft, light and thin objects, e.g. small fingers
- over the last 4 mm of the closing movement
- during resetting
- when closing the sliding sunroof again manually immediately after automatic reversing

This means that the reversing function cannot prevent someone being trapped in these situations. There is a risk of injury.

When closing make sure that no parts of the body are in the closing area.

If someone is trapped:

- release the switch immediately or
- press the switch in any direction during the automatic closing process

The closing process is stopped.

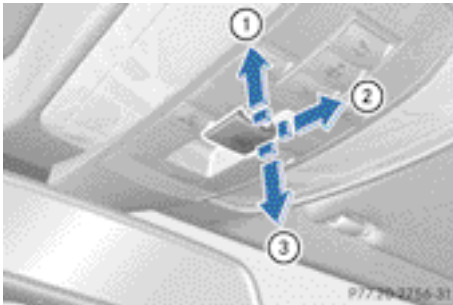

Operating the sliding sunroof

Opening and closing



Overhead control panel

- ① To raise
- ② To open
- ③ To close/lower

- ▶ Turn the key to position **1** or **2** in the ignition lock.
- ▶ Press or pull the  switch in the corresponding direction.
- ❗ If you press the  switch beyond the point of resistance, an automatic opening/closing process is started in the corresponding direction. You can stop automatic operation by pressing again.

Rain-closing feature

When the key is in position **0** in the ignition lock or is removed, the sliding sunroof closes automatically:

- if it starts to rain
- at extreme outside temperatures
- after six hours
- if there is a malfunction in the power supply

The sliding sunroof remains raised at the rear in order to allow ventilation of the vehicle interior.

- ❗ If the sliding sunroof is obstructed when being closed by the rain-closing feature, it opens again slightly. The rain-closing feature is then deactivated.

The sliding sunroof does not close if:

- it is raised at the rear.
- it is blocked.
- no rain is falling on the area of the wind-screen being monitored by the rain sensor, e.g. because the vehicle is under a bridge.

Operating the roller sunblind for the sliding sunroof

General notes

The roller sunblind shields the vehicle interior from sunlight. The roller sunblind can only be opened and closed when the sliding sunroof is closed.

WARNING

When opening or closing the roller sunblind parts of the body could be trapped between the roller sunblind and the frame or sliding sunroof. There is a risk of injury.

When opening or closing make sure that no parts of the body are in the sweep of the roller sunblind.

If someone is trapped:

- release the switch immediately or
- press the switch in any direction during the automatic opening/closing process

The opening/closing process is stopped.

Roller sunblind reversing feature

The roller sunblind is equipped with an automatic reversing feature. If an object blocks or restricts the roller sunblind during the closing process, the roller sunblind opens again automatically. The automatic reversing feature is however only an aid and is no substitute for your attention when closing the roller sunblind.

⚠ WARNING

The reversing function does not react:

- to soft, light and thin objects, e.g. small fingers
- when closing the roller sunblind again manually immediately after automatic reversing

This means that the reversing function cannot prevent someone being trapped in these situations. There is a risk of injury.

When closing make sure that no parts of the body are in the sweep of the roller sunblind.

If someone is trapped:

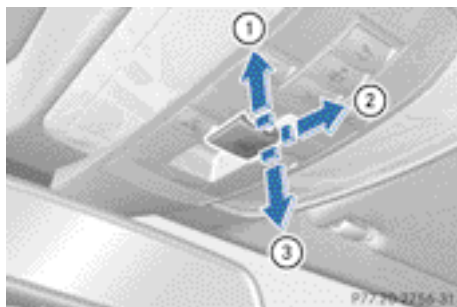

- release the switch immediately or
- press the switch in any direction during the automatic opening/closing process

The closing process is stopped.

Opening and closing





Overhead control panel

- ① To open
- ② To open
- ③ To close

- ▶ Turn the key to position **1** or **2** in the ignition lock.
- ▶ Press or pull the  switch in the corresponding direction.
- i** If you press the  switch beyond the point of resistance, an automatic opening/closing process is started in the corresponding direction. You can stop automatic operation by pressing again.

Resetting the sliding sunroof and the roller sunblind

Reset the sliding sunroof and the roller sunblind if the sliding sunroof or the roller sunblind does not move smoothly.

- ▶ Turn the key to position **1** or **2** in the ignition lock.
- ▶ Pull the  switch repeatedly to the point of resistance in the direction of arrow ③ until the sliding sunroof is fully closed.
- ▶ Keep the  switch pulled for an additional second.
- ▶ Pull the  switch repeatedly to the point of resistance in the direction of arrow ③ until the roller sunblind is fully closed.
- ▶ Keep the  switch pulled for an additional second.
- ▶ Make sure that the sliding sunroof (▷ page 99) and the roller sunblind (▷ page 100) can be fully opened again.
- ▶ If this is not the case, repeat the steps above again.

- !** If the sliding sunroof and the roller sunblind cannot be fully closed or reset, contact a qualified specialist workshop.

Problems with the sliding sunroof

Problem: the sunroof cannot be closed and you cannot see the cause.

⚠ WARNING

If you close the sliding sunroof again immediately after it has been blocked or reset, the sliding sunroof closes with increased or maximum force. The reversing function is then not active. Parts of the body could be trapped in the closing area in the process. This poses an increased risk of injury or even fatal injury.

Make sure that no parts of the body are in the closing area.

If someone is trapped:

- release the switch immediately or
- press the switch in any direction during the automatic opening/closing process

The closing process is stopped.

If the sliding sunroof is obstructed during closing and reopens again slightly:

- ▶ Immediately after the sliding sunroof blocks, pull the  switch in the overhead control panel down to the point of resistance and hold it until the sliding sunroof is closed.
The sliding sunroof is closed with increased force.

If the sliding sunroof is obstructed again during closing and reopens again slightly:

- ▶ Immediately after the sliding sunroof blocks, pull the  switch in the overhead control panel down to the point of resistance and hold it until the sliding sunroof is closed.
The sliding sunroof is closed without the anti-entrapment feature.

Useful information	104
Correct driver's seat position	104
Seats	105
Steering wheel	110
Mirrors	112
Memory function	115

Useful information

i This Owner's Manual describes all models, series and optional equipment for your vehicle that were available at the time of going to press. National variations are possible. Note that your vehicle may not be equipped with all of the functions described. This is also the case for systems and functions relevant to safety.

i Read the information on qualified specialist workshops: (▷ page 28).

Correct driver's seat position



- ▶ Observe the safety guidelines on seat adjustment (▷ page 105).
- ▶ Make sure that seat ③ is correctly adjusted.

Manual and electrical seat adjustment
(▷ page 106)

Electrical seat adjustment (▷ page 106)

When adjusting the seat, make sure that:

- you are as far away from the driver's airbag as possible.
- you are sitting in a normal upright position.
- you can fasten the seat belt properly.

- you have moved the backrest to an almost vertical position.
- you have set the seat angle so that your thighs are gently supported.
- you can depress the pedals properly.
- ▶ Check whether the head restraint is adjusted correctly.

When doing so, make sure that you have adjusted the head restraint so that the back of your head is supported at eye level by the centre of the head restraint.

- ▶ Observe the safety guidelines on steering wheel adjustment (▷ page 110).
- ▶ Make sure that steering wheel ① is adjusted correctly.

Adjusting the steering wheel manually
(▷ page 111)

Adjusting the steering wheel electrically
(▷ page 111)

When adjusting the steering wheel, make sure that:

- you can hold the steering wheel with your arms slightly bent.
- you can move your legs freely.
- you can see all the displays in the instrument cluster clearly.
- ▶ Observe the safety guidelines for seat belts (▷ page 56).
- ▶ Check whether you have fastened seat belt ② properly (▷ page 57).

The seat belt should:

- fit snugly across your body
- be routed across the middle of your shoulder
- be routed in your pelvic area across the hip joints
- ▶ Before starting off, adjust the rear-view mirror and the exterior mirrors so that you have a good view of road and traffic conditions (▷ page 112).
- ▶ **Vehicles with a memory function:** save the seat, steering wheel and exterior mirror

settings with the memory function
(▷ page 115).

Seats

Important safety notes

WARNING

If children adjust the seats, they could become trapped, especially if they are unattended. There is a risk of injury.

When leaving the vehicle, always take the key with you and lock the vehicle. Never leave children unattended in the vehicle.

WARNING

You could lose control of the vehicle while driving if you:

- adjust the driver's seat, steering wheel or mirrors
- fasten the seat belt

There is a risk of an accident.

Adjust the driver's seat, head restraint, steering wheel and mirrors and fasten your seat belt before starting the engine.

WARNING

If you adjust the seat height carelessly, you or other vehicle occupants could be trapped and thereby injured. Children in particular could accidentally press the electrical seat adjustment buttons and become trapped. There is a risk of injury.

While moving the seats, make sure that your hands or other body parts do not get under the lever assembly of the seat adjustment system.

WARNING

When adjusting a seat, you or another vehicle occupant could become trapped by the guide rail of the seat, for instance. There is a risk of injury.

Make sure that no one has any part of their body within the sweep of the seat when adjusting it.

WARNING

The head restraints cannot provide the intended protection unless they are fitted and adjusted correctly. There is an increased risk of injury to the head and neck in the event of an accident or sudden braking, for example. Always drive with the head restraints fitted. Ensure that the centre of the head restraints support the back of each vehicle occupant's head at eye level before driving off.

WARNING

The seat belt does not offer the intended level of protection if the backrest is not in the upright position. When braking or in the event of an accident, you could slide underneath the seat belt and sustain abdomen or neck injuries, for example. This poses an increased risk of injury or even fatal injury.

Adjust the seat properly before beginning your journey. Always make sure that the seat is in the upright position.

 To avoid damage to the seats and the seat heating, observe the following information:

- do not spill any liquids on the seats. If liquid is spilled on the seats, dry them as soon as possible.
- if the seat covers are damp or wet, do not switch on the seat heating. The seat heating should also not be used to dry the seats.
- clean the seat covers as recommended; see the "Interior care" section.
- do not transport heavy loads on the seats. Do not place sharp objects on the seat cushions, e.g. knives, nails or tools. The seats should only be occupied by passengers, if possible.
- when the seat heating is in operation, do not cover the seats with insulating mate-

rials, e.g. blankets, coats, bags, seat covers, child seats or booster seats.

! Make sure that there are no objects in the footwell or behind the seats when moving the seat back. There is a risk that the seats and/or the objects could be damaged.

i Vehicles without the through-loading feature: the head restraints cannot be removed from the rear compartment seats. For more information, contact a qualified specialist workshop.

i Further related subjects:

- Rear bench seat through-loading feature

Adjusting the seats manually and electrically

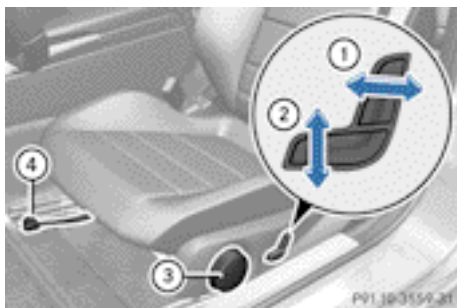

- ① Backrest angle
- ② Seat height
- ③ Seat cushion angle
- ④ Seat fore-and-aft adjustment

i Adjust the seat cushion angle so that your thighs are lightly supported.

Seat fore-and-aft adjustment

- ▶ Lift handle ④ and slide the seat forwards or rearwards.
- ▶ Release lever ④ again. Make sure that you hear the seat engage in position.

Seat cushion angle

- ▶ Turn handwheel ③ in the desired direction.

Adjusting the seats electrically

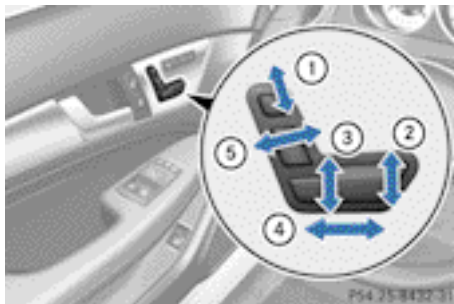

- ① Head restraint height
- ② Seat cushion angle
- ③ Seat height
- ④ Seat fore-and-aft adjustment
- ⑤ Backrest angle

i Vehicles with memory function: if PRE-SAFE® has been triggered, the front-passenger seat will be moved to a better position if it was previously in an unfavourable position.

i You can store the seat settings using the memory function (▶ page 115).

Adjusting the head restraints

! WARNING

You could lose control of the vehicle while driving if you:

- adjust the driver's seat, steering wheel or mirrors
- fasten the seat belt

There is a risk of an accident.

Adjust the driver's seat, head restraint, steering wheel and mirrors and fasten your seat belt before starting the engine.

⚠ WARNING

The head restraints cannot provide the intended protection unless they are fitted and adjusted correctly. There is an increased risk of injury to the head and neck in the event of an accident or sudden braking, for example. Always drive with the head restraints fitted. Ensure that the centre of the head restraints support the back of each vehicle occupant's head at eye level before driving off.

General notes

Pay attention to the important safety notes (▷ page 105).

Do not interchange the head restraints of the front and rear seats. Otherwise, you cannot adjust the height and angle of the head restraints to the correct position.

Adjusting the head restraints manually**Adjusting the head restraint height**

- ▶ **To raise:** pull the head restraint up to the desired position.
- ▶ **To lower:** press release catch ① and push the head restraint down to the desired position.

Adjusting the head restraints electrically

- ▶ **To adjust the head restraint height:** slide the switch for head restraint adjustment (▷ page 106) up or down in the direction of the arrow.

Folding the front-seat backrests forward/back**Important safety notes****⚠ WARNING**

If the backrest is not engaged, it could fold forwards during a braking manoeuvre or in the event of an accident, for example. The seat backrest will then push the vehicle occupant against the seat belt. The seat belt cannot protect as intended and could result in additional injury. This poses an increased risk of injury.

Before each journey, make sure that the backrest engages fully as described.

⚠ WARNING

The seat belt does not offer the intended level of protection if the backrest is not in the upright position. When braking or in the event of an accident, you could slide underneath the seat belt and sustain abdomen or neck injuries, for example. This poses an increased risk of injury or even fatal injury.

Adjust the seat properly before beginning your journey. Always make sure that the seat is in the upright position.

⚠ WARNING

When adjusting a seat, you or another vehicle occupant could become trapped by the guide rail of the seat, for instance. There is a risk of injury.

Make sure that no one has any part of their body within the sweep of the seat when adjusting it.

Folding the seat backrest forwards

With the EASY-ENTRY feature, the seat moves forwards if:

- you have folded the seat backrest forwards and
- the seat is in the rear half of the adjustment range

This makes it easier for passengers to get into and out of the rear compartment. The head restraint also lowers on vehicles with electric seat adjustment.

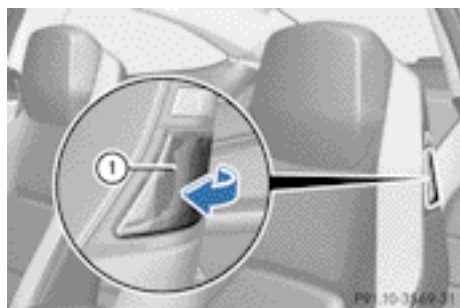

- ▶ **Vehicles without memory function:** release the head restraint if necessary and push it down.
- ▶ Pull seat release handle ① forwards and fold the backrest forwards until the seat backrest engages.
- ▶ Push the seat as far forwards as it will go.
- ▶ **Vehicles with memory function:** pull seat release handle ① forwards and fold the backrest forwards as far as it will go. The seat moves automatically to the foremost position.

Folding back the seat backrest

- ▶ **Vehicles without memory function:** push the seat backrest back horizontally until the seat reaches the position that was previously set.
- ▶ Fold the seat backrest backwards until you hear it engage. Do so in a smooth manner.
- ▶ After the seat backrest has been folded back, check the position of the head restraint and set it to the correct position.
- ▶ **Vehicles with memory function:** swing back the seat backrest. The seat moves automatically to the stored position.

Adjusting the 4-way lumbar support

You can adjust the contour of the front seat backrests individually to provide optimum support for your back.

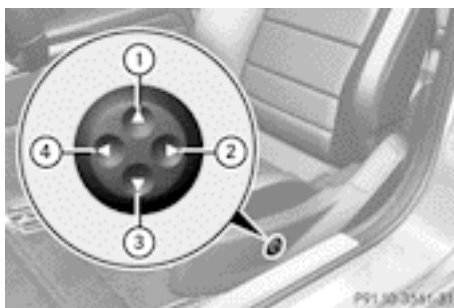

- ① To raise the backrest contour
- ② To soften the backrest contour
- ③ To lower the backrest contour
- ④ To harden the backrest contour

Switching the seat heating on/off

Switching on/off

⚠ WARNING

If you repeatedly switch on seat heating, the seat cushion and backrest padding may become very hot. The health of vehicle occupants with limited temperature sensitivity or a limited ability to react to excessively high temperatures may be affected or they may even suffer burn-like injuries. There is a risk of injury.

Therefore, do not switch on the seat heating repeatedly.

The three red indicator lamps in the button indicate the heating level you have selected.

- ❗ If the battery voltage is too low, the seat heating may switch off.



Driver's and front-passenger seat

The system automatically switches down from level **3** to level **2** after approximately eight minutes.

The system automatically switches down from level **2** to level **1** after approximately ten minutes.

The system automatically switches off approximately 20 minutes after it is set to level **1**.

- ▶ Make sure that the key is in position **1** or **2** in the ignition lock.
- ▶ **To switch on:** press button ① repeatedly until the desired heating level is set.
- ▶ **To switch off:** press button ① repeatedly until all the indicator lamps go out.

Problems with the seat heating

Problem	Possible causes/consequences and ► Solutions
The seat heating has switched off prematurely or cannot be switched on.	The on-board voltage is too low because too many electrical consumers are switched on. ► Switch off electrical consumers that you do not need, such as the rear window heating or interior lighting.

Switching the seat ventilation on/off

Switching on/off

The three blue indicator lamps in the buttons indicate the ventilation level you have selected.

- ❗ If the battery voltage is too low, the seat ventilation may switch off.



- Make sure that the key is in position **1** or **2** in the ignition lock.
- **To switch on:** press button ① repeatedly until the desired ventilation level is set.
- ❗ You can open the front side windows and the sliding sunroof using the "Convenience opening" feature (▷ page 96). The seat ventilation of the driver's seat automatically switches to the highest level.
- **To switch off:** press button ① repeatedly until all the indicator lamps go out.

Problems with the seat ventilation

The seat ventilation has switched off prematurely or cannot be switched on. The vehicle's electrical system voltage is too low because too many electrical consumers are switched on.

- Switch off electrical consumers that you do not need, such as the rear window heating or interior lighting.

Steering wheel

Important safety notes

⚠ WARNING

You could lose control of the vehicle while driving if you:

- adjust the driver's seat, steering wheel or mirrors
- fasten the seat belt

There is a risk of an accident.

Adjust the driver's seat, head restraint, steering wheel and mirrors and fasten your seat belt before starting the engine.

⚠ WARNING

Children could become trapped by the steering wheel if they adjust it. There is a risk of injury.

When leaving the vehicle, always take the key with you and lock the vehicle. Never leave children unattended in the vehicle.

Adjusting the steering wheel manually

WARNING

The steering wheel may move unexpectedly if you adjust it while driving. This could cause you to lose control of the vehicle. There is a risk of an accident.

Make sure that the steering wheel is locked before driving off. Never unlock the steering wheel when the vehicle is in motion.

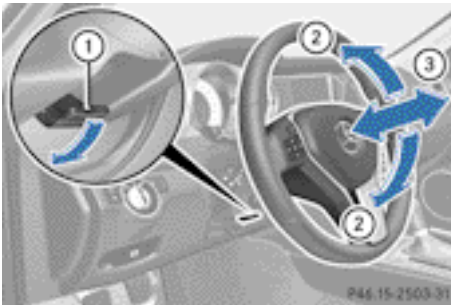

- ① Release lever
 - ② To adjust the steering wheel height
 - ③ To adjust the steering wheel position (fore-and-aft adjustment)
- ▶ Push release lever ① down completely. The steering column is unlocked.
 - ▶ Adjust the steering wheel to the desired position.
 - ▶ Push release lever ① up completely. The steering column is locked.
 - ▶ Check if the steering column is locked. When doing so, try to push the steering wheel up or down or try to move it in the fore-and-aft direction.

Adjusting the steering wheel electrically

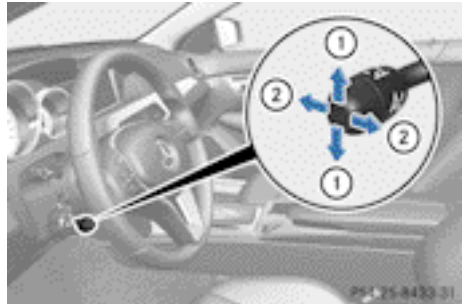

- ① To adjust the steering wheel height
- ② To adjust the steering wheel position (fore-and-aft adjustment)

The steering wheel can also be adjusted when the key is removed from the ignition lock.

Further related subjects:

- EASY-ENTRY/EXIT feature (> page 111)
- Storing settings (> page 115)

EASY-ENTRY/EXIT feature

Important safety notes

WARNING

When the EASY-ENTRY/EXIT feature adjusts the steering wheel, you and other vehicle occupants – particularly children – could become trapped. There is a risk of injury.

While the EASY-ENTRY/EXIT feature is making adjustments, make sure that no one has any body parts in the sweep of the steering wheel.

If someone is trapped:

- press one of the memory function position buttons, or
- move the switch for steering wheel adjustment in the opposite direction to that in which the steering wheel is moving.

The adjustment process is stopped.

⚠ WARNING

If you drive off while the EASY-ENTRY/EXIT feature is making adjustments, you could lose control of the vehicle. There is a risk of an accident.

Always wait until the adjustment process is complete before driving off.

The EASY-ENTRY/EXIT feature makes getting in and out of your vehicle easier.

You can activate and deactivate the EASY-ENTRY/EXIT feature in the on-board computer (▷ page 235).

Position of the steering wheel when the EASY-ENTRY/EXIT feature is active

The steering wheel tilts upwards if you:

- remove the key from the ignition lock
- open the driver's door and KEYLESS-GO is in position **1**
- open the driver's door and the key is in position **0** or **1** in the ignition lock

i The steering wheel only moves upwards if it has not already reached the upper end stop.

Position of the steering wheel for driving

The steering wheel is moved to the previously set position if:

- the driver's door is closed and
- you insert the key into the ignition lock or
- you press the Start/Stop button once on vehicles with KEYLESS-GO.

If you close the driver's door with the key inserted into the ignition lock, the steering wheel is automatically moved to the previously set position.

The last position of the steering wheel is stored when you switch off the ignition or when you store the setting with the memory function (▷ page 115).

Crash-responsive EASY-EXIT feature

If the crash-responsive EASY-EXIT feature is triggered in an accident, the steering column will move upwards when the driver's door is opened. This occurs irrespective of the position of the key in the ignition lock. This makes it easier to exit the vehicle and rescue the occupants.

The crash-responsive EASY-EXIT feature is only operational if the EASY-EXIT/ENTRY feature is activated in the on-board computer.

Mirrors**Rear-view mirror**

► **Anti-dazzle mode:** flick anti-dazzle switch ① forwards or back.

Exterior mirrors**Adjusting the exterior mirrors****⚠ WARNING**

The exterior mirrors reduce the size of the image. Objects visible in the mirrors are closer than they appear. You could misjudge the distance from road users driving behind you when changing lanes, for instance. There is a risk of an accident.

You should therefore always look over your shoulder to determine the actual distance from road users driving behind you.

The convex exterior mirrors provide a larger field of vision.

After the engine has been started, the exterior mirrors are automatically heated if the rear window heating is switched on and the outside temperature is low. Heating takes a maximum of 10 minutes.

- i** The exterior mirrors can also be heated manually by switching on the rear window heating.

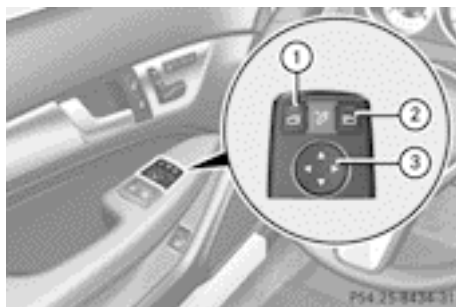

- ▶ Make sure that the key is in position **1** or **2** in the ignition lock.
- ▶ Press button **①** for the left-hand exterior mirror or button **②** for the right-hand exterior mirror. The indicator lamp in the corresponding button lights up in red. The indicator lamp goes out again after some time. You can adjust the selected mirror using adjustment button **③** as long as the indicator lamp is lit.
- ▶ Press adjustment button **③** up, down, or to the left or right until you have adjusted the exterior mirror to the correct position. You should have a good overview of traffic conditions.

Folding the exterior mirrors in/out electrically



- ▶ Make sure that the key is in position **1** or **2** in the ignition lock.
- ▶ Briefly press button **①**. Both exterior mirrors fold in or out.
- i** Make sure that the exterior mirrors are always folded out fully while driving. They could otherwise vibrate.

Setting the exterior mirrors

If the battery has been disconnected or completely discharged, the exterior mirrors must be reset. The exterior mirrors will otherwise not fold in when you select the "Fold in mirrors when locking" function in the on-board computer (▶ page 236).

- ▶ Make sure that the key is in position **1** in the ignition lock.
- ▶ Briefly press button **①**.

Folding the exterior mirrors in/out automatically

If the "Fold in mirrors when locking" function is activated in the on-board computer (▶ page 236):

- the exterior mirrors fold in automatically as soon as you lock the vehicle from the outside.
- the exterior mirrors fold out again automatically as soon as you unlock the vehicle and then open the driver's or front-passenger door.

- i** If the exterior mirrors have been folded in manually, they do not fold out.

Exterior mirror pushed out of position

If an exterior mirror has been pushed out of position, proceed as follows.

- ▶ **Vehicles without electrically folding exterior mirrors:** move the exterior mirror into the correct position manually.
- ▶ **Vehicles with electrically folding exterior mirrors:** press and hold the mirror-folding button until you hear a click and then the mirror engage in position (▷ page 113).
The mirror housing is engaged again and you can adjust the exterior mirrors as usual (▷ page 112).

Automatic anti-dazzle mirrors

The rear-view mirror and the exterior mirror on the driver's side automatically go into anti-dazzle mode if the following conditions are met simultaneously:

- the ignition is switched on and
- incident light from headlamps strikes the sensor in the rear-view mirror

The mirrors do not go into anti-dazzle mode if reverse gear is engaged.

Parking position of the exterior mirror on the front-passenger side

Setting and storing the parking position

Using reverse gear

You can set the front-passenger side exterior mirror so that you can see the rear wheel on that side as soon as you engage reverse gear. You can store this position.

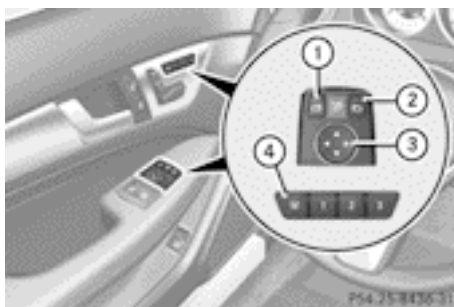

- ▶ Make sure that the vehicle is stationary and that the key is in position **2** in the ignition lock.
- ▶ Press button **2** for the exterior mirror on the front-passenger side.
- ▶ Engage reverse gear.
The exterior mirror on the front-passenger side moves to the preset parking position.
- ▶ Use adjustment button **3** to adjust the exterior mirror to a position that allows you to see the rear wheel and the kerb.
The parking position is stored.
- i** If you shift the transmission to another position, the exterior mirror on the front-passenger side returns to the driving position.

Using the memory button

You can set the front-passenger side exterior mirror so that you can see the rear wheel on that side as soon as you engage reverse gear. This setting can be stored using memory button **M** **4**.

- ▶ Make sure that the key is in position **2** in the ignition lock.
- ▶ With the exterior mirror on the front-passenger side activated, use adjustment button **3** to adjust the exterior mirror. In the exterior mirror, the rear wheel and the kerb should be visible.

- ▶ Press memory button **M** ④ and one of the arrows on adjustment button ③ within three seconds.

The parking position is stored if the exterior mirror does not move.

- ▶ If the mirror moves out of position, repeat the steps.

Calling up a stored parking position setting

- ▶ Turn the key to position **2** in the ignition lock.
- ▶ Adjust the exterior mirror on the front-passenger side using button ②.
- ▶ Engage reverse gear.

The exterior mirror on the front-passenger side moves to the stored parking position.

The exterior mirror on the front-passenger side moves back to its original position:

- as soon as you exceed a speed of 15 km/h
- if you press button ① for the exterior mirror on the driver's side

Memory function

Storing settings

WARNING

If you use the memory function on the driver's side while driving, the adjustments could cause you to lose control of the vehicle. There is a risk of an accident.

Only use the memory function on the driver's side while the vehicle is stationary.

WARNING

When the memory function adjusts the seat or steering wheel, you and other vehicle occupants – particularly children – could become trapped. There is a risk of injury.

While the memory function is making adjustments, make sure that no one has any body parts in the sweep of the seat or steering

wheel. If somebody becomes trapped, immediately release the memory function position button. The adjustment process is stopped.

WARNING

If children activate the memory function, they could become trapped, especially if they are unattended. There is a risk of injury.

When leaving the vehicle, always take the key with you and lock the vehicle. Never leave children unattended in the vehicle.

With the memory function, you can store up to three different settings, e.g. for three different people.

The following settings are stored as a single memory preset:

- position of the seat, backrest and head restraint
- driver's side: steering wheel position
- driver's side: position of the exterior mirrors on the driver's and front-passenger sides

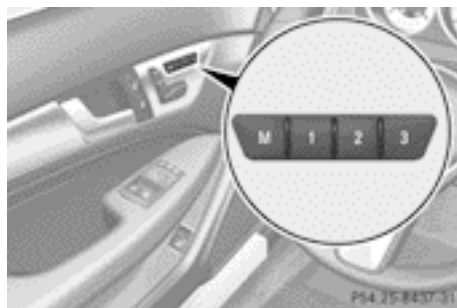

- ▶ Adjust the seat (▷ page 106).
- ▶ On the driver's side, adjust the steering wheel (▷ page 111) and the exterior mirrors (▷ page 112).
- ▶ Briefly press the **M** memory button and then press storage position button **1**, **2** or **3** within three seconds. The settings are stored in the selected preset position. A tone sounds when the settings have been completed.

Calling up a stored setting

- ❗ If you want to move the seat from the fully reclined position to a stored seat position, first raise the backrest. The seat could otherwise be damaged.
- ▶ Press and hold the relevant storage position button **1**, **2** or **3** until the seat, steering wheel and exterior mirrors are in the stored position.
- i The setting procedure is interrupted as soon as you release the storage position button.

Useful information	118
Exterior lighting	118
Interior lighting	125
Replacing bulbs	125
Windscreen wipers	129

Useful information

i This Owner's Manual describes all models, series and optional equipment for your vehicle that were available at the time of going to press. National variations are possible. Note that your vehicle may not be equipped with all of the functions described. This is also the case for systems and functions relevant to safety.

i Read the information on qualified specialist workshops: (▷ page 28).

Exterior lighting

General notes

For reasons of safety, Mercedes-Benz recommends that you drive with the lights switched on even during the daytime. In some countries, operation of the headlamps varies due to legal requirements and self-imposed obligations.

Notes on driving abroad

General notes

If your journey takes you to countries where vehicles are driven on the opposite side of the road to the country in which the vehicle is registered, your headlamps must be switched to symmetrical dipped beam as soon as possible after crossing the border (exception: vehicles with halogen headlamps). This prevents oncoming traffic from being dazzled. Symmetrical lights do not illuminate as large an area of the edge of the carriageway.

Vehicles with halogen headlamps

It is not necessary to switch your headlamps to symmetrical dipped beam when driving in countries where vehicles are driven on the opposite side of the road to the country in which the vehicle is registered. Legal require-

ments are fulfilled without switching the headlamps to symmetrical dipped beam.

Vehicles with bi-xenon headlamps

► Before crossing the border, set the headlamps to symmetrical dipped beam and when returning to asymmetrical dipped-beam using the "Dipped-beam headlamps for driving on the right or left" function on the on-board computer (▷ page 232).

If the headlamps are converted to symmetrical dipped beam, the "motorway mode" and "extended range foglamps" functions are not available.

Setting the exterior lighting

Setting options

Exterior lighting can be set using the:



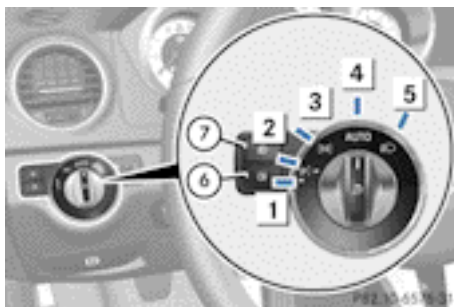

- light switch
- headlamp range control (vehicles with halogen headlamps only) (▷ page 120)
- combination switch (▷ page 121)
- on-board computer (▷ page 218) (vehicles with a 4-button multifunction steering wheel) or (▷ page 231) (vehicles with a 12-button multifunction steering wheel)

Light switch

Operation



- 1** Left-hand parking lamps
2 Right-hand parking lamps

- 3  Side lamps, licence plate and instrument cluster lighting
- 4  Automatic headlamp mode, controlled by the light sensor
- 5  Dipped-beam/main-beam headlamps
- 6  Rear fog lamp
- 7  Foglamp (vehicles with front foglamps only)

If you hear a warning tone when you leave the vehicle, the lights may still be switched on.

► Turn the light switch to **AUTO**.

The exterior lighting (except the side lamps/parking lamps) switches off automatically if you:

- remove the key from the ignition lock
- open the driver's door with the key in position **0**

Automatic headlamp mode

WARNING

When the light switch is set to **AUTO**, the dipped-beam headlamps may not be switched on automatically if there is fog, snow or other causes of poor visibility due to the weather conditions such as spray. There is a risk of an accident.

In such situations, turn the light switch to



The automatic headlamp feature is only an aid. The driver is responsible for the vehicle lighting at all times.

AUTO is the preferred light switch setting. The light setting is automatically selected according to the brightness of the ambient light (exception: poor visibility due to weather conditions such as fog, snow or spray):

- Key in position **1** in the ignition lock: the side lamps are switched on or off automatically depending on the brightness of the ambient light.
- With the engine running: if you have switched on the daytime driving lights func-

tion in the on-board computer, the daytime driving lights or the side lamps and dipped-beam headlamps are switched on or off automatically depending on the brightness of the ambient light.

► **To switch on automatic headlamp mode:** turn the light switch to **AUTO**.

The daytime driving lights improve the detectability of your vehicle during the day. The "daytime driving lights" function must be switched on via the on-board computer (► page 218) (vehicles with 4-button multifunction steering wheel) or (► page 231) (vehicles with 12-button multifunction steering wheel).

When the dipped-beam headlamps are switched on, the  indicator lamp in the instrument cluster lights up and the daytime driving lights switch off.

Dipped-beam headlamps



WARNING

When the light switch is set to **AUTO**, the dipped-beam headlamps may not be switched on automatically if there is fog, snow or other causes of poor visibility due to the weather conditions such as spray. There is a risk of an accident.

In such situations, turn the light switch to







When the ignition is switched on and the light switch is in position , the side lamps and dipped-beam headlamps are switched on even if the light sensor does not sense dark ambient light conditions. This is advantageous when there is fog or rain.

- **To switch on the dipped-beam headlamps:** turn the key in the ignition lock to position **2** or start the engine.
- Turn the light switch to . The green  indicator lamp in the instrument cluster lights up.

Foglamps





In conditions where visibility is poor due to fog, snow or rain, the foglamps improve visibility as well as making it easier for other road users to see you. They can be operated together with the side lamps or together with the side lamps and dipped-beam headlamps.

- ▶ **To switch on the foglamps:** turn the key in the ignition lock to position **2** or start the engine.
- ▶ Turn the light switch to  or **AUTO**.
- ▶ Press the  button.
The green  indicator lamp in the instrument cluster lights up.
- ▶ **To switch off the front foglamps:** press the  button.
The green  indicator lamp in the instrument cluster goes out.

Only vehicles with front foglamps are equipped with the "Foglamp" function; for how to operate the foglamps on vehicles with the Intelligent Light System (▷ page 123).



Rear fog lamp

The rear foglamp improves the visibility of your vehicle in heavy fog for the following traffic. Please observe the country-specific laws on the use of rear foglamps.

- ▶ **To switch on the rear foglamp:** turn the key in the ignition lock to position **2** or start the engine.
- ▶ Turn the light switch to  or **AUTO**.
- ▶ Press the  button.
The yellow  indicator lamp in the instrument cluster lights up.
- ▶ **To switch off the rear foglamp:** press the  button.
The yellow  indicator lamp in the instrument cluster goes out.

Side lamps



⚠ If the battery has been excessively discharged, the side lamps or parking lamps are automatically switched off to enable the next engine start. Always park your

vehicle safely and sufficiently lit according to legal standards. Avoid the continuous use of the  side lamps for several hours. If possible, switch on the  right or the  left parking lamp.

- ▶ **To switch on:** turn the light switch to .
The green indicator lamp in the instrument cluster lights up.

Parking lamps

Switching on the parking lamps ensures that the corresponding side of the vehicle is illuminated.

- ▶ **To switch on the parking lamps:** the key is not in the ignition lock or it is in position **0**.
- ▶ Turn the light switch to  (left-hand side of the vehicle) or  (right-hand side of the vehicle).

Adjusting the headlamp range (halogen headlamps)

The headlamp range control allows you to adjust the cone of light from the headlamps to suit the vehicle load.

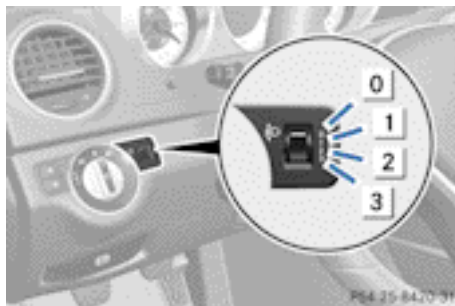

Headlamp range control

- 0** Driver's seat and front-passenger seat occupied
- 1** Driver's seat, front-passenger seat and rear seats occupied

- ② Driver's seat, front-passenger seat and rear seats occupied, boot laden
- ③ Driver's and front-passenger seats occupied and maximum permissible rear axle load utilised, e.g. when towing a trailer

- ▶ Start the engine.
- ▶ Turn the headlamp range control to the position which corresponds to the load in your vehicle.

Combination switch

Turn signals

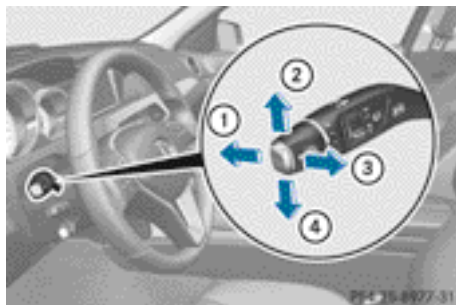

- ① Main-beam headlamps
- ② Turn signal, right
- ③ Headlamp flasher
- ④ Turn signal, left

- ▶ **To indicate briefly:** press the combination switch briefly to the pressure point in the direction of arrow ② or ④. The corresponding turn signal flashes three times.
- ▶ **To indicate:** press the combination switch beyond the pressure point in the direction of arrow ② or ④.

Main-beam headlamps

- ▶ **To switch on the main-beam headlamps:** turn the key in the ignition lock to position 2 or start the engine.
- ▶ Turn the light switch to  or **AUTO**.

- ▶ Press the combination switch beyond the pressure point in the direction of arrow ①.

In the **AUTO** position, the main-beam headlamps are only switched on when it is dark and the engine is running.

The  indicator lamp in the instrument cluster lights up when the main-beam headlamps are switched on.

- ▶ **To switch off the main-beam headlamps:** move the combination switch back to its normal position.

The  indicator lamp in the instrument cluster goes out.

Headlamp flasher

- ▶ **To switch on:** turn the key in the ignition lock to position 1 or 2, or start the engine.
- ▶ Pull the combination switch in the direction of arrow ③.

Hazard warning lamps



The hazard warning lamps switch on automatically if:

- an airbag is deployed or
- the vehicle decelerates rapidly from a speed of more than 70 km/h and comes to a standstill
- ▶ **To switch on the hazard warning lamps:** press button ①. All turn signals flash. If you now switch on a turn signal using the combination switch,

only the turn signal lamp on the corresponding side of the vehicle will flash.

- **To switch off the hazard warning lamps:** press button ①.

The hazard warning lamps switch off automatically if the vehicle reaches a speed of over 10 km/h again after a full brake application.

- ❗ The hazard warning lamps still operate if the ignition is switched off.

Headlamp cleaning system

The headlamps are cleaned automatically if the "Wipe with washer fluid" function is operated five times while the lights are on and the engine is running (▷ page 129). When you switch off the ignition, the automatic headlamp cleaning system is reset and counting is resumed from 0.

Intelligent Light System

General notes

The Intelligent Light System is a system that adjusts the headlamps automatically to suit the prevailing driving and weather conditions. It offers advanced functions for improved illumination of the road surface, e.g. depending on the vehicle speed or weather conditions. The system includes the active light function, cornering light function, motorway mode and extended range foglamps. The system is only active when it is dark.

You can activate or deactivate the "Intelligent Light System" function using the on-board computer (▷ page 232).

Active light function

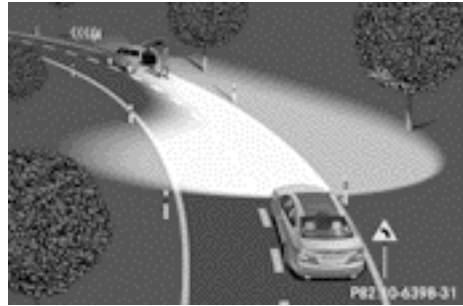

The active light function is a system that moves the headlamps according to the steering movements of the front wheels. In this way, relevant areas remain illuminated while driving. This allows you to recognise pedestrians, cyclists and animals.

Active: when the lights are switched on.

Cornering light function



The cornering light function improves the illumination of the road over a wide angle in the direction you are turning, enabling better visibility in tight bends, for example. The cornering light function can only be activated when the dipped-beam headlamps are switched on.

Active:

- if you are driving at speeds below 40 km/h and the turn signal is activated or the steering wheel is turned.
- if you are driving at speeds between 40 km/h and 70 km/h and turn the steering wheel.

Not active: if you are driving at speeds above 40 km/h or switch off the turn signal or turn the steering wheel to the straight-ahead position.

The cornering lamp may remain lit for a short time, but is automatically switched off after no more than three minutes.

Motorway mode



Motorway mode increases the range of the beam.

Active:

- if you are driving at speeds above 110 km/h and do not make any large steering movements for 1,000 m.
- if you are driving at speeds above 130 km/h.

Not active: if you are driving at speeds below 80 km/h following activation.

Extended range foglamps

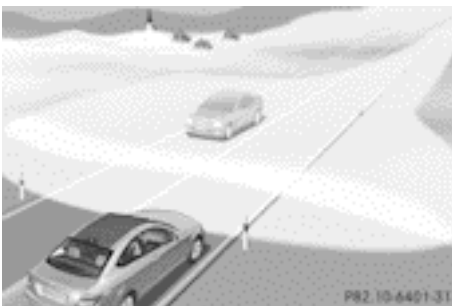

The extended range foglamps reduce the glare experienced by the driver and improve

the illumination of the edge of the carriageway.

Active: if you are driving at speeds below 70 km/h and you switch on the rear foglamp.

Not active: if, following activation, you are driving at speeds above 100 km/h or if you switch off the rear foglamp.

Adaptive Highbeam Assist

Important safety notes

WARNING

Adaptive Highbeam Assist does not recognise road users:

- who have no lights, e.g. pedestrians
- who have poor lighting, e.g. cyclists
- whose lighting is blocked, e.g. by a barrier

In very rare cases, Adaptive Highbeam Assist recognises road users too late or not at all. In this, or in similar situations, the automatic main-beam headlamps will not be deactivated or activated regardless. There is a risk of an accident.

Always carefully observe the traffic conditions and switch off the main-beam headlamps in good time.

Adaptive Highbeam Assist cannot take into account road, weather or traffic conditions. Adaptive Highbeam Assist is only an aid. You are responsible for adjusting the vehicle's lighting to the prevailing light, visibility and traffic conditions.

In particular, the detection of obstacles can be restricted if there is:

- poor visibility, e.g. due to fog, heavy rain or snow
- dirt on the sensors or the sensors are obscured

General notes

You can use this function to set the headlamps to change between dipped beam and main beam automatically. The system recog-

nises vehicles with their lights on, either approaching from the opposite direction or travelling in front of your vehicle, and consequently switches the headlamps from main beam to dipped beam.

The system automatically adapts the dipped-beam headlamp range depending on the distance to the other vehicle. Once the system no longer detects any other vehicles, it reactivates the main-beam headlamps.

The system's optical sensor is located behind the windscreen near the overhead control panel.



Switching Adaptive Highbeam Assist on/off

- ▶ **To switch on:** switch on the Adaptive Highbeam Assist function using the on-board computer (▷ page 232).
- ▶ Turn the light switch to **AUTO**.
- ▶ Press the combination switch beyond the pressure point in the direction of arrow ① (▷ page 121).
The  indicator lamp in the multifunction display lights up when it is dark and the light sensor activates the dipped-beam headlamps.



If you are driving at speeds above approximately 45 km/h:

The headlamp range is set automatically depending on the distance between the vehicle and other road users.

If you are driving at speeds above approximately 55 km/h and no other road users are detected:

The main-beam headlamps are switched on automatically. The  indicator lamp in the instrument cluster also lights up.

If you are driving at speeds below 45 km/h or other road users are detected or the roads are adequately lit:

The main-beam headlamps are switched off automatically. The  indicator lamp in the instrument cluster goes out. The  indicator lamp in the multifunction display remains lit.

- ▶ **To deactivate:** move the combination switch back to its normal position.
The  indicator lamp in the multifunction display goes out.

Headlamps misted up on the inside





The headlamps may mist up on the inside if there is high atmospheric humidity.

- ▶ Switch on the lights and drive off.
The level of moisture diminishes, depending on the length of the journey and the weather conditions (humidity and temperature).
- If the level of moisture does not diminish:
- ▶ Have the headlamps checked at a qualified specialist workshop.

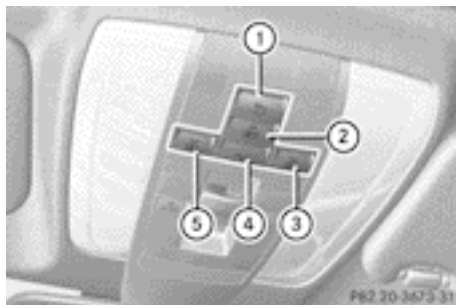
Interior lighting

Overview of interior lighting



- ①  Switches the rear interior lighting on/off
- ②  Switches the automatic interior lighting control on/off
- ③  Switches the right-hand front reading lamp on/off
- ④  Switches the front interior lighting on/off
- ⑤  Switches the left-hand front reading lamp on/off

Interior lighting control

General notes

In order to prevent the vehicle's battery from discharging, the interior lighting functions are automatically deactivated after some time except for when the key is in position **2** in the ignition lock.

Automatic interior lighting control



- ▶ **To switch on/off:** press the  button.
When the automatic interior lighting control is activated, the button is flush with the overhead control panel.

The interior lighting automatically switches on if you:

- unlock the vehicle
- open a door
- remove the key from the ignition lock

The interior lighting is activated for a short time when the key is removed from the ignition lock. You can activate this delayed switch-off using the on-board computer (▷ page 233).

Manual interior lighting control

- ▶ **To switch the interior lighting on/off:** press the  button.
- ▶ **To switch the reading lamps on/off:** press the  button.

Crash-responsive emergency lighting

The interior lighting is activated automatically if the vehicle is involved in an accident.

- ▶ **To switch off the crash-responsive emergency lighting:** press the hazard warning lamp button.

or

- ▶ Lock and then unlock the vehicle using the key.

Replacing bulbs

Important safety notes

Xenon bulbs

DANGER

Xenon bulbs are under high voltage. You can get an electric shock if you remove the cover of the xenon bulb and touch the electrical contacts. There is a risk of fatal injury.

Never touch the parts or the electrical contacts of the xenon bulb. Always have work on the xenon bulbs carried out at a qualified specialist workshop.

If your vehicle is equipped with xenon bulbs, you can recognise this by the following: the cone of light from the xenon bulbs moves from the top to the bottom and back again when you start the engine. For this to be

observed, the lights must be switched on before starting the engine.

Bulbs and lamps are an important aspect of vehicle safety. You must therefore make sure that these function correctly at all times. Have the headlamp setting checked regularly.

Other bulbs

WARNING

Bulbs, lamps and plug connectors can become very hot during use. When replacing a bulb, you could burn yourself on these components. There is a risk of injury.

Allow these components to cool down before replacing the bulb.

Do not use a bulb that has been dropped or if its glass tube has been scratched.

The bulb may explode if:

- you touch it
- it is hot
- you drop it
- you scratch it

Only operate bulbs in enclosed lamps designed for that purpose. Only fit spare bulbs of the same type and the specified voltage.

Marks on the glass tube reduce the service life of the bulbs. Do not touch the glass tube with your bare hands. If necessary, clean the glass tube when cold with alcohol or spirit and rub it off with a lint-free cloth.

Protect bulbs from moisture during operation. Do not allow bulbs to come into contact with liquids.

There are bulbs other than the xenon bulbs that you cannot replace yourself. Replace only the bulbs listed (▷ page 126). Have the bulbs that you cannot replace yourself replaced at a qualified specialist workshop.

If you require assistance replacing bulbs, consult a qualified specialist workshop.

If the new bulb still does not light up, consult a qualified specialist workshop.

Bulbs and lamps are an important aspect of vehicle safety. You must therefore make sure that these function correctly at all times. Have the headlamp setting checked regularly.

Overview of bulb replacement – bulbs

You can replace the following bulbs. The details for the bulb type can be found in the legend.

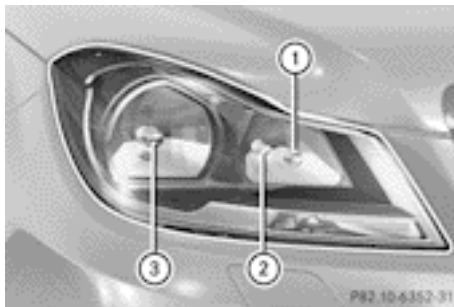

Halogen headlamps

- ① Side lamp/parking lamp: W 5 W
- ② Main-beam headlamp: H7 55 W
- ③ Dipped-beam headlamp: H7 55 W



Vehicles with Intelligent Light System

- ① Cornering lamp: H7 55 W

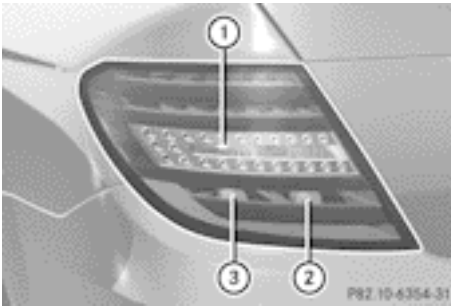

Tail lamps

- ① Reversing lamp: P 21 W
- ② Brake lamp: P 21 W
- ③ Brake lamp/side lamp: P 21 W

Replacing the front bulbs

Dipped-beam headlamps (halogen headlamps)

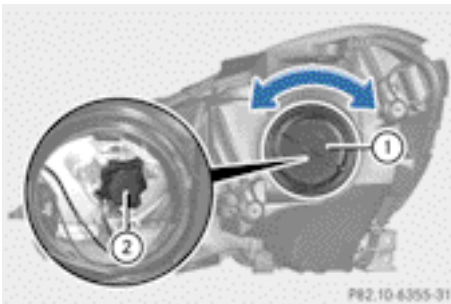

- ▶ Switch off the lights.
- ▶ Open the bonnet.
- ▶ Turn housing cover ① anti-clockwise and pull it out.
- ▶ Turn bulb holder ② anti-clockwise and pull it out.
- ▶ Take the bulb out of bulb holder ②.
- ▶ Insert the new bulb into bulb holder ②.
- ▶ Insert bulb holder ② into the lamp and turn it clockwise.
- ▶ Align housing cover ① and turn it clockwise until it engages.

Main-beam headlamps (halogen headlamps)

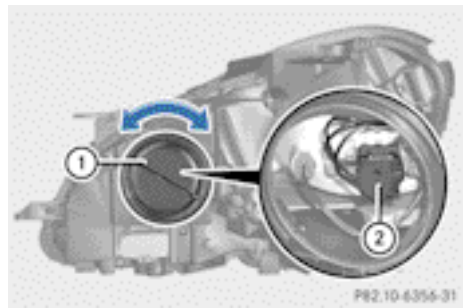

- ▶ Switch off the lights.
- ▶ Open the bonnet.
- ▶ Turn housing cover ① anti-clockwise and pull it out.
- ▶ Turn bulb holder ② anti-clockwise and pull it out.
- ▶ Take the bulb out of bulb holder ②.
- ▶ Insert the new bulb into bulb holder ②.
- ▶ Insert bulb holder ② into the lamp and turn it clockwise.
- ▶ Align housing cover ① and turn it clockwise until it engages.

Side lamps/parking lamps (halogen headlamps)

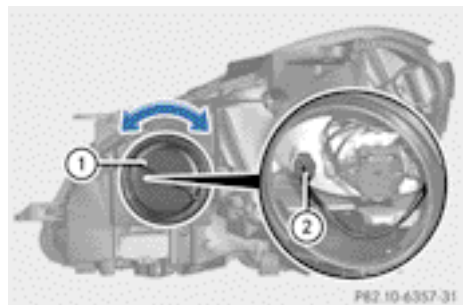

- ▶ Switch off the lights.
- ▶ Open the bonnet.
- ▶ Turn housing cover ① anti-clockwise and pull it out.
- ▶ Pull out bulb holder ②.

- ▶ Take the bulb out of bulb holder ②.
- ▶ Insert the new bulb into bulb holder ②.
- ▶ Insert bulb holder ②.
- ▶ Align housing cover ① and turn it clockwise until it engages.

Cornering lamps (Intelligent Light System)

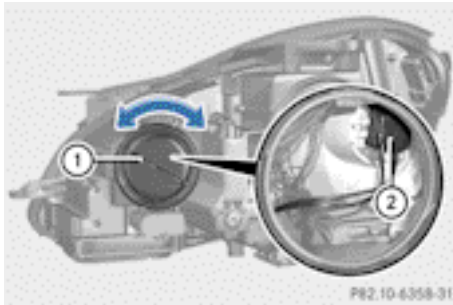

- ▶ Switch off the lights.
- ▶ Open the bonnet.
- ▶ Turn housing cover ① anti-clockwise and pull it out.
- ▶ Turn bulb holder ② anti-clockwise and pull it out.
- ▶ Take the bulb out of bulb holder ②.
- ▶ Insert the new bulb into bulb holder ②.
- ▶ Insert bulb holder ② into the lamp and turn it clockwise.
- ▶ Align housing cover ① and turn it clockwise until it engages.

Replacing the rear bulbs

Opening and closing the side trim panels

You must open the side trim panel in the boot and remove the first-aid kit before you can replace the bulbs in the tail lamps.

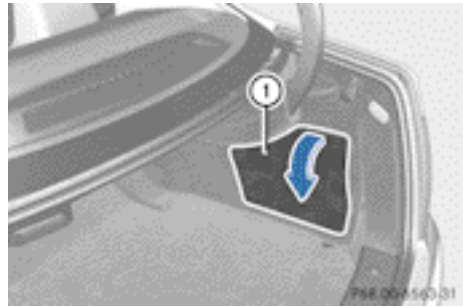

Right-hand side trim panel

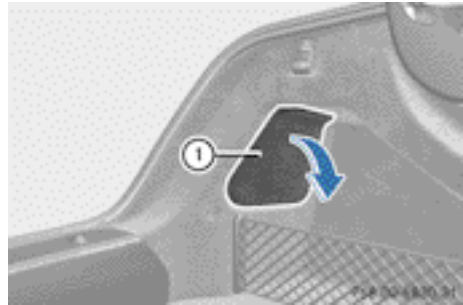

Left-hand side trim panel (vehicles without a sound system or trailer tow hitch)

- ▶ **To open:** release side trim panel ① at the top and fold it down in the direction of the arrow.
- ▶ **To close:** insert side panel ①.

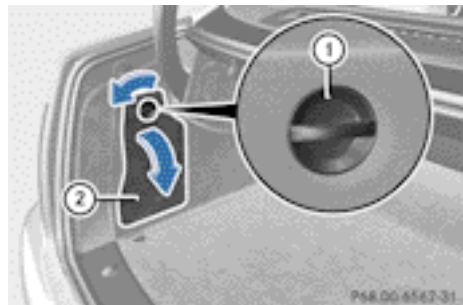

Left-hand side trim panel (vehicles with a sound system or trailer coupling)

- ▶ **To open:** turn rotary catch ① 90° in the direction of the arrow and remove side trim panel ②.
- ▶ **To close:** insert side trim panel ② and turn rotary catch ① 90° in the opposite direction to the arrow.

Tail lamps

- ▶ Switch off the lights.
- ▶ Open the boot.
- ▶ Open the side trim panel (▷ page 128).

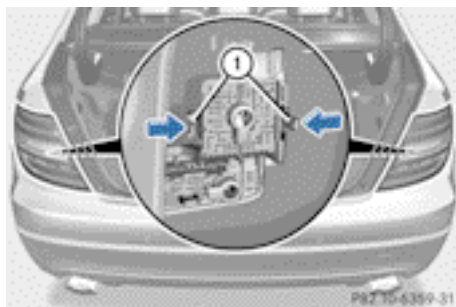

- ▶ Remove the tail lamp connector
- ▶ Simultaneously press retaining lugs ① in the direction of the arrow and slightly pull out the bulb holder with the bulbs.
- ▶ Remove the connector for LED light functions from the top of the bulb holder.
- ▶ Pull the bulb holder out with the bulbs.

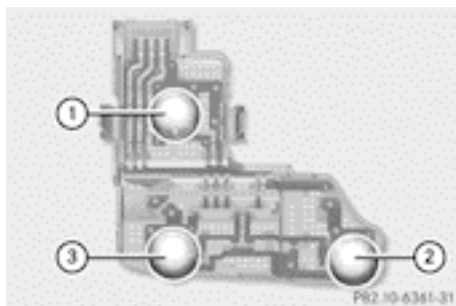

- ① Reversing lamp
- ② Brake lamp
- ③ Side lamp/brake lamp

⁵ Rain sensor set to low sensitivity.

- ▶ Press the respective bulb ①, ② or ③ back and turn it anti-clockwise to remove it from the bulb holder.
- ▶ Insert the new bulb into the bulb holder and turn it clockwise.
- ▶ Reinsert the connector for LED light functions in the bulb holder.
- ▶ Insert the bulb holder again and lock it in place.
- ▶ Insert the tail lamp connector.
- ▶ Close the side trim panel (▷ page 128).

Windscreen wipers



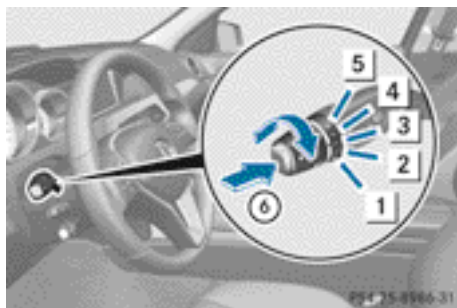

Switching the windscreen wipers on/off

- ⚠ Do not operate the windscreen wipers when the windscreen is dry, as this could damage the wiper blades. Moreover, dust that has collected on the windscreen can scratch the glass if wiping takes place when the windscreen is dry.
- ⚠ If the windscreen wipers leave smears on the windscreen after the vehicle has been washed in an automatic car wash, this may be due to wax or other residue. Clean the windscreen with washer fluid after an automatic car wash.



Combination switch





- ① 0 Windscreen wipers off
- ② ... Intermittent wipe, low⁵

- 3  Intermittent wipe, high⁶
- 4  Continuous wipe, slow
- 5  Continuous wipe, fast
- 6  Single wipe /  to wipe the windscreen using washer fluid

- ▶ Turn the key to position **1** or **2** in the ignition lock.
- ▶ Turn the combination switch to the corresponding position.

! Intermittent wiping with rain sensor: due to optical influences and the windscreen becoming dirty in dry weather conditions, the windscreen wipers may be activated inadvertently. This could damage the windscreen wiper blades or scratch the windscreen.

For this reason, you should always switch off the windscreen wipers in dry weather.

In the  or  position, the appropriate wiping frequency is set automatically according to the intensity of the rain. In the  position, the rain sensor is more sensitive than in the  position, causing the windscreen wipers to wipe more frequently.

If the wiper blades are worn, the windscreen will no longer be wiped properly. This could prevent you from observing the traffic conditions. Replace the wiper blades twice a year, ideally in spring and autumn.

Replacing the wiper blades

Important safety notes

WARNING

If the windscreen wipers begin to move while you are changing the wiper blades, you can be trapped by the wiper arm. There is a risk of injury.

Always switch off the windscreen wipers and ignition before changing the wiper blades.

! Never open the bonnet if a windscreen wiper arm has been folded away from the windscreen.

Never fold a windscreen wiper arm without a wiper blade back onto the windscreen.

Hold the windscreen wiper arm firmly when you change the wiper blade. If you release the windscreen wiper arm without a wiper blade and it falls onto the windscreen, the windscreen may be damaged by the force of the impact.

Mercedes-Benz recommends that you have the wiper blades changed at a qualified specialist workshop.

! To avoid damaging the windscreen wiper blades, make sure that you touch only the wiper arm of the windscreen wiper.

Replacing the wiper blades

Removing the wiper blades

- ▶ Remove the key from the ignition lock or turn the key to position **0** (KEYLESS-GO).
- ▶ Fold the wiper arm away from the windscreen until it engages.

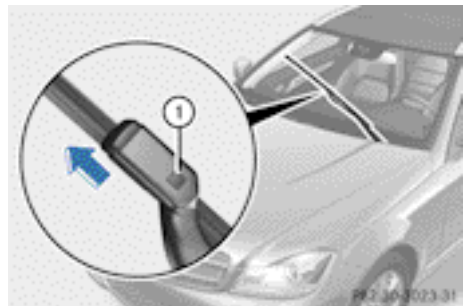

- ▶ Firmly press release knob ① and pull the wiper blade upwards from the wiper arm in the direction of the arrow.

⁶ Rain sensor set to high sensitivity.

Fitting the wiper blades

- ▶ Position the new wiper blade in the retainer on the wiper arm and slide it into place in the opposite direction to the arrow. The wiper blade audibly engages.
- ▶ Make sure that wiper blade is seated correctly.
- ▶ Fold the wiper arm back onto the windscreen.

Problems with the windscreen wipers

Problem	Possible causes/consequences and ► Solutions
The windscreen wipers are jammed.	Leaves or snow, for example, may be obstructing the windscreen wiper movement. The wiper motor has been deactivated. <ul style="list-style-type: none"> ► For safety reasons, you should remove the key from the ignition lock. or <ul style="list-style-type: none"> ► Switch off the engine using the Start/Stop button and open the driver's door. ► Remove the cause of the obstruction. ► Switch the windscreen wipers back on.
The windscreen wipers fail completely.	The windscreen wiper drive is malfunctioning. <ul style="list-style-type: none"> ► Select another wiper speed on the combination switch. ► Have the windscreen wipers checked at a qualified specialist workshop.
The windscreen washer fluid from the spray nozzles no longer hits the centre of the windscreen.	The spray nozzles are misaligned. <ul style="list-style-type: none"> ► Have the spray nozzles adjusted at a qualified specialist workshop.

Useful information	134
Overview of climate control systems	134
Operating the climate control system	136
Adjusting the air vents	145

Useful information

- i** This Owner's Manual describes all models, series and optional equipment for your vehicle that were available at the time of going to press. National variations are possible. Note that your vehicle may not be equipped with all of the functions described. This is also the case for systems and functions relevant to safety.
- i** Read the information on qualified specialist workshops: (▷ page 28).

Overview of climate control systems

Important safety notes

Observe the settings recommended on the following pages. The windows could otherwise mist up.

To prevent the windows from misting up:

- switch off climate control only briefly
- switch on air-recirculation mode only briefly
- switch on the cooling with air dehumidification function
- switch on the defrost windscreen function briefly, if required

Climate control regulates the temperature and the humidity in the vehicle interior and filters undesirable substances out of the air.

Climate control is only operational when the engine is running. Optimum operation is only achieved when the side windows and the roof are closed.

- i** Ventilate the vehicle for a brief period during warm weather, e.g. using the convenience opening feature (▷ page 96). This will speed up the cooling process and the desired vehicle interior temperature will be reached more quickly.
- i** The integrated filter filters out most particles of dust and soot and completely filters out pollen. It also reduces gaseous pol-

lutants and odours. A clogged filter reduces the amount of air supplied to the vehicle interior. For this reason, you should always observe the interval for replacing the filter, which is specified in the Service Booklet. As it depends on environmental conditions, e.g. heavy air pollution, the interval may be shorter than stated in the Service Booklet.

Control panel for THERMATIC automatic climate control (2-zone)

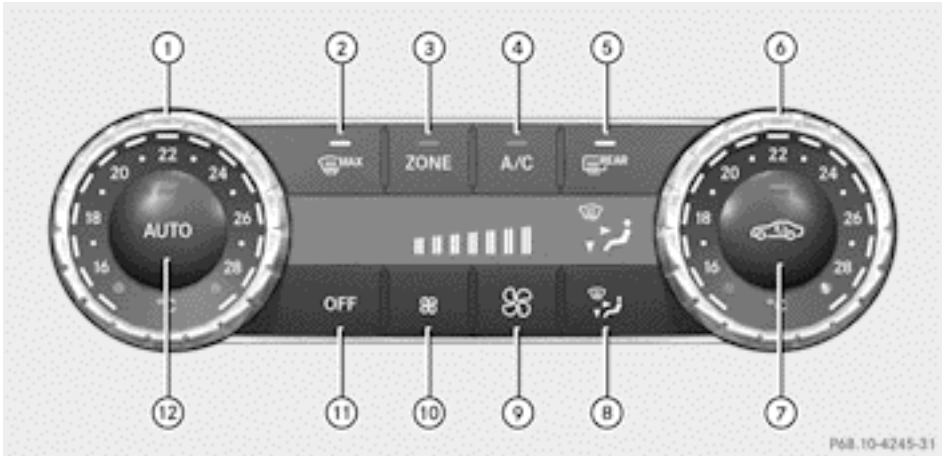

- ① To set the temperature, left (▷ page 137)
- ② To demist the windscreen (▷ page 138)
- ③ To switch the ZONE function on/off (▷ page 138)
- ④ To activate/deactivate cooling with air dehumidification (▷ page 136)
- ⑤ To switch the rear window heating on/off (▷ page 139)
- ⑥ To set the temperature, right (▷ page 137)
- ⑦ To activate/deactivate air-recirculation mode (▷ page 140)
- ⑧ To set the air distribution (▷ page 137)
- ⑨ To increase the airflow (▷ page 138)
- ⑩ To reduce the airflow (▷ page 138)
- ⑪ To switch climate control on/off (▷ page 136)
- ⑫ To set climate control to automatic mode (▷ page 137)

Notes on using THERMATIC automatic climate control

Automatic climate control

The following contains notes and recommendations on optimum use of THERMATIC automatic climate control.

- Activate climate control using the **AUTO** and **A/C** buttons. The indicator lamps in the **AUTO** and **A/C** buttons light up.
- Set the temperature to 22 °C.
- Only use the "windscreen demisting" function briefly until the windscreen is clear again.
- Only use air-recirculation mode briefly, e.g. if there are unpleasant outside odours or when in a tunnel. The windows could otherwise mist up as no fresh air is drawn into the vehicle in air-recirculation mode.
- Use the ZONE function to adopt the temperature settings on the driver's side for the front-passenger side as well. The indicator lamp in the **ZONE** button goes out.

ECO start/stop function

During automatic engine switch-off in the ECO start/stop function, the climate control system only operates at a reduced capacity. If you require the full climate control output, you can switch off the ECO start/stop function by pressing the ECO button (▷ page 154).

- i** The ECO start/stop function is not available on AMG vehicles.

Operating the climate control system

Switching climate control on/off

General notes

When the climate control is switched off, the air supply and air circulation are also switched off. The windows could mist up. Therefore, only switch off climate control briefly.

- i** Switch on climate control primarily using the **AUTO** button (▷ page 137).

Activating/deactivating

- ▶ Turn the key to position **2** in the ignition lock (▷ page 149).
 - ▶ **To switch on:** press the **AUTO** button. The indicator lamp in the **AUTO** button lights up. Airflow and air distribution are set to automatic mode.
- or
- ▶ Press the **OFF** button. The indicator lamp in the **OFF** button goes out. The previous settings are reactivated.
 - ▶ **To switch off:** press the **OFF** button. The indicator lamp in the **OFF** button lights up.

Activating/deactivating the cooling with air dehumidification function

General notes

If you deactivate the "Cooling with air-dehumidification" function, the air inside the vehicle will not be cooled. The air inside the vehicle will also not be dehumidified. The windows can mist up more quickly. Therefore, only switch off cooling with air dehumidification for a short period.

The "Cooling with air dehumidification" function is only available when the engine is running. The air inside the vehicle is cooled and dehumidified according to the temperature selected.

Condensation may drip from the underside of the vehicle when cooling mode is active. This is normal and not a sign that there is a malfunction.

Activating/deactivating

- ▶ **To activate:** press the **A/C** button. The indicator lamp in the **A/C** button lights up.
- i** In vehicles with auxiliary heating, one of the indicator lamps on the auxiliary heating button lights up when the "cooling with air dehumidification" function is activated.
- ▶ **To deactivate:** press the **A/C** button. The indicator lamp in the **A/C** button goes out. The "Cooling with air dehumidification" function has a delayed switch-off feature.

Problems with the "Cooling with air dehumidification" function

Problem	Possible causes/consequences and ► Solutions
The indicator lamp in the  button flashes three times or remains off. The cooling with air dehumidification system cannot be switched on.	Cooling with air dehumidification has been deactivated due to a malfunction. ► Visit a qualified specialist workshop.

Setting climate control to automatic mode



General notes

In automatic mode, the set temperature is maintained automatically at a constant level. The system automatically regulates the temperature of the dispensed air, the airflow and the air distribution.

The automatic mode functions optimally when the "Cooling with air dehumidification" function is activated. If desired, cooling with air dehumidification can be deactivated.



If you deactivate the "Cooling with air-dehumidification" function, the air inside the vehicle will not be cooled. The air inside the vehicle will also not be dehumidified. The windows can mist up more quickly. Therefore, only switch off cooling with air dehumidification for a short period.

Activating/switching

- Turn the key to position **2** in the ignition lock (▷ page 149).
- Set the desired temperature.
- **To activate:** press the  button. The indicator lamp in the  button lights up. Automatic air distribution and airflow are activated.

- **To switch to manual mode:** press the  button.

or

- Press the  or  button. The indicator lamp in the  button goes out. Automatic air distribution and airflow are deactivated.



Setting the temperature





Different temperatures can be set for the driver's and front-passenger sides.

- Turn the key to position **2** in the ignition lock (▷ page 149).
- **To increase/reduce:** turn controls ① and ② clockwise or anti-clockwise (▷ page 135).
Only change the temperature setting in small increments. Start at 22 °C.

Setting the air distribution

Air distribution settings

-  Directs the airflow through the centre and side air vents
-  Directs the airflow through the footwell air vents
-  Directs the airflow through the centre and side air vents as well as the footwell air vents



-  Directs the airflow through the demister vents
-  Directs the airflow through the demister, centre and side air vents
-  Directs the airflow through the footwell and demister vents
-  Directs the airflow through the demister vents, the centre and side air vents as well as the footwell air vents

i Regardless of the air distribution setting, airflow is always directed through the side air vents. The side air vents can only be closed when the controls on the side air vents are turned downwards.

Adjusting



- ▶ Turn the key to position **2** in the ignition lock (▷ page 149).
- ▶ Press the  button repeatedly until the desired symbol appears in the display. The indicator lamp in the **AUTO** button goes out. Automatic control is deactivated and the air distribution is controlled according to the selected setting.

Setting the airflow

- ▶ Turn the key to position **2** in the ignition lock (▷ page 149).
- ▶ **To increase/reduce:** press the  or  button.



If the battery is not sufficiently charged, blower output may be reduced. As soon as the battery is sufficiently charged, full blower output will be available.

Switching the ZONE function on/off

- ▶ **To switch on:** press the  button. The indicator lamp in the  button lights up.

The temperature setting for the driver's side is not adopted for the front-passenger side.

When the buttons for temperature, airflow or air distribution are pressed, the temperature setting on the driver's side is not adopted for the other climate control zones.



- ▶ **To switch off:** press the  button. The indicator lamp in the  button goes out.

The temperature setting for the driver's side is adopted for the front-passenger side.

Demisting the windscreen

You can use this function to defrost the windscreen or to demist the inside of the windscreen and the side windows.



- i** You should only select the "windscreen demisting" function until the windscreen is clear again.

- ▶ Turn the key to position **2** in the ignition lock (▷ page 149).
- ▶ **To activate:** press the  button. The indicator lamp in the  button lights up.

The climate control system switches to the following functions:

- high airflow
- high temperature
- air distribution to the windscreen and front side windows
- air-recirculation mode off

If the battery is not sufficiently charged, blower output may be reduced. As soon as the battery is sufficiently charged, full blower output will be available.

- ▶ **To deactivate:** press the  button. The indicator lamp in the  button goes out. The previous settings are reactivated.

Air-recirculation mode remains deactivated.

or

- ▶ Press the **AUTO** button.

The indicator lamp in the  button goes out. Airflow and air distribution are set to automatic mode.

or

- ▶ Turn temperature control ① or ⑥ clockwise or anti-clockwise (▷ page 135).



or

- ▶ Press the  or  button.

switches off automatically after several minutes.



If the battery voltage is too low, the rear window heating may switch off.

Activating/deactivating

- ▶ Turn the key to position **2** in the ignition lock (▷ page 149).
- ▶ Press the  button.
The indicator lamp in the  button lights up or goes out.



Demisting the windows

Windows misted up on the inside

- ▶ Activate the  cooling with air dehumidification function.
- ▶ Activate automatic mode **AUTO**.
- ▶ Adjust the side air vents so that the heated air is directed towards the side windows.
- ▶ If the windows continue to mist up, activate the  "Windscreen demisting" function.

i You should only select this setting until the windscreen is clear again.

Windows misted up on the outside

- ▶ Activate the windscreen wipers.
- ▶ Press the  button repeatedly until the  or  symbol appears in the display.
- ▶ Adjust the side air vents so that no air is directed towards the side windows.

Rear window heating

General notes

The rear window heating has a high current draw. You should therefore switch it off as soon as the window is clear. It otherwise

Problems with the rear window heating

Problem	Possible causes/consequences and ► Solutions
The rear window heating has switched off prematurely or cannot be activated.	<p>The battery has not been sufficiently charged.</p> <p>► Switch off any consumers that are not required, e.g. reading lamps, interior lighting or the seat heating.</p> <p>When the battery is sufficiently charged, the rear window heating can be activated again.</p>

Activating/deactivating air-recirculation mode





General notes

You can deactivate the flow of fresh air if unpleasant odours are entering the vehicle from outside. The air already inside the vehicle will then be recirculated.

If you switch on air-recirculation mode, the windows can mist up more quickly, in particular at low temperatures. Only use air-recirculation mode briefly to prevent the windows misting up.

The operation of air-recirculation mode is the same for all control panels.

Activating/deactivating

- Turn the key to position **2** in the ignition lock (► page 149).
- **To activate:** press the  button. The indicator lamp in the  button lights up.
- ❗ Air-recirculation mode is activated automatically at high outside temperatures. When air-recirculation mode is activated automatically, the indicator lamp in the  button is not lit. Outside air is added after about 30 minutes.
- **To deactivate:** press the  button. The indicator lamp in the  button goes out.

Convenience opening/closing using the air-recirculation button



⚠ WARNING



When the convenience closing feature is operating, parts of the body could become trapped in the closing area of the side window and the sliding sunroof. There is a risk of injury.

Observe the complete closing procedure when the convenience closing feature is operating. When closing make sure that no parts of the body are in the closing area.









⚠ WARNING

During convenience opening parts of the body could be drawn in or become trapped between the side window and window frame. There is a risk of injury.

When opening, make sure that nobody is touching the side window. If someone becomes trapped, press the  switch immediately to open/close the side window in the door. The side window stops. To continue closing the side window, pull on the  switch.

- **Convenience closing feature:** press and hold the  button until the side windows and the panorama sliding sunroof are closed. The indicator lamp in the  button lights up. Air-recirculation mode is activated.

If parts of the body are in the closing area during convenience closing, proceed as follows:

- ▶ Press the  button for opening/closing the side windows.
The side window stops.
- ▶ To then open the side window, press the  button again.
- ▶ Press the  switch for opening/closing the panorama sliding sunroof.
The panorama sliding sunroof stops.
- ▶ To then open the panorama sliding sunroof, pull back on the  switch.
- i** If the sliding sunroof is raised and closes, press the  switch, to stop the sliding sunroof. Do not pull back on the  switch afterwards. The sliding sunroof closes before it opens.
- i** Notes on the automatic reversing function for:
 - the side window (▷ page 95)
 - the panorama sliding sunroof (▷ page 98)
- ▶ **Convenience opening feature:** press and hold the  button until the side windows and the panorama sliding sunroof have opened. The side windows and the panorama sliding sunroof move back to their original position.
The indicator lamp in the  button goes out. Air-recirculation mode is deactivated.
- i** If you open the side windows or the panorama sliding sunroof manually after closing with the convenience closing feature, they will remain in this position when opened using the convenience opening feature.

Auxiliary heating

Important safety notes

DANGER

If the exhaust pipe is blocked or sufficient ventilation is not possible, toxic exhaust fumes can enter the vehicle, especially carbon monoxide. This is the case, e.g. in enclosed spaces, or if the vehicle is stuck in snow. There is a risk of fatal injuries.

You should switch off the auxiliary heating in enclosed spaces which do not have an extraction system, e.g. a garage. If the vehicle is stuck in snow and you must leave the auxiliary heating running, keep the exhaust pipe and the area around the vehicle clear of snow. To guarantee a sufficient supply of fresh air, open a window on the side of the vehicle away from the wind.

WARNING

When the auxiliary heating is switched on, parts of the vehicle can become very hot. Flammable material such as leaves, grass or twigs may ignite if they come into contact with hot parts of the exhaust system for extended periods. There is a risk of fire.

When the auxiliary heating is switched on, make sure that no flammable material can come into contact with hot vehicle components.

- !** Operating the auxiliary heating/ventilation draws on the vehicle battery. After you have heated or ventilated the vehicle a maximum of two times, drive for a longer distance.

- i** Switch the auxiliary heating on regularly once a month for about ten minutes.

The auxiliary heating heats the air in the vehicle interior to the set temperature. This occurs without using the heat of the running engine. The auxiliary heating is operated directly using the vehicle's fuel. For this reason, the tank content must be at least at

reserve fuel level to ensure that the auxiliary heating functions.

The auxiliary heating/ventilation automatically adjusts to changes in temperature and weather conditions. For this reason, the auxiliary heating could switch from ventilation mode to heating mode or from heating mode to ventilation mode.

The auxiliary heating switches off automatically after 50 minutes. This time limit can be altered. To do this, visit a qualified specialist workshop.

You cannot use the auxiliary ventilation to cool the vehicle interior to a temperature lower than the outside temperature.

Before switching on

- ▶ Turn the key to position **2** in the ignition lock (▷ page 149).
- ▶ Set the desired temperature (▷ page 137).

The auxiliary heating/ventilation can be activated even when climate control is set to manual. Optimum comfort can be attained when the system is set to automatic mode. Set the temperature to 22 °C.

The auxiliary heating/ventilation can be activated or deactivated using the remote control or the button on the centre console.

The on-board computer can be used to specify up to three departure times, one of which may be preselected (▷ page 234).

Switching the auxiliary heating/ventilation on/off using the centre console button



The colours of the indicator lamps on the button have the following meanings:

- Blue Auxiliary ventilation switched on
- Red Auxiliary heating switched on
- Yellow Departure time preselected (▷ page 234)

Switching on the auxiliary heating/ventilation

- ▶ Press button ①.
- The red or blue indicator lamp in button ① lights up.

Switching off the auxiliary heating/ventilation

- ▶ Press button ①.
- The red or blue indicator lamp in button ① goes out.

Switching the auxiliary heating/ventilation on/off using the remote control

General notes

Your vehicle comes with one remote control. You may use two additional remote controls for your vehicle. For more information, please contact a qualified specialist workshop.

The remote control has a maximum range of approximately 300 metres. This range is reduced by:

- sources of radio interference
- solid objects between the remote control and the vehicle
- the remote control being in an unfavourable position in relation to the vehicle
- transmitting from an enclosed space

i The optimum range can be achieved if you hold the remote control vertically, pointing upwards when you press one of the buttons.

i A battery symbol appears in the display when the battery in the remote control is low. Replace the remote control battery (▷ page 144).

Switching the auxiliary heating/ventilation on/off



Remote control

- ① Display
- ② To check the status/set the departure time
- ③ To switch off the auxiliary heating/ventilation
- ④ To switch on the auxiliary heating/ventilation
- ⑤ To check the status/set the departure time

- ▶ **To switch on:** press the button. ON is shown in the remote control display.
- ▶ **To deactivate:** press the button. OFF is shown in the remote control display.







Checking the status of the auxiliary heating/ventilation



- ▶ Press the or button.



The following messages may appear in the display:

Display	Meaning
	The auxiliary heating/ventilation is switched off.
	The auxiliary ventilation is switched on. The number in the display shows the remaining time (in minutes) for the auxiliary ventilation.
	The auxiliary heating is switched on. The number in the display shows the remaining time (in minutes) for the auxiliary heating.
	A departure time has been activated. The departure time appears in the display.
	A departure time has been activated. The auxiliary ventilation is currently activated. The departure time appears in the display.
	A departure time has been activated. The auxiliary heating is currently activated. The departure time appears in the display.





Setting the departure time

- ▶ Press the  or  button repeatedly until the time to be changed appears in the display.
- ▶ Press the  and  buttons simultaneously.
The  symbol in the remote control display flashes.
- ▶ Press the  or  button to set the desired departure time.





i The longer you press the  or  button, the faster the time changes.

- ▶ Press the  and  buttons simultaneously.
The new departure time is stored.

Activating the set departure time

- ▶ Press the  or  button repeatedly until the desired departure time appears in the display.
- ▶ Press the  button.
The  symbol and the departure time appear in the display.

Deactivating a set departure time

- ▶ Press the  or  button.
The status of the auxiliary heating is shown in the display.
- ▶ Press the  button.
The first departure time stored appears in the display.
- ▶ Press the  button.
OFF is shown in the remote control display.

Replacing the remote control battery**⚠ WARNING**

Batteries contain toxic and corrosive substances. If batteries are swallowed, it can result in severe health problems. There is a risk of fatal injury.

Keep batteries out of the reach of children. If a battery is swallowed, seek medical attention immediately.

♻ Environmental note

Batteries contain pollutants. It is illegal to dispose of them with the household rubbish. They must be collected separately and disposed of in an environmentally responsible recycling system.



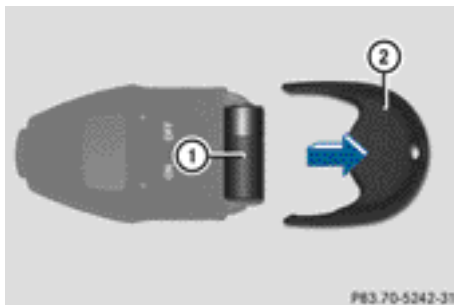

Dispose of batteries in an environmentally responsible manner. Take discharged batteries to a qualified specialist workshop or to a collection point for used batteries.

One 6 V pin battery, type 2CR11108 is required.



- ▶ Prise apart the side arms of battery cover ② and pull off battery cover ②.
- ▶ Remove old battery ①.
- ▶ Insert the new battery. Observe the polarity signs on the back of the remote control when doing so.
- ▶ Slide battery cover ② back onto the remote control.
- ▶ Use the remote control to check the vehicle's auxiliary heating functions.

Problems with the auxiliary heating/ventilation

Display messages	Possible causes/consequences and ► Solutions
FAIL	<p>The starter battery is not charged sufficiently or the system is faulty.</p> <ul style="list-style-type: none"> ► Charge the starter battery. ► Make another attempt to switch on the auxiliary heating using the remote control. ► Have the auxiliary heating checked at a qualified specialist workshop.
 FAIL	<p>The signal transmission between the transmitter and the vehicle is faulty.</p> <ul style="list-style-type: none"> ► Change your position in relation to the vehicle, moving closer if necessary. ► Make another attempt to switch the auxiliary heating on or off using the remote control.
 FAIL	<p>There is insufficient fuel in the fuel tank. This means that the tank content is below reserve fuel level.</p> <ul style="list-style-type: none"> ► Refuel at the nearest filling station. ► Make another attempt to switch on the auxiliary heating using the remote control.
	<p>The auxiliary heating is faulty.</p> <ul style="list-style-type: none"> ► Have the auxiliary heating checked at a qualified specialist workshop.

Adjusting the air vents

Important safety notes

 **WARNING**

Very hot or very cold air can flow from the air vents. This could result in burns or frostbite in the immediate vicinity of the air vents. There is a risk of injury.

Make sure that all vehicle occupants always maintain a sufficient distance to the air outlets. If necessary, redirect the airflow to another area of the vehicle interior.

In order to ensure the direct flow of fresh air through the air vents into the vehicle interior, please observe the following notes:

- never cover the vents or ventilation grilles in the vehicle interior.
-  For virtually draught-free ventilation, adjust the sliders of the air vents to the centre position.

Setting the centre air vents

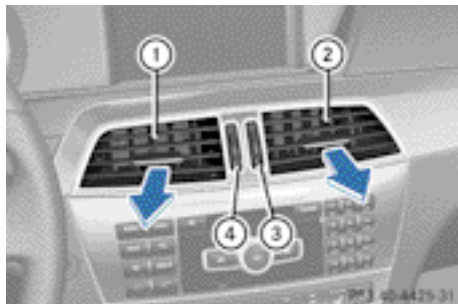

- ① Centre air vent, left
- ② Centre air vent, right
- ③ Centre vent thumbwheel, right
- ④ Centre vent thumbwheel, left

► **To open/close:** turn thumbwheels ③ and ④ up or down.

Adjusting the side air vents



- ① Side window demister vent
- ② Side air vent
- ③ Control for side air vent

► **To open/close:** turn thumbwheel ③ to the left or right.

Adjusting the glove compartment air vent

When automatic climate control is activated, the glove compartment can be ventilated, for instance to cool its contents. The level of air-

flow depends on the airflow and air distribution settings.

► **To open/close:** Close the air vent when heating the vehicle.

At high outside temperatures, open the air vent and activate the "cooling with air dehumidification" function. Otherwise, temperature-sensitive items stored in the glove compartment could be damaged.



- ① Air vent thumbwheel
- ② Air vent

► **To open/close:** turn thumbwheel ① clockwise or anti-clockwise.

Setting the rear-compartment air vents

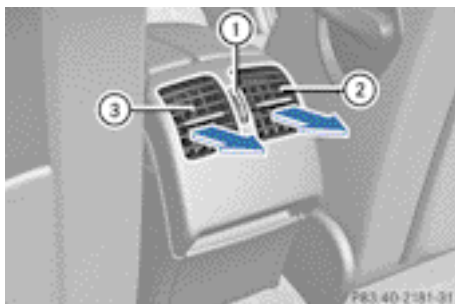

- ① Rear-compartment air vent thumbwheel
- ② Rear-compartment air vent, right
- ③ Rear-compartment air vent, left

► **To open/close:** turn thumbwheel ① up or down.

Useful information	148
Running-in notes	148
Driving	148
Manual transmission	157
Automatic transmission	158
Refuelling	165
Parking	169
Driving tips	171
Driving systems	174
Towing a trailer	209

Useful information

- i** This Owner's Manual describes all models, series and optional equipment for your vehicle that were available at the time of going to press. National variations are possible. Note that your vehicle may not be equipped with all of the functions described. This is also the case for systems and functions relevant to safety.
- i** Read the information on qualified specialist workshops: (▷ page 28).

Running-in notes

Important safety notes

New brake pads/linings and discs that have been replaced only achieve optimum braking effect after several hundred kilometres of driving. Compensate for the reduced braking effect by applying greater force to the brake pedal.

The first 1500 km

If you treat the engine with sufficient care from the very start, you will be rewarded with excellent performance for the remainder of the engine's life.

- Drive at varying vehicle speeds and engine speeds for the first 1500 km.
- Avoid overstraining the vehicle during this period, e.g. driving at full throttle.
- Change gear in good time, before the rev counter needle is $\frac{2}{3}$ of the way to the red area of the rev counter.
- Do not shift down a gear manually in order to brake.

Vehicles with automatic transmission:

- Try to avoid depressing the accelerator pedal beyond the point of resistance (kick-down).
- The shift ranges **3**, **2** or **1** should only be engaged when driving slowly, e.g. when driving in mountainous terrain.

After 1500 km, you may gradually accelerate the vehicle to full road and engine speeds.

Additional running-in notes for AMG vehicles:

- Do not drive at speeds above 140 km/h for the first 1,500 km.
- Only allow the engine to reach a maximum engine speed of 4,500 rpm briefly.

- i** You should also observe these notes on running-in if the engine or parts of the drivetrain on your vehicle have been replaced.

AMG vehicles with self-locking rear axle differential

Your vehicle is equipped with a self-locking differential on the rear axle. Change the oil after a running-in period of 3,000 km to improve protection of the rear axle differential. This oil change prolongs the service life of the differential. Have the oil change carried out at a qualified specialist workshop.

Driving

Important safety notes

WARNING

Objects in the driver's footwell may restrict the clearance around the pedals or block a depressed pedal. This jeopardises the operating and road safety of the vehicle. There is a risk of an accident.

Stow all objects securely in the vehicle so that they do not get into the driver's footwell. Always fit the floor mats securely and as prescribed in order to ensure that there is always sufficient room for the pedals. Do not use

loose floor mats and do not place several floor mats on top of one another.

WARNING

Unsuitable footwear can hinder correct usage of the pedals, e.g.:

- shoes with thick soles
- shoes with high heels
- slippers

There is a risk of an accident.

Wear suitable footwear to ensure correct usage of the pedals.

WARNING

If you switch off the ignition while driving, safety-relevant functions are only available with limitations, or not at all. This could affect, for example, the power steering and the brake boosting effect. You will require considerably more effort to steer and brake. There is a risk of an accident.

Do not switch off the ignition while driving.

WARNING

If the parking brake has not been fully released when driving, the parking brake can:

- overheat and cause a fire
- lose its hold function.

There is a risk of fire and an accident. Release the parking brake fully before driving off.

! Warm up the engine quickly. Do not use the engine's full performance until it has reached operating temperature.

Only set the automatic transmission to the respective drive positions when the vehicle is stationary.

Where possible, avoid spinning the drive wheels when pulling away on slippery roads. Otherwise, you could damage the drive train.

! **AMG vehicles:** at low engine oil temperatures (below +20 °C), the maximum engine speed is restricted in order to pro-

tect the engine. To protect the engine and maintain smooth engine operation, avoid driving at full throttle when the engine is cold.

Key positions

Key

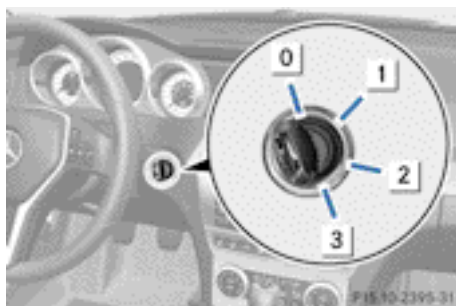

- 0** To remove the key
- 1** Power supply for some consumers, such as the windscreen wipers
- 2** Ignition (power supply for all consumers) and drive position
- 3** To start the engine

The steering wheel is locked when the key is removed from the ignition lock.

- i** If the key does not belong to the vehicle, it can still be turned in the ignition lock. However, the ignition will not be switched on. The engine cannot be started.

KEYLESS-GO

General notes

- Do not keep the KEYLESS-GO key:
 - with electronic devices, e.g. a mobile phone or another key
 - with metallic objects, e.g. coins or metal film
 - inside metallic objects, e.g. a metal case

This can affect the function of the key with KEYLESS-GO.

Vehicles with KEYLESS-GO are equipped with a key featuring an integrated KEYLESS-GO function and a detachable Start/Stop button. The Start/Stop button must be inserted in the ignition lock and the key must be in the vehicle.

Pressing the Start/Stop button several times in succession corresponds to the different key positions in the ignition lock. This is only the case if you are not depressing the brake pedal.

If you depress the brake pedal and press the Start/Stop button, the engine starts immediately.

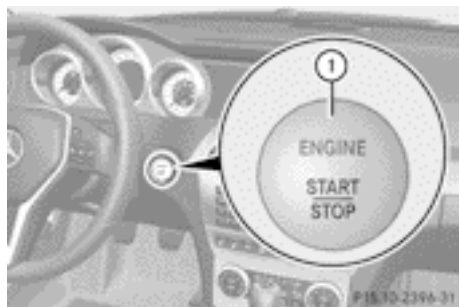

► **Position 0:** if Start/Stop button ① has not yet been pressed, this corresponds to the key being removed from the ignition.

► **Position 1:** press Start/Stop button ①. You can now activate the windscreen wipers, for example.

❗ If you then open the driver's door when in this position, the power supply is deactivated.

► **Position 2: (ignition):** press Start/Stop button ① twice.

❗ The power supply is switched off again if:

- the driver's door is opened and
- you press Start/Stop button ① once when in this position

Removing the Start/Stop button

You can remove the Start/Stop button from the ignition lock and start the vehicle as normal using the key.

❗ You do not have to remove the Start/Stop button from the ignition lock when you leave the vehicle.

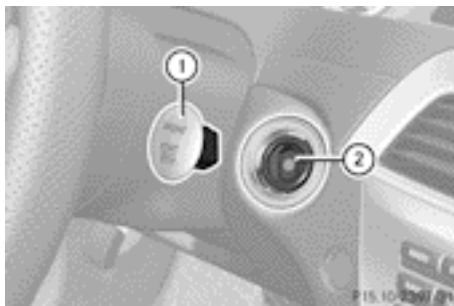

► Remove Start/Stop button ① from ignition lock ②.

❗ When you insert Start/Stop button ① into ignition lock ②, the system needs approximately two seconds recognition time. You can then use Start/Stop button ①.

Starting the engine

Important safety notes

⚠ WARNING

If children are left unsupervised in the vehicle, they could:

- open the doors, thus endangering other people or road users.
- get out and disrupt traffic.
- operate the vehicle's equipment.

Additionally, children could set the vehicle in motion if, for example, they:

- release the parking brake.
- shift the automatic transmission out of parking position P.

- shift the manual transmission into neutral.
- start the engine.

There is a risk of an accident and injury.

When leaving the vehicle, always take the key with you and lock the vehicle. Never leave children or animals unattended in the vehicle. Always keep the key out of reach of children.

WARNING

Combustion engines emit poisonous exhaust gases such as carbon monoxide. Inhaling these exhaust gases leads to poisoning. There is a risk of fatal injury. Therefore never leave the engine running in enclosed spaces without sufficient ventilation.

WARNING

Flammable materials introduced through environmental influence or by animals can ignite if in contact with the exhaust system or parts of the engine that heat up. There is a risk of fire.

Carry out regular checks to make sure that there are no flammable foreign materials in the engine compartment or in the exhaust system.

-  Do not depress the accelerator pedal when starting the engine.

General notes

-  **Vehicles with a petrol engine:** the catalytic converter is preheated for up to approximately 30 seconds after a cold start. The sound of the engine may change during this time.





Manual transmission

- ▶ Depress the brake pedal and keep it depressed.
- ▶ Fully depress the clutch pedal.
- ▶ Shift to neutral **N**.
-  You can only start the engine when the clutch pedal is fully depressed.

Automatic transmission

- ▶ Shift the transmission to position **P**.
The transmission position display in the multifunction display shows **P**.
-  You can also start the engine when the transmission is in position **N**.

Starting procedure with the key

-  To start the engine using the key instead of KEYLESS-GO, pull the Start/Stop button out of the ignition lock.
- ▶ **To start a petrol engine:** turn the key to position **3** in the ignition lock (▷ page 149) and release it as soon as the engine is running.
- ▶ **To start a diesel engine:** turn the key to position **2** in the ignition lock (▷ page 149).
The  preglow indicator lamp in the instrument cluster lights up.
- ▶ When the  preglow indicator lamp goes out, turn the key to position **3** (▷ page 149) and release it as soon as the engine is running.
-  You can start the engine without preglow if the engine is warm.

Using KEYLESS-GO to start the engine

You can start the engine if a valid key with the integrated KEYLESS-GO function is in the vehicle. Always take the key with you when leaving the vehicle, even if you only leave it for a short time. Pay attention to the important safety notes.

-  The Start/Stop button can be used to start the vehicle manually without inserting the key into the ignition lock. The key must be in the vehicle and the Start/Stop button must be inserted in the ignition lock. This mode for starting the engine operates independently of the ECO start/stop automatic engine start function.

- ▶ Depress the brake pedal and keep it depressed.
- ▶ **To start a petrol engine:** press the Start/Stop button once (▷ page 149). The engine starts.
- ▶ **To start a diesel engine:** press the Start/Stop button once (▷ page 149). Preglow is activated and the engine starts.

Pulling away

Manual transmission

- ▶ Depress the brake pedal and keep it depressed.
 - ▶ Fully depress the clutch pedal.
 - ▶ Shift to either first gear or reverse gear **R**.
 - ▶ Release the parking brake (▷ page 170).
 - ▶ Release the brake pedal.
 - ▶ Slowly release the clutch pedal and gently depress the accelerator pedal.
- !** Change gear in good time and avoid spinning the wheels. Otherwise, you could damage the vehicle.
- i** Follow the shift recommendations in the multifunction display for an economical driving style (▷ page 158).

- i** The vehicle locks centrally once you have pulled away. The locking knobs in the doors drop down.
- You can open the doors from the inside at any time.
- You can also deactivate the automatic door lock (▷ page 234).

Automatic transmission

WARNING

If the engine speed is above the idling speed and you engage transmission position **D** or **R**, the vehicle could pull away suddenly. There is a risk of an accident.

When engaging transmission position **D** or **R**, always firmly depress the brake pedal and do not simultaneously accelerate.

- i** It is only possible to shift the transmission from position **P** to the desired position if you depress the brake pedal. Only then is the selector lever lock released.
- ▶ Depress the brake pedal and keep it depressed.
 - ▶ Shift the transmission to position **D** or **R**.
 - ▶ Release the parking brake (▷ page 170).
 - ▶ Release the brake pedal.
 - ▶ Carefully depress the accelerator pedal.
- i** The vehicle locks centrally once you have pulled away. The locking knobs in the doors drop down.
- You can open the doors from the inside at any time.
- You can also deactivate the automatic locking feature (▷ page 234).
- i** Upshifts take place at higher engine speeds after a cold start. This helps the catalytic converter to reach its operating temperature more quickly.

Hill start assist

Hill start assist helps you when pulling away forwards or in reverse on an uphill gradient. It holds the vehicle for a short time after you have removed your foot from the brake pedal. This gives you enough time to move your foot from the brake pedal to the accelerator pedal and depress it before the vehicle begins to roll.

WARNING

After a short time, hill start assist will no longer brake your vehicle and it could roll away. There is a risk of an accident and injury.

Therefore, quickly move your foot from the brake pedal to the accelerator pedal. Never leave the vehicle when it is held by hill start assist.

- ▶ Take your foot off the brake pedal.
The vehicle is then held for about a second.
- ▶ Pull away.

Hill start assist is not active if:

- you are pulling away on a level road or a downhill gradient.
- on vehicles with automatic transmission, the transmission is in position **N**.
- the parking brake is engaged.
- ESP® is malfunctioning.

ECO start/stop function

Introduction

The ECO start/stop function switches the engine off automatically if the vehicle is stopped under certain conditions.

When pulling away again, the engine starts automatically. The ECO start/stop function thereby helps you to reduce the fuel consumption and emissions of your vehicle.

Important safety notes

WARNING

If the engine is switched off automatically and you exit the vehicle, the engine is restarted automatically. The vehicle may begin moving. There is a risk of accident and injury.

If you wish to exit the vehicle, always turn off the ignition and secure the vehicle against rolling away.

General notes

If the **ECO** symbol is shown in green in the multifunction display, the ECO start/stop function switches the engine off automatically if the vehicle stops moving.

Every time you switch on the engine using the key or the Start/Stop button, the ECO start/stop function is activated.

If the ECO start/stop function has been manually deactivated (▶ page 154) or a malfunc-

tion has caused the system to be deactivated, the **ECO** symbol is not displayed.

Automatic engine switch-off

General notes

The ECO start/stop function is operational and the **ECO** symbol is displayed in green in the multifunction display, if:

- the indicator lamp in the ECO button is lit green
- the outside temperature is within the range that is suitable for the system
- the engine is at normal operating temperature
- the set temperature for the vehicle interior has been reached
- the battery is sufficiently charged
- the system detects that the windscreen is not misted up when the air-conditioning system is switched on
- the bonnet is closed
- the driver's door is closed and the driver's seat belt is fastened

If not all conditions for automatic engine switch-off are fulfilled, the **ECO** symbol is shown in yellow.

i All of the vehicle's systems remain active when the engine is switched off automatically.

i The engine can be switched off automatically a maximum of four times (initial stop, then three subsequent stops) in succession. The **ECO** symbol is shown in yellow in the multifunction display after the engine has been started automatically for the fourth time. When the **ECO** symbol is shown in green in the multifunction display, automatic engine switch-off is again possible.

Vehicles with manual transmission

The ECO start/stop function switches off the engine automatically at low speeds.



- ▶ Brake the vehicle.
- ▶ Engage neutral **N** (> page 158) (follow gearshift instruction ① to engage neutral **N**, if necessary).
- ▶ Release the clutch pedal.
The engine is switched off automatically.

Vehicles with automatic transmission

If the vehicle is braked to a standstill in **D** or **N**, the ECO start/stop function switches off the engine automatically.

- ① The HOLD function can be activated if the engine has been switched off automatically. It is then not necessary to continue applying the brakes during the automatic stop phase. When you depress the accelerator pedal, the engine starts automatically and the braking effect of the HOLD function is deactivated.

Automatic engine start

General notes

The engine is started automatically if:

- you switch off the ECO start/stop function by pressing the ECO button
- you engage reverse gear **R**
- the vehicle starts to roll
- the brake system requires this
- the temperature in the vehicle interior deviates from the set range
- the system detects moisture on the windscreen when the air-conditioning system is switched on

- the battery's charge status is too low
- the driver's seat belt is released or the driver's door is opened

Vehicles with manual transmission

- ❗ Only engage gear when the clutch pedal is depressed.

The engine is started automatically if you:

- depress the clutch pedal fully
- depress the accelerator pedal

Vehicles with automatic transmission

The engine is started automatically if you:

- release the brake pedal when HOLD is not activated and the transmission is in position **D** or **N**
- depress the accelerator pedal
- move the transmission out of position **P**

- ① Shifting the transmission to position **P** does not start the engine.

- ① If you shift the transmission from **R** to **D**, the ECO start/stop function is available again once the **ECO** symbol reappears in green in the multifunction display.

Deactivating/activating the ECO start/stop function



ECO button

- ▶ **To switch off:** press button ①. Indicator lamp ② on button ① and the **ECO** symbol in the multifunction display go out.

- ▶ **To switch on:** press button ①.

Indicator lamp ② lights up.

If all conditions for automatic engine switch-off (▷ page 153) are fulfilled, the **ECO** symbol is shown in green in the multifunction display.

If not all conditions for automatic engine switch-off (▷ page 153) are fulfilled, the **ECO** symbol is shown in yellow in the multifunction display. If this is the case, the ECO start/stop function is not available.

- i** If indicator lamp ② is off, the ECO start/stop function has been deactivated manually or as the result of a malfunction. The engine will then not be switched off automatically when the vehicle stops.

Problems with the engine

Problem	Possible causes/consequences and ► Solutions
The engine does not start.	<p>The HOLD function or DISTRONIC PLUS is activated.</p> <ul style="list-style-type: none"> ► Deactivate the HOLD function (▷ page 188) or DISTRONIC PLUS (▷ page 179). ► Try to start the engine again.
The engine does not start. The starter motor can be heard.	<ul style="list-style-type: none"> • There is a malfunction in the engine electronics. • There is a malfunction in the fuel supply. <p>► Turn the key back to position 0 in the ignition lock before attempting to start the engine again.</p> <p>or</p> <p>► Press the Start/Stop button repeatedly until all indicator lamps in the instrument cluster go out.</p> <p>► Try to start the engine again (▷ page 150). Avoid excessively long and frequent attempts to start the engine, as this will drain the battery.</p> <p>If the engine does not start after several attempts:</p> <ul style="list-style-type: none"> ► Consult a qualified specialist workshop.
The engine does not start. The starter motor can be heard. The reserve fuel warning lamp is lit and the fuel gauge display shows 0 .	<p>The fuel tank is empty.</p> <ul style="list-style-type: none"> ► Refuel the vehicle.
The engine does not start. You cannot hear the starter motor.	<p>The on-board voltage is too low because the battery is too weak or discharged.</p> <ul style="list-style-type: none"> ► Jump-start the vehicle (▷ page 338). <p>If the engine does not start despite attempts to jump-start it:</p> <ul style="list-style-type: none"> ► Consult a qualified specialist workshop. <p>The starter motor was exposed to a thermal load that was too high.</p> <ul style="list-style-type: none"> ► Allow the starter motor to cool down for approximately two minutes. ► Try to start the engine again. <p>If the engine still does not start:</p> <ul style="list-style-type: none"> ► Consult a qualified specialist workshop.

Problem	Possible causes/consequences and ► Solutions
Vehicles with a petrol engine: The engine is not running smoothly and is misfiring.	<p>There is a malfunction in the engine electronics or in a mechanical component of the engine management system.</p> <ul style="list-style-type: none"> ► Only depress the accelerator pedal slightly. Otherwise, non-combusted fuel may get into the catalytic converter and damage it. ► Have the cause rectified immediately at a qualified specialist workshop.
The coolant temperature display is showing more than 120 °C. The coolant warning lamp may also be on and a warning tone may sound.	<p>The coolant level is too low. The coolant is too hot and the engine is no longer being cooled sufficiently.</p> <ul style="list-style-type: none"> ► Stop as soon as possible and allow the engine and the coolant to cool down. ► Check the coolant level (► page 318). Observe the warning notes as you do so and top up the coolant if necessary. <p>If the coolant level is correct, the engine radiator fan may be faulty. The coolant is too hot and the engine is no longer being cooled sufficiently.</p> <ul style="list-style-type: none"> ► If the coolant temperature is below 120 °C, you can continue driving to the nearest qualified specialist workshop. ► Avoid heavy loads on the engine as you do so, e.g. driving in mountainous terrain and stop-start traffic.

Manual transmission

Gear lever

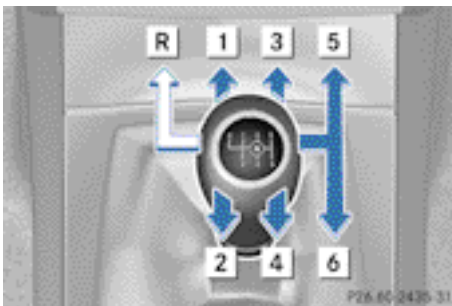

Gear lever

- R** Reverse gear
- 1** to **6** Forward gears

! Only engage gear when the clutch pedal is depressed.

! When shifting between **5th** and **6th** gear, you should always push the gear lever all the way to the right. Otherwise, you could shift unintentionally into **3rd** or **4th** gear and damage the transmission.

If you shift down at too high a speed (transmission braking), this can cause the engine to overrev, leading to engine damage.

Do not use the clutch bite point to keep the vehicle stationary on uphill gradients.

There is otherwise a risk of damaging the clutch.

! On long and steep downhill gradients, especially if the vehicle is laden or towing a trailer, you must shift into gear **1**, **2** or **3** in good time. This uses the engine's braking effect. This relieves the load on the brake system and prevents the brakes from overheating and wearing too quickly.

Shifting to neutral (N)



- ▶ Depress the clutch pedal fully.
- ▶ Move the gear lever to position **N** ①.

Engaging reverse gear

- ❗ Only shift into reverse gear **R** when the vehicle is stationary. Otherwise, you could damage the transmission.
- i The ECO start/stop function is not available when reverse gear is engaged. For further information on the ECO start/stop function, see (▷ page 153).
- ▶ Move the gear lever firmly to the left beyond the point of resistance and then forwards.

Gearshift recommendation

The gearshift recommendations assist you in adopting an economical driving style. The recommended gear is shown in the multifunction display.



- ▶ Shift gear according to gearshift recommendation ① when shown in the multifunction display of the instrument cluster.

Automatic transmission

Important safety notes

⚠ WARNING

If the engine speed is above the idling speed and you engage transmission position **D** or **R**, the vehicle could pull away suddenly. There is a risk of an accident.

When engaging transmission position **D** or **R**, always firmly depress the brake pedal and do not simultaneously accelerate.

⚠ WARNING

The automatic transmission switches to neutral position **N** when you switch off the engine. The vehicle may roll away. There is a risk of an accident.

After switching off the engine, always switch to parking position **P**. Prevent the parked vehicle from rolling away by applying the parking brake.

- i Bear in mind that the power transmission between the engine and the transmission is interrupted when the engine is switched off. For this reason, shift the automatic transmission to **P** when the engine is switched off and the vehicle is at a standstill. Apply the parking brake to prevent the vehicle from rolling away.

Selector lever

Overview of transmission positions

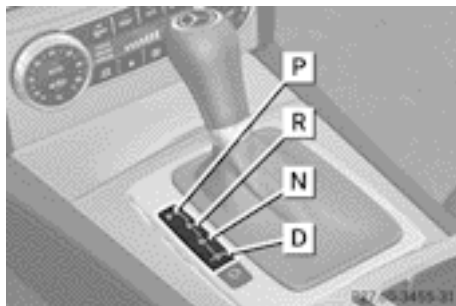

Selector lever (example)

- P** Park position with selector lever lock
- R** Reverse gear
- N** Neutral
- D** Drive

Transmission position and drive program display



- ① Transmission position display
- ② Drive program display

The current transmission position and drive program appear in the multifunction display.

Transmission positions

P **Park position**
This prevents the vehicle from rolling away when stopped. Do not shift the transmission into position **P** (▷ page 169) unless the vehicle is stationary.

The key can only be removed if the transmission is in position **P**. If the key is removed from the ignition lock, the selector lever is locked.

R **Reverse gear**
Only shift the transmission to **R** when the vehicle is stationary.

N **Neutral**
Do not shift the transmission to **N** while driving. Otherwise, the automatic transmission could be damaged.

Releasing the brakes will allow you to move the vehicle freely, e.g. to push it or tow it.

If ESP® is deactivated or faulty: only shift the transmission to position **N** if the vehicle is in danger of skidding, e.g. on icy roads.

! Rolling in neutral **N** can lead to damage to the transmission.

D **Drive**
The automatic transmission changes gear automatically. All forward gears are available.

Changing gear

The automatic transmission shifts to the individual gears automatically when it is in transmission position **D**. Gearshifting is determined by:

- a shift range restriction, if selected
- the selected drive program (▷ page 160)

- the position of the accelerator pedal
- the road speed

Driving tips

Accelerator pedal position

Your style of driving influences how the automatic transmission shifts gear:

- little throttle: early upshifts
- more throttle: late upshifts

AMG vehicles

When shifting down, the double-clutch function is active regardless of the currently selected drive program. The double-clutch function reduces load change reactions and is conducive to a sporty driving style. The sound generated by the double-clutch function depends on the drive program selected.

Kickdown

Use kickdown for maximum acceleration.

- ▶ Depress the accelerator pedal beyond the pressure point.
The transmission shifts to a lower gear depending on the engine speed.
- ▶ Ease off the accelerator pedal once the desired speed is reached.
The automatic transmission shifts back up.

Towing a trailer

- ▶ Drive in the middle of the engine speed range on uphill gradients.
- ▶ Shift down to shift range **3** or **2** (▷ page 162) depending on the uphill or downhill gradient, even if cruise control or SPEEDTRONIC is activated.

Program selector button

General notes

The program selector button allows you to choose between different driving characteristics.

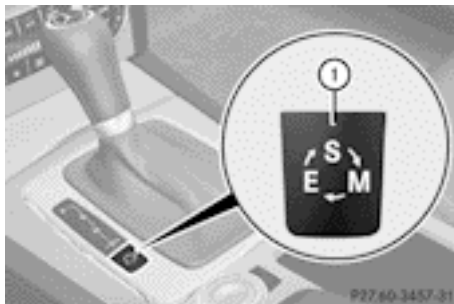

Example: program selector button

E Economy	Comfortable, economical driving
S Sport	Sporty driving style
M Manual	Manual gearshifting

- i** For further information on the automatic drive program, see (▷ page 161).
- ▶ Press program selector button ① repeatedly until the letter for the desired drive program appears in the multifunction display.
- i** The automatic transmission switches to automatic drive program **E** each time the engine is started.

AMG vehicles



Drive program selector with manual drive program

C Controlled Efficiency	Comfortable, economical driving
S Sport	Sporty driving style
S+ SportPlus	Extremely sporty driving style
M Manual	Manual gearshifting
RS RACE START	Optimal vehicle acceleration from a standstill

- i** For further information on the automatic drive program, see (▷ page 161).
- ▶ Turn drive program selector ① until the desired drive program appears in the multifunction display in the speedometer. The drive program indicator on drive program selector ① lights up in red.
- i** The automatic transmission switches to automatic drive program **C** each time the engine is started.
- i** **RS** cannot be selected during normal driving. For further information on RACE START; see (▷ page 190).

Steering wheel gearshift paddles



- ① Left-hand steering wheel gearshift paddle
- ② Right-hand steering wheel gearshift paddle

In the automatic drive program, you can restrict or derestrict the shift range by using the steering wheel gearshift paddles or the selector lever (▷ page 162).

In the manual drive program, you can change gear using the steering wheel gearshift paddles or the selector lever (▷ page 163).

- i** You can only change gear with the steering wheel gearshift paddles when the transmission is in position **D**.

Automatic drive program

Drive program **E** (drive program **C** on AMG vehicles) is characterised by the following:

- comfort-oriented engine and automatic transmission settings.
- optimal fuel consumption resulting from the automatic transmission shifting up sooner.
- the vehicle pulling away more gently in forward and reverse gears unless the accelerator pedal is depressed fully.
- increased sensitivity. This improves driving stability on slippery road surfaces, for example.
- the automatic transmission shifting up sooner. This results in the vehicle being driven at lower engine speeds and the wheels being less likely to spin.

Drive program **S** (or, in the case of AMG vehicles, drive programs **S** and **S+**) is characterised by the following:

- sporty engine and automatic transmission settings.
- the vehicle pulling away in first gear.
- the automatic transmission shifting up later.
- as a result of the later automatic transmission shift points, the fuel consumption possibly being higher.

Shift ranges

Introduction

When the automatic transmission is in position **D**, it is possible to restrict or derestrict the shift range (▷ page 162).

The shift range selected is shown in the multifunction display. The automatic transmission shifts only as far as the selected gear.

Shift range:

3	To use the engine's braking effect
2	To use the braking effect of the engine on downhill gradients and for driving: <ul style="list-style-type: none"> • on steep mountain roads • in mountainous terrain • in arduous conditions
1	To use the braking effect of the engine on extremely steep downhill gradients and on long downhill stretches

Restricting the shift range

- ▶ Press the selector lever to the left towards **D-**.

or

- ▶ Pull the left-hand steering wheel gearshift paddle.

The automatic transmission shifts down one gear and restricts the shift range to the relevant gear.

- i** If the engine exceeds the maximum engine speed when shifting down, the automatic transmission protects against engine damage by not shifting down.
- i** If the maximum engine speed for the shift range is reached and you continue to accelerate, the automatic transmission shifts up, even if the shift range is restricted. This prevents the engine from overrevving.

Extending the shift range

- ▶ Briefly press the selector lever to the right towards **D+**.

or

- ▶ Pull the right-hand steering wheel gearshift paddle.
The shift range is derestricted.

Clearing the shift range restriction

- ▶ Press and hold the selector lever towards **D+** until **D** is shown once more in the multifunction display.

or

- ▶ Pull and hold the right-hand steering wheel gearshift paddle until **D** is shown again in the multifunction display.
The automatic transmission shifts from the current shift range directly to **D**.

Selecting the ideal shift range

- ▶ Press the selector lever to the left towards **D-** and hold it in position.

or

- ▶ Pull the left-hand steering wheel gearshift paddle and hold it in position.
The automatic transmission shifts to the gear which allows optimum acceleration

and deceleration. To do this, the automatic transmission shifts down one or more gears.

Manual drive program

Activating the manual drive program

Manual drive program **M** can be selected using the program selector or the drive program selector button. If the transmission is in position **D**, you can change gear using the steering wheel gearshift paddles or the selector lever in manual drive program **M**.

- ▶ Press the program selector button (▷ page 160) repeatedly until **M** appears in the multifunction display.
- ▶ **AMG vehicles:** turn the drive program selector (▷ page 161) until **M** appears in the multifunction display.
The indicator **M** on the drive program selector lights up in red.

Shifting up

- ▶ Briefly press the selector lever to the right towards **D+**.

or

- ▶ Pull the right-hand steering wheel gearshift paddle (▷ page 161).
The automatic transmission shifts up to the next gear.

AMG vehicles

- ! In manual gearshift program **M**, the automatic transmission does not shift up automatically even when the engine limiting speed for the current gear is reached. When the engine limiting speed is reached, the fuel supply is cut to prevent the engine from overrevving. You must make sure that the engine speed does not reach the red area of the rev counter. Otherwise, there is a risk of engine damage.

- ▶ If the colour in the speedometer multifunction display changes to red and the **UP** display message is shown, shift up a gear.

Gearshift recommendation



The gearshift recommendations assist you in adopting an economical driving style. The recommended gear is shown in the multifunction display.

- ▶ If relevant gearshift recommendation ① appears in the multifunction display on the instrument cluster, pull on the right-hand steering wheel gearshift paddle (▷ page 161).
The automatic transmission shifts to recommended gear ②.

Downshifting

- ▶ Briefly press the selector lever to the left towards **D-**.

or

- ▶ Pull the left-hand steering wheel gearshift paddle (▷ page 161).
The automatic transmission shifts down to the next gear.

- i If you slow down or stop without shifting down, the automatic transmission automatically shifts down.
- i For maximum acceleration, push the selector lever to the left or pull the left-hand steering wheel gearshift paddle until the transmission selects the optimum gear for the current speed.

Kickdown

- ▶ **i AMG vehicles:** it is not possible to use kickdown in manual drive program **M**.

You can also use kickdown for maximum acceleration in manual drive program **M**.

- ▶ Depress the accelerator pedal beyond the pressure point.
The transmission shifts to a lower gear depending on the engine speed.

Deactivating the manual drive program

- ▶ **Vehicles without the dynamic handling package with sports mode:** press the program selector button (▷ page 160) repeatedly until **E** or **S** appears in the multifunction display.
- ▶ **Vehicles with the dynamic handling package with sports mode:** press the program selector button (▷ page 160). **M** is no longer shown in the multifunction display.
- ▶ **AMG vehicles:** turn the drive program selector (▷ page 161) until **C**, **S** or **S+** appears in the multifunction display.

Problems with the transmission

Problem	Possible causes/consequences and ► Solutions
The transmission has problems shifting gear.	The transmission is losing oil. ► Have the transmission checked at a qualified specialist workshop immediately.
The acceleration ability is deteriorating. The transmission no longer changes gear.	The transmission is in emergency mode. It is only possible to shift into second gear and reverse gear. ► Stop. ► Shift the transmission to position P . ► Switch off the engine. ► Wait at least ten seconds before restarting the engine. ► Shift the transmission to position D or R . If D is selected, the transmission shifts into second gear; if R is selected, the transmission shifts into reverse gear. ► Have the transmission checked at a qualified specialist workshop immediately.

Releasing the parking lock manually

If an electrical fault occurs, you can release the selector lever lock manually to move it out of position **P**. You may need to do this, for example, if you wish to tow the vehicle.



! Do not use any sharp-edged objects to remove the selector lever gaiter from the centre console. This could damage the selector lever gaiter.

- Apply the parking brake.
- Prise out selector lever gaiter ① with a flat, blunt object (e.g. a screwdriver wrapped in

cloth) from the right-hand edge. Pull selector lever gaiter ① up and out.

- Press release button ② down and simultaneously move the selector lever out of position **P**.
The selector lever can now be moved freely until it is returned to position **P**.

Refuelling

Important safety notes

WARNING

Fuel is highly flammable. If you handle fuel incorrectly, there is a risk of fire and explosion.

You must avoid fire, naked flames, creating sparks and smoking. Switch off the engine and, if applicable, the auxiliary heating before refuelling.

WARNING

Fuels are poisonous and hazardous to health. There is a danger of injury.

Do not swallow fuel or let it come into contact with skin, eyes or clothing. Do not inhale fuel vapours. Keep fuels out of the reach of children.

If you or others come into contact with fuel, observe the following:

- Wash the fuel off any affected areas of skin with water and soap immediately.
- If you get fuel in your eyes, rinse them thoroughly with clean water immediately. Seek immediate medical attention.
- If fuel is swallowed, seek immediate medical attention. Do not induce vomiting.
- Change any clothing that has come into contact with fuel immediately.

WARNING

Electrostatic charge can cause sparks and thereby ignite fuel vapours. There is a risk of fire and explosion.

Always touch the vehicle body before opening the fuel filler flap or touching the fuel pump nozzle. This discharges any electrostatic charge that may have built up.

WARNING

Vehicles with a diesel engine:

If you mix diesel fuel with petrol, the flash point of this fuel mixture is lower than that of pure diesel fuel. When the engine is running, components in the exhaust system may overheat unnoticed. There is a risk of fire.

Never refuel with petrol. Never add petrol to diesel fuel.

- !** Do not use petrol to refuel vehicles with a diesel engine. Do not use diesel to refuel vehicles with a petrol engine. Do not switch on the ignition if you accidentally refuel with the wrong fuel. Otherwise, the fuel will enter the fuel system. Even small amounts of the wrong fuel could result in damage to the fuel system and the engine. The repair costs are high. Notify a qualified specialist workshop and have the fuel tank and fuel lines drained completely.

- !** Overfilling the fuel tank could damage the fuel system.

- !** Take care not to spill any fuel on painted surfaces. You could otherwise damage the paintwork.

- !** Use a filter when adding fuel from a fuel can. The fuel lines and/or the diesel injection system could otherwise be blocked by particles from the fuel can.

Do not get into the vehicle again during the refuelling process. Otherwise, electrostatic charge could build up again.

If you overfill the fuel tank, some fuel may spray out when you remove the fuel pump nozzle.

For further information on fuel and fuel quality (▷ page 372).

Refuelling

Opening/closing the fuel filler flap

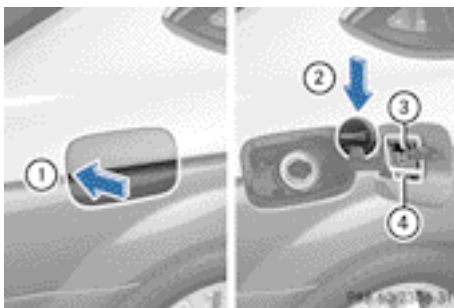

- ① To open the fuel filler flap
- ② To insert the fuel filler cap
- ③ Tyre pressure table
- ④ Fuel type to be refuelled

The fuel filler flap is unlocked or locked automatically when you open or close the vehicle with the key or using KEYLESS-GO.

The position of the fuel filler cap  is displayed in the instrument cluster. The arrow next to the filling pump indicates the side of the vehicle.

Opening

- ▶ Switch off the engine.
- ▶ Remove the key from the ignition lock.
- ▶ KEYLESS-GO: open the driver's door.
This corresponds to key position **0**: "key removed".
The driver's door can be closed again.
- ▶ Press the fuel filler flap in the direction of arrow ①.
The fuel filler flap opens slightly.
- ▶ Open the fuel filler flap fully.
- ▶ Turn the fuel filler flap anti-clockwise and remove it.
- ▶ Insert the fuel filler cap into the holder bracket on the inside of filler flap ②.
- ▶ Completely insert the filler neck of the fuel pump nozzle into the tank, hook in place and refuel.
- ▶ Only fill the tank until the pump nozzle switches off.
- ▶ **i** Do not add any more fuel after the pump stops filling for the first time. Otherwise, fuel may leak out.

Closing

- ▶ Replace the cap on the filler neck and turn clockwise until it engages audibly.
- ▶ Close the fuel filler flap.
- ▶ **i** Close the fuel filler flap before locking the vehicle.

Problems with the fuel and fuel tank	
Problem	Possible causes/consequences and ► Solutions
Fuel is leaking from the vehicle.	<p>The fuel line or the fuel tank is faulty.</p> <p> WARNING</p> <p>There is a risk of fire or explosion.</p> <ul style="list-style-type: none"> ► Turn the key to position 0 in the ignition lock immediately and remove it (▷ page 149). ► Do not restart the engine under any circumstances. ► Consult a qualified specialist workshop.
The engine does not start.	<p>The fuel tank of a vehicle with a diesel engine has been run completely dry.</p> <ul style="list-style-type: none"> ► Refuel the vehicle with at least 5 litres of diesel. ► Turn the ignition on for approximately ten seconds (▷ page 149). ► Start the engine continuously for a maximum of ten seconds until it runs smoothly. <p>If the engine does not start:</p> <ul style="list-style-type: none"> ► Turn the ignition on again a maximum of ten seconds (▷ page 149). ► Start the engine again continuously for a maximum of ten seconds until it runs smoothly. <p>If the engine does not start after three attempts:</p> <ul style="list-style-type: none"> ► Consult a qualified specialist workshop.
The fuel filler flap cannot be opened.	<p>The fuel filler flap is not unlocked.</p> <p>or</p> <p>The key battery is discharged.</p> <ul style="list-style-type: none"> ► Unlock the vehicle using the emergency key element (▷ page 84). <p>The fuel filler flap is unlocked, but the opening mechanism is jammed.</p> <ul style="list-style-type: none"> ► Consult a qualified specialist workshop.

Parking

Important safety notes

⚠ WARNING
 Flammable material such as leaves, grass or twigs may ignite if they come into contact with hot parts of the exhaust system or exhaust gas flow. There is a risk of fire.
 Park the vehicle so that no flammable material can come into contact with hot vehicle components. In particular, do not park on dry grassland or harvested grain fields.

⚠ WARNING
 If you switch off the ignition while driving, safety-relevant functions are only available with limitations, or not at all. This could affect, for example, the power steering and the brake boosting effect. You will require considerably more effort to steer and brake. There is a risk of an accident.
 Do not switch off the ignition while driving.

⚠ WARNING
 If you leave children unattended in the vehicle, they may be able to set the vehicle in motion if, for example, they:

- release the parking brake
- shift the automatic transmission out of park position **P** or shift manual transmission into neutral
- start the engine

In addition, they may operate vehicle equipment and become trapped. There is a risk of an accident and injury.
 When leaving the vehicle, always take the key with you and lock the vehicle. Never leave children unattended in the vehicle.

! Always secure the vehicle correctly against rolling away. Otherwise, the vehicle or its drivetrain could be damaged.

To ensure that the vehicle is secured against rolling away unintentionally:

- the parking brake must be applied.
- on vehicles with manual transmission, engage first gear or reverse gear.
- on vehicles with automatic transmission, the transmission must be in position **P** and the key must be removed from the ignition lock.
- on uphill or downhill gradients, the front wheels must be turned towards the kerb.

Switching off the engine

Important safety notes

⚠ WARNING
 The automatic transmission switches to neutral position **N** when you switch off the engine. The vehicle may roll away. There is a risk of an accident.
 After switching off the engine, always switch to parking position **P**. Prevent the parked vehicle from rolling away by applying the parking brake.

Vehicles with manual transmission

- ▶ Shift to either first gear or reverse gear **R**.
- ▶ Turn the key to position **0** in the ignition lock and remove it.
 The immobiliser is activated.
- ▶ Firmly depress the parking brake.

Vehicles with automatic transmission

- ▶ Firmly depress the parking brake.
- ▶ Shift the transmission to position **P**.

Using the key

- ▶ Turn the key to position **0** in the ignition lock and remove it.
 The immobiliser is activated.
- i** The key can only be removed if the transmission is in position **P**.

Using KEYLESS-GO

- ▶ Press the Start/Stop button (▷ page 149). The engine stops and all the indicator lamps in the instrument cluster go out.
- i** When the driver's door is closed, this corresponds to key position **1**. When the driver's door is open, this corresponds to key position **0**: "key removed".
- i** The engine can be switched off while the vehicle is in motion by pressing and holding the Start/Stop button for about three seconds. This function operates independently of the ECO start/stop automatic engine switch-off function.

Parking brake

WARNING

If you must brake the vehicle with the parking brake, the braking distance is considerably longer and the wheels could lock. This increases the risk of skidding and an accident.

Only use the parking brake to brake the vehicle when the service brake is faulty. Do not apply the parking brake too firmly. If the wheels lock, release the parking brake until the wheels begin turning again.

WARNING

If you leave children unattended in the vehicle, they could set the vehicle in motion by, for example:



- releasing the parking brake
- shifting an automatic transmission out of parking position **P**
- shifting a manual transmission into neutral
- starting the engine

They could also operate vehicle equipment. There is a risk of an accident and injury.

When leaving the vehicle, always take the key with you and lock the vehicle. Never leave children unattended in the vehicle.

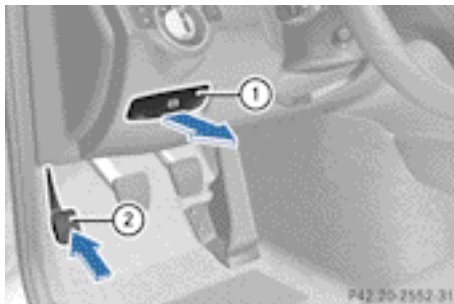
The brake lights do not light up when you brake the vehicle with the parking brake.



- ▶ **To apply:** depress parking brake **②** firmly. The  indicator lamp in the instrument cluster lights up if the engine is running.
- ▶ **To release:** depress the brake pedal and keep it depressed.
- ▶ Pull release handle **①**. The  indicator lamp in the instrument cluster goes out.

Parking up the vehicle

If you leave the vehicle parked up for longer than four weeks, the battery may be damaged by exhaustive discharging.

- ▶ Disconnect the battery or connect it to a trickle charger.
- i** You can obtain information about trickle chargers from a qualified specialist workshop.

If you leave the vehicle parked up for longer than six weeks, the vehicle may suffer damage as a result of lack of use.

- ▶ Visit a qualified specialist workshop and seek advice.

Driving tips

General driving tips

Important safety notes

WARNING

If you switch off the ignition while driving, safety-relevant functions are only available with limitations, or not at all. This could affect, for example, the power steering and the brake boosting effect. You will require considerably more effort to steer and brake. There is a risk of an accident.

Do not switch off the ignition while driving.

ECO display

The ECO display provides feedback on how economical your driving characteristics are. The ECO display assists you in achieving the most economical driving style for the selected settings and prevailing conditions. Consumption can be significantly influenced by your driving style.



Example: ECO display

The ECO display consists of three bars:

- **Acceleration**
- **Constant**
- **Coasting**

The percentage count is the mean value of the three bar values. The three bars and the mean value begin at the value of 50%. A higher percentage count indicates a more economical driving style.

The ECO display does not indicate the actual fuel consumption and a fixed percentage count in the ECO display does not indicate a fixed consumption figure.

In addition to driving style, the consumption is affected by many other factors, such as:

- load
- tyre pressure
- cold start
- choice of route
- the use of electrical consumers

These factors are not included in the ECO display.

The evaluation of your driving style takes the following three categories into consideration:

- **Acceleration** (evaluation of all acceleration processes):
 - The bar fills up: moderate acceleration, especially at higher speeds
 - The bar empties: sporty acceleration
- **Constant** (assessment of driving behaviour at all times):
 - The bar fills up: constant speed and avoidance of unnecessary acceleration and deceleration
 - The bar empties: fluctuations in speed
- **Coasting** (assessment of all deceleration processes):
 - The bar fills up: anticipatory driving, keeping your distance and early release of the accelerator. The vehicle can coast without use of the brakes.
 - The bar empties: frequent braking

i An economical driving style involves driving at a moderate engine speed.

To achieve a higher value in the categories **Acceleration** and **Constant**:

- observe the gearshift recommendation.
- drive the vehicle in drive program **E** (vehicles with automatic transmission).

i On long journeys at a constant speed, e.g. on the motorway, only the bar for **Constant** will change.

i The ECO display summarises the driving characteristics from the start of the journey to its completion. Therefore, there are

dynamic changes in the bars at the start of a journey. During a prolonged driving time, these changes are smaller. For more dynamic changes, perform a manual reset.

For further information on the ECO display, see (▷ page 223).

Braking

Important safety notes

WARNING

If you shift down on a slippery road surface in an attempt to increase the engine's braking effect, the drive wheels could lose their grip. This increases the risk of skidding and having an accident.

Do not shift down for additional engine braking on a slippery road surface.

Downhill gradients

On long and steep downhill gradients, you must:

- shift to a lower gear in good time, or
- on vehicles with automatic transmission, select shift gear **1, 2** or **3**.

Take particular note of this when driving a laden vehicle and when towing a trailer.

- i** This also applies if you have activated cruise control, SPEEDTRONIC or DIS-TRONIC PLUS.

This will use the braking effect of the engine, so less braking will be required to maintain vehicle speed. This relieves the load on the brake system and prevents the brakes from overheating and wearing too quickly.

Heavy and light loads

WARNING

The braking system can overheat if you leave your foot on the brake pedal while driving. This increases the braking distance and could

even cause the braking system to fail. There is a risk of an accident.

Never use the brake pedal as a footrest. Do not simultaneously depress both the brake pedal and the accelerator pedal while driving.

- !** Depressing the brake pedal constantly results in excessive and premature wear to the brake pads.

If heavy demands are made on the brakes, do not park the vehicle immediately. Drive on for a short while. This allows the airflow to cool the brakes more quickly.

If the brakes have been used only moderately, you should occasionally test their effectiveness. To do this, brake more firmly from a higher speed. This improves the grip of the brakes.

Wet road surfaces

If you have driven for a long time in heavy rain without braking, there may be a delayed reaction from the brakes when braking for the first time. This may also occur after the vehicle has been washed.

You have to depress the brake pedal more firmly. Maintain a greater distance from the vehicle in front.

After driving on a wet road or having the vehicle washed, brake firmly while paying attention to the traffic conditions. This will warm up the brake discs, thereby drying them more quickly and protecting them against corrosion.

Limited braking performance on salt-treated roads

If you drive on salt-treated roads, a layer of salt may form on the brake discs and pads. This can increase the braking distance considerably.

- Brake occasionally to remove any possible salt residue. Ensure that you do not endanger other road users when doing so.
- Carefully depress the brake pedal at the end of the journey and when starting the next journey.
- Maintain a much greater distance to the vehicle in front.

New brake pads/linings

New brake pads/brake pads and discs that have been replaced only achieve optimum braking effect after several hundred kilometres of driving. Compensate for the reduced braking effect by applying greater force to the brake pedal.

For safety reasons, Mercedes-Benz recommends that you only have brake pads/linings fitted to your vehicle which have been approved for Mercedes-Benz vehicles or which correspond to an equivalent quality standard. Brake pads/linings which have not been approved for Mercedes-Benz vehicles or which are not of an equivalent quality could affect your vehicle's operating safety.

High-performance brake system for AMG vehicles

The high-performance brake system is designed for high loads. This may lead to noise when braking. This is dependent on:

- speed
- braking force
- environmental conditions, such as temperature and humidity

The wear and tear on individual brake system components, e.g. brake pads or discs, depends on:

- the individual driving style
- the operating conditions

For this reason, it is impossible to state a mileage (service life) that will be valid under all circumstances. An aggressive driving style will lead to high wear. You can obtain further

information about this from your Mercedes-Benz Service Centre.

New brake pads/linings and discs that have been replaced only achieve optimum braking effect after several hundred kilometres of driving. Compensate for the reduced braking effect by applying greater force to the brake pedal. Always be aware of this and adapt your driving and braking accordingly during the running-in period.

Excessive heavy braking results in correspondingly high brake wear. Observe the brake wear warning lamp in the instrument cluster and note any brake status messages in the multifunction display. If you regularly drive at high speeds, it is particularly important to have the brake system checked and maintained regularly.

Driving on wet roads

Aquaplaning

If water has accumulated to a certain depth on the road surface, there is a danger of aquaplaning occurring, even if:

- you are driving at low speeds
 - the tyres have adequate tread depth
- For this reason, do not drive in tyre ruts and brake carefully.

Driving on flooded roads

If you have to drive on stretches of road on which water has collected, please bear in mind that:

- the maximum permissible fording depth in still water is 25 cm
- you should drive no faster than walking pace

! Bear in mind that vehicles travelling in front or in the opposite direction create waves. This may cause the maximum permissible water depth to be exceeded.

These notes must be observed under all circumstances. You could otherwise dam-

age the engine, the electronics or the transmission.

Winter driving

Important safety notes

WARNING

If you shift down on a slippery road surface in an attempt to increase the engine's braking effect, the drive wheels could lose their grip. This increases the risk of skidding and having an accident.

Do not shift down for additional engine braking on a slippery road surface.

DANGER

If the exhaust pipe is blocked or adequate ventilation is not possible, poisonous gases such as carbon monoxide (CO) may enter the vehicle. This is the case, e.g. if the vehicle becomes trapped in snow. There is a risk of fatal injury.

If you leave the engine or the auxiliary heating running, make sure the exhaust pipe and area around the vehicle are clear of snow. To ensure an adequate supply of fresh air, open a window on the side of the vehicle that is not facing into the wind.

Have your vehicle winterproofed at a qualified specialist workshop at the onset of winter.

Observe the notes in the "Winter operation" section (▷ page 348).

Driving with summer tyres

Observe the notes in the "Winter operation" section (▷ page 348).

Slippery road surfaces

WARNING

If you shift down on a slippery road surface in an attempt to increase the engine's braking effect, the drive wheels could lose their grip.

This increases the risk of skidding and having an accident.

Do not shift down for additional engine braking on a slippery road surface.

You should drive particularly carefully on slippery road surfaces. Avoid sudden acceleration, steering and braking manoeuvres.

If the vehicle threatens to skid or cannot be stopped when moving at low speed:

- ▶ **Vehicles with manual transmission:** shift to neutral.
- ▶ **Vehicles with automatic transmission:** shift the transmission to position **N**.
- ▶ Try to bring the vehicle under control by using corrective steering.

 For more information on driving with snow chains, see (▷ page 349).

The outside temperature indicator is not designed to serve as an ice-warning device and is therefore unsuitable for that purpose. Changes in the outside temperature are displayed after a short delay.

Indicated temperatures just above the freezing point do not guarantee that the road surface is free of ice. The road may still be icy, especially in wooded areas or on bridges. The vehicle could skid if you fail to adapt your driving style. Always adapt your driving style and drive at a speed to suit the prevailing weather conditions.

You should pay special attention to road conditions when temperatures are around the freezing point.

Driving systems

Cruise control

Important safety notes

Cruise control maintains a constant road speed for you. It brakes automatically in order to avoid exceeding the set speed. You must select a low gear in good time on long and

steep downhill gradients, especially if the vehicle is laden or towing a trailer. On vehicles with automatic transmission, select shift range **1**, **2** or **3**. By doing so, you will make use of the braking effect of the engine. This relieves the load on the brake system and prevents the brakes from overheating and wearing too quickly.

Use cruise control only if road and traffic conditions make it appropriate to maintain a steady speed for a prolonged period. You can store any road speed above 30 km/h.

If you fail to adapt your driving style, cruise control can neither reduce the risk of an accident nor override the laws of physics. Cruise control cannot take into account road, weather or traffic conditions. Cruise control is only an aid. You are responsible for the distance to the vehicle in front, for vehicle speed, for braking in good time, and for staying in the lane.

Do not use cruise control:

- in road and traffic conditions which do not allow you to maintain a constant speed (e.g. in heavy traffic or on winding roads)
- on smooth or slippery roads. Braking or accelerating can cause the drive wheels to lose traction and the vehicle could then skid
- when there is poor visibility, e.g. due to fog, heavy rain or snow

If there is a change of drivers, advise the new driver of the speed stored.

Cruise control lever

You can operate cruise control and variable SPEEDTRONIC with the cruise control lever. The LIM indicator lamp on the cruise control lever indicates which system you have selected:

- **LIM indicator lamp off:** cruise control is selected.
- **LIM indicator lamp on:** variable SPEEDTRONIC is selected.

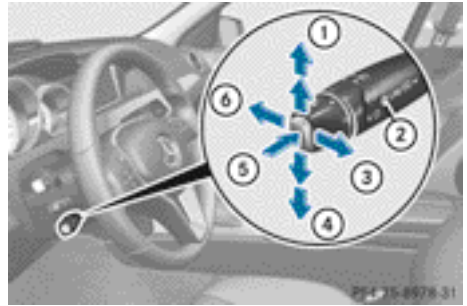

- ① To activate or increase speed
- ② LIM indicator lamp
- ③ To activate at the current speed/last stored speed
- ④ To activate or reduce speed
- ⑤ To switch between cruise control and variable SPEEDTRONIC
- ⑥ To deactivate cruise control

When you activate cruise control, the stored speed is shown in the multifunction display for five seconds. Vehicles with the 4-button multifunction steering wheel: the stored speed is then permanently displayed in the status indicator together with the  symbol. Vehicles with the 12-button multifunction steering wheel: the segments from the stored speed up to the maximum speed light up in the multifunction display.

Selecting cruise control

- ▶ Check whether LIM indicator lamp ② is off. If it is off, cruise control is already selected. If it is not, press the cruise control lever in the direction of arrow ⑤. LIM indicator lamp ② in the cruise control lever goes out. Cruise control is selected.

Storing and maintaining the current speed

You can store the current speed if you are driving faster than 30 km/h.

- ▶ Accelerate the vehicle to the desired speed.
- ▶ Briefly press the cruise control lever up ① or down ④.
- ▶ Remove your foot from the accelerator pedal.
Cruise control is activated. The vehicle automatically maintains the speed.
- ❗ Cruise control may be unable to maintain the stored speed on uphill gradients. The stored speed is resumed when the gradient evens out. Cruise control maintains the stored speed on downhill gradients by automatically braking the vehicle.
- ❗ Vehicles with manual transmission:
 - always drive at adequate, but not excessive, engine speeds.
 - change gear in good time.
 - if possible, do not change down several gears at a time.

Storing the current speed and calling up the last stored speed

WARNING

If you call up a stored speed and this is different from the current speed, the vehicle accelerates or brakes. If you do not know what the stored speed is, the vehicle may accelerate or brake unexpectedly. There is a risk of an accident.

Take the traffic conditions into account before calling up the stored speed. If you do not know what the stored speed is, store the desired speed again.

- ▶ Briefly pull the cruise control lever towards you ③.
- ▶ Remove your foot from the accelerator pedal.
The first time cruise control is activated, it stores the current speed or regulates the speed of the vehicle to the previously stored speed.

Setting a speed

Keep in mind that it may take a brief moment until the vehicle has accelerated or braked to the set speed.

- ▶ Press the cruise control lever up ① for a higher speed or down ④ for a lower speed.
- ▶ Keep the cruise control lever pressed until the desired speed is reached.
- ▶ Release the cruise control lever.
The new speed is stored.
- ▶ **To adjust the set speed in 1 km/h increments:** briefly press the cruise control lever up ① or down ④ to the pressure point.
The last stored speed increases or decreases in 1 km/h increments.
- ▶ **To adjust the set speed in 10 km/h increments:** press the cruise control lever briefly up ① or down ④ beyond the pressure point.
The last stored speed increases or decreases in 10 km/h increments.

- ❗ Cruise control is not deactivated if you depress the accelerator pedal. For example, if you accelerate briefly to overtake, cruise control adjusts the vehicle's speed to the last speed stored after you have finished overtaking.

Deactivating cruise control

There are several ways to deactivate cruise control:

- ▶ Briefly press the cruise control lever forwards ⑥.

or

- ▶ Brake

or

- ▶ Briefly press the cruise control lever in the direction of arrow ⑤.

Variable SPEEDTRONIC is selected. LIM indicator lamp ② in the cruise control lever lights up.

Cruise control is automatically deactivated if:

- you depress the parking brake.
- you are driving at less than 30 km/h.
- ESP® intervenes or you deactivate ESP®.
- you shift into neutral in a vehicle with manual transmission while driving or depress the clutch pedal for longer than six seconds.
- on vehicles with manual transmission, you shift to a gear that is too high, and as a result the engine speed is too low.
- on vehicles with automatic transmission, you shift into position **N** while driving.

If cruise control is deactivated, you will hear a warning tone. You will see the **Cruise control off** message in the multifunction display for approximately five seconds.

- ❗ The last speed stored is cleared when you switch off the engine.

SPEEDTRONIC

Important safety notes

SPEEDTRONIC brakes automatically so that you do not exceed the set speed. You must select a low gear in good time on long and steep downhill gradients, especially if the vehicle is laden or towing a trailer. On vehicles with automatic transmission, select shift range **1**, **2** or **3**. By doing so, you will make use of the braking effect of the engine. This relieves the load on the brake system and prevents the brakes from overheating and wearing too quickly. If you need additional braking, depress the brake pedal repeatedly rather than continuously.

If you fail to adapt your driving style, SPEEDTRONIC can neither reduce the risk of an accident nor override the laws of physics. SPEEDTRONIC cannot take into account road, weather or traffic conditions. SPEEDTRONIC is only an aid. You are responsible for the distance to the vehicle in front, for vehicle

speed, for braking in good time, and for staying in the lane.

If there is a change of drivers, advise the new driver of the speed stored.

You can set a variable or permanent limit speed:

- **variable** for speed limits, e.g. in built-up areas
- **permanent** for long-term speed restrictions, e.g. when driving with winter tyres fitted (> page 179)

- ❗ The speed indicated in the speedometer may differ slightly from the limit speed stored.

Variable SPEEDTRONIC

General notes

With the cruise control lever, you can operate cruise control or DISTRONIC PLUS and variable SPEEDTRONIC.

The LIM indicator lamp on the cruise control lever indicates which system you have selected:

- **LIM indicator lamp off:** cruise control or DISTRONIC PLUS is selected.
- **LIM indicator lamp on:** variable SPEEDTRONIC is selected.

You can use the cruise control lever to limit the speed to any speed above 30 km/h while the engine is running.

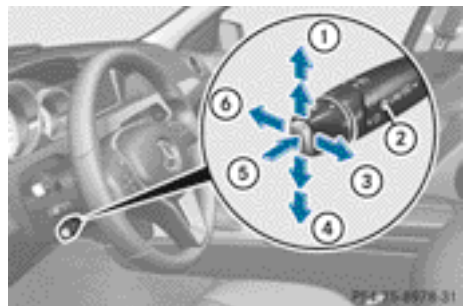

- ① To store the current speed or a higher speed
- ② LIM indicator lamp

- ③ To store the current speed and call up the last stored speed
- ④ To store the current speed or a lower speed
- ⑤ To switch between cruise control and variable SPEEDTRONIC
- ⑥ To deactivate variable SPEEDTRONIC

Selecting variable SPEEDTRONIC

- ▶ Check whether LIM indicator lamp ② is on. If it is on, variable SPEEDTRONIC is already selected.
If it is not, press the cruise control lever in the direction of arrow ⑤.
LIM indicator lamp ② in the cruise control lever lights up. Variable SPEEDTRONIC is selected.

Storing the current speed

You can use the cruise control lever to limit the speed to any speed above 30 km/h while the engine is running.

- ▶ Briefly press the cruise control lever to the pressure point up ① or down ④.
The current speed is stored. For five seconds, the multifunction display shows the stored speed, e.g. **Limit 100 km/h**.
Vehicles with the 4-button multifunction steering wheel: the stored speed is permanently displayed in the status indicator, e.g. **LIM 100 km/h**.

Vehicles with a 12-button multifunction steering wheel: on the speedometer, the segments from the start of the scale up to the stored speed are lit up.

Storing the current speed and calling up the last stored speed

WARNING

If you call up the stored speed and it is lower than the current speed, the vehicle decelerates. If you do not know the stored speed, the vehicle could decelerate unexpectedly. There is a risk of an accident.

Pay attention to the road and traffic conditions before calling up the stored speed. If you do not know the stored speed, store the desired speed again.

- ▶ Briefly pull the cruise control lever towards you ③.

Making adjustments in 1 km/h increments

- ▶ Briefly press the cruise control lever to the pressure point, up ① for a higher speed or down ④ for a lower speed.

or

- ▶ Keep the cruise control lever pressed to the pressure point until the desired speed is set. Press the cruise control lever up ① for a higher speed or down ④ for a lower speed.

Making adjustments in 10 km/h increments

- ▶ Briefly press the cruise control lever beyond the pressure point, up ① for a higher speed or down ④ for a lower speed.

or

- ▶ Keep the cruise control lever pressed beyond the pressure point until the desired speed is set. Press the cruise control lever up ① for a higher speed or down ④ for a lower speed.

Deactivating variable SPEEDTRONIC

It is not possible to deactivate variable SPEEDTRONIC by braking.

There are several ways to deactivate variable SPEEDTRONIC:

- ▶ Briefly press the cruise control lever forwards ⑥.

or

- ▶ Briefly press the cruise control lever in the direction of arrow ⑤.
LIM indicator lamp ② in the cruise control lever goes out. Variable SPEEDTRONIC is deactivated.

Cruise control is selected.

Variable SPEEDTRONIC is automatically deactivated if:

- you depress the accelerator pedal beyond the pressure point (kickdown), but only if your current speed does not differ by more than 20 km/h from the stored speed. You will hear a warning tone if this is the case.
- on vehicles with manual transmission, if you shift to a higher gear and as a result, the engine speed is too low.

i The last speed stored is cleared when you switch off the engine.

Permanent SPEEDTRONIC

You can use the on-board computer to limit the speed permanently to a value between 160 km/h (e.g. for driving on winter tyres) and the maximum speed (▷ page 233).

Shortly before the stored speed is reached, it appears in the multifunction display.

Permanent SPEEDTRONIC remains active, even if variable SPEEDTRONIC is deactivated. You cannot exceed the stored limit speed, even if you depress the accelerator pedal beyond the pressure point (kickdown).

DISTRONIC PLUS

Important safety notes

DISTRONIC PLUS regulates the speed and automatically helps you maintain the distance to the vehicle detected in front. DISTRONIC PLUS brakes automatically so that the set speed is not exceeded.

You must select a low gear in good time on long and steep downhill gradients, especially if the vehicle is laden or towing a trailer. On vehicles with automatic transmission, select shift range **1**, **2** or **3**. By doing so, you will make use of the braking effect of the engine. This relieves the load on the brake system and prevents the brakes from overheating and wearing too quickly.

If DISTRONIC PLUS detects a slower-moving vehicle in front, your vehicle is braked in order to maintain the preset distance to the vehicle in front.

WARNING

DISTRONIC PLUS does not react to:

- people or animals
- stationary obstacles on the road, e.g. stopped or parked vehicles
- oncoming and crossing traffic

As a result, DISTRONIC PLUS may neither give warnings nor intervene in such situations. There is a risk of an accident.

Always pay careful attention to the traffic situation and be ready to brake.

WARNING

DISTRONIC PLUS cannot always clearly identify other road users and complex traffic situations.

In such cases, DISTRONIC PLUS may:

- give an unnecessary warning and then brake the vehicle
- neither give a warning nor intervene
- accelerate unexpectedly

There is a risk of an accident.

Continue to drive carefully and be ready to brake, in particular when warned to do so by DISTRONIC PLUS.

WARNING

DISTRONIC PLUS brakes your vehicle with up to 40% of the maximum braking force. If this braking force is insufficient, DISTRONIC PLUS warns you visually and audibly. There is a risk of an accident.

In such cases, apply the brakes yourself and try to take evasive action.

! If DISTRONIC PLUS or the HOLD function is activated, the vehicle brakes automatically in certain situations. To prevent damage to the vehicle, deactivate DISTRONIC PLUS and the HOLD function in the following or other similar situations:

- when towing the vehicle
- in the car wash

If you fail to adapt your driving style, DISTRONIC PLUS can neither reduce the risk of an accident nor override the laws of physics. DISTRONIC PLUS cannot take road and weather conditions or traffic conditions into account. DISTRONIC PLUS is only an aid. You are responsible for the distance to the vehicle in front, for vehicle speed, for braking in good time, and for staying in the lane.

Do not use DISTRONIC PLUS:

- in road and traffic conditions which do not allow you to maintain a constant speed (e.g. in heavy traffic or on winding roads)
- on smooth or slippery roads. Braking or accelerating can cause the drive wheels to lose traction and the vehicle could then skid
- when there is poor visibility, e.g. due to fog, heavy rain or snow

DISTRONIC PLUS may not detect narrow vehicles driving in front, e.g. motorcycles, or vehicles driving on a different line.

In particular, the detection of obstacles can be impaired in the case of:

- dirt on the sensors or obscured sensors
- snow or heavy rain
- interference by other radar sources
- the possibility of strong radar reflections, for example, in multi-storey car parks

If DISTRONIC PLUS no longer detects a vehicle in front, it may unexpectedly accelerate to the speed stored.

This speed can:

- be too high for a filter lane or a slip road
- be so high in the right lane that you pass vehicles driving on the left
- be so high in the left lane that you pass vehicles driving on the right

If there is a change of drivers, advise the new driver of the speed stored.

If there is no vehicle in front, DISTRONIC PLUS operates in the same way as cruise control in the speed range between 30 km/h and 200 km/h. If a vehicle is driving in front of you, it operates in the speed range between 0 km/h and 200 km/h.

Do not use DISTRONIC PLUS on roads with steep gradients.

Cruise control lever

With the cruise control lever, you can operate DISTRONIC PLUS and variable SPEED-TRONIC.

The LIM indicator lamp on the cruise control lever indicates which system you have selected:

- **LIM indicator lamp off:** DISTRONIC PLUS is selected.
- **LIM indicator lamp on:** variable SPEED-TRONIC is selected.

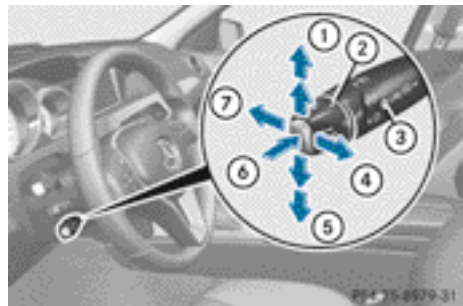

- ① To store the current speed or a higher speed
- ② To set the specified minimum distance
- ③ LIM indicator lamp

- ④ To store the current speed and call up the last stored speed
- ⑤ To store the current speed or a lower speed
- ⑥ To switch between DISTRONIC PLUS and variable SPEEDTRONIC
- ⑦ To deactivate DISTRONIC PLUS

Selecting DISTRONIC PLUS

- ▶ Check whether LIM indicator lamp ③ is off. If it is off, DISTRONIC PLUS is already selected. If it is not, press the cruise control lever in the direction of arrow ⑥. LIM indicator lamp ③ in the cruise control lever goes out. DISTRONIC PLUS is selected.

Activating DISTRONIC PLUS, storing and maintaining the current speed

Activation conditions

To activate DISTRONIC PLUS, the following conditions must be fulfilled:

- the engine must be running. It may take up to two minutes of driving before DISTRONIC PLUS is ready for use.
- the parking brake must be released.
- ESP® must be switched on, but not intervening.
- the transmission must be in position **D**.
- the bonnet must be closed.
- the driver's door must be closed when you shift from **P** to **D** or your seat belt must be fastened.
- the front-passenger door must be closed.
- the vehicle must not be skidding.

Activating while driving

When driving at speeds below 30 km/h, you can only activate DISTRONIC PLUS if the vehicle in front has been detected and is shown in the multifunction display. If the vehicle in front is no longer detected and displayed,

DISTRONIC PLUS switches off and you will hear a tone.

- ▶ Briefly pull the cruise control lever towards you ④, or press it up ① or down ⑤. DISTRONIC PLUS is activated.
- ▶ Keep the cruise control lever pressed up ① or down ⑤ until the desired speed is set.
- ▶ Remove your foot from the accelerator pedal. Your vehicle adapts its speed to that of the vehicle in front, but only up to the desired stored speed.

i If you do not fully release the accelerator pedal, the **DISTRONIC PLUS inactive** message appears in the multifunction display. The set distance to a slower-moving vehicle in front will then not be maintained. You will be driving at the speed you determine by the position of the accelerator pedal.

Activating when driving towards a stationary vehicle

If the vehicle in front of you is stationary, you can only activate DISTRONIC PLUS once your vehicle is stationary as well.

- ▶ Briefly pull the cruise control lever towards you ④, or press it up ① or down ⑤. DISTRONIC PLUS is activated.
- i** DISTRONIC PLUS can only be activated at under 30 km/h if a vehicle in front has been detected. For this reason, it is helpful if you have the DISTRONIC PLUS distance display shown in the instrument cluster (▷ page 228).
- ▶ Keep the cruise control lever pressed up ① or down ⑤ until the desired speed is set.

i You can use the cruise control lever to set the stored speed and the control on the cruise control lever to set the specified minimum distance (▷ page 184).

Pulling away

► **If the vehicle in front pulls away:** remove your foot from the brake pedal.

► Briefly pull the cruise control lever towards you ④.

or

► Accelerate briefly.

Your vehicle pulls away and adapts its speed to that of the vehicle in front.

Driving

If there is no vehicle in front, DISTRONIC PLUS operates in the same way as cruise control.

If DISTRONIC PLUS detects that the vehicle in front has slowed down, it brakes your vehicle. In this way, the distance you have selected is maintained.

If DISTRONIC PLUS detects that the vehicle in front is driving faster, it accelerates your vehicle, but only up to the speed you have stored.

Changing lanes

If you change to the overtaking lane, DISTRONIC PLUS supports you if:

- you are driving faster than 60 km/h
- DISTRONIC PLUS is maintaining the distance to a vehicle in front
- you switch on the respective turn signal
- DISTRONIC PLUS does not detect a danger of collision

If these conditions are met, your vehicle is accelerated. Acceleration will be interrupted if changing lanes takes too long or if the distance between your vehicle and the vehicle in front becomes too small.

i When you change lanes, DISTRONIC PLUS monitors the left lane for left-hand-drive vehicles and the right lane for right-hand-drive vehicles.

Vehicles with COMAND Online

i The following function is not operational in all countries.

DISTRONIC PLUS uses additional information from your navigation system so that it can adapt to certain traffic situations. This is the case if, while following a vehicle, DISTRONIC PLUS is active and you:

- approach or drive around a roundabout
- approach a T-junction
- turn off at a motorway exit

Even if the vehicle in front leaves the detection range, DISTRONIC PLUS temporarily maintains the current driving speed and does not accelerate. This is based on the current map data in the navigation system.

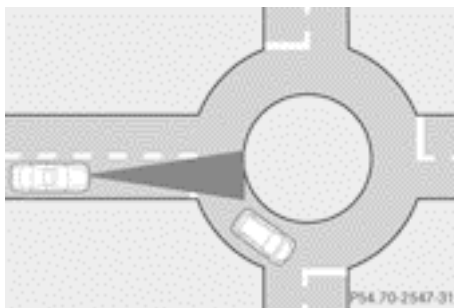

Example: roundabout

The current speed is maintained:

- approximately ten seconds before the roundabout/T-junction and for approximately 1.5 seconds when driving on the roundabout
- approximately twelve seconds before reaching a motorway exit and approximately four seconds after the motorway exit

Afterwards, the vehicle accelerates back to the set speed you specified.

Stopping

WARNING

When leaving the vehicle, even if it is braked only by DISTRONIC PLUS, it could roll away if:

- there is a malfunction in the system or in the voltage supply.
- DISTRONIC PLUS has been deactivated with the cruise control lever, e.g. by a vehicle occupant or from outside the vehicle.
- the electrical system in the engine compartment, the battery or the fuses have been tampered with.
- the battery is disconnected.
- the accelerator pedal has been depressed, e.g. by a vehicle occupant.

There is a risk of an accident.

If you wish to exit the vehicle, always turn off DISTRONIC PLUS and secure the vehicle against rolling away.

Deactivating DISTRONIC PLUS

(▷ page 185).

If DISTRONIC PLUS detects that the vehicle in front is stopping, it brakes your vehicle until it is stationary.

Once your vehicle is stationary, it remains stationary and you do not need to depress the brake.

- i** Depending on the specified minimum distance, your vehicle will come to a standstill at a sufficient distance behind the vehicle in front. The specified minimum distance is set using the control on the cruise control lever.

You will see a warning message in the multifunction display if DISTRONIC PLUS is activated and:

- the driver's door is open and the driver's seat belt is unfastened
- the engine is switched off, unless it is automatically switched off by the ECO start/stop function
- the bonnet is opened

Select Park (P)

- ▶ Shift the transmission to position **P** to prevent the vehicle from rolling away. DISTRONIC PLUS is deactivated. The warning message in the multifunction display disappears.

The horn will also sound at regular intervals if DISTRONIC PLUS is activated and you:

- switch the engine off, open the driver's door and take off your seat belt
- open the bonnet

The sounding of the horn alerts you to the fact that the vehicle has been parked while DISTRONIC PLUS is still activated. The sound becomes louder if you attempt to lock the vehicle. The vehicle is not locked until DISTRONIC PLUS is deactivated.

- i** If the engine has been switched off, it cannot be started again until DISTRONIC PLUS has been deactivated.

If DISTRONIC PLUS is activated and a fault occurs in the system or if there is a disruption in the voltage supply, the **Brake immediately** message is shown in the multifunction display. Immediately depress the brake firmly until the warning message in the multifunction display goes out or shift the transmission to position **P**. DISTRONIC PLUS is deactivated.

Setting a speed

- ▶ Press the cruise control lever up **①** for a higher speed or down **⑤** for a lower speed.
- ▶ Keep the cruise control lever pressed until the desired speed is reached.
- ▶ Release the cruise control lever. The new speed is stored. DISTRONIC PLUS is activated and adjusts the vehicle's speed to the new speed stored.
- ▶ **To adjust the set speed in 1 km/h increments:** briefly press the cruise control

lever up ① or down ② to the pressure point.

The last stored speed increases or decreases in 1 km/h increments.

- ▶ **To adjust the set speed in 10 km/h increments:** press the cruise control lever briefly up ① or down ② beyond the pressure point.
The last stored speed increases or decreases in 10 km/h increments.

i DISTRONIC PLUS is not deactivated if you depress the accelerator pedal. If you accelerate to overtake, DISTRONIC PLUS adjusts the vehicle's speed to the last speed stored after you have finished overtaking.

Storing the current speed or calling up the stored speed

- ▶ Briefly pull the cruise control lever towards you ④.
- ▶ Remove your foot from the accelerator pedal.
DISTRONIC PLUS is activated. The first time it is activated, the current speed is stored. Otherwise, it sets the vehicle cruise speed to the previously stored value.

Setting the specified minimum distance

You can set the specified minimum distance for DISTRONIC PLUS by varying the time span between one and two seconds. With this function, you can set the minimum distance that DISTRONIC PLUS keeps to the vehicle in front, dependent on vehicle speed. You can see this distance in the multifunction display (▷ page 185).

i Make sure that you maintain a sufficient distance to the vehicle in front and comply with the minimum distance as required by law. Adjust the distance to the vehicle in front if necessary.

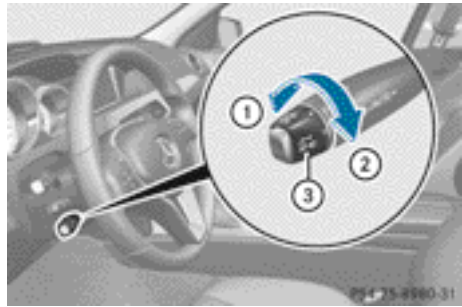

- ▶ **To increase:** turn control ③ in direction ②.
DISTRONIC PLUS then maintains a greater distance between your vehicle and the vehicle in front.
- ▶ **To decrease:** turn control ③ in direction ①.
DISTRONIC PLUS then maintains a shorter distance between your vehicle and the vehicle in front.

Displaying DISTRONIC PLUS in the speedometer



Example: vehicles with automatic transmission

When DISTRONIC PLUS is activated, one or two segments ② in the set speed range light up.

i For design reasons, the speed displayed in the speedometer may differ slightly from the speed set for DISTRONIC PLUS.

If DISTRONIC PLUS detects a vehicle in front, segments ② between speed of the vehicle in front ① and stored speed ③ light up.

Displaying DISTRONIC PLUS in the multifunction display

General notes

In the assistance menu (▷ page 227) of the on-board computer, you can select the assistance display.

Display when DISTRONIC PLUS is deactivated

- ▶ Select the **Assist. graphic** function using the on-board computer (▷ page 228).

When DISTRONIC PLUS is deactivated, you will see the following in the multifunction display:



Example: vehicles with automatic transmission

- ① Vehicle in front, if detected
- ② Distance indicator: current distance to the vehicle in front
- ③ Specified minimum distance to the vehicle in front; adjustable
- ④ Own vehicle

Display when DISTRONIC PLUS is activated

- ▶ Select the **Assist. graphic** function using the on-board computer (▷ page 228).

You will see the stored speed for approximately five seconds when you activate DISTRONIC PLUS. After this time, you will see the following in the multifunction display while DISTRONIC PLUS is activated:



Example: vehicles with automatic transmission

- ① Vehicle in front, if detected
- ② Specified minimum distance to the vehicle in front; adjustable
- ③ Own vehicle
- ④ DISTRONIC PLUS activated

Deactivating DISTRONIC PLUS

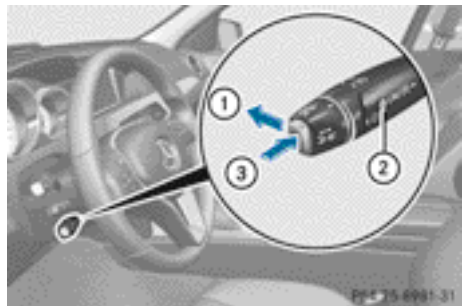

There are several ways to deactivate DISTRONIC PLUS:

- ▶ Briefly press the cruise control lever forwards ①.

or

- ▶ Brake, unless the vehicle is stationary.

or

- ▶ Briefly press the cruise control lever in the direction of arrow ③.

Variable SPEEDTRONIC is selected. LIM indicator lamp ② in the cruise control lever lights up.

When you deactivate DISTRONIC PLUS, you will see the **DISTRONIC PLUS off** message

in the multifunction display for approximately five seconds.

i The last speed stored remains stored until you switch off the engine.

DISTRONIC PLUS is automatically deactivated if:

- you apply the parking brake
- you are driving slower than 25 km/h and there is no vehicle in front, or if the vehicle in front is no longer detected
- ESP® intervenes or you deactivate ESP®
- the transmission is in the **P**, **R** or **N** position
- you pull the cruise control lever towards you in order to pull away and the front-passenger door is open
- the vehicle has skidded

If DISTRONIC PLUS is deactivated, you will hear a warning tone. You will see the **DIS-TRONIC PLUS off** message in the multifunction display for approximately five seconds.

If the vehicle has been stopped by DISTRONIC PLUS and a fault occurs in the system, the **Brake immediately** message appears in the multifunction display. Depress the brake pedal immediately so that the vehicle does not roll away. DISTRONIC PLUS is then deactivated and the message disappears.

Tips for driving with DISTRONIC PLUS

General notes

The following contains descriptions of certain road and traffic conditions in which you must be particularly attentive. In such situations, brake if necessary. DISTRONIC PLUS is then deactivated.

Cornering, going into and coming out of a bend

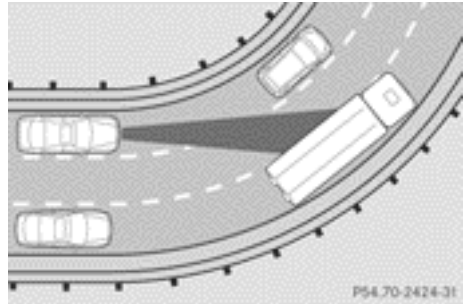

The ability of DISTRONIC PLUS to detect vehicles when cornering is limited. Your vehicle may brake unexpectedly or late.

Vehicles which are not driving in the middle of their lane

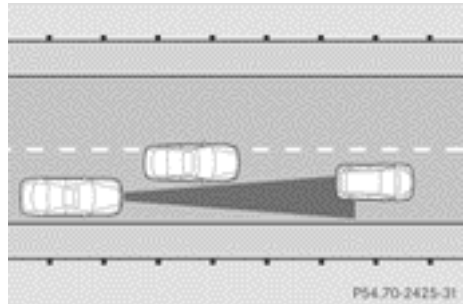

DISTRONIC PLUS may not detect vehicles which are not driving in the middle of their lane. The distance to the vehicle in front will be too short.

Other vehicles changing lane

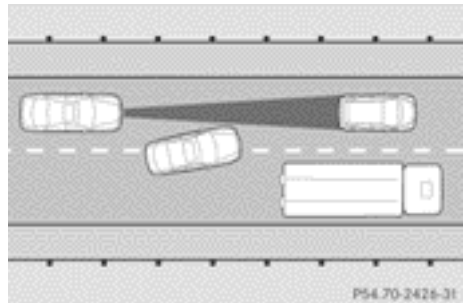

DISTRONIC PLUS has not detected the vehicle cutting in yet. The distance to this vehicle will be too short.

Narrow vehicles

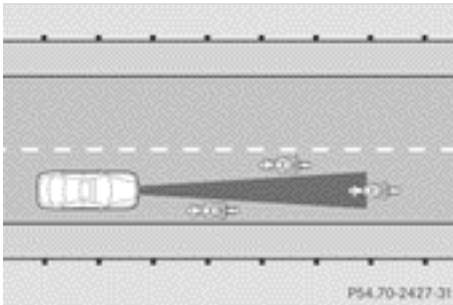

DISTRONIC PLUS has not yet detected the vehicle in front on the edge of the carriageway, because of its narrow width. The distance to the vehicle in front will be too short.

Obstructions and stationary vehicles

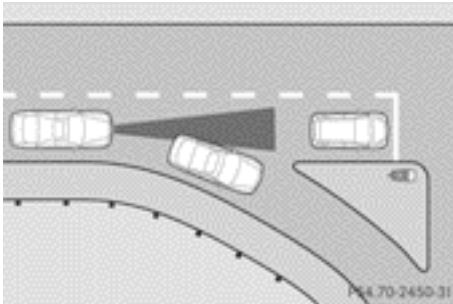

DISTRONIC PLUS does not brake for obstacles or stationary vehicles. If, for example, the detected vehicle turns a corner and reveals an obstacle or stationary vehicle, DISTRONIC PLUS will not brake for these.

Crossing vehicles

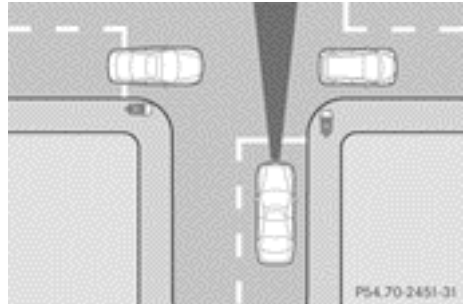

DISTRONIC PLUS may mistakenly detect vehicles that are crossing your lane. Activating DISTRONIC PLUS at traffic lights with crossing traffic, for example, could cause your vehicle to pull away unintentionally.

Dynamic handling package with sports mode

General notes

The most important part of the dynamic handling package with sports mode is the adjustable damping system. This automatically controls and adapts the suspension to the respective driving situation.

The calibration of the suspension depends on:

- your driving style
- the road surface conditions
- your individual selection; see the following description

If your vehicle is equipped with automatic transmission, the dynamic handling package with sports mode also includes steering wheel gearshift paddles (▷ page 161) with a manual drive program (▷ page 163).



Example: position of dynamic handling package with sports mode button

- ▶ Start the engine.

Sports tuning

The firmer setting of the suspension tuning in sports mode ensures even better contact with the road. Select this mode when employing a sporty driving style, e.g. on winding country roads.

Your selection remains stored until you switch off the engine.

- ▶ Press button ②.
Indicator lamp ① lights up. The sports suspension setting is selected. Depending on the engine output, the accelerator pedal is more responsive. On vehicles with automatic transmission, drive program **S** is selected.

Comfort tuning

In Comfort mode, the driving characteristics of your vehicle are more comfortable. Therefore, select this mode if you prefer a more comfortable driving style. Select Comfort mode also when driving fast on straight roads, e.g. on straight stretches of motorway.

- ▶ Press button ②.
Indicator lamp ① goes out. Comfortable suspension setting is selected. On vehicles with automatic transmission, drive program **E** is selected.

HOLD function

General notes

The HOLD function can assist the driver in the following situations:

- when pulling away, especially on steep slopes
- when manoeuvring on steep slopes
- when waiting in traffic

The vehicle is kept stationary without the driver having to depress the brake pedal.

The braking effect is cancelled and the HOLD function is deactivated when you depress the accelerator pedal to pull away.

Important safety notes

WARNING

When leaving the vehicle, it can still roll away despite being braked by the HOLD function if:

- there is a malfunction in the system or in the voltage supply
- the HOLD function is deactivated by the accelerator pedal being depressed, e.g. by a vehicle occupant
- the electrical system in the engine compartment, the battery or the fuses are tampered with
- the battery is disconnected

There is a risk of an accident.

Before leaving the vehicle, always deactivate the HOLD function and secure the vehicle from rolling away.

- ❗ If DISTRONIC PLUS or the HOLD function is activated, the vehicle brakes automatically in certain situations. To prevent damage to the vehicle, deactivate DISTRONIC PLUS and the HOLD function in the following or other similar situations:

- when towing the vehicle
- in the car wash

Deactivate the HOLD function (▶ page 189).

Activation conditions

You can activate the HOLD function if:

- the vehicle is stationary.
- the engine is running or if it has been automatically switched off by the ECO start/stop function.
- the driver's door is closed or if your seat belt is fastened.
- the parking brake is released.
- the bonnet is closed.
- the selector lever is in position **D**, **R** or **N** on vehicles with automatic transmission.
- DISTRONIC PLUS is deactivated.

Activating the HOLD function

- ▶ Make sure that the activation conditions are met.
- ▶ Depress the brake pedal.
- ▶ Quickly depress the brake pedal further until **HOLD** appears in the multifunction display. The HOLD function is activated. You can release the brake pedal.

i If depressing the brake pedal the first time does not activate the HOLD function, wait briefly and then try again.

Deactivating the HOLD function

The HOLD function is deactivated automatically if:

- you accelerate. On vehicles with automatic transmission: only when the transmission is in position **D** or **R**.
- the transmission is in position **P** on vehicles with automatic transmission.
- you depress the brake pedal again with a certain amount of pressure until **HOLD** disappears from the multifunction display.
- you activate DISTRONIC PLUS.

You will see a warning message in the multifunction display if the HOLD function is activated and:

- the driver's door is open and the driver's seat belt is unfastened
- the engine is switched off, unless it is automatically switched off by the ECO start/stop function
- the bonnet is opened

Vehicles with manual transmission:

Brake immediately

- ▶ Immediately depress the brake pedal firmly until the warning message in the multifunction display goes out. This deactivates the HOLD function.

In vehicles with automatic transmission:

Select Park (P).

- ▶ Shift the transmission to position **P** to prevent the vehicle from rolling away. The HOLD function is deactivated. The warning message in the multifunction display disappears.

A horn will also sound at regular intervals if the HOLD function is activated and you:

- switch the engine off, open the driver's door and take off your seat belt
- open the bonnet

The sounding of the horn alerts you to the fact that the vehicle has been parked while the HOLD function is still activated. If you attempt to lock the vehicle, the tone becomes louder. The vehicle is not locked until the HOLD function is deactivated.

- i** If the engine has been switched off, it cannot be started again until the HOLD function has been deactivated.

If there is a fault in the system or power supply while the HOLD function is activated, the **Brake immediately** message is shown in the multifunction display. Immediately depress the brake firmly until the warning message in the multifunction display goes out.

On vehicles with automatic transmission, you can also shift into position **P**. This deactivates the HOLD function.

RACE START

Important safety notes

- ⓘ Observe the safety notes for the SPORT handling mode (▷ page 75).

Only activate RACE START on dedicated race circuits. Always adapt your speed and driving style to the prevailing road and weather conditions.

RACE START enables optimum acceleration from a standing start. The precondition for this is a suitable high-grip road surface.

- ⓘ RACE START is only available in AMG vehicles.

Activation conditions

You can activate RACE START if:

- the doors are closed.
- the engine is running and it has reached an operating temperature of approximately 80 °C. This is the case when the engine oil temperature in the multifunction display stops flashing.
- SPORT handling mode is activated (▷ page 75).
- the steering wheel is in the straight-ahead position.
- the vehicle is stationary and the brake pedal is depressed (left foot).
- the transmission is in position **D**.

Activating RACE START

- ▶ Depress the brake pedal with your left foot and keep it depressed.
- ▶ Turn the drive program selector clockwise (▷ page 160) until the **RS** lamp lights up. The **RACE START Confirm: Paddle UP Cancel: Paddle DOWN** message appears in the multifunction display.
- ⓘ If the activation conditions are no longer fulfilled, RACE START is cancelled. The multifunction display shows the **RACE START cancelled** message.

- ▶ To cancel: pull the left steering wheel shift paddle (▷ page 161).

or

- ▶ To confirm: pull the right steering wheel shift paddle (▷ page 161). The **RACE START available Depress accelerator** message appears in the multifunction display.

- ⓘ If you do not depress the accelerator pedal fully within two seconds, RACE START is cancelled. The **RACE START not possible See Owner's Manual** message appears in the multifunction display.

- ▶ Fully depress the accelerator pedal. The engine speed rises to approximately 3,500 rpm.

The **RACE START Release brake to start message** appears in the multifunction display.

- ⓘ If you do not release the brake pedal within five seconds, RACE START is cancelled. The multifunction display shows the **RACE START cancelled** message.

- ▶ Take your foot off the brake, but keep the accelerator pedal depressed. The vehicle pulls away at maximum acceleration.

The **RACE START active** message appears in the multifunction display.

RACE START is deactivated when the vehicle reaches a speed of approximately 50 km/h. Drive program **S+** is activated. SPORT handling mode remains activated.

RACE START is deactivated immediately if you release the accelerator pedal during RACE START or if any of the activation conditions are no longer fulfilled. The **RACE START not possible See Owner's Manual** message appears in the multifunction display.

- ⓘ After using it several times in short succession, RACE START will be unavailable until a certain distance has been driven.

PARKTRONIC

Important safety notes

PARKTRONIC is an electronic parking aid with ultrasonic sensors. It monitors the area around your vehicle using six sensors in the front bumper and four sensors in the rear bumper. PARKTRONIC indicates the distance between your vehicle and an object.

PARKTRONIC is only an aid. It is not a substitute for your attention to the immediate surroundings. The responsibility for safe manoeuvring and parking remains with you. Make sure that there are no persons, animals or objects in range while manoeuvring and parking.

! When parking, pay particular attention to objects above or below the sensors, such as flower pots or trailer drawbars. PARKTRONIC does not detect such objects when they are in the immediate vicinity of the vehicle. You could damage the vehicle or the objects.

The sensors may not detect snow and objects which absorb ultrasonic sources. Ultrasonic sources, such as an automatic car wash, a lorry's compressed-air brakes or a pneumatic drill, could cause PARKTRONIC to malfunction.

PARKTRONIC may not function correctly on uneven terrain.

PARKTRONIC is activated automatically if you:

- switch on the ignition
- shift to position **D**, **R** or **N** on vehicles with automatic transmission
- release the parking brake

PARKTRONIC is deactivated at speeds above 18 km/h. It is reactivated at lower speeds.

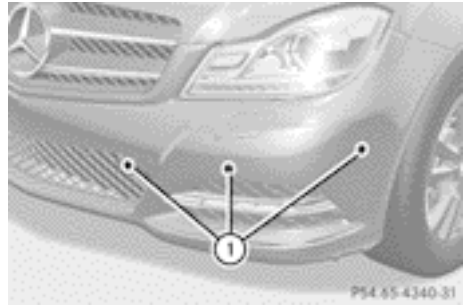

- ① Example: sensors in the front bumper, left-hand side

Range of the sensors

General notes

PARKTRONIC does not take into account obstacles located:

- below the detection range, e.g. persons, animals or objects
- above the detection range, e.g. overhanging loads, tail sections or loading ramps of goods vehicles

The sensors must be free of dirt, ice and slush. Otherwise, they may not function correctly. Clean the sensors regularly, taking care not to scratch or damage them (▷ page 322).

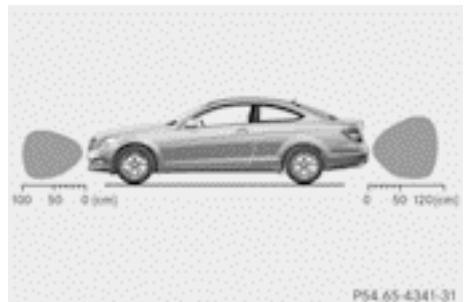

Side view

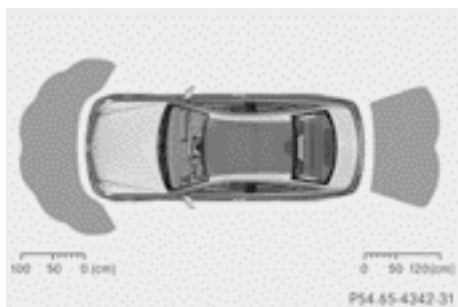

Top view

Front sensors

Centre	Approx. 100 cm
Corners	Approx. 60 cm

Rear sensors

Centre	Approx. 120 cm
Corners	Approx. 80 cm

Minimum distance

Centre	Approx. 20 cm
Corners	Approx. 15 cm

If there is an obstacle within this range, the relevant warning displays light up and a warning tone sounds. If the distance falls below the minimum, the distance may no longer be shown.

Warning displays

The warning displays show the distance between the sensors and the obstacle. The warning display for the front area is located on the dashboard above the centre air vents. The warning display for the rear area is located on the roof lining in the rear compartment.

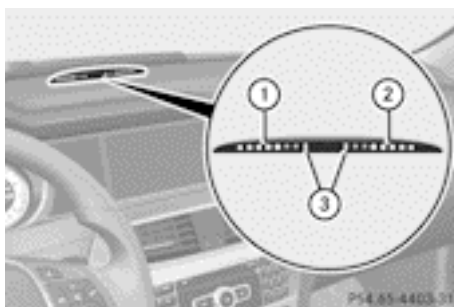

Warning display for the front area

- ① Segments on the left-hand side of the vehicle
- ② Segments on the right-hand side of the vehicle
- ③ Segments showing operational readiness

The warning display for each side of the vehicle is divided into five yellow and two red segments. PARKTRONIC is operational if yellow segments showing operational readiness ③ light up.

The gear lever position or the transmission position of the automatic transmission and the direction in which the vehicle is rolling determine which warning display is active when the engine is running.

Manual transmission:

Gear lever position	Warning display
Forwards gear or Neutral	Front area activated
Reverse gear, or the vehicle is rolling backwards	Rear and front areas activated

Automatic transmission:

Transmission position	Warning display
D	Front area activated
R, N or the vehicle is rolling backwards	Rear and front areas activated
P	No areas activated

One or more segments light up as the vehicle approaches an obstacle, depending on the vehicle's distance from the obstacle.

From the:

- sixth segment onwards, you will hear an intermittent warning tone for approximately two seconds
- seventh segment onwards, you will hear a warning tone for approximately two seconds. This indicates that you have now reached the minimum distance.

Deactivating/activating PARKTRONIC



- ① Indicator lamp
- ② To deactivate/activate PARKTRONIC

If indicator lamp ① lights up, PARKTRONIC is deactivated. Parking Guidance is also deactivated.

- ❗ PARKTRONIC is automatically activated when you turn the key to position 2 in the ignition lock.

Towing a trailer

- ❗ Fold in the ball coupling if the trailer tow hitch is not required. PARKTRONIC measures the minimum detection range to an obstacle from the bumper, not the ball coupling.

PARKTRONIC is deactivated for the rear area when you establish an electrical connection between your vehicle and a trailer.

Problems with PARKTRONIC

Problem	Possible causes/consequences and ► Solutions
<p>Only the red segments in the PARKTRONIC warning displays are lit. You also hear a warning tone for approximately two seconds.</p> <p>PARKTRONIC is deactivated after approximately 20 seconds, and the indicator lamp in the PARKTRONIC button lights up.</p>	<p>PARKTRONIC has malfunctioned and has switched off.</p> <p>► If problems persist, have PARKTRONIC checked at a qualified specialist workshop.</p>
<p>Only the red segments in the PARKTRONIC warning displays are lit. PARKTRONIC is deactivated after approximately 20 seconds.</p>	<p>The PARKTRONIC sensors are dirty or there is interference.</p> <p>► Clean the PARKTRONIC sensors (► page 322).</p> <p>► Switch the ignition back on.</p>
	<p>The problem may be caused by an external source of radio or ultrasound waves.</p> <p>► See if PARKTRONIC functions in a different location.</p>

Parking Guidance

Important safety notes

Parking Guidance is an electronic parking aid with ultrasound. Ultrasound is used to measure the road on both sides of the vehicle. A suitable parking space is indicated by the parking symbol. You receive steering instructions when parking. You may also use PARKTRONIC (► page 191).

Parking Guidance is only an aid. It is not a substitute for your attention to the immediate surroundings. The responsibility for safe manoeuvring and parking remains with you. Make sure that there are no persons, animals or objects in range while manoeuvring and parking.

WARNING

If objects are located above the detection range, Parking Guidance may provide steering

instructions too soon. This could cause a collision. There is a risk of an accident.

If objects are located above the detection range, stop and switch off Parking Assist.

When PARKTRONIC is deactivated, Parking Guidance is also unavailable.

Use Parking Guidance for parking spaces:

- that are parallel to the direction of travel
- that are on straight roads, not bends
- that are on the same level as the road, i.e. not on the pavement, for example. Parking Guidance may not detect flat kerbs

Parking tips:

- on narrow roads, drive as closely as possible past the parking space.
- parking spaces that are littered, overgrown or partially occupied by trailer drawbars might be identified incorrectly or not at all.

- snowfall or heavy rain may lead to a parking space being measured inaccurately.
- pay attention to the PARKTRONIC (▷ page 192) warning messages during the parking procedure.
- when transporting a load which protrudes from your vehicle, you must not use Parking Guidance.
- never use Parking Guidance with snow chains or an emergency spare wheel fitted.
- make sure that the tyre pressures are always correct. This has a direct effect on the steering instructions.
- the way your vehicle is positioned in the parking space after parking is dependent on various factors. These include the position and shape of the vehicles parked in front and behind it and the conditions of the location. In some cases, Parking Guidance may guide you too far or not far enough into a parking space. In some cases, it may also lead you across or onto the kerb. If necessary, cancel the parking procedure with Parking Guidance.

! If unavoidable, you should drive over obstacles such as kerbs slowly and not at a sharp angle. Otherwise, you may damage the wheels or tyres.

Detecting parking spaces



Example: vehicles with automatic transmission

- ① Detected parking space on the left
- ② Parking symbol
- ③ Detected parking space on the right

Parking Guidance is automatically activated when you drive forwards. The system is operational at speeds of up to approximately 35 km/h. While in operation, the system inde-

pendently locates and measures parking spaces on both sides of the vehicle. When driving at speeds below 30 km/h, you will see parking symbol ② as a status indicator in the instrument cluster.

When a parking space has been detected, an arrow towards the right ③ or the left ① also appears. Parking Guidance only displays parking spaces on the front-passenger side as standard. Parking spaces on the driver's side are displayed as soon as the turn signal on the driver's side is activated. To park on the driver's side, you must leave the driver's side turn signal switched on until you have engaged reverse gear.

Parking Guidance will only detect parking spaces:

- that are parallel to the direction of travel
- that are at least 1.5 m wide
- that are at least 1.3 m longer than your vehicle

A parking space is displayed while you are driving past it, and until you are approximately 15 m away from it.

Parking

► Stop the vehicle when the parking symbol shows the desired parking space in the instrument cluster.

► Vehicles with manual transmission: shift to reverse gear.

Vehicles with automatic transmission: shift into position **R**.

The multifunction display shows the **Check vehicle surroundings Confirm with OK** message.

► Press the **OK** button on the multifunction steering wheel to confirm.

The multifunction display switches to Parking Guidance.

Depending on your distance from the parking space, the **Please drive backwards** message will appear in the multifunction display.



Example: vehicles with automatic transmission

- ▶ If necessary, reverse towards the parking space. This is indicated by an arrow pointing backwards.

Continue reversing until you hear a tone. Stop – the parking position has been reached. The arrow is white.

The **Please steer to the right** or **Please steer to the left** message appears in the multifunction display.



Example: vehicles with automatic transmission

- ▶ While the vehicle is stationary, turn the steering wheel in the specified direction until the arrow is white and a warning tone sounds.

- ▶ **To reverse into the parking space:** maintain the steering wheel angle and reverse carefully.

- ▶ Stop as soon as you hear a warning tone. The vehicle has reached the position in which you need to countersteer.

The **Please steer to the left** or **Please steer to the right** message appears in the multifunction display.

- ▶ **Countersteering:** while the vehicle is stationary, turn the steering wheel in the specified direction until the arrow is white and a warning tone sounds.

- ▶ **To reverse into the parking space:** maintain the steering wheel angle and reverse carefully.

- ▶ Stop as soon as you hear a warning tone. at the latest when PARKTRONIC sounds the continuous warning tone.

The **Parking Guidance finished** message appears in the multifunction display and a tone sounds. You may be asked to steer in a different direction and then change gear. In this case, further displays in the multifunction display will direct you to the final position.

- ▶ Manoeuvre if necessary.

- ▶ Always observe the warning messages displayed by PARKTRONIC (▷ page 192).

Canceling Parking Guidance

- ▶ Press the PARKTRONIC button on the centre console (▷ page 193). Parking Guidance is cancelled immediately and PARKTRONIC is deactivated.

Parking Guidance is cancelled automatically if it is no longer possible to guide you into the parking space, or if a malfunction occurs.

The parking space symbol goes out and a warning tone sounds. The **Parking Guidance cancelled** message appears in the multifunction display.

Towing a trailer

For vehicles with a trailer tow hitch, the minimum length for parking spaces is slightly increased.

If you have attached a trailer to your vehicle, you should not use Parking Guidance. When the electrical connection is established between your vehicle and the trailer, Parking Guidance ceases to be available. PARKTRONIC is deactivated for the rear area.

Reversing camera

General notes

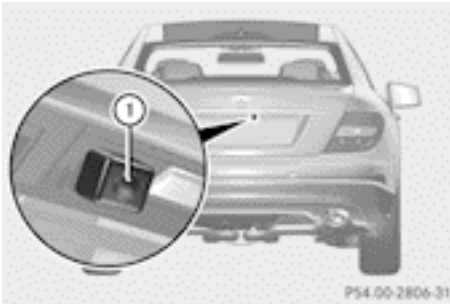

① Reversing camera

Reversing camera ① is an optical parking and manoeuvring aid. It shows the area behind your vehicle in the COMAND display. The reversing camera is located in the handle strip of the boot lid.

Important safety notes

The reversing camera is only an aid. It is not a substitute for your attention to the immediate surroundings. The responsibility for safe manoeuvring and parking remains with you. Make sure that there are no persons, animals or objects in range while manoeuvring and parking.

Under the following circumstances, the reversing camera will not function, or will function in a limited manner:

- if the boot lid is open
- in heavy rain, snow or fog
- at night or in very dark places
- if the camera is exposed to very bright light
- if the area is lit by fluorescent light or LED lighting (the display may flicker)
- if there is a sudden change in temperature, e.g. when driving into a heated garage in winter
- if the camera lens is dirty or obstructed
- if the rear of your vehicle is damaged. In this case, have the camera position and

setting checked at a qualified specialist workshop.

The field of vision and other functions of the reversing camera may be restricted due to additional accessories on the rear of the vehicle (e.g. licence plate holder, bicycle rack).

View through the camera

The area behind the vehicle is displayed as a mirror image, as in the rear-view mirror.

The reversing camera may show a distorted view of obstacles or show them incorrectly or not at all. Obstacles are not shown by the reversing camera in the following locations:

- very close to the rear bumper
- under the rear bumper
- in the area immediately above the tailgate handle

! Objects not at ground level may appear to be further away than they actually are, e.g.:

- the bumper of a parked vehicle
- the drawbar of a trailer
- the ball coupling of a trailer tow hitch
- the rear section of an HGV
- a slanted post

Use the guidelines only for orientation. Approach objects no further than the bottom-most guideline.

Activating the reversing camera

- ▶ Make sure that the key is in position **2** in the ignition lock.
- ▶ Make sure that the "Reversing camera" function is selected in COMAND Online; see the separate operating instructions for COMAND Online.
- ▶ Engage reverse gear. The area behind the vehicle is shown in the COMAND display.

ATTENTION ASSIST

Important safety notes

ATTENTION ASSIST is only an aid. It cannot always detect fatigue or lapses in concentration until too late or not at all. The system is not a substitute for a well-rested and attentive driver.

ATTENTION ASSIST helps you during long, monotonous journeys such as on motorways and trunk roads. It is active in the 80 km/h to 180 km/h range.

If ATTENTION ASSIST detects typical indicators of fatigue or increasing lapses in concentration on the part of the driver, it suggests taking a break.

ATTENTION ASSIST assesses your level of fatigue or lapses in concentration by taking the following criteria into account:

- your personal driving style, e.g. steering characteristics
- journey-related parameters, e.g. time of day, length of journey

The functionality of ATTENTION ASSIST is restricted, and warnings may be delayed or not occur at all:

- if the road condition is poor, e.g. if the surface is uneven or if there are potholes
- if there is a strong side wind
- if you have adopted a sporty driving style with high cornering speeds or high rates of acceleration
- if you are predominantly driving slower than 80 km/h or faster than 180 km/h
- if you are currently using COMAND Online or making a telephone call with COMAND Online
- if the time has been set incorrectly
- in active driving situations, such as when you change lanes or change your speed

Warning and display messages in the multifunction display

- ▶ Activate ATTENTION ASSIST using the on-board computer (▷ page 229).

If ATTENTION ASSIST is active, you will be warned no sooner than 20 minutes after your journey has begun. You then hear an intermittent warning tone twice and the **Attention Assist: Drowsiness detected** message appears in the multifunction display.

- ▶ If necessary, take a break.
- ▶ Press the **OK** button to confirm the message.

On long journeys, take regular breaks in good time to allow yourself to rest properly. If you do not take a break, you will be warned again after 15 minutes at the earliest. This will only happen if ATTENTION ASSIST still detects typical indicators of fatigue or increasing lapses in concentration.

ATTENTION ASSIST is reset and starts assessing your tiredness again when you continue your journey if:

- you switch off the engine
- you take off your seat belt and open the driver's door, e.g. for a change of drivers or to take a break

The assistance graphic shows the **OFF** symbol when ATTENTION ASSIST is deactivated (▷ page 228).

Speed Limit Assist

General notes

Speed Limit Assist shows you detected speed limits in the multifunction display. Data from the navigation system is also used for this purpose. If a traffic sign indicating a speed limit or the end of a speed limit is detected, it is shown in the multifunction display. If Speed Limit Assist does not detect any traffic signs, the speed limit from the digital road map is taken and shown in the display.

Speed Limit Assist detects the traffic signs with a camera attached behind the top of the windscreen.

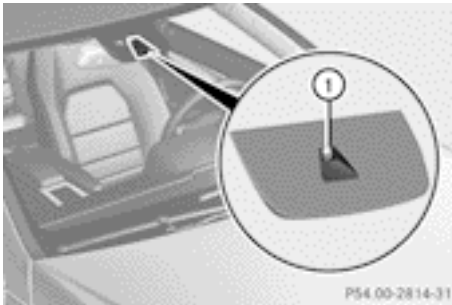

① Speed Limit Assist camera

Important safety notes

Speed Limit Assist is only an aid and does not always detect traffic signs specifying the maximum permissible speed. Traffic signs always have priority over the Speed Limit Assist display.

The system may be impaired or may not function if:

- there is poor visibility, e.g. due to snow, rain, fog or spray
- there is glare, e.g. from the sun or from oncoming traffic
- the windscreen is dirty, misted up or covered, for instance by a sticker, in the vicinity of the camera
- the traffic signs are covered, for instance by dirt, snow or trees
- the traffic signs are poorly illuminated
- there are ambiguous traffic signs, for instance near roadworks or on multi-lane roads

Information in the multifunction display

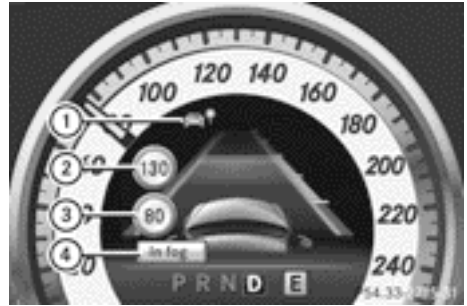

- ① Speed Limit Assist is available and switched on
- ② Maximum permitted speed (example)
- ③ Maximum permitted speed for vehicles for which the restriction in the additional sign is relevant (example)
- ④ Additional character in fog

Briefly showing detected traffic signs in the multifunction display

- ▶ Activate the Speed Limit Assist warning function using the on-board computer (> page 228).

A traffic sign indicating a speed limit or the end of a speed limit ① appears in the multifunction display for around five seconds as soon as it is detected. Any other information in the multifunction display is hidden for this period.

Permanently showing detected traffic signs in the multifunction display

- ▶ Display Speed Limit Assist using the on-board computer (> page 228).
- ▶ Display the assistance graphic using the on-board computer (> page 228).

A traffic sign indicating a speed limit or the end of a speed limit appears in the multifunction display as soon as it is detected.

Traffic sign indicating a speed limit ① is generally displayed until:

- a traffic sign indicating the end of the speed limit is detected.
- you make a turn.

- you leave or enter a town.
- the road type changes (e.g. motorway, country road).
- you have travelled a certain minimum distance without the traffic sign being repeated or detected again.

i You can also activate Speed Limit Assist using COMAND Online. The maximum permissible speed is shown in the COMAND display; see the COMAND Online operating instructions.

Lane Tracking package

General notes

The Lane Tracking package consists of Blind Spot Assist (▷ page 200) and Lane Keeping Assist (▷ page 202).

Blind Spot Assist

General notes

Blind Spot Assist uses a radar sensor system to monitor the areas on both sides of your vehicle. It supports you from speeds of 30 km/h. A warning display in the exterior mirrors draws your attention to vehicles detected in the monitored area. If you then switch on the corresponding turn signal to change lane, you will also receive an optical and audible collision warning. For monitoring, Blind Spot Assist uses sensors in the rear bumper.

For Blind Spot Assist to assist you when driving, the radar sensor system must be operational.

Important safety notes

Blind Spot Assist is only an aid. It may fail to detect some vehicles and is no substitute for attentive driving. Always ensure that there is sufficient distance to the side for other road users and obstacles.

WARNING

Blind Spot Assist does not react to vehicles:

- overtaken too closely on the side, placing them in the blind spot area
- when the difference in the speed of approach and overtaking is too great

As a result, Blind Spot Assist cannot warn drivers in these situations. There is a risk of an accident.

Always pay careful attention to the traffic situation and maintain a safe distance at the side of the vehicle.

Monitoring range of the sensors

In particular, the detection of obstacles can be impaired in the case of:

- dirt on the sensors or the sensors are obscured
- poor visibility, e.g. due to fog, heavy rain, snow or spray
- narrow vehicles, e.g. motorcycles or bicycles
- very wide lanes
- narrow lanes
- vehicles not driving in the middle of their lane
- barriers or other road boundaries

Vehicles in the monitoring range are then not indicated.

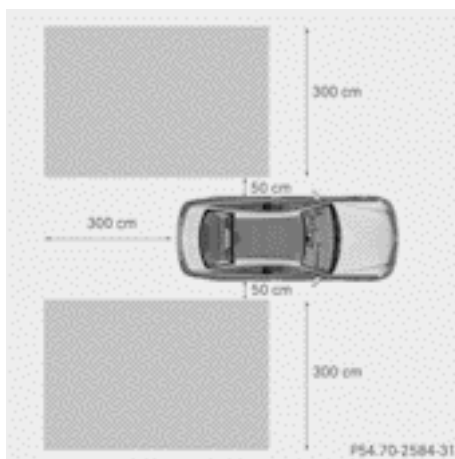

Blind Spot Assist monitors the area up to 3.0 m behind your vehicle and directly next to your vehicle, as shown in the diagram.

If the lanes are narrow, vehicles driving in the lane beyond the lane next to your vehicle may be indicated, especially if the vehicles are not driving in the middle of their lane. This may be the case if there are vehicles at the edge of their lane nearest your vehicle.

Due to the nature of the system:

- warnings may be issued in error when driving close to crash barriers or similar solid lane borders.
- warnings may be interrupted when driving alongside long vehicles, for example lorries, for a prolonged time.

The two radar sensors for Blind Spot Assist are integrated into the sides of the rear bumper. Make sure that the bumper is free of dirt, ice or slush in the vicinity of the sensors. The sensors must not be covered, for example by cycle racks or overhanging loads. Following a severe impact or in the event of damage to the bumpers, have the function of the sensors checked at a qualified specialist workshop. Blind Spot Assist may otherwise not work properly.

Indicator and warning display

Blind Spot Assist is not active at speeds below approximately 30 km/h. Vehicles in the monitoring range are then not indicated.

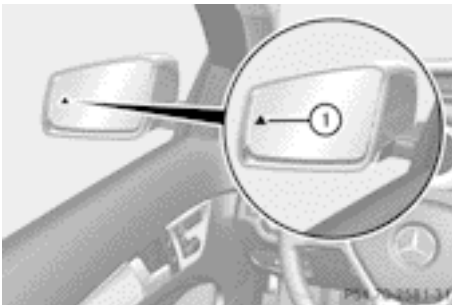

① Yellow indicator lamp/red warning lamp

If Blind Spot Assist is activated, indicator lamp ① in the exterior mirrors lights up yellow

up to a speed of 30 km/h. At speeds above 30 km/h, the indicator lamp goes out and Blind Spot Assist is operational.

If a vehicle is detected within the monitoring range of Blind Spot Assist at speeds above 30 km/h, warning lamp ① on the corresponding side lights up red. This warning always occurs when a vehicle enters the blind spot monitoring range from behind or from the side. When you overtake a vehicle, the warning only occurs if the difference in speed is less than 12 km/h.

The yellow indicator lamp goes out if reverse gear is engaged. Blind Spot Assist is then deactivated.

The brightness of the indicator/warning lamps is adjusted automatically according to the ambient light.

Collision warning

If a vehicle is detected in the monitoring range of Blind Spot Assist and you switch on the corresponding turn signal, a double warning tone sounds. Red warning lamp ① flashes. If the turn signal remains on, detected vehicles are indicated by the flashing of red warning lamp ①. There are no further warning tones.

Activating Blind Spot Assist

- ▶ Make sure that Blind Spot Assist (▷ page 229) is activated in the on-board computer.
- ▶ Turn the key to position **2** in the ignition lock. Warning lamps ① in the exterior mirrors light up red for approximately 1.5 seconds and then turn yellow.

Towing a trailer

If you attach a trailer, make sure that you have correctly established the electrical connection. This can be accomplished by checking the trailer lighting. Blind Spot Assist is then deactivated. The indicator lamp lights up yellow in the exterior mirrors and the **Blind Spot Assist currently unavailable**

See **Owner's Manual** message appears in the multifunction display.

i You can deactivate the indicator lamps in the exterior mirrors.

To do so, deactivate Blind Spot Assist if:

- the key is in position **2** in the ignition lock
- the engine is not running
- the electrical connection to the trailer has been established

Lane Keeping Assist

General notes

Lane Keeping Assist monitors the area in front of your vehicle by means of a camera ①, at the top of the windscreen. Lane Keeping Assist detects lane markings on the road and warns you before you leave your lane unintentionally.

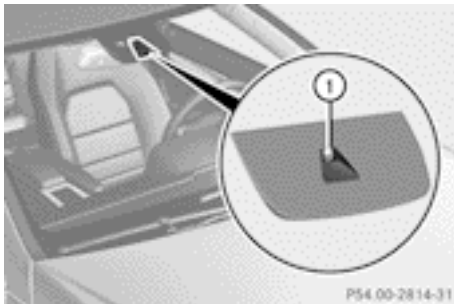

① Active Lane Keeping Assist camera

If you select **km** on the on-board computer in the **Display unit Speed-/odometer** function (▷ page 230), Lane Keeping Assist is active starting at a speed of 60 km/h. If the **miles** display unit is selected, the assistance range begins at 40 mph.

A warning may be given if a front wheel passes over a lane marking. It will warn you by means of intermittent vibration in the steering wheel for up to 1.5 seconds.

Important safety notes

If you fail to adapt your driving style, Lane Keeping Assist can neither reduce the risk of an accident nor override the laws of physics.

Lane Keeping Assist cannot take into account road, weather or traffic conditions. Lane Keeping Assist is only an aid. You are responsible for the distance to the vehicle in front, for vehicle speed, for braking in good time, and for staying in the lane.

⚠ WARNING

Lane Keeping Assist cannot always clearly identify lane markings.

In these cases, Lane Keeping Assist may:

- give an unnecessary warning
- not give a warning

There is a risk of an accident.

Always pay particular attention to the traffic situation and keep in lane, especially if Lane Keeping Assist alerts you.

⚠ WARNING

The Lane Keeping Assist warning does not return the vehicle to the original lane. There is a risk of an accident.

Always steer, apply the brakes or accelerate the vehicle yourself, especially if Lane Keeping Assist alerts you.

Lane Keeping Assist does not keep your vehicle in its lane.

The system may be impaired or may not function if:

- there is poor visibility, e.g. due to insufficient illumination of the road, or due to snow, rain, fog or spray
- there is glare, e.g. from oncoming traffic, the sun or reflection from other vehicles (e.g. if the road surface is wet)
- the windscreen is dirty, misted up, damaged or covered, for instance by a sticker in the vicinity of the camera
- no, or several, unclear lane markings are present for one lane, e.g. in a construction area
- the lane markings are worn away, dark or covered up, e.g. by dirt or snow

- the distance to the vehicle in front is too small and the lane markings thus cannot be detected
- the lane markings change quickly, e.g. lanes branch off, cross one another or merge
- the road is narrow and winding
- there are highly variable shade conditions on the road

Activating Lane Keeping Assist

- ▶ Activate Lane Keeping Assist using the on-board computer; to do so, select **Standard** or **Adaptive** (▷ page 230). If you drive at speeds above 60 km/h and lane markings are detected, the lines in the assistance graphic display (▷ page 228) are shown in green. Lane Keeping Assist is ready for use.

Standard

If **Standard** is selected, no warning vibration occurs if:

- you have switched on the turn signals. In this case, the warnings are suppressed for a certain period of time.
- a driving safety system intervenes, such as ABS, BAS or ESP®.

Adaptive

When **Adaptive** is selected, no warning vibration occurs if:

- you have switched on the turn signals. In this case, the warnings are suppressed for a certain period of time.
- a driving safety system intervenes, such as ABS, BAS or ESP®.
- you accelerate hard, e.g. kickdown.
- you brake hard.
- you steer actively, e.g. swerve to avoid an obstacle or change lane quickly.
- you cut the corner on a sharp bend.

In order that you are warned only when necessary and in good time if you cross the lane marking, the system recognises certain conditions and warns you accordingly.

The warning vibration occurs earlier if:

- you approach the outer lane marking on a bend.
- the road has very wide lanes, e.g. a motorway.
- the system recognises solid lane markings.

The warning vibration occurs later if:

- the road has narrow lanes.
- you cut the corner on a bend.

Towing a trailer

If you attach a trailer, make sure that you have correctly established the electrical connection. This can be accomplished by checking the trailer lighting.

Active Driving Assistance package

General notes

The Active Driving Assistance package consists of DISTRONIC PLUS (▷ page 179), Active Blind Spot Assist (▷ page 203) and Active Lane Keeping Assist (▷ page 206).

Active Blind Spot Assist

General notes

Active Blind Spot Assist uses a radar sensor system to monitor the area to the sides of your vehicle which are behind the driver. A warning display in the exterior mirrors draws your attention to vehicles detected in the monitored area. If you then switch on the corresponding turn signal to change lanes, you will also receive an optical and audible collision warning. If a risk of side impact is detected, corrective braking may help you avoid a collision. To support the course-correcting brake application, Active Blind Spot Assist also uses the forward-facing radar sensor system. The space available in the direction of travel as well as to the side of the vehicle is evaluated before a course-correcting braking application is performed.

Active Blind Spot Assist supports you from a speed of approximately 30 km/h.

For Active Blind Spot Assist to assist you when driving, the radar sensor system must be operational.

Important safety notes

Active Blind Spot Assist is only an aid. It does not detect all traffic situations and road users and is no substitute for attentive driving. Always ensure that there is sufficient distance to the side for other road users and obstacles.

WARNING

Active Blind Spot Assist does not react to vehicles:

- overtaking too closely on the side, placing them in the blind spot area
- if the difference in the speed of approach and overtaking is too great

As a result, Active Blind Spot Assist may neither give warnings nor intervene in such situations. There is a risk of an accident.

Always pay careful attention to the traffic situation and maintain a safe distance at the side of the vehicle.

Monitoring range of the sensors

WARNING

Active Blind Spot Assist does not detect all traffic situations and road users. There is a risk of an accident.

Always make sure that there is sufficient distance to the side for other traffic or obstacles.

In particular, the detection of obstacles can be impaired in the case of:

- dirt on the sensors or the sensors are obscured
- poor visibility, e.g. due to rain, snow or spray

Vehicles in the monitoring range are then not indicated.

Active Blind Spot Assist may not detect narrow vehicles, such as motorcycles or bicycles, or may only detect them too late.

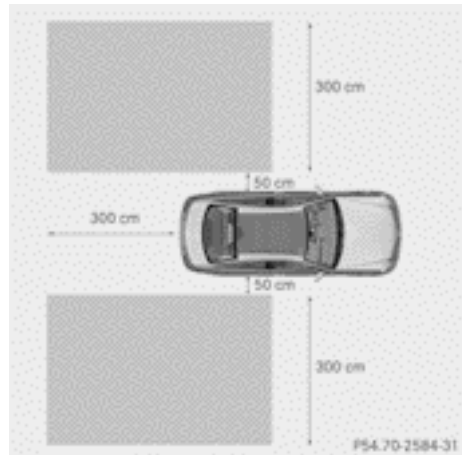

Active Blind Spot Assist monitors the area up to three metres behind your vehicle and directly next to your vehicle as shown in the diagram. For this purpose, Active Blind Spot Assist uses radar sensors in the rear bumper.

If the lanes are narrow, vehicles driving in the lane beyond the lane next to your vehicle may be indicated, especially if the vehicles are not driving in the middle of their lane. This may be the case if there are vehicles at the edge of their lane nearest your vehicle.

Due to the nature of the system:

- warnings may be issued in error when driving close to crash barriers or similar solid lane borders.
- warnings may be interrupted when driving alongside long vehicles, for example lorries, for a prolonged time.

Two Active Blind Spot Assist radar sensors are integrated into the front and rear bumpers respectively. An additional radar sensor is located behind the cover in the radiator grille. Make sure that the sensors and the areas around them are free of dirt, ice or slush. The rear sensors must not be covered, e.g. by bicycle racks or overhanging loads. Following a severe impact or in the event of damage to

the bumpers, have the function of the sensors checked at a qualified specialist workshop. Blind Spot Assist may otherwise not work properly.

Indicator and warning display

Active Blind Spot Assist is not active at speeds below approximately 30 km/h. Vehicles in the monitoring range are then not indicated.

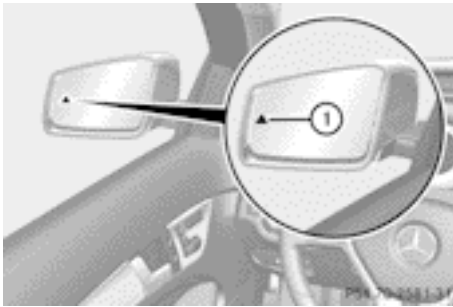

① Yellow indicator lamp/red warning lamp

If Active Blind Spot Assist is switched on, indicator lamp ① in the exterior mirrors lights up yellow up to a speed of 30 km/h. At speeds above 30 km/h, the indicator lamp goes out and Active Blind Spot Assist is operational.

If a vehicle is detected within the monitoring range of Blind Spot Assist at speeds above 30 km/h, warning lamp ① on the corresponding side lights up red. This warning always occurs when a vehicle enters the blind spot monitoring range from behind or from the side. When you overtake a vehicle, the warning only occurs if the difference in speed is less than 12 km/h.

The yellow indicator lamp goes out if reverse gear is engaged. Active Blind Spot Assist is then no longer active.

The brightness of the indicator/warning lamps is adjusted automatically according to the ambient light.

Visual and acoustic collision warning

When you switch on the turn signals to change lanes and a vehicle is detected in the side monitoring range, you receive a visual and acoustic collision warning. You then hear a double warning tone and red warning lamp ① flashes. If the turn signal remains on, detected vehicles are indicated by the flashing of red warning lamp ①. There are no further warning tones.

Course-correcting brake application

⚠ WARNING

A course-correcting brake application cannot always prevent a collision. There is a risk of an accident.

Always steer, brake or accelerate yourself, especially if Active Blind Spot Assist warns you or makes a course-correcting brake application. Always maintain a safe distance at the sides.

In very rare cases, the system may make an inappropriate brake application. An inappropriate brake application may be interrupted at any time if you steer slightly in the opposite direction or accelerate.

If Active Blind Spot Assist detects a risk of a side impact in the monitoring range, a course-correcting brake application is carried out. This is designed to help you avoid a collision.

The course-correcting brake application is available in the speed range between 30 km/h and 200 km/h.

If a course-correcting brake application occurs, red warning lamp ① flashes in the exterior mirror and the following is shown in the multifunction display, for example:



Example: vehicles with automatic transmission

Either a very slight course-correcting brake application, or none at all, may occur if:

- there are vehicles or obstacles, e.g. crash barriers, on both sides of your vehicle
- a vehicle approaches too closely on the side
- you have adopted a sporty driving style with high cornering speeds
- you brake or accelerate decisively
- a driving safety system intervenes, such as ESP® or PRE-SAFE® Brake
- ESP® is deactivated
- a loss of tyre pressure or a defective tyre is detected

Activating Active Blind Spot Assist

- ▶ Make sure that Active Blind Spot Assist (> page 229) is activated in the on-board computer.
- ▶ Turn the key to position **2** in the ignition lock.
Warning lamps ① in the exterior mirrors light up red for approximately 1.5 seconds and then turn yellow.

Towing a trailer

If you attach a trailer, make sure that you have correctly established the electrical connection. This can be accomplished by checking the trailer lighting. Active Blind Spot Assist is then deactivated. The indicator lamp lights up yellow in the exterior mirrors and the **Active Blind Spot Assist currently unavailable See Owner's Manual** message appears in the multifunction display.

Active Lane Keeping Assist

General notes

Active Lane Keeping Assist monitors the area in front of your vehicle by means of camera ① mounted at the top of the windscreen. Active Lane Keeping Assist detects lane markings on the road and warns you before you leave your lane unintentionally. If you do not react to the warning, a lane-correcting

application of the brakes can bring the vehicle back into the original lane.

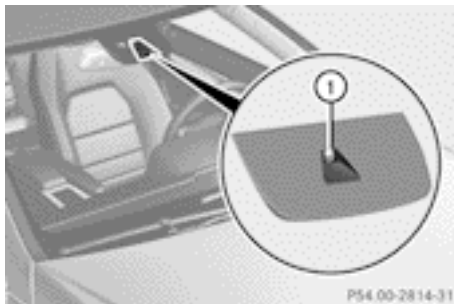

① Active Lane Keeping Assist camera

If you select **km** in the **Display unit Speed-/odometer**: function on the on-board computer (> page 230), Active Lane Keeping Assist is activated starting at a speed of 60 km/h. If the **miles** display unit is selected, the assistance range begins at 40 mph.

Important safety notes

If you fail to adapt your driving style, Active Lane Keeping Assist can neither reduce the risk of an accident nor override the laws of physics. Lane Keeping Assist cannot take into account road, weather or traffic conditions. Lane Keeping Assist is only an aid. You are responsible for the distance to the vehicle in front, for vehicle speed, for braking in good time, and for staying in the lane.

Active Lane Keeping Assist cannot continuously keep your vehicle in its lane.

⚠ WARNING

Active Lane Keeping Assist cannot always clearly detect lane markings.

In such cases, Active Lane Keeping Assist can:

- give an unnecessary warning and then make a course-correcting brake application to the vehicle
- neither give a warning nor intervene

There is a risk of an accident.

Always pay particular attention to the traffic situation and keep within the lane, especially

if Active Lane Keeping Assist alerts you. Terminate the intervention in a non-critical driving situation.

The system may be impaired or may not function if:

- there is poor visibility, e.g. due to insufficient illumination of the road, or due to snow, rain, fog or spray
- there is glare, e.g. from oncoming traffic, the sun or reflection from other vehicles (e.g. if the road surface is wet)
- the windscreen is dirty, misted up, damaged or covered, for instance by a sticker in the vicinity of the camera
- no, or several, unclear lane markings are present for one lane, e.g. in a construction area
- the lane markings are worn away, dark or covered up, e.g. by dirt or snow
- the distance to the vehicle in front is too small and the lane markings thus cannot be detected
- the lane markings change quickly, e.g. lanes branch off, cross one another or merge
- the road is narrow and winding
- there are highly variable shade conditions on the roadway
- no vehicle is detected in the adjacent lane and there are broken lane markings

Warning vibration through the steering wheel

A warning may be given if a front wheel passes over a lane marking. It will warn you by means of intermittent vibration in the steering wheel for up to 1.5 seconds.

In order that you are warned only when necessary and in good time if you cross the lane marking, the system recognises certain conditions and warns you accordingly.

The warning vibration occurs earlier if:

- you approach the outer lane marking on a bend.
- the road has very wide lanes, e.g. a motorway.
- the system recognises solid lane markings.

The warning vibration occurs later if:

- the road has narrow lanes.
- you cut the corner on a bend.

Lane-correcting brake application

WARNING

A lane-correcting brake application cannot always bring the vehicle back into the original lane. There is a risk of an accident.

Always steer, brake or accelerate yourself, especially if Active Lane Keeping Assist warns you or makes a lane-correcting brake application.

WARNING

Active Lane Keeping Assist does not detect traffic conditions or road users. In very rare cases, the system may make an inappropriate brake application, e.g. after intentionally driving over a solid lane marking. There is a risk of an accident.

An inappropriate brake application may be interrupted at any time if you steer slightly in the opposite direction. Always make sure that there is sufficient distance to the side for other traffic or obstacles.

If you leave your lane under certain circumstances, the vehicle will brake briefly on one side. This is intended to help you return the vehicle to the original lane.

This function is available in the range between 60 km/h and 200 km/h.

A lane-correcting brake application can only be made after driving over a solid, recognisable lane marking. Before this, a warning must have been issued by means of intermittent vibration through the steering wheel. In addition, a lane with lane markings on both

sides must be recognised. The brake application also slightly reduces driving speed.

If a lane-correcting brake application occurs, the following appears in the multifunction display:

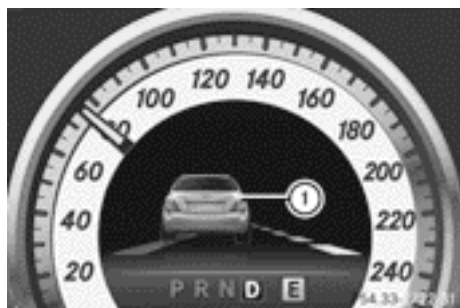

Example: vehicles with automatic transmission

i A further lane-correcting brake application can only occur after your vehicle has returned to the original lane.

No lane-correcting brake application occurs if:

- you clearly and actively steer, brake or accelerate.
- you cut the corner on a sharp bend.
- you have switched on the turn signals.
- a driving safety system intervenes, such as ESP®, PRE-SAFE® Brake or Active Blind Spot Assist.
- you have adopted a sporty driving style with high cornering speeds or high rates of acceleration.
- on vehicles with a trailer tow hitch, the electrical connection to the trailer has been correctly established.
- ESP® is deactivated.
- the transmission is not in position **D**.
- a loss of tyre pressure or a defective tyre has been detected and displayed.

Active Lane Keeping Assist does not detect road and traffic conditions. An inappropriate brake application may be interrupted at any time if:

- you steer slightly in the opposite direction.
- you use a turn signal.
- you clearly brake or accelerate.

A lane-correcting brake application is interrupted automatically if:

- a driving safety system intervenes, such as ESP®, PRE-SAFE® Brake or Active Blind Spot Assist.
- lane markings are no longer be detected.

Activating Active Lane Keeping Assist

► Activate Active Lane Keeping Assist using the on-board computer; to do so, select **Standard** or **Adaptive** (> page 230).

If you drive at speeds above 60 km/h and lane markings are detected, the lines in the assistance graphic display (> page 228) are shown in green. Lane Keeping Assist is ready for use.

If **Standard** is selected, no warning vibration occurs if:

- you have switched on the turn signals. In this case, the warnings are suppressed for a certain period of time.
- a driving safety system intervenes, such as ABS, BAS or ESP®.

When **Adaptive** is selected, no warning vibration occurs if:

- you have switched on the turn signals. In this case, the warnings are suppressed for a certain period of time.
- a driving safety system intervenes, such as ABS, BAS or ESP®.
- you accelerate hard, e.g. kickdown.
- you brake hard.
- you steer actively, e.g. swerve to avoid an obstacle or change lane quickly.
- you cut the corner on a sharp bend.

Towing a trailer

If you attach a trailer, make sure that you have correctly established the electrical connection. This can be accomplished by checking the trailer lighting.

Towing a trailer

Notes on towing a trailer

Important safety notes

WARNING

The braking system can overheat if you leave your foot on the brake pedal while driving. This increases the braking distance and could even cause the braking system to fail. There is a risk of an accident.

Never use the brake pedal as a footrest. Do not simultaneously depress both the brake pedal and the accelerator pedal while driving.

WARNING

You could lose control of the vehicle/trailer combination if it begins to swerve. The vehicle/trailer combination could even overturn. There is a risk of an accident.

On no account should you attempt to straighten out the vehicle/trailer combination by increasing speed. Decrease your speed and do not countersteer. Brake if necessary.

WARNING

If the maximum the permissible load for a carrier system is exceeded, the carrier could come loose from the vehicle and endanger other road users. There is a risk of an accident and injury.

Never exceed the permissible noseweight when using a carrier.

 Depressing the brake pedal constantly results in excessive and premature wear to the brake pads.

If you exceed the maximum permissible noseweight of the trailer drawbar on the ball coupling, the following may become damaged:

- your vehicle
- the trailer
- the ball coupling
- the trailer tow hitch

The vehicle/trailer combination could become unstable.

If the noseweight used is lower than the minimum permissible noseweight, the vehicle/trailer combination could also become unstable.

To avoid hazardous situations:

- make sure to check the noseweight before each journey.
- use a drawbar noseweight as close as possible to the maximum noseweight.
- do not exceed the maximum permissible noseweight.
- do not use a noseweight lower than the minimum permissible trailer drawbar noseweight.

When reversing the vehicle towards the trailer, make sure there is nobody between the trailer and the vehicle.

Couple and uncouple the trailer carefully. If you do not couple the trailer to the towing vehicle correctly, the trailer could become detached.

Make sure that the following values are not exceeded:

- the permissible trailer drawbar noseweight
- the permissible trailer load
- the permissible rear axle load of the towing vehicle
- the maximum permissible gross vehicle weight of both the towing vehicle and the trailer

The applicable permissible values, which must not be exceeded, can be found:

- in the vehicle documents
- on the identification plates of the trailer tow hitch, the trailer and the vehicle

If the values differ, the lowest value applies.

You will find the values approved by the manufacturer on the vehicle identification plates and those for the towing vehicle under "Technical data" (▷ page 382).

When towing a trailer, your vehicle's handling characteristics will be different in comparison to when driving without a trailer.

The vehicle/trailer combination:

- is heavier
- is restricted in its acceleration and gradient-climbing capability
- has an increased braking distance
- is affected more by strong crosswinds
- demands more sensitive steering
- has a larger turning circle

This can impair the vehicle's handling characteristics. Adapt your style of driving accordingly. Maintain a safe distance. Drive carefully.

When towing a trailer, always adjust your speed to the current road and weather conditions. Do not exceed the maximum permissible speed for your vehicle/trailer combination.

General notes

- i** When towing a trailer, set the tyre pressure on the rear axle of the towing vehicle for a maximum load; see the tyre pressure table in the fuel filler flap (▷ page 350).

Please note that when towing a trailer, PARKTRONIC (▷ page 191), Parking Guidance (▷ page 194) and Blind Spot Assist (▷ page 200) are only available with limitations, or not at all.

- i** The height of the ball coupling changes with the load of the vehicle. If necessary,

use a trailer with a height-adjustable drawbar.

You will find fitting dimensions and loads under "Technical data" (▷ page 381).

Driving tips

- i** Observe the notes on ESP® trailer stabilisation (▷ page 76).

The maximum permissible speed for vehicle/trailer combinations depends on the type of trailer. Before beginning the journey, check the trailer's documents to see what the maximum permitted speed is. Observe the legally prescribed maximum speed in the relevant country.

For certain Mercedes-Benz vehicles, the maximum permissible rear axle load is increased when towing a trailer. Refer to the "Technical data" section to find out whether this applies to your vehicle.

If you utilise any of the added maximum rear axle load when towing a trailer, the vehicle/trailer combination may not exceed a maximum speed of 100 km/h for reasons concerning the operating permit. This also applies in countries in which the permissible maximum speed for vehicle/trailer combinations is above 100 km/h.

When towing a trailer, your vehicle's handling characteristics will be different in comparison to when driving without a trailer and it will consume more fuel.

Change into a lower gear in good time on long and steep downhill gradients. On vehicles with automatic transmission, you must select shift range **1**, **2** or **3**.

- i** This also applies if you have activated cruise control, SPEEDTRONIC or DIS-TRONIC PLUS.

This will use the braking effect of the engine, so less braking will be required to maintain vehicle speed. This relieves the load on the brake system and prevents the brakes from overheating and wearing too quickly. If you

need additional braking, depress the brake pedal repeatedly rather than continuously.

Driving tips

- Maintain a greater distance from the vehicle in front than when driving without a trailer.
- Avoid braking abruptly. If possible, brake gently at first to allow the trailer to run on. Then, increase the braking force rapidly.
- The values given for gradient-climbing capabilities from a standstill refer to sea level. When driving in mountainous areas, note that the power output of the engine, and consequently the vehicle's gradient-climbing capability, decrease with increasing altitude.

If the trailer swings from side to side:

- ▶ Do not accelerate.
- ▶ Do not countersteer.
- ▶ Brake if necessary.

Folding out the ball coupling

Before you can tow a trailer with your vehicle, you must fold out the ball coupling.

The release wheel is located behind the left-hand side trim panel in the boot.

WARNING

If the ball coupling is not correctly engaged, the trailer can detach. There is a risk of an accident.

Always engage the ball coupling as described.

WARNING

If you release the ball coupling or it does not engage correctly when folding in, it will swing out. Within pivoting range of the ball coupling, there is an increased risk of an accident and injury.

Only release the ball coupling if the pivoting range is unobstructed. Always make sure that the ball coupling engages when folding in.

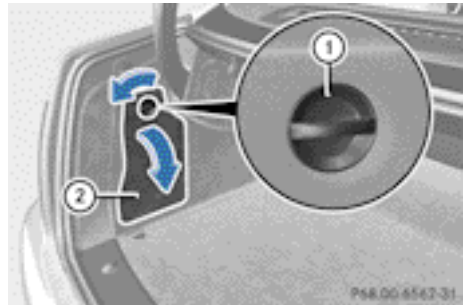

- ▶ **To open the cover:** turn handle ① anti-clockwise and fold down cover ②.

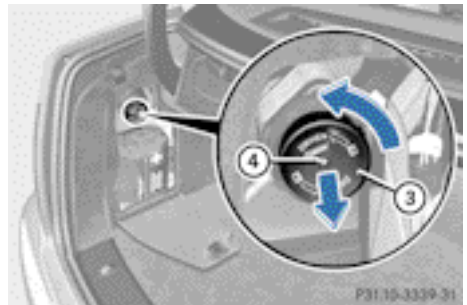

- ▶ Pull out release wheel ③.
- ▶ Turn release wheel ③ anti-clockwise until the ball coupling releases and folds out from under the rear bumper. Indicator lamp ④ flashes.



- ▶ Pull the ball coupling in the direction of the arrow until it engages in a vertical position. Indicator lamp ④ goes out. The power socket folds down automatically.

Vehicles with a 4-button multifunction steering wheel: the **Trailer hitch Check Lock mech.** display message is shown in the multifunction display until the ball coupling has engaged.

Vehicles with a 12-button multifunction steering wheel: the **Trailer hitch Check Lock mech.** display message is shown in the multifunction display until the ball coupling has engaged.

- ▶ Remove the protective covering from the ball coupling and store it in a safe place.
- ▶ Make sure that the ball of the ball coupling is clean and that it is either greased or dry (grease free), depending on the instructions for the trailer.

Coupling up a trailer

WARNING

If you uncouple a trailer with an engaged overrun brake, you could trap your hand between the vehicle and the trailer drawbar. This poses a risk of injury.

Do not uncouple a trailer with an engaged overrun brake.

- ▶ Make sure that the transmission is in position **P**.
- ▶ Engage the parking brake.
- ▶ Position the trailer level behind the vehicle.
- ▶ Couple up the trailer.
- ▶ Establish the electric connection between the vehicle and the trailer.
- ▶ Check that the trailer lighting system is working.

Uncoupling a trailer

WARNING

Vehicles with level control:

If you disconnect the trailer cable, the vehicle is lowered. This can cause you or others to become trapped between the vehicle body

and tyres, or underneath the vehicle. This poses a risk of injury.

Make sure that no-one is in the immediate vicinity of the wheel arch or underneath the vehicle when disconnecting the trailer cable.

- ❗ Do not disconnect a trailer with an engaged overrun brake. Otherwise, your vehicle could be damaged by the rebounding of the overrun brake.
- ▶ Make sure that the transmission is in position **P**.
- ▶ Engage the parking brake.
- ▶ Secure the trailer against rolling away.
- ▶ Remove the trailer cable and decouple the trailer.

Folding in the ball coupling

WARNING

If you release the ball coupling or it does not engage correctly when folding in, it will swing out. Within pivoting range of the ball coupling, there is an increased risk of an accident and injury.

Only release the ball coupling if the pivoting range is unobstructed. Always make sure that the ball coupling engages when folding in.

- ❗ Fold the ball coupling back in if you are not using the trailer tow hitch.
- ▶ Place the protective covering on the ball coupling.

The release wheel is located behind the left-hand side trim panel in the boot.

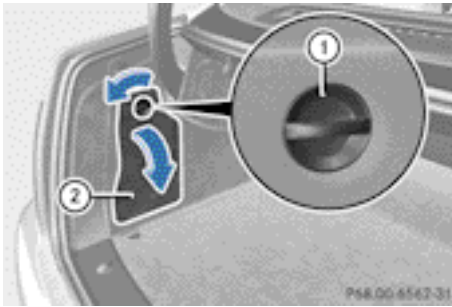

- ▶ **To open the cover:** turn handle ① anti-clockwise and fold down cover ②.

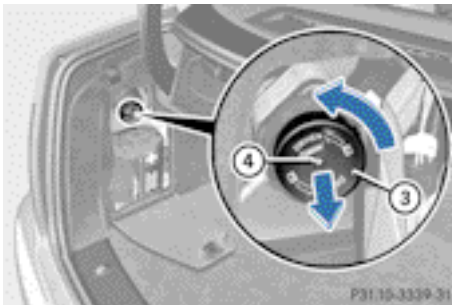

- ▶ Pull out release wheel ③.
- ▶ Turn release wheel ③ anti-clockwise. The ball coupling unlocks and lowers. Indicator lamp ④ flashes.



- ▶ Press the ball coupling in the direction of the arrow until it engages behind the bumper. Indicator lamp ④ goes out and the message in the multifunction display disappears.

Trailer power supply

When it leaves the factory, your vehicle's trailer socket is equipped with a permanent power supply and a power supply that is switched on via the ignition lock.

The permanent power supply is supplied via trailer socket pin 9.

The power supply that is switched on via the ignition lock is supplied via trailer socket pin 10.

- ❗ You can connect accessories with a power rating of up to 240 W to the permanent power supply and with a power rating of up to 180 W to the power supply that is switched on via the ignition lock.

The trailer battery may not be charged from the power supply.

The trailer's permanent power supply is switched off in the event of low vehicle supply voltage and after six hours at the latest.

You can find more information about fitting the trailer electrics at a qualified specialist workshop.

- ▶ **To switch the connected power supply on or off:** turn the key in the ignition lock to position **2** or **0** respectively.

Bulb failure indicator for LED lamps

- ❗ If LED lamps are fitted in the trailer, an error message may appear in the multifunction display even if there is no fault. The reason for the error message could be that the current has fallen below the minimum of 50 mA.

To ensure reliable operation of the bulb failure indicator, each LED chain in the trailer lighting must be guaranteed a minimum current of 50 mA.

Trailer with 7-pin connector

General notes

Trailer with 7-pin connector: you can connect to the 13-pin socket on the ball coupling using an adapter or, if necessary, an adapter cable. Both can be obtained at a qualified specialist workshop.

Fitting the adapter

! Make sure that there is sufficient cable play so that the cable cannot become detached when cornering.

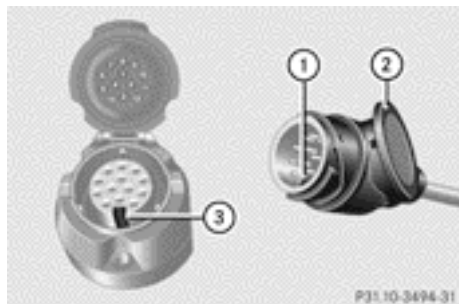

- ▶ Open the socket cover.
- ▶ Insert the plug connector with lug ① into groove ③ on the socket. Turn bayonet connection ② clockwise to the stop.
- ▶ Let the cover engage.
- ▶ If you are using an adapter cable, secure the cable to the trailer with cable ties.

Useful information	216
Important safety notes	216
Displays and operation (4-button multifunction steering wheel)	216
Displays and operation (12-button multifunction steering wheel)	219
Display messages	240
Warning and indicator lamps in the instrument cluster	281

Useful information

- i** This Owner's Manual describes all models, series and optional equipment for your vehicle that were available at the time of going to press. National variations are possible. Note that your vehicle may not be equipped with all of the functions described. This is also the case for systems and functions relevant to safety.
- i** Read the information on qualified specialist workshops: (▷ page 28).

Important safety notes

WARNING

Operating the integrated information systems and communications equipment in the vehicle while driving will distract you from traffic conditions. You could then lose control of the vehicle. There is a risk of an accident.

Only operate these devices if road traffic conditions permit. If you are unsure about the surrounding conditions, pull over to a safe location and make entries only while the vehicle is stationary.

WARNING

If the instrument cluster has failed or malfunctioned, you may not recognise function restrictions relevant to safety. The operating safety of your vehicle may be impaired. There is a risk of an accident.

Drive on carefully. Have the vehicle checked at a qualified specialist workshop immediately.

You must observe the legal requirements for the country in which you are currently driving when operating the on-board computer.

The on-board computer only shows messages or warnings from certain systems in the multifunction display. You should therefore make sure your vehicle is operating safely at all

times. Otherwise, a vehicle that is not operating safely may cause an accident.

For an overview, see the instrument cluster illustration for vehicles with:



- 4-button multifunction steering wheel (▷ page 34)
- 12-button multifunction steering wheel (▷ page 37)

Displays and operation (4-button multifunction steering wheel)

Instrument cluster lighting

The lighting in the instrument cluster, in the displays and the controls in the vehicle interior can be adjusted using the brightness control knob.

The brightness control knob is located on the bottom left of the instrument cluster (▷ page 37).

- ▶ Turn the brightness control knob clockwise or anti-clockwise.
If the light switch is set to ,  or , the brightness is dependant upon the brightness of the ambient light.

- i** The light sensor in the instrument cluster automatically controls the brightness of the multifunction display.

In daylight, the displays in the instrument cluster are not illuminated.

Coolant temperature gauge

The coolant temperature gauge is in the instrument cluster on the left-hand side.

Under normal operating conditions and with the specified coolant level, the coolant temperature may rise to 120 °C.

At high outside temperatures and when driving uphill, the coolant temperature may rise to the end of the scale.

Rev counter

The red band in the rev counter indicates the engine's overrevving range.

- !** Do not drive in the overrevving range.
Doing so will damage the engine.

The fuel supply is interrupted to protect the engine when the red band is reached.

Outside temperature display

You should pay special attention to road conditions when temperatures are around the freezing point.

The outside temperature display is in the instrument cluster (▷ page 34).

Changes in the outside temperature are displayed after a short delay.

Operating the on-board computer

The on-board computer is activated as soon as you turn the key to position **1** in the ignition lock. You can use the on-board computer to call up information relating to your vehicle and to make and adjust settings.

- i** You can have certain functions set at a qualified specialist workshop, e.g. a Mercedes-Benz Service Centre.

Examples:

- automatic door locking
- speed limit for winter tyres

You can obtain information about this at any Mercedes-Benz Service Centre.

You can control the multifunction display and the settings in the on-board computer using the buttons on the multifunction steering wheel.



- ① Multifunction display
- ② Increases the volume
- ③ Decreases the volume
- ④ Scrolls through lists/adjusts values/confirms display messages
- ⑤ Selects a menu

- i** If you press and hold the button, the standard display appears.

- i** In the **Day. driv. lights** menu, you can use the or button to switch the function **on** or **off**. You cannot adjust the volume when in the **Day. driv. lights**: menu.

Multifunction display

To activate the multifunction display:

- switch on the ignition
- switch on the lights
- open the driver's door



Values and settings as well as display messages are shown in multifunction display ①.

Menu overview

Operating the on-board computer (▷ page 217).

- Standard display (▷ page 218)
- Trip computer (▷ page 218)
- Range (▷ page 218)
- Current fuel consumption
- Digital speedometer
- Message memory (▷ page 240)
- Service (▷ page 312)
- Tyre pressure loss warning system (▷ page 351)
- Daytime driving lights (▷ page 218)
- Time (▷ page 219)

Standard display



- ▶ Press and hold the  button on the steering wheel until the standard display with trip meter ① and total distance recorder ② is shown.

- ▶ **To reset the trip meter:** press and hold the  button until the standard display appears.
- ▶ Press and hold the **R** button until the value has been reset.

Trip computer

- ▶ Press the  button on the steering wheel repeatedly until the trip computer appears.



- ① Distance
- ② Average speed
- ③ Time
- ④ Average fuel consumption

- ▶ **To reset the trip computer:** press and hold the **R** button on the steering wheel until the values have been reset.

Calling up the range

- ▶ Press the  button on the steering wheel repeatedly until the approximate range appears.

The approximate range which can be covered depends on the fuel level and your current driving style. If there is only a small amount of fuel left in the fuel tank, the display shows a vehicle being refuelled  instead of the range.



Switching the daytime driving lights on/off

If you have activated the **Day. driv. Lights**: function and the light switch is in the





AUTO position, the daytime driving lights are switched on automatically when the engine is running. When it is dark, the side lamps and the dipped-beam headlamps are switched on automatically.

On vehicles with daytime driving lamps, the factory setting is **on**.

If you want to change the setting for the **Day. driv. lights**: function, you have to turn the key in the ignition lock to position **1**.

- ▶ Press the  button on the steering wheel repeatedly until the **Day. driv. lights**: menu appears.
You will see the selected setting: **on** or **off**.
- ▶ Press the  or  button to change the setting.

Time/date



- ❗ Depending on your vehicle's equipment, the time can be set using the on-board computer or the audio system/COMAND, see the separate operating instructions.
- ▶ Press the  button on the steering wheel repeatedly until the "Time/date" menu appears.
- ▶ **To set:** use the  button to select the display you want to change: hour, minutes, day, month, year.
- ▶ Press  or  to set the selected display.
- ▶ **To save:** press the  button.
The next display is selected.

Displays and operation (12-button multifunction steering wheel)

Instrument cluster lighting

The lighting in the instrument cluster, in the displays and the controls in the vehicle interior can be adjusted using the brightness control knob.

The brightness control knob is located on the bottom left of the instrument cluster (▷ page 37).

- ▶ Turn the brightness control knob clockwise or anti-clockwise.
If the light switch is set to ,  or , the brightness is dependant upon the brightness of the ambient light.

- ❗ The light sensor in the instrument cluster automatically controls the brightness of the multifunction display.
In daylight, the displays in the instrument cluster are not illuminated.

Coolant temperature gauge

WARNING

If you open the bonnet while the engine is overheating or while there is a fire in the engine compartment, you could come into contact with hot gases or other leaking service products. There is a danger of injury. Allow an overheating engine to cool down before opening the bonnet. If there is a fire in the engine compartment, leave the bonnet closed and notify the fire brigade.

The coolant temperature gauge is in the instrument cluster on the left-hand side. Under normal operating conditions and with the specified coolant level, the coolant temperature may rise to 120 °C. At high outside temperatures and when driving uphill, the coolant temperature may rise to the end of the scale.

Rev counter

The red band in the rev counter indicates the engine's overrevving range.

- ❗ Do not drive in the overrevving range.
Doing so will damage the engine.

The fuel supply is interrupted to protect the engine when the red band is reached.

Outside temperature display

You should pay special attention to road conditions when temperatures are around the freezing point.

The outside temperature display is in the multifunction display (▷ page 221).

Changes in the outside temperature are displayed after a short delay.

Speedometer with segments

The segments in the speedometer indicate which speed range is available.

- Cruise control activated (▷ page 174):
The segments light up from the stored speed to the maximum speed.
- Variable SPEEDTRONIC activated (▷ page 177):
The segments light up from the start of the scale to the selected limit speed.
- DISTRONIC PLUS activated (▷ page 179):
One or two segments in the set speed range light up.
- DISTRONIC PLUS detects a vehicle in front:
The segments between the speed of the vehicle in front and the stored speed light up.

Operating the on-board computer

Overview

The on-board computer is activated as soon as you turn the key to position **1** in the ignition lock.

You can control the multifunction display and the settings in the on-board computer using the buttons on the multifunction steering wheel.



- ① Multifunction display
- ② Switches on LINGUATRONIC; see the separate operating instructions
- ③ Right control panel
- ④ Left control panel
- ⑤ Back button

Left control panel



- Calls up the menu and menu bar





Press briefly:





- Scrolls through lists
- Selects a submenu or function
- In the **Audio** menu: selects a stored station, an audio track or a video scene
- In the **Tel** (telephone) menu: switches to the phone book and selects a name or telephone number

▲	Press and hold:
▼	
	<ul style="list-style-type: none"> In the Audio menu: selects the previous/next station or selects an audio track or a video scene using rapid scrolling In the Tel (Telephone) menu: starts rapid scrolling of the phone book if it is open
OK	<ul style="list-style-type: none"> Confirms selection/display message In the Tel (Telephone) menu: switches to the telephone book and starts dialling the selected number In the Audio menu: stops the station search function at the desired station

Right control panel

	<ul style="list-style-type: none"> Rejects or ends a call Exits telephone book/redial memory
	<ul style="list-style-type: none"> Makes or accepts a call Switches to the redial memory
+	<ul style="list-style-type: none"> Adjusts the volume
-	
	<ul style="list-style-type: none"> Mute

Back button

	Press briefly:
	<ul style="list-style-type: none"> Back Switches off LINGUATRONIC; see the separate operating instructions Hides display messages/calls up the last Trip menu function used Exits the telephone book/redial memory
	Press and hold:
	<ul style="list-style-type: none"> Calls up the standard display in the Trip menu

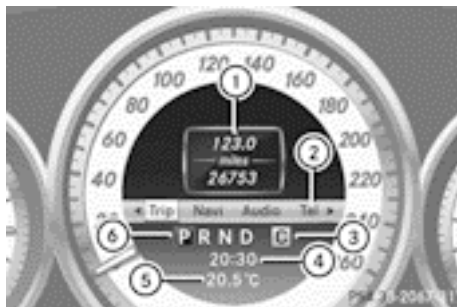

Multifunction display

Values and settings as well as display messages are shown in the multifunction display.



Example: automatic transmission multifunction display

- ① Text field
- ② Menu bar
- ③ Drive program
- ④ Time
- ⑤ Permanent display: outside temperature or speed (> page 231)
- ⑥ Transmission position

► **To show the menu bar** ②: press the  or  button on the steering wheel. Menu bar ② disappears after a few seconds.

Text field ① shows the selected menu or submenu as well as display messages.

- ① You can set the time using the audio system or COMAND Online, see the separate operating instructions.

Vehicles with manual transmission: the indicators in the lower part of the multifunction display differ from the display shown here.

The following messages may appear in the multifunction display:

- ↑ Gearshift recommendation, manual transmission (▷ page 158) or automatic transmission (▷ page 163)
- ← [P] → Parking Guidance (▷ page 194)
- [CC] Cruise control (▷ page 174)
- [LIM] SPEEDTRONIC (▷ page 177)
- [AHB] Adaptive Highbeam Assist (▷ page 123)
- [ECO] ECO start/stop function (▷ page 153)
- [HOLD] HOLD function (▷ page 188)
- 120 Maximum permissible speed exceeded (only for certain countries)

Menu overview

Operating the on-board computer (▷ page 220).

Depending on the equipment fitted in the vehicle, you can call up the following menus:

- **Trip** menu (▷ page 222)
- **Navi** menu (navigation instructions) (▷ page 224)
- **Audio** menu (▷ page 225)
- **Tel** menu (telephone) (▷ page 226)
- **Assist.** menu (assistance)
- **Service** menu (▷ page 230)
- **Settings** menu (settings) (▷ page 230)
- **AMG** menu in AMG vehicles (▷ page 236)

The **Audio**, **Navi** and **Tel** menus differ slightly in vehicles with an audio system and in vehi-

cles with COMAND Online. The examples given in this Owner's Manual apply to vehicles equipped with COMAND Online.

Trip menu

Standard display



- ▶ Press and hold the [Menu] button on the steering wheel until the **Trip** menu with trip meter ① and total distance recorder ② is shown.

Trip computer "From start" or "From reset"



Example: "From start" trip computer

- ① Distance
- ② Time
- ③ Average speed
- ④ Average fuel consumption

- ▶ Press the [Left] or [Right] button on the steering wheel to select the **Trip** menu.
- ▶ Press the [Up] or [Down] button to select **From start** or **From reset**.

The values in the **From start** submenu are calculated from the start of a journey whilst the values in the **From reset** submenu are calculated from the last time the submenu was reset (▷ page 223).

The **From start** trip computer is automatically reset if:

- the ignition has been switched off for more than four hours.
- 999 hours have been exceeded.
- 9,999 kilometres have been exceeded.

The **From reset** trip computer is automatically reset if the value exceeds 9,999 hours or 99,999 kilometres.

Displaying the range and current fuel consumption

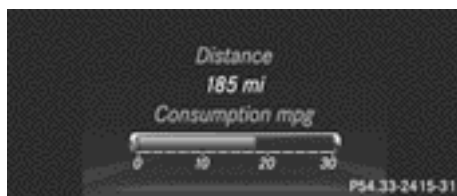

- ▶ Press the or button on the steering wheel to select the **Trip** menu.
- ▶ Press the or button to select the current fuel consumption and the approximate range (except for AMG vehicles).

The approximate range which can be covered depends on the fuel level and your current driving style. If there is only a small amount of fuel left in the fuel tank, the display shows a vehicle being refuelled  instead of the range.

ECO display



Example: ECO display

- ▶ Press the or button on the steering wheel to select the **Trip** menu.
- ▶ Press the or button to select **ECO DISPLAY**.

If the ignition remains switched off for longer than four hours, the ECO display will be automatically reset.

For further information on the ECO display, see (▶ page 171).

Digital speedometer



- ① Gearshift recommendation, manual transmission (▶ page 158) or automatic transmission (▶ page 163)
 - ② Digital speedometer
- ▶ Press the or button on the steering wheel to select the **Trip** menu.
 - ▶ Press the or button to select the digital speedometer.

Resetting values



Example: resetting the trip computer "From start"

- ▶ Press the or button on the steering wheel to select the **Trip** menu.
- ▶ Press the or button to select the function that you wish to reset.
- ▶ Press the button.
- ▶ Press the button to select **Yes** and press the button to confirm.

You can reset the values of the following functions:

- trip meter
- trip computer "From start"



- trip computer "From reset"
- ECO display

i If you reset the values in the ECO display, the values in the "From start" trip computer are also reset. If you reset the values in the "From start" trip computer, the values in the ECO display are also reset.

Navigation menu

Displaying navigation instructions

In the **Navi** menu, the multifunction display shows navigation instructions. For more information, see the separate operating instructions.

- ▶ Switch on the audio system with Becker® MAP PILOT or COMAND Online; see the separate operating instructions.
- ▶ Press the  or  button on the steering wheel to select the **Navi** menu.

Route guidance not active



- ① Direction of travel
- ② Current road

Activating route guidance

No change of direction announced



- ① Distance to the destination
- ② Distance to the next change of direction

- ③ Current road
- ④ Symbol indicating "follow the road's course"

Change of direction announced without a lane recommendation



- ① Road to which the change of direction leads
- ② Distance to change of direction and visual distance display
- ③ Change-of-direction symbol

When a change of direction is announced, you will see symbol ③ for the change of direction and distance graphic ②. This shortens towards the top of the display as you approach the point of the announced change of direction.

Change of direction announced with a lane recommendation



- ① Road to which the change of direction leads
- ② Distance to change of direction and visual distance display
- ③ New lane during a change of direction
- ④ Lane continues through change of direction
- ⑤ Lane recommendation
- ⑥ Change-of-direction symbol

On multilane roads, the system can display lane recommendation ⑤ for the next change

of direction. During the change of direction, additional lanes may be displayed.

Lane recommendations are only displayed if the relevant data is available on the digital map.



Other status indicators of the navigation system

- : you have reached the destination or an intermediate destination.
- **New route...** or **Calculating route:** calculating a new route
- **Off map** or **Off road:** the vehicle position is outside the area of the digital map (off-map position).
- **No route:** no route could be calculated to the selected destination.

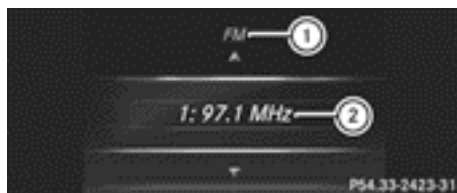

Audio menu

Selecting a radio station





- ① Waveband
- ② Station frequency with memory position
- **i** Station ② is displayed with the station frequency or station name. The memory position is only displayed along with station ② if this has been stored.
- ▶ Switch on the audio system or COMAND Online and select Radio (see the separate operating instructions).
- ▶ Press the  or  button on the steering wheel to select the **Audio** menu.

▶ **To select a stored station:** briefly press the  or  button.

▶ **To select a station from the station list:** press and briefly hold the  or  button.

If no station list is received:

▶ **To select a station using the station search:** press and briefly hold the  or  button.

• **i** For information on switching wavebands and storing stations, see the separate operating instructions.

• **i** DAB radio mode (**D**igital **A**udio **B**roadcasting); see the separate operating instructions.







Audio player or audio media operation





Example: CD/DVD changer display

① Current track

Audio data from various audio devices or media can be played, depending on the equipment fitted in the vehicle.

- ▶ Switch on the audio system or COMAND Online and select the audio player or medium, see the separate operating instructions.
- ▶ Press the  or  button on the steering wheel to select the **Audio** menu.
- ▶ **To select the next/previous track:** briefly press the  or  button.
- ▶ **To select a track from the track list (rapid scrolling):** press and hold the  or  button until desired track has been reached.

If you press and hold the  or  button, the rapid scrolling speed is increased.

Not all audio devices or media support this function.

If track information is stored on the audio device or medium, the multifunction display will show the number and name of the track. The current track does not appear in audio AUX mode (**A**uxiliary audio mode: external audio source connected).

Video DVD operation



Example: CD/DVD changer display

① Current scene

- ▶ Switch on COMAND Online and select video DVD; see the separate operating instructions.
- ▶ Press the ◀ or ▶ button on the steering wheel to select the **Audio** menu.
- ▶ **To select the next or previous scene:** briefly press the ▲ or ▼ button.
- ▶ **To select a scene from the scene list (rapid scrolling):** press and hold the ▲ or ▼ button until desired scene has been reached.

Telephone menu

Introduction

WARNING

Operating the integrated information systems and communications equipment in the vehicle while driving will distract you from traffic conditions. You could then lose control of the vehicle. There is a risk of an accident.

Only operate these devices if road traffic conditions permit. If you are unsure about the surrounding conditions, pull over to a safe

location and make entries only while the vehicle is stationary.

When telephoning, you must observe the legal requirements for the country in which you are currently driving.

- ▶ Switch on your mobile phone and audio system or COMAND Online, see the separate operating instructions.
- ▶ Place a mobile phone in the mobile phone bracket (▷ page 302), or establish a Bluetooth® connection with the audio system or COMAND Online (see the separate operating instructions).
- ▶ Press the ◀ or ▶ button on the steering wheel to select the **Te1** menu.

You will see one of the following display messages in the multifunction display:

- **Please enter PIN:** the mobile phone has been placed in the mobile phone bracket and the PIN has not been entered. When you enter your PIN via the mobile phone, LINGUATRONIC, the audio system or COMAND Online, the mobile phone searches for a network.
- **Telephone ready** or the name of the network provider: the mobile phone has found a network and is ready to receive.
- **Telephone No service:** there is no network available or the mobile phone is searching for a network.

i You can obtain further information about suitable mobile phones and connecting mobile phones via Bluetooth®:

- from any Mercedes Benz Service Centre
- on the Internet at: <http://www.mercedes-benz.com/connect>

Accepting a call

If someone calls you when you are in the **Te1** menu, a display message appears in the multifunction display, for example:

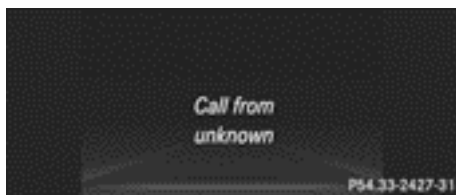

Example: incoming call

- ▶ Press the button on the steering wheel to accept an incoming call.

You can accept a call even if you are not in the **Te1** menu.

Rejecting or ending a call

- ▶ Press the button on the steering wheel.

You can end or reject a call even if you are not in the **Te1** menu.

Dialling an entry from the phone book

- ▶ Press the or button on the steering wheel to select the **Te1** menu.
- ▶ Press the , or button to switch to the phone book.
- ▶ Press the or button to select the desired name.

or

- ▶ **To begin rapid scrolling:** press and hold the or button for longer than one second.
Rapid scrolling stops when you release the button or reach the end of the list.
- ▶ **If only one telephone number is stored for a name:** press the or button to start dialling.

or

- ▶ **If there is more than one number for a particular name:** press the or button to display the numbers.
- ▶ Press the or button to select the number you want to dial.
- ▶ Press the or button to start dialling.

or

- ▶ **To exit the telephone book:** press the or button.

Redialling

The on-board computer saves the last names or numbers dialled in the redial memory.

- ▶ Press the or button on the steering wheel to select the **Te1** menu.
- ▶ Press the button to switch to the redial memory.
- ▶ Press the or button to select the desired name or number.
- ▶ Press the or button to start dialling.

or

- ▶ **If you do not want to make a call:** press the or button.

Assistance menu

Introduction

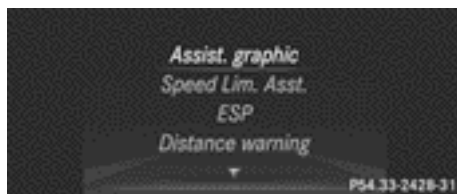





In the **Assist** menu, you have the following options:

- Showing the assistance graphic (▷ page 228)
- Showing Speed Limit Assist and activating/deactivating its message function (▷ page 228)
- Activating/deactivating ESP® (▷ page 228)
- Activating/deactivating PRE-SAFE® Brake (▷ page 229)
- Activating/deactivating ATTENTION ASSIST (▷ page 229)



- Activating/deactivating Blind Spot Assist or Active Blind Spot Assist (▷ page 229)
- Activating/deactivating Lane Keeping Assist or Active Lane Keeping Assist (▷ page 230)

Showing the assistance graphic

- ▶ Press the  or  button on the steering wheel to select the **Assist** menu.
- ▶ Press  or  to select **Assistance graphic**.
- ▶ Press the  button.
The multifunction display shows the DIS-TRONIC PLUS distance display in the assistance graphic (▷ page 185).





The assistance graphic can display the status of and information from other driving systems or driving safety systems.

The assistance graphic shows:







- the  symbol when ATTENTION ASSIST (▷ page 198) is deactivated.
- the lane markings as bright lines when Lane Keeping Assist (▷ page 202) or Active Lane Keeping Assist (▷ page 206) is activated.
- the  symbol when Speed Limit Assist (▷ page 198) is operational.
The assistance graphic can also display traffic signs that are detected and indicate speed limits.
- the  symbol when PRE-SAFE® Brake (▷ page 77) is deactivated.

Speed Limit Assist

Displaying Speed Limit Assist

- ▶ Press the  or  button on the steering wheel to select the **Assist** menu.
- ▶ Press the  or  button to select **Speed Lim. Asst..**
- ▶ Press the  button.
Under certain conditions, detected speed limits are shown in the multifunction display (▷ page 198).

Activating/deactivating the Speed Limit Assist message function

- ▶ Press the  or  button on the steering wheel to select the **Assist** menu.
- ▶ Press the  or  button to select **Speed Lim. Asst.**
- ▶ Press the  button.
The multifunction display shows Speed Limit Assist.
- ▶ Press the  button.
The current selection is displayed.
- ▶ **To activate or deactivate:** press .
If the Speed Limit Assist message function is activated, a detected speed limit is automatically displayed for five seconds. Other items in the multifunction display are not shown during this time.

When Speed Limit Assist is operational and the message function is activated, the assistance graphic shows the  symbol.

Deactivating/activating ESP®

- ❗ Observe the "Important safety notes" section in the description of ESP (▷ page 73).

WARNING

If you deactivate ESP®, ESP® no longer stabilises the vehicle. There is an increased risk of skidding and an accident.









Only deactivate ESP® in the situations described in the following.

It may be best to deactivate ESP® in the following situations:



- when using snow chains
- in deep snow
- on sand or gravel

Deactivating/activating ESP® on AMG vehicles (▷ page 75).

For further information about ESP®, see (▷ page 73).

- ▶ Start the engine.
- ▶ Press the  or  button on the steering wheel to select the **Assist** menu.
- ▶ Press the  or  button to select **ESP**.
- ▶ Press the  button.
- ▶ **To deactivate:** press  again.
The  warning lamp in the instrument cluster lights up.
- ▶ **To activate:** press  again.
The  warning lamp in the instrument cluster goes out.

ESP® is deactivated if the  warning lamp in the instrument cluster lights up continuously when the engine is running.







If the  warning lamp and the  warning lamp are lit continuously, ESP® is not available due to a malfunction.

Observe the information on warning lamps (▷ page 284).

Observe the information on display messages (▷ page 247).

Activating/deactivating PRE-SAFE® Brake

PRE-SAFE® Brake is only available in vehicles with DISTRONIC PLUS.







- ▶ Press the  or  button on the steering wheel to select the **Assist** menu.
- ▶ Press the  or  button to select **PRE-SAFE Brake**.
- ▶ Press the  button.
The current selection is displayed.
- ▶ **To activate/deactivate:** press the  button again.
When PRE-SAFE® Brake is deactivated, the assistance graphic shows the  symbol in the multifunction display.

If the **PRE-SAFE Brake: Sensors deactivated** message appears, the radar sensor system is deactivated.

- ▶ Switch on the radar sensor system (▷ page 234).







For more information on PRE-SAFE® Brake, see (▷ page 77).

Activating/deactivating ATTENTION ASSIST

- ▶ Press the  or  button on the steering wheel to select the **Assist** menu.
- ▶ Press the  or  button to select **Attention Assist**.
- ▶ Press the  button.
The current selection is displayed.
- ▶ **To activate/deactivate:** press the  button again.
When ATTENTION ASSIST is deactivated, the  symbol appears in the multifunction display in the assistance graphics display.

For further information about ATTENTION ASSIST, see (▷ page 198).

Activating/deactivating Blind Spot Assist

- ▶ Press the  or  button on the steering wheel to select the **Assist** menu.
- ▶ Press the  or  button to select **Blind Spot Assist**.
- ▶ Press the  button.
The current selection is displayed.
- ▶ **To activate/deactivate:** press the  button again.









If the **Blind Spot Assist Sensors deactivated** or **Act. B. Spot Assist Sensors deactivated** message appears, the radar sensor system is deactivated.

- ▶ Switch on the radar sensor system (▷ page 234).

For further information about Blind Spot Assist, see (▷ page 200).

For further information about Active Blind Spot Assist, see (▷ page 203).

Activating/deactivating Lane Keeping Assist

- ▶ Press the  or  button on the steering wheel to select the **Assist** menu.
- ▶ Press the  or  button to select **Lane Keep. Assist**
- ▶ Press the  button.
The current selection is displayed.
- ▶ Press  to confirm.
- ▶ Press the  or  button to set **Off**, **Standard** or **Adaptive**.
- ▶ Press the  button to save the setting.
When Lane Keeping Assist or Active Lane Keeping Assist is activated, the multifunction display shows the lane markings as bright lines in the assistance graphic.

For further information about Lane Keeping Assist; see (▷ page 202).

For further information about Active Lane Keeping Assist; see (▷ page 206).

Service menu



In the **Service** menu, you have the following options:

- Calling up display messages (▷ page 240)
- Restarting the tyre pressure loss warning system (▷ page 351) or checking the tyre pressure electronically (▷ page 353)
- Calling up the service due date (▷ page 312)

Settings menu

Introduction



In the **Settings** menu, you have the following options:





- Changing the instrument cluster settings (▷ page 230)
- Changing the light settings (▷ page 231)
- Changing the vehicle settings (▷ page 233)
- Changing the auxiliary heating settings (▷ page 234)
- Changing the convenience settings (▷ page 235)
- Restoring the factory settings (▷ page 236)



Instrument cluster

Selecting the unit of measurement for distance

The **Display unit Speed-/odometer:** function allows you to choose whether certain displays appear in kilometres or miles in the multifunction display.

You can determine whether the multifunction display shows some messages in miles or kilometres.

- ▶ Press the  or  button on the steering wheel to select the **Settings** menu.
- ▶ Press the  or  button to select the **Instrument cluster** submenu.
- ▶ Press  to confirm.

- ▶ Press the  or  button to select the **Display unit Speed-/odometer:** function. You will see the selected setting: **km** or **miles**.
- ▶ Press the  button to save the setting.

The selected unit of measurement for distance applies to:

- The digital speedometer in the **Trip** menu
- Total distance recorder and the trip meter
- Trip computer
- Current consumption and the range
- The navigation instructions in the **Navi** menu
- Cruise control
- SPEEDTRONIC
- DISTRONIC PLUS
- ASSYST PLUS service interval display









Switching the additional speedometer on/off

Vehicles for the United Kingdom: this function is unavailable.

Only vehicles with manual transmission have this function.

The **Addit. Speedo [mph]** function allows you to choose whether the status area in the multifunction display always shows the speed in mph instead of the outside temperature.









You can determine whether the multifunction display permanently shows your speed or the outside temperature.

- ▶ Press the  or  button on the steering wheel to select the **Settings** menu.
- ▶ Press the  or  button to select the **Instrument cluster** submenu.
- ▶ Press  to confirm.
- ▶ Press the  or  button to select the **Addit. Speedo (mph)** function. You will see the selected setting: **on** or **off**.
- ▶ Press the  button to save the setting.

Selecting the permanent display function

Vehicles for the United Kingdom: this function is unavailable.

You can determine whether the multifunction display permanently shows your speed or the outside temperature.









- ▶ Press the  or  button on the steering wheel to select the **Settings** menu.
- ▶ Press the  or  button to select the **Instrument cluster** submenu.
- ▶ Press  to confirm.
- ▶ Press the  or  button to select the **Permanent display:** function. You will see the selected setting: **outside temperature** or **Dig. speedo [mph]**.
- ▶ Press the  button to save the setting.

 The speed is displayed in mph.

Lights









Switching the daytime driving lights on/off

The **Daytime driving lights** function can only be switched on with the engine turned off.

- ▶ Press the  or  button on the steering wheel to select the **Settings** menu.
- ▶ Press the  or  button to select the **Light** submenu.
- ▶ Press  to confirm.
- ▶ Press the  or  button to select the **Daytime driving lights** function. If the **Daytime driving lights** function has been switched on, the cone of light and the  symbol in the multifunction display are shown in orange.
- ▶ Press the  button to save the setting.

Further information on daytime driving lights (▷ page 119).

Switching the Intelligent Light System on/off

- ▶ Press the  or  button on the steering wheel to select the **Settings** menu.
- ▶ Press the  or  button to select the **Light** submenu.
- ▶ Press  to confirm.
- ▶ Press the  or  button to select the **Intell. Light System** function.
If the **Intell. Light System** function has been switched on, the cone of light and the  symbol in the multifunction display are shown in orange.
- ▶ Press the  button to save the setting.





When you activate **Intell. Light System**, you activate the following functions:



- Motorway mode
- Active light function
- Cornering light function
- Extended range foglamps

If you set the dipped-beam headlamps for driving on the right/left, the multifunction display shows the **Intell. Light System: System inoperative Inactive for left-side traffic** or **Intell. Light System: System inoperative Inactive for right-side traffic** display message instead of the **Intell. Light System: function** in the **Light** submenu.

Further information on the Intelligent Light System (▷ page 122).

Setting the dipped-beam headlamps for driving on the left/right

- ▶ Press the  or  button on the steering wheel to select the **Settings** menu.
- ▶ Press the  or  button to select the **Light** submenu.
- ▶ Press  to confirm.

- ▶ Press the  or  button to select the **Dipped beams Setting for:** function.
You will see the selected setting: **Right-side traffic** or **Left-side traffic**.
- ▶ Press the  button to save the setting.
If you change the setting, conversion does not take place until the next time the vehicle is stationary.









This function is only available on vehicles with the Intelligent Light System.

You can use this function to switch between symmetrical and asymmetrical dipped beam (▷ page 118).

If you set the dipped-beam headlamps for driving on the right/left, then motorway mode and the extended range foglamps are unavailable.





A qualified specialist workshop can set the dipped-beam headlamps for driving on the right or left.

Switching Adaptive Highbeam Assist on/off

- ▶ Press the  or  button on the steering wheel to select the **Settings** menu.
- ▶ Press the  or  button to select the **Light** submenu.
- ▶ Press  to confirm.
- ▶ Press the  or  button to select the **Adapt. main beam** function.
If the **Adapt. main beam** function has been switched on, the cone of light and the  symbol in the multifunction display are shown in orange.
- ▶ Press the  button to save the setting.

For further information about Adaptive Highbeam Assist, see (▷ page 123).

Activating/deactivating the surround lighting and exterior lighting delayed switch-off

- ▶ Press the  or  button on the steering wheel to select the **Settings** menu.
- ▶ Press the  or  button to select the **Light** submenu.

- ▶ Press **OK** to confirm.
- ▶ Press the **▼** or **▲** button to select the **Surround Lighting** function.
When the **Surround lighting** function is activated, the light cone and the area around the vehicle are displayed in orange in the multifunction display.
- ▶ Press the **OK** button to save the setting.

Deactivating delayed switch-off of the exterior lighting temporarily:

- ▶ Before leaving the vehicle, turn the key to position **0** in the ignition lock.
- ▶ Turn the key to position **2** in the ignition lock.
The exterior lighting delayed switch-off is deactivated.

Delayed switch-off of the exterior lighting is reactivated the next time you start the engine.

If you have activated the **Surround lighting** function and the light switch is set to **AUTO**, the following functions are activated when it is dark:

- **surround lighting:** the exterior lighting remains lit for 40 seconds after unlocking with the key. If you start the engine, the surround lighting is switched off and automatic headlamp mode is activated (▷ page 119).

- **exterior lighting delayed switch-off:** the exterior lighting remains lit for 60 seconds after the engine is switched off. If you close all the doors and the boot lid, the exterior lighting goes off after 5 seconds.

i Depending on your vehicle's equipment, when the surround lighting and delayed switch-off exterior lighting are on, the following light up:

- side lamps
- foglamps
- dipped-beam headlamps

- daytime driving lights
- surround lighting in the exterior mirrors

Activating/deactivating the interior lighting delayed switch-off

If you activate the **Lighting delayed sw.-off** function, the interior lighting remains on for 20 seconds after you remove the key from the ignition lock.

- ▶ Press the **◀** or **▶** button on the steering wheel to select the **Settings** menu.
- ▶ Press the **▼** or **▲** button to select the **Lights** submenu.
- ▶ Press **OK** to confirm.
- ▶ Press the **▼** or **▲** button to select the **Lighting delayed sw.-off** function.
If the **Lighting delayed sw.-off** function has been switched on, the vehicle interior is displayed in orange in the multifunction display.
- ▶ Press the **OK** button to save the setting.









Vehicle

Setting permanent SPEEDTRONIC

- ▶ Press the **◀** or **▶** button on the steering wheel to select the **Settings** menu.
- ▶ Press the **▼** or **▲** button to select the **Vehicle** submenu.
- ▶ Press **OK** to confirm.
- ▶ Press **▼** or **▲** to select the **Limit speed (winter tyres):** function.
You will see the current setting.
- ▶ Press **OK** to confirm.
- ▶ Press the **▼** or **▲** button to adjust permanent SPEEDTRONIC in increments of ten (**230 km/h to 160 km/h**). The **Off** setting switches permanent SPEEDTRONIC off.
- ▶ Press the **OK** button to store the entry.

For further information on permanent SPEEDTRONIC (▷ page 179).

Switching the automatic locking feature on/off









- ▶ Press the  or  button on the steering wheel to select the **Settings** menu.
- ▶ Press the  or  button to select the **Vehicle** submenu.
- ▶ Press  to confirm.
- ▶ Press the  or  button to select the **Auto. door locks** function.
When the **Auto. door locks** function is activated, the vehicle doors are displayed in orange in the multifunction display.
- ▶ Press the  button to save the setting.

If you activate the **Auto. door locks** function, the vehicle is centrally locked above a speed of around 15 km/h.





For further information on the automatic locking feature; see (▷ page 90).



Activating/deactivating the acoustic locking confirmation

If you switch on the **Acoustic Lock** function, an acoustic signal sounds when you lock the vehicle.

- ▶ Press the  or  button on the steering wheel to select the **Settings** menu.
- ▶ Press the  or  button to select the **Vehicle** submenu.
- ▶ Press  to confirm.
- ▶ Press the  or  button to select the **Acoustic Lock** function.
If the **Acoustic Lock** function is activated, the  symbol in the multifunction display lights up orange.
- ▶ Press the  button to save the setting.

Activating/deactivating the radar sensor system

- ▶ Press the  or  button on the steering wheel to select the **Settings** menu.
- ▶ Press the  or  button to select the **Vehicle** submenu.
- ▶ Press  to confirm.

- ▶ Press the  or  button to select **Radar sensor (See Owner's Man.)**.
You will see the selected setting: **on** or **off**.
- ▶ Press the  button to save the setting.

The following systems are switched off when the radar sensor system is deactivated:

- DISTRONIC PLUS (▷ page 179)
- BAS PLUS (▷ page 71)
- PRE-SAFE® Brake (▷ page 77)
- Blind Spot Assist (▷ page 200)
- Active Blind Spot Assist (▷ page 203)

Heating

Auxiliary heating departure time

Only vehicles with auxiliary heating (▷ page 141) have this function.

In the **Heating** submenu, you can select a stored departure time or change a departure time.

The auxiliary heating timer function calculates the switch-on time according to the outside temperature so that the vehicle is preheated by the departure time. When the departure time is reached, the auxiliary heating continues to heat for a further five minutes and then switches off. The auxiliary heating adopts the THERMATIC or THERMOTRONIC temperature setting.

You can switch off the auxiliary heating by using the remote control or the auxiliary heating button on the centre console.

DANGER

If the exhaust pipe is blocked or sufficient ventilation is not possible, toxic exhaust fumes can enter the vehicle, especially carbon monoxide. This is the case, e.g. in enclosed spaces, or if the vehicle is stuck in snow. There is a risk of fatal injuries.

You should switch off the auxiliary heating in enclosed spaces which do not have an extraction system, e.g. a garage. If the vehicle is stuck in snow and you must leave the auxiliary

heating running, keep the exhaust pipe and the area around the vehicle clear of snow. To guarantee a sufficient supply of fresh air, open a window on the side of the vehicle away from the wind.

WARNING









When the auxiliary heating is switched on, parts of the vehicle can become very hot. Flammable material such as leaves, grass or twigs may ignite if they come into contact with hot parts of the exhaust system for extended periods. There is a risk of fire.

When the auxiliary heating is switched on, make sure that no flammable material can come into contact with hot vehicle components.

-  Operating the auxiliary heating/ventilation draws on the vehicle battery. After you have heated or ventilated the vehicle a maximum of two times, drive for a longer distance.















-  Switch the auxiliary heating on regularly once a month for about ten minutes.

Selecting the departure time or deactivating a selected departure time

- ▶ Press the  or  button on the steering wheel to select the **Settings** menu.
- ▶ Press the  or  button to select the **Heating** submenu.
- ▶ Press  to confirm.
You will see the selected setting.
- ▶ Press  to confirm.
- ▶ Press the  or  button to select one of the three departure times or **Timer off** (no timer active).
- ▶ Press  to confirm.

If a departure time is selected, the yellow indicator lamp lights up on the auxiliary heating button.

Changing the departure time

- ▶ Press the  or  button on the steering wheel to select the **Settings** menu.
- ▶ Press the  or  button to select the **Heating** submenu.
- ▶ Press  to confirm.
You will see the selected setting.
- ▶ Press  to confirm.
- ▶ Press the  or  button to select **A**, **B** or **Change C**.
- ▶ Press  to confirm.
You can now change the departure time.
- ▶ Press the  or  button to select the display to be changed: hours, minutes.
- ▶ Press the  or  button to set the selected display.
- ▶ Press the  button to store the entry.
The yellow indicator lamp on the auxiliary heating button lights up.

Convenience

Activating/deactivating the EASY-ENTRY/EXIT feature









WARNING

When the EASY-ENTRY/EXIT feature adjusts the steering wheel, you and other vehicle occupants – particularly children – could become trapped. There is a risk of injury. While the EASY-ENTRY/EXIT feature is making adjustments, make sure that no one has any body parts in the sweep of the steering wheel.

If someone is trapped:









- press one of the memory function position buttons, or
- move the switch for steering wheel adjustment in the opposite direction to that in which the steering wheel is moving.

The adjustment process is stopped.

- ▶ Press the  or  button on the steering wheel to select the **Settings** menu.
- ▶ Press the  or  button to select the **Convenience** submenu.
- ▶ Press  to confirm.
- ▶ Press the  or  button to select the **Easy Entry/Exit:** function.
If the **Easy Entry/Exit** function is activated, the vehicle steering wheel is displayed in orange in the multifunction display.
- ▶ Press the  button to save the setting.

Further information on the EASY-ENTRY/EXIT feature (▷ page 111).

Switching belt adjustment on/off





- ▶ Press the  or  button on the steering wheel to select the **Settings** menu.
- ▶ Press the  or  button to select the **Convenience** submenu.
- ▶ Press  to confirm.
- ▶ Press the  or  button to select the **Belt adjustment** function.
When the **Belt adjustment** function is activated, the vehicle seat belt is displayed in orange in the multifunction display.
- ▶ Press the  button to save the setting.



For further information on belt adjustment, see (▷ page 57).

Switching the fold in mirrors when locking function on/off

This function is only available on vehicles with a memory function (▷ page 115).









When you activate the **Auto. fold in** function, the exterior mirrors are folded in when the vehicle is locked. When you unlock the vehicle and then open a door, the exterior mirrors fold out again.

- ▶ Press the  or  button on the steering wheel to select the **Settings** menu.
- ▶ Press the  or  button to select the **Convenience** submenu.
- ▶ Press  to confirm.

- ▶ Press the  or  button to select the **Auto. fold in** function.
If the **Auto. fold in** function is activated, the vehicle's exterior mirror is displayed in orange in the multifunction display.
- ▶ Press the  button to save the setting.

If you have switched the **Auto. fold in** function on and you fold the exterior mirrors in using the button on the door (▷ page 113), they will not fold out automatically. The exterior mirrors can then only be folded out using the button on the door.

Resetting to factory settings

- ▶ Press the  or  button on the steering wheel to select the **Settings** menu.
- ▶ Press the  or  button to select the **Factory settings** submenu.
- ▶ Press  to confirm.
The **Reset all settings?** message appears.
- ▶ Press the  or  button to select **No** or **Yes**.
- ▶ Press the  button to confirm the selection.
If you have selected **Yes**, the multifunction display shows a confirmation message.

For safety reasons, not all functions are reset: the **Limit speed (winter tyres):** function in permanent SPEEDTRONIC can only be set in the **Vehicle** submenu. If you want to reset the **Daytime driving lights** in the **Light** submenu, you must turn the key to position 1 in the ignition lock.

AMG menu in AMG vehicles

AMG displays

- ▶ Press  or  on the steering wheel to select the **AMG** menu.

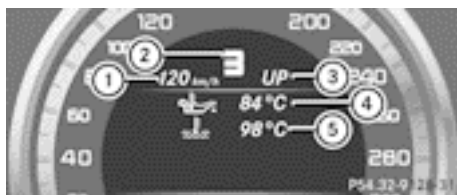

- ① Digital speedometer
- ② Gear indicator
- ③ Upshift indicator
- ④ Engine oil temperature
- ⑤ Coolant temperature

Upshift indicator **UP** ③ indicates that the engine has reached the overrevving range when in the manual gearshift program. Upshift indicator **UP** ③ fades out other messages until you have shifted up.

If the engine oil temperature is below 80 °C the oil temperature is shown in blue. Avoid using the full output of the engine during this time.

SETUP

SETUP shows the drive program, the ESP® (Electronic Stability Program) mode and the SPORT handling mode.

- ▶ Press or on the steering wheel to select the **AMG** menu.
- ▶ Press the button repeatedly until SETUP is displayed.

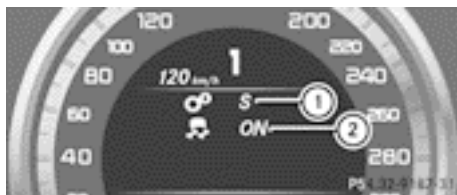

- ① Drive program (C/SS+/M)
- ② ESP® mode (ON/OFF) or SPORT handling mode (SPORT)

RACETIMER

Displaying and starting the RACETIMER

The RACETIMER is only intended for use on a closed race circuit. Do not use the function on public roads.

You can use the RACETIMER to store lap times.

- ▶ Press or on the steering wheel to select the **AMG** menu.
- ▶ Press the button repeatedly until the RACETIMER is shown.

- ❗ If the RACETIMER is selected, the and buttons cannot be used to call up the menu bar.



- ① Lap
- ② RACETIMER

You can start the RACETIMER when the engine is running or if the key is in position **2** in the ignition lock.

- ▶ **To start:** press the button to start the RACETIMER.

Displaying the intermediate time



- ▶ Press the or button to select **Interm. Time**.
- ▶ Press to confirm. The intermediate time is displayed for five seconds.

Starting a new lap

- ▶ Press to confirm **New Lap**.



- ① RACETIMER
- ② Fastest lap time (best lap)
- ③ Lap

i It is possible to store a maximum of sixteen laps. The 16th lap can only be completed with **Finish Lap**.

Stopping the RACETIMER

- ▶ Press the button on the steering wheel.



- ▶ Press to confirm **Yes**.

The RACETIMER interrupts timing if you stop the vehicle and turn the key to position **1** in the ignition lock. If you turn the key to position **2** or **3** and then press to confirm **Start**, timing is continued.

Resetting the current lap

- ▶ Stop the RACETIMER.
- ▶ Press the or button to select **Reset Lap**.
- ▶ Press to reset the lap time to "0".

Deleting all laps

If you switch off the engine, the RACETIMER is reset to "0" after 30 seconds. All laps are deleted.

You cannot delete individual stored laps. If you have stopped 16 laps, the current lap does not have to be reset.

- ▶ Reset the current lap.
- ▶ Press to confirm **Reset**. **Reset Race Timer?** appears in the multifunction display.



- ▶ Press the button to select **Yes** and press the button to confirm. All laps are deleted.

Overall evaluation

This function is shown if you have stored at least one lap and stopped the RACETIMER.



- ▶ Press or on the steering wheel to select the **AMG** menu.
- ▶ Press the button repeatedly until the overall evaluation is shown.





- ① RACETIMER overall evaluation
- ② Total time driven
- ③ Average speed
- ④ Distance covered
- ⑤ Maximum speed

Lap evaluation

This function is only available if you have stored at least two laps and have stopped the RACETIMER.

- ▶ Press  or  on the steering wheel to select the **AMG** menu.
- ▶ Press the  button repeatedly until the lap evaluation is shown.
Each lap is shown in a separate submenu.
The fastest lap is indicated by flashing symbol ①.



- ① Lap
 - ② Lap time
 - ③ Average lap speed
 - ④ Lap length
 - ⑤ Top speed during lap
- ▶ Press the  or  button to select a different lap evaluation.

Display messages

General notes

Display messages appear in the multifunction display.

Display messages with graphic symbols are simplified in the Owner's Manual and may differ from the symbols in the multifunction display.

Please respond in accordance with the display messages and follow the additional notes in this Owner's Manual.

Certain display messages are accompanied by an audible warning tone or a continuous tone.



When the ignition is switched off, all display messages are deleted apart from some high-priority display messages. Once the causes of the high-priority display messages have been rectified, the corresponding display messages are also deleted.

When you stop and park the vehicle, please observe the notes on the HOLD function (▷ page 188) and parking (▷ page 169).

Hiding display messages

► **Vehicles with a 4-button multifunction steering wheel:** press  on the steering wheel to clear the display message.

The display message is cleared.

► **Vehicles with a 12-button multifunction steering wheel:** press  or  on the steering wheel to clear the display message.

The display message is cleared.

The multifunction display shows high-priority display messages in red. Some high-priority display messages cannot be hidden.

The multifunction display shows these messages continuously until the causes for the messages have been remedied.

Message memory

Vehicles with a 4-button multifunction steering wheel

The on-board computer saves certain display messages. You can call up these display messages in the **message memory**.

► Press the  button on the steering wheel repeatedly until the **message memory** is shown.







If there are no display messages, you will see **No messages**. If there are display messages, the multifunction display shows, **2 messages**, for example.

► Using the  button, scroll through the display messages.







For some display messages, the  symbol appears in the multifunction display. You will find detailed information about these display messages in the section which follows.





Vehicles with a 12-button multifunction steering wheel





The on-board computer saves certain display messages. You can call up the display messages in the **message memory**.









- ▶ Press the  or  button on the steering wheel to select the **Service** menu.
If there are display messages, the multifunction display shows **2 messages**, for example.
- ▶ Press the  or  button to select the entry, e.g. **2 messages**.
- ▶ Press  to confirm.
- ▶ Press the  or  button to scroll through the display messages.





Safety systems (4-button multifunction steering wheel)

Display messages	Possible causes/consequences and ► Solutions
<p>ABS curr. unavail.</p>	<p>ABS (Anti-lock Braking System), ESP® (Electronic Stability Program), BAS (Brake Assist), PRE-SAFE®, the HOLD function, hill start assist and ESP® trailer stabilisation are temporarily unavailable.</p> <p>The adaptive brake lights may also have failed.</p> <p>In addition, the ,  and  warning lamps light up in the instrument cluster.</p> <p>Possible causes:</p> <ul style="list-style-type: none"> • self-diagnosis is not yet complete. • the on-board voltage may be insufficient. <p>⚠ WARNING</p> <p>The brake system continues to function normally, but without the functions listed above. The wheels could therefore lock if you brake hard, for example.</p> <p>The steerability and braking characteristics may be severely affected. The braking distance in an emergency braking situation can increase.</p> <p>If ESP® is not operational, ESP® is unable to stabilise the vehicle. The danger of skidding and having an accident increases.</p> <p>► Carefully drive on a suitable stretch of road, making slight steering movements at a speed above 20 km/h.</p> <p>If the display message disappears, the functions mentioned above are available again.</p> <p>If the display message continues to be displayed:</p> <ul style="list-style-type: none"> ► Drive on carefully. ► Visit a qualified specialist workshop.
<p>ABS inoperative</p>	<p>ABS, ESP®, BAS, PRE-SAFE®, the HOLD function, hill start assist and ESP® trailer stabilisation are unavailable due to a malfunction.</p> <p>The adaptive brake lights may also have failed.</p> <p>In addition, the , ,  and  warning lamps light up in the instrument cluster.</p> <p>⚠ WARNING</p> <p>The brake system continues to function normally, but without the functions listed above. The wheels could therefore lock if you brake hard, for example.</p>







Display messages	Possible causes/consequences and ► Solutions
	<p>The steerability and braking characteristics may be severely affected. The braking distance in an emergency braking situation can increase.</p> <p>If ESP® is not operational, ESP® is unable to stabilise the vehicle. The danger of skidding and having an accident increases.</p> <ul style="list-style-type: none"> ► Drive on carefully. ► Visit a qualified specialist workshop.
<p>EBD and ABS inoperative</p>	<p>EBD (electronic brake force distribution), ABS, ESP®, BAS, PRE-SAFE®, hill start assist and ESP® trailer stabilisation are not available due to a malfunction.</p> <p>The adaptive brake lights may also have failed.</p> <p>In addition, the ,  and  warning lamps light up in the instrument cluster and a warning tone sounds.</p> <p>⚠ WARNING</p> <p>The brake system continues to function normally, but without the functions listed above. The front and rear wheels could therefore lock if you brake hard, for example.</p> <p>The steerability and braking characteristics may be severely affected. The braking distance in an emergency braking situation can increase.</p> <p>If ESP® is not operational, ESP® is unable to stabilise the vehicle. The danger of skidding and having an accident increases.</p> <ul style="list-style-type: none"> ► Drive on carefully. ► Visit a qualified specialist workshop immediately.
<p> Release parking brake</p>	<p>You are driving with the parking brake applied. A warning tone also sounds.</p> <ul style="list-style-type: none"> ► Release the parking brake.







Display messages	Possible causes/consequences and ► Solutions
 <p>Brake immediately</p>	<p>A malfunction has occurred while the HOLD function or DIS-TRONIC PLUS is active.</p> <p>or</p> <p>Vehicles with manual transmission: with the HOLD function activated, you have either:</p> <ul style="list-style-type: none"> • opened the driver's door and released the seat belt or • switched off the engine or • opened the bonnet <p>A tone may also sound at regular intervals. If you attempt to lock the vehicle, the tone becomes louder.</p> <p>You cannot start the engine.</p> <p>► Paying attention to the traffic situation, immediately depress the brake pedal firmly and hold until the display message disappears.</p> <p>► Use the folding wheel chock (► page 357), from the vehicle tool kit to secure the vehicle against rolling away.</p> <p>You can restart the engine.</p>
 <p>Check brake fluid level</p>	<p>There is insufficient brake fluid in the brake fluid reservoir.</p> <p>In addition, the red  warning lamp lights up in the instrument cluster and a warning tone sounds.</p> <p>▲ WARNING</p> <p>The braking efficiency may be impaired.</p> <p>There is a risk of an accident.</p> <p>► Pull over and stop the vehicle safely as soon as possible, paying attention to road and traffic conditions. Do not continue driving under any circumstances.</p> <p>► Secure the vehicle against rolling away (► page 169).</p> <p>► Consult a qualified specialist workshop.</p> <p>► Do not top up the brake fluid. This does not correct the error.</p>
 <p>Check brake wear</p>	<p>The brake pads/linings have reached their wear limit.</p> <p>► Visit a qualified specialist workshop.</p>
<p>PRE-SAFE inoperative</p>	<p>▲ WARNING</p> <p>Important functions of PRE-SAFE® have failed. All other occupant safety systems, e.g. airbags, remain available.</p> <p>This poses an increased risk of injury.</p> <p>► Visit a qualified specialist workshop.</p>





Display messages	Possible causes/consequences and ► Solutions
	<p>If the symbol appears in the multifunction display, a seat belt tongue has been inserted into a rear seat belt buckle.</p> <p>Further information on the status indicator for the rear seat belts (▷ page 58).</p>
	<p>If the symbol appears in the multifunction display, a seat belt tongue has not been inserted in a rear seat belt buckle.</p> <p> WARNING</p> <p>A seat belt which is not worn correctly, or which has not been engaged in the seat belt buckle correctly, cannot provide the intended level of protection.</p> <p>This poses an increased risk of injury.</p> <p>► If necessary, ask the occupants in the rear to fasten their seat belts (▷ page 57).</p> <p>Further information on the status indicator for the rear seat belts (▷ page 58).</p>
 <p>Malfunction -Workshop-</p>	<p>There is a malfunction in the SRS (Supplemental Restraint System). The  warning lamp also lights up in the instrument cluster.</p> <p> WARNING</p> <p>The airbags or belt tensioners may either be triggered unintentionally or, in the event of an accident, may not be triggered.</p> <p>This poses an increased risk of injury.</p> <p>► Visit a qualified specialist workshop.</p> <p>For further information about the Supplemental Restraint System, see (▷ page 49).</p>
 <p>FL malfunc. -Workshop- or FR malfunc. -Workshop-</p>	<p>SRS has malfunctioned at the front on the left or right. The  warning lamp also lights up in the instrument cluster.</p> <p> WARNING</p> <p>The airbags or belt tensioners may either be triggered unintentionally or, in the event of an accident, may not be triggered.</p> <p>This poses an increased risk of injury.</p> <p>► Visit a qualified specialist workshop.</p>

Display messages	Possible causes/consequences and ► Solutions
 <p>RL malfunc. Workshop- or RR malfunc. -Workshop-</p>	<p> WARNING</p> <p>The airbags or belt tensioners may either be triggered unintentionally or, in the event of an accident, may not be triggered. This poses an increased risk of injury.</p> <p>SRS has malfunctioned at the rear on the left or right. The  warning lamp also lights up in the instrument cluster.</p> <p>► Visit a qualified specialist workshop.</p>
<p>Left windowbag malfunction:wkshp or Right windowbag malfunction:wkshp</p>	<p>There is a malfunction in the left-hand and/or right-hand windowbag.</p> <p>The  warning lamp also lights up in the instrument cluster.</p> <p> WARNING</p> <p>The left or right windowbag may either be triggered unintentionally or, in the event of an accident, may not be triggered. This poses an increased risk of injury.</p> <p>► Visit a qualified specialist workshop.</p>

Safety systems (12-button multifunction steering wheel)







Display messages	Possible causes/consequences and ► Solutions
 <p>currently unavailable See Owner's Manual</p>	<p>ABS (Anti-lock Braking System), ESP® (Electronic Stability Program), BAS (Brake Assist), PRE-SAFE®, the HOLD function, hill start assist and ESP® trailer stabilisation are temporarily unavailable.</p> <p>The adaptive brake lights, BAS PLUS and PRE-SAFE® Brake may also have failed.</p> <p>In addition, the ,  and  warning lamps light up in the instrument cluster.</p> <p>ATTENTION ASSIST is deactivated.</p> <p>Possible causes:</p> <ul style="list-style-type: none"> • self-diagnosis is not yet complete. • the on-board voltage may be insufficient. <p>⚠ WARNING</p> <p>The brake system continues to function normally, but without the functions listed above. The wheels could therefore lock if you brake hard, for example.</p> <p>The steerability and braking characteristics may be severely affected. The braking distance may increase in an emergency braking situation.</p> <p>If ESP® is not operational, ESP® is unable to stabilise the vehicle. There is an increased danger of skidding and risk of an accident.</p> <p>► Carefully drive on a suitable stretch of road, making slight steering movements at a speed above 20 km/h.</p> <p>If the display message disappears, the functions mentioned above are available again.</p> <p>If the display message continues to be displayed:</p> <ul style="list-style-type: none"> ► Drive on carefully. ► Visit a qualified specialist workshop.
 <p>inoperative See Owner's Manual</p>	<p>ESP®, BAS, PRE-SAFE®, the HOLD function, hill start assist and ESP® trailer stabilisation are not available due to a malfunction.</p> <p>The adaptive brake lights, BAS PLUS and PRE-SAFE® Brake may also have failed.</p> <p>In addition, the  and  warning lamps light up in the instrument cluster.</p> <p>The self-diagnosis function, for example, may not be complete. ATTENTION ASSIST is deactivated.</p> <p>⚠ WARNING</p>

Display messages	Possible causes/consequences and ► Solutions
	<p>The brake system continues to function normally, but without the functions listed above.</p> <p>The braking distance may thus increase in an emergency braking situation.</p> <p>If ESP® is not operational, ESP® is unable to stabilise the vehicle. There is an increased danger of skidding and risk of an accident.</p> <p>► Carefully drive on a suitable stretch of road, making slight steering movements at a speed above 20 km/h.</p> <p>If the display message disappears, the functions mentioned above are available again.</p> <p>If the display message continues to be displayed:</p> <p>► Drive on carefully.</p> <p>► Visit a qualified specialist workshop.</p>
<div style="display: flex; align-items: center;"> <div style="margin-right: 10px;">   </div> <div style="margin-right: 10px;">  </div> </div> <p data-bbox="85 727 277 783">inoperative See Owner's Manual</p>	<p>EBD (electronic brake force distribution), ABS, ESP®, BAS, PRE-SAFE®, the HOLD function, hill start assist and ESP® trailer stabilisation are unavailable due to a malfunction.</p> <p>The adaptive brake lights, BAS PLUS and PRE-SAFE® Brake may also have failed.</p> <p>In addition, the ,  and  warning lamps light up in the instrument cluster and a warning tone sounds.</p> <p>⚠ WARNING</p> <p>The brake system continues to function normally, but without the functions listed above. The front and rear wheels could therefore lock, for example, if you brake hard.</p> <p>The steerability and braking characteristics may be severely affected. The braking distance may increase in an emergency braking situation.</p> <p>If ESP® is not operational, ESP® is unable to stabilise the vehicle. There is an increased danger of skidding and risk of an accident.</p> <p>► Drive on carefully.</p> <p>► Visit a qualified specialist workshop immediately.</p>
<div style="margin-bottom: 5px;"></div> <p data-bbox="85 1313 277 1369">Release parking brake</p>	<p>You are driving with the parking brake applied. A warning tone also sounds.</p> <p>► Release the parking brake.</p>

Display messages	Possible causes/consequences and ► Solutions
 <p>Brake immediately</p>	<p>A fault has occurred while the HOLD function or DISTRONIC PLUS is active.</p> <p>or</p> <p>Vehicles with manual transmission: with the HOLD function activated, you have:</p> <ul style="list-style-type: none"> • opened the driver's door and released the seat belt or • switched off the engine or • opened the bonnet <p>A tone may also sound at regular intervals. If you attempt to lock the vehicle, the tone becomes louder.</p> <p>You cannot start the engine.</p> <ul style="list-style-type: none"> ► Paying attention to the traffic situation, immediately depress the brake pedal firmly and hold until the display message disappears. ► Use the folding wheel chock (► page 357) from the vehicle tool kit to secure the vehicle against rolling away. <p>You can restart the engine.</p>
 <p>Check brake fluid level</p>	<p>There is insufficient brake fluid in the brake fluid reservoir. In addition, the red  warning lamp lights up in the instrument cluster and a warning tone sounds.</p> <p> WARNING</p> <p>The braking efficiency may be impaired.</p> <p>There is a risk of an accident.</p> <ul style="list-style-type: none"> ► Pull over and stop the vehicle safely as soon as possible, paying attention to road and traffic conditions. Do not continue driving under any circumstances. ► Secure the vehicle against rolling away (► page 169). ► Consult a qualified specialist workshop. ► Do not top up the brake fluid. This does not correct the fault.
 <p>Check brake pad wear</p>	<p>The brake pads/linings have reached their wear limit.</p> <ul style="list-style-type: none"> ► Visit a qualified specialist workshop.
<p>PRE-SAFE inoperative See Owner's Manual</p>	<p>Important functions of PRE-SAFE® have failed. All other occupant safety systems, e.g. airbags, remain available.</p> <ul style="list-style-type: none"> ► Visit a qualified specialist workshop immediately.

Display messages	Possible causes/consequences and ► Solutions
<p>PRE-SAFE Functions currently limited See Owner's Manual</p>	<p>PRE-SAFE® Brake temporarily inoperative. Possible causes:</p> <ul style="list-style-type: none"> • the function is impaired due to heavy rain or snow. • the sensors in the radiator trim and in the bumpers are dirty. • the radar sensor system is temporarily inoperative, e.g. due to electromagnetic radiation emitted by nearby TV or radio stations or other sources of electromagnetic radiation. • AMG vehicles: ESP® is deactivated. • the system is outside the operating temperature range. • the on-board voltage is too low. <p>Once the causes listed above no longer apply, the display message goes out.</p> <p>PRE-SAFE® Brake is operational again.</p> <p>If the display message does not disappear:</p> <ul style="list-style-type: none"> ► Pull over and stop the vehicle safely as soon as possible, paying attention to road and traffic conditions. ► Secure the vehicle against rolling away (▷ page 169). ► Clean the sensors in the radiator grille and the bumper (▷ page 322). ► Restart the engine. ► AMG vehicles: reactivate ESP® (▷ page 75).
<p>PRE-SAFE Functions limited See Owner's Manual</p>	<p>PRE-SAFE® Brake is inoperative due to a fault. BAS PLUS or the distance warning signal may also have failed.</p> <ul style="list-style-type: none"> ► Visit a qualified specialist workshop.
	<p>If the symbol appears in the multifunction display, a seat belt tongue has been inserted into a rear seat belt buckle.</p> <p>Further information on the status indicator for the rear seat belts (▷ page 58).</p>



Display messages	Possible causes/consequences and ► Solutions
	<p>If the symbol appears in the multifunction display, a seat belt tongue has not been inserted in a rear seat belt buckle.</p> <p>⚠ WARNING</p> <p>A seat belt which is not worn correctly, or which has not been engaged in the seat belt buckle correctly, cannot provide the intended level of protection.</p> <p>This poses an increased risk of injury.</p> <p>► If necessary, ask the occupants in the rear to fasten their seat belts (▷ page 57).</p> <p>Further information on the status indicator for the rear seat belts (▷ page 58).</p>
 <p>Restraint sys. malfunction Consult workshop</p>	<p>There is a malfunction in the SRS (Supplemental Restraint System). The  warning lamp also lights up in the instrument cluster.</p> <p>⚠ WARNING</p> <p>The airbags or belt tensioners may either be triggered unintentionally or, in the event of an accident, may not be triggered.</p> <p>This poses an increased risk of injury.</p> <p>► Visit a qualified specialist workshop.</p> <p>For further information about the Supplemental Restraint System; see (▷ page 49).</p>
 <p>Front left malfunction Consult workshop or Front right malfunction Consult workshop</p>	<p>SRS has malfunctioned at the front on the left or right. The  warning lamp also lights up in the instrument cluster.</p> <p>⚠ WARNING</p> <p>The airbags or belt tensioners may either be triggered unintentionally or, in the event of an accident, may not be triggered.</p> <p>This poses an increased risk of injury.</p> <p>► Visit a qualified specialist workshop.</p>









Display messages	Possible causes/consequences and ► Solutions
 <p>Rear left malfunction Consult workshop or Rear right malfunction Consult workshop</p>	<p> WARNING</p> <p>The airbags or belt tensioners may either be triggered unintentionally or, in the event of an accident, may not be triggered. This poses an increased risk of injury.</p> <p>SRS has malfunctioned at the rear on the left or right. The  warning lamp also lights up in the instrument cluster.</p> <p>► Visit a qualified specialist workshop.</p>
 <p>Left windowbag malfunction Consult workshop or Right windowbag malfunction Consult workshop</p>	<p>There is a malfunction in the left-hand and/or right-hand windowbag.</p> <p>The  warning lamp also lights up in the instrument cluster.</p> <p> WARNING</p> <p>The left or right windowbag may either be triggered unintentionally or, in the event of an accident, may not be triggered. This poses an increased risk of injury.</p> <p>► Visit a qualified specialist workshop.</p>







Lights (4-button multifunction steering wheel)



i Display messages about LEDs:

This display message will only appear if all the LEDs have failed.

Display messages	Possible causes/consequences and ► Solutions
 <p>Left cornering light or Right cornering light</p>	<p>The left or right-hand cornering light is faulty.</p> <p>► Check whether you are permitted to replace the bulb yourself (> page 125).</p> <p>or</p> <p>► Visit a qualified specialist workshop.</p>
 <p>Left dipped beam or Right dipped beam</p>	<p>The left or right-hand dipped-beam headlamp is faulty.</p> <p>► Check whether you are permitted to replace the bulb yourself (> page 125).</p> <p>or</p> <p>► Visit a qualified specialist workshop.</p>
 <p>Trailer left tail lamp or Trailer right tail lamp</p>	<p>The left or right-hand trailer tail lamp is faulty.</p> <p>► Observe the separate operating instructions provided by the trailer manufacturer.</p>

Display messages	Possible causes/consequences and ► Solutions
 <p>Trailer left indic. or Trailer right indic.</p>	<p>The left or right-hand trailer turn signal lamp is faulty.</p> <ul style="list-style-type: none"> ► Observe the separate operating instructions provided by the trailer manufacturer.
 <p>Trailer brake lamp</p>	<p>The trailer brake lamp is faulty.</p> <ul style="list-style-type: none"> ► Observe the separate operating instructions provided by the trailer manufacturer.
 <p>Rear left indicator or Rear right indicator</p>	<p>The rear left-hand or rear right-hand turn signal is faulty.</p> <ul style="list-style-type: none"> ► Visit a qualified specialist workshop.
 <p>Front left indicator or Front right indicator</p>	<p>The front left-hand or front right-hand turn signal is faulty.</p> <ul style="list-style-type: none"> ► Visit a qualified specialist workshop.
 <p>Left mirror indicator or Right mirror indicator</p>	<p>The turn signal in the left-hand or right-hand exterior mirror is faulty.</p> <ul style="list-style-type: none"> ► Visit a qualified specialist workshop.
 <p>Third brake lamp</p>	<p>The third brake lamp is faulty.</p> <ul style="list-style-type: none"> ► Visit a qualified specialist workshop.
 <p>Tail/brake lamp, left or Tail/brake lamp, right</p>	<p>The left or right-hand tail lamp/brake lamp is faulty.</p> <ul style="list-style-type: none"> ► Check whether you are permitted to replace the bulb yourself (▷ page 125). or ► Visit a qualified specialist workshop.
 <p>Left main beam or Right main beam</p>	<p>The left or right-hand main-beam headlamp is faulty.</p> <ul style="list-style-type: none"> ► Check whether you are permitted to replace the bulb yourself (▷ page 125). or ► Visit a qualified specialist workshop.
 <p>Left fog lamp or Right fog lamp</p>	<p>The left-hand or right-hand front foglamp is faulty.</p> <ul style="list-style-type: none"> ► Visit a qualified specialist workshop.





Display messages	Possible causes/consequences and ► Solutions
 Rear fog lamp	The rear fog lamp is faulty. ► Visit a qualified specialist workshop.
 Front left parking lamp or Front right parking lamp	The front left or front right parking lamp is faulty. ► Check whether you are permitted to replace the bulb yourself (▷ page 125). or ► Visit a qualified specialist workshop.
 Left revers. lamp or Right revers. lamp	The reversing lamp is faulty. ► Check whether you are permitted to replace the bulb yourself (▷ page 125). or ► Visit a qualified specialist workshop.
 Rear left marker lamp or Rear right marker lamp	The rear left or right side marker lamp is faulty. ► Visit a qualified specialist workshop.
 Left daytime driving lamp or Right daytime driving lamp	The left-hand or right-hand daytime driving lamp is faulty. ► Visit a qualified specialist workshop.
 Malfunction	The exterior lighting is faulty. ► Visit a qualified specialist workshop.
	Vehicles with trailer tow hitch: a fuse may have blown. ► Check the fuses (▷ page 343). ► If necessary, replace the blown fuse. Observe the warning notes as you do so. If the display message continues to be displayed: ► Visit a qualified specialist workshop.
 Malfunction	The exterior lighting is faulty. ► Visit a qualified specialist workshop.









Display messages	Possible causes/consequences and ► Solutions
 AUTO lights inoperative	The light sensor is faulty. ► Visit a qualified specialist workshop.
 Switch off lights	The lights are still switched on when you leave the vehicle. A warning tone also sounds. ► Turn the light switch to AUTO .







Lights (12-button multifunction steering wheel)

i Display messages about LEDs:

This display message will only appear if all the LEDs have failed.

Display messages	Possible causes/consequences and ► Solutions
 Left cornering light or Right cornering light	The left or right-hand cornering light is faulty. ► Check whether you are permitted to replace the bulb yourself (▷ page 125). or ► Visit a qualified specialist workshop.
 Left dipped beam or Right dipped beam	The left or right-hand dipped-beam headlamp is faulty. ► Check whether you are permitted to replace the bulb yourself (▷ page 125). or ► Visit a qualified specialist workshop.
 Trailer left tail lamp or Trailer right tail lamp	The left or right-hand trailer tail lamp is faulty. ► Observe the separate operating instructions provided by the trailer manufacturer.
 Trailer left turn signal or Trailer right turn signal	The left or right-hand trailer turn signal lamp is faulty. ► Observe the separate operating instructions provided by the trailer manufacturer.
 Trailer brake lamp	The trailer brake lamp is faulty. ► Observe the separate operating instructions provided by the trailer manufacturer.



Display messages	Possible causes/consequences and ► Solutions
 Rear left turn signal or Rear right turn signal	The rear left-hand or rear right-hand turn signal is faulty. ► Visit a qualified specialist workshop.
 Front left turn signal or Front right turn signal	The front left-hand or front right-hand turn signal is faulty. ► Visit a qualified specialist workshop.
 Left mirror turn signal or Right mirror turn signal	The turn signal in the left-hand or right-hand exterior mirror is faulty. ► Visit a qualified specialist workshop.
 Third brake lamp	The third brake lamp is faulty. ► Visit a qualified specialist workshop.
 Left-hand tail lamp/brake lamp or Right-hand tail lamp/brake lamp	The left or right-hand tail lamp/brake lamp is faulty. ► Check whether you are permitted to replace the bulb yourself (> page 125). or ► Visit a qualified specialist workshop.
 Left main beam or Right main beam	The left or right-hand main-beam headlamp is faulty. ► Check whether you are permitted to replace the bulb yourself (> page 125). or ► Visit a qualified specialist workshop.
 Left fog lamp or Right fog lamp	The left-hand or right-hand front fog lamp is faulty. ► Visit a qualified specialist workshop.
 Rear fog lamp	The rear fog lamp is faulty. ► Visit a qualified specialist workshop.





Display messages	Possible causes/consequences and ► Solutions
 <p>Front left parking lamp or Front right parking lamp</p>	<p>The front left or front right parking lamp is faulty.</p> <ul style="list-style-type: none"> ► Check whether you are permitted to replace the bulb yourself (▷ page 125). <p>or</p> <ul style="list-style-type: none"> ► Visit a qualified specialist workshop.
 <p>Left revers. lamp or Right revers. lamp</p>	<p>The left or right-hand reversing lamp is faulty.</p> <ul style="list-style-type: none"> ► Check whether you are permitted to replace the bulb yourself (▷ page 126). <p>or</p> <ul style="list-style-type: none"> ► Visit a qualified specialist workshop.
 <p>Rear left side marker lamp or Rear right side marker lamp</p>	<p>The rear left or right side marker lamp is faulty.</p> <ul style="list-style-type: none"> ► Visit a qualified specialist workshop.
 <p>Left daytime driving lamp or Right daytime driving lamp</p>	<p>The left-hand or right-hand daytime driving lamp is faulty.</p> <ul style="list-style-type: none"> ► Visit a qualified specialist workshop.
 <p>Intell. Light System inoperative</p>	<p>The Intelligent Light System is faulty. The lights remain available without the Intelligent Light System.</p> <ul style="list-style-type: none"> ► Visit a qualified specialist workshop.
 <p>Malfunction See Owner's Manual</p>	<p>The exterior lighting is faulty.</p> <ul style="list-style-type: none"> ► Visit a qualified specialist workshop. <p>Vehicles with trailer tow hitch: a fuse may have blown.</p> <ul style="list-style-type: none"> ► Check the fuses (▷ page 343). ► If necessary, replace the blown fuse. Observe the warning notes as you do so. <p>If the display message continues to be displayed:</p> <ul style="list-style-type: none"> ► Visit a qualified specialist workshop.
 <p>AUTO lights inoperative</p>	<p>The light sensor is faulty.</p> <ul style="list-style-type: none"> ► Visit a qualified specialist workshop.

Display messages	Possible causes/consequences and ► Solutions
 Switch off lights	The lights are still switched on when you leave the vehicle. A warning tone also sounds. ► Turn the light switch to AUTO .
Adaptive Highbeam Assist inoperative	Adaptive Highbeam Assist is faulty. ► Visit a qualified specialist workshop.
Adaptive Highbeam Assist currently unavailable See Owner's Manual	Adaptive Highbeam Assist is deactivated and temporarily inoperative. Possible causes: <ul style="list-style-type: none"> • the windscreen is dirty in the camera's field of vision. • visibility is impaired due to heavy rain, snow or fog. ► Clean the windscreen. If the system detects that the camera is fully operational again, the Adaptive Highbeam Assist available again message is displayed. Adaptive Highbeam Assist is operational again.



Engine (4-button multifunction steering wheel)



Display messages	Possible causes/consequences and ► Solutions
Coolant washer fluid	The coolant level is too low. ► Top up the coolant, observing the warning notes before doing so (> page 318). ► If the coolant needs topping up more often than usual, have the engine coolant system checked at a qualified specialist workshop.
	The fan motor is faulty. ► If the coolant temperature is below 120 °C you can continue driving to the nearest qualified specialist workshop. ► Avoid heavy loads on the engine as you do so, e.g. driving in mountainous terrain and stop-start traffic.





Display messages	Possible causes/consequences and ► Solutions
 <p data-bbox="115 229 316 285">Stop vehicle Sw. eng. Off</p>	<p data-bbox="370 177 600 201">The coolant is too hot.</p> <p data-bbox="370 213 659 237">A warning tone also sounds.</p> <p data-bbox="381 256 535 284">⚠ WARNING</p> <p data-bbox="370 300 1033 384">Never drive with an overheated engine. Driving when your engine is overheated can cause some fluids which may have leaked into the engine compartment to catch fire.</p> <p data-bbox="370 392 1033 448">Steam from an overheated engine can cause serious burns, which can occur just by opening the bonnet.</p> <p data-bbox="370 456 611 480">There is a risk of injury.</p> <ul style="list-style-type: none"> <li data-bbox="370 496 1033 552">► Stop the vehicle immediately, paying attention to road and traffic conditions, and switch off the engine. <li data-bbox="370 560 936 584">► Secure the vehicle against rolling away (▷ page 169). <li data-bbox="370 592 790 616">► Wait until the engine has cooled down. <li data-bbox="370 632 986 687">► Make sure that the air supply to the engine radiator is not blocked, e.g. by frozen slush. <li data-bbox="370 695 1033 780">► Do not start the engine again until the display message goes out and the coolant temperature is below 120 °C. The engine may otherwise be damaged. <li data-bbox="370 788 894 812">► Pay attention to the coolant temperature display. <li data-bbox="370 820 1014 876">► If the temperature increases again, visit a qualified specialist workshop immediately. <p data-bbox="370 892 1033 948">Under normal operating conditions and with the specified coolant level, the coolant temperature may rise to 120 °C.</p>
	<p data-bbox="370 963 708 987">The battery is not being charged.</p> <p data-bbox="370 1000 659 1024">A warning tone also sounds.</p> <p data-bbox="370 1037 540 1061">Possible causes:</p> <ul style="list-style-type: none"> <li data-bbox="370 1077 561 1101">• faulty alternator <li data-bbox="370 1109 555 1133">• torn poly-V-belt <li data-bbox="370 1141 717 1165">• a malfunction in the electronics <ul style="list-style-type: none"> <li data-bbox="370 1181 1033 1236">► Stop the vehicle immediately, paying attention to road and traffic conditions, and switch off the engine. <li data-bbox="370 1244 574 1268">► Open the bonnet. <li data-bbox="370 1284 781 1308">► Check whether the poly-V-belt is torn. <p data-bbox="370 1316 641 1340">If the poly-V-belt is torn:</p> <ul style="list-style-type: none"> <li data-bbox="370 1356 1033 1388">! Do not continue driving. The engine could otherwise overheat. <li data-bbox="370 1404 799 1428">► Consult a qualified specialist workshop. <p data-bbox="370 1444 628 1468">If the poly-V-belt is OK:</p> <ul style="list-style-type: none"> <li data-bbox="370 1484 766 1508">► Visit a qualified specialist workshop.

Display messages	Possible causes/consequences and ► Solutions
 <p data-bbox="85 228 286 284">Checking the engine oil level</p>	<p data-bbox="342 177 899 236">The engine oil level has dropped to the minimum level. A warning tone also sounds.</p> <ul style="list-style-type: none"> <li data-bbox="342 248 902 308">► Check the oil level when next refuelling, at the latest (> page 316). <li data-bbox="342 316 854 341">► If necessary, top up the engine oil (> page 317). <li data-bbox="342 349 992 408">► Have the engine checked at a qualified specialist workshop if the engine oil needs topping up more often than usual.
 <p data-bbox="85 488 311 513">Reserve fuel level</p>	<p data-bbox="342 437 988 528">The fuel level has dropped into the reserve range. Operation of the auxiliary heating is deactivated if the fuel level drops into the reserve range.</p> <ul style="list-style-type: none"> <li data-bbox="342 536 723 561">► Refuel at the nearest filling station.
	<p data-bbox="342 596 764 655">There is very little fuel in the fuel tank. The auxiliary heating cannot be operated.</p> <ul style="list-style-type: none"> <li data-bbox="342 663 843 689">► Refuel at the nearest filling station without fail.
 <p data-bbox="85 767 322 793">Replace air cleaner</p>	<p data-bbox="342 716 1005 775">Vehicles with a diesel engine: the engine air filter is dirty and must be replaced.</p> <ul style="list-style-type: none"> <li data-bbox="342 783 736 809">► Visit a qualified specialist workshop.
 <p data-bbox="85 895 322 954">Clean the fuel filter</p>	<p data-bbox="342 844 1005 903">Vehicles with a diesel engine: there is water in the fuel filter. The water must be drained off.</p> <ul style="list-style-type: none"> <li data-bbox="342 911 736 936">► Visit a qualified specialist workshop.

Engine (12-button multifunction steering wheel)

Display messages	Possible causes/consequences and ► Solutions
 <p>Top up coolant See Owner's Manual</p>	<p>The coolant level is too low.</p> <p>! Avoid making long journeys with too little coolant in the engine cooling system. The engine will otherwise be damaged.</p> <ul style="list-style-type: none"> ► Top up the coolant, observing the warning notes before doing so (► page 318). ► If the coolant needs topping up more often than usual, have the engine coolant system checked at a qualified specialist workshop.
	<p>The fan motor is faulty.</p> <ul style="list-style-type: none"> ► If the coolant temperature is below 120 °C you can continue driving to the nearest qualified specialist workshop. ► Avoid heavy loads on the engine as you do so, e.g. driving in mountainous terrain and stop-start traffic.
 <p>Coolant Stop vehicle Switch engine off</p>	<p>The coolant is too hot. A warning tone also sounds.</p> <p>⚠ WARNING</p> <p>Never drive with an overheated engine. Driving when your engine is overheated can cause some fluids which may have leaked into the engine compartment to catch fire.</p> <p>Steam from an overheated engine can cause serious burns, which can occur just by opening the bonnet.</p> <p>There is a risk of injury.</p> <ul style="list-style-type: none"> ► Stop the vehicle immediately, paying attention to road and traffic conditions, and switch off the engine. ► Secure the vehicle against rolling away (► page 169). ► Wait until the engine has cooled down. ► Make sure that the air supply to the engine radiator is not blocked, e.g. by frozen slush. ► Do not start the engine again until the display message goes out and the coolant temperature is below 120 °C. The engine may otherwise be damaged. ► Pay attention to the coolant temperature display. ► If the temperature increases again, visit a qualified specialist workshop immediately. <p>Under normal operating conditions and with the specified coolant level, the coolant temperature may rise to 120 °C.</p>

Display messages	Possible causes/consequences and ► Solutions
	<p>The battery is not being charged. A warning tone also sounds.</p> <p>Possible causes:</p> <ul style="list-style-type: none"> • faulty alternator • torn poly-V-belt • a malfunction in the electronics <p>► Stop the vehicle immediately, paying attention to road and traffic conditions, and switch off the engine.</p> <p>► Secure the vehicle against rolling away (▷ page 169).</p> <p>► Open the bonnet.</p> <p>► Check whether the poly-V-belt is torn.</p> <p>If the poly-V-belt is torn:</p> <p>! Do not continue driving. The engine could otherwise overheat.</p> <p>► Consult a qualified specialist workshop.</p> <p>If the poly-V-belt is OK:</p> <p>► Visit a qualified specialist workshop.</p>
 <p>Check eng. oil lev. when next refuelling</p>	<p>The engine oil level has dropped to the minimum level. A warning tone also sounds.</p> <p>► Check the oil level when next refuelling, at the latest (▷ page 316).</p> <p>► If necessary, top up the engine oil (▷ page 317).</p> <p>► Have the engine checked at a qualified specialist workshop if the engine oil needs topping up more often than usual.</p> <p>Information on approved engine oils can be obtained from any qualified specialist workshop or on the Internet at http://bevo.mercedes-benz.com.</p>
 <p>Add 1 litre engine oil when next refuelling</p>	<p>AMG vehicles: the engine oil level is too low.</p> <p>► Check the oil level when next refuelling, at the latest (▷ page 316).</p> <p>► If necessary, top up the engine oil (▷ page 317).</p> <p>► Have the engine checked at a qualified specialist workshop if the engine oil needs topping up more often than usual.</p> <p>Information on approved engine oils can be obtained from any qualified specialist workshop or on the Internet at http://bevo.mercedes-benz.com.</p>



Display messages	Possible causes/consequences and ► Solutions
 Reserve fuel level	The fuel level has dropped into the reserve range. Operation of the auxiliary heating is deactivated if the fuel level drops into the reserve range. ► Refuel at the nearest filling station.
	There is very little fuel in the fuel tank. The auxiliary heating cannot be operated. ► Refuel at the nearest filling station without fail.
 Replace air cleaner	Vehicles with a diesel engine: the engine air filter is dirty and must be replaced. ► Visit a qualified specialist workshop.
 Clean the fuel filter	Vehicles with a diesel engine: there is water in the fuel filter. The water must be drained off. ► Visit a qualified specialist workshop.

Driving systems (4-button multifunction steering wheel)



Display messages	Possible causes/consequences and ► Solutions
 Off	The HOLD function is deactivated. The vehicle is skidding. A warning tone also sounds. ► Reactivate the HOLD function later (► page 188).
	The HOLD function is deactivated. When the brake pedal is firmly depressed, an activation condition is not fulfilled. A warning tone also sounds. ► Check the activation conditions for the HOLD function (► page 188).
Cruise ctrl. / LIM Inoperative	SPEEDTRONIC and cruise control are malfunctioning. A warning tone also sounds. ► Visit a qualified specialist workshop.
Limit --- km/h	While depressing the accelerator pedal beyond the pressure point (kickdown), SPEEDTRONIC cannot be activated.

Display messages	Possible causes/consequences and ► Solutions
Cruise control  --- km/h	A condition for activating cruise control has not been met. You have tried to store a speed below 30 km/h, for example. <ul style="list-style-type: none"> ► If conditions permit, drive faster than 30 km/h and store the speed. ► Check the activation conditions for cruise control (▷ page 174).
120 km/h 120 km/h	Only for certain countries: the maximum speed has been exceeded. <ul style="list-style-type: none"> ► Drive more slowly.

Driving systems (12-button multifunction steering wheel)

Display messages	Possible causes/consequences and ► Solutions
 Attention Assist: Take a break!	Based on certain criteria, ATTENTION ASSIST has detected fatigue or a lack of concentration on the part of the driver. A warning tone also sounds. <ul style="list-style-type: none"> ► If necessary, take a break. During long journeys, take regular breaks in good time so that you get enough rest.
 Attention Assist inoperative	ATTENTION ASSIST is inoperative. <ul style="list-style-type: none"> ► Visit a qualified specialist workshop.
Speed Limit Assist currently unavailable See Owner's Manual	Speed Limit Assist is deactivated and temporarily inoperative. Possible causes: <ul style="list-style-type: none"> • the windscreen is dirty in the camera's field of vision. • visibility is impaired due to heavy rain, snow or fog. If the display message does not disappear: <ul style="list-style-type: none"> ► Pull over and stop the vehicle safely as soon as possible, paying attention to road and traffic conditions. ► Secure the vehicle against rolling away (▷ page 169). ► Clean the windscreen. If the system detects that the camera is fully operational, the display message disappears. Speed Limit Assist is operational again.
Speed Limit Assist inoperative	Speed Limit Assist is faulty. <ul style="list-style-type: none"> ► Visit a qualified specialist workshop.

Display messages	Possible causes/consequences and ► Solutions
<div style="border: 1px solid black; padding: 2px; display: inline-block; margin-bottom: 5px;">HOLD</div> Off	<p>The HOLD function is deactivated. The vehicle is skidding. A warning tone also sounds.</p> <ul style="list-style-type: none"> ► Reactivate the HOLD function later (▷ page 188). <p>The HOLD function is deactivated. When the brake pedal is firmly depressed, an activation condition is not fulfilled. A warning tone also sounds.</p> <ul style="list-style-type: none"> ► Check the activation conditions for the HOLD function (▷ page 188).
Radar sensor deactivated See Owner's Manual	<p>The radar sensor system is deactivated.</p> <ul style="list-style-type: none"> ► Switch on the radar sensor system (▷ page 234).
Lane Keeping Assist currently unavailable See Owner's Manual or Active Lane Keeping Assist currently unavailable See Owner's Manual	<p>Lane Keeping Assist or Active Lane Keeping Assist is deactivated and temporarily inoperative. Possible causes:</p> <ul style="list-style-type: none"> • the windscreen is dirty in the camera's field of vision. • visibility is impaired due to heavy rain, snow or fog. • there are no lane markings for a longer period. • the lane markings are worn, dark or covered, e.g. by dirt or snow. <p>Once the causes listed above no longer apply, the display message goes out.</p> <p>Lane Keeping Assist or Active Lane Keeping Assist is operational again.</p> <p>If the display message does not disappear:</p> <ul style="list-style-type: none"> ► Pull over and stop the vehicle safely as soon as possible, paying attention to road and traffic conditions. ► Secure the vehicle against rolling away (▷ page 169). ► Clean the windscreen.
Lane Keeping Assist inoperative or Active Lane Keeping Assist inoperative	<p>Lane Keeping Assist or Active Lane Keeping Assist is faulty.</p> <ul style="list-style-type: none"> ► Visit a qualified specialist workshop.

Display messages	Possible causes/consequences and ► Solutions
<p>Blind Spot Assist currently unavailable See Owner's Manual or Active Blind Spot Assist currently unavailable See Owner's Manual</p>	<p>Blind Spot Assist or Active Blind Spot Assist is temporarily inoperative.</p> <p>You have established the electrical connection between the trailer and your vehicle.</p> <p>► Press  on the steering wheel to confirm the display message.</p> <p>Blind Spot Assist or Active Blind Spot Assist is deactivated while towing a trailer.</p> <p>Blind Spot Assist or Active Blind Spot Assist is temporarily inoperative. Possible causes:</p> <ul style="list-style-type: none"> • the sensors are dirty. • the function is impaired due to heavy rain or snow. • the radar sensor system is outside the operating temperature range. • the radar sensor system is temporarily inoperative, e.g. due to electromagnetic radiation emitted by nearby TV or radio stations or other sources of electromagnetic radiation. <p>The yellow  indicator lamps also light up in the exterior mirrors.</p> <p>Once the causes listed above no longer apply, the display message goes out.</p> <p>Blind Spot Assist or Active Blind Spot Assist is operational again.</p> <p>If the display message does not disappear:</p> <ul style="list-style-type: none"> ► Pull over and stop the vehicle safely as soon as possible, paying attention to road and traffic conditions. ► Secure the vehicle against rolling away (▷ page 169). ► Clean the sensors (▷ page 322). ► Restart the engine.
<p>Blind Spot Assist inoperative or Active Blind Spot Assist inoperative</p>	<p>Blind Spot Assist or Active Blind Spot Assist is faulty.</p> <p>The yellow  indicator lamps also light up in the exterior mirrors.</p> <p>► Visit a qualified specialist workshop.</p>
<p>Parking Guidance inoperative</p>	<p>Parking Guidance is malfunctioning (▷ page 194).</p> <p>► Restart the engine.</p> <p>If the display message continues to be displayed:</p> <p>► Visit a qualified specialist workshop.</p>

Display messages	Possible causes/consequences and ► Solutions
Parking Guidance cancelled	<p>Parking Guidance is deactivated. Possible causes:</p> <ul style="list-style-type: none"> • the vehicle is skidding. • the sensors are dirty. • a malfunction has occurred. <p>A warning tone also sounds.</p> <p>► Reactivate Parking Guidance later (▷ page 194).</p> <p>If the parking space symbol does not appear in the multifunction display at speeds below 30 km/h:</p> <p>► Clean the sensors (▷ page 322).</p> <p>► Restart the engine.</p> <p>If the parking space symbol still does not appear in the multifunction display at speeds below 30 km/h:</p> <p>► Visit a qualified specialist workshop.</p> <hr/> <p>Parking Guidance has been deactivated because you are no longer following the recommended path.</p> <p>► Park again and, while doing so, observe the display messages in the multifunction display.</p>
Parking Guidance finished	<p>The vehicle is parked. A warning tone also sounds. The display message disappears automatically.</p>
DISTRONIC PLUS off	<p>DISTRONIC PLUS has been deactivated (▷ page 179). If it was deactivated automatically, a warning tone also sounds.</p>
DISTRONIC PLUS available again	<p>DISTRONIC PLUS is operational again after having been temporarily unavailable. You can now reactivate DISTRONIC PLUS (▷ page 179).</p>



Display messages	Possible causes/consequences and ► Solutions
<p>DISTRONIC PLUS currently unavailable See Owner's Manual</p>	<p>DISTRONIC PLUS is temporarily inoperative. Possible causes:</p> <ul style="list-style-type: none"> • the function is impaired due to heavy rain or snow. • the sensors in the radiator trim and in the bumpers are dirty. • the radar sensor system is temporarily inoperative, e.g. due to electromagnetic radiation emitted by nearby TV or radio stations or other sources of electromagnetic radiation. • the system is outside the operating temperature range. • the on-board voltage is too low. <p>A warning tone also sounds.</p> <p>Once the causes listed above no longer apply, the display message goes out.</p> <p>DISTRONIC is operational again.</p> <p>If the display message does not disappear:</p> <ul style="list-style-type: none"> ► Pull over and stop the vehicle safely as soon as possible, paying attention to road and traffic conditions. ► Secure the vehicle against rolling away (▷ page 169). ► Clean the sensors in the radiator grille and the bumper (▷ page 322). ► Restart the engine.
<p>DISTRONIC PLUS inoperative</p>	<p>DISTRONIC PLUS is faulty. BAS PLUS and PRE-SAFE® Brake may also have failed.</p> <p>A warning tone also sounds.</p> <ul style="list-style-type: none"> ► Visit a qualified specialist workshop.
<p>DISTRONIC PLUS inactive</p>	<p>You have depressed the accelerator pedal. DISTRONIC PLUS is no longer controlling the speed of the vehicle.</p> <ul style="list-style-type: none"> ► Remove your foot from the accelerator pedal.
<p>DISTRONIC PLUS - - - km/h</p>	<p>An activation condition for DISTRONIC PLUS is not fulfilled.</p> <ul style="list-style-type: none"> ► Check the activation conditions for DISTRONIC PLUS (▷ page 179).
<p>DISTRONIC PLUS and SPEEDTRONIC</p>	<p>DISTRONIC PLUS and SPEEDTRONIC are faulty. A warning tone also sounds.</p> <ul style="list-style-type: none"> ► Visit a qualified specialist workshop.
<p>Cruise control and SPEEDTRONIC inoperative</p>	<p>SPEEDTRONIC and cruise control are malfunctioning.</p> <p>A warning tone also sounds.</p> <ul style="list-style-type: none"> ► Visit a qualified specialist workshop.

Display messages	Possible causes/consequences and ► Solutions
Limit --- km/h	While depressing the accelerator pedal beyond the pressure point (kickdown), SPEEDTRONIC cannot be activated.
Cruise control - - - km/h	<p>A condition for activating cruise control has not been met. You have tried to store a speed below 30 km/h, for example.</p> <ul style="list-style-type: none"> ► If conditions permit, drive faster than 30 km/h and store the speed. ► Check the activation conditions for cruise control (> page 174).
120 km/h! Maximum speed exceeded	<p>Only for certain countries: the maximum speed has been exceeded.</p> <p>In addition, the multifunction display shows 120 km/h!.</p> <ul style="list-style-type: none"> ► Drive more slowly.

Tyres (4-button multifunction steering wheel)

Display messages	Possible causes/consequences and ► Solutions
Check tyres	<p>The tyre pressure loss warning system has detected a significant loss in pressure. A warning tone also sounds.</p> <p> WARNING</p> <p>With tyre pressures which are too low, there is a risk of the following hazards:</p> <ul style="list-style-type: none"> • the tyres may burst, especially as the load and vehicle speed increase. • the tyres may wear excessively and/or unevenly, which may greatly impair tyre traction. • the driving characteristics, as well as steering and braking, may be greatly impaired. <p>There is a risk of an accident.</p> <ul style="list-style-type: none"> ► Stop the vehicle without making any sudden steering or braking manoeuvres. Pay attention to the traffic conditions as you do so. ► Secure the vehicle against rolling away (▷ page 169). ► Check the tyres and, if necessary, follow the instructions for a flat tyre (▷ page 330). ► Check the tyre pressures and, if necessary, correct the tyre pressure. ► Restart the tyre pressure loss warning system when the tyre pressure is correct (▷ page 351).
Check tyres Restart system	<p>The tyre pressure loss warning system generated a display message and has not been restarted since.</p> <ul style="list-style-type: none"> ► Set the correct tyre pressure in all four tyres. ► Restart the tyre pressure loss warning system (▷ page 351).
Run Flat Indicator inoperative	<p>The tyre pressure loss warning system is faulty.</p> <ul style="list-style-type: none"> ► Visit a qualified specialist workshop.





Tyres (12-button multifunction steering wheel)	
Display messages	Possible causes/consequences and ► Solutions
Tyre pressure Check tyres	<p>The tyre pressure loss warning system has detected a significant loss in pressure.</p> <p>A warning tone also sounds.</p> <p> WARNING</p> <p>With tyre pressures which are too low, there is a risk of the following hazards:</p> <ul style="list-style-type: none"> • the tyres may burst, especially as the load and vehicle speed increase. • the tyres may wear excessively and/or unevenly, which may greatly impair tyre traction. • the driving characteristics, as well as steering and braking, may be greatly impaired. <p>There is a risk of an accident.</p> <ul style="list-style-type: none"> ► Stop the vehicle without making any sudden steering or braking manoeuvres. Pay attention to the traffic conditions as you do so. ► Secure the vehicle against rolling away (► page 169). ► Check the tyres and, if necessary, follow the instructions for a flat tyre (► page 330). ► Check the tyre pressures and, if necessary, correct the tyre pressure. ► Restart the tyre pressure loss warning system when the tyre pressure is correct (► page 351).
Run Flat Indicator then restart Run Flat Indicator	<p>The tyre pressure loss warning system generated a display message and has not been restarted since.</p> <ul style="list-style-type: none"> ► Set the correct tyre pressure in all four tyres. ► Restart the tyre pressure loss warning system (► page 351).
Run Flat Indicator inoperative	<p>The tyre pressure loss warning system is faulty.</p> <ul style="list-style-type: none"> ► Visit a qualified specialist workshop.
Rectify tyre pressure	<p>The tyre pressure is too low in at least one of the tyres, or the tyre pressure difference between the wheels is too great.</p> <ul style="list-style-type: none"> ► Check the tyre pressures at the next opportunity (► page 353). ► If necessary, correct the tyre pressure. ► Restart the tyre pressure monitor (► page 355).

Display messages	Possible causes/consequences and ► Solutions
<p>Check tyres</p>	<p>The tyre pressure in one or more tyres has dropped significantly. The wheel position is displayed in the multifunction display. A warning tone also sounds.</p> <p> WARNING</p> <p>With tyre pressures which are too low, there is a risk of the following hazards:</p> <ul style="list-style-type: none"> • the tyres may burst, especially as the load and vehicle speed increase. • the tyres may wear excessively and/or unevenly, which may greatly impair tyre traction. • the driving characteristics, as well as steering and braking, may be greatly impaired. <p>There is a risk of an accident.</p> <ul style="list-style-type: none"> ► Stop the vehicle without making any sudden steering or braking manoeuvres. Pay attention to the traffic conditions as you do so. ► Secure the vehicle against rolling away (▷ page 169). ► Check the tyres and, if necessary, follow the instructions for a flat tyre (▷ page 330). ► Check the tyre pressure (▷ page 353). ► If necessary, correct the tyre pressure.
<p>Warning tyre defect</p>	<p>The tyre pressure in one or more tyres has dropped suddenly. The wheel position is displayed in the multifunction display.</p> <p> WARNING</p> <p>If you drive with a flat tyre, there is a risk of the following hazards:</p> <ul style="list-style-type: none"> • a flat tyre affects the ability to steer or brake the vehicle. • you could lose control of the vehicle. • continued driving with a flat tyre will cause excessive heat build-up and possibly a fire. <p>There is a risk of an accident.</p> <ul style="list-style-type: none"> ► Stop the vehicle without making any sudden steering or braking manoeuvres. Pay attention to the traffic conditions as you do so. ► Secure the vehicle against rolling away (▷ page 169). ► Check the tyres and, if necessary, follow the instructions for a flat tyre (▷ page 330).

Display messages	Possible causes/consequences and ► Solutions
Tyre press. monitor currently unavailable	<p>Due to a source of radio interference, no signals can be received from the wheel sensors. The tyre pressure monitor is temporarily malfunctioning.</p> <p>► Drive on. The tyre pressure monitor restarts automatically as soon as the cause has been rectified.</p>
Wheel sensor(s) missing	<p>There is no signal from the tyre pressure sensor of one or several wheels. The pressure of the affected tyre is not displayed in the multifunction display.</p> <p>► Have the faulty tyre pressure sensor replaced at a qualified specialist workshop.</p>
Tyre press. monitor inoperative No wheel sensors	<p>The wheels fitted do not have a suitable tyre pressure sensor. The tyre pressure monitor is deactivated.</p> <p>► Fit wheels with suitable tyre pressure sensors. The tyre pressure monitor is activated automatically after driving for a few minutes.</p>
Tyre pressure monitor inoperative	<p>The tyre pressure monitor is faulty.</p> <p>► Visit a qualified specialist workshop.</p>

Vehicle (4-button multifunction steering wheel)





Display messages	Possible causes/consequences and ► Solutions
To start engine, shift to P or N	<p>You have attempted to start the engine with the transmission in position R or D.</p> <p>► Shift the transmission to position P or N.</p>
P Select Park (P)	<p>You have switched off the engine with the Start/Stop button and opened the driver's door. You wanted to lock the vehicle. A warning tone also sounds. or You have switched off the engine with the Start/Stop button and opened the driver's door with the transmission in position N.</p> <p>► Shift the transmission to position P.</p>







Display messages	Possible causes/consequences and ► Solutions
	<p>With the Hold function activated, you have either:</p> <ul style="list-style-type: none"> • opened the driver's door and released the seat belt or • switched off the engine or • opened the bonnet. <p>A tone may also sound at regular intervals. If you attempt to lock the vehicle, the tone becomes louder.</p> <p>You cannot start the engine.</p> <p>► Shift the transmission to position P. You can restart the engine.</p>
	<p>The boot lid is open.</p> <p>► Close the boot lid.</p>
	<p>Vehicles with an anti-theft alarm system: the bonnet is open. A warning tone also sounds.</p> <p>▲ WARNING</p> <p>The open bonnet may then block your view when the vehicle is in motion.</p> <p>There is a risk of an accident.</p> <p>► Pull over and stop the vehicle safely as soon as possible, paying attention to road and traffic conditions.</p> <p>► Secure the vehicle against rolling away (▷ page 169).</p> <p>► Close the bonnet.</p>
	<p>At least one door is open. A warning tone also sounds.</p> <p>► Close all doors.</p>
 <p>Front left seat backr. not locked or Front right seat backr. not locked</p>	<p>The driver's or front-passenger seat backrest is not engaged. A warning tone also sounds.</p> <p>► Push the backrest back until it engages.</p>

Display messages	Possible causes/consequences and ► Solutions
Check trailer hitch lock	<p>Vehicles with a retractable trailer coupling: The trailer tow hitch is not correctly engaged. A warning tone also sounds.</p> <ul style="list-style-type: none"> ► Stop the vehicle immediately, paying attention to road and traffic conditions, and switch off the engine. ► Secure the vehicle against rolling away (▷ page 169). ► Engage the trailer coupling's ball coupling in the end position (▷ page 211).
Pwr. steering Malfunction	<p>The power steering assistance is faulty. A warning tone also sounds.</p> <p> WARNING</p> <p>You will need to use more force to steer. There is a risk of an accident.</p> <ul style="list-style-type: none"> ► Check whether you are able to apply the extra force required. ► If you are able to steer safely: carefully drive on to a qualified specialist workshop. ► If you are unable to steer safely: do not drive on. Contact the nearest qualified specialist workshop.
Top up washer fluid	<p>The washer fluid level in the washer fluid reservoir has dropped below the minimum.</p> <ul style="list-style-type: none"> ► Top up the washer fluid (▷ page 318).

Vehicle (12-button multifunction steering wheel)



Display messages	Possible causes/consequences and ► Solutions
To start engine, shift to either P or N	<p>You have attempted to start the engine with the transmission in position R or D.</p> <ul style="list-style-type: none"> ► Shift the transmission to position P or N.
Risk of rolling Select Park (P)	<p>You have switched off the engine with the Start/Stop button and opened the driver's door. You wanted to lock the vehicle. A warning tone also sounds.</p> <p>or</p> <p>You have switched off the engine with the Start/Stop button and opened the driver's door with the transmission in position N.</p> <ul style="list-style-type: none"> ► Shift the transmission to position P.



Display messages	Possible causes/consequences and ► Solutions
	<p>While the HOLD function or DISTRONIC PLUS is active, you have:</p> <ul style="list-style-type: none"> • opened the driver's door and released the seat belt or • switched off the engine or • opened the bonnet <p>A tone may also sound at regular intervals. If you attempt to lock the vehicle, the tone becomes louder.</p> <p>You cannot start the engine.</p> <p>► Shift the transmission to position P. You can restart the engine.</p>
	<p>The boot lid is open.</p> <p>► Close the boot lid.</p>
	<p>The bonnet is open. A warning tone also sounds.</p> <p>⚠ WARNING</p> <p>The open bonnet may then block your view when the vehicle is in motion.</p> <p>There is a risk of an accident.</p> <p>► Pull over and stop the vehicle safely as soon as possible, paying attention to road and traffic conditions.</p> <p>► Secure the vehicle against rolling away (> page 169).</p> <p>► Close the bonnet.</p> <p>If the active bonnet (pedestrian protection) has been triggered:</p> <p>► Reset the bonnet (> page 314).</p> <p>► Close the bonnet.</p>
<p>Active bonnet malfunction See Owner's Manual</p>	<p>The active bonnet (pedestrian protection) is not active due to a malfunction.</p> <p>► Visit a qualified specialist workshop.</p>
	<p>At least one door is open. A warning tone also sounds.</p> <p>► Close all doors.</p>
 <p>Front left seat backrest not locked or Front right seat backrest not locked</p>	<p>The driver's or front-passenger seat backrest is not engaged. A warning tone also sounds.</p> <p>► Push the backrest back until it engages.</p>

Display messages	Possible causes/consequences and ► Solutions
 <p>Check trailer hitch lock</p>	<p>The trailer tow hitch is not correctly engaged. A warning tone also sounds.</p> <ul style="list-style-type: none"> ► Stop the vehicle immediately, paying attention to road and traffic conditions, and switch off the engine. ► Secure the vehicle against rolling away (► page 169). ► Engage the trailer coupling's ball coupling in the end position (► page 211).
 <p>inoperative Battery low</p>	<p>The on-board voltage is too low. The auxiliary heating has switched itself off or cannot be switched on (► page 141).</p> <ul style="list-style-type: none"> ► Drive for a longer distance. The battery is being charged. The auxiliary heating is operational again as soon as the on-board electrical system voltage is sufficient.
 <p>inoperative Refuel vehicle</p>	<p>There is too little fuel in the fuel tank. The auxiliary heating cannot be switched on (► page 141).</p> <ul style="list-style-type: none"> ► Refuel at the nearest filling station.
 <p>inoperative See Owner's Manual</p>	<p>The auxiliary heating has a temporary malfunction or is faulty.</p> <ul style="list-style-type: none"> ► When the vehicle is on a level surface and the engine has cooled down, make up to four attempts to switch on the auxiliary heating, waiting several minutes between each attempt (► page 141). ► If the auxiliary heating does not switch on, consult a qualified specialist workshop.
 <p>Power steering malfunction See Owner's Manual</p>	<p>The power steering assistance is faulty. A warning tone also sounds.</p> <p> WARNING</p> <p>You will need to use more force to steer. There is a risk of an accident.</p> <ul style="list-style-type: none"> ► Check whether you are able to apply the extra force required. ► If you are able to steer safely: carefully drive on to a qualified specialist workshop. ► If you are unable to steer safely: do not drive on. Contact the nearest qualified specialist workshop.



Display messages	Possible causes/consequences and ► Solutions
Telephone No service	Your vehicle is outside the network provider's transmitter/receiver range. ► Wait until the mobile phone operational readiness symbol appears in the multifunction display.
 Top up washer fluid	The washer fluid level in the washer fluid reservoir has dropped below the minimum. ► Top up the washer fluid (▷ page 318).





Key (4-button multifunction steering wheel)

Display messages	Possible causes/consequences and ► Solutions
Key does not belong to vehicle	You have put the wrong key in the ignition lock. ► Use the correct key.
 You need a new key	The key needs to be replaced. ► Visit a qualified specialist workshop.
 Change battery	The batteries of the KEYLESS-GO key are discharged. ► Change the batteries (▷ page 85).
Key not detected (Red display message)	The KEYLESS-GO key is not in the vehicle. A warning tone also sounds. If the engine is switched off, you can no longer lock the vehicle centrally or start the engine. ► Pull over and stop the vehicle safely as soon as possible, paying attention to road and traffic conditions. ► Secure the vehicle against rolling away (▷ page 169). ► Locate the KEYLESS-GO key. The KEYLESS-GO key is not detected while the engine is running because there is interference from a strong source of radio waves. A warning tone also sounds. ► Pull over and stop the vehicle safely as soon as possible, paying attention to road and traffic conditions. ► Secure the vehicle against rolling away (▷ page 169). ► Operate the vehicle with the key in the ignition lock if necessary.

Display messages	Possible causes/consequences and ► Solutions
Key not detected (White display message)	The KEYLESS-GO key cannot be detected at present. ► Change the location of the key with the KEYLESS-GO functions in the vehicle. If the KEYLESS-GO key is still not detected: ► Change the location of the key with the KEYLESS-GO functions in the vehicle. ► Operate the vehicle with the key in the ignition lock if necessary.
 Key still in vehicle	The KEYLESS-GO key has been detected inside the vehicle during locking. ► Remove the KEYLESS-GO key from the vehicle.
 Insert key	KEYLESS-GO is temporarily malfunctioning or is defective. A warning tone also sounds. ► Insert the key into the ignition lock and turn it to the desired position. ► Visit a qualified specialist workshop.
Close doors to lock veh.	At least one door is open. A warning tone also sounds. ► Close all doors and lock the vehicle again.





Key (12-button multifunction steering wheel)

Display messages	Possible causes/consequences and ► Solutions
 Key does not belong to vehicle	You have put the wrong key in the ignition lock. ► Use the correct key.
 Replace key	The key needs to be replaced. ► Visit a qualified specialist workshop.
 Change key batteries	The batteries of the KEYLESS-GO key are discharged. ► Change the batteries (► page 85).





Display messages	Possible causes/consequences and ► Solutions
 <p>Key not detected (red display message)</p>	<p>The KEYLESS-GO key is not in the vehicle. A warning tone also sounds. If the engine is switched off, you can no longer lock the vehicle centrally or start the engine.</p> <ul style="list-style-type: none"> ► Pull over and stop the vehicle safely as soon as possible, paying attention to road and traffic conditions. ► Secure the vehicle against rolling away (▷ page 169) (▷ page 169). ► Locate the KEYLESS-GO key. <p>The KEYLESS-GO key is not detected while the engine is running because there is interference from a strong source of radio waves. A warning tone also sounds.</p> <ul style="list-style-type: none"> ► Pull over and stop the vehicle safely as soon as possible, paying attention to road and traffic conditions. ► Secure the vehicle against rolling away (▷ page 169). ► Operate the vehicle with the key in the ignition lock if necessary.
 <p>Key not detected (white display message)</p>	<p>The KEYLESS-GO key cannot be detected at present.</p> <ul style="list-style-type: none"> ► Change the location of the key with the KEYLESS-GO functions in the vehicle. <p>If the KEYLESS-GO key is still not detected:</p> <ul style="list-style-type: none"> ► Operate the vehicle with the key in the ignition lock if necessary.
 <p>Key still in vehicle</p>	<p>The KEYLESS-GO key has been detected inside the vehicle during locking.</p> <ul style="list-style-type: none"> ► Remove the KEYLESS-GO key from the vehicle.
 <p>Remove starting button, then insert key</p>	<p>The KEYLESS-GO key is not continually detected. KEYLESS-GO is temporarily malfunctioning or is defective. A warning tone also sounds.</p> <ul style="list-style-type: none"> ► Insert the key into the ignition lock and turn it to the desired position. ► Visit a qualified specialist workshop.
 <p>Close doors to lock vehicle</p>	<p>At least one door is open. A warning tone also sounds.</p> <ul style="list-style-type: none"> ► Close all doors and lock the vehicle again.



Warning and indicator lamps in the instrument cluster







Seat belts







Problem	Possible causes/consequences and ► Solutions
 <p>Only for certain countries: the red seat belt warning lamp lights up for six seconds after the engine starts.</p>	<p>The seat belt warning lamp reminds the driver and front passenger to fasten their seat belts.</p> <ul style="list-style-type: none"> ► Fasten your seat belt (▷ page 57).
 <p>Only for certain countries: the red seat belt warning lamp lights up after the engine starts. In addition, a warning tone sounds for up to six seconds.</p>	<p>The driver's seat belt is not fastened.</p> <ul style="list-style-type: none"> ► Fasten your seat belt (▷ page 57). The warning tone ceases.
 <p>The red seat belt warning lamp lights up after the engine starts, as soon as the driver's or the front-passenger door is closed.</p>	<p>The driver or passenger has not fastened their seat belt.</p> <ul style="list-style-type: none"> ► Fasten your seat belt (▷ page 57). The warning lamp goes out. <p>There are objects on the front-passenger seat.</p> <ul style="list-style-type: none"> ► Remove the objects from the front-passenger seat and stow them in a secure place. The warning lamp goes out.
 <p>The red seat belt warning lamp flashes and an intermittent audible warning sounds.</p>	<p>The driver or passenger has not fastened their seat belt. At the same time, the car is being driven faster than 25 km/h or has been briefly driven faster than 25 km/h.</p> <ul style="list-style-type: none"> ► Fasten your seat belt (▷ page 57). The warning lamp goes out and the intermittent warning tone ceases. <p>There are objects on the front-passenger seat. At the same time, the car is being driven faster than 25 km/h or has been briefly driven faster than 25 km/h.</p> <ul style="list-style-type: none"> ► Remove the objects from the front-passenger seat and stow them in a secure place. The warning lamp goes out and the intermittent warning tone ceases.





Safety systems





Problem	Possible causes/consequences and ► Solutions
 <p>The red brake system warning lamp comes on while the engine is running. A warning tone also sounds.</p>	<p>There is insufficient brake fluid in the brake fluid reservoir.</p> <p> WARNING</p> <p>The braking efficiency may be impaired. There is a risk of an accident.</p> <ul style="list-style-type: none"> ► Pull over and stop the vehicle safely as soon as possible, paying attention to road and traffic conditions. Do not continue driving under any circumstances. ► Secure the vehicle against rolling away (▷ page 169). ► Do not top up the brake fluid. Topping up will not rectify the fault. ► Consult a qualified specialist workshop. ► Observe the additional display messages in the multifunction display.
 <p>The yellow ABS warning lamp is lit while the engine is running.</p>	<p>ABS (Anti-lock Brake System) has been deactivated due to a fault. For this reason, BAS (Brake Assist), BAS PLUS, ESP® (Electronic Stability Program), PRE-SAFE®, PRE-SAFE® Brake, the HOLD function, hill start assist, the adaptive brake lights and ESP® trailer stabilisation are also deactivated, for example. ATTENTION ASSIST is deactivated.</p> <p> WARNING</p> <p>The brake system continues to function normally, but without the functions listed above. The wheels could therefore lock if you brake hard, for example.</p> <p>The steerability and braking characteristics may be severely affected. The braking distance in an emergency braking situation can increase.</p> <p>If ESP® is not operational, ESP® is unable to stabilise the vehicle. The danger of skidding and having an accident increases.</p> <ul style="list-style-type: none"> ► Observe the additional display messages in the multifunction display. ► Drive on carefully. ► Visit a qualified specialist workshop. <p>If the ABS control unit is faulty, there is also a possibility that other systems, such as the navigation system or the automatic transmission, will not be available.</p>



Problem	Possible causes/consequences and ► Solutions
 <p>The yellow ABS warning lamp is lit while the engine is running.</p>	<p>ABS is temporarily unavailable. Therefore, BAS, BAS PLUS, ESP®, EBD (electronic brake force distribution), PRE-SAFE®, PRE-SAFE® Brake, the HOLD function, hill start assist, the adaptive brake lights and ESP® trailer stabilisation, for example, are also deactivated.</p> <p>Possible causes:</p> <ul style="list-style-type: none"> • self-diagnosis is not yet complete. • the on-board voltage may be insufficient. <p>ATTENTION ASSIST is deactivated.</p> <p> WARNING</p> <p>The brake system continues to function normally, but without the functions listed above. The front and rear wheels could therefore lock if you brake hard, for example.</p> <p>The steerability and braking characteristics may be severely affected. The braking distance in an emergency braking situation can increase.</p> <p>If ESP® is not operational, ESP® is unable to stabilise the vehicle. There is a risk of an accident.</p> <p>► Carefully drive on a suitable stretch of road, making slight steering movements at a speed above 20 km/h. The functions mentioned above are available again when the warning lamp goes out.</p> <p>If the warning lamp is still on:</p> <ul style="list-style-type: none"> ► Observe the additional display messages in the multifunction display. ► Drive on carefully. ► Visit a qualified specialist workshop.



Problem	Possible causes/consequences and ► Solutions
 <p>The yellow ABS warning lamp is lit while the engine is running. A warning tone also sounds.</p>	<p>EBD is not available due to a malfunction. Therefore, ABS, BAS, BAS PLUS, ESP[®], PRE-SAFE[®], PRE-SAFE[®] Brake, the HOLD function, hill start assist, the adaptive brake lights and ESP[®] trailer stabilisation, for example, are not available either. ATTENTION ASSIST is deactivated.</p> <p> WARNING</p> <p>The brake system continues to function normally, but without the functions listed above. The front and rear wheels could therefore lock if you brake hard, for example.</p> <p>The steerability and braking characteristics may be severely affected. The braking distance in an emergency braking situation can increase.</p> <p>If ESP[®] is not operational, ESP[®] is unable to stabilise the vehicle. The danger of skidding and having an accident increases.</p> <ul style="list-style-type: none"> ► Observe the additional display messages in the multifunction display. ► Drive on carefully. ► Visit a qualified specialist workshop.
    <p>The red brake warning lamp, the yellow ESP[®] and ESP[®] OFF warning lamps and the yellow ABS warning lamp are lit while the engine is running.</p>	<p>ABS and ESP[®] are not available due to a fault. Therefore, BAS, BAS PLUS, EBD, PRE-SAFE[®], PRE-SAFE[®] Brake, the HOLD function, hill start assist, the adaptive brake lights and ESP[®] trailer stabilisation, for example, are not available either. ATTENTION ASSIST is deactivated.</p> <p> WARNING</p> <p>The brake system continues to function normally, but without the functions listed above. The front and rear wheels could therefore lock if you brake hard, for example.</p> <p>The steerability and braking characteristics may be severely affected. The braking distance in an emergency braking situation can increase.</p> <p>If ESP[®] is not operational, ESP[®] is unable to stabilise the vehicle. The danger of skidding and having an accident increases.</p> <ul style="list-style-type: none"> ► Observe the additional display messages in the multifunction display. ► Drive on carefully. ► Visit a qualified specialist workshop.

Problem	Possible causes/consequences and ► Solutions
  The yellow ESP® warning lamp flashes while the vehicle is in motion.	ESP® or traction control has intervened because there is a risk of skidding or at least one wheel has started to spin. Cruise control or DISTRONIC PLUS is deactivated. <ul style="list-style-type: none"> ► Only depress the accelerator pedal as far as necessary when pulling away. ► Accelerate more gently while the vehicle is in motion. ► Adapt your driving style to suit the road and weather conditions. ► Do not deactivate ESP®. Exceptions: (► page 73)
 The yellow ESP® OFF warning lamp is lit while the engine is running.	ESP® is deactivated. <p> WARNING</p> If ESP® is switched off, ESP® is unable to stabilise the vehicle. The danger of skidding and having an accident increases. <ul style="list-style-type: none"> ► Reactivate ESP®. Exceptions: (► page 73) <ul style="list-style-type: none"> ► Adapt your driving style to suit the road and weather conditions. If ESP® cannot be activated: <ul style="list-style-type: none"> ► Drive on carefully. ► Have ESP® checked at a qualified specialist workshop.
 AMG vehicles only: The yellow SPORT handling mode warning lamp is lit while the engine is running.	SPORT handling mode is activated. <p> WARNING</p> When SPORT handling mode is switched on, ESP® is unable to stabilise the vehicle. The danger of skidding and having an accident increases. <ul style="list-style-type: none"> ► Only switch to SPORT handling mode in accordance with the conditions written in the "Activating/deactivating SPORT handling mode" section (► page 75).

Problem	Possible causes/consequences and ► Solutions
   <p>The yellow ESP[®] and ESP[®] OFF warning lamps are lit while the engine is running.</p>	<p>ESP[®], BAS, BAS PLUS, PRE-SAFE[®], PRE-SAFE[®] Brake, the HOLD function, hill start assist, the adaptive brake lights and ESP[®] trailer stabilisation are not available due to a malfunction. ATTENTION ASSIST is deactivated.</p> <p> WARNING</p> <p>The brake system continues to function normally, but without the functions listed above.</p> <p>The braking distance in an emergency braking situation can thus increase.</p> <p>If ESP[®] is not operational, ESP[®] is unable to stabilise the vehicle. The danger of skidding and having an accident increases.</p> <ul style="list-style-type: none"> ► Observe the additional display messages in the multifunction display. ► Drive on carefully. ► Visit a qualified specialist workshop.





Problem	Possible causes/consequences and ► Solutions
 <p>The yellow ESP[®] and ESP[®] OFF warning lamps are lit while the engine is running.</p>	<p>ESP[®], BAS, PRE-SAFE[®], the HOLD function, hill start assist and ESP[®] trailer stabilisation are temporarily unavailable.</p> <p>The adaptive brake lights, BAS PLUS and PRE-SAFE[®] Brake may also have failed.</p> <p>ATTENTION ASSIST is deactivated.</p> <p>Self-diagnosis is not yet complete.</p> <p> WARNING</p> <p>The brake system continues to function normally, but without the functions listed above.</p> <p>The braking distance in an emergency braking situation can thus increase.</p> <p>If ESP[®] is not operational, ESP[®] is unable to stabilise the vehicle. The danger of skidding and having an accident increases.</p> <ul style="list-style-type: none"> ► Carefully drive on a suitable stretch of road, making slight steering movements at a speed above 20 km/h. The functions mentioned above are available again when the warning lamp goes out. <p>If the warning lamp is still on:</p> <ul style="list-style-type: none"> ► Observe the additional display messages in the multifunction display. ► Drive on carefully. ► Visit a qualified specialist workshop.
 <p>The red SRS warning lamp is lit while the engine is running.</p>	<p>There is a malfunction in the SRS (Supplemental Restraint System).</p> <p> WARNING</p> <p>The airbags or belt tensioners may either be triggered unintentionally or, in the event of an accident, may not be triggered. This poses an increased risk of injury.</p> <ul style="list-style-type: none"> ► Drive on carefully. ► Have SRS checked at a qualified specialist workshop immediately. <p>For further information about the Supplemental Restraint System, see (► page 49).</p>





Engine	
Problem	Possible causes/consequences and ► Solutions
 <p>The yellow engine diagnostics warning lamp lights up while the engine is running.</p>	<p>There may be a fault, for example:</p> <ul style="list-style-type: none"> • in the engine management • in the fuel injection system • in the exhaust system • in the ignition system (for vehicles with petrol engines) • in the fuel system <p>The emission limit values may be exceeded and the engine may be running in emergency mode.</p> <p>► Have the vehicle checked as soon as possible at a qualified specialist workshop.</p> <p>Vehicles with a diesel engine: the fuel tank has been run dry (► page 168).</p> <p>► Start the engine three to four times after refuelling. If the yellow engine diagnostics warning lamp goes out, emergency running mode is cancelled. The vehicle need not be checked.</p>
 <p>The yellow reserve fuel warning lamp lights up while the engine is running.</p>	<p>The fuel level has dropped into the reserve range.</p> <p>Operation of the auxiliary heating is deactivated if the fuel level drops into the reserve range.</p> <p>► Refuel at the nearest filling station.</p>
 <p>The red coolant warning lamp lights up while the engine is running and the coolant temperature gauge is at the start of the scale.</p>	<p>The temperature sensor for the coolant temperature gauge is faulty.</p> <p>The coolant temperature is no longer being monitored. There is a risk of engine damage if the coolant temperature is too high.</p> <p>► Stop the vehicle immediately, paying attention to road and traffic conditions, and switch off the engine. Do not continue driving under any circumstances.</p> <p>► Secure the vehicle against rolling away (► page 169).</p> <p>► Consult a qualified specialist workshop.</p>

Problem	Possible causes/consequences and ► Solutions
 <p>The red coolant warning lamp comes on while the engine is running.</p>	<p>The coolant level is too low.</p> <p>If the coolant level is correct, the airflow to the engine radiator may be blocked or the electric engine radiator fan may be malfunctioning.</p> <p>The coolant is too hot and the engine is no longer being cooled sufficiently.</p> <ul style="list-style-type: none"> ► Observe the additional display messages in the multifunction display. ► Stop the vehicle immediately, paying attention to road and traffic conditions, and switch off the engine. ► Secure the vehicle against rolling away (► page 169). ► Wait until the engine has cooled down. ► Make sure that the air supply to the engine radiator is not blocked, e.g. by frozen slush. ► Check the coolant level and top up the coolant (► page 318). Observe the warning notes as you do so. ► If you have to top up the coolant frequently, have the engine cooling system checked. ► If the coolant temperature is below 120 °C you can continue driving to the nearest qualified specialist workshop. ► Avoid heavy loads on the engine as you do so, e.g. driving in mountainous terrain and stop-start traffic.
 <p>The red coolant warning lamp comes on while the engine is running. A warning tone also sounds.</p>	<p>The coolant temperature has exceeded 120 °C. The airflow to the engine radiator may be blocked or the coolant level may be too low.</p> <p> WARNING</p> <p>The engine is not being cooled sufficiently and may be damaged. Never drive with an overheated engine. Driving when your engine is overheated can cause some fluids which may have leaked into the engine compartment to catch fire.</p> <p>Steam from an overheated engine can cause serious burns, which can occur just by opening the bonnet.</p> <p>There is a risk of injury.</p> <ul style="list-style-type: none"> ► Observe the additional display messages in the multifunction display. ► Stop the vehicle immediately, paying attention to road and traffic conditions, and switch off the engine. ► Secure the vehicle against rolling away (► page 169). ► Wait until the engine has cooled down.

Problem	Possible causes/consequences and ► Solutions
	<ul style="list-style-type: none"> ► Make sure that the air supply to the engine radiator is not blocked, e.g. by frozen slush. ► Check the coolant level and top up the coolant (▷ page 318). Observe the warning notes as you do so. ► If you have to top up the coolant frequently, have the engine cooling system checked. ► If the coolant temperature is below 120 °C you can continue driving to the nearest qualified specialist workshop. ► Avoid heavy loads on the engine as you do so, e.g. driving in mountainous terrain and stop-start traffic.

Driving systems

Problem	Possible causes/consequences and ► Solutions
 <p>The red distance warning lamp lights up while the vehicle is in motion.</p>	<p> WARNING</p> <p>The distance to the vehicle in front is too small for the speed selected. There is a risk of an accident.</p> <ul style="list-style-type: none"> ► Increase the distance.
 <p>The red distance warning lamp lights up while the vehicle is in motion. A warning tone also sounds.</p>	<p> WARNING</p> <p>You are approaching a vehicle or a stationary obstacle in your line of travel at too high a speed. There is a risk of an accident.</p> <ul style="list-style-type: none"> ► Be prepared to brake immediately. ► Pay careful attention to the traffic situation. You may have to brake or take evasive action. <p>More information about DISTRONIC PLUS (▷ page 179) and PRE-SAFE® Brake (▷ page 77).</p>

Tyres	
Problem	Possible causes/consequences and ► Solutions
 <p>The yellow tyre pressure monitor warning lamp (pressure loss/malfunction) is lit.</p>	<p>The tyre pressure monitor has detected a loss of pressure in at least one of the tyres.</p> <p> WARNING</p> <p>With tyre pressures which are too low, there is a risk of the following hazards:</p> <ul style="list-style-type: none"> • the tyres may burst, especially as the load and vehicle speed increase. • the tyres may wear excessively and/or unevenly, which may greatly impair tyre traction. • the driving characteristics, as well as steering and braking, may be greatly impaired. <p>There is a risk of an accident.</p> <ul style="list-style-type: none"> ► Stop the vehicle without making any sudden steering or braking manoeuvres. Pay attention to the traffic conditions as you do so. ► Secure the vehicle against rolling away (▷ page 169). ► Observe the additional display messages in the multifunction display. ► Check the tyres and, if necessary, follow the instructions for a flat tyre (▷ page 330). ► Check the tyre pressure (▷ page 353). ► If necessary, correct the tyre pressure.
 <p>The yellow tyre pressure monitor warning lamp (pressure loss/malfunction) flashes for approximately one minute and then remains lit.</p>	<p>The tyre pressure monitor is faulty.</p> <p> WARNING</p> <p>The system is possibly unable to recognise or register low tyre pressure.</p> <p>There is a risk of an accident.</p> <ul style="list-style-type: none"> ► Observe the additional display messages in the multifunction display. ► Visit a qualified specialist workshop.

Useful information	294
Loading guidelines	294
Stowage areas	294
Features	299

Useful information

- i** This Owner's Manual describes all models, series and optional equipment for your vehicle that were available at the time of going to press. National variations are possible. Note that your vehicle may not be equipped with all of the functions described. This is also the case for systems and functions relevant to safety.
- i** Read the information on qualified specialist workshops: (▷ page 28).

Loading guidelines

WARNING

If objects, luggage or loads are not secured or not secured sufficiently, they could slip, tip over or be flung around and thereby hit vehicle occupants. There is a risk of injury, especially when braking or abruptly changing directions. Always store objects so that they cannot be flung around. Secure objects, luggage or loads against slipping or tipping before the journey.

WARNING

Combustion engines emit poisonous exhaust gases such as carbon monoxide. Exhaust gases can enter the vehicle interior if the boot lid is open when the engine is running, especially if the vehicle is in motion. There is a risk of poisoning.

Always switch off the engine before opening the boot lid. Never drive with the boot lid open.

The handling characteristics of a laden vehicle are dependent on the distribution of the load within the vehicle. For this reason, you should observe the following notes when transporting a load:

- when transporting a load, never exceed the maximum permissible gross vehicle weight

or the permissible axle loads for the vehicle (including occupants).

- the boot is the preferred place to carry objects.
 - position heavy loads as far forwards as possible and as low down in the boot as possible.
 - the load must not protrude above the upper edge of the seat backrests.
 - always place the load against the rear or front seat backrests. Make sure that the seat backrests are securely locked into place.
 - always place the load behind unoccupied seats if possible.
 - use the lashing eyelets and the luggage nets to transport loads and luggage.
 - only use lashing eyelets and fastening components that are suitable for the weight and size of the load.
 - secure the load with sufficiently strong and wear-resistant lashing material. Pad sharp edges for protection.
- i** Load restraints are available at any qualified specialist workshop, e.g. a Mercedes-Benz Service Centre.

Stowage areas

Stowage spaces

Important safety notes

WARNING

If you do not correctly store objects in the vehicle interior, they can slip or be flung around, thus striking vehicle occupants. There is a risk of injury, especially when braking or abruptly changing directions.

- Always store objects so that they cannot be flung around in these or in similar situations.
- Always make sure that objects do not protrude from stowage compartments, luggage nets or stowage nets.

- Close lockable stowage compartments while driving.
- Stow and secure objects that are heavy, hard, pointy, sharp-edged, fragile or too large in the boot.

Observe the loading guidelines (▷ page 294).

Front stowage compartments

Glove compartment

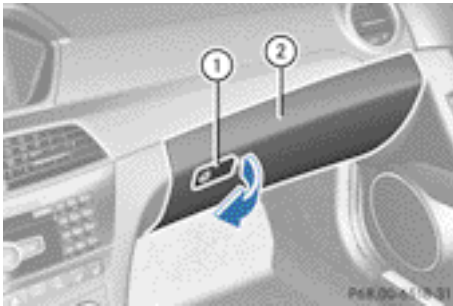

- ▶ **To open:** pull handle ① and open glove compartment flap ②.
- ▶ **To close:** fold glove compartment flap ② upwards until it engages.

The glove compartment can only be locked and unlocked using the emergency key element.

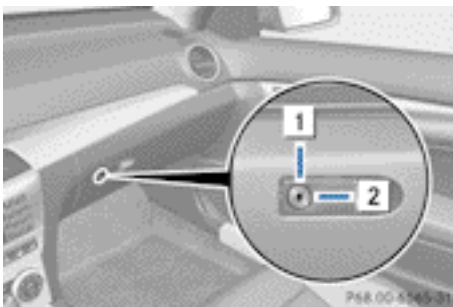

- ▶ **To lock:** insert the emergency key element into the lock and turn it 90° clockwise to position ②.
- ▶ **To unlock:** insert the emergency key element into the lock and turn it 90° anti-clockwise to position ①.

- ❗ The glove compartment can be cooled (▷ page 146).

Stowage compartment in the centre console

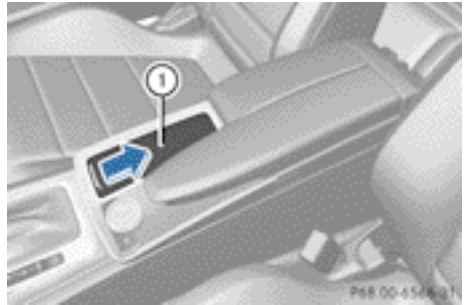

- ▶ **To open:** slide cover ① in the direction of the arrow.

Stowage compartment/telephone compartment under the armrest

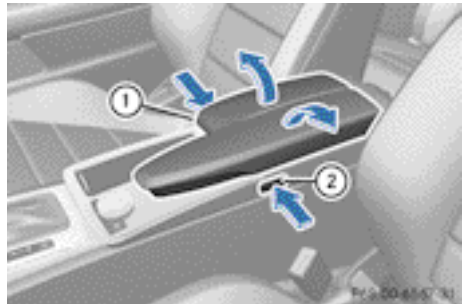

- ▶ **To open:** press left-hand button ② or right-hand button ①. The stowage compartment opens.

- ❗ Depending on the vehicle's equipment, a USB port and an AUX-IN jack or a Media Interface are installed in the stowage compartment. A Media Interface is a universal interface for portable audio equipment, e.g. for an iPod® or MP3 player (see the separate Audio or COMAND Online operating instructions).

Before using these connections, you must remove the mobile phone bracket (see the separate installation instructions) and fold

up the preinstalled mobile phone holder (▷ page 303).

Stowage net

Stowage nets are located in the front-passenger footwell and on the left-hand side of the boot.

Observe the loading guidelines (▷ page 294) and the safety notes regarding stowage spaces (▷ page 294).

Through-loading facility in the rear bench seat

Important safety notes

WARNING

If the rear bench seat/rear seat and seat backrest are not engaged they could fold forwards, e.g. when braking suddenly or in the event of an accident.

- The vehicle occupant would thereby be pushed into the seat belt by the rear bench seat/rear seat or by the seat backrest. The seat belt cannot protect as intended and could result in additional injury.
- Objects or loads in the boot cannot be restrained by the seat backrest.

This poses an increased risk of injury.

Before every trip, make sure that the seat backrests and the rear bench seat/rear seat are engaged before every trip.

Observe the loading guidelines (▷ page 294). The left-hand and right-hand rear seat backrests can be folded down separately to increase the boot capacity.

Folding the seat backrest forwards



i Vehicles with memory function: when you fold one or both parts of the rear seat backrest forwards, the respective front seat moves forward slightly, when necessary, in order to avoid contact.

- ▶ Vehicles without memory function: if necessary, move the driver's or front-passenger seat forwards.
- ▶ Open the boot.
- ▶ Pull right-hand or left-hand rear seat backrest release handle ①. The corresponding rear seat backrest is released.

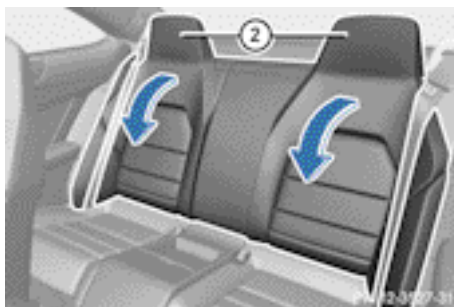

- ▶ Fold rear seat backrest ② forwards.
- ▶ Move the driver's or front-passenger seat back if necessary.

Folding back the seat backrest

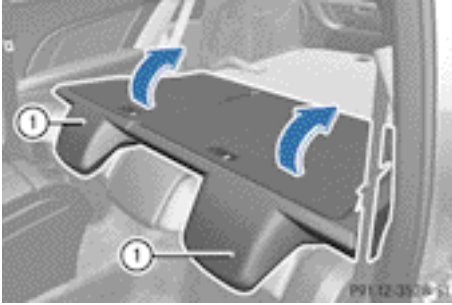

- ▶ Move the driver's or front-passenger seat forward if necessary.

! Make sure that the seat belt does not become trapped when folding the rear seat backrest back. Otherwise, it could be damaged.

- ▶ Fold rear seat backrest ① back until it engages.
If the rear seat backrest is not engaged and locked, this will be shown in the multifunction display in the instrument cluster. A warning tone also sounds.

i If you do not need the through-loading feature, you should always engage the rear seat backrests. This will prevent unauthorised access to the boot from the vehicle interior.

- ▶ Move the driver's or front-passenger seat back if necessary.

Securing a load

Lashing eyelets

Observe the following notes on securing loads:

- Observe the loading guidelines (▷ page 294).
- Secure the load using the lashing eyelets.
- Distribute the load on the lashing eyelets evenly.

- Do not use elastic straps or nets to secure a load, as these are only intended as an anti-slip protection for light loads.
- Do not route lashing materials across sharp edges or corners.
- Pad sharp edges for protection.

There are four lashing eyelets in the boot.



Vehicle with through-loading feature in the rear bench seat

- ① Lashing eyelets

Bag hook

! WARNING

The bag hooks cannot restrain heavy objects or items of luggage. Objects or items of luggage could be flung around and thereby hit vehicle occupants when braking or abruptly changing directions. There is a risk of injury. Only hang light objects on the bag hooks. Never hang hard, sharp-edged or fragile objects on the bag hooks.

- !** The bag hook can bear a maximum load of 5 kg. Do not use it to secure a load.

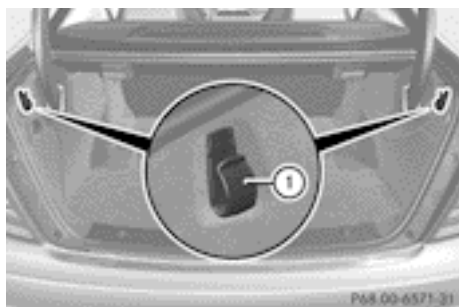

① Bag hook

Stowage well under the boot floor

The TIREFIT kit, the vehicle tool kit, etc. are located in the stowage compartment.

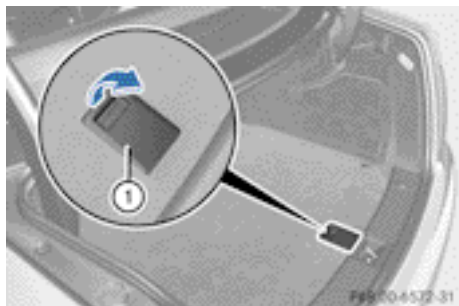

► **To open:** pull handle ① up.



► Hook handle ① into rain trough ②.

❗ Remove the handle again before closing the boot lid and snap it in tightly to prevent the handle flap from protruding. Otherwise, you could damage the handle.

Roof carrier

Important safety notes

⚠ WARNING

When a load is transported on the roof, the vehicle's centre of gravity rises and the handling changes. If you exceed the maximum roof load, the handling as well as steering and braking characteristics are severely affected. There is a risk of an accident.

Always observe the maximum roof load and adapt your driving style.

❗ Mercedes-Benz recommends that you only use roof carriers that have been tested and approved for Mercedes-Benz vehicles. This helps to prevent damage to the vehicle.

Position the load on the roof carrier in such a way that the vehicle will not sustain damage even when it is in motion.

Depending on the vehicle equipment, ensure that when the roof carrier is fitted you can:

- open the panorama sliding sunroof fully
- open the boot lid fully

❗ To avoid damaging or scratching the covers, do not use metallic or hard objects to open them.

The maximum roof load is 100 kg.

An incorrectly secured roof carrier or roof load may become detached from the vehicle. You must therefore ensure that you observe the roof carrier manufacturer's installation instructions.

Attaching the roof carrier

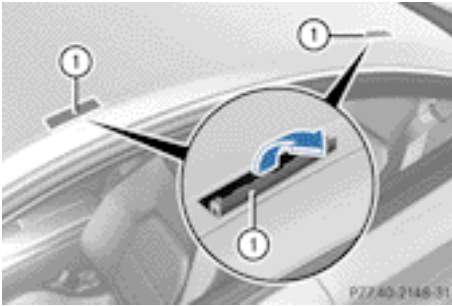

Vehicles with a steel roof

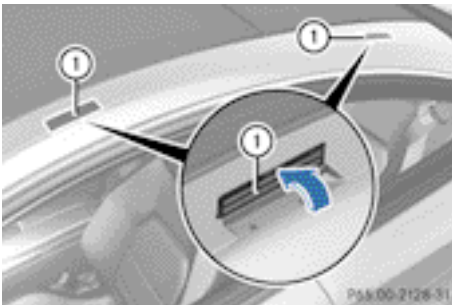

Vehicles with a panorama sliding sunroof

- ▶ Open covers ① carefully in the direction of the arrow.
- ▶ Fold covers ① upwards.
- ▶ Only secure the roof carrier to the anchorage points under covers ①.
- ▶ Observe the manufacturer's installation instructions.

Features

Cup holders

Important safety notes

- ❗ Only use the cup holders for containers of the right size and which have lids. The drinks could otherwise spill.

Cup holder in the front centre console

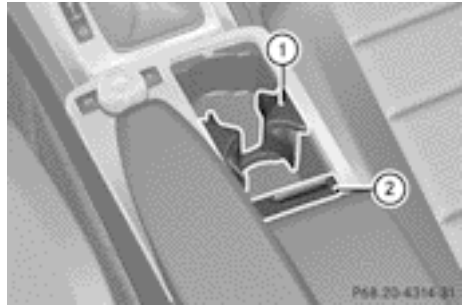

- ① Cup holders
- ② Cover

- ▶ **To open:** slide cover ② back.

Removing and fitting the cup holder
Removing

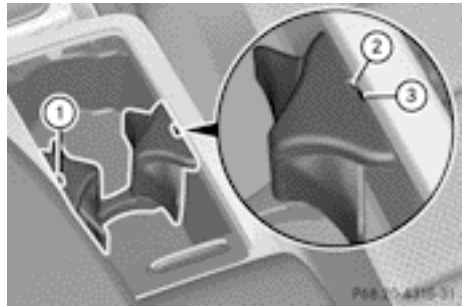

- ▶ Pry groove ② away carefully on the front-passenger side using a suitable tool until lug ③ becomes visible.
- ▶ Pull the cup holder upwards slightly, to the stop.
- ▶ Pry groove ① away carefully on the driver's side using a suitable tool. At the same time, pull the cup holder upwards slightly to the stop.
- ▶ Pry groove on driver's side ① and front-passenger side ② away alternately. When doing so, lift the cup holder upwards until it can be removed.

Fitting

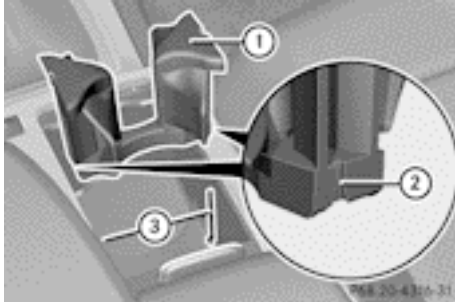

- ▶ Insert left-hand and right-hand grooves (2) of the cup holder into lateral springs (3). Insert the cup holder so that the wedge of the upper section of cup holder (1) faces forwards.
- ▶ Press the cup holder downwards until it engages on the front-passenger side.

Cup holder in the rear storage box

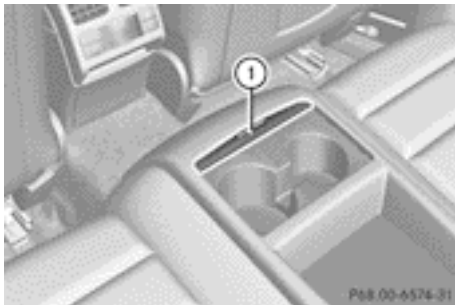

- ▶ **To open:** slide cover (1) forwards.

Sun visors

Overview

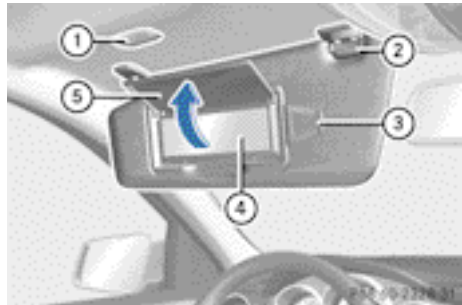

- ① Mirror light
- ② Bracket
- ③ Retaining clip, e.g. for a car park ticket
- ④ Vanity mirror
- ⑤ Mirror cover

Vanity mirror in the sun visor

Mirror light (1) only functions if the sun visor is clipped into retainer (2) and mirror cover (5) has been folded up.

Glare from the side

- ▶ Fold down the sun visor.
- ▶ Pull the sun visor out of retainer (2).
- ▶ Swing the sun visor to the side.

Ashtray

Front ashtray

! The stowage space under the ashtray is not heat resistant. Before placing lit cigarettes in the ashtray, make sure that the ashtray is properly engaged. Otherwise, the stowage space could be damaged.

- i** You can remove the ashtray insert and use the resulting compartment for stowage.

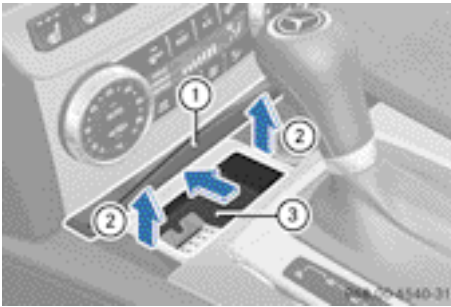

- ▶ **To open:** slide cover ① forwards until it engages.
- ▶ **To remove the insert:** hold insert ③ by the ribbing at the sides and lift it up ② and out.
- ▶ **To refit the insert:** press insert ③ into the holder until it engages.
- ▶ **To close:** briefly press cover ① at the front. The cover moves back.

Rear-compartment ashtray

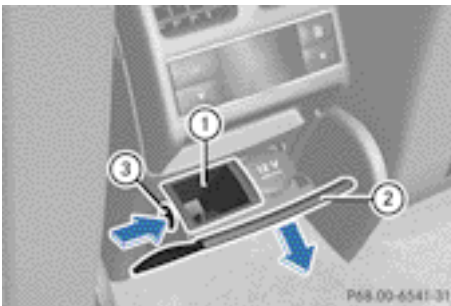

- ▶ **To open:** pull cover ② out by its top edge.
- ▶ **To remove the insert:** press release button ③ and lift the insert up and out.
- ▶ **To fit the insert:** fit insert ① from above into the holder and press down into the holder until it engages.

Cigarette lighter

⚠ WARNING

You can burn yourself if you touch the hot heating element or the socket of the cigarette lighter.

In addition, flammable materials can ignite if:

- the hot cigarette lighter falls
- a child holds the hot cigarette lighter to objects, for example

There is a risk of fire and injury.

Always hold the cigarette lighter by the knob. Always make sure that the cigarette lighter is out of reach of children. Never leave children unattended in the vehicle.

Your attention must always be focused on the traffic conditions. Only use the cigarette lighter when road and traffic conditions permit.

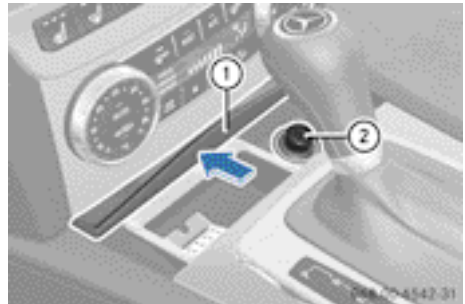

- ▶ Turn the key to position 2 in the ignition lock (▷ page 149).
- ▶ **To open:** slide cover ① forwards until it engages.
- ▶ Press in cigarette lighter ②. Cigarette lighter ② will pop out automatically when the heating element is red-hot.
- ▶ **To close:** briefly press cover ① at the front. The cover moves back.

12 V sockets

General notes

The sockets can be used for accessories with a maximum draw of 180 W (15 A). Accessories include such items as bulbs or chargers for mobile phones.

If you use the sockets for long periods when the engine is switched off, the battery may discharge.

- ▶ Turn the key to position **1** in the ignition lock (▷ page 149).

i An emergency cut-off ensures that the on-board voltage does not drop too low. If the on-board voltage is too low, the power to the sockets is automatically cut. This ensures that there is sufficient power to start the engine.

Socket in the front centre console

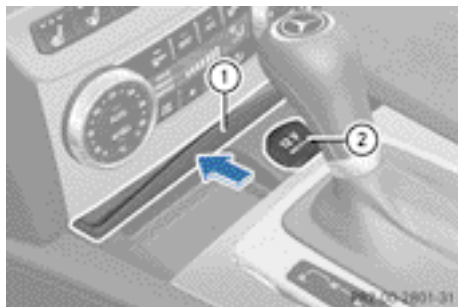

- ▶ **To open:** slide cover **1** forwards until it engages.
- ▶ Lift up the cover of socket **2**.
- ▶ **To close:** briefly press cover **1** at the front. The cover retracts.

Socket in the rear-compartment centre console

A socket is fitted in the centre console in the rear compartment in vehicles with an ashtray and a cigarette lighter.

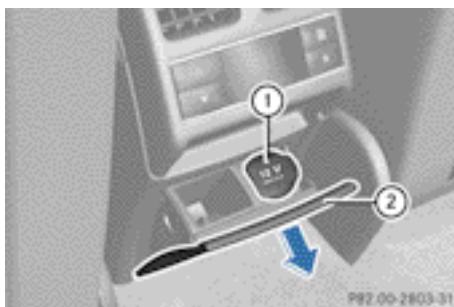

- ▶ Pull cover **2** out by its top edge.
- ▶ Lift up the cover of socket **1**.

Mobile phone

Important safety notes

WARNING

Operating mobile communications equipment while driving distracts you from paying attention to traffic conditions. This could also cause you to lose control of the vehicle. There is a risk of an accident.

Use this device only when the vehicle is stationary.

i You must observe the legal requirements for the country in which you are currently driving when operating mobile communications equipment in the vehicle.

If it is permitted by law to operate communications equipment while the vehicle is in motion, you may only do so if the traffic situation permits. You may otherwise be distracted from the traffic conditions, cause an accident and injure yourself and others.

Excessive levels of electromagnetic radiation may cause damage to your health and to the health of others. The use of an exterior aerial takes into consideration the scientific discussion surrounding the possible health risk posed by electromagnetic fields.

Mercedes-Benz recommends the use of an approved exterior aerial. This ensures:

- optimal mobile phone reception quality in the vehicle.
- mutual interference between the vehicle electronics and mobile phones is minimised.

An exterior aerial has the following advantages:

- it conducts the electromagnetic fields generated by a wireless device to the exterior.
- the field strength in the vehicle interior is lower than in a vehicle that does not have an exterior aerial.

Information on retrofitting two-way radios and mobile phones (RF transmitters) (▷ page 370).

General notes

There are various mobile phone brackets that may be fitted in your vehicle; in some cases, these are country-specific.

You can connect a Bluetooth®-capable mobile phone with Audio 20 or COMAND Online via the Bluetooth® interface. This also applies if your vehicle is equipped with convenience telephony.

More information on suitable mobile phones, mobile phone brackets and on connecting Bluetooth®-capable mobile phones with Audio 20 or COMAND Online can be obtained:

- at your Mercedes-Benz Service Centre
- on the Internet at <http://www.mercedes-benz.com/connect>



i The functions and services available when you use the phone depend on your mobile phone model and service provider.

Using a mobile phone

If the mobile phone is inserted in the mobile phone bracket, the mobile phone will be charged and connected with the exterior aerial.

- ▶ Open the telephone compartment (▷ page 295).
- ▶ Place the mobile phone bracket into the pre-installed fitting (see the separate installation instructions for the mobile phone fitting).
- ▶ Insert the mobile phone into the mobile phone bracket (see the separate installation instructions for the mobile phone fitting).

Operating the mobile phone

You can operate the telephone using the  and  buttons on the luxury multi-function steering wheel. You can operate other mobile phone functions via the on-board computer (▷ page 226).

When you remove the key from the ignition lock, the mobile phone is disconnected from the hands-free system. Active calls will first be transferred to the mobile phone directly.

Mobile phone bracket in the stowage compartment



You can fold the pre-installed bracket up to improve access to the stowage space beneath it. Depending on the vehicle's equipment, a USB connection and an AUX-IN connection/Media Interface are fitted in the stowage compartment.

- ▶ **To fold the bracket up:** press button ①.
- ▶ **To fold the bracket down:** press the bracket down and allow it to engage.

Garage door opener

Important safety notes

WARNING

When you operate or program the garage door opener with the integrated garage door opener, persons in the range of movement of the garage door can become trapped or struck by the garage door. There is a risk of injury.

When using the integrated garage door opener, always make sure that nobody is within the range of movement of the garage door.

WARNING

Combustion engines emit poisonous exhaust gases such as carbon monoxide. Inhaling these exhaust gases leads to poisoning. There is a risk of fatal injury. Therefore never leave the engine running in enclosed spaces without sufficient ventilation.

The HomeLink® garage door opener integrated in the rear-view mirror allows you to operate up to three different door and gate systems.

When programming a garage door opener, park the vehicle outside the garage.

- i** The garage door opener is only available for certain countries. Observe the legal requirements for each individual country. The HomeLink® garage door opener is compatible with most European garage and gate opener drives. More information on HomeLink® and/or compatible products is available:

- at a qualified specialised workshop
- via the HomeLink® Hotline (0) 08000 466 354 65 or alternatively +49 (0) 6838 907-277
- on the Internet at:
<http://www.homelink.com>

Programming

Programming buttons

Observe the "Important safety notes" (> page 304).

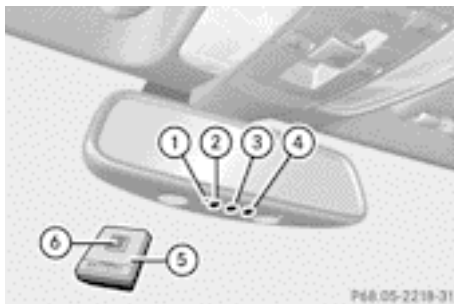

Integrated garage door opener in the rear-view mirror

Garage door remote control ⑤ is not part of the integrated garage door opener.

- ▶ Before programming for the first time, clear the memory of the integrated garage door opener (> page 306).

- ▶ Turn the key to position **2** in the ignition lock.
- ▶ Press and hold one of buttons ② to ④ on the integrated garage door opener. After a short time, indicator lamp ① begins to light up yellow.

- i** Indicator lamp ① lights up yellow immediately the first time button ②, ③ or ④ is programmed. If the selected button has already been programmed, indicator lamp ① lights up yellow after ten seconds have elapsed.

- ▶ Release button ②, ③ or ④. Indicator lamp ① flashes yellow.
- ▶ Point garage door remote control ⑤ towards buttons ② to ④ on the rear-view mirror at a distance of 5 to 20 cm.

- i** The required distance between remote control ⑤ and the integrated garage door opener depends on the garage door drive system. Several attempts may be required.

You should test every position for at least 25 seconds before trying another position.

- ▶ Press and hold button ⑥ on remote control ⑤ until indicator lamp ① lights up green. If indicator lamp ① lights up green or flashes, then programming has been successful.
- ▶ Release button ⑥ of remote control ⑤ of the garage door drive.
- ▶ If indicator lamp ① blinks red: repeat the programming process for the corresponding button on the rear-view mirror. When doing so, vary the distance between remote control ⑤ and the rear-view mirror.

i If the indicator lamp flashes green after successful programming, the garage door system is using a rolling code. After programming, you must synchronise the garage door opener integrated in the rear-view mirror with the receiver of the garage door system.

Synchronising the rolling code

Observe the "Important safety notes" (▷ page 304).

Your vehicle must be within range of the garage door or exterior gate drive. Make sure that neither your vehicle nor any persons/objects are present within the sweep of the door or gate.

- ▶ Turn the key to position **2** in the ignition lock.
- ▶ Press the programming button of the door or gate drive (see the door or gate drive operating instructions, e.g. under "Programming of additional remote controls").
- i** Usually, you now have 30 seconds to initiate the next step.
- ▶ Press previously programmed button ②, ③ or ④ of the integrated garage door opener until the door closes. The rolling code synchronisation is then complete.

Problems when programming

If you have problems when programming the integrated garage door opener, please note the following:

- Check the transmitter frequency of garage door drive remote control ⑤. This can usually be found on the back of the remote control.
- Replace the batteries in garage door remote control ⑤. This increases the likelihood that garage door remote control ⑤ will transmit a strong and precise signal to the integrated garage door opener in the rear-view mirror.
- When programming, hold remote control ⑤ at varying distances and angles from the button which you are programming. Try various angles at a distance between 5 and 30 cm or at the same angle but at varying distances.
- If there is another remote control for the same garage door drive, perform the programming steps again using this remote control. Before performing these steps, make sure that new batteries have been fitted in garage door drive remote control ⑤.
- Note that some remote controls transmit only for a limited period (the indicator lamp on the remote control goes out). Press button ⑥ on remote control ⑤ again before transmission ends.
- Align the aerial cable of the garage door opener unit. This can improve signal reception/transmission.

Opening or closing the garage door

Once programmed, the integrated garage door opener will assume the function of the garage door system's remote control. Please also read the operating instructions for the garage door system.

- ▶ Turn the key to position **2** in the ignition lock.
- ▶ Press button ②, ③ or ④ which you have programmed to operate the garage door. Garage door system with a fixed code: indicator lamp ① lights up green.
Garage door system with a rolling code: indicator lamp ① flashes green.
- ❗ The transmitter will transmit a signal for as long as the button is pressed. The transmission is halted after a maximum of ten seconds and indicator lamp ① lights up yellow. Press button ②, ③ or ④ again if necessary.

Clearing the memory

- ▶ Turn the key to position **2** in the ignition lock.
- ▶ Press buttons ② and ④.
The indicator lamp lights up yellow.
- ▶ Press and hold buttons ② and ④ until the indicator lamp turns green.
- ❗ Make sure that you clear the memory of the integrated garage door opener before selling the vehicle.

Frequencies

Europe

Country	Radio type approval number Frequency range (MHz)
AD (Andorra)	20 July 2005 MHz: 27, 30, 40, 433, 868
AT (Austria)	Article 6 of Directive 1999/5/EC R&TTE 18 May 05 MHz: 27, 40, 433, 868
BE (Belgium)	Article 6 of Directive 1999/5/EC R&TTE 18 May 05 MHz: 27, 40, 433, 868

Country	Radio type approval number Frequency range (MHz)
BG (Bulgaria)	Article 6 of Directive 1999/5/EC R&TTE 12 April 07 MHz: 27, 40, 433, 868
CH (Switzerland)	Article 6 of Directive 1999/5/EC R&TTE 14357 27 May 05 MHz: 27, 40, 433, 868
CY (Cyprus)	Article 6 of Directive 1999/5/EC R&TTE 5 May 05 MHz: 27, 40, 433, 868
CZ (Czech Republic)	General Licence GL-30/R/2000 Reg No. 844 13 May 05 MHz: 27, 40, 433
DK (Denmark)	Article 6 of Directive 1999/5/EC R&TTE 20 April 05 MHz: 27, 40, 433, 868
DE (Germany)	Article 6 of Directive 1999/5/EC R&TTE 7519301 29 April 05 MHz: 27, 40, 433, 868
EE (Estonia)	Article 6 of Directive 1999/5/EC R&TTE 11 May 05 MHz: 27, 40, 433, 868
ES (Spain)	000438/2005, 000439/2005, 000440/2005 000441/2005, 000445/2005, 000446/2005 000447/2005 MHz: 27, 40, 433, 868

Country	Radio type approval number Frequency range (MHz)
FI (Finland)	Article 6 of Directive 1999/5/EC R&TTE 10668 13 May 05 MHz: 27, 40, 433, 868
FR (France)	Article 6 of Directive 1999/5/EC R&TTE 10668 13 May 05 27, 30, 40, 433, 868
GI (Gibraltar)	Article 6 of Directive 1999/5/EC R&TTE 10668 13 May 05 (UK) MHz: 27, 40, 418, 433, 868
GR (Greece)	Article 6 of Directive 1999/5/EC R&TTE 11409/18/4/2005 18 May 05 MHz: 27, 40, 433, 868
HR (Croatia)	SDR 224/06 MHz: 27, 40, 433, 868
HU (Hungary)	Article 6 of Directive 1999/5/EC R&TTE 18 May 05 MHz: 27, 40, 433, 868
IC (Canary Islands)	000438/2005, 000439/2005 000440/2005, 000441/2005 000445/2005, 000446/2005 000447/2005, 3rd June 2005 MHz: 27, 40, 433, 868
IE (Ireland)	Article 6 of Directive 1999/5/EC R&TTE 18 May 05 MHz: 27, 40, 433, 868

Country	Radio type approval number Frequency range (MHz)
IS (Iceland)	Article 6 of Directive 1999/5/EC R&TTE 18 May 05 MHz: 27, 40, 433, 868
IT (Italy)	DGPGRS/II/347487/ FOR/15347 DGPGRS/II/347487/ FOR/15348 DGPGRS/II/347487/ FOR/15350 DGPGRS/II/347487/ FOR/15357 DGPGRS/II/347487/ FOR/15358 DGPGRS/II/347487/ FOR/15359 MHz: 27, 40, 433, 868
LI (Liechtenstein)	Article 6 of Directive 1999/5/EC R&TTE 14357 27 May 05 MHz: 27, 40, 433, 868
LT (Lithuania)	Article 6 of Directive 1999/5/EC R&TTE 27.4-1B-1609 6 May 05 MHz: 27, 40, 433, 868
LU (Luxembourg)	Article 6 of Directive 1999/5/EC R&TTE 150405/9538 24 May 05 MHz: 27, 40, 433, 868
LV (Latvia)	Article 6 of Directive 1999/5/EC R&TTE 27.4-1B-1609 26 April 06 MHz: 27, 40, 433, 868
MC (Monaco)	Article 6 of Directive 1999/5/EC R&TTE 10668 13 May 05 MHz: 27, 40, 433, 868

Country	Radio type approval number Frequency range (MHz)
MT (Malta)	Article 6 of Directive 1999/5/EC R&TTE 18 May 05 MHz: 27, 40, 433, 868
NL (Netherlands)	Article 6 of Directive 1999/5/EC R&TTE 18 May 05 MHz: 27, 40, 433, 868
NO (Norway)	Article 6 of Directive 1999/5/EC R&TTE 05/02424-SA644 18 May 05 MHz: 27, 40, 433, 868
PL (Poland)	Article 6 of Directive 1999/5/EC R&TTE 21 April 05 MHz: 27, 40, 433, 868
PT (Portugal)	ANCOM-S08399/05 27, 40, 433, 868
RO (Romania)	Article 6.4 of Directive 1999/5/EC R&TTE MHz: 27, 30, 40, 433, 868
RU (Russian Federation)	POCC DE.MJ05.H00015 13 May 05 MHz: 433
SE (Sweden)	Article 6 of Directive 1999/5/EC R&TTE 18 May 05 MHz: 27, 40, 433, 868
SI (Slovenia)	Article 6 of Directive 1999/5/EC R&TTE 500-1/2005-437 9 May 05 MHz: 27, 40, 433, 868

Country	Radio type approval number Frequency range (MHz)
SK (Slovakia)	Article 6 of Directive 1999/5/EC R&TTE Slovak 206/11/2005 4 May 05 MHz: 27, 40, 433, 868
UK (United Kingdom)	Article 6 of Directive 1999/5/EC R&TTE 18 May 05 MHz: 27, 40, 418, 433, 868

Africa

Country	Radio type approval number Frequency range (MHz)
EG (Egypt)	W-KLE-17/08 Mar. 06 MHz: 27, 30, 40, 418, 433, 868
RE (Réunion)	Article 6 of Directive 1999/5/EC R&TTE 11 July 05 MHz: 27, 40, 433, 868
ZA (South Africa)	11 October 2005 MHz: 27, 40, 433

America

Country	Radio type approval number Frequency range (MHz)
BB (Barbados)	Registration not required MHz: 27, 40, 433, 868
CL (Chile)	38447/F-23 No.3.3634 MHz: 40, 433 3943/DFRS05 165/F-50 MHz: 280 to 433

Country	Radio type approval number Frequency range (MHz)
GF (French Guyana)	Article 6 of Directive 1999/5/EC R&TTE 10668 13 May 05 MHz: 27, 30, 40, 433, 868
GP (Guadeloupe)	Article 6 of Directive 1999/5/EC R&TTE 10668 13 May 05 MHz: 27, 30, 40, 433, 868
MQ (Martinique)	Article 6 of Directive 1999/5/EC R&TTE 11 July 05 MHz: 27, 30, 40, 433, 868
MX (Mexico)	MHz: 280 to 390

Asia

Country	Radio type approval number Frequency range (MHz)
AE (United Arab Emirates)	1623/5/10-2/26/76 MHz: 433
JO (Jordan)	TRC/LPD/2005/23 MHz: 27, 30, 40, 433, 868
KW (Kuwait)	5 October 2005 MHz: 27, 30, 40, 418, 433, 868
SA (Saudi Arabia)	11_02_05/5024-5-6 MHz: 418, 433
SY (Syria)	279/4/14 / 05 March 06
TR (Turkey)	National Certification 23 July 07 MHz: 433

Australia

Country	Radio type approval number Frequency range (MHz)
AU (Australia)	28 June 2005 MHz: 27, 30, 40, 433, 868
NZ (New Zealand)	20 March 06 MHz: 27, 30, 40, 433

Floormat on the driver's side

WARNING

Objects in the driver's footwell may restrict the clearance around the pedals or block a depressed pedal. This jeopardises the operating and road safety of the vehicle. There is a risk of an accident.

Stow all objects securely in the vehicle so that they do not get into the driver's footwell. Always fit the floormats securely and as prescribed in order to ensure that there is always sufficient room for the pedals. Do not use loose floormats and do not place several floormats on top of one another.

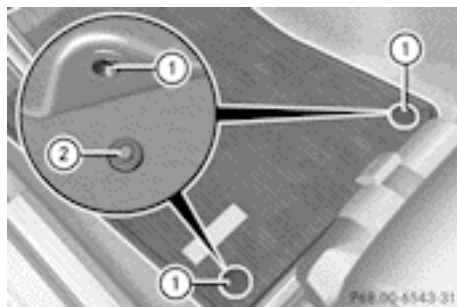

- ▶ Slide the seat backwards.
- ▶ **To fit:** lay the floormat in the footwell.
- ▶ Press studs ① onto retainers ②.
- ▶ **To remove:** pull the floormat away from retainers ②.
- ▶ Remove the floormats.

Retrofitted anti-glare film

Retrofitted anti-glare film on the inside of the windows can interfere with radio/mobile telephone reception. This is particularly the case for conductive or metallic-coated films. You can obtain information about anti-glare film from a qualified specialist workshop.

Useful information	312
ASSYST PLUS	312
Engine compartment	313
Care	319

Useful information

- i** This Owner's Manual describes all models, series and optional equipment for your vehicle that were available at the time of going to press. National variations are possible. Note that your vehicle may not be equipped with all of the functions described. This is also the case for systems and functions relevant to safety.
- i** Read the information on qualified specialist workshops: (▷ page 28).

ASSYST PLUS

Service messages

The ASSYST PLUS service interval display informs you of the next service due date.

Information on the type of service and service intervals (see separate Service Booklet).

You can obtain further information from a Mercedes-Benz Service Centre.

- i** The ASSYST PLUS service interval display does not show any information on the engine oil level. Observe the notes on the engine oil level (▷ page 316).

The multifunction display shows a service message for a few seconds, e.g.:

- **Service A in .. days**
- **Service A due**
- **Service A overdue by ... days**

Depending on the operating conditions of the vehicle, the remaining time or distance until the next service due date is displayed.

The letter indicates which service is due. **A** stands for a minor service and **B** for a major service. A number or another letter may be displayed after the letter. This figure indicates any necessary additional maintenance work to be performed.

If you notify a qualified specialist workshop of this display, you will receive a statement on the associated costs.

The ASSYST PLUS service interval display does not take into account any periods of time during which the battery is disconnected.

Maintaining the time-dependent service schedule:

- ▶ Note down the service due date displayed in the multifunction display before disconnecting the battery.

or

- ▶ After reconnecting the battery, subtract the battery disconnection periods from the service date shown on the display.

Hiding a service message

- ▶ **4-button multifunction steering wheel:** press the **R** button.
- ▶ **12-button multifunction steering wheel:** press the **←** or **OK** button.

Displaying service messages

- ▶ Switch the ignition on.

4-button multifunction steering wheel

- ▶ Use the **☰** button to select the **Service** menu.
The service due date appears in the multifunction display.

12-button multifunction steering wheel

- ▶ Press the **◀** or **▶** button to select the **Service** menu.
- ▶ Press the **▲** or **▼** button to select the **ASSYST PLUS** submenu and confirm by pressing the **OK** button.
The service due date appears in the multifunction display.

Information about Service

Resetting the ASSYST PLUS service interval display

! If the ASSYST PLUS service interval display has been inadvertently reset, this setting can be corrected at a qualified specialist workshop.

Have service work carried out as described in the Service Booklet. This may otherwise lead to increased wear and damage to the major assemblies or the vehicle.

A qualified specialist workshop, e.g. a Mercedes-Benz Service Centre, will reset the ASSYST PLUS service interval display after the service work has been carried out. You can also obtain further information on maintenance work, for example.

Special service requirements

The prescribed service interval is based on normal operation of the vehicle. Service work will need to be performed more often if the vehicle is operated under arduous conditions or increased loads, for example:

- regular city driving with frequent intermediate stops
- if the vehicle is primarily used to travel short distances
- for frequent operation in mountainous terrain or on poor road surfaces
- if the engine is often left idling for long periods

In these or similar operating conditions, have the air filter, engine oil and oil filter, for example, changed more frequently. The tyres must be checked more frequently if the vehicle is operated under increased loads. Further information can be obtained at a qualified specialist workshop, e.g. a Mercedes-Benz Service Centre.

Driving abroad

An extensive Mercedes-Benz Service network is also available in other countries. The Service Hotline's current telephone numbers for use when you are abroad are to be found in the "Mercedes-Benz Service24h" section of the Service Booklet.

Engine compartment

Bonnet

Important safety notes

WARNING

An unlocked bonnet may open while driving and block your view. There is a risk of an accident.

Never unlock the bonnet while driving.

WARNING

When being opened and closed, the bonnet may suddenly fall into the closed position. There is a risk of injury to persons in the range of movement of the bonnet.

Open and close the bonnet only when nobody is in the range of movement.

WARNING

If you open the bonnet while the engine is overheating or while there is a fire in the engine compartment, you could come into contact with hot gases or other leaking service products. There is a danger of injury.

Allow an overheating engine to cool down before opening the bonnet. If there is a fire in the engine compartment, leave the bonnet closed and notify the fire brigade.

WARNING

There are parts in the engine compartment that move. Certain components may continue to run even if the ignition is switched off or may suddenly start again, e.g. the radiator fan. There is a danger of injury.

If you need to access the engine compartment:

- switch off the ignition
- never enter the danger area of moving components, e.g. the rotation area of the fan
- keep items of clothing away from moving parts

WARNING

The ignition system and the fuel injection system operate with a high voltage. If you touch the live components, you could receive an electric shock. There is a danger of injury.

Never touch components of the ignition system or the fuel injection system when the ignition is switched on.

Active bonnet (pedestrian protection)

Operating principle

! Do not try to press down the raised bonnet at the back. Otherwise, the bonnet could be damaged.

i The active bonnet is only available in certain countries. It is available for all models, except for AMG vehicles.

The active bonnet can reduce the risk of injury to pedestrians in certain accident situations. Raising the active bonnet increases the clearance to hard components, such as the engine.

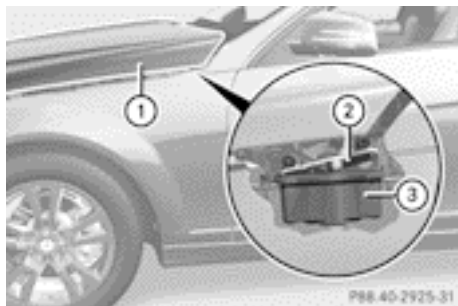

If active bonnet ① has been triggered, it will be raised at the back by about 50 mm. Lids ② will then no longer rest on housings ③.

You can reset a triggered active bonnet yourself.

Even if the active bonnet has been triggered, you can still continue driving and have it reset at a qualified specialist workshop. If you pull the bonnet release lever, you must reset the bonnet before driving on.

Resetting

WARNING

Certain components in the engine compartment could be very hot, e.g. the engine, the radiator and parts of the exhaust system. There is a risk of injury when accessing the engine compartment.

As far as possible, allow the engine to cool down and only touch the following components.

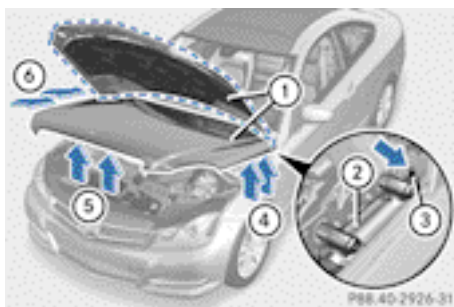

- ▶ Open the bonnet (▷ page 315).
- ▶ With both hands, lift the bonnet up in the centre ⑤. The bonnet is open wide enough when both lids of bonnet lifter ② no longer move.
- ▶ If you push the lids back, you will notice a resistance.
- ▶ Release bonnet ①.
- ▶ Check whether the lids of bonnet lifter ② are resting on housings ③ (arrow).

- ▶ **The lids of bonnet lifter ② are resting on the housings:** close bonnet ① (▷ page 315).

or

- ▶ **The lids of bonnet lifter ② are not resting on the housings:** first lift up bonnet ① on left-hand side ④ and then on right-hand side ⑥. Lift up bonnet ① until the respective lid of bonnet lifter ② no longer moves.

The lids of bonnet lifter ② must rest on housings ③ (arrow).

- ▶ Close bonnet ① (▷ page 315).

If you cannot close the bonnet ① or if the  symbol appears in the multifunction display, repeat the steps.

If the bonnet still does not engage correctly or the  symbol appears in the multifunction display, do not drive any further. Contact a qualified specialist workshop.

Opening the bonnet

WARNING

Certain components in the engine compartment could be very hot, e.g. the engine, the radiator and parts of the exhaust system. There is a risk of injury when accessing the engine compartment.

As far as possible, allow the engine to cool down and only touch the following components.

WARNING

When the bonnet is open, and the windscreen wipers are set in motion, you can be injured by the wiper linkage. There is a risk of injury. Always switch off the windscreen wipers and the ignition before opening the bonnet.

- ▶ **!** Make sure that the windscreen wipers are not folded away from the windscreen. Otherwise, you could damage the windscreen wipers or the bonnet.

- ▶ Make sure that the windscreen wipers are switched off.

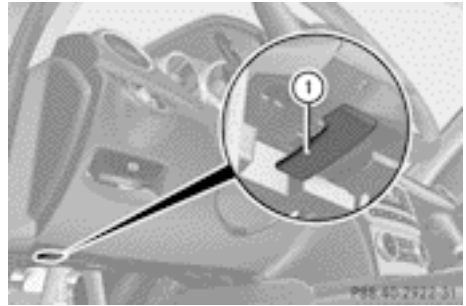

- ▶ Pull release lever ① on the bonnet. The bonnet is released.



- ▶ Reach into the gap, pull bonnet catch handle ② up and lift the bonnet. If you lift the bonnet by approximately 40 cm, the bonnet is opened and held open automatically by the gas-filled strut.

Closing the bonnet

- ▶ Lower the bonnet and let it fall from a height of approximately 20 cm.
- ▶ Check that the bonnet has engaged properly. If the bonnet can be raised slightly, it is not properly engaged. Open it again and close it with a little more force.

Radiator

Vehicles with a diesel engine: do not cover the radiator. Do not use thermal mats, insect

protection covers or anything similar. Doing so can cause the Onboard Diagnostics System to display inaccurate values. Some of these values are legally required and must always be correct.

Engine oil

General notes on oil level

Depending on your driving style, the vehicle consumes up to 0.8 l of oil per 1,000 km. The oil consumption may be higher than this when the vehicle is new or if you frequently drive at high engine speeds.

Depending on the engine, the oil dipstick may be installed at a different location.

When checking the oil level:

- park the vehicle on a level surface.
- the engine should be switched off for approximately five minutes if the engine is at normal operating temperature.
- if the engine is not at normal operating temperature, e.g. if the engine was only started briefly, wait about 30 minutes before carrying out the measurement.

Checking the oil level using the oil dipstick

WARNING

Certain components in the engine compartment could be very hot, e.g. the engine, the radiator and parts of the exhaust system. There is a risk of injury when accessing the engine compartment.

As far as possible, allow the engine to cool down and only touch the following components.

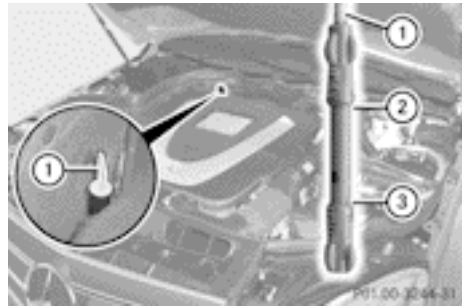

Example: vehicles with a petrol engine

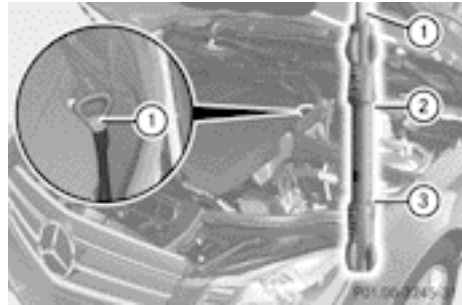

Example: vehicles with a diesel engine

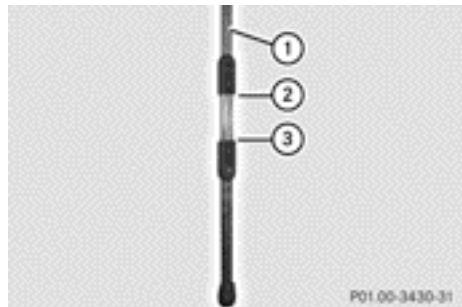

Example: AMG vehicles

- ▶ Park the vehicle on a level surface.
 - To check the oil level with the engine at normal operating temperature, switch the engine off and wait for approximately five minutes.
- ▶ Pull oil dipstick ① out of the oil dipstick tube.
- ▶ Wipe off oil dipstick ①.

- ▶ Slowly slide oil dipstick ① into the guide tube to the stop, and take it out again. If the level is between MIN mark ③ and MAX mark ②, the oil level is correct.
- ▶ If the oil level has dropped to MIN mark ③ or below, top up with 1.0 l of engine oil.

Adding engine oil

WARNING

Certain components in the engine compartment could be very hot, e.g. the engine, the radiator and parts of the exhaust system. There is a risk of injury when accessing the engine compartment.

As far as possible, allow the engine to cool down and only touch the following components.

WARNING

If engine oil comes into contact with hot components in the engine compartment, it may ignite. There is a risk of fire and injury.

Make sure that engine oil does not spill out over the filler neck. Allow the engine to cool down and thoroughly clean the components that have come into contact with engine oil before you start the engine.

Environmental note

When topping up the oil, take care not to spill any. If oil enters the soil or waterways, it is harmful to the environment.

- ❗ Only use engine oils and oil filters that have been approved for vehicles with a service system. You can obtain a list of the engine oils and oil filters tested and approved in accordance with the Mercedes-Benz Specifications for Service Products at any Mercedes-Benz Service Centre.

Damage to the engine or exhaust system is caused by the following:

- using engine oils and oil filters that have not been specifically approved for the service system
- changing the engine oil and oil filter after missing the change interval required by the service system
- using engine oil additives

- ❗ Do not add too much oil. If the oil level is above the "max" mark on the dipstick, too much oil has been added. This can lead to damage to the engine or the catalytic converter. Have excess oil siphoned off.



Example: engine oil filler cap

- ▶ Turn cap ① anti-clockwise and remove it.
- ▶ Top up the engine oil. If the oil level is at or below the MIN mark on the oil dipstick, top up with 1.0 l of engine oil.
- ▶ Replace cap ① on the filler neck and turn clockwise. Make sure that the cap locks securely into place.
- ▶ Check the oil level again with the oil dipstick (▷ page 316).

For further information on engine oil; see (▷ page 376).

Checking and adding other service products

Checking the coolant level

WARNING

Certain components in the engine compartment could be very hot, e.g. the engine, the radiator and parts of the exhaust system. There is a risk of injury when accessing the engine compartment.

As far as possible, allow the engine to cool down and only touch the following components.

WARNING

The engine cooling system is under pressure, particularly if the engine is warm. You could be scalded by hot coolant spraying out when opening the cap. There is a danger of injury. Allow the engine to cool before opening the cap. Wear gloves and protective eyewear when opening. Slowly turn the cap half a turn to allow pressure to escape.

Only check the coolant level if the vehicle is on a level surface and the engine has cooled down.

- ▶ Turn the key to position **2** in the ignition lock (▷ page 149).
On vehicles with KEYLESS-GO, press the Start/Stop button (▷ page 149) twice.
- ▶ Check the coolant temperature display in the instrument cluster.
The coolant temperature must be below 70 °C.



- ▶ Slowly turn cap **①** half a turn anti-clockwise and allow excess pressure to escape.
- ▶ Turn cap **①** further anti-clockwise and remove it.
If the coolant is at the level of marker bar **③** in the filler neck when cold, there is enough coolant in coolant expansion tank **②**.
If the coolant level is approximately 1.5 cm above marker bar **③** in the filler neck when warm, there is enough coolant in coolant expansion tank **②**.
- ▶ If necessary, top up with coolant that has been tested and approved by Mercedes-Benz.
- ▶ Replace cap **①** and turn it clockwise as far as it will go.

For further information on coolant, see (▷ page 378).

Topping up the windscreen washer system/headlamp cleaning system

WARNING

Certain components in the engine compartment could be very hot, e.g. the engine, the radiator and parts of the exhaust system. There is a risk of injury when accessing the engine compartment.

As far as possible, allow the engine to cool down and only touch the following components.

WARNING

Windscreen washer concentrate is highly flammable. If it comes into contact with hot engine components or the exhaust system it could ignite. There is a risk of fire and injury. Make sure that no windscreen washer concentrate is spilled next to the filler neck.

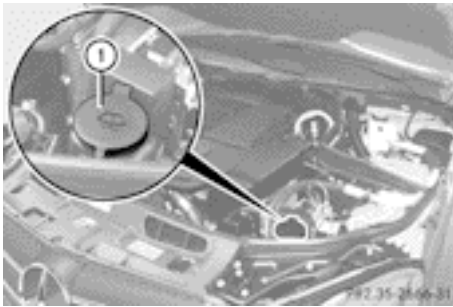

- ▶ **To open:** pull cap ① upwards by the tab.
- ▶ Top up with the premixed washer fluid.
- ▶ **To close:** press cap ① onto the filler neck until it engages.

The washer fluid reservoir is used for both the windscreen washer system and the headlamp cleaning system.

If the washer fluid level drops below the recommended minimum of 1 litre, a message appears in the multifunction display prompting you to top up the washer fluid (> page 275) (vehicles with 4-button multifunction steering wheel) or (> page 278) (vehicles with 12-button multifunction steering wheel).

Further information on windscreen washer fluid/antifreeze (> page 379).

Care

General Notes

- ❗ For cleaning your vehicle, do not use any of the following:
 - dry, rough or hard cloths
 - abrasive cleaning agents
 - solvents
 - cleaning agents containing solvents
- Do not scrub.
- Do not touch the surfaces or protective films with hard objects, e.g. a ring or ice scraper. You could otherwise scratch or damage the surfaces and protective film.

Environmental note

Dispose of empty packaging and cleaning cloths in an environmentally responsible manner.

- ❗ Do not park up the vehicle for an extended period straight after cleaning it, particularly after having cleaned the wheels with wheel cleaner. Wheel cleaners could cause increased corrosion of the brake discs and brake pads/linings. For this reason, you should drive for a few minutes after cleaning. Braking heats the brake discs and the brake pads/linings, thus drying them. The vehicle can then be parked up.

Regular care of your vehicle is a condition for retaining the quality in the long term.

Use care products and cleaning agents recommended and approved by Mercedes-Benz.

Care of the exterior

Automatic car wash

WARNING

Braking efficiency is reduced after the vehicle has been washed. There is a risk of an accident.

After washing the vehicle, brake carefully while paying attention to the traffic conditions in order to restore full braking efficiency.

- ❗ If DISTRONIC PLUS or the HOLD function is activated, the vehicle brakes automatically in certain situations. To prevent damage to the vehicle, deactivate DISTRONIC PLUS and the HOLD function in the following or other similar situations:
 - when towing the vehicle
 - in the car wash
- ❗ Make sure that the automatic transmission is in position **N** when washing your vehicle in a tow-through car wash. The vehicle could be damaged if the transmission is in another position.

! Make sure that:

- the side windows and sliding sunroof are closed completely.
- the blower for the ventilation/heating is switched off (OFF button is depressed).
- the windscreen wiper switch is at position **0**.

The vehicle could otherwise be damaged.

You can wash the vehicle in an automatic car wash from the very start.

Wash off excess dirt before cleaning the vehicle in an automatic car wash.

After using an automatic car wash, wipe off wax from the windscreen and the wiper blades. This will prevent smears and reduce wiping noises caused by residue on the windscreen.

Washing by hand

In some countries, washing by hand is only allowed at specially equipped washing bays. Observe the legal requirements for each individual country.

- ▶ Do not use hot water and do not wash the vehicle in direct sunlight.
- ▶ Use a soft sponge to clean.
- ▶ Use a mild cleaning agent, such as a car shampoo approved by Mercedes-Benz.
- ▶ Thoroughly hose down the vehicle with a gentle jet of water.
- ▶ Do not point the water jet directly towards the air inlet.
- ▶ Use plenty of water and rinse out the sponge frequently.
- ▶ Rinse the vehicle with clean water and dry thoroughly with a chamois.
- ▶ Do not let the cleaning agent dry on the paintwork.

When using the vehicle in winter, remove all traces of road salt deposits carefully and as soon as possible.

High-pressure cleaning equipment

WARNING

The water jet of circular-jet nozzles (dirt grinders) can cause damage not visible from the outside to tyres or chassis components. Components damaged in this way can unexpectedly fail. There is a risk of an accident.

Do not use high-pressure cleaners with circular-jet nozzles to clean the vehicle. Have damaged tyres or chassis components replaced immediately.

! Always maintain a distance of at least 30 cm between the vehicle and the high-pressure cleaner nozzle. Information about the correct distance is available from the equipment manufacturer.

Move the high-pressure cleaner nozzle around when cleaning your vehicle.

Do not aim directly at any of the following:

- tyres
- door gaps, roof gaps, joints etc.
- electrical components
- battery
- connectors
- lights
- seals
- trim elements
- ventilation slots

Damaged seals or electrical components can lead to leaks or failures.

Cleaning the wheels

! Do not use acidic wheel cleaning products to remove brake dust. This could damage wheel bolts and brake components.

! Do not park up the vehicle for an extended period straight after cleaning it, particularly after having cleaned the wheels with wheel cleaner. Wheel cleaners could cause increased corrosion of the brake discs and brake pads/linings. For this reason, you should drive for a few minutes after clean-

ing. Braking heats the brake discs and the brake pads/linings, thus drying them. The vehicle can then be parked up.

Cleaning the paintwork

Scratches, corrosive deposits, areas affected by corrosion and damage caused by inadequate care cannot always be completely repaired. In such cases, visit a qualified specialist workshop.

- ▶ Remove impurities immediately, where possible, whilst avoiding rubbing too hard.
- ▶ Soak insect remains with insect remover and rinse off the treated areas afterwards.
- ▶ Soak bird droppings with water and rinse off the treated areas afterwards.
- ▶ Remove coolant, brake fluid, tree resin, oils, fuels and greases by rubbing gently with a cloth soaked in petroleum ether or lighter fluid.
- ▶ Use tar remover to remove tar stains.
- ▶ Use silicone remover to remove wax.

! Do not affix:

- stickers
 - films
 - magnetic plates or similar items
- to painted surfaces. You could otherwise damage the paintwork.

Care and treatment of matt paintwork

If your vehicle has a clear matt finish, observe the following instructions in order to avoid damage to the paintwork due to incorrect care.

These notes also apply to light-alloy wheels with a clear matt finish.

! Never polish the vehicle or the light alloy wheels. Polishing makes the paintwork shiny.

! The following may cause the paint to become shiny and thus reduce the matt effect:

- Vigorous rubbing with unsuitable materials.
- Frequent use of car washes.
- Washing the vehicle in direct sunlight.

! Never use paint cleaner, buffing or polishing products, or gloss preserver, e.g. wax. These products are only suitable for high-gloss surfaces. Their use on vehicles with matt finish leads to considerable surface damage (shiny, spotted areas).

Always have paintwork repairs carried out at a qualified specialist workshop.

! Do not use wash programs with a hot wax treatment under any circumstances.

i The vehicle should preferably be washed by hand using a soft sponge, car shampoo and plenty of water.

i Use only insect remover and car shampoo from the range of recommended and approved Mercedes-Benz care products.

Cleaning the windows

WARNING

If the windscreen wipers are set in motion when cleaning the windscreen or wiper blades, you could become trapped. There is a danger of injury.

Always switch off the windscreen wipers and the ignition before cleaning the windscreen or wiper blades.

! Only fold the windscreen wipers away from the windscreen when vertical. Otherwise, you will damage the bonnet.

! Do not use dry cloths, abrasive products, solvents or cleaning agents containing solvents to clean the inside of the windows. Do not touch the insides of the windows with hard objects, e.g. an ice scraper or

ring. There is otherwise a risk of damaging the windows.

- ❗ Clean the water drainage channels of the windscreen and the rear window at regular intervals. Deposits such as leaves, petals and pollen may under certain circumstances prevent water from draining away. This can lead to corrosion damage and damage to electronic components.
- ▶ Clean the inside and outside of the windows with a damp cloth and a cleaning agent that is recommended and approved by Mercedes-Benz.

Cleaning the wiper blades

WARNING

If the windscreen wipers are set in motion when cleaning the windscreen or wiper blades, you could become trapped. There is a danger of injury.

Always switch off the windscreen wipers and the ignition before cleaning the windscreen or wiper blades.

- ❗ Only fold the windscreen wipers away from the windscreen when vertical. Otherwise, you will damage the bonnet.
- ❗ Do not pull on the wiper blade. Otherwise, the wiper blade could be damaged.
- ❗ Do not clean wiper blades too often and do not rub them too hard. Otherwise, the graphite coating could be damaged. This could cause wiper noise.
- ❗ Hold the wiper arm securely when folding back. The windscreen could be damaged if the wiper arm hits against it suddenly.
- ▶ Fold the wiper arms away from the windscreen.
- ▶ Clean the wiper blades carefully using a damp cloth.
- ▶ Fold the windscreen wipers back again before switching on the ignition.

Cleaning the exterior lighting

- ❗ Only use cleaning agents or cleaning cloths that are suitable for plastic lenses. Unsuitable cleaning agents or cleaning cloths could scratch or damage the plastic lenses of the exterior lighting.
- ▶ Clean the plastic lenses of the exterior lighting using a wet sponge and a mild cleaning agent, e.g. Mercedes-Benz car shampoo. Or clean the exterior lighting with cleaning cloths.

Cleaning the mirror turn signal

- ❗ Only use cleaning agents or cleaning cloths that are suitable for plastic lenses. Unsuitable cleaning agents or cleaning cloths could scratch or damage the plastic lenses of the mirror turn signals.
- ▶ Clean the plastic lenses of the mirror turn signals using a wet sponge and a mild cleaning agent, e.g. Mercedes-Benz car shampoo. Cleaning cloths may be used as well.

Cleaning the sensors

- ❗ If you clean the sensors with a high-pressure cleaner, make sure that you keep a distance of at least 30 cm between the vehicle and the high-pressure cleaner nozzle. Information about the correct distance is available from the equipment manufacturer.

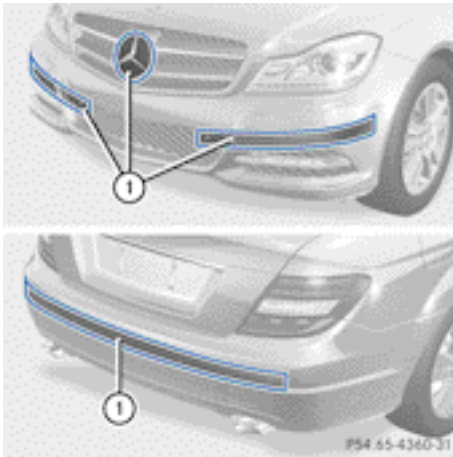

- ▶ Clean sensors ① of the driving systems with water, car shampoo and a soft cloth.

Cleaning the reversing camera

- ❗ Do not clean the camera lens and the area around the reversing camera with a high-pressure cleaner.

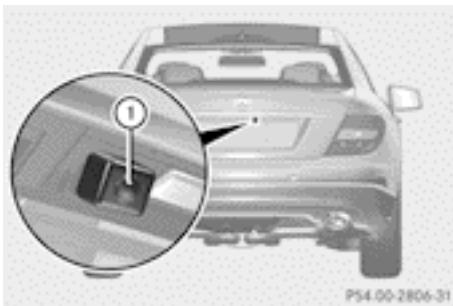

- ▶ Use clear water and a soft cloth to clean camera lens ①.

Cleaning the exhaust tail pipes

- ❗ Do not clean the exhaust pipe with acid-based cleaning agents such as sanitary cleansers or wheel cleaners.

Impurities combined with the effects of road grit and corrosive environmental factors may cause flash rust to form on the surface. You can restore the original shine of the exhaust

tail pipe by cleaning it regularly, especially in winter and after washing.

- ▶ Clean the exhaust tail pipes with a chrome care product tested and approved by Mercedes-Benz.

Cleaning the trailer tow hitch

ⓘ Environmental note

Dispose of oily and greasy cloths in an environmentally-responsible manner.

- ❗ Do not clean the ball coupling with a high-pressure cleaner. Do not use solvents.

- ❗ Observe the note on care provided by the trailer manufacturer.

The ball coupling must be cleaned if it becomes dirty or corroded.

- ▶ Remove rust, e.g. with a wire brush.
- ▶ Remove dirt with a clean, lint-free cloth or a brush.



- ▶ After cleaning, lightly oil or grease ball coupling ①.
- ▶ Check that the vehicle's trailer tow hitch is working properly.

- ⓘ You can also have the maintenance work on the ball coupling and the trailer tow hitch carried out by a qualified specialist workshop.

Interior care

Cleaning the display

! For cleaning, do not use any of the following:

- alcohol-based thinner or petrol
- abrasive cleaning agents
- commercially-available household cleaning agents

These may damage the display surface. Do not put pressure on the display surface when cleaning. This could lead to irreparable damage to the display.

- ▶ Before cleaning the display, make sure that it is switched off and has cooled down.
- ▶ Clean the display surface using a commercially available microfibre cloth and TFT/LCD display cleaner.
- ▶ Dry the display surface using a dry microfibre cloth.

Cleaning the plastic trim

WARNING

Care products and cleaning agents containing solvents can cause surfaces in the cockpit to become porous. This could result in plastic parts breaking away when the airbags are deployed. There is a danger of injury.

Do not use care products and cleaning agents containing solvents to clean the cockpit.

! Do not affix the following to plastic surfaces:

- stickers
- films
- scented oil bottles or similar items

You could otherwise damage the plastic.

! Do not allow cosmetics, insect repellent or sunscreen to come in contact with the plastic trim. This maintains the high-quality look of the surfaces.

▶ Wipe the plastic trim with a damp, lint-free cloth, e.g. a microfibre cloth.

▶ **Heavy soiling:** use car care and cleaning products recommended and approved by Mercedes-Benz.

The surface may change colour temporarily. Wait until the surface is dry again.

Cleaning the steering wheel and gear or selector lever

▶ Thoroughly wipe with a damp cloth or use leather care agents that have been recommended and approved by Mercedes-Benz.

Cleaning wooden trim and trim elements

! Do not use solvent-based cleaning agents such as tar remover, wheel cleaners, polishes or waxes. There is otherwise a risk of damaging the surface.

▶ Wipe the wooden trim and trim elements with a damp, lint-free cloth, e.g. a microfibre cloth.

▶ **Heavy soiling:** use car care and cleaning products recommended and approved by Mercedes-Benz.

Cleaning the seat covers

General notes

! Do not use microfibre cloths to clean genuine leather, artificial leather or Alcantara® covers. If used often, these can damage the cover.

i Note that regular care is essential to make sure that the appearance and comfort of the covers are retained over time.

Genuine leather seat covers

Leather is a natural product.

It has natural surface properties, e.g.:

- unevenness in structure
- marks caused by growth and injury
- subtle colour differences

These are characteristics of leather and not material faults.

- !** To retain the natural appearance of the leather, observe the following cleaning instructions:
- Clean genuine leather covers carefully with a damp cloth and then wipe the covers down with a dry cloth.
 - Make sure that the leather does not become soaked. It may otherwise become rough and cracked.
 - Only use leather care agents that have been tested and approved by Mercedes-Benz. You can obtain these from a qualified specialist workshop.

Seat covers from other materials

- !** Observe the following when cleaning:
- Clean artificial leather covers with a cloth moistened with a solution containing 1% detergent (e.g. washing-up liquid).
 - Clean cloth covers with a microfibre cloth moistened with a solution containing 1% detergent (e.g. washing-up liquid). Rub carefully, and always wipe entire seat sections to avoid leaving visible lines. Leave the seat to dry afterwards. Cleaning results depend on the type of dirt and how long it has been there.
 - Clean Alcantara® covers with a damp cloth. Make sure that you wipe entire seat sections to avoid leaving visible lines.

Cleaning the seat belts

WARNING

Seat belts may be severely weakened if bleached or coloured. This may lead to the seat belts, for example, tearing or failing in an accident. There is an increased risk of injury, possibly even fatal.

Never bleach or colour seat belts.

- !** Do not clean the seat belts using chemical cleaning agents. Do not dry the seat belts

at temperatures above 80 °C or in direct sunlight.

- Use clean, lukewarm water and soap solution.

Cleaning the roof lining and carpets

- **Roof lining:** if it is very dirty, use a soft brush or a cleaning agent recommended and approved by Mercedes-Benz.
- **Carpets:** use the carpet and textile cleaning agents recommended and approved by Mercedes-Benz.

Useful information	328
Where will I find...?	328
Flat tyre	330
Battery (vehicle)	334
Jump-starting	338
Towing and tow-starting	340
Electrical fuses	343

Useful information

- i** This Owner's Manual describes all models, series and optional equipment for your vehicle that were available at the time of going to press. National variations are possible. Note that your vehicle may not be equipped with all of the functions described. This is also the case for systems and functions relevant to safety.
- i** Read the information on qualified specialist workshops: (▷ page 28).

Where will I find...?

Warning triangle

Removing the warning triangle

The warning triangle is secured on the inside of the boot lid.

- ▶ Open the boot lid.

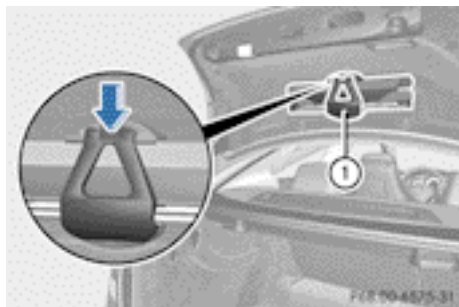

- ▶ Press warning triangle holder ① up in the direction of the arrow, open it and remove the warning triangle.

Setting up the warning triangle

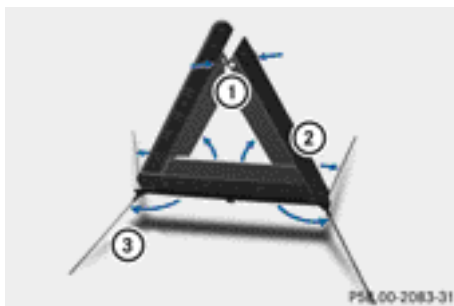

- ▶ Fold feet ③ down and out to the side.
- ▶ Fold side reflectors ② upwards to form a triangle and lock them at the top using press stud ①.

First-aid kit

Depending on the vehicle's equipment, the first-aid kit is located either in an open storage space or behind the left-hand side trim panel.

- ▶ Open the boot lid.

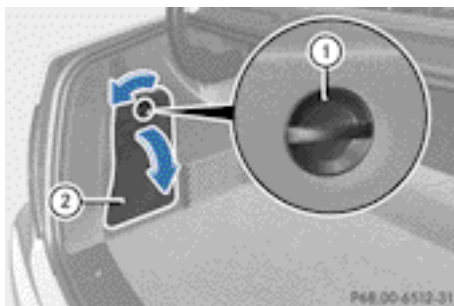

Example: first-aid kit behind the side trim panel

- ▶ **To open the cover:** turn rotary knob ① in the direction of the arrow and fold down cover ②.
- ▶ Remove the first-aid kit.

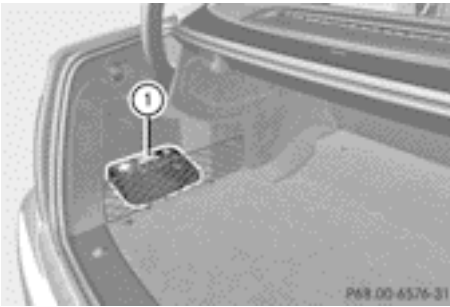

Example: first-aid kit in an open stowage compartment

► Remove first-aid kit ①.

i Check the expiry date on the first-aid kit at least once a year. Replace the contents if necessary, and replace any missing items.

Fire extinguisher

The fire extinguisher is located underneath the front of the driver's seat.

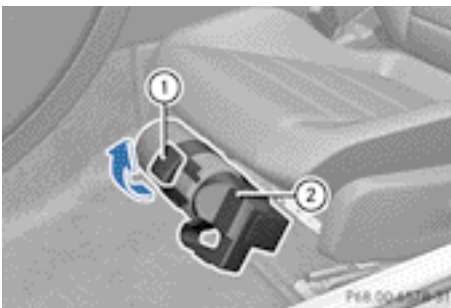

► Pull tab ① upwards.

► Remove fire extinguisher ②.

i Have the fire extinguisher refilled after each use and checked every one or two years. It may otherwise fail in an emergency.

Observe the legal requirements for each individual country.

Vehicle tool kit

The vehicle tool kit can be found in the stowage well under the boot floor.

i Apart from some country-specific variants, vehicles are not equipped with tyre-changing tools. Some tools for changing a wheel are specific to the vehicle. For more information on which tools are required to perform a wheel change on your vehicle, consult a qualified specialist workshop.

Necessary tyre-changing tools can include, for example:

- Jack
- Wheel chock
- Wheel wrench
- Ratchet ring spanner
- Centring pin

► **Vehicles with a TIREFIT kit:** lift up the boot floor (► page 298).

► Use the TIREFIT kit (► page 331).

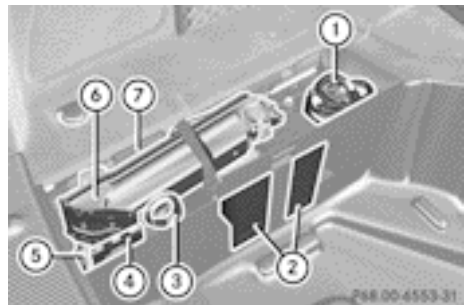

① Tyre sealant filler bottle

② Tyre inflation compressor

③ Towing eye

④ Folding wheel chock

⑤ Wheel wrench

⑥ Jack

⑦ One pair of gloves (behind jack)

► **Vehicles with a spare wheel/"Minispare" emergency spare wheel:** lift up the boot floor (► page 298).

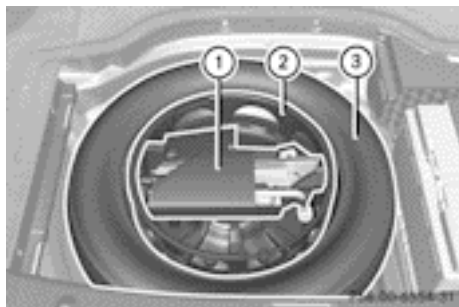

- ① Vehicle tool kit tray
- ② Stowage tray
- ③ Spare wheel/"Minispare" emergency spare wheel

The vehicle tool kit contains:

- Foldable wheel chock
- Fuse allocation chart
- Jack
- One pair of gloves
- Wheel wrench
- Towing eye

Flat tyre

Preparing the vehicle

Your vehicle may be equipped with:

- MOExtended tyres (tyres with run-flat characteristics) (▷ page 330)
Vehicle preparation is not necessary on vehicles with MOExtended tyres.
- a TIREFIT kit (▷ page 329)
- an emergency spare wheel (only for certain countries) (▷ page 365)

Information on changing/fitting a wheel (▷ page 356).

- ▶ Stop the vehicle as far away as possible from traffic on solid, non-slippery and level ground.
- ▶ Switch on the hazard warning lamps.
- ▶ Secure the vehicle against rolling away (▷ page 169).

- ▶ If possible, bring the front wheels into the straight-ahead position.
- ▶ Switch off the engine.
- ▶ **Vehicles without KEYLESS-GO:** remove the key from the ignition lock.
- ▶ **Vehicles with KEYLESS-GO:** open the driver's door.
The on-board electronics have status **0**, which is the same as the key having been removed.
- ▶ **Vehicles with KEYLESS-GO:** remove the Start/Stop button from the ignition lock (▷ page 149).
- ▶ All occupants must get out of the vehicle. Make sure that they are not endangered as they do so.
- ▶ Make sure that no one is near the danger area while a wheel is being changed. Anyone who is not directly assisting in the wheel change should, for example, stand behind the barrier.
- ▶ Get out of the vehicle. Pay attention to traffic conditions when doing so.
- ▶ Close the driver's door.
- ▶ Place the warning triangle (▷ page 328) a suitable distance away. Observe legal requirements.

MOExtended tyres (tyres with run-flat characteristics)

General notes

With MOExtended tyres (tyres with run-flat characteristics), you can continue to drive your vehicle even if there is a total loss of pressure in one or more tyres. The affected tyre must not show any clearly visible damage.

MOExtended tyres may only be used in conjunction with an active tyre pressure loss warning system or tyre pressure monitoring system.

If the pressure loss warning message appears in the multifunction display:

• Vehicles with a 4-button multifunction steering wheel:

observe the instructions in the display messages (▷ page 270).

• Vehicles with a 12-button multifunction steering wheel:

observe the instructions in the display messages (▷ page 271).

- check the tyre for damage.
- if driving on, observe the following notes.

The maximum driving distance is approximately 80 km when the vehicle is partially laden and approximately 30 km when the vehicle is fully laden.

In addition to the vehicle load, the driving distance possible depends upon:

- speed
- road condition
- outside temperature

The driving distance possible in run-flat mode may be reduced by extreme driving conditions/manoeuvres, or it can be increased through a moderate style of driving.

The maximum permissible distance which can be driven in run-flat mode is counted from the moment the tyre pressure loss warning appears in the multifunction display.

You must not exceed a maximum speed of 80 km/h.

- i** When replacing one or all tyres, make sure that you use only:

- the tyre size specified for the vehicle and
- tyre(s) marked "MOExtended"

If a tyre has gone flat and cannot be replaced with an MOExtended tyre, a standard tyre may be used as a temporary measure. Make sure that you use the proper size and type (summer or winter tyre).

- i** Vehicles with MOExtended tyres are not equipped with a TIREFIT kit at the factory.

It is therefore recommended that you additionally equip your vehicle with a TIREFIT kit if you fit tyres that do not feature run-flat characteristics, e.g. winter tyres. A TIREFIT kit can be obtained from a qualified specialist workshop.

Important safety notes

WARNING

When driving in emergency mode, the driving characteristics deteriorate, e.g. when cornering, accelerating quickly and when braking. There is a risk of accident.

Do not exceed the stated maximum speed. Avoid abrupt steering and driving manoeuvres, and driving over obstacles (kerbs, pot-holes, off-road). This applies in particular to a laden vehicle.

Stop driving in emergency mode if:

- you hear banging noises.
- the vehicle starts to shake.
- you see smoke and smell rubber.
- ESP® is intervening constantly.
- there are tears in the sidewalls of the tyre.

After driving in emergency mode, have the wheel rims checked at a qualified specialist workshop with regard to their further use. The faulty tyre must be replaced.

TIREFIT kit

Important safety notes

TIREFIT is a tyre sealant.

You can use TIREFIT to seal punctures of up to 4 mm, particularly those in the tyre tread. You can use TIREFIT at outside temperatures down to -20 °C.

⚠ WARNING

In the following situations, the tyre sealant is unable to provide sufficient breakdown assistance, as it is unable to seal the tyre properly:

- there are cuts or punctures in the tyre larger than those mentioned above.
- the wheel rim is damaged.
- you have driven at very low tyre pressures or on a flat tyre.

There is a risk of an accident.

Do not drive any further. Contact a qualified specialist workshop.

⚠ WARNING

The tyre sealant is harmful and causes irritation. It must not come into contact with your skin, eyes or clothing or be swallowed. Do not inhale TIREFIT fumes. Keep tyre sealant away from children. There is a risk of injury.

If you come into contact with the tyre sealant, observe the following:

- Rinse off the tyre sealant from your skin immediately with water.
- If the tyre sealant comes into contact with your eyes, immediately rinse them thoroughly with clean water.
- If tyre sealant is swallowed, immediately rinse your mouth out thoroughly and drink plenty of water. Do not induce vomiting, and seek medical attention immediately.
- Immediately change out of clothing which has come into contact with tyre sealant.
- If an allergic reaction occurs, seek medical attention immediately.

- !** Do not operate the tyre inflation compressor for longer than eight minutes at a time without a break. It may otherwise overheat.

The tyre inflation compressor can be operated again once it has cooled down.

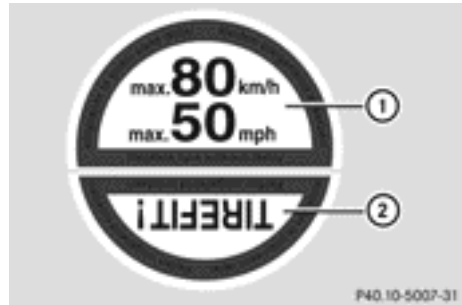
Using the TIREFIT kit

TIREFIT sticker, 2-part

- ▶ Do not remove any foreign objects which have penetrated the tyre, e.g. screws or nails.
- ▶ Remove the tyre sealant bottle, the accompanying "max. 80 km/h" sticker and the tyre inflation compressor from the stowage well underneath the boot floor (▷ page 329).
- ▶ Affix part ① of the sticker within the driver's field of vision.
- ▶ Affix part ② of the sticker near the valve on the wheel with the defective tyre.

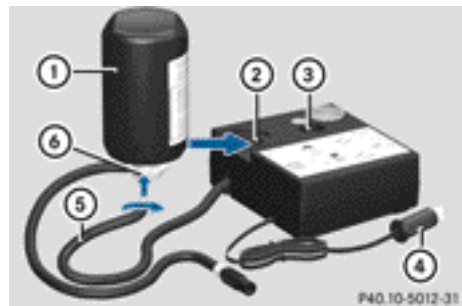

- ▶ Pull plug ④ with the cable and hose ⑤ out of the housing.
- ▶ Screw hose ⑤ onto flange ⑥ of tyre sealant bottle ①.
- ▶ Place tyre sealant bottle ① head downwards into recess ② of the tyre inflation compressor.

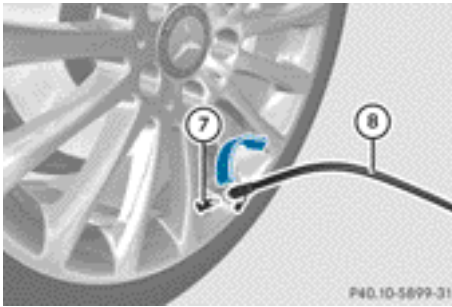

- ▶ Remove the cap from valve ⑦ on the faulty tyre.
- ▶ Screw filler hose ⑧ onto valve ⑦.
- ▶ Insert plug ④ into the cigarette lighter socket (▷ page 301) or into a 12 V socket (▷ page 302) in your vehicle.
- ▶ Turn the key to position 1 (▷ page 149) in the ignition lock.
- ▶ Press on/off switch ③ on the tyre inflation compressor to I. The tyre inflation compressor is switched on. The tyre is inflated.

i First, tyre sealant is pumped into the tyre. The pressure can briefly rise to approximately 500 kPa (5 bar/73 psi).

Do not switch off the tyre inflation compressor during this phase.

- ▶ Let the tyre inflation compressor run for five minutes. The tyre should then have attained a pressure of at least 180 kPa (1.8 bar/26 psi).

If a pressure of 180 kPa (1.8 bar/26 psi) has been attained after five minutes, see (▷ page 333).

If a pressure of 180 kPa (1.8 bar/26 psi) has not been attained after five minutes, see (▷ page 333).

- i** If the tyre sealant leaks out, allow it to dry. It can then be removed like a layer of film. If you get tyre sealant on your clothing, have it cleaned as soon as possible with perchloroethylene.

Tyre pressure not reached

If a pressure of 180 kPa (1.8 bar/26 psi) has not been achieved after five minutes:

- ▶ Switch off the tyre inflation compressor.
- ▶ Unscrew the filler hose from the valve of the faulty tyre.
- ▶ Very slowly drive forwards or reverse approximately 10 m.
- ▶ Pump up the tyre again.
 - After a maximum of five minutes the tyre pressure must be at least 180 kPa (1.8 bar/26 psi).

⚠ WARNING

If the required tyre pressure is not reached after the specified time, the tyre is too badly damaged. The tyre sealant cannot repair the tyre in this instance. Damaged tyres and a tyre pressure that is too low can significantly impair the vehicle's braking and driving characteristics. There is a risk of accident.

Do not continue driving. Contact a qualified specialist workshop.

Tyre pressure reached

- ▶ Switch off the tyre inflation compressor.
- ▶ Unscrew the filler hose from the valve of the faulty tyre.
- !** After use, excess tyre sealant may run out of the filler hose. This could cause stains. Therefore, place the filler hose in the plastic bag that contained the TIREFIT kit.
- ▶ Stow the tyre sealant bottle, the tyre inflation compressor and the warning triangle.
- ▶ **Pull away immediately.**

⚠ WARNING

A tyre temporarily sealed with tyre sealant impairs the driving characteristics and is not suitable for higher speeds. There is a risk of accident.

You should therefore adapt your driving style accordingly and drive carefully. Do not exceed

the specified maximum speed with a tyre that has been repaired using tyre sealant.

The maximum speed for a tyre sealed with tyre sealant is 80 km/h. The "max. 80 km/h" sticker must be affixed to the instrument cluster within the driver's field of vision.

- ▶ Stop after driving for approximately ten minutes and check the tyre pressure with the tyre inflation compressor. The tyre pressure must now be at least 130 kPa (1.3 bar/19 psi).

WARNING

If the required tyre pressure is not reached after driving for a short period, the tyre is too badly damaged. The tyre sealant cannot repair the tyre in this instance. Damaged tyres and a tyre pressure that is too low can significantly impair the vehicle's braking and driving characteristics. There is a risk of accident.

Do not continue driving. Contact a qualified specialist workshop.

- i** In your vehicle, you will find a sticker with the Mercedes-Benz Service24h telephone number, e.g. on the B-pillar on the driver's side.

- ▶ Correct the tyre pressure if it is still at least 130 kPa (1.3 bar/19 psi) (see the fuel filler flap for values).
- ▶ **To increase the tyre pressure:** switch on the tyre inflation compressor.

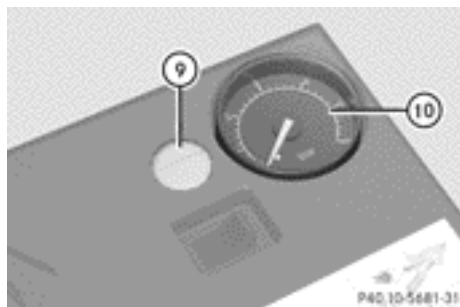

- ▶ **To reduce the tyre pressure:** depress pressure release button (9) next to pressure gauge (10).

- ▶ Stow the tyre sealant bottle, the tyre inflation compressor and the warning triangle.
- ▶ Drive to the nearest qualified specialist workshop and have the tyre changed there.
- ▶ Have the tyre sealant bottle replaced as soon as possible at a qualified specialist workshop.

Environmental note

Have the used tyre sealant bottle disposed of professionally, e.g. at a qualified specialist workshop.

- ▶ Have the tyre sealant bottle replaced every four years at a qualified specialist workshop.

Battery (vehicle)

Important safety notes

Work on the battery, e.g. removing or fitting, requires specialist knowledge and the use of special tools. Therefore, always have work on the battery carried out at a qualified specialist workshop.

WARNING

Work carried out incorrectly on the battery may lead to a malfunction, e.g. a short circuit. This, in turn, may restrict the functions of the safety-relevant systems, e.g. the lighting system, ABS (Anti-lock Braking System) or ESP® (Electronic Stability Program). The operating safety of your vehicle may then be compromised. You could then lose control of the vehicle, e.g.:

- when braking
- when making sudden steering movements and/or travelling at an inappropriate speed.

There is a risk of an accident.

In the event of a short circuit or similar situation, inform a qualified specialist workshop immediately. Do not drive any further. You should have all work involving the battery carried out at a qualified specialist workshop.

For further information about ABS (▷ page 71) and ESP® (▷ page 73).

WARNING

Electrostatic build-up can lead to the creation of sparks, which could ignite the highly explosive gases of a battery. There is a risk of an explosion.

Before handling the battery, touch the vehicle body to remove any existing electrostatic build-up.

The highly flammable gas mixture is created while the battery is charging and when jump-starting.

Always make sure that neither you nor the battery is electrostatically charged. Electrostatic charge is created, for example:

- by wearing synthetic fibre clothing
- due to friction between clothing and the seat
- when you pull or push the battery across carpet or other synthetic materials
- when you rub the battery with a cloth

WARNING

Battery acid is caustic. There is a risk of injury. Avoid contact with the skin, eyes or clothing. Do not inhale any battery gases. Do not lean over the battery. Keep children away from batteries. Wash battery acid immediately with water and seek medical attention.

WARNING

During the charging process, a battery produces hydrogen gas. If a short circuit occurs or sparks are created, the hydrogen gas can ignite. There is a risk of an explosion.

- Make sure that the positive terminal of a connected battery does not come into contact with vehicle parts.
- Never place metal objects or tools on a battery.
- It is important that you observe the described order of the battery terminals when connecting and disconnecting a battery.
- When jump-starting, make sure that the battery poles with identical polarity are connected.
- It is particularly important to observe the described order when connecting and disconnecting the jump leads.
- Never connect or disconnect the battery terminals while the engine is running.

WARNING

During charging and jump-starting, explosive gases can escape from the battery. There is a risk of an explosion.

Particularly avoid fire, naked flames, creating sparks and smoking. Ensure there is sufficient ventilation while charging and jump-starting. Do not lean over a battery.

Environmental note



Batteries contain pollutants. It is illegal to dispose of them with the household rubbish. They must be collected separately and disposed of in an environmentally responsible recycling system.



Dispose of batteries in an environmentally responsible manner. Take discharged batteries to a qualified specialist workshop or to a collection point for used batteries.

- ❗ Have the battery checked regularly at a qualified specialist workshop.

Observe the service intervals in the Service Booklet or contact a qualified specialist workshop for more information.

! You should have all work involving the battery carried out at a qualified specialist workshop. In the exceptional case that it is necessary for you to disconnect the battery yourself, make sure that:

- you switch off the engine and remove the key. On vehicles with KEYLESS-GO, ensure that the ignition is switched off. Check that all the indicator lamps in the instrument cluster are off. Otherwise, electronic components, such as the alternator, may be damaged.
- you first remove the negative terminal clamp and then the positive terminal clamp. Never swap the terminal clamps. Otherwise, the vehicle's electronic system may be damaged.
- in vehicles with automatic transmission, the transmission is locked in position **P** after disconnecting the battery. The vehicle is secured against rolling away. You can then no longer move the vehicle.

The battery and the cover of the positive terminal clamp must be fitted securely during operation.

Comply with safety precautions and take protective measures when handling batteries.



WARNING



Fire, naked flames and smoking are prohibited when handling the battery. Avoid creating sparks.



Battery acid is caustic. Avoid contact with the skin, eyes or clothing. Wear suitable protective clothing, in particular gloves, an apron and a face mask.

Immediately rinse acid splashes off with clean water. Consult a doctor if necessary.



Wear eye protection.



Keep children away.



Observe this Owner's Manual.

In order for the battery to achieve the maximum possible service life, it must always be sufficiently charged.

Have the battery charge checked more frequently if you use the vehicle mainly for short trips or if you leave it standing idle for a lengthy period. Consult a qualified specialist workshop if you wish to leave your vehicle parked up for a long period of time.

Like other batteries, the vehicle battery may discharge over time if you do not use the vehicle. In such cases, have the battery disconnected at a qualified specialist workshop. You can also charge the battery with a charger recommended by Mercedes-Benz. For more information, please contact a qualified specialist workshop.

i When you park the vehicle, remove the key if you do not require any electrical consumers. The vehicle will then use very little energy, thus conserving battery power.

i If the power supply has been interrupted, e.g. if the battery was discharged, you will have to:

- set the clock; see the separate operating instructions.

On vehicles with COMAND Online and a navigation system, the clock is set automatically.

- reset the function for automatically folding the exterior mirrors in/out by folding the mirrors out once (▷ page 113)

Charging the battery

WARNING

During charging and jump-starting, explosive gases can escape from the battery. There is a risk of an explosion.

Particularly avoid fire, naked flames, creating sparks and smoking. Ensure there is sufficient ventilation while charging and jump-starting. Do not lean over a battery.

WARNING

Battery acid is caustic. There is a risk of injury. Avoid contact with the skin, eyes or clothing. Do not inhale any battery gases. Do not lean over the battery. Keep children away from batteries. Wash battery acid immediately with water and seek medical attention.

WARNING

A discharged battery can freeze at temperatures below freezing point. When jump-starting the vehicle or charging the battery, gases can escape from the battery. There is a risk of an explosion.

Allow the frozen battery to thaw out before charging it or jump-starting.

! Only charge the installed battery with a battery charger which has been tested and approved by Mercedes-Benz. These battery chargers allow the battery to be charged while still installed in the vehicle.

! Only use battery chargers with a maximum charging voltage of 14.8 V.

! Only charge the battery using the jump-start connection point.

The jump-starting connection point is in the engine compartment (▷ page 338).

- ▶ Open the bonnet.
- ▶ Connect the battery charger to the positive terminal and earth point in the same order as when connecting the donor battery in the jump-starting procedure (▷ page 338).

- ▶ Read the battery charger's operating instructions before charging the battery.

Jump-starting

For the jump-starting procedure, use only the jump-starting connection point, consisting of a positive terminal and an earth point, in the engine compartment.

WARNING

Battery acid is caustic. There is a risk of injury.

Avoid contact with the skin, eyes or clothing. Do not inhale any battery gases. Do not lean over the battery. Keep children away from batteries. Wash battery acid immediately with water and seek medical attention.

WARNING

During charging and jump-starting, explosive gases can escape from the battery. There is a risk of an explosion.

Particularly avoid fire, naked flames, creating sparks and smoking. Ensure there is sufficient ventilation while charging and jump-starting. Do not lean over a battery.

WARNING

During the charging process, a battery produces hydrogen gas. If a short circuit occurs or sparks are created, the hydrogen gas can ignite. There is a risk of an explosion.

- Make sure that the positive terminal of a connected battery does not come into contact with vehicle parts.
- Never place metal objects or tools on a battery.
- It is important that you observe the described order of the battery terminals when connecting and disconnecting a battery.
- When jump-starting, make sure that the battery poles with identical polarity are connected.
- It is particularly important to observe the described order when connecting and disconnecting the jump leads.
- Never connect or disconnect the battery terminals while the engine is running.

WARNING

Non-combusted fuel can collect in the exhaust system and ignite. There is a risk of fire. Avoid repeated and lengthy starting attempts.

! **Vehicles with a petrol engine:** avoid repeated and lengthy starting attempts. Otherwise, the non-combusted fuel may damage the catalytic converter.

Do not use a rapid charging device to start the vehicle. If your vehicle's battery is discharged, the engine can be jump-started from another vehicle or from a second battery using jump leads. Observe the following points:

- The battery is not accessible in all vehicles. If the other vehicle's battery is not accessible, jump-start the vehicle using a second battery or a jump-starting device.
- **Vehicles with a petrol engine:** only jump-start the vehicle when the engine and exhaust system are cold.
- Do not start the engine if the battery is frozen. Let the battery thaw first.
- Jump-starting may only be performed from batteries with a nominal voltage of 12 V.

- Only use jump leads that have a sufficient cross-section and insulated terminal clamps.
- If the battery is fully discharged, leave the battery that is being used to jump-start connected for a few minutes before attempting to start. This charges the empty battery a little.
- Make sure that the two vehicles do not touch.

Make sure that:

- the jump leads are not damaged.
 - bare parts of the terminal clamp do not come into contact with other metal parts while the jump leads are connected to the battery.
 - the jump leads cannot come into contact with parts such as the V-belt pulley or the fan. These parts move when the engine is started and while it is running.
- ▶ Firmly depress the parking brake.
- ▶ **Manual transmission:** depress the clutch pedal fully and shift to neutral.
- ▶ **Automatic transmission:** move the selector lever to **P**.
- ▶ Switch off all electrical consumers, e.g. rear window heating, lighting etc.
- ▶ Open the bonnet.

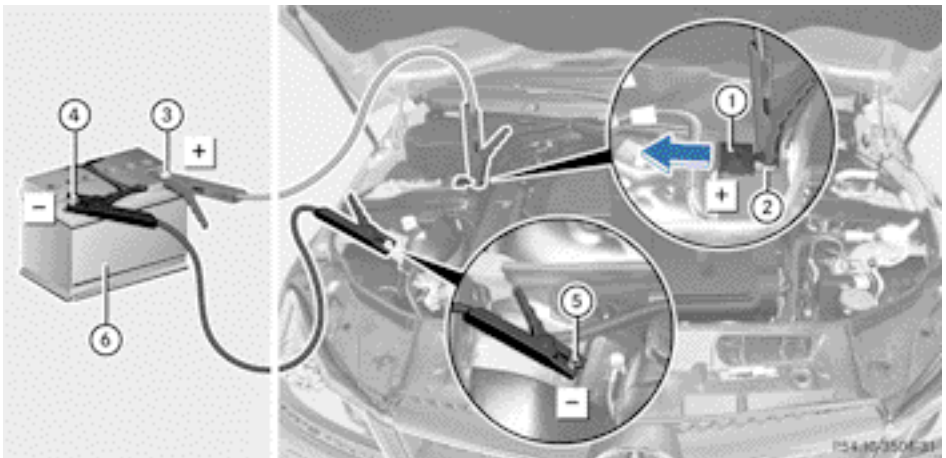

Position number ⑥ identifies the charged battery of the other vehicle or an equivalent jump-starting device.

- ▶ Slide cover ① of positive terminal ② in the direction of the arrow.
- ▶ Connect positive terminal ② on your vehicle to positive terminal ③ of donor battery ⑥ using the jump lead, beginning with your own battery.
- ▶ Start the engine of the donor vehicle and run it at idling speed.
- ▶ Connect negative terminal ④ of donor battery ⑥ to earth point ⑤ of your vehicle using the jump lead, connecting the jump lead to donor battery ⑥ first.
- ▶ Start the engine.
- ▶ Before disconnecting the jump leads, let the engines run for several minutes.

- ▶ First, remove the jump leads from earth point (5) and negative terminal (4), then from positive clamp (2) and positive terminal (3). Begin each time at the contacts on your own vehicle first.
 - ▶ Close cover (1) of positive clamp (2) after removing the jump leads.
 - ▶ Have the battery checked at a qualified specialist workshop.
- i** Jump-starting is not considered to be a normal operating condition.
- i** Jump-starting cables and further information regarding jump starting can be obtained at any qualified specialist workshop.

Towing and tow-starting

Important safety notes

Observe the legal requirements for the relevant countries when towing and tow-starting.

WARNING

If the steering wheel lock is engaged, the vehicle can no longer be steered. There is a risk of an accident.

Always switch on the ignition when towing with a tow rope or a towing bar.

WARNING

If the weight of the vehicle to be towed or tow-started is greater than the permissible gross weight of your vehicle:

- the towing eye could detach itself
- the vehicle/trailer combination could overturn.

There is a risk of an accident.

When towing or tow-starting another vehicle, its weight should not be greater than the permissible gross weight of your vehicle.

Information on your vehicle's gross vehicle weight rating can be found on the vehicle identification plate (▷ page 372).

! If DISTRONIC PLUS or the HOLD function is activated, the vehicle brakes automatically in certain situations. To prevent damage to the vehicle, deactivate DISTRONIC PLUS and the HOLD function in the following or other similar situations:

- when towing the vehicle
- in the car wash

! You may tow the vehicle for a maximum of 50km. A towing speed of 50 km/h must not be exceeded.

For towing distances over 50 km, the entire vehicle must be lifted up and transported.

! Only secure the tow rope or towing bar to the towing eyes. The vehicle may otherwise be damaged.

! Do not use the towing eyes for recovery purposes as this could damage the vehicle. If in doubt, recover the vehicle with a crane.

! Pull away smoothly when towing away or tow-starting a vehicle. If the tractive power is too high, the vehicles could be damaged.

! On vehicles with KEYLESS-GO, use the key instead of the Start/Stop button. Turn the key to position **2** in the ignition lock and shift the automatic transmission to **N**. Then, turn the key back to **0** and leave it in the ignition lock.

It is better to have the vehicle transported than to have it towed.

When towing a vehicle with an automatic transmission, the transmission must be in position **N**.

The battery must be connected and charged. Otherwise, you:

- cannot turn the key in the ignition lock to position **2**
- cannot shift the transmission to position **N** on vehicles with automatic transmission

Vehicles with automatic transmission:

release the selector lever lock manually to move it out of position **P** (▷ page 165).

- i** Deactivate the automatic locking feature (▷ page 90). You could otherwise be locked out when pushing or towing the vehicle. Deactivate tow-away protection (▷ page 79) before the vehicle is towed.

Fitting/removing the towing eye

Fitting the towing eye

⚠ WARNING

The exhaust tail pipe may be extremely hot. There is a risk of burning when removing the rear cover.

Do not touch the exhaust tail pipe. Use extreme caution when removing the rear cover.

Vehicles with a trailer tow hitch do not have a bracket for the screw-in towing eye at the back. If you intend to use the vehicle for towing, fold out the ball coupling (▷ page 211) and secure the towbar to it.

- ▶ Remove the towing eye from the vehicle tool kit (▷ page 329).

The brackets for the screw-in towing eyes are located in the bumpers. They are under the covers at the front and at the rear on vehicles without a trailer coupling. On vehicles with a trailer coupling, the bracket is at the front under the cover.

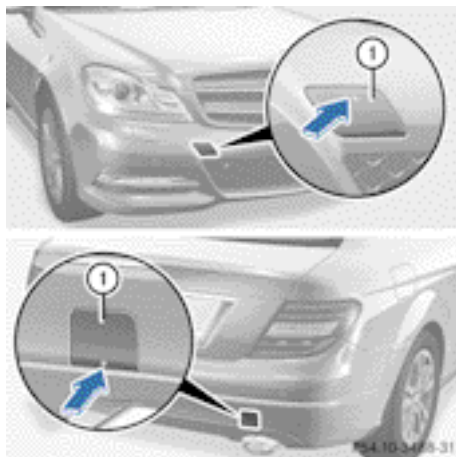

- ▶ Remove cover ① from the opening.
- ▶ Screw the towing eye in clockwise to the stop and tighten it.

Removing the towing eye

- ▶ Loosen the towing eye and unscrew it.
- ▶ Attach cover ① to the bumper and press until it engages.
- ▶ Place the towing eye in the vehicle tool kit.

Towing the vehicle with the rear axle raised

When towing your vehicle with the rear axle raised, it is important that you observe the safety instructions (▷ page 340).

- !** The ignition must be switched off if you are towing the vehicle with the rear axle raised. Intervention by ESP[®] could otherwise damage the brake system.
- ▶ Switch on the hazard warning lamps (▷ page 121).
- ▶ Turn the key in the ignition lock to position **0** and remove the key from the ignition lock.
- ▶ When leaving the vehicle, take the key or the KEYLESS-GO key with you.

Towing the vehicle with both axles on the ground

It is important that you observe the safety instructions when towing away your vehicle (▷ page 340).

- ▶ Switch on the hazard warning lamps (▷ page 121).
- ❗ When towing with the hazard warning lamps switched on, use the combination switch as usual to signal a change of direction. In this case, only the turn signals for the desired direction flash. When you reset the combination switch, the hazard warning lamps start flashing again.
- ▶ Turn the key to position **2** in the ignition lock.
- ▶ When the vehicle is stationary, depress the brake pedal and keep it depressed.
- ▶ **Vehicles with manual transmission:** depress the clutch pedal fully and shift to neutral.
- or
- ▶ **Vehicles with automatic transmission:** shift the automatic transmission to position **N**.
- ▶ Release the brake pedal.
- ▶ Release the parking brake.

Transporting the vehicle

The towing eyes or trailer tow hitch can be used to pull the vehicle onto a trailer or transporter if you wish to transport it.

- ▶ **Vehicles with manual transmission:** depress the clutch pedal fully and shift to neutral.
- ▶ **Vehicles with automatic transmission:** turn the key to position **2** in the ignition lock.
- ▶ Move the selector lever to **N**.

As soon as the vehicle is loaded:

- ▶ Prevent the vehicle from rolling away by applying the parking brake.
 - ▶ **Vehicles with manual transmission:** depress the clutch pedal fully and engage first or reverse gear.
 - ▶ **Vehicles with automatic transmission:** move the selector lever to **P**.
 - ▶ Turn the key in the ignition lock to position **0** and remove the key from the ignition lock.
 - ▶ Secure the vehicle.
- ❗ You may only secure the vehicle by the wheels, not by parts of the vehicle such as axle or steering components. Otherwise, the vehicle could be damaged.

Tow-starting (emergency engine starting)

When tow-starting, it is important that you observe the safety notes (▷ page 340) and the legal requirements in each respective country.

- ❗ Vehicles with automatic transmission must not be tow-started. The transmission may otherwise be damaged.

You can find information on "Jump-starting" under (▷ page 338).

Before tow-starting the following conditions must be fulfilled:

- the battery is connected.
- the engine has cooled down.
- the exhaust system has cooled down.
- ▶ Switch on the hazard warning lamps (▷ page 121).
- ▶ Fit the towing eye (▷ page 341).
- ▶ Secure the rigid towing bar or the towing rope.
- ▶ Depress and hold the brake pedal.
- ▶ Turn the key to position **2** in the ignition lock.

- ▶ Depress the clutch pedal fully, engage second gear and keep the clutch pedal fully depressed.
- ▶ Release the brake pedal.
- ▶ Tow-start the vehicle.
- ▶ Release the clutch pedal slowly; do not depress the accelerator pedal while doing so.
- ▶ When the engine starts, immediately depress the clutch pedal fully and shift to neutral.
- ▶ Stop at a suitable place, paying attention to road and traffic conditions.
- ▶ Depress the parking brake.
- ▶ Remove the rigid towing bar or towing rope.
- ▶ Remove the towing eye (▷ page 341).
- ▶ Switch off the hazard warning lamps.

Electrical fuses

Important safety notes

WARNING

If you manipulate, bridge or replace a faulty fuse with a fuse of a higher amperage, the electric cables could be overloaded. This may result in a fire. There is a risk of an accident and injury.

Always replace faulty fuses with specified new fuses of the correct amperage.

- ❗ Only use fuses that have been approved for Mercedes-Benz vehicles and which have the correct fuse rating for the system concerned. Otherwise, components or systems could be damaged.

The fuses in your vehicle serve to disconnect faulty circuits. If a fuse blows, all the components on the circuit and their functions will fail.

Blown fuses must be replaced with fuses of the same rating, which you can recognise by the colour and fuse rating. The fuse ratings are listed in the fuse allocation chart.

If the newly inserted fuse also blows, have the cause traced and rectified at a qualified specialist workshop, e.g. a Mercedes-Benz Service Centre.

Before replacing a fuse

- ▶ Secure the vehicle against rolling away (▷ page 169).
- ▶ Switch off all electrical consumers.
- ▶ Turn the key to position **0** in the ignition lock and remove it (▷ page 149).

or

- ▶ On vehicles with KEYLESS-GO, make sure the ignition is switched off (▷ page 149).

All indicator lamps in the instrument cluster must be off.

The fuses are located in various fuse boxes:

- fuse box in the engine compartment on the left-hand side of the vehicle, when viewed in the direction of travel
- fuse box in the boot on the right-hand side of the vehicle, when viewed in the direction of travel

The fuse allocation chart is located in the vehicle tool kit in the stowage compartment under the boot floor (▷ page 329).

Fuse box in the engine compartment

WARNING

When the bonnet is open, and the windscreen wipers are set in motion, you can be injured by the wiper linkage. There is a risk of injury. Always switch off the windscreen wipers and the ignition before opening the bonnet.

- ❗ Make sure that no moisture can enter the fuse box when the cover is open.

- ❗ When closing the cover, make sure that it is lying correctly on the fuse box. Moisture seeping in or dirt could otherwise impair the operation of the fuses.

- ▶ Make sure that the windscreen wipers are switched off.
- ▶ Open the bonnet.



- ▶ **To open:** release cover ① at the top and open it downwards in the direction of the arrow.

- ▶ Remove any existing moisture from the fuse box using a dry cloth.
- ▶ **To open:** take lines ② from the guides.
- ▶ Open clamps ①.
- ▶ Remove the fuse box cover forwards.
- ▶ **To close:** check whether the rubber seal is lying correctly in the cover.
- ▶ Insert the cover at the rear of the fuse box into the retainer.
- ▶ Fold down cover and close clamps ①.
- ▶ Secure lines ② in the guides.
- ▶ Close the bonnet.

Fuse box in the boot

- ❗ Make sure that no moisture can enter the fuse box when the cover is open.
- ❗ When closing the cover, make sure that it is lying correctly on the fuse box. Moisture seeping in or dirt could otherwise impair the operation of the fuses.
- ▶ Open the boot lid.

Useful information	346
Important safety notes	346
Operation	347
Winter operation	348
Tyre pressure	350
Changing a wheel	356
Fitting a wheel	357
Wheel and tyre combinations	361
Emergency spare wheel	365

Useful information

- i** This Owner's Manual describes all models, series and optional equipment for your vehicle that were available at the time of going to press. National variations are possible. Note that your vehicle may not be equipped with all of the functions described. This is also the case for systems and functions relevant to safety.
- i** Read the information on qualified specialist workshops: (▷ page 28).

Important safety notes

⚠ WARNING

If wheels and tyres of the wrong size are used, the wheel brakes or suspension components may be damaged. There is a risk of an accident.

Always replace wheels and tyres with those that fulfil the specifications of the original part.

When replacing wheels, make sure to fit the correct:

- designation
- type

When replacing tyres, make sure to fit the correct:

- designation
- manufacturer
- type

⚠ WARNING

A flat tyre severely impairs the driving, steering and braking characteristics of the vehicle. There is a risk of accident.

Tyres without run-flat characteristics:

- do not drive with a flat tyre.
- immediately replace the flat tyre with your emergency spare wheel or spare wheel, or consult a qualified specialist workshop.

Tyres with run-flat characteristics:

- pay attention to the information and warning notices on MOExtended tyres (tyres with run-flat characteristics).

Accessories that are not approved for your vehicle by Mercedes-Benz or that are not being used correctly can impair operating safety.

Before purchasing and using non-approved accessories, visit a qualified specialist workshop and enquire about:

- suitability
- legal stipulations
- factory recommendations

Information on the dimensions and types of wheels and tyres for your vehicle can be found in the "Wheel/tyre combinations" section (▷ page 361).

Information on air pressure for the tyres on your vehicle can be found:

- on the tyre pressure label on the fuel filler flap
- in the "Tyre pressure" section

Modification work on the brake system and wheels is not permitted, nor is the use of spacer plates or brake dust shields. This invalidates the general operating permit for the vehicle.

Modification work on the brake system and wheels is not permitted. The use of wheel spacers or brake dust shields is not permitted. This invalidates the general operating permit for the vehicle.

- i** Further information on wheels and tyres can be obtained at any qualified specialist workshop.

Operation

Information on driving

- Check the tyre pressures when the vehicle is heavily laden and, if necessary, adjust.
- While driving, pay attention to vibrations, noises and unusual handling characteristics, e.g. pulling to one side. This may indicate that the wheels or tyres are damaged. If you suspect that a tyre is defective, reduce your speed immediately. Stop the vehicle as soon as possible to check the wheels and tyres for damage. Hidden tyre damage could also be causing the unusual handling characteristics. If you find no signs of damage, have the tyres and wheels checked at a qualified specialist workshop.
- When parking your vehicle, make sure that the tyres do not get deformed by the kerb or other obstacles. If it is necessary to drive over kerbs, speed humps or similar elevations, try to do so at an obtuse angle. Otherwise, the tyres, particularly the sidewalls, can get damaged.

Regular checking of wheels and tyres

WARNING

Damaged tyres can cause tyre inflation pressure loss. As a result, you could lose control of your vehicle. There is a risk of accident.

Check the tyres regularly for signs of damage and replace any damaged tyres immediately.

- Regularly check the wheels and tyres of your vehicle for damage at least once a month, as well as after driving off-road or on rough roads. Damaged wheels can

cause a loss of tyre pressure. Pay particular attention to damage such as:

- cuts in the tyres
- punctures
- tears in the tyres
- bulges on tyres
- deformation or severe corrosion on wheels
- Regularly check the tyre tread depth and the condition of the tread across the whole width of the tyre (> page 347). If necessary, turn the front wheels to full lock in order to inspect the inner side of the tyre surface.
- All wheels must have a valve cap to protect the valve against dirt and moisture. Do not fit anything onto the valve other than the standard valve cap or other valve caps approved by Mercedes-Benz for your vehicle. Do not fit any other valve caps or systems, e.g. tyre pressure monitoring systems.
- Regularly check the pressure of all the tyres including the emergency spare wheel or the spare wheel, particularly prior to long trips, and correct the pressure as necessary (> page 350).

Observe the notes on the emergency spare wheel (> page 365).

The service life of tyres depends on various factors, including the following:

- Driving style
- Tyre pressure
- Mileage

Important safety notes on the tyre tread

WARNING

Insufficient tyre tread will reduce tyre traction. The tyre is no longer able to dissipate water. This means that on wet road surfaces, the risk of aquaplaning increases, in particular

where speed is not adapted to suit the driving conditions. There is a risk of accident.

If the tyre pressure is too high or too low, tyres may exhibit different levels of wear at different locations on the tyre tread. Thus, you should regularly check the tread depth and the condition of the tread across the entire width of all tyres.

Minimum tyre tread depth for:

- summer tyres: 3 mm
- M+S tyres: 4 mm

For safety reasons, replace the tyres before the legally prescribed limit for the minimum tyre tread depth is reached..

Selecting, fitting and replacing tyres

- Only fit tyres and wheels of the same type and make.

Exception: it is permissible to fit a different type or make in the event of a flat tyre.

Observe the "MOExtended tyres (tyres with run-flat characteristics)" section (▷ page 330).

- Only fit tyres of the correct size onto the wheels.
- After fitting new tyres, run them in at moderate speeds for the first 100 km, as they only reach their full performance after this distance.
- Do not drive with tyres which have too little tread depth, as this significantly reduces the traction on wet roads (aquaplaning).
- Replace the tyres after six years at the latest, regardless of wear.

Observe the notes on the emergency spare wheel (▷ page 365).

MOExtended tyres (tyres with run-flat characteristics)

With MOExtended tyres (tyres with run-flat characteristics), you can continue to drive

your vehicle even if there is a total loss of pressure in one or more tyres.

Only use MOExtended tyres in conjunction with an activated tyre pressure loss warning system or tyre pressure monitoring system and only on tyres specifically inspected by Mercedes-Benz.

- i Vehicles with MOExtended tyres are not equipped with a TIREFIT kit at the factory. It is therefore recommended that you additionally equip your vehicle with a TIREFIT kit if you fit tyres that do not feature run-flat characteristics, e.g. winter tyres. A TIREFIT kit can be obtained from a qualified specialist workshop.

Notes on driving with MOExtended tyres in the event of a flat tyre can be found in the "Breakdown assistance" section (▷ page 330).

Winter operation

Points to remember

Have your vehicle winterproofed at a qualified specialist workshop at the onset of winter.

Observe the notes in the "Changing a wheel" section (▷ page 356).

Driving with summer tyres

At temperatures below +7 °C, summer tyres lose elasticity and therefore traction and braking power. Change the tyres on your vehicle to M+S tyres. Using summer tyres at very cold temperatures could cause tears to form, thereby damaging the tyres permanently. Mercedes-Benz cannot accept responsibility for this type of damage.

M+S tyres

WARNING

M+S tyres with a tyre tread depth of less than 4 mm are not suitable for use in winter as they

do not provide sufficient traction. There is a risk of accident.

M+S tyres with a tread depth of less than 4 mm must be replaced.

At temperatures below +7 °C, use winter tyres or all-season tyres. Both types of tyre are identified by the M+S marking.

Only winter tyres bearing the  snowflake symbol in addition to the M+S marking provide the best possible grip in wintry road conditions. Only these tyres will allow driving safety systems such as ABS and ESP® to function optimally in winter. These tyres have been developed specifically for driving in snow.

Use M+S tyres of the same make and tread on all wheels to maintain safe handling characteristics.

Always observe the maximum permissible speed specified for the M+S tyres you have fitted.

If you fit M+S tyres that have a lower maximum permissible speed than that of the vehicle, affix an appropriate warning sign in the driver's field of vision. This can be obtained at a qualified specialist workshop.

Under these circumstances, you should also restrict the maximum speed of the vehicle using permanent SPEEDTRONIC so that it does not exceed the maximum permissible speed for the M+S tyres (▷ page 179).

If you have fitted M+S tyres:

- ▶ Check the tyre pressures (▷ page 350).
- ▶ Restart the tyre pressure loss warning system (▷ page 351).
- ▶ Restart the tyre pressure monitor (▷ page 355).

For more information on driving with the emergency spare wheel, see (▷ page 365).

Snow chains

WARNING

If you have fitted snow chains to the front wheels, they may scrape against the vehicle body or chassis components. This could cause damage to the vehicle or the tyres. There is a risk of an accident.

To avoid hazardous situations:

- never fit snow chains on the front wheels
- fit snow chains to the rear wheels in pairs.

! **Vehicles with steel wheels:** if you wish to fit snow chains to steel wheels, make sure that you remove the respective wheels' hubcaps first. The hubcaps may otherwise be damaged.

For safety reasons, Mercedes-Benz recommends that you only use snow chains that have been specially approved for your vehicle by Mercedes-Benz, or that are of a corresponding standard of quality.

If you intend to fit snow chains, please bear the following points in mind:

- snow chains cannot be fitted to all wheel-tyre combinations. Permissible wheel-tyre combinations (▷ page 361).
 - only use snow chains when the road surface is completely snow-covered. Remove the snow chains as soon as possible when you come to a road that is not snow-covered.
 - local regulations may restrict the use of snow chains. Observe the appropriate regulations if you wish to fit snow chains.
 - do not exceed the maximum permissible speed of 50 km/h.
- i** You may wish to deactivate ESP® (▷ page 73) when pulling away with snow chains fitted. This way you can allow the wheels to spin in a controlled manner, achieving an increased driving force (cutting action).

For more information on driving with the emergency spare wheel, see (▷ page 365).

Tyre pressure

Tyre pressure specifications

WARNING

Underinflated or overinflated tyres pose the following risks:

- the tyres may burst, especially as the load and vehicle speed increase.
- the tyres may wear excessively and/or unevenly, which may greatly impair tyre traction.
- the driving characteristics, as well as steering and braking, may be greatly impaired.

There is a risk of an accident.

Observe the recommended tyre pressure and check the tyre pressure of all the tyres including the spare wheel:

- at least every two weeks
- when the load changes
- before embarking on a longer journey
- for changed operating conditions, e.g. off-road driving

If necessary, correct the tyre pressure.

You will find a table of tyre pressures for various operating conditions on the inside of your vehicle's fuel filler flap.

Operation with an emergency spare wheel: (▷ page 361).

Operation with a trailer: the applicable value for the rear tyres is the maximum tyre pressure value stated in the table inside the fuel filler flap.

The table inside the fuel filler flap may state tyre pressures for different load conditions. These are defined in the table as different numbers of passengers and amounts of luggage. The actual number of seats may vary; for more information, please refer to the vehicle's registration documents.

The tyre pressures specified on the fuel filler flap apply to all tyres approved for this vehicle, if not stated otherwise.

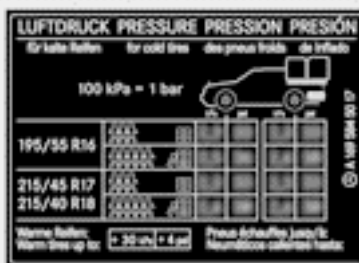

	für kalte Reifen	für warme Reifen	für große Lasten	für Infanterie
195/55 R16	2.5 bar	2.5 bar	2.5 bar	2.5 bar
215/45 R17	2.5 bar	2.5 bar	2.5 bar	2.5 bar
215/45 R18	2.5 bar	2.5 bar	2.5 bar	2.5 bar

100 kPa = 1 bar

Mercedes-Benz
Warm-Up for: 2.2 bar / 3.2 bar
Pressure Adjustment: 2.2 bar / 3.2 bar

P40.00-2193-31

If a tyre size precedes a tyre pressure, the following tyre pressure information is only valid for that tyre size.

To test tyre pressure, use a suitable pressure gauge. The outer appearance of a tyre does not permit any reliable conclusion about the tyre pressure. On vehicles fitted with the electronic tyre pressure monitor, the tyre pressure can be checked using the on-board computer.

WARNING

If you fit unsuitable accessories onto tyre valves, the tyre valves may be overloaded and malfunction, which can cause tyre pressure loss. Due to their design, retrofitted tyre pressure monitors keep the tyre valve open. This can also result in tyre pressure loss. There is a risk of accident.

Only screw standard valve caps or valve caps specifically provided by Mercedes-Benz for your vehicle onto the tyre valve.

WARNING

If the tyre pressure drops repeatedly, the wheel, valve or tyre may be damaged. Tyre pressure that is too low may result in a tyre blow-out. There is a risk of accident.

- Check the tyre for foreign objects.
- Check whether the wheel is losing air or the valve is leaking.

If you are unable to rectify the damage, contact a qualified specialist workshop.

If possible, only correct tyre pressures when the tyres are cold.

The tyres are cold:

- if the vehicle has been parked with the tyres out of direct sunlight for at least three hours and
- if the vehicle has not been driven further than 1.6 km

Depending on the ambient temperature, the speed at which you are driving and the load on the tyres, the tyre temperature and thus the tyre pressure change by approximately 10 kPa per 10 °C (0.1 bar/1.5 psi). Take this into account when checking the pressure of warm tyres and only correct it if it is too low for the current operating conditions.

Driving with tyre pressure that is too high or too low can:

- shorten the service life of the tyres
- cause increased tyre damage
- have a negative effect on handling characteristics and thus the driving safety (e.g. aquaplaning)

i The tyre pressure values given for low loads are minimum values which offer you good ride comfort characteristics.

However, you can also use the values given for higher loads. These are permissible and will not adversely affect the running of the vehicle.

The values on the tyre pressure information label (fuel filler flap) for the vehicle in "partially laden" and "fully laden" conditions apply when driving at maximum speed. Despite the values stated on the tyre pressure information label, for the vehicle with "**partially laden up to 210 km/h**" status, the values can be reduced as follows, without a reduction in safety:

- -30 kPa (-0.3 bar/-4 psi) for all models

This does not apply to vehicles towing a trailer.

This improves the ride comfort of your vehicle; however, the fuel consumption may increase slightly.

Environmental note

Check the tyre pressure regularly, at least every 14 days.

Tyre pressure loss warning system

General notes

While the vehicle is in motion, the tyre pressure loss warning system monitors the set tyre pressure using the rotational speed of the wheels. This enables the system to detect significant pressure loss in a tyre. If the speed of rotation of a wheel changes as a result of a loss of pressure, a corresponding warning message will appear in the multifunction display.

You can recognise the tyre pressure loss warning by the **Run Flat Indicator active Restart with OK** message which appears in the **Service** menu of the multifunction display. Information on the message display can be found in the "Restarting the tyre pressure loss warning system" section (> page 352).

Important safety notes

The tyre pressure warning system does not warn you of an incorrectly set tyre pressure. Observe the notes on the recommended tyre pressure (> page 350).

The tyre pressure loss warning does not replace the need to regularly check the tyre pressures. An even loss of pressure on several tyres at the same time cannot be detected by the tyre pressure loss warning system. The tyre pressure monitor is not able to warn you of a sudden loss of pressure, e.g. if the tyre is penetrated by a foreign object. In the event of a sudden loss of pressure, bring the vehicle to a halt by braking carefully. Avoid abrupt steering manoeuvres.

The function of the tyre pressure loss warning system is limited or delayed if:

- snow chains are fitted to your vehicle's tyres.
- road conditions are wintry.
- you are driving on sand or gravel.
- you adopt a very sporty driving style (cornering at high speeds or driving with high rates of acceleration).
- you are towing a very heavy or large trailer.
- you are driving with a heavy load (in the vehicle or on the roof).



Restarting the tyre pressure loss warning system

Restart the tyre pressure loss warning system if you have:

- changed the tyre pressure
 - changed the wheels or tyres
 - fitted new wheels or tyres
- ▶ Before restarting, consult the table of tyre pressures on the inside of the fuel filler flap to ensure that the tyre pressure in all four tyres is set correctly for the respective operating conditions.
- The tyre pressure loss warning system can only give reliable warnings if you have set the correct tyre pressure. If an incorrect tyre pressure is set, these incorrect values will be monitored.
- ▶ Observe the notes in the section on tyre pressures (▶ page 350).

Restarting using the 4-button multifunction steering wheel

- ▶ Make sure that the key is in position **2** in the ignition lock.
- ▶ Press the  button to select **Tyre pressure Menu: R**.

- ▶ Press the  button.
The **RFI active Restart: R** message appears in the multifunction display.
- ▶ Press the  button.
The **Tyre press. OK?** message appears in the multifunction display.

If you wish to confirm the restart:





- ▶ Press the  button.
The **Run Flat Indicator restarted** message appears in the multifunction display.
After a teach-in period, the tyre pressure loss warning system will monitor the set tyre pressures of all four tyres.

or





If you wish to cancel the restart:

- ▶ Press the  button.
The tyre pressure values stored at the last restart will continue to be monitored.

Restarting using the 12-button multifunction steering wheel

- ▶ Make sure that the key is in position **2** in the ignition lock.
- ▶ Press the  or  button to select the **Service** menu.
- ▶ Press the  or  button to select **Tyre pressure**.
- ▶ Press the  button.
The **Run Flat Indicator active Restart with OK** message appears in the multifunction display.

If you wish to confirm the restart:

- ▶ Press the  button.
The **Tyre pressure now OK?** message appears in the multifunction display.
- ▶ Press the  or  button to select **Yes**.
- ▶ Press the  button.
The **Run Flat Indicator restarted** message appears in the multifunction display.



After a teach-in period, the tyre pressure loss warning system will monitor the set tyre pressures of all four tyres.

or

If you wish to cancel the restart:

► Press the  button.

or

► If the **Tyre pressure now OK?** message appears, use the  or  button to select **Cancel**.

► Press the  button.

The tyre pressure values stored at the last restart will continue to be monitored.

Tyre pressure monitor

General notes

If a tyre pressure monitor system is fitted, the vehicle's wheels have sensors fitted that monitor the tyre pressures in all four tyres. The tyre pressure monitor warns you if the pressure drops in one or more of the tyres. The tyre pressure monitor only functions if the corresponding sensors are fitted to all wheels.

Information on tyre pressures is shown in the multifunction display. After a few minutes of driving, the current tyre pressure of each tyre is shown in the **Service** menu of the multifunction display.



Example: current tyre pressure display

For further information on displaying this message, refer to the "Checking the tyre pressure electronically" section (▷ page 354).

Important safety notes

It is the driver's responsibility to set the tyre pressure to the recommended cold tyre pressure suitable for the operating situation (▷ page 350). Note that the correct tyre pressure for the current operating situation must first be taught-in to the tyre pressure monitor. If there is a substantial loss of pressure, the warning threshold for the warning message is aligned to the reference values taught-in. Restart the tyre pressure monitor after adjusting to the cold tyre pressure (▷ page 355). The current pressures are saved as new reference values. This will ensure that a warning message will only appear if the tyre pressure drops significantly. The tyre pressure monitor does not warn you of an incorrectly set tyre pressure. Observe the notes on the recommended tyre pressure (▷ page 350).

The tyre pressure monitor is not able to warn you of a sudden loss of pressure, e.g. if the tyre is penetrated by a foreign object. In the event of a sudden loss of pressure, bring the vehicle to a halt by braking carefully. Avoid sudden steering movements.

The tyre pressure monitor has a yellow warning lamp in the instrument cluster for indicating a pressure loss or malfunction. Depending on how the warning lamp flashes or lights up, a tyre pressure that is too low or a malfunction in the tyre pressure monitor is indicated:

- if the warning lamp is lit continuously, the tyre pressure on one or more tyres is significantly too low. The tyre pressure monitor is not malfunctioning.
- if the warning lamp flashes for around a minute and then remains lit constantly, the tyre pressure monitor is malfunctioning.

i In addition to the warning lamp, a message appears in the multifunction display.

Further information can be found on:

- Vehicles with a 4-button multifunction steering wheel: (▷ page 270).
- Vehicles with a 12-button multifunction steering wheel: (▷ page 271).

If the tyre pressure monitor is malfunctioning, it may take more than ten minutes for the tyre pressure warning lamp to inform you of the malfunction by flashing for approximately one minute and then remaining lit. When the fault has been rectified, the tyre pressure warning lamp goes out after you have driven for a few minutes.

The tyre pressure values indicated by the on-board computer may differ from those measured at a filling station using a pressure gauge. The tyre pressures shown by the on-board computer refer to those measured at sea level. At high altitudes, the tyre pressure values indicated by a pressure gauge are higher than those shown by the on-board computer. In this case, do not reduce the tyre pressures.

The operation of the tyre pressure monitor can be affected by interference from radio transmitting equipment (e.g. radio head-phones, two-way radios) that may be being operated in or near the vehicle.

Checking the tyre pressure electronically

- ▶ Make sure that the key is in position 2 in the ignition lock (▷ page 149).
- ▶ Press the ◀ or ▶ button on the steering wheel to select the **Service** menu.
- ▶ Press the ▲ or ▼ button to select **Tyre pressure**.
- ▶ Press the **OK** button.

The current tyre pressure for each wheel will be displayed in the multifunction display.

If the vehicle has been parked for over 20 minutes, the **Tyre pressures will be displayed after a few minutes of driving** message appears.

After a teach-in period, the tyre pressure monitor automatically recognises new wheels or new sensors. As long as a clear allocation of the tyre pressure values to the individual wheels is not possible, the **Tyre pressure monitor active** display message is shown instead of the tyre pressure display. The tyre pressures are already being monitored.

- ❗ If a spare wheel/emergency spare wheel is fitted, for a few minutes the system may continue to show the tyre pressure of the wheel that has been removed. If this occurs, the value displayed for the position where the spare wheel/emergency spare wheel is fitted is not the same as the spare wheel/emergency spare wheel's current tyre pressure.

Warning messages of the tyre pressure monitor

If the tyre pressure monitor detects a pressure loss in one or more tyres, a warning message is shown in the multifunction display and the yellow tyre pressure monitor warning light comes on.

- If the **Please correct tyre pressure** message appears in the multifunction display, the tyre pressure in at least one tyre is too low and must be corrected at the next opportunity.
- If the **Check tyre(s)** message appears in the multifunction display, the tyre pressure in one or more tyres has dropped significantly and the tyres must be checked.
- If the **Tyre malfunction** appears in the multifunction display, the tyre pressure in one or more tyres has dropped suddenly and the tyres must be checked.

Observe the instructions and safety notes in the display messages in the "Tyres" section (▷ page 271).

- ❗ If the wheel positions on the vehicle are interchanged, the tyre pressures may be displayed for the wrong positions for a

short time. This is rectified after a few minutes of driving and the tyre pressures are displayed for the correct positions.





Restarting the tyre pressure monitor

When you restart the tyre pressure monitor, all existing warning messages are deleted and the warning lamps go out. The monitor uses the currently set tyre pressures as the reference values for monitoring. In most cases, the tyre pressure monitor will automatically detect the new reference values after you have changed the tyre pressure. However, you can also define reference values manually as described here. The tyre pressure monitor then monitors the new tyre pressure values.

i You will find an overview of the menus on (▷ page 222).

- ▶ Use the table on the inside of the fuel filler flap to ensure that the tyre pressure is set correctly in all four tyres for the current operating conditions.

Also observe the notes in the section on tyre pressures (▷ page 350).

- ▶ Make sure that the key is in position **2** in the ignition lock.
- ▶ Press the  or  button on the steering wheel to select the **Service** menu.
- ▶ Press the  or  button to select **Tyre pressure**.
- ▶ Press the  button.

The multifunction display shows the current tyre pressure for the individual tyres or the **Tyre pressures will be displayed after a few minutes of driving** message.

- ▶ Press the  button. The **Use current pressures as new reference values** message appears in the multifunction display.

If you wish to confirm the restart:

- ▶ Press the  button. The **Tyre press. monitor restarted** message appears in the multifunction display.

After you have driven for a few minutes, the system checks whether the current tyre pressures are within the specified range. The new tyre pressures are then accepted as reference values and monitored.

If you wish to cancel the restart:

- ▶ Press the  button. The tyre pressure values stored at the last restart will continue to be monitored.

Radio type approval for the tyre pressure monitor

In certain countries, a radio type approval for the tyre pressure monitor may be required. The radio type approval number for the tyre pressure monitor can be found online at: <http://www.mercedes-benz.de/betriebsanleitung>.

Country	Radio type approval number
Brazil	1489-10-4415 Model: MRXMERTX1
Dubai	TRA, Registered NO: 0016161/08 TRA, Registered NO ER0076990/11 Dealer-NO: DA0047074/10
Morocco	MR5526 ANRT 2010/ 27/04/2010 MR6706 ANRT 2011/ 17/11/2011
Philippines	ESD-1105558C
Serbia	I 011 12

Country	Radio type approval number
Singapore	Compliance with IDA Standard N0140-09
South Africa	TA-2008/1068 TA-2011/1370

Changing a wheel

Flat tyre

You can find information on what to do in the event of flat tyre in the "Flat tyre" section (▷ page 330).

Information on driving with MOExtended tyres in the event of a flat tyre can be found under "Breakdown assistance" (▷ page 330).

Vehicles with an emergency spare wheel:

in the event of a flat tyre, the emergency spare wheel is fitted according to the description under "Fitting a wheel" (▷ page 357).

Interchanging the wheels

WARNING

Interchanging the front and rear wheels may severely impair the driving characteristics if the wheels or tyres have different dimensions. The wheel brakes or suspension components may also be damaged. There is a risk of accident.

Interchange front and rear wheels only if the wheels and tyres are of the same dimensions.

! On vehicles fitted with a tyre pressure monitor, electronic components are located in the wheel.

Tyre-fitting tools should not be applied in the area of the valve, as this could damage the electronic components.

Only have tyres changed at a qualified specialist workshop.

Interchanging the front and rear wheels of differing dimensions can render the general operating permit invalid.

Observe the instructions and safety notes in the "Fitting a wheel" section (▷ page 357).

The wear patterns on the front and rear tyres differ, depending on the operating conditions. Interchange the wheels before a clear wear pattern has formed on the tyres. Front tyres typically wear more on the shoulders and the rear tyres in the centre.

On vehicles that have the same size front and rear wheels, you can interchange the wheels every 5,000 to 10,000 km depending on the degree of tyre wear. Ensure the direction of rotation is maintained.

Clean the contact surfaces of the wheel and the brake disc thoroughly every time a wheel is interchanged. Check the tyre pressure and, if necessary, restart the tyre pressure loss warning system or the tyre pressure monitor.

Direction of rotation

Tyres with a specified direction of rotation have additional benefits, e.g. if there is a risk of aquaplaning. You will only gain these benefits if the correct direction of rotation is observed.

An arrow on the sidewall of the tyre indicates its correct direction of rotation.

Storing wheels

Store wheels in a cool, dry and preferably dark place if they are not being used. Protect the tyres against oil, grease, petrol and diesel.

Cleaning the wheels

WARNING

The water jet of circular-jet nozzles (dirt grinders) can cause damage not visible from the outside to tyres or chassis components. Com-

ponents damaged in this way can unexpectedly fail. There is a risk of an accident.

Do not use high-pressure cleaners with circular-jet nozzles to clean the vehicle. Have damaged tyres or chassis components replaced immediately.

Fitting a wheel

Preparing the vehicle

- ▶ Stop the vehicle on solid, non-slippery and level ground.
- ▶ Apply the parking brake.
- ▶ Move the front wheels to the straight-ahead position.
- ▶ **Vehicles with manual transmission:** depress the clutch pedal fully and engage first or reverse gear.
- ▶ **Vehicles with automatic transmission:** move the selector lever to **P**.
- ▶ Switch off the engine.
- ▶ **Vehicles without KEYLESS-GO:** remove the key from the ignition lock.
- ▶ **Vehicles with KEYLESS-GO:** open the driver's door.
The on-board electronics have status **0**, which is the same as the key having been removed.
- ▶ **Vehicles with KEYLESS-GO:** remove the Start/Stop button from the ignition lock (▷ page 149).
- ▶ If a trailer is coupled to the vehicle, uncouple it.
- ▶ If included in the vehicle equipment, remove the tyre-change tool kit from the vehicle.
- ▶ Secure the vehicle to prevent it from rolling away.

i Apart from some country-specific variants, vehicles are not equipped with tyre-changing tools. Some tools for changing a wheel are specific to the vehicle. For more information on which tools are required to

perform a wheel change on your vehicle, consult a qualified specialist workshop. Necessary wheel-changing tools can include, for example:

- Jack
- Wheel chock
- Wheel wrench
- Centring pin

Securing the vehicle against rolling away

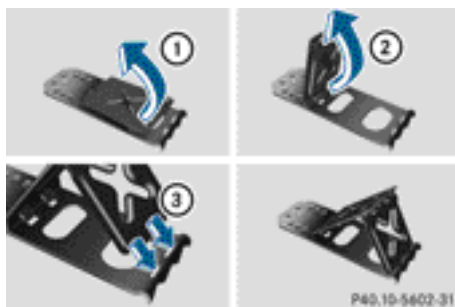

If your vehicle is equipped with a wheel chock, it can be found in the tyre-change tool kit (▷ page 329).

The folding wheel chock is an additional securing measure to prevent the vehicle from rolling away, for example when changing a wheel.

- ▶ Fold both plates upwards ①.
- ▶ Fold out lower plate ②.
- ▶ Guide the lugs on the lower plate fully into the openings in base plate ③.



Securing the vehicle on level ground

- **On level ground:** place chocks or other suitable items under the front and rear of the wheel that is diagonally opposite the wheel you wish to change.

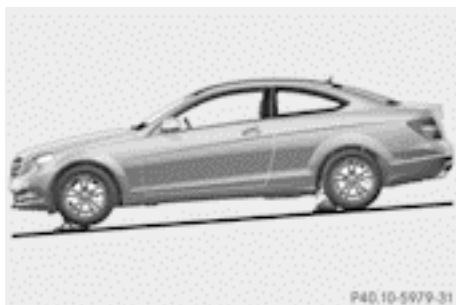

Securing the vehicle on slight downhill gradients

- **On light downhill gradients:** place chocks or other suitable items in front of the wheels of the front and rear axle.

Raising the vehicle

WARNING

If you do not position the jack correctly at the appropriate jacking point of the vehicle, the jack could tip over with the vehicle raised. There is a risk of injury.

Only position the jack at the appropriate jacking point of the vehicle. The base of the jack must be positioned vertically, directly under the jacking point of the vehicle.

The following must be observed when raising the vehicle:

- to raise the vehicle, only use the vehicle-specific jack that has been tested and approved by Mercedes-Benz. If the jack is used incorrectly, it could tip over while the vehicle is raised.
- the jack is designed only to raise and hold the vehicle for a short time while a wheel is being changed. It is not suited for performing maintenance work under the vehicle.
- avoid changing the wheel on uphill and downhill slopes.
- before raising the vehicle, secure it from rolling away by applying the parking brake and positioning wheel chocks. Never release the parking brake while the vehicle is raised.
- the jack must be placed on a firm, flat and non-slip surface. On a loose surface, a large, load-bearing underlay must be used. On a slippery surface, a non-slip underlay must be used, e.g. rubber mats.
- do not use wooden blocks or similar objects as a jack underlay. Otherwise, the jack will not be able to achieve its load-bearing capacity due to the restricted height.
- make sure that the distance between the underside of the tyres and the ground does not exceed 3 cm.
- never place your hands or feet under the raised vehicle.
- never lie under the raised vehicle.
- never start the engine when the vehicle is raised.
- never open or close a door or the boot lid when the vehicle is raised.
- make sure that no persons are present in the vehicle when the vehicle is raised.

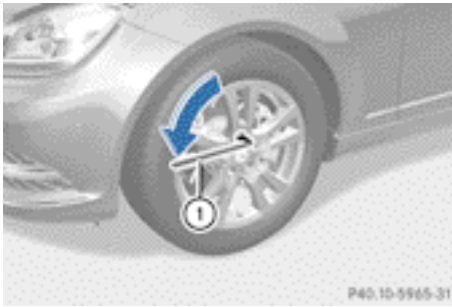

- ▶ Using wheel wrench (1), loosen the bolts on the wheel you wish to change by about one full turn. Do not unscrew the bolts completely.

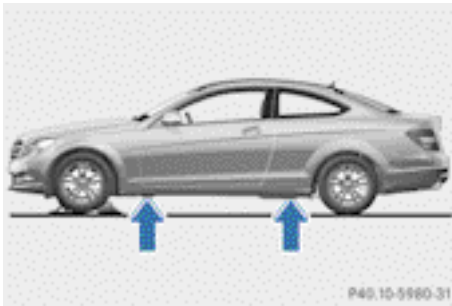

The jacking points are located just behind the front wheel arches and just in front of the rear wheel arches (arrows).

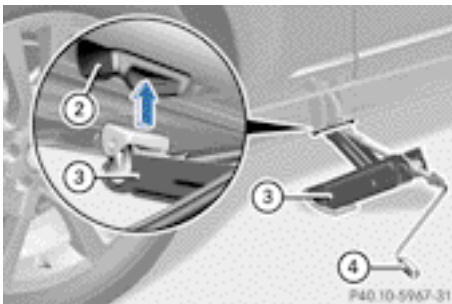

- ▶ Position jack (3) at jacking point (2).

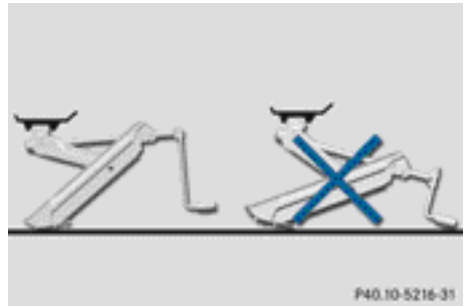

- ▶ Make sure that the base of the jack is positioned vertically under the jacking point.
- ▶ Turn crank (4) clockwise until jack (3) sits completely on jacking point (2) and the base of the jack lies evenly on the ground.
- ▶ Turn crank (4) until the tyre is raised a maximum of 3 cm off the ground.

Removing a wheel

- ▶ **!** Do not place wheel bolts in sand or dirt. The threads of the wheel bolts and wheel hubs could otherwise be damaged when the bolts are tightened.
- ▶ Unscrew the wheel bolts.
- ▶ Remove the wheel.

Fitting a new wheel

WARNING

Oiled or greased wheel bolts or damaged wheel bolts/hub threads can cause the wheel bolts to come loose. As a result, you could lose a wheel while driving. There is a risk of accident.

Never oil or grease wheel bolts. In the event of damage to the threads, contact a qualified specialist workshop immediately. Have the damaged wheel bolts or hub threads replaced/renewed. Do not continue driving.

WARNING

If you tighten the wheel bolts or wheel nuts when the vehicle is raised, the jack could tip over. There is a risk of injury.

Only tighten the wheel bolts or wheel nuts when the vehicle is on the ground.

Always pay attention to the instructions and safety notices in "Changing a wheel" (▷ page 356).

Only use wheel bolts that have been designed for the wheel and the vehicle. For safety reasons, Mercedes-Benz recommends that you only use wheel bolts which have been approved for Mercedes-Benz vehicles and the respective wheel.

Be sure to use the original-length wheel bolts when refitting the original wheel after it has been repaired.

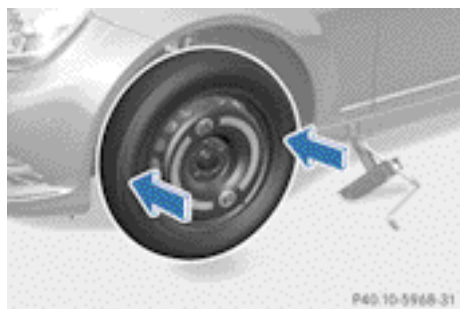

- ▶ Clean the wheel and wheel hub contact surfaces.
- ▶ Place the new wheel on the wheel hub and push it on.
- ▶ Tighten the wheel bolts until they are finger-tight.

Lowering the vehicle

WARNING

The wheels could work loose if the wheel nuts and bolts are not tightened to the specified tightening torque. There is a risk of accident.

Have the tightening torque immediately checked at a qualified specialist workshop after a wheel is changed.

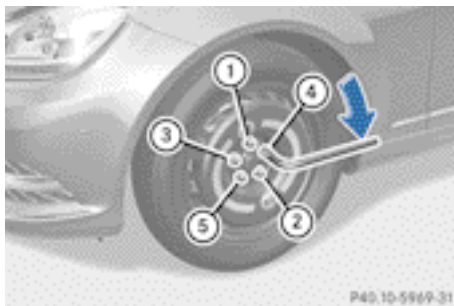

- ▶ Turn the crank of the jack anti-clockwise until the vehicle is once again standing firmly on the ground.
 - ▶ Place the jack to one side.
 - ▶ Tighten the wheel bolts evenly in a cross-wise pattern in the sequence indicated (① to ⑤). The tightening torque must be **130 Nm**.
 - ▶ Turn the jack back to its initial position and store it together with the rest of the tyre-change tool kit in the stowage well under the boot floor.
 - ▶ Transport the faulty wheel in the boot.
- or
- ▶ Depending on the size of the wheel, you may also be able to secure the faulty wheel in the spare wheel well. In this case, you will have to remove the stowage tray from the spare wheel well and stow it securely in the boot.
 - ▶ Check the air pressure of the newly fitted wheel and adjust accordingly. Observe the recommended tyre pressure (▷ page 350).

i Vehicles with a tyre pressure control system: all fitted wheels must be equipped with functioning sensors.

Wheel and tyre combinations

General notes

! For safety reasons, Mercedes-Benz recommends that you only use tyres and wheels which have been approved by Mercedes-Benz specifically for your vehicle.

These are specially adapted to the control systems, such as ABS or ESP® and are marked as follows:

- MO = Mercedes-Benz Original
- MOE = Mercedes-Benz Original Extended (tyres featuring run-flat characteristics)
- MO1 = Mercedes-Benz Original (only certain AMG tyres)

Mercedes-Benz Original Extended tyres may only be used on wheels that have been specifically approved by Mercedes-Benz.

Only use tyres, wheels or accessories tested and approved by Mercedes-Benz. Certain characteristics, e.g. handling, vehicle noise emissions or fuel consumption, may otherwise be adversely affected. In addition, when driving with a load, tyre dimension variations could cause the tyres to come into contact with the bodywork and axle components. This could result in damage to the tyres or the vehicle.

Mercedes-Benz accepts no liability for damage resulting from the use of tyres, wheels or accessories other than those tested and approved.

Further information about wheels, tyres and approved combinations can be obtained from any qualified specialist workshop.

! Retreaded tyres are neither tested nor recommended by Mercedes-Benz, since previous damage cannot always be detected on retreaded tyres. As a result, Mercedes-Benz cannot guarantee vehicle safety if retreaded tyres are fitted. Do not fit used tyres if you have no information about their previous usage.

! Large wheels: the lower the section width for a certain wheel size, the lower the ride comfort is on poor road surfaces. Roll comfort and suspension comfort are reduced and the risk of damage to the wheels and tyres as a result of driving over obstacles increases.

i You will find a table of tyre pressures on the inside of your vehicle's fuel filler flap. For further information on tyre pressure, see (▷ page 350). Check tyre pressures regularly and only when the tyres are cold.

i Notes on the vehicle equipment – always fit the vehicle:

- with tyres of the same size on a given axle (left/right)
- with the same type of tyres at a given time (summer tyres, winter tyres, MOExtended tyres)

i Vehicles with MOExtended tyres are not equipped with a TIREFIT kit at the factory. It is therefore recommended that you additionally equip your vehicle with a TIREFIT kit if you fit tyres that do not feature run-flat characteristics, e.g. winter tyres. A TIREFIT kit can be obtained from a qualified specialist workshop.

i Overview of abbreviations used in the following tyre tables:

- BA: both axles
- FA: front axle
- RA: rear axle

In the following table, the wheel/tyre combinations are allocated to the vehicle models through variants, e.g. V1, V2 etc.:

V1	C 180
V2	C 220 CDI BlueEFFICIENCY Edition
V3	C 200, C 220 CDI
V4	C 250, C 250 CDI
V5	C 350, C 350 4MATIC

V6 C 250 Sport, C 250 CDI Sport

V7 C 63 AMG

- i** Not all wheel/tyre combinations can be fitted at the factory in all countries.

Tyres										
	Summer tyres	Light-alloy wheels	V1	V2	V3	V4	V5	V6	V7	
BA	195/60 R16 89 V ⁷	6.0 J x 16 H2 ET 39	•	–	–	–	–	–	–	–
BA	205/55 R16 91 V ⁷	7.0 J x 16 H2 ET 43	•	•	•	–	–	–	–	–
BA	205/55 R16 91 W ⁷	7.0 J x 16 H2 ET 43	•	•	•	•	–	–	–	–
BA	225/50 R16 92 V ⁷	7.5 J x 16 H2 ET 53	•	–	•	–	–	–	–	–
BA	225/50 R16 92 W ⁷	7.5 J x 16 H2 ET 53	•	–	•	•	–	–	–	–
BA	225/45 R17 91 W ⁷	7.5 J x 17 H2 ET 47	•	–	•	•	•	–	–	–
BA	225/45 R17 91 W MOExtended ^{7, 8}	7.5 J x 17 H2 ET 47	•	–	•	•	•	–	–	–
FA	225/45 R17 91 W	7.5 J x 17 H2 ET 47	•	–	•	•	•	–	–	–
RA	245/40 R17 91 W ⁹	8.5 J x 17 H2 ET 58								
FA	225/45 R17 91 W MOExtended ⁸	7.5 J x 17 H2 ET 47	•	–	•	•	•	–	–	–
RA	245/40 R17 91 W MOExtended ^{8, 9}	8.5 J x 17 H2 ET 58								
BA	225/40 R18 92 Y XL ^{7, 10}	7.5 J x 18 H2 ET 47	•	–	•	•	•	–	–	–
FA	225/40 R18 92 Y	7.5 J x 18 H2 ET 47	•	–	•	•	•	–	–	–
RA	XL ¹⁰	8.5 J x 18 H2 ET 58								
	245/35 R18 92 Y XL ^{9, 10}									
FA	225/40 R18 92 Y	7.5 J x 18 H2 ET 47	•	–	•	•	•	•	–	–
RA	XL ¹⁰	8.5 J x 18 H2 ET 54								
	255/35 R18 94 Y XL ^{9, 10, 11}									
FA	225/40 R18 92 Y	8.0 J x 18 H2 ET 50	•	–	•	•	•	•	–	–
RA	XL ¹⁰	8.5 J x 18 H2 ET 54								
	255/35 R18 94 Y XL ^{9, 10, 11}									

⁷ Not in combination with sports suspension code 486 or dynamic handling package code 483.











⁸ MOExtended tyres (tyres with run-flat characteristics) only in combination with an activated tyre pressure loss warning system or tyre pressure monitor.

⁹ Use of snow chains is not permitted. Observe the notes in the "Snow chains" section.

¹⁰ Observe notes on "Large wheels" in the "Wheel/tyre combinations" section.

¹¹ Additional measures necessary (hub caps on rear axle, code 776).

	Summer tyres	Light-alloy wheels	V1	V2	V3	V4	V5	V6	V7
FA	235/40 ZR18 95 Y XL	8.0 J x 18 H2 ET 45	–	–	–	–	–	–	•
RA	255/35 ZR18 94 Y XL ^{9, 10}	9.0 J x 18 H2 ET 54							
FA	235/35 ZR19 XL ¹⁰	8.0 J x 19 H2 ET 45	–	–	–	–	–	–	•
RA	255/30 ZR19 XL ^{9, 10}	9.0 J x 19 H2 ET 54							



	Winter tyres	Light-alloy wheels	V1	V2	V3	V4	V5	V6	V7
BA	195/60 R16 89 H M+S  ⁷	6.0 J x 16 H2 ET 39	•	–	–	–	–	–	–
BA	205/55 R16 91 H M+S 	7.0 J x 16 H2 ET 43	•	•	•	•	–	–	–
BA	225/50 R16 92 H M+S 	7.5 J x 16 H2 ET 53	•	–	•	•	–	–	–
BA	225/45 R17 91 H M+S 	7.5 J x 17 H2 ET 46.5	–	–	–	–	–	•	–
BA	225/45 R17 91 H M+S  MOExtended ⁸	7.5 J x 17 H2 ET 46.5	–	–	–	–	–	•	–
BA	225/45 R17 91 H M+S 	7.5 J x 17 H2 ET 47	•	–	•	•	•	–	–
BA	225/45 R17 91 H M+S  MOExtended ⁸	7.5 J x 17 H2 ET 47	•	–	•	•	•	–	–
BA	225/40 R18 92 H XL M+S  ¹⁰	7.5 J x 18 H2 ET 47	•	–	•	•	•	•	–
BA	225/40 R18 92 V XL M+S  ¹⁰	8.0 J x 18 H2 ET 45	–	–	–	–	–	–	•
BA	225/40 R18 92 H XL M+S  ¹⁰	8.0 J x 18 H2 ET 50	•	–	•	•	•	•	–

⁹ Use of snow chains is not permitted. Observe the notes in the "Snow chains" section.

¹⁰ Observe notes on "Large wheels" in the "Wheel/tyre combinations" section.

⁷ Not in combination with sports suspension code 486 or dynamic handling package code 483.

⁸ MOExtended tyres (tyres with run-flat characteristics) only in combination with an activated tyre pressure loss warning system or tyre pressure monitor.

	Winter tyres	Light-alloy wheels	V1	V2	V3	V4	V5	V6	V7
BA	235/40 R18 95 V XL M+S  ⁹	8.0 J x 18 H2 ET 45	–	–	–	–	–	–	•
FA RA	235/40 R18 95 V XL M+S  255/35 R18 94 V XL M+S  ^{9, 10}	8.0 J x 18 H2 ET 45 9.0 J x 18 H2 ET 54	–	–	–	–	–	–	•

Emergency spare wheel

Important safety notes

WARNING

The wheel/tyre dimensions and the tyre type of the spare wheel/emergency spare wheel and the wheel to be replaced may differ. Fitting a spare wheel/emergency spare wheel may severely impair the driving characteristics. There is a risk of accident.

To prevent hazardous situations:

- Adapt your driving style accordingly and drive carefully.
- Never fit more than one spare wheel/emergency spare wheel if the dimensions are different to those of the wheel being replaced.
- Only use a spare wheel/emergency spare wheel briefly if the dimensions are different to those of the wheel being replaced.
- Do not switch off ESP[®].
- Have the spare wheel/emergency spare wheel in question replaced at the nearest qualified specialist workshop. Make sure that the wheel/tyre dimensions and tyre type are correct.

When using an emergency spare wheel or spare wheel of a different size, you must not exceed the maximum speed of 80 km/h. Snow chains must not be fitted to emergency spare wheels.

General notes

You should regularly check the pressure of all your tyres, including the emergency spare wheel, particularly prior to long trips, and correct the pressure as necessary (▷ page 350). The applicable value is found on the wheel or under "Technical data" (▷ page 361).

- ❗ If you are driving with the collapsible emergency spare wheel fitted, the tyre pressure loss warning system or the tyre pressure monitor cannot function reliably. Only restart the tyre pressure loss warning system/tyre pressure monitor when the defective wheel has been replaced with a new wheel.

Vehicles with tyre pressure monitor:

after mounting an emergency spare wheel, the system may still display the tyre pressure of the removed wheel for a few minutes. The value displayed for the mounted emergency spare wheel is not the same as the current tyre pressure of the emergency spare wheel.

An emergency spare wheel may also be fitted against the direction of rotation. Observe the time restriction on use as well as the speed limitation specified on the emergency spare wheel.

Replace the tyres after six years at the latest, regardless of wear. This also applies to the emergency spare wheel.

⁹ Use of snow chains is not permitted. Observe the notes in the "Snow chains" section.

¹⁰ Observe notes on "Large wheels" in the "Wheel/tyre combinations" section.

Spare wheel/"Minispare" emergency spare wheel

The spare wheel or "Minispare" emergency spare wheel can be found in the stowage well under the boot floor.

- ▶ Lift the boot floor upwards (▷ page 298).

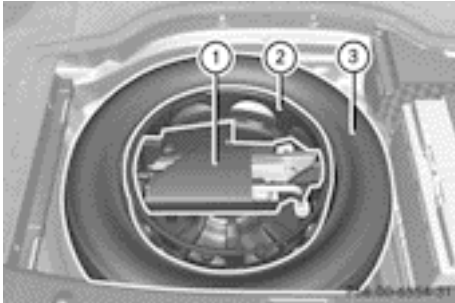

- ▶ **To remove the spare wheel or "Minispare" emergency spare wheel:** remove vehicle tool kit tray ①.
- ▶ Turn stowage tray ② anti-clockwise and remove it.
- ▶ Remove the spare wheel or "Minispare" emergency spare wheel ③.

Observe the instructions and safety notes in the "Fitting a wheel" section (▷ page 356).

Technical data								
"Minispare" emergency spare wheel ¹²								
Tyres	Wheels	V1	V2	V3	V4	V5	V6 13	V7
T 125/90 R16 98 M Tyre pressure: 420 kPa (4.2 bar/ 61 psi)	3.5 B x 16 H2 ET 20	•	•	•	•	–	–	–
T 125/80 R17 99 M Tyre pressure: 420 kPa (4.2 bar/ 61 psi)	3.5 B x 17 H2 ET 20	•	–	•	•	•	–	–
T 125/70 R18 99 M Tyre pressure: 420 kPa (4.2 bar/ 61 psi)	3.5 B x 18 H2 ET 20	–	–	–	–	–	–	•

Your vehicle may be equipped with TIREFIT or a "Minispare" emergency spare wheel, depending on the country, the engine and the wheels fitted.

- i** The specified tyre pressure is printed in yellow on the emergency spare wheel.

¹² Use of snow chains not permitted. Observe the notes in the "Snow chains" section.

¹³ No spare tyre possible. Observe the notes on "TIREFIT" in the "Breakdown assistance" section.

Useful information	370
Information on technical data	370
Vehicle electronics	370
Identification plates	372
Service products and capacities	372
Vehicle data	380
Trailer tow hitch	381

Useful information

- i** This Owner's Manual describes all models, series and optional equipment for your vehicle that were available at the time of going to press. National variations are possible. Note that your vehicle may not be equipped with all of the functions described. This is also the case for systems and functions relevant to safety.
- i** Read the information on qualified specialist workshops: (▷ page 28).

Information on technical data

General notes

You can find current technical data on the Internet at:
<http://www.mercedes-benz.com>

- i** The technical data was determined in accordance with EU Directives. All data applies to the vehicle's standard equipment. The data may therefore differ for vehicles with optional equipment. You can obtain further information from a Mercedes-Benz Service Centre.

Vehicle electronics

Tampering with the engine electronics

- !** Only have work carried out on the engine electronics and its associated parts, such as control units, sensors and connector leads, at a qualified specialist workshop. Vehicle components may otherwise wear more quickly and the vehicle's operating permit may be invalidated.

Retrofitting two-way radios and mobile phones (RF transmitters)

WARNING

If RF transmitters are tampered with or not properly retrofitted, the electromagnetic radiation they emit can interfere with the vehicle electronics. This may jeopardise the operational safety of the vehicle. There is a risk of an accident.

You should have all work on electrical and electronic components carried out at a qualified specialist workshop.

WARNING

If you use the RF transmitter in the vehicle in an improper way, its electromagnetic radiation can disrupt vehicle electronics, e.g. if:

- the RF transmitter is not connected to an exterior aerial
- the exterior aerial is fitted incorrectly or is not a low-reflection aerial

This can jeopardise the operating safety of the vehicle. There is a risk of an accident.

Have the low-reflection exterior aerial fitted at a qualified specialist workshop. When operating in the vehicle, always connect the RF transmitter to the low-reflection exterior aerial.

- !** The operating permit may be invalidated if the instructions for installation and use of RF transmitters are not observed.

In particular, the following conditions must be complied with:

- only approved wavebands may be used.
- observe the maximum permissible output in these wavebands.
- only approved aerial positions may be used.

Excessive levels of electromagnetic radiation may cause damage to your health and to the health of others. The use of an exterior aerial takes into consideration the scientific discus-

sion surrounding the possible health risk posed by electromagnetic fields.

Observe the notes on operating mobile phones (▷ page 302).

The following aerial positions may be used for the correct installation of RF transmitters:

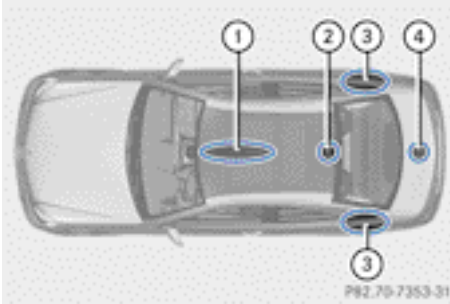

Approved aerial positions

- ① Front roof area
- ② Rear roof area
- ③ Rear wing
- ④ Boot lid

i On vehicles with panorama sliding sunroof, fitting an aerial to the front or rear roof area is not permitted.

On the rear wing, it is recommended that you position the aerial on the side of the vehicle closest to the centre of the road.

Use Technical Specification ISO/TS 21609 (Road Vehicles - "EMC guidelines for fitting aftermarket radio frequency transmitting equipment") when retrofitting RF (radio frequency) transmitters. Comply with the legal requirements for add-on parts.

If your vehicle has fittings for two-way radio equipment, use the power supply or aerial connections intended for use with the basic wiring. Be sure to observe the manufacturer's additional instructions when installing.

Deviations with respect to wavebands, maximum transmission outputs or aerial positions must be approved by Mercedes-Benz.

The maximum transmission output (PEAK) at the base of the aerial must not exceed the following values:

Waveband	Maximum transmission output
Short wave 3 - 54 MHz	100 W
4 m waveband 68 - 87.5 MHz	30 W
2 m waveband 144 - 174 MHz	50 W
Trunked radio/Tetra 380 - 460 MHz	35 W
70 cm waveband 400 - 460 MHz	35 W
GSM/DCS/PCS 850/900/1800/1900	10 W
UMTS/LTE	10 W

The following can be used in the vehicle without restrictions:

- RF transmitters with a maximum transmission output of up to 100 mW
- Mobile phones (GSM/DCS/PCS/UMTS/LTE)

There are no restrictions when positioning the aerial on the outside of the vehicle for the following wavebands:

- Trunked radio/Tetra
- 70 cm waveband
- GSM/DCS/PCS
- UMTS/LTE

Identification plates

Vehicle identification plate with vehicle identification number (VIN)



- ▶ Open the right-hand door.
You will see vehicle identification plate ①.

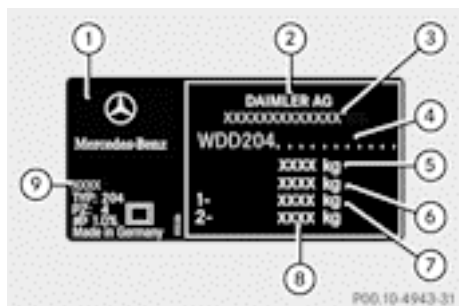

Example: vehicle identification plate

- ① Vehicle identification plate
- ② Vehicle manufacturer (Daimler AG)
- ③ EU type approval number (only for certain countries)
- ④ VIN
- ⑤ Maximum permissible gross vehicle weight (kg)
- ⑥ Maximum permissible mass of vehicle/trailer combination (kg)
- ⑦ Maximum permissible front axle load (kg)
- ⑧ Maximum permissible rear axle load (kg)
- ⑨ Paint code

i The data shown on the identification plate is example data. This data is different for every vehicle and can deviate from the data shown here. You can find the data applica-

ble to your vehicle on the vehicle's identification plate.

VIN

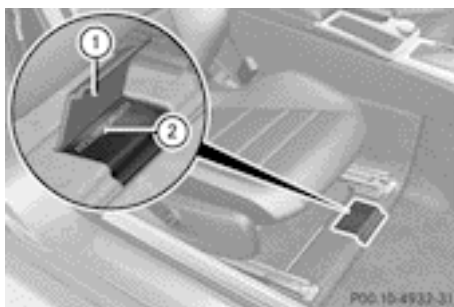

- ▶ Slide the right-hand front seat to its rearmost position.
- ▶ Fold floor covering ① upwards.
You will see VIN ②.

The VIN can also be found on the vehicle identification plate (▷ page 372).

Engine number

The engine number is stamped onto the crankcase. You can obtain further information from any qualified specialist workshop.

Service products and capacities

Important safety notes

⚠ WARNING

Service product can be poisonous and hazardous to health. There is a risk of injury. Observe the instructions on the respective original container when using, storing and disposing off service products. Always store service products in the sealed original container. Always keep service products out of the reach of children.

**Environmental note**

Dispose of service products in an environmentally-responsible manner.

Service products include the following:

- Fuels (e.g. petrol, diesel)
- Lubricants (e.g. engine oil, transmission oil)
- Coolant
- Brake fluid
- Windscreen washer fluid
- Climate control system refrigerant

When handling, storing and disposing of any service products, please observe the relevant regulations.

Components and service products must be matched. Mercedes-Benz recommends that you use products tested and approved by Mercedes-Benz. They are listed in this Mercedes-Benz Owner's Manual in the appropriate section.

You can identify service products approved by Mercedes-Benz by the following inscriptions on the container:

- MB-Freigabe (e.g. MB-Freigabe 229.51)
- MB Approval (e.g. MB Approval 229.51)

Other designations or recommendations indicate a level of quality or a specification in accordance with an MB Sheet Number (e.g. MB 229.5). They have not necessarily been approved by Mercedes-Benz.

Further information can be obtained from any Mercedes-Benz Service Centre or on the Internet at <http://bevo.mercedes-benz.com>.

Fuel**Important safety notes****WARNING**

Fuel is highly flammable. If you handle fuel incorrectly, there is a risk of fire and explosion.

You must avoid fire, naked flames, creating sparks and smoking. Switch off the engine

and, if applicable, the auxiliary heating before refuelling.

**WARNING**

Fuels are poisonous and hazardous to health. There is a danger of injury.

Do not swallow fuel or let it come into contact with skin, eyes or clothing. Do not inhale fuel vapours. Keep fuels out of the reach of children.

If you or others come into contact with fuel, observe the following:

- Wash the fuel off any affected areas of skin with water and soap immediately.
- If you get fuel in your eyes, rinse them thoroughly with clean water immediately. Seek immediate medical attention.
- If fuel is swallowed, seek immediate medical attention. Do not induce vomiting.
- Change any clothing that has come into contact with fuel immediately.

Tank capacity

The total capacity of the fuel tank may vary, depending on the vehicle equipment.

Model	Total capacity
C 350 C 350 4MATIC C 63 AMG	66.0 l
All other models	59 l or 66.0 l

Model	Of which reserve fuel
C 63 AMG	Approx. 14.0 l
All other models	Approx. 8.0 l

Petrol (EN 228, E DIN 51626-1)

Fuel grade

! Do not use diesel to refuel vehicles with a petrol engine. Do not switch on the ignition if you accidentally refuel with the wrong fuel. Otherwise, fuel can enter the fuel system. Even small amounts of the wrong fuel could result in damage to the fuel system and the engine. Notify a qualified specialist workshop and have the fuel tank and fuel lines drained completely.

! Only refuel using premium-grade unleaded petrol with at least 95 ROZ/85 MOZ, that conforms to European standard EN 228 or E DIN 51626-1 or an equivalent specification.

Fuel of this specification can contain up to 10 % ethanol.

Fuel that does not conform to EN 228 or E DIN 51626-1 can lead to increased wear and damage the engine and exhaust system.

! Only use the fuel recommended. Operating the vehicle with other fuels can lead to engine failure.

! Do not use the following:

- E85 (petrol with 85% ethanol)
- E100 (100% ethanol)
- M15 (petrol with 15% methanol)
- M30 (petrol with 30% methanol)
- M85 (petrol with 85% methanol)
- M100 (100% methanol)
- Petrol with additives containing metal
- Diesel

Do not mix such fuels with the fuel recommended for your vehicle. Do not use additives. This can otherwise lead to engine damage. This does not include cleaning additives for the removal and prevention of residue build-up. Petrol must only be mixed with additives recommended by Mercedes-Benz; see "Additives". You can obtain fur-

ther information from any Mercedes-Benz Service Centre.

Usually you will find information about the fuel grade on the pump. If you cannot find the label on the petrol pump, ask the filling station staff.

i E10 fuel contains up to 10% bioethanol. Your vehicle is suitable for use with E10 fuel. You can refuel your vehicle using E10 fuel.

i **C 180 BlueEFFICIENCY:** as a temporary measure, if the recommended fuel is not available, you may also use unleaded petrol with an octane rating of 93 RON/83 MON.

All other models: as a temporary measure, if the recommended fuel is not available, you may also use unleaded petrol with an octane rating of 91 RON/82 MON. This may reduce engine performance and increase fuel consumption. Avoid driving at full throttle.

i In some countries, the available petrol may not be sufficiently low in sulphur. This fuel can temporarily produce unpleasant odours, especially on short journeys. As soon as sulphur-free fuel (sulphur content < 10 ppm) is used for refuelling, the odours are reduced.

Information on refuelling (> page 165).

AMG vehicles

! Only refuel using super unleaded petrol with at least 98 RON/88 MON that conforms to European standard EN 228 or an equivalent specification.

You can otherwise impair engine output or damage the engine.

! Premium-grade unleaded petrol with an octane rating of 95 RON/85 MON may be used as a temporary measure if the recommended fuel is not available. This may reduce engine performance and increase fuel consumption. As much as possible, avoid driving at full throttle.

! Regular unleaded petrol with an octane rating of 91 RON/82.5 MON may also be used as a temporary measure if the recommended fuel is not available.

Doing so results in noticeably higher fuel consumption, and the engine power output is noticeably reduced. Avoid driving at full throttle.

If only regular unleaded petrol with an octane rating of 91 RON/82.5 MON or lower is available, you must have the vehicle adapted to this fuel at a qualified specialist workshop.

i E10 fuel contains up to 10% bioethanol. Your vehicle is suitable for use with E10 fuel. You can refuel your vehicle using E10 fuel.

C 350

! Only refuel using premium-grade sulphur-free unleaded petrol with at least 95 RON/85 MON that conforms to European standard EN 228 or an equivalent specification. You could otherwise impair engine output or damage the emission control system.

i In some countries, the available petrol may not be sufficiently low in sulphur. This fuel can temporarily produce unpleasant odours, especially on short journeys. As soon as sulphur-free fuel (sulphur content < 10 ppm) is used for refuelling, the odours are reduced.

Additives

! Operating the engine with fuel additives added later can lead to engine failure. Do not mix fuel additives with fuel. This does not include additives for the removal and prevention of residue build-up. Petrol must only be mixed with additives recommended by Mercedes-Benz. Observe the instructions for use in the product description. More information about recommended additives can be obtained from any Mercedes-Benz Service Centre.

Mercedes-Benz recommends that you use fuel brands that have additives.

The quality of the fuel available in some countries may not be sufficient. Residue could build up as a result. In such cases, and in consultation with a Mercedes-Benz Service Centre, the petrol may be mixed with the cleaning additive recommended by Mercedes-Benz (part no. A000989254512). You must observe the notes and mixing ratios specified on the container.

Diesel (EN 590)

Fuel grade

WARNING

If you mix diesel fuel with petrol, the flash point of this fuel mixture is lower than that of pure diesel fuel. When the engine is running, components in the exhaust system may overheat unnoticed. There is a risk of fire.

Never refuel with petrol. Never add petrol to diesel fuel.

! When refuelling, only use diesel fuel that conforms to the European standard EN 590 or is of equivalent quality. Fuel that does not conform to EN 590 can lead to increased wear as well as damage to the engine and exhaust system.

! Do not use the following:

- marine diesel
- heating oil
- bio-diesel
- vegetable oil
- petrol
- paraffin
- kerosene

Do not mix such fuels with diesel fuel and do not use any special additives. This can otherwise lead to engine damage. This does not include flow improver additives. For further information, see "Flow improvers".

! **Vehicles with a diesel particle filter:** in countries outside the EU, only refuel with low-sulphur Euro diesel with a sulphur content under 50 ppm; otherwise the emission control system could be damaged.

! **Vehicles without a diesel particle filter:** in countries where only diesel fuel with a high sulphur content is available, you will need to carry out your vehicle's oil change at shorter intervals. More information about the interval for oil change can be obtained from any qualified specialist workshop.

Usually you will find information about the fuel grade on the pump. If you cannot find the label on the petrol pump, ask the filling station staff.

Information on refuelling (▷ page 165).

Low outside temperatures

In winter months, diesel fuel with an improved cold flow quality is available. In Europe, the EN 590 standard defines various climate-dependent temperature categories. Malfunctions can be avoided by refuelling with diesel fuel that corresponds to the climatic specifications outlined in EN 590. At unusually low outside temperatures, it is possible that the flow characteristics of the diesel fuel could be insufficient. Accordingly, diesel fuel from warmer areas may not be suitable for operation in colder climatic conditions.

i Further information on country-specific fuel properties can be obtained from oil companies, e.g. at filling stations.

Fuel consumption information

Environmental note

CO₂ (carbon dioxide) is the gas which scientists believe to be principally responsible for global warming (the greenhouse effect). Your vehicle's CO₂ emissions are directly related to fuel consumption and therefore depend on:

- efficient use of the fuel by the engine
- driving style
- other non-technical factors, such as environmental influences, road conditions or traffic flow

You can minimise your vehicle's CO₂ emissions by driving carefully and having it serviced regularly.

The vehicle will use more fuel than usual in the following situations:

- at very low outside temperatures
- in urban traffic
- on short journeys
- in mountainous terrain
- when towing a trailer

i Only for certain countries: you can find the current consumption and emission values of your vehicle in the COC documents (EU CERTIFICATE OF CONFORMITY). These documents are delivered with your vehicle.

The consumption figures were in each case based on the currently applicable version:

- for vehicles that comply with standards up to and including the EURO 4 standard, in accordance with EU Directive 80/1268/EEC
- for vehicles that comply with or exceed the EURO 5 standard, in accordance with Regulation (EC) No. 715/2007

Deviations from these values may occur under normal operating conditions.

Engine oil

General notes

When handling engine oil, observe the important safety notes on service products (▷ page 372).

The quality of the engine oil is decisive for the function and service life of an engine. After extensive tests, Mercedes-Benz approves

engine oils that correspond to the current technical standard.

Therefore, only Mercedes-Benz approved engine oils may be used in Mercedes-Benz engines.

Further information on tested and approved engine oils can be obtained from any Mercedes-Benz Service Centre. Mercedes-Benz recommends that you have the oil change carried out at a qualified specialist workshop. Mercedes-Benz approval is indicated on the oil container by the inscription "MB Approval" and the corresponding designation, e.g. MB Approval 229.51.

You can call up an overview of approved engine oils on the Internet at <http://bevo.mercedes-benz.com> by entering the designation, e.g. 229.5.

The table shows which engine oils have been approved for your vehicle.

Petrol engines: in certain countries, different engine oils can be used, provided that the maintenance intervals are reduced. For more information, please contact a qualified specialist workshop.

Petrol engines	MB Approval
All models	229.5

Diesel engines with diesel particle filter	MB Approval
C 220 CDI	228.51,
C 220 CDI BlueEFFICIENCY Edition	229.31, 229.51
C 250 CDI	
C 250 CDI Sport	

Use only SAE 0W-40 or SAE 5W-40 engine oils for AMG vehicles.

i If the engine oils listed in the table are not available, you may add the following engine oils until the next oil change:

- vehicles with a petrol engine: MB Approval 229.1, 229.3 or ACEA A3
- diesel engines: MB Approval 229.1, 229.3, 229.5 or ACEA C3

This must only be added once and the amount must not be greater than 1.0 l.

Capacities

The following values refer to an oil change including the oil filter.

Model	Replacement amount
C 180	6.0 l
C 200	5.5 l
C 250	
C 250 Sport	
All other models	6.5 l
C 63 AMG	With external oil cooler: 8.5 l

Additives

! Do not use any additives with the engine oil. This could damage the engine.

Engine oil viscosity

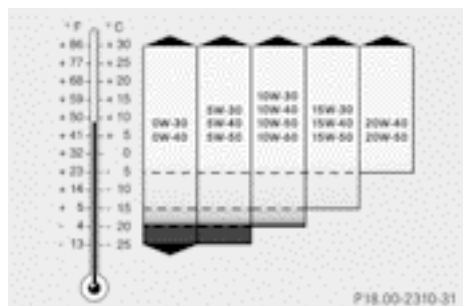

Viscosity describes the flow characteristics of a fluid. If an engine oil has a high viscosity

rating, it flows slowly; the lower the viscosity, the faster it flows.

Engine oil selection is based on the respective outside temperatures and in accordance with the SAE classification (viscosity). The table shows you which SAE classifications are to be used. The low-temperature properties of engine oils can be significantly impaired during operation due to, for example, ageing or soot and fuel accretion. It is therefore strongly recommended to observe regular oil changes using an approved engine oil with the appropriate SAE classification.

Brake fluid

WARNING

The brake fluid continuously absorbs moisture from the air. This results in the boiling point of the brake fluid lowering. If the boiling point of the brake fluid is too low, vapour pockets may form when the brakes are subjected to a heavy load. This would impair braking efficiency. There is a risk of an accident. Have the brake fluid renewed at the prescribed intervals.

When handling brake fluid, observe the important safety notes on service products (> page 372).

The brake fluid change intervals can be found in the Service Booklet.

Only use brake fluid approved by Mercedes-Benz according to MB Approval 331.0.

Information about approved brake fluid can be obtained at any qualified specialist workshop or on the Internet at: <http://bevo.mercedes-benz.com>.

-  Have the brake fluid regularly replaced at a qualified specialist workshop and the replacement confirmed in the Service Booklet.

Coolant

Important safety notes

WARNING

If antifreeze comes into contact with hot components in the engine compartment, it may ignite. There is a risk of fire and injury.

Let the engine cool down before you top up the antifreeze. Make sure that antifreeze is not spilled next to the filler neck. Thoroughly clean the antifreeze from components before starting the engine.

-  Only add coolant that has been premixed with the desired antifreeze protection. You could otherwise damage the engine.

Further information on coolants can be found in the Mercedes-Benz Specifications for Service Products, MB Specifications for Service Products 310.1, e.g. on the Internet at <http://bevo.mercedes-benz.com>. Or contact a qualified specialist workshop.

-  Always use a suitable coolant mixture, even in countries where high temperatures prevail.

Otherwise, the engine cooling system is not sufficiently protected from corrosion and overheating.

-  Have the coolant regularly replaced at a qualified specialist workshop and the replacement confirmed in the Service Booklet.

Comply with the important safety precautions for service products when handling coolant (> page 372).

The coolant is a mixture of water and antifreeze/corrosion inhibitor. It is responsible for the following:

- anti-corrosion protection
- antifreeze protection
- raising the boiling point

If antifreeze/corrosion inhibitor is present in the correct concentration, the boiling point of

the coolant during operation will be approximately 130 °C.

The antifreeze/corrosion inhibitor concentration in the engine cooling system should:

- be at least 50%. This will protect the engine cooling system against freezing down to approximately -37 °C.
- not exceed 55% (antifreeze protection down to -45 °C). Heat will otherwise not be dissipated as effectively.

If the vehicle has lost coolant, top it up with equal amounts of water and antifreeze/corrosion inhibitor.

Mercedes-Benz recommends an antifreeze/corrosion inhibitor concentrate in accordance with MB Specifications for Service Products 3 10.1.

- i** When the vehicle is first delivered, it is filled with a coolant mixture that ensures adequate antifreeze and corrosion protection.
- i** The coolant is checked at every maintenance interval at a qualified specialist workshop.

Windscreen washer system and headlamp cleaning system

Important safety notes

WARNING

Windscreen washer concentrate is highly flammable. If it comes into contact with hot engine components or the exhaust system it could ignite. There is a risk of fire and injury. Make sure that no windscreen washer concentrate is spilled next to the filler neck.

- !** Only use washer fluid that is suitable for plastic lamp lenses, e.g. MB SummerFit or MB WinterFit. Unsuitable washer fluid could damage the plastic lenses of the headlamps.

- !** Do not use distilled or de-ionised water in the washer fluid reservoir. Otherwise, the level sensor may be damaged.

- !** Only the washer fluids SummerFit and WinterFit can be mixed. Otherwise, the spraying nozzles could become blocked.

When handling washer fluid, observe the important safety notes on service products (> page 372).

At temperatures above freezing:

- ▶ Fill the washer fluid reservoir with a mixture of water and washer fluid, e.g. MB SummerFit.
- ▶ Mix 1 part MB SummerFit to 100 parts water.

At temperatures below freezing:

- ▶ Fill the washer fluid reservoir with a mixture of water and washer fluid, e.g. MB WinterFit.

Adapt the mixing ratio to the outside temperature.

- Down to -10 °C: mix 1 part MB WinterFit to 2 parts water.
- Down to -20 °C: mix 1 part MB WinterFit to 1 part water.
- Down to -29 °C: mix 2 parts MB WinterFit to 1 part water.

- i** Add washer fluid concentrate, e.g. MB SummerFit or MB WinterFit, to the washer fluid all year round.

Vehicle data

General notes

Please note that for the specified vehicle data:

- the heights specified may vary as a result of:
 - tyres
 - load
 - condition of the suspension
 - optional equipment
- optional equipment reduces the maximum payload.
- vehicle-specific weight information can be found on the vehicle identification plate (▷ page 372).
- only for certain countries: you can find vehicle-specific vehicle data in the COC documents (CERTIFICATE OF CONFORMITY). These documents are delivered with your vehicle.

Dimensions and weights

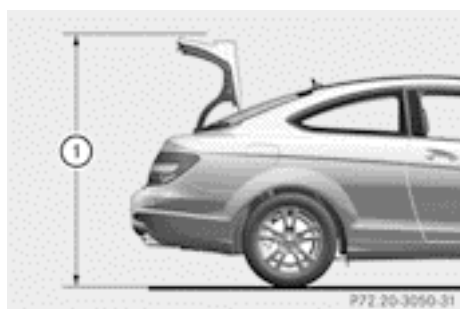

Missing values were not available at the time of going to print.

Model	①Opening height
C 180	1668 mm
C 220 CDI C 220 CDI BlueEFFICIENCY Edition	1665 mm

Model	①Opening height
C 63 AMG	
All other models	1669 mm

Missing values were not available at the time of going to print.

All models (except AMG vehicles)	
Vehicle length	4590 mm
Vehicle width including exterior mirrors	1997 mm
Vehicle width excluding exterior mirrors	1770 mm
Wheelbase	2760 mm
Maximum roof load	100 kg
Maximum boot load	100 kg

Model	Vehicle height
C 180	1406 mm
C 200	1407 mm
C 250 C 250 Sport C 350	1407 mm
C 350 4MATIC	
C 220 CDI C 220 CDI BlueEFFICIENCY Edition	1403 mm
C 250 CDI C 250 CDI Sport	1407 mm

C 63 AMG	
Vehicle length	
Vehicle width including exterior mirrors	
Vehicle width excluding exterior mirrors	
Vehicle height	
Wheelbase	
Maximum roof load	
Maximum boot load	

Trailer tow hitch

Mounting dimensions

! If you have a trailer tow hitch retrofitted, changes to the cooling system may be necessary, depending on the vehicle type.

If you have a trailer tow hitch retrofitted, observe the anchorage points on the chassis frame.

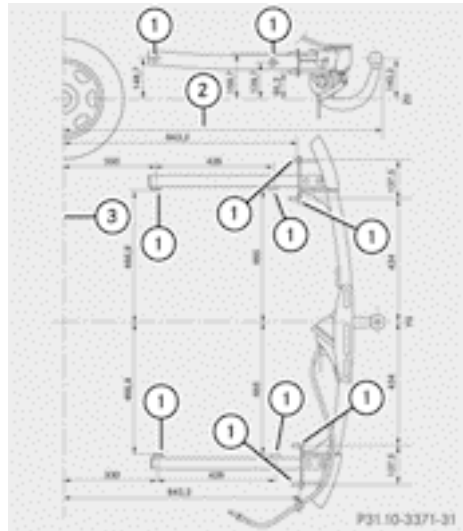

Example: anchorage points for the trailer tow hitch

- ① Anchorage points
- ② Overhang dimension
- ③ Rear axle centre line

Vehicles without the AMG sports package: for trailer tow hitches fitted at the factory, the overhang dimension including protective covering is 1,154 mm.

Vehicles with the AMG sports package: for trailer tow hitches fitted at the factory, the overhang dimension including protective covering is 1,181 mm.

Trailer loads

! Use a drawbar noseweight as close as possible to the maximum permissible noseweight. Do not use a noseweight of less than 50kg, otherwise the trailer may come loose.

Note that the payload and the rear axle load are reduced by the actual payload.

The C 63 AMG model cannot be used to tow a trailer.

Missing values for the C 350 4MATIC model were not available at the time of going to print.

	All models (except C 350 4MATIC and C 63 AMG)
Permissible trailer load, unbraked	750 kg ¹⁴
Permissible trailer load, braked ¹⁵	1800 kg
Maximum drawbar noseweight ¹⁶	75 kg

The actual noseweight may not be higher than the value which is given. The value can be found on the trailer tow hitch or trailer identification plates. The lowest weight applies.

You can attach carrier systems, e.g. bicycle racks or load-bearing implements, on the ball coupling. The maximum noseweight of 75 kg applies when using carrier systems on the ball coupling.

Permissible rear axle load when towing a trailer

The C 63 AMG model cannot be used to tow a trailer.

	Manual transmission	Automatic transmission
C 180	1130 kg	1135 kg
C 200	1155 kg	1155 kg
C 250	–	1160 kg
C 250 Sport	–	1160 kg
C 350	–	1190 kg
C 350 4MATIC	–	1190 kg
C 220 CDI	1150 kg	1155 kg
C 220 CDI ¹⁷ Edition	1150 kg	–

¹⁴ C 180 with manual transmission: 745 kg.

¹⁵ At a minimum gradient-climbing capability of 12% from a standstill.

¹⁶ The drawbar noseweight is not included in the trailer load.

¹⁷ BlueEFFICIENCY

	Manual transmission	Automatic transmission
C 250 CDI	1180 kg	1185 kg
C 250 CDI Sport	-	1185 kg

Publication details

Internet

Further information about Mercedes-Benz vehicles and about Daimler AG can be found on the following websites:

<http://www.mercedes-benz.com>

<http://www.daimler.com>

Editorial office

You are welcome to forward any queries or suggestions you may have regarding this Owner's Manual to the technical documentation team at the following address:

Daimler AG, HPC: CAC, Customer Service,
70546 Stuttgart, Germany

©Daimler AG: not to be reprinted, translated or otherwise reproduced, in whole or in part, without written permission from Daimler AG.

Vehicle manufacturer

Daimler AG
Mercedesstraße 137
70327 Stuttgart
Germany

As at 31.10.2012

Nur für internen Gebrauch / For internal use only



2045843783Z102

Order no. 65150797 02 Part no. 2045843783Z102 Edition ÄJ 2013-1a

Nur für internen Gebrauch / For internal use only