

E 320

E 320 4MATIC

E 500

E 500 4MATIC

E 55 AMG

Our company and staff congratulate you on the purchase of your new Mercedes-Benz.

Your selection of our product is a demonstration of your trust in our company name. Furthermore, it exemplifies your desire to own an automobile that will be as easy as possible to operate and provide years of service.

Your Mercedes-Benz represents the efforts of many skilled engineers and craftsmen. To help assure your driving pleasure, as well as your and your passengers' safety, we ask you to make a small investment of time:

- Please read this manual carefully, then return it to your vehicle where it will be handy for your reference.
- Please follow the recommendations contained in this manual. They are designed to assist you with the operation of your Mercedes-Benz.
- Please pay attention to the warnings and cautions contained in this manual. They are designed to help improve the safety of the vehicle operator and occupants.

We extend our best wishes for many miles of safe, pleasurable driving.

Mercedes-Benz USA, LLC
A DaimlerChrysler Company

Contents

Introduction	9	At a glance	19	Getting started	29
Product information	9	Cockpit	20	Unlocking	30
Operator's Manual	10	Instrument cluster	22	Unlocking with the SmartKey	30
Service and warranty information ..	10	Multifunction steering wheel	24	Unlocking with KEYLESS-GO*	32
Important notice for California		Center console	25	Adjusting	34
retail buyers and lessees of		Upper part	25	Seats	34
Mercedes-Benz automobiles	11	Lower part	26	Steering wheel	37
Maintenance	12	Overhead control panel	27	Mirrors	38
Roadside Assistance	12	Door control panel	28	Driving	40
Change of address or ownership....	12			Fastening the seat belts	40
Operating your vehicle outside				Starting the engine	43
the USA or Canada	13			Switching on headlamps	47
Where to find it	14			Turn signals and high beam	47
Symbols	15			Windshield wipers	48
Operating safety	16			Problems while driving	50
Proper use of the vehicle	16			Parking and locking	51
Problems with your vehicle	17			Parking brake	51
Reporting safety defects	18			Switching off headlamps	52
Reporting safety defects	18			Turning off engine	52

Contents

Safety and Security	55	Controls in detail	87	Memory function	116
Occupant safety.....	56	Locking and unlocking.....	88	Storing positions in memory	117
Airbags.....	57	SmartKey	88	Recalling positions from	
Seat belts.....	62	SmartKey with KEYLESS-GO*	91	memory.....	117
Children in the vehicle.....	65	Opening the doors from the inside.....	97	Storing exterior rear view	
Blocking of rear door window		Opening the trunk	97	mirror parking position	118
operation.....	72	Closing the trunk.....	99	Lighting	119
Panic alarm.....	73	Trunk lid opening/closing		Exterior lamp switch	119
Activating.....	73	system*	99	Combination switch	123
Deactivating.....	73	Trunk lid emergency release	104	Hazard warning flasher	123
Driving safety systems.....	74	Separately locking the trunk	105	Interior lighting	124
ABS	74	Separately unlocking the trunk	106	Door entry lamps	125
BAS	76	Automatic central locking	106	Trunk lamp.....	125
ESP.....	76	Locking and unlocking from		Instrument cluster	126
The SBC brake system	79	the inside	107	Instrument cluster illumination	126
Four wheel electronic traction		Seats	108	Coolant temperature gauge	127
system (4MATIC) with the ESP	82	Easy-entry / exit feature*	108	Trip odometer	127
Anti-theft systems.....	83	Removing and installing front		Tachometer.....	128
Immobilizer.....	83	seat head restraints	109	Outside temperature indicator	128
Anti-theft alarm system	84	Rear seat head restraints	110		
Tow-away alarm	85	Multicontour seat*	111		
		Drive-Dynamic seat*	112		
		Heated seats*	113		
		Seat ventilation*	114		

Contents

Control system	129	Good visibility	168	Automatic climate control*	184
Multifunction display.....	129	Rear view mirror	168	Setting the temperature	188
Multifunction steering wheel.....	130	Windshield wipers.....	169	Adjusting air distribution	189
Menus	132	Headlamp cleaning system*	170	Adjusting air volume	190
Standard display menu	134	Sun visors	170	Maximum cooling MAX COOL.....	190
AUDIO menu	134	Rear window sunshade*	172	Defrosting.....	190
NAVI* menu.....	136	Roller sunblind* in the rear doors.	172	Air recirculation mode	191
Distronic* menu.....	136	Rear window defroster.....	173	Charcoal filter	192
Malfunction memory menu	137	Climate control.....	174	Deactivating the climate	
Settings menu	138	Setting the temperature.....	178	control system.....	193
Trip computer menu.....	153	Adjusting air distribution.....	178	Air conditioning	194
TEL menu*	155	Adjusting air volume	179	Residual heat and ventilation.....	194
Automatic transmission.....	158	Defrosting	179	Rear air conditioning.....	195
One-touch gearshifting.....	159	Air recirculation mode	180	Power windows	197
Gear ranges	160	Deactivating the climate		Opening and closing the windows	197
Gear selector lever position	161	control system	181	Synchronizing power windows.....	200
Steering wheel gearshift control		Air conditioning.....	182	Sliding / pop-up roof*	201
(Speedshift) E 55 AMG.....	162	Residual heat and ventilation*	182	Opening and closing the	
Program mode selector switch.....	164			sliding / pop-up roof.....	201
Accelerator position.....	164			Synchronizing the	
Manual shift program E 55 AMG..	165			sliding / pop-up roof.....	204
Emergency operation					
(Limp Home Mode)	167				

Contents

Panorama sliding / pop-up roof*	205	Loading	233	Operation	265
Opening and closing the		Roof rack*	233	The first 1000 miles (1500 km)	266
roller sunblinds.....	205	Ski sack*	233	Driving instructions	267
Opening and closing the		Split rear bench seat*	236	Drive sensibly – save fuel.....	267
panorama sliding / pop-up roof.....	206	Expanding the cargo area*	239	Drinking and driving.....	267
Synchronizing the panorama		Loading instructions.....	240	Pedals	267
sliding / pop-up roof	209	Cargo tie-down rings*	241	Power assistance	268
Solar panel*	210	Useful features	242	Brakes.....	268
Driving systems	211	Interior storage spaces	242	Driving off	270
Cruise control.....	211	Ashtrays	246	Parking.....	270
Distronic*	214	Cigarette lighter	247	Tires	270
Airmatic DC (Dual Control)*	226	12-V socket*	248	Hydroplaning.....	271
Parktronic system*		Heated steering wheel*	248	Tire traction	272
(Parking assist).....	229	Telephone*	249	Tire speed rating.....	272
		Tele Aid*	250	Winter driving instructions	273
		Garage door opener	258	Standing water.....	274
				Passenger compartment.....	274
				Driving abroad	274
				Control and operation of	
				radio transmitter	275
				Catalytic converter.....	275
				Emission control	276
				Coolant temperature.....	277

Contents

At the gas station	278	Winter driving	295	Practical hints	309
Check regularly and before		Winter tires	295	What to do if	310
a long trip.....	279	Block heater* (Canada only).....	296	Lamps in instrument cluster	310
Engine compartment	281	Snow chains.....	296	Lamp in center console	317
Hood	281	Maintenance.....	297	Messages in the display.....	318
Engine oil	282	Flexible Service System PLUS		Where will I find ...?	350
Transmission fluid level.....	285	(FSS PLUS).....	297	First aid kit.....	350
Coolant level	285	Clearing the service indicator	298	Vehicles with TIREFIT kit	
Battery	287	Service term exceeded	298	(E 55 AMG)	350
Windshield washer system and		Calling up the service indicator.....	298	Spare wheel.....	350
headlamp cleaning system*	288	Resetting the service indicator	298	Luggage box	351
Tires and wheels.....	289	Setting the date for special		Vehicle tool kit.....	352
Important guidelines	289	works	300	Unlocking/locking in an emergency..	353
Life of tire.....	290	Calling up the service data		Unlocking the vehicle	353
Direction of rotation.....	290	information	301	Locking the vehicle	354
Checking tire inflation pressure ...	290	Vehicle care.....	302	Changing batteries in the	
Rotating wheels	293	Cleaning and care of vehicle	302	SmartKey/ SmartKey with	
				KEYLESS-GO*	355
				Fuel filler flap emergency release .	357
				Manually unlocking the	
				transmission selector lever.....	357
				Opening / closing in an emergency.....	358
				Sliding / pop-up roof* or panorama	
				sliding / pop-up roof*	358

Contents

Replacing bulbs	359		
Bulbs	359		
Replacing bulbs for front lamps....	361		
Replacing bulbs for rear lamps.....	363		
Replacing wiper blades	364		
Removing wiper blades	364		
Installing wiper blades.....	365		
Flat tire	366		
Preparing the vehicle.....	366		
Sealing tires with TIREFIT (E 55 AMG).....	366		
Mounting the spare wheel	370		
Batteries	375		
Disconnecting the battery	376		
Removing the battery	377		
Charging and reinstalling the battery.....	377		
Reconnecting the battery	377		
Jump starting	378		
Towing the vehicle	381		
Installing towing eye bolt.....	384		
Fuses	385		
Fuse box in passenger compartment.....	385		
		Technical data	387
		Spare parts service.....	388
		Warranty coverage.....	389
		Loss of Service and Warranty Information Booklet	389
		Identification labels	390
		Layout of poly-V-belt drive	391
		E 320 / E 500	391
		E 55 AMG.....	391
		Engine.....	392
		Rims and tires.....	394
		Same size tires.....	394
		Mixed size tires (E 55 AMG only)	396
		Minispare wheel.....	396
		Electrical system	397
		Main dimensions	398
		Weights.....	399
		Fuels, coolants, lubricants etc.....	400
		Capacities	400
		Engine oils	403
		Engine oil additives	403
		Air conditioning refrigerant	403
		Brake fluid.....	403
		Premium unleaded gasoline	404
		Fuel requirements.....	404
		Gasoline additives.....	404
		Coolants	405
		Windshield and headlamp washer system.....	407
		Consumer information.....	408
		Uniform tire quality grading	408
		Technical terms.....	411
		Index.....	417

▼ **Product information**

Please observe the following in your own best interest:

We recommend using genuine Mercedes-Benz parts as well as conversion parts and accessories explicitly approved by us for your vehicle model.

We have tested these parts to determine their reliability, safety and special suitability for Mercedes-Benz vehicles.

We are unable to make an assessment for other products and therefore cannot be held responsible for them, even if in individual cases an official approval or authorization by governmental or other agencies should exist. Use of such parts and accessories could adversely affect the safety, performance or reliability of your vehicle. Please do not use them.

Genuine Mercedes-Benz parts as well as conversion parts and accessories approved by us are available at your authorized Mercedes-Benz Center where you will receive comprehensive information, also on permissible technical modifications, and where proper installation will be performed.

Introduction

Operator's Manual

▼ Operator's Manual

This Operator's Manual contains a great deal of useful information. We urge you to read it carefully and familiarize yourself with the vehicle before driving.

For your own safety and longer service life of the vehicle, we urge you to follow the instructions and warnings contained in this manual. Ignoring them could result in damage to the vehicle or personal injury to you or others. Vehicle damage caused by failure to follow instructions is not covered by the Mercedes-Benz Limited Warranty.

Your vehicle may have some or all of the equipment described in this manual. Therefore, you may find explanations for optional equipment not installed in your vehicle. If you have any questions about the operation of any equipment, your authorized Mercedes-Benz Center will be glad to demonstrate the proper procedures.

We continuously strive to improve our product, and ask for your understanding that we reserve the right to make changes in design and equipment. Therefore, information, illustrations and descriptions in this Operator's Manual might differ from your vehicle.

Optional equipment is also described in this manual, including operating instructions wherever necessary. Since they are special-order items, the descriptions and illustrations herein may vary slightly from the actual equipment of your vehicle.

If there are any equipment details that are not shown or described in this Operator's Manual, your authorized Mercedes-Benz Center will be glad to inform you of correct care and operating procedures.

The Operator's Manual and Service Booklet are important documents and should be kept with the vehicle.

Service and warranty information

The Service and Warranty Information Booklet contains detailed information about the warranties covering your Mercedes-Benz, including:

- New Car Limited Warranty
- Emission System Warranty
- Emission Performance Warranty
- California, Maine, Massachusetts, and Vermont Emission Control System Warranty (California, Maine, Massachusetts, and Vermont only)
- State Warranty Enforcement Laws (Lemon Laws)

Important notice for California retail buyers and lessees of Mercedes-Benz automobiles

Under California law you may be entitled to a replacement of your vehicle or a refund of the purchase price or lease price, if Mercedes-Benz USA, LLC and /or its authorized repair or service facilities fail to fix one or more substantial defects or malfunctions in the vehicle that are covered by its express warranty after a reasonable number of repair attempts. During the period of 18 months from original delivery of the vehicle or the accumulation of 18000 miles (approximately 29000 km) on the odometer of the vehicle, whichever occurs first, a reasonable number of repair attempts is presumed for a retail buyer or lessee if one or more of the following occurs:

- (1) the same substantial defect or malfunction results in a condition that is likely to cause death or serious bodily injury if the vehicle is driven, that defect or malfunction has been subject to repair two or more times, and you have directly notified Mercedes-Benz USA, LLC in writing of the need for its repair,
- (2) the same substantial defect or malfunction of a less serious nature than category (1) has been subject to repair four or more times and you have directly notified us in writing of the need for its repair, or
- (3) the vehicle is out of service by reason of repair of the same or different substantial defects or malfunctions for a cumulative total of more than 30 calendar days. Written notification should be sent to us, not a dealer, at Mercedes-Benz USA, LLC, Customer Assistance Center, One Mercedes Drive, Montvale, NJ 07645-0350.

Introduction

Operator's Manual

Maintenance

The Service Booklet describes all the necessary maintenance work which should be performed at regular intervals.

Always have the Service Booklet with you when you take the vehicle to your authorized Mercedes-Benz Center for service. The service advisor will record each service in the booklet for you.

Roadside Assistance

The Mercedes-Benz Roadside Assistance Program provides factory trained technical help in the event of a breakdown. Calls to the toll-free Roadside Assistance number

1-800-FOR-MERCEdes (in the USA)
1-800-387-0100 (in Canada)

will be answered by Mercedes-Benz Customer Assistance Representatives 24 hours a day, 365 days a year.

For additional information refer to the Mercedes-Benz Roadside Assistance Program Brochure in your glove box.

Change of address or ownership

If you change your address, be sure to send in the "Change of Address Notice" found in the Service and Warranty Information Booklet, or simply call the Mercedes-Benz Customer Assistance Center (in the USA) at 1-800-FOR-MERCEdes, or Customer Service (in Canada) at 1-800-387-0100. It is in your own interest that we can contact you should the need arise.

If you sell your Mercedes, please leave all literature with the vehicle to make it available to the next operator.

If you bought this vehicle used, be sure to send in the "Notice of Purchase of Used Car" found in the Service and Warranty Information Booklet, or call the Mercedes-Benz Customer Assistance Center (in the USA) at 1-800-FOR-MERCEdes, or Customer Service (in Canada) at 1-800-387-0100.

Operating your vehicle outside the USA or Canada

If you plan to operate your vehicle in foreign countries, please be aware that:

- service facilities or replacement parts may not be readily available,
- unleaded gasoline for vehicles with catalytic converters may not be available; the use of leaded fuels will damage the catalyts,
- gasoline may have a considerably lower octane rating, and improper fuel can cause engine damage.

Certain Mercedes-Benz models are available for delivery in Europe under our European Delivery Program. For details, consult your authorized Mercedes-Benz Center or write to:

In the USA:

Mercedes-Benz USA, LLC
European Delivery Department
One Mercedes Drive
Montvale, NJ 07645-0350

In Canada:

Mercedes-Benz Canada, Inc.
European Delivery Department
849 Eglinton Avenue East
Toronto, Ontario M4G 2L5

Introduction

Where to find it

▼ Where to find it

This Operator's Manual is designed to provide comprehensive support information for you, the vehicle operator. For easy access, each section has its own reference color:

At a glance

Here you will find an overview of all the controls that can be operated from the driver's seat.

Getting started

Here you will find all the information you need for your first drive. You should read this section first if this is your first Mercedes-Benz vehicle or if you are renting or borrowing this vehicle.

Safety and Security

Here you will find descriptions of the safety features of your vehicle.

Controls in detail

Here you will find detailed information about the equipment installed in your vehicle. This section expands on the "Getting started" section and also describes technical innovations. If you are already familiar with the basic functions of your vehicle, this section will be of particular interest to you.

Operation

Here you will find all the information you need for the proper operation of your vehicle.

Practical hints

This section provides fast assistance for dealing with problems you may encounter.

Technical data

All important technical data for your vehicle can be found in this section.

Indexes

The glossary provides explanations of the most important technical terms.

The table of contents and the index are designed to help you find information quickly and easily.

The following publications are part of your vehicle documentation:

- this Operator's Manual
- the Service Booklet

Separate operating instructions will be provided as required depending on the equipment options installed in your vehicle.

▼ Symbols

The following symbols are found in this Operator's Manual:

- * Optional equipment is identified with an asterisk. Since standard equipment varies between models, the descriptions and illustrations in this manual may differ slightly from the actual equipment of your vehicle.

Warning!



Warning notices draw your attention to hazards that may endanger your health or life, or the health or life of others.



Highlights hazards that may result in damage to your vehicle.



Helpful hints or further information you may find useful.

- ▶ This symbol points to instructions for you to follow.
- ▶ A number of these symbols appearing in succession indicates a multiple-step procedure.
 - ▷ Page This symbol tells you where to look for further information on a topic.
 - ▷▷ This continuation symbol marks an interrupted procedure which will be continued on the next page.
 - > In the glossary of technical terms, this symbol is used to indicate cross-references to term definitions.
 - DISPLAY Words appearing in the multi-function display are printed in the type shown here.

Introduction

Operating safety

▼ Operating safety

Warning!



Work improperly carried out on electronic components and associated software could cause them to cease functioning. Because the vehicle's electronic components are interconnected, any modifications made may produce an undesired effect on other systems. Electronic malfunctions could seriously impair the operating safety of your vehicle.

See your authorized Mercedes-Benz Center for repairs or modifications to electronic components.

Other improper work or modifications on the vehicle could also have a negative impact on the operating safety of the vehicle.

Some safety systems only function while the engine is running. You should therefore never turn off the engine while driving.

Warning!



Heavy blows against the vehicle underbody or tires / wheels, for example when running over an obstacle, road debris or a pothole, may cause serious damage to and impair the operating safety of your vehicle. If you feel a sudden strong vibration or ride disturbance, or you suspect that damage to your vehicle has occurred, you should turn on your hazard warning flashers, carefully slow down, and drive with caution to an area which is a safe distance from the road.

Inspect the vehicle underbody and tires / wheels for possible damage. If the vehicle appears unsafe, have it towed to the nearest authorized Mercedes-Benz Center or other qualified maintenance or repair facility for further inspection or repairs.

Proper use of the vehicle

Proper use of the vehicle requires that you are familiar with the following information and rules:

- the safety precautions in this manual
- the “Technical data” section in this manual
- traffic rules and regulations
- motor vehicle laws and safety standards

Warning!



Various warning labels are attached to your vehicle. These warning labels are intended to make you and others aware of various risks. You should not remove any of these warning labels unless explicitly instructed to do so by information on the label itself. Removal of any of these labels may cause you and others to be unaware of certain risks which may result in an accident and/or personal injury.

▼ **Problems with your vehicle**

If you should experience a problem with your vehicle, particularly one that you believe may affect its safe operation, we urge you to immediately contact your authorized Mercedes-Benz to have the problem diagnosed and corrected if required. If the matter is not handled to your satisfaction, please discuss the problem with the Mercedes-Benz Center management, or if necessary contact us at one of the following addresses:

In the USA:

Customer Assistance Center
Mercedes-Benz USA, LLC
One Mercedes Drive
Montvale, NJ 07645-0350

In Canada:

Customer Relations Department
Mercedes-Benz Canada, Inc.
849 Eglinton Avenue East
Toronto, Ontario, M4G 2L5

Introduction

Reporting safety defects

▼ Reporting safety defects

For the USA only:

The following text is published as required of manufacturers under Title 49, Code of U.S. Federal Regulations, Part 575 pursuant to the “National Traffic and Motor Vehicle Safety Act of 1966.”

Reporting safety defects

If you believe that your vehicle has a defect which could cause a crash or could cause injury or death, you should immediately inform the National Highway Traffic Safety Administration (NHTSA) in addition to notifying Mercedes-Benz USA, LLC.

If NHTSA receives similar complaints, it may open an investigation, and if it finds that a safety defect exists in a group of vehicles, it may order a recall and remedy campaign. However, NHTSA cannot become involved in individual problems between you, your dealer, or Mercedes-Benz USA, LLC.

To contact NHTSA, you may either call the Auto Safety Hotline toll-free at 1-888-327-4236 (or 366-0123 in Washington, D.C. area) or write to: NHTSA, U.S. Department of Transportation, Washington, D.C. 20590. You can also obtain other information about motor vehicle safety from the Hotline.

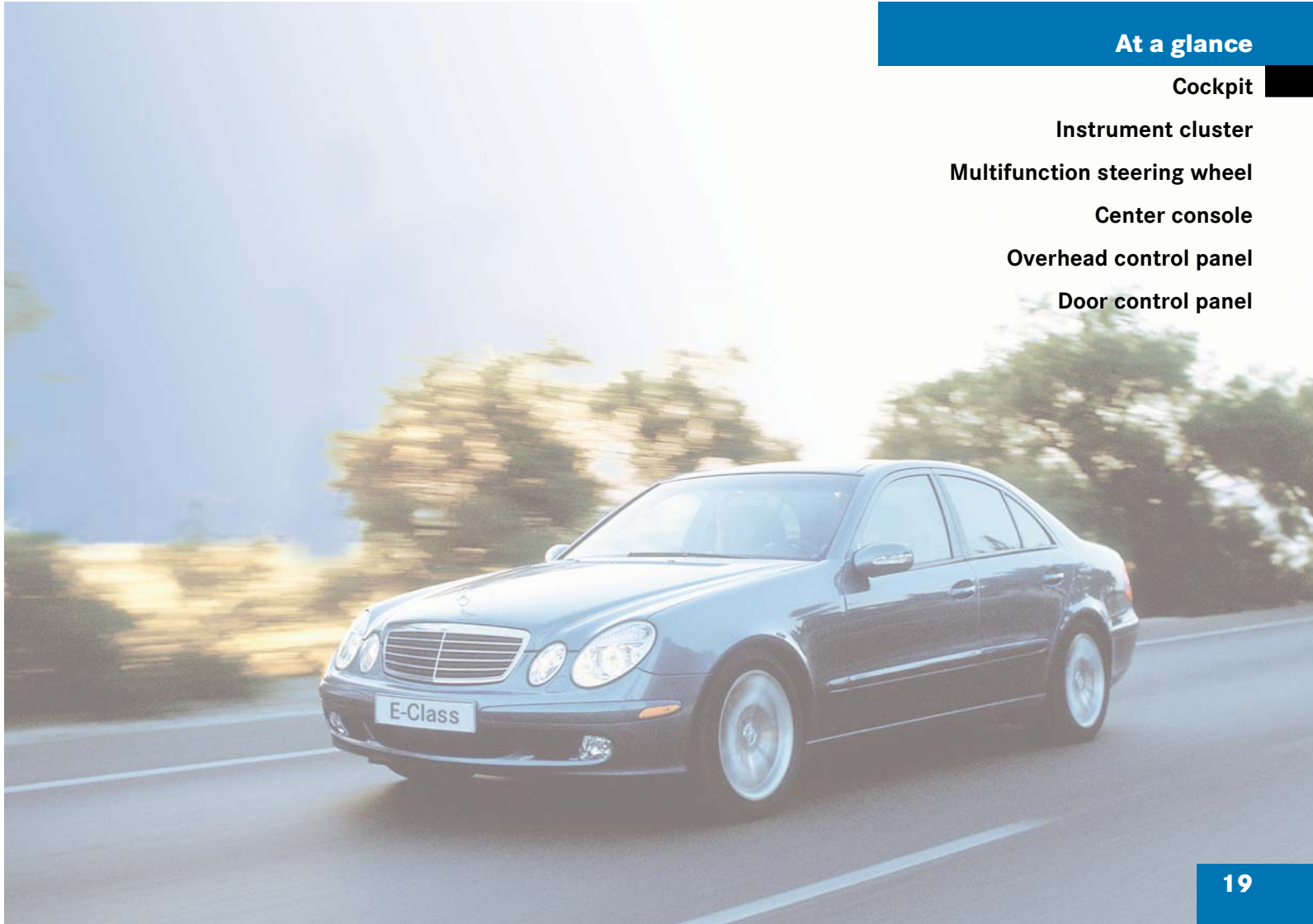

At a glance

Cockpit

Instrument cluster

Multifunction steering wheel

Center console

Overhead control panel

Door control panel

At a glance

Cockpit

▼ Cockpit

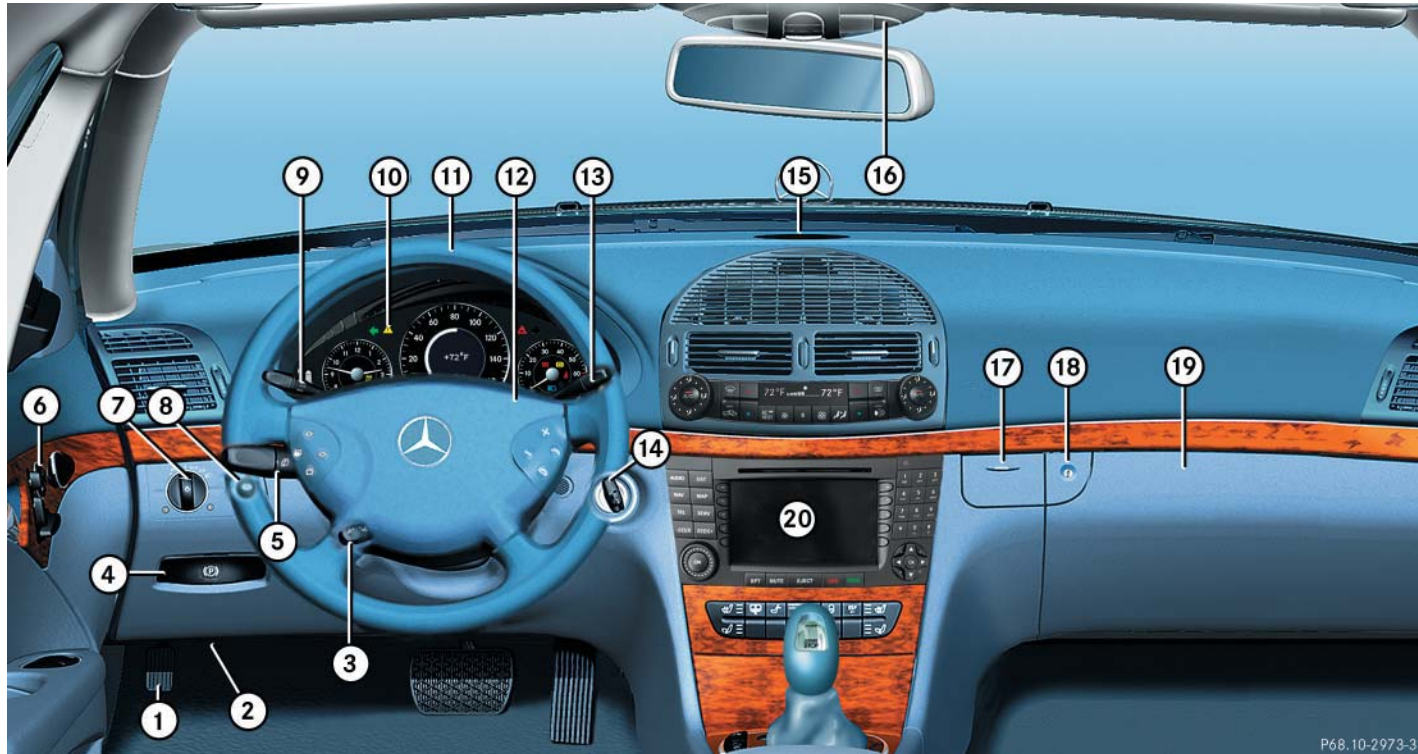

P68.10-2973-31

At a glance

Cockpit

Item	Page
① Parking brake pedal	45, 51
② Hood lock release	281
③ Steering wheel adjustment stalk	37
Heated steering wheel*	248
④ Parking brake release	45
⑤ Combination switch	
• Turn signals	47
• Windshield wipers	48
• High beam	47
⑥ Door control panel	28
⑦ Exterior lamp switch	119

Item	Page
⑧ Headlamp washer button*	170
⑨ Cruise control lever	
• Cruise control	218
• Distronic*	214
⑩ Instrument cluster	22, 126
⑪ Multifunction steering wheel	24, 130
⑫ Horn	
⑬ Lever for voice control system*, see separate operating instructions	

Item	Page
⑭ Starter switch	31
⑮ Front Parktronic* warning indicator	229
⑯ Overhead control panel	27
⑰ Mobile phone/Glasses box	242
⑱ Glove box lid release, glove box lock	242
⑲ Glove box	242
⑳ Center console	25

At a glance



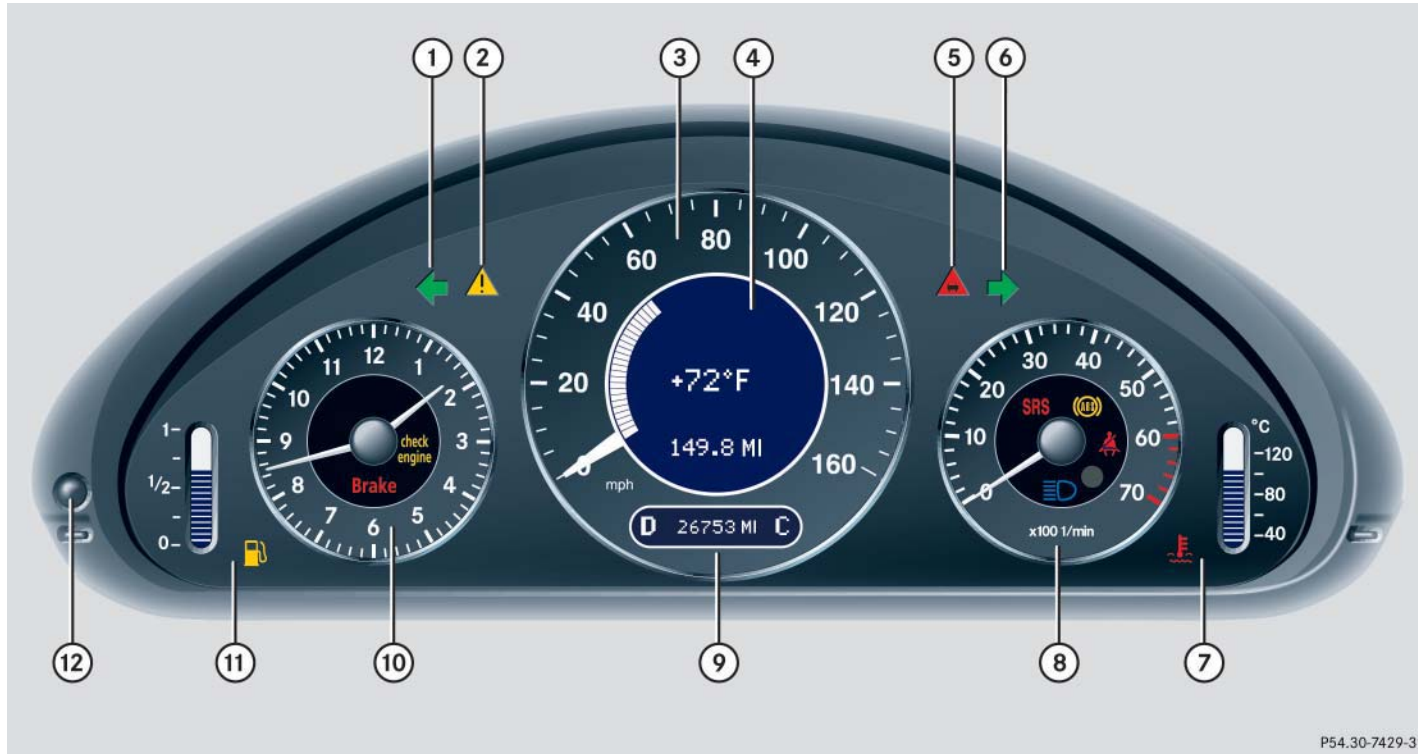

Instrument cluster





▼ Instrument cluster







At a glance

Instrument cluster

Item	Page
①  Left turn signal indicator lamp	
②  Antilock Brake System (ABS)/Electronic Stability Program (ESP) warning lamp	311
③ Speedometer	
④ Multifunction display with:	
Basic display with outside temperature display	141
Status indicator with malfunction warning message	
Trip odometer	127
⑤  Distance warning lamp ¹	315
⑥  Right turn signal indicator lamp	

Item	Page
⑦ Coolant temperature display with:	
 Coolant temperature warning lamp	314
⑧ Tachometer with:	
 Supplemental restraint system indicator lamp	316
 Antilock Brake System (ABS) malfunction indicator lamp	310
 Seat belt non-usage warning lamp	315
 High beam headlamp indicator	123
⑨ Main odometer with:	
• Selector lever position	43
• Program mode	164

Item	Page
⑩ Clock with:	143
 Brake warning lamp, except Canada	312
 Brake warning lamp, Canada only	312
 Engine malfunction indicator lamp	313
⑪ Fuel display with:	
 Fuel reserve warning lamp	315
⑫ Reset button for:	
• Resetting trip odometer	127
• Adjusting instrument cluster illumination	126
• Confirming new time settings	143





¹ Vehicles without Distronic*: Warning lamp without function. It illuminates with the ignition on. It should go out when the engine is running.



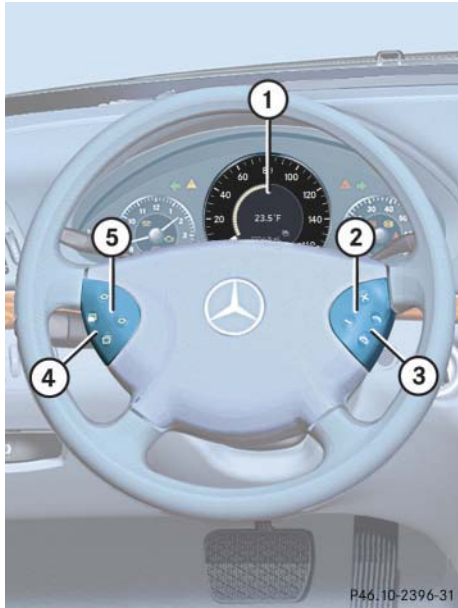

At a glance

Multifunction steering wheel

▼ Multifunction steering wheel



Item	Page
① Multifunction display in speedometer	129
Operating control system	130
② Selecting the submenu or setting the volume	
 down/to decrease  up/to increase	
③ Telephone*: Press button	
 to take a call to dial a call  to end a call to reject an incoming call	

Item	Page
④ Menu systems: Press button	
 for next system  for previous system	
⑤ Moving within a menu: Press button	
 for next display  for previous display	

At a glance

Center console

▼ Center console

Upper part



P68.20-2851-31

Item	Page
① Automatic climate control*	184
② COMAND system, see separate operating instructions	
③ Seat heater*, front passenger side	113
④ Electronic Stability Program (ESP) control switch	78
⑤ Central locking switch	107
⑥ Opening/closing button for storage tray or CD changer*, see separate operating instructions	243
⑦ Rear seat head restraints switch, folding down	110

Item	Page
⑧ Rear window sunshade*	78
⑨ Seat heater*, driver's side	113
⑩ Hazard warning flasher switch	123
⑪ PASSENGER AIRBAG OFF indicator lamp	67

At a glance

Center console

Lower part

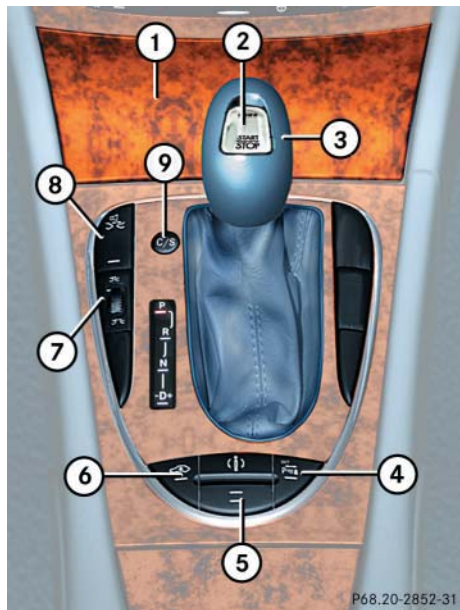

Item	Page
① Ashtray	246
② KEYLESS-GO* start/stop button	33
③ Selector lever for automatic transmission	43, 161
④ Parking assist (Parktronic system)* deactivation switch	229
⑤ Adaptive damping system (ADS)* switch	226

Item	Page
⑥ Vehicle level control switch*	227
⑦ Thumbwheel for setting distance for DISTRONIC*	221
⑧ Distance warning function* on/off switch	222
⑨ Program mode selector for automatic transmission	164

At a glance

Overhead control panel

▼ Overhead control panel

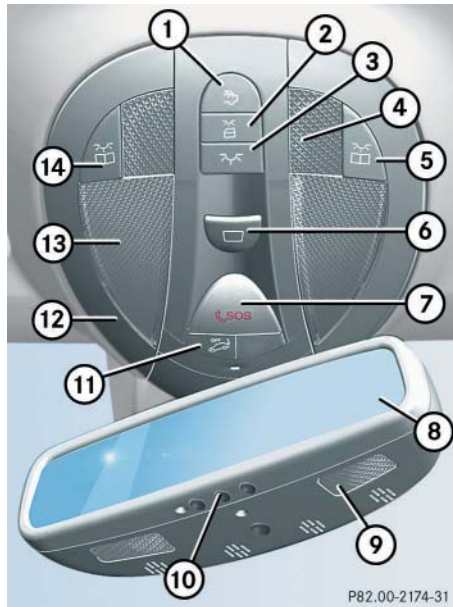

Item	Page
① Rear interior lighting on/off	125
② Automatic interior lighting	124
③ Front interior lighting on/off	124
④ Temperature sensor	
⑤ Right reading lamp on/off	124
⑥ Sliding/pop-up roof* or panorama sliding/pop-up roof*	201, 205

Item	Page
⑦ Tele Aid (emergency call system) button	250
⑧ Rear view mirror	168
⑨ Reading lamps	124
⑩ Garage door opener	258
⑪ Tow-away alarm button	85
⑫ Ambient lighting	147
⑬ Interior lighting	
⑭ Left reading lamp on/off	125

At a glance

Door control panel

▼ Door control panel

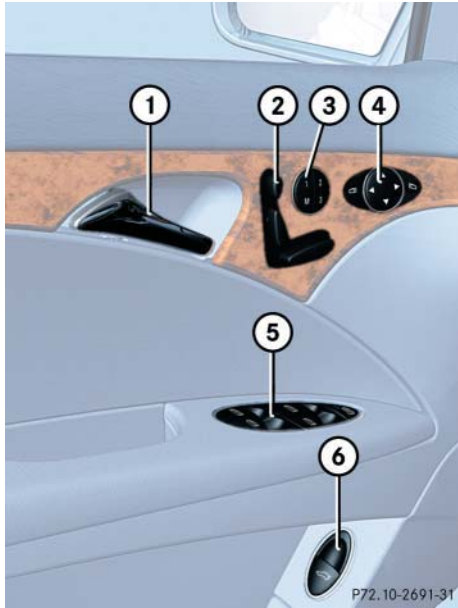

	Item	Page
①	Door handle	97
②	Seat adjustment	35
③	Memory function (for storing seat, exterior mirror and steering wheel settings)	116
④	Exterior rear view mirror adjustment	38
⑤	Switches for opening/closing front and rear side windows, rear window override switch	197
⑥	Remote trunk lid release switch, Trunk lid opening/closing system*	99

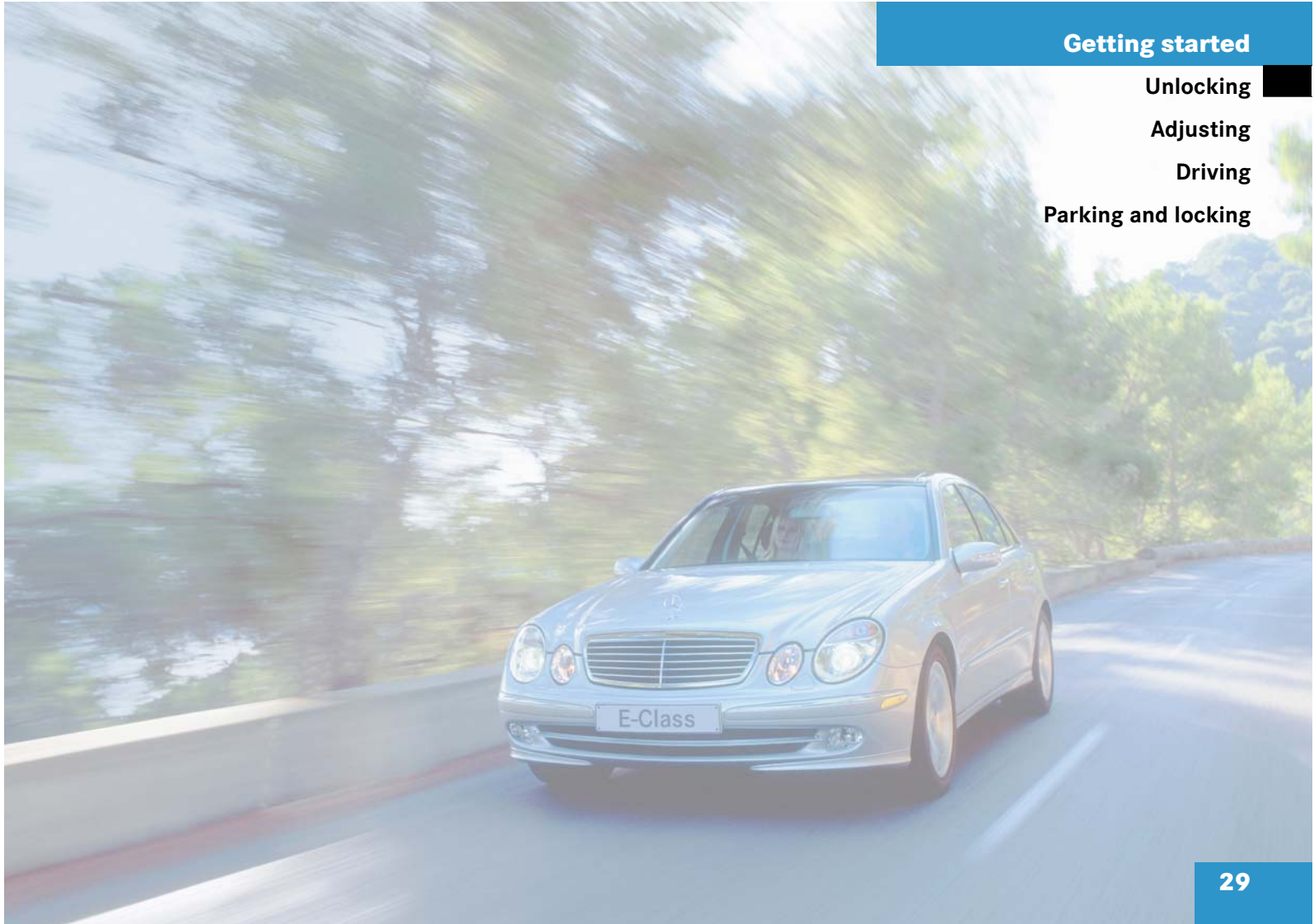

Getting started

Unlocking

Adjusting

Driving

Parking and locking

Getting started

Unlocking

The “Getting started” section provides an overview of the vehicle’s most basic functions. First-time Mercedes-Benz owners should pay special attention to the information given here.



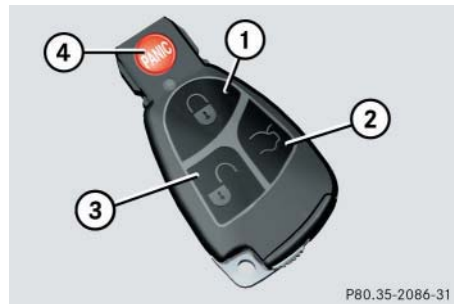

If you are already familiar with the basic functions described here, the “Controls in detail” section will provide you with further information. The corresponding page references are located at the end of each segment.

▼ Unlocking

Unlocking with the SmartKey



SmartKey

- ①  Lock button
- ②  Unlock button for trunk lid
- ③  Unlock button
- ④  Panic button (▷ page 73)

- ▶ Press unlock button  on the SmartKey.

All turn signal lamps flash once. The locking knobs in the doors move up.

The SBC brake system is activated.

- ▶ Get in the vehicle and insert the SmartKey in the starter switch.

More information can be found in the “Controls in detail” section (▷ page 88).

Starter switch positions

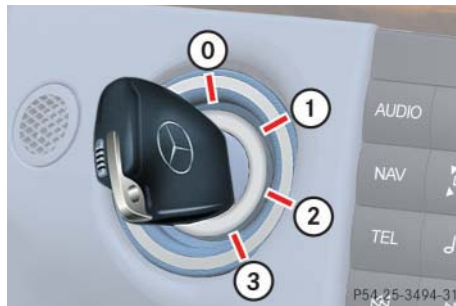

Starter switch

- 0 For removing SmartKey
- 1 Power supply to some electrical consumers, such as seat adjustment
- 2 Ignition (power supply for all electrical consumers) and driving position
- 3 Starting position

Warning!



When leaving the vehicle, always take the SmartKey with you and lock the vehicle. Do not leave children unattended in the vehicle, or with access to an unlocked vehicle. Unsupervised use of vehicle equipment may cause an accident and/or serious personal injury.



The SmartKey can only be removed from the starter switch with the gear selector lever in position **P**.



If the SmartKey cannot be turned, the battery may not be sufficiently charged.

- ▶ Check the battery and charge it if necessary (▷ page 287).
- ▶ Get a jump start (▷ page 378).

To prevent accelerated battery discharge or a completely discharged battery, always remove the SmartKey from the starter switch when the engine is not in operation.

Getting started

Unlocking

Unlocking with KEYLESS-GO*

If you have the KEYLESS-GO function, your vehicle checks whether the SmartKey with KEYLESS-GO is valid when you pull the door handle. If your SmartKey is valid, the doors will unlock, and you can open them.

The function of the SmartKey overrides the KEYLESS-GO function.



To unlock the vehicle, the SmartKey with KEYLESS-GO must be outside the vehicle, no further than approximately 3 feet (1 meter) away from the door.

- ▶ Pull the door handle.
The turn signal lamps flash once. The locking knobs on the doors move up.
The SBC brake system is activated.

If the SmartKey is inside the vehicle, pressing the KEYLESS-GO start/stop button on the gear selector lever corresponds to turning the SmartKey to the various starter switch positions.

Warning!



When leaving the vehicle, always take the SmartKey with KEYLESS-GO with you, and lock the vehicle. Do not leave children unattended in the vehicle, or with access to an unlocked vehicle. Unsupervised use of vehicle equipment may cause an accident and/or serious personal injury.

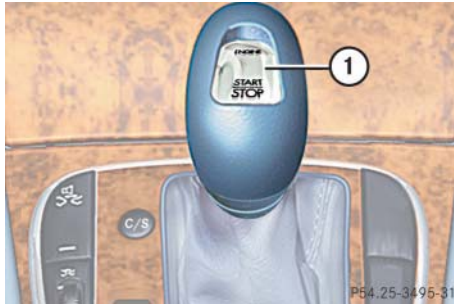

① KEYLESS-GO start/stop button

Before you press the KEYLESS-GO start/stop button, the vehicle's on-board electronics have status **0** (as with SmartKey removed).

The SmartKey with KEYLESS-GO must be located in the vehicle.

- ▶ Make sure the gear selector lever is set to **P**.
- ▶ Do not depress the brake pedal.

Position 1

- ▶ Press the KEYLESS-GO start/stop button once.

This supplies power to some electrical consumers, such as seat adjustment.



If you now press the KEYLESS-GO start/stop button

- once again, the ignition (position **2**) is switched on.
- twice, the power supply is again switched off.

Ignition (or position 2)

- ▶ Press the KEYLESS-GO start/stop button twice.

This supplies power to all electrical consumers. All the lights in the instrument cluster come on.



If you now press the KEYLESS-GO start/stop button once, the power supply is again switched off.

More information can be found in the “Controls in detail” section (▷ page 91). For information on starting the engine using the KEYLESS-GO start/stop button, see “Starting with KEYLESS-GO” (▷ page 44).

Getting started

Adjusting

▼ Adjusting

Warning!



All seat, head restraint, steering wheel, and rear view mirror adjustments, as well as fastening of seat belts, must be done before the vehicle is put into motion.

Seats

Warning!



Do not adjust the driver's seat while driving. Adjusting the seat while driving could cause the driver to lose control of the vehicle.

Never ride in a moving vehicle with the seat back reclined. Sitting in an excessively reclined position can be dangerous. You could slide under the seat belt in a collision. If you slide under it, the belt would apply force at the abdomen or neck. That could cause serious or fatal injuries. The seat back and seat belts provide the best restraint when the wearer is in an upright position and belts are properly positioned on the body.

Your seat must be adjusted so that you can correctly fasten your seat belt (▷ page 40).

Never place hands under the seat or near any moving parts while a seat is being adjusted.

Warning!



When leaving the vehicle, always remove the SmartKey from the starter switch, take the SmartKey with KEYLESS-GO* with you, and lock your vehicle.

The power seats can also be operated with the driver's or passenger door open. Do not leave children unattended in the vehicle, or with access to an unlocked vehicle. Unsupervised use of vehicle equipment may cause an accident and / or serious personal injury.

Warning!



Children 12 years old and under must never ride in the front seat, except in a Mercedes-Benz authorized BabySmart™ compatible child seat, which operates with the BabySmart™ system installed in the vehicle to deactivate the passenger front airbag when it is properly installed. Otherwise they will be struck by the airbag when it inflates in a crash. If this happens, serious or fatal injury will result.

According to accident statistics, children are safer when properly restrained in the rear seating positions than in the front seating positions. Infants and small children must ride in back seats and be seated in an appropriate infant or child restraint system, which is properly secured with the vehicle's seat belt and top tether strap, or secured via lower anchors and top tether strap, fully in accordance with the child seat manufacturer's instructions.

A child's risk of serious or fatal injuries is significantly increased if the child restraints are not properly secured in the vehicle and the child is not properly secured in the child restraint.

Seat adjustment

The seat adjustment switches are located on the front doors.

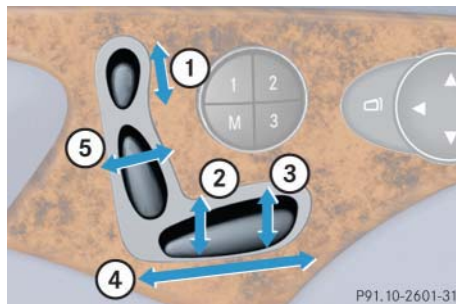

- ① Head restraint height
- ② Seat height
- ③ Seat cushion tilt
- ④ Seat fore and aft adjustment
- ⑤ Backrest tilt

- ▶ Turn the SmartKey in the starter switch to position **1** or **2** (▷ page 31) or
- ▶ Press the KEYLESS GO* start/stop button once or twice (▷ page 33). or
- ▶ Open the driver's or passenger door.

Seat fore and aft adjustment

- ▶ Press the switch forward or backward in the direction of arrow ④.

Adjust a comfortable seating position that still allows you to reach the accelerator / brake pedal safely. The position should be as far to the rear as possible, consistent with ability to properly operate controls.



When moving the seat, be sure there are no items in the footwell or behind the seats. Otherwise you could damage the seats.

The memory function (▷ page 116) lets you store the setting for the seat position together with the setting for the steering wheel and the exterior rear view mirrors.

Getting started

Adjusting

Getting started

Adjusting

Seat cushion tilt

- ▶ Press the switch up or down in the direction of arrow ③ until your upper legs are lightly supported.

Backrest tilt

- ▶ Press the switch forward or backward in the direction of arrow ④ until your arms are slightly angled when holding the steering wheel.

Seat height

- ▶ Press the switch up or down in the direction of arrow ②.

Head restraint height

- ▶ Press the switch up or down in the direction of arrow ⑤.

Warning!



For your protection, drive only with properly positioned head restraints.

Adjust head restraint so that the center of the head restraint supports the back of the head at eye level. This will reduce the potential for injury to the head and neck in the event of an accident or similar situation.

Do not drive the vehicle without the seat head restraints. Head restraints are intended to help reduce injuries during an accident.

Head restraint tilt

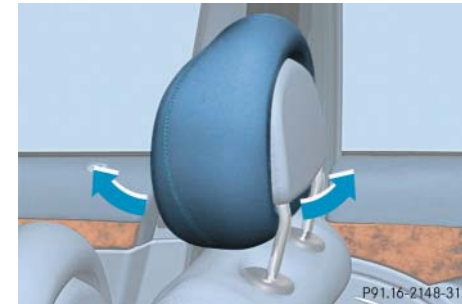

Manually adjust the angle of the head restraint.

- ▶ Push or pull on the lower edge of the head restraint cushion.

More information on seats can be found in the “Controls in detail” section (▷ page 108).

Steering wheel

Warning!



Do not adjust the steering wheel while driving. Adjusting the steering wheel while driving could cause the driver to lose control of the vehicle.

When leaving the vehicle, always remove the SmartKey from the starter switch, take the SmartKey with KEYLESS-GO* with you and lock your vehicle.

The steering wheel adjustment feature can also be operated with the driver's door open. Do not leave children unattended in the vehicle, or with access to an unlocked vehicle. Unsupervised use of vehicle equipment may cause an accident and/or serious personal injury.

Steering wheel adjustment

The stalk for steering wheel adjustment is located on the steering column (lower left).

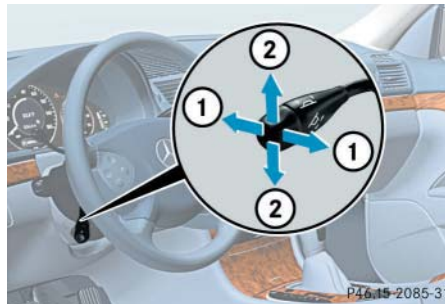

- ① Adjusting steering column, in or out
 - ② Adjusting steering column, up or down
- ▶ Turn the SmartKey in the starter switch to position **1** or **2**.
or
 - ▶ Press the KEYLESS GO* start/stop button once or twice.
or
 - ▶ Open the driver's door.

Getting started

Adjusting

Adjusting steering column in or out

- ▶ Move stalk forward or back in the direction of arrow ① until a comfortable steering wheel position is reached with your arms slightly bent at the elbow.

Adjusting steering column up or down

- ▶ Move stalk up or down in the direction of arrow ②.

Make sure your legs can move freely and that all the displays (incl. malfunction and indicator lamps) on the instrument cluster are clearly visible.



The memory function (▷ page 116) lets you store the setting for the seat position together with the setting for the steering wheel and the exterior rear view mirrors.

For more information, see "Heated steering wheel*" (▷ page 248).

Getting started

Adjusting

Mirrors

Adjust the interior and exterior rear view mirrors before driving so that you have a good view of the road and traffic conditions.

Warning!



In the case of an accident liquid electrolyte may escape the mirror housing if the mirror glass breaks.

Electrolyte has an irritating effect. Do not allow the liquid to come into contact with eyes, skin, clothing, or respiratory system. In case it does, immediately flush affected area with water, and seek medical help if necessary.

Interior rear view mirror

- ▶ Manually adjust the interior rear view mirror.

More information can be found in the “Controls in detail” section (▶ page 168).

Exterior rear view mirror

Warning!



Exercise care when using the passenger side exterior rear view mirror. The mirror surface is convex (outwardly curved surface for a wider field of view). Objects in mirror are closer than they appear. Check your interior rear view mirror or glance over your shoulder before changing lanes.



Electrolyte drops coming into contact with the vehicle paint finish can only be completely removed while in their liquid state and by applying plenty of water.

The buttons are located on the driver's door.

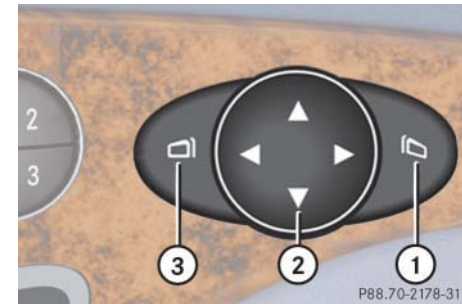

- ① Passenger-side exterior rear view mirror button
- ② Adjustment button
- ③ Driver's side exterior rear view mirror button

- ▶ Make sure the ignition is switched on.
All the lamps in the instrument cluster come on.
- ▶ Press button ③ for the left mirror or button ① for the right mirror.
- ▶ Push adjustment button ② up, down, left or right according to the setting desired.



If an exterior rear view mirror was forcibly pushed forward (hit from the rear) or forcibly pushed rearward (hit from the front), reposition it by applying firm pressure until it snaps into place. The mirror housing is now properly positioned and you can adjust the mirror normally.



The memory function (▷ page 116) lets you store the setting for the seat position together with the setting for the steering wheel and the exterior rear view mirrors.

At low ambient temperatures, the mirrors will be heated automatically.

For more information, see “Activating exterior rear view mirror parking position” (▷ page 169).

Getting started

Driving

▼ Driving

Warning!



Do not lay any objects in the driver's footwell. Be careful that floor mats or carpets in the driver's footwell have sufficient clearance for the pedals.

During sudden driving or braking maneuvers the objects could get caught between the pedals. You could then no longer brake or accelerate.

Fastening the seat belts

Warning!



Always fasten your seat belt before driving off. Always make sure your passengers are properly restrained, even those sitting in the rear and pregnant women.

Failure to wear and properly fasten and position your seat belt greatly increases your risk of injuries and their likely severity in an accident. You and your passengers should always wear seat belts.

If you are ever in an accident, your injuries can be considerably more severe without your seat belt properly buckled. Without your seat belt buckled, you are much more likely to hit the interior of the vehicle or be ejected from it. You can be seriously injured or killed.

In the same crash, the possibility of injury or death is lessened if you are wearing your seat belt. The airbags can only protect as expected if the occupants are using their seat belts (▷ page 62).

Warning!



Children 12 years old and under must never ride in the front seat, except in a Mercedes-Benz authorized BabySmart™ compatible child seat, which operates with the BabySmart™ system installed in the vehicle to deactivate the passenger front airbag when it is properly installed. Otherwise they will be struck by the airbag when it inflates in a crash. If this happens, serious or fatal injury will result.

According to accident statistics, children are safer when properly restrained in the rear seating positions than in the front seating positions. Infants and small children must ride in back seats and be seated in an appropriate infant or child restraint system, which is properly secured with the vehicle's seat belt and top tether strap, or secured via lower anchors and top tether strap, fully in accordance with the child seat manufacturer's instructions.

A child's risk of serious or fatal injuries is significantly increased if the child restraints are not properly secured in the vehicle and the child is not properly secured in the child restraint.

Warning!



Never let more people ride in the vehicle than there are seat belts available. Be sure everyone riding in the vehicle is correctly restrained with a separate seat belt.

Warning!



Never ride in a moving vehicle with the seat backrest reclined. Sitting in an excessively reclined position can be dangerous. You could slide under the seat belt in a collision. If you slide under it, the belt would apply force at the abdomen or neck. That could cause serious or even fatal injuries. The seat backrest and seat belt provide the best restraint when the wearer is in an upright position and the belt is properly positioned on the body.

Warning!



Read and observe the additional warning notices printed in the "Safety and security" section (▷ page 62).

BabySmart™ is a trademark of Siemens Automotive Corp.

Getting started

Driving



- ① Retractor
- ② Latch plate
- ③ Buckle
- ④ Release button

Getting started

Driving

- ▶ Pull the seat belt smoothly from the seat belt outlet.
- ▶ Place the belt over your shoulder.
- ▶ Push latch plate ② into buckle ③ until it clicks.
- ▶ If necessary, tighten the lap portion to a snug fit by pulling shoulder portion up.

Belt outlet height adjustment

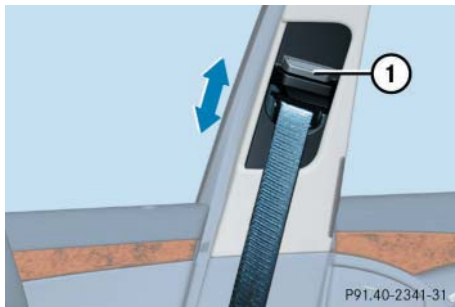

- ① Release button
- ▶ Press release button ① and move the seat belt height adjuster upward or downward.

Proper use of seat belts

- Do not twist the belt when fastening.
- Adjust seat belt so that the shoulder portion is located as close as possible to the middle of the shoulder (it should not touch the neck or pass under the arm).
- Position the lap belt as low as possible on your hips (over hip joint) and not across the abdomen.
- Place the seat backrest in a nearly upright position.
- Never use a seat belt for more than one person at a time.
- Do not fasten a seat belt around a person and another object at the same time.
- Check your seat belt during travel to ensure that it is properly positioned.
- Ensure that the seat belt is always fitted snugly. You should avoid wearing bulky clothing, such as winter coats, when traveling in the vehicle.

Warning!



Do not pass belts over sharp edges. They could tear.

Do not allow the belt to get caught in the door or in the seat adjustment mechanism. This could damage the belt.

Never attempt to make modifications to seat belts. This could impair the effectiveness of the belts.

Damaged seat belts or belts that were highly stressed in an accident must be replaced. Contact an authorized Mercedes-Benz Center.

Starting the engine

Warning!



Inhalation of exhaust gas is hazardous to your health. All exhaust gas contains carbon monoxide, and inhaling it can cause unconsciousness and lead to death.

Do not run the engine in confined areas (such as a garage) which are not properly ventilated. If you think that exhaust gas fumes are entering the vehicle while driving, have the cause determined and corrected immediately. If you must drive under these conditions, drive only with at least one window fully open.

Automatic transmission

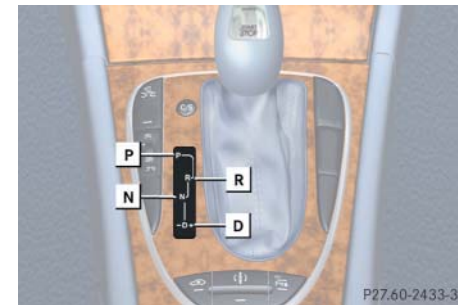

Gearshift pattern for automatic transmission

- P** Park position with gear selector lever lock
- R** Reverse gear
- N** Neutral
- D** Drive position

More information can be found in the “Controls in detail” section (▷ page 160).

Getting started

Driving

Starting with the SmartKey

- ▶ Make sure the gear selector lever is set to **P**.
- ▶ Do not depress the accelerator.
- ▶ Turn the SmartKey in the starter switch to position **3** and hold until the engine starts (▷ page 31).



You can also use the “touch-start” function. Turn the SmartKey to position **3** and release it again immediately. The engine then starts automatically.

- ▶ Depress the brake pedal.

The selector lever lock is released.

For information on turning off the engine with the SmartKey, see “Turning off engine” (▷ page 52).

Starting with KEYLESS-GO*

You can start your vehicle without the SmartKey in the starter switch using the KEYLESS-GO start/stop button on the gear selector lever.

The SmartKey with KEYLESS-GO must be located in the vehicle.

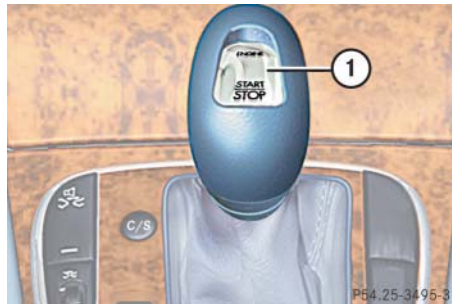

① KEYLESS-GO start/stop button

- ▶ Make sure the gear selector lever is set to **P**.

- ▶ Depress the brake pedal during the starting procedure. Do not depress accelerator.

The selector lever lock is released.

- ▶ Press KEYLESS-GO start/stop button ① once.

The engine starts automatically if the SmartKey with KEYLESS-GO is in the vehicle.

For information on turning off the engine with KEYLESS-GO, see “Turning off with KEYLESS-GO*” (▷ page 53).

Starting difficulties

If the engine does not start as described, carry out the following steps:

- ▶ If you are starting the engine with the SmartKey, turn SmartKey in starter switch to position **0** and repeat starting procedure.
- ▶ If you are starting the engine with KEYLESS-GO: Close any doors that may be open to allow for better detection of the SmartKey with KEYLESS-GO.
Or:
Start the engine with the SmartKey as radio signals from another source may be interfering with the SmartKey with KEYLESS-GO.
- ▶ Repeat the starting procedure (▷ page 43). Remember that extended starting attempts can drain the battery.
- ▶ Get a jump start (▷ page 378).

If the engine does not start after several starting attempts, there could be a malfunction in the engine electronics or in the fuel supply system.

- ▶ Notify an authorized Mercedes-Benz Center.

Parking brake

- ① Parking brake pedal
- ② Parking brake release handle

Warning!

When leaving the vehicle, always remove the SmartKey from the starter switch, take the SmartKey with KEYLESS-GO* with you and lock the vehicle. Do not leave children unattended in the vehicle, or with access to an unlocked vehicle. Children could release the parking brake, which could result in an accident and/or serious injury.

- ▶ Release the parking brake by pulling on handle ②.

The warning lamp **BRAKE** (USA only) or **(P)** (Canada only) in the clock goes out.

Getting started

Driving

Driving

- ▶ Depress the brake pedal.
- ▶ Move selector lever to position **D** or **R**.



Wait for the gear selection process to complete before setting the vehicle in motion.

- ▶ Release the brake pedal.
- ▶ Carefully depress the accelerator pedal.

Once the vehicle is in motion, the automatic central locking system engages and the locking knobs drop down.



You can open a locked door from the inside. Open door only when conditions are safe to do so.



If you hear a warning signal when driving off, you have forgotten to release the parking brake.

Release the parking brake.

After a cold start the automatic transmission engages at a higher revolution. This allows the catalytic converter to reach its operating temperature earlier.

Warning!



On slippery road surfaces, never downshift in order to obtain braking action. This could result in drive wheel slip and reduced vehicle control. Your vehicle's ABS will not prevent this type of loss of control.

Warning!



It is dangerous to shift the gear selector lever out of **P** or **N** if the engine speed is higher than idle speed. If your foot is not firmly on the brake pedal, the vehicle could accelerate quickly forward or in reverse. You could lose control of the vehicle and hit someone or something. Only shift into gear when the engine is idling normally and when your right foot is firmly on the brake pedal.

More information on driving can be found in the "Operation" section (▷ page 267).



Simultaneously depressing the accelerator pedal and applying the brake reduces engine performance and causes premature brake and drivetrain wear.

Switching on headlamps



Exterior lamp switch

- ① Off
- ② Low beam headlamps on

► Turn the switch to .

More information can be found in the “Controls in detail” section (► page 119).

Turn signals and high beam

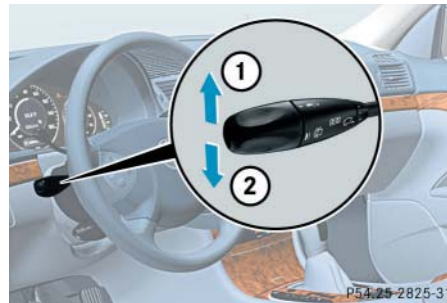

The combination switch is located on the left of the steering column.



Combination switch

- ① Turn signal, right
- ② Turn signal, left

► Press the combination switch up ① or down ②.

The corresponding turn signal indicator lamp  or  flashes in the instrument cluster.

i

To signal minor directional changes, move combination switch to point of resistance only and release. The turn signal flashes three times.

High beam

► Push the combination switch forward.

The high beam headlights are switched on.

The high beam symbol  in the tachometer comes on.

More information can be found in the “Controls in detail” section (► page 123).

Getting started

Driving

Windshield wipers

The combination switch is located on the left of the steering column.

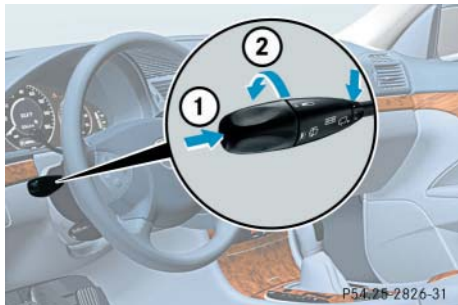

Combination switch

- ① Single wipe
- ② Switching on windshield wipers

- ▶ Make sure the ignition is switched on.
All the lights in the instrument cluster come on.

Switching on windshield wipers

- ▶ Turn the combination switch to the desired position depending on the intensity of the rain.

- 0 Windshield wipers off
- I Intermittent wiping (interval dependent on wetness of windshield)
- II Normal wiper speed
- III Fast wiper speed



The intermittent wiping interval is dependent on wetness of windshield. Wiping will not occur with a door open.



Do not leave windshield wipers in intermittent setting when the vehicle is taken to an automatic car wash or during windshield cleaning. Wipers will operate in the presence of water sprayed on the windshield, and wipers may be damaged as a result.

The switch should not be left in intermittent setting as the wipers will wipe the windshield once every time the engine is started. Dust that accumulates on the windshield might scratch the glass and / or damage the wiper blades when wiping occurs on a dry windshield.

Single wipe

- ▶ Press switch briefly in the direction of arrow ①.

The windshield wipers wipe one time without washer fluid.

Wiping with windshield washer fluid

- ▶ Push switch in the direction of arrow ① past the resistance point.

The windshield wipers operate with washer fluid.

Information on filling up the washer reservoir can be found in the “Operation” section (▷ page 288).



If anything blocks the windshield wipers (leaves, snow, etc.), switch them off immediately.

- For safety reasons,
 - turn off the engine by turning the SmartKey to position **0** and withdraw SmartKey from starter switch
- or
- turn off the engine by pressing the KEYLESS-GO* start/stop button and open the driver's door (with the driver's door open, starter switch is in position **0**, same as with SmartKey removed from starter switch)

before attempting to remove any blockage.

- Remove blockage.
- Turn the windshield wipers on again.

If windshield wipers fail to function at all in switch position **I**,

- set the combination switch to the next highest wiper speed
- have the windshield wipers checked at the nearest authorized Mercedes-Benz Center

Getting started

Driving

Problems while driving

The engine runs erratically and misfires

- An ignition cable may be damaged.
- The engine electronics may not be operating properly.
- Unburned gasoline may have entered the catalytic converter and damaged it.
- ▶ Give very little gas.
- ▶ Have the problem repaired by an authorized Mercedes-Benz Center as soon as possible.

The coolant temperature is over 248°F (120°C)

The coolant is too hot and is no longer cooling the engine.

- ▶ Stop the vehicle as soon as possible and turn off the engine. Allow engine and coolant to cool.
- ▶ Check the coolant level and add coolant if necessary (▷ page 285).

In case of accident

If the vehicle is leaking gasoline:

- ▶ Do not start the engine under any circumstances.
- ▶ Notify local fire and/or police authorities.

If the extent of the damage cannot be determined:

- ▶ Notify an authorized Mercedes-Benz Center.

If no damage can be determined on the

- major assemblies
- fuel system
- engine mount
- ▶ Start the engine in the usual manner.

▼ Parking and locking

You have now completed your first drive. You have properly stopped and parked your vehicle. End your drive as follows.

Warning!



Wait until the vehicle is stationary before removing the SmartKey from the starter switch. The vehicle cannot be steered when the SmartKey is removed.

Warning!



With the engine not running, there is no power assistance for the brake and steering systems. In this case, it is important to keep in mind that a considerably higher degree of effort is necessary to brake and steer the vehicle.

Warning!



Do not park this vehicle in areas where combustible materials such as grass, hay or leaves can come into contact with the hot exhaust system, as these materials could be ignited and cause a vehicle fire.

To reduce the risk of personal injury as a result of vehicle movement, before turning off the engine and leaving the vehicle always:

- Keep right foot on brake pedal.
- Firmly depress parking brake pedal.
- Move the selector lever to position **P**.
- Slowly release brake pedal.
- When parked on an incline, turn front wheel towards the road curb.
- Turn the SmartKey to starter switch position **0** and remove, or press start-/stop button (vehicles with KEYLESS-GO*).
- Take the SmartKey or the SmartKey with KEYLESS-GO* and lock vehicle when leaving.

Getting started

Parking and locking

Parking brake

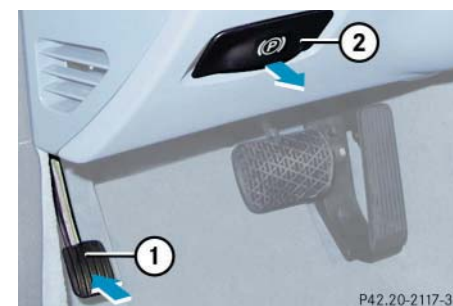

- ① Parking brake
- ② Release handle

- Step firmly on parking brake ①.

When the engine is running, the warning lamp **BRAKE** (USA only) or  (Canada only) in the instrument cluster will be illuminated.

Getting started

Parking and locking

Warning!



When leaving the vehicle, always remove the SmartKey from the starter switch, take the SmartKey with KEYLESS-GO* with you and lock the vehicle. Do not leave children unattended in the vehicle, or with access to an unlocked vehicle. Children could release the parking brake and/or move the gear selector lever from position **P**, either of which could result in an accident and/or serious injury.

Warning!



Getting out of your vehicle with the gear selector lever not fully engaged in position **P** is dangerous. Also, when parked on an incline, position **P** alone may not prevent your vehicle from moving, possibly hitting people or objects.

Always set the parking brake in addition to shifting to position **P**.

When parked on an incline, turn front wheels towards the road curb.

Switching off headlamps

- ▶ Turn the exterior lamp switch to **0** (▷ page 47).

More information can be found in the “Controls in detail” section (▷ page 119).

Turning off engine

- ▶ Place the gear selector lever in position **P**.



Always set the parking brake in addition to shifting to position **P**.

On steep slopes, turn the front wheels towards the road curb.

Turning off with the SmartKey

- ▶ Turn the SmartKey in the starter switch (▷ page 31) to position **0** and remove it.
The immobilizer is activated.



The SmartKey can only be removed from the starter switch with the gear selector lever in position **P**.

- ▶ Press the seat belt release button (▷ page 41).
Allow the retractor to completely re-wind the seat belt by guiding the latch plate.



With the SmartKey removed and the driver's door open, a warning sounds if the vehicle's exterior lamps are not switched off.

Warning!



To prevent possible personal injury, always keep hands and fingers away from the door openings when closing the doors. Be especially careful when small children are around.

Before closing doors, make sure that there is no possibility of someone getting caught in a door during closing.

- ▶ After exiting the vehicle press the lock button  on the SmartKey (▷ page 30).

All turn signal lamps flash three times. The locking knobs on the doors move down.

Getting started

Parking and locking

Warning!



When leaving the vehicle, always remove the SmartKey from the starter switch and lock your vehicle. Do not leave children unattended in the vehicle, or with access to an unlocked vehicle. Unsupervised use of vehicle may cause an accident and/or serious personal injury.

More information can be found in the "Controls in detail" section (▷ page 88).

Turning off with KEYLESS-GO*

- ▶ Place the gear selector lever in **P**.
- ▶ Press the KEYLESS-GO start/stop button to shut off the engine.

With the driver's door closed, the starter switch is now in position **1**. With the driver's door opened, the starter switch is set to position **0**, same as SmartKey removed from starter switch (▷ page 31).



Getting started

Parking and locking

- ▷▷▶ Press the seat belt release button (▷ page 41).



If you hear a warning signal, you have either

- forgotten to switch off the vehicle's exterior lamps before opening the driver's door,
- or
- tried to turn off the engine while the gear selector lever is not in **P**.

Turn off the lights or place the gear selector lever in **P**.



Opening a door causes the windows on the side of the car to open slightly. They will return to the up position when the door is closed.

Warning!



To prevent possible personal injury, always keep hands and fingers away from the door openings when closing the doors. Be especially careful when small children are around.

Before closing doors, make sure that there is no possibility of someone getting caught in a door during closing.

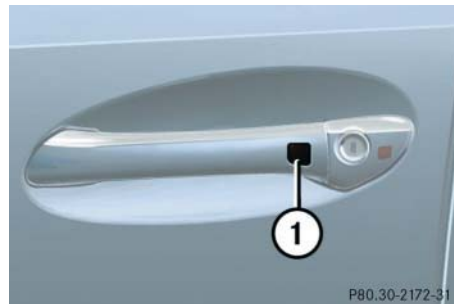

① Lock button on the door handle

- ▶ After exiting the vehicle, press lock button ① on the door handle or on the trunk lid.

All turn signal lamps flash three times. The locking knobs on the doors move down.

Warning!



When leaving the vehicle, always remove the SmartKey from the starter switch, take the SmartKey with KEYLESS-GO* with you, and lock your vehicle. Do not leave children unattended in the vehicle, or with access to an unlocked vehicle. Unsupervised use of vehicle equipment may cause an accident and/or serious personal injury.

More information can be found in the "Controls in detail" section (▷ page 91).



Safety and Security

Occupant safety

Panic alarm

Driving safety systems

Anti-theft systems

Safety and Security

Occupant safety

▼ Occupant safety

In this section you will learn the most important facts about the restraint systems of the vehicle.

The restraint systems are

- Seat belts
- Emergency tensioning device
- Airbags
- Child seats
- Child seat recognition
- Lower anchors and tethers for children (LATCH)

As independent systems, their protective effects work in conjunction with each other.



For information on infants and children traveling with you in the vehicle and restraint systems for infants and children, see “Children in the vehicle” (▷ page 65).

The **SRS** indicator lamp in the instrument cluster comes on

- for about four seconds when you turn the SmartKey in the starter switch to position **1** or press the KEYLESS-GO* start/stop button once. It then goes out briefly, comes on again and remains lit until you start the engine.
- for about four seconds when you start the engine by turning the SmartKey or pressing the KEYLESS-GO* start/stop button.



The **SRS** indicator lamp comes on and remains lit if the SmartKey is turned to position **2** and left there or the KEYLESS-GO* start/stop button is pressed twice. The indicator lamp will go out when you start the engine.

The restraint systems are fully operational if the **SRS** indicator lamp is not lit when the engine is running.

A malfunction in the system has been detected if the **SRS** indicator lamp:

- fails to go out after approximately four seconds
- does not come on at all
- comes on after the engine was started or while driving

For safety reasons, we strongly recommend that you visit an authorized Mercedes-Benz Center immediately to have the system checked.

More information can be found in the “Practical hints” section (▷ page 316).

Warning!



In the event that the **SRS** indicator lamp comes on during driving or does not come on at all, the SRS may not be operational. For your safety, we strongly recommend that you visit an authorized Mercedes-Benz Center immediately to have the system checked; otherwise the SRS may not be activated when needed in an accident, which could result in serious or fatal injury, or it might deploy unexpectedly and unnecessarily which could also result in injury.

Improper work on the restraint systems, including incorrect installation and removal, can lead to possible injury through an unintended activation of the SRS.

In addition, through improper work there is a risk of rendering the SRS inoperative or causing unintended airbag deployment. Work on the SRS must therefore only be performed by qualified technicians. Contact your authorized Mercedes-Benz Center.

Airbags

Warning!



Airbags are designed to reduce the potential of injury and fatality in certain frontal impacts (front airbags), side impacts (side impact airbags and head protection window curtain airbags) or rollovers (head protection window curtain airbags). However, no system available today can totally eliminate injuries and fatalities.

The activation of the SRS temporarily releases a small amount of dust from the airbags. This dust, however, is neither injurious to your health, nor does it indicate a fire in the vehicle. The dust might cause some temporary breathing difficulty for people with asthma or other breathing trouble. To avoid this, you may wish to get out of the vehicle as soon as it is safe to do so. If you have any breathing difficulty but cannot get out of the vehicle after the airbag inflates, then get fresh air by opening a window or door.

Warning!



To reduce the risk of injury when the front airbags inflate, it is very important for the driver and front passenger to always be in a properly seated position and to wear your seat belts.

For maximum protection in the event of a collision always be in normal seated position with your back against the backrest. Fasten your seat belt and ensure that it is properly positioned on your body.

Since the airbag inflates with considerable speed and force, a proper seating and hands on steering wheel position will help to keep you at a safe distance from the airbag. Occupants who are unbelted, out of position or too close to the airbag can be seriously injured by an airbag as it inflates with great force in the blink of an eye:

- Sit properly belted in an upright position with your back against the seat backrest.



Safety and Security

Occupant safety



- Adjust the driver seat as far as possible rearward, still permitting proper operation of vehicle controls. The distance from the center of the driver's breastbone to the center of the airbag cover on the steering wheel must be at least 10 in (25 cm) or more. You should be able to accomplish this by a combination of adjustments to the seat and steering wheel. If you have any problems, please see your authorized Mercedes-Benz Center.
- Do not lean with your head or chest close to the steering wheel or dashboard.
- Keep hands on the outside of steering wheel rim. Placing hands and arms inside the rim can increase the risk and potential severity of hand/arm injury when driver front airbag inflates.
- Adjust the front passenger seat as far as possible rearward from the dashboard when the seat is occupied.

- Occupants, especially children, should never lean their heads in the area of the door where the side airbag inflates. This could result in serious injuries or death should the airbag be triggered. Always sit upright, properly use the seat belts and appropriate size infant or child restraint system.
- Children 12 years old and under must never ride in the front seat, except in a Mercedes-Benz authorized BabySmart™ compatible child seat, which operates with the BabySmart™ system installed in the vehicle to deactivate the passenger front airbag when it is properly installed. Otherwise they will be struck by the airbag when it inflates in a crash. If this happens, serious or fatal injury will result.

Failure to follow these instructions can result in severe injuries to you or other occupants.

If you sell your vehicle you are responsible to make the buyer aware of these points. Be sure to give the buyer this Operator's Manual.

Warning!



Accident research shows that the safest place for children in an automobile is in the rear seat. Should you choose to place a child 12 years old or under in the passenger front seat of your vehicle, you must properly use a BabySmart™ child restraint which will turn off the passenger front airbag. BabySmart™ will not, however, turn off any side impact airbag.

It should be noted that with respect to both front and rear side impact airbags there is a possibility for a side airbag related injury if occupants, especially children, are not properly seated or restrained when next to a side airbag which needs to deploy rapidly in a side impact in order to do its job.

Safety and Security

Occupant safety

To help avoid the possibility of injury, please follow these guidelines:

- (1) Occupants, especially children, should never place their bodies or lean their heads in the area of the door where the side airbag inflates. This could result in serious injuries or death should the side airbag be activated
- (2) Always sit upright, properly use the seat belts and use an appropriately sized infant or child restraint system for all children 12 years old or under.
- (3) Always wear seat belts properly.

If you believe that, even with the use of these guidelines, it would be safer for your rear seat occupants to have the rear mounted side airbags deactivated, then deactivation can be accomplished upon your written request to do so at your authorized Mercedes-Benz Center at an additional cost.

Please contact your local authorized Mercedes-Benz Center or call our Customer Assistance Center at 1-800-FOR-MERCEdes (1-800-367-6372) for details.



Airbags are designed to activate only in certain frontal impacts (front air bags), side impacts (side impact and head protection window curtain airbags) which exceed preset thresholds and in certain rollovers (head protection window curtain airbags). Only during these events will they provide their supplemental protection.

The driver and passengers should always wear their seat belts. Otherwise it is not possible for airbags to provide their supplemental protection.

In case of other types of impacts and impacts below air bag deployment thresholds, airbags will not be activated. The driver and passenger will then be protected to the extent possible by a properly fastened seat belt. A properly fastened seat belt is also needed to provide the best possible protection in a rollover.

We caution you not to rely on the presence of the airbags in order to avoid wearing your seat belt.

Your vehicle was originally equipped with airbags that are designed to activate in certain impacts exceeding a preset threshold to reduce the potential and severity of injury. It is important to your safety and that of your passengers that you replace deployed airbags and repair any malfunctioning airbags to ensure that the vehicle will continue to provide supplemental crash protection for occupants.

Safety and Security

Occupant safety

Safety guidelines for the seat belt, emergency tensioning device and airbag

Warning!



- Damaged seat belts or belts that were highly stressed in an accident must be replaced and their anchoring points must also be checked. Use only belts installed or supplied by an authorized Mercedes-Benz Center.
- Airbags and emergency tensioning devices (ETDs) are designed to function on a one-time-only basis. An airbag or ETD that was activated must be replaced.
- Do not pass belts over sharp edges. They could tear.
- Do not make any modification that could change the effectiveness of the belts.

- No modifications of any kind may be made to any components or wiring of the SRS. This includes changing or removing any component or part of the SRS, the installation of additional trim material, badges etc. over the steering wheel hub, front passenger airbag cover, door trim panels, or door frame trims, and installation of additional electrical/electronic equipment on or near SRS components and wiring. Keep area between airbags and occupants free from objects (e.g. packages, purses, umbrellas, etc.).
- Do not hang items such as coat hangers from the coat hooks or handles over the door. These items may turn into projectiles and cause head and other injuries when curtain airbag is deployed.
- An airbag system component within the steering wheel gets hot after the airbag has inflated. Do not touch.
- Improper work on the system, including incorrect installation and removal, can lead to possible injury through an unintended activation of the SRS.

- In addition, through improper work there is a risk of rendering the SRS inoperative or causing unintended airbag deployment. Work on the SRS must therefore only be performed by qualified technicians. Contact your authorized Mercedes-Benz Center.
- For your protection and the protection of others, when scrapping the airbag unit or emergency tensioning device, our safety instructions must be followed. These instructions are available from your authorized Mercedes-Benz Center.
- Given the considerable deployment speed and the textile structure of the airbags, there is the possibility of abrasions or other injuries resulting from airbag deployment.

When you sell your vehicle we strongly urge you to give notice to the subsequent owner that it is equipped with an SRS by alerting them to the applicable section in the Operator's Manual.

Front airbags



- ① Driver airbag
- ② Passenger airbag

Driver and passenger airbags are deployed:

- in the event of a frontal impact
- if impact exceeds a preset deployment threshold
- independently of the side impact airbags

The airbags will not deploy in impacts which do not exceed the system's deployment thresholds. You will then be protected by the fastened seat belts.

The front passenger airbag will only be deployed if:

- the front passenger seat is occupied
- the PASSENGER AIRBAG OFF indicator lamp in the center console is not lit (▷ page 67)
- the impact exceeds a preset deployment threshold



Do not place objects heavier than 20 lbs (9 kg) on the front passenger seat. This could cause the front or side impact airbag on the front passenger side to deploy in a crash which exceeds the system's deployment threshold.

Side impact airbags, window curtain airbags

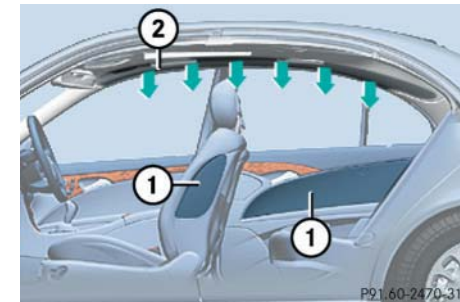

- ① Side impact airbags
- ② Window curtain airbag

The side impact airbags and window curtain airbags are deployed:

- on the impacted side of the vehicle
- in impacts exceeding a preset deployment threshold
- independently of the front airbags

In addition, the window curtain airbags ② are deployed:

- in certain vehicle rollovers



Safety and Security

Occupant safety

The front passenger side airbag will only deploy if the system senses that the front passenger seat is occupied.

The side impact airbags and window curtain airbags are not deployed in impacts which do not exceed the system's deployment threshold.

Seat belts

When the engine is started, the seat belt non-usage warning lamp  illuminates to remind you and your passengers to fasten your seat belts. If the driver's seat belt is not fastened before the engine is started, the seat belt non-usage warning lamp  illuminates and a warning chime sounds for approximately six seconds when the engine is started.

The use of seat belts and infant and child restraint systems is required by law in all 50 states, the District of Columbia, the U.S. territories and all Canadian provinces.

Even where this is not the case, all vehicle occupants should have their seat belts fastened whenever the vehicle is in motion.

For more information, see "Fastening the seat belts" (▷ page 40).



For information on infants and children traveling with you in the vehicle and restraint systems for infants and children, see "Children in the vehicle" (▷ page 65).

Warning!



Always fasten your seat belt before driving off. Always make sure your passengers are properly restrained, even those sitting in the rear and pregnant women.

Failure to wear and properly fasten and position your seat belt greatly increases your risk of injuries and their likely severity in an accident. You and your passengers should always wear seat belts.

If you are ever in an accident, your injuries can be considerably more severe without your seat belt properly buckled. Without your seat belt buckled, you are much more likely to hit the interior of the vehicle or be ejected from it. You can be seriously injured or killed.

In the same crash, the possibility of injury or death is lessened if you are properly wearing your seat belt. Airbags can only protect as they are designed if the occupants are properly wearing their seat belts.

Safety and Security

Occupant safety

Warning!



Never ride in a moving vehicle with the seat backrest reclined. Sitting in an excessively reclined position can be dangerous. You could slide under the seat belt in a collision. If you slide under it, the belt would apply force at the abdomen or neck. That could cause serious or even fatal injuries. The seat backrest and seat belt provide the best restraint when the wearer is in an upright position and the belt is properly positioned on the body.

Warning!



Never let more people ride in the vehicle than there are seat belts available. Be sure everyone riding in the vehicle is correctly restrained with a separate seat belt.

Warning!



Damaged seat belts or belts that were highly stressed in an accident must be replaced and their anchoring points must also be checked.

Only use seat belts which have been approved by Mercedes-Benz.

Do not make any modifications to the seat belts. This can lead to unintended activation or to failure.

Have all work carried out only by qualified technicians. Contact an authorized Mercedes-Benz Center.

Warning!



USE SEAT BELTS PROPERLY

- Seat belts can only work when used properly. Never wear seat belts in any other way than as described in this section, as that could result in serious injuries in case of an accident.
- Each occupant should wear their seat belt at all times, because seat belts help reduce the likelihood of and potential severity of injuries in accidents, including rollovers. The integrated restraint system includes SRS (driver airbag, front passenger airbag, side impact airbags, head protection window curtain airbags for side windows), ETD (seat belt emergency tensioning device), and front seat knee bolsters. The system is designed to enhance the protection offered to properly belted occupants in certain frontal (front airbags) and side (side impact and window curtain airbags) impacts which exceed preset deployment thresholds and in certain rollovers (window curtain airbags).



Safety and Security

Occupant safety



- Never wear the shoulder belt under your arm, against your neck or off your shoulder. In a crash, your body would move too far forward. That would increase the chance of head and neck injuries. The belt would also apply too much force to the ribs or abdomen, which could severely injure internal organs such as your liver or spleen.
- Never wear belts over rigid or breakable objects in or on your clothing, such as eyeglasses, pens, SmartKeys etc., as these might cause injuries.
- Position the lap belt as low as possible on your hips and not across the abdomen. If the belt is positioned across your abdomen, it could cause serious injuries in a crash.
- Never use a seat belt for more than one person at a time. Do not fasten a seat belt around a person and another person or other objects.

- Belts should not be worn twisted. In a crash, you wouldn't have the full width of the belt to manage impact forces. The twisted belt against your body could cause injuries.
- Pregnant women should also use a lap-shoulder belt. The lap belt portion should be positioned as low as possible on the hips to avoid any possible pressure on the abdomen.
- Never place your feet on the instrument panel or on the seat. Always keep both feet on the floor in front of the seat.

Emergency tensioning device (ETD), seat belt force limiter

The seat belts for the front and rear outer seats are equipped with emergency tensioning devices and belt force limiters.

The ETD is designed to activate in the following cases when the seat belts are fastened:

- in frontal or rear-end impacts exceeding a preset severity level
- in certain vehicle rollovers
- if the restraint systems are operational and functioning correctly, see **SRS** indicator lamp (▷ page 56)

In an impact, emergency tensioning devices remove slack from the belts in such a way that the seat belts fit more snugly against the body. Belt force limiters reduce the force exerted by the seat belts on occupants during a crash.

Warning!



An emergency tensioning device (ETD) that was activated must be replaced.

When disposing of the emergency tensioning device, our safety instructions must be followed. These are available at your authorized Mercedes-Benz Center.



Do not place objects heavier than 20 lbs (9 kg) on the front passenger seat. This could cause the front or side impact airbag on the front passenger side to deploy in a crash which exceeds the system's deployment threshold.

Automatic comfort-fit feature seat belt

An automatic comfort-fit feature for front seats reduces the retracting force of the seat belts when they are in normal use.

Children in the vehicle

If an infant or child is traveling with you in the vehicle:

- Secure the child using an infant or child restraint appropriate to the age and size of the child and recommended for use by Mercedes-Benz.
- Ensure that the infant or child is properly secured all times while the vehicle is in motion.

Infant and child restraint seats and information on choosing an appropriate restraint system can be obtained from any Mercedes-Benz Center.

Infant and child restraint systems

Use only a BabySmart™¹ compatible child restraint for the front passenger seat in this vehicle.

We recommend all infants and children be properly restrained at all times while the vehicle is in motion.

All lap-shoulder belts except the driver's seat belt have special seat belt retractors for secure fastening of child restraints.

To fasten a child restraint, follow child restraint instructions for mounting. Then pull the shoulder belt out completely and let it retract. During seat belt retraction, a ratcheting sound can be heard to indicate that the special seat belt retractor is activated. The belt is now locked. Push down on child restraint to take up any slack.

¹ BabySmart™ is a trademark of Siemens Automotive Corp.

Safety and Security

Occupant safety

To deactivate, release seat belt buckle and let seat belt retract completely. The seat belt can again be used in the usual manner.



Information on child seats with mounting fittings for tether anchorages (▷ page 69).

For information on LATCH-type child seat mounts (▷ page 71).

Warning!



Never release the seat belt buckle while the vehicle is in motion, since the special seat belt retractor will be deactivated.



The use of infant or child restraints is required by law in all 50 states, the District of Columbia, the U.S. territories and all Canadian provinces.

Infants and small children should be seated in an appropriate infant or child restraint system properly secured by a lap-shoulder belt or, if so equipped, a child restraint lower anchorage system that complies with U.S. Federal Motor Vehicle Safety Standards 213 and 225 and Canadian Motor Vehicle Safety Standards 213 and 210.2.

A statement by the child restraint manufacturer of compliance with this standard can be found on the instruction label on the restraint and in the instruction manual provided with the restraint.

When using any infant or child restraint system, be sure to carefully read and follow all manufacturer's instructions for installation and use.

Please read and observe warning labels affixed to the inside of the vehicle and to infant or child restraints.

Safety and Security

Occupant safety

Warning!



Children 12 years old and under must never ride in the front seat, except in a Mercedes-Benz authorized BabySmart™ compatible child seat, which operates with the BabySmart™ system installed in the vehicle to deactivate the passenger front airbag when it is properly installed. Otherwise they will be struck by the airbag when it inflates in a crash. If this happens, serious or fatal injury will result.

According to accident statistics, children are safer when properly restrained in the rear seating positions than in the front seating positions. Infants and small children must ride in back seats and be seated in an appropriate infant or child restraint system, which is properly secured with the vehicle's seat belt and top tether strap, or secured via lower anchors and top tether strap, fully in accordance with the child seat manufacturer's instructions.

Infants and small children should never share a seat belt with another occupant. During an accident, they could be crushed between the occupant and seat belt.

A child's risk of serious or fatal injuries is significantly increased if the child restraints are not properly secured in the vehicle and the child is not properly secured in the child restraint.

Children too big for child restraint systems must ride in back seats using regular seat belts. Position shoulder belt across chest and shoulder, not face or neck. A booster seat may be necessary to achieve proper belt positioning for children from 41 lbs until they reach a height where a lap/shoulder belt fits properly without a booster.

When the child restraint is not in use, remove it from the vehicle or secure it with the seat belt to prevent the child restraint from becoming a projectile in the event of an accident.

Do not leave children unattended in the vehicle, even if the children are secured in a child restraint system. Unsupervised children in a child restraint system may use vehicle equipment and may cause an accident and/or serious personal injury.

BabySmart™¹ airbag deactivation system

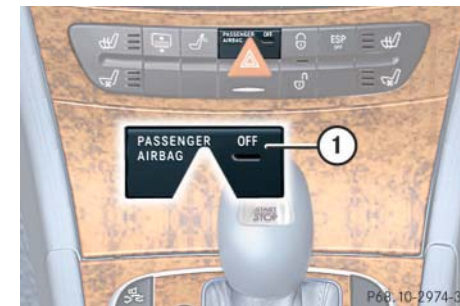

① Indicator lamp

¹ BabySmart™ is a trademark of Siemens Automotive Corp.

Safety and Security

Occupant safety

Special BabySmart^{TM1} compatible child seats, designed for use with the Mercedes-Benz system and available at any authorized Mercedes-Benz Center, are required for use with the BabySmartTM airbag deactivation system. With the special child seat properly installed, the passenger front airbag will not deploy.

The PASSENGER AIRBAG OFF indicator lamp ① located in the center console will be illuminated, except with the SmartKey removed or in starter switch position 0.



The system does not deactivate the side impact airbag, the window curtain airbag and the emergency tensioning device.

Self-test BabySmartTM without special child seat installed

After turning the SmartKey in the starter switch to position 1 or 2 or pressing the KEYLESS-GO* start/stop button once or twice, the PASSENGER AIRBAG OFF indicator lamp ① located in the center console comes on for approximately six seconds and then goes out.

If the indicator lamp should not come on or is continuously lit, the system is not functioning. You must see an authorized Mercedes-Benz Center before seating any child on the passenger seat.

More information can be found in the "Practical hints" section (▷ page 317).

Warning!



The BabySmartTM airbag deactivation system will ONLY work with a special child seat designed to operate with it. It will not work with child seats which are not BabySmartTM compatible.

Never place anything between seat cushion and child seat (e.g. pillow), since it reduces the effectiveness of the deactivation system. The bottom of the child seat must make full contact with the passenger seat cushion. An incorrectly mounted child seat could cause injuries to the child in case of an accident, instead of protecting the child.

Follow the manufacturer's instructions for installation of special child seats.

¹ BabySmartTM is a trademark of Siemens Automotive Corp.

Safety and Security

Occupant safety

Warning!



When using a BabySmart™ compatible child seat on the front passenger seat, the passenger front airbag will not deploy only if the PASSENGER AIRBAG OFF indicator lamp remains illuminated.

Please be sure to check the indicator every time you use the special system child seat. Should the light go out while the restraint is installed, please check installation. If the light remains out, do not use the BabySmart™ restraint to transport children on the front passenger seat until the system has been repaired.

Warning!



Do not place powered-on laptops, cell phones and like electronic devices on the front passenger seat. Signals from such devices may interfere with the BabySmart™ system. Such signal interference may cause the PASSENGER AIRBAG OFF indicator lamp not to come on during self-test or be continuously lit, indicating that the system is not functioning.

Installation of infant and child restraint systems

This vehicle is equipped with tether anchorages for a top tether strap at each of the rear seating positions.

Not foldable rear seat backrest

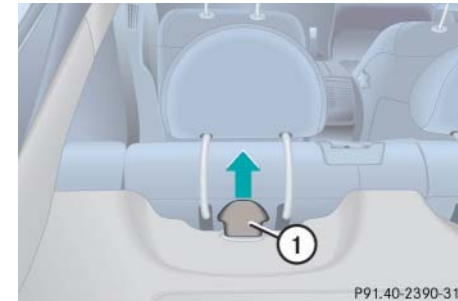

① Cover

- ▶ Remove cover ① from anchorage ring.
- ▶ Guide tether strap between head restraint and top of the seat back.
- ▶ Head restraint must be positioned such that the top tether strap can pass freely between the head restraint and the top of the seat back.

Make sure the tether strap is not twisted. >>

Safety and Security

Occupant safety

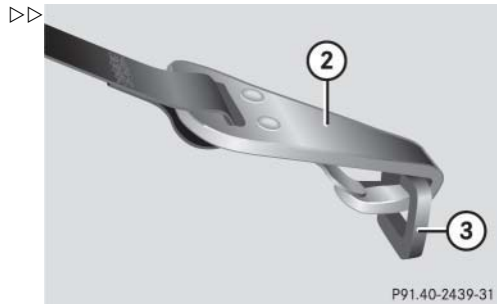

- ② Hook
- ③ Anchorage ring

- ▶ Securely fasten the hook ② to the anchorage ring ③.



For safety, make sure the hook ② has attached to the ring ③ beyond the safety catch, as illustrated.

Foldable rear seat backrest*

- ▶ Fold rear seat backrest slightly forward.
- ▶ Guide tether strap between head restraint and top of the seat back.
- ▶ Head restraint must be positioned such that the top tether strap can pass freely between the head restraint and the top of the seat back.

Make sure the tether strap is not twisted.

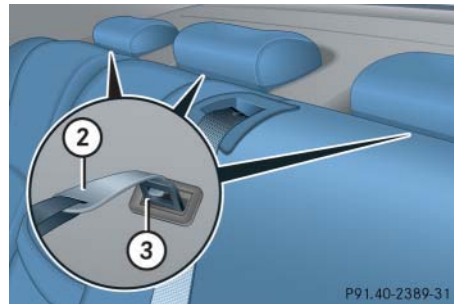

- ② Hook
- ③ Anchorage ring

- ▶ Securely fasten the hook ② to the anchorage ring ③.



For safety, make sure the hook ② has attached to the ring ③ beyond the safety catch, as illustrated below.

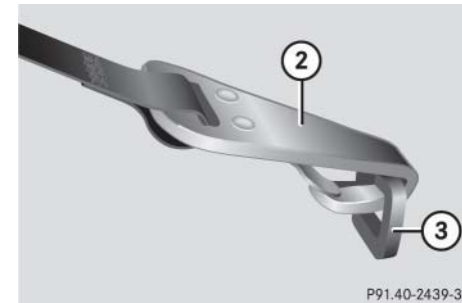

- ② Hook
- ③ Anchorage ring

- ▶ Swing rear seat backrest to the rear until it engages.
- ▶ Check the rear seat backrest to be locked in its upright position (▷ page 325).

Safety and Security

Occupant safety

Child seat anchors - LATCH type

This vehicle is equipped with two LATCH (Lower Anchors and Tethers for Children) type anchors (at each of the outer rear seats) for the installation of a “LATCH” child seat with the matching anchor fittings.

The anchors are located behind an upholstery blend.



- ① Indicates the position of the anchors
- ② Anchors

- ▶ Install child seat according to the manufacturer’s instructions.



Make sure the seat belt for the center seat can operate freely with a child seat installed.



Non-LATCH type child seats may also be used and can be installed using the vehicle’s seat belt system. Install child seat according to the manufacturer’s instructions.

Safety and Security

Occupant safety

Warning!



Children too big for child restraint systems must ride in back seats using regular seat belts. Position shoulder belt across chest and shoulder, not face or neck. A booster seat may be necessary to achieve proper belt positioning for children from 41 lbs until they reach a height where a lap/shoulder belt fits properly without a booster.

Install child seat according to manufacturer's instructions.

The child seat must be firmly attached in the right and left side anchors ②.

An incorrectly mounted child seat may come loose during an accident which could result in serious injury or death to your child.

Damaged or impact damaged child seats or child seat mounting fittings must be replaced.

Do not leave children unattended in the vehicle, even if the children are secured in a child restraint system.

Blocking of rear door window operation



- ① Override switch
- ② Indicator lamp

- ▶ Press override switch ①.

Indicator lamp ② comes on. The rear door windows can no longer be operated using the switches located in the rear doors.



Operation of the rear door windows with the switches located on the door control panel of the driver's door is still possible.

Warning!



Activate the override switch when children are riding in the back seats of the vehicle. The children may otherwise injure themselves, e.g. by becoming trapped in the window opening.

When leaving the vehicle, always remove the SmartKey from the starter switch, and lock the vehicle. Do not leave children unattended in the vehicle, or with access to an unlocked vehicle. Unsupervised use of vehicle equipment can cause an accident and/or serious personal injury.

For more information on power windows, see the "Controls in detail" section (▷ page 197).

▼ Panic alarm

An audible alarm and flashing exterior lamps will operate for approximately 2½ minutes.



① PANIC button

Activating

- ▶ Press and hold button ① for at least 1 second.

Deactivating

- ▶ Press button ① again.
- or
- ▶ Insert SmartKey in starter switch.

i

For operation in the USA only: This device complies with Part 15 of the FCC Rules. Operation is subject to the following two conditions:

- (1) This device may not cause harmful interference, and
- (2) this device must accept any interference received, including interference that may cause undesired operation.

Any unauthorized modification to this device could void the user's authority to operate the equipment.

Safety and Security

Driving safety systems

▼ Driving safety systems

In this section you will find information on the following driving safety systems:

- ABS (Antilock Brake System)
- BAS (Brake Assist System)
- ESP (Electronic Stability Program)
- SBC (Sensotronic Brake Control)
- 4MATIC (Four Wheel Electronic Traction System)



In winter operation, the maximum effectiveness of the ABS, the BAS, the ESP, SBC and 4MATIC is only achieved with winter tires (M+S tires), or snow chains as required.

Warning!



The following factors increase the risk of accidents:

- Excessive speed, especially in turns
- Wet and slippery road surfaces
- Following another vehicle too closely

The ABS, BAS, ESP, SBC and 4MATIC cannot reduce this risk.

Always adjust your driving style to the prevailing road and weather conditions.

ABS

Warning!



Do not pump the brake pedal. Use firm, steady brake pedal pressure instead. Pumping the brake pedal defeats the purpose of the ABS and significantly reduces braking effectiveness.

The Antilock Brake System (ABS) regulates the brake pressure so that the wheels do not lock during braking. This allows you to maintain the ability to steer your vehicle.

The ABS is functional above a speed of approximately 5 mph (8 km/h) independent of road surface conditions.

On slippery road surfaces, the ABS will respond even with light brake pressure.

The  malfunction warning lamp in the instrument cluster comes on when you turn the SmartKey in the starter switch to position **2** or press the KEYLESS-GO* start/stop button twice. It goes out when the engine is running.

Braking

If the ABS activates during braking, the ABS/ESP warning lamp  in the instrument cluster dial flashes. Because of the SBC brake system, you will not feel any pulsation in the brake pedal.

- ▶ Keep firm and steady pressure on the brake pedal.

Continuous, steady brake pedal pressure yields the advantages provided by the ABS, namely braking power and the ability to steer the vehicle.

The ABS/ESP warning lamp  flashes whenever the ABS is activated which can be an indication of hazardous road conditions and functions as a reminder to take extra care while driving.

Emergency brake maneuver

- ▶ Keep continuous full pressure on the brake pedal.

Safety and Security

Driving safety systems

Warning!



The ABS cannot prevent the natural laws of physics from acting on the vehicle, nor can it increase braking or steering efficiency beyond that afforded by the condition of the vehicle brakes and tires or the traction. The ABS cannot prevent accidents, including those resulting from excessive speed in turns, following another vehicle too closely, or hydroplaning. Only a safe, attentive, and skillful driver can prevent accidents. The capabilities of an ABS equipped vehicle must never be exploited in a reckless or dangerous manner which could jeopardize the user's safety or the safety of others.

More information can be found in the "Practical hints" section (▷ page 311).

Safety and Security

Driving safety systems

BAS

The Brake Assist System (BAS) operates in emergency situations. If you apply the brakes very quickly, the BAS automatically provides full brake boost, thereby potentially reducing the braking distance. Apply continuous full braking pressure until the emergency braking situation is over. The ABS will prevent the wheels from locking.

When you release the brake pedal, the brakes function again as normal. The BAS is then deactivated.

Warning!





The BAS cannot prevent the natural laws of physics from acting on the vehicle, nor can it increase braking efficiency beyond that afforded by the condition of the vehicle brakes and tires or the traction. The BAS cannot prevent accidents, including those resulting from excessive speed in turns, following another vehicle too closely, or hydroplaning. Only a safe, attentive, and skillful driver can prevent accidents. The capabilities of a BAS equipped vehicle must never be exploited in a reckless or dangerous manner which could jeopardize the user's safety or the safety of others.

ESP

The Electronic Stability Program (ESP) monitors the vehicle's traction (force of adhesive friction between the tires and the road surface) and handling.

The ESP recognizes when a wheel is spinning or if the vehicle starts to skid. By applying brakes to the appropriate wheel and by limiting engine output, the ESP works to stabilize the vehicle. The ESP is especially useful while driving off and on wet or slippery road surfaces.

The ABS/ESP warning lamp  in the instrument cluster flashes when the ESP is engaged.

The ABS/ESP warning lamp  in the instrument cluster comes on when you turn the SmartKey in the starter switch to position **2** or press the KEYLESS-GO* start/stop button twice. It goes out when the engine is running.

Warning!



Never switch off the ESP when you see the ABS/ESP warning lamp  flashing in the instrument cluster. In this case proceed as follows:

- While driving off, apply as little throttle as possible.
- While driving, ease up on the accelerator.
- Adapt your speed and driving style to the prevailing road conditions.

Failure to observe these guidelines could cause the vehicle to skid.

The ESP cannot prevent accidents resulting from excessive speed.

Warning!



The ESP cannot prevent the natural laws of physics from acting on the vehicle, nor can it increase the traction afforded. The ESP cannot prevent accidents, including those resulting from excessive speed in turns, or hydroplaning. Only a safe, attentive, and skillful driver can prevent accidents. The capabilities of an ESP equipped vehicle must never be exploited in a reckless or dangerous manner which could jeopardize the user's safety or the safety of others.



The ESP will only function properly if you use wheels of the recommended tire size (▷ page 394).



Vehicles without 4MATIC:

Because of the ESP's automatic operation, the engine and ignition must be shut off (SmartKey in starter switch position **0** or **1** or KEYLESS-GO start/stop button* in position **0** or **1**) when:

- the parking brake is being tested on a brake test dynamometer
- the vehicle is being towed with the front axle raised

Active braking action through the ESP may otherwise seriously damage the brake system.

For information on vehicles with 4MATIC, see "Four wheel electronic traction system (4MATIC) with the ESP" (▷ page 82).

More information can be found in the "Practical hints" section (▷ page 311).

Safety and Security

Driving safety systems

Switching off the ESP

Warning!



The ESP should not be switched off during normal driving other than in the circumstances described below. Disabling of the system will reduce vehicle stability in driving maneuvers.

To improve the vehicle's traction, turn off the ESP in driving situations where it would be advantageous to have drive wheels spin and thus cut into surfaces for better grip such as:

- starting out on slippery surfaces and in deep snow in conjunction with snow chains
- in sand or gravel



Turn on the ESP immediately if the aforementioned circumstances do not apply anymore.



DISTRONIC* cannot be activated when the ESP has been deactivated.

The switch is located on the center console.



① ESP off/on switch

- ▶ Press ESP switch ① until the ABS/ESP warning lamp  in the instrument cluster comes on.

The ESP is deactivated.

If one or more drive wheels are spinning, the ABS/ESP warning lamp  in the instrument cluster flashes, regardless of the speed.

Traction control brakes a spinning wheel even when the ESP is deactivated.

The ESP always operates when you are braking, even when it has been deactivated.



Avoid spinning of a drive wheel for an extended period with the ESP switched off. This may cause serious damage to the drivetrain which is not covered by the Mercedes-Benz Limited Warranty.

Warning!



When the ABS/ESP warning lamp  is illuminated continuously, the ESP is switched off.

Adapt your speed and driving to the prevailing road conditions and to the non-operating status of the ESP.

Switching on the ESP

- ▶ Press ESP button .

The ABS/ESP warning lamp  in the instrument cluster goes out.

You are now again in normal driving mode.





Turn on the ESP immediately if the aforementioned circumstances do not apply anymore.

The SBC brake system

The SBC brake system combines a hydraulic brake circuit with electronically controlled brake servo assistance. You have increased braking safety and improved braking comfort.

Warning!



Never ignore a brake malfunction indicated in the speedometer display, for example by the  (USA only) or  (Canada only) warning lamp. Refer to the “Practical hints” section (> page 312). Also read and observe the messages in the instrument cluster display (> page 318).

Warning!



The SBC brake system requires electrical power to operate.

A malfunction in the vehicle’s power supply or electrical system may impair brake system operation and switch it into its emergency operation mode. In such a case, the red brake warning lamp (> page 312) and warning messages in the instrument cluster (> page 318) come on while driving. To brake, the driver must then apply significantly greater brake pedal pressure and depress the pedal much further to obtain the expected braking effect. If necessary, apply full pressure to the brake pedal. Brakes may only be applied to the front wheels. Stopping distance is increased! >>

Safety and Security

Driving safety systems



If there is a malfunction in the SBC brake system, we recommend that the vehicle be transported with all wheels off the ground using flatbed or appropriate wheel lift/dolly equipment. A tow bar must be used if circumstances do not permit the use of the recommended towing methods and the vehicle requires towing with all four wheels on the ground. Towing the vehicle with all four wheels on the ground is only permissible for distances up to 30 miles (50 km) and at a speed not to exceed 30 mph (50 km/h). For more information, refer to “Towing the vehicle” (▷ page 381).

The SBC brake system is automatically activated when you:

- unlock the vehicle with the SmartKey or the KEYLESS-GO*
- open the driver’s or passenger door
- turn the SmartKey in the starter switch to position **1**
- in vehicles with KEYLESS-GO*, press the start/stop button on gear selector lever once
- depress the brake pedal
- release the parking brake



If the SBC brake system is activated as the brake pedal is first depressed, you may feel a reduced pedal resistance and longer pedal travel than normal. When releasing the pedal, you may also feel the brake pedal pulsate and you may hear a sound which is caused by the activation of the SBC brake system-pump. This is normal and not an indication of a malfunction. Pedal travel returns to normal when you release the brake pedal and the sound soon ceases.

If you experience the above while driving and the red brake warning lamp (▷ page 312) illuminates and/or warning messages appear in the instrument cluster (▷ page 318), the brake system is malfunctioning. Follow the instructions of the warning message(s) and have the brake system checked immediately.

Safety and Security

Driving safety systems

Warning!



Have brake pad replacement and other work on the SBC brake system carried out by qualified technicians only. Contact your Mercedes-Benz Center for further information. The SBC brake system must be deactivated prior to working on the system. High pressure is intermittently built up in the system as part of its automatic self-test. In addition, the system is automatically activated when the vehicle is unlocked by SmartKey, when the driver or passenger door is opened, when the starter switch is turned to position **1**, when the brake pedal is depressed or when the parking brake is released. Failure to deactivate the system prior to maintenance will cause brake pistons to extend and brake fluid to leak, which may result in injuries (contusions and acid burns). Extended brake pistons may also cause injury.

The SBC brake servo assistance switches off automatically

- approximately two minutes after you turned the SmartKey in the starter switch to position **0** or removed the SmartKey
- approximately two minutes after you pressed the KEYLESS-GO* start/stop button to turn off the engine or power supply and opened the driver's door (with driver's door open, the starter switch is set to position **0**, same as SmartKey removed from starter switch)
- approximately 20 seconds after you locked the vehicle from outside

Note on driving with the SBC

- Following extended periods of only minor loads to your brake system, you should occasionally apply the brakes when traveling at high speeds. This improves the grip of the brake pads.

Warning!



Be very careful not to endanger other road users when you apply the brakes.

- After driving on wet or snow-covered roads, you should apply your brakes firmly before parking your vehicle. This produces heat which serves to dry the brake disks and help prevent corrosion.
- On long and steep grades, shift to a lower gear (gear range **1**, **2**, or **3**) to prevent the brakes from overheating and to reduce brake wear.
- After hard braking, it is advisable to drive on for some time so that the air stream will cool down the brakes faster.
- Only Mercedes-Benz approved components (e.g. brake pads) should be installed on your vehicle. Brake pads not approved by Mercedes-Benz may impair the safety of your vehicle.

Safety and Security

Driving safety systems

Four wheel electronic traction system (4MATIC) with the ESP

Models with all-wheel-drive only.

The 4MATIC improves vehicle's ability to use available traction, e.g. during winter operation in mountains under snowy conditions, by applying power to all four wheels.

Warning!



If you see the ESP warning lamp  flashing in the speedometer, proceed as follows:

- While driving off, apply as little throttle as possible
- While driving, ease up on the accelerator
- Adapt your speed and driving style to the prevailing road conditions

Failure to observe these guidelines could cause the vehicle to skid.

The ESP cannot prevent accidents resulting from excessive speed.



Do not tow with one axle raised.

Otherwise the transfer case can be damaged, which is not covered by the Mercedes-Benz Limited Warranty.



Performance testing must only be conducted on a two-axle dynamometer.

Otherwise the transfer case can be damaged, which is not covered by the Mercedes-Benz Limited Warranty.



Because of the ESP's automatic operation, the engine and ignition must be shut off (SmartKey in starter switch position **0** or **1** or KEYLESS-GO start/stop button* in position **0** or **1**) when the parking brake is being tested on a brake test dynamometer.

Active braking action through ESP may otherwise seriously damage the front or rear axle brake system.

Operational tests with the engine running can only be conducted on a two-axle dynamometer.

▼ Anti-theft systems

Immobilizer

The immobilizer prevents unauthorized persons from starting your vehicle.

Activating

- With the SmartKey: Removing the SmartKey from the starter switch activates the immobilizer.
- With KEYLESS-GO*: Turning off the engine by means of the KEYLESS-GO start/stop button on the gear selector lever activates the immobilizer.

Deactivating

- With the SmartKey: Inserting the SmartKey in the starter switch deactivates the immobilizer.
- With KEYLESS-GO*: Starting the engine by means of the start/stop button on the gear selector lever deactivates the immobilizer.



In case the engine cannot be started (yet the vehicle's battery is charged), the system is not operational. Contact an authorized Mercedes-Benz Center or call 1-800-FOR-MERCEdes (in the USA), or 1-800-387-0100 (in Canada).

Safety and Security

Anti-theft systems

Anti-theft alarm system

Once the alarm system has been armed, a visual and audible alarm is triggered when someone opens

- a door
- the trunk
- the hood.

The alarm will stay on, even if the activating element (a door, for example) is immediately closed.

The alarm system will also be triggered when

- someone attempts to raise the vehicle.



If the alarm stays on for more than 20 seconds, an emergency call is initiated automatically by the Tele Aid system* (▷ page 250) provided Tele Aid service was subscribed to and properly activated, and that necessary cellular service and GPS coverage are available.

Arming the alarm system

The alarm system is armed within approximately ten seconds after locking the vehicle with the SmartKey or KEYLESS-GO*. The turn signal lamps flash three times to indicate that the alarm system is activated. The indicator lamp in the central locking switch (▷ page 25) begins to flash after arming the alarm system.



If the turn signal lamps do not flash three times one of the following elements may not be properly closed:

- a door
- the trunk lid

Close the respective element and lock the vehicle again.

Disarming the alarm system



The alarm system is disarmed when you unlock your vehicle with the SmartKey or KEYLESS-GO*. The turn signal lamps flash once to indicate that the alarm system is deactivated.

Canceling the alarm

With the SmartKey

- ▶ Insert the SmartKey in the starter switch.

or

- ▶ Press the  or  button on the SmartKey.

The alarm is canceled.

*With KEYLESS-GO**

- ▶ Grasp the outside door handle.

or

- ▶ Press the KEYLESS-GO* start/stop button.

The alarm is canceled.

Tow-away alarm

Once the tow-away alarm is armed, a visual and audible alarm will be triggered when someone attempts to raise the vehicle.



The tow-away protection alarm is triggered, for example, if the vehicle is lifted on one side.

If the alarm stays on for more than 20 seconds, an emergency call is initiated automatically by the Tele Aid system* (> page 250), provided that the Tele Aid service was subscribed to and properly activated, and that necessary cellular service and GPS coverage are available.

Arming the tow-away alarm

When you lock your vehicle, the tow-away alarm is automatically armed after about 30 seconds.

When you unlock your vehicle, the tow-away protection disarms automatically.

Disarming the tow-away alarm

To prevent triggering the tow-away alarm feature, switch off the tow-away alarm before towing the vehicle, or when parking on a surface subject to movement, such as a ferry or auto train.

The button is located on the overhead control panel.

Safety and Security

Anti-theft systems



① Tow-away alarm off button

- ▶ Switch off the ignition and remove the SmartKey.



You cannot disarm the tow-away alarm when the ignition is switched on.



- ▶ Press button ①.
The indicator lamp in the button comes on briefly.
- ▶ Exit and lock your vehicle with the SmartKey or (vehicles with KEYLESS-GO*) the lock button at each door handle.

The tow-away alarm remains disarmed until you lock your vehicle again.

Canceling tow-away alarm

To cancel the alarm:

With the SmartKey

- ▶ Insert the SmartKey in the starter switch.
- or
- ▶ Press the  or  button on the SmartKey.

With KEYLESS-GO*

- ▶ Grasp the outside door handle.
- or
- ▶ Press the KEYLESS-GO start/stop button.



Controls in detail

Locking and unlocking

Seats

Memory function

Lighting

Instrument cluster

Control system

Automatic transmission

Good visibility

Climate control

Automatic climate control*

Power windows

Sliding / pop-up roof*

Panorama sliding / pop-up roof*

Driving systems

Loading

Useful features

Controls in detail

Locking and unlocking

In the “Controls in detail” section you will find detailed information on how to operate the equipment installed on your vehicle. If you are already familiar with the basic functions of your vehicle, this section will be of particular interest to you.

To quickly familiarize yourself with the basic functions of the vehicle, refer to the “Getting started” section of this manual. The corresponding page numbers are given at the beginning of each segment.

▼ Locking and unlocking

SmartKey

Your vehicle comes supplied with two SmartKeys, each with remote controls and a removable mechanical key. The locking tabs for the mechanical key portion of the two SmartKeys are a different color to help distinguish each key unit.





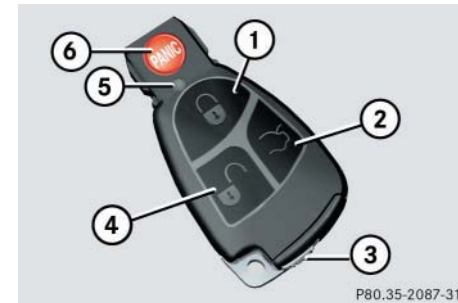

The SmartKey provides an extended operating range. To prevent theft, however, it is advisable to only unlock the vehicle when you are in close proximity to it.

The SmartKey centrally locks and unlocks

- the doors
- the trunk
- the fuel filler flap



SmartKey

- ①  Lock button
- ②  Unlock button for the trunk lid
- ③  Mechanical key locking tab
- ④  Unlock button
- ⑤  Battery check lamp
- ⑥  PANIC Panic button (> page 73)

Warning!



When leaving the vehicle, always remove the SmartKey from the starter switch, take the SmartKey with KEYLESS-GO* with you and lock the vehicle. Do not leave children unattended in the vehicle, or with access to an unlocked vehicle. It is possible for children to open a locked door from the inside, which could result in an accident or serious injury.



To prevent possible malfunction, avoid exposing the SmartKey to high levels of electromagnetic radiation.



You can also open and close the power windows (▷ page 197) and sliding / pop-up roof* (▷ page 201) or panorama sliding / pop-up roof* (▷ page 208) using the SmartKey.

Factory setting

Global unlocking

- ▶ Press button

All turn signal lamps flash once. The locking knobs in the doors move up.

The vehicle will lock again automatically within approximately 40 seconds of unlocking if:

- neither door nor trunk is opened
- the SmartKey is not inserted in the starter switch
- the central locking switch is not activated

Global locking

- ▶ Press button

All turn signal lamps flash three times. The locking knobs in the doors move down.

Controls in detail

Locking and unlocking

Selective setting

If you frequently travel alone, you may wish to reprogram the SmartKey so that pressing only unlocks the driver's door and the fuel filler flap.

- ▶ Press and hold buttons and simultaneously for about five seconds until battery check lamp (5) flashes twice.

The SmartKey will then function as follows:

Unlocking driver's door and fuel filler flap

- ▶ Press button once.

Global unlocking

- ▶ Press button twice.



Global locking

- ▶ Press button .

Controls in detail

Locking and unlocking

Restoring to factory setting

- ▶ Press and hold buttons  and  simultaneously for about six seconds until battery check lamp  flashes twice.



If you can no longer lock or unlock the vehicle with the SmartKey, then the batteries in the SmartKey are discharged, the SmartKey is malfunctioning or the vehicle battery is drained.

- Check the batteries in the SmartKey (▷ page 91) and replace them if necessary (▷ page 355).
- Use the mechanical key to unlock the doors (▷ page 353).
- Have the vehicle batteries and their connections checked.

- Use the mechanical key to lock the doors (▷ page 353) and the trunk lid (if applicable) (▷ page 105).

If the SmartKey is malfunctioning, contact an authorized Mercedes-Benz Center.

Unlocking and opening the trunk lid

You can unlock and open the trunk separately.

A minimum height clearance of 5.90 ft (1.80 m) is required to open the trunk lid.

- ▶ Press button  until trunk unlocks and begins to open.



The trunk lid swings open upwards automatically. Always make sure there is sufficient overhead clearance.

Vehicles with trunk lid opening/closing system*: to stop the opening procedure, press button . The trunk lid stops moving.





If the trunk lid does not open, it is still locked separately (▷ page 105).

If the vehicle was previously centrally locked, the trunk lid will lock automatically when closed (▷ page 99). The turn signals will flash three times to confirm locking.

The trunk can also be opened from its inside in an emergency, see “Trunk lid emergency release” (▷ page 104).

Checking the batteries

- ▶ Press button  or .

Battery check lamp  comes on briefly to indicate that the SmartKey batteries are in order.





If battery check lamp  does not come on briefly during check, then the SmartKey batteries are discharged.

Replace the batteries (▷ page 355).

You can obtain the required batteries at any authorized Mercedes-Benz Center.



If the batteries are checked within signal range of the vehicle, pressing the button  or  will lock or unlock the vehicle accordingly.

Loss of SmartKey or mechanical key

If you lose a SmartKey or mechanical key, you should do the following:

- ▶ Have the SmartKey deactivated by an authorized Mercedes-Benz Center.
- ▶ Report the loss of the SmartKey or the mechanical key immediately to your car insurance company.
- ▶ If necessary, have the mechanical lock replaced.

Your authorized Mercedes-Benz Center will be glad to supply you with a replacement.

SmartKey with KEYLESS-GO*

Specially equipped vehicles come with two SmartKeys with KEYLESS-GO, each with remote controls and a removable mechanical key. The locking tabs for the mechanical key portion of the two SmartKeys are a different color to help distinguish each SmartKey unit.

The KEYLESS-GO function is integrated into the SmartKey. On these vehicles, the validity of the SmartKey with KEYLESS-GO is checked every time you grasp a door handle.

If the SmartKey with KEYLESS-GO is valid, your vehicle unlocks

- the doors
- the trunk lid
- the fuel filler flap

Controls in detail

Locking and unlocking

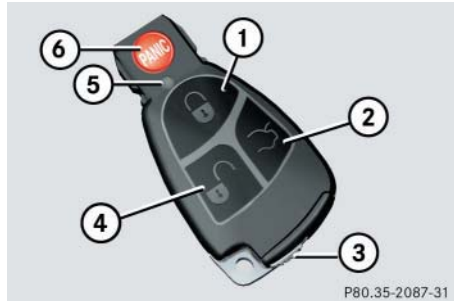

SmartKey

- ① Lock button
- ② Unlock button for the trunk lid
- ③ Mechanical key locking tab
- ④ Unlock button
- ⑤ Battery check lamp
- ⑥ PANIC button (▷ page 73)

For more information on using the SmartKey buttons, see “SmartKey” (▷ page 88).

Warning!



When leaving the vehicle, always remove the SmartKey from the starter switch, take the SmartKey with KEYLESS-GO* with you and lock the vehicle. Do not leave children unattended in the vehicle, or with access to an unlocked vehicle. Unsupervised use of vehicle equipment may cause serious personal injury.



To prevent possible malfunction, avoid exposing the SmartKey with KEYLESS-GO to high levels of electromagnetic radiation.



You can also open and close the power windows (▷ page 197) and sliding / pop-up roof* (▷ page 201) or panorama sliding / pop-up roof* (▷ page 208) using the SmartKey.

Important notes on using KEYLESS-GO

- You can also use the SmartKey with KEYLESS-GO like a normal SmartKey (▷ page 88).
 - You can combine KEYLESS-GO functions with normal SmartKey functions (e.g. unlocking with KEYLESS-GO and locking with the remote control).
 - Always carry the SmartKey with KEYLESS-GO with you.
 - Never store the SmartKey with KEYLESS-GO together with:
 - Electronic items such as a cellular phone or another SmartKey with KEYLESS-GO
 - Metallic objects such as coins or metal foil
- Doing so could impair the function of the KEYLESS-GO system.

Controls in detail

Locking and unlocking

- To lock or unlock the vehicle, the SmartKey must be located outside the vehicle within approximately 3 ft (1 m) of a door or the trunk.
- In order to start the engine with the SmartKey with KEYLESS-GO:
 - The SmartKey with KEYLESS-GO must be located in the vehicle.
 - All the doors must be closed.
 - The brake pedal must be firmly depressed. Do not depress the accelerator.
- If you have started the engine with the KEYLESS-GO start / stop button, you can only turn it off again with this button, even if you have put the SmartKey in the starter switch in the meantime.
- This does not apply if, after starting, the selector lever is still in position **P** and then the SmartKey is inserted in the starter switch. The SmartKey will then have priority over the KEYLESS-GO function and the vehicle's electrical system will operate according to the position of the SmartKey in the starter switch, even stopping the engine.
- If the SmartKey with KEYLESS-GO is positioned farther away from the vehicle and can no longer be recognized by the system, the vehicle cannot be locked or the engine started via the KEYLESS-GO system.
- If the SmartKey with KEYLESS-GO is removed from the vehicle while the ignition is switched on (e.g. if passenger exits the vehicle with the SmartKey), the message *Key not recognized!* will appear in the multifunction display.

Find the SmartKey or change its present location immediately (e.g. place it on the front passenger seat or insert it in shirt pocket).
- Remember that the engine can be started by anyone with a SmartKey with KEYLESS-GO that is left inside the vehicle. If you leave the SmartKey with KEYLESS-GO behind when exiting and locking the vehicle, the message *Key recognized in vehicle!* will appear in the multifunction display.

Controls in detail

Locking and unlocking

Factory setting

Global unlocking

- ▶ Grasp the door handle.

The vehicle will lock again automatically within approximately 40 seconds if neither door nor trunk is opened.

Global locking

- ▶ Press lock button at door handle (▷ page 54) or trunk lid (▷ page 96).



If you can no longer lock or unlock the vehicle with the SmartKey, then the batteries in the SmartKey are discharged, the SmartKey is malfunctioning or the vehicle battery is drained.



- Check the batteries in the SmartKey (▷ page 91) and replace them if necessary (▷ page 355).

- Use the mechanical key to unlock the doors (▷ page 353).
- Have the vehicle batteries and their connections checked.
- Use the mechanical key to lock the doors (▷ page 353) and the trunk lid (if applicable) (▷ page 105).

If the SmartKey is malfunctioning, contact an authorized Mercedes-Benz Center.

Selective setting

If you frequently travel alone, you may wish to reprogram the SmartKey with KEYLESS-GO so when you grasp the driver's door handle only the driver's door and the fuel filler flap unlocks.

- ▶ Press and hold buttons  and  simultaneously for about five seconds until battery check lamp ⑤ flashes twice.

The SmartKey with KEYLESS-GO will then function as follows:

Unlocking driver's door and fuel filler flap

- ▶ Press button  once.



Global unlocking

- ▶ Press button  twice.

Global locking

- ▶ Press button .

Restoring to factory setting

- ▶ Press and hold buttons  and  simultaneously for about six seconds until battery check lamp ⑤ flashes twice.



If you can no longer lock or unlock the vehicle with the SmartKey with KEYLESS-GO, then the batteries in the SmartKey are discharged, the SmartKey with KEYLESS-GO is malfunctioning or the vehicle battery is drained.

- Check the batteries in the SmartKey with KEYLESS-GO (▷ page 91) and replace them if necessary (▷ page 355).
- Use the mechanical key to unlock the doors (▷ page 353).
- Have the vehicle battery checked by an authorized Mercedes-Benz Center.
- Use the mechanical key to lock the doors (▷ page 353) and the trunk lid (if applicable) (▷ page 105).

If the SmartKey with KEYLESS-GO is malfunctioning, contact an authorized Mercedes-Benz Center.

Unlocking and opening the trunk lid

A minimum height clearance of 5.90 ft (1.80 m) is required to open the trunk lid.

The handle is located in the rear license plate recess.

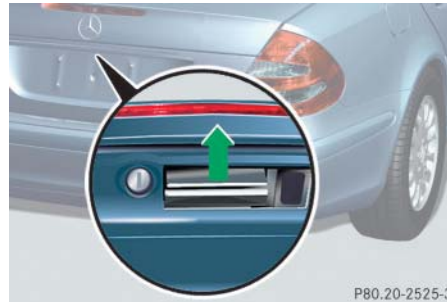

You can unlock and open the trunk lid separately.

- ▶ Pull on the handle
or
- ▶ Press and hold button  until the trunk lid unlocks and opens.

Controls in detail

Locking and unlocking



The trunk lid swings open upwards automatically. Always make sure there is sufficient overhead clearance.

Vehicles with trunk lid opening/closing system*: to stop the opening procedure, press button  on the SmartKey. The trunk lid stops moving.



If the trunk lid does not open, it is still locked separately (if applicable) (▷ page 105).

If the vehicle was previously centrally locked, the trunk lid will lock automatically when closed. The turn signals will flash three times to confirm locking.

The trunk can also be opened from the inside in an emergency, see “Trunk lid emergency release” (▷ page 104).

Controls in detail

Locking and unlocking

Locking the vehicle

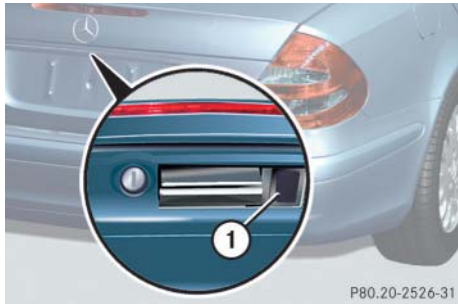

① Lock button at trunk

- ▶ Press the lock button ①.

or

- ▶ Press the lock button at the outside door handle (▷ page 54).

or

- ▶ Vehicles with trunk lid opening/closing system*, press the KEYLESS-GO locking/closing switch in the trunk (▷ page 103).

The vehicle locks. The turn signals flashes three times to confirm locking.

Checking the batteries

- ▶ Press button  or .

Battery check lamp ⑤ comes on briefly to indicate that the SmartKey batteries are in order.





If battery check lamp ⑤ does not come on briefly during check, then the SmartKey batteries are discharged.

Replace the batteries (▷ page 355).

You can obtain the required batteries at any authorized Mercedes-Benz Center.



If the batteries are checked within signal range of the vehicle, pressing the button  or  will lock or unlock the vehicle accordingly.

Loss of the SmartKey with KEYLESS-GO

If you lose your SmartKey with KEYLESS-GO, you should do the following:

- ▶ Have the SmartKey with KEYLESS-GO deactivated by an authorized Mercedes-Benz Center.
- ▶ Report the loss immediately to your car insurance company.
- ▶ Have the mechanical lock replaced if necessary.

Your authorized Mercedes-Benz Center will be glad to supply you with a replacement.

Controls in detail

Locking and unlocking

Opening the doors from the inside

You can open a locked door from the inside. Open door only when conditions are safe to do so.

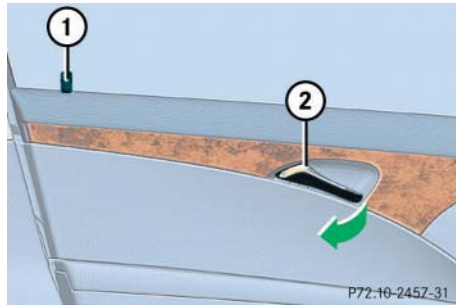

- ① Locking knob
- ② Inside door handle

► Pull on door handle ②.



If door was locked, locking knob ① will move up.



If the vehicle has previously been locked from the outside with the SmartKey, opening a door from the inside will trigger the anti-theft alarm system.

To cancel the alarm, do one of the following:

With the SmartKey

- Insert the SmartKey in the starter switch.
- Press the  or  button on the SmartKey.

With KEYLESS-GO*

- Grasp the outside door handle.
- Press the KEYLESS-GO* start/stop button.

Opening the trunk

Opening the trunk from the outside

A minimum height clearance of 5.90 ft (1.80 m) is required to open the trunk lid.

The handle is located above the rear license plate recess.



- Pull on the handle.
The trunk opens.

Controls in detail

Locking and unlocking



The trunk lid swings open upwards automatically. Always make sure there is sufficient overhead clearance.



If the trunk lid does not open, it is still locked separately (if applicable) (▷ page 105) or the vehicle is locked centrally (▷ page 88).

Vehicles with KEYLESS-GO*: If the vehicle was previously centrally locked, the trunk lid will lock automatically when closed (▷ page 91). The turn signals will flash three times to confirm locking.

The trunk can also be opened using the SmartKey (▷ page 90) or from its inside in an emergency, see “Trunk lid emergency release” (▷ page 104).

Opening the trunk from the inside

You can open the trunk from the inside if the vehicle is stationary.

A minimum height clearance of 5.90 ft (1.80 m) is required to open the trunk lid.

The switch is located on the driver's door.



① Remote trunk lid release switch with indicator lamp

- ▶ Pull remote trunk lid release switch ① until the trunk begins to open.

The trunk lid opens. The indicator lamp in the switch comes on and remains lit until the trunk is closed.



The trunk lid swings open upwards automatically. Always make sure there is sufficient overhead clearance.



If the trunk lid does not open, it is still locked separately (if applicable) (▷ page 105).

If the vehicle was previously centrally locked, the trunk lid will lock automatically when closed (▷ page 99). The turn signals will flash three times to confirm locking.

The trunk can also be opened using the SmartKey (▷ page 90) or from its inside in an emergency, see “Trunk lid emergency release” (▷ page 104).

Controls in detail

Locking and unlocking

Closing the trunk



① Handle

- ▶ Lower trunk lid by pulling firmly on handle ①.
- ▶ Close trunk lid with hands placed flat on it.

Warning!



To prevent possible personal injury, always keep hands and fingers away from the trunk opening when closing the trunk. Be especially careful when small children are around.

Warning!



Only drive with the trunk closed as, among other dangers such as visibility blockage, exhaust fumes may enter the vehicle interior.



Do not place the SmartKey in the open trunk. You may lock yourself out.

Vehicles with KEYLESS-GO:

To prevent a possible inadvertent lock-out, the trunk lid will open automatically if a SmartKey with KEYLESS-GO is recognized inside the vehicle or in the trunk.

Trunk lid opening/closing system*

You can open the trunk from the inside if the vehicle is stationary.

Opening from the inside

A minimum height clearance of 5.90 ft (1.80 m) is required to open the trunk lid.

The switch for opening and closing the trunk is located on the driver's door.

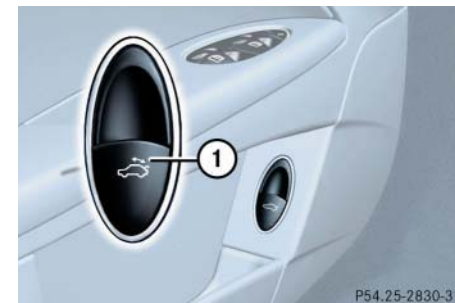

- ① Remote trunk lid switch with indicator lamp

Controls in detail

Locking and unlocking

- ▶ Pull remote trunk lid switch ① until the trunk begins to open.

The trunk lid opens automatically. The indicator lamp in the switch comes on and remains lit until the trunk is closed.



The trunk lid swings open upwards automatically. Always make sure there is sufficient overhead clearance. To stop the opening procedure, press or pull the remote trunk lid switch.



If the trunk lid does not open, it is still locked separately (if applicable) (▷ page 105).

If the vehicle was previously centrally locked, the trunk lid will lock automatically when closed (▷ page 99). The turn signals will flash three times to confirm locking.

The trunk can also be opened using the SmartKey (▷ page 90) or from its inside in an emergency, see “Trunk lid emergency release” (▷ page 104).

Limiting opening height of trunk lid

The trunk lid opening height can be limited when transporting goods on a roof rack (e.g. presence of an MB sport luggage container). When activated, the trunk lid opens to approximately the height of the roof edge.

You can activate the limiting opening height of trunk lid using the control system (▷ page 150).

Closing from the inside

- ▶ Press the remote trunk lid switch (▷ page 99) until the indicator lamp in the switch goes out and the trunk lid is closed.

To interrupt the closing procedure:

- ▶ Release the remote trunk lid switch.

Warning!



Maintain sight of trunk area while operating the door mounted switch. Monitor the closing procedure carefully to ensure that no one is in danger of being injured.

To interrupt the closing procedure, release the door mounted remote trunk lid switch.

If the trunk lid comes into contact with an object while closing (e.g. luggage that has been piled too high), the closing procedure is stopped and the trunk re-opens slightly.

Closing the trunk from the outside (vehicles without KEYLESS-GO*)



- ① Trunk lid closing switch
- ▶ Press trunk lid closing switch ① briefly.
The trunk lid closes.

When closing, if the trunk lid comes into contact with an object (e.g. luggage that has been piled too high), the closing procedure is stopped and the trunk re-opens slightly.



Do not place the SmartKey in the open trunk. You may lock yourself out.

Warning!



Only drive with the trunk closed as, among other dangers such as visibility blockage, exhaust fumes may enter the vehicle interior.

Controls in detail

Locking and unlocking

Warning!



Monitor the closing procedure carefully to ensure that no one is in danger of being injured. To prevent possible personal injury, always keep hands and fingers away from the trunk opening when closing the trunk. Be especially careful when small children are around. To stop the closing procedure, press the remote trunk lid switch (on the driver's door), the trunk lid closing switch ① or the  button on the SmartKey.

When leaving the vehicle, always remove the SmartKey from the starter switch, take the SmartKey you, and lock your vehicle. Do not leave children unattended in the vehicle, or with access to an unlocked vehicle. Unsupervised use of vehicle equipment may cause an accident and/or serious personal injury.

Controls in detail

Locking and unlocking

Closing the trunk from the outside (vehicles with KEYLESS-GO*)



- ① Trunk lid closing switch
- ▶ Make sure you have the SmartKey with KEYLESS-GO with you.
 - ▶ Press trunk lid closing switch ① briefly.
- The trunk lid closes.



To prevent a possible inadvertent lock-out, the trunk lid will open automatically if a SmartKey with KEYLESS-GO is recognized inside the vehicle or in the trunk.

If the trunk lid comes into contact with an object while closing (e.g. luggage that has been piled too high), the closing procedure is stopped and the trunk re-opens slightly.

Warning!



Only drive with the trunk closed as, among other dangers such as visibility blockage, exhaust fumes may enter the vehicle interior.

Warning!



Monitor the closing procedure carefully to ensure that no one is in danger of being injured. To prevent possible personal injury, always keep hands and fingers away from the trunk opening when closing the trunk. Be especially careful when small children are around. To stop the closing procedure, press the remote trunk lid switch (on the driver's door), the trunk lid closing switch ① or the  button on the SmartKey with KEYLESS-GO.

When leaving the vehicle, always remove the SmartKey from the starter switch, take the SmartKey with KEYLESS-GO with you, and lock your vehicle. Do not leave children unattended in the vehicle, or with access to an unlocked vehicle. Unsupervised use of vehicle equipment may cause an accident and/or serious personal injury.

Closing the trunk and locking the vehicle from the outside (vehicles with KEYLESS-GO*)



① KEYLESS-GO* locking/closing switch
You can close the trunk lid and lock the vehicle simultaneously.

- ▶ Make sure you have the SmartKey with KEYLESS-GO with you.
- ▶ Press switch ① briefly.

The vehicle is locked and the trunk lid closes automatically. The turn signals flash three times to confirm locking.

If the trunk lid comes into contact with an object while closing (e.g. luggage that has been piled too high), the closing procedure is stopped and the trunk re-opens slightly.



To prevent a possible inadvertent lock-out, the trunk lid will open automatically if a SmartKey with KEYLESS-GO is recognized inside the vehicle or in the trunk.

Controls in detail

Locking and unlocking

Warning!



Monitor the closing procedure carefully to ensure that no one is in danger of being injured. To prevent possible personal injury, always keep hands and fingers away from the trunk opening when closing the trunk. Be especially careful when small children are around. To stop the closing procedure, press the remote trunk lid switch (on the driver's door), the trunk lid closing switch ①, the  button on the SmartKey with KEYLESS-GO or the remote trunk lid opening switch (located on the driver's door).

When leaving the vehicle, always remove the SmartKey from the starter switch, take the SmartKey with KEYLESS-GO* with you, and lock your vehicle. Do not leave children unattended in the vehicle, or with access to an unlocked vehicle. Unsupervised use of vehicle equipment may cause an accident and/or serious personal injury.

Controls in detail

Locking and unlocking

Warning!



Only drive with the trunk closed as, among other dangers such as visibility blockage, exhaust fumes may enter the vehicle interior.

Trunk lid emergency release

The emergency release button is located on the inside of the trunk lid.



① Emergency release button

- ▶ Briefly press emergency release button ①.

The trunk unlocks and the trunk lid opens.



The emergency release button unlocks and opens the trunk while the vehicle is standing or driving.

The emergency release button does not open the trunk lid, if the vehicle battery is discharged or disconnected.

Illumination of the emergency release button:



- The button will flash for 30 minutes after opening the trunk.
- The button will flash for 60 minutes after closing the trunk.



If the emergency release button is pressed and the vehicle was centrally locked from the outside using the SmartKey, the exterior lamps will flash and the alarm will sound as the trunk lid opens.

To cancel the alarm, do one of the following:

With the SmartKey

- Insert the SmartKey in the starter switch.
- Press the  or  button on the SmartKey.

With KEYLESS-GO*

- Grasp the outside door handle.
- Press the KEYLESS-GO* start/stop button.

Separately locking the trunk

Your vehicle may be equipped with a function permitting the separate locking of the trunk using the mechanical key. If present, this feature can permit you to deny any unauthorized person access to the trunk by locking the trunk separately and leaving the SmartKey less the mechanical key with the vehicle.

To verify the presence of this feature, use the mechanical key to lock the trunk and then attempt to open the trunk.

The lock is located next to the recessed handle.

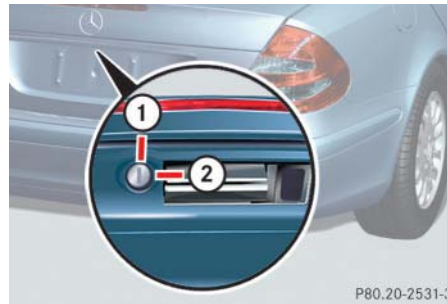

- ① Unlocked
- ② Locked

- ▶ Close the trunk lid (▷ page 99).
- ▶ Pull the mechanical key out of the SmartKey (▷ page 353).

Controls in detail

Locking and unlocking

- ▶ Insert the mechanical key in the trunk lid lock.
- ▶ Turn the mechanical key clockwise to position ①.

The trunk remains locked even when the vehicle is centrally unlocked.



You can only cancel the separate trunk locking mode by means of the mechanical key.

Controls in detail

Locking and unlocking

Separately unlocking the trunk

- ▶ Pull the mechanical key out of the SmartKey (▷ page 353).
- ▶ Insert the mechanical key in the trunk lid lock.
- ▶ Turn the mechanical key completely to the left to position ②, (▷ page 105).

You can now open the trunk (▷ page 97).

A minimum height clearance of 5.90 ft (1.80 m) is required to open the trunk lid.



Unlocking the trunk with the mechanical key will trigger the anti-theft alarm system. To cancel the alarm, do one of the following:

- Press button or on the SmartKey.
- Insert the SmartKey in the starter switch.

Automatic central locking

The doors and the trunk automatically lock when the ignition is switched on and the wheels are turning at vehicle speeds of approximately 9 mph (15 km/h) or more.

You can open a locked door from the inside. Open door only when conditions are safe to do so.



The doors unlock automatically after an accident if the force of the impact exceeds a preset threshold.

The vehicle automatically locks when the ignition is switched on and the wheels are turning at vehicle speeds of approximately 9 mph (15 km/h) or more. You could therefore lock yourself out when the vehicle

- is pushed or towed
- is on a test stand

Information on towing the vehicle can be found in the “Practical hints” section (▷ page 381).

You can deactivate the automatic locking mode over the control system (▷ page 149).

Controls in detail

Locking and unlocking

Locking and unlocking from the inside

You can lock or unlock the doors and the trunk from inside using the central locking switch. This can be useful, for example, if you want to lock the vehicle before starting to drive.

The fuel filler flap cannot be locked or unlocked with the central locking switch.

Warning!



When leaving the vehicle, always remove the SmartKey from the starter switch, take it with you and lock the vehicle. Do not leave children unattended in the vehicle, or with access to an unlocked vehicle. Unsupervised use of vehicle equipment may cause an accident and / or serious personal injury.

The switch is located in the center console.

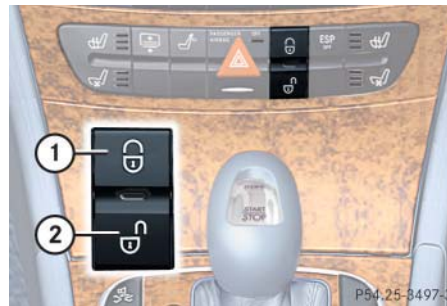

Central locking switch

- ① Locking
- ② Unlocking

Locking

- ▶ Press upper half ① of the central locking switch.

If both front doors are closed, the vehicle locks.

Unlocking

- ▶ Press lower half ② of the central locking switch.

The vehicle unlocks.



You can open a locked door from the inside. Open door only when conditions are safe to do so.

If the vehicle was previously centrally locked using the SmartKey, it will not unlock using the central locking switch.

If the vehicle was previously locked with the central locking switch

- while in the selective remote control mode, only the door opened from the inside is unlocked.
- while in the global remote control mode, the vehicle is unlocked completely when a door is opened from the inside.

Controls in detail

Seats

▼ Seats

Information on seat adjustment can be found in the “Getting started” section (▷ page 35).

Easy-entry / exit feature*

With the easy-entry / exit feature activated, the steering wheel tilts upwards and the driver's seat moves to the rear.

This allows easier entry into and exit from the vehicle when the driver's door is opened. However, the engine must be turned off.

When the SmartKey is inserted in the starter switch or you have pressed the Keyless-Go* start/stop button and the driver's door is closed, the steering wheel and the driver's seat return to their last set positions.

Warning!



You must ensure that no one can become trapped or injured by the moving steering wheel and driver's seat when the easy-entry / exit feature is activated, the driver's door is being opened and the engine is turned off or the SmartKey removed from the starter switch.

Do not leave children unattended in the vehicle, or with access to an unlocked vehicle. Children could open the driver's door and unintentionally activate the easy-entry / exit feature*, which could result in an accident and / or serious personal injury.

You can activate the following functions:

- Steering column:
Only the steering column is adjusted.
- Steering column and seat:
The steering column and the seat are adjusted.

The easy-entry / exit feature can be switched on or off in the convenience submenu of the control system (▷ page 150).



To cancel seat / steering wheel movement, do one of the following:

- Press seat adjustment switch (▷ page 28).
- Move steering column stalk (▷ page 37).
- Press the memory switch (▷ page 28).

Removing and installing front seat head restraints

Information on head restraint adjustment can be found in the “Getting started” section (▷ page 36).

Warning!



For your protection, drive only with properly positioned head restraints.

Adjust head restraint so that the center of the head restraint supports the back of the head at eye level. This will reduce the potential for injury to the head and neck in the event of an accident or similar situation.

Do not drive the vehicle without the seat head restraints. Head restraints are intended to help reduce injuries during an accident.



Tilt the backrest to the rear for easier removal and installation of the head restraints.

Front seat head restraints



Removing front head restraints

- ▶ Press switch ① upwards and hold until the head restraint is fully extended.
- ▶ Pull out head restraint.

Installing front head restraints:

- ▶ Press switch ① upwards and hold for about five seconds.
- ▶ Push the head restraint down until it engages.
- ▶ Adjust head restraint to desired position (▷ page 36).

Controls in detail

Seats

Rear seat head restraints



The rear seat head restraints cannot be adjusted.

Folding head restraints back with switch in the center console

The rear seat head restraints can be folded backward for increased visibility.



① Head restraint release switch

- ▶ Make sure the ignition is switched on.
All the lights in the instrument cluster come on.
- ▶ Press the symbol-side on rocker switch ① to release the head restraints.
The head restraints will fold backward.

Warning!



For safety reasons, always drive with the rear head restraints in the upright position when the rear seats are occupied.

Keep the area around head restraints clear of articles (e.g. clothing) to not obstruct the folding operation of the head restraints.

Placing head restraints upright



- ▶ Pull the head restraint forward until it locks into position.



Make sure the head restraints engage when placing them upright. Otherwise their protective function cannot be assured.

Removing and installing rear seat head restraints

For removing and installing rear seat head restraints, see “Expanding the cargo area*” (▷ page 239)

Multicontour seat*

The multicontour seat has a movable seat cushion and inflatable air cushions built into the backrest to provide additional lumbar and side support.

The seat cushion movement, backrest cushion height and curvature can be continuously varied with switches on the right side of the seat after turning the SmartKey in the starter switch to position **2** or pressing the KEYLESS-GO* start/stop button twice.

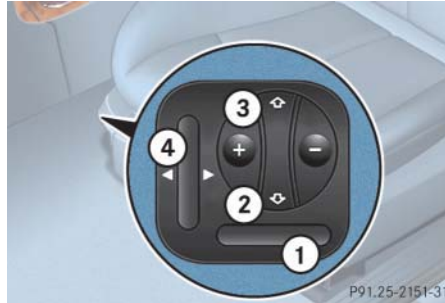

- ① Seat cushion depth
- ② Backrest bottom
- ③ Backrest center
- ④ Backrest side bolster adjustment

► Make sure the ignition is switched on.

All lights in the instrument cluster come on.

Controls in detail

Seats

Seat cushion depth

- Adjust the seat cushion depth to the length of your upper leg using switch ①.

Backrest contour

- Adjust the contour of the backrest to the desired position using **+** or **-**.
- Move the backrest support to the bottom by using button ② or to the center by using button ③.

Backrest side bolsters

- Adjust the side bolsters so that they provide good lateral support using switch ④.

Controls in detail

Seats

Drive-Dynamic seat*

The Drive-Dynamic seat automatically adjusts the lateral support provided by the backrest to your driving style.

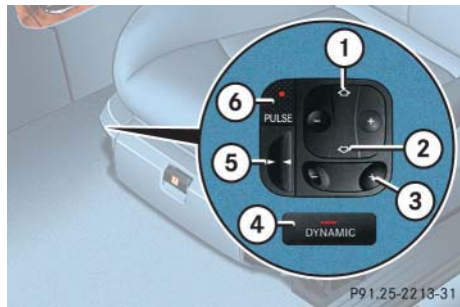

- ① Backrest center
- ② Backrest bottom
- ③ Seat cushion depth
- ④ Activate drive dynamic function
- ⑤ Backrest side bolsters
- ⑥ Massage function

The drive-Dynamic seat electronically controls the air pressure in the air chambers of the backrest side bolsters. This function improves driving comfort and pleasure.

Activating

- ▶ Press button ④.

The indicator lamp in the button comes on for five seconds and the following display appears in the multi-function display for about five seconds.



i

You can adjust the characteristics of the Drive-Dynamic seat using the control system (▷ page 153).

Deactivating

- ▶ Press button ④ again.

The indicator lamp in the button goes out.

i

When the engine is turned off, the last cushion setting is retained in memory. The cushion is automatically adjusted to this setting when the engine is restarted.

Massage function (PULSE)

The massage function can help prevent muscle tension during long drives.

- ▶ Press button ⑥.

The indicator lamp in button ② comes on. The air cushions in the lumbar area pulsate.



The massage function turns off automatically after approximately five minutes.

Heated seats*

Both switches for the front seats are located in the center console. The red indicator lamps in the switch come on to show which heating level you have selected.

Level	
off	No indicator lamps on
1	One indicator lamp on
2	Two indicator lamps on
	The seat heater automatically switches to level 1 after approximately ten minutes.
3	Three indicator lamps on
	The seat heater automatically switches to level 2 after approximately five minutes.

Controls in detail

Seats



① Seat heating switch

- ▶ Make sure the ignition is switched on. All lights in the instrument cluster come on.

Switching seat heating on

- ▶ Press button ① repeatedly until the desired heating level is set.

One or more red indicator lamps on the switch show the selected heater level

Controls in detail

Seats

Switching seat heating off

- ▶ Press button ① repeatedly until all indicator lamps go out.



The seat heating will be automatically switched off after approximately 20 minutes.



If one or more of the lamps on the seat heater switch are flashing, there is insufficient voltage available since too many electrical consumers are turned on. The seat heater switches off automatically.

The seat heater will switch back on again automatically as soon as sufficient voltage is available.

Seat ventilation*

The switch is located on the center console. Seat ventilation can be activated manually with the ignition on, or by the summer opening feature (▷ page 199).

The blue indicator lamps on the switch show the ventilation level selected:

Level	
3	Three indicator lamps lit
2	Two indicator lamps lit
1	One indicator lamp lit
off	No indicator lamp lit



① Seat ventilation switch

- ▶ Make sure the ignition has been switched on.

All lights in the instrument cluster come on.

Switching seat ventilation on

- ▶ Press button ① repeatedly until the desired ventilation level is set.

Switching seat ventilation off

- ▶ Press button ① repeatedly until all indicator lamps go out.



The seat ventilation is automatically set to the highest level if activated via summer opening feature (▷ page 199).



If one or all of the lamps flash on the seat ventilation switch, there is insufficient voltage due to too many electrical consumers being switched on. The seat ventilation switches off automatically.

The seat ventilation will switch back on again automatically as soon as sufficient voltage is available.

Controls in detail

Memory function

▼ Memory function



Prior to operating the vehicle, the driver should check and adjust the seat height, seat position fore and aft, and seat backrest angle if necessary, to ensure adequate control, reach and comfort. The head restraint should also be adjusted for proper height. See also the section on airbags (▷ page 57) for more information on proper seat positioning.

In addition, adjust the steering wheel to ensure adequate control, reach, operation and comfort. Both the interior and outside rear view mirrors should be adjusted for adequate rear vision.

Fasten seat belts. Infants and small children should be seated in a properly secured restraint system that complies with U.S. Federal Motor Vehicle Safety Standards 213 and 225 and Canadian Motor Vehicle Safety Standards 213 and 210.2.

You can store up to three different settings per SmartKey.

The following settings are saved for each stored position:

- Driver's seat and backrest position
- Steering wheel position
- Driver's side exterior rear view mirror position
- Passenger side exterior rear view mirror position
- Front passenger seat position

These SmartKey-dependent memory settings can be deactivated if desired (▷ page 152).

Warning!



Do not activate the memory function while driving. Activating the memory function while driving could cause the driver to lose control of the vehicle.

Controls in detail

Memory function

The memory switch is located on the door.



M Memory button

1, 2, 3 Stored positions

- ▶ Be sure the ignition is switched on or the relevant door is open and the SmartKey is inserted in the starter switch.

Storing positions in memory

- ▶ Adjust the seats, steering wheel and exterior rear view mirrors to the desired position (▷ page 34).
- ▶ Press memory button **M**.
- ▶ Release memory button and press stored position button **1**, **2** or **3** within three seconds.

All the settings are stored at the selected position.

Recalling positions from memory

- ▶ On memory button, press and hold stored position button **1**, **2** or **3** until the seat, steering wheel and exterior rear view mirrors have fully moved to the stored positions.



Releasing the button immediately stops movement to the stored positions.

Warning!



Do not operate the power seats using the memory button if the seat backrest is in an excessively reclined position. Doing so could cause damage to front or rear seats. First move backrest to an upright position.

Controls in detail

Memory function

Storing exterior rear view mirror parking position

For easier parking you can adjust the passenger-side exterior rear view mirror so that you can see the right rear wheel as soon as you engage reverse gear **R**.

For information on activating the parking position, see “Activating exterior rear view mirror parking position” (▷ page 169).



You can store a parking position for the passenger side exterior rear view mirror for each SmartKey using the memory button.

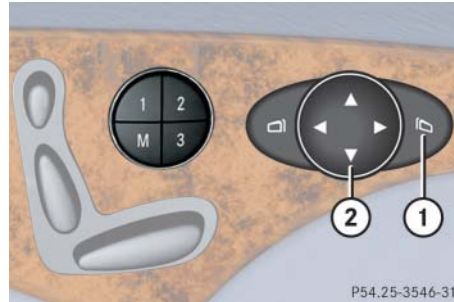

- ① Passenger side, exterior rear view mirror
 - ② Adjustment button
- ▶ Stop the vehicle.
 - ▶ Switch on ignition (if not already on).
 - ▶ Press button ①.

The passenger-side exterior rear view mirror is selected.

- ▶ Adjust the exterior rear view mirror with button ② so that you see the rear wheel and the road curb.
- ▶ Press memory button **M**.
- ▶ Within three seconds, press bottom of adjustment button ②.

The parking position is stored if the mirror does not move.



If the mirror does move, repeat the above steps. After the setting is stored, you can move the mirror again.

▼ Lighting

For notes on how to switch on the headlamps and use the turn signals, see the “Getting started” section (▷ page 47).



If you drive in countries where vehicles drive on the other side of the road than the country where the vehicle is registered, you must have the headlamps modified for symmetrical low beams. Relevant information can be obtained at your authorized Mercedes-Benz Center.

Exterior lamp switch

The exterior lamp switch is located on the dashboard to the left of the steering wheel.



Controls in detail

Lighting

- 0** Off
- AUTO** Automatic headlamp mode
- P** Parking lamps (also side marker lamps, tail lamps, license plate lamps, instrument panel lamps)
Canada only:
When engine is running, the low beam is also switched on.
- P<** Parking lamps plus low beam or high beam headlamps (combination switch pushed forward).
- P<→** Standing lamps, right (turn left one stop)
- P** Standing lamps, left (turn left two stops)

Controls in detail

Lighting



If you remove the SmartKey and open the driver's door while the parking lamps or low beam headlamps are switched on, then

- a warning sounds
-  appears in the multifunction display
- the message *Switch off lights!* appears in the multifunction display



With the daytime running lamp mode activated and the engine running, the low beam headlamps cannot be switched off manually.

Manual headlamp mode

The low beam headlamps and parking lamps can be switched on and off with the exterior lamp switch (▷ page 119).

Automatic headlamp mode

The parking lamps, low beam headlamps and license plate lamps switch on and off automatically depending on the brightness of the ambient light.

- ▶ Turn the exterior lamp switch to **AUTO**.



Warning!



If the exterior lamp switch is set to **AUTO**,

- the headlamps may switch off unexpectedly when the system senses bright ambient light, for example light from oncoming traffic.
- the headlamps will not be automatically switched on under foggy conditions.

To minimize risk to you and to others, activate headlamps by turning exterior lamp switch to  when driving or when traffic and /or ambient lighting conditions require you to do so.

In low ambient lighting conditions, only switch from position **AUTO** to  with the vehicle at a standstill. Switching from **AUTO** to  will briefly switch off the headlamps. Doing so while driving in low ambient lighting conditions may result in an accident.

The automatic headlamp feature is only an aid to the driver. The driver is responsible for the operation of the vehicle's lights at all times.



With the daytime running lamp mode activated, the low beam headlamps will not be switched off automatically.



The front fog lamps and rear fog lamp cannot be switched on manually with exterior lamp switch in position **AUTO**. To activate the fog lamps, turn exterior lamp switch to position  and pull the exterior lamp switch to first or second stop (▷ page 122).

Daytime running lamp mode

- ▶ Turn exterior lamp switch to position **0** or **AUTO**.

When the engine is running, the low beam headlamps are automatically switched on. In low ambient light conditions the parking lamps will also switch on.

Canada only

When you shift from a driving gear to position **N** or **P**, the low beam switches off (with a three-minute delay).

For nighttime driving you should turn the exterior lamp switch to position  to permit activation of the high beam headlamps.

Controls in detail

Lighting

USA only

The high beam headlamps can also be activated when driving with the daytime running lamp mode activated and exterior lamp switch in position **0**.

To activate the daytime running lamp mode, see “Setting daytime running lamp mode” (▷ page 146).



See notes on the exterior lamp switch (▷ page 119).

Locator lighting and night security illumination

Locator lighting and night security illumination are described in the control system section under “Setting locator lighting” (▷ page 147) and “Setting night security illumination” (▷ page 148).



Controls in detail

Lighting

Switching on fog lamps

Warning!



In low ambient lighting or foggy conditions, only switch from position **AUTO** to  with the vehicle at a standstill. Switching from **AUTO** to  will briefly switch off the headlamps. Doing so while driving in low ambient lighting conditions may result in an accident.



Fog lamps will operate with the parking lamps and/or the low beam headlamps on. Fog lamps should only be used in conjunction with low beam headlamps. Consult your State or Province Motor Vehicle Regulations regarding allowable lamp operation.



The front fog lamps and rear fog lamp cannot be switched on manually with exterior lamp switch in position **AUTO**. To activate the fog lamps, turn exterior lamp switch to position  and pull the exterior lamp switch to first or second stop (\triangleright page 119).

Switching on front fog lamps

- ▶ Make sure the low beam headlamps are switched on.
- ▶ Pull out exterior lamp switch to first stop.

The green indicator lamp  in the lamp switch comes on.

Switching on rear fog lamps

- ▶ Make sure the low beam headlamps are switched on.
- ▶ Pull out exterior lamp switch to second stop.

The yellow indicator lamp  in the lamp switch comes on.

Combination switch

The combination switch is located on the left side of the steering column.

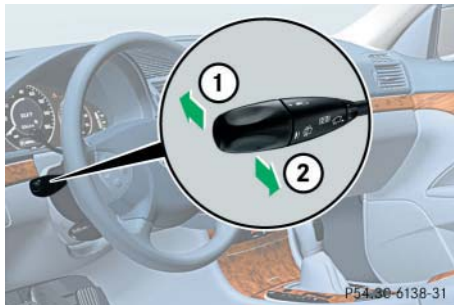

- ① High beam
- ② High beam flasher

Switching on high beams

- ▶ Turn exterior lamp switch to position  (▷ page 119).

- ▶ Push the combination switch in direction ①.

The high beam indicator  on the instrument cluster is illuminated (▷ page 22).

High beam flasher

- ▶ Pull the combination switch briefly in direction ②.

Hazard warning flasher

The hazard warning flasher can be activated with the ignition switched on or off. It is activated automatically when an airbag is deployed.

The switch is located on the center console.

Controls in detail

Lighting



- ① Hazard warning flasher switch

Controls in detail

Lighting

Switching on the hazard warning flasher

- ▶ Press the hazard warning flasher switch.

All turn signals will flash.



With the hazard warning flasher activated and the combination switch set for either left or right turn, only the respective left or right turn signals will operate when the SmartKey in the starter switch is in position 1 or 2.

Switching off the hazard warning flasher

- ▶ Press hazard warning flasher switch again.



If the hazard warning flasher was activated automatically, press switch ① twice.

Interior lighting

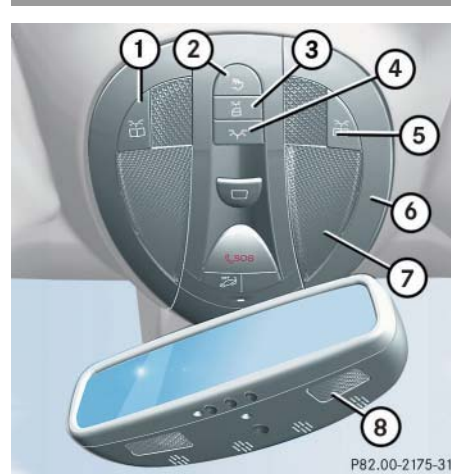

- ① Switch for reading lamp, left
- ② Switch for rear compartment lighting
- ③ Switch for automatic function
- ④ Switch for interior lighting in front
- ⑤ Switch for reading lamp, right
- ⑥ Ambient lighting
- ⑦ Interior lighting
- ⑧ Reading lamps

The controls are located in the overhead control panel.

Activating automatic control

- ▶ Press the switch ③.

Interior lamps are switched on in darkness, when you

- unlock the vehicle
- open a door
- remove the SmartKey from the starter switch

The interior lamps are switched off following an adjustable time delay (▷ page 149).



If the door remains open, the interior lamps switch off automatically after approximately five minutes when the SmartKey is removed or in starter switch position 0.

An interior lamp switched on manually does not go out automatically.

Deactivating automatic control

- ▶ Press the switch ③.
The interior lighting remains switched off, even when you
 - centrally unlock the vehicle
 - open a door
 - remove the SmartKey from the starter switch

Manual control

Switching rear interior lights on and off

- ▶ Press button ②.
The lights in the rear passenger compartment go on.
- ▶ Press button ② again.
The lights in the rear passenger compartment go out.

Switching left front reading lamp on and off

- ▶ Press button ①.
The left reading lamp goes on.
- ▶ Press button ① again.
The left reading lamp goes out.

Switching right front reading lamp on and off

- ▶ Press button ⑤.
The right reading lamp goes on.
- ▶ Press button ⑤ again.
The right reading lamp goes out.

Door entry lamps

The appropriate door entry lamp switches on if a door is opened in darkness and if the interior lighting is switched to the automatic function.

The entry lamp goes out automatically when the door is closed.



If you turn the SmartKey in the starter switch to position **0** or remove the SmartKey, the door entry lamps will remain lit for approximately five minutes.

Trunk lamp

The trunk lamp switches on if the trunk lid is opened.

If you leave the trunk open for an extended period of time, the trunk lamp will switch off automatically after approximately ten minutes.

Controls in detail

Instrument cluster

▼ Instrument cluster

A full view illustration of the instrument cluster can be found in the “At a glance” section of this manual (▷ page 22).

The instrument cluster is activated when you

- open a door
- turn on the ignition
- press the reset button (▷ page 22)
- switch on the exterior lamps

You can change the instrument cluster settings in the instrument cluster submenu of the control system (▷ page 141).

Instrument cluster illumination

Use the reset button (▷ page 22) to adjust the illumination brightness for the instrument cluster.



The instrument cluster illumination is dimmed or brightened automatically to suit ambient light conditions.

The instrument cluster illumination will also be adjusted automatically when you switch on the vehicle’s exterior lamps.

To brighten illumination

- ▶ Turn the reset button in the instrument cluster clockwise (▷ page 22).

The instrument cluster illumination will brighten.

To dim illumination

- ▶ Turn the reset button in the instrument cluster counterclockwise (▷ page 22).

The instrument cluster illumination will dim.

Coolant temperature gauge

Warning!



- Driving when your engine is overheated can cause some fluids which may have leaked into the engine compartment to catch fire. You could be seriously burned.
- Steam from an overheated engine can cause serious burns and can occur just by opening the hood. Stay away from the engine if you see or hear steam coming from it.

Turn off the engine, get out of the vehicle and do not stand near the vehicle until the engine has cooled down.



Excessive coolant temperature trigger a warning in the multifunction display (▷ page 314).

During severe operating conditions, e. g. stop-and-go traffic, the coolant temperature may rise close to 248°F (120°C).



The engine should not be operated with the coolant temperature above 248°F (120°C). Doing so may cause serious engine damage which is not covered by the Mercedes-Benz Limited Warranty.

Controls in detail

Instrument cluster

Trip odometer

Make sure you are viewing the trip odometer display (▷ page 129).

- ▶ If it is not displayed, press the  or  repeatedly until the trip odometer appears.
- ▶ Press and hold the reset button on the instrument cluster (▷ page 22) until the trip odometer is reset.

Controls in detail

Instrument cluster

Tachometer

The red marking on the tachometer denotes excessive engine speed.



Avoid driving at excessive engine speeds, as it may result in serious engine damage that is not covered by the Mercedes-Benz Limited Warranty.

To help protect the engine, the fuel supply is interrupted if the engine is operated within the red marking.

E 55 AMG

The tachometer of the E 55 AMG does not have a red marking denoting excessive engine speed.

To help protect the engine, the fuel supply is interrupted if the engine is operated at an excessive engine speed.

Outside temperature indicator

Warning!



The outside temperature indicator is not designed to serve as an ice-warning device and is therefore unsuitable for that purpose.

Indicated temperatures just above the freezing point do not guarantee that the road surface is free of ice. The road may still be icy, especially in wooded areas or on bridges.

The outside temperature is displayed in the instrument cluster (▷ page 22). For information on how to select the unit of the displayed temperature, i.e. degrees Celsius (°C) or degrees Fahrenheit (°F), see “Selecting temperature display mode” (▷ page 141).

The temperature sensor is located in the front bumper area. Due to its location, the sensor can be affected by road or engine heat during idling or slow driving. This means that the accuracy of the displayed temperature can only be verified by comparison to a thermometer placed next to the sensor, not by comparison to external displays (e.g. bank signs etc.).

When moving the vehicle into colder ambient temperatures (e.g. when leaving your garage), you will notice a delay before the lower temperature is displayed.

A delay also occurs when ambient temperatures rise. This prevents inaccurate temperature indications caused by heat radiated from the engine during idling or slow driving.

▼ Control system

The control system is activated as soon as the SmartKey in the starter switch is turned to position **1** or as soon as the KEYLESS-GO start/stop button* is in position **1**. The control system enables you to:

- call up information about your vehicle
- change vehicle settings.

For example, you can use the control system to find out when your vehicle is next due for service, to set the language for messages in the instrument cluster display, and much more.



The displays for the audio systems (radio, CD player) will appear in English, regardless of the language selected.

Warning!



A driver's attention to the road and traffic conditions must always be his / her primary focus when driving.

For your safety and the safety of others, selecting features through the multifunction steering wheel should only be done by the driver when traffic and road conditions permit it to be done safely.

Bear in mind that at a speed of just 30 mph (approximately 50 km / h), your vehicle is covering a distance of 44 feet (approximately 13.5 m) every second.

The control system relays information to the multifunction display.

Controls in detail

Control system

Multifunction display



- ① Segment ring
- ② Standard display
- ③ Trip odometer

Controls in detail

Control system

Multifunction steering wheel

The displays in the multifunction display and the settings in the control system (▷ page 129) are controlled by the buttons on the multifunction steering wheel.

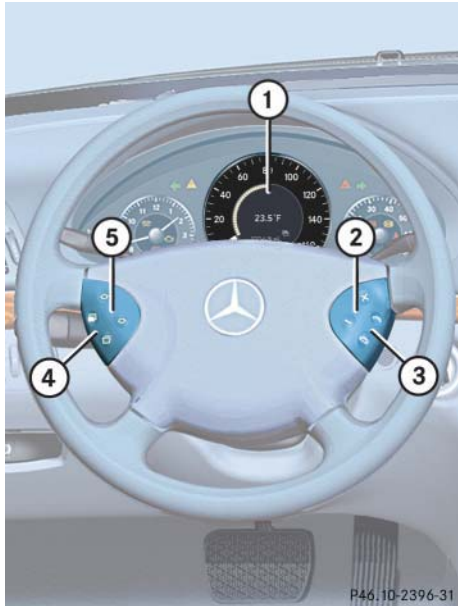

Pressing any of the buttons on the multifunction steering wheel will alter what is shown in the multifunction display.

- ① Multifunction display in the speedometer

Operating the control system

- ② Selecting the submenu or setting the volume

— down / to decrease

+ up / to increase

- ③ Telephone*

☎ to take a call

☎ to end a call

- ④ Menu systems

☰ for next menu

☰ for previous menu

- ⑤ Moving within a menu





⬆ for next display

⬇ for previous display

The information available in the multifunction display is arranged in menus, each containing a number of functions or sub-menus.

The individual functions are then found within the relevant menu (radio or CD operations under *Audio*, for example). These functions serve to call up relevant information or to customize the settings for your vehicle.

It is helpful to think of the menus, and the functions within each menu, as being arranged in a circular pattern.

- If you press button  or  repeatedly, you will pass through each menu one after the other.
- If you press button  or  repeatedly, you will pass through each function display, one after the other, in the current menu.

In the **Settings** menu, instead of functions you will find a number of submenus for calling up and changing settings. For instructions on using these submenus, see the “Settings menu” section (▷ page 139).

The number of menus available in the system depends on which optional equipment is installed in your vehicle.

The menus are described on the following pages.

Controls in detail

Control system

Menus

This is what you will see when you scroll through the menus.

The table on the next page provides an overview of the individual menus.

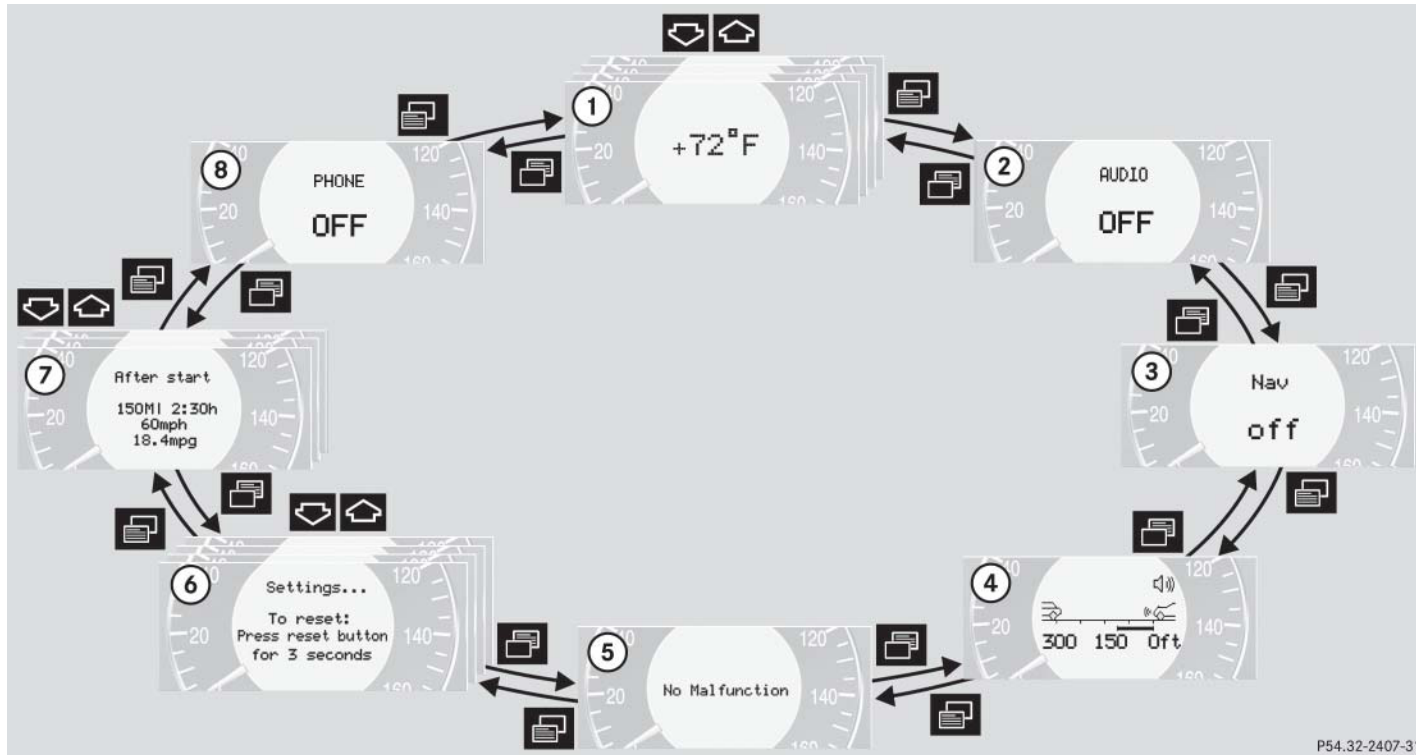

P54.32-2407-31

Menus, submenus and functions

	Menu ①	Menu ②	Menu ③	Menu ④	Menu ⑤	Menu ⑥	Menu ⑦	Menu ⑧
	Standard display	AUDIO	NAVI*	Distronic*	Malfunction memory	Settings	Trip computer	Telephone
Commands/submenus	Digital speedometer	Select radio station	Activate route guidance	Call up settings	Call up malfunction messages	Reset to factory settings	Fuel consumption statistics after start	Load phone book
	Call up FSS PLUS	Operate CD player				Instrument cluster submenu	Fuel consumption statistics since the last reset	Search for name in phone book
	Check tire pressure*					Time/Date submenu	Call up range	
	Check engine oil level					Lighting submenu		
						Vehicle submenu		
						Convenience submenu		
						Dynamic seat* submenu		

Controls in detail

Control system



The headings used in the menus table are designed to facilitate navigation within the system and are not necessarily identical to those shown in the control system displays.

The first function displayed in each menu will automatically show you which part of the system you are in.

Standard display menu

You can select the functions in the standard display menu with button or .

The following functions are available:

Function	Page
Call up digital speedometer	134
Call up FSS PLUS	297
Check tire pressure*	291
Check engine oil level	283

Display digital speedometer

- ▶ Press button twice.

The current vehicle speed is shown in the multifunction display.

AUDIO menu

The functions in the Audio menu operate the audio equipment which you currently have turned on.

If no audio equipment is currently turned on, the message AUDIO OFF is shown in the display.

The following functions are available:

Function	Page
Select radio station	134
Select satellite radio station*	135
Operate CD player	135

Select radio station

- ▶ Turn on the radio. Refer to separate operating instructions.
- ▶ Press button or repeatedly until you see the currently tuned station in the display.

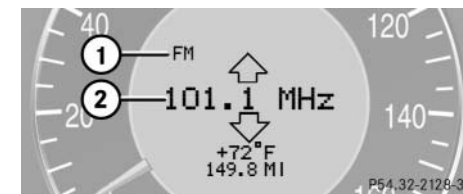

- ① Waveband setting
- ② Station frequency

- ▶ Press button or repeatedly until the desired station is found.



You can only store new stations using the corresponding feature on the radio, see separate operating instructions.

You can also operate the radio in the usual manner.

Select satellite radio station*

The satellite radio is treated as a radio application.

- ▶ Select SAT radio with the corresponding softkey in the radio menu.



- ① SAT mode and preset number
- ② Setting for station selection using memory
- ③ Channel name or number

- ▶ Press button or repeatedly until the desired channel is found.



Feature description is based on preliminary information available at time of printing.

Additional optional satellite radio equipment and a subscription to satellite radio service provider are required for satellite radio operation. At time of printing, no date for the availability of optional equipment required for satellite radio operation had been set.

Contact your authorized Mercedes-Benz Center for details and availability for your vehicle.

For more information, refer to separate COMAND operating instructions.

Operate the CD player

- ▶ Turn on the radio and select the CD player. Refer to separate operating instructions.

Controls in detail

Control system

- ▶ Press button or repeatedly until the settings for the CD currently being played are shown in the display.

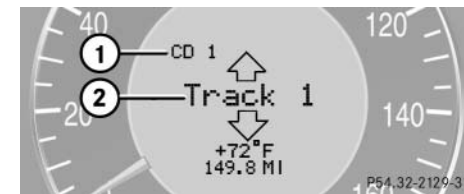

- ① Current CD (for CD changer*)
- ② Current track

- ▶ Press button or repeatedly until the desired track is selected.





To select a CD from the magazine, press a number on the COMAND system SmartKey pad located in the center console.

Controls in detail

Control system

NAVI* menu

The Navi menu contains the functions needed to operate your navigation system.

- ▶ Press button  or  repeatedly until you see the message Navi in the display.
- If the navigation system is switched off, the message Navi Off is shown in the display.
- If the navigation system is switched on, the message Navi Active is shown in the display.



Please refer to the COMAND manual for instructions on how to activate the route guidance system.

Distronic* menu

Use the Distronic menu to display the current settings for your Distronic system.

What information is shown in the display depends on whether the Distronic system is active or inactive.

Please refer to the “Driving systems” section of this manual (▷ page 214) for instructions on how to activate Distronic.

- ▶ Press button  or  repeatedly until you see one of the following two pictures in the display.

Distronic deactivated

When Distronic is deactivated, you will see the standard display in the display.

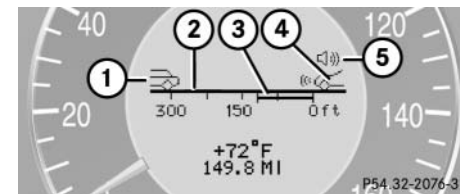

- ① Vehicle ahead, if detected
- ② Actual distance to vehicle ahead
- ③ Preset distance threshold to vehicle ahead
- ④ Your vehicle
- ⑤ Symbol for activated distance warning function

Distronic activated

When Distronic is activated, Distronic and the set speed are seen in the display.

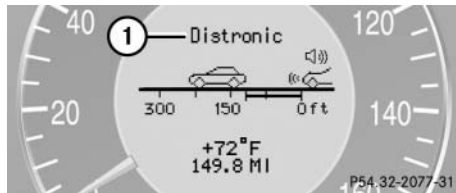

① Distronic activated

Malfunction memory menu

Use the malfunction memory menu to scan malfunction and warning messages that may be stored in the system. What information is shown in the display depends on whether malfunctions have actually occurred.



Warning!



Malfunction and warning messages are only indicated for certain systems and are intentionally not very detailed. The malfunction and warning messages are simply a reminder with respect to the operation of certain systems and do not replace the owner's and/or driver's responsibility to maintain the vehicle's operating safety by having all required maintenance and safety checks performed on the vehicle and by bringing the vehicle to an authorized Mercedes-Benz Center to address the malfunction and warning messages (▷ page 318).

Controls in detail

Control system

- ▶ Press button  or  repeatedly until you see the malfunction message memory in the display.

No malfunction messages

If no malfunctions have occurred, the message in the display is:

No Malfunction



Malfunctions have occurred

If malfunctions have occurred, you will see the number of malfunctions in the display:



Controls in detail

Control system

- ▶ Press button  or .

The stored messages will now be displayed in order. See the “Practical hints” section for malfunction and warning messages (▷ page 318).



Should any malfunctions occur while driving, the number of malfunctions will reappear in the display when the SmartKey in the starter switch is turned to position **0** or removed from the starter switch.



The message memory will be cleared when you turn the SmartKey in the starter switch to position **1** or **2**. You will then only see high priority malfunctions. These are highlighted by red background (▷ page 318).

Settings menu

In the Settings menu there are two functions:

- The function To reset: Press reset button for 3 seconds, with which you can reset all the settings to the original factory settings.
 - A collection of submenus with which you can make individual settings for your vehicle.
- ▶ Press button  or  repeatedly until the Settings menu is seen in the display.



Resetting all settings

You can reset all the functions of all submenus to the factory settings.

- ▶ Press the reset button in the instrument cluster (▷ page 22) for approximately three seconds.

In the display you will see the request to press the reset button again to confirm.

- ▶ Press the reset button again.

The functions of all the submenus will reset to factory settings.





The settings you have changed will not be reset unless you confirm the action by pressing the reset button a second time.

Submenus in the Settings menu

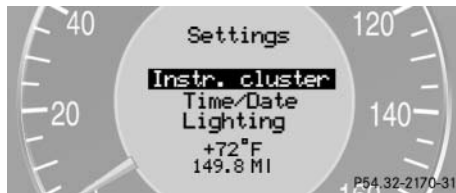

- ▶ Press button  or .



In the display you see the collection of the submenus.





- ▶ Press button .

The selection marker moves to the next submenu.

The submenus are arranged by hierarchy. Scroll down with the  button, scroll up with the  button.

Move within the submenus with the  or  button to the individual functions.

The settings themselves are made with button  or .

Resetting the functions of a submenu

For each submenu you can reset all the functions to the factory settings.

- ▶ Move to a function in the submenu.
- ▶ Press the reset button (▷ page 22) in the instrument cluster for approximately three seconds.

In the display you will see the request to press the reset button again to confirm.

- ▶ Press the reset button again.

All functions of the submenu will reset to factory settings.

Controls in detail

Control system

The table below shows what settings can be changed within the various menus. Detailed instructions on making individual settings can be found on the following pages.

INSTRUMENT CLUSTER	TIME/DATE	LIGHTING	VEHICLE	CONVENIENCE	DYNAMIC SEAT*
Select temperature display mode	Synchronizing the time	Set daytime running lamp mode (USA only)	Set automatic locking	Activate easy-entry / exit feature	Set level for dynamic seat, driver
Select speedometer display mode	Set time (hours)	Set locator lighting		Set SmartKey-dependency	Set level for dynamic seat, passenger
Select language	Set time (minutes)	Ambient lighting		Set parking position for exterior rear view mirror	
Select display (speed display or outside temperature) for status line	Set date (month)	Exterior lamps delayed shut-off			
Select display (speed display or outside temperature) for basic display	Set date (day)	Interior lighting delayed shut-off			
Tire pressure unit display*	Set date (year)				

Instrument cluster submenu

Access the Instr. cluster submenu via the Settings menu. Use the Instr. cluster submenu to change the instrument cluster display settings. The following functions are available:

Function	Page
Select temperature display mode	141
Select speedometer display mode	141
Select language	142
Select display (speed display or outside temperature) for status display	142
Select display (speed display or outside temperature) for basic display	143
Tire pressure display*	143

Selecting temperature display mode

- ▶ Move the selection marker with the **+** or **-** button to the Instr. cluster submenu.
- ▶ Press button **↕** or **↘** repeatedly until you see this message in the display: Temp. indicator.

The selection marker is on the current setting.

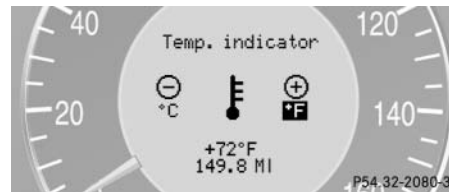

- ▶ Press **+** or **-** to set the temperature unit to degrees Celsius (°C) or degrees Fahrenheit (°F).

Selecting speedometer display mode

- ▶ Move the selection marker with the **+** or **-** button to the Instr. cluster submenu.
- ▶ Press button **↕** or **↘** repeatedly until you see this message in the display: Display unit Speed-/odometer.

The selection marker is on the current setting.

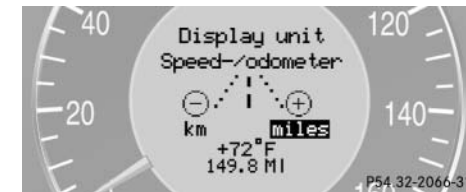

- ▶ Press **+** or **-** to set speedometer unit to km or miles.

Controls in detail

Control system

Selecting language

- ▶ Move the selection marker with the **+** or **-** button to the Instr. cluster submenu.
- ▶ Press button **▲** or **▼** repeatedly until you see this message in the display: Language.

The selection marker is on the current setting.



- ▶ Press **+** or **-** to select the language to be used for the multifunction display messages.

Available languages:

- German
- English
- French
- Italian
- Spanish

Selecting display (speed display or outside temperature) for status display

- ▶ Move the selection marker with the **+** or **-** button to the Instr. cluster submenu.
- ▶ Press button **▲** or **▼** repeatedly until you see this message in the display: Status line display.

The selection marker is on the current setting.

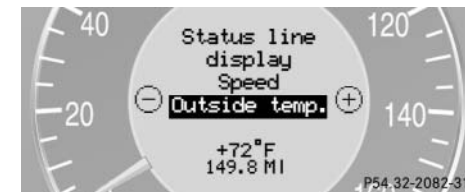

- ▶ Press **+** or **-** to select the status line to degrees Fahrenheit (°F) or miles.



You will see the status indicator when you have called up a different display from the standard display.

Controls in detail

Control system

Selecting display (speed display or outside temperature) for basic display

- ▶ Move the selection marker with the **+** or **-** button to the Instr. cluster submenu.
- ▶ Press button **↶** or **↷** repeatedly until you see this message in the display: Basic display.

The selection marker is on the current setting.

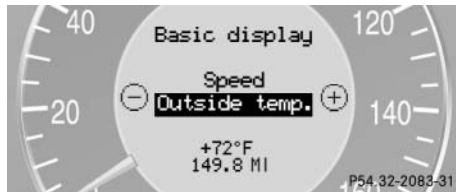

- ▶ Press **+** or **-** to select the display permanently shown in the multi-function display.

Tire pressure display*

Use this function to set the unit for the tire pressure display.

- ▶ Move the selection marker with the **+** or **-** button to the Instr. cluster submenu.
- ▶ Press button **↶** or **↷** repeatedly until you see this message in the display: Display unit Tire pressure.

The selection marker is on the current setting.



- ▶ Press **+** or **-** to select the desired tire pressure unit.

Time / Date submenu

Access the Time/Date submenu via the Settings menu. Use the Time/Date submenu to change the time and date display settings. The following functions are available:

Function	Page
Synchronizing the time	144
Set time (hours)	144
Set time (minutes)	144
Set date (month)	145
Set date (day)	145
Set date (year)	145



Information on setting the time, refer to separate COMAND instructions.

Controls in detail

Control system

Synchronizing the time

This function can only be seen on vehicles with COMAND and navigation module*.

- ▶ Move the selection marker with the **+** or **-** button to the Time/Date submenu.
- ▶ Press button **↕** or **↴** repeatedly until you see this message in the display: Time sync. with head unit.

The selection marker is on the current setting.



- ▶ Press **+** or **-** to select the desired setting.

Set time (hours)

This function can only be seen when synchronization is switched off.

- ▶ Move the selection marker with the **+** or **-** button to the Time/Date submenu.
- ▶ Press button **↕** or **↴** repeatedly until you see this message in the display: Clock, hours.

The selection marker is on the hour setting.



- ▶ Press **+** or **-** to set the hour.
- ▶ Confirm by pressing reset button.

Set time (minutes)

This function can only be seen when synchronization is switched off.

- ▶ Move the selection marker with the **+** or **-** button to the Time/Date submenu.
- ▶ Press button **↕** or **↴** repeatedly until you see this message in the display: Clock, minutes.

The selection marker is on the minute setting.



- ▶ Press **+** or **-** to set the minutes.
- ▶ Confirm by pressing reset button.

Set date (month)

- ▶ Move the selection marker with the **+** or **-** button to the Time/Date submenu.
- ▶ Press button **▲** or **▼** repeatedly until you see this message in the display: Set date month.

The selection marker is on the month setting.

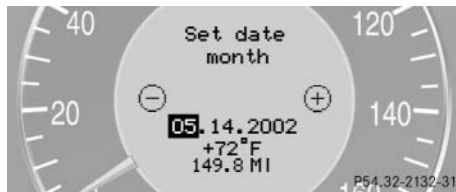

- ▶ Press **+** or **-** to set the month.

Set date (day)

- ▶ Move the selection marker with the **+** or **-** button to the Time/Date submenu.
- ▶ Press button **▲** or **▼** repeatedly until you see this message in the display: Set date day.

The selection marker is on the day setting.



- ▶ Press **+** or **-** to set the day.

Set date (year)

- ▶ Move the selection marker with the **+** or **-** button to the Time/Date submenu.
- ▶ Press button **▲** or **▼** repeatedly until you see this message in the display: Set date year.

The selection marker is on the year setting.

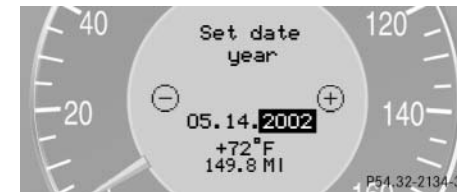

- ▶ Press **+** or **-** to set the year.

Controls in detail



Control system

Lighting submenu

Access the Lighting submenu via the Settings menu. Use the Lighting submenu to change the lamp and lighting settings on your vehicle. The following functions are available:

Function	Page
Set daytime running lamp mode (USA only)	146
Set locator lighting	147
Ambient light level	147
Exterior lamps delayed shut-off	148
Interior lighting delayed shut-off	149

Setting daytime running lamp mode (USA only)

- ▶ Move the selection marker with the **+** or **-** button to the Lighting submenu.
- ▶ Press button  or  repeatedly until you see this message in the display: Lamp circuit headlamp.

The selection marker is on the current setting.



- ▶ Press **+** or **-** to select manual or daytime running lamp (constant) mode. This function is not available in countries where daytime running lamps are mandatory.

With daytime running lamp mode selected and the exterior lamp switch at position 0, the following lamps will come on automatically when the engine is turned on:

- Parking lamps and low beam headlamps
- License plate lamps (in low ambient light conditions)



If you turn the exterior lamp switch to another position, the corresponding lamp(s) will switch on.

For safety reasons, resetting the Lighting submenu to factory settings (> page 138) while driving will not reset the daytime running lamp mode.

In the display you will then see the message: Lighting

Setting locator lighting

During darkness, the following lamps will come on when the exterior lamp switch is in position **AUTO**, the locator lighting feature is activated and the vehicle is unlocked by SmartKey:

- Parking lamps
- Tail lamps
- License plate lamps
- Front fog lamps

The locator lighting switches off when the driver's door is opened. It switches off automatically after a period of approximately 40 seconds.

- ▶ Move the selection marker with the **+** or **-** button to the Lighting submenu.
- ▶ Press button **▲** or **▼** repeatedly until you see this message in the display: *Function Surround lighting*.
The selection marker is on the current setting.



- ▶ Press **+** or **-** to select the desired setting.
The locator lighting will be switched on or off.

Ambient light level

Using this function, you can adjust the brightness of the ambient lighting.

- ▶ Move the selection marker with the **+** or **-** button to the Lighting submenu.
- ▶ Press button **▲** or **▼** repeatedly until you see the message *Ambient light Level* in the display.
The selection marker is on the current setting.

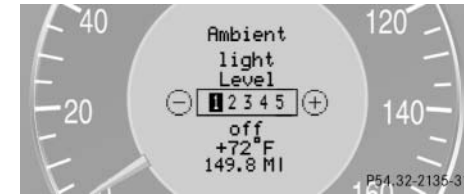

- ▶ Press **+** or **-** to select the brightness of the lighting. 1 represents the darkest setting and 5 represents the brightest setting.
The ambient light is switched off below setting 1 or above setting 5. The selection marker points to off.

Controls in detail

Control system

Setting night security illumination (Exterior lamps delayed shut-off)

Use the Headlamps delayed shut-off function to set whether and for how long you would like the exterior lamps to illuminate during darkness after all doors are closed. When the delayed shut-off feature is activated and the exterior lamp switch is in position **AUTO**, the following lamps will remain lit after you remove the SmartKey from the starter switch:

- Parking lamps
- Tail lamps
- License plate lamps
- Front fog lamps



You can reactivate this function within ten minutes by opening a door.

If you do not open a door after removing the SmartKey, the lamps will automatically switch off after 60 seconds.

- ▶ Move the selection marker with the **+** or **-** button to the Lighting submenu.

- ▶ Press button or repeatedly until you see this message in the display: Headlamps delayed shut-off.

The selection marker is on the current setting.



- ▶ Press **+** or **-** to select the desired lamp-on period.

You can select:

- 0 s, the delayed shut-off feature is deactivated.
 - 15 s, 30 s, 45 s or 60 s, the delayed shut-off feature is activated.
- ▶ Turn the exterior lamp switch to position **AUTO**.

You can temporarily deactivate the delayed shut-off feature:

- ▶ Before leaving the vehicle, turn the SmartKey in the starter switch to position **0**.
- ▶ Then turn the SmartKey in the starter switch to position **2** and back to **0**.

The delayed shut-off feature is deactivated. It will reactivate as soon as you reinsert the SmartKey in the starter switch.

Vehicles with KEYLESS-GO*:

- ▶ Press the KEYLESS-GO start / stop button on the gear selector lever (▷ page 33).

Interior lighting delayed shut-off

Use this function to set whether and for how long you would like the interior lighting to remain lit during darkness after the SmartKey is removed from the starter switch.

- ▶ Move the selection marker with the **+** or **-** button to the Lighting submenu.
- ▶ Press button **↶** or **↷** repeatedly until you see this message in the display: Interior lamp delayed shut-off.

The selection marker is on the current setting.



- ▶ Press **+** or **-** to select the desired lamp-on time period. You can select:
 - 0 s, the delayed shut-off feature is deactivated.
 - 5 s, 10 s, 15 s or 20 s, the delayed shut-off feature is activated.

Vehicle submenu

Access the Vehicle submenu via the Settings menu. Use the Vehicle submenu to make general vehicle settings. The following functions are available:



Function	Page
Set automatic locking	149
Limiting opening height of trunk lid*	150

Setting automatic locking

Use this function to activate or deactivate the automatic central locking. With the automatic central locking system activated, the vehicle is centrally locked at vehicle speeds of approximately 9 mph (15 km/h).

Controls in detail

Control system

- ▶ Move the selection marker with the **+** or **-** button to the Vehicle submenu.
- ▶ Press button  or  repeatedly until you see this message in the display: Automatic door lock.



The selection marker is on the current setting.



- ▶ Press **+** or **-** to switch Automatic door lock on or off.

Limiting opening height of trunk lid*

Use this function to activate or deactivate the limiting opening height of trunk lid.

- ▶ Move the selection marker with the **+** or **-** button to the Vehicle submenu.
- ▶ Press button  or  repeatedly until you see this message in the display: Opening limiter trunk lid.

The selection marker is on the current setting.



- ▶ Press **+** or **-** to switch Opening limiter Trunk lid On or Off.

Convenience submenu

Access the Convenience submenu via the Settings menu. Use the Convenience submenu to change the settings for a number of convenience features. The following functions are available:

Function	Page
Activate easy-entry / exit feature	150
Set SmartKey-dependency	152
Set parking position for exterior rear view mirror	152

Activating easy-entry / exit feature*

Use this function to activate and deactivate the easy-entry / exit feature. When the feature is activated, the steering wheel and driver's seat will move back to facilitate exiting when you

- remove the SmartKey from the starter switch
- open the driver's door

However, the engine must be turned off.

Warning!



You must make sure that no one can become trapped or injured by the moving steering wheel and the driver's seat when the easy-entry / exit feature is in operation and the driver's door is being opened or the SmartKey is removed from the starter switch.

Do not leave children unattended in the vehicle, or with access to an unlocked vehicle. Children could open the driver's door and unintentionally activate the easy-entry / exit feature, which could result in an accident and / or personal injury.

After entering the vehicle, the steering wheel and seat will move into the position stored in memory when

- the driver's door is closed
- you put the SmartKey in the starter switch or press the KEYLESS-GO start/stop button*

- you press the appropriate stored position button on the memory switch (▷ page 117).



To cancel seat / steering wheel movement, do one of the following:

- Press seat adjustment switch (▷ page 35).
 - Move the steering column stalk (▷ page 37).
 - Press the memory button (▷ page 117).
- ▶ Move the selection marker with the **+** or **-** button to the Convenience submenu.
- ▶ Press button **↕** or **↘** repeatedly until you see this message in the display: Function Easy-entry feature. The selection marker is on the current setting.

Controls in detail

Control system

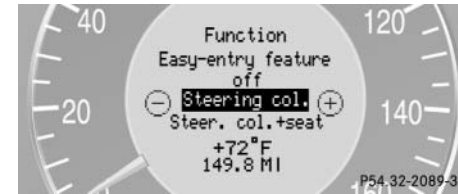

- ▶ Press **+** or **-** to change the easy-entry / exit setting.

The following settings are available for the easy-entry / exit feature

off	The easy-entry / exit feature is deactivated
Steering col.	Only the steering column is moved.
Steering col. + seat	Both the steering column and the seat are moved.

Controls in detail

Control system

Setting SmartKey-dependency

Use this function to set whether the memory settings for the seats, the steering wheel, the mirrors and other settings of the control system should be stored separately for each SmartKey (▷ page 88).

- ▶ Move the selection marker with the **+** or **-** button to the Convenience submenu.
- ▶ Press button **▲** or **▼** repeatedly until you see this message in the display: Key-dependent.

The selection marker is on the current setting.

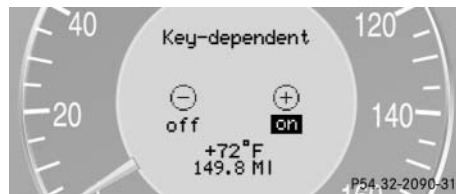

- ▶ Press **+** or **-** to set SmartKey-dependency to on or off.

Setting parking position for exterior rear view mirror

Use the Mirror adjustment parking aid function to select whether the passenger-side exterior rear view mirror should be turned downward during parking maneuvers when reverse gear **R** is engaged. For additional information, see "Activating exterior rear view mirror parking position" (▷ page 168).

- ▶ Move the selection marker to the Convenience submenu using the **+** or **-** button.
- ▶ Press button **▲** or **▼** repeatedly until you see this message in the display: Mirror adjustment parking aid.

The selection marker is on the current setting.



- ▶ Press **+** or **-** to switch function on or off.

Dynamic seat* submenu

Access the Dynamic Seat submenu via the Settings menu. Use the Dynamic Seat submenu to change the settings for the dynamic seats. The following functions are available:

Function	Page
Adjust driver seat	153
Adjust passenger seat	141

Controls in detail

Control system

Adjusting the dynamic seat

The function dynamic seat adjustment lets you determine the way the seat adjusts while driving.

- ▶ Move the selection marker with the **+** or **-** button to the Dynamic Seat submenu.
- ▶ Press button **↶** or **↷** repeatedly until you see this message in the display: Dyn. Multi-cont. Seat, driver for the driver seat or Dyn. Multi-cont. Seat, fr. pass. for the passenger seat.

The selection marker is on the current setting.



- ▶ Press **+** or **-** to switch function Level 1 or Level 2.

Trip computer menu

Use the trip computer menu to call up statistical data on your vehicle. The following information is available:

Function	Page
Fuel consumption statistics after start	153
Fuel consumption statistics since last reset	154
Call up range (distance to empty)	154

Fuel consumption statistics after start

- ▶ Press button **☰** or **☷** repeatedly until you see the first function of the Trip computer menu.
- ▶ Press button **↶** or **↷** repeatedly until you see this message in the left display: After start.

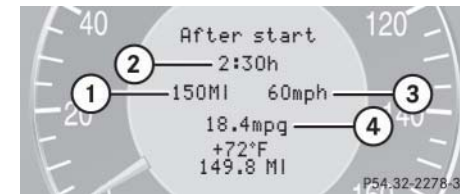





- ① Distance driven since start
- ② Time elapsed since start
- ③ Average speed since start
- ④ Average fuel consumption since start

Controls in detail

Control system

Fuel consumption since last reset

- ▶ Press button  or  repeatedly until you see the first function of the Trip computer menu.
- ▶ Press button  or  repeatedly until you see this message in the display: After reset.

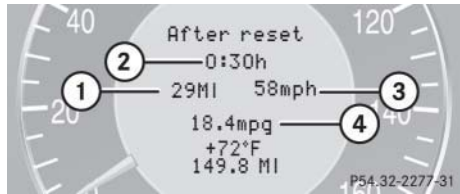





- ① Distance driven since last reset
- ② Time elapsed since last reset
- ③ Average speed since last reset
- ④ Average fuel consumption since last reset







All statistics stored since the last engine start will be reset approximately four hours after the SmartKey in the starter switch is turned to position **0** or removed from the starter switch.

Resetting will not occur if you turn the SmartKey back to position **1** or **2** within this time period.

Resetting fuel consumption statistics

- ▶ Press button  or  repeatedly until you see the first function of the Trip computer menu.
- ▶ Press button  or  repeatedly until you see the reading that you want to reset in the display.
- ▶ Press and hold the reset button in the instrument cluster (▷ page 22) until the value is reset to 0.

Call up range (distance to empty)

- ▶ Press button  or  repeatedly until you see the first function of the Trip computer menu.
- ▶ Press button  or  repeatedly until you see this message in the display: Range:

In the display you will see the calculated range based on the current fuel tank level.

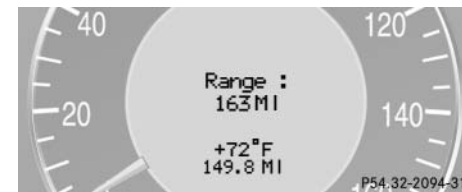

TEL menu*

Warning!





A driver's attention to the road must always be his/her primary focus when driving. For your safety and the safety of others, we recommend that you pull over to a safe location and stop before placing or taking a telephone call. If you choose to use the telephone while driving, please use the hands-free device and only use the telephone when weather, road and traffic conditions permit.

Some jurisdictions prohibit the driver from using a cellular telephone while driving a vehicle.

Bear in mind that at a speed of just 30 mph (approximately 50 km/h), your vehicle is covering a distance of approximately 44 feet (approximately 13.5 m) every second.

Never operate radio transmitters equipped with a built-in or attached antenna (i.e. without being connected to an external antenna) from inside the vehicle while the engine is running. Doing so could lead to a malfunction of the vehicle's electronic system, possibly resulting in an accident and/or personal injury.

You can use the functions in the TEL menu to operate your telephone, provided it is connected to a hands-free system and switched on.

- ▶ Switch on the telephone and COMAND.
- ▶ Press button  or  on the steering wheel repeatedly until you see the Tel menu in the display.

Which messages will appear in the display field depends on whether your telephone is switched on or off:

- If the telephone is off, the message in the multifunction display is: PHONE OFF.

Controls in detail

Control system

- If the telephone is on:

The telephone will then search for a network. During this time the display is empty.

As soon as the telephone has found a network, READY appears in the display.



This standby message indicates that your telephone is ready for use and you can operate it using the control system.

Controls in detail

Control system

Answering a call

When your telephone is ready to receive calls, you can answer a call at any time. In the display you will then see the message:



- ▶ Press button .

You have answered the call. In the display you see the length of the call.



If you do not wish to accept a call, press button .



Ending a call

- ▶ Press button .

You have ended the call. In the display you will again see the standby message.

Dialing a number from the phone book



If your telephone is ready to receive calls, you may select and dial a number from the phone book at any time.

- ▶ Press button  or  repeatedly until you see the **TEL** menu in the display.

- ▶ Press button  or .



The control system reads the phone book which is stored in the telephone. This may take up to 30 seconds. In the display you will see the message **Please wait**.

When the message **Please wait** disappears, the phone book has been loaded.

- ▶ Press button  or  repeatedly until the desired name appears in the display.

The stored names are displayed in ascending or descending alphabetical order.



If you press and hold  or  for longer than one second, the system scrolls rapidly through the list of names until you release the button again.

Cancel the quick search mode by pressing .

- ▶ Press button .

The system dials the selected phone number.

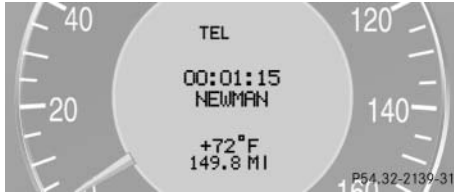

- If the connection is successful, the name of the party you called and the duration of the call will appear in the display.



- If no connection is made, the control system stores the dialed number in the redial memory.



Redialing

The control system stores the most recently dialed phone numbers. This eliminates the need to search through your entire phone book.

▶ Press button  or  repeatedly until you see the Tel menu in the display.

▶ Press button .

In the display you see the first number in the redial memory.

▶ Press button  or  repeatedly until the desired name appears in the display.

▶ Press button .

The control system dials the selected phone number.

Controls in detail

Automatic transmission

▼ Automatic transmission

Information on driving with an automatic transmission is found in the “Getting started” section (▷ page 43).

Your vehicle’s transmission adapts its gear shifting process to your individual driving style by continually adjusting the shift points up or down. These shift point adjustments are performed based on current operating and driving conditions.

If the operating conditions change, the automatic transmission reacts by adjusting its gear shift program.



During the brief warm-up, transmission upshifting is delayed. This allows the catalytic converter to heat up more quickly to operating temperature.

The automatic transmission selects individual gears automatically, depending on:

- the gear selector lever position **D** with gear ranges (▷ page 160)
- the selected shift program (**C/S**) (▷ page 164)
or
(C/S/M) (E 55 AMG only) (▷ page 165)
- the position of the accelerator pedal (▷ page 164)
- the vehicle speed

The current gear selector lever position and shift program (C/S) or (C/S/M) appear in the multifunction display (▷ page 129).

An additional indication of the current gear selector lever position can be found on the cover of the shifting-gate. The indicators come on when you activate a switch (e.g. unlocking the vehicle or opening a door) and go out after approximately 15 minutes.

Warning!



It is dangerous to shift the gear selector lever out of **P** or **N** if the engine speed is higher than idle speed. If your foot is not firmly on the brake pedal, the vehicle could accelerate quickly forward or reverse. You could lose control of the vehicle and hit someone or something. Only shift into gear when the engine is idling normally and when your right foot is firmly on the brake pedal.

When the gear selector lever is in position **D**, you can influence transmission shifting by:

- limiting the gear range
- changing gears manually

One-touch gearshifting

Even with an automatic transmission you can change the gears manually when the gear selector lever is in position **D**.

Downshifting

- ▶ Briefly press the gear selector lever to the left in the **D-** direction.

The transmission will shift from the current gear to the next lower gear. This action simultaneously limits the gear range of the transmission (> page 160).

Warning!



On slippery road surfaces, never downshift in order to obtain braking action. This could result in drive wheel slip and reduced vehicle control. Your vehicle's ABS will not prevent this type of loss of control.



To avoid overrevving the engine when the gear selector lever is moved to the **D-** direction, the transmission will not shift to a lower gear if the engine's max. speed would be exceeded.

Upshifting

- ▶ Briefly press the gear selector lever to the right in the **D+** direction.

The transmission will shift from the current gear to the next higher gear as permitted by the shift program. This action simultaneously extends the gear range of the transmission.

Controls in detail

Automatic transmission

Canceling gear range limit

- ▶ Press and hold the gear selector lever in the **D+** direction until **D** reappears in the multifunction display.

The transmission will shift from the current gear range directly to gear range **D**.

Shifting into optimal gear range

- ▶ Press and hold the gear selector lever in the **D-** direction.

The transmission will automatically select the gear range suited for optimal acceleration and deceleration. This will involve shifting down one or more gears.

Controls in detail

Automatic transmission

Gear ranges

With the gear selector lever in position **D**, you can limit the transmission's gear range by pressing the gear selector lever to the left (**D-**), and reverse the gear range limit by pressing the gear selector lever to the right (**D+**).

The selected gear range appears in the multifunction display. If you press on the accelerator when the engine has reached its rpm limit, the transmission will upshift beyond any gear range limit selected.

	Effect
6	The transmission shifts through sixth gear only (applies only to vehicles with 7-speed automatic transmission).
5	The transmission shifts through fifth gear only (applies only to vehicles with 7-speed automatic transmission).
4	The transmission shifts through fourth gear only.
3	The transmission shifts through third gear only. With this selection you can use the braking effect of the engine.

	Effect
2	The transmission shifts through second gear only. Allows the use of engine's braking power when driving: <ul style="list-style-type: none">• on steep downgrades• in mountainous regions• under extreme operating conditions
1	The transmission operates in first gear only. For maximum use of engine's braking effect on very steep or lengthy downgrades.

Controls in detail

Automatic transmission

Gear selector lever position

	Effect
P	Park position Gear selector lever position when the vehicle is parked. Place gear selector lever in position P only when vehicle is stopped. The park position is not intended to serve as a brake when the vehicle is parked. Rather, the driver should always set the parking brake in addition to placing the gear selector lever in position P to secure the vehicle.

	Effect
	The SmartKey can only be removed from the starter switch with the gear selector lever in position P . With the SmartKey removed, the gear selector lever is locked in position P . If the vehicle's electrical system is malfunctioning, the gear selector lever could remain locked in position P (▷ page 357).
R	Reverse gear Place gear selector lever in position R only when vehicle is stopped.

	Effect
N	Neutral No power is transmitted from the engine to the drive axle. When the brakes are released, the vehicle can be moved freely (pushed or towed). To avoid damage to the transmission, never engage N while driving. If the ESP is deactivated or malfunctioning: Move gear selector lever to N only if the vehicle is in danger of skidding, e.g. on icy roads.
D	Drive The transmission shifts automatically. All forward gears are available.

Controls in detail

Automatic transmission



Coasting the vehicle, or driving for any other reason with gear selector lever in **N** can result in transmission damage that is not covered by the Mercedes-Benz Limited Warranty.

Warning!



Getting out of your vehicle with the gear selector lever not fully engaged in position **P** is dangerous. Also, position **P** alone is not intended to or capable of preventing your vehicle from moving, possibly hitting people or objects.

Always set the parking brake in addition to shifting to position **P** (▷ page 51).

When parked on an incline, turn the front wheels towards the road curb.

Do not park this vehicle in areas where combustible materials such as grass, hay or leaves can come into contact with the hot exhaust system, as these materials could be ignited and cause a vehicle fire.

Warning!



When leaving the vehicle, always remove the SmartKey from the starter switch, take the SmartKey with KEYLESS-GO* with you and lock the vehicle. Do not leave children unattended in the vehicle, or with access to an unlocked vehicle. Children could move the gear selector lever from position **P**, which could result in an accident and/or serious personal injury.

Steering wheel gearshift control (Speedshift) E 55 AMG

You can change the gears manually on the steering wheel or by using the gear selector lever (▷ page 159).

Allow engine to warm up under low load use. Do not place full load on the engine until the operating temperature has been reached. Shift into reverse gear only when the vehicle is stopped.



Avoid spinning of a drive wheel for an extended period when driving off on slippery road surfaces. This may cause serious damage to the drive train which is not covered by the Mercedes-Benz Limited Warranty.

The steering wheel gearshift buttons are located to the left and right of the steering wheel.

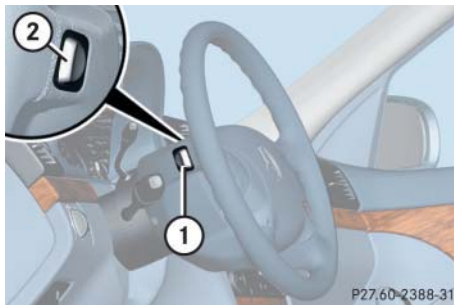

- ① Left button: downshift
- ② Right button: upshift

Downshifting

- ▶ Press button ① on the left side of the steering wheel.

The gear range is limited when you are not driving in the manual program mode (▷ page 160).

When driving in the manual program mode (▷ page 165), the transmission will shift from the current gear to the next lower gear (▷ page 166).

Warning!



On slippery road surfaces, never downshift in order to obtain braking action. This could result in drive wheel slip and reduced vehicle control. Your vehicle's ABS will not prevent this type of loss of control.



You cannot shift with the steering wheel gearshift buttons when the gear selector lever is in position **P**, **N** or **R**.

Upshifting

- ▶ Press button ② on the right side of the steering wheel.

The gear range is extended when you are not driving in the manual program mode (▷ page 160).

When driving in the manual program mode (▷ page 165), the transmission will shift from the current gear to the next higher gear (▷ page 166).



You cannot shift with the steering wheel gearshift buttons when the gear selector lever is in position **P**, **N** or **R**.

Controls in detail

Automatic transmission

Program mode selector switch

The program mode selector switch is located on the lower part of the center console.

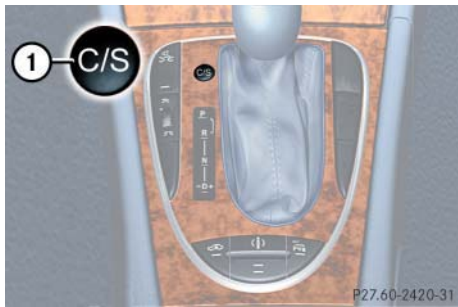

① Program mode selector switch

S Sport For standard driving

C Comfort For comfort driving



Never change the program mode when the gear selector lever is out of position **P**. This could result in a change of driving characteristics for which you may not be prepared.

- ▶ Press program mode selector switch ① repeatedly until the letter of the desired shift program appears in the multifunction display (▷ page 129).

Select **C** for comfort driving:

- The vehicle starts out in second gear (both forward and reverse) for gentler starts. This does not apply if full throttle is applied or gear range **1** is selected.
- Traction and driving stability are improved on icy roads.
- Upshifts occur earlier even when you give more gas. The engine then operates at lower rpms and the wheels are less likely to spin.
- The power transmission ratio for gear selector lever position **R** changes depending on the program mode selected (**S** or **C**).

Accelerator position

Your driving style influences the transmission's shifting behavior:

Less throttle Earlier upshifting

More throttle Later upshifting

Kickdown

Use kickdown when you want maximum acceleration.

- ▶ Press the accelerator past the point of resistance.

The transmission shifts into a lower gear.

- ▶ Ease on the accelerator when you have reached the desired speed.

The transmission shifts up again.

Manual shift program E 55 AMG

In the manual shift program mode you can change the gears manually (▷ page 162) on the steering wheel or by using the gear selector lever (▷ page 159).

Allow engine to warm up under low load use. Do not place full load on the engine until the operating temperature has been reached. Shift into reverse gear only when the vehicle is stopped.



Avoid spinning of a drive wheel for an extended period when driving off on slippery road surfaces. This may cause serious damage to the drive train which is not covered by the Mercedes-Benz Limited Warranty.

Program mode selector switch

The program mode selector switch is located on the lower part of the center console.

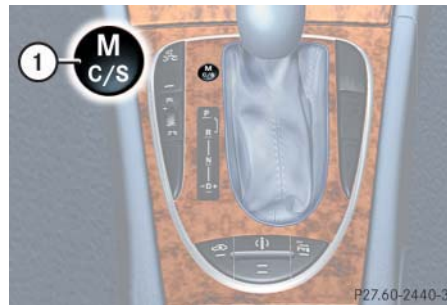

① Program mode selector switch

S Sport For standard driving

C Comfort For comfort driving

M Manual For manual gear shifting

The selected shift program (C/S/M) is indicated in the multifunction display (▷ page 129).

Activating manual shift program

- ▶ Press program mode selector switch ① repeatedly until the M for manual shift program appears in the multifunction display.

The program mode switches to manual program mode **M**. Automatic shifting is switched off. The gear range is not limited.

You can change the gears manually when the gear selector lever is in position **D**. You can upshift or downshift through the gears in succession.

The current gear selector lever position and the selected shift program (C/S/M) is indicated in the multifunction display (▷ page 129).

Controls in detail

Automatic transmission

Downshifting

- ▶ Briefly press the gear selector lever to the left in the **D-** direction (▷ page 159).

or

- ▶ Press button ① on the left side of the steering wheel (▷ page 162).

The transmission shifts to the next lower gear.

Warning!



On slippery road surfaces, never downshift in order to obtain braking action. This could result in drive wheel slip and reduced vehicle control. Your vehicle's ABS will not prevent this type of loss of control.

Upshifting

- ▶ Briefly press the gear selector lever to the right in the **D+** direction (▷ page 159).

or

- ▶ Press button ② on the right side of the steering wheel (▷ page 162).

The transmission shifts to the next higher gear.

Kickdown

The kickdown can also be used for maximum acceleration when driving in the manual program mode.

- ▶ Press the accelerator past the point of resistance.

The transmission shifts to a lower gear.

- ▶ Shift up once the desired speed has been reached.



When driving at full throttle, the transmission shifts to the next higher gear when maximum engine speed has been reached.

When you brake or stop, the transmission shifts down to a gear from which you can easily accelerate or take off.

Deactivating manual shift program

- ▶ Press the program mode selector switch repeatedly until **S** or **C** appears in the multifunction display.

or

- ▶ Restart the engine.

The transmission will go into the last automatic shift program mode selected (**S** or **C**).

Program mode **M** is not stored.



The last selected automatic program mode (**S** or **C**) is switched on when the engine is restarted in the automatic program mode.

Emergency operation (Limp Home Mode)

If vehicle acceleration worsens or the transmission no longer shifts, the transmission is most likely operating in limp home (emergency operation) mode. In this mode only second gear and reverse gear can be activated.

- ▶ Stop the vehicle.
- ▶ Move gear selector lever to **P**.
- ▶ Turn off the engine.
- ▶ Wait at least ten seconds before restarting.
- ▶ Restart the engine.
- ▶ Move gear selector lever to position **D** (for second gear) or **R**.
- ▶ Have the transmission checked at an authorized Mercedes-Benz Center as soon as possible.

Controls in detail

Good visibility

▼ Good visibility

Information on the windshield wipers (▷ page 48) and for setting the rear view mirrors (▷ page 38) is found in the “Getting started” section.

Rear view mirror

Automatic antiglare rear view mirror

The reflection brightness of the exterior rear view mirror on the driver’s side and the interior rear view mirror will respond automatically to glare when:

- the ignition is switched on, and
- incoming light from headlamps falls on the sensor in the interior rear view mirror

The rear view mirror will not react if

- reverse gear is engaged
- the interior lighting is turned on

Warning!



The automatic antiglare function does not react if incoming light is not aimed directly at sensors in the interior rear view mirror.

The interior rear view mirror and the exterior rear view mirror on the driver’s side do not react, for example, if the rear window sunshade is in raised position.

Glare can endanger you and others.

Warning!



In the case of an accident liquid electrolyte may escape from the mirror housing if the mirror glass breaks.

Electrolyte has an irritating effect. Do not allow the liquid to come into contact with eyes, skin, clothing, or respiratory system. In case it does, immediately flush affected area with water, and seek medical help if necessary.

Warning!



Exercise care when using the passenger side exterior rear view mirror. The mirror surface is convex (outwardly curved surface for a wider field of view). Objects in mirror are closer than they appear. Check your interior rear view mirror or glance over your shoulder before changing lanes.



Electrolyte drops coming into contact with the vehicle paint finish can be completely removed only while in the liquid state by applying plenty of water.

Activating exterior rear view mirror parking position

Follow these steps to activate the mirror parking position so that the passenger-side exterior rear view mirror will be turned downward to the stored position.

- ▶ Make sure you have stored a parking position for the passenger-side exterior rear view mirror (▷ page 118).
- ▶ Make sure the Mirror adjustment parking aid function in the Convenience submenu of the control system is switched on (▷ page 152).
- ▶ Switch on ignition (if not already on).
- ▶ Press button ② for the passenger-side exterior rear view mirror.
- ▶ Place the gear selector lever in reverse gear **R**.

The passenger-side exterior rear view mirror will be turned downward to the stored position.

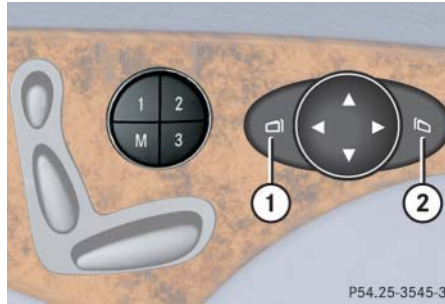

- ① Driver's side exterior rear view mirror button
- ② Passenger-side exterior rear view mirror button

The exterior rear view mirror returns to its previously stored driving position:

- ten seconds after you put the gear selector lever out of position **R**
- immediately once your vehicle exceeds a speed of approximately 6 mph (10 km/h)
- immediately when you press button ① for driver's side mirror.

Windshield wipers

Information on the windshield wipers is found in the "Getting started" section (▷ page 48).



Intermittent wiping is interrupted when the vehicle is at a standstill and a front door is opened.

A rain sensor automatically controls the windshield wipers depending on how wet the windshield is.

- ▶ Switch on ignition.
- ▶ Set the wiper switch to position **I** (▷ page 48).

After the initial wipe, pauses between wipes are automatically controlled by the rain sensor.

Controls in detail

Good visibility



Do not leave windshield wipers in intermittent setting when the vehicle is taken to an automatic car wash or during windshield cleaning. Wipers will operate in the presence of water sprayed on the windshield, and wipers may be damaged as a result.

The switch should not be left in intermittent setting as the wipers will wipe the windshield once every time the engine is started. Dust that accumulates on the windshield might scratch the glass and / or damage the wiper blades when wiping occurs on a dry windshield.

Headlamp cleaning system*

The button is located on the left side of the dashboard.



① Headlamp washer button

- ▶ Switch on ignition.
- ▶ Press button ①.

The headlamps are cleaned with a high-pressure water jet.

Information on filling up the washer reservoir can be found in the “Operation” section (▷ page 288).

Sun visors

The sun visors protect you from sun glare while driving.

Warning!



Do not use the vanity mirror while driving.

Keep the mirrors in the sun visors closed while vehicle is in motion. Reflected glare can endanger you and others.

- ▶ Swing sun visors down when you experience glare.

Controls in detail

Good visibility

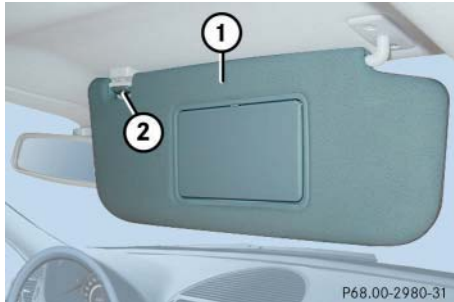

- ① Sun visor
- ② Mounting

- ▶ Swing sun visor ① down when you experience glare.

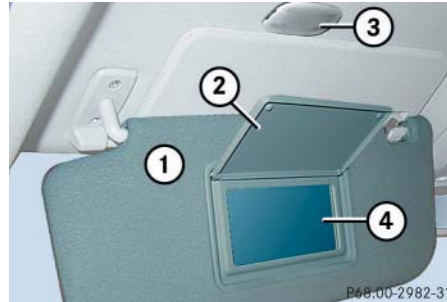

- ① Sun visor
- ② Mirror cover
- ③ Mirror lamp
- ④ Vanity mirror

- ▶ Make sure the sun visor is properly engaged in the mounting.
- ▶ Lift the mirror cover to access the mirror.
Lamp ③ switches on.

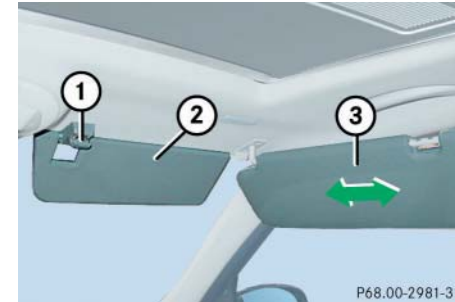

- ① Mounting
- ② Additional visor*
- ③ Sun visor

If sunlight enters through a side window:

- ▶ Disengage sun visor from mounting ①.
- ▶ Pivot sun visor to the side.

The sun visors are extendable.

- ▶ Adjust the sun visors by pushing or pulling in the direction of the arrows.

Controls in detail

Good visibility



If sunlight enters through a side window, disengage sun visor from mounting ① and pivot to the side.

Mirror lamp ③ will switch off.

Rear window sunshade*

The switch is located in the center console.



- ▶ Turn the SmartKey to starter switch position **1** or **2**. Vehicles with KEY-LESS-GO*: press the start / stop button once or twice.
- ▶ Press the switch briefly at ① to raise the sunshade.

- ▶ Press the switch briefly at ① to lower the sunshade.

Always raise the sunshade fully for its support against the window frame.

Warning!



When operating the rear window sunshade, be sure that there is no danger of anyone being harmed by the raising or lowering procedure.

The raising or lowering procedure can be immediately halted by briefly pressing switch ①. To reverse direction of movement, press switch ① again.

Warning!



When leaving the vehicle, always remove the SmartKey from starter switch, and lock your vehicle. Do not leave children unattended in the vehicle, or with access to an unlocked vehicle. Unsupervised use of vehicle equipment can cause an accident and / or serious personal injury.

Roller sunblind* in the rear doors

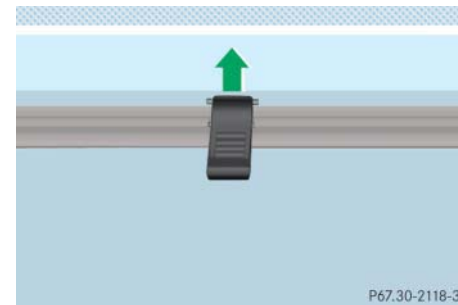

- ▶ Pull the roller sunblind out using the hooks.
- ▶ Attach the hooks at the top.



Always guide the sunblind by hand. Do not let it snap back, as the retractor could be damaged.

Rear window defroster

The rear window defroster uses a large amount of power. To keep the battery drain to a minimum, switch off the defroster as soon as the rear window is clear. The defroster is automatically deactivated after approximately 6 to 17 minutes of operation depending on the outside temperature.

Activating

- ▶ Press button  on the climate control panel (> page 173) or the automatic climate control panel (> page 176).

The indicator lamp on the button comes on.

Deactivating

- ▶ Press button  again.

The indicator lamp on the button goes out.

Warning!



Any accumulation of snow and ice should be removed from the rear window before driving. Visibility could otherwise be impaired, endangering you and others.



If the rear window defroster switches off too soon and the indicator lamp starts flashing, this means that too many electrical consumers are operating simultaneously and there is insufficient voltage in the battery. The system responds automatically by deactivating the rear window defroster.

As soon as the battery has sufficient voltage, the rear window defroster automatically turns itself back on.

Controls in detail

Climate control

▼ Climate control

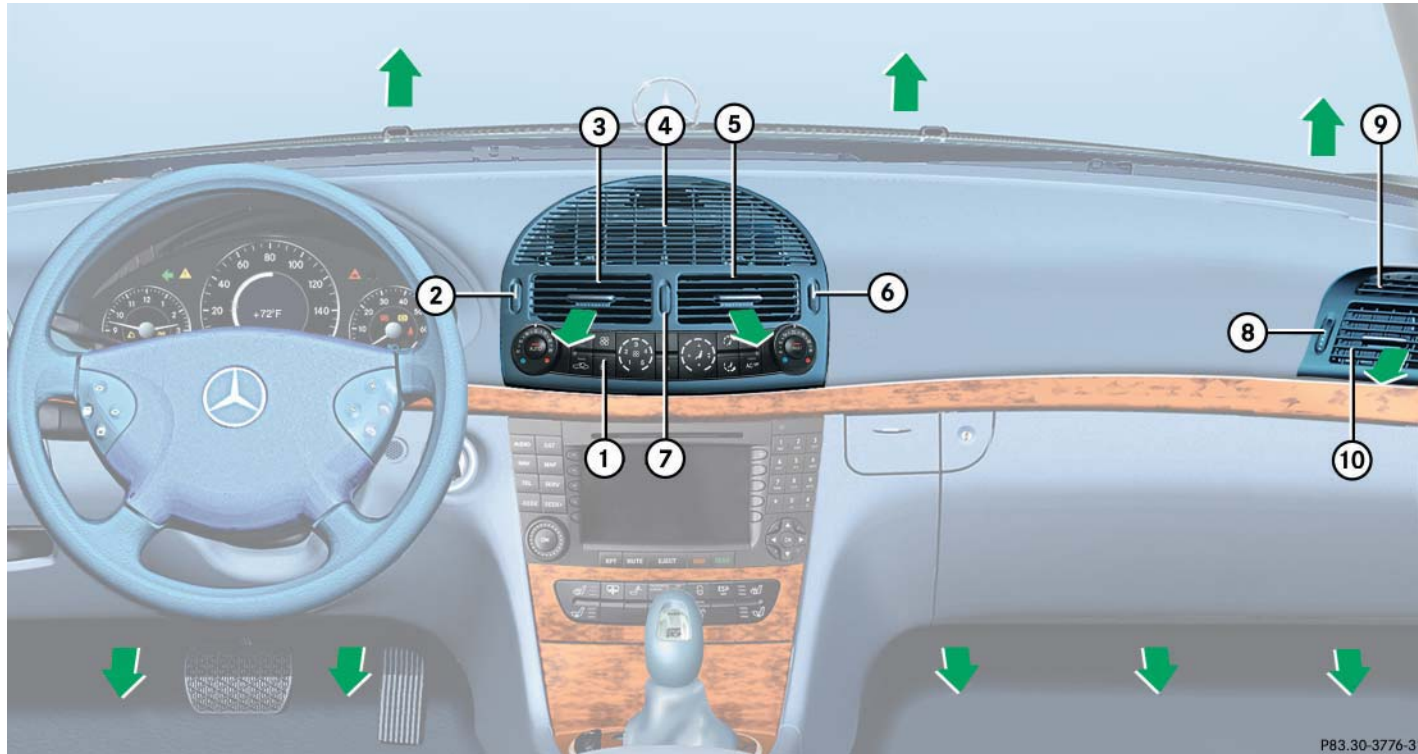

	Item
①	Climate control panel
②	Thumbwheel for air volume control for left center air vent
③	Left center air vent, adjustable
④	Center air vent, fixed
⑤	Right center air vent, adjustable
⑥	Thumbwheel for air volume control for right center air vent
⑦	Thumbwheel for air volume control for adding cold air
⑧	Thumbwheel for air volume control for side air vent
⑨	Side defroster vent, fixed
⑩	Side air vent, adjustable



For draft-free ventilation, move the sliders for the center vents ③ and ⑤ to the middle position.

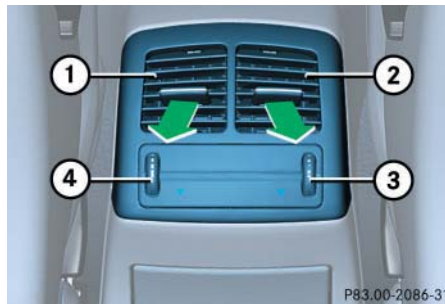

Rear air vents

Controls in detail

Climate control

	Item
①	Left rear center air vent, adjustable
②	Right rear center air vent, adjustable
③	Thumbwheel for air volume control for right rear center air vent
④	Thumbwheel for air volume control for left rear center air vent

The storage compartment between the front seats can be ventilated (▷ page 244).

Controls in detail

Climate control

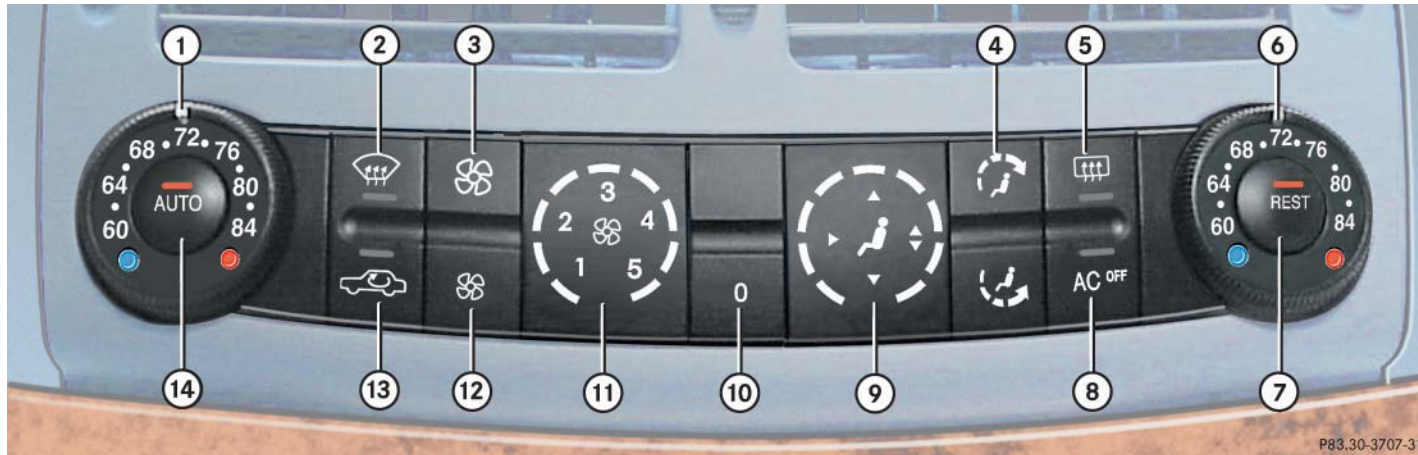

P83.30-3707-31

	Item
①	Left-side temperature control
②	Windshield defroster
③	Increase air volume
④	Air distribution
⑤	Rear window defroster
⑥	Right-side temperature control

	Item
⑦	Residual heat / ventilation
⑧	AC cooling on / off (AC^{OFF})
⑨	Air distribution display
⑩	Climate control on / off
⑪	Air volume display
⑫	Decrease air volume

	Item
⑬	Air recirculation
⑭	Air distribution and air volume (automatic, manual)

The climate control is operational whenever the engine is running. You can operate the climate control system in either the automatic or manual mode. The system cools or heats the interior depending on the selected interior temperature and the current outside temperature.

Warning!



When operating the automatic climate control, the air that enters the passenger compartment through the air vents in the footwell can be very hot or very cold (depending on the set temperature). This may cause burns or frostbite to unprotected skin in the immediate area of the air vents. Always keep sufficient distance between unprotected parts of the body and the footwell air vents. If necessary change the air flow using the air distribution controls (▷ page 176) to direct the air away from the footwell air vents.

Nearly all dust particles, pollutants and odors are filtered out before outside air enters the passenger compartment through the air distribution system.

The air conditioning will not engage (no cooling) if the **AC^{OFF}** mode is selected (▷ page 182).

Warning!



Follow the recommended settings for heating and cooling given on the following pages. Otherwise the windows could fog up, impairing visibility and endangering you and others.

Controls in detail

Climate control



Severe conditions (e.g. strong air pollution) may require replacement of the filter before its scheduled interval. A clogged filter will reduce the air volume to the interior.

If the vehicle interior is hot, ventilate the interior before driving off.

Keep the air intake grille in front of the windshield free of snow and debris.

Do not obstruct air flow by placing objects on the air flow-through exhaust slots below the rear window.

Controls in detail

Climate control

Setting the temperature

Use temperature controls ① and ⑥ to separately adjust the air temperature on each side of the passenger compartment. You should raise or lower the temperature setting in small increments, preferably starting at 72°F (22°C).

Increasing

- ▶ Turn the temperature control ① or ⑥ slightly to the right.

The climate control system will correspondingly adjust the interior air temperature.

Decreasing





- ▶ Turn the temperature control ① or ⑥ slightly to the left.

The climate control system will correspondingly adjust the interior air temperature.

Adjusting air distribution

Adjusting manually

Use air distribution control ④ (▷ page 176) to adjust the air distribution.

Symbol	Function
	Directs air through the center, side and rear passenger compartment air vents
	Directs air to the windows
	Directs air into the entire vehicle interior
	Directs air to the footwells

- ▶ Press the **AUTO** button.

The indicator lamp on the **AUTO** button goes out.

- ▶ Press air distribution rocker switch ④ (▷ page 176) until the display shows the desired setting.

The current air distribution appears in the air distribution display ⑨.

Adjusting automatically

- ▶ Press the **AUTO** button.

The indicator lamp on the button comes on. The air distribution and volume is adjusted automatically.

Adjusting center air vents:

The thumbwheels for left ② and right ⑥ center air vents are automatically positioned for optimum interior airflow. In this position, center air vent ④ and adjustable left and right center vents ③ and ⑤ are fully opened.

Heating:

Only in manual mode is it possible to lower the temperature in the headroom by regulating the cold-airflow using thumbwheel ⑦ (▷ page 174).



Windshield fogged on the outside

- ▶ Switch the windshield wipers on (▷ page 48).
- ▶ Press the **AUTO** button.
The indicator lamp on the button comes on.

Adjusting air volume

Adjusting manually

Five blower speeds are available.

- ▶ Press  to decrease or  to increase air volume to the desired level.
The *Auto* display disappears and the automatic mode is switched off. The selected blower speed is shown in the display.

Controls in detail

Climate control

Adjusting automatically



- ▶ Press the **AUTO** button.
The air volume is adjusted automatically.

Defrosting



These settings should only be selected for a short time.

Activating

- ▶ Press button .
The indicator lamp on the button comes on.
or
- ▶ Switch off air recirculation, if selected. Press button .
The indicator lamp on the button goes out. ▷▷

Controls in detail

Climate control

- ▷▷▶ Close center air vents.
- ▶ Open left and right side air vents and adjust side air vents upwards.

Deactivating

- ▶ Press button .
- The indicator lamp on the button goes out. Defrosting is turned off.

Air recirculation mode

Switch to air recirculation mode to prevent unpleasant odors from entering the vehicle from the outside. This setting cuts off the intake of outside air and recirculates the air in the passenger compartment.

Warning!



When the outside temperature is below 41°F (5°C), only switch to air recirculation mode for short periods to prevent window fogging.

Activating

- ▶ Press button .

The indicator lamp on the button comes on.



The air recirculation mode is activated automatically at high outside temperatures.

If you have turned off the air conditioning (▷ page 182) or the outside temperature is below 41°F (5°C), the air recirculation mode will not switch on automatically.

Warning!



Never operate the windows and sliding / pop-up roof* or panorama sliding / pop-up roof* if there is the possibility of anyone being harmed by the opening or closing procedure.

In case the procedure causes potential danger:

Vehicles with sliding / pop-up roof: The procedure for the windows can be immediately halted by pressing or pulling the respective window switch. The procedure for the sliding / pop-up roof can be immediately halted by moving the switch for the sliding / pop-up roof in any direction.

The closing of the side windows and the sliding / pop-up roof can be reversed by again pressing and holding the  button.

Vehicles with panorama sliding / pop-up roof: The procedure for the windows and panorama sliding / pop-up roof can be immediately halted by releasing the  button.

Deactivating

- ▶ Press button .

The indicator lamp on the button goes out.



If you keep button  pressed, the side windows and sliding / pop-up roof* or panorama sliding / pop-up roof* will return to their previous position.

The air recirculation mode is deactivated automatically:

- after five minutes if the outside temperature is below approximately 41°F (5°C)
- after five minutes if the air conditioning is turned off
- after 30 minutes if the outside temperature is above approximately 41°F (5°C)

Controls in detail

Climate control

At outside temperatures above 79°F (26°C), the system will not automatically switch back to outside air. A quantity of outside air is added after approximately 30 minutes.

Deactivating the climate control system

Deactivating

- ▶ Press button  (▷ page 176).

Reactivating

- ▶ Press button  again (▷ page 176).
- or
- ▶ Press any button on the climate control panel (▷ page 176).

Controls in detail

Climate control

Air conditioning

The air conditioning is operational while the engine is running and cools the interior air to the temperature set by the operator.



Condensation may drip out from underneath the vehicle. This is normal and not an indication of a malfunction.

Deactivating

It is possible to deactivate the air conditioning (cooling) function of the climate control system. The air in the vehicle will then no longer be cooled or dehumidified.

- ▶ Press button **AC^{OFF}** (▷ page 176).

The indicator lamp on the button **AC^{OFF}** comes on.

Activating

Moist air can fog up the windows. You can dehumidify the air with the air conditioning.

- ▶ Press **AC^{OFF}** again (▷ page 176).

The indicator lamp on the button **AC^{OFF}** goes out.

The air conditioning uses the refrigerant R134a. This refrigerant is free of CFCs which are harmful to the ozone layer.



If the air conditioning cannot be turned on again, this indicates that the air conditioning is losing refrigerant. The compressor has turned itself off.

Have the air conditioning checked at the nearest authorized Mercedes-Benz Center.

Residual heat and ventilation*

With the engine switched off, it is possible to continue to heat or ventilate the interior for up to 30 minutes. This feature makes use of the residual heat produced by the engine.

Activating

- ▶ Turn the SmartKey in the starter switch to position **0** or **1**, or remove it from the starter switch.
- ▶ Press button **REST** (▷ page 176).

The indicator lamp on button **REST** comes on.



How long the system will provide heating depends on the coolant temperature and the temperature set by the operator. The blower will run at speed setting 1 regardless of the air distribution control setting.

Deactivating

► Press button **REST** (▷ page 176).

The indicator lamp on button **REST** goes out.

The residual heat is automatically turned off:

- when the ignition is switched on
- after about 30 minutes
- if the battery voltage drops

Controls in detail

Automatic climate control*

▼ Automatic climate control*

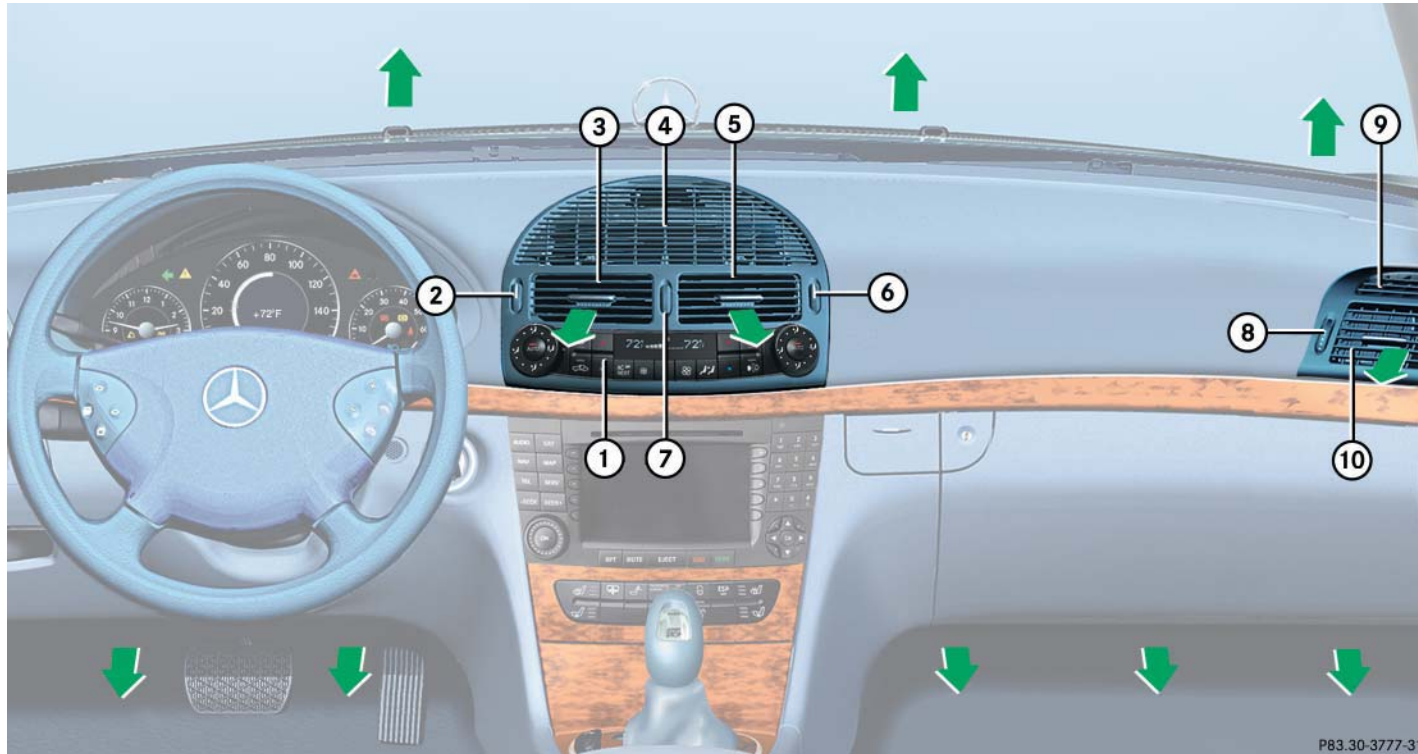

P83.30-3777-31

	Item
①	Automatic climate control panel
②	Thumbwheel for air volume control for left center air vent
③	Left center air vent, adjustable
④	Air vent, fixed
⑤	Right center air vent, adjustable
⑥	Thumbwheel for air volume control for right center air vent
⑦	Thumbwheel for air volume control for adding cold air
⑧	Thumbwheel for air volume control for side air vent
⑨	Side defroster vent, fixed
⑩	Side air vent, adjustable

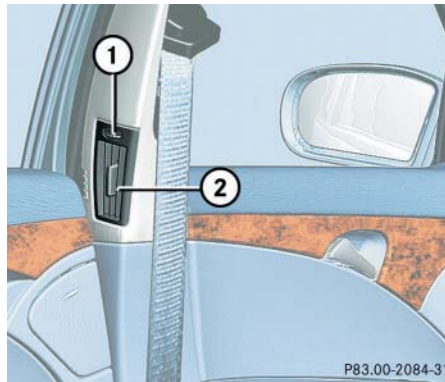

	Item
①	Thumbwheel for air volume control for side air vent
②	Side air vent, adjustable

Controls in detail

Automatic climate control*

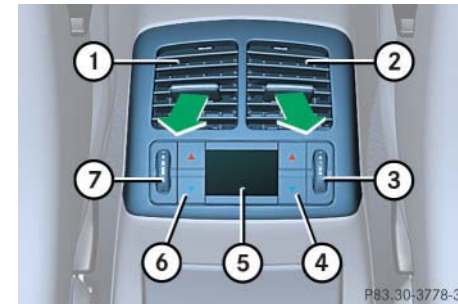

	Item
①	Left rear center air vent, adjustable
②	Right rear center air vent, adjustable
③	Air volume control for right rear center air vent
④	Temperature rocker switch, right
⑤	Display
⑥	Temperature rocker switch, left
⑦	Air volume control for left rear center air vent

Controls in detail

Automatic climate control*

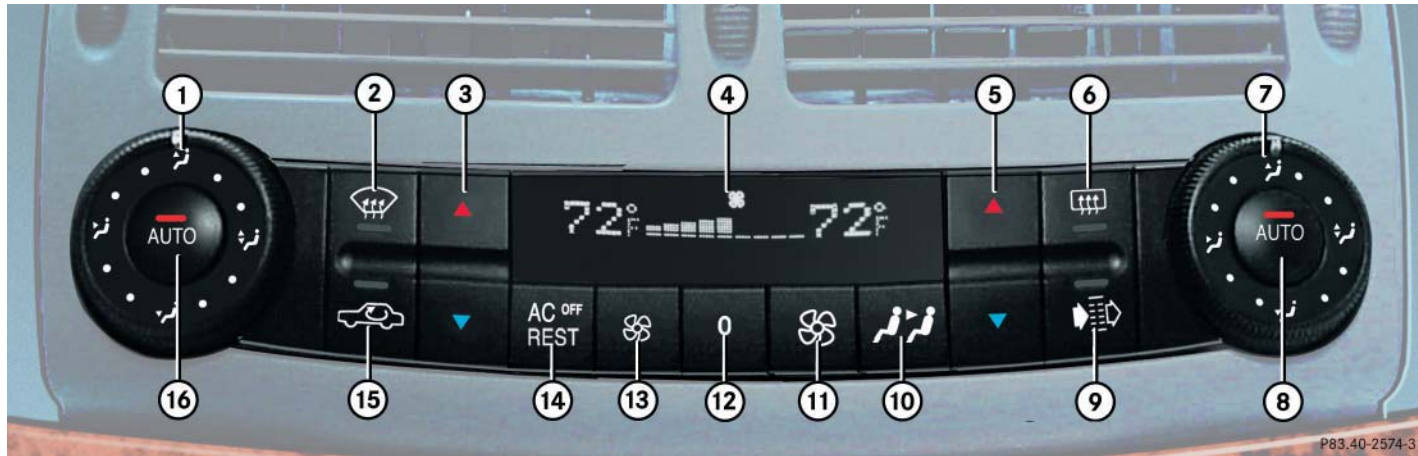

P83.40-2574-31

	Item
①	Air distribution, left
②	Defrosting
③	Temperature rocker switch, left
④	Display
⑤	Temperature rocker switch, right
⑥	Rear window defroster

	Item
⑦	Air distribution, right
⑧	Air distribution and air volume, right (automatic, manual)
⑨	Activated charcoal filter
⑩	Rear air-conditioning remote control
⑪	Increase air volume

	Item
⑫	Automatic climate control on / off
⑬	Decrease air volume
⑭	AC cooling on / off (AC^{OFF}) Residual heat / ventilation (REST)
⑮	Air recirculation
⑯	Air distribution and air volume, left (automatic, manual)

Warning!



When operating the automatic climate control, the air that enters the passenger compartment through the air vents in the footwell can be very hot or very cold (depending on the set temperature). This may cause burn or frostbite to unprotected skin in the immediate area of the air vents. Always keep sufficient distance between unprotected parts of the body and the footwell air vents. If necessary change the air flow using the air distribution controls (> page 186) to direct the air away from the footwell air vents.

The automatic climate control is a 4-zone intelligent climate control system. Your vehicle interior is divided into 4 zones.

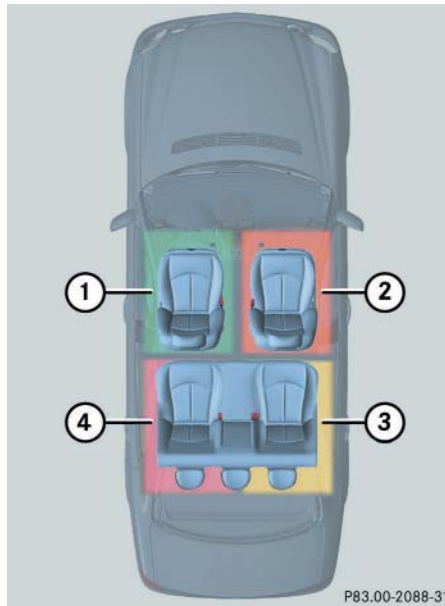

P83.00-2088-31

Controls in detail

Automatic climate control*

With the help of a sun sensor, the automatic climate control determines the relation of the sun to the vehicle and automatically adjusts the inside temperature for every individual zone.

You can set the temperature for each of the 4 zones separately. These settings can be assigned to a SmartKey and stored in memory (> page 152).

The automatic climate control is operational whenever the engine is running. It cools the vehicle's interior according to the angle and intensity of the sun's rays, the outside temperature and the selected temperature. You can operate the climate control system in either the automatic or manual mode.

Controls in detail

Automatic climate control*

Nearly all dust particles, pollutants and odors are filtered out before outside air enters the passenger compartment through the air distribution system.

The air conditioning will not engage (no cooling) if the **AC^{OFF}** mode is selected (▷ page 186).

Warning!



Follow the recommended settings for heating and cooling given on the following pages. Otherwise the windows could fog up, impairing visibility and endangering you and others.



Severe conditions (e.g. strong air pollution) may require replacement of the filter before its scheduled interval. A clogged filter will reduce the air volume to the interior.

If the vehicle interior is hot, ventilate the interior before driving off.

Keep the air intake grille in front of the windshield free of snow and debris.

Do not obstruct air flow by placing objects on the air flow-through exhaust slots below the rear window.

Setting the temperature

Use temperature control ③ for the left side or ⑤ for the right side to separately adjust the air temperature on each side of the passenger compartment. You should raise or lower the temperature setting in small increments, preferably starting at 72°F (22°C).



When operating the climate control system in automatic mode, you will only rarely need to adjust the temperature, air volume and air distribution.

Increasing

- ▶ Push top of temperature control rocker switch ③ and/or ⑤.

The automatic climate control system will correspondingly adjust the interior air temperature.

Decreasing

- ▶ Push bottom of temperature control rocker switch ③ and/or ⑤.





The automatic climate control system will correspondingly adjust the interior air temperature.

Heating:

Only in manual air distribution mode is it possible to lower the temperature in the headroom by adding outside air using thumbwheel ⑦ (▷ page 184) in the dashboard.

Adjusting air distribution

Use the air distribution controls ① and ⑦ (▷ page 176) to separately adjust the air distribution on each side of the passenger compartment. The following symbols are found on the controls:

Symbol	Function
	Directs air through the center, side and rear passenger compartment air vents
	Directs air to the windows
	Directs air into the entire vehicle interior
	Directs air to the footwells

Controls in detail

Automatic climate control*

Adjusting manually

- ▶ Press left or right **AUTO**.
- The indicator lamp in the **AUTO** button goes out.
- ▶ Turn air distribution controls on each side of the passenger compartment to the desired symbol.

Adjusting automatically

- ▶ Press left or right **AUTO** button again.
- The indicator lamp in the **AUTO** button illuminates. The air distribution is adjusted automatically.

Windshield fogged on the outside

- ▶ Switch the windshield wipers on.
- ▶ Press the left or right **AUTO** button.



Controls in detail

Automatic climate control*

Adjusting air volume

Adjusting manually

Nine blower speeds are available.

- ▶ Press  to decrease or  to increase air volume to the desired level.

The Auto display disappears and the automatic mode is switched off. The selected blower speed is shown in the display.

Adjusting automatically

- ▶ Press left or right **AUTO** button.
The air volume is adjusted automatically.

Maximum cooling MAX COOL

If the left and right air distribution controls as well as the airflow volume control are set to **AUTO** and there is a high need for cooling, the display “MAX COOL” appears in the front and rear display.

This provides the fastest possible cooling of the vehicle interior (when windows and sliding / pop-up roof* or panorama sliding / pop-up roof* are closed).

Defrosting



These settings should only be selected for a short time.

Activating

- ▶ Press button .

The indicator lamp on the button comes on.

or

Switch off air recirculation, if selected.

- ▶ Press button .

The indicator lamp on the button goes out.

- ▶ Close center air vents.
- ▶ Adjust side air vents upwards.

Deactivating

- ▶ Press button .

The indicator lamp on the button goes out. Defrosting is turned off.

Air recirculation mode

Switch to air recirculation mode to prevent unpleasant odors from entering the vehicle from the outside. This setting cuts off the intake of outside air and recirculates the air in the passenger compartment.

Warning!



When the outside temperature is below 41°F (5°C), only switch to air recirculation mode for short periods to prevent window fogging.



If you keep button  pressed, the side windows and the sliding / pop-up roof* or panorama sliding / pop-up roof* or will close.

Activating

- ▶ Press button .

The indicator lamp on the button comes on.



The air recirculation mode is activated automatically:

- at high outside temperatures
- if the concentration of carbon monoxide and nitrogen oxide in the outside air increases, for example in a tunnel (charcoal filter activated (▷ page 192))

If you have turned off the air conditioning (▷ page 182) or the outside temperature is below 41°F (5°C), the air recirculation mode will not switch on automatically.

Controls in detail

Automatic climate control*

Warning!



Never operate the windows and sliding / pop-up roof* or panorama sliding / pop-up roof* if there is the possibility of anyone being harmed by the opening or closing procedure.

In case the procedure causes potential danger:

Vehicles with sliding / pop-up roof: The procedure for the windows can be immediately halted by pressing or pulling the respective window switch. The procedure for the sliding / pop-up roof can be immediately halted by moving the switch for the sliding / pop-up roof in any direction.

The closing of the side windows and the sliding / pop-up roof can be reversed by again pressing and holding the  button.

Vehicles with panorama sliding / pop-up roof: The procedure for the windows and panorama sliding / pop-up roof can be immediately halted by releasing the  button.

Controls in detail

Automatic climate control*

Deactivating

- ▶ Press button .

The indicator lamp on the button goes out.



If you keep button  pressed, the side windows and the sliding / pop-up roof* or panorama sliding / pop-up roof* will return to their previous position.

The air recirculation mode is deactivated automatically:

- after five minutes if the outside temperature is below approximately 41°F (5°C)
- after five minutes if the air conditioning is turned off (**AC^{OFF}**)
- after 30 minutes if the outside temperature is above approximately 41°F (5°C)

At outside temperatures above 79°F (26°C) the system will not automatically switch back to outside air. A quantity of outside air is added after approximately 30 minutes.

Charcoal filter

An activated charcoal filter markedly reduces bad odors and removes pollutants from air entering the passenger compartment.

Activating

- ▶ Press button .

The indicator lamp on the button comes on.



If you keep button  pressed, the side windows and the sliding / pop-up roof* or panorama sliding / pop-up roof* will close.

Warning!



Never operate the side windows and sliding / pop-up roof* or panorama sliding / pop-up roof* if there is the possibility of anyone being harmed by the opening or closing procedure.

Vehicles with sliding/pop-up roof: The procedure for the windows can be immediately halted by pressing or pulling the respective window switch. The procedure for the sliding/pop-up roof can be immediately halted by moving the switch for the sliding/pop-up roof in any direction.

The closing of the side windows and the sliding/pop-up roof can be reversed by again pressing and holding the  button.

Vehicles with panorama sliding/pop-up roof: The procedure for the windows and panorama sliding/pop-up roof can be immediately halted by releasing the  button.

Deactivating

- ▶ Press button .

The indicator lamp on the button goes out.



If you keep button  pressed, the side windows and the sliding / pop-up roof* will return to their previous position.

The system switches automatically to the air recirculation mode if the carbon monoxide (CO) or nitrogen oxide (NO_x) concentration of the outside air increases beyond a predetermined level.

The automatic air recirculation mode does not function if **AC^{OFF}** mode is selected or if the outside temperature has fallen below 41°F (5°C).

The activated charcoal filter should be switched off when windows fog up on the inside, or if the passenger compartment needs to be quickly heated or cooled down.

Deactivating the climate control system

Deactivating

It is possible to deactivate the automatic climate control system.

- ▶ Press button  until the display is cleared.

The climate control system is deactivated.

Controls in detail

Automatic climate control*

Reactivating

- ▶ Press button  again.



With the climate control system deactivated, the air flow and circulation are switched off.

Only choose this setting temporarily to prevent the windows from fogging up.

Controls in detail

Automatic climate control*

Air conditioning

The air conditioning is operational while the engine is running and cools the interior air to the temperature set by the operator.



Condensation may drip out from underneath the vehicle. This is normal and not an indication of a malfunction.

Deactivating

It is possible to deactivate the air conditioning (cooling) function of the automatic climate control system. The air in the vehicle will then no longer be cooled or dehumidified.

- ▶ Press button .

The indicator lamp on the button  comes on.

Activating

Moist air can fog up the windows. You can dehumidify the air with the air conditioning.

- ▶ Press  again.

The indicator lamp on the  button goes out.

The air conditioning uses the refrigerant R134a. This refrigerant is free of CFCs which are harmful to the ozone layer.



If the air conditioning cannot be turned on again, this indicates that the air conditioning is losing refrigerant. The compressor has turned itself off.

Have the air conditioning checked at the nearest authorized Mercedes-Benz Center.

Residual heat and ventilation

With the engine switched off, it is possible to continue to heat or ventilate the interior for up to 30 minutes. This feature makes use of the residual heat produced by the engine.

Activating

- ▶ Turn the SmartKey in the starter switch to position **0** or **1**, or remove it from the starter switch.

- ▶ Press button .

The indicator lamp on button  comes on.

Deactivating

- ▶ Press button .

The indicator lamp on button  goes out.

The residual heat is automatically turned off

- when the ignition is switched on
- after about 30 minutes
- if the battery voltage drops



How long the system will provide heating depends on the coolant temperature and the temperature set by the operator. The blower will run at speed setting 1 regardless of the air distribution control setting.

Rear air conditioning

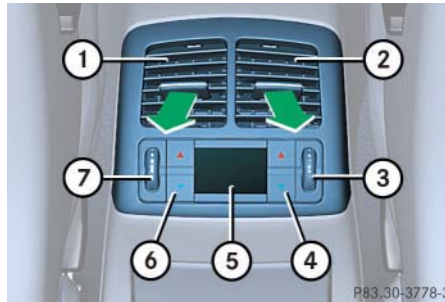

- ① Left rear center air vent, adjustable
- ② Right rear center air vent, adjustable
- ③ Thumbwheel for air volume control for right rear center air vent
- ④ Temperature rocker switch, right
- ⑤ Display
- ⑥ Temperature rocker switch, left
- ⑦ Thumbwheel for air volume control for left rear center air vent

Controls in detail

Automatic climate control*

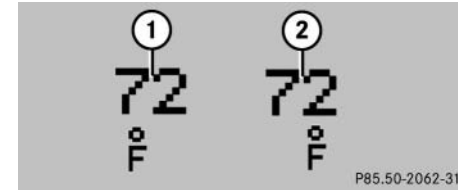

Display

- ① Temperature, left
- ② Temperature, right

Basic settings

We recommend setting the temperature on both the left- and right-hand sides to 72°F. This ensures a pleasant temperature in the rear of the vehicle.

The temperatures for the left- and right-hand sides can be set using temperature rocker switches ④ and ⑥.

Controls in detail

Automatic climate control*



The rear air conditioning will not cool the air when **AC^{OFF}** mode has been selected in the front control panel.

Adjusting the rear settings with the front control panel

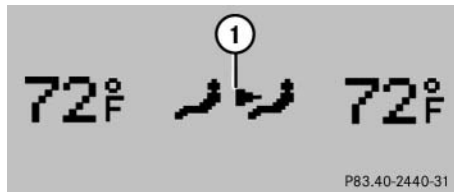

Display

- ▶ Press the  button (▷ page 186).

The display switches over.

The temperature for the rear left- and right-hand sides of the vehicle can be set with temperature rocker switches ③ and ⑤.

The temperature display disappears approximately five seconds after the last SmartKey confirmation and switches back to the normal display.



The normal display will appear when the  button is pressed again.

▼ Power windows

Opening and closing the windows

The side windows can be opened and closed electrically. The switches for all of the side windows are on the driver's door. The switches for the respective windows are on the front passenger door and the rear doors.

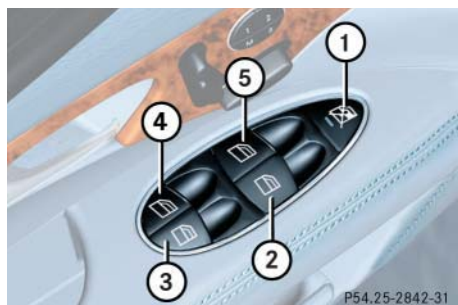

- ① Rear window override switch
(▷ page 72)
- ② Right front window
- ③ Right rear window
- ④ Left rear window
- ⑤ Left front window

Warning!



When closing the windows, make sure that there is no danger of anyone being harmed by the closing procedure.

The closing of the door windows can be immediately halted by releasing the switch or, if switch was pulled past the resistance point and released, by either pressing or pulling the respective switch.

If the window encounters an obstruction that blocks its path in a circumstance where you pulled the switch past the resistance point and released it to close the window, the automatic reversal function will stop the window and open it slightly.

If the window encounters an obstruction that blocks its path in a circumstance where you are closing the window by pulling and holding the switch, by pressing and holding button  on the SmartKey, or by pressing and holding the lock button (vehicles with KEYLESS-GO*) on the door handle,

Controls in detail



Power windows

the automatic reversal function will not operate.

When leaving the vehicle, always remove the SmartKey from starter switch, take the SmartKey with KEYLESS-GO* with you, and lock your vehicle. Do not leave children unattended in the vehicle, or with access to an unlocked vehicle. Unsupervised use of vehicle equipment can cause an accident and/or serious personal injury.



You can also open or close the windows using the following:

- SmartKey (summer opening/convenience feature) (▷ page 199)
- Button  in the control panel of the climate control (▷ page 176)
- Button  in the control panel of the automatic climate control (▷ page 186)

Controls in detail

Power windows

- ▶ Turn SmartKey in the starter switch to position **1** or **2** or press the KEY-LESS-GO* start/stop button once or twice.



You can still operate the windows when the key is in starter switch position **0** or has been removed:

- until the driver's or front passenger door has been opened
- though for no more than five minutes

Opening the windows

- ▶ Press switch ② to ⑤ to the resistance point.

The corresponding window will move downwards until you release the switch.

Closing the windows

- ▶ Pull switch ② to ⑤ to the resistance point.

The corresponding window will move upwards until you release the switch.

Warning



If you pull and hold the switch up when closing the window, and upward movement of the window is blocked by some obstruction including but not limited to arms, hands, fingers, etc., the automatic reversal will not operate.

Fully opening the windows (Express-open)

- ▶ Press switch ② to ⑤ past the resistance point and release.

The corresponding window opens completely.

Fully closing the windows (Express-close)

- ▶ Pull switch ② to ⑤ past the resistance point and release.

The corresponding window closes completely.

If the upward movement of the window is blocked during the closing procedure, the window will stop and open slightly.

Warning!



Driver's door only:

If within five seconds switch is again pulled past the resistance point and released, the automatic reversal will not operate.

Stopping windows

- ▶ Press or pull respective switch again.



Opening and closing the windows with the SmartKey

The sliding / pop-up roof* (▷ page 202) or panorama sliding / pop-up roof* (▷ page 208) will also be opened or closed when the power windows are operated with the SmartKey.

Warning!



Never operate the windows or sliding / pop-up roof or panorama sliding / pop-up roof* if there is the possibility of anyone being harmed by the opening or closing procedure.

In the event that the procedure causes potential danger, the procedure can be immediately halted by releasing the button on the SmartKey. To reverse direction of movement, press  for opening or  for closing.

- ▶ Aim transmitter eye at the front door handle.

Opening (Summer opening feature)

If the weather is warm, you can ventilate the vehicle before driving off by simultaneously:

- opening the sliding / pop-up roof
- opening the side windows
- switching on the seat ventilation

To do so, follow the instructions below:

- ▶ Press and hold button  after unlocking the vehicle.

The windows and sliding / pop-up roof or panorama sliding / pop-up roof* begin to open after approximately one second.

- ▶ Release the  button to stop procedure.

Controls in detail

Power windows

Closing (Convenience feature)

- ▶ Press and hold button  after locking the vehicle.

The windows and sliding / pop-up roof or panorama sliding / pop-up roof* begin to close after approximately one second.

- ▶ Release the  button to stop procedure.

Make sure all side windows and the sliding / pop-up roof or panorama sliding / pop-up roof* are properly closed before leaving the vehicle.

Controls in detail

Power windows

Closing the side windows with KEY-LESS-GO*

- ▶ Press and hold lock button at door (▷ page 54) until the side windows and the sliding / pop-up roof or panorama sliding/pop-up roof* are closed.

Warning!



When closing the windows and the sliding / pop-up roof*, be sure that there is no danger of anyone being harmed by the closing procedure.

If potential danger exists, proceed as follows:

- Release the lock button.
- Pull on the door handle and hold firmly. The side windows and the sliding / pop-up roof* will open for as long as the door handle is held but the door not opened.

Synchronizing power windows

The power window must be resynchronized each time

- after the battery has been disconnected.
- if the power windows cannot be fully opened (Express-open) or closed (Express-close).

Synchronizing the power windows

- ▶ Switch on ignition.
- ▶ Pull the power window switches until the side windows are closed.

Hold the switches for approximately one second.

The power windows are synchronized.

▼ Sliding/pop-up roof*

Opening and closing the sliding/pop-up roof

The sliding/pop-up roof can be opened and closed electrically. The switch for the sliding/pop-up roof is on the overhead control panel.



- ① Push back to slide roof open
- ② Push forward to slide roof closed
- ③ Push up to raise roof at rear
- ④ Pull down to lower roof at rear

With the roof closed or tilted open, a screen can be slid into the roof opening to guard against sun rays. When sliding the roof open, the screen will also retract.

Warning!



When closing the sliding/pop-up roof, make sure that there is no danger of anyone being harmed by the closing procedure.

The closing procedure of the sliding/pop-up roof can be immediately halted by releasing the switch or, if the switch was moved past the resistance point and released, by moving the switch in any direction.

When leaving the vehicle, always remove the SmartKey from starter switch, take the SmartKey with KEYLESS-GO* with you, and lock your vehicle. Do not leave children unattended in the vehicle, or with access to an unlocked vehicle. Unsupervised use of vehicle equipment can cause an accident and/or serious personal injury.

Controls in detail

Sliding/pop-up roof*





To avoid damaging the seals, do not transport any objects with sharp edges which can stick out of the sliding/pop-up roof.

Open the sliding/pop-up roof only if the roof is clear of snow or ice.

The sliding/pop-up roof can be opened or closed manually should an electrical malfunction occur (▷ page 358).



You can also open or close the sliding/pop-up roof using:

- SmartKey, (▷ page 202)
- Button  in the control panel of the climate control (▷ page 176) or automatic climate control (▷ page 186)
- Button  in the control panel of the automatic climate control (▷ page 186)

Controls in detail

Sliding/pop-up roof*

- ▶ Turn SmartKey in the starter switch to position **1** or **2** or press the KEYLESS-GO* start/stop button once or twice.

Opening and closing the sliding/pop-up roof

- ▶ To open, close, raise or lower the sliding/pop-up roof, move the switch to resistance point in the required direction ① to ④.

Release the switch when the roof has reached the desired position.

Fully opening (Express-open) and closing (Express-close) the sliding/pop-up roof

- ▶ To open, close, raise or lower the sliding/pop-up roof, move the switch past the resistance point in the required direction ① to ④ and release.

The sliding/pop up roof opens or closes completely.

Stopping the sliding/pop-up roof

- ▶ Move the switch in any direction.



If the movement of the sliding/pop-up roof is blocked during the closing procedure, the roof will stop and reopen slightly.

Opening and closing the sliding/pop-up roof with the SmartKey

The power windows (▷ page 199) will also be opened or closed when you operate the sliding/pop-up roof with the SmartKey.

Warning!



Never operate the windows or sliding/pop-up roof if there is the possibility of anyone being harmed by the opening or closing procedure.

In case the procedure causes potential danger, the procedure can be immediately halted by releasing the remote control button.

To reverse direction of movement press for opening or for closing.

- ▶ Aim transmitter eye at the front door handle.

Opening (Summer opening feature)

If the weather is warm, you can ventilate the vehicle before driving off by simultaneously:

- opening the sliding/pop-up roof
- opening the side windows
- switching on the seat ventilation*

To do so, follow the instructions below:

- ▶ Press and hold button  after unlocking the vehicle.

The windows and sliding/pop-up roof begin to open after approximately one second.

- ▶ Release transmit button to interrupt procedure.

Closing (Convenience feature)

- ▶ Press and hold button  after locking the vehicle.

The windows and sliding/pop-up roof begin to close after approximately one second.

- ▶ Release the  button to stop procedure.

Make sure all side windows and the sliding/pop-up roof are properly closed before leaving the vehicle.

Closing the sliding/pop-up roof with KEYLESS-GO*

The power windows (▷ page 200) will also be closed when you operate the sliding/pop-up roof with KEYLESS-GO.

- ▶ Press and hold lock button at door (▷ page 54) until the side windows and the sliding/pop-up roof are closed.

Controls in detail

Sliding/pop-up roof*

Warning!



When closing the windows and the sliding/pop-up roof, be sure that there is no danger of anyone being harmed by the closing procedure.

The sliding/pop-up roof will not automatically reopen if blocked during convenience closing.

If potential danger exists, proceed as follows:

- Release the lock button.
- Pull on the door handle and hold firmly. The side windows and the sliding/pop-up roof will open for as long as the door handle is held but the door not opened.

Controls in detail

Sliding/pop-up roof*

Synchronizing the sliding/pop-up roof

The sliding/pop-up roof must be resynchronized each time

- after the battery has been disconnected
- the sliding/pop-up roof has been closed manually (▷ page 358)
- the sliding/pop-up roof does not open smoothly
- a malfunction

Synchronizing

- ▶ Remove the fuse from the main fuse box (▷ page 385).
- ▶ Replace the fuse in the main fuse box.
- ▶ Switch on the ignition.
- ▶ Press and hold the switch in direction ③ until the sliding/pop-up roof is fully raised at the rear.

Hold the switch for approximately one second.

The sliding/pop-up roof is synchronized.

▼ Panorama sliding / pop-up roof*

Warning!



When opening or closing the panorama sliding / pop-up roof, make sure that there is no danger of anyone being harmed by the opening or closing procedure.

If the panorama sliding / pop-up roof is closed with the convenience closing feature and becomes blocked, it will not open automatically. Should this occur, press the  button on the SmartKey and hold it down; the panorama sliding / pop-up roof opens again.

The panorama roof is made out of glass. In the event of an accident, the glass may shatter. This may result in an opening in the roof.

In a vehicle rollover, occupants not wearing their seat belts or not wearing them properly may be thrown out of the opening. Such an opening also presents a potential for injury for occupants wearing their seat belts properly as entire body parts or portions of them may protrude from the passenger compartment.

Opening and closing the roller sunblinds

The roller sunblinds can only be opened or closed when the panorama sliding / pop-up roof is closed. The front and rear roller sunblind cannot be operated individually.



Panorama sliding / pop-up roof switch

- ① Open
- ② Close

Controls in detail

Panorama sliding / pop-up roof*

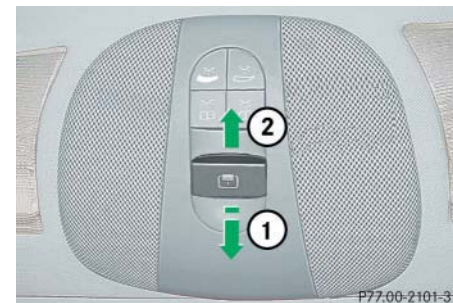

Roller sunblinds switch, rear

- ① Open
- ② Close

- ▶ Turn SmartKey in the starter switch to position **1** or **2** or press the KEYLESS-GO* start/stop button.

Opening and closing the roller sunblinds

- ▶ To open or close the roller sunblinds, move the panorama sliding / pop-up roof switch or the rear roller sunblind switch to resistance point in the required direction ① or ②. >>

Controls in detail

Panorama sliding/pop-up roof*

- ▷▷ Release the switch when the roller sunblinds have reached the desired position.

Warning!



When closing the roller sunblinds, make sure that no one is in danger of being injured by the closing procedure. The closing of the roller sunblinds can be immediately halted by releasing the switch.

Fully opening the roller sunblinds (Express-open)

- ▶ Move the panorama sliding/pop-up roof switch or the rear roller sunblind switch past the resistance point in direction ① and release.

The roller sunblinds opens completely.

Stopping the roller sunblinds

- ▶ Move the switch in any direction.

Opening and closing the panorama sliding/pop-up roof

The panorama sliding/pop-up roof can be opened and closed electrically. The switch for the panorama sliding/pop-up roof is on the overhead control panel.

The panorama sliding/pop-up roof only operates with the sunblinds opened.



- ① Push back to slide roof open
- ② Push forward to slide roof closed
- ③ Push up to raise roof
- ④ Pull down to lower roof

Warning!



When opening or closing the panorama sliding/pop-up roof, make sure that there is no danger of anyone being harmed by the opening or closing procedure.

The opening procedure of the panorama sliding/pop-up roof can be immediately halted by releasing the switch or, if the switch was moved past the resistance point and released, by moving the switch in any direction.

The closing procedure of the panorama sliding/pop-up roof can be immediately halted by releasing the switch.

When leaving the vehicle, always remove the SmartKey from starter switch, take the SmartKey with KEYLESS-GO* with you, and lock your vehicle. Do not leave children unattended in the vehicle, or with access to an unlocked vehicle. Unsupervised use of vehicle equipment can cause an accident and/or serious personal injury.





Do not transport any objects that protrude out of the panorama sliding / pop-up roof as the seals could be damaged.

Do not open the panorama sliding / pop-up roof if there is snow or ice on the roof, as this could result in malfunctions.

The panorama sliding / pop-up roof can be opened or closed manually should an electrical malfunction occur (▷ page 358).



You can also open or close the panorama sliding / pop-up roof using the:

- SmartKey (summer opening / convenience future) (▷ page 199)
 - button  in the control panel of the automatic climate control (▷ page 186)
 - button  in the control panel of the automatic climate control (▷ page 192)
- ▶ Turn SmartKey in the starter switch to position **1** or **2** or press the KEYLESS-GO* start / stop button once or twice.

Controls in detail

Panorama sliding / pop-up roof*

Opening and closing the panorama sliding / pop-up roof

- ▶ To open or close the panorama sliding / pop-up roof, move the switch to resistance point in the required direction ① to ④.

Release the switch when the roof has reached the desired position.

Fully opening the panorama sliding / pop-up roof (Express-open)

- ▶ Move the switch past the resistance point in direction ① and release.

The panorama sliding / pop-up roof opens completely.



The panorama sliding / pop-up roof cannot be closed fully (Express-close)

Stopping the panorama sliding / pop-up roof

- ▶ Move the switch in any direction.

Controls in detail

Panorama sliding / pop-up roof*



Opening and closing panorama sliding / pop-up roof with the SmartKey

The power windows (▷ page 197) will also be opened or closed when the panorama sliding / pop-up roof is operated with the SmartKey.

Warning!



Never operate the windows or panorama sliding / pop-up roof if there is the possibility of anyone being harmed by the opening or closing procedure.

In case the procedure causes potential danger, the procedure can be immediately halted by releasing the remote control button. To reverse direction of movement press  for opening or  for closing.

- ▶ Aim transmitter eye at the driver's door handle.

Opening (Summer opening feature)

If the weather is warm, you can ventilate the vehicle before driving off by simultaneously:

- opening the sliding / pop-up roof
- opening the side windows
- switching on the seat ventilation*

If roller sunblinds are closed:

- ▶ Press and hold button  after unlocking the vehicle.

The windows and roller sunblinds begin to open after approximately one second.

- ▶ Press and hold button  again.

The panorama sliding / pop-up roof tilts and opens.

If roller sunblinds are already open:

- ▶ Press and hold button  after unlocking the vehicle.
The windows move down and the panorama sliding / pop-up roof tilts and opens after approximately one second.
- ▶ Release transmit button to stop procedure.

Closing (Convenience feature)

- ▶ Press and hold button  after locking the vehicle.

The windows and panorama sliding / pop-up roof begin to close after approximately one second.

- ▶ Release the  button to stop procedure.

Make sure all side windows and the panorama sliding / pop-up roof are properly closed before leaving the vehicle.

Closing the panorama sliding / pop-up roof with KEYLESS-GO*

The power windows (▷ page 197) will also be closed when the panorama sliding / pop-up roof is operated with KEYLESS-GO.

- ▶ Press and hold lock button at driver's door (▷ page 54) until the side windows and the panorama sliding / pop-up roof are closed.

Warning!



When closing the windows and the panorama sliding / pop-up roof, be sure that there is no danger of anyone being harmed by the closing procedure.

If potential danger exists, proceed as follows:

- Release the lock button.
- Pull on the door handle and hold firmly. The side windows and the panorama sliding / pop-up roof will open for as long as the door handle is held but the door is not opened.

Controls in detail

Panorama sliding / pop-up roof*

Synchronizing the panorama sliding / pop-up roof

It is necessary to resynchronize the panorama sliding / pop-up roof after

- voltage supply interruption due to a disconnected or discharged battery
 - the roof has been closed manually
 - the roof has been opened with an abrupt movement
 - a malfunction.
- ▶ Remove the fuse from the main fuse box (▷ page 385).
 - ▶ Replace the fuse in the main fuse box.
 - ▶ Switch on ignition.
 - ▶ Press the switch in direction ② (▷ page 206).



Controls in detail

Panorama sliding / pop-up roof*

- ▷▷▶ Wait until the roller sunblinds are closed and then keep the switch pressed for approximately one second.
- ▶ Move the switch in direction ① (▷ page 206).
- ▶ Wait until the roller sunblinds are opened.
- ▶ Move the switch in direction ③ (▷ page 206).
- ▶ Wait until the panorama sliding / pop-up roof is raised and then keep the switch pressed for approximately one second.

- ▶ Move the switch in direction ② (▷ page 206).
- ▶ Wait until the panorama sliding / pop-up roof is closed and then keep the switch pressed for approximately one second.

The panorama sliding / pop up roof is synchronized.

The synchronization must be repeated if the panorama sliding / pop-up roof cannot be fully opened (Express-open).

Solar panel*

A solar panel is available in combination with the panorama sliding / pop-up roof. The solar cells convert natural light into electrical energy. When the engine is switched off, the energy generated automatically switches on the ventilation fan. The constant air flow creates a cooler temperature for cars parked in the sunlight.

The air flow depends on the intensity of the solar radiation. The ventilation starts two minutes after switching off the engine.

▼ Driving systems

The following driving systems are explained on the following pages:

- Cruise control and Distronic*, with which the vehicle can maintain a preset speed
- Airmatic* adjusts the vehicle suspension characteristics automatically and controls the vehicle level
- Parktronic system*, which assists the driver during parking maneuvers

The BAS, ABS, ESP and SBC are described in the “Safety and Security” section (▷ page 74).

Cruise control

The cruise control automatically maintains the speed you set for your vehicle.

Use of cruise control is recommended for driving at a constant speed for extended periods of time. You can set any speed over 20 mph (30 km/h).

The cruise control function is operated by means of the cruise control lever.

The cruise control lever is the uppermost lever found on the left-hand side of the steering column (▷ page 20).

Controls in detail

Driving systems

Warning!



Cruise control is a convenience system designed to assist the driver during vehicle operation. The driver is and must always remain responsible for the vehicle speed and for safe brake operation.

Only use cruise control if the road, traffic and weather conditions make it advisable to travel at a steady speed.

- The use of cruise control can be dangerous on winding roads or in heavy traffic because conditions do not allow safe driving at a steady speed.
- The use of cruise control can be dangerous on slippery roads. Rapid changes in tire traction can result in wheel spin and loss of control.
- Deactivate cruise control when driving in fog.

The “Resume” function should only be operated if the driver is fully aware of the previously set speed and wishes to resume this particular preset speed.

Controls in detail

Driving systems

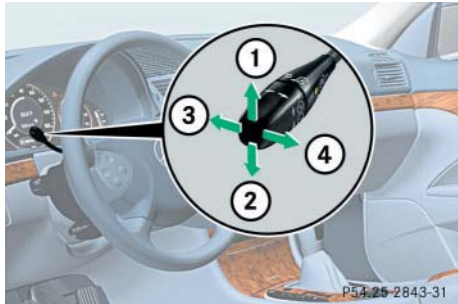

- ① Set current or higher speed
- ② Set current or lower speed
- ③ Cancel cruise control
- ④ Resume at previously set speed

Saving current speed

- ▶ Accelerate or decelerate to the desired speed.
- ▶ Briefly lift ① or depress ② the cruise control lever.

The current speed is set.

- ▶ Remove your foot from the accelerator pedal.

Cruise control is activated.



On uphill or downhill grades, cruise control may not be able to maintain the set speed. Once the grade eases, the set speed will be resumed.

Canceling cruise control

There are several ways to cancel cruise control:

- ▶ Step on the brake pedal.
- or
- ▶ Briefly push the cruise control lever to position ③.

Cruise control will be canceled. The last speed set will be stored for later use.



Moving gear selector lever to position **N** while driving also cancels cruise control. However, the gear selector lever should not be moved to position **N** while driving except to coast when the vehicle is in danger of skidding (e.g. on icy roads).



The last stored speed is canceled when you turn off the engine.

Setting stored speed (“Resume” function)

Warning!



The speed stored in memory should only be set again if prevailing road conditions permit. Possible acceleration or deceleration differences arising from returning to preset speed could cause an accident and/or serious injury to you and others.

- ▶ Briefly push the cruise control lever to position ④.
The cruise control will resume the last previously set speed.
- ▶ Remove your foot from the accelerator pedal.

Setting a higher speed

- ▶ Lift the cruise control lever to position ① and hold it up until the desired speed is reached.
- ▶ Release the cruise control lever.
The new speed is set.



Depressing the accelerator pedal does not deactivate cruise control. After brief acceleration (e.g. for passing), cruise control will resume the last speed set.

Setting a lower speed

- ▶ Depress the cruise control lever to position ② and hold it down until the desired speed is reached.
- ▶ Release the cruise control lever.
The new speed is set.

Controls in detail

Driving systems



When you use the cruise control lever to decelerate, the transmission will automatically downshift if the engine's braking power does not brake the vehicle sufficiently.

Fine adjustment in 1 mph (Canada: 1 km/h) increments

Faster

- ▶ Briefly tip the cruise control lever in the direction of arrow ①.

Slower

- ▶ Briefly tip the cruise control lever in the direction of arrow ②.

Controls in detail

Driving systems

Distronic*

When activated, the DISTRONIC adaptive cruise control system increases driving convenience afforded by the cruise control during travel on expressways and other major roads.

- If the DISTRONIC distance sensor detects a slower moving vehicle directly ahead, your vehicle speed will be reduced so that you follow that vehicle at a preset distance.
- If there is no vehicle directly ahead of you, DISTRONIC will function in the same way as cruise control (> page 218).

Warning!



DISTRONIC adaptive cruise control is no substitute for active driving involvement. It does not react to stationary objects, nor recognize or predict the curvature and lane layout or the movement of vehicles ahead. DISTRONIC can only apply a maximum of 20% of the vehicle's braking power.

It is the driver's responsibility at all times to be attentive to traffic and road conditions and to provide the steering, braking and other driving inputs necessary to retain control of the vehicle.

Warning!



DISTRONIC is a convenience system. Its speed adjustment reduction capability is intended to make cruise control more effective and usable when traffic speeds vary. However, it is not intended to, nor does it, replace the need for extreme care. The responsibility for the vehicle speed and the distance to the vehicle ahead, including most importantly brake operation to assure safe stopping distance, always rests with the driver.

DISTRONIC cannot take street and traffic conditions into account.

Warning!



DISTRONIC requires familiarity with its operational characteristics. We strongly recommend that you review the following information carefully before operating the system.

i

For operation in the USA only: This device complies with Part 15 of the FCC Rules. Operation is subject to the following two conditions:

- this device may not cause harmful interference, and
- this device must accept any interference received, including interference that may cause undesired operation.

Any unauthorized modification to this device could void the user's authority to operate the equipment.

Controls in detail

Driving systems

Warning!



Distronic cannot take street and traffic conditions into account. Only use Distronic if the road, weather and traffic conditions make it advisable to travel at a steady speed.

Warning!



Use of Distronic can be dangerous on slippery roads. Rapid changes in tire traction can result in wheel spin and loss of control. Distronic does not act upon adverse sight distance conditions. Do not use Distronic during conditions of fog and heavy rain, snow or sleet.

Warning!



Close attention to road and traffic conditions is imperative at all times, regardless of whether or not Distronic is activated.

Use of Distronic can be dangerous on winding roads or in heavy traffic because conditions do not allow safe driving at a steady speed.

Distronic will not react to stationary objects in the roadway (e.g. a stopped vehicle in a traffic jam or a disabled vehicle). Distronic will also not respond to oncoming vehicles.

Switch off Distronic:

- when changing from the left to the right lane if vehicles are moving more slowly in the left lane
- when entering a turn lane or highway off ramp
- in complex driving situations, such as in highway construction zones

In these situations, Distronic will continue to maintain the set speed unless deactivated.

Distronic is designed and intended only to maintain a set speed and keep a set distance from moving objects in front of it.

Warning!



The “Resume” function should only be operated if the driver is fully aware of the previously set speed and wishes to resume this particular preset speed.

Controls in detail

Driving systems

Distronic displays in the speedometer dial



① Set speed

If DISTRONIC is activated, one or two segments come on around the set speed.



The vehicle speed displayed on the speedometer can briefly vary from the speed setting on the DISTRONIC system.



① Segments

If DISTRONIC detects a vehicle directly ahead, the segments from the speed of the vehicle ahead to the set speed come on.

If DISTRONIC calculates that there is a danger of collision:

- The DTR warning lamp  in the instrument cluster comes on red.
 - An intermittent warning sounds.
- Immediately brake the vehicle to avoid a collision.

Under no circumstances should the driver await the intermittent warning sound before braking. See the following warning note.

The intermittent warning sound ceases and the red DTR warning lamp  goes out when the necessary distance to the vehicle ahead is again established.

Warning!



An intermittent warning sounds and the DTR warning lamp in the instrument cluster is illuminated if the Distronic system calculates that the distance to the vehicle ahead and your vehicle's current speed indicate that Distronic will not be capable of slowing the vehicle sufficiently to maintain the preset following distance, which creates a danger of a collision.

Immediately brake the vehicle to increase the distance to the vehicle in front of you. The warning sound is intended as a final caution that you have not interceded with your own braking inputs to avoid a potentially dangerous situation. Do not wait for the operation of the warning signal to intercede with your own braking, as that will result in potentially dangerous emergency braking which will not always result in an impact being avoided.

Tailgating increases the risk of an accident.

Warning!



Distronic brakes your vehicle with a maximum deceleration of 6.5 ft/s^2 (2 m/s^2). This corresponds to about 20% of the maximum deceleration ability of your vehicle.



Distronic brakes the vehicle in an effort to restore the preset distance or to maintain the speed. The brake pedal is automatically applied as this happens which results in the brake pedal moving.

Keep driver's foot area clear at all times, including the area under the brake pedal. Objects stored in this area may impair pedal movement which could interfere with the braking ability of the Distronic system.

Do not place your foot under the brake pedal – your foot could become caught.

Distronic menu in the control system

In the Distronic menu you can read the current settings for Distronic. What appears in the display depends on whether Distronic and the distance warning function are turned on or off.

- ▶ Press button  or  repeatedly until you see one of the following displays.

Controls in detail

Driving systems

Distronic deactivated

If DISTRONIC is deactivated you can see the standard display of DISTRONIC in the multifunction display.

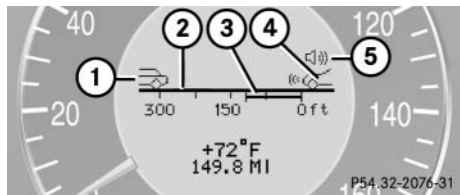

- ① Vehicle ahead, if detected
- ② Actual distance to vehicle ahead
- ③ Preset distance threshold to vehicle ahead
- ④ Your vehicle
- ⑤ Symbol for activated distance warning function

Distronic activated

If you turn DISTRONIC on, you will see the set speed in the multifunction display for about five seconds. If DISTRONIC is activated, you can see the following display in the multifunction display.

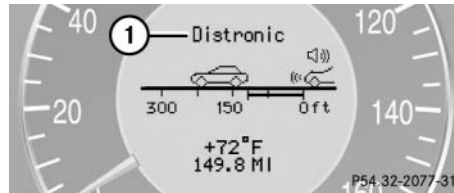

- ① DISTRONIC activated

Cruise control lever

The DISTRONIC system is operated by means of the cruise control lever.

The cruise control lever is the uppermost lever found on the left-hand side of the steering column.

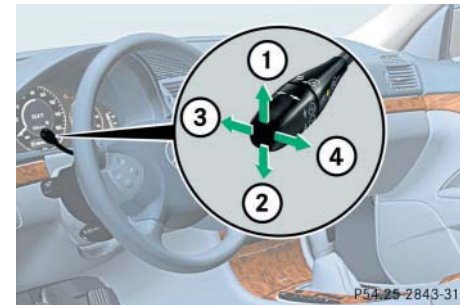

- ① Set current or higher speed
- ② Set current or lower speed
- ③ Deactivate DISTRONIC
- ④ Resume at previously set speed

Activating Distronic

You can activate Distronic if:

- you are driving between 25 mph (40 km/h) and 110 mph (180 km/h)
- the ESP is activated (> page 76)

If Distronic has not been activated after pressing the cruise control lever you will see the message --- in the multifunction display.

In the following cases you cannot activate Distronic:

- Up to two minutes after starting the engine
- When you brake
- If you have set the parking brake
- If the gear selector lever is in position **P**, **R** or **N**
- If the ESP is switched off

Setting the current speed

- ▶ Accelerate or decelerate to the desired speed.
- ▶ Briefly lift or depress the cruise control lever.

Distronic is activated and the current speed is set.

- ▶ Remove your foot from the accelerator pedal.



If you do not take your foot off of the accelerator completely, the following message will appear in the multifunction display:

Distronic override. The distance to a slower moving vehicles in front of you will not be set. Your vehicle speed will then be determined only by the accelerator pedal position.

Setting a higher speed

- ▶ Briefly tip the cruise control lever in the direction of arrow ① (> page 218) to increase vehicle speed in increments of 5 mph (Canada: 10 km/h).

The new speed is set.

The stored speed is displayed in the multifunction display for approximately five seconds (> page 218), and one or two segments around the stored speed come on on the speedometer (> page 216).



Depressing the accelerator pedal does not deactivate Distronic. After brief acceleration (e.g. for passing), cruise control will resume the last speed set.

Controls in detail

Driving systems

Setting a lower speed

- ▶ Briefly tip the cruise control lever in the direction of arrow ② (▷ page 218) to decrease vehicle speed in increments of 5 mph (Canada: 10 km/h).

The new speed is set.

The stored speed is displayed in the multifunction display for approximately five seconds (▷ page 218), and one or two segments around the stored speed come on on the speedometer (▷ page 216).



When you use the cruise control lever to decelerate, the transmission will automatically downshift if the rate of deceleration is too low.

Fine adjustment in 1 mph (Canada: 1 km/h) increments

Faster

- ▶ Briefly tip the cruise control lever in the direction of arrow ④ (▷ page 218).

Setting stored speed ("Resume" function)

Warning!



The speed stored in memory should only be set again if prevailing road conditions permit. Possible acceleration or deceleration differences arising from returning to preset speed could cause an accident and/or serious injury to you and others.

- ▶ Briefly tip the cruise control lever in the direction of arrow ④ (▷ page 218).
DISTRONIC is activated and set to the last stored speed.
- ▶ Remove your foot from the accelerator pedal.

Deactivating Distronic

There are several ways to deactivate the Distronic system:

- ▶ Briefly tip the cruise control lever in the direction of arrow ③ (▷ page 218).
- or
- ▶ Step on the brake pedal.

Distronic will be deactivated. The last speed set will be stored in memory.



The following message will appear in the multifunction display for approximately five seconds: *Distronic off*.

The last stored speed is deleted when you turn off the engine.

Distronic deactivates automatically when:

- you set the parking brake
- you drive slower than 25 mph (40 km/h)
- the ESP is active (▷ page 76) or you deactivate the ESP
- you move the transmission selector lever into position **N**

A signal will sound. The *Distronic off* message appears in the multifunction display for approximately five seconds.

Warning!



Distronic switches off and releases the brakes when the vehicle decelerates below the minimum speed of approximately 25 mph (40 km/h) by operation of the system. At that time the driver must apply the brakes in order to reduce vehicle speed further or bring it to a stop.

Setting the following distance in Distronic

You can set the specified following distance for Distronic by varying the time setting between 1.0 and 2.0 seconds. Using this time setting and the current speed of your vehicle, Distronic calculates and sets the required following distance to the vehicle ahead. The set distance will be shown in the multifunction display field.

The thumbwheel for making the time setting is located on the lower section of the center console.

Warning!



It is up to the driver to exercise discretion to select the appropriate setting given road conditions, traffic, driver's preferred driving style and applicable laws and driving recommendations for safe following distance.

Controls in detail

Driving systems

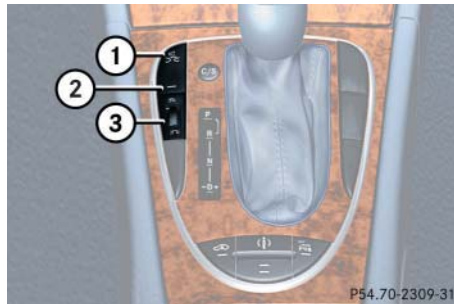

- ① Distance warning function on / off switch
- ② Control lamp
- ③ Thumbwheel for setting distance

Increasing distance

Increasing the distance setting tells Distronic to maintain a greater following distance to the vehicle ahead.

- ▶ Turn thumbwheel ③ towards .

Decreasing distance

Decreasing the distance setting tells Distronic to maintain a shorter following distance to the vehicle ahead.

- ▶ Turn thumbwheel ③ towards .

Distance warning function

When Distronic is deactivated, this function will continue to warn you when recognizing a stationary obstacle or a slower vehicle moving in the vehicle's path and the danger of a collision exists:

- The distance warning lamp  in the instrument cluster comes on.
- An intermittent warning sounds.

If these warnings are issued, you must brake manually to maintain a safe distance and avoid a collision with the vehicle ahead.

When pressing the brake pedal, the warning sound stops. The warning sound also stops when the distance to the vehicle

ahead is sufficient again without applying the brake pedal. In this case the distance warning lamp also extinguishes.

Warning!



If the DTR warning lamp  in the instrument cluster comes on while driving and / or an intermittent warning sounds, immediate attention on the part of the driver is required.

As required by the traffic situation, apply the brakes and navigate around a possible obstacle. However, do not drive by relying on the distance warning function, as this will result in an emergency braking application. Especially depending on road surface conditions and driver reaction, this will not always enable you to avoid a collision.

i

Complex driving situations are not always fully recognized by Distronic. This could result in wrong or missing distance warnings.

Activating

- ▶ Press button ①.

Indicator lamp ② on the button comes on. A loudspeaker symbol appears in the multifunction display (▶ page 218).

Deactivating

- ▶ Press button ①.

Indicator lamp ② on the button goes out. No loudspeaker symbol appears in the multifunction display.

Driving with Distronic

This section describes a number of driving situations where special precaution is required on the part of the driver. Be prepared to brake in such situations. This will deactivate the Distronic system.

Warning!



Distronic works to maintain the speed selected by the driver unless a moving obstacle proceeding directly ahead of it in the same travel direction is detected (e.g. following another vehicle ahead of you at a distance set by Distronic). This means that:

- Your vehicle can pass another vehicle after you change lanes
- While in a sharp turn or if the vehicle in front is in a sharp turn, Distronic could lose sight of a vehicle traveling in front of it, then your vehicle could accelerate to the previously selected speed.

Controls in detail

Driving systems

Distronic regulates only the distance between your vehicle and those directly ahead of it, but does not register stationary objects in the road, e.g.:

- A stopped vehicle in a traffic jam
- A disabled vehicle
- An oncoming vehicle

The driver must always be on the alert, observe all traffic and intercede as required by steering or braking the vehicle.

Warning!



Distronic should not be used in snowy or icy road conditions.

Controls in detail

Driving systems

The most likely cause for a malfunctioning system is a dirty sensor (located behind the hood grille), especially at times of snow and ice or heavy rain. In such a case, Distronic will switch off, and the message *Currently unavailable* see oper. manual appears in the multifunction display.

For cleaning and care of the Distronic sensor, see "Cleaning the Distronic system sensor" (▷ page 305).



If the message "Distronic - clean sensor!" See oper. manual disappears during driving and the last speed stored flashes for approximately five seconds, the dirt (e.g. slush) has dissolved; Distronic works again.

Turns and bends

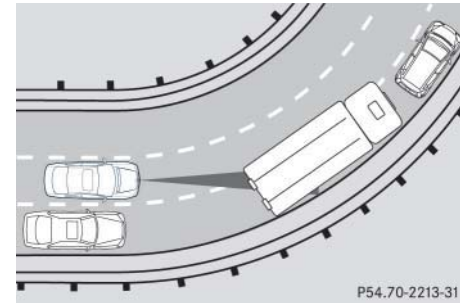

In turns or bends, Distronic may not detect a moving vehicle in front, or it may detect one too soon. This may cause your vehicle to brake late or unexpectedly.

Offset driving

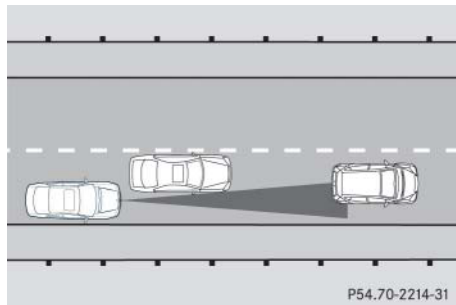

A vehicle traveling in your lane but offset from your direct line of travel may not be detected by Distronic. There will be insufficient distance to the vehicle ahead.

Lane changing

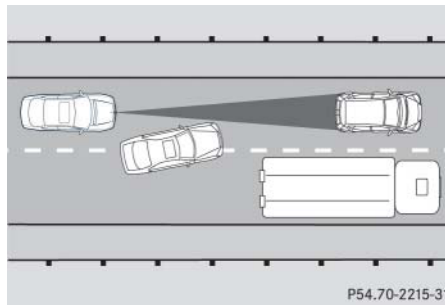

Distronic has not yet detected the vehicle changing lanes. There will be insufficient distance to the lane-changing vehicle.

Narrow vehicles

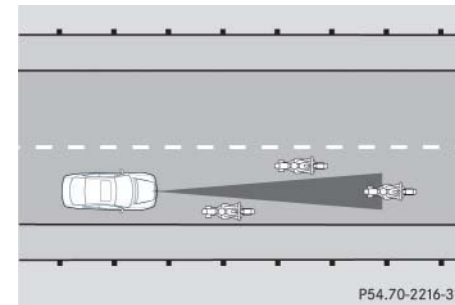

Because of its narrow profile, the vehicle traveling near the edge of the roadway has not yet been detected by Distronic. There will be insufficient distance to the vehicle ahead.

Controls in detail

Driving systems

Airmatic DC (Dual Control)*

Airmatic automatically selects the optimum suspension tuning and ride height for your vehicle. The Airmatic consists of two components:

- Adaptive Damping System (ADS)
- Vehicle level control

The ADS automatically selects the optimum damping for the respective driving conditions. At the same time the suspension is set to either sporty or comfort.

Suspension tuning

The suspension tuning is set according to:

- Your driving style
- Road surface conditions
- Your choice of suspension style, “sporty I”, “sporty II” or “comfortable”, which you select using the damping button.

The following suspension styles are available:

- Comfortable
Both indicator lamps ② are off.
- Sporty I
One indicator lamp ② is on.
- Sporty II
Both indicator lamps ② are on.

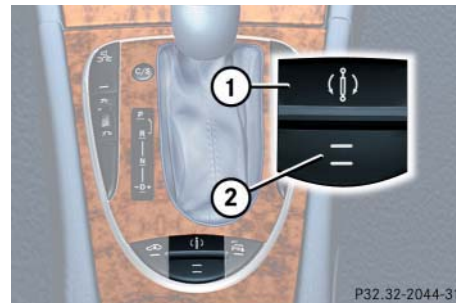

- ① Damping button
- ② Indicator lamps

- ▶ Start the engine.
- ▶ Press the damping button ① until the desired suspension style is set.



The selected suspension style is stored in memory, even after the SmartKey is removed from the starter switch.



In the sporty suspension style the vehicle is lowered up to 0.6 in (15 mm).

Vehicle level control

Your vehicle automatically adjusts its ride height to

- reduce fuel consumption
- increase vehicle safety

The following vehicle chassis ride heights can be selected:

- Normal
- Raised

The vehicle chassis ride height is raised or lowered according to the selected level setting and to the vehicle speed:

- At a speed above approximately above 68 mph (110 km / h) and the sporty suspension style selected (▷ page 226), ride height is reduced automatically by up to approximately 0.6 in (15 mm).
- With decreasing speed, the ride height is again raised to the “Normal” level.



These height adjustments are so small that you may not notice any change.

Select the “Raised” level only when required by current driving conditions. Otherwise

- fuel consumption may increase
- handling may be impaired

Warning!



To help avoid personal injury, keep hands and feet away from wheel housing area, and stay away from under the vehicle when lowering the vehicle chassis.

Controls in detail

Driving systems

The following vehicle level settings can be selected when the vehicle is stationary and the engine is running:

Vehicle level when stationary	Use for	Ride height increase over normal	Automatic lowering	Indicator lamp (▷ page 228)
Normal	Normal operation	None	Max. approx. 0.6 in (15 mm)	Lamp off
Raised	Driving with snow chains or very rough road surface conditions	Approximately 0.8 in (20 mm)	Max. approx. 1.4 in (35 mm)	Lamp on

The button is located in the lower section of the center console.

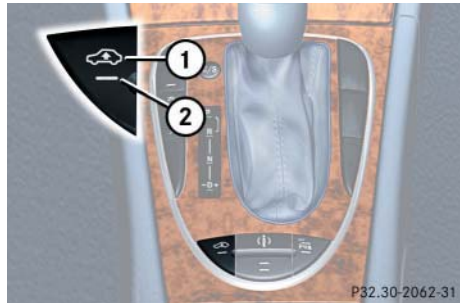

- ① Vehicle level control button
- ② Indicator lamp

- ▶ Briefly press button ① to change from “Normal” level to “Raised” level. When vehicle is at “Raised” level, pressing the switch will return the vehicle to “Normal” level.



At a speed of approximately above 75 mph (120 km/h) or if the speed amounts to between 50 mph (80 km/h) and 75 mph (120 km/h)

for approximately five minutes, the setting “Raised” is canceled. The message `Level selec. canceled` appears in the multifunction display.

If you do not drive in this speed range, the “Raised” level remains stored even if the SmartKey is removed from the starter switch.

Parktronic system* (Parking assist)

Warning!



The Parktronic system is a supplemental system. It is not intended to, nor does it replace, the need for extreme care. The responsibility during parking and other critical maneuvers always rests with the driver.

Special attention must be paid to objects with smooth surfaces or low silhouettes (e.g. trailer couplings, painted posts, or road curbs). Such objects may not be detected by the system and can damage the vehicle.

The operational function of the Parktronic system can be affected by dirty sensors, especially at times of snow and ice. See "Cleaning the Parktronic system sensors" (▷ page 305).

Interference caused by other ultrasonic signals (e.g. working jackhammers or the air brakes of trucks) can cause the system to send erratic indications, and should be taken into consideration.

Warning!



Make sure that no persons or animals are in the area in which you are maneuvering. You could otherwise injure them.

The Parktronic system is an electronic aid designed to assist the driver during parking maneuvers. It visually and audibly indicates the relative distance between the vehicle and an obstacle.

The Parktronic system is automatically activated when you switch on the ignition and release the parking brake. The Parktronic system deactivates at speeds over 11 mph (18 km/h). At lower speeds the Parktronic system turns on again.

Controls in detail

Driving systems

The Parktronic system monitors the surroundings of your vehicle with six sensors in the front bumper and four sensors in the rear bumper.

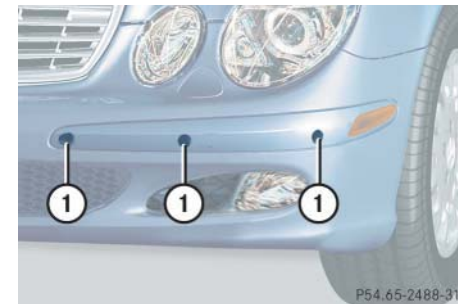

① Sensors in the front bumper

Controls in detail

Driving systems

Range of the sensors

To function properly, the sensors must be free of dirt, ice, snow and slush. Clean the sensors regularly, being careful not to scratch or damage the sensors.

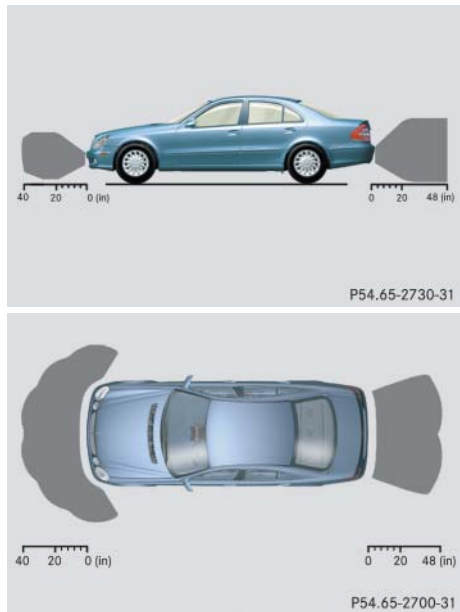

Front sensors

Center	approx. 40 in (100 cm)
Corners	approx. 48 in (120 cm)

Rear sensors

Center	approx. 48 in (120 cm)
Corners	approx. 32 in (80 cm)



During parking maneuvers, pay special attention to objects located above or below the height of the sensors (e.g. planters or trailer hitches). The Parktronic system will not detect such objects at close range and damage to your vehicle or the object may result.

Ultrasonic signals from outside sources (e.g. truck air brakes or jackhammers) may impair the operation of the Parktronic system.

Minimum distance

Center	approx. 8 in (20 cm)
Corners	approx. 6 in (15 cm)

If the system detects an obstacle in this range, all the warning lamps come on and you hear a warning signal. If the obstacle is closer than the minimum distance, the actual distance might no longer be indicated by the system.

Warning indicators

Visual signals indicate to the driver the relative distance between the sensors and an obstacle. The warning indicator for the front area is located above the center air vents in the dashboard. The warning indicator for the rear area is integrated in the rear trim.

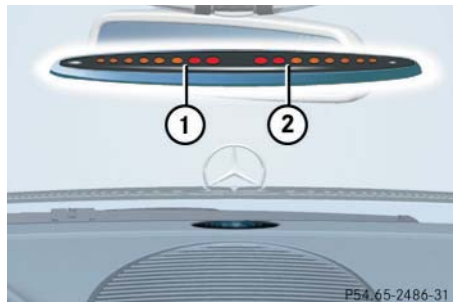

Front area warning indicator

- ① Left side of the vehicle
- ② Right side of the vehicle

Each warning indicator is divided into six yellow and two red segments for either side of the vehicle. The Parktronic system is ready when the border around the indicator is illuminated.

The position of the gear selector lever determines which warning indicators will be activated.

Selector lever position	Warning indicator
D	Front area activated
R or N	Front and rear area activated
P	Neither activated

As your vehicle approaches an object, one or more segments will come on, depending on the distance. When the eighth segment comes on, you have reached the minimum distance.

- **Front area:** An intermittent acoustic warning will sound as the first red segment comes on and a constant acoustic warning lasting a maximum of three seconds will sound for the second red segment. The signal is canceled when the selector lever is placed in position **P** and the parking brake is activated.
- **Rear area:** An intermittent acoustic warning will sound as the first red segment comes on and a constant acoustic warning lasting a maximum of three seconds will sound for the second red segment. The signal is canceled when the selector lever is placed in position **D** or **P** and the parking brake is activated.

Controls in detail

Driving systems

Switching the Parktronic system on/off

You can switch off the Parktronic system manually.

The Parktronic system switch is located in the lower section of the center console.

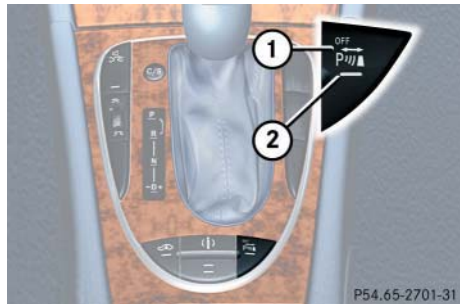

- ① Parktronic system on/off
- ② Indicator lamp

Switching off the Parktronic system

- ▶ Press button ①.
- Indicator lamp ② comes on.

Switching on the Parktronic system

- ▶ Press button ① again.
- Indicator lamp ② goes out.

Parktronic system malfunction

There is a malfunction in the Parktronic system if the red segments of the Parktronic system warning indicator come on and a warning sounds. The Parktronic system will switch itself off after 30 seconds and the indicator lamp on the Parktronic system switch comes on.

- ▶ Have the Parktronic system checked by an authorized Mercedes-Benz Center as soon as possible.

If only the red segments of the Parktronic system warning indicator come on and no warning sounds, then the sensors of the Parktronic system are dirty or malfunctioning. Malfunction may also be caused by interference from other radio or ultrasonic signals. The Parktronic system will switch itself off after 20 seconds.

- ▶ Clean Parktronic system sensors (▷ page 305).
- ▶ Switch on the ignition.
or
- ▶ Check Parktronic system operation at another location to rule out interference from outside radio or ultrasonic signals.

▼ Loading

Roof rack*

Warning!



Use only roof racks approved by Mercedes-Benz for your vehicle model to avoid damage to the vehicle. Follow manufacturer's installation instructions.

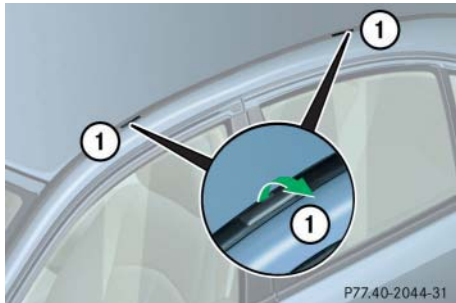

① Trim

Preparing roof rack installation

- ▶ Open trim ① at the trim strips in the roof.
- ▶ Secure the roof rack according to manufacturer's instructions for installation.



Load the roof rack in such a way that the vehicle cannot be damaged while driving.

Make sure

- you can fully raise the sliding / pop-up roof* or panorama sliding / pop-up roof*
- you can fully open the trunk

Controls in detail

Loading

Ski sack*

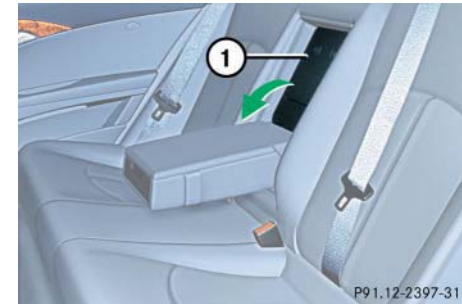

Unfolding and loading

- ▶ Fold armrest down (arrow).
- ▶ Swing cover ① down.



Controls in detail

Loading



- ▶ Open hook and loop strap ①.
- ▶ Pull ski sack into passenger compartment and unfold.



- ▶ From trunk, slide skis into ski sack.

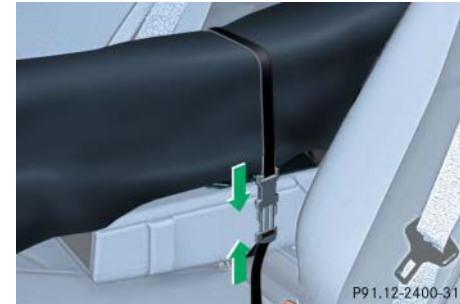

- ▶ Wrap strap around ski sack and armrest.
- ▶ Close clasp (arrows) and pull strap tight to firmly secure skis.

Warning!



The ski sack is designed for up to four pairs of skis. Do not load the ski sack with other objects.

Always fasten the ski sack securely. In an accident, an unfastened ski sack can cause injury to vehicle occupants.

Controls in detail

Loading

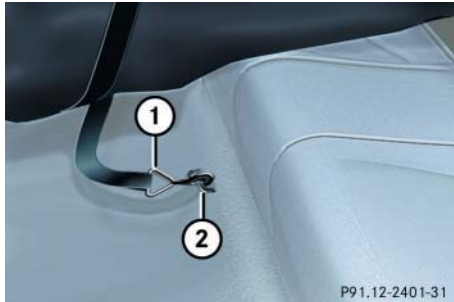

- ▶ Connect snap hook ① of front strap to eye ② located on center tunnel in front of rear seat bench.

Unloading and folding



- ▶ Loosen strap, open clasp by pressing tabs together (arrows).
- ▶ Unload skis.
- ▶ Close flap in trunk.
- ▶ Fold and flatten ski sack lengthwise and place folded ski sack inside recess of backrest.



- ▶ Close ski sack compartment cover.

Controls in detail

Loading

Removal of ski sack

For removal of the ski sack we recommend that you contact an authorized Mercedes-Benz Center.

Warning!



Never drive vehicle with trunk open while the ski sack is removed. Deadly carbon monoxide (CO) gases may enter vehicle interior, resulting in unconsciousness and death.



To prevent unauthorized persons from access to the trunk, always close the cover.

Split rear bench seat*

To expand the trunk, you can fold down the left and right rear seat backrests.

The two sections can be folded down separately to enlarge the trunk.

Warning!



When expanding the luggage compartment, always fold the seat cushions fully forward.

Unless you are transporting cargo, the backrests must remain properly locked in the upright position.

In an accident, during hard braking or sudden maneuvers, loose items will be thrown around inside the vehicle, and cause injury to vehicle occupants unless the items are securely fastened in the vehicle.

Always use the cargo tie down rings (▷ page 241).

Folding the backrest forward



You must always release the seat cushion and fold it up before folding the seat backrests forward. The upholstery on the seat backrest may otherwise be damaged.

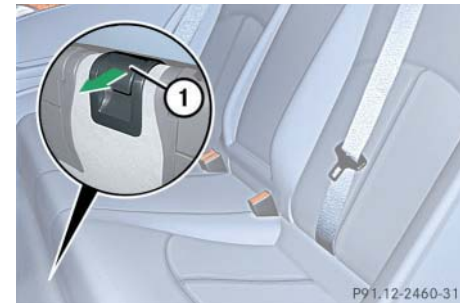

① Release handle

Controls in detail

Loading



If tall persons have occupied the driver's and front passenger seats, it may be necessary to move these seats forward slightly in order to fold the rear seat backrests forward.

- ▶ Pull release handle ①.

The seat cushion automatically springs upward slightly.

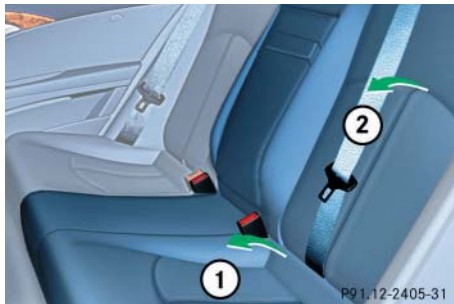

- ① Seat cushion
- ② Seat backrest

- ▶ Grip the back of seat cushion ① and fold forward.
- ▶ Push the rear seat head restraints all the way in.



If the rear center seat is to be occupied while driving, it may be necessary to fold the seat belt buckle up again.

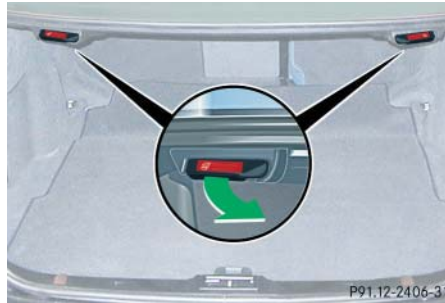

- ▶ Pull the handle in the trunk.
The seat backrest is released and the head restraints fold back.
- ▶ Fold the seat backrest forward.



Make sure the head restraints fit all the way into the seat cushion pockets. This will prevent the backrests from being damaged during loading.

Controls in detail

Loading

Returning seat backrest to original position

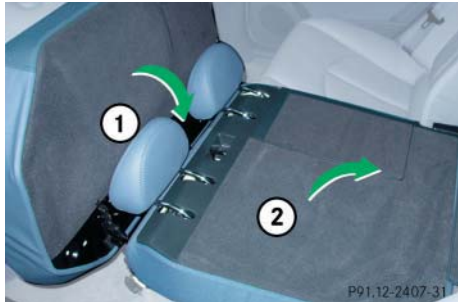

- ① Seat cushion
- ② Seat backrest

- ▶ Swing seat backrest ② to the rear until it engages.
- ▶ Swing seat cushion ① to the rear and press the center front of the cushion until it audibly engages.

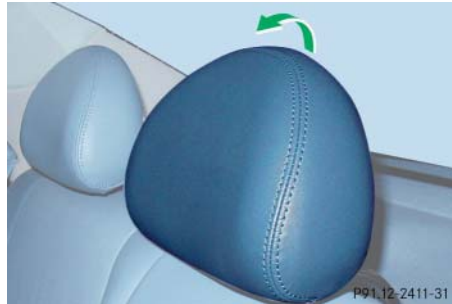

- ▶ Swing the head restraint forward by hand until it engages.

Warning!



Always lock backrest in its upright position when rear seat bench is occupied, or the extended trunk compartment is not in use. Check for secure locking by pushing and pulling on the backrest.

In an accident, during hard braking or sudden maneuvers, loose items will be thrown around inside the vehicle, and cause injury to vehicle occupants unless the items are securely fastened in the vehicle.

To help avoid personal injury during a collision or sudden maneuver, exercise care when transporting cargo.

Expanding the cargo area*

Removing the rear seat cushions will provide you with a larger, flat cargo area.

- ▶ Fold the seat cushions and the backrests forward.
- ▶ Remove the head restraints. (Raise the seat backrest and fold the head restraints forward.)

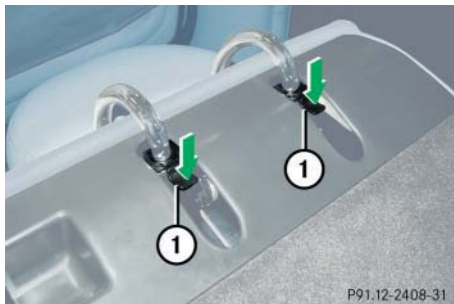

① Release catch

- ▶ Press head restraint release catch ① and pull the head restraints out of the guides.
- ▶ Fold the backrest into the vertical position.

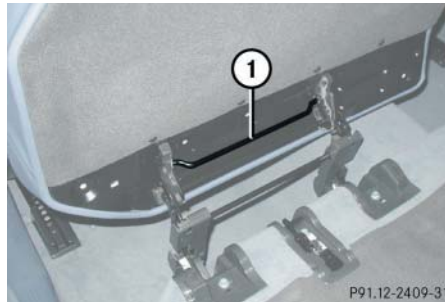

① Release lever

- ▶ Pull seat cushion release lever ① and remove the seat cushion by pulling it upward.



- ▶ Fold the seat backrest forward.

Controls in detail

Loading



Leave the seat cushion hinge in this position. The upholstery could be damaged if you fold the hinge back.

Controls in detail

Loading

Loading instructions

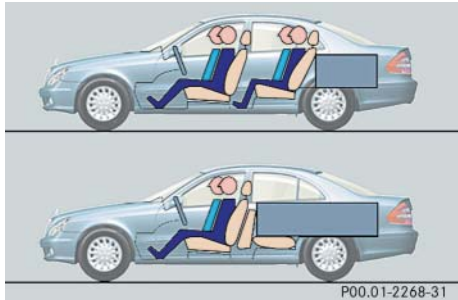

The total load weight including vehicle occupants and luggage / cargo should not exceed the vehicle capacity weight indicated on the certification tag which can be found on the left door pillar.

The handling characteristics of a fully loaded vehicle depend greatly on the load distribution. It is therefore recommended to load the vehicle according to the illustrations shown, with the heaviest items being placed towards the front of the vehicle.

Always place items being carried against front or rear seat backrests, and fasten them as securely as possible.

The heaviest portion of the cargo should always be kept as low as possible since it influences the handling characteristics of the vehicle.

Warning!



Always fasten items being carried as securely as possible.

In an accident, during hard braking or sudden maneuvers, loose items will be thrown around inside the vehicle and can cause injury to vehicle occupants unless the items are securely fastened in the vehicle.

To help avoid personal injury during a collision or sudden maneuver, exercise care when transporting cargo. Put luggage or cargo in the trunk if possible. Do not pile luggage or cargo higher than the seat backs. Do not place anything on the rear-window shelf.

Never drive vehicle with trunk open. Deadly carbon monoxide (CO) gases may enter vehicle interior resulting in unconsciousness and death.

Cargo tie-down rings*

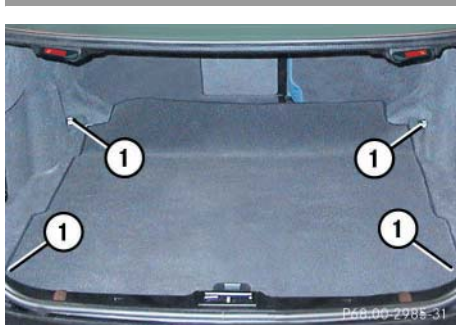

Four rings ① are located in the trunk.

- ▶ Carefully secure cargo by applying even load on all rings with rope of sufficient strength to hold down the cargo.

Always follow loading instructions (▷ page 240).

Rear seat

There is a cargo tie-down ring located on each side of the footwell under the rear seat.



Controls in detail

Useful features

▼ Useful features

Interior storage spaces

Warning!



To help avoid personal injury during a collision or sudden maneuver, exercise care when stowing objects in the vehicle. Put luggage or cargo in the trunk if possible. Do not pile luggage or cargo higher than the seat backs. Do not place anything on the shelf below the rear window.

Luggage nets cannot secure hard or heavy objects.

Keep compartment lids closed. This will help to prevent stored objects from being thrown about and injuring vehicle occupants during an accident.

Parcel net in front passenger footwell

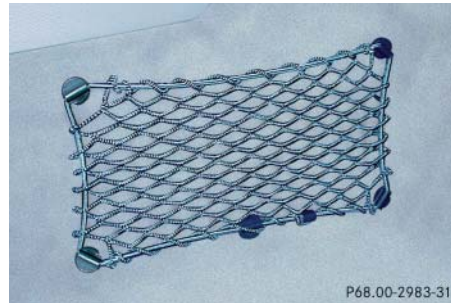

A small convenience parcel net is located in the front passenger footwell. It is for small and light items, such as road maps, mail, etc.

Warning!



The parcel net is intended for storing light-weight items only.

Heavy objects, objects with sharp edges or fragile objects may not be transported in the parcel net.

The parcel net cannot protect transported goods in the event of an accident.

Glove box

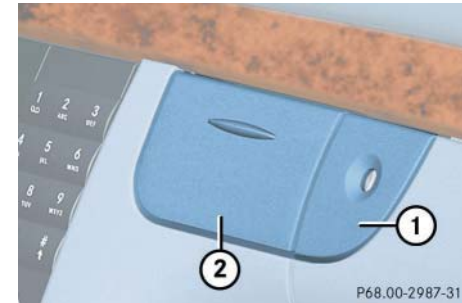

- ① Glove box lid release
- ② Compartment for mobile phone / glasses

Opening the glove box

- ▶ Push lid release ①.
The glove box lid opens downward.

Closing the glove box

- ▶ Push lid up to close.



Prior to closing the glove box, close the compartment for glasses first.

Storage compartment in the center console (no CD changer* installed)



① Opening/closing button

- ▶ Press button ① to open.

The control panel swings out upward and the storage compartment extends out.



Never place any medications in the storage compartment. If there is a power failure, the storage compartment cannot be opened.

- ▶ Press button ① to close.

Cup holder in the center console



- ▶ Briefly press the marking in the back of the cover.

The cover opens.



- ▶ Briefly press marking on the cup holder.

The cup holder extends automatically.



The cup holder can be removed for cleaning. Clean the cup holder only with clear, lukewarm water. Make sure to insert the cup holder in the guides when reinstalling it.



Controls in detail

Useful features

Controls in detail

Useful features

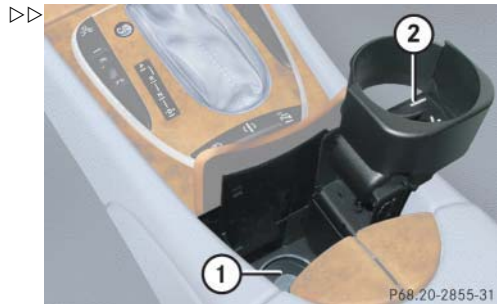

- ① Left cup holder
- ② Right cup holder

Warning!



When not in use, keep the cup holder closed while traveling. Place only containers that fit into the cup holder to prevent spills. Use lids on open containers and do not fill containers to a height where the contents, especially hot liquids, could spill during vehicle maneuvers.

Storage space under armrest

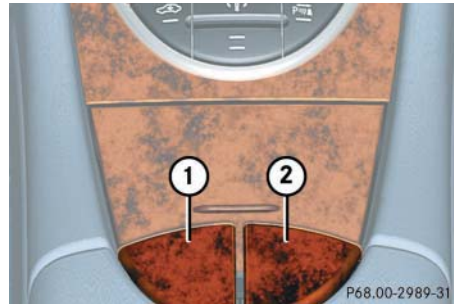

- ① Storage compartment
- ② Storage tray

Opening storage tray

- ▶ Pull handle ②.

Opening storage compartment

- ▶ Pull handle ①.

Front center console storage compartment ventilation

The front center console storage compartment under the armrest has its own air vent. The air temperature is about the same as that of the dashboard air vents.

The lever is located in the front center vent.

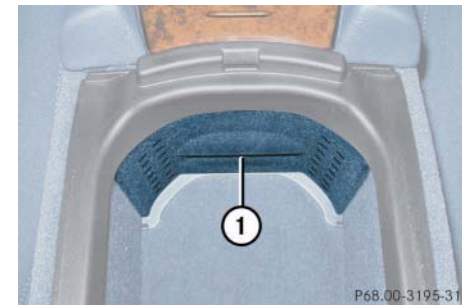

- ① Lever

- ▶ To open air vent slide the lever up.
- ▶ To close air vent slide the lever down.



The compartment can get very warm due to its confined space. When storing heat sensitive objects (e.g. groceries) in the compartment, close the air vent while heating the passenger compartment

Storage compartment in the rear center console



- ▶ Briefly press the top of the compartment. It extends automatically.

Controls in detail

Useful features

Ruffled storage bags



Ruffled storage bags are located on the back of the front seats.

Warning!



The ruffled storage bag is intended for storing light-weight items only.

Heavy objects, objects with sharp edges or fragile objects may not be transported in the ruffled storage bag.

The ruffled storage bag cannot protect transported goods in the event of an accident.

Controls in detail

Useful features

Storage compartment in the rear armrest

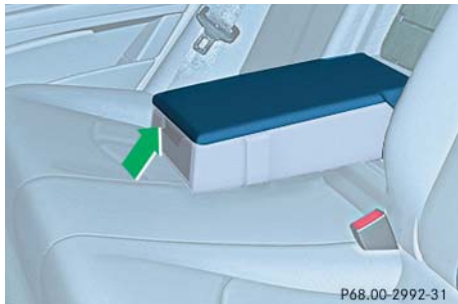

- ▶ Press the handle upward and fold the armrest up.

Rear cup holder

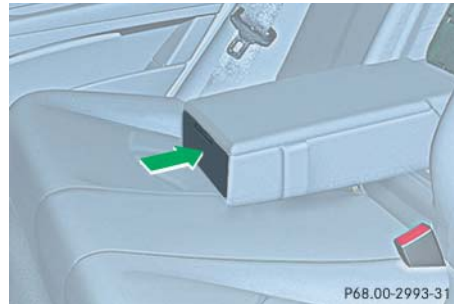

- ▶ Briefly press the front of the center armrest.
The cup holder extends automatically.

Warning!



When not in use, keep the cup holder closed while traveling. Place only containers that fit into the cup holder to prevent spills. Use lids on open containers and do not fill containers to a height where the contents, especially hot liquids, could spill during vehicle maneuvers.

Ashtrays

Center console ashtray



Opening ashtray

- ▶ Briefly press the marking on the bottom of cover ①.
The ashtray opens automatically.

i

A small rubber mat is located in the glove box. If you wish to store coins / tokens, remove the ashtray insert and insert the rubber mat in its place. Empty ashtray insert and store

it in a convenient location in the vehicle.

Warning!



Only use rubber mat in conjunction with storing coins / tokens. Always remove rubber mat and / or all other contents and reinsert ashtray insert before placing hot cigarettes or other hot smoking materials in this compartment.

Removing ashtray insert

Warning!



Remove front ashtray only with vehicle standing still. Set the parking brake to secure vehicle from movement. Move gear selector lever to position **N**. With gear selector lever in position **N**, turn off the engine.

- ▶ Secure vehicle from movement by setting the parking brake. Move the gear selector lever to position **N**.

Now you have more room to take out the insert.

- ▶ Push sliding button ② to the right and hold.
- ▶ Grip and remove insert from ashtray frame.

Reinstalling ashtray insert

- ▶ Install insert by pushing it back into frame until it engages again.

Rear seat ashtray



Opening rear seat ashtray

- ▶ Briefly press the top of the ashtray.
The ashtray opens.

Cigarette lighter

The cigarette lighter is located in the center console compartment in front of the armrest (▷ page 26).



① Cigarette lighter

- ▶ Turn ignition on.
- ▶ Push in cigarette lighter ①.

The lighter will pop out automatically when hot.

Controls in detail

Useful features

Controls in detail

Useful features

Warning!



Never touch the heating element or sides of the lighter; they are extremely hot. Hold the knob only.

When leaving the vehicle, always remove the SmartKey from the starter switch, take the SmartKey with KEYLESS-GO* with you, and lock your vehicle. Do not leave children unattended in the vehicle, or with access to an unlocked vehicle. Unsupervised use of vehicle equipment may cause an accident and / or serious personal injury.



The lighter socket can be used to accommodate electrical accessories up to a maximum 85 W.

12-V socket*



The socket is located in the rear of the center console storage compartment.

The socket can be used for accessories up to a maximum of 180 W.

Heated steering wheel*

The steering wheel heating warms up the leather area of the steering wheel.

The stalk with the heated steering wheel switch is on the lower left-hand side of the steering wheel.

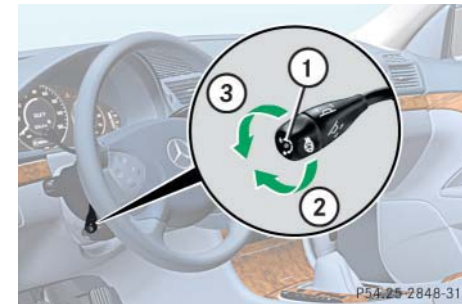

- ① Indicator lamp
- ② Switching off
- ③ Switching on

Switching on

- ▶ Switch on ignition.
All lamps in the instrument cluster come on.
- ▶ Turn switch at the tip of stalk in the direction of arrow ③.
The steering wheel is heated. Indicator lamp ① comes on.

Switching off

- ▶ Turn switch at the tip of stalk in direction of arrow ②.
The heated steering wheel is turned off. Indicator lamp ① goes out.



The steering wheel heating does not turn off automatically.

Telephone*

Warning!



Never operate radio transmitters equipped with a built-in or attached antenna (i.e. without being connected to an external antenna) from inside the vehicle while the engine is running. Doing so could lead to a malfunction of the vehicle's electronic system, possibly resulting in an accident and / or serious personal injury.

Radio transmitters, such as a portable telephone or a citizens band unit, should only be used inside the vehicle if they are connected to an antenna that is installed on the outside of the vehicle.

The external antenna must be approved by Mercedes-Benz. Please contact an authorized Mercedes-Benz Center for information on the installation of an approved external antenna. Refer to the radio transmitter operation instructions regarding use of an external antenna.

Controls in detail

Useful features

Warning!



Please do not forget that your primary responsibility is to drive the vehicle. A driver's attention to the road must always be his / her primary focus when driving. For your safety and the safety of others, we recommend that you pull over to a safe location and stop before placing or taking a telephone call.

If you choose to use the telephone¹ while driving, please use the hands-free device and only use the telephone when road, weather and traffic conditions permit. Some jurisdictions prohibit the driver from using a cellular telephone while driving a vehicle.

Only operate the COMAND (Cockpit Management and Data System)

if road, weather and traffic conditions permit.





¹ Observe all legal requirements.

Controls in detail

Useful features

- ▷▷ Bear in mind that at a speed of just 30 mph (approximately 50 km/h), your vehicle is covering a distance of approximately 44 feet (approximately 13.5 m) every second.

You can take and place telephone calls using the  and  buttons on the steering wheel. To carry out other telephone functions, use the control system (▷ page 129).

See separate operating manual for instructions on how to use the telephone.

Warning!



Some jurisdictions prohibit the driver from using a cellular telephone while driving a vehicle. Whether or not prohibited by law, for safety reasons, the driver should not use the cellular telephone while the vehicle is in motion.

Stop the vehicle in a safe location before answering or placing a call.

Tele Aid*



The initial activation of the Tele Aid system may only be performed by completing the subscriber agreement and placing an acquaintance call using the SOS button. Failure to complete either of these steps will result in a system that is not activated. If the system is not activated, the indicator lamp in the SOS button stays on after turning the SmartKey in starter switch to position **2**, or pressing the KEYLESS-GO* start/stop button twice to position **2**. The message *Tele Aid - not activated* will be shown in the multifunction display for approximately 10 seconds.

If you have any questions regarding activation, please call the Response Center at 1-800-756-9018 (in the USA) or 1-888-923-8367 (in Canada).



The Tele Aid system



(Telematic Alarm Identification on Demand)

The Tele Aid system consists of three types of response:

- automatic and manual emergency
- roadside Assistance and
- information



The Tele Aid system is operational providing that the vehicle's battery is charged, properly connected, not damaged and cellular and GPS coverage is available.

The speaker volume of a Tele Aid call can be adjusted when using the volume control on the multifunction steering wheel. To raise, press button  and to lower, press button .

- ▶ To activate, press the SOS button, the Roadside Assistance button  or the Information button , depending on the type of response required.



The SOS button is located above the interior rear view mirror.



The Roadside Assistance button  and the Information button  are located below the center armrest cover.

Shortly after the completion of your acquaintance call, you will receive a user ID and password via first call mail. By visiting www.mbusa.com and selecting “Tele Aid” (USA only), you will have access to account information, remote door unlock and more.



The Tele Aid system utilizes the cellular network for communication and the GPS (Global Positioning System) satellites for vehicle location. If either of these signals are unavailable, the Tele Aid system may not function and if this occurs, assistance must be summoned by other means.

System self-check

Initially, after turning the ignition on, malfunctions are detected and indicated (the indicator lamps in the SOS button, the Roadside Assistance button  and the Information button  stay on longer than ten seconds or do not come on). The message TELE AID - VISIT WORKSHOP! appears for approximately 10 seconds in the multifunction display.

Controls in detail

Useful features

Warning!



If the indicator lamps in the SOS button, in the Roadside Assistance button and / or in the Information button remain illuminated constantly in red and / or the message TELE AID - VISIT WORKSHOP! is displayed in the multifunction display after the system self-check, a malfunction in the system has been detected.

If a malfunction is indicated as outlined above, the system may not operate as expected. Have the system checked at the nearest Mercedes-Benz Center as soon as possible.

Controls in detail

Useful features

Emergency calls

An emergency call is initiated automatically:

- following an accident in which the emergency tensioning devices (ETDs) or airbags deploy
- if the anti-theft alarm or the tow-away alarm stays on for more than 20 seconds. See anti-theft alarm system (▷ page 84) and tow-away alarm (▷ page 85)

An emergency call can also be initiated manually by opening the cover next to the interior rear view mirror labeled SOS, then briefly pressing the button located under the cover. See below for instructions on initiating an emergency call manually.

Once the emergency call is in progress, the indicator lamp in the SOS button will begin to flash. The message `EMERGENCY CALL - CONNECTING CALL` appears in the multifunction display. When the connection is established, the message `EMERGENCY CALL - CALL CONNECTED` appears in the multifunc-

tion display. All information relevant to the emergency, such as the location of the vehicle (determined by the GPS satellite location system), vehicle model, identification number and color are generated.

A voice connection between the Response Center and the occupants of the vehicle will be established automatically soon after the emergency call has been initiated. When a voice connection is established, the audio system mutes and the message `TELE AID - EMERGENCY CALL ACTIVE` appears in the multifunction display. The Response Center will attempt to determine more precisely the nature of the accident provided they can speak to an occupant of the vehicle.

The Tele Aid system is available if:

- it has been activated and is operational. Activation requires a subscription for monitoring services, connection and cellular air time
- the relevant cellular phone network and GPS signals are available and pass the information on to the response center



Location of the vehicle on a map is only possible if the vehicle is able to receive signals from the GPS satellite network and pass the information on to the response center.

Controls in detail

Useful features

Warning!



If the indicator lamp in the SOS button is illuminated continuously and there was no voice connection to the Response Center established, then the Tele Aid system could not initiate an emergency call (e.g. the relevant cellular phone network is not available). The message **EMERGENCY CALL - CALL FAILED** appears in the multifunction display for approximately 10 seconds.

Should this occur, assistance must be summoned by other means.

Initiating an emergency call manually



- ① Cover
- ② SOS button

- ▶ Briefly press on cover ①.
The cover will open.
- ▶ Press SOS button ② briefly.
The indicator lamp in SOS button ② will flash until the emergency call is concluded.
- ▶ Wait for a voice connection to the Response Center.
- ▶ Close cover after the emergency call is concluded.

Warning!



If you feel at any way in jeopardy when in the vehicle (e.g. smoke or fire in the vehicle, vehicle in a dangerous road location), please do not wait for voice contact after you have pressed the emergency button. Carefully leave the vehicle and move to a safe location. The Response Center will automatically contact local emergency officials with the vehicle's approximate location if they receive an automatic SOS signal and cannot make voice contact with the vehicle occupants.

Controls in detail

Useful features

Roadside Assistance button

Located below the center armrest cover is the Roadside Assistance button .

- ▶ Press and hold the button (for longer than 2 seconds).

A call to a Mercedes-Benz Roadside Assistance dispatcher will be initiated. The button will flash while the call is in progress. The message **ROADSIDE ASSISTANCE - CONNECTING CALL** will appear in the multifunction display.

When the connection is established, the message **ROADSIDE ASSISTANCE - CALL CONNECTED** appears in the multifunction display. The Tele Aid system will transmit data generating the vehicle identification number, model, color and location (subject to availability of cellular and GPS signals).

A voice connection between the Roadside Assistance dispatcher and the occupants of the vehicle will be established. When a voice connection is established, the audio system mutes and the message

TELE AID - ROADSIDE ASSISTANCE CALL ACTIVE appears in the multifunction display.



- ▶ Describe the nature of the need for assistance.

The Mercedes-Benz Roadside Assistance dispatcher will either dispatch a qualified Mercedes-Benz technician or arrange to tow your vehicle to the nearest authorized Mercedes-Benz Center. For services such as labor and/or towing, charges may apply. Refer to the Roadside Assistance manual for more information.

These programs are only available in the USA:

- Sign and Drive services: Services such as a jump start, a few gallons of fuel or the replacement of a flat tire with the vehicle spare tire are obtainable.
- Remote Vehicle Diagnostics: This function permits the Mercedes-Benz Roadside Assistance dispatcher to download malfunction codes and actual vehicle data.



The indicator lamp on the Roadside Assistance button  remains illuminated in red for approximately 10 seconds during the system self-check after turning the ignition on (together with the SOS button and the Information button .

See system self-check (▷ page 251) when the indicator lamp does not come on in red or stays on longer than approximately 10 seconds.

If the indicator lamp on the Roadside Assistance button  is illuminated continuously and there was no voice connection to the Response Center established, then the Tele Aid system could not initiate a Roadside Assistance call (e.g. the relevant cellular phone network is not available). The message **ROADSIDE ASSISTANCE - CALL FAILED** appears in the multifunction display.

Roadside Assistance calls can be terminated using the  button on the multifunction steering wheel.

Information button

The Information button  is located below the center armrest cover.

- ▶ Press and hold button (for longer than 2 seconds).

A call to the Customer Assistance Center will be initiated. The button will flash while the call is in progress. The message `INFO - CONNECTING CALL` will appear in the multifunction display.



When the connection is established, the message `INFO - CALL CONNECTED` appears in the multifunction display. The Tele Aid system will transmit data generating the vehicle identification number, model, color and location (subject to availability of cellular and GPS signals).

A voice connection between the Customer Assistance Center representative and the occupants of the vehicle will be estab-

lished. When a voice connection is established, the audio system is muted and the message `TELE AID - INFO CALL ACTIVE` appears in the multifunction display. Information regarding the operation of your vehicle, the nearest authorized Mercedes-Benz Center or Mercedes-Benz USA products and services is available to you.

For more details concerning the Tele Aid system, please visit www.mbusa.com and use your ID and password (sent to you separately) to learn more (USA only).





The indicator lamp on the Information button  remains illuminated in red for approximately 10 seconds during the system self-check after turning the SmartKey in the starter switch to position **2** (together with the SOS button and the Roadside Assistance button .

Controls in detail

Useful features

See system self-check (▷ page 251) when the indicator lamp does not come on in red or stays on longer than approximately ten seconds.

If the indicator lamp on the Information button  is illuminated continuously and there was no voice connection to the Response Center established, then the Tele Aid system could not initiate an Information call (e.g. the relevant cellular phone network is not available). The message `INFO - CALL FAILED` appears in the multifunction display.

Information calls can be terminated using the  button on the multifunction steering wheel.

Controls in detail

Useful features



If the indicator lamps do not start flashing after pressing one of the buttons or remain illuminated (in red) at any time, the Tele Aid system has detected a fault or the service is not currently active, and may not initiate a call. Visit your authorized Mercedes-Benz Center and have the system checked or contact the Response Center at 1-800-756-9018 (in the USA) or 1-888-923-8367 (in Canada) as soon as possible.

Upgrade signals

The Tele Aid system processes calls using the following priority:

- Automatic emergency – First priority
- Manual emergency – Second priority
- Roadside assistance – Third priority
- Information – Fourth priority

Should a higher priority call be initiated while you are connected, an upgrade (alternating) tone will be heard, and the appropriate indicator lamp will flash. If certain information such as vehicle identification number or customer information is not available, the operator may need to retransmit.

During this time you will hear a beep and voice contact will be interrupted. Voice contact will resume once the retransmission is completed. Once a call is concluded, a beep will be heard and the respective indicator lamp will stop flashing. The COMAND system operation will resume.



If the indicator lamp continues to flash or the system does not reset, contact the Response Center at 1-800-756-9018 (in the USA) or 1-888-923-8367 (in Canada), or Mercedes-Benz Customer Assistance at 1-800-FOR-MERCEdes (1-800-367-6372) in the USA or Customer Service at 1-800-387-0100 in Canada.



The indicator lamp in the respective button flashes until the call is concluded. Calls can only be terminated by a Response Center or Customer Assistance Center representative except Roadside Assistance and Information calls, which can also be terminated by pressing button  on the multifunction steering wheel.



When a Tele Aid call has been initiated, the audio system or the COMAND system audio is muted and the selected mode (radio or CD) pauses. The optional cellular phone (if installed) switches off. If you must use this phone, the vehicle must be parked. Disconnect the coiled cord and place the call. The COMAND navigation system (if engaged) will continue to run. The display in the instrument cluster is available for use, and spoken commands are only available by pressing the RPT button on the COMAND unit. A pop-up window will appear in the COMAND display to indicate that a Tele Aid call is in progress.

Remote door unlock

In case you have locked your vehicle unintentionally (e.g. SmartKey inside vehicle), and the reserve SmartKey is not handy:

- ▶ Contact the Mercedes-Benz Response Center at 1-800-756-9018 (in the USA) or 1-888-923-8367 (in Canada).

You will be asked to provide your password which you provided when you completed the subscriber agreement.

- ▶ Then return to your vehicle and pull the trunk recessed handle for a minimum of 20 seconds until the SOS button is flashing.

The message **EMERGENCY CALL - CALL CONNECTED** appears in the multifunction display.

As an alternative, you may unlock the vehicle via Internet using the ID and password sent to you shortly after the completion of your acquaintance call.

Controls in detail

Useful features

The Response Center will then unlock your vehicle with the remote door unlocking feature.



The remote door unlock feature is available if the relevant cellular phone network is available.

The SOS button will flash and the message **EMERGENCY CALL - CALL CONNECTED** will appear in the multifunction display to indicate receipt of the door unlock command.

Once the vehicle is unlocked, a Response Center specialist will attempt to establish voice contact with the vehicle occupants.

If the trunk recessed handle was pulled for more than 20 seconds before door unlock authorization was received by the Response Center, you must wait 15 minutes before pulling the trunk recessed handle again.

Controls in detail

Useful features

Stolen vehicle tracking services

In the event your vehicle was stolen:

- ▶ Report the incident to the police.
The police will issue a numbered incident report.
- ▶ Pass this number on to the Mercedes-Benz Response Center along with your password issued to you when you subscribed to the service.

The Response Center will then attempt to covertly contact the vehicle's Tele Aid system. Once the vehicle is located, the Response Center will contact the local law enforcement and you. The vehicle's location will only be provided to law enforcement.

Garage door opener

The built-in remote control is capable of operating up to three separately controlled devices, for example garage door openers, gate openers, or other devices compatible with HomeLink® or some other systems.

You can program the signal transmitter buttons.

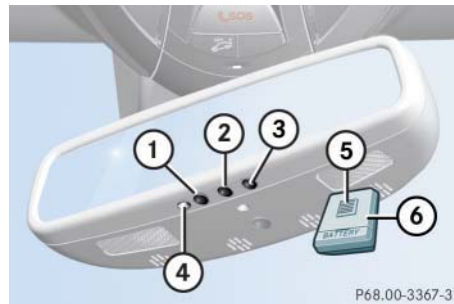

- ①②③ Signal transmitter key
- ④ Indicator lamp
- ⑤ Hand-held transmitter button
- ⑥ Hand-held remote control transmitter (not part of the vehicle equipment)

Warning!



Before programming the integrated remote control to a garage door opener or gate operator, make sure that people and objects are out of the way of the device to prevent potential harm or damage.

When programming a garage door opener, the door moves up or down. When programming a gate operator, the gate opens or closes.

Do not use the integrated remote control with any garage door opener that lacks safety stop and reverse features as required by U.S. federal safety standards (this includes any garage door opener model manufactured before April 1, 1982). A garage door that cannot detect an object - signaling the door to stop and reverse - does not meet current U.S. federal safety standards.



Certain types of garage door openers are incompatible with the integrated opener. If you should experience difficulties with programming the transmitter, contact your authorized Mercedes-Benz Center, or call Mercedes-Benz Customer Assistance Center (in the USA only) at 1-800-FOR-MERCEdes, or Customer Service (in Canada) at 1-800-387-0100.



For operation in the USA only: This device complies with Part 15 of the FCC Rules. Operation is subject to the following two conditions:

- (1) This device may not cause harmful interference, and
- (2) this device must accept any interference received, including interference that may cause undesired operation.

Any unauthorized modification to this device could void the user's authority to operate the equipment.

Controls in detail

Useful features

Programming or reprogramming the integrated remote control

Step 1:

- ▶ Switch on ignition.

Step 2:

- ▶ If you have previously programmed an integrated signal transmitter button and wish to retain its programming, proceed to step 3. Otherwise, press and hold the two outer signal transmitter buttons ① and ③ and release them only when the indicator light begins to flash after approximately 20 seconds (do not hold the button for longer than 30 seconds). This procedure erases any previous settings for all three channels and initializes the memory. If you later wish to program a second and/or third hand-held transmitter to the remaining two signal transmitter buttons, do not repeat this step and begin directly with step 3. >>

Controls in detail

Useful features

▷▷ Step 3:

- ▶ Hold the end of the hand-held remote control transmitter ⑥ of the device you wish to train approximately 2 to 5 in (5 to 12 cm) away from the surface of the integrated remote control located on the interior rear view mirror, keeping the indicator lamp ④ in view.

Step 4:

- ▶ Using both hands, simultaneously press the hand-held transmitter button ⑤ and the desired integrated signal transmitter button (①, ② or ③). Do not release the buttons until completing step 5.

The indicator lamp ④ on the integrated remote control will flash, first slowly and then rapidly.



The indicator lamp ④ flashes the first time the signal transmitter button is programmed. If this button has already been programmed, the indicator lamp will only start flashing after 20 seconds.

Step 5:

- ▶ When the indicator lamp ④ flashes rapidly, release both buttons.

Step 6:

- ▶ Press and hold the just-trained integrated signal transmitter button and observe the indicator lamp ④.

If the indicator lamp ④ stays on constantly, programming is complete and your device should activate when the integrated signal transmitter button is pressed and released.



If the indicator lamp ④ blinks rapidly for about two seconds and then turns to a constant light, continue with programming steps 8 through 12 as your garage door opener may be equipped with the “rolling code” feature.

Step 7:

- ▶ To program the remaining two buttons, repeat the steps above starting with step 3.

Rolling code programming

To train a garage door opener (or other rolling code devices) with the rolling code feature, follow these instructions after completing the “Programming” portion (steps 1 through 6) of this text. (A second person may make the following training procedures quicker and easier.)

Step 8:

- ▶ Locate “training” button on the garage door opener motor head unit.

Exact location and color of the button may vary by garage door opener brand. Depending on manufacturer, the “training” button may also be referred to as “learn” or “smart” button. If there is difficulty locating the transmitting button, refer to the garage door opener operator’s manual.

Step 9:

- ▶ Press “training” button on the garage door opener motor head unit.

The “training light” is activated.

You have 30 seconds to initiate the following step.

Step 10:

- ▶ Firmly press, hold for two seconds and release the programmed integrated signal transmitter button (①, ② or ③).

Step 11:

- ▶ Press, hold for two seconds and release same button a second time to complete the training process.

Some garage door openers (or other rolling code equipped devices) may require you to perform this procedure a third time to complete the training.

Step 12:

- ▶ Confirm the garage door operation by pressing the programmed integrated signal transmitter button (①, ② or ③).

Step 13:

- ▶ To program the remaining two buttons, repeat the steps above starting with step 3.

Controls in detail

Useful features

Gate operator/Canadian programming

Canadian radio-frequency laws require transmitter signals to “time-out” (or quit) after several seconds of transmission which may not be long enough for the integrated signal transmitter to pick up the signal during programming. Similar to this Canadian law, some U.S. gate operators are designed to “time-out” in the same manner.

If you live in Canada or if you are having difficulties programming a gate operator (regardless of where you live) by using the programming procedures, replace step 4 with the following:

Step 4:

- ▶ Continue to press and hold the integrated signal transmitter button (①, ② or ③) while you press and re-press (“cycle”) your hand-held remote control transmitter (⑥) every two seconds until the frequency signal has been learned. Upon successful training, the indicator lamp (④) will flash slowly and then rapidly after several seconds.
- ▶ Proceed with programming step 5 and step 6 to complete.

Operation of integrated remote control

- ▶ Switch on ignition.
- ▶ Select and press the appropriate integrated signal transmitter button (①, ② or ③) to activate the remote controlled device.

The integrated remote control transmitter continues to send the signal as long as the button is pressed – up to 20 seconds.

Erasing the integrated remote control memory

- ▶ Switch on ignition.
- ▶ Simultaneously hold down the signal transmitter buttons ① and ③, for approximately 20 seconds, until the indicator lamp ④ blinks rapidly. Do not hold for longer than 30 seconds.

The codes of all three channels are erased.



If you sell your vehicle, erase the codes of all three channels.

Reprogramming a single integrated signal transmitter button

To program a device using a signal transmitter button previously trained, follow these steps:

- ▶ Press and hold the desired signal transmitter button (①, ② or ③). Do not release the button.
- ▶ The indicator lamp will begin to flash after 20 seconds. Without releasing the integrated signal transmitter button, proceed with programming starting with step 3.



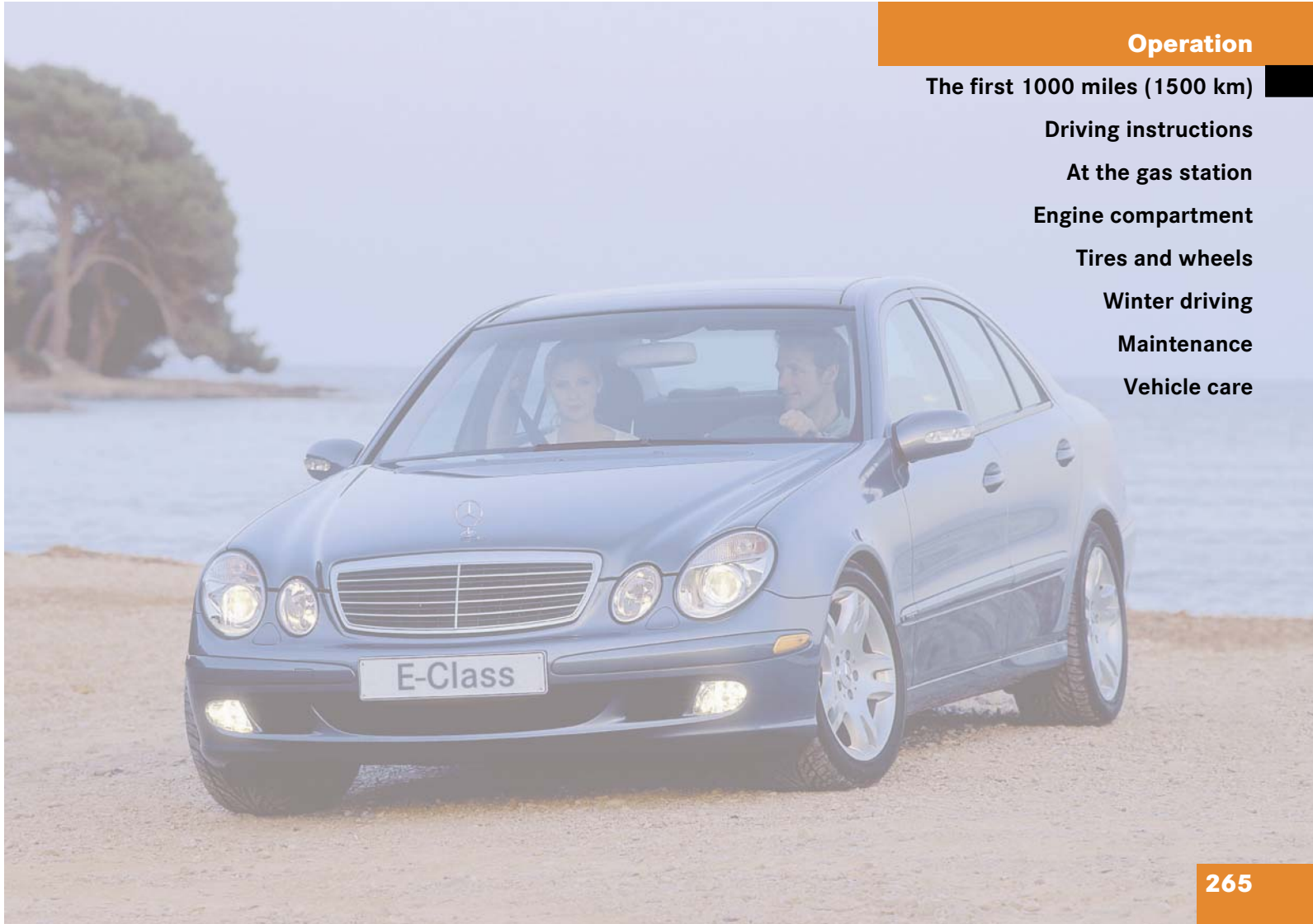

Operation

The first 1000 miles (1500 km)

Driving instructions

At the gas station

Engine compartment

Tires and wheels

Winter driving

Maintenance

Vehicle care

Operation

The first 1000 miles (1500 km)

In the “Operation” section you will find detailed information on operating, maintaining and caring for your vehicle.

▼ The first 1000 miles (1500 km)

The more cautiously you treat your vehicle during the break-in period, the more satisfied you will be with its performance later on.

- Drive your vehicle during the first 1000 miles (1500 km) at varying but moderate vehicle and engine speeds.
- During this period, avoid heavy loads (full throttle driving) and excessive engine speeds (no more than $\frac{2}{3}$ of maximum rpm in each gear).
- Avoid accelerating by kick-down.
- Do not attempt to slow the vehicle down by shifting to a lower gear using the selector lever.
- Select positions **3**, **2** or **1** only when driving at moderate speeds (for hill driving).

After 1000 miles (1500 km) you may gradually increase vehicle and engine speeds to the permissible maximum.



Additional instructions for AMG vehicles:

- During the first 1000 miles (1500 km), do not exceed a speed of 85 mph (140 km/h).
- During this period, avoid engine speeds above 4500 rpm in each gear.

All of the above, as may apply to your vehicle type, also apply when driving the first 1000 miles (1500 km) after the engine or the rear differential has been replaced.



Always obey applicable speed limits.

▼ **Driving instructions**

Drive sensibly – save fuel

Fuel consumption, to a great extent, depends on driving habits and operating conditions.

To save fuel you should:

- Keep tires at the recommended inflation pressures.
- Remove unnecessary loads.
- Remove roof rack when not in use.
- Allow engine to warm up under low load use.
- Avoid frequent acceleration and deceleration.
- Have all maintenance work performed at the intervals specified in the Service Booklet and as required by the FSS. Contact your authorized Mercedes-Benz Center.

Fuel consumption is also increased by driving in cold weather, in stop-and-go traffic, on short trips and in hilly country.

Drinking and driving

Warning!



Drinking and driving and / or taking drugs and driving are very dangerous combinations. Even a small amount of alcohol or drugs can affect your reflexes, perceptions and judgement.

The possibility of a serious or even fatal accident are greatly increased when you drink or take drugs and drive.

Do not drink or take drugs and drive or allow anyone to drive who has been drinking or taking drugs.

Pedals

Warning!



Keep driver's foot area clear at all times. Objects stored in this area may impair pedal movement.

Operation

Driving instructions

Power assistance

Warning!



The brake system requires electrical energy for operation.

A malfunction in the vehicle's power supply or electrical system may impair brake system operation and switch it into its emergency operation mode. In such a case, the red brake warning lamp (▷ page 312) and warning messages in the instrument cluster (▷ page 318) come on while driving. To brake, the driver must then apply significantly greater brake pedal pressure and depress the pedal much further to obtain the expected braking effect. If necessary, apply full pressure to the brake pedal. Brakes may only be applied to the front wheels. Stopping distance is increased! If there is a malfunction in the SBC brake system, we recommend that the vehicle be transported

with all wheels off the ground using flatbed or appropriate wheel lift/dolly equipment. A tow bar must be used if circumstances do not permit the use of the recommended towing methods and the vehicle requires towing with all four wheels on the ground. Towing the vehicle with all four wheels on the ground is only permissible for distances up to 30 miles (50 km) and at a speed not to exceed 30 mph (50 km/h). For more information, refer to "Towing the vehicle" (▷ page 381). For more information see SBC brake system (▷ page 79).

With the engine not running, there is no power assistance for the brake and steering systems. In this case, it is important to keep in mind that a considerably higher degree of effort is necessary to brake and steer the vehicle.

Brakes

Warning!



After driving in heavy rain for some time without applying the brakes or through water deep enough to wet brake components, the first braking action may be somewhat reduced and increased pedal pressure may be necessary to obtain expected braking effect. Maintain a safe distance from vehicles in front.

Resting your foot on the brake pedal will cause excessive and premature wear of the brake pads.

It can also result in the brakes overheating, thereby significantly reducing their effectiveness. It may not be possible to stop the vehicle in sufficient time to avoid an accident.

To help prevent brake disk corrosion after driving on wet road surfaces (particularly salted roads), it is advisable to brake the vehicle with considerable force prior to parking. The heat generated serves to dry the brakes.

If your brake system is normally only subjected to moderate loads, you should occasionally test the effectiveness of the brakes by applying above-normal braking pressure at higher speeds. This will also enhance the grip of the brake pads.



Be very careful not to endanger other road users when you apply the brakes.

Refer to the description of the Brake Assist System (BAS) (▷ page 76).

If the parking brake is released and the brake warning lamp in the instrument cluster stays on, there is a malfunction in the SBC brake system (▷ page 79) or the brake fluid level in the reservoir is too low.

Brake pad wear or a leak in the system may be the reason for low brake fluid in the reservoir.

Have the brake system inspected by qualified technicians immediately. Contact your authorized Mercedes-Benz Center.

All checks and service work on the brake system should be carried out by qualified technicians only. Contact your authorized Mercedes-Benz Center.

Only install brake pads and brake fluid recommended by Mercedes-Benz.

Warning!



If other than recommended brake pads are installed, or other than recommended brake fluid is used, the braking properties of the vehicle can be degraded to an extent that safe braking is substantially impaired. This could result in an accident.

Be certain to read and observe the warning notices on brake pad replacement (▷ page 326).



When driving down long and steep grades, relieve the load on the brakes by shifting into a lower gear to use the engine's braking power. This helps prevent overheating of the brakes and reduces brake pad wear.

After hard braking, it is advisable to drive on for some time, rather than immediately parking, so that the air stream will cool down the brakes faster.

Operation

Driving instructions

Driving off

Apply the brakes to test them briefly after driving off. Perform this procedure only when the road is clear of other traffic.

Warm up the engine smoothly. Do not place full load on the engine until the operating temperature has been reached.

When starting off on a slippery surface, do not allow a drive wheel to spin for an extended period with the ESP switched off. Doing so may cause serious damage to the drive train which is not covered by the Mercedes-Benz Limited Warranty.



Simultaneously depressing the accelerator pedal and applying the brake reduces engine performance and causes premature brake and drivetrain wear.

Parking



Set the parking brake whenever parking or leaving the vehicle. In addition, move gear selector lever to position **P**. When parking on hills, always set the parking brake and turn front wheel against road curb.

Warning!



Do not park this vehicle in areas where combustible materials such as grass, hay or leaves can come into contact with the hot exhaust system, as these materials could be ignited and cause a vehicle fire.

To reduce the risk of personal injury as a result of vehicle movement, before turning off the engine and leaving the vehicle always:

- Keep right foot on brake pedal.
- Firmly depress parking brake pedal.
- Move the selector lever to position **P**.

- Slowly release brake pedal.
- When parked on an incline, turn front wheel towards the road curb.
- Turn the SmartKey to starter switch position **0** and remove, or press KEYLESS-GO* start/stop button (vehicles with KEYLESS-GO*).
- Take the SmartKey or the SmartKey with KEYLESS-GO* with you and lock vehicle when leaving.

Tires

Warning!



If you feel a sudden significant vibration or ride disturbance, or you suspect that possible damage to your vehicle has occurred, you should turn on the hazard warning flashers, carefully slow down, and drive with caution to an area which is a safe distance from the road.

Inspect the tires and the vehicle underbody for possible damage. If the vehicle or tires appear unsafe, have it towed to the nearest Mercedes-Benz Center or tire dealer for repairs.

Tread wear indicators (TWI) are required by law. These indicators are located in six places on the tread circumference and become visible at a tread depth of approximately $\frac{1}{16}$ in (1.6 mm), at which point the tire is considered worn and should be replaced.

The tread wear indicator appears as a solid band across the tread.

Warning!



Although the applicable federal motor vehicle safety laws consider a tire to be worn when the tread wear indicators (TWI) become visible at approximately $\frac{1}{16}$ in (1.6 mm), we recommend that you do not allow your tires to wear down to that level. As tread depth approaches $\frac{1}{8}$ in (3 mm), the adhesion properties on a wet road are sharply reduced.

Depending upon the weather and/or road surface (conditions), the tire traction varies widely.

Specified tire pressures must be maintained. This applies particularly if the tires are subjected to high loads (e.g. high speeds, heavy loads, high ambient temperatures).

Operation

Driving instructions

Warning!



Do not drive with a flat tire. A flat tire affects the ability to steer or brake the vehicle. You may lose control of the vehicle. Continued driving with a flat tire or driving at high speed with a flat tire will cause excessive heat build-up and possibly a fire.

Hydroplaning

Depending on the depth of the water layer on the road, hydroplaning may occur, even at low speeds and with new tires. Reduce vehicle speed, avoid track grooves in the road and apply brakes cautiously in the rain.

Operation

Driving instructions

Tire traction

The safe speed on a wet, snow covered or icy road is always lower than on a dry road.

You should pay particular attention to the condition of the road whenever the outside temperatures are close to the freezing point.

Warning!



If ice has formed on the road, tire traction will be substantially reduced. Under such weather conditions, drive, steer and brake with extreme caution.

Mercedes-Benz recommends M+S rated radial-ply tires with a minimum tread depth of approximately $\frac{1}{6}$ in (4 mm) on all four wheels for the winter season to ensure normal balanced handling characteristics. On packed snow, they can reduce your stopping distance compared to summer tires. Stopping distance, however, is still

considerably greater than when the road is not covered with snow or ice. Exercise appropriate caution.

Tire speed rating

Regardless of the tire speed rating, local speed limits should be obeyed. Use prudent driving speeds appropriate to prevailing conditions.

Warning!



Even when permitted by law, never operate a vehicle at speeds greater than the maximum speed rating of the tires.

Exceeding the maximum speed for which tires are rated can lead to sudden tire failure, causing loss of vehicle control and possibly resulting in an accident and/or personal injury and possible death, for you and for others.

E 320, E 320 4MATIC, E 500, E 500 4MATIC

Your vehicle is factory equipped with “H”-rated tires, which have a speed rating of 130 mph (210 km/h).

E 320 4MATIC (Sport Package*), E 500 4MATIC (Sport Package*)

Your vehicle is factory equipped with “H”-rated tires, which have a speed rating of 130 mph (210 km/h).

E 320 (Sport Package*), E 500 (Sport Package*)

Your vehicle is factory equipped with “W”-rated tires, which have a speed rating of 168 mph (270 km/h).

An electronic speed limiter prevents your vehicle from exceeding a speed of 130 mph (210 km/h).

E 55 AMG

Your vehicle is factory equipped with “Z”-rated tires, which have a speed rating above 149 mph (above 240 km/h).

An electronic speed limiter prevents your vehicle from exceeding a speed of 155 mph (250 km/h).



For information on speed ratings for winter tires, see “Winter driving” (> page 295).

Winter driving instructions

The most important rule for slippery or icy roads is to drive sensibly and to avoid abrupt acceleration, braking and steering maneuvers. Do not use the cruise control system under such conditions.

When the vehicle is in danger of skidding, move gear selector lever to position N or in case you have a manual transmission, de-clutch. Try to keep the vehicle under control by corrective steering action.



For more information on driving with snow chains, see “Snow chains” (> page 296).

Warning!



On slippery road surfaces, never downshift in order to obtain braking action. This could result in drive wheel slip and reduced vehicle control. Your vehicle’s ABS will not prevent this type of control loss.

Operation

Driving instructions

Road salts and chemicals can adversely affect braking efficiency. Increased pedal force may become necessary to produce the normal braking effect.

Depressing the brake pedal periodically when traveling at length on salt-strewn roads can bring road-salt-impaired braking efficiency back to normal.

If the vehicle is parked after being driven on salt-treated roads, the braking efficiency should be tested as soon as possible after driving is resumed.

Warning!



Make sure not to endanger any other road users when carrying out these braking maneuvers.

Operation

Driving instructions

Warning!



If the vehicle becomes stuck in snow, make sure that snow is kept clear of the exhaust pipe and from around the vehicle with the engine running. Otherwise, deadly carbon monoxide (CO) gases may enter vehicle interior resulting in unconsciousness and death.

To assure sufficient fresh air ventilation, open a window slightly on the side of the vehicle not facing the wind

Warning!



The outside temperature indicator is not designed to serve as an ice-warning device and is therefore unsuitable for that purpose. Indicated temperatures just above the freezing point do not guarantee that the road surface is free of ice.

For more information, see “Winter driving” (▷ page 295)

Standing water



Do not drive through flooded areas or water of unknown depth. Before driving through water, determine its depth. Never accelerate before driving into water. The bow wave could force water into the engine and auxiliary equipment, thus damaging them.

If you must drive through standing water, drive slowly to prevent water from entering the passenger compartment or the engine compartment. Water in these areas could cause damage to electrical components or wiring of the engine or transmission, or could result in water being ingested by the engine through the air intake causing severe internal engine damage. Any such damage is not covered by the Mercedes-Benz Limited Warranty.

Passenger compartment

Warning!



Always fasten items being carried as securely as possible.

In an accident, during hard braking or sudden maneuvers, loose items will be thrown around inside the vehicle, and cause injury to vehicle occupants unless the items are securely fastened in the vehicle.

The trunk is the preferred place to carry objects.

Driving abroad

Abroad, there is an extensive Mercedes-Benz service network at your disposal. If you plan to drive into areas which are not listed in the index of your Mercedes-Benz Center directory, you should request pertinent information from your authorized Mercedes-Benz Center.

Control and operation of radio transmitter

COMAND, radio and telephone*

Warning!



Please do not forget that your primary responsibility is to drive the vehicle safely. Only operate the COMAND (Cockpit Management and Data System), radio or telephone¹ if road, weather and traffic conditions permit.

Bear in mind that at a speed of just 30 mph (approximately 50 km/h), your vehicle is covering a distance of approximately 44 feet (approximately 13.5 m) every second.

¹ Observe all legal requirements

Telephones and two-way radios

Warning!



Never operate radio transmitters equipped with a built-in or attached antenna (i.e. without being connected to an external antenna) from inside the vehicle while the engine is running. Doing so could lead to a malfunction of the vehicle's electronic system, possibly resulting in an accident and/or personal injury.

Radio transmitters, such as a portable telephone or a citizens band unit should only be used inside the vehicle if they are connected to an antenna that is installed on the outside of the vehicle.

Refer to the radio transmitter operation instructions regarding use of an external antenna.

Catalytic converter

Your Mercedes-Benz is equipped with monolithic-type catalytic converters, an important element in conjunction with the oxygen sensors to achieve substantial control of the pollutants in the exhaust emissions. Keep your vehicle in proper operating condition by following our recommended maintenance instructions as outlined in your Service Booklet.



To prevent damage to the catalytic converters, use only premium unleaded gasoline in this vehicle.

Any noticeable irregularities in engine operation should be repaired promptly. Otherwise, excessive unburned fuel may reach the catalytic converter, causing it to overheat, which could start a fire.

Operation

Driving instructions

Warning!



As with any vehicle, do not idle, park or operate this vehicle in areas where combustible materials such as grass, hay or leaves can come into contact with the hot exhaust system, as these materials could be ignited and cause a vehicle fire.

Emission control

Certain systems of the engine serve to keep the toxic components of the exhaust gases within permissible limits required by law.

These systems, of course, will function properly only when maintained strictly according to factory specifications. Any adjustments on the engine should, therefore, be carried out only by qualified Mercedes-Benz Center authorized technicians. Engine adjustments should not be altered in any way. Moreover, the specified service jobs must be carried out regularly according to Mercedes-Benz servicing requirements. For details refer to the Service Booklet.

Warning!



Inhalation of exhaust gas is hazardous to your health. All exhaust gas contains carbon monoxide, and inhaling it can cause unconsciousness and lead to death.

Do not run the engine in confined areas (such as a garage) which are not properly ventilated. If you think that exhaust gas fumes are entering the vehicle while driving, have the cause determined and corrected immediately. If you must drive under these conditions, drive only with at least one window fully open at all times.

Coolant temperature

During severe operating conditions and stop-and-go city traffic, the coolant temperature may rise close to approximately 248°F (120°C).

The engine should not be operated with the coolant temperature over 248°F (120°C). Doing so may cause serious engine damage which is not covered by the Mercedes-Benz Limited Warranty.

Warning!



- Driving when your engine is badly overheated can cause some fluids, which may have leaked into the engine compartment, to catch fire. You could be seriously burned.
- Steam from an overheated engine can cause serious burns and can occur just by opening the engine hood. Stay away from the engine if you see or hear steam coming from it.

Turn off the engine, get out of the vehicle and do not stand near the vehicle until the engine has cooled down.

Operation

At the gas station

▼ At the gas station

Warning!



Gasoline is highly flammable and poisonous. It burns violently and can cause serious injury. Whenever you are around gasoline, avoid inhaling fumes and skin contact, extinguish all smoking materials. Never allow sparks, flame or smoking materials near gasoline!

The fuel filler flap is located on the right-hand side of the vehicle towards the rear. Locking/unlocking the vehicle with the SmartKey or the SmartKey with KEYLESS-GO* automatically locks/unlocks the fuel filler flap.



- ▶ Turn the engine off
 - by turning the SmartKey to position **0**. Remove the SmartKey from the starter switch.
 - by pressing the KEYLESS-GO* start/stop button. Open the driver's door (with the driver's door open, starter switch is now in position **0**, same as SmartKey removed from starter switch).
- ▶ Open the fuel filler flap by pushing at the point indicated by the arrow. The fuel filler flap springs open.
- ▶ Turn the fuel cap to the left and hold on to it until possible pressure is released.
- ▶ Take off the cap and set it in the recess on the fuel filler flap.
 - To prevent fuel vapors from escaping into open air, fully insert filler nozzle unit.
- ▶ Only fill your tank until the filler nozzle unit cuts out – **do not top up or overfill.**

Warning!



Overfilling of the fuel tank may create pressure in the system which could cause a gas discharge. This could cause the gas to spray back out when removing the fuel pump nozzle, which could cause personal injury.

- ▶ Replace the fuel cap by turning it to the right.
You will hear when the fuel cap is tightened.
- ▶ Close the fuel filler flap.



Use only premium unleaded gasoline with a minimum Posted Octane Rating of 91 (average of 96 RON / 86 MON). Information on gasoline quality can normally be found on the fuel pump.

More information on gasoline can be found in the Factory Approved Service Products Pamphlet.



Leaving the engine running and the fuel cap open can cause the  lamp to illuminate.

Operation

At the gas station

Check regularly and before a long trip

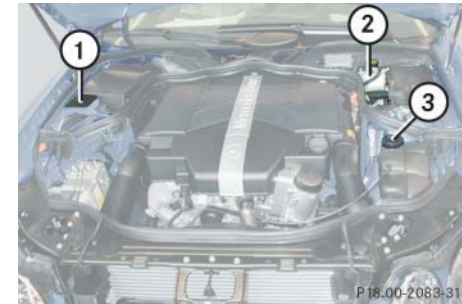

- ① Windshield washer and headlamp cleaning system*
For more information on refilling the reservoir (▷ page 288).
- ② Brake fluid
More information on brake fluid can be found in the “Technical data” section (▷ page 403).
- ③ Coolant level
More information on the coolant level (▷ page 285).

Operation

At the gas station



If you find that the brake fluid in the brake fluid reservoir has fallen to the minimum mark or below, have the brake system checked for brake pad thickness and leaks immediately. Notify an authorized Mercedes-Benz Center immediately. Do not add brake fluid as this will not solve the problem. For more information, see “Practical hints” (▷ page 312).

Engine oil level

More information on engine oil (▷ page 282).

See also “Opening hood” (▷ page 281).

Vehicle lighting

Check function and cleanliness. For more information on replacing light bulbs, see the “Practical hints” section (▷ page 359).

See also the section on the exterior lamp switch (▷ page 119).

Tire inflation pressure

More information on tire inflation pressure (▷ page 290).

▼ Engine compartment

Hood

Warning!



Do not pull the release lever while the vehicle is in motion. Otherwise the hood could be forced open by passing air flow.

Opening



① Hood release

- ▶ Pull lever ① downwards.

The hood is unlocked and handle ② will extend out of the radiator grille.



To avoid damage to the windshield wipers or hood, never open the hood if the wiper arms are folded forward away from the windshield.



② Handle for opening the hood

Operation

Engine compartment

- ▶ Pull handle ② to its stop out of radiator grille.
- ▶ Pull up on the hood (do not pull up on the handle) and then release it.

The hood will be automatically held open at shoulder height by gas-filled struts.

Warning!



To help prevent personal injury, stay clear of moving parts when the hood is open and the engine is running. Make sure the hood is properly closed before driving. When closing the hood, use extreme caution not to catch hands or fingers.

The radiator fan may continue to run for approximately 30 seconds or even restart after the engine has been turned off. Stay clear of fan blades.

Operation

Engine compartment

Warning!



If you see flames or smoke coming from the engine compartment, or if the coolant temperature gauge indicates that the engine is overheated, do not open the hood. Move away from vehicle and do not open the hood until the engine has cooled. If necessary, call the fire department.

Warning!



The engine is equipped with a transistorized ignition system. Because of the high voltage it is dangerous to touch any components (ignition coils, spark plug sockets, diagnostic socket) of the ignition system

- with the engine running
- while starting the engine
- if ignition is “on” and the engine is turned manually

Closing

Warning!



Be careful that you do not close the hood on anyone.

- ▶ Let the hood drop from a height of approximately 1 ft (30 cm).

The hood will lock audibly.

- ▶ Check to make sure the hood is fully closed.

If you can raise the hood at a point above the headlamps, then it is not properly closed. Open it again and let it drop with somewhat greater force.

Engine oil

The amount of oil your engine needs will depend on a number of factors, including driving style. Higher oil consumption can occur when

- the vehicle is new
- the vehicle is driven frequently at higher engine speeds

Engine oil consumption checks should only be made after the vehicle break-in period.



Do not use any special lubricant additives, as these may damage the drive assemblies. Using special additives not approved by Mercedes-Benz will restrict your warranty entitlement.

More information on this subject is available at any Mercedes-Benz Center.

Checking engine oil level



When checking the oil level the vehicle must

- be parked on level ground
- be at normal operating temperature
- have been stationary for at least five minutes with the engine turned off

To check the engine oil level via the multifunction display, do the following:

- ▶ Turn the SmartKey in the starter switch to position **2** or press the KEYLESS-GO start/stop button* twice.

The standard display (▷ page 134) should appear in the multifunction display.

- ▶ Press button  or , on the steering wheel until the following message is seen in the multifunction display:



Engine oil level - Measuring now!
Measurement correct only if veh.
level



One of the following messages will subsequently appear in the indicator:

- Engine oil level ok
- Add 1.0 qt. to reach max. oil level!
(Canada: 1.0 liter)
- Add 1.5 qts. to reach max. oil level!
(Canada: 1.5 liters)
- Add 2.0 qts. to reach max. oil level!
(Canada: 2.0 liters)



If you want to interrupt the checking procedure, press the  or  button on the multifunction steering wheel.

- ▶ If necessary, add engine oil.

For adding engine oil see (▷ page 284).

More information on engine oil can be found in the “Technical data” section (▷ page 400) and (▷ page 403).

Other display messages

If the SmartKey or KEYLESS-GO start/stop button* is not in position **2**, the following message will appear:

Turn on ignition
to see engine oil level!

- ▶ Switch on the ignition.

If you see the message:

Observe waiting period

Operation

Engine compartment

- ▶ If engine is at normal operating temperature, wait five minutes before repeating check procedure.
- ▶ If engine is not yet at normal operating temperature, wait 30 minutes before repeating check procedure.

If you see the message:

Engine oil level
Not when engine on!

- ▶ Turn off the engine.
- ▶ If the engine is at normal operating temperature, wait five minutes before checking oil.
- ▶ If the engine is not yet at normal operating temperature, you must wait 30 minutes before checking oil.

If there is excess engine oil with the engine at normal operating temperature, the following message will appear:

Engine oil level
Reduce oil level!

- ▶ Have excess oil siphoned or drained off. Contact an authorized Mercedes-Benz Center.



Excess oil must be siphoned or drained off. It could cause damage to the engine and catalytic converter not covered by the Mercedes-Benz Limited Warranty.

More information on messages in the display concerning engine oil can be found in the “Practical hints” section (▷ page 333).

Adding engine oil



Only use approved engine oils. For a listing of approved engine oils, refer to the Factory Approved Service Products pamphlet in your vehicle literature portfolio.

In addition, check the oil filler cap for important information pertaining to the engine oil needing to meet a specific Mercedes-Benz specification (e.g. MB 229.5). If such information is printed on the oil filler cap, only use an engine oil from the list of approved engine oils in the Factory Approved Service Products pamphlet that meets the specification indicated on the oil filler cap. Using engine oils of other specification may cause the FSS to incorrectly determine the next service interval and will result in engine damage not covered by the Mercedes-Benz Limited Warranty.



① Filler cap

- ▶ Unscrew filler cap ① from filler neck.
- ▶ Add engine oil as required. Be careful not to overfill with oil.

Be careful not to spill any oil when adding. Avoid environmental damage caused by oil entering the ground or water.



Excess oil must be siphoned or drained off. It could cause damage to the engine and catalytic converter not covered by the Mercedes-Benz Limited Warranty.

- ▶ Screw filler cap ① back on filler neck.

More information on engine oil can be found in the “Technical data” section (▷ page 400) and (▷ page 403).

Transmission fluid level

The transmission fluid level does not need to be checked. If you notice transmission fluid loss or gear shifting malfunctions, have an authorized Mercedes-Benz Center check the transmission.

Coolant level

The engine coolant is a mixture of water and anticorrosion/antifreeze. To check the coolant level, the vehicle must be parked on level ground and the engine must be cool.

The coolant expansion tank is located on the driver's side of the engine compartment.

Operation

Engine compartment

Warning!



In order to avoid any possibly serious burns:

- Use extreme caution when opening the hood if there are any signs of steam or coolant leaking from the cooling system, or if the coolant temperature gauge indicates that the coolant is overheated.
- Do not remove pressure cap on coolant reservoir if engine temperature is above 194°F (90°C). Allow engine to cool down before removing cap. The coolant reservoir contains hot fluid and is under pressure.
- Using a rag, slowly open the cap approximately $\frac{1}{2}$ turn to relieve excess pressure. If opened immediately, scalding hot fluid and steam will be blown out under pressure.
- Do not spill antifreeze on hot engine parts. Antifreeze contains ethylene glycol which may burn if it comes into contact with hot engine parts.

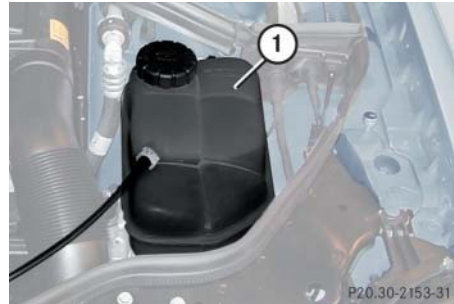

① Coolant expansion tank

- ▶ Using a rag, turn the cap slowly approximately one half turn to the left to release any excess pressure.
- ▶ Continue turning the cap to the left and remove it.

The coolant level is correct if the level:

- for cold coolant: reaches the black top part of the reservoir
- for warm coolant: is approximately 0.6 in (1.5 cm) higher

- ▶ Add coolant as required.
- ▶ Replace and tighten cap.

More information on coolant can be found in the “Technical data” section (▷ page 405).

Battery

Your vehicle is equipped with two batteries:

- Auxiliary battery (located in the engine compartment).
- Main battery (starter and electrical consumers; located in the trunk).

These batteries should always be sufficiently charged in order to achieve their rated service life. Refer to Service Booklet for battery maintenance intervals.

If you use your vehicle mostly for short-distance trips, you will need to have the battery charge checked more frequently.

When replacing batteries, always use batteries approved by Mercedes-Benz.

If you do not intend to operate your vehicle for an extended period of time, consult an authorized Mercedes-Benz Center about steps you need to observe.



Observe all safety instructions and precautions when handling automotive batteries.



Risk of explosion



Keep flames or sparks away from battery. Do not smoke.



Battery acid is caustic. Do not allow it to come into contact with skin, eyes or clothing.

In case it does, immediately flush affected area with clear water and seek medical help if necessary.

Operation

Engine compartment



Wear eye protection.



Keep children away.



Follow the instructions in this Operator's Manual.

Batteries contain materials that can harm the environment if disposed of improperly. Recycling of batteries is the preferred method of disposal. Many states require sellers of batteries to accept old batteries for recycling.

Operation

Engine compartment

Windshield washer system and headlamp cleaning system*

The windshield washer reservoir is located in the engine compartment.

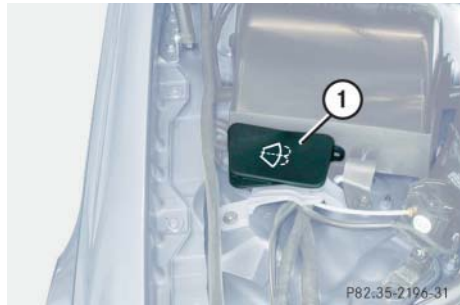

① Washer fluid reservoir

Fluid for the windshield washer system and the headlamp cleaning system is supplied from the windshield washer reservoir. It has a capacity of:

- Vehicles without headlamp cleaning system: approximately 4.8 US qt (4.5 l).
- Vehicles with headlamp cleaning system: approximately 7.4 US qt (7 l).

During all seasons, add MB Windshield Washer Concentrate “S” to water. Premix the windshield washer fluid in a suitable container.

- ▶ Refill the reservoir with MB Windshield Washer Concentrate and water (or commercially available premixed windshield washer solvent / antifreeze, depending on ambient temperatures).

Always use washer solvent/antifreeze where temperatures may fall below freezing point. Failure to do so could result in damage to the washer system/reservoir.



Only use washer fluid which is suitable for plastic lenses. Improper washer fluid can damage the plastic lenses of the headlamps.



The windshield washer system on this vehicle is heated, so a fluid mixture produced to resist freezing at temperatures of approximately 14° F (-10° C) should be sufficient.

Warning!



Washer solvent / antifreeze is highly flammable. Do not spill washer solvent / antifreeze on hot engine parts, because it may ignite and burn. You could be seriously burned.

More information can be found in the “Technical data” section (▷ page 407).

▼ Tires and wheels

See your authorized Mercedes-Benz Center for information on tested and recommended rims and tires for summer and winter operation. They can also offer advice concerning tire service and purchase.

Warning!



Replace rims or tires with the same designation, manufacturer and type as shown on the original part. See your authorized Mercedes-Benz Center for further information. If incorrectly sized rims and tires are mounted:

- The wheel brakes or suspension components can be damaged
- The correct operating clearance of the wheels and the tires are no longer guaranteed

Warning!



Worn, old tires can cause accidents. If the tire tread is badly worn, or if the tires have sustained damage, replace them.

When replacing rims, use only genuine Mercedes-Benz wheel bolts specified for the particular rim type. Failure to do so can result in the bolts loosening and possibly an accident.

Retreaded tires are not tested or recommended by Mercedes-Benz, since previous damage cannot always be recognized on retreads. Mercedes-Benz can therefore not assure the operating safety of the vehicle when such tires are used.

See your authorized Mercedes-Benz Center for information on tested and recommended rims and tires for summer and winter operation.

Operation

Tires and wheels

Important guidelines

- Only use sets of tires and rims of the same type and make.
- Tires must be of the correct size for the rim.
- Break in new tires for approximately 60 miles (100 km) at moderate speeds.
- Regularly check the tires and rims for damage. Dented or bent rims can cause tire pressure loss and damage to the tire beads.
- If vehicle is heavily loaded, check tire pressure and correct as required.
- Do not allow your tires to wear down too far. Adhesion properties on wet roads are sharply reduced at tread depths under $\frac{1}{8}$ in (3 mm).
- When replacing individual tires, you should mount new tires on the front wheels first (on vehicles with same-sized wheels all around).

Operation

Tires and wheels

Life of tire

The service life of a tire is dependent upon varying factors including but not limited to:

- Driving style
- Tire pressure
- Distance driven

Warning!



Tires and spare tire should be replaced after six years, regardless of the remaining tread.



Keep unmounted tires in a cool, dry place with as little exposure to light as possible. Protect tires from contact with oil, grease and gasoline.

Direction of rotation

Unidirectional tires offer added advantages, such as better hydroplaning performance. To benefit, however, you must ensure that the tires rotate in the direction specified.

An arrow on the sidewall indicates the intended direction of tire rotation.

Checking tire inflation pressure

Warning!



If the tire pressure drops repeatedly:

- Check the tires for punctures from foreign objects.
- Check to see whether air is leaking from the valves or from around the rim.

Regularly check your tire pressure at intervals of no more than 14 days.

Correct the tire pressure only when tires are cold.

If the tires are warm, you should only correct the tire pressure if it is too low for current operating conditions.

A table on the fuel filler flap lists the specified tire inflation pressures for warm and cold tires as well as for various operating conditions.



The pressures listed for light loads are minimum values offering high driving comfort.

Increased inflation pressures listed for heavier loads may also be used for light loads. These higher pressures produce favorable handling characteristics. The ride of the vehicle, however, will be somewhat harder. Never exceed the maximum values or inflate tires below the minimum values listed in the fuel filler flap.

Tire pressure changes by approximately 1.5 psi (0.1 bar) per 18°F (10°C) of air temperature change. Keep this in mind when checking tire pressure where the temperature is different from the outside temperature.

Tire temperature and tire pressure are also increased while driving, depending on the driving speed and the tire load.

Check the spare tire periodically for condition and inflation. Spare tires will age and become worn over time even if never used, and thus should be inspected and replaced when necessary.

Warning!



Follow recommended inflation pressures.

Do not overinflate tires. Overinflated tires can result in sudden deflation (blowout) because they are more likely to become punctured or damaged by road debris, potholes, etc.

Do not underinflate tires. Underinflated tires wear unevenly, adversely affect handling and fuel economy, and are more likely to fail from being overheated.

Do not overload the tires by exceeding the specified vehicle capacity weight (as indicated by the label on the pillar in the driver's door opening). Overloading the tires can overheat them, possibly causing a blowout.

Checking tire pressure electronically*

The tire inflation pressure monitor only functions on wheels that are equipped with the proper electronic sensors. It monitors the tire inflation pressure, as selected by the driver, in all four tires. A warning is issued to alert you to a decrease in pressure in one or more of the tires.

Tire pressure inquiries are made using the multifunction display (> page 129). The present inflation pressures are displayed only after a few minutes' travel time.

You can select the unit of measure used for the tire inflation pressure by changing the setting in the control system (> page 143).



Possible differences between the readings of a tire pressure gauge of an air hose, e.g. gas station equipment, and the vehicle's control system can occur. The readings issued by the control system are more precise.

- ▶ Switch on ignition.
- ▶ Press the  button until the current inflation pressures for each tire appear in the multifunction display.

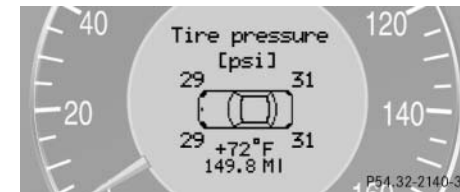

Operation

Tires and wheels

Warning!



The tire inflation pressure monitor does not indicate a warning for wrongly selected inflation pressures. Always adjust tire inflation pressure according to the label on the fuel filler cap.



The tire inflation pressure monitor is not able to issue a warning due to a sudden dramatic loss of pressure (e.g. tire blowout caused by a foreign object). In this case bring the vehicle to a halt by carefully applying the brakes and avoiding abrupt steering maneuvers.





Operating radio transmission equipment (e.g. wireless headsets, two-way radios) in or near the vehicle could cause the tire inflation pressure monitor to malfunction.

Activating the tire inflation pressure monitor

You must activate the tire inflation pressure monitor in the following cases:

- If you have changed the tire pressure
 - If you have replaced the wheels or tires
 - If you have installed new wheels or tires
- ▶ Make sure the tire pressure is correctly set.
- ▶ Press button  or  on the multifunction steering wheel repeatedly until the standard display menu appears in the multifunction display (▷ page 134).

- ▶ Press the  or  button repeatedly until you see the current inflation pressures for each tire appear in the display or the following message appears in the display

Tire pres. monitor
Pres. display after driving a few mins. Reactivate using R button



If transporting a deflated road wheel or additional wheel sensors in the vehicle, the tire inflation pressure monitor should not be reactivated until the deflated wheel or additional wheel sensors have been removed from the vehicle. Otherwise, the deflated wheel or additional sensors could cause the tire inflation pressure monitor system to malfunction.

- ▶ Press the reset button (▷ page 22).

The following message will appear in the multifunction display:
Check current tire pres.?

- ▶ Press the **+** button.

The following message will appear in the multifunction display field:
Tire pres. monitor acitvated

The tire inflation pressure monitor will now monitor the tire inflation pressure values of all four tires.

The following message will appear in the multifunction display field:
Tire pres. monitor
Pres. display after driving a few mins. Reactivate using R button

This display appears until the individual inflation pressure values are matched with the tires. The individual values are then displayed (▷ page 340).

If you wish to cancel activation:

- ▶ Press the **-** button.

If the following message appears in the multifunction display field:

Reactivate tire
Pres. monitor
or
Tire pres.
Check tires!

- ▶ Check the tire inflation pressures and correct them if necessary.
- ▶ Reactivate the tire inflation pressure monitor.

Operation

Tires and wheels

Rotating wheels

Warning!



Rotate front and rear wheels only if they are of the same size.

On vehicles with the same wheel size all around, wheels can be rotated every 3000 to 6000 miles (5000 to 10000 km), or sooner if necessary, according to the degree of tire wear. The same direction of tire rotation must be retained.

Rotate the wheels before the characteristic tire wear pattern becomes visible (shoulder wear on front wheels and tread center wear on rear wheels).

Thoroughly clean the inner side of the wheels after each rotation. Check and ensure proper tire inflation pressure.

Operation

Tires and wheels



If your vehicle is equipped with a tire inflation pressure monitor*, there are electronic components built into the wheel.

Do not use mounting tools in the area of the valve as they could damage the electronic components.

To prevent damage or incorrect installation, have the tires changed at an authorized Mercedes-Benz Center.

Warning!



Have the tightening torque checked after changing a wheel. Wheels could become loose if not tightened with a torque of 96 lb-ft (130 Nm).

Use only genuine Mercedes-Benz wheel bolts specified for your vehicle's rims.

For information on wheel change, see the “Practical hints” section (▷ page 350) and (▷ page 366).

▼ **Winter driving**

Before the onset of winter, have your vehicle winterized at an authorized Mercedes-Benz Center. This service includes:

- Check of anticorrosion and antifreeze concentration.
- Addition of cleaning concentrate to the water of the windshield and headlamp cleaning system. Add MB Concentrate “S” to a premixed windshield washer solvent / antifreeze which is formulated for temperatures below freezing point (▷ page 406).
- Battery test. Battery capacity drops with decreasing ambient temperature. A well charged battery helps to ensure that the engine can be started and the SBC brake system will be fully operational, even at low ambient temperatures.

- Tire change. Mercedes-Benz recommends M+S rated radial-ply tires with a minimum tread depth of approximately $\frac{1}{6}$ in (4 mm) on all four wheels for the winter season.

Winter tires

Always use winter tires at temperatures below 45°F (7°C) and whenever wintry road conditions prevail. Use of winter tires is the only way to achieve the maximum effectiveness of the ABS, ESP and 4MATIC in winter operation.

For safe handling, ensure that all mounted winter tires are of the same make and have the same tread design.

Warning!



Winter tires with a tread depth of less than $\frac{1}{6}$ in (4 mm) must be replaced. They are no longer suitable for winter operation.

Always observe the speed rating of the winter tires installed on your vehicle. If the maximum speed for which your tires are rated is below the speed rating of your vehicle, you must place a notice to this effect where it will be seen by the driver. Such notices are available at your tire dealer or any authorized Mercedes-Benz Center.

Warning!



If you use your spare tire when winter tires are fitted on the other wheels, be aware that the difference in tire characteristics may very well impair turning stability and that overall driving stability may be reduced. Adapt your driving style accordingly.

Have the spare tire replaced with a winter tire at the nearest authorized Mercedes-Benz Center.

Operation

Winter driving

Block heater* (Canada only)

The engine is equipped with a block heater.

The electrical cable may be installed at your authorized Mercedes-Benz Center.

Snow chains



When driving with snow chains, always select the raised level of the level control system Airmatic* (▷ page 227). Other settings may result in damage to your vehicle.

Snow chains should only be driven on snow-covered roads at speeds not to exceed 30 mph (50 km/h). Remove chains as soon as possible when driving on roads without snow.



When driving with snow chains, you may wish to deactivate the ESP (▷ page 78) before setting the vehicle in motion. This will improve the vehicle's traction.

Please observe the following guidelines when using snow chains:

- Use of snow chains is not permissible with all wheel/tire combinations.
- Snow chains should only be used on the rear wheels. Follow the manufacturer's mounting instructions.

- Only use snow chains that are approved by Mercedes-Benz. Your authorized Mercedes-Benz Center will be glad to advise you on this subject.
- Use of snow chains may be prohibited depending on location. Always check local and state laws before installing snow chains.



Even on vehicles with all-wheel-drive, use snow chains on rear tires only.

Use of snow chains is not permissible with the Minispare wheel and with tires of size 245/40 ZR 18 or 265/35 ZR18 (▷ page 394).

▼ Maintenance

Flexible Service System PLUS (FSS PLUS)

We strongly recommend that you have your vehicle serviced by your authorized Mercedes-Benz Center, in accordance with the Service Booklet at the times called for by the FSS PLUS (Flexible Service System PLUS).

Failure to have the vehicle maintained in accordance with the Service Booklet at the designated times/mileage called for by the FSS PLUS may result in vehicle damage not covered by the Mercedes-Benz Limited Warranty.

FSS PLUS will notify you when your next service is due.

Approximately one month before your next service is due, one of the following messages will appear in the multifunction display while you are driving or when you switch on the ignition (example service A):

Service A in XXXX miles (km)
Service A in XX days
Service A in X day
Service A due now!

The type of service due is indicated in the speedometer display field:

from Service A
(Minor service)
to Service H
(Major service)



Operation

Maintenance



The additional + after the type of service indicates the degree of wear of the brake pads.

The brake pads may reach their wear limit in the time period up to the next service interval.

Have the brake pads checked and, if necessary, replaced by an authorized Mercedes-Benz Center during your next service appointment.



The interval between services depends on your driving habits. A gentle driving style, moderate engine speeds and the avoidance of short-distance trips will lengthen the interval between services.

Operation

Maintenance

Clearing the service indicator

You can clear the service indicator

- ▶ Press the  button on the multifunction steering wheel.

The service indicator is cleared and the standard display appears in the multifunction display.



Service term exceeded

If you have exceeded the suggested service term, you will see the following message in the multifunction display:

Service A exceeded by XXXXX miles (km)
Service A exceeded by XXX days
Service A exceeded by X day

Any authorized Mercedes-Benz Center will reset the service indicator following a completed service.

Calling up the service indicator

- ▶ Switch the ignition on.
The standard display of the control system appears (▷ page 129).
- ▶ Press button  or  on the multifunction steering wheel until the FSS PLUS indicator appears in the multifunction display.





If the battery is disconnected, the days of disconnection will not be included in the count shown by the service indicator. To arrive at the true service deadline, you will need to subtract these days from the days shown in the service indicator.

Do not confuse the service indicator with the engine oil level indicator .

Resetting the service indicator

In the event that a service on your vehicle is not carried out by an authorized Mercedes-Benz Center, you can reset the service indicator yourself.

- ▶ Switch the ignition on.
The standard display of the control system appears (▷ page 134).
- ▶ Press button  or  on the multifunction steering wheel until the FSS PLUS indicator appears in the multifunction display.
- ▶ Press the reset button (▷ page 22) for about five seconds.

The SERVICE MENU appears in the multifunction display.



- ▶ Select the CONFIRMATION menu with the **+** or **-** button.

- ▶ Press the  button.

The service indicator now displays the CONFIRMATION menu.

The selection marker is on CONFIRM.



- ▶ Press the  button.

The service indicator now displays the CONFIRM menu.

The selection maker is on STANDARD OIL.

- ▶ Press the  button.

The words SERVICE CONFIRMED appear in the multifunction display.



The service indicator is reset.

- ▶ Press the  button on the multifunction steering wheel until the standard display appears in the multifunction display.

FSS PLUS now recalculates the values. You cannot call up the service display or the service menu during this time.



If the service indicator was inadvertently reset, have an authorized Mercedes-Benz Center correct it.

Only reset if the proper service has been performed. Resetting the system without performing proper service as called for by the FSS PLUS will cause the FSS PLUS to incorrectly determine the next service interval which will result in engine damage not covered by the Mercedes-Benz Limited Warranty.

Operation



Maintenance

Setting the date for special works

You can enter appointments for exhaust gas analysis and general inspection over FSS PLUS.

- ▶ Switch ignition on.

The standard display of the control system appears (▷ page 129).



- ▶ Press button  or  on the multifunction steering wheel until the FSS PLUS indicator appears in the multifunction display.
- ▶ Press the reset button (▷ page 22) for about five seconds.

The SERVICE MENU appears in the multifunction display.

- ▶ Select the SPECIAL WORK menu with the  or  button.
- ▶ Press the  button.

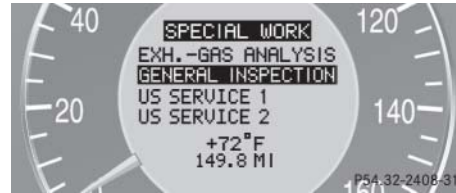
The service indicator now displays the SPECIAL WORK menu.







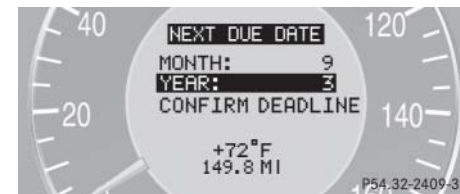

- ▶ Select the EXH.-GAS ANALYSIS or GENERAL INSPECTION menu with the  or  button.

- ▶ Press the  button.

The service indicator now displays the NEXT DUE DATE menu.



- ▶ Select the MONTH and YEAR with the  or  button.
 - ▶ Press button  or  on the multifunction steering wheel to set the month and year.
 - ▶ Select CONFIRM DEADLINE with the  or  button.
 - ▶ Press the  button.
- The new date is set.

- ▶ Press the  button on the multifunction steering wheel until the standard display appears in the multifunction display.





FSS PLUS now recalculates the values. You cannot call up the service display or the service menu during this time.

Calling up the service data information

FSS PLUS shows the service type (letters A-H) in the multifunction display approximately one month before the service appointment is due in miles (distance criterion) or in days (time criterion). This service type is based on the service items to be carried out. The service items are described in the Service Booklet.

The service items to be carried out under the corresponding service type can be displayed in the multifunction display.

Calling up the service item menu

- ▶ Switch ignition on.
The standard display of the control system appears (▷ page 134).
- ▶ Press button  or  on the multifunction steering wheel until the FSS PLUS indicator appears in the multifunction display.
- ▶ Press the reset button (▷ page 22) for about five seconds.
The SERVICE MENU appears in the multifunction display (▷ page 134).
- ▶ Select the ITEMS menu with the  or  button.
- ▶ Press the  button.

Operation

Maintenance

The service indicator now displays the ITEMS menu.



The service items to be carried out are shown in this menu.

Please refer to the Service Booklet for a description of each service item.

- ▶ Press button  on the multifunction steering wheel until the standard display appears in the multifunction display.

Operation

Vehicle care

▼ Vehicle care

Cleaning and care of vehicle

Warning!



Many cleaning products can be hazardous. Some are poisonous, others are flammable. Always follow the instructions on the particular container. Always open your vehicle's doors or windows when cleaning the inside. Never use fluids or solvents that are not designed for cleaning your vehicle.

While in operation, even while parked, your vehicle is subjected to varying external influences which, if gone unchecked, can attack the paintwork as well as the undercarriage and cause lasting damage.

Such damage is caused not only by extreme and varying climatic conditions, but also by:

- Air pollution
- Road salt
- Tar
- Gravel and stone chipping

To avoid paint damage, you should immediately remove:

- Grease and oil
- Fuel
- Coolant
- Brake fluid
- Bird droppings
- Insects
- Tree resins etc.

Frequent washing reduces and /or eliminates the aggressiveness and potency of the above adverse influences.

More frequent washings are necessary to deal with unfavorable conditions:

- Near the ocean
- In industrial areas (smoke, exhaust emissions)
- During winter operation

You should check your vehicle from time to time for stone chipping or other damage. Any damage should be repaired as soon as possible to prevent corrosion.

In doing so, do not neglect the underbody of the vehicle. A prerequisite for a thorough check is a washing of the underbody followed by a thorough inspection. Damaged areas need to be re-undercoated.

Your vehicle has been treated at the factory with a wax-base rustproofing in the body cavities which will last for the lifetime of the vehicle. Post-production treatment is neither necessary nor recommended by Mercedes-Benz because of the possibility of incompatibility between materials used in the production process and others applied later.

We have selected car-care products and compiled recommendations which are specially matched to our vehicles and which always reflect the latest technology. You can obtain Mercedes-Benz approved car-care products at your authorized Mercedes-Benz Center.

Scratches, corrosive deposits, corrosion or damage due to negligent or incorrect care cannot always be removed or repaired with the car-care products recommended here. In such cases it is best to seek aid at your authorized Mercedes-Benz Center.

The following topics deal with the cleaning and care of your vehicle and give important “how-to” information as well as references to Mercedes-Benz approved car-care products.

Additional information can be found in the booklet “Vehicle Care Guide”.

Power washer

When using a power washer for cleaning the vehicle, always observe the manufacturer’s operating instructions.



Vehicles with KEYLESS-GO*:

If a door handle is hit by a strong jet of water, and a SmartKey with KEYLESS-GO* is in close proximity, i.e. within approximately 3 ft (approximately 1 m), the vehicle could be inadvertently locked or unlocked.



Never use a round nozzle to power-wash tires. The intense jet of water can result in damage to the tire.

Always replace a damaged tire.

Always keep the jet of water moving across the surface. Do not aim directly at electrical parts, electrical connectors, seals, or other rubber parts.

Tar stains

Quickly remove tar stains before they dry and become more difficult to remove. A tar remover is recommended.

Paintwork, painted body components

Mercedes-Benz approved Paint Care should be applied when water drops on the paint surface do not “bead up”, normally every three to five months, depending on climate and washing detergent used.

Mercedes-Benz approved Paint Cleaner should be applied if the paint surface shows signs of embedded dirt (i.e. loss of gloss).

Do not apply any of these products or wax if your vehicle is parked in the sun or if the hood is still hot.

Use the appropriate MB-Touch-Up Stick for quick and provisional repairs of minor paint damage (i.e. chips from stones, vehicle doors, etc.).

Operation

Vehicle care

Engine cleaning

Prior to cleaning the engine compartment, make sure to protect electrical components and connectors from contact with water and cleaning agents.

Corrosion protection, such as MB Anticorrosion Wax should be applied to the engine compartment after every engine cleaning. Before applying, all control linkage bushings and joints should be lubricated. The poly-V-belt and all pulleys should be protected from any wax.

Vehicle washing

Do not use hot water or wash your vehicle in direct sunlight. Use only a mild car wash detergent, such as Mercedes-Benz approved Car Shampoo.

Thoroughly spray the vehicle with a diffused jet of water. Direct only a very weak spray towards the ventilation intake. Use plenty of water and rinse the sponge and chamois frequently.

Rinse with clear water and thoroughly dry with a chamois. Do not allow cleaning agents to dry on the finish.

Due to the width of the vehicle, fold in outside mirrors prior to running the vehicle through an automatic car wash to prevent damage to the mirrors.

In the winter, thoroughly remove all traces of road salt as soon as possible.

When washing the undercarriage, do not forget to clean the inner sides of the wheels.



Vehicles with KEYLESS-GO*:
If a door handle is hit by a strong jet of water, and a SmartKey with KEYLESS-GO* is in close proximity, i.e. within approximately 3 ft (approximately 1 m), the vehicle could be inadvertently locked or unlocked.

Ornamental moldings

For regular cleaning and care of very dirty chrome-plated parts, use a chrome cleaner.

Headlamps, tail lamps, side markers, turn signal lenses

Use a mild car wash detergent, such as Mercedes-Benz approved Car Shampoo, with plenty of water.

To prevent scratches, never apply strong force and use only a soft, non-scratchy cloth when cleaning the lenses. Do not attempt to wipe dirty lenses with a dry cloth or sponge.

Cleaning the Distronic* system sensor cover

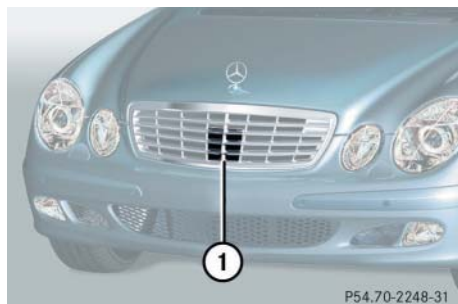

① Distronic system sensor cover

Use a mild car wash detergent, such as Mercedes-Benz approved Car Shampoo, with plenty of water to clean sensor cover ①.

To prevent scratches, never apply strong force and use only a soft, non-scratchy cloth when cleaning the sensor cover. Do not attempt to wipe dirty sensors with a dry cloth or sponge.



Restart the engine after cleaning sensor cover ①.

Cleaning the Parktronic* system sensors

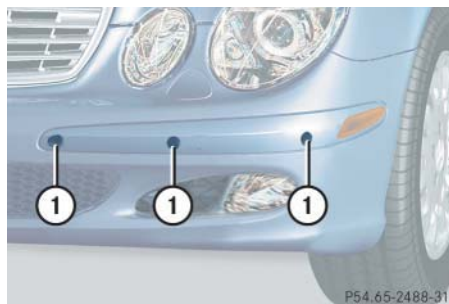

① Parktronic* sensors

Use a mild car wash detergent, such as Mercedes-Benz approved Car Shampoo with plenty of water.

When using a steam cleaner or power washer, aim nozzle only briefly from a minimum distance of 11.8 in (30 cm) at sensors ①.

To prevent scratches, never apply strong force and use only a soft, non-scratchy cloth when cleaning the sensor. Do not attempt to wipe dirty sensors with a dry cloth or sponge.

Wiper blades



Fold the windshield wiper arms away from the windshield to a vertical position only. They could otherwise damage the hood.

- Turn on the wipers and place it in a vertical position.

For information on placing the wipers in a vertical position, see “Replacing wiper blades” (▷ page 364).



Operation

Vehicle care



Warning!



For safety reasons, switch off wipers and remove SmartKey from starter switch before cleaning the wiper blades, otherwise the wiper motor might suddenly turn on and cause injury.

- ▶ Clean the wiper blade inserts with a clean cloth and detergent solution.



Fold the windshield wiper arms back onto the windshield before turning the SmartKey in the starter switch.

Hold on to the wiper when folding the wiper arm back. If released, the force of the impact from the tensioning spring could crack the windshield.

Window cleaning



Fold the windshield wiper arms away from the windshield to a vertical position only. They could otherwise damage the hood.

- ▶ Turn on the wipers and place it in a vertical position.

For information on placing the wipers in a vertical position, see “Replacing wiper blades” (▷ page 364).

Warning!



For safety reasons, switch off wipers and remove SmartKey from starter switch before cleaning the windshield, otherwise the wiper motor might suddenly turn on and cause injury.

Use a window cleaning solution on all glass surfaces. An automotive glass cleaner is recommended.



Fold the windshield wiper arms back onto the windshield before turning the SmartKey in the starter switch.

Hold on to the wiper when folding the wiper arm back. If released, the force of the impact from the tensioning spring could crack the windshield.

Light alloy wheels

Mercedes-Benz approved Wheel Care should be used for regular cleaning of the light alloy wheels.

If possible, clean wheels once a week with Mercedes-Benz approved Wheel Care, using a soft bristle brush and a strong spray of water.

Follow the instructions on the container.



Use only acid-free cleaning materials. Acid could lead to corrosion.

Instrument cluster

Use a gentle dishwashing detergent or mild detergent for delicate fabrics as a washing solution. Wipe with a cloth moistened in a lukewarm solution. Do not use scouring agents.

Steering wheel and gear selector lever

Wipe with a damp cloth and dry thoroughly or clean with Mercedes-Benz approved Leather Care.

Cup holder

Use a gentle dishwashing detergent or mild detergent for delicate fabrics as a washing solution. Wipe with a cloth moistened in lukewarm solution. Do not use scouring agents.

Hard plastic trim items

Pour Mercedes-Benz approved Interior Care onto a soft, lint-free cloth and apply with light pressure.

Headliner and shelf below rear window

Clean with a soft bristle brush, or use a dry-shampoo cleaner in case of excessive dirt.

Seat belts

The webbing must not be treated with chemical cleaning agents. Use only clear, lukewarm water and soap. Do not dry the webbing at temperatures above 176°F (80°C) or in direct sunlight.

Warning!

Do not bleach or dye seat belts as this may severely weaken them. In a crash they may not be able to provide adequate protection.

Operation

Vehicle care

Leather upholstery

Using aftermarket seat covers or wearing clothing that has the tendency to give off coloring (e.g. when wet, etc.) may cause the upholstery to become permanently discolored. By lining the seats with a proper intermediate cover, contact-discoloration will be prevented.

Wipe leather upholstery with a damp cloth and dry thoroughly or clean with Mercedes-Benz approved Leather Care. Exercise particular care when cleaning perforated leather as its underside should not become wet.

Nubuck leather upholstery (E 55 AMG)

The nubuck leather upholstery is treated with a protective coating. Wipe nubuck leather upholstery with damp microfiber cloth to remove dust and other light stains. Carefully dab nubuck leather upholstery with a microfiber cloth to remove oil stains.



Do not use Mercedes-Benz approved Leather Care or any solvents to clean nubuck leather upholstery.

Avoid hard scrubbing on nubuck leather upholstery.

MB Tex upholstery

Pour Mercedes-Benz approved Interior Care onto a soft, lint-free cloth and apply with light pressure.

Plastic and rubber parts

Do not use oil or wax on these parts.

Wood trims

Dampen cloth using water and use damp cloth to clean wood trims in your vehicle. Do not use solvents like tar remover or wheel cleaner nor polishes or waxes as these may be abrasive.

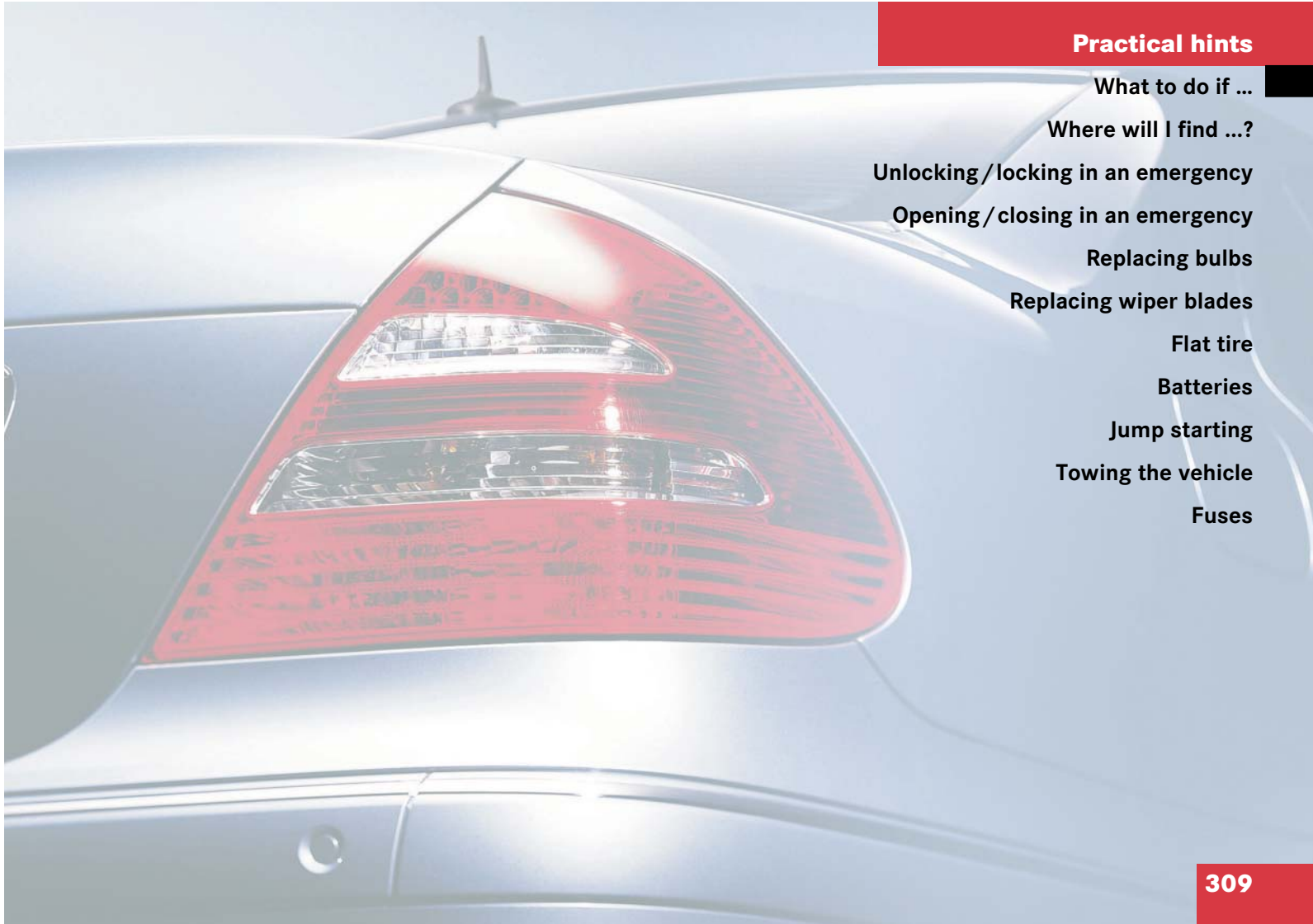

Practical hints

What to do if ...

Where will I find ...?

Unlocking/locking in an emergency

Opening/closing in an emergency

Replacing bulbs

Replacing wiper blades

Flat tire

Batteries

Jump starting

Towing the vehicle

Fuses

Practical hints

What to do if ...

▼ What to do if ...

Lamps in instrument cluster

General information:



If a bulb in the instrument cluster fails to come on during the bulb self-check when

turning the SmartKey in the starter switch to position **2**, have it checked and replaced if necessary.

Problem	Possible cause	Suggested solution
 The yellow ABS malfunction warning lamp comes on while driving.	<p>The ABS has detected a malfunction and has switched off. The BAS and the ESP are also switched off (see messages in display).</p> <p>The SBC brake system is still functioning normally but without the ABS available.</p> <p>If the ABS control unit is malfunctioning, other systems such as the Parktronic system*, DISTRONIC*, or the automatic transmission may also be malfunctioning.</p>	<ul style="list-style-type: none"> ▶ Continue driving with added caution. Wheels may lock during hard braking, reducing steering capability. ▶ Have the system checked at an authorized Mercedes-Benz Center as soon as possible. <p>Failure to follow these instructions increases the risk of an accident.</p> <ul style="list-style-type: none"> ▶ Read and observe messages in the display (▷ page 318).
	<p>The charging voltage has fallen below 10 volts. The ABS has switched off.</p>	<p>When the voltage is above this value again, the ABS is operational again.</p> <ul style="list-style-type: none"> ▶ If necessary, have the generator and battery checked.



Practical hints

What to do if ...

Problem	Possible cause	Suggested solution
 The yellow ABS / ESP warning lamp comes on while driving.	The ESP is deactivated. Risk of accident! Adapt your speed and driving to the prevailing road conditions.	<ul style="list-style-type: none">▶ Turn the ESP back on (▷ page 79). If the ESP cannot be turned back on, have the system checked at an authorized Mercedes-Benz Center as soon as possible.
 The yellow ABS / ESP warning lamp flashes while driving.	The ABS, ESP or traction control has come into operation because of detected traction loss in at least one tire. Distronic* is deactivated. Distronic* is switched off.	<ul style="list-style-type: none">▶ When driving off, apply as little throttle as possible.▶ While driving, ease up on the accelerator.▶ Adapt your speed and driving to the prevailing road and weather conditions.▶ Do not deactivate the ESP. Exceptions: (▷ page 79). Failure to follow these instructions increases the risk of accidents.

Practical hints

What to do if ...

Problem	Possible cause	Suggested solution
 (Canada only)  (USA only) The red brake warning lamp comes on while driving and you hear a warning sound.	You are driving with the parking brake set.	<ul style="list-style-type: none"> ▶ Release the parking brake. ▶ Observe the additional message in the display.
The red brake warning lamp comes on while driving.	<ul style="list-style-type: none"> • There is a malfunction in the SBC brake system. • There is insufficient brake fluid in the reservoir. 	<ul style="list-style-type: none"> ▶ Risk of accident! Do not drive any further. Consult a Mercedes-Benz Service Center. Under no circumstances should you top up the brake fluid. This will not solve the problem.

Warning!



Driving with the brake warning lamp illuminated can result in an accident. Have your brake system checked immediately if the brake warning lamp stays on. Do not add brake fluid before checking the brake system.

Overfilling the brake fluid reservoir can result in spilling brake fluid on hot engine parts and the brake fluid catching fire. You can be seriously burned.



If you find that the brake fluid in the brake fluid reservoir has fallen to the minimum mark or below, have the brake system checked for brake pad thickness and leaks.



Practical hints

What to do if ...

Problem	Possible cause	Suggested solution
CHECK ENGINE The yellow "CHECK ENGINE" malfunction indicator lamp comes on while driving.	There is a malfunction in: <ul style="list-style-type: none">• The fuel management system• The ignition system• The emission control system• Systems which affect emissions Such malfunctions may result in excessive emissions values and may switch the engine to its limp-home (emergency operation) mode.	▶ Have the vehicle checked as soon as possible by an authorized Mercedes-Benz Center. An on-board diagnostic connector is used by the service station to link the vehicle to the shop diagnostics system. It allows the accurate identification of system malfunctions through the readout of diagnostic trouble codes. It is located in the front left area of the footwell next to the parking brake.
	The fuel cap is not closed tightly.	▶ Check the fuel cap.
	Your gas tank is empty.	▶ After refuelling, start the engine three or four times in succession. The limp-home mode is canceled. You do not need to have your vehicle checked.

Practical hints

What to do if ...

Problem	Possible cause	Suggested solution
 <p>The red coolant warning lamp comes on when the engine is running.</p>	<p>There is insufficient coolant in the reservoir.</p> <p>If this warning lamp comes on frequently, there is a leak in the cooling system.</p> <p>If the coolant level is correct, the electric radiator fan may be broken.</p>	<ul style="list-style-type: none"> ▶ Immediately add coolant to prevent engine from overheating (▷ page 285). ▶ Have the cooling system checked. ▶ If the coolant temperature is below 257 °F (125 °C), you can continue driving to the nearest authorized Mercedes-Benz Center. ▶ Avoid high engine loads (e.g. driving uphill) and stop-and-go driving.
 <p>The red coolant warning lamp comes on while driving and you hear a warning sound.</p>	<p>The coolant temperature has exceeded 257 °F (125 °C).</p>	<ul style="list-style-type: none"> ▶ Stop as soon as possible and allow the engine and coolant to cool down.

Warning!



Driving when your engine is badly overheated can cause some fluids which may have leaked into the engine compartment to





catch fire. You could be seriously burned.

Steam from an overheated engine can cause serious burns and can occur just by opening the engine hood. Stay away from the engine if you see or hear steam coming from it.

Turn off the engine, get out of the vehicle and do not stand near the vehicle until the engine has cooled down.

Practical hints

What to do if ...

Problem	Possible cause	Suggested solution
 The red DTR warning lamp comes on while driving.	You are too close to the vehicle in front of you to maintain selected speed.	▶ Apply the brakes immediately to increase the following distance.
 The red DTR warning lamp comes on while driving and you hear a warning sound.	<ul style="list-style-type: none">• You are gaining too rapidly on the vehicle ahead of you.• The distance warning system has recognized a stationary obstacle on your probable line of travel.	<ul style="list-style-type: none">▶ Apply the brakes immediately.▶ Carefully observe the traffic situation. You may need to brake or maneuver to avoid hitting an obstacle.
 The yellow fuel tank reserve warning lamp comes on while driving.	The fuel level has gone below the reserve mark.	▶ Refuel at the next gas station (▷ page 278).
 The red seat belt warning lamp flashes for a brief period after starting the engine.	The warning lamp reminds you to fasten seat belts.	▶ Fasten your seat belt.

Practical hints

What to do if ...

Problem	Possible cause	Suggested solution
SRS The red SRS indicator lamp comes on while driving.	There is a malfunction in the restraint systems. The airbags or emergency tensioning devices (ETDs) could deploy unexpectedly or fail to activate in an accident.	► Drive with added caution to the nearest authorized Mercedes-Benz Center.

Warning!



In the event a malfunction of the SRS is indicated as outlined above, the SRS may not be operational. For your safety, we strongly recommend that you visit an authorized Mercedes-Benz Center immediately to have the system checked; otherwise the SRS may not be activated when needed in an accident, which could result in serious or fatal injury, or it might deploy unexpectedly and unnecessarily which could also result in an accident and /or injury to you or to others.

Lamp in center console

Problem	Possible cause	Suggested solution
<p>PASSENGER AIRBAG OFF</p> <p>The indicator lamp comes on.</p>	<p>A BabySmart™ child seat is installed on the front passenger seat. Therefore, the front passenger airbag is switched off.</p> <p>The system is malfunctioning when there is no BabySmart™ child seat installed on the front passenger seat.</p>	<ul style="list-style-type: none"> ▶ Have the system checked as soon as possible by an authorized Mercedes-Benz Center.
<p>PASSENGER AIRBAG OFF</p> <p>The indicator lamp does not come on with a BabySmart™ child seat properly installed on the front passenger seat.</p>	<p>The system is malfunctioning.</p>	<ul style="list-style-type: none"> ▶ Make sure there is nothing between seat cushion and child seat and check installation of the child seat. ▶ If the light remains out, have the system checked as soon as possible by an authorized Mercedes-Benz Center. <p>Do not use the BabySmart™ restraint to transport children on the front passenger seat until the system has been repaired.</p>

Practical hints

What to do if ...

Messages in the display

The control system shows warning and malfunction messages in the multifunction display.

Certain warning and malfunction messages are accompanied by an audible signal.

Address these messages accordingly and follow the additional instructions given in this Operator's Manual.

Selecting the malfunction memory menu in the control system (▷ page 129) displays both cleared and uncleared messages.

High-priority messages appear in the multifunction display in red color.

Certain messages of high priority cannot be cleared from the multifunction display using the reset button.

Other messages of high priority and messages of less immediate priority can be cleared from the multifunction display using the reset button (▷ page 22) and are then stored in the malfunction message memory (▷ page 137).

Warning!



All categories of messages contain important information which should be taken note of and, where a malfunction is indicated, addressed as soon as possible at an authorized Mercedes-Benz Center.

Failure to repair condition noted may cause damage not covered by the Mercedes-Benz Limited Warranty, or result in property damage or personal injury.

Warning!



No messages will be displayed if either the instrument cluster or the multifunction display is inoperative.

Contact your nearest authorized Mercedes-Benz Center.



Turning the SmartKey in the starter switch to position **2**, or pressing the KEYLESS-GO* start / stop button twice to position **2** causes all lamps as well as the multifunction display to come on. Ensure that they are all in working order before starting your journey.

On the pages that follow, you will find a compilation of the most important warning and malfunction messages that may appear in the display. High priority messages appear on a red background.

Text messages

Display	Display message	Possible cause	Possible solution
ABS	Malfunction! Visit workshop!	The ABS has detected a malfunction and has switched off. The ESP and the BAS are also deactivated. The SBC brake system is still functioning normally but without the ABS available.	<ul style="list-style-type: none"> ▶ Continue driving with added caution. Wheels will lock during hard braking, reducing steering capability. ▶ Have the system checked at an authorized Mercedes-Benz Center as soon as possible. <p>Failure to follow these instructions increases the risk of accident.</p>
	Display malfunction Visit workshop!	The ABS or the ABS display is malfunctioning.	<ul style="list-style-type: none"> ▶ Continue driving with added caution. ▶ Visit an authorized Mercedes-Benz Center as soon as possible. <p>Failure to follow these instructions increases the risk of accident.</p>

Practical hints

What to do if ...

Display	Display message	Possible cause	Possible solution
Battery Protection	Conven. Functions Temporarily Unavailable	The battery has insufficient voltage and can no longer supply convenience functions such as the rear window defroster.	As soon as the on-board voltage is sufficient, the consumers will switch on again.
Please Note:	Conven. Functions Available Again	On-board voltage is sufficient; the consumers will switch on again.	
Cruise control	Visit workshop!	Cruise control or Distronic* is malfunctioning.	▶ Have the cruise control or Distronic* checked by an authorized Mercedes-Benz Center.
Distronic	External interference Reactivate!	The Distronic* is switched off and is temporarily unavailable.	▶ Try activating the Distronic* again later.
	Visit workshop!	The Distronic* is malfunctioning or the display is malfunctioning.	▶ Visit an authorized Mercedes-Benz Center as soon as possible.

Practical hints

What to do if ...

Display	Display message	Possible cause	Possible solution
DISTRONIC	Currently unavailable see oper. manual	DISTRONIC* is switched off if: <ul style="list-style-type: none">• the DISTRONIC cover in the area of the radiator grille is dirty• the functionality is impaired by heavy rain or thick fog	<ul style="list-style-type: none">▶ If necessary, clean the DISTRONIC cover in the area of the radiator grille.▶ Restart the vehicle. or DISTRONIC* becomes operational again without the engine being restarted when: <ul style="list-style-type: none">• dirt on the grille falls off while driving (e.g. slush or snow)• the system recognizes full sensor availability (due to lessening rain or the road surface drying)• the message in the multifunction display disappears• the speed last stored flashes in the display for five seconds. You can operate DISTRONIC* as usual again.

Practical hints

What to do if ...

Display	Display message	Possible cause	Possible solution
ESP	Malfunction! Visit workshop!	The ESP has detected a malfunction and switched off. The SBC brake system is still functioning normally. The ABS may still be operational.	<ul style="list-style-type: none">▶ Continue driving with added caution.▶ Have the system checked at an authorized Mercedes-Benz Center as soon as possible. Failure to follow these instructions increases the risk of an accident.
	Display malfunction Visit workshop!	The ESP or the ESP display is malfunctioning.	<ul style="list-style-type: none">▶ Continue driving with added caution.▶ Visit an authorized Mercedes-Benz Center as soon as possible. Failure to follow these instructions increases the risk of accident.

Practical hints

What to do if ...

Display	Display message	Possible cause	Possible solution
ESP	not available! See Operator's Manual	The ESP is deactivated because of a malfunction or interrupted power supply. The SBC brake system is still functioning normally.	<ul style="list-style-type: none"> ▶ Synchronize the ESP. With the vehicle stationary, turn the steering wheel completely to the left and then to the right to synchronize the ESP. <p>If the ESP message does not go out:</p> <ul style="list-style-type: none"> ▶ Continue driving with added caution. ▶ Visit an authorized Mercedes-Benz Center as soon as possible. <p>Failure to follow these instructions increases the risk of accident.</p>
P	Gear selector lever in P	You have turned off the engine with the KEYLESS-GO* start/stop button* and opened the driver's door.	▶ Place the gear selector lever in position P .
P/N	Shift to N or P	You have attempted to start the engine with the KEYLESS-GO* start/stop button while the gear selector lever was in position R or D .	▶ Place the gear selector lever in position P or N .

Practical hints



What to do if ...

Symbol messages

Display symbol	Display messages	Possible cause	Possible solution
	Undervoltage Switch off consumers	The battery has insufficient voltage.	▶ Turn off unnecessary electrical consumers.
	Visit workshop!	The battery was charged with a battery charger or jump started.	▶ Have the battery checked at a service station.
		The battery is no longer charging. Possible causes: <ul style="list-style-type: none"> • alternator malfunctioning • broken poly-V-belt Do not forget that the brake system requires electrical energy and may be operating with restricted capability. Considerably greater brake pedal force is required and the stopping distance is increased.	▶ Stop immediately and check the poly-V-belt. If it is broken: <ul style="list-style-type: none"> ▶ Do not continue to drive. Otherwise the engine will overheat due to an inoperative water pump which may result in damage to the engine. Notify an authorized Mercedes-Benz Center. If it is intact: <ul style="list-style-type: none"> ▶ Drive immediately to the nearest authorized Mercedes-Benz Center. Adjust driving to be consistent with reduced braking responsiveness.





Practical hints

What to do if ...

Display symbol	Display messages	Possible cause	Possible solution
	Battery/Alternator Stop vehicle!	The battery is malfunctioning. The SBC brake system requires electrical energy and therefore has only limited operation. Considerably greater brake pedal force is required and the stopping distance is increased.	<ul style="list-style-type: none"> ▶ Stop the vehicle as soon as it is safe to do so. Adjust driving to be consistent with reduced braking responsiveness. ▶ Notify an authorized Mercedes-Benz Center.
	Undervoltage Charge battery	The battery has insufficient voltage.	▶ Start the engine (▷ page 43).
	Malfunction Electrical consumers switched off	The consumer battery has insufficient voltage and can no longer supply the convenience functions such as seat ventilation*.	The electrical consumers will come back online as soon as on-board voltage is sufficient.
	Backrest, rear right not locked	The rear seat backrest is not engaged.	▶ Adjust the rear seat backrest until it is fully engaged in position.
	Backrest rear left not locked	The rear seat backrest is not engaged.	▶ Adjust the rear seat backrest until it is fully engaged in position.



Practical hints

What to do if ...

Display symbol	Display messages	Possible cause	Possible solution
	Brake wear Visit workshop!	The brake pads have reached their wear limit.	<ul style="list-style-type: none"> ▶ Brake pad thickness must be visually inspected at the intervals specified in the Service Booklet. ▶ Have the brake pads replaced as soon as possible.
	Brake malfunction Stop vehicle	<p>The SBC brake system is in the emergency operation mode. Considerably greater brake pedal force is required and the stopping distance is increased.</p> <p>Do not exceed a speed of 55 mph (90 km/h).</p>	<ul style="list-style-type: none"> ▶ Do not drive any further. ▶ Stop the vehicle and notify an authorized Mercedes-Benz Center. ▶ Significantly greater force must be applied to the brake pedal. ▶ Call for Roadside Assistance.
Except Canada:  Canada only: 	Reduced braking effect Start engine! Longer stopping dist. Start engine!	The battery has insufficient voltage and cannot supply sufficient power to the SBC brake system.	<ul style="list-style-type: none"> ▶ Start the engine. <p>The message disappears when sufficient voltage is available</p>



Practical hints

What to do if ...

Display symbol	Display messages	Possible cause	Possible solution
Except Canada:  Canada only: 	Reduced braking effect Visit workshop! Longer stopping dist. Visit workshop!	The SBC brake system is in emergency operation mode. Considerable brake pedal force is required and the stopping distance is increased.	<ul style="list-style-type: none"> ▶ Continue driving with added caution. ▶ Adjust driving to be consistent with reduced braking responsiveness.
	Service brake! Visit workshop!	There are malfunctions, but the SBC brake system is operating normally.	<ul style="list-style-type: none"> ▶ Visit an authorized Mercedes-Benz Center as soon as possible.
	Brake overheated! Drive carefully!	The brake system is overheated due to an excessive load on the brakes.	<ul style="list-style-type: none"> ▶ Relieve the load on the brake system. ▶ Drive more smoothly and think ahead to avoid unnecessary braking. ▶ When driving down slopes, shift into a lower gear to use the engine's braking power (▷ page 159). ▶ Cautiously continue driving so that the air stream will cool down the brakes.
	Release park. brake!	You are driving with the parking brake set.	<ul style="list-style-type: none"> ▶ Release the parking brake (▷ page 45).

Practical hints

What to do if ...

Display symbol	Display messages	Possible cause	Possible solution
Except Canada:  Canada only: 	Brake fluid Visit workshop!	There is insufficient brake fluid in the reservoir.	► Risk of accident! Stop the vehicle and notify an authorized Mercedes-Benz Center. Do not add brake fluid! This will not solve the problem.

Warning!



Driving while these messages are displayed can result in an accident. Have your brake system checked immediately.

If there is a malfunction in the SBC brake system, we recommend that the vehicle be transported with all wheels off the ground using flatbed or appropriate wheel lift / dolly equipment.

A tow bar must be used if circumstances do not permit the use of the recommended towing methods and the vehicle requires towing with all four wheels on the ground.

Towing the vehicle with all four wheels on the ground is only permissible for distances up to 30 miles (50 km) and at a speed not to exceed 30 mph (50 km/h). For more information, refer to "Towing the vehicle" (▷ page 381).

If the SBC brake system enters its emergency operation mode, the driver must apply significantly greater brake pedal pressure and depress the pedal much further than normal to obtain braking effect. If necessary, apply full pressure to the brake pedal. Brakes may only be applied to the front wheels. Stopping distance is increased!

Low brake fluid in the reservoir may cause the braking system to fail!

Don't add brake fluid before checking the brake system. Overfilling the brake fluid reservoir can result in spilling brake fluid on hot engine parts and the brake fluid catching fire. You can be seriously burned.





If you find that the brake fluid in the brake fluid reservoir has fallen to the minimum mark or below, have the brake system checked for brake pad thickness and leaks.



Brake pad thickness must be visually inspected by a qualified technician at the intervals specified in the Service Booklet.

Practical hints

What to do if ...

Display symbol	Display messages	Possible cause	Possible solution
	Visit workshop!	There may be a malfunction in the: <ul style="list-style-type: none">• fuel injection system• ignition system• exhaust system• fuel system	<ul style="list-style-type: none">▶ Have the measuring system checked by an authorized Mercedes-Benz Center.
	Coolant Check level	The coolant level is too low.	<ul style="list-style-type: none">▶ Add coolant (▷ page 285).▶ If you have to add coolant frequently, have the cooling system checked by an authorized Mercedes-Benz Center.

Warning!



Do not spill antifreeze on hot engine parts. Antifreeze contains ethylene glycol which may burn if it comes into contact with hot engine parts. You can be seriously burned.



Do not ignore the low engine coolant level warning. Extended driving with the message and symbol displayed may cause serious engine damage not covered by the Mercedes-Benz Limited Warranty.

Do not drive without sufficient amount of coolant in the cooling system. The engine will overheat causing major engine damage.

Practical hints

What to do if ...

Display symbol	Display messages	Possible cause	Possible solution
	Coolant Stop, engine off!	The coolant is too hot.	<ul style="list-style-type: none">▶ Stop the vehicle.▶ Only start the engine again after the message disappears. You could otherwise damage the engine.

Warning!



Driving when your engine is badly overheated can cause some fluids which may have leaked into the engine compartment to catch fire. You could be seriously burned.

Steam from an overheated engine can cause serious burns and can occur just by opening the engine hood. Stay away from the engine if you see or hear steam coming from it.

Turn off the engine, get out of the vehicle and do not stand near the vehicle until the engine has cooled down.

During severe operation conditions and stop-and-go city traffic, the coolant temperature may rise close to 248°F (120°C).



The engine should not be operated with the coolant temperature above 248°F (120°C). Doing so may cause serious damage which is not covered by the Mercedes-Benz Limited Warranty.



Practical hints

What to do if ...

Display symbol	Display messages	Possible cause	Possible solution
	Coolant Stop, engine off!	The poly-V-belt could be broken.	<ul style="list-style-type: none">▶ Stop immediately and check the poly-V-belt. If it is broken: <ul style="list-style-type: none">▶ Do not continue to drive. Otherwise the engine will overheat due to an inoperative water pump which may result in damage to the engine. Notify an authorized Mercedes-Benz Center. If it is intact: <ul style="list-style-type: none">▶ Do not continue to drive the vehicle with this message displayed. Doing so could result in serious engine damage that is not covered by the Mercedes-Benz Warranty.
	Coolant Visit workshop!	The cooling fan for the coolant is malfunctioning.	<ul style="list-style-type: none">▶ Observe the coolant temperature display.▶ Have the fan replaced as soon as possible.

Practical hints

What to do if ...

Display symbol	Display messages	Possible cause	Possible solution
	Display malfunction	The instrument cluster display is malfunctioning.	<ul style="list-style-type: none"> ▶ Continue driving with added caution. ▶ Visit an authorized Mercedes-Benz Center as soon as possible.
	Display malfunction Visit workshop!	The displays for several systems have malfunctioned. Some systems themselves may also have malfunctioned.	<ul style="list-style-type: none"> ▶ Have the electronic systems checked by an authorized Mercedes-Benz Center.
	Display malfunction Visit workshop!	<p>Certain electronic systems are unable to relay information to the control system. The following systems may have failed:</p> <ul style="list-style-type: none"> • Coolant temperature display • Tachometer • Cruise control display 	<ul style="list-style-type: none"> ▶ Have the electronic systems checked by an authorized Mercedes-Benz Center.
	Door open	You are attempting to drive with one or more doors open.	<ul style="list-style-type: none"> ▶ Close the doors.

Practical hints

What to do if ...

Display symbol	Display messages	Possible cause	Possible solution
	<p>USA only: Add 1 Qt. engine oil at next refueling</p> <p>Canada only: Add 1 Liter engine oil at next refueling</p>	The engine oil level is too low.	<ul style="list-style-type: none"> ▶ Add engine oil (▷ page 284) and check the engine oil level (▷ page 283).
	Engine oil level Stop, engine off!	There is no oil in the engine. There is a danger of engine damage.	<ul style="list-style-type: none"> ▶ Carefully bring the vehicle to a halt as soon as possible. ▶ Turn off the engine. ▶ Add engine oil (▷ page 284) and check the engine oil level (▷ page 283).
	Engine oil level Reduce oil level!	You have added too much engine oil. There is a risk of damaging the engine or the catalytic converter.	<ul style="list-style-type: none"> ▶ Have oil siphoned or drained off. Observe all legal requirements with respect to its disposal.

Practical hints

What to do if ...

Display symbol	Display messages	Possible cause	Possible solution
	Engine oil Visit workshop!	The engine oil has dropped to a critical level.	<ul style="list-style-type: none"> ▶ Check the engine oil level (▷ page 283) and add oil as required (▷ page 284). ▶ If you must add engine oil frequently, have the engine checked for possible leaks.
		It may be that there is water in the engine oil.	▶ Have the engine oil checked.
	Engine oil level Visit workshop!	The measuring system is malfunctioning.	▶ Have the measuring system checked by an authorized Mercedes-Benz Center.

When the Engine oil - Visit workshop! message appears while the engine is running and at operating temperature, the engine oil level has dropped to approximately the minimum level.

When this occurs, the warning will first come on intermittently and then stay on if the oil level drops further.



If no oil leaks are noted, continue to drive to the nearest service station where the engine oil should be topped to the required level with an approved oil.



The engine oil level warnings should not be ignored. Extended driving with the symbol displayed could result in serious engine damage that is not covered by the Mercedes-Benz Limited Warranty.

Practical hints

What to do if ...

Display symbol	Display messages	Possible cause	Possible solution
	Reserve fuel	The fuel level has dropped below the reserve mark.	▶ Refuel at the next gas station (▷ page 278).
	Hood open!	You are driving with the hood open.	▶ Close the hood (▷ page 281).
	Key Check battery!	The SmartKey with KEYLESS-GO* batteries are discharged.	▶ Change the batteries (▷ page 355).
	Key not recognized!	The SmartKey with KEYLESS-GO* is not recognized while the engine is running because <ul style="list-style-type: none"> • the SmartKey with KEYLESS-GO* is not in the vehicle • there is strong radio-frequency interference 	▶ Stop the vehicle as soon as it is safe to do so. ▶ Search for the SmartKey. Otherwise the vehicle cannot be centrally locked nor can the engine be started again after the engine is stopped.
		The SmartKey with KEYLESS-GO* is momentarily not recognized.	▶ Change the position of the SmartKey in the vehicle. ▶ Operate the vehicle with the SmartKey in the starter switch if necessary.

Practical hints

What to do if ...

Display symbol	Display messages	Possible cause	Possible solution
	Key detected in vehicle!	A SmartKey with KEYLESS-GO* left in the vehicle was recognized while locking the vehicle from the outside.	▶ Take the SmartKey out of the vehicle.
	Keyless go Check system	The KEYLESS-GO* system is malfunctioning.	▶ Visit an authorized Mercedes-Benz Center as soon as possible.
	Key Do not forget key	This display appears (for a maximum of 60 seconds) if the driver's door is opened with the engine shut off and no SmartKey in the starter switch. This message is only a reminder.	▶ Insert SmartKey in the starter switch. ▶ Take the SmartKey with KEYLESS-GO* with you when leaving the vehicle.
	Remove key!	You have forgotten to remove the SmartKey.	▶ Remove the SmartKey from the starter switch.
	Replace key	There is no additional code available for SmartKey or SmartKey with KEYLESS-GO*.	▶ Visit an authorized Mercedes-Benz Center as soon as possible.

Practical hints

What to do if ...

Display symbol	Display messages	Possible cause	Possible solution
	Brake light Visit workshop!	Brake lamp illumination is delayed or lamp is permanently on.	▶ Visit an authorized Mercedes-Benz Center as soon as possible.
	Brake light, left Back-up light on!	The left brake lamp is malfunctioning. A backup bulb is being used.	▶ Visit an authorized Mercedes-Benz Center as soon as possible.
	Brake light, right Back-up light on!	The right brake lamp is malfunctioning. A backup bulb is being used.	▶ Visit an authorized Mercedes-Benz Center as soon as possible.
	Display malfunction Visit workshop!	The display for the lamps or the system is malfunctioning.	▶ Visit an authorized Mercedes-Benz Center as soon as possible.
	Front foglight, left	The left front fog lamp is malfunctioning.	▶ Replace the bulb as soon as possible.
	Front foglight, right	The right front fog lamp is malfunctioning.	▶ Replace the bulb as soon as possible.
	Headlt. cornering	The Bi-Xenon cornering lamps system is malfunctioning.	▶ Visit an authorized Mercedes-Benz Center as soon as possible.
	Headlt. cornering Back- up light on	The Bi-Xenon cornering lamps system is malfunctioning. Another light is being used.	▶ Visit an authorized Mercedes-Benz Center as soon as possible.
	Headlt. cornering malfunction Visit workshop!	The Bi-Xenon cornering lamps system is malfunctioning.	▶ Visit an authorized Mercedes-Benz Center as soon as possible.

Practical hints

What to do if ...

Display symbol	Display messages	Possible cause	Possible solution
	High beam, left	The left high beam lamp is malfunctioning.	► Replace the bulb as soon as possible.
	High beam, right	The right high beam lamp is malfunctioning.	► Replace the bulb as soon as possible.
	License plate lamp, left	The left license plate lamp is malfunctioning.	► Replace the bulb as soon as possible.
	License plate lamp, right	The right license plate lamp is malfunctioning.	► Replace the bulb as soon as possible.
	Lamp sensor Visit workshop!	The lamp sensor is malfunctioning. The headlamps switch on automatically.	<ul style="list-style-type: none"> ► In the control system, set lamp operation to manual mode (▷ page 146). ► Switch on headlamps using the exterior lamp switch.
	Low beam, left	The left low beam lamp is malfunctioning.	► Visit an authorized Mercedes-Benz Center as soon as possible.
	Low beam, right	The right low beam lamp is malfunctioning.	► Visit an authorized Mercedes-Benz Center as soon as possible.



Practical hints

What to do if ...

Display symbol	Display messages	Possible cause	Possible solution
	Marker light, front left	The front left side marker lamp is malfunctioning.	▶ Replace the bulb as soon as possible.
	Marker light front right	The front right side marker lamp is malfunctioning.	▶ Replace the bulb as soon as possible.
	Park. light, front left Back-up light on!	The left parking lamps are malfunctioning. A backup bulb is being used.	▶ Visit an authorized Mercedes-Benz Center as soon as possible.
	Park. light, front right Back-up light on!	The right parking lamps are malfunctioning. A backup bulb is being used.	▶ Visit an authorized Mercedes-Benz Center as soon as possible.
	Rear foglight Back-up light on!	The rear fog lamp is malfunctioning. A backup bulb is being used.	▶ Replace the bulb as soon as possible.
	Reverse light, left	The left reverse light is malfunctioning.	▶ Replace the bulb as soon as possible.
	Reverse light, right	The right backup lamp is malfunctioning.	▶ Replace the bulb as soon as possible.
	Switch off lights!	Lamps have been turned on although the SmartKey in the starter switch is in position 0 .	▶ Switch off the headlights.
	Tail light, left Back-up light on!	The left tail lamp is malfunctioning. A backup bulb is being used.	▶ Visit an authorized Mercedes-Benz Center as soon as possible.
	Tail light, right Back-up light on!	The right tail lamp is malfunctioning. A backup bulb is being used.	▶ Visit an authorized Mercedes-Benz Center as soon as possible.

Practical hints

What to do if ...

Display symbol	Display messages	Possible cause	Possible solution
	Turn signal, rear left Back-up light on!	The left rear turn signal lamp is malfunctioning. A backup bulb is being used.	► Replace the bulb as soon as possible.
	Turn signal, rear right Back-up light on!	The right rear turn signal lamp is malfunctioning. A backup bulb is being used.	► Replace the bulb as soon as possible.
	Turn sig., front left Back-up light on!	The left front turn signal lamp is malfunctioning. A backup bulb is being used.	► Replace the bulb as soon as possible.
	Turn sig., front right Back-up light on!	The right front turn signal lamp is malfunctioning. A backup bulb is being used.	► Replace the bulb as soon as possible.
	Turn sig., left mirror	The left turn signal in the side mirror is malfunctioning. This message will only appear if all light emitting diodes have stopped working.	► Have the LEDs replaced as soon as possible.
	Turn sig., right mirror	The right turn signal in the side mirror is malfunctioning. This message will only appear if all light emitting diodes have stopped working.	► Have the LEDs replaced as soon as possible.
	Tire pres. monitor activated!	The tire pressure is being checked.	
	Tire pres. monitor Reactivate	The tire inflation pressure monitor* is deactivated.	► Activate the tire inflation pressure monitor* (▷ page 292).

Practical hints

What to do if ...

Display symbol	Display messages	Possible cause	Possible solution
	Tire pres. monitor not activated!	The tire inflation pressure monitor* is unable to monitor the tire pressure due to <ul style="list-style-type: none">• the presence of several wheel sensors in the vehicle.• excessive wheel sensor temperatures.• a nearby radio interference source.• unrecognized wheel sensors mounted.	► Check the tire pressure at the next service station.
	Tire pres. monitor Pres. display after driving a few mins. Re-activate using R button	The tire pressure is being checked.	

Warning!



Do not drive with a flat tire. A flat tire affects the ability to steer or brake the vehicle.

You may lose control of the vehicle. Continued driving with a flat tire will cause excessive heat build-up and possibly a fire.

Practical hints

What to do if ...

Display symbol	Display messages	Possible cause	Possible solution
	Tire pres. monitor Visit workshop!	The tire inflation pressure monitor is malfunctioning. A wheel without proper sensor was installed.	<ul style="list-style-type: none"> ▶ Have the tire inflation pressure monitor checked by an authorized Mercedes-Benz Center. ▶ Change the wheel (▷ page 370).
	Tire pres. Caution, tire defect!	The tire pressure has decreased significantly in one or more tires.	<ul style="list-style-type: none"> ▶ Check and correct tire pressure as required (▷ page 290).
	Tire pres. Caution, tire defect	One or more tires is deflating.	<ul style="list-style-type: none"> ▶ Carefully bring the vehicle to a halt, avoiding abrupt steering and braking maneuvers. ▶ Change the wheel (▷ page 370).
	Tire pres. Check tires!	The tire pressure in one or more tires is already below the minimum value. The tire pressure in one or more tires is low.	<ul style="list-style-type: none"> ▶ Carefully bring the vehicle to a halt, avoiding abrupt steering and braking maneuvers. ▶ Change the wheel (▷ page 370).

Warning!



Do not drive with a flat tire. A flat tire affects the ability to steer or brake the vehicle.

You may lose control of the vehicle. Continued driving with a flat tire will cause excessive heat build-up and possibly a fire.

Practical hints

What to do if ...

Display symbol	Display messages	Possible cause	Possible solution
	Tire pres. RL Caution Tire defect	The left rear tire is deflating.	<ul style="list-style-type: none"> ▶ Carefully bring the vehicle to a halt, avoiding abrupt steering and braking maneuvers. ▶ Change the wheel (▷ page 370).
	Tire pres. RL Check tires!	The left rear tire pressure is low.	<ul style="list-style-type: none"> ▶ Carefully bring the vehicle to a halt. ▶ Check the tire pressure. ▶ Change the wheel (▷ page 370).
	Tire pres. RR Caution Tire defect	The right rear tire is deflating.	<ul style="list-style-type: none"> ▶ Carefully bring the vehicle to a halt, avoiding abrupt steering and braking maneuvers. ▶ Change the wheel (▷ page 370).
	Tire pres. RR Check tires!	The right rear tire pressure is low.	<ul style="list-style-type: none"> ▶ Carefully bring the vehicle to a halt. ▶ Check the tire pressure. ▶ Change the wheel (▷ page 370).

Warning!



Do not drive with a flat tire. A flat tire affects the ability to steer or brake the vehicle.

You may lose control of the vehicle. Continued driving with a flat tire will cause excessive heat build-up and possibly a fire.

Practical hints

What to do if ...

Display symbol	Display messages	Possible cause	Possible solution
	Tire pres. FL Caution Tire defect	The left front tire is deflating.	<ul style="list-style-type: none"> ▶ Carefully bring the vehicle to a halt, avoiding abrupt steering and braking maneuvers. ▶ Change the wheel (▷ page 370).
	Tire pres. FL Check tires!	The right rear tire pressure is low.	<ul style="list-style-type: none"> ▶ Carefully bring the vehicle to a halt. ▶ Check the tire pressure. ▶ Change the wheel (▷ page 370).
	Tire pres. FR Caution Tire defect	The right front tire is deflating.	<ul style="list-style-type: none"> ▶ Carefully bring the vehicle to a halt, avoiding abrupt steering and braking maneuvers. ▶ Change the wheel (▷ page 370).
	Tire pres. FR Check tires!	The right front tire pressure is low.	<ul style="list-style-type: none"> ▶ Carefully bring the vehicle to a halt. ▶ Change the wheel (▷ page 370).

Warning!





Do not drive with a flat tire. A flat tire affects the ability to steer or brake the vehicle.

You may lose control of the vehicle. Continued driving with a flat tire will cause excessive heat build-up and possibly a fire.





Practical hints

What to do if ...

Display symbol	Display messages	Possible cause	Possible solution
	Driver's seat belt Fasten seatbelt!	The display reminds you and your passengers to fasten seat belts.	▶ Fasten the seat belts.
	Fr pass. seat belt Fasten seatbelt!	The display reminds you and your passengers to fasten seat belts.	▶ Fasten the seat belts.
	Seat belt system Visit workshop!	The seat belt system is malfunctioning.	▶ Visit an authorized Mercedes-Benz Center as soon as possible.
	Service memory full See Operator's Manual	The FSS Plus service memory cannot save any more data.	▶ Have the service memory checked by an authorized Mercedes-Benz Center.

Practical hints

What to do if ...

Display symbol	Display messages	Possible cause	Possible solution
	Tele Aid defective Visit workshop!	One or more main functions of the Tele Aid system are malfunctioning.	► Have the Tele Aid system checked by an authorized Mercedes-Benz Center.
	Tele Aid battery Visit workshop!	The emergency power battery for the Tele Aid system is malfunctioning. If the vehicle battery is also dead, Tele Aid will not be operational.	► Have the Tele Aid system checked by an authorized Mercedes-Benz Center.
	Restraint system malfunction Visit workshop!	The system is malfunctioning.	► Drive with added caution to the nearest authorized Mercedes-Benz Center.
	Function Not available!	This display appears if button  or  on the multifunction steering wheel is pressed and the vehicle is not equipped with a telephone.	

Warning!





In the event a malfunction of the SRS is indicated as outlined above, the SRS may not be operational.

For your safety, we strongly recommend that you visit an authorized Mercedes-Benz

Center immediately to have the system checked; otherwise the SRS may not be activated when needed in an accident, which could result in serious or fatal injury, or it might deploy unexpectedly and unnecessarily which could also result in injury.

Practical hints

What to do if ...

Display symbol	Display messages	Possible cause	Possible solution
	Steering oil Visit workshop!	The steering gear oil level is too low. There is a danger of steering gear damage.	▶ Have the system checked by an authorized Mercedes-Benz Center.
	Entry position Do not drive!	Seat, mirrors and steering wheel have not yet moved to their preset driving positions.	▶ Wait until the seat, mirrors and steering wheel have moved to their driving positions. The message disappears.
	Trunk open!	This message will appear whenever the trunk lid is open.	▶ Close the trunk lid.
	Washer fluid Check level!	The fluid level has dropped to about $\frac{1}{3}$ of total reservoir capacity.	▶ Add washer fluid (▷ page 288).

Warning!



If the level of steering gear oil in reservoir is too low, the steering power assistance could fail. Much greater effort will then be needed to turn the steering wheel.

Do not add steering oil without checking the steering system.

Do not drive the vehicle. Have the system checked at your authorized Mercedes-Benz Center as soon as possible.

Practical hints

What to do if ...

Display symbol	Display messages	Possible cause	Possible solution
	Vehicle rising!	Your vehicle is adjusting to your level selection.	
	Level selec. canceled	The "Raised" level setting is canceled at vehicle speeds of over 75 mph (120 km/h).	▶ Reactivate the "Raised" level setting.
	Stop, car too low!	The vehicle level control is malfunctioning.	Avoid excessive steering input. The fender or tires could otherwise be damaged. Listen for scraping noises. Do not drive faster than 50 mph (80 km/h). ▶ Drive to the side of the road and select a higher vehicle level. Depending on the type of malfunction, this may raise the vehicle's level. There is otherwise danger of an accident.
	Visit workshop!	The system is functional only to a limited extent. The system display or the system is malfunctioning.	▶ Do not drive faster than 50 mph (80 km/h). ▶ Have the vehicle checked at an authorized Mercedes-Benz Center.

Warning!



Driving while these messages are displayed can result in an accident. Have your brake system checked immediately.

If there is a malfunction in the SBC brake system, we recommend that the vehicle be transported with all wheels off the ground using flatbed or appropriate wheel lift / dolly equipment.

A tow bar must be used if circumstances do not permit the use of the recommended towing methods and the vehicle requires towing with all four wheels on the ground. Towing the vehicle with all four wheels on the ground is only permissible for distances up to 30 miles (50 km) and at a speed not to exceed 30 mph (50 km / h). For more information, refer to "Towing the vehicle" (▷ page 381).

If the SBC brake system enters its emergency operation mode, the driver must apply significantly greater brake pedal pressure and depress the pedal much further than normal to obtain braking effect. If necessary, apply full pressure to the brake pedal. Brakes may only be applied to the front wheels. Stopping distance is increased!

Low brake fluid in the reservoir may cause the braking system to fail!

Don't add brake fluid before checking the brake system. Overfilling the brake fluid reservoir can result in spilling brake fluid on hot engine parts and the brake fluid catching fire. You can be seriously burned.

Practical hints

What to do if ...



If you find that the brake fluid in the brake fluid reservoir has fallen to the minimum mark or below, have the brake system checked for brake pad thickness and leaks.



Brake pad thickness must be visually inspected by a qualified technician at the intervals specified in the Service Booklet.

Practical hints

Where will I find ...?

▼ Where will I find ...?

First aid kit

The first aid kit is in the storage compartment at the front edge of the front passenger seat.

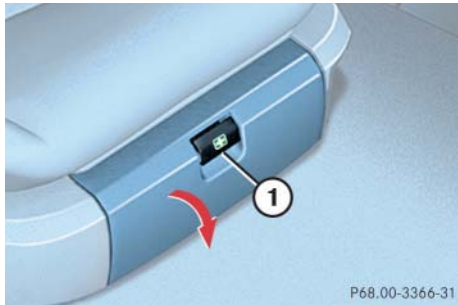

- ▶ Pull tab ① upward.
- ▶ Fold the covering forward.
- ▶ Remove the first aid kit.



Check expiration dates and contents for completeness at least once a year and replace missing/expired items.

Vehicles with TIREFIT kit (E 55 AMG)

The TIREFIT kit is located under the trunk floor.

- ▶ Lift the trunk floor and engage the handle in the upper edge of trunk.
- ▶ Remove the luggage box (▷ page 351).

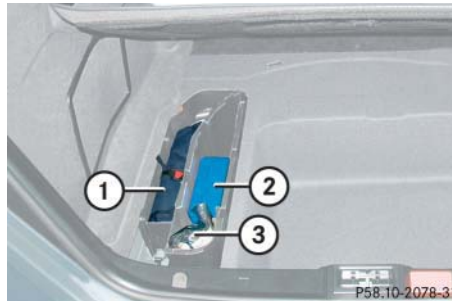

- ① Vehicle tool kit and jack
- ② Electric air pump
- ③ TIREFIT kit

Spare wheel

The spare wheel is located under the trunk floor.

- ▶ Lift the trunk floor and engage the handle in the upper edge of trunk.
- ▶ Remove the luggage box (▷ page 351).

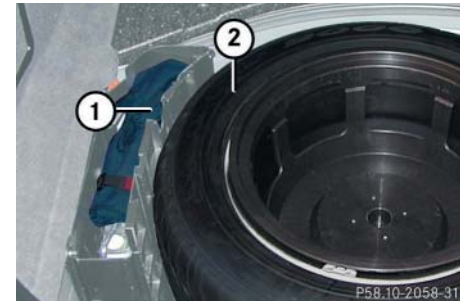

- ① Vehicle tool kit
Wheel bolt wrench
Jack
- ② Spare wheel

Removing the spare wheel

- ▶ Turn luggage bowl counterclockwise.
- ▶ Remove spare wheel ②.

Storing the spare wheel

- ▶ Place spare wheel ② in wheel well.
- ▶ Turn luggage bowl clockwise to its stop to secure the spare wheel.



Always lower trunk floor before closing trunk lid.

Minispare wheel

Warning!



The dimensions of the Minispare wheel are different from those of the road wheels. As a result, the vehicle handling characteristics change when driving with a Minispare wheel mounted.

The Minispare wheel should only be used temporarily, and replaced with a regular road wheel as quickly as possible.

In the case of a flat tire, you may temporarily use the Minispare wheel when observing the following restrictions:

- Do not exceed a vehicle speed of 50 mph (80 km/h).
- Drive to the nearest tire repair facility to have the flat tire repaired or replaced as appropriate.
- Do not operate vehicle with more than one spare wheel mounted.

Practical hints

Where will I find ...?

More information can be found in the “Technical data” section (▷ page 396).

Luggage box

Remove luggage box



- ① Fastening clip
- ② Luggage box

- ▶ Turn fastening clips ① to the left upwards from fastening bolts.
- ▶ Lift luggage box in the area of the fastening bolts and remove it from trunk.

Practical hints

Where will I find ...?

Install luggage box



- ▶ Insert luggage box into trunk so that fastening clips are in line with fastening bolts.
- ▶ Push front edge of luggage box in direction of arrow under cover of trunk sill.
- ▶ Press fastening clips onto fastening bolts until they lock into place.

Vehicle tool kit

The vehicle tool kit is stored in the compartment underneath the trunk floor (▷ page 350).

The vehicle tool kit includes:

- One towing eye bolt
- One wheel wrench
- One alignment bolt
- One fuse extractor
- Spare fuses

Unlocking/locking in an emergency

▼ **Unlocking/locking in an emergency**

Unlocking the vehicle

If you are unable to unlock the vehicle with the SmartKey, open the driver's door and the trunk using the mechanical key.



Unlocking your vehicle with the mechanical key will trigger the anti-theft alarm system. To cancel the alarm, do one of the following:

- Press button or on the SmartKey.
- Insert the SmartKey in the starter switch.
- Press the KEYLESS-GO* start/stop button (▷ page 33).



- ① Mechanical key locking tab
- ② Mechanical key
- ▶ Move locking tab ① in the direction of the arrow and slide mechanical key ② out of the housing.

Unlocking the driver's door

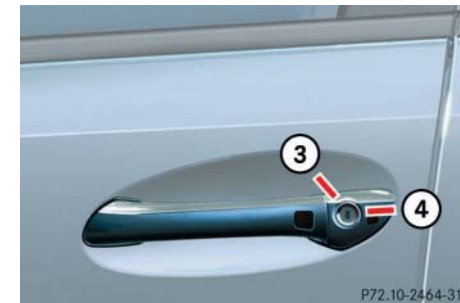

- ③ Unlocking
- ④ Locking
- ▶ Unlock the door with the mechanical key. To do so, push the mechanical key in the lock until it stops and turn it to the left.

Practical hints

Unlocking/locking in an emergency

Unlocking the trunk

A minimum height clearance of 5.90 ft (1.80 m) is required to open the trunk lid.

If you are unable to unlock the trunk with the SmartKey or KEYLESS-GO*, open the trunk with the mechanical key.

The handle is located above the rear license plate recess.

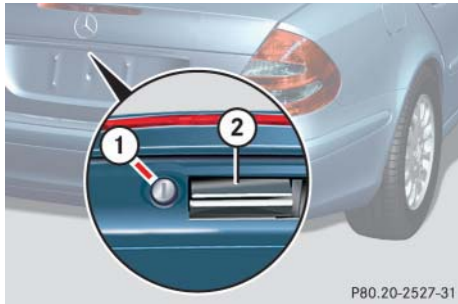

① Unlocking in an emergency

② Handle

- ▶ Insert the mechanical key into the trunk lid lock.



- ▶ Turn the mechanical key counterclockwise to position ① and hold it in this position.
- ▶ Pull trunk lid handle ② and lift the trunk lid.



Always make sure there is sufficient overhead clearance.



Unlocking your vehicle with the mechanical key will trigger the anti-theft alarm system. To cancel the alarm, do one of the following:

- Press button  or  on the SmartKey.
- Insert the SmartKey in the starter switch.

Vehicles with KEYLESS-GO*:

- Grasp the outside door handle.
- Press the start /stop button.

Locking the vehicle

If you are unable to lock the vehicle with the SmartKey, lock it with the mechanical key as follows:

- ▶ Close the passenger doors and the trunk.
- ▶ Press the central locking switch in the cockpit (▷ page 107).
- ▶ Check to see whether the locking knobs on the passenger doors are still visible. If necessary, push them down manually.
- ▶ Slide mechanical key ② out of the SmartKey.
- ▶ Lock the driver's door with the mechanical key (▷ page 354).
- ▶ Check if the trunk is locked. If necessary lock the trunk with the mechanical key (if applicable) (▷ page 105).

Changing batteries in the SmartKey/ SmartKey with KEYLESS-GO*

If the batteries in the SmartKey are discharged, the vehicle can no longer be locked or unlocked. It is recommended to have the batteries replaced at an authorized Mercedes-Benz Center.

Warning!



Keep the batteries out of reach of children.
If a battery is swallowed, seek medical help immediately.

Batteries contain materials that can harm the environment if disposed of improperly. Recycling of batteries is the preferred method of disposal. Many states require sellers of batteries to accept old batteries for recycling.

SmartKey



When changing batteries, always replace both batteries.

The required replacement batteries are available at any Mercedes-Benz Center.



- ① Mechanical key
- ② Battery compartment

Replacement batteries: Lithium, type CR 2025 or equivalent.

Practical hints

Unlocking/locking in an emergency

- ▶ Remove mechanical key ① (▷ page 353).
- ▶ Insert the mechanical key in side opening and push gray slide.
The battery compartment is unlatched.
- ▶ Pull the battery compartment out of the SmartKey housing in direction of arrow.
- ▶ Remove the batteries.

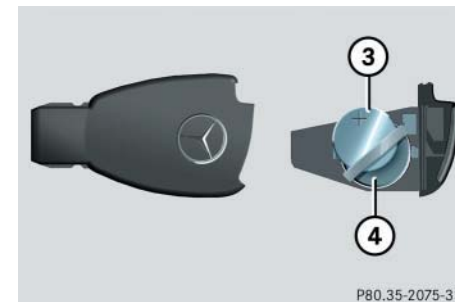

- ③ Battery
- ④ Contact spring

Practical hints

Unlocking/locking in an emergency

- ▶ Using a lint-free cloth, insert new batteries under the contact spring with the plus (+) side facing up.
- ▶ Return battery compartment into housing until it locks into place.

SmartKey with KEYLESS-GO*



When changing batteries, always replace both batteries.

The required replacement batteries are available at any Mercedes-Benz Center.

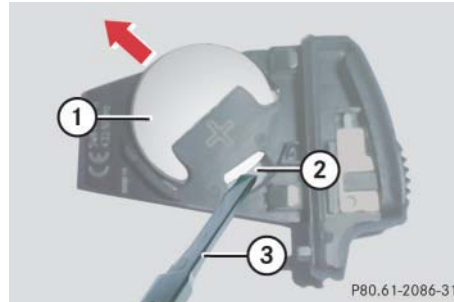

- ① Battery
- ② Tilt battery up
- ③ Mechanical key

Replacement batteries: Lithium, type CR 2025 or equivalent.

- ▶ Remove mechanical key (▷ page 353).
- ▶ Insert the mechanical key in side opening and push grey slide.

The battery compartment is unlatched.

- ▶ Pull the battery compartment out of the SmartKey housing in direction of arrow.
- ▶ Using mechanical key ③ apply pressure to position ②.
Battery ① tilts up slightly.
- ▶ Pull out batteries ① in direction of arrow.
- ▶ Using a lint-free cloth, insert new batteries with the plus (+) side facing up.
- ▶ Return battery compartment into housing until it locks into place.

Unlocking/locking in an emergency

Fuel filler flap emergency release

In case the central locking system does not release the fuel filler flap, you can open it manually.

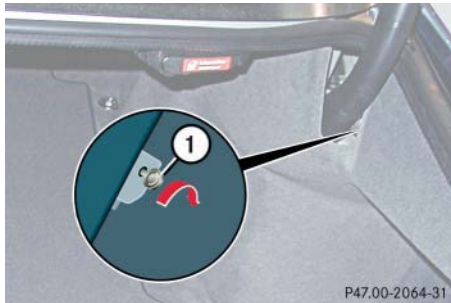

① Release knob

- ▶ Open trunk lid.
- ▶ Remove right-side tail trim.
- ▶ Turn release knob ① clockwise (arrow).

The fuel filler flap can now be opened.

Manually unlocking the transmission selector lever

In the case of power failure, the transmission selector lever can be manually unlocked, e.g. to tow the vehicle.



① Pin

- ▶ Open the storage compartment in the center console (▷ page 244).
- ▶ Take out the cup holder*.

Using two fingers in the horizontal slot at the upper rear side of the cup holder, lift cup holder upwards to remove.

- ▶ Hold the cover at a 45° angle.
- ▶ Insert a suitable object ① (e.g. a pin) through the hole and press the pin downward.
- ▶ Remove pin ①.



The selector lever is locked again when moving it to position **P**.

Practical hints

Opening/closing in an emergency

▼ Opening/closing in an emergency

Sliding/pop-up roof* or panorama sliding/pop-up roof*

You can open or close the sliding/pop-up roof or panorama sliding/pop-up roof manually should an electrical malfunction occur.

The sliding/pop-up roof or panorama sliding/pop-up roof drive is located behind lens ① of the interior overhead light.

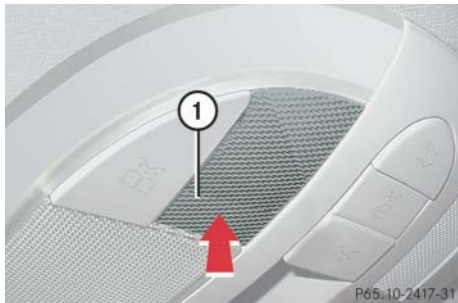

① Screen

- ▶ Fold screen ① down.

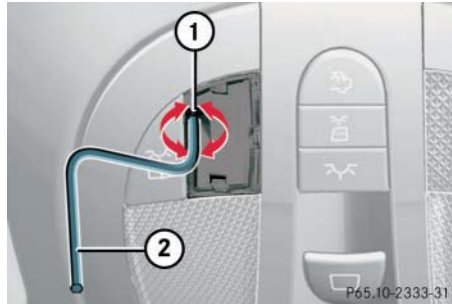

- ▶ Turn crank ② counterclockwise to:

- slide roof open
- lower roof at the rear

The sliding/pop-up roof or panorama sliding/pop-up roof must be resynchronized after being operated manually (▷ page 204).



Do not disconnect the electrical connectors.

- ▶ Obtain crank ②.
- ▶ Insert crank ② through hole ①.
- ▶ Turn crank ② clockwise to:
 - Slide roof closed
 - Raise roof at the rear

Practical hints

Replacing bulbs

▼ Replacing bulbs

Safe vehicle operation depends on proper exterior lighting and signaling. It is therefore essential that all bulbs and lamp assemblies are in good working order at all times.

Correct headlamp adjustment is extremely important. Have headlamps checked and readjusted at regular intervals and when a bulb has been replaced. See your authorized Mercedes-Benz Center for headlamp adjustment.



Backup bulbs will be brought into use when the following lamps malfunction:

- Standing lamps
- Tail lamps

Bulbs

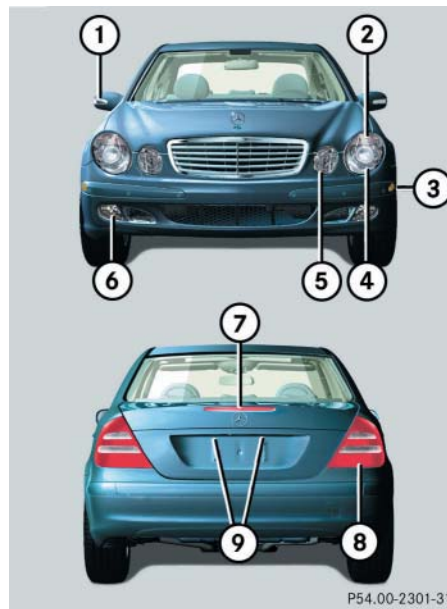

P54.00-2301-31

Front lamps

	Lamp	Type
①	Additional turn signal lamps	LED
②	Turn signal lamp	1156 NA
③	Side marker lamp	W 5 W
④	Halogen headlamps: Low beam	H7 (55 W)
	Bi-Xenon* headlamps: Low and high beam ¹	D2S-35 W
⑤	Halogen headlamps: High beam/high beam flasher	H7 (55 W)
	Bi-Xenon* headlamps: High beam flasher	H7 (55 W)
	Parking and standing lamps	W 5 W
⑥	Fog lamp	H1 (55 W)

¹ Vehicles with Bi-Xenon headlamps* do not replace the Bi-Xenon bulbs yourself.

Practical hints

Replacing bulbs

Rear lamps

	Lamp	Type
⑦	High mounted brake lamp	LED
⑧	Brake, tail, parking, standing, backup lamps and turn signal lamps. Rear fog lamp (driver's side).	HiP LED*
⑨	License plate lamps	C 5 W

Notes on bulb replacement

Warning!



Keep bulbs out of reach of children.

Bulbs and bulb sockets can be very hot. Allow the lamp to cool down before changing a bulb.

Halogen lamps contain pressurized gas. A bulb can explode if you:

- touch or move it when hot
- drop the bulb
- scratch the bulb

Wear eye and hand protection.

Because of high voltage in Bi-Xenon* lamps, it is dangerous to replace the bulb or repair the lamp and its components. We recommend that you have such work done by a qualified technician.

- Use only 12 volt bulbs of the same type and with the specified watt rating.
- Switch lights off before changing a bulb to prevent short circuits.
- Always use a clean lint-free cloth when handling bulbs.
- Your hands should be dry and free of oil and grease.
- If the newly installed bulb does not light up, visit an authorized Mercedes-Benz Center.
- Have the LEDs and bulbs for the following lamps replaced by an authorized Mercedes-Benz Center:
 - Additional turn signal lamps in the exterior rear view mirrors
 - High mounted brake lamp
 - Bi-Xenon* lamps
 - Front fog lamps

Practical hints

Replacing bulbs

Replacing bulbs for front lamps

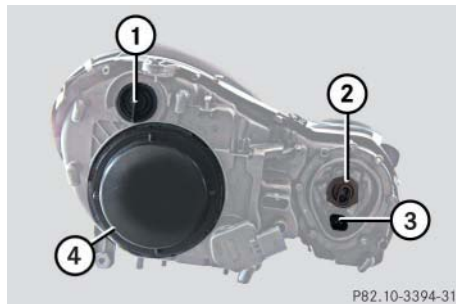

- ① Bulb socket for turn signal lamp
- ② High beam halogen bulb
- ③ Bulb socket for parking and standing lamp
- ④ Cover for Bi-Xenon* (low beam and high beam) or halogen (low beam) headlamp

Bi-Xenon* headlamps

Warning!



Do not remove the cover ④ for the Bi-Xenon headlamp. Because of high voltage in Xenon lamps, it is dangerous to replace the bulb or repair the lamp and its components. We recommend that you have such work done by a qualified technician.

Low beam halogen bulb

- ▶ Switch off the lights.
- ▶ Open the hood (▷ page 281).
- ▶ Turn the locking mechanism counter-clockwise and remove headlamp cover ④.
- ▶ Pull electrical connector off.
- ▶ Release the retaining springs and take out the bulb.
- ▶ Insert the new bulb in the socket so that the base is in the recess on the lower left.
- ▶ Attach the retaining springs.
- ▶ Insert connector into the bulb.
- ▶ Align headlamp cover and click into place.

Practical hints

Replacing bulbs

High beam halogen bulb

- ▶ Switch off the lights.
- ▶ Open the hood (▷ page 281).
- ▶ Press the clamp and remove headlamp cover.
- ▶ Pull electrical connector off.
- ▶ Turn the locking mechanism counterclockwise and take out the high beam bulb ②.
- ▶ Insert the new bulb in the socket so that the base is in the recess on the lower left.
- ▶ Attach the retaining springs.
- ▶ Insert connector into the bulb.
- ▶ Align headlamp cover and click into place.

Front turn signal lamp bulb

- ▶ Switch off the lights.
- ▶ Open the hood (▷ page 281).
- ▶ Twist bulb socket 1 counterclockwise and pull out.
- ▶ Push bulb into socket, turn counterclockwise and remove.
- ▶ Insert new bulb in socket, push in and twist clockwise.
- ▶ Reinsert bulb socket in lamp and twist clockwise.

Parking and standing lamp bulb

- ▶ Switch off the lights.
- ▶ Open the hood (▷ page 281).
- ▶ Press the clamp and remove headlamp cover.
- ▶ Pull out the bulb socket ③ with the bulb.
- ▶ Pull the bulb out of the bulb socket.
- ▶ Insert a new bulb in the socket.
- ▶ Reinstall the bulb socket.
- ▶ Align headlamp cover and click into place.

Side marker lamp bulb



- ▶ Switch off the lights.
- ▶ Carefully slide lamp towards front.
- ▶ Remove rear end first.
- ▶ Twist bulb socket counterclockwise and pull out.
- ▶ Pull bulb out of the bulb socket.
- ▶ Insert new bulb in socket.
- ▶ Reinstall bulb socket, push in and twist clockwise.
- ▶ To reinstall lamp, set rear end in bumper and let front end snap into place.



To prevent scratches, we recommend that you have the sidemarker bulb replaced by an authorized Mercedes-Benz Center.

Replacing bulbs for rear lamps

Tail lamp assemblies

The tail lamps are equipped with HiP bulbs.

Warning!



The bulbs in the tail lamps cannot be replaced individually. The tail lamp bulbs are under pressure and could explode during an attempt to replace them.

If the tail lamps are malfunctioning, have them exchanged at an authorized Mercedes-Benz Center.

Practical hints

Replacing bulbs

License plate lamp

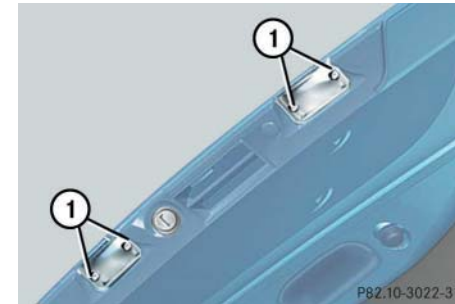

① Screw

- ▶ Switch off the lights.
- ▶ Loosen both screws ① and remove lamp.
- ▶ Replace the tubular lamp and reinstall lamp.
- ▶ Retighten the screws.

Practical hints

Replacing wiper blades

▼ Replacing wiper blades



To avoid damage to the hood, the wiper arms should only be folded forward when in the vertical position.



Removing wiper blades

- ▶ Turn SmartKey in starter switch to position **1**.
- ▶ Turn combination switch to wiper setting **II** (> page 48).
- ▶ With wiper arm in the vertical position, turn SmartKey in starter switch to position **0**.

Warning!



For safety reasons, remove SmartKey from starter switch before replacing a wiper blade. Otherwise the motor could suddenly turn on and cause injury.

- ▶ Fold the wiper arm forward until it snaps into place.

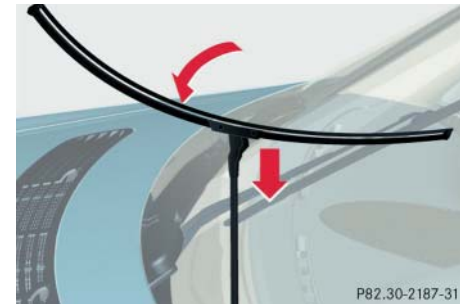

- ▶ Turn the wiper blade at a right angle to wiper arm.
- ▶ Slide the wiper blade sideways out of the retainer.

Installing wiper blades

- ▶ Slide wiper blade onto wiper arm until it locks in place.
- ▶ Rotate wiper blade into position parallel to wiper arm.
- ▶ Fold the wiper arm backward to rest on the windshield. Make sure you hold on to the wiper when folding the wiper arm back.



Never open the hood when the wiper arm is folded forward.

Hold on to the wiper when folding the wiper arm back. If released, the force of the impact from the tensioning spring could crack the windshield.

Do not allow the wiper arms to contact the windshield glass without a wiper blade inserted.

Make certain that the wiper blades are properly installed. Improperly installed wiper blades may cause windshield damage.

For your convenience, we recommend that you have this work carried out by an authorized Mercedes-Benz Center.

Practical hints

Flat tire

▼ Flat tire

Preparing the vehicle

- ▶ Park the vehicle as far as possible from moving traffic on a hard surface.
- ▶ Turn on the hazard warning flashers.
- ▶ Engage the steering wheel lock in the straight-ahead position and set the parking brake.
- ▶ Move the selector lever to **P**.
- ▶ Have any passenger exit the vehicle at a safe distance from the roadway.

Sealing tires with TIREFIT (E 55 AMG)

Warning!



Keep TIREFIT away from sparks, open flame or heat source.

Do not smoke.

Small tire punctures, only those in the tread, can be sealed with TIREFIT. TIREFIT can be used in ambient temperatures down to -4°F (-20°C).

Warning!



Take care not to allow the contents of TIREFIT to come in contact with hair, eyes or clothing. TIREFIT is harmful if inhaled, swallowed or absorbed through the skin. It causes skin, eye and respiratory irritation.

Any contact with eyes or skin should be flushed immediately with plenty of water.

If clothing comes in contact with TIREFIT, change clothing as soon as possible.

In case of allergic reaction or rash, consult a physician immediately.

Warning!



Keep TIREFIT out of reach of children.

If swallowed, rinse mouth immediately with plenty of water and drink plenty of water.

Do not induce vomiting!

Consult a physician immediately.

Keep away from open flame or heat source.

Warning!



TIREFIT is a limited repair device. TIREFIT cannot be used for:

- cuts or punctures larger than approximately 0.16 in (4 mm)
- on a flat tire, or a damaged wheel
- tire damage caused by driving with extremely low tire pressure

Do not drive the vehicle under such circumstances.

Contact your nearest Mercedes-Benz Center for assistance or call Roadside Assistance.

- ▶ Take the TIREFIT kit out of the trunk (▷ page 350).
- ▶ Foreign objects (e.g. screws or nails) should not be removed from the tire.
- ▶ Attach the sticker where it will be easily seen by the driver on the instrument cluster.

Preparing TIREFIT

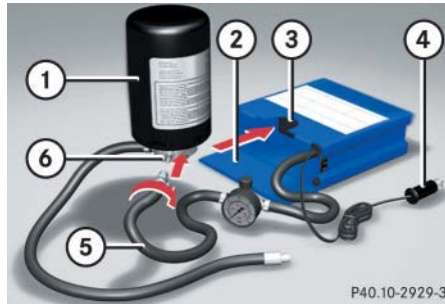

- ① TIREFIT container
- ② Flap
- ③ Notch
- ④ Electrical plug
- ⑤ Air hose
- ⑥ Flange

- ▶ Open flap ② on the electric air pump.
- ▶ Pull plug ④ and air hose ⑤ out of the pump housing.
- ▶ Screw the air pump's air hose ⑤ onto flange ⑥ of the TIREFIT container.

Practical hints

Flat tire

- ▶ Stick TIREFIT container ① upside down into notch ③ of the electric air pump.

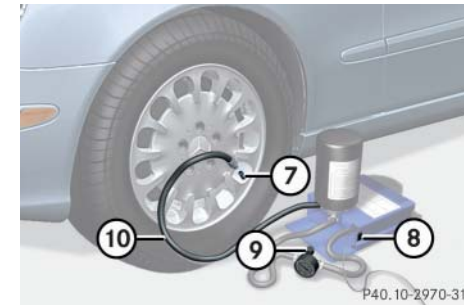

- ⑦ Tire valve
- ⑧ Electric air pump switch
- ⑨ Air hose with pressure gauge and vent screw
- ⑩ Filler hose

Warning!



Observe safety instructions on air pump label.

Practical hints

Flat tire



If sealant has leaked out, let it dry. You can then peel it off.

- ▶ Unscrew the valve cap from tire valve ⑦.
- ▶ Screw filler hose ⑩ onto tire valve ⑦.
- ▶ Insert electrical plug ④ into vehicle cigarette lighter socket.
- ▶ Turn SmartKey in starter switch to position 1 (▷ page 31).

or

- ▶ Press the KEYLESS-GO* start/stop button (▷ page 33) on the selector lever once. Do not depress brake pedal.
- ▶ Press I on electric air pump switch ⑧.
The electric air pump should now switch on and inflate the tire.



Do not operate the electric air pump longer than eight minutes without interruption. Otherwise it may overheat.

You may operate the air pump again after it has cooled off.

After five minutes, the pressure gauge must display at least 26 psi (1.8 bar). The air hose can become hot during inflation. Please exercise appropriate caution.

- ▶ If this tire pressure is not attained, turn off the electric air pump, detach the filler hose from the tire valve, and drive vehicle back and forth very slowly approximately 30 ft (10 m).

This serves to better distribute the TIREFIT sealant material inside the tire.

- ▶ Unscrew the air pump's air hose ⑤ from flange ⑥ of the TIREFIT container.
- ▶ Screw air hose ⑤ onto tire valve ⑦. Inflate the tire again.

Warning!



If a tire pressure of 26 psi (1.8 bar) is not attained, tire is too severely damaged for TIREFIT to provide a reliable tire repair.

In this case, TIREFIT cannot properly seal the tire.

Do not drive the vehicle.

Contact the nearest Mercedes-Benz Center or call Roadside Assistance.

- ▶ After attaining a tire pressure of 26 psi (1.8 bar), press 0 on electric air pump switch ⑧.

The electric air pump should now be switched off.

- ▶ Turn SmartKey in starter switch to position **0** (▷ page 31).
- or
- ▶ Press the KEYLESS-GO* start / stop button (▷ page 33) on the selector lever twice. Do not depress brake pedal.
 - ▶ Detach the electric air pump.
The air hose may still be hot. Please exercise appropriate caution.
 - ▶ Store the electrical plug and the air hose behind the flap and place the air pump back in the trunk.
 - ▶ Close the trunk lid.
 - ▶ Drive away immediately.
The TIREFIT sealant will distribute itself evenly inside the tire.

Warning!



Do not exceed vehicle speed of 50 mph (80 km / h). A TIREFIT repair is not designed to operate at higher speeds.

The sticker must be attached on the instrument cluster where it will be easily seen by the driver.

Vehicle handling characteristics may change. Adapt your driving accordingly.

- ▶ After driving vehicle for an initial 10 minutes, check tire pressure using the pressure gauge on the air pump.

Practical hints

Flat tire

Warning!



If tire pressure has fallen below 20 psi (1.3 bar) do not continue to drive the vehicle.

Park your vehicle safely away from the roadway and contact the nearest authorized Mercedes-Benz Center or Roadside Assistance.

If tire pressure is at least 20 psi (1.3 bar), inflate tire to correct pressure (see label on fuel filler flap), and drive vehicle to nearest tire repair facility to have tire repaired or replaced.

Recommended maximum duration of use: 300 miles (500 km) at 50 mph (80 km / h) with the recommended tire pressure.



Practical hints

Flat tire



Warning!



Follow recommend inflation pressures.

Do not overinflate tires. Overinflating tires can result in sudden deflation (blowout) because they are more likely to become punctured or damaged by road debris, potholes etc.

Do not underinflate tires. Underinflated tires wear unevenly, adversely affect handling and fuel economy, and are more likely to fail from being overheated.

Do not overload the tires by exceeding the specified vehicle capacity weight (as indicated by the label on the pillar in the driver's door opening). Overloading the tires can overheat them, possibly causing a blowout.

- ▶ Visit an authorized Mercedes-Benz Center as soon as possible to obtain a new TIREFIT container.
- ▶ Bring used TIREFIT materials to an authorized Mercedes-Benz Center for proper disposal.

Warning!



Do not exceed vehicle speed of 50 mph (80 km/h). A TIREFIT repair is not designed to operate at higher speeds.

The sticker must be attached on the instrument cluster where it will be easily seen by the driver.

Vehicle handling characteristics may change. Adapt your driving accordingly.

- ▶ Replace your TIREFIT container every four years. Replacement containers are available at your authorized Mercedes-Benz Center.

Mounting the spare wheel

Preparing the vehicle

Prepare the vehicle as described under "Preparing the vehicle" on this page.

- ▶ Take the spare wheel out of the trunk (▷ page 350).

Lifting the vehicle

- ▶ Prevent the vehicle from rolling away by blocking wheels with wheel chocks (not included) or other sizable objects.

When changing wheel on a level surface:

- ▶ Place one chock in front of and one behind the wheel that is diagonally opposite to the wheel being changed.

When changing wheel on a hill:

- ▶ Place chocks on the downhill side blocking both wheels of the other axle.
- ▶ Take the two-piece wheel wrench and the jack out of the trunk (▷ page 352). Assemble wheel wrench.

Warning!



The jack is designed exclusively for jacking up the vehicle at the jack take-up brackets built into either side of the vehicle. To help avoid personal injury, use the jack only to lift the vehicle during a wheel change. Never get beneath the vehicle while it is supported by the jack. Keep hands and feet away from the area under the lifted vehicle. Always firmly set parking brake and block wheels before raising vehicle with jack.

Do not disengage parking brake while the vehicle is raised. Be certain that the jack is

always vertical (plumb line) when in use, especially on hills. Always try to use the jack on level surface. Be sure that the jack arm is fully seated in the jack take-up bracket. Always lower the vehicle onto sufficient capacity jackstands before working under the vehicle.



- ▶ On wheel to be changed, loosen but do not yet remove the wheel bolts (approximately one full turn with wrench).

Practical hints

Flat tire

The jack take-up brackets are located directly behind the front wheel housing and in front of the rear wheel housing.

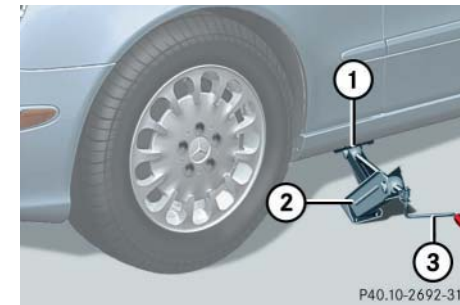

- ① Jack take-up bracket
- ② Jack
- ③ Crank

- ▶ Position jack ② on firm ground under the respective jack take-up bracket ①.

Practical hints

Flat tire

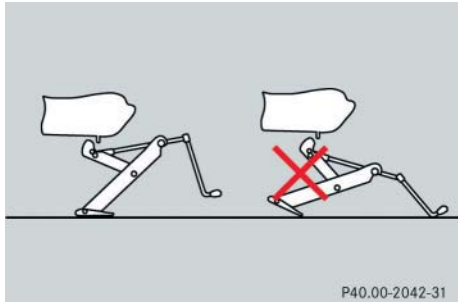

Make sure the foot of the jack is directly under the take-up bracket so that it is always vertical (plumb-line) as seen from the side, even if the vehicle is parked on an incline

- ▶ Turn crank ③ until the tire is a maximum of 1.2 in (3 cm) off the ground. Never start engine while vehicle is raised.

Warning!



Position the jack only on the jack take-up brackets designed for this purpose. If the jack is not properly positioned, the vehicle may slip off of the jack.

Warning!



The jack is intended only for lifting the vehicle briefly for wheel changes. It is not suited for performing maintenance work under the vehicle. Never lie down under the raised vehicle. Do not start the engine when the vehicle is raised.

Removing the wheel

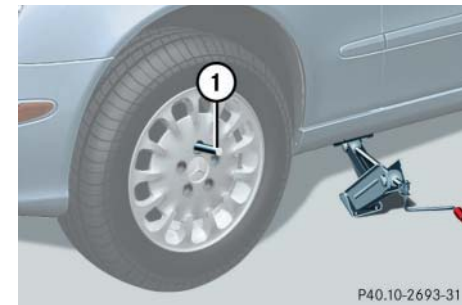

① Alignment bolt

- ▶ Unscrew the upper-most wheel bolt and remove.
- ▶ Replace this wheel bolt with alignment bolt ① supplied in the tool kit.
- ▶ Remove the remaining bolts.



Do not place wheel bolts in sand or dirt. This could result in damage to the bolt and wheel hub threads.

- ▶ Remove the wheel.

Mounting the Minispare wheel

- ▶ Clean contact surfaces of wheel and wheel hub.
- ▶ Guide the spare wheel onto the alignment bolt and push it on.
- ▶ Insert wheel bolts and tighten them slightly.



To avoid paint damage, place wheel flat against hub and hold it there while installing first wheel bolt.

Warning!



Always replace wheel bolts that are damaged or rusted.

Never apply oil or grease to wheel bolts.

Damaged wheel hub threads should be repaired immediately. Do not continue to drive under these circumstances! Contact an authorized Mercedes-Benz Center or call Roadside Assistance.

Incorrect wheel bolts or improperly tightened wheel bolts can cause the wheel to come off. This could cause an accident. Be sure to use the correct wheel bolts.

Practical hints

Flat tire

Warning!



Use only genuine equipment Mercedes-Benz wheel bolts. They are identified by the Mercedes star. Other wheel bolts may come loose.

Do not tighten the wheel bolts when the vehicle is raised. Otherwise the vehicle could tip over.

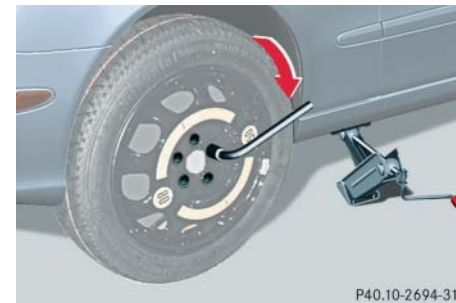

- ▶ Unscrew the alignment bolt, install last wheel bolt and tighten slightly.

Practical hints

Flat tire

Warning!



The dimensions of the Minispare wheel are different from those of the road wheels. As a result, the vehicle handling characteristics change when driving with a Minispare wheel mounted.

The spare wheel should only be used temporarily, and replaced with a regular road wheel as quickly as possible.

In the case of a flat tire, you may temporarily use the Minispare wheel when observing the following restrictions:

- Do not exceed a vehicle speed of 50 mph (80 km/h).
- Drive to the nearest tire repair facility to have the flat tire repaired or replaced as appropriate.
- Do not operate vehicle with more than one spare wheel mounted.

Lowering the vehicle

- ▶ Lower vehicle by turning crank counterclockwise until vehicle is resting fully on its own weight.
- ▶ Remove the jack.

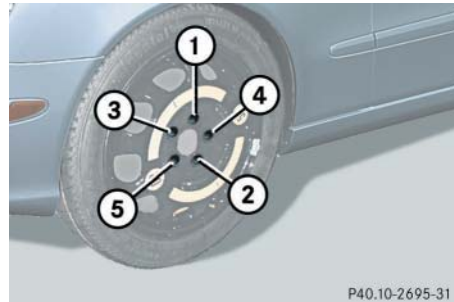

① - ⑤ Wheel bolts

- ▶ Tighten the five wheel bolts evenly, following the diagonal sequence illustrated (① to ⑤), until all bolts are tight. Observe a tightening torque of 96 lb-ft (130 Nm).

Warning!



Have the tightening torque checked after changing a wheel. The wheels could come loose if they are not tightened to a torque of 96 lb-ft (130 Nm).

- ▶ Before storing the jack in the trunk, it should be fully collapsed.



Wrap the damaged wheel in the protective film that comes with the spare wheel and put the wheel in the trunk.

You can also place the damaged wheel down into the spare wheel well. In this case, you must stow the holder from the spare wheel well in the trunk.

Do not activate the tire inflation pressure monitor until the depressurized tire is no longer in the vehicle.

▼ Batteries

Your vehicle is equipped with two batteries:

- Main battery (battery for starter and electrical consumers; located in the trunk).
- Auxiliary battery (back-up battery; stabilizes the electrical system if the main battery is discharged; located in the engine compartment)

The main battery is in the trunk under the luggage box. Remove the luggage box (> page 351).



Vehicles with spare wheel

- ① Negative terminal
- ② Positive terminal



E55 AMG:

The main battery is located inside the trunk area at the top instead of to the right.

Warning!



Jump starting must only be done using the main battery in the trunk.

Practical hints

Batteries

Warning!



Failure to follow these instructions can result in severe injury or death.

Observe all safety instructions and precautions when handling automotive batteries (> page 287).

Never lean over batteries while connecting, you might get injured.

Battery fluid contains sulfuric acid. Do not allow this fluid to come in contact with eyes, skin or clothing. In case it does, immediately flush affected area with water and seek medical help if necessary.

A battery will also produce hydrogen gas, which is flammable and explosive. Keep flames or sparks away from battery, avoid improper connection of jumper cables, smoking etc.

Practical hints

Batteries



Never loosen or detach battery terminal clamps while the engine is running or the SmartKey is in the starter switch. Otherwise the alternator and other electronic components could be severely damaged.

Have the battery checked regularly by an authorized Mercedes-Benz Center.

Refer to Service Booklet for maintenance intervals or contact your authorized Mercedes-Benz Center for further information.

Warning!



Do not place metal objects on the battery as this could result in a short circuit.

Use leak-proof battery only to avoid the risk of acid burns in the event of an accident.

Warning!



The SBC brake system requires electrical power to operate.

A malfunction in the vehicle's power supply or electrical system may impair brake system operation and switch it into its emergency operation mode. The same applies if battery is disconnected. To brake, the driver must then apply significantly greater brake pedal pressure and depress the pedal much further to obtain the expected braking effect. If necessary, apply full pressure to the brake pedal. Brakes may only be applied to the front wheels. Stopping distance is increased! Adjust your driving style accordingly. For more information, refer to "SBC brake system" (> page 79).

Disconnecting the battery

Warning!



With a disconnected battery

- you will no longer be able to turn the SmartKey in the starter switch and pressing the KEYLESS-GO* start/stop button on the gear selector lever will have no effect
- the gear selector lever will remain locked in position **P**

- ▶ Depress parking brake firmly or move gear selector lever to position **P**.
 - ▶ Turn off all electrical consumers.
 - ▶ Remove SmartKey from starter switch.
- Vehicles with KEYLESS-GO*:
- ▶ Press the start / stop button until the engine shuts off.
 - ▶ Open the driver's door.
 - ▶ Open the trunk.

- ▶ Remove the luggage box (▷ page 351).
- ▶ Disconnect battery negative lead ①.
- ▶ Remove cover ② from the positive terminal.
- ▶ Disconnect the battery positive lead.

Removing the battery

- ▶ Remove the screw-nuts securing the battery.
- ▶ Remove the battery bracket.
- ▶ Take out the battery.

Charging and reinstalling the battery

Warning!



Never charge a battery while still installed in the vehicle. Gases may escape during charging and cause explosions that may result in paint damage, corrosion or personal injury.

- ▶ Charge battery in accordance with the instructions of the battery charger manufacturer.
- ▶ Reinstall the charged battery. Follow the previously described steps in reverse order.

Reconnecting the battery

- ▶ Turn off all electrical consumers.
- ▶ Connect the positive lead and fasten its cover.
- ▶ Connect the negative lead.



Never invert the terminal connections!

- ▶ Install the luggage box (▷ page 351).



The battery, its filler caps and the vent tube must always be securely installed when the vehicle is in operation.

Practical hints

Batteries



The following procedures must be carried out following any interruption of battery power (e.g. due to reconnection):

- Set the clock (▷ page 143) (see COMAND operator's manual).
- Resynchronize the side windows (▷ page 200).
- Resynchronize the sliding / pop-up roof* (▷ page 204) or the panorama sliding / pop-up roof* (▷ page 209).

Batteries contain materials that can harm the environment if disposed of improperly. Large 12 volt storage batteries contain lead. Recycling of batteries is the preferred method of disposal. Many states require sellers of batteries to accept old batteries for recycling.

Practical hints

Jump starting

▼ Jump starting

Warning!



Failure to follow these directions will cause damage to the electronic components, and can lead to a battery explosion and severe injury or death.

Never lean over batteries while connecting or jump starting, you might get injured.

Battery fluid contains sulfuric acid. Do not allow this fluid to come in contact with eyes, skin or clothing. In case it does, immediately flush affected area with water, and seek medical help if necessary.

A battery will also produce hydrogen gas, which is flammable and very explosive. Keep flames or sparks away from battery, avoid improper connection of jumper cables, smoking, etc.

Attempting to jump start a frozen battery can result in it exploding, causing personal injury.

Read all instructions before proceeding.

If the battery is discharged, the engine can be started with jumper cables and the battery of another vehicle. Observe the following:

- Jump starting should only be performed when the engine and catalytic converter are cold.
- Do not start the engine if the battery is frozen. Let the battery thaw out first.
- Only jump start from batteries with the same voltage rating (12 V). Jump starting with a more powerful battery could damage the vehicle's electrical system, which will not be covered by the Mercedes-Benz Limited Warranty.
- Use only jumper cables with sufficient cross-section and insulated terminal clamps.
- Always make sure the jumper cables are not on or near pulleys, fans or other parts that move when the engine is started or running.



Jump starting may only be performed on the main battery installed in the trunk.

Avoid repeated and lengthy starting attempts.

Do not attempt to start the engine using a battery quick charge unit.

If the engine does not run after several unsuccessful starting attempts, have it checked at the nearest authorized Mercedes-Benz Center.

Excessive unburned fuel generated by repeated failed starting attempts may damage the catalytic converter.

Make sure the jumper cables do not have loose or missing insulation.

Make sure the cable clamps do not touch any other metal part while the other end is still attached to a battery.

Warning!



Keep flames or sparks away from battery.
Do not smoke.

Observe all safety instructions and precautions when handling automotive batteries (▷ page 287).

The battery is located in the trunk underneath the luggage box (▷ page 351). Only jump start the vehicle from the battery in the trunk.

- ▶ Make sure the two vehicles do not touch.
- ▶ Turn off all electrical consumers.
- ▶ Apply parking brake.
- ▶ Shift gear selector lever to position **P**.
- ▶ Connect positive terminals ① and ③ of the batteries with the jumper cable. Clamp cable to charged battery ③ first.



Never invert the terminal connections!

Practical hints

Jump starting

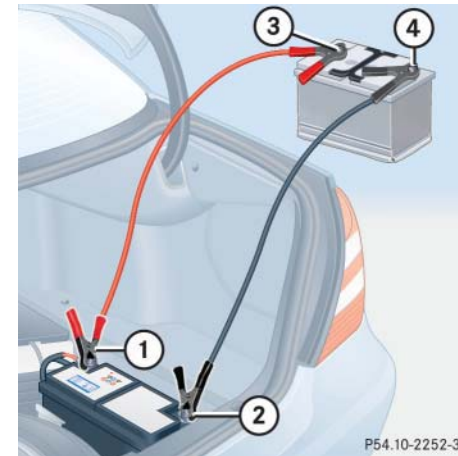

- ① Positive terminal of discharged battery
- ② Negative terminal of discharged battery
- ③ Positive terminal of charged battery
- ④ Negative terminal of charged battery

Practical hints

Jump starting

- ▶ Start engine of the vehicle with the charged battery and run at idle speed.
- ▶ Connect negative terminals ④ and ② of the batteries with the jumper cable. Clamp cable to charged battery ④ first.
- ▶ Start the engine of the disabled vehicle.



The message Malfunction - electric consumers switched off may appear in the instrument cluster. It will disappear as soon as the battery is sufficiently charged.

Now you can again turn on the electrical consumers. Do not turn on the lights under any circumstances.

- ▶ Remove the jumper cables first from negative terminals ② and ④ and then from positive terminals ① and ③.

Now you can turn on the lights.

- ▶ Have the battery checked at the nearest authorized Mercedes-Benz Center.



Do not tow-start the vehicle.

▼ Towing the vehicle

Mercedes-Benz recommends that the vehicle be transported with all wheels off the ground using flatbed or appropriate wheel lift/dolly equipment. This method is preferable to other types of towing.



Use flatbed or wheel lift/dolly equipment with SmartKey in starter switch turned to position **0**.

Do not tow with sling-type equipment. Towing with sling-type equipment over bumpy roads will damage radiator and supports.

To prevent damage during transport, do not tie down vehicle by its chassis or suspension parts.

Switch off the tow-away alarm and the automatic central locking

Do not tow-start the vehicle.

When circumstances do not permit the recommended towing methods, the vehicle may be towed with all wheels on the ground or front wheels raised (except vehicles with 4MATIC) only so far as necessary to have the vehicle moved to a safe location where the recommended towing methods can be employed.



Vehicles with 4MATIC:
Do not tow with one axle raised. Doing so could damage the transfer case, which is not covered by the Mercedes-Benz Limited Warranty.

All wheels must be on or off the ground. Observe instructions for towing the vehicle with all wheels on the ground.

Practical hints

Towing the vehicle



If the vehicle is towed with the front axle raised (not permissible for vehicles with 4MATIC), the engine must be shut off (SmartKey in starter switch position **0** or **1**). Otherwise the ESP will immediately be engaged and will apply the rear wheel brakes.

When towing the vehicle with all wheels on the ground, the selector lever must be in position **N** and the SmartKey must be in starter switch position **2**.

When towing the vehicle with all wheels on the ground or the front axle raised, the vehicle may be towed only for distances up to 30 miles (50 km) and at a speed not to exceed 30 mph (50 km/h).

Practical hints

Towing the vehicle



To be certain to avoid a possibility of damage to the drive train, however, we recommend the drive shaft be disconnected at the rear axle drive flange (vehicles with 4MATIC: disconnected at the front and rear axle drive flanges) for any towing beyond a short tow to a nearby garage.

Warning!



If circumstances require towing the vehicle with all wheels on the ground, always tow with a tow bar if:

- the engine will not run
- there is a malfunction in the SBC brake system
- there is a malfunction in the power supply or in the vehicle's electrical system

as that will be necessary to adequately control the towed vehicle.

Prior to towing the vehicle with all wheels on the ground, make certain that the SmartKey is in starter switch position **2**.

If the SmartKey is left in the starter switch position **0** for an extended period of time, it can no longer be turned in the switch. In this case, the steering is locked. To unlock, remove SmartKey from starter switch and reinsert.

Warning!



The brake system requires electrical power to operate.

A malfunction in the vehicle's power supply or electrical system may impair brake system operation and switch it into its emergency operation mode. To brake, the driver must then apply significantly greater brake pedal pressure and depress the pedal much further to obtain the expected braking effect. If necessary, apply full pressure to the brake pedal. Brakes may only be applied to the front wheels. Stopping distance is increased! Adapt your driving style accordingly. For more information, refer to "SBC brake system" (▷ page 79).

With the engine not running, there is no power assistance for the steering system. In this case, it is important to keep in mind that a considerably higher degree of effort is necessary to steer the vehicle. Adapt your driving accordingly.



To signal turns while being towed with the hazard warning flasher in use, turn SmartKey in starter switch to position **2** and activate the combination switch for the left or right turn signal in the usual manner – only the selected turn signal will operate.

Upon canceling the turn signal, the hazard warning flasher will operate again.



When towing the vehicle with all wheels on the ground, please note the following:

With the automatic central locking activated and the SmartKey in starter switch position **2**, or KEYLESS-GO* start / stop button in position **2**, the vehicle doors lock if the left front wheel as well as the right rear wheel are turning at vehicle speeds of approximately 9 mph (15 km/h) or more.

Switch off the tow-away alarm (▷ page 85).

To prevent the vehicle door locks from locking, deactivate the automatic central locking (▷ page 106).

Towing of the vehicle should only be done using the properly installed towing eye bolt. Never attach tow cable, tow rope or tow rod to the vehicle chassis, frame or suspension parts.

Practical hints

Towing the vehicle



The selector lever will remain locked in position **P** and the SmartKey will not turn in the starter switch if the battery is disconnected or discharged. See notes on the battery (▷ page 375) or on jump starting (▷ page 378).

Manual unlocking transmission selector lever (▷ page 357).

Practical hints

Towing the vehicle

Installing towing eye bolt

Front of vehicle

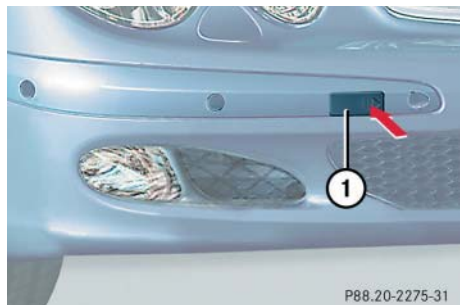

① Cover on right side of front bumper

To remove cover:

- ▶ Press mark on cover in direction of arrow.
- ▶ Lift cover off to reveal threaded hole for towing eye bolt.

The towing eye bolt is supplied with the tool kit (located in the storage compartment under the trunk floor).

- ▶ Screw towing eye bolt in to its stop and tighten with lug wrench.

To reinstall cover:

- ▶ Fit cover and snap into place.

Rear of vehicle

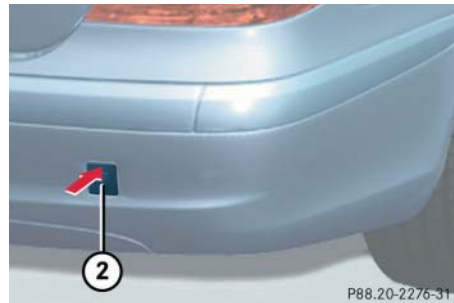

② Cover on right side of rear bumper

To remove cover:

- ▶ Pull cover in the direction of the arrow.
- ▶ Fold cover down to reveal threaded hole for the towing eye bolt.

The towing eye bolt is supplied with the tool kit (located in the storage compartment under the trunk floor).

- ▶ Screw towing eye bolt in to its stop and tighten with lug wrench.

To reinstall cover:

- ▶ Fit cover and snap into place.

▼ Fuses



Only install fuses that have been tested and approved by Mercedes-Benz and that have the specified amperage rating.

Never attempt to repair or bridge a blown fuse. Have the cause determined and remedied by an authorized Mercedes-Benz Center.

Fuse box in passenger compartment



① Cover

Opening

- ▶ Pull cover ① open with a screwdriver or similar tool.
- ▶ Remove cover ① rearward.

Closing

- ▶ Attach cover ① in the front.
- ▶ Fold cover ① in until it engages.

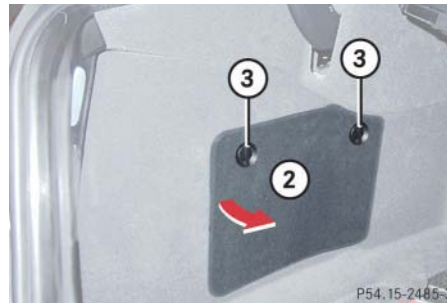

- ② Cover
- ③ Catches

- ▶ Turn catches ③ anti-clockwise and remove cover ②.

Fuse chart

The fuse chart is found in the fuse box in the passenger compartment. The amperages of the fuses are also given there.

Spare fuses

Spare fuses are found in the vehicle tool kit in the trunk.

Fuse extractor

The fuse extractor is found in the vehicle tool kit in the trunk.



Only install fuses that have been tested and approved by Mercedes-Benz and that have the specified amperage rating.

Never attempt to repair or bridge a blown fuse. Have the cause determined and remedied by an authorized Mercedes-Benz Center.



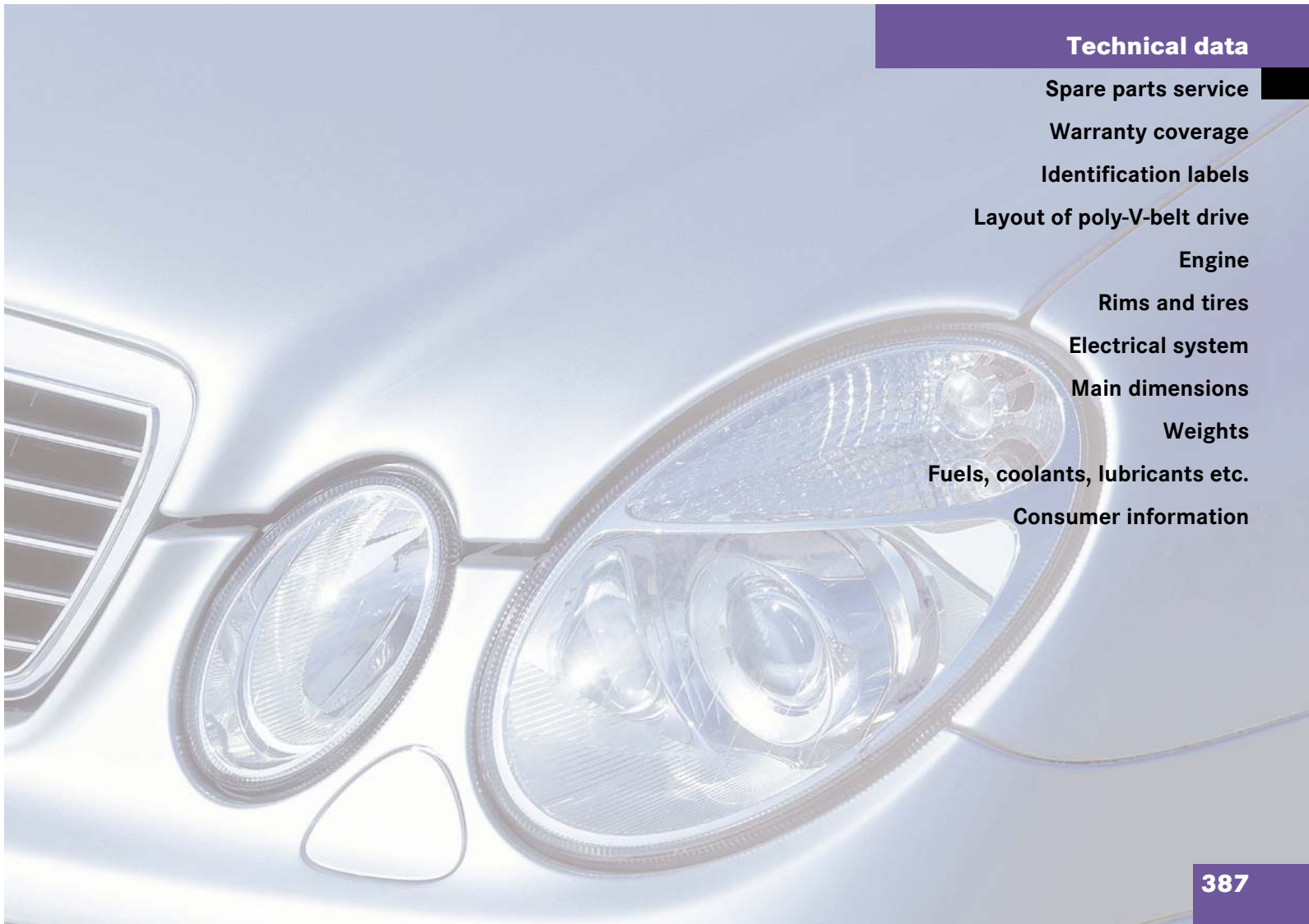

Technical data

Spare parts service

Warranty coverage

Identification labels

Layout of poly-V-belt drive

Engine

Rims and tires

Electrical system

Main dimensions

Weights

Fuels, coolants, lubricants etc.

Consumer information

Technical data

Spare parts service

The “Technical data” section provides the necessary technical data for your vehicle.

▼ Spare parts service

All authorized Mercedes-Benz Centers maintain a stock of genuine Mercedes-Benz parts required for maintenance and repair work. In addition, strategically located parts distribution centers provide quick and reliable parts service.

More than 300 000 different spare parts for Mercedes-Benz models are available.

Genuine Mercedes-Benz parts are subjected to stringent quality inspections. Each part has been specifically developed, manufactured or selected for and adapted to Mercedes-Benz vehicles.

Therefore, genuine Mercedes-Benz parts should be installed.



The use of non-genuine Mercedes-Benz parts and accessories not authorized by Mercedes-Benz could damage the vehicle, which is not covered by the Mercedes-Benz Limited Warranty, or could compromise the vehicle’s durability or safety.

▼ **Warranty coverage**

Your vehicle is covered under the terms of the warranties printed in the Service and Warranty Information Booklet. Your authorized Mercedes-Benz Center will exchange or repair any defective parts originally installed in the vehicle in accordance with the terms of the following warranties:

- New Car Limited Warranty
- Emission System Warranty
- Emission Performance Warranty
- California, Maine, Massachusetts, and Vermont Emission Control System Warranty

Replacement parts and accessories are covered by the Mercedes-Benz Spare Parts and Accessories Warranties, copies of which are available at any authorized Mercedes-Benz Center.

Loss of Service and Warranty Information Booklet

Should you lose your Service and Warranty Information Booklet, have your authorized Mercedes-Benz Center arrange for a replacement. It will be mailed to you.

Technical data

Identification labels

▼ Identification labels

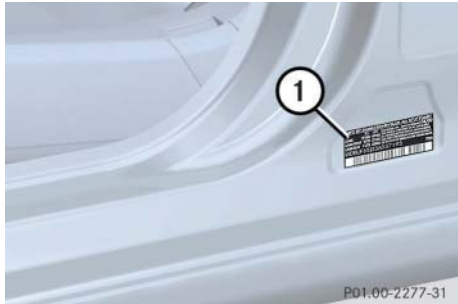

① Certification label



② Vehicle Identification Number (VIN)

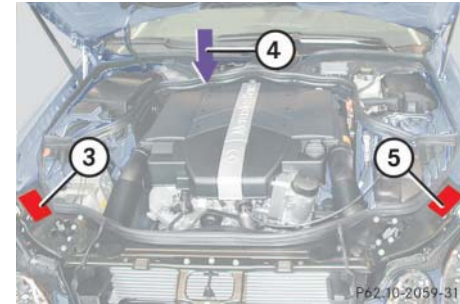

- ③ Information label, California version Vacuum line routing for emission control system
- ④ Engine number (engraved on engine)
- ⑤ Emission control label

When ordering spare parts, please specify vehicle identification and engine numbers.

▼ Layout of poly-V-belt drive

E 320 / E 500

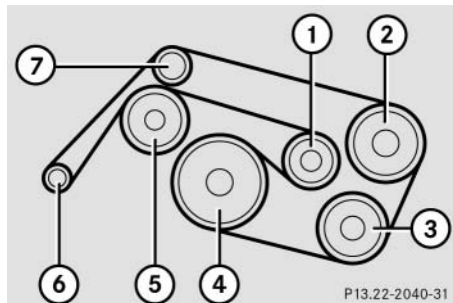

- ① Automatic belt tensioner
- ② Power steering pump
- ③ Air conditioning compressor
- ④ Crankshaft
- ⑤ Coolant pump
- ⑥ Generator (alternator)
- ⑦ Idler pulley

E 55 AMG

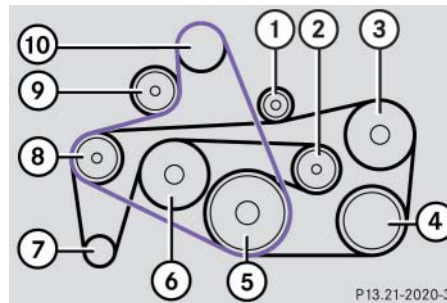

The E 55 AMG has two poly-V-belts (belt one shown in purple / belt two shown in black).

- ① Idler pulley
- ② Automatic belt tensioner
- ③ Power steering pump
- ④ Air conditioning compressor
- ⑤ Crankshaft
- ⑥ Coolant pump
- ⑦ Generator (alternator)
- ⑧ Idler pulley
- ⑨ Automatic belt tensioner
- ⑩ Super charger

Technical data

Engine

▼ Engine

Model	E 320 (211.065 ¹)	E 500 (211.070 ¹)
	E 320 4MATIC (211.082 ¹)	E 500 4MATIC (211.083 ¹)
Engine	112	113
Mode of operation	4-stroke engine, gasoline injection	4-stroke engine, gasoline injection
No. of cylinders	6	8
Bore	3.54 in (89.90 mm)	3.82 in (97.00 mm)
Stroke	3.31 in (84.00 mm)	3.31 in (84.00 mm)
Total piston displacement	195.2 cu.in. (3199 cm ³)	303.0 cu.in. (4966 cm ³)
Compression ratio	10:1	10:1
Output acc. to SAE J 1349	221 hp / 5600 rpm (165 kW / 5600 rpm)	302 hp / 5600 rpm (225 kW / 5600 rpm)
Maximum torque acc. to SAE J 1349	232 lb-ft / 3000 rpm-4800 rpm (315 Nm / 3000 rpm-4800 rpm)	339 lb-ft / 2700 rpm-4250 rpm (460 Nm / 2700 rpm-4250 rpm)
Maximum engine speed	6000 rpm	6000 rpm
Firing order	1-4-3-6-2-5	1-5-4-2-6-3-7-8
Poly-V-belt	2390 mm	2390 mm

¹ The quoted data apply only to the standard vehicle. See an authorized Mercedes-Benz Center for the corresponding data of all special bodies and special equipment.

Technical data

Engine

Model	E 55 AMG (211.076¹)
Engine	113
Mode of operation	4-stroke engine, gasoline injection
No. of cylinders	8
Bore	3.82 in (97.00 mm)
Stroke	3.60 in (92.00 mm)
Total piston displacement	331.8 cu.in. (5439 cm ³)
Compression ratio	9:1
Output acc. to SAE J 1349	469 hp/6100 rpm (350 kW/6100 rpm)
Maximum torque acc. to SAE J 1349	516 lb-ft/2650 rpm (700 Nm/2650 rpm-4500 rpm)
Maximum engine speed	6500 rpm
Firing order	1-5-4-2-6-3-7-8
Poly-V-belts	Belt one: 1289 mm Belt two: 2449 mm

¹ The quoted data apply only to the standard vehicle. See an authorized Mercedes-Benz Center for the corresponding data of all special bodies and special equipment.

Technical data

Rims and tires

▼ Rims and tires

Use only tires and rims which have been specifically developed for your vehicle and tested and approved by Mercedes-Benz. Other tires and rims can have detrimental effects, such as:

- Poor handling characteristics
- Increased noise
- Increased fuel consumption



Moreover, tires and rims not approved by Mercedes-Benz may, under load, exhibit dimensional variations and different tire deformation characteristics that could cause them to come into contact with the vehicle body or axle parts. This may result in damage to the tires or the vehicle.



Further information on tires and rims is available at any authorized Mercedes-Benz Center. A tire inflation pressure table is located on the fuel filler flap of the vehicle. The tire pressure should be checked regularly and should only be adjusted on cold tires. Follow the tire manufacturer's maintenance recommendation included with the vehicle.

Same size tires

16" tires

	E 320 / E 320 4MATIC
Rims (light alloy)	8 J x 16
Wheel offset	1.4 in (36 mm)
Summer tires(radial-ply tires)	-
All-season tires (radial-ply tires)	225/55 R 16 95H M+S
Winter tires (radial-ply tires)	-

Technical data

Rims and tires

17" tires

	E 320 / E 500 (Sport Package*)	E 500 / E 500 4MATIC	E 320 4MATIC E 500 4MATIC (Sport Package*)
Rims (light alloy)	8 J x 17	8 1/2 J x 17	8 J x 17
Wheel offset	1.5 in (38 mm)	1.5 in (38 mm)	1.5 in (38 mm)
Summer tires (radial-ply tires)	245 / 45 R 17 95W	-	-
All-season tires (radial-ply tires)	-	245 / 45 R 17 95H M+S	245 / 45 R 17 95H M+S
Winter tires (radial-ply tires)	245 / 45 R 17 95V M+S	245 / 45 R 17 95V M+S	245 / 45 R 17 95V M+S

18" tires

	E 55 AMG
Rims (light alloy)	8 J x 18
Wheel offset	1.18 in (30 mm)
Summer tires (radial-ply tires)	-
All-season tires (radial-ply tires)	-
Winter tires (radial-ply tires)	245 / 40 R 18 93H M+S or 245 / 40 R 18 97V Extra Load M+S

Technical data

Rims and tires

Mixed size tires (E 55 AMG only)

		E 55 AMG
Front axle:	AMG light alloy rims	8 J x 18
	Wheel offset	1.18 in (30 mm)
	Summer tires (radial-ply tires)	245 / 40 ZR18 ¹
Rear axle:	AMG light alloy rims	9 J x 18
	Wheel offset	1.54 in (39 mm)
	Summer tires (radial-ply tires)	265 / 35 ZR18 Extra Load M0 ¹

¹ Must not be used with snow chains

Minispare wheel

	E 320 / E 320 4MATIC E 500 / E 500 4MATIC
Rim	4 J x 17
Wheel offset	1.34 (34 mm)
Tire	T 155/70 R 17 110 M ¹

¹ Must not be used with snow chains.



The E 55 AMG does not have a spare wheel. The E 55 AMG is equipped with TIREFIT (> page 350).

Technical data**Electrical system****▼ Electrical system**

Model	E 320 / E 320 4MATIC	E 500 / E 500 4MATIC	E 55 AMG
Generator (alternator)	14 V / 150 A	14 V / 150 A	14 V / 180 A
Starter motor	14 V / 1.4 kW	14 V / 1.7 kW	14 V / 1.7 kW
Battery (auxiliary)	12 V / 12 Ah	12 V / 12 Ah	12 V / 12 Ah
Battery (main)	12 V / 95 Ah	12 V / 95 Ah	12 V / 95 Ah
Spark plugs	Bosch F8 DPP 332U NGK PFR 5R-11	Bosch F8 DPP 332U NGK PFR 5R-11	NGK IL FR 6 A
Electrode gap	0.039 in (1.00 mm)	0.039 in (1.00 mm)	0.031 in (0.8 mm)
Tightening torque	18.5 - 22 lb-ft (25 - 30 Nm)	18.5 - 22 lb-ft (25 - 30 Nm)	18.5 - 22 lb-ft (25 - 30 Nm)

Technical data

Main dimensions

▼ Main dimensions

Model	E 320 / E 320 4MATIC	E 500 / E 500 4MATIC	E 55 AMG
Overall vehicle length	190.3 in (4833 mm)	190.3 in (4833 mm)	190.9 in (4849 mm)
Overall vehicle width	71.7 in (1822 mm)	71.7 in (1822 mm)	71.7 in (1822 mm)
Overall vehicle height	57.1 in (1449 mm)		
Overall vehicle height (Airmatic DC*) (optional on E320; standard on E500 / E55 AMG)	56.2 in (1429 mm)	56.3 in (1431 mm)	55.6 in (1412 mm)
Wheelbase	112.4 in (2854 mm)	112.4 in (2854 mm)	112.4 in (2854 mm)
Track, front	61.4 in (1559 mm)	61.7 in (1567 mm)	62.3 in (1583 mm)
Track, rear	61.1 in (1552 mm)	61.4 in (1560 mm)	61.3 in (1558 mm)

Technical data

Weights

▼ Weights

Roof load max.	220 lbs (100 kg)
Trunk load max.	220 lbs (100 kg)

Technical data

Fuels, coolants, lubricants etc.

▼ Fuels, coolants, lubricants etc.

Capacities

Vehicle components and their respective lubricants must match. Therefore use only brands tested and approved by us.

Please refer to the Factory Approved Service Products Pamphlet, or inquire at your authorized Mercedes-Benz Center.

	Model	Capacity	Fuels, coolants, lubricants etc.
Engine with oil filter	E 320 / E 320 4MATIC	8.5 US qt (8.0 l)	Approved engine oils
	E 500 / E 500 4MATIC	8.0 US qt (7.5 l)	
	E 55 AMG	9.0 US qt (8.5 l)	
Automatic transmission		8.0 US qt (7.5 l)	MB Automatic Transmission Oil
Front axle	E 320 4MATIC / E 500 4MATIC	0.63 US qt (0.6 l)	Hypoid gear oil SAE 85 W 90
Rear axle	E 320 / E 320 4MATIC	1.06 US qt (1 l)	Hypoid gear oil SAE 85 W 90
	E 500 / E 500 4MATIC/ E 55 AMG	1.37 US qt (1.3 l)	
Transfer case	E 320 4MATIC / E 500 4MATIC	0.62 US qt (0.585 l)	MB Transfer Case Fluid

Technical data

Fuels, coolants, lubricants etc.

	Model	Capacity	Fuels, coolants, lubricants etc.
Power steering		approx. 1.1 US qt (1 l)	MB Power Steering Fluid (Pentosin CHF 11S)
Front wheel hubs		approx. 3.0 oz (85 g) each	High temperature roller bearing grease
Brake system		1.1 US qt (1.05 l)	MB Brake Fluid (DOT 4+)
Cooling system	E 320 / E 320 4MATIC	10.7 US qt (10 l)	MB 325.0 Anticorrosion / Antifreeze
	E 500 / E 500 4MATIC	11.9 US qt (11.3 l)	
	E 55 AMG	13.8 US qt (13.2 l)	
Fuel tank including a reserve of		21.12 US gal (80.0 l)	Premium unleaded gasoline: Posted Octane 91 (Avg. of 96 RON/86 MON)
		2.38 US gal (9.0 l)	

Technical data

Fuels, coolants, lubricants etc.

	Model	Capacity	Fuels, coolants, lubricants etc.
Air conditioning system			R-134a refrigerant and special PAG lubricant oil (never R-12)
Windshield washer		4.8 US qt (4.5 l)	MB Windshield Washer Concentrate ¹
Windshield washer and headlamp cleaning system		7.4 US qt (7.0 l)	MB Windshield Washer Concentrate ¹

¹ Use MB Windshield Washer Concentrate "S" and water for temperatures above freezing or MB Windshield Washer Concentrate "S" and commercially available pre-mixed windshield washer solvent / antifreeze for temperatures below freezing point. Follow suggested mixing ratios (▷ page 407).

Engine oils

Engine oils are specifically tested for their suitability in our engines. Therefore, use only engine oils recommended by Mercedes-Benz. Information on recommended brands is available in the Factory Approved Service Products Pamphlet, or at your authorized Mercedes-Benz Center.



Always check the oil filler cap (> page 285) for important information pertaining to the engine oil needing to meet a specific Mercedes-Benz specification (e.g. MB 229.5). If such information is printed on the oil filler cap, only use an engine oil from the list of approved engine oils in the Factory Approved Service Products pamphlet that meets the specification indicated on the oil filler cap.

Using engine oils of other specification may cause the FSS to incorrectly determine the next service interval and will result in engine damage not covered by the Mercedes-Benz Limited Warranty.

Please follow FSS recommendations for scheduled oil changes. Failure to do so could result in engine damage not covered by the Mercedes-Benz Limited Warranty.

Engine oil additives

Do not blend oil additives with engine oil. They may damage the engine.

Damage or malfunctions resulting from blending oil additives are not covered by the Mercedes-Benz Limited Warranty.

Air conditioning refrigerant

R-134a (HFC) refrigerant and special PAG lubricating oil is used in the air conditioning system.

Never use R-12 (CFC) or mineral-based lubricating oil. Otherwise damage to the system will occur.

Brake fluid

During vehicle operation, the boiling point of the brake fluid is continuously reduced through the absorption of moisture from the atmosphere. Under extremely strenuous operating conditions, this moisture content can lead to the formation of bubbles in the system, thus reducing the system's efficiency.

Therefore, the brake fluid must be replaced every two years, preferably in the spring.

Only brake fluid approved by Mercedes-Benz is recommended. Your authorized Mercedes-Benz Center will provide you with additional information.

Technical data

Fuels, coolants, lubricants etc.

Premium unleaded gasoline



To maintain the engine's durability and performance, premium unleaded gasoline must be used. If premium unleaded gasoline is not available and low octane fuel is used, follow these precautions:

- Have the fuel tank only partially filled with unleaded regular and fill up with premium unleaded as soon as possible
- Avoid full throttle driving and abrupt acceleration
- Do not exceed an engine speed of 3000 rpm if the vehicle is loaded with a light load such as two persons and no luggage
- Do not exceed 2 / 3 of maximum accelerator pedal position if the vehicle is fully loaded or operating in mountainous terrain

Fuel requirements

Use only premium unleaded gasoline meeting ASTM standard D 439:

- The octane number (posted at the pump) must be 91 min. It is an average of both the Research (R) Octane Number and the Motor (M) Octane Number: $(R+M) / 2$. This is also known as the ANTI-KNOCK INDEX.

Unleaded gasoline containing oxygenates such as ethanol, IPA, IBA and TBA can be used provided the ratio of any one of these oxygenates to gasoline does not exceed 10%; MTBE must not exceed 15%.

The ratio of methanol to gasoline must not exceed 3% plus additional cosolvents.

Using mixtures of ethanol and methanol is not allowed. Gasohol, which contains 10% ethanol and 90% unleaded gasoline, can be used.

These blends must also meet all other fuel requirements, such as resistance to spark knock, boiling range, vapor pressure, etc.

Gasoline additives

A major concern among engine manufacturers is carbon build-up caused by gasoline. Mercedes-Benz recommends only the use of quality gasoline containing additives that prevent the build-up of carbon deposits.

After an extended period of using fuels without such additives, carbon deposits can build up especially on the intake valves and in the combustion area, leading to engine performance problems such as:

- Warm-up hesitation
- Unstable idle
- Knocking / pinging
- Misfire
- Power loss

Do not blend any specific fuel additives with fuel. This only results in unnecessary costs and may be harmful to the engine operation.

Damage or malfunctions resulting from poor fuel quality or from blending specific fuel additives are not covered by the Mercedes-Benz Limited Warranty.

Coolants

The engine coolant is a mixture of water and anticorrosion / antifreeze, which provides:

- Corrosion protection
- Freeze protection
- Boiling protection (by increasing the boiling point)

The cooling system was filled at the factory with a coolant providing freeze protection to approximately -22°F (-30°C) and corrosion protection.

If the antifreeze mixture is effective to -22°F (-30°C), the boiling point of the coolant in the pressurized cooling system is reached at approximately 266°F (130°C).

The coolant solution must be used year-round to provide the necessary corrosion protection and increase boil-over protection. Refer to Service Booklet for replacement interval

Coolant system design and coolant used stipulate the replacement interval. The replacement interval published in the Service Booklet is only applicable if MB 325.0 anticorrosion / antifreeze solution or other Mercedes-Benz approved products of equal specification (see Factory Approved Service Products pamphlet) are used to renew the coolant concentration or bring it back up to the proper level.

To provide important corrosion protection, the solution must be at least 45% anticorrosion / antifreeze [equivalent to freeze protection to approximately -22°F (-30°C)]. If you use a solution that is more than 55% anticorrosion / antifreeze [freeze protection to approximately -49°F (-45°C)], the engine temperature will increase due to the lower heat transfer capability of the solution. Therefore, do not use more than this amount of anticorrosion / antifreeze.

Technical data

Fuels, coolants, lubricants etc.

If the coolant level is low, water and MB Anticorrosion / Antifreeze should be used to bring it up to the proper level (have cooling system checked for signs of leakage). Please make sure the mixture is in accordance with label instructions.

The water in the cooling system must meet minimum requirements, which are usually satisfied by normal drinking water. If you are not sure about the water quality, consult your authorized Mercedes-Benz Center.

Anticorrosion / antifreeze

Your vehicle contains a number of aluminum parts. The use of aluminum components in motor vehicle engines necessitates that anticorrosion / antifreeze coolant used in such engines be specifically formulated to protect the aluminum parts. (Failure to use such anticorrosion / antifreeze coolant will result in a significantly shortened service life.)

Therefore, the following product is strongly recommended for use in your vehicle:
Mercedes-Benz 325.0
Anticorrosion / Antifreeze Agent.

Before the start of the winter season (or once a year in hot southern regions), you should have the anticorrosion / antifreeze concentration checked. The coolant is also regularly checked each time you bring your vehicle to your authorized Mercedes-Benz Center for service.

Anticorrosion / antifreeze quantity

Model	Approx. freeze protection	
	- 35°F (- 37°C)	- 49°F (- 45°C)
E 320 / E 320 4MATIC	5.3 US qt (5.0 l)	5.9 US qt (5.5 l)
E 500 / E 500 4MATIC	6.0 US qt (5.65 l)	6.6 US qt (6.2 l)
E 55 AMG	7.0 US qt (6.6 l)	7.7 US qt (7.3 l)

Windshield and headlamp washer system

Both the windshield and headlamp washer systems are supplied from the windshield washer fluid reservoir.

The washer fluid reservoir has a capacity of approximately:

- 7.4 US qt. (7 l) in vehicles with a headlamp cleaning system* or heated reservoir
- 4.8 US qt. (4.5 l) in vehicles without a headlamp cleaning system

- ▶ Refill the reservoir with MB Windshield Washer Concentrate and water (or concentrate and commercially available premixed windshield washer solvent / antifreeze, depending on ambient temperatures).

Warning



Washer solvent / antifreeze is highly flammable. Do not spill washer solvent / antifreeze on hot engine parts, because it may ignite and burn. You can be seriously burned.

Technical data

Fuels, coolants, lubricants etc.

Windshield and headlamp washer fluid mixing ratio

For temperatures above freezing, use MB Windshield Washer Concentrate “S” and water:

- 1 part “S” to 100 parts water
[40 ml “S” to 1 gallon (4 liters) water].

For temperatures below freezing point use MB Windshield Washer Concentrate “S” and commercially available premixed windshield washer solvent / antifreeze:

- 1 part “S” to 100 parts solvent
[40 ml “S” to 1 gallon (4 liters) solvent].

Technical data

Consumer information

▼ Consumer information

The following text is published as required of all manufacturers of passenger cars under Title 49, Code of U.S. Federal Regulations, Part 575 pursuant to the “National Traffic and Motor Vehicle Safety Act of 1966”.

Uniform tire quality grading

Quality grades can be found, where applicable, on the tire sidewall between tread shoulder and maximum section width. For example:

Tread wear	Traction	Temperature
200	AA	A

All passenger car tires must conform to federal safety requirements in addition to these grades.

Tread wear

The tread wear grade is a comparative rating based on the wear rate of the tire when tested under controlled conditions on a specified government test course. For example, a tire graded 150 would wear one and one-half (1½) times as well on the government course as a tire graded 100. The relative performance of tires depends upon the actual conditions of their use, however, and may depart significantly from the norm due to variations in driving habits, service practices and differences in road characteristics and climate.

Traction

The traction grades, from highest to lowest, are AA, A, B, and C. Those grades represent the tire’s ability to stop on wet pavement as measured under controlled conditions on specified government test surfaces of asphalt and concrete. A tire marked C may have poor traction performance.

Warning



The traction grade assigned to this tire is based on straight ahead braking traction tests, and does not include acceleration, cornering, hydroplaning, or peak traction characteristics.

Temperature

The temperature grades are A (the highest), B, and C, representing the tire's resistance to the generation of heat and its ability to dissipate heat when tested under controlled conditions on a specified indoor laboratory test wheel. Sustained high temperature can cause the material of the tire to degenerate and reduce tire life, and excessive temperature can lead to sudden tire failure. Grade C corresponds to a level of performance which all passenger car tires must meet under the Federal Motor Vehicle Safety Standard No. 109. Grades B and A represent higher levels of performance on the laboratory test wheel than the minimum required by law.

Warning



The temperature grade for this tire is established for a tire that is properly inflated and not overloaded. Excessive speed, underinflation, or excessive loading, either separately or in combination, can cause excessive heat build-up and possible tire failure.



ABS

(Antilock Brake System)

Prevents the wheels from locking up during braking so that the vehicle can continue to be steered.

ADS

(Adaptive Damping System)

Automatically adapts the optimum suspension damping to prevailing driving conditions.

Airmatic DC

(Airmatic Dual Control)

Automatically selects the optimum suspension tuning and ride height for your vehicle. Airmatic consists of two components:

- Adaptive Damping System
- Vehicle level control

Alignment bolt

Metal pin with thread. The centering pin is an aid used when changing a tire to align the wheel with the wheel hub.

BabySmart™ airbag deactivation system

This system detects if a special system compatible child restraint seat is installed on the front passenger seat. The system will automatically deactivate the passenger front airbag when such a seat is properly installed (PASSENGER AIRBAG OFF indicator lamp located in the center console comes on). See your authorized Mercedes-Benz Center for availability.

BabySmart™ compatible child seats

Special restraint system for children. The sensor system for the passenger seat prevents deployment of the passenger front airbag if a BabySmart™ compatible child seat is installed.

BAS

(Brake Assist System)

System for potentially reducing braking distances in emergency braking situations. The system is activated when it senses an emergency based on how fast the brake is applied.

Bi-Xenon headlamps*

Headlamps which use an electric arc as a light source and produce a more intense light than filament headlamps. Bi-Xenon headlamps produce low beam and high beam.

CAC

(Customer Assistance Center)

Mercedes-Benz customer service center which can help you with any questions about your vehicle and provide assistance in the event of a breakdown.

CAN system

(Controller Area Network)

Data bus network serving to control vehicle functions such as door locking or windshield wiping.

Cockpit

All instruments, switches, buttons and indicator/warning lamps in the passenger compartment needed for vehicle operation and monitoring.

Technical terms

COMAND

(Cockpit Management and Data System)

Information and operating center for vehicle sound and communications systems, including the radio and navigation system, as well as other optional equipment (CD changer, telephone, etc.).

Control system

The control system is used to call up vehicle information and to change component settings. Information and messages appear in the multifunction display. The driver uses the buttons on the multifunction steering wheel to navigate through the system and to adjust settings.

Cruise control

Driving convenience system for automatically maintaining the vehicle speed set by the driver.

Distronic*

A driving convenience cruise control system which helps the driver maintain a pre-selected speed:

- If there is no vehicle directly ahead, the system operates in the same way as conventional ->cruise control.
- If a slower moving vehicle is ahead, Distronic will reduce your vehicle speed to the extent permitted by reduced throttle and up to 20% braking power to maintain the preset minimum following distance.

DTR

(->Distronic*)

Engine number

The number set by the manufacturer and placed on the cylinder block to uniquely identify each engine produced.

Engine oil viscosity

Measurement for the inner friction (viscosity) of the oil at different temperatures. The higher the temperature an oil can tolerate without becoming thin, or the lower the temperature it can tolerate without becoming viscous, the better the viscosity.

ESP

(Electronic Stability Program)

Improves vehicle handling and directional stability.

ETD

(Emergency Tensioning Device)

Device which deploys in certain frontal and rear collisions exceeding the system's threshold to tighten the seat belts.

->SRS

FSS PLUS

(Flexible Service System PLUS)

Service indicator in the multifunction display that informs the driver when the next vehicle maintenance service is due.

Gear range

Number of gears which are available to the automatic transmission for shifting. The automatic gear shifting process can be adapted to specific operating conditions using the selector lever.

GPS

(Global Positioning System)
Satellite-based system for relaying geographic location information to and from vehicles equipped with special receivers. Employs DVD digital maps for navigation.

Instrument cluster

The displays and indicator/warning lamps in the driver's field of vision, including the tachometer, speedometer and fuel gauge.

Kickdown

Depressing the accelerator past the point of resistance shifts the transmission down to the lowest possible gear. This very quickly accelerates the vehicle and should not be used for normal acceleration needs.

Lock button

Button on the door which indicates whether the door is locked or unlocked. Pushing the lock button down on an individual door from inside will lock that door.

Memory function*

Used to store three individual seat, steering wheel and exterior mirror positions for each SmartKey.

Menu

The control system displays are arranged in menus. Each menu contains a number of commands for particular systems. In the Audio menu, for example, you will find the commands **SELECT RADIO STATION** or **OPERATE CD PLAYER**. Using commands, you can directly change the settings for your vehicle.

MON

(Motor Octane Number)
The Motor Octane Number for gasoline as determined by a standardized method. It is an indication of a gasoline's ability to resist undesired detonation (knocking). The average of both the MON (Motor Octane Number) and ->RON (Research Octane Number) is posted at the pump, also known as ANTI-KNOCK INDEX.

Technical terms

Multifunction display

The display field in the instrument cluster used to present information provided by the control system.

Multifunction steering wheel

Steering wheel with buttons for operating the control system.

Overspeed range

Engine speeds within the red marking on the tachometer dial. Avoid this engine speed range, as it may result in serious engine damage that is not covered by the Mercedes-Benz Limited Warranty.

Poly-V-belt drive

Drives engine-components (alternator, AC compressor, etc.) from the engine.

Power train

Collective term designating all components used to generate and transmit motive power to the drive axles, including:

- Engine
- Clutch/torque converter
- Transmission
- Transfer case*
- Drive shaft
- Axle shafts/axles

Program mode selector switch

Used to switch the automatic transmission between standard operation **S** and operation **C**.

E 55 AMG with steering wheel gearshift control and manual shift program: in addition to **S** and **C** (for sporty **S** or comfortable **C** operation), you can use **M** for manual shift program.

Remote Vehicle Diagnostics

Transmission of vehicle data and current location to the Mercedes-Benz Customer Assistance Center for subscribers to the Tele Aid service.

Restraint systems

Seat belts, belt tensioners, airbags and child restraint systems. As independent systems, their protective functions complement one another.

RON

(Research Octane Number)

The Research Octane Number for gasoline as determined by a standardized method. It is an indication of a gasoline's ability to resist undesired detonation (knocking). The average of both the →MON (Motor Octane Number) and RON (Research Octane Number) is posted at the pump, also known as ANTI-KNOCK INDEX.

SBC

(Sensotronic Brake Control)
Electronically controlled hydraulic braking system for increased braking safety and comfort.

Shift lock

When the vehicle is parked, this lock prevents the transmission selector lever from being moved out of position **P** without SmartKey turned and brake pedal depressed.

SRS

(Supplemental Restraint System)
Seat belts, emergency tensioning device and airbags. Though independent systems, they are closely interfaced to provide effective occupant protection.

Tele Aid System

(Telematic Alarm Identification on De-mand)
The Tele Aid system consists of three types of response: automatic and manual emergency, roadside assistance and information. Tele Aid is initially activated by completing a subscriber agreement and placing an acquaintance call.
The Tele Aid system is operational provided that the vehicle's battery is charged, properly connected, not damaged and cellular and GPS coverage is available.

Telematics*

A combination of the terms "telecommunications" and "informatics".

Tightening torque

Force times lever arm (e.g. a lug wrench) with which threaded fasteners such as wheel bolts are tightened.

Tire speed rating

Part of a tire designation; indicates the speed range for which a tire is approved.

Traction

Force exerted by the vehicle on the road via the tires.

Vehicle level control

The ground clearance of the vehicle is automatically controlled according to a selected setting and speed. The driver can set the ground clearance manually for example on very rough roads.

VIN

(Vehicle Identification Number)
The number set by the manufacturer and placed on the body to uniquely identify each vehicle produced.

Voice control system*

Voice control system for car phones, portable cell phones and audio systems (radio, CD, etc.).



A

- ABS 74, 411
 - ABS control 75
 - Malfunction indicator lamp 310
 - Messages in display 319
 - Warning lamp 310
- Accelerator position, automatic transmission 164
- Accident
 - In case of 50
- Activating
 - Air conditioning (cooling) 182, 194
 - Air recirculation mode 180, 191
 - Anti-theft alarm system 84
 - Automatic climate control 186
 - Central locking (control system) 149
 - Charcoal filter 192
 - Climate control 176
 - Defrosting 179
 - Distance warning function* 223
 - DISTRONIC* 219
 - Easy-entry/exit feature* 150
 - ESP 79
 - Exterior headlamps 47
 - Exterior lamps 120
 - Front fog lamps 122
 - Hazard warning flasher 124
 - Headlamps 47
 - High beams 123
 - Ignition 31
 - Ignition with KEYLESS-GO* 33
 - Immobilizer 53, 83
 - Rear fog lamp 121, 122
 - Rear window defroster 173
 - Residual heat 182, 194
 - Seat heater* 113
 - Tow-away alarm 85
 - Windshield wipers 48
- Adding
 - Engine oil 284
- Additional turn signal 359
- Adjustable air vents, rear passenger compartment 195
- Adjusting 34
 - Air distribution 178, 189
 - Air volume 178, 179, 190
 - Backrest tilt 36
 - Exterior rear view mirror 38
 - Head restraint height 36
 - Head restraint tilt 36
 - Instrument cluster illumination 126
 - Interior rear view mirror 38
 - Mirrors 38
 - Multicontour seat* 111
 - Seat cushion depth 111
 - Seat cushion tilt 36
 - Seat fore and aft adjustment 35
 - Seat height 36
 - Seats 34
 - Steering column height 37
 - Steering wheel 37
- Adjusting steering column in or out 37
- Adjusting steering column up or down 37
- Adjusting the dynamic seat 153
- Air conditioning (cooling)
 - Turning off 182, 194
 - Turning on 182, 194
- Air distribution
 - Adjusting 178, 189
- Air pressure see Tire inflation pressure 290
- Air recirculation mode 180, 191
 - Activating 180, 191
 - Deactivating 181, 192

Index

- Air vents, rear passenger compartment
 - Adjustable 195
- Air volume
 - Adjusting 178, 179, 190
- AIRBAG OFF indicator lamp 317
- Airbags 57
 - BabySmart™ airbag deactivation system 411
 - Children 58
 - Front 61
 - Passenger 61
 - Safety guidelines 60
 - Side impact 61
 - Window curtain 61
- Airmatic DC (Dual Control)* 226
- Alarm
 - Audible 73, 85
 - Canceling 85
 - Visual 84
- Alarm system
 - Anti-theft 84
- Alignment bolt (vehicle tool kit) 352, 372, 411
- Antiglare
 - Automatic 168
- Antilock brake system (ABS) 411
- Anti-theft alarm system
 - Arming 84
 - Canceling alarm 85
 - Disarming 84
- Anti-theft systems 83
 - Anti-theft alarm system 84
 - Immobilizer 83
 - Tow-away alarm 85
- Aquaplaning see Hydroplaning 271
- Ashtray 246
- At the gas station 278
- AUDIO menu 134
 - Selecting radio station 134
 - Selecting satellite radio* station 135
- Audio system
 - CD mode 135
- Automatic antiglare for rear view mirror 168
- Automatic central locking
 - Activating/deactivating (control system) 149
- Automatic climate control
 - Temperature sensor 27
- Automatic climate control* 184
 - Adjusting air distribution 189
 - Adjusting air volume 179, 190
 - Air recirculation mode 191
 - Defrosting 190
 - Rear window defroster 173
 - Residual heat utilization 194
 - Residual ventilation 194
 - Setting the temperature 188
- Automatic headlamp mode 120
- Automatic lighting control
 - Activating 124
 - Deactivating 125
- Automatic locking when driving 106
- Automatic transmission 158
 - Accelerator position 164
 - Emergency operation (Limp Home Mode) 167
 - Gear ranges 160
 - Gear selector lever position 161
 - Gear shifting malfunctions 167
 - Kickdown 164

- Manual shift program mode (SL 55 AMG Kompressor) 165
 - Manual shifting 159
 - One-touch gearshifting 159
 - Program mode selector switch 164
 - Selector lever position 158
 - Starting the engine 43
 - Winter program mode 164
- B**
- BabySmart™
 - Airbag deactivation system 67
 - Compatible child seats 411
 - Self-test 68
 - BabySmart™ airbag deactivation system 411
 - Backrest
 - Folding forward 236
 - Folding rearward 238
 - BAS 76, 411
 - Batteries, SmartKey
 - Changing 355, 356
 - Check lamp 90, 94
 - Checking 91, 96
 - Batteries, SmartKey with KEYLESS-GO*
 - Changing 355, 356
 - Checking 91, 96
 - Batteries, vehicle
 - Charging 377
 - Disconnecting 376
 - Messages in display 320, 324, 325
 - Reconnecting 377
 - Removing 377
 - Service 375
 - Battery discharged
 - Jump starting 378
 - Bi-Xenon headlamps* 411
 - Block heater* 296
 - Blocking
 - Rear window operation 72
 - Brake assist system (BAS) 411
 - Brake fluid 279, 328
 - Brake pads
 - Message in display 326
 - Brakes
 - Warning lamp 312
 - Break-in period 266
 - Bulbs, replacing
 - Additional turn signals 359
 - Fog lamps 359
 - Front lamps 359, 361
 - High beam 359
 - High beam bulb (Bi-Xenon* headlamps only) 362
 - High beam bulb (Halogen headlamps only) 362
 - High mounted brake lamp 360
 - License plate lamps 360, 363
 - Low beam 359
 - Parking lamps 360, 362
 - Side marker lamps 359, 363
 - Standing lamps 360, 362
 - Tail lamp 360
 - Tail lamp assemblies 363
 - Turn signal lamp 359

Index

C

- CAC (Customer Assistance Center) 411
- Calling up
 - Distronic* settings 136
 - Range (distance to empty) 154
 - Service indicator 298
- CAN system 411
- Cargo tie-down rings 241
- CD player
 - Operating 135
- Center console
 - Lower part 26
 - PASSENGER AIRBAG OFF indicator lamp 317
 - Upper part 25
- Centigrade
 - Setting temperature units 141
- Central locking
 - Automatic 106
 - From inside 107
 - Switch 107
 - Switching on/off (control system) 149
 - Unlocking from inside 107
- Central locking switch 107
- Changing
 - Batteries (SmartKey with KEYLESS-GO*) 355, 356
 - Batteries (SmartKey) 355, 356
 - Smartkey setting 150
 - Vehicle level 228
- Charcoal filter 192
 - Activating 192
 - Deactivating 193
- Charging
 - Vehicle batteries 377
- CHECK ENGINE malfunction indicator lamp 313
- Checking
 - Coolant level 285
 - Oil level 279, 282
 - Tire inflation pressure 279
 - Vehicle lighting 279
- Child safety 65
 - Airbags 58
 - Infant and child restraint systems 62, 65
 - LATCH child seat anchors 71
- Child safety switch see Blocking of rear window operation 72
- Cigarette lighter 247
- Cleaning
 - Headlamps 170
 - Light alloy wheels 305
 - Parktronic* system sensor 305
 - Windshield 49
 - Wood trims 308
- Climate control 174
 - Adjusting 178
 - Defrosting 179
 - Setting the temperature 178
- Clock 144
- Closing
 - Glove box 242
 - Panorama sliding/pop-up roof 206
 - Panorama sliding/pop-up roof with KEYLESS-GO* 209
 - Panorama sliding/pop-up roof* with KEYLESS-GO* 200
 - Roller sunblinds 205
 - Side windows 198

- Side windows with
 - KEYLESS-GO* 200, 203
- Sliding/pop-up roof* 201
- Sliding/pop-up roof* with
 - KEYLESS-GO* 200, 203
- Sliding/pop-up roof* with
 - SmartKey 202
- Trunk
 - Vehicle with KEYLESS-GO* 102, 103
 - Trunk lid 99
 - Windows 197
 - Windows with SmartKey 199
- Closing the trunk lid 102, 103
- Cockpit 20, 411
- Cockpit management and data system (COMAND) 412
- COMAND 412
- COMAND* see separate operating instructions
- Combination switch 123
 - High beam flasher 47
 - Turn signals 47
 - Windshield wipers 48
- Consumer information 408
- Control system 129, 412
 - AUDIO menu 134
 - Convenience submenu 150
 - Display digital speedometer 134
 - Distronic* menu 136
 - Functions 133
 - Instrument cluster submenu 141, 143
 - Lighting submenu 146
 - Malfunction memory menu 137
 - Menus 132, 133, 413
 - Multifunction display 129
 - Multifunction steering wheel 130
 - Selecting radio system 134
 - Selecting satellite radio* system 135
 - Settings menu 138
 - Standard display menu 134
 - Submenus 131, 133
 - TEL* menu 155
 - Trip computer menu 153
 - Vehicle submenu 149
- Convenience submenu 150
 - Activating easy-entry/exit feature* 150
 - Adjusting dynamic seat* 153
 - Setting parking position for exterior rear view mirror 152
 - Setting Smartkey-dependency 152
- Coolant
 - Checking level 285
 - Messages in display 329, 330, 331
 - Temperature gauge 127
 - Warning lamp 314
- Coolant temperature 277
- Cruise control 211, 412
 - Canceling 212
 - Driving downhill 212
 - Driving uphill 212
 - Fine adjustment 213
 - Lever 218
 - Saving current speed 212
 - Setting speeds 213
- Cruise control lever 211
- Cup holder in the center console 243
- Customer Assistance Center (CAC) 411

Index

D

- Daytime running lamp mode 121
 - Setting 146
- Deactivating
 - Air conditioning 182
 - Air recirculation mode 181, 192
 - Alarm 84
 - Anti-theft alarm system 84
 - Automatic climate control 181, 186
 - Central locking (control system) 149
 - Climate control 176
 - Cruise control 212
 - Defrost 180, 190
 - Distance warning function* 223
 - DISTRONIC* 221
 - Engine with KEYLESS-GO* 53
 - ESP 78
 - Exterior lamps 120
 - Hazard warning flasher 124
 - Headlamps 52
 - Immobilizer 83
 - Interior lighting delayed
 - switch-off 149
 - Rear window defroster 173
 - Residual heat 183
 - Seat heater* 113
 - Seat ventilation* 114
 - SmartKey
 - Turning off the engine 53
 - Tow-away alarm 85
- Deceleration
 - With DISTRONIC* 217
- Defogging
 - Windshield 179, 189
- Defrosting 179, 190
- Delayed switch-off
 - Interior lighting 149
- Dialing
 - A number (telephone) 156
- Difficulties
 - While driving see Problems while driving 50
 - With starting 45
- Digital speedometer 134
- Direction of rotation 290
- Discharged battery
 - Jump starting 378
- Disconnecting
 - Vehicle battery 376
- Display
 - Selecting 142, 143
- Displays
 - Digital speedometer 134
 - DISTRONIC* 216
 - Messages 283
 - Selecting 142
 - Service indicator 297
 - Showing malfunctions 137
- Distance
 - Decreasing in DISTRONIC* 222
 - Increasing in DISTRONIC* 222
 - Warning function 222
- Distance to empty (range)
 - Calling up 153
- Distance warning function* 222
 - Activating 223
 - Deactivating 223
 - DTR* warning lamp 222
 - Intermittent warning sound 222
 - Symbol in multifunction display 136

- Distronic* 214, 412
 - Activated 218
 - Activating 219
 - Calling up settings 136, 217
 - Cleaning system sensor 305
 - Cruise control lever 218
 - Deactivated 218
 - Deactivating 221
 - Deceleration 217
 - Decreasing distance 222
 - Displays in the speedometer dial 216
 - Distance warning function 222
 - Driving hints 223
 - Increasing distance 222
 - Intermittent signal tone 216
 - Menu 217
 - Messages in display 320
 - Sensor cover 305
 - Setting a higher speed 219
 - Setting a slower speed 220
 - Setting the current speed 219
 - Setting the following distance in
 - Distronic 221
 - Warning and indicator lamps 216
- Door control panel 28
- Door entry lamps 125
- Door handle 28
- Door unlock
 - With Tele Aid* 257
- Doors
 - Message in display 332
 - Opening from inside vehicle 97
 - Opening from outside 94
- Downhill driving
 - Cruise control 212
- Downshifting 159
- Drive-Dynamic seat* 112
- Driving
 - General instructions 40
 - Hydroplaning 271
 - In winter 273
 - Problems 50
 - Safety systems 74
 - With DISTRONIC* 223
- Driving hints
 - SBC brake system 81
- Driving instructions 267
- Driving off 270
- Driving safety systems
 - 4MATIC 82
 - ABS 74
 - BAS 76
 - ESP 76, 412
 - SBC brake system 79
- Driving systems 211
 - Airmatic DC* 226
 - Cruise control 211
 - Distronic* 214
 - Driving safety systems 74
 - Vehicle level control 227
- DTR see DISTRONIC* 412
- Dual control*
 - Airmatic DC* 226
- E**
- Easy-entry/exit
 - Message in display 327, 347
- Easy-entry/exit feature* 108
 - Activating 150
 - Interrupting movement 108, 151
- Electrical fuses 385
- Electrical system 397

Index

- Electronic Stability Program see ESP 76, 412
- Emergency call system* 250
- Emergency calls
 - Initiating an emergency call 253
 - With Tele Aid* 252
- Emergency operation (Limp Home Mode) 167
 - Opening/closing Sliding/pop-up roof* or panorama sliding/pop-up roof* 358
 - Releasing trunk lid from inside 104
- Emergency operations
 - Remote door unlock 257
 - Unlocking the trunk lid 354
 - Unlocking the vehicle 353
- Emergency tensioning device see ETD 64, 412
- Emission control 276
- Ending
 - A call (telephone) 156
- Engine 392
 - Compartment 281
 - Message in the display 313
 - Starting 43
 - Starting with KEYLESS-GO* 44
 - Starting with the SmartKey 44
 - Turning off with the key 53
- Engine compartment
 - Hood 281
- Engine malfunction indicator lamp 313
- Engine number 412
- Engine oil
 - Adding 284
 - Additives 403
 - Checking level 282
 - Consumption 282
 - Display messages 333
 - Filler neck 285
 - Messages in display 283
 - Viscosity 412
- Entry position
 - Messages in the display 347
- ESP 76, 412
 - Four wheel electronic traction system with ESP 82
 - Switching off 78
 - Switching on 79
 - Synchronizing 323
 - Warning lamp 311
- ETD 412
 - Safety guidelines 60
- Exterior lamp switch 119
- Exterior rear view mirrors
 - Adjusting 38
 - Parking position for 152
- F**
- Fahrenheit
 - Setting temperature units 141
- Fastening the seat belts 40
- Fine adjustment
 - Cruise control 213
- First aid kit 350
- Flat tire 366
 - Mounting the spare wheel 370
 - Spare wheel 370
- Flexible 297

- Flexible Service System (FSS) 297, 412
 - Fog lamp, rear 122
 - Fog lamps, front 122
 - Messages in display 337
 - Replacing bulbs 359
 - Switching on 122
 - Following distance in DISTRONIC* 221
 - Four wheel electronic traction system (4MATIC) with ESP 82
 - 4MATIC 82
 - Front airbags 61
 - Front lamps 359
 - Messages in display 338
 - Replacing bulbs 361
 - Switching on 119
 - Front seat head restraints
 - Power seat 109
 - removing and installing 109
 - Front seats
 - Heater* 113
 - FSS (Flexible Service System) 297, 412
 - Fuel 279
 - Fuel tank reserve warning lamp 315
 - Premium unleaded gasoline 279
 - Fuel consumption statistics
 - After start 153
 - Since last reset 154
 - Fuel filler flap 278
 - Locking 278
 - Unlocking 278
 - Fuel reserve tank
 - Message in display 335
 - Fuel tank
 - Filler flap 278
 - Fuels, coolants, lubricants etc. 400
 - Fully closing (Express-close) the sliding/pop-up roof 202
 - Fully opening (Express-open) the sliding/pop-up roof 202
 - Functions (control system) 133
 - Resetting 139
 - Fuse chart 385
 - Fuses 385
 - Fuse chart 385
 - Fuse extractor 385
 - Spare fuses 385
- G**
- Garage door opener 27, 258
 - Erasing the integrated remote control 263
 - Integrated remote control 259
 - Rolling code programming 261
 - Gasoline see Fuel 279
 - Gear range 413
 - Automatic transmission 160
 - Limiting 160
 - Shifting into optimal 159
 - Gear range limit
 - Canceling 159
 - Gear selector lever
 - Position 161
 - Global
 - Locking 89
 - Locking with KEYLESS-GO* 94
 - Unlocking 89
 - Unlocking with KEYLESS-GO* 94
 - Global Positioning System (GPS) 413
 - Glove box 242
 - Closing 242
 - Opening 242
 - Good visibility 168

Index

- GPS 413
- GPS see COMAND 251
- H**
- Hand-held transmitter
 - Programming integrated remote control 259
 - Reprogramming integrated remote control 263
- Hazard warning flasher 123
 - Switching off 124
 - Switching on 124
- Headlamps
 - Automatic control 120
 - Bi-Xenon* 411
 - Cleaning system* 170
 - Switching off 52
 - Switching on 47
- Headlamps, tail lamps, side markers, turn signal lenses 304
- Heated seats* 113
- Heated steering wheel* 248
- Height adjustment
 - Head restraints 36
 - Steering wheel 37
 - Vehicle level 227
- High beam flasher 47, 123
- High beam headlamps
 - Messages in display 338
 - Replacing bulbs 359
 - Switching on 123
- Hood 281
 - Closing 281
 - Message in display 335
 - Opening 281
- Hydroplaning 271
- I**
- Identification labels 390
- Ignition 31, 33
 - Switching on 44
- Immobilizer 83
 - Activating 83
 - Deactivating 83
- Indicator lamps see Lamps, indicator and warning
- Infant and child restraint systems 65
 - Installing 69
 - LATCH child seat anchors 71
- Information
 - About service and warranty 10
 - Button for Tele Aid* 255
- Inside rear view mirror
 - Antiglare 168
- Installing
 - Infant and child restraint systems 69
 - Towing eye bolt 384
 - Wiper blades 365
- Instrument cluster 22, 126, 307, 413
 - Coolant temperature gauge 127
 - Illumination 126
 - Multifunction display 129
 - Outside temperature indicator 128
 - Selecting language 142
- Instrument lighting 126, 127
- Integrated remote control
 - Canadian programming 262
 - Erasing memory 263
 - Gate operator 262
 - Hand-held transmitter 259
 - Operation 262
 - Rolling code programming 261

Interior lighting 124
 Activating automatic control 124
 Deactivating automatic control 125
 Delayed switch-off 149
 Manual operation 125
 Interior rear view mirror
 Adjusting 38
 Interior storage spaces 242
 Glove box 242

J

Jack 350
 Jump starting 378

K

Key, Mechanical 353
 Key, SmartKey
 Changing the batteries 355, 356
 Key, SmartKey with KEYLESS-GO*
 Changing the batteries 355, 356

KEYLESS-GO*

Activating ignition with 33
 Closing
 Trunk 102, 103
 Closing panorama sliding/pop-up
 roof* 200, 203
 Closing side windows 200, 203
 Closing sliding/pop-up roof* 200,
 203
 Factory setting 94
 Global locking 94
 Global unlocking 94
 Important notes 92
 Locking the vehicle 96
 Remote controls 91
 Starting the engine 44
 Turning off engine 53
 Unlocking and opening, trunk lid 95
 Unlocking with 32
 Kickdown 164, 413
 Kilometers/miles in speedometer 141
 Km/h or mph in speedometer 141

L

Lamp bulbs, exterior 359
 Lamps, exterior
 Front 359
 Light sensor 338
 Messages in display 338-??
 Replacing bulbs for rear 360, 363
 Lamps, indicator and warning
 ABS 310
 Airbag Off 61
 Battery (SmartKey) 89, 94
 Brakes 312
 CHECK ENGINE 313
 Coolant 314
 DTR* 216
 Engine diagnostics 313
 ESP 311
 Fuel reserve 313
 SBC 79
 Seat belts 313, 315
 Service indicator 297
 SRS 57

Index

- Language
 - Multifunction display 142
 - Setting 142
 - LATCH child seat anchors 71
 - Layout of poly-V-belt drive 391
 - Leather upholstery
 - Cleaning 308
 - Level control system*
 - Airmatic DC* 226
 - Lever
 - For cruise control 218
 - License plate lamps 360
 - Messages in display 338
 - Replacing bulbs 363
 - Light alloy wheels
 - Cleaning 307
 - Light sensor 338
 - Lighter see Cigarette lighter 247
 - Lighting 119
 - Automatic headlamp mode 120
 - Combination switch 123
 - Daytime running lamp mode 121
 - Door entry lamps 125
 - Exterior lamp switch 119
 - Front fog lamps 122
 - High beams 123
 - Instrument cluster illumination 126
 - Instruments 126, 127
 - Interior 124
 - Locator lighting 121
 - Low beam 119
 - Manual headlamp mode 120
 - Night security illumination 121
 - Parking lamps 119
 - Rear fog lamp 122
 - Settings (control system) 146
 - Trunk lamp 125
- Limiting the gear range 160
 - Limp Home Mode 167
 - Loading 233
 - Cargo tie-down rings 241
 - Instructions 240
 - Roof rack* 233
 - Ski sack* 233
 - Split rear bench seat* 236
 - Locator lighting 121
 - Setting 147
 - Lock button 413
 - Door handle (KEYLESS-GO*) 54
 - Locking 51, 88
 - Automatic while driving 106
 - Centrally from inside 107
 - Fuel filler flap 278
 - Global with KEYLESS-GO* 94
 - Global, SmartKey 89
 - Separately the trunk 105
 - Vehicle in an emergency 354
 - Vehicle with KEYLESS-GO* 96
 - Loss of SmartKeys 91, 96
 - Low beam headlamps
 - Messages in display 338
 - Replacing bulbs 359
 - Lowering
 - Vehicle 374

M

Main Dimensions 398
 Maintenance 12
 Malfunction
 Displaying 137
 Malfunction memory 137
 Calling up 137
 Clearing 138
 MANUAL
 Shift program mode
 (SL 55 AMG Kompressor) 165
 Manual headlamp mode 120
 Manual operations
 Fuel filler flap 357
 Interior lighting control 125
 Locking the trunk 105
 Sliding/pop-up roof* or panorama sliding/pop-up roof* 358
 Unlocking the driver's door 353
 Unlocking the transmission lever 357
 Unlocking the trunk lid 354
 Massage function 113
 MAXCOOL maximum cooling 190
 Mechanical key 353

Memory function 116, 413
 Recalling positions from memory 117
 Storing exterior rear view mirror parking positions 118
 Storing SmartKey dependent settings 117
 Menus 132
 AUDIO 134
 Control system 413
 Distronic* 136, 217
 In control system 132, 133
 Malfunction memory 137
 Settings menu 138
 Standard display 134
 Submenus 131
 TEL* 155
 Trip computer 153
 Miles/kilometers in speedometer
 Setting 141
 Minispare wheel
 Mounting 373

Mirrors

Adjusting 38
 Automatic antiglare for rear view mirror 168
 Automatic antiglare* for inside mirror 168
 Exterior rear view mirror 38
 Exterior rear view mirror parking positions 152, 169
 Interior rear view mirror 38
 Storing exterior mirror parking position 118
 MON 279
 MON (Motor Octane Number) 413
 Mph or km/h in speedometer 141
 Multicontour seat* 111
 Multifunction display 129, 414
 Selecting language 142
 Standard display 133
 Multifunction display messages
 ABS 319
 Batteries 320, 324, 325
 Brake fluid 328
 Brake pads 326
 Check engine 313

Index

Coolant 330, 331
Coolant level 329
Distronic* 320
Doors 332
Easy-entry/exit feature 327, 347
Fuel reserve tank 335
Hood 335
Lamps 338-??
Parking brake 327
SBC brake system 326, 327
SmartKey 336
SmartKey with KEYLESS-GO* 335
Steering gear oil level 347
Tele Aid 345, 346
Telephone* 346
Tires 342
Trunk 347
Washer fluid 347
Multifunction steering wheel 24, 130, 414
Buttons 130
Navigation system
See separate COMAND operating instructions 136
Night security illumination 121

O

Occupant safety 56
Airbags 57
Children and airbags 58
Children in the vehicle 65
Fastening the seat belt 40
Infant and child restraint systems 65
LATCH child seat anchors 71
Seat belts 40, 60
Oil
Adding 284
Checking level 283
Consumption 282
Filler neck 284
Viscosity 412
Oil level
Checking 283
One-touch gearshifting 159
Canceling gear range limit 159
Downshifting 159
Upshifting 159
Opening 358
Ashtray 246
Doors from the inside 97
Fuel filler flap 278
Fuel filler flap manually 357
Glove box 242
Panorama sliding/pop-up roof 206
Panorama sliding/pop-up roof* in an emergency 358
Roller sunblinds 205
Side windows 198
Sliding/pop-up roof* 201
Sliding/pop-up roof* in an emergency 358
Sliding/pop-up roof* with SmartKey 202
Trunk 97
Trunk from the inside 98
Trunk lid with SmartKey 90
Windows 197
Windows with SmartKey 199

- Opening and closing
 - Panorama sliding/pop-up roof with SmartKey 208
 - Opening from the inside
 - Trunk 99
 - Opening the trunk from the outside 97
 - Operating
 - CD player 135
 - Radio 134
 - Safety 16
 - Telephone* 155
 - Vehicle outside the USA and Canada 13
 - Operating safety 16
 - Operation
 - Garage door opener 262
 - Integrated remote control 262
 - Operator's Manual 10
 - Ornamental moldings 304
 - Outside temperature indicator 128
 - Overdue service 297
 - Overhead control panel 27
 - Garage door opener 258
 - Overspeed range 414
- P**
- Paintwork 303
 - Panic alarm 73
 - Panic button on SmartKey 73
 - Panorama sliding/pop-up roof
 - Opening and closing with SmartKey 208
 - Panorama sliding/pop-up roof* 205
 - Parcel net in front passenger footwell 242
 - Parking 51
 - Parking brake 45, 51
 - Engaging 51
 - Message in display 327
 - Releasing 45
 - Parking lamps 359
 - Replacing the bulbs 362
 - Switching on 119
 - Parking position
 - Exterior rear view mirrors 118, 152, 169
 - Parktronic*
 - Malfunctioning 232
 - Sensor 305
 - PASSENGER AIRBAG OFF indicator lamp 317
 - Passenger compartment
 - Fuse box 385
 - Interior lighting 124
 - Interior rear view mirror 38
 - Passenger safety see Occupant safety 56
 - Pedals 267
 - Phone book*
 - Loading 156
 - Quick search 156
 - Phone number*
 - Dialing 156
 - Redialing 157
 - Plastic and rubber parts
 - Cleaning 308
 - Pliers, universal (vehicle tool kit) 352
 - Poly-V-belt drive 414
 - Positions (Memory function)
 - Recalling from memory 117
 - Positions (Memory function*)
 - Storing into memory 117
 - Power assistance 268

Index

- Power seat
 - Adjusting backrest tilt 36
 - Adjusting head restraint height 36
 - Adjusting head restraint tilt 36
 - Adjusting seat cushion tilt 36
 - Adjusting seat height 36
 - Memory function 116
 - Removing/installing head restraints 109
 - Seat fore and aft adjustment 35
- Power train 414
- Power washer 303
- Power windows 197
 - Blocking of rear window operation 72
 - Side windows 197
 - Synchronizing 200
- Practical hints
 - First aid kit 350
- Practical hints
 - Jump starting 378
 - Lamp in center console 317
 - Lamps in instrument cluster 310
 - Messages in the display 318
 - Spare wheel 350
 - TIREFIT(E 55 AMG) 350
- Vehicle tool kit 352
- Problems
 - While driving 50
 - With vehicle 17
- Product information 9
- Program mode selector switch 414
 - Automatic transmission 164
- PULSE function (Massage function) 113
- Q**
- Quick search
 - Phone book* 156
- R**
- Radio
 - Selecting stations 134
 - Selecting stations (satellite*) 135
- Radio transmitters, control and operation 275
- Range (distance to empty)
 - Calling up 154
- Rear bench seat
 - Foldable 236
- Rear fog lamp
 - Bulb 359
 - Switching on 122
- Rear lamp bulbs 360
- Rear lamps see Tail lamps
- Rear passenger compartment
 - Adjustable air vents 195
- Rear view mirror automatic antiglare 168
- Rear view mirrors see Mirrors 168
- Rear window
 - Blocking operation 72
- Rear window defroster 173
 - Activating 173
 - Deactivating 173
- Rear window sunshade* 172
- Reconnecting
 - Vehicle battery 377
- Regular checks 279
- Reinstalling the battery 377
- Remote controls
 - Integrated 259
 - SmartKey 88, 92
 - SmartKey with KEYLESS-GO* 91
- Remote door unlock
 - With Tele Aid* 257
- Remote Vehicle Diagnostics 414

- Removing
 - Ski sack 236
 - Vehicle battery 377
 - Wheel 372
 - Wiper blades 365
- removing and installing
 - Front seat head restraints 109
- Replacing
 - Bulbs 359
 - Front lamp bulbs 361
 - Front turn signal lamp bulb 362
 - Fuses 385
 - License plate lamp bulbs 363
 - Parking and standing lamp bulb 362
 - Rear lamp bulbs 360, 363
 - Side marker lamp bulb 363
 - Wiper blades 364
- Reporting
 - Safety defects 18
- Reprogramming
 - integrated remote control 263
- Reset button in the instrument cluster 138
- Resetting
 - All functions (control system) 138
 - All functions of a submenu 139
 - Fuel consumption 154
 - Service indicator (FSS) 298, 300, 301
 - Trip odometer 127
- Residual heat utilization 182, 194
- Residual ventilation 182, 194
- REST (Residual engine heat utilization) 194
- Restraint system see Infant and child restraint systems 65
- Rims and Tires 394
- Roadside Assistance
 - Tele Aid* 250
- Roadside assistance 12
- Rolling code programming 261
- RON (Research Octane Number) 279, 414
- Roof rack* 233
- Rotating wheels 293
- Rubber parts
 - Cleaning 308
- Resetting
 - All functions (control system) 138
 - All functions of a submenu 139
 - Fuel consumption 154
 - Service indicator (FSS) 298, 300, 301
 - Trip odometer 127
- Residual heat utilization 182, 194
- Residual ventilation 182, 194
- REST (Residual engine heat utilization) 194
- Restraint system see Infant and child restraint systems 65
- Rims and Tires 394
- Roadside Assistance
 - Tele Aid* 250
- Roadside assistance 12
- Rolling code programming 261
- RON (Research Octane Number) 279, 414
- Roof rack* 233
- Rotating wheels 293
- Rubber parts
 - Cleaning 308
- S**
- Safety
 - Occupant 56
 - Safety belts see Seat belts 40
 - Safety defects
 - Reporting 18
 - Safety systems
 - Driving 74
 - Saving current speed 212
 - SBC 79
 - SBC brake system 415
 - Activation 80
 - Deactivation 81
 - Driving hints 81
 - Messages in display 326, 327
 - Self-check 81
 - Warning lamp 79
 - Sealing tires with TIREFIT 366
 - Seat belt force limiter 64
 - Seat belts 62
 - Cleaning 307
 - Fastening 40
 - Proper use of 42, 63
 - Safety guidelines 60
 - Warning lamp 315

Index

- Seat cushion depth
 - Adjusting 111
- Seat heater*
 - Switching off 113
 - Switching on 113
- Seat ventilation*
 - Switching off 114
 - Switching on 114
- Seats 108
 - Adjusting 34
 - Easy entry/exit feature* 108
 - Heater* 113
 - Multicontour seat* 111
 - Split rear bench seat* 236
 - Ventilation 114
- Securing cargo
 - Cargo tie-down rings 241
- Selecting display 142, 143
- Selector lever
 - Lock 43
 - Message in the display 323
 - Position (automatic transmission) 158
- Self-test
 - BabySmart™ airbag deactivation system 68
 - Tele Aid* 251
- Service
 - Batteries 375
 - Calling up the service indicator 298
 - Major service (Service H) 297
 - Minor service (Service A) 297
 - Overdue 298
 - Types 297
 - When due 297
- Service and warranty information 10
- Service indicator 297
 - Calling up 298
 - Clearing 298
- Service life (tires) 290
- Service System see FSS 297
- Setting
 - Convenience functions 140, 150
 - Cruise control 212
 - Daytime running lamp mode 146
 - Distronic* time interval 221
- Exterior rear view mirror parking position 118
- Higher speed in cruise control 213
- Higher speed in Distronic* 219
- Hours (clock) 144
- Individual vehicle settings 138
- Instrument lighting 126, 127
- Interior lighting delayed switch-off 149
- Lamps and lighting (control system) 146
- Language, multifunction display 142
- Locator lighting 147
- Lower speed in cruise control 213
- Lower speed in Distronic* 220
- Miles/kilometers in speedometer 141
- Minutes (clock) 144, 145
- Parking position for exterior rear view mirrors 152
- Slower speed in cruise control 213
- Slower speed in Distronic* 220
- Smartkey dependent memory 152

- Speed in cruise control 213
- Speed in DISTRONIC* 219
- Speedometer display mode 141
- Suspension tuning 226
- Synchronizing the time 144
- Temperature (interior) 178, 188
- Temperature indicator 141
- Tire inflation pressure 143
- Units
 - Speedometer 141
 - Temperature 141
 - Tire inflation pressure 143
- Vehicle level control 227
- Settings
 - Calling up DISTRONIC* 136, 217
 - Convenience functions 150
 - Factory, KEYLESS-GO* 94
 - Factory, SmartKey 89
 - Individual 152
 - Lighting (control system) 146
 - Menus and submenus 131
 - Resetting all (control system) 138
 - Resetting in the submenu 139
 - Selective 89, 94
- Settings menu
 - Functions in 138
 - Individual vehicle settings 138
 - Submenus 139
- Shift lock 415
- Shifting
 - Gear selector lever positions 161
 - Into optimal gear range (automatic transmission) 159
- Side impact airbags 61
- Side marker lamps 359, 363
- Side windows
 - Automatic opening 198
 - Cleaning 306
 - Closing 197, 198, 199
 - Closing with KEYLESS-GO* 200, 203
 - Closing with SmartKey 199
 - Opening 197, 199
 - Opening fully (Express-open) 198
 - Opening with SmartKey 199
 - Stopping 199
 - Synchronizing power windows 200
- Simultaneous wiping and washing
 - Windshield wipers 49
- Single wipe 49
- Ski sack* 233
 - Removing 236
 - Unfolding and loading 233
 - Unloading and folding 235
- SL 55 AMG Kompressor
 - MANUAL shift program mode 165
- Sliding/pop-up roof* 201
 - Closing 201
 - Closing with KEYLESS-GO* 200, 203
 - Closing with SmartKey 202
 - Opening 201
 - Opening with SmartKey 202
 - Stopping 202
 - Synchronizing 204
- Sliding/pop-up roof* or panorama sliding/pop-up roof*
 - Emergency operations 358
- SmartKey 88
 - Battery check lamp 89, 94
 - Checking the batteries 91, 96
 - Factory setting 89
 - Global locking 89
 - Global locking and unlocking 89
 - Global unlocking 89

Index

- Locking and unlocking 88
- Loss of 91
- Opening and closing the sliding/pop-up roof* with 202
- Opening and closing windows with 199
- Opening the panorama sliding/pop-up roof* with SmartKey 208
- positions in starter switch 31
- Remote controls 88, 92
- Restoring to factory setting 90, 94
- Selective setting 89, 94
- Starting the engine 44
- Unlocking with 30
- SmartKey with KEYLESS-GO* 91
 - Global locking and unlocking 94
 - Locking the vehicle 96
 - Loss of 96
 - Messages in display 335
 - Remote controls 91
 - Turning off the engine 53
 - Unlocking with 32
- Smartkey-dependency memory Settings 152
- Snow chains 296
- Solar panel* 210
- Spare fuses 385
- Spare parts service 388
- Spare wheel 350
- Speed
 - Saving current 212
- Speed settings
 - Cruise control 213
 - Distronic* 219, 220
- Speedometer
 - Displays 216
 - Settings units 141
- Speedometer display mode
 - Selecting 141
- Split rear bench seat* 236
- Sporty driving style 226
- SRS 415
- SRS indicator lamp 23, 56, 316
- Standing lamps 119
 - Replacing bulbs 362
- Standing water 274
- Starter switch 31
 - Positions 31
- Starting difficulties 45
- Starting position 31
- Starting the engine 43
- Steering column
 - Height adjustment 37
 - Length adjustment 37
- Steering gear oil
 - Message in display 347
- Steering wheel
 - Adjusting 37
 - Cleaning 308
 - Electrical adjustment 37
- Stolen vehicle
 - Tracking services 258
- Stopping
 - Panorama sliding/pop-up roof 207
 - Sliding/pop-up roof* 202
 - Windows 199
- Storage compartments
 - Glove box 242
- Storage space under armrest 244
- Storing (Memory function*)
 - Positions into memory 117

- Submenus
 - Convenience 150
 - For settings 131
 - In control system 133
 - Instrument cluster 141, 143
 - Lighting 146
 - Resetting functions in Control system 139
 - Selecting 139
 - Settings menu 139
 - Vehicle 149
- Sun visors 170
- Supplemental Restraint System (SRS) 415
- Suspension tuning
 - For comfortable driving style 226
 - For sporty driving style 226
- Switching off
 - Automatic central locking (control system) 149
 - Engine 52
 - ESP 78
 - Hazard warning flasher 124
 - Headlamps 52
 - Seat heating* 114
- Switching on
 - Automatic central locking (control system) 149
 - ESP 79
 - Front fog lamps 122
 - Hazard warning flasher 124
 - Headlamps 47
 - High beams 123
 - Parking lamps 119
 - Rear fog lamp 122
 - Seat heating* 114
 - Windshield wipers 48
- Symbol (Distrionic*)
 - Distance warning function* 136
- Synchronizing
 - ESP 323
 - Panorama sliding/pop-up roof* 209
 - Power windows 200
 - Sliding/pop-up roof* 204
 - Time 144
- T**
- Tachometer 128
 - Displaying gear range 160
 - Overspeed range 128
- Tail lamps 360, 363
- Tar stains 303
- Tele Aid
 - Messages in display 345, 346
- Tele Aid System 415
- Tele Aid* 250
 - Emergency calls 252
 - Information 255
 - Initiating an emergency call manually 253
 - Remote door unlock 257
 - Roadside Assistance 254
 - SOS button 253
 - Stolen vehicle tracking services 258
 - System self-check 251
 - Tele Aid System 250
 - Upgrade signals 256
- Telematics* 415
- Telephone* 24, 249
 - Answering a call 156
 - Dialing a number from the phone book 156
 - Ending a call 156
 - Loading phone book* 156
 - Messages in the display 346
 - Operating 155
 - Redialing 157

Index

- Temperature
 - Display mode 141
 - Sensor 27
 - Setting interior temperature 178, 188
 - Setting units in display 141
 - Tires 291
- The coolant level is correct if the level 286
- Tie-down rings (trunk) 241
- Tightening torque 374, 415
- Time
 - Setting hours 144
 - Setting minutes 144, 145
- Tire inflation pressure 368
 - Setting units 143
- Tire speed rating 415
- Tire traction 272
- TIREFIT 350
- TIREFIT kit
 - Preparing TIREFIT 367
 - Sealing tires with TIREFIT 366
 - TIREFIT kit 366
- Tires 408
 - Driving instructions 270
 - Messages in display 342
 - Messages in the display 340, 341
 - Retreads 289
 - Service life 290
 - Temperature 291
 - Tread depth 295
 - Wear pattern 293
 - Winter 295
- Tires and wheels
 - Tire inflation pressure 290
- Tools 352
- Tow-away alarm 85
 - Arming 85
 - Disarming 85
 - Disarming for transport 85
- Towing eye bolt (vehicle tool kit)
 - Installing 384
- Towing the vehicle 381
- Tracking services
 - For stolen vehicle 258
- Traction 164, 415
- Transmission fluid level 285
- Tread depth (tires) 295
- Trip computer 153
- Trip odometer
 - Resetting 127
- Trunk
 - Closing the lid 99
 - Lamp 125
 - Lock button, KEYLESS-GO* 96
 - Message in display 347
 - Opening 97
 - Opening from inside vehicle 98
 - Opening from the inside 99
 - Separately locking 105
 - Tie-down rings 241
 - Trunk lid 99
 - Trunk lid emergency release 104
 - Unlocking and opening with KEYLESS-GO* 95
 - Unlocking and opening with SmartKey 90
 - Unlocking in an emergency 354
- Trunk lid
 - Closing 99
- Turn signals 47
 - Additional in mirrors 359
 - Front bulbs 359
- Turning off
 - Engine 52

U

- Units
 - Setting speedometer units 141
 - Setting temperature units 141
 - Setting tire inflation pressure units 143
- Unlocking 30, 88, 353
 - Centrally from inside 107
 - Driver's door in an emergency 353
 - Fuel filler flap 278
 - Global 89
 - Global with KEYLESS-GO* 94
 - Selective settings 89, 94
 - Trunk in an emergency 354
 - Trunk lid with KEYLESS-GO* 95
 - Trunk lid with SmartKey 90
 - Vehicle in an emergency 257
 - With KEYLESS-GO* 32
 - With the SmartKey 30
- Upgrade signals
 - Tele Aid* 256
- Uphill driving
 - Cruise control 212
- Upshifting 159

Useful features 242

- Ashtrays 246
- Cigarette lighter 247
- Garage door opener 258
- Heated steering wheel* 248
- Tele Aid* 250
- Telephone* 249

V

- Vehicle
 - Individual settings 138, 140
 - Locking in an emergency 354
 - Lowering 374
 - Towing 381
 - Unlocking in an emergency 353
- Vehicle care
 - Cup holder 307
 - Distronic* system sensor cover 305
 - Engine cleaning 304
 - Gear selector lever 307
 - Hard plastic trim items 307
 - Leather upholstery 308
 - Light alloy wheels 307
 - Ornamental moldings 304
 - Paintwork 303
 - Parktronic* system sensor 305

- Plastic and rubber parts 308
- Power washer 303
- Seat belts 307
- Steering wheel 307
- Tar stains 303
- Vehicle washing 304
- Window cleaning 306
- Wood trims 308
- Vehicle level
 - Changing 228
 - Setting 228
 - Automatic 228
 - Manual 228
- Vehicle level control system*
 - Airmatic DC* 226
- Vehicle tool kit 352
 - Alignment bolt 352
 - Fuse extractor 352
 - Hex-socket wrench 352
 - Open-end wrench 352
 - Screwdriver 352
 - Spare fuses 352
 - Towing eye bolt 352
 - Universal pliers 352
 - Vehicle jack 350
 - Wheel wrench 352

Index

Vehicle washing 304
Vehicle with TIREFIT kit (E 55 AMG) 350
VIN (Vehicle Identification Number) 415
Voice control system* 415

W

Warning lamps see Lamps, indicator and warning
Warning sounds
 Distance warning function* 222
 Distronic* 216
 Drivers seat belts 62
 Parking brake 46
Warranty coverage 389
Washing the vehicle 302
Wear pattern (tires) 293
Weights 399
Wheel change 370
 Tightening torque 374
Wheels
 Rotating 293
 Tires and wheels 289
Window curtain airbags 61

Windows see Side windows 197
Windshield
 Defogging 179, 189
 Refilling washer fluid 288
 Replacing wiper blades 365
 Washer fluid 288
Windshield washer fluid
 Message in display 347
 Refilling 288
 Wiping with 49
Windshield wipers 48, 169
 Fast wiper speed 48
 Intermittent wiping 48
 Replacing wiper blades 364, 365
 Single wipe 49
 Switching on 48
 Wiping with windshield washer fluid 49
Winter driving
 Block heater* 296
 Snow chains 296
 Tires 295
 Transmission program mode 164
 Winter tires 295

Winter driving instructions 273
Winter tires 295
Wiper blades 305
 Installing 365
 Removing 365
 Replacing 365
Wiping
 And washing simultaneously 49
 Interval 48
 With windshield washer fluid 49
Wood trims
 Cleaning 308
X
Xenon headlamps*
 Bi-Xenon* 411

Service and Literature

Your authorized Mercedes-Benz Center has trained technicians and original Mercedes-Benz parts to service your vehicle properly.
For expert advice and quality service, see your authorized Mercedes-Benz Center.

If you are interested in obtaining service literature for your vehicle, please contact your authorized Mercedes-Benz Center. We consider this the best way for you to obtain accurate information for your vehicle.

For further information you can find us on the Mercedes-Benz web-site www.mbusa.com or www.mercedes-benz.ca.

Warning



To help avoid personal injury, be extremely careful when performing any service work or repairs. Improper or incomplete service or the use of incorrect or inappropriate parts or materials may damage the vehicle or its equipment, which may in turn result in personal injury.

If you have any questions about carrying out any type of service, turn to the advice of an authorized Mercedes-Benz Center.

We reserve the right to modify the technical details of the vehicle as given in the data and illustrations of this Operator's Manual. Re-printing, translation and copying, even of excerpts, is not permitted without our prior authorization in writing.

Title illustration no. P00.01-2282-31

Press time 07 / 16 / 03

GSP / TIP

Printed in Germany

